

BME

BROADCAST MANAGEMENT/ENGINEERING

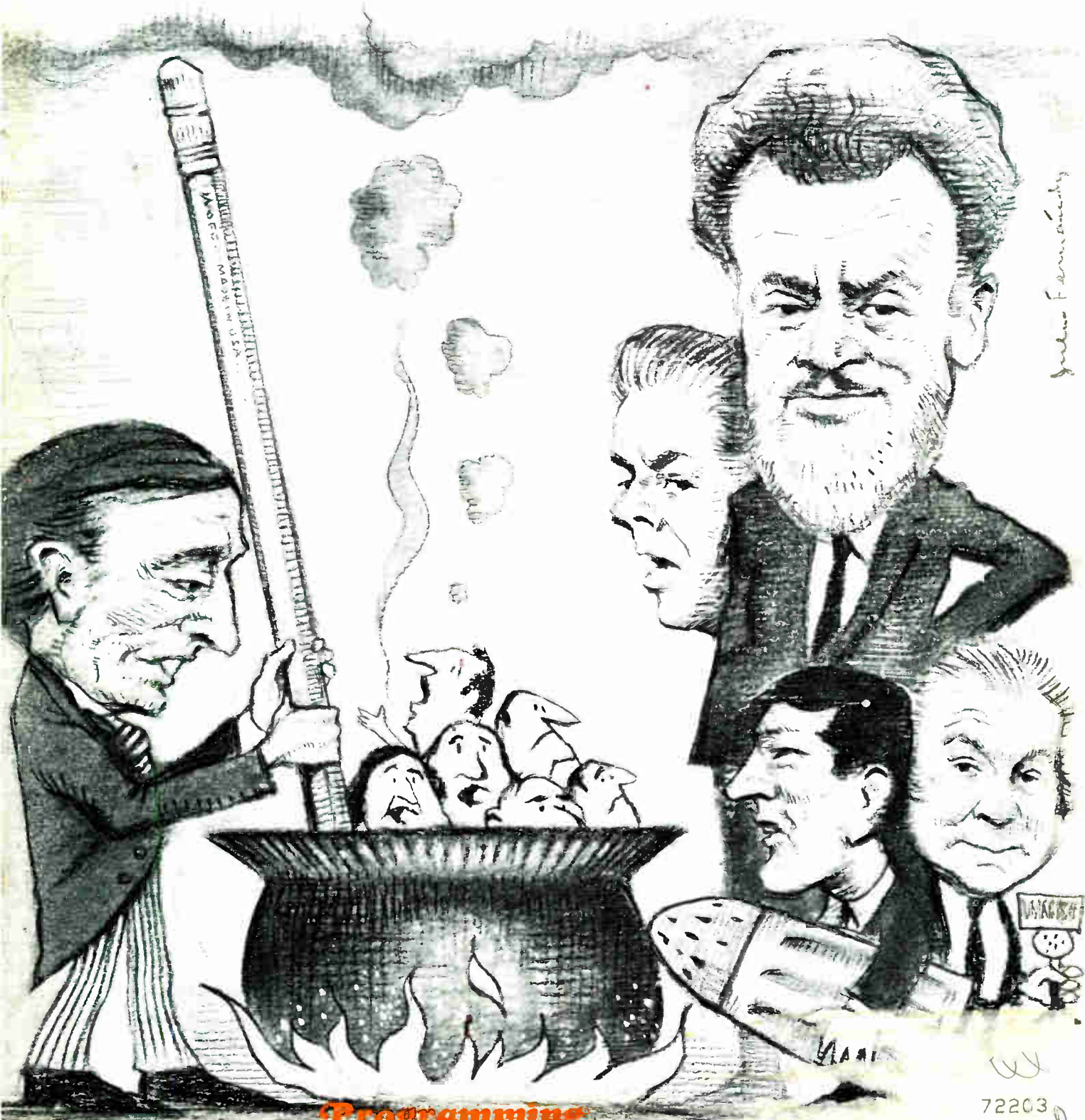

Programming
For Best Results, Stir Furiously

When you're in command of a Riker switcher, you've got the video right where you want it. Under control. You can select or mix your video sources with new ease and flexibility.

A button. A dial. A lever. And video things happen. Like additive/nonadditive mixing. Special effects by the score. Film control/tape start-stop. Automatic double re-entry. And lots more.

High performance in differential phase, gain and frequency response ensure excellent picture quality. Switching speeds in the nanosecond range during the vertical interval result in smooth, invisible transitions.

If you're interested in building the switching and quality control capabilities of your station, write or call Riker—the one company in the TV broadcast industry offering a complete line of all solid-state instrumentation for video analysis, simulation and control.



no other switcher lets you do so much with your video

RIKER

PRODUCTS FOR VIDEO ANALYSIS, SIMULATION & CONTROL

RIKER VIDEO INDUSTRIES, INC. 100 Parkway Drive South, Hauppauge, Long Island, N.Y. 11787 (516) 483-5200

Circle 1 on Reader Service Card



hp
TDR
shows...

42' of 75-ohm cable to a defective house tap.

50' down the line, capacitive defect caused by water in cable.

66' farther is inductive fault caused by spliced line.

110' from the splice, the cable has been deformed by sinking concrete wall.

55' from deformation is open caused by open termination.

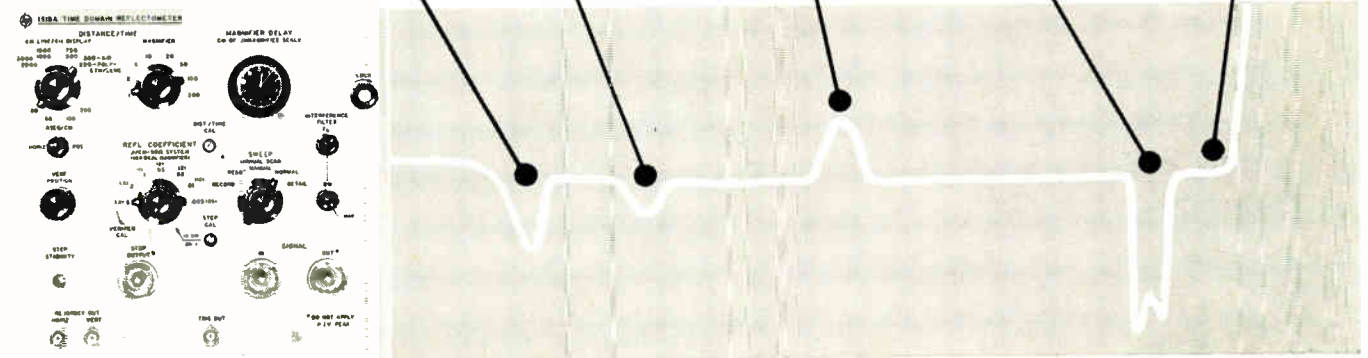

CABLE FAULT GUESSWORK ENDS HERE

*Improve Picture Quality,
Quickly Identify and Locate
Cable Faults with hp TDR*

Spend your time on the air . . . not up in the air! With hp's E75-140A CATV Fault Locator Package, you save time and money because you can (1) quickly locate and identify cable faults, (2) detect faults *before* they can cause downtime, (3) get your system back on the air much sooner in the event of a sudden crippling fault, and (4) consistently maintain high picture quality.

Use the hp E75-140A package to get a graphic picture of cable quality—and such faults as shorts, opens, loose connectors, defective tapoffs, splices and mismatched terminations. High sensitivity and resolution of the package detects faults to within 5 percent of the actual distance from the test point.

The E75-140A, factory calibrated for your 75Ω system, makes it easy for you to locate faults in up to 3000 feet of cable, and read the distance in feet. With a flick of the front panel slide switch, you can choose the calibrated scale for either polyfoam or polyethylene cable. The vertical scale is calibrated in percent of reflection for easy use. A slide rule is supplied to convert the proper value for dielectrics other than polyfoam or polyethylene.

Long persistence P7 phosphor CRT eliminates annoying flicker when you view the slow sweep speed in DETAIL mode. Special 75Ω overlays allow you to read impedance levels directly off the CRT face. Use the recorder outputs to make permanent records of your system.

The hp E75-140A CATV Fault Locator Package includes an hp 140A Oscilloscope mainframe with P7 phosphor CRT, hp H08-1415A Fault Locator Plug-in, hp 10458A 75Ω adapter with CRT overlay, and hp Application Note 67 with TDR slide rule.

For complete specifications on the special CATV Fault Locator Package, contact your local hp field engineer. Or, write to Hewlett-Packard, Palo Alto, California 94304. Europe: 54 Route des Acacias. Price: hp E75-140A CATV Fault Locator Package, \$1900.

hp140A — The Scope System that gives you



**20 MHz Wideband • High-Sensitivity, no drift • 150 ps TDR
12.4 GHz Sampling • Variable Persistence and Storage**

HEWLETT  PACKARD
An extra measure of performance

087/35

Circle 4 on Reader Service Card

BM/E

BROADCAST MANAGEMENT/ ENGINEERING

Co-Publishers:
HAROLD. H. SHORT
JAMES A. LIPPKE

Editor:
JAMES A. LIPPKE

Assistant Editor:
ALBERT P. LAHNDR, JR.

Broadcast Consulting Editor:
VERNE M. RAY

Cable Distribution Contributing Editor:
LON CANTOR

Art Director:
SUSAN CUTTLER

Production Manager:
ARLINE G. JACOBS

Circulation Director:
JAMES R. ASTOR

Advertising Services Manager:
JILL FISHER

Reader Service Manager:
R. R. BELL

Promotion Manager:
OREN HELMING

President:
RALPH RICHARDSON

This month's cover: Talk radio and talk TV is big. The more acidic or outrageous the program, the better. The more insolent the talk host, the greater his popularity. Julio Fernandez caricaturizes some of New York's best. (l to r) William F. Buckley, Jr. (WOR-TV), Joe Pyne (WNEW-TV), Alan Burke (WNEW-TV), Barry Gray (WMCA), and Long John Nebel (WNBC). Mr. Fernandez's interpretations of famous personalities have appeared in such publications as "Harpers," "The New Leader," and "Columbia Journalism Review."

- 6 **Broadcast Industry News**
Focus on CATV, p. 10.
- 16 **Interpreting FCC Rules and Regulations**
The FCC's Position on Television-CATV Cross-Ownership
- 24 **Editorial**
Random and Associative Musings on Programming and Equipment
- 29 **How The Independents Program**
 - 31 Can a U Compete in Top Markets?
 - 33 How to Cross Up the Networks
 - 34 WOR-TV Matches Technical Equipment to Programming Philosophy
 - 36 Economics of Operation
- 37 **CATV and Radio: Natural Allies**
A case of two halves making more than one
- 42 **It Is Not Enough To Program: Program and Promote**
Don't hide your station's light under a bushel, use a media mix to spread the word.
- 46 **College Station WGSU-FM Extends Beyond the Campus**
Colleges often are community centers. WGSU shows how to program for students and nonstudents successfully.
- 48 **Convention Log**
NAEB Exhibition Scores Several Firsts
- 53 **All-News, All-Music, All-Ghetto Radio is a Success**
Special interest broadcasting—a nearly sure-fire method for getting a fat slice of the pie
- 58 **Broadcast Equipment**
Reports on newly-introduced products and equipment
- 72 **Names in the News**
- 76 **Broadcasters Speak**
Feedback and chit-chat from *BM/E* Readers
Reader Service Card
USE FREE postage paid card to receive more data on new products and literature described in this issue.
- 88 **Literature of Interest**
Valuable data you can obtain by using the Reader Service Card between pages 86 and 87
- 90 **Engineering Casebook**
Here's how a Pennsylvania station eliminated its land-line connection for an a-m station and a remotely-located affiliate.
- 92 **Classified Marketplace**
- 94 **Index to Advertisers**

Mactier Publishing Corp.
820 Second Ave., New York, N.Y. 10017, 212 661-0450

Publishers also of:
BROADCAST EQUIPMENT BUYERS GUIDE
EEE
ELECTRONIC PROCUREMENT



BM/E, Broadcast Management/Engineering, is published monthly by Mactier Publishing Corp. All notices pertaining to undeliverable mail or subscriptions should be addressed to 820 Second Ave., New York, N.Y. 10017.

BM/E is circulated without charge to those responsible for station operation and for specifying and authorizing the purchase of equipment used in broadcast facilities. These facilities include a-m, fm, and TV broadcast stations; CATV systems; ETV stations, networks and studios; audio and video recording studios; consultants, etc. Subscription prices to others are: U.S., its possessions and Canada—\$5.00 one year, \$9.00 two years; elsewhere—\$7.50 one year, \$14.00 two years.

Copyright © 1968 by Mactier Publishing Corp., New York City. Controlled Circulation postage paid at Duluth, Minn.



Mobile TV Systems: TV coverage capability in a class by itself. Goes anywhere, sees everything. Whether it's two cameras or twelve, CBS Laboratories will design and produce vans for your particular needs.



Cameras for special television needs. The sophisticated Minicam III multi-purpose wireless camera may be used at waist-level, eye-level, or periscope viewing positions.

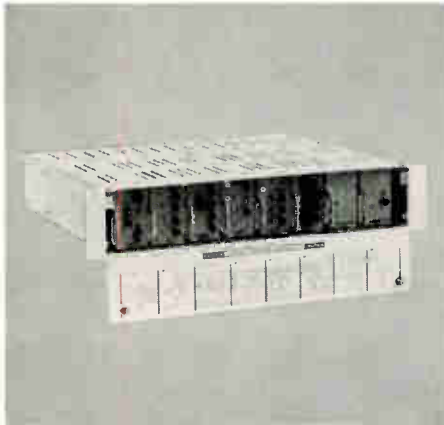

Image Enhancers for color or monochrome TV cameras. Provides both vertical and horizontal aperture equalization — plus "crispening" Made only by CBS Laboratories.



Audimax/Volumax: Provides automatic, hands-off audio level and modulation control — without distortion. Available in AM, FM, and FM stereo.

Tomorrow's electronics today from CBS Laboratories

The greatest television program in the world is no better than the equipment that produces it. And there's no better equipment made than the equipment that bears the label, "CBS Laboratories".

Whether it's precise automatic audio controls, television display systems, video distribution and control equipment, or highly versatile mobile TV systems, these Professional Products will give your programming the sound and picture quality it deserves.

And with greater profit. Reason? Not because the equipment is the least expensive. It's not. But because it's the best. That means a one-time investment in quality — and that's the kind that pays off.

It's good business to buy the best answers to equipment problems. So if you are looking for a solution to a problem — or even if you don't think there is a solution — write or call us collect (203) 327-2000. We're on your side.

PROFESSIONAL
PRODUCTS



CBS LABORATORIES

Stamford, Connecticut. A Division of
Columbia Broadcasting System, Inc.

Circle 5 on Reader Service Card

BROADCAST INDUSTRY NEWS

Educator Hails TV, Computer

The President of Northern Illinois University, Dr. Rhoten A. Smith, calling for the use of technical tools in higher education, said "to the machines and to the books, as always, will be vouchsafed those things they can do better than humans can do—dissemination of facts, drill and recitation, and background information . . . We ironically shrink from bringing technology and science to bear on our own problems because we view the application of tools to teaching as the last step which will reduce the college experience to an automated and barren production process." The culmination of this process he said, "approaches us in the forms of the television camera, the teaching machine, and the computer." While cautioning about a surrender to hardware that would pervert the educational process to

an Orwellian nightmare of indoctrination, conscious or not, Smith said, "it is only through these tools, I believe, that we have any chance of putting the educational process once more on a human level."

Are Your Monitors Emitting X-Radiation?

If your color monitors use inadequately shielded 6BK4 shunt regulator tubes, chances are good that X-radiation is being emitted at a level greater than 0.5 mR/hr, 2 inches from the cabinet surface—the generally agreed upon safe level established by the National Council on Radiation Protection.

Early in December, the Department of Health, Education and Welfare announced that it had requested the Electronic Industries Association to cooperate in a nationwide program to evaluate the potential hazard to health posed

by excessive radiation from color television receivers. The potential hazard applies equally to monitors since its primary sources—the picture tube, the high voltage rectifier tube and the shunt regulator tube—are common to both receivers and monitors.

General Electric and Conrac have instituted modification procedures for their receivers and monitors. Essentially, the modification consists of replacing the 6BK4 shunt regulator tube with a 6LHA.

Commenting on a report of a survey of 131 color television receivers—38 of which emitted side radiation—, Surgeon General William H. Stewart emphasized that the potential biological damage is quite low and added that even this potential could be minimized by operating the set within power limits (rated chassis voltage) which would not increase X-ray emissions; having servicing done only by authorized repair personnel with adequate equipment to check power level; maintaining viewing distance of about 6-10 feet in front of a color television set; and avoiding any prolonged exposure in the rear and side areas of color set.

Measurement procedures established by Consumers Union include the use of a Victoreen Thyac AC-3 Model 490 geiger counter with a thin end window probe, Model 489-35. Twelve brands of color receivers caused excessive readings in the Consumers Union tests—each backed up with X-ray film confirmation.

Official Count

The radio (a-m and fm) and television broadcasting industry reported annual revenues of over \$3-billion for 1966, an increase of 11.5 percent over 1965. Industry profits (before federal income tax) increased by 12.3 percent to \$590.2-million. Radio accounted for 28.3 percent of total broadcast revenues but only 16.4 percent of profits. The four nationwide radio networks reported a loss of \$1.7-million in network

1000th High Band VTR



The 1000th high band color videotape recorder manufactured by Ampex Corporation went to WCIA-TV, Champaign, Illinois. August C. Meyer, president of Midwest Television, Inc., operator of the station, and Betty Filip of the WCIA-TV staff look over the newly-purchased machine.

NEW
FROM TEKTRONIX

SOLID-STATE VECTORSCOPE

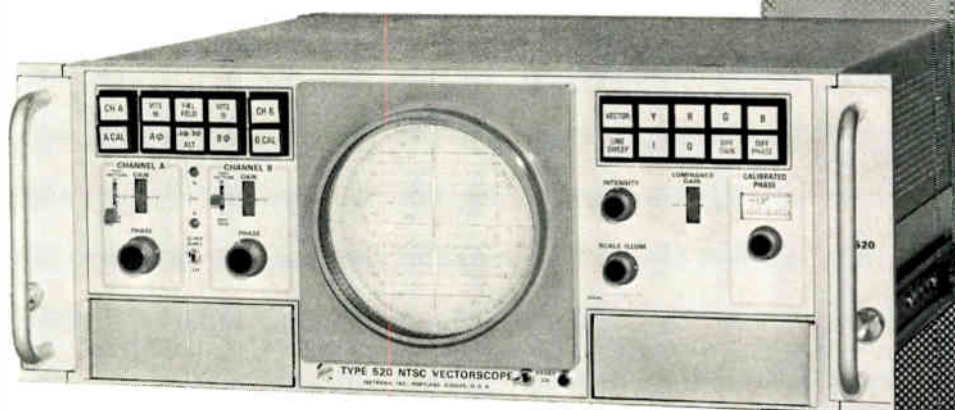

New measurement capabilities

Push-button operating convenience

Accurate chrominance and luminance amplitude measurements

All silicon solid-state reliability—cool, quiet operation

The Tektronix Type 520 NTSC Vectorscope provides new operator convenience, new measurement capability and silicon solid-state reliability. Push-button operating controls permit rapid selection of displays for quick analysis of color signal characteristics. A new luminance channel separates the luminance (Y) component of composite color signals for display at a line rate. Combining the Y component with the chrominance demodulator outputs provides displays of the Red (R), Green (G), and Blue (B) values, revealing luminance to chrominance amplitude and delay errors if present. Line Rate displays of chrominance demodulated along the I or Q axis are provided for checking encoder performance.

Phase and amplitude accuracy of the vector presentation is verified by internally generated test signals. Errors in color encoding, video tape recording or transmission processes are readily apparent and are easily measured. Separate 0° to 360° phase shifters provide independent phase control of channel A and B displays. Excellent resolution for measuring small phase-angles is provided by a 30° precision calibrated phase shifter where 1 inch of dial movement represents approximately 1° of phase shift. Differential gain and differential phase measurements are made with accuracies within 1% for gain of 0.2° for phase. A unique graticule switching arrangement provides automatic selection of an IRE

graticule or an illuminated parallax-free vector graticule. The selection occurs at the same time the operating mode is established.

The Type 520 Vectorscope provides the ability to check equipment performance during regular programming times through the utilization of Vertical Interfield Test Signals. A digital line selector permits positive selection of Vertical Interval Test Signals from lines 7 through 21 of either field 1 or field 2.

For a demonstration contact your nearby Tektronix field engineer or write: Tektronix, Inc., P.O. Box 500, Beaverton, Oregon 97005.

Type 520 NTSC Vectorscope \$1850
Rack Mount Type R520 \$1850

U.S. Sales Prices, FOB Beaverton, Oregon



Tektronix, Inc.

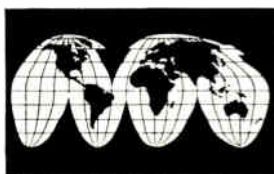

Circle 6 on Reader Service Card

A network of field service centers,
part of our commitment
to continuing customer service

operations, compared to a \$1.0-million loss in 1965, although the 19 network owned and operated stations reported pre-tax profits of \$5.4 million, up 32 percent from 1965.

CCTV Test Standard

What is claimed to be the only accurate standard test pattern for ETV, video recording and CCTV is available from Video Concepts Corporation, Brookfield, Conn., for \$24.25. Manual, included in purchase price, and 11- × 14-in. pattern enable technical or non-technical personnel to set up camera and monitor and adjust controls. Information on lighting and equipment adjustment, analysis and evaluation are also included.

Circle 200 on Reader Service Card

New Emmy Rules

The National Academy of Television Arts and Sciences has announced that for the 1967-68 Television Academy Awards, each artist and craftsman will be invited to enter his own single outstanding achievement in the various categories or areas. Performing achievements will continue to be entered by the general membership of the academy as the craft achievements have been in the past.

AES Meet Set

The 34th National Convention of the Audio Engineering Society will be held April 29th through May 2, 1968 at the Hollywood Roosevelt Hotel, Hollywood, California.

New News Network

The first phase of a new nationwide news transmission network, designed, furnished and installed by Lenkurt Electric Co., was put into service recently by the Associated Press in Los Angeles, Calif.

H. K. Krengel, vice president of marketing at Lenkurt, said the first phase, which cost some \$850,000, connects 12 western and southwestern AP bureaus in the cities of Los Angeles, San Francisco, Portland, Seattle, Spokane, Salt Lake City, Phoenix, Albuquerque, Dallas, Oklahoma City, Denver and Kansas City.

At a later date the wire system will be expanded to interconnect AP bureaus, 12 midwestern, 10

southern and three northeastern cities. AP officials said the new network, when completed this year, will serve more than 4200 newspaper, TV and radio station members in the U.S.

CBS Marketing Loudness Meter

CBS Laboratories has announced the availability of its new Model 710 Loudness Controller as part of its standard product line.

"The new product has been in development for nearly three years," said Barton C. Conant, general manager of Professional Products." Initial, limited production was made early in January.

The Loudness Controller analyzes audio material for such factors as frequency content, combinations of complex signals, peak signal factor and other related phenomena, and compares results against human hearing response standards. If the controller determines that a signal is louder than surrounding program material, it automatically reduces the gain of the signal to an acceptable level.

The controller is priced at \$825 and is available on a 30-day free trial basis.

Circle 201 on Reader Service Card

New Financial News Service

Reuters, the worldwide news agency, and the Ultronic Systems subsidiary of Sylvania, announced plans late in September to establish on January 1, 1968, a financial news service in the United States using advanced electronic systems and high-speed teleprinters.

In a joint statement Gerald Long, general manager of Reuters, and Gene K. Beare, president of Sylvania, said:

"The Reuter-Ultronic Report will be compiled and edited by Reuters, and will specialize in domestic and international news and data affecting the business and financial community. Ultronic will distribute the service coast-to-coast at 100 words a minute by teleprinter and by television-video techniques. The service will be sold to brokerage houses, financial institutions and industry."

Ultronic was founded in 1960 to manufacture stock and securities market information retrieval systems. Its Stockmaster unit, a

Continued on page 13

Philips to be Its Own Sales/Service Agent

Effective May 10, 1968, Philips Broadcast Equipment Corporation will assume direct service and sales support to the networks, and to group and independent stations nationwide with Norelco Plumbicon color television cameras and other Norelco broadcast equipment. The termination of the sales/service arrangement with Visual Electronics Corporation ends a three-year agreement which has won Norelco a major share of the broadcast color camera market.

James B. Tharpe, president of Visual, in announcing the change, said "the principle reason for the termination was a foreseeable overlap of product lines manufactured by Visual with those manufactured by Philips Broadcast." Both companies plan early introduction of new TV transmitters, new audio product lines, new closed circuit television equipment and new color television equipment. Visual has undertaken a program for developing its own color camera line, expected to be ready for fall '68 programming.

Anthony R. Pignoni, director of marketing at Philips Broadcast Equipment Corp., in announcing the assumption by the company of sales and service throughout the United States, said, "With our own service capability more than double its capacity of a year ago and to be doubled again in 1968, and with sales offices being established in major broadcast centers across the United States, it will be to our customers' advantage to have this direct line to our company."

Philips Broadcast will provide the industry with rapid response by factory-trained service personnel from the main plant in New Jersey through five regional offices.

YEARS AHEAD IN

VIDEO

SWITCHING

DESIGN

CAM	CAM	CAM	FILM	FILM	VTR	VTR	NET	REM.
1	2	3	1	2	1	2		

CAM	CAM	CAM	FILM	FILM	VTR	VTR	NET	REM.
1	2	3	1	2	1	2		

ALL SOLID-STATE VERTICAL INTERVAL SWITCHERS

- Most compact switchers available
- Integrated circuits
- Automatic sensing for Comp/Non-comp, Synchronous/Non-synchronous operations
- Independent power and trigger pulse supply for each buss.
- Uniform size modules throughout
- Engineered for studio production, or automatic programming
- 8 standard models available, or custom design.
- Short term delivery

NOW SHIPPING SOLID-STATE DEMODULATORS • Write for complete details.



WARD ELECTRONIC INDUSTRIES

142 CENTRAL AVE., CLARK, N. J. 07066 • (201) 382-3700

Circle 7 on Reader Service Card

FOCUS ON CATV

Copyright Problem Moves Toward Solution

After five months of discussion, an ad hoc committee of broadcasters and cable TV operators has recommended ten basic points of agreement.* It left two other points for further discussion.

Co-chaired by broadcaster George C. Hatch and CATV operator Alfred R. Stern, the committee pointed out that the two industries have been asked by Congress to reach agreement on cable TV provisions to be written into pending copyright legislation.

In transmitting its report, the committee stressed the importance

of working toward satisfactory legislation now, since copyright laws are changed so infrequently. The bill currently under consideration is the first rewrite in 60 years.

If the ad hoc committee's recommendations are accepted by the NAB and the NCTA and written into the copyright bill, CATV operators won't have to pay copyright fees for the programs of local channels; they will receive a compulsory copyright license for distant stations brought into underserved areas, unless the area they serve is not in the grade B contour of any channel, in which case no fees will be required; and they will be protected by some sort of grandfather clause, with retroactive exclusion of statutory copyright fees for existing systems.

The ad hoc committee also urged the NAB and the NCTA to

continue the conferences on a formal basis.

If the NAB and the NCTA fail to come to an agreement, or Congress does not pass new copyright legislation early this year, the pending Supreme Court copyright case will be the law of the land.

The Supreme Court is scheduled to review a lower court decision holding *Fortnightly Corp.*, a cable TV operator, liable to United Artists for copyright payments. The case will be heard in March, with the decision expected about June, 1968.

The CATV industry feels fortunate that the issue will be decided so quickly. U.S. Solicitor General Griswold had suggested that the Supreme Court delay their review until Congress amends the copyright laws. However, both *Fortnightly Corp.* and *United Artists*

- *1. System carrying TV stations in markets located in the grade B coverage areas of such stations should not be required to pay copyright fees for such carriage (provided material is carried simultaneously as transmitted).
2. Systems bringing outside stations to underserved areas located within the grade B predicted contour of one or more TV stations should receive a compulsory copyright license for the minimum additional signals required for adequate service.
3. Cable systems and translators located outside the grade B contour of any television station should not be required to pay copyright fees for bringing station services to unserved areas.
4. Nonprofit secondary transmissions operating in areas receiving grade B service from

- at least one television station should be subject to statutory copyright fees.
5. Common carriers providing direct television service to the public should be subject to statutory copyright fees.
6. Some form of grandfather clause and retroactive exclusion of statutory copyright fees for existing systems will be necessary to avoid major disruption of present services to the public.
7. Provisions covering copyright liability for carriage of radio stations on cable systems should be clarified.
8. A simple and efficient system should be provided for notice of restrictive terms of broadcaster-copyright contracts affecting cable television, and for the determination of the application of exclusivity provisions.

9. Proposals to provide live broadcasts with copyright protection should be carefully reviewed.
 10. Uhf stations have particular problems relative to exclusivity and carriage that require special consideration and further study.
- Unresolved:**
1. Should cable TV's origination of entertainment programs and/or commercials (directly or by private transmission) change the cable operator's copyright obligations, if any, in the carriage of station signals?
 2. Should cable TV's carriage of outside signals in underserved areas, pursuant to compulsory copyright license, be subject to the restrictive covenants contained in broadcaster-copyright contracts?

TO ALL CP HOLDERS:



argued that there should be no delay and the Supreme Court agreed.

Commenting on this, Frederick W. Ford, NCTA president, said, "By agreeing to decide the many-sided question of whether an industry should be held liable for copyright, the highest court in the land has recognized the seriousness of the issues as they affect some 10-million Americans who now receive their television signals via cable."

The Supreme Court had previously agreed to review a Ninth Circuit Court of Appeals decision which casts doubt on the FCC's authority over CATV.

Supreme Court decisions in these two areas will go a long way toward clearing the air in the CATV industry.

FCC decisions puzzle industry

The FCC has not yet acted on the Bartley plan to break the logjam of some 220 waiver requests by allowing the CATV Task Force authority to waive hearings in certain cases. Despite this, the Commission has taken enough action recently to confuse a number of observers.

Their most controversial decision was to deny Vision Cable Co. of Rhode Island, Inc., permission to carry Boston and Worcester channels. This is the first time a system has been prohibited from carrying channels that provide grade A signals in the area served by the cable.

The FCC's reason for the denial was to protect an inoperative uhf channel. The Commission said it was concerned "with the potential impact . . . upon the activation of channel 16." In fairness to the cable company, the FCC scheduled a review of Vision's proposal in six months if channel 16 was not putting out a signal by that time.

On the other hand, the FCC gladdened CATV hearts by denying a Lancaster, Pa. TV station's petition questioning the waiver of the top 100 markets rule for seven Pennsylvania CATV systems. The FCC said the waiver is "consistent with Commission policy granting waivers to carry distant uhf signals where vhf signals from the same market provided predicted grade B service."

The FCC also authorized Peninsula Broadcasting Corp. to operate a CATV system in Murfreesboro,

North Carolina, without even a hearing. Murfreesboro is 50 miles from the nearest TV channel and the FCC noted that "there is no uhf allocation close to Murfreesboro and there is no commercial uhf activity in the area."

Other recent Commission actions on signal importation include:

1) Rejection of a petition to prevent Kar-Mel CATV Systems Inc. from importing signals. The unusual aspect of this case is that it was initiated by Stephen Jepko, who operates a competitive system in Mt. Carmel, Pa. Jepko imports the same signals, but is protected by a "grandfather clause." The FCC agreed its laws were being violated, but said that denying distant signals to Kar-Mel would only "allow one CATV system rather than another to provide service in Mt. Carmel."

2) Allowed GE's Cable TV system in Watertown, N.Y. to import WOR-TV and WNEW-TV from New York City via microwave, despite the protests of WWNV-TV in Watertown. The Commission said that there is no evidence addition of the two channels will "cause economic injury to the detriment of the public interest."

Continued on page 86

Extraordinary FM Monitor Offer

McMartin will help you get started

McMartin guarantees in writing that a new TBM-3500 Monaural Monitor will be worth \$800 if you trade it, even as late as 1973.*

Many FM operators start with monaural broadcasting and later add Stereo and SCA.

Choose a McMartin TBM-3500 monaural monitor and receive with it a trade-in certificate worth \$800.

When you go Stereo or SCA within five years*, return the TBM-3500 Monaural Monitor and certificate as \$800 down payment on the purchase of a TBM-4000A FM/SCA Modulation Monitor or a TBM-4500A FM Stereo Modulation Monitor.

That's a pretty fair offer when a new TBM-3500 costs \$995. Look at it this way: it's like getting your TBM-3500 almost free.

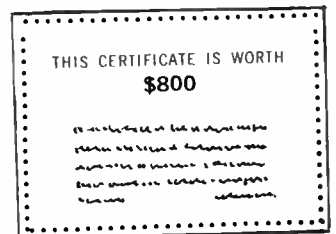

McMartin[®]

McMartin Industries, Inc.
3104 Farnam Street
Omaha, Nebraska 68131

*Offer effective February 1, 1968, and applies only to orders received on or after that date. This offer may be withdrawn at any time.

Circle 8 on Reader Service Card



Sure your programming looks good in color. But how does it look in black and white?

It might look like this if you're operating cameras without separate luminance.

But, you needn't worry, if a separate luminance channel is carrying your black and white signal.

It's something you don't even have to think about with General Electric's PE-250 live color camera. Even if your picture is misregistered 1%, as the one above is.

The PE-250 delivers perfect color and

perfect black and white all the time. Why? Separate luminance, registration stability, common sweep amplifier, negative registration. All are key factors in making the PE-250 the broadcasters' preferred image builder — for both black and white, and color.

The PE-250 is so dependable three major networks in North America use it, the largest remote network in the world uses it, and it's the only live color camera permanently installed in a blimp. GE-54.

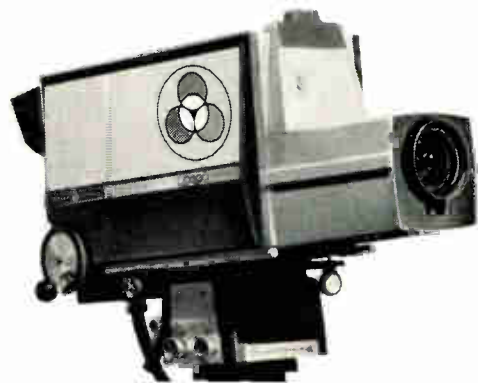

GENERAL  ELECTRIC

Circle 9 on Reader Service Card

World Radio History

If you don't believe your eyes, call and ask to see our "81%" presentation.

ATLANTA

General Electric Company
Visual Communication Products Department
Room 517
1330 W. Peachtree St., NW
Atlanta, Georgia 30309
404 • 892-0101

CHICAGO

General Electric Company
Visual Communication Products Department
117 S. Main St.
Mt. Prospect, Illinois 60056
312 • 255-3200

CLEVELAND

General Electric Company
Visual Communication Products Department
910 Williamson Building
Cleveland, Ohio 44114
216 • 781-6822

DALLAS

General Electric Company
Visual Communication Products Department
Room 400, 4447 N. Central Expwy.
Dallas, Texas 75205
214 • 526-0426

HOLLYWOOD

General Electric Company
Visual Communication Products Department
Room 304, 3518 W. Cahuenga Blvd.
Hollywood, California 90028
213 • 466-5241

KANSAS CITY

General Electric Company
Visual Communication Products Department
3628 West 95th Street
Leawood, Kansas 66206
913 • 649-7131

NEW YORK

General Electric Company
Visual Communication Products Department
Graybar Bldg., Room 2613
420 Lexington Avenue
New York, New York 10017
212 • 751-1311

SYRACUSE

General Electric Company
Visual Communication Products Department
1900 Brewerton Road
Mattydale, New York 13211
315 • 456-3686, 2165

WASHINGTON, D.C.

General Electric Company
Visual Communication Products Department
777 14th Street, NW
Washington, D.C. 20005
202 • 393-3600

Visual Communication Products Department,
Electronics Park, Syracuse, New York 13201

GENERAL  ELECTRIC

desk-top price information unit, is used in more than 8000 installations across the country. Ultronic became a subsidiary of Sylvania in June.

NIAC Alerting System To Be Tested

A new standardized signalling system, designed to alert the general public to emergency broadcasts, is in the process of being field tested by the National Industry Advisory Committee (NIAC) Special Working Group. NIAC is a government-industry committee formed in 1963 to advise the government on the use of broadcast stations for alerting the public in time of emergency.

The new standardized signal is the first authorized system tested to alert the public directly. It is based on a two-tone signal broadcast by radio and television stations. The signal automatically turns on specially designed emergency receivers set at a specific

Public Broadcasting Act of 1967

Title I. This section extends the construction program for three years, increasing federal aid to the construction of non-commercial stations from 59 to 75 percent. It approves, for the first time, Federal support for noncommercial radio construction as well as educational television. The amounts authorized are \$10.5-million for fiscal 1968; \$12.5-million for the next fiscal year, and \$15-million for fiscal 1970.

Title II. This section creates the Corporation for Public Broadcasting. It will be headed by a 15-man Board of Directors appointed by the President and approved by the Senate. A total of \$9-million has been authorized for the Corporation for the first year to be used for grants to local noncommercial television and radio stations to improve the quality of programming. There is a limit of \$250,000 which may be made to any one station or project.

Title III. This section authorizes \$500,000 for a study of instructional television and radio to be conducted by the Department of Health, Education and Welfare. Findings are to be reported to the Congress by 1969.

frequency for receiving emergency information. The signal currently in use alerts only broadcast stations operating in the Emergency Broadcast System.

The new alerting system was developed by NIAC following Federal Communications Commission action in 1963 soliciting proposals for a new system for use by the general public. Various firms and other interested parties submitted suggestions at the time. Prototype receivers were constructed and have been undergoing tests at the FCC laboratory since January, 1967. The field tests are being conducted with actual production equipment.

A.V.C. Buys 6 U's

In a waiver of its Top Fifty Interim Policy, the FCC granted transfer of control of permittees of five uhf television stations from D.H. Overmyer to U.S. Communications Corporation, a subsidiary of the diversified investment company, A.V.C. Corporation. All applications involved stations in the Top Fifty television markets. In granting the policy waiver, the Commission said the grant of the applications would foster development of uhf television stations which would serve the public interest.

EIA Tackles Service Technician Shortage

The EIA Consumer Product Division has allotted \$100,000 for 1967-68 fiscal year and over half a million dollars over the next five years for a far-ranging program to increase the number of qualified service technicians for consumer electronic products. EIA feels the nation is short today over 30,000 service technicians. The program to be initiated by Richard W. Tinnell, will involve career guidance, teacher and student training, curricula upgrading, job placement, and public relations.

New Math for Parents

"Modern General Math for Parents" ten 30-minute lessons explaining the modern mathematics now taught at the high school level has been produced by the Denver (Colorado) Public Schools at KRMA-TV and is available from Great Plains National ITV Library, University of Nebraska, Lincoln, Nebraska 68508.

Circle 202 on Reader Service Card



The Norelco "Little Shaver" does everything its big brother, the PC-70, can do ...and gets around a lot more.

This is the new Norelco PCP-70 Portable Color Television Camera. We call it the "Little Shaver" for short.

Like its big brother, the PC-70, which is used on the majority of top network live



and taped shows, it employs the exclusive Norelco 3-Plumbicon* tube system that provides the truest color, highest resolution and maximum sensitivity available today.

The "Little Shaver" goes where the action is.

Sports. News and documentaries. Political events . . . just about anywhere a man can go.

The "Little Shaver" is fully compatible with the camera control unit of the PC-70 studio camera. Thus, present PC-70 owners have an even greater advantage in that they can have the versatility of the PCP-70 with



no further expense for control equipment.

Instantly accepted by *all* the major networks, the Norelco PCP-70 is the portable that gives you the

world's best color television picture.

If you want faithful color reproduction in a port-



able camera, you want the "Little Shaver." For a live demonstration and technical data, call or write our representative, Visual Electronics.

*Registered trade mark for television camera tubes.



Norelco PHILIPS BROADCAST EQUIPMENT CORP.

299 Route 17, Paramus, N.J. 07652 • 201/262-7300

Circle 10 on Reader Service Card

INTERPRETING THE FCC RULES & REGULATIONS

The FCC's Position on Television-CATV Cross-Ownership

PREVIOUS BM/E ARTICLES have dealt with the Commission's long-standing concern with any actions increasing monopoly of the communications industry. (See (1) *BM/E*, May 1966, "The Drive For Diversified Ownership," (2) *BM/E*, June 1966, "Concentration Of Control Of Mass Media," and (3) *BM/E*, July 1966, "The Multiple Ownership Philosophy.") These FCC interests have been aimed primarily at cross ownership between radio, TV and newspapers. Currently, the Commission is considering the application of similar "monopoly" restraints to CATV.

Background

With the extraordinary growth of CATV, the Commission's concern was evidenced in the case *Lompoc Valley Cable TV* (2 RR 2d 22), adopted March 4, 1964, when it was faced with the following question:

. . . [A]s a matter of policy, whether a multiple owner should be permitted to acquire . . . extensive holdings in the community antenna field or whether the policy underlying the Commission's multiple ownership rules requires that the Commission strive to prevent such entry.

The question was not then answered, since the Commission determined that a hearing was required on independent grounds and, in addition, that a pending application (2400-C1-TV-(9)-64) for transfer of *Lompoc Valley's* parent corporation would "provide a more convenient vehicle for Commission consideration." The following week, on March 11, 1964, the Commission adopted its Opinion in *Rust Craft Broadcasting Company*, FCC 64-208 (2 RR 2d 83), in which *although it consented to the transfer of control of a television broadcast station in Clarksburg, West Virginia to a CATV system operator in that city, it stated, in relevant part, as follows:*

[W]e regard situations of this kind with growing concern and therefore propose in the near future to institute an inquiry into the problem of joint ownership of CATV systems and television stations in the same communities. Pending that event, we serve notice that any applications involving such combined ownership—however accomplished—will be carefully scrutinized and may, in appropriate cases, be deferred until we finally develop a long range policy with respect to this problem.

In addition, other activities illustrated the increasing problems facing the Commission in this general area. For example, a television broadcast licensee in Dayton applied to the Dayton

City Council for a franchise to operate a CATV system in Dayton. Similarly, the television station licensee in Utica, New York obtained a franchise for a community antenna system to serve Utica, and applications for microwave relay facilities to serve the system were before the Commission. Apart from these specific cases, there were many instances in which television broadcasters acquired ownership interests in the CATV field outside of their own service areas. These acquisitions, of course, did not require Commission approval unless authorizations issued by the Commission were involved. The Commission believed that it was the appropriate time to institute an inquiry looking toward establishing and clarifying its policy with respect to broadcast licensee ownership of CATV systems. If it was to carry out its statutory responsibilities in this field, policy determinations had to be made without further delay.

Early Proposal for Rule

For the purpose of obtaining pertinent information on the problems described above, on April 16, 1964, an inquiry was instituted (*In the Matter of Acquisition of Community Antenna Television Systems By Television Broadcast Licensees*, Docket No. 15415.) Views and data were invited from the broadcasting industry, the CATV industry, and any other interested groups or members of the public. The particular questions included the following: (1) to what extent do television broadcast licensees now own interest in CATV systems; (2) to what extent and in what manner do CATV systems originate any programming, including commercial announcements, which they furnish to their subscribers; (3) to what extent, if any, does ownership of CATV systems, or interests therein, by television broadcast licensees conflict with §73.636 (a) (2) of the Commission's rules relating to concentration of control, or the policies underlying such rule; (4) under what conditions, if any, should television broadcast licensees be permitted to own CATV systems, or interest therein, where the CATV systems serve portions of the area served by the licensee's television broadcast station; and (5) does ownership by a television broadcast licensee of CATV interests, in substantially the same area or in different areas, raise any question of conflict of

This section, providing broad interpretation of FCC rules and policies, does not substitute for competent legal counsel. Legal advice on any given problem is predicated on the particular facts of each case. Therefore, when specific problems arise, you would be well advised to consult your own legal counsel.

BALL BROTHERS RESEARCH GREW UP ON SOLID STATE

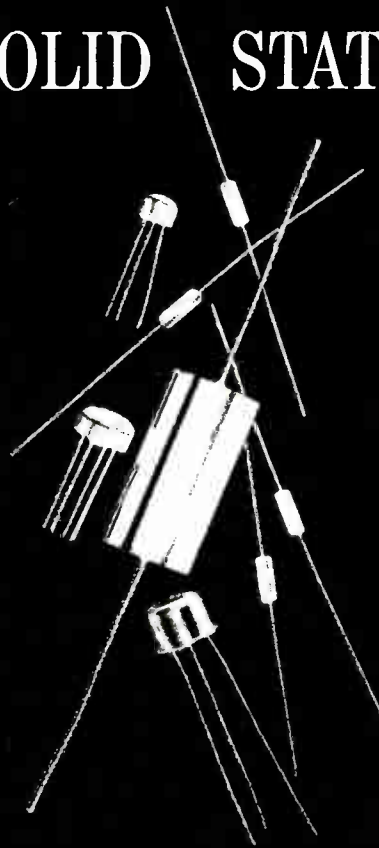

Ball Brothers Research Corporation's video technology is almost tubeless. Our Miratel Division has more solid-state picture monitor experience than any other monitor maker. Miratel has developed, manufactured and sold more solid-state monitors than anyone.

BBRC's other video products are solid-state, too.

Next time you're in the market for any of the products we make, consider buying some solid-state experience. Ours.



BALL BROTHERS RESEARCH CORPORATION • BOULDER, COLO. 80302
MIRATEL DIVISION • 3600 RICHARDSON STREET • NEW BRIGHTON • ST. PAUL, MINN. 55112

Circle 11 on Reader Service Card

interest detrimental to the public interest in television broadcasting?

The comments received in response to the *Notice of Inquiry* generally took the following positions:

- (1) CATVs are not broadcast stations, particularly since they generally do not originate programs, and they therefore do not come under the Commission's multiple ownership rules. Nor should CATVs be deemed to come within the spirit of the multiple ownership rules, since they promote diversity by bringing in new signals, and do not really compete with television broadcast stations.
- (2) There really is no problem on common ownership. CATVs serve very few people in comparison to television stations. Furthermore, they provide a complementary service, and broadcasters are in a good position to enter this new field with their existing knowledge. Additionally, the interests of subscribers and viewers will not be subordinated because the investments in both the cable system and the television station are large. Local bodies and the Commission are also present to make sure that the interests of CATV subscribers and television audiences are both protected.
- (3) In many places, especially small communities, CATV will come in any event and it is necessary for the television station to own the CATV to protect it against ruinous competition.
- (4) Program origination by CATVs is not a problem at this time since it is very expensive and cannot compete with the regular popular television programs. At the present time program origination is limited to weather scanning with few exceptions.
- (5) Television broadcasters have an absolute right to enter any legitimate business, and it would be arbitrary to permit CATVs to de-

velop in great numbers in other hands, including multiple ownerships, while preventing broadcasters from entering this business.

On July 27, 1965, the Commission adopted its *First Report* terminating this proceeding. While no anti-cross ownership rules were adopted, the Commission indicated that it was concerned with the possibility that cross-ownership between CATV systems and television broadcast licensees might give rise to abuses inconsistent with the public interest—at least in particular cases. However, *two things persuaded the Commission that the danger of such abuses is not sufficiently great to warrant an overall or across-the-board prohibition against cross-ownership of CATV system and television stations.* The inquiry that the Commission conducted in the docket did not disclose any substantial evidence of widespread abuses. Further, since the issuance of the Notice Of Inquiry and Opinion, referred to above, the Commission issued its *First Report and Order* in Dockets No. 14895 and 15233 (4 RR 2d 1725) and its *Notice of Inquiry and Notice of Proposed Rule Making in Docket No. 15971* (4 RR 2d 1679). The rules that the Commission promulgated and proposed to promulgate appeared to be adequate to prevent discriminatory use of a CATV system to favor one local broadcaster against another. Additionally, the Commission's general rules should ordinarily suffice to insure a technically efficient operation by any broadcaster; and any broadcaster who fails to make a reasonable effort to put out an efficient signal runs the risk of losing his license. The Commission believed that these considerations were adequate

WHEN IT COMES TO HEAD-ENDS

...can you afford anything but the very best?

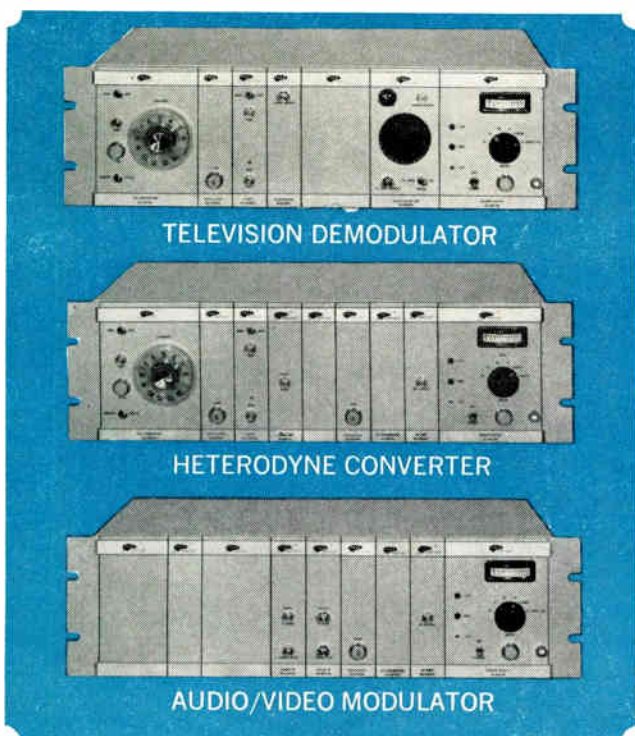

The most critical part of any CATV system is the head-end and, so far, not even the best has been good enough. But now, DYN AIR can supply a completely solid-state head-end package — to your specifications — that will perform with broadcast precision.

DYN AIR head-end equipment includes **all three** basic signal-processing units, with interchangeable modules used to minimize maintenance problems. Sophisticated military-type RF shielding on each module eliminates interference common to equipment using standard commercial packaging. Precise frequency control and AGC circuitry assures interference-free full-color pictures.

Not just **another** head-end, but truly professional equipment designed by a company with years of experience with broadcast television transmission and solid-state CATV head-end equipment.

WE DIDN'T CUT CORNERS . . . SHOULD YOU?

6360 FEDERAL BOULEVARD
SAN DIEGO, CALIF. 92114
TELEPHONE (714) 582-9211



The **experienced** manufacturer of solid-state head-end equipment.

Circle 12 on Reader Service Card

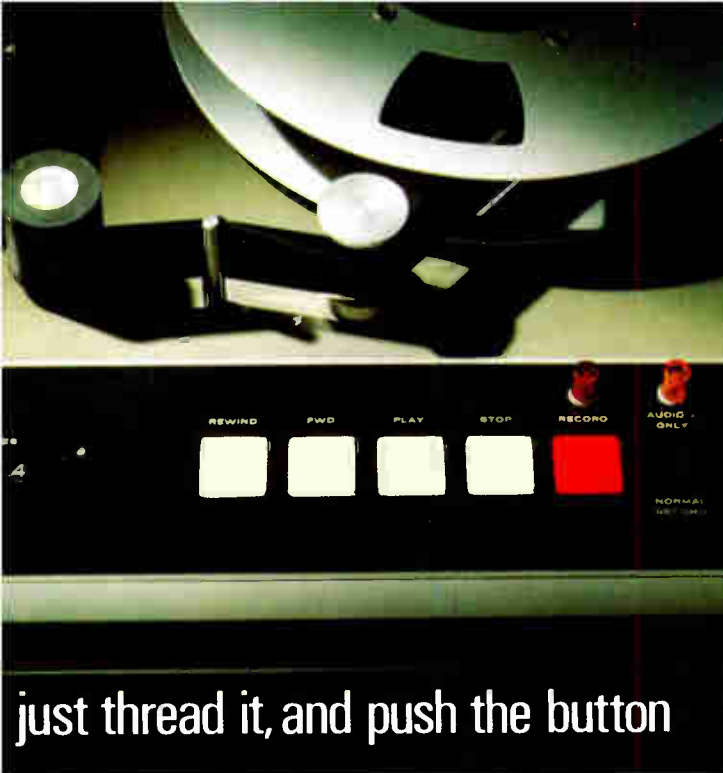

just thread it, and push the button

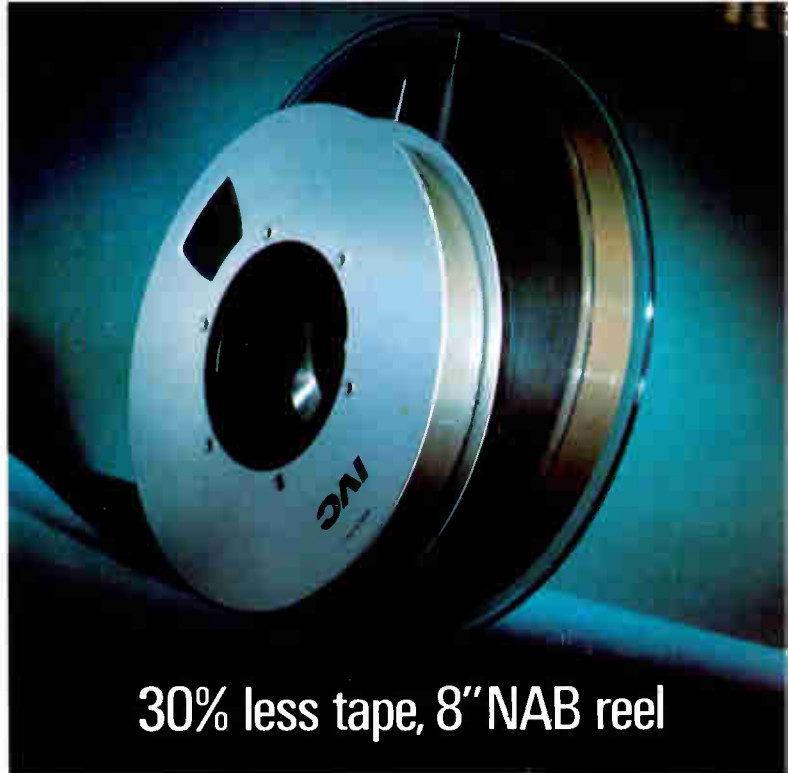

30% less tape, 8" NAB reel

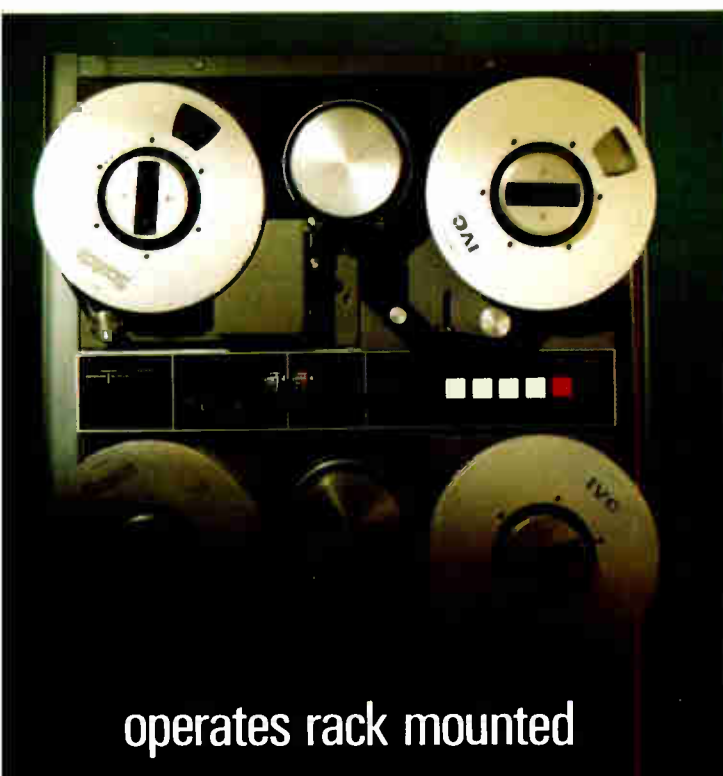

operates rack mounted



award-winning design

**all this
and NTSC color
too!**

The IVC-800, engineered and manufactured by International Video Corporation, Mountain View, California, is the first helical-scan video recorder to offer this exciting combination of features at any price. A recorder that's not only low-cost, but is versatile, easy-to-operate and maintain. NTSC color system results in more faithful reproduction with chroma stability not previously attainable. The IVC-800 is a significant breakthrough in helical-scan recorder design. Turn the page for price and details.

IVC

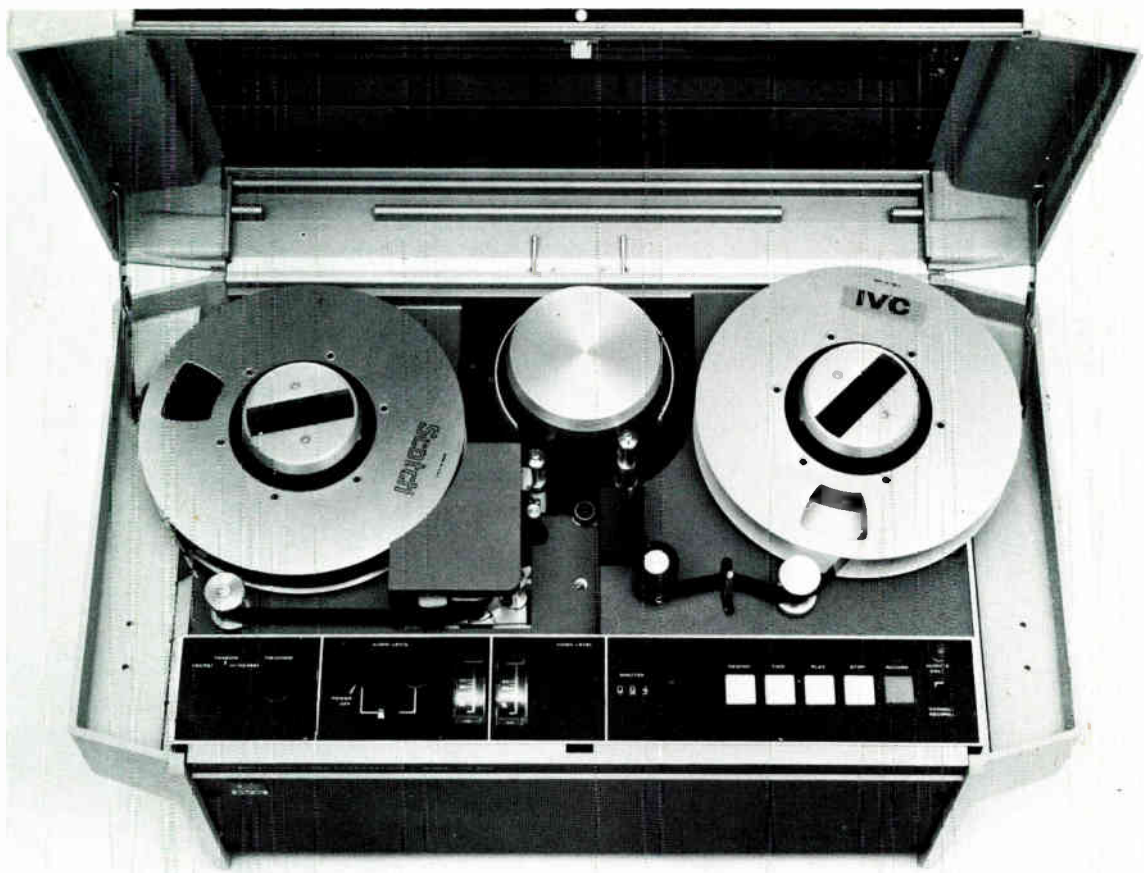

All this for \$4200 complete! (monochrome \$3800)

Full NTSC Color capability

All monochrome machines will record NTSC color signals. Single plug-in circuit board instantly converts unit for NTSC color playback. Conversion may be accomplished by anyone in the field purchasing a plug-in circuit board for \$400.00.

High resolution

Patented pulse interval modulation signal system provides bandwidth exceeding 4.2 MHz resulting in 400 lines of picture information.

Just thread it and push the button

Electrical push-button control of transport permits all tape motion functions to be remotely controlled. Advance "Alpha" helical-scan tape path configuration with precisely fixed tape guides eliminates "lost" picture information and allows easier threading.

Full electrical remote control

Electrical push-button control with interlocked logic circuit permits all tape functions to be remotely controlled. Tape is automatically relaxed when stopped thereby eliminating unnecessary wear. These features permit the IVC-800 to be used in dial access applications.

90 second fast forward and rewind

Separate turntable motors for take-up and supply permit rapid fast forward, rewind and shuttling. Dynamic braking eliminates the possibility of tape damage. End of tape sensor activates stop circuit preventing tape spillage.

30% less tape, 8" NAB reel

Full one hour recording requires only 2150 feet of 1" tape operating at 6.9 ips, an average saving of \$15.00 per hour.

Operates rack mounted

IVC-800 is the only recorder which can be rack mounted in 12 1/4"

of vertical space. Maintenance is made easier through use of full-suspension, pull-out mounting slides.

60 second head replacement

Video head may be quickly replaced by anyone anywhere using the special tool that is stored under the scanner cover. The head automatically seats itself in the correct position. Advanced design ferrite head is guaranteed for 500 hours (or six months).

Audio cue track

Second audio channel is provided for secondary audio or dial access control signals.

Weighs only 52 pounds

Precision casting and state-of-the-art engineering techniques have produced a rugged, yet truly portable recorder. Dust-proof cover eliminates tape contamination possibility.

Machine-to-machine compatibility guaranteed

All tapes recorded on any IVC-800 can be played back on any recorder using the 1" IVC format.*

Stop-Motion feature

All units are equipped with stop-motion as standard feature. Electronic editing and slow-motion are options available.

NATIONAL SERVICE PROGRAM Field service, applications engineering, and systems engineering back-up is provided every IVC customer. Factory trained service personnel are available through our franchise distributors or on a direct factory basis. Standard industry warranty on all IVC products.

FULL NTSC COLOR SYSTEMS CAPABILITY WITH THE IVC LOW COST CCTV NTSC COLOR CAMERA. A demonstration of the complete IVC CCTV color system can be arranged by contacting IVC Marketing Operations, (415 — 968-7650). International Video Corporation, 67 E. Evelyn Avenue, Mountain View, California 94040. Detailed product literature on request.

* Bell and Howell; GPL

to prevent the dangers of any general abuse of cross-ownership.

The Commission realized that the problems involved in determining the proper role for CATV in the mass communications system are complex and far reaching and involve many interrelated policies. These considerations were mentioned by the Commission to emphasize the fact that this Report with the conclusions stated therein were (1) preliminary, (2) tentative, and (3) subject to further consideration and modification.

Current Inquiry and Proposal to Restrict CATV-Broadcast Monopoly

True to its promise, on April 12, 1967, the Commission instituted an *Inquiry into Developing Patterns of Ownership in the CATV Industry* (Docket No. 17371, 32 Fed. Reg. 6221). No proposed rules were appended.

The Commission observed that the emerging pattern of growth indicates that CATV is ceasing to be simply a passive reception device of utility solely in outlying areas away from regular television service; rather, it is developing into a significant force in communications on its own merits. Coupled with this development, the Commission observed an increasing trend toward *program origination on CATV systems*. Taken together, the rapid spread and changing nature of CATV call for consideration by the Commission of the long range function and role of CATV in the totality of communication services. Consequently, the Commission believes that the promised emergence of CATV systems with programming capability in large metropolitan markets requires that it begin to consider the application of more traditional policies and rules on *concentration of control, duopoly, and diversification of mass media*. This proceeding again inaugurated *general inquiry into the present ownership of the CATV industry and the probable future ownership of the industry*. On the basis of the limited information available, the Commission does not believe it appropriate to do more at this time than *seek views and suggested courses of action from interested parties*; however, if the early responses to this inquiry appear to justify such action, this inquiry may be expanded to include *proposed rule making designed appropriately to establish guidelines for the ownership and control of the CATV industry*.

Without intending to restrict comment, the Commission believes it helpful to point out that *its main areas of concern at this time are focused on the public interest questions arising from ownership and control of CATV systems by Commission licensees* in other communication services, excluding the new Community Antenna Relay Service; and the public interest problems that may be inherent in such cross-ownership. As indicated, it also desires comments on the question of *whether its present rules and policies relating to such matters as multiple ownership, duopoly, concentration of control and diversification of mass media should be adapted to ownership and control of CATV by licensees*, or whether other more appropriate standards are indicated.

Comments were filed in June 1967, and the Commission has not yet issued its comments or decision. Nevertheless, this proceeding is basically

Benco's latest design transformer-type TV and TV/FM outlets

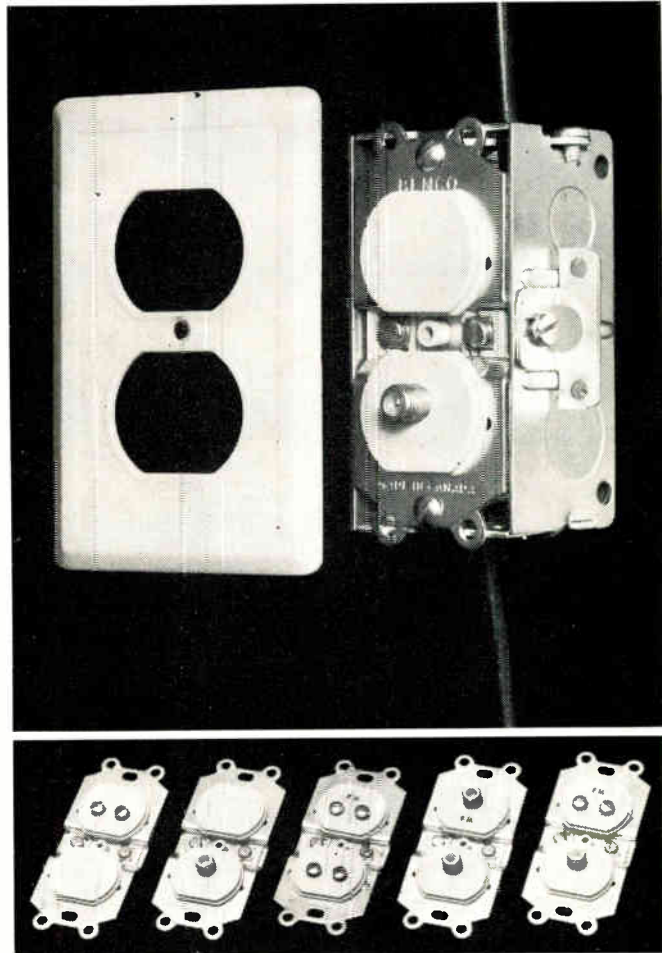

Benco's transformer-type TV and TV/FM outlets are available in 23, 17, 12 Db and 12T tap-off attenuation values. In addition, the Model OP-300/O is a 75 Ω in 300 Ω out wall-mounted set matching transformer; the OP-75/O is a 75 Ω in and out feed thru plate.

FEATURES:

- Transformer coupled
- Backmatched, low VSWR
- Low insertion loss
- Solderless installation
- Cover plate

Please write for specifications and prices to:



In U.S.A.: Benco Television Corporation
P. O. Box 10068, Jacksonville, Florida 32207
Telephone: 904-398-6907 Telex: 5-6203

In Canada: Benco Television Associates
27 Taber Road, Rexdale, Ontario, Canada
Telephone: 416-244-4296 Telex: 02-21211

Circle 16 on Reader Service Card

For a top job in broadcasting . . . get a FIRST CLASS FCC LICENSE ... or your money back!

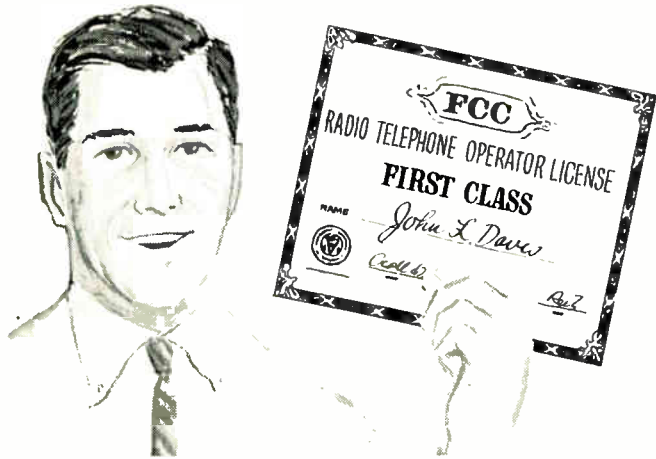

YOUR key to future success in electronics is a First-Class FCC License. It will permit you to operate and maintain transmitting equipment used in aviation, broadcasting, marine, microwave, mobile communications, or Citizens-Band. Cleveland Institute home study is the ideal way to get your FCC License. Here's why:

Our electronics course will *quickly* prepare you for a First-Class FCC License. Should you fail to pass the FCC examination after completing your course, you will get a *full refund* of all tuition payments. You get an FCC License . . . or your money back!

And only CIE offers you new, up-to-the-minute lessons in all these subjects: Logical Troubleshooting, Microminiaturization, Single Sideband Technique, Pulse Theory and Application, Boolean Algebra, and many more.

You owe it to yourself, your family, your future to get the complete details on our "proven effective" Cleveland Institute home study. Just send the coupon below for FREE book or write to Cleveland Institute of Electronics, 1776 E. 17th St., Dept. BM-6, Cleveland, Ohio 44114.

ENROLL UNDER NEW G.I. BILL

All CIE courses are available under the new G.I. Bill. If you served on active duty since January 31, 1955, or are in service now, check box in coupon for G.I. Bill information.

MAIL COUPON TODAY FOR FREE BOOK

CIE Cleveland Institute of Electronics
1776 East 17th Street, Cleveland, Ohio 44114

Please send me your FREE book, "How To Get A Commercial FCC License."

Name _____ (please print)

Address _____

City _____ State _____ Zip _____

Occupation _____ Age _____

Check here for G.I. Bill information.

Accredited Member National Home Study Council
A Leader in Electronics Training . . . since 1934

BM-6

Circle 17 on Reader Service Card

a continuation of the previous investigation of the entire cross-ownership problem in Docket 15415, supra. In any event, *this proceeding seems to lay a foundation for sweeping rules restricting such cross ownership in the following possible ways:* (1) preclusion of cross ownership of broadcast and CATV facilities in the same or closely related markets, (2) limitation as to the number of CATVs that may be owned by the same individual, group of individuals, corporation, or individuals, groups, or corporations related thereto. (3) limitations upon ownership of newspaper and CATV in the same or related communities, (4) application to CATV of something akin to the diversification of control of mass media, multiple ownership and duopoly (overlap) rules and policies now applicable to broadcasters, and (5) furtherance or restriction of program origination by CATV.

Such restrictions serve as "two-edged swords," cutting both ways. That is, the adverse effects, potential herein, may injure broadcasters and CATV operators alike. Consider the following possible effects of such rules.

1. A restriction as to the number of CATVs that may be owned by one group will restrict somewhat the potential buyers of CATV properties and tend to depress CATV prices or, at the minimum, decrease future appreciation.
2. A preclusion of broadcast-CATV ownership in the same or related areas (e.g., within the Grade B of a TV or the 1 mV/m contours in a-m and fm) would:
 - (a) Prevent the broadcaster from acquiring a CATV in the area specified, and
 - (b) Prevent the CATV owner from acquiring a broadcast facility in the said area.
3. Restriction of newspaper-CATV ownership will similarly reduce (a) investment opportunities for such newspapers and (b) eliminate many, affluent would-be buyers.
4. In general, such rules will militate against "bigness" in CATV.

In both 2(a) and 2(b) above, we have situations that tend to diminish the opportunities of the broadcaster and the cablecaster from logical expansion into a closely related business. Not only does this diminish investment opportunities but will constitute further reduction of potential buyers for radio, television, and CATV properties.

We have indicated, in previous articles, that the Commission is gradually directing its policies toward complete separation among, and diversification of, broadcast facilities and newspaper interests. *Effectively, the Commission seeks the greatest possible diversity of public opinion sources. Ideally, it would like to separate the ownership of TV from a-m, a-m from fm, and newspaper from TV, a-m, and fm, in every community.*

With the emergence of CATV as a program originator, the Commission may be expected to add CATV to the list. Moreover, unlike broadcasting, it has an opportunity to "nip CATV in the bud."

We recommend that all licensees keep a close watch on this proceeding, and, consult with their communications counsel whenever the Commission requests further comments that may affect their interests. While the time for filing comments has passed, it may well be advisable to file informal comments expressing your views — be they pro or con.

You have probably replaced your High Voltage Rectifier Tubes for the last time.

New Silicon "Doorbell" Rectifier Modules just plug in, last almost forever, save you lots of money, and let your equipment keep its cool.

- Modules with current ratings from 0.67 amps to 6.6 amps, and PIV's from 2.5 KV to 15 KV just screw together to permanently replace over 50 different types of tubes. Ratings to over 100 KV.
- Reduce cabinet temperatures by 60°F to 100°F — prolong the life of your other components.
- Reduce power consumption by eliminating filament.
- Designed by high-voltage engineers who built in tremendous capacity to handle overload surges.
- Only void-free, whiskerless, controlled avalanche, individually fused-in-glass Unitrode diodes are used.

For fast action, call Fred Swymer COLLECT at (617) 926-0404



Send for Bulletin N-130A. It's 16 pages of really complete specs, diagrams, pictures, cutaway drawings, application dope, case histories, and direct replacement data. CHECK 18 ON INQUIRY CARD.

UNITRODE®

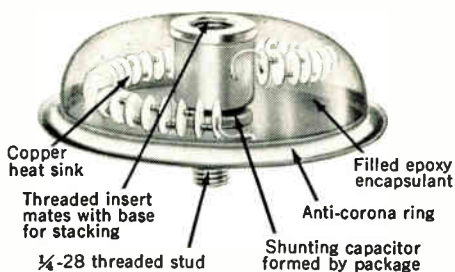

UNITRODE CORPORATION • 580 Pleasant St., Watertown, Mass. 02172 • Telephone (617) 926-0404 • TWX (710) 327-1296

SAVE \$2.00 ON THIS SPECIAL PREPUB OFFER!

A Complete Guide on Ways to Develop Better Ratings, Improve Results, & Increase Sales!

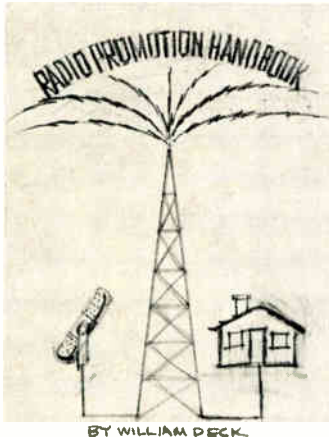

- ◆ BRAND NEW
- ◆ 256 PAGES
- ◆ 14 CHAPTERS
- ◆ UP-TO-DATE
- ◆ ONLY \$7.95

Indispensable For:

- Managers
- Program Directors
- Sales Managers
- Executives
- Disc Jockeys
- Copywriters
- Producers
- Advertising Personnel
- Sportscasters

It's a proven fact! Clever and well-planned promotional campaigns lead to bigger audience ratings and greater sales! This brand-new publication, by noted station promotion authority William Peck, is aimed at helping broadcast stations reap benefits of bigger and better promotional campaigns. Jam-packed with literally hundreds of ideas, and complete with scores of factual examples to spark hot, new ways of promoting a station, "RADIO PROMOTION HANDBOOK" is a book no progressive station should be without! The author, drawing on many years work with a variety of formats and advertising agency experience, tells how to make everything that happens at your station help to PROMOTE your station.

CONTENTS
• CONTESTS IN GENERAL
• "YOU PHONE US" CONTESTS
• "WE'LL PHONE YOU" CONTESTS
• TREASURE HUNTS
• "DROP US A CARD OR LETTER" CONTEST
• NUMBERS GAMES
• STUNTS
• PROGRAMMING AS PROMOTION
• PUBLIC SERVICE AS PROMOTION
• THE NEWS AS PROMOTION
• OFF-AIR PROMOTION
• SALES PROMOTION
• SALES SPARKERS
• COPY IDEA SPARKERS

Both on-air and off-air campaigns are included: How to integrate on-air promotions with programming by means of contests, stunts, games, jokes, promotional announcements, station breaks, etc. Also, how to develop and tie-in off-air campaigns, personal appearances, sales promotionals, public relations, and advertising in other media. Chapter 1 looks into contests in general—what is a good contest and what makes a contest not so good. Chapters 2 through 7 describe specific types of promotions—"You Phone Us," "We'll Phone You" and "Drop Us A Card" contests, numbers games, treasure hunts, and stunts. Chapter 8 treats programming as promotion, tells how to program to attract attention, how to develop a theme, promotional announcements, IDs, etc. Chapters 9 and 10 suggest ways to use public service and news programming to promote your station. Ideas include benefits, recruiting drives, employment opportunities, current news, mobile units, etc. An entire Chapter on off-air promotion tells how to tie-in the off-air theme with the on-air theme, the use of outdoor, transportation, newspaper, and broadcast advertising, mobile studio, direct mail and sponsor tie-ins. The final Chapter includes many sales promotion ideas; sales presentation material, trade-oriented advertising, direct mail, using your own station, "personal" promotion, entertaining, station parties, internal promotion, etc. Ideas to develop specific client sales campaigns and many actual sample copy examples are included in the appendices.

"RADIO PROMOTION HANDBOOK" will be available on Jan. 30th, 1968. Order now at the Special Prepublication Price of only \$7.95 (offer good only through Feb. 28th, 1968; regular price is \$9.95) at our risk . . . for 10-day FREE examination. SEND NO MONEY! Simply fill in and mail NO RISK coupon below for this indispensable volume! (Note—3 or more copies ordered at one time are subject to a 10% discount.)

PUBLISHER'S GUARANTEE

Put the information in this book to work for you for 10 days. If it doesn't prove to be worth several times its cost, return it and we'll cancel invoice.

NO RISK COUPON—MAIL TODAY

TAB BOOKS, Blue Ridge Summit, Pa. 17214
 Please send me.....copies of
 "RADIO PROMOTION HANDBOOK" at the
 special prepublication price of only \$7.95
 (10% discount on 3 or more copies).
 I enclose \$.....
 Please invoice on 10-day FREE trial
 Name.....
 Company.....
 Address.....
 City..... State..... Zip.....
 Save postage by remitting with order BR 28

Circle 19 on Reader Service Card

FROM THE EDITOR

Random and Associative Musings on Programing and Equipment

This next summer, one arm of higher fashion will draw the hemline at mid-calf—a big comedown from mid-thigh. In this mad mod world, the new dress style is called midi-mania. What will the fashion be in radio and TV? A return to soap operas and adventures of Jack Armstrong, the nonsuper boy? Or can the acid throwing talk generals of the late 60's shock us a while longer? Will cultural diversity and fragmentation go so far that we will have to recycle to cultural integration?

For better or worse, we suspect the trend of outrageous opinions (lower case) and personalized radio, and soon personalized TV, will continue for some time before a turning point is reached. We're headed into a world of leisure and the era of the sensate. Electronics will play new roles in programming.

The equipment may be an electronic music generator—or a noise generator producing random and associative, but nevertheless pleasurable, sounds. To add variety and drama to all-news shows, more sound effects simulating on-the-scene reporting will be needed. (On the scene, the distortion will be eliminated to assure intelligibility. Back in the studio, the effect of a poor quality tape recorder will be added to achieve realism.)

CBS-TV's plan next year to enliven baseball games includes more TV cameras, instant replay recorders, eavesdropper microphones to get the pitcher-catcher conference, and pre-programmed data display devices to haul out and tote up vital player statistics. Triangle Stations have already structured fictional all-time all-star games and played them by computer (World Dream Series). Why not an electronic coach in the announcer's booth with a computer to call the event ahead of time. Electronics will thus add a basic new dimension to the game to make it more lively.

So far, broadcasters' routes to the pleasure centers of our brain are restricted to aural and visual channels. But not forever. Certainly odor transmission and/or reproduction will come, as predicted, and we expect to hear soon of an fm subcarrier being used for such purposes. (The first scent will undoubtedly be popcorn, since it is doubtful whether the FCC would approve of fatal perfumes or riot gases as being in the public interest.)

Skipping ahead 30 years or so, direct electric stimulation of the brain's pleasure centers is foreseen by operation-researcher turned-prophet, Herman Kahn of Hudson Institute. An implanted electrical circuit is connected to the brain. You press a button and have a pleasurable experience. For unexpected thrills, a person might tune to his favorite station which is broadcasting a series of signals designed to trigger the various brain electrodes. If you don't get the proper kicks, spin the dial. Enough of this electro-mania. Switch off.

James A. Lippke



The AM4A mixes everything

Sermons, choirs, congregations and background music; musicians, soloists, audience and sound tracks. Wagnerian sopranos or folk-rock singers; wherever you have a requirement for sound mixing, that's where you need an AM4A.

A single AM4A with 4 output channels, can mix and match the inputs from up to 20 microphones, controlling HF and LF, equalize, reverb and mix . . . mono or stereo. You can even solo any given microphone.

Prices start at less than \$3500, and most important, you buy only the channels you need. Each channel is a pre-wired plug-in module. Just unpack the AM4A, connect your input and output lines, drop in the modules and you're ready to go.

But don't take our word for it. If you are a qualified customer you can try an AM4A on a **free 30-day trial**. That's how confident we are that once you have it in operation, you'll never let it go.

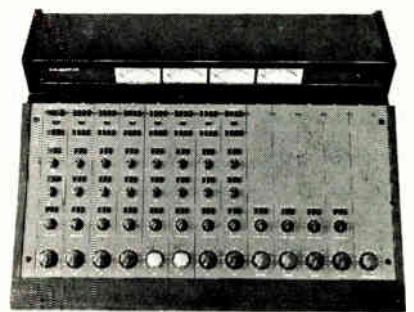

Langevin

1801 EAST CARNEGIE AVENUE, SANTA ANA, CALIFORNIA 92702 (714) 546-8830

Circle 20 on Reader Service Card

The International Set.

Conrac watches television in about a hundred languages. Japanese, Thai, Swedish, Norwegian, Hebrew, French, German, you name it. In fact, just about every major TV broadcaster in the world uses Conrac monitors. Except the Russians. (But, you know how that is.)

conrac

Circle 21 on Reader Service Card

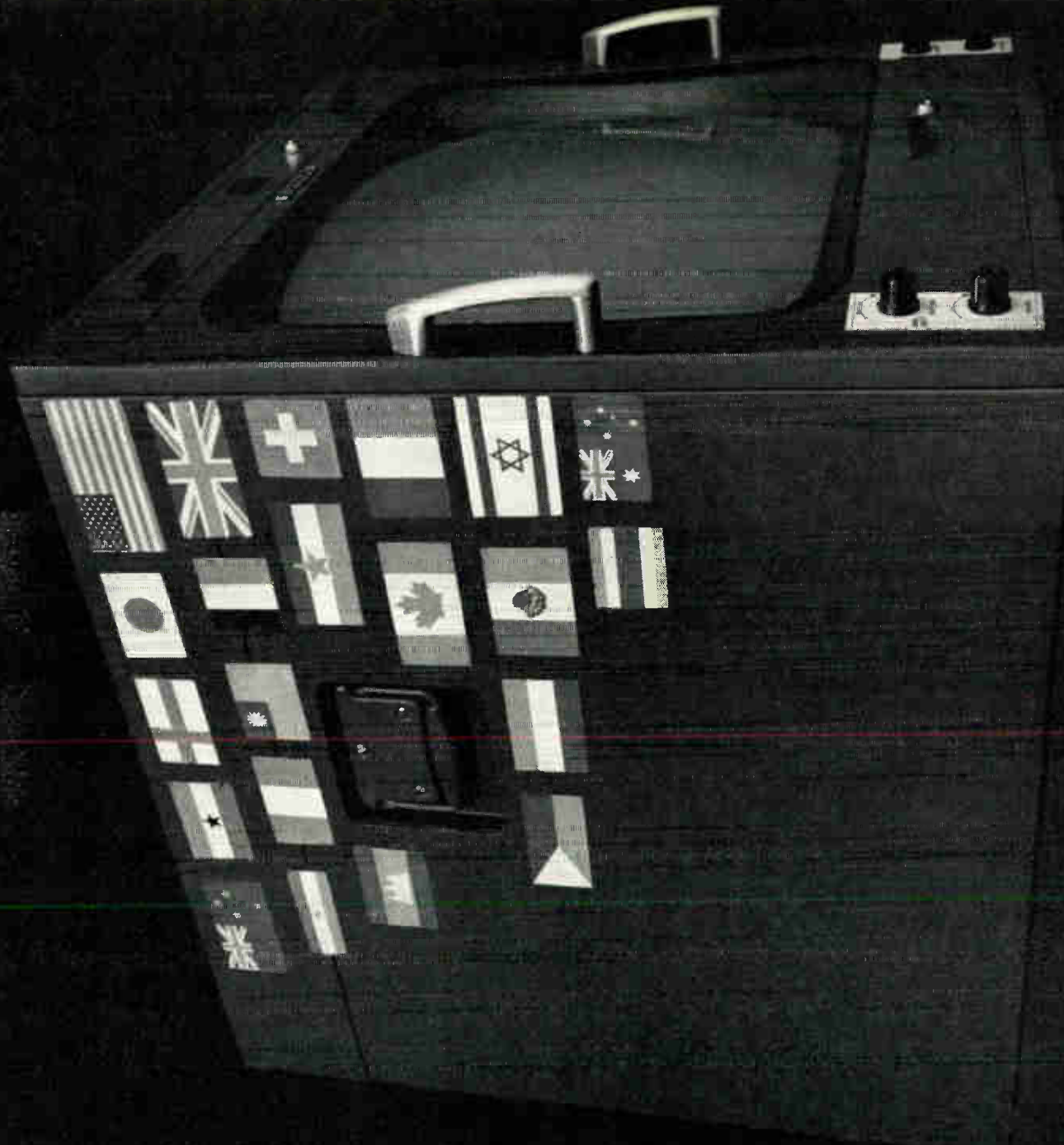

3M WOLLENSAK HAS THE OPTICS ANSWERS:

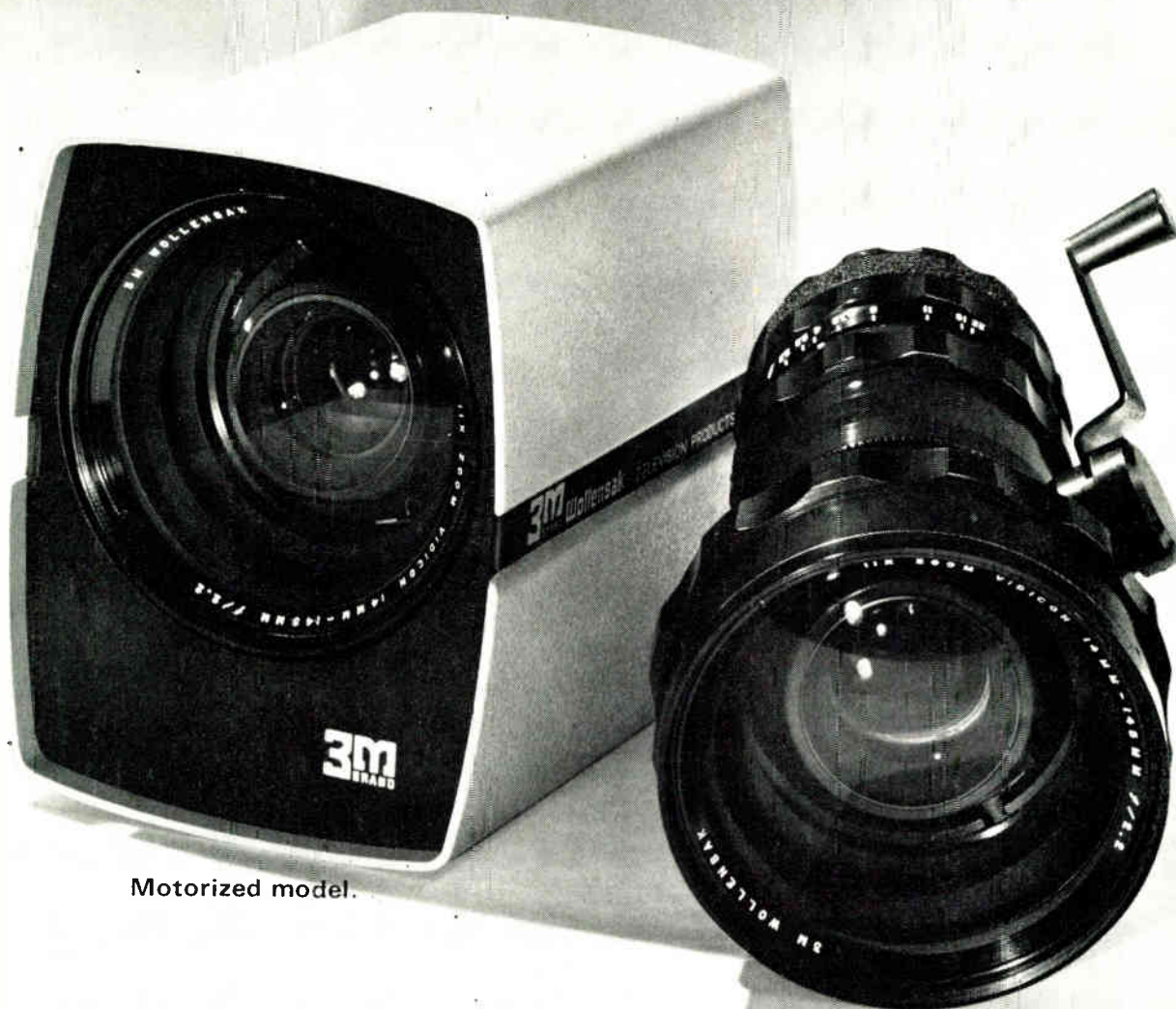

Motorized model.

Manual model.

This is the new 3M Wollensak 11:1 Television Zoom Lens. Available in motorized or manual models. It has a range of 14mm to 145mm. And it's fast— $f/2.2$. Each model is compact and lightweight. And each is American made. Designed with "C" mount to fit all Vidicon cameras. Price: \$1775 for motorized. \$875 for manual. Newest in a line of fixed focal and zoom lenses.

Contact your dealer or write to:

3M
COMPANY

Wollensak

TELEVISION PRODUCTS

St. Paul, Minnesota 55101, Dept. FMJ-28

Circle 22 on Reader Service Card

HOW THE INDEPENDENTS PROGRAM

Kaiser's Us and WOR-TV are doing counter programming. It all started with Metromedia.

Can a U Compete in Top Markets? Kaiser's Act like V's and Do

PHILADELPHIA'S WKBS, channel 48, is the most viewed uhf station in the country, its prime time audience having risen more than 100 percent in the last year. In Detroit, WKBD, channel 50, has overtaken its vhf independent competitor in several important areas. In Boston, WKBG, channel 56, was showing significant rating figures after only eight months on the air.

Is uhf actually competing successfully with independent commercial vhf channels? Richard C. Block, vice president and general manager of Kaiser Broadcasting Corporation, which owns and runs the above stations, says "people watch television programs, not megacycles."

And Kaiser is certainly providing the programs. With the addition of channel 44, in San Francisco, KBHK, and Cleveland's channel 61, WKBF, and the activation of its Los Angeles, channel 52, KMTV, Kaiser will serve 7.1-million homes in six of the nation's top eight markets (the company is looking to buy its seventh uhf outlet in Chicago or New York) and will probably become the largest program buyer in the industry outside of Metromedia, in terms of price paid for syndicated product. In fact, Kaiser executives do not try to hide the fact that they have incorporated some of Metromedia's programming policies, and they feel they have learned to profit from the mistakes of independent vhf's.

Kaiser's programming hooks are major sports attractions and popular kid shows, believing their power to be strong enough to break old viewing habits, backed up with first rate local news coverage, talk shows, first run movies, and popular off-network shows such as *I Love Lucy*, *Hazel*, *Combat*, *Perry Mason*, and the *Honeymooners*, to hold the viewer.

Its Philadelphia station has the National Hockey Flyers, for Boston Kaiser got the Celtics, for Detroit the Pistons and the NHL Redwings, its new San Francisco station will carry NBA Warrior Basketball, as well as 25 of the games of the new

Oakland Athletics, who have signed a 10-year deal with Atlantic Richfield and KBHK.

All Kaiser stations carry major children's shows . . . *Yogi Bear*, *Huckleberry Hound*, *Three Stooges*, *Quick Draw McGraw*, *Astro Boy*, *Marine Boy*, *The Little Rascals*, *Superman*, *The Flintstones*, *Fantastic 8th Man*, *Bowery Boys* etc.

It's the kids and sports fans that discover U channels. Frank Tuoti, director of sales is convinced that U tuning is no insurmountable handicap. "Kids find us all on their own; they teach the adults." Tuoti reports. When Boston went on the air, its first sports game drew an 8 rating. Detroit and Philadelphia have increased their audiences 100 percent in one year. In prime time alone Detroit went from 19,500 viewers to 33,500—a 72 percent increase.

Fall programming purchases have exceeded \$6-million for properties such as the 90-minute *Woody Woodbury Show*, and 200 movies including "The Pawnbroker," "Umbrellas of Cherbourg" and "La Dolce Vita."

Joe Pyne, David Susskind and Alan Burke will all be on the Cleveland channel, as they are on the ones already on the air, as well as the Lou Gordon Show, the Detroit talk show that is in the same rating league there as the *Alan Burke Show* on WNEW-TV is in New York.

The new San Francisco station KBHK will be tailored specially for the local San Francisco audience and will feature a variety program live, in color 90 minutes of entertainment each weekday night, plus talk shows with local personalities Don Sherwood ("Mr. San Francisco") and Joe Dolan's controversial 45-minute talk show five times weekly. KBHK will have in depth news coverage with ½-hour news programs at 7:00 P.M. and 10:00 P.M. Monday through Friday, produced by a 15- to 20-man news team. Kaiser has begun to step up its news operations and by the end of next year expects to have expanded the use of news on all six stations.



Above: Talk shows are "in" in San Francisco. The Joe Dolan Show, above is in the controversial class. Note the RCA TK-42 color cameras. The Cleveland and San Francisco stations represent investments of \$5-6 million each.

Right: Tall tower extends a station's reach. Tower going up here extends 1079 feet above Cleveland terrain.

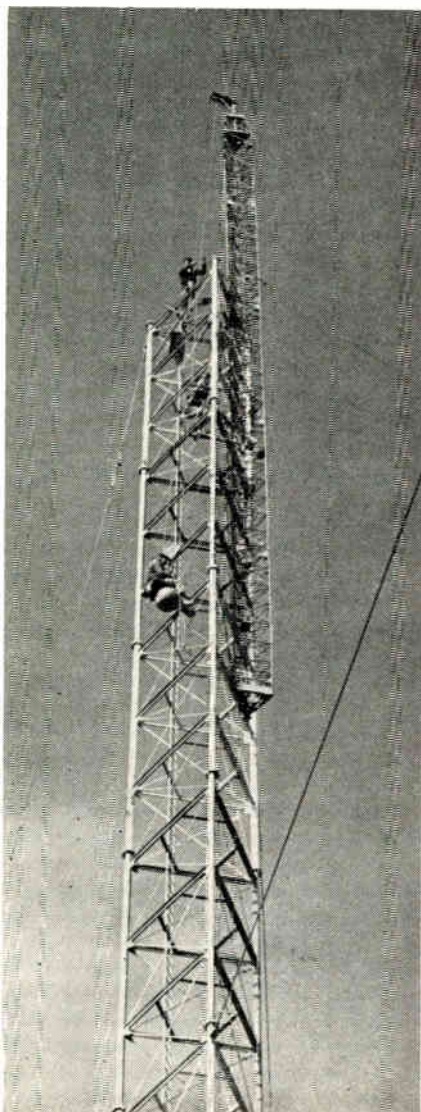

About \$2½-3 million will be spent on building news coverage this coming year. Kaiser hired Hardie Mintzer who captained Metromedia's success at WNEW-TV with 10 P.M. news to build Kaiser's news department. Mintzer starts in Philadelphia.

Kaiser spokesmen say that "Kaiser Broadcasting is succeeding because we are going first class." All Kaiser stations are fully equipped with color cameras, high-band color videotape, color mobile units and are transmitting from tall towers that provide proper coverage of the respective markets." Executives anticipate that Detroit and Philadelphia will begin operating at a consistent profit by the 1968-69 season. In fact, Kaiser's problem does not seem to be money, but having something to spend it on.

The operations of the Los Angeles channel have been held up, and the station will ease into operations over the next 18 months, because there are so many independent channels, four unaffiliated vhf's and three uhf's that Kaiser can't get into the buying picture until next year when new off-network programs become available. Kaiser does plan the eventual interconnection of its Los Angeles and San Francisco stations.

Kaiser's investment in uhf broadcasting is now over \$36,000,000 and by 1970 Kaiser's officials predict it will climb to \$89-90 million. Mr. Block of Kaiser said that Henry J. Kaiser's credo to

\$700,000 In Seven Weeks

WKBF-TV, Kaiser's Cleveland station, is finding ready sales in the eighth-ranked market. James D. Boaz, sales manager at channel 61, reports that in seven weeks' time his five-man sales staff has already sold time schedules totaling in excess of \$700,000.

"We believe this is the highest advance sales record in the history of the uhf industry," Boaz commented, "and that it reflects the fine program schedule Kaiser Broadcasting has developed for the Cleveland market."

All of Cleveland's top ten advertising agencies, plus many others, have already purchased time schedules for their clients on channel 61, which began broadcasting January 1. The majority are 52-week advertisers and represent this area's top advertisers. National accounts such as Sears, Roebuck and Company, Carling Brewing Company and RCA Mainline Distributors are advertising along with local merchants such as Superior Meats, D.O. Summers and the Fisher-Fazio-Costa food chain.

Three of Cleveland's top four banks, four major automobile companies, and Northeastern Ohio's largest furniture chain have already signed contracts. Associated Theaters and the Cleveland Plain Dealer indicate acceptance by a wide cross section of advertisers.

"find a need and fill it" has led us to make this heavy commitment in major market television. "Now that the penetration of all-channel homes is so high, we plan to contribute fresh and imaginative programming in our markets, develop exciting in-depth news services which will add to rather than duplicate existing services and to become a close-knit part of our communities."

The \$36-million investment includes losses for the three years. The future investment may see Kaiser operating the fourth commercial network which is its immodest goal. Kaiser hopes to succeed where United Network (Overmeyer) failed by building, first, strong O & O stations in the top markets (their current six stations are in

the top eight markets). These stations will underwrite strong programs so they can be fed to affiliates at reasonable costs.

BM/E asked whether Kaiser could get into the black with \$60 and \$75 spots (currently being quoted in San Francisco and Cleveland). Can they sell enough? Part of the answer is in the Cleveland sales success story of \$700,000 sales in seven weeks (see box). Low rate spots are sold on a distribution plan and are pre-emptible. Tuoti claims salesmen are already having trouble clearing this plan because of higher sales. Kaiser counts on it taking a year to develop viewer habits and dependable ratings. By the third year they expect to be "in".

How to Cross Up the Networks

A strong new force in the television industry is making large waves in an area formerly dominated by the major networks. With the networks relying more and more on movies produced for theatrical release and on copies of copies of once popular formula shows, Metromedia television is stressing programming innovations and community involvement. Metromedia stations enthusiastically involved in the communities in which they are located are weaning away from the major networks their once dominant viewing audience.

In New York, Washington and Los Angeles, Metromedia television stations are making strong inroads in prime-time programming ratings; in all three markets they dominate children's programming by a large lead. Metromedia's KMBC-TV in Kansas City, an ABC-TV affiliate, with an emphasis on local news, children's daytime shows and city-wide involvement, now is an aggressive and vital member of that community. Metromedia special telecasts now often air to larger audiences than do some of the biggest and longest established network offerings. Trade publications such as "Variety" are hailing Metromedia television and Albert P. Krivin, its president, as among the few who are now setting the trends and who have become the new leaders of the industry, filling the spots formerly held by network presidents.

Countering Movies and Formula Shows

The Metromedia television produced "Truth or Consequences" now is seen in more than 60 different markets covering 80 percent of the nation's television homes. The 90-minute "Woody Woodbury Show" is aired daily in 17 major cities and the provocative and much discussed "Joe Pyne" program is broadcast on all Metromedia stations and is syndicated to 75 other stations throughout the country. The KTTV produced "Ray Coniff Christmas Show" special in December aired on more than 70 different stations. "Les Crane," a recent late-night entry, is seen on KTTV, WTTG and WNEW-TV and has just entered the syndication market.

Metromedia television is now producing more than 28 hours of color programming

each week for syndication. In developing its own programming, Metromedia is able to provide its stations with a first-run quality product that is competitive in each of Metromedia's areas and at the same time amortize production costs over many markets by syndication. "Opinion: Washington" and "Face To Face," which focus on major national and international issues, originate at WTTG in Washington but are seen on the Metromedia stations and a large number of other commercial and educational stations throughout the nation. Such specials as "O.R. 5," the dramatic heart operation videotaped by WNEW-TV in New York, "The Steve Paul Scene," a modern music extravaganza, "Expo '67," "Morality of Anti-Communism," "The Warren Commission Findings; A Majority Report," and "There Are No Instant Negroes," a documentary on the Los Angeles Watts situation two years later, have attracted national acclaim. KTTV's "Medal of Valor," honoring Los Angeles Police officers for heroic deeds, was nominated for the individual station "Emmy."

At all Metromedia television stations, members of a "community involvement" board comprised of the top executives monthly interview opinion makers and civic leaders representative of all facets of each city. Those interviewed are asked "What can our television station do to assist in making this a better community in which to live and to assure the city's children a brighter future?" From such monthly meetings come such public affairs programming as KTTV's 18-hour "Job-A-Thon" that produced more than 25,000 job opportunities for Los Angeles' unemployed and a KMBC-TV sponsored "New Citizens" fund in the memory of a young Kansas City resident who was killed by a gang of hoodlums when he came to the aid of his citizenship teacher. WNEW-TV's "Muscular Dystrophy Telethon" starring Jerry Lewis raised \$1,126,846, breaking every previous telethon fund-raising record.

The creativeness and effectiveness of Metromedia television's sales efforts are indicated in growing revenue and profits during a period of sluggish nationwide TV spot advertising. While most of the industry was reporting sales equal to or below a year ago, Metromedia television in 1967 enjoyed a substantial increase in gross revenue over the previous year and profits reached record-breaking levels.

WOR-TV Matches

Technical Equipment to Programming Philosophy

As one of three independent stations in the New York City market bucking three network flagships and three ETV stations, WOR-TV can never count on having it made. The situation calls for aggressive but finely-tuned programming and sophisticated but cost-conscious equipment expenditures.

THE INDEPENDENT STATION can be vital and alive by being live and upbeat when others are going the canned comedy/drama route. Viewer involvement rather than viewer entertainment is a clue to the new programming being done by WOR-TV.

WOR-TV, as do other independents, has its situation comedy and drama, but it's in the form of reruns already market tested (*Make Room for Daddy*, *Gilligan's Island*, *Time Tunnel*, *The Monroes*, *Wagon Train*, *Laredo*).

Outrageous Opinions, a daily series with outspoken Helen Gurely Brown (of "Sex and the Single Girl" fame and now Editor of *Cosmopolitan Magazine*—for adventurous playgirls), is an example of WOR-TV's upbeat and lively scene. It is co-produced by WOR-TV and King Features. WOR-TV runs *Outrageous Opinions* one half-hour daily at 2:00 P.M. to capture women viewers and two ½ hr prime time (10:30 P.M.) on Tuesdays and Fridays to captivate men.

Liveliness and fun in the early evening is achieved with the proven *Mike Douglas Show* 6:00-7:30 P.M. Fun starts at 10:30 in the morning at WOR-TV with the *Joe Franklin Variety Show*. It's live for the kids in the morning with the *Romper Room*, a one-hour daily show.

When you're the only independent station in town you can calculate to win with Merv Griffin, Joe Pyne, or Alan Burke to name a few of the top nonnetwork syndicated shows. But in New York, Metromedia's WNEW-TV has first crack at its own productions and early bought the *Merv Griffin Show* from Group W. Against such success you counter-counter-program and that's exactly what General Manager Jerome Bess and Director of Programming and Operations John Koushouris have done.

WOR-TV will, for example, buck all entertainment with sports. Wednesdays at 8:30 it's the *New York Knicks Game of the Week*, live* in color. On Saturdays it's the *New York Rangers Game of the Week*. WOR-TV is also the official station for the New York Mets and broadcasts home and road games. *Jets Huddle* is a popular WOR-TV pro-football strategy session which precedes hockey.

Basketball and hockey rate well with men and this year in the absence of male-oriented programs *I Spy* and *Chrysler Theater* competing in the

same time slot, WOR-TV has captured even more male viewers.

If WOR-TV can't go for the top male program it tries to avoid direct competition with other programs strongly identified with a specific audience group. For example, *Time Tunnel* is young adult and plays against CBS's *Gunsmoke* (older), NBC's *Monkees* (teenage), and ABC's *Cowboy in Africa* (young).

In an area surfeited with news (several all news radio stations) plus Metromedia's one-hour TV news show starting at 10:00 P.M. an hour ahead of the network offering, WOR-TV ignores it. Mike Douglas is scheduled opposite the 6:00-7:30 P.M. news. At 11:00 P.M., the late night flick starts.

Million Dollar Movie has been a staple at WOR-TV during prime time for years. Movies start at 8:00 P.M. on Tuesdays, Thursdays, and weekends. On Monday nights it's 2½ hours of uncut first run feature films. "La Dolce Vita," "The Pawnbroker," "Through A Glass Darkly," and "Lord of the Flies" are a few of the first run movies to be shown this season. The network's movie nights, NBC (Tuesday), ABC (Wednesday), CBS (Thursday) have nothing on WOR-TV. Independent WNEW goes with the *Merv Griffin Show* during these hours and independent WPIX-TV starts its movie at 10:30 P.M.

WOR-TV's use of first run movies (*The Big Preview*) was successful this year but the competition for movies is getting keener. The cost of pictures locally in the New York market range from \$20,000 to \$35,000. However, since the entry of the three networks with a heavy fare of movies in prime time, six-nights this season and seven next fall, the availability of first runs for local stations is fast dwindling.

For The Best On-Air Look

With the need for good live shows, on budgets that are but a fraction of that of slick comedies, the independent must pay particular attention to his equipment investment. WOR-TV provides a good case history. To succeed, it had to move into new studios. This forced a decision on equipment. The object of equipping a station, Koushouris says "is to get the best-on-air look at least cost per hour." Since almost everything on the air comes from the studio or film-VTR areas as opposed to a feed from a network, the job of getting a good look is more difficult than that faced by network affiliated station. More elements are handled. Fluffs have to be kept to the minimum since rebates to clients cut into profit.

To achieve flexibility in handling commercials between program elements WOR-TV uses a semi-automatic switching system. Next events or sources

*Some are on ½ hour tape delay.

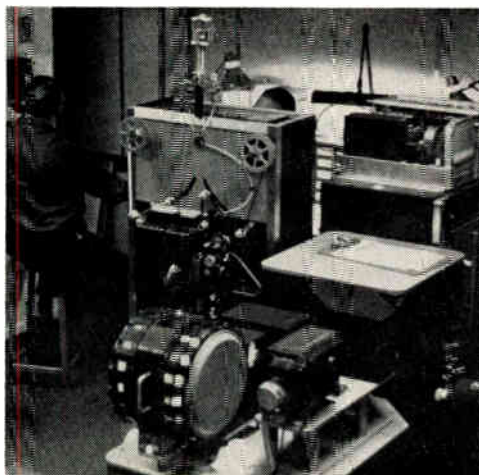
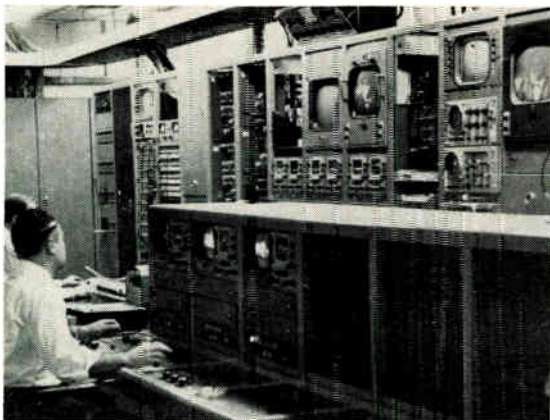

Top left:
View of technical operations central.

Top right:
View of film equipment.

Bottom (2 views):
Master control room shows large digital display readout of next events. Video operator decides when to switch.

are programmed into the switch system and large readouts give the operator visually the ON-AIR event, the IN-PREVIEW event, and the "next event" preview. To switch a source ON AIR, it is first selected in preview where the operator may check it for technical quality and correctness of source. Operation of the TAKE button then transfers this source into the program row. In the case of film and tapes, these are controlled by the ROLL button and the two pre-roll timers, the switch being effected after the adjustable pre-roll timer has run down to the machine start position. The HOLD button will inhibit the timer when pressed and so stop machine operation.

A fade or a wipe transition can be made by presetting the instruction. The illuminated readout automatically advances the stored information.

It would be a small step to automate the switcher entirely so that the next source would be automatically switched at the close of the event on air. WOR-TV, however, insists that the transition be effected by an operator who punches the TAKE or ROLL button. The station wants everything to come up clean and an on-the-spot operator is the best judge. WOR-TV switches only when the last syllable is uttered. When the next event is switched on, video precedes audio by 1/2 second so the transition is smooth. Cartridge tape control is controlled by the program bar and starts when the TAKE button is pressed. (Other choices are: audio follow video, announce, or cartridge tape and an-

nouncer mix.)

The switcher used by WOR-TV was built by Central Dynamics, Ltd. and is basically CDL's type VSA102. This means the events programmed into the switch are stored by magnetic latching relays which store up to 12 audio/video programming events. They are loaded in proper sequence by means of the preview buss. Any one event can be bypassed and the next event brought up by a SKIP button.

Signals from the central memory automatically perform such functions as positioning the mirror of the film/slide projector properly, starting film or tape pre-roll timers, starting the audio cartridge and advancing the tally lights of the illuminated readouts. There are 18 interlocked audio/video inputs possible plus seven additional audio-only inputs to accommodate up to six cartridge tapes and one announce booth.

The central switch was the first part of the system to be specified by WOR-TV and pre-dated final installation in the new studio facility by two years. If the station had it to do all over again they would probably have picked a larger memory but would stay with operator control of the TAKE button between events. The object of the gear is to assist the switcher. He can actually rehearse switching at the optimum time.

The video preview bar provides two composite outputs and if sync pulses are similar wipes, fades and dissolves can be made (if not, a direct take

must be made). The audio program level is automatically controlled to maintain standard levels.

Any new facility these days must be all-color and this is exactly what WOR-TV is—all color. The new quarters—an old Paramount (?) film shooting studio completely redone—contain two studios equipped with six GE PE-250 color cameras. A mobile van, just completed to cover sports events, will contain an additional three new GE PE-250's. Although economy originally dictated keeping the six RCA TK-41 color cameras purchased several years ago, WOR-TV finally decided to trade them. The old b&w cameras, TK-10's and 11's, were donated to a school. WOR-TV likes the portability features of the PE-250's. They can, if needed, take three cameras from the studio and add them to the color van bringing its complement to six.

WOR-TV has a heavy investment in VTRs; they own seven. Three are Ampex 2000 models; three are RCA TRT-1B (low band); one is a TRT-3 playback unit converted to a record-playback, high band. VTRs are an essential tool for a station that originates a lot of its own programming.

The film island equipment consists of two new RCA TK-27 units and two older TK-27 units.

The VTRs are all located in the studio facility. Because of excellent broad band telephone interconnections within the metropolitan New York area, it was not felt necessary to put VTRs in the mobile vans.

The studios are equipped with \$74,000 worth of Kleigl lights including an electronic board which can be preset for five different scenes or shows.

Some six sync generators are used: two per studio, two in master control and two more located in the mobile van. Riker and Cohu units are used, depending on which unit makes most sense in a given application.

Plant modernization and a physical move are always costly affairs. WOR-TV's move was relatively easy. The critical element was master control. Since new master control equipment was being installed, the old was left intact just in case problems developed. None did. Once master control proved out, VTRs and film chains were moved gradually. The two new studios were finished one at a time, and went on the air when finished.

All moving and installation was done with the existing engineering and maintenance crew. WOR-TV has a parallel organizational structure. Dick Quodomine is the technical operations manager and supplies the staff. John Leay is chief engineer and is responsible for the equipment. Both were delighted with the way the move went. From a reporter's perspective the task looked immense but the accomplishment was understandable. The esprit de corp of both the technical and management staff of this swinging independent is fantastic. But if you know Bess and Koushouris you know whereof it springs.

Economics of Operation

The independent station faces the problem of operating with fewer viewers (since it is assumed the network high budget entertainment offerings will attract the greatest numbers) yet needing technical equipment equal to that of the large affiliates.

The revenue per television home for stations in the four or more station market average \$20 and ranges from \$12 to \$27. For most markets the revenue should be approximately 20 times the number of homes divided by the stations sharing the market. In Phoenix the number of ARB homes in 1965 was 446,700; in Chicago 2,493,100; in New York City 6,353,300. For the smaller markets, cost of equipment and cost of programming is very important. (The same is true of course for network affiliates in the smaller markets.)

The challenge in programming is to out rate the networks. This is now being done by the Metromedia station in Washington, WTTG. U's can hardly expect such achievement since all channel (uhf-vhf) set penetration is but 50 to 70 percent of the total. Of course to the extent that homes have more than one television set

it is not necessarily the three network stations against the independent, or one independent against another independent. As a whole, and despite the gains being made by imaginative counter programming by independents, non-network station viewing is less and revenues (as a result of lower spot charges) garnered by these stations is not always enough to meet expenses.

As a rule in watching expenses, independent stations pay out less money for technical operations and more for programs than do their network-affiliated counterparts. The chart indicates the higher percentages paid by independents for film and talent although, again, wages paid to programming personnel were less.

Cost of equipment may not be the place to economize. You have to equal or better the competition. The average investment of a vhf station is \$1.5 million according to FCC figures and that of a uhf station is \$710,000 (about 70 percent of this is in electronics). But if you are competing in a top market these averages can be way off. Kaiser claims its equipment investment in both Cleveland and San Francisco is over \$5-million.

DISTRIBUTION OF EXPENSES
(percent)^a

	Technical		Program			Wages Total
	Total	Wages	Total	Wages	Film	
Affiliates: ^b						
Total	16.0	10.5	38.6	14.6	11.6	2.3
Independents:						
Total	12.6	9.1	54.8	9.8	29.2	4.1

^aTotal expenses=100%. These are four main groups: "Technical," "Program," "Selling," and "General and Administrative" (G&A). "Technical" and "Program" subtracted from 100 (total) leaves a residual of "Selling" and "G&A." Program expenses are broken down in the following categories: film and tape rental, records and transcriptions, outside news service, talent (musicians, artists, etc.), music license fees, other performance or program rights.

^bExcluding O & O's and independents.

Source: "The Economics of Programming the Independent Television Station." Master's thesis by John Hagborg.

CAMERA HEAD:

12" X 23" X 18 1/2" — 110 lbs

Hard to believe a commercial TV color camera can be so compact?

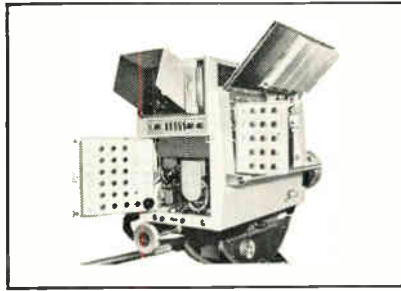
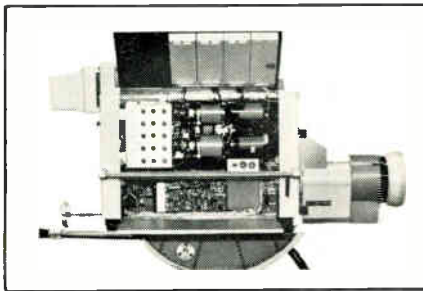

Not hard at all . . . when it is Toshiba TV broadcast equipment! Besides being compact, the Model IK-37 camera chain provides improved compatibility and sharper pictures with wider grayscale on both types of receiver, color and black-and-white. A 3" Toshiba image-

orthicon tube for Y signal and three Toshiba SENSICON tubes for C signal, arranged for easy servicing in this camera head, give signals that are ideal for colorplexing and equal in quality to any straight monochrome signals.

- All solid-state circuits with high-grade Toshiba semiconductor elements throughout the chain.
- Lightweight and easy-to-pan camera.
- Plug-in units for simplified maintenance.
- SENSICON tubes with nearly 100% conversion efficiency and twice as high sensitivity as that of ordinary vidicons.
- Optical system and coil assemblies fixed rigidly and reliably in an anti-shock arrangement.
- No need of adjusting the picture in view finder as its input is fed back from the controller.
- Provisions for mounting servo-operated zoom lens and for d-c remote control (up to 40 yards) of the zoom.

Tokyo Shibaura Electric Co., Ltd.

Producer Goods Export Division, Uchisaiwaicho, Tokyo, Japan

Toshiba America Inc.,

530 Ave, New York, NY 10036 Phone MU7-5471

Circle 13 on Reader Service Card



Our VA 2034 video distribution amplifier



**holds better than 1% gain stability
within operating temperature range**

In other words, "Set it! Forget it!"—it's that reliable. And you'll notice other features that maintain signal quality. For example, better than 40 db ground loop hum rejection; the modular arrangement that permits plugging or unplugging one amplifier in a rack without disturbing the others; four identical outputs per amplifier; optional sync and/or blanking adding. Complete technical literature is yours by return mail.

The VA 2034 is crafted by Central Dynamics — international leader in terminal equipment designed for maximum operating efficiency and operator convenience.



CENTRAL DYNAMICS CORPORATION

HEAD OFFICE: 903 Main St., Cambridge, Mass. 02139

Circle 15 on Reader Service Card

CATV and Radio

Natural Allies

When the radio station owns the cable system, a talent can be shared.

A LOT OF PEOPLE—including FCC Commissioner Nicholas Johnson—feel that cable TV operators have not only the right, but the duty to provide locally originated telecasts. The problem is, how?

How does a CATV system with limited funds and facilities provide local programming to compete for viewer interest with network programming? What kind of programs can you afford to create for an audience of a few thousand? And how can expenditures for local program origination be justified economically?

One of the answers to these complex questions seems to be a sharing of talent and facilities between CATV operators and local radio stations. This solution is especially attractive when the owner of the local radio station also happens to own the cable system. In a number of areas in the country, this happy coincidence does exist and is being utilized to advantage.

To get a closeup view of how a radio station and a cable system can work together, *BM/E* visited two such systems: Holly City Cable TV in Millville, New Jersey and Winchester Cable TV in Winchester, Virginia.

Fred M. Wood, who operates *WMVB* (1440 kHz) and *WMVB-FM* (97.3 MHz) in Millville, New Jersey also owns Holly City Cable TV, a CATV system serving the same area. A pioneer in radio, Fred was the first announcer on Philadelphia's famous *Dawn Patrol* in 1935.

He went into cablecasting almost in self defense. His system, which went into operation a little over a year ago, ran smack into the FCC's Second Report and Order. Since cable systems all around Fred's are giving their subscribers New York City channels, as well as those from Philadelphia, Fred assumed he could also. However, his application for a waiver has been pending for more than a year and a half and he has no idea when the FCC will ever get to it.

With a tower and a good antenna, the residents of Millville can get everything the cable system offers—even if the quality is not as good. Therefore, Fred decided to give them something extra.

"Local origination is our plus," he said. "A lot of people needed an extra incentive to get them to give up their towers and hook onto the cable. Local programming has really been an effective sales tool—there's no doubt about it."

How effective has it been? Holly City Cable

TV has a potential of 3500. After being in business only a year, they have already achieved more than 50 percent saturation—without the New York channels.

Fred achieves high standards by using talent freely between the radio stations and the cable system. Fred himself is one of the most respected radio personalities in South Jersey. He does 5 hours a day on *WMVB*, but still finds time to appear on many cable programs.

Ed Bold is chief engineer of all of Wood's communications facilities. He handles everything from supervising cable hookups and balancing the head end, to manning the camera and solving technical problems at the radio stations.

Jim Lewis, news editor of *WMVB*, serves as program director of channel 4, Millville's local channel. Jim evidently loves his dual role, demanding though it is.

He gets up early every morning to do a 6:30 A.M. radio newscast. Then, he takes out the mobile unit to gather local news from 7 to 10 A.M. At 10:15, he's on the cable with a complete news report, including national and international news from a wire service, plus the local news he has gathered. Often, he uses 8 × 10 photos for video, but most of the time the camera is on him.

Jim also plans and directs all other channel 4 programs. He is helped tremendously by suggestions from the community.

"People are always giving me ideas for programs," he said, "and many of them are darned good."

Even office personnel is shared. Attractive Jessica Ingetta serves as receptionist for both Holly City Cable TV and *WMVB*. Dorothy Carlson, who, according to Fred Wood, "actually runs the radio station," also helps to keep things at the cable system running smoothly.

Aside from technicians, Fred's sole CATV-only employee is Ann Taylor, who serves as office manager for Holly City Cable TV.

Virginia System Must Cablecast

John Lewis, who runs both *WINC* and Winchester Cable TV in Winchester, Virginia, went into local origination for quite another reason. His franchise requires him to provide at least 30 hours of programming per month.

When the Winchester City Council was considering the cable franchise, *TAME** opposed it on the grounds that a cable system would discourage anyone who was thinking of putting up a local uhf channel. Pro-cable interests

*The now defunct Television Accessory Manufacturer's Institute—formed "To Safeguard the American System of Television."

WINCHESTER

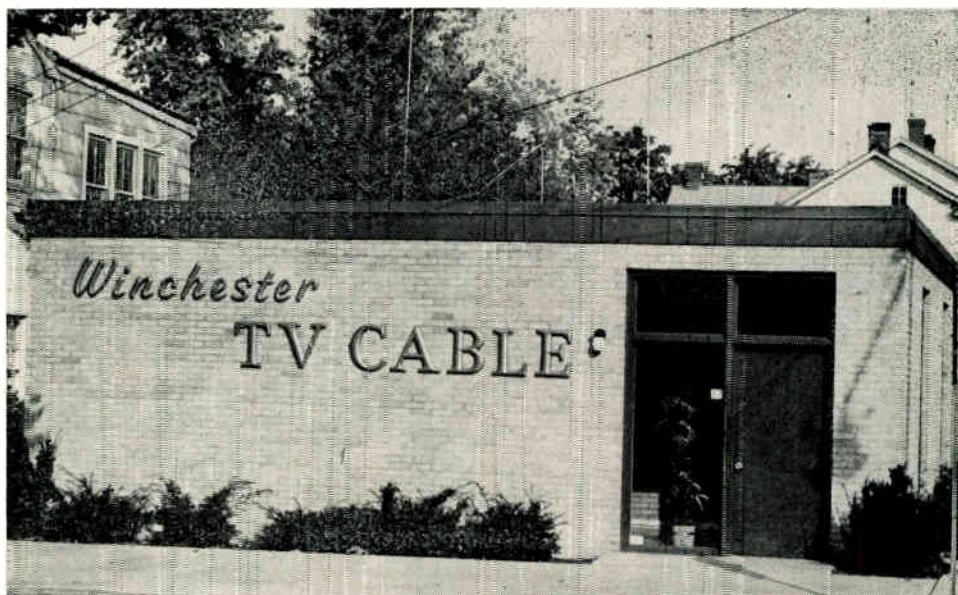

1



2



3

1 Modern, attractive Winchester TV Cable office also serves as originating studio.

2 John Lewis (left), an experienced broadcaster and part-owner of Winchester TV Cable, emcees programs on volunteer rescue squad activities. This is part of a weekly half-hour interview series.

3 Winchester TV Cable Company employs talented high school student to man camera.

4 Winchester TV Cable Manager Ed Cunningham handles control panel during cablecasts.

5 Time-weather-music origination fills in at Winchester TV Cable between cablecasts.



4

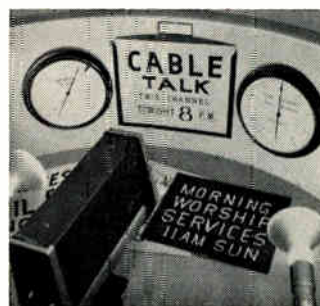

5

argued that a Winchester uhf channel was improbable in any case, since it was unlikely that the area could support it economically.

The City Council decided to have a cable system and local programming too. They granted the franchise only with the proviso that Winchester Cable telecast locally originated programs.

John has found it relatively easy to comply. Like Fred Wood, he uses radio talent to staff his cablecasting operation. John, himself, handles the bulk of the program planning and he is on camera often. Joe Pasquali serves as sports director for both WINC and Winchester TV Cable. Also, Anne Q. Hardy doubles in brass, doing interviews on both cable and radio, as well as selling cable TV subscriptions.

Barbara Sandal, an actress, handles a cable program called *Kaleidoscope*, featuring all of the arts.

John feels that aside from satisfying franchise requirements, local origination has been important to his system.

"Cablecasting is the bonus that people sign up for," he said.

Types Of Programs

Holly City and Winchester cablecast the same type of programs, but Holly City productions tend to be more elaborate and they are on the air a much greater percentage of the time.

Both feel that high school football and election returns are their most exciting programs.

Winchester often runs simultaneous radio and cable programs. For example, each Monday Joe Pasquali emcees *Coaches Corner*, where he interviews local coaches about the games played the past weekend and discusses upcoming games. This is broadcast for 15 minutes over both radio and cable TV. Then, for cable subscribers only, Joe runs a 45-minute videotape of the most recent game. He and the coach act as commentators, analyzing and discussing key plays.

Election returns are also handled by WINC and Winchester TV Cable simultaneously. It takes a lot of personnel to handle an election properly, but the experienced radio staff gives the cable system truly professional coverage.

Holly City Cable TV, on the other hand, has made a more sizable investment in cablecasting equipment. (See Fig. 1). They own two good cameras, a VTR, and a switcher, along with audio equipment.

In addition to channel 4, they have channel 2 as a 24-hour local time-weather channel. Incidentally, WBMV-FM serves as background music for channel 2. This is yet another way in which the radio operation helps the cable system.

Fred Wood has invested more than \$15,000 in cablecasting equipment. So far, John Lewis gets along with a single camera and a VTR.

Holly City Cable TV videotapes football games independently of the radio broadcasts.

Fred Wood hires a local football buff, Victor Zeigler, to do the cablecast commentary, while his regular announcers handle the radio play-by-play.

Ed Bold, manning the camera, listens to Vic Zeigler over a pair of earphones. When Vic talks about a certain defensive linebacker or the cheerleaders, Ed pans the camera to that linebacker or those cheerleaders. And, of course, Vic sees the game on a monitor as it's picked up by the camera. This coordination gives the finished cablecast a very professional look, and the citizens of Millville eat it up. The Thanksgiving day game, for example, was cablecast on Friday evening. Fred got so many phone calls from enthusiastic viewers, that he re-ran the game the following Monday.

Holly City Cable TV also provides excellent election night coverage. Like Winchester TV Cable, they have people at all polling places calling in election news as soon as it is available. However, in Millville, the information is relayed from the radio studio to the cable studio, where it is entered on a huge tote board. Fred Wood and Jim Lewis do analysis and interview local politicians to keep interest high. The mayor, members of the city council and candidates drop into the cable studio and discuss the election. The cable company has handled two elections thus far, and both have been extremely successful in generating viewer interest.

Holly City Cable TV provides a lot of local political coverage. For example, before the primaries last year, they scored a first with a face-to-face debate by the two Democratic candidates. This was a case of not only reporting news, but making it. The local press was invited to the studio and interest was so high that they ran out of chairs.

Once a month, Jim Lewis interviews a member of the City Council. These programs are completely unrehearsed. Jim asks penetrating questions and invites viewers to send in questions. He also videotapes City Council meetings two days a month.

"We feel that we're providing a wonderful service to the community in presenting these programs," said Jim Lewis. "And so do the Mayor and the City Council."

Holly City Cable TV offers a wide range of programming in addition to sports and politics. Each morning at 10:00 A.M. they present a 15-minute inspirational program in conjunction with the Ministerial Association. A different priest, rabbi or minister handles the program each day, giving a talk rather than a sermon. Often the clergyman brings a choir and an organist.

Jim is most proud of his specials. For example, last Christmas he presented an hour concert with the Cumberland County College Choir singing Christmas music. Then, a local minister read an engaging Christmas story with the camera moving to Christmas pictures and a nativity scene.

He also likes to schedule cultural programs, such as the African Genesis Art Exhibit he re-

MILLVILLE

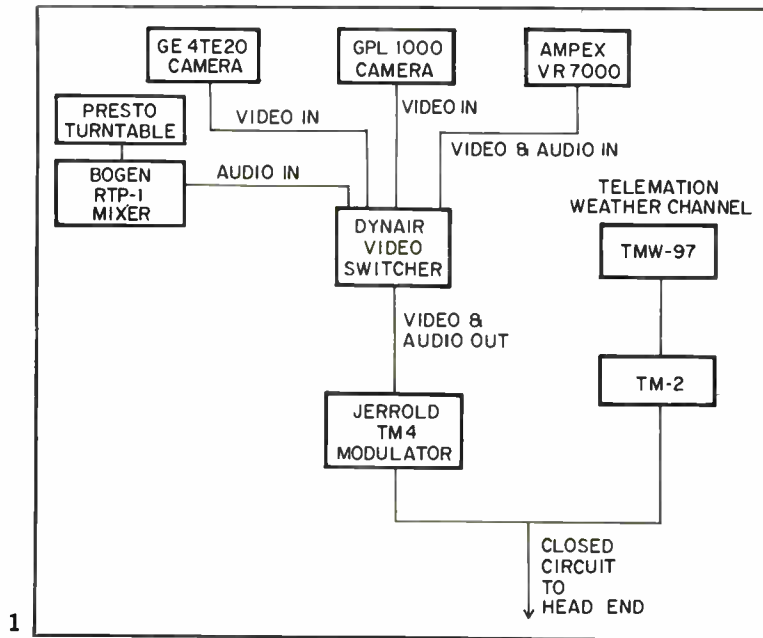

1 Millville cablecasting studio includes two cameras and a VTR. It cost more than \$15,000.

2 Ed Bold focuses camera on Jim Lewis as he delivers his morning news program to Millville cable subscribers.

3 Fred Wood and Jessica Ingetta split time between radio stations and Holly City Cable TV office.

4 Millville's Ed Bold handles videotape recorder. Many programs are taped and played back at a later time.



cently taped. This exhibit, held in neighboring Vineland, was given even more of a local flavor by having a Millville woman who runs an art studio interview the people who ran the show.

"This is the best way that the people of Millville can learn about these things," explained Fred Wood. "We can announce an art show on the air, but the video makes it much more meaningful and dramatic."

Some of the best rated programs on channel 4 are parades. Ed Bold has mounted a platform on the roof of their High Street office and they tape all parades as they pass by. "Millville is very big on parades," said Jim Lewis.

Despite their small operating budget, Winchester, too, has been able to provide an impressive variety of programming.

Using local talent, often on a voluntary basis, and ingenuity, they have also cablecast political debates, the Apple Blossom Parade, the dedication of historic shrines, square dancing, and a weekly half hour discussion between ministers and laymen.

"We don't try to compete with Washington stations," said John Lewis. "We provide what nobody else can—local TV expression."

While Holly City Cable TV is just moving into ETV, Winchester TV Cable is using their system regularly for education.

This service also came about by necessity. Afraid that TV coverage might hurt their gate at football games, the Board of Education was reluctant to allow cablecasting. However, they gave John ballgame rights in exchange for the cablecasting of a weekly music lesson, taught by the local music teacher. Like most CATV operators, John provides free cable service to all schools in the area, so the music program can be seen by all students in Winchester. Pleased with the results, the Board of Education would like to expand ETV telecasts.

Advertising On Cablecasts

The question of selling time on cablecasts is complicated by the FCC and pending copyright legislation, as well as economic factors.

Winchester TV Cable, however, has moved aggressively into cablecast advertising. John Lewis charges a flat \$50 per program sponsored on the cable. For \$50 his advertisers are exposed on cable TV once a day for an entire month. John also sells package deals including both cable TV and radio when programs are broadcast simultaneously.

Fred Wood reports a great deal of interest in advertising on his local channel 4, but he is reluctant to take advantage of it. With no franchised mandate to provide cablecasts. Fred is afraid he'll run afoul of the FCC, hurting his chances of getting waivers on the New York City channels. A local Chevrolet dealer sponsors his City Council meetings, but Fred doesn't really push for advertising. Further, he doesn't charge his fm advertisers extra for the homes they get by

being exposed to cable subscribers on channel 2.

Both men agree that advertising revenue doesn't begin to pay for the costs of cablecasting. But both are glad to be providing a public service.

In spite of this factor, Fred Wood, prodded by Program Director Jim Lewis, is constantly adding to his cablecasting facilities.

"The trouble is, you can't stop," he said. "We started with one camera, then bought another, then a VTR, and so on. Now, we want to change our lighting, expand our studio, get a switcher-fader—it never seems to end."

"The more you do, the more you want to do," agreed Jim Lewis.

The situation is analogous to the expansion of the cable system itself. "We started with a 45-mile system, but before Jerrold left, they had installed a 60-mile system. When we started to get customers, it was hard to stop. The extra 15 miles cost us an extra \$60,000. It's a good investment, but there's a limit to how much you can invest," said Fred Wood.

Holly City Cable TV had the tower and head end built locally, but Mr. Wood had high praise for Jerrold, who turnkeyed the rest of the system, using their new solid-state Starline equipment.

"Jerrold did a fabulous job," he said. "The system worked well from the first tap to the last and we've no trouble at all with keeping our subscribers supplied with top quality pictures."

Radio Sells Cable Service

Aside from providing cablecasting talent, radio has helped both operators to sell cable hookups. Both use newspaper advertising, but the bulk of their subscriptions come from radio spots.

In Millville, the local newspaper is hostile to the cable system, considering it a rival. They refuse to list cable programs or to publicize local cablecasts. But Fred uses his radio station to plug cablecast programs hard, as well as to sell subscriptions.

"Radio ads are not only cheaper," he says, "but they give us more coverage."

John Lewis of Winchester agrees, saying "Radio is much better than newspapers for selling cable TV subscriptions."

These two case histories make it apparent that radio and CATV are natural allies. While the relationship is not really symbiotic, cooperation between cablecasters and radio program originators can be mutually beneficial. CATV may not help the radio station much, but the radio station can definitely provide some of the answers to the problems of local organization.

The story of the railroads is a business cliché. As the legend goes, railroad men lost out to the airlines by insisting that they were in the railroad business rather than recognizing the fact that they were in the transportation business. Fred Wood and John Lewis have at least recognized that they are not in the radio business, but in the business of communication. ●

It Is Not Enough to Program:

Promotion is means to higher ratings for broadcasters; for cable operators it's more cash subscribers.

WCBS NEWSRADIO 88 in New York converted to an all-news format last September. Not the least of the changes effected then was the employment of a new director of public information and advertising.

Since then the Public Information Office's output of print media to potential listeners and advertisers almost equals the electronic message! David Martin, who heads the office, estimates almost 50 pages of news releases go out each week. Martin has six classes of releases: Features, Sports, Editorials, News/Information, Trade News, and Specials. Martin doesn't say how long he's going to keep this barrage up, but he's going for the overkill. Nobody is going to not know that WCBS/Newsradio 88 has a new all-news format.

But do the releases get used? According to Martin one class is working very well. It is a complete news release containing verbatim accounts of new Broadway shows and films as reported by WCBS Newsradio 88's theater and film critic, David Goldman. Goldman's incisive comments have made a name for him and his station. If his reviews are favorable his comments are used to promote the play, musical or whatever. And theatrical promoters are using WCBS/Newsradio 88 as an advertising medium since they assume there is a good theatre-movie going crowd tuning in to hear Goldman.

One of Martin's special releases was the full transcript of an exclusive interview with Mayor Hugh Addonizio of Newark who declared he will run again if necessary to get a job done in riot-torn Newark. Many newspapers ran a story on the interview. Complete transcripts go out on another program, *WCBS Radio Looks at Television*. David Susskind's views were picked up by *Broadcasting* and *Variety* as well as newspapers. It's pretty hard for advertisers and agencies not to know newspapers are making the scene on WCBS/Newsradio 88.

It's fairly standard practice for stations to issue releases of outstanding upcoming programs. Hopefully these will be picked up on the radio-TV pages of local newspapers and gain additional viewers. KPIX-TV of San Francisco, a Group W station, does a good job issuing advance releases and also frequently puts out releases after the show. KPIX is forever winning awards and they let everybody know. Very effective promotion.

Two educational networks that actively promote up-coming programs are the Alabama Educational Television Commission, Marianne B. Sharbel, director of information, and Georgia Educational Television Network, Lou Peneguy, TV information director.



1



2



3

1 WYND Radio disk jockeys (l to r) Butch Lake, Chuck Davis and Johnny Dark display a portion of the more than 65-million valentines and "mash notes" received by the station during a promotion contest.

2 CATV talent show, emceed by local entertainer Richards, gains local interest for Selden, Long Island.

3 Walk into Gusow's Broadway Maintenance Selden CATV office and there's always a prize.

Program *and* Promote

Grand Rapids, Michigan, station WOOD-TV-AM-FM is owned by Time-Life Broadcast Inc. Time-Life's expertise on effective promotion is not lost on WOOD. We haven't any idea of just how effective WOOD's promotion is but we're sure they'd be worse off without it.

WBT-AM-FM and WBTW, Charlotte, North Carolina, sends out a press release daily on its editorials. These are sometimes provocative and invitations to respond are sent to parties challenged or criticized. When there is a rejoinder extra promotion mileage is achieved, particularly when the individual has national prominence—such as when Barry Goldwater accepted an invitation to respond.

Miami is probably an ideal employment location for radio station promotion managers—or maybe it's the most nightmarish place. Being exposed to the news releases of WFUN, WQAM, and WRIZ, all of Miami, we'd say these stations know the value of promotion. (See Feb. 1967 *BM/E*'s full story on WFUN's approach to promotion.) Contests and stunts seem the order of the day. WQAM has such things going, for example, as a VW chicken coupe which is the marathon residence of a disk jockey until some listener guesses the contents of a 300-pound concrete egg at a nearby shopping center. Clues are broadcast and the winner gets the chicken coupe. WQAM recently cashed in on Governor Kirk's much publicized war on crime and won a special award. The station has won other public service awards all of which is good promotion. WFUN gets a lot of mileage out of sponsoring a Miss Teenage Miami contest, but also goes in for public service and promotes the fact that it has helped, for example, hemophilia victims. WFUN also consistently wins awards and promotes these heavily.

WRIZ, Coral Gables, is the newest station to enter the highly competitive Miami market. To make a splash President Jack Roth lined up Vic Damone to do a series of jingle promos. Based on the recurrent theme of "WRIZ—Rise to the right side of your dial," the jingles were set in a number of different musical styles ranging from light beguine to heavy bossa nova and samba. Damone was identified with WRIZ for one month with the use of seventeen voice-only cuts. Following that, the station used Damone's singing signatures against an instrumental background.

Promotion might almost backfire, WHH Norfolk, Va., ran a school spirit contest in April of 1967. Twenty schools caught the spirit and 179,824,633 votes were sent in. A warehouse had to be rented to store the ballots. WNYD of Sarasota, Fla. had a similar experience. They offered to sponsor a Valentine dance for the school, turning in the most valentines and love letters. Seven million came in the first four days, and 65,000,000 altogether.

A fairly standard form of news release employed by many stations is to announce new business. If you land a big account publicize it, it may influence others. If your station plays an unusual role in production let others know about it. Channel 22 in Springfield, Mass. WWCP, called attention to itself when one of its personalities, Kitty Broman, was used by an agency to kick off a new national advertising campaign.

Too frequently, we suspect, a station's press list of possible recipients is quite small. When *BM/E* gets an onion skin carbon rather than an offset or mimeo copy, we wince. We obviously are one of the select few, and if we round file it, the chances of good mileage for the release are indeed reduced. One's mailing list should be reviewed frequently and kept pared down but don't trim it too thin.

Unfortunately, publicity managers may never know how effective their mailings are. Some send along an envelope with a request that if the item is used please send a clip. This is a waste of an envelope.

Cable TV: Get a Paying Viewer

Promotions for radio and TV broadcasters are designed to attract more listeners and viewers. The score is kept by ratings. For the cable TV operator the stakes are higher: the viewer has to pay—initially for a hookup and then every month.

A unique charity drive added considerable lustre to the image of WHVW Radio. On Sunday, January 22, 1967, WHVW conducted the "Mile of Dimes" for the March of Dimes. The idea was to place dimes end-to-end to see if they'd stretch a mile. Dimes were purchased by the station and Scotch-taped (3M furnished the tape) ten to the foot for 2000 feet. An all-day broadcast by 26-MHz fm short-wave from the F.D. Roosevelt National Historic site at Hyde Park invited listeners to buy pre-taped dimes and put them in the ribbon. Over 3000 listeners turned out, and over half a mile of dimes was collected for the March of Dimes.

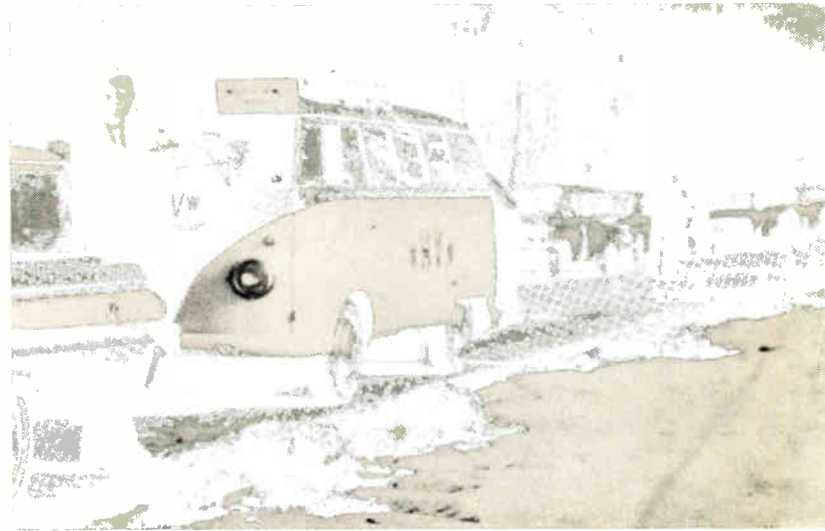

National Cable Push

Feb. 4-10, 1968 is the second annual National Cable TV Week. Sponsored by the National Cable Television Association, the week offers its members (and non-member CATV systems) an opportunity to participate in a highly professional and expensive advertising and public relations campaign to add new subscribers and spread good will among current ones. Last year, the NCTA got off to a little bit of a late start and was not surprised that the number of participating systems was not too large. But those who did participate were very pleased with the results. One system operator, as a result of the promotion from the Cable TV Week, increased his subscribers by 1090, better than a 10 percent gain.

This year NCTA has started work much earlier and the Association figures maximum impact will be reached in the third year when system operators too have learned to start early in the game. NCTA advises operators to begin working on the promotion the week of December 11th by familiarizing themselves with contents of the National Cable TV Week kit and planning all the things the system might do to observe the week in its community.

This year's kit put out by the Association included an instruction manual, giving all information needed on the best possible use of the promotion material, publicity kit, with news releases, proclamation to be issued by the town's mayor, feature stories, programs and photographs, and 60- and 30-second radio commercials. In addition, a new color film telling the CATV story, TV slides and scripts to make a complete TV commercial, full color information booklet that tells the benefits CATV can bring to the community and the customer, certificates of appreciation to be awarded to important people in the community who help make National TV Cable Week successful, display material, newspaper mats, and giveaway balloon and buttons can be ordered from NCTA.

A sample survey of operators by NCTA indicates that newspaper ads, dealer tie-ins, and radio ads are the most popular devices with cable systems this year.

THE TRANSIT STRIKE: WE HOPE FOR THE BEST, BUT WE'RE READY FOR THE WORST.

As all New Yorkers do, we hope the contract talks are successful before the strike deadline.

If they aren't, WCBS/NEWSRADIO 88 has made preparations to provide you with everything you'll need to know.

NEGOTIATIONS

We are already covering the transit talks round-the-clock, with reporters standing by at the Americana Hotel, City Hall, Gracie Mansion, and TWU headquarters. When news breaks, we'll be there.

TRAFFIC

Our two WCBS/NEWSRADIO 88 helicopters will be ranging over the entire metropolitan area. They will take off early and stay up as long as necessary to keep you posted on bottlenecks and tieups. We'll also cover all boroughs to provide you with constant updating as traffic conditions change.

OFFICIAL WORD

We'll have a direct line to Henry Barnes, New York's Traffic Commissioner. When he makes a statement you'll hear it immediately.

ALTERNATE ROUTES

As we see it, our job is to tell you how to get to work. So we'll give you alternate routes into the city—from New Jersey, Queens, Brooklyn, the Bronx, Staten Island, and Upper Manhattan.

COMMUTER SERVICES

Our traffic desk will be checking all railroads, bus lines and transit services to advise you on extra trains, schedules, station crowding, and everything else commuters should know. You'll also hear direct reports from our newsmen at Grand Central, Penn Station, the Port Authority, and major suburban railroad stations.

THE COVERAGE

All the people and facilities of WCBS/NEWSRADIO 88 will

center on the strike. This means the largest radio news staff in the tri-state area equipped with 3 mobile units, two helicopters, the latest, most sophisticated electronic equipment—and, we think, some of the fastest feet in the news business.

That's our plan: to give you the best coverage, should the worst occur.

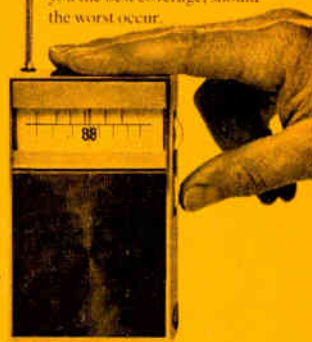

WCBS NEWSRADIO 88

CHANNEL 13 BRINGS YOU AN IMPORTANT MESSAGE. TODAY IT WILL LAST 8 HOURS.

Channel 13's live coverage of the 134th annual meeting of the American Association for the Advancement of Science continues today with these topics:



9:00 A. M.

"Research in Birth Control and Changing Sex Behavior"

12:00 NOON

Interviews with leading participants.

2:00 P. M.

"Speculations on the Next Thirty-Three Years"

Newspaper advertisements on these pages all appeared with "New York Times" on December 29, 1967. Which is more effective, the WCBS or WINS ad? Channel 13, as you may have guessed, is one of New York's noncommercial stations.

The score is kept directly on the P&L statement.

In an unserved or underserved (less than three stations) area, promotion for a cable operator is no problem. Customers beat a path to his doorstep. His main promotion may simply be to keep irate customers calmed when system trouble develops. But in adequately served TV areas, promotion is the number one task of a cable operator. He has to get customers and keep them. As a case in point, take Broadway Maintenance CATV Corp., Selden, Long Island. The general manager is Art Gusow. His title is director of marketing. His principle job before he got into CATV was promotion and that is what he was hired for now.

Gusow's problems are unique: 1. Selden is 45 miles from New York City and seven New York City stations come in adequately. Additionally Bridgeport and Hartford, from across Long Island Sound, can be received on a roto antenna. With a disc antenna, uhf stations channels 31 and 47 from New York can be received. 2. Selden is a modest income area. Residents are mostly home owners but they settled in this area because real estate was cheap. They are hard working families and not at all affluent with loads of leisure time for cultural pursuits or heavy community involvement. The \$5 monthly fee is dear money.

Because of these factors Gusow uses local closed circuit programs 4-½ hours a week, not for lofty community local expression, but hard promotion. He learned early cultural and education programs didn't score. So Gusow doesn't try to identify strongly with the community; rather he identifies with his customers and considers them members of his cable TV club. It is a club that customers join for fun, prizes, and even cash discounts—as well as better TV signals.

Because the community isn't high income, merchants, too, have to promote. Gusow signed up a select number who offer 5 percent discounts to cable subscribers. His directory of participating stores included about 25.

Gusow's monthly newspaper to his customers refers to the cable system as "your (the subscriber's) system." Viewers can participate in every one of the four shows shown on the closed circuit. The Tuesday night show (6:30 to 7:30) is a public interest show moderated by Gusow. The topic may be auto insurance. Subscribers can call in specific questions. On Wednesday night it's games and prizes. This time the cable system calls about a dozen subscribers (names drawn from a hat) and asks them questions. Prizes for right answers are donations from local merchants. On Thursday night, it's a home grown variety show emceed by a local entertainer, Sal Richard. Again viewers can call in personal requests. On Saturday morning it's entertain the kids with the *Beep the Clown Show*. Again more prizes and gifts. The studio for all shows is the office.

Every month sees a heavy promotion for new customers. Next month it's a free trip to Puerto Rico for one of the month's new subscribers. Last month it was a color TV set for one lucky

FRIDAY, DECEMBER 29, 1967

This New Year's you might really have a chance to walk it off.

WINS is bringing you blow-by-blow coverage of the transit negotiations. 24 hours a day, Doug Edelson, Mike Levine, Stan Scott and the WINS news team will be practically living with the union, the Transit Authority and the mediators. Right up to zero hour. Or, if there is a strike, till it's settled.



winner. The month before it was a free wristwatch to every new subscriber. And it's a free hookup every month!

Gusow budgets \$5 to get a new customer. If he can get 50 new customers in a month by simply offering a trip to Puerto Rico, that more than pays for the air tickets for the winner.

Walk into Broadway Maintenance's office and there is a promotion of some sort waiting for you. One is a free stay at a Florida motel if you pay a year's service charge (\$60) ahead of time. Or it may simply be jackets for school books. Gusow expects next to offer renting a color TV for a total monthly charge of cable and set for no more than buying a color set on the installment plan.

Does Broadway Maintenance keep its customers? Stu Helmig, system engineer, says his disconnects since regular cablecasting began last September are as fantastically few as one or two a month in the year and a half since the system started. 3000 subscribers have been signed up. The potential for the present 83-mile system is 7000. Next spring an additional 40 miles will be added in a nearby community. It will be interesting to see what new promotion stunts Gusow will come up with next year. In 1967, incidentally, his outstanding effort won him not only customers but an award at the 1967 NCTA convention. ●



Dr. Robert W. MacVittie, president of the State University College at Geneseo (l) with News Director Andersen Rapp during the Premier of "Appointment '67."

WGSU-FM College Station Extends Beyond The Campus

By Dr. Myron B. Shaw

WGSU-FM is the voice of the State University College at Geneseo (N.Y.), but it is more than that, it's a community station. In 1966 it was designated Station of the Year by "College Radio" magazine because of its community affairs programming

A NEWS DOCUMENTARY concerning a spectacular hotel-fire in Geneseo, a conversation with College President Dr. Robert W. MacVittie, a piano concert by Jeffrey Segal, play-by-play coverage of high school and college football, basketball and soccer games, an all-college discussion on drugs, a public hearing on urban renewal, the Paul Winter Jazz Ensemble, an address by Governor Nelson Rockefeller, thorough election coverage, College Band and Choral Concerts . . . these are the sounds which highlight the programming of WGSU, the voice of the State University College at Geneseo, New York. Since its opening broadcast on March 15, 1963, the station, which is under the administration of the Division of Speech, has endeavored to serve its campus and community audience with informational, instructional, cultural, and entertaining programming.

WGSU has a sizable and loyal audience as revealed by a personal interview survey, which included virtually every home in Geneseo, taken during the summer of 1967. Most popular programs are local issues, sports events (especially), church services, and guest artists and speakers on campus. Community affairs programs on urban renewal, public meetings of the school board, and annual election results are well received. WGSU will always focus on local issues and events but

Author Shaw is Associate Professor of Speech at State University College and Faculty Consultant for Programming. He has been staff announcer of several campus radio stations during his student years.

provides its listeners with programs as diverse as Bach and the Beach Boys.

The campus and community station, which broadcasts at 89.3 MHz with a power of 2 kW, was developed from a carrier current operation largely through the efforts of Dr. John E. Paul, director of the Division of Speech, Professor William R. Berry, director of broadcasting, and Fred Ambrose, chief engineer.

From its studios in Blake Hall and direct lines to six remote locations on campus and in the Geneseo Central School, WGSU originates more than eighty hours of programming per week, including sixteen hours on Saturday and twelve hours on Sunday.

This extensive service is provided by a very enthusiastic and capable staff which includes approximately thirty-five students and five faculty members: Professor Berry and Mr. Ambrose, station manager-program director, John Davlin, Dr. Myron Shaw and Professor Robert Greene, consultants for programming and management, respectively. The student staff includes those enrolled in the broadcasting curricula on both the undergraduate levels as well as numerous students who are majoring in speech, history, political science, education, English and library science.

Typical Schedule

WGSU begins its weekly schedule with the *Good Morning Show*, a program of popular music, news, weather reports, features and frequent time checks. This is followed at mid-morning with the *Empire State Fm School of the Air*. Broadcast for 30 minutes at 10:00 A.M. and 1:30 P.M., these daily programs provide direct in-school instruction for elementary school students throughout New York State.

Highlighting the late afternoon programming is *Accent on Music*, ninety minutes of popular music and features. *Perspective*, a full hour of news, commentary, weather and sports, follows at 5:30. This program features background on the

news. Station Manager Davlin and News Director Andersen Rapp, a graduate student, stress the importance of providing the listener with a thorough treatment and accurate perspective on local, state, national and international issues and events of consequence.

The station also produces documentaries which usually focus on local issues and have concerned Geneseo's need for an additional doctor, the fire which destroyed the Geneseo Hotel and threatened an entire block of the business district, the 175th Anniversary of Geneseo, Homecoming, election campaigns, and the life and works of Carl Sandburg.

Among the most popular of WGSU's wide variety of music programs is *Candlelight Concert*, an hour of instrumental dinner music which is presented each weekday evening at 6:30. Other music series which attract considerable interest include *Classics in Hi-Fi*, a late evening program of classical music, *Sunday Concert*, a program of classical music which covers the development of music chronologically from 1700 to the present, *After Hours*, a fully scripted two-hour potpourri of music presented each Friday night at 11:00, *Hymns of Faith*, *Broadway By Night*, *Broadway Showcase*, *Just Jazz*, and *New Folks in Town*, which features folk and jazz. Music is also an integral part of *CBC Presents*, produced by the Canadian Broadcasting Corporation, and is also featured occasionally on *WGSU Presents*, which focuses on local issues and events such as the appearance of concert artists on campus. A broad diversity of music programs are also presented on Saturday and Sunday including rock 'n' roll, popular, Broadway, light classics, classics, and on Sunday evenings, full-length operas.

Another feature of Sunday's programming is *Appointment '68*, a three-hour program devoted to live interviews with campus guests, faculty members, students, and community residents, on *Counterpoint* at 1:15, 2:15, and 3:15; news commentary on *Viewpoint*, man-on-the-street interviews on *Pinpoint*, satirical sketches concerning today's soap operas on *Weakpoint*, news and music.

A highlight of Saturday's schedule is *Countdown*, a showcase of the top 40 hits of the week as determined by a survey of interest in the various dormitories on the Geneseo campus. The songs are presented from number 40 through the most popular song of the week from noon until 2:00 each Saturday afternoon. Rock 'n' roll music is also prominent in Saturday's programming as are news, weather and sports reporting, including live remotes.

Sports Via Delayed Tape

WGSU maintains its emphasis on sports programming, which has evoked considerable audience response. Since its inception, the station has broadcast the home basketball games of the Geneseo State Blue Knights. In September 1966, WGSU began play-by-play coverage of the Geneseo

High School home football games and two road games at Dansville and York. Last fall, the radio station broadcast the Geneseo home football games, as well as those at Caledonia-Mumford, Mt. Morris and Cowanesque, Pennsylvania, live, and aired the game at Livonia on a tape delay basis by "bicycling" the tapes back to Geneseo immediately following the first half and the conclusion of the game. WGSU also carries the home basketball games of the Geneseo Central Blue Devils. These broadcasts serve a particular community need due to the very limited seating capacity in the Central School gym. Last fall, the station initiated play-by-play coverage of the two college soccer games which were played in Geneseo on Saturday. Since there are no telephone lines available at the field, it was necessary to utilize battery-operated tape recorders and bicycle the tapes to the control room at the half following the game. Thus, listeners could "join the game" an hour after the kickoff. It is hoped that this service to the campus and community will stimulate additional interest in collegiate soccer.

Sports reports with particular emphasis on local and area events including interviews with area coaches, are featured daily on *Perspective*, while *Meet the Knights*, presented each Friday evening at 7:30, focuses on athletes and coaches at the College.

Another program series of local interest is *The Church Hour*, a worship service recorded each Sunday morning in a Geneseo church and broadcast Monday evenings at 9:00 following an hour of uninterrupted sacred music on *Hymns of Faith*. The broadcasts are rotated each week among the four participating churches. During the months with five Sundays, an area church service is broadcast or a distinguished guest clergyman on campus, or in the community, or a special program of sacred music is presented.

With this programming, WGSU strives to provide its listeners with information, instruction, cultural stimulation and enrichment, and entertainment of value. ●

Station Manager-Program Director John Davlin, (l) discusses WGSU program guide with Dale Hartnett and Chuck Agonito.



CONVENTION LOG

NAEB Exhibition Scores Several Firsts

Traffic was heavy in the NAEB exhibit area last November for good reason. Technology's latest wonders were there. Several new products were premiered.

Counterclockwise: Ampex used an attractive artist with palette to demonstrate color. Visual (Norelco) and GE successfully blended models and education to draw attention to their studio equipment. RCA played it straight with an honest to goodness teacher. Sarkes Tarzian focused only on its abstract model, *The Fugue*.

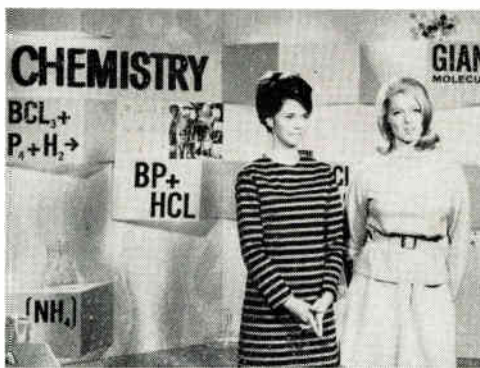
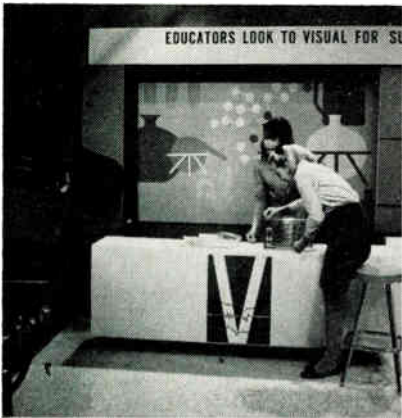
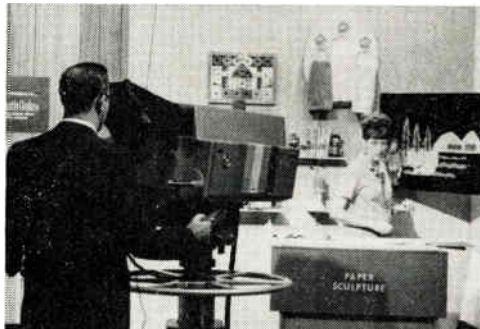

FCC Chairman Rosel H. Hyde, and FCC Educational Broadcasting Branch Chief, Dr. Robert Hilliard, watch the Norelco man-pack color camera pan a pretty conventioneer.



From the exhibitor's point of view NAEB was a not-so-mini mini NAB or, as George Tillman of GE put it, "welcome to NAB-II."

NAB-II had a number of first time showings—normally all important products are unwrapped at NAB-I. Among those that caught attention were these.

- A man-pack broadcast-quality color camera from Norelco.

- A new helical-scan color VTR and color camera system from International Video Corp.

- Three new helical-scan VTRs with color adapters from Diamond Power.

- A new low-cost quad head color VTR from RCA and two new high-band units from Ampex.

- A new video switcher including a 108-point crossbar assembly and video processor from Vital Industries.

- A new color film chain, PE-240, from GE (not brand new, but a first showing).

- A new solid-state monitor from Conrac.

- A new 11.1 TV zoom lens from 3M (Wollensak).

- A new video display to film transfer machine from Milliken Camera.

- A new 2500-MHz transmitter with color capability from Jerrold and modular head ends.

There were also a host of new vidicon cameras and video processing units which we didn't count. Raytheon and GPL had cameras, Cohu, Grass Valley, and Riker had new pieces of video processing equipment.

The major camera equipment manufacturers, as at NAB, vied with each other for most favorable attention. RCA had the biggest exhibit space and the widest product line since it showed both broadcast and CCTV equipment. Norelco (Philips Broadcast) assured itself of maximum attention by introducing its hand held color camera (See *BM/E* Dec. p. 6). Visual and Philips were quick to point out that the color videotapes being shown at competitors booths were made on PC-70 cameras. General Electric claimed its color reproduction was the best at the show. Ampex had the prettiest girl. (*BM/E* opinion. The monitor pictures were beautiful and could have been off several hues without our noticing.)

Sarkes Tarzian gave up girls for the modern piece of sculpture, *The Fugue*. It made an impact but not the same kind.

Probably the exhibit that made the greatest impact was Interna-

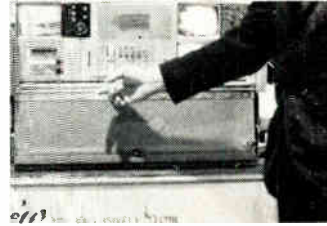

Clockwise: Audio Video Industries, RCA, Continuous Progress for Education, and Video Systems, Inc. were among those showing compact camera control and switching unit.

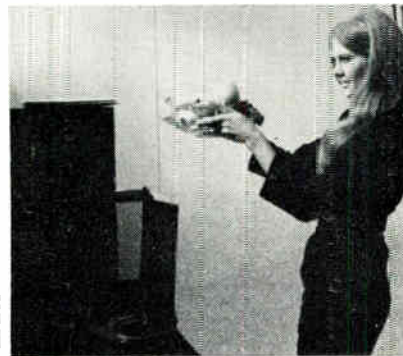

Clockwise: RCA TR-50 is high band unit for \$54,500. Diamond Power DP-3 (\$8500) handles NTSC color with adapter. International Video Corp. stopped traffic with color fidelity of its \$15,000 camera and VTR combo.

tional Video Corp.'s. For under \$15,000 one could get a color camera (\$9850) and a color videotape recorder (\$4200) both meeting NTSC standards. Chroma and hue stability appeared good and the booth had sex appeal. (It's on this score only that IVC faulted—other exhibitors made sure their comely girls were groomed to look like they *could* have been school teachers. IVC models could only have taught fire making.)

New VTRs, color and black, and, white, helical scan and quad head, were featured in many exhibits. Ampex introduced two new high-band VTRs: the VR 2000B, \$66,500 base price, and the VR 1200B, starting at \$46,500. (The VR 1200B specs approach those of the VR 2000B.) RCA announced a high band TR-50 model priced at \$54,500 (one third less than the TR-70.) The fully transistorized RCA VTR measured only 33 inches wide and 24 inches deep.

Diamond Power showed helical scan units priced at \$1000, \$4000 and \$8500. These new units of Nippon Victor manufacture were demonstrated with color adapters. The DP 1 uses 1/2-in. tape. The DP 2 and the DP 3 use 1-in. tapes. The DP 3 unit has an internal editing unit. Both 1-in. models have 350-line resolution and the DP 3 meets FCC broadcast standards for stability. Sony demonstrated its hand held portable VTR (1/2-in., 20-min.) and hand held vidicon camera.

Vital Industries displayed, with great pride evidenced, its first television production switches for professional broadcast quality work. The switch contains some outstanding features designed, President Nubar Donoyan said, to uphold the high image Vital Industries achieved in the video processing amplifier field. In only a 5 1/4-inch rack space Vital has packaged a complete 18-input-by-6-output matrix. The 108-crosspoint unit, complete with 108 logic control points (using integrated circuits, input amplifier for video amplitude and dc level control, pulse release amplifiers for each matrix, output amplifiers, vertical pulse former (for switching in vertical blanking interval) and power supply regulator takes up only one rack, 5 1/4 inches in height.

Film equipment was in evidence at many exhibits. For GE's PE-240 film chain system (broadcast quality), this was a first public showing. Many showed inexpensive 16mm film chains—Cohu, Pack-

Vital Industries unveiled its new flexible vertical interval production switcher and compact solid-state 18 x 6 matrix.

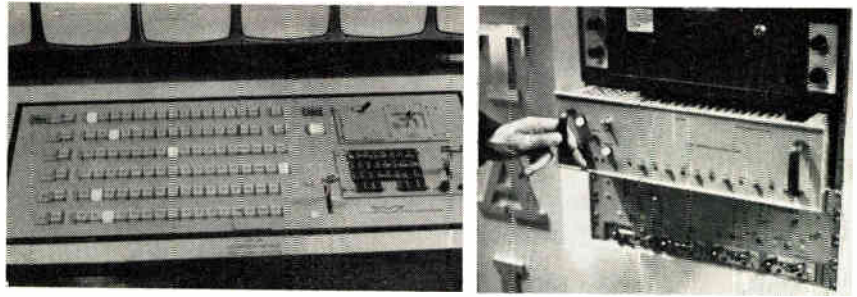

Ball Brothers' magician drew crowds and attention to its video products.

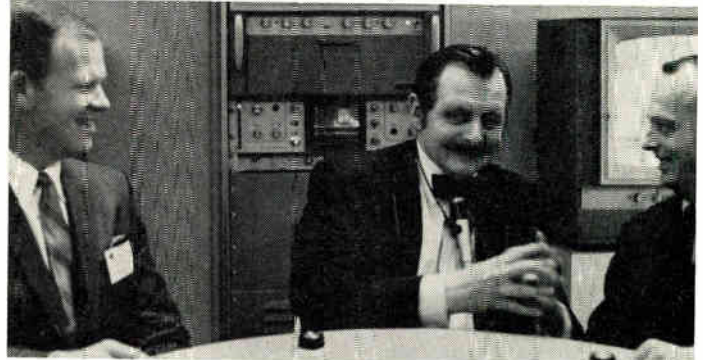

Products primarily for education on display included an electronic x-y cursor to pinpoint an area of interest by Raytheon. A camera peering into a microscope (GPL) CRT projection system by Kalart.

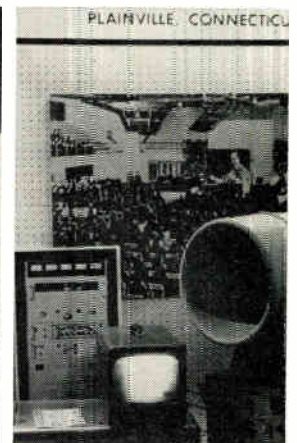
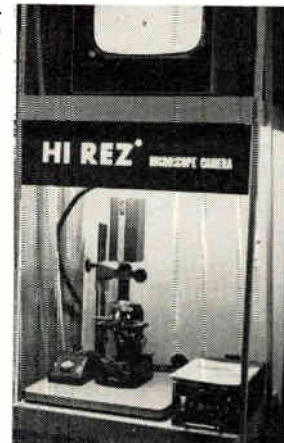
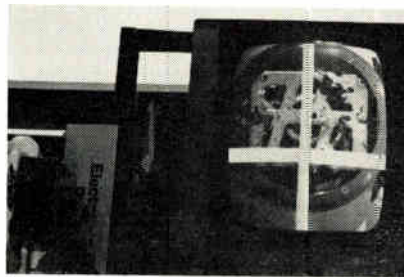

Left to right: Slide and film projection equipment was prominent. GE displayed its new PE-240 color film chain system. Cohu and Packard Bell showed 16mm film chain gear. Spindler and Sauppe Inc. had a dual slide system on display. In the strictly film area, Kodak showed 8mm projectors with magnetic sound capability.

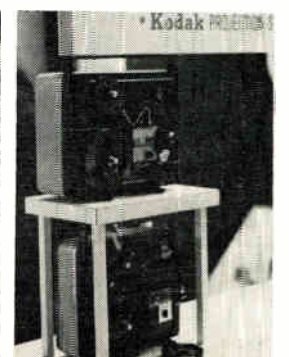
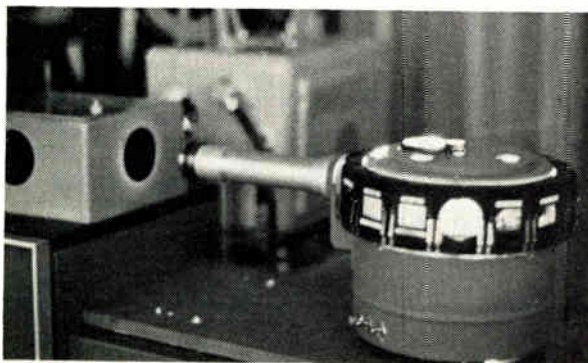
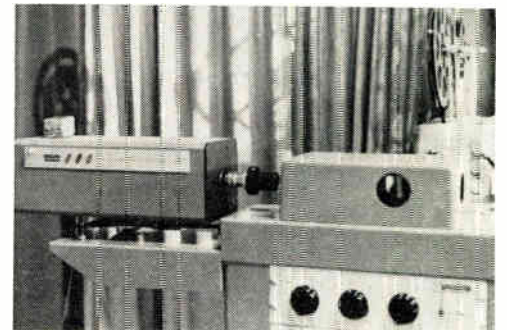

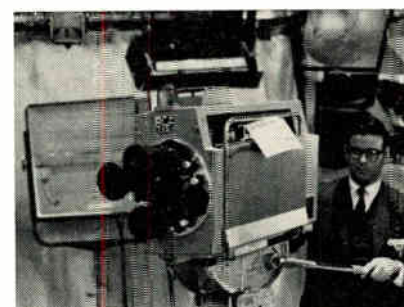
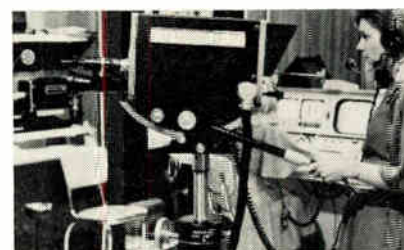
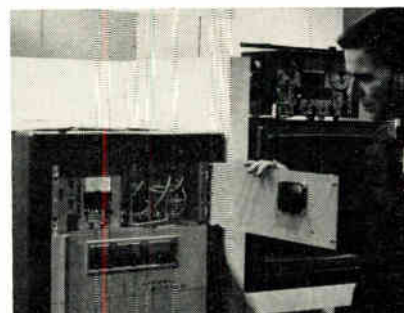
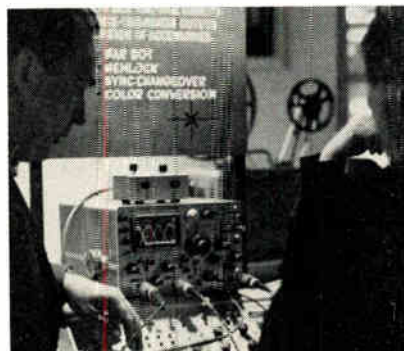
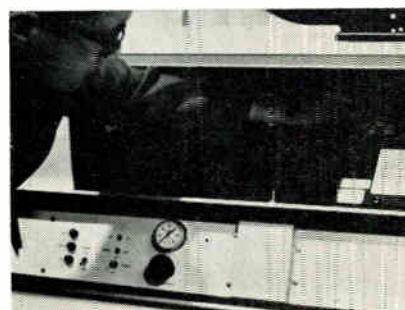
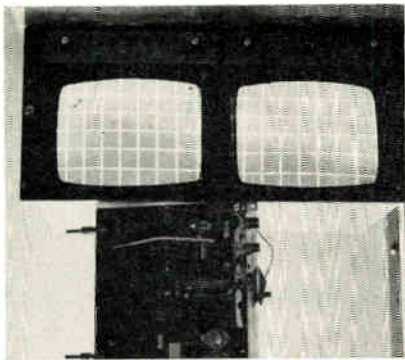

Left (Top to Bottom):

Conrac premiered the Conrac II solid state monitor. A pair fits in a 19-inch width. Sony was promising delivery of a new handheld vidicon camera and 1/2-inch VTR toted by a shoulder strap. Video to 16mm film camera without a shutter bar was the feature of a new kinescope recording camera by D.B. Milliken Co. Mini-skirted Dynair booth attendant accented this company's miniature solid-state CCTV components. Emcor modulator enclosure systems can be color coordinated as color swatches show.

Right (Top to Bottom)

3M showed a new \$875 11:1 f2.2 TV zoom lens by Wollensak. TeleMation demonstrated features of its stable sync generator. A solid-state modular 2500-MHz transmitter capable of color transmission was shown by Jerrold. Simplicity of CCTV operation was underscored by Sylvania's all girl studio crew. Lighting of all types was exhibited by Colortran.

ard Bell and RCA. RCA's PFS-16 is a \$5490 system designed for broadcast or CCTV uses. A new color slide system was introduced by Spindler and Sauppe Inc. Color slides could be multiplexed or uniplexed with the dual system. D.B. Milliken showed a new 16mm video film recording system that included a camera without a shutter bar. Milliken claimed its compressed air transport could pull down and stabilize film in less time than a TV vertical blanking period.

Conrac chose the NAEB convention to show the Conrac II, a solid-state \$225 unit claiming 600-line-center and 400-line-corner resolution. A pair could fit a standard 19-in.-wide rack. Bandwidth is 7 MHz and high voltage power supply is completely encapsulated.

3M's Wollensak 11:1 f 2.2 TV zoom lens was a hit since the price was right for budget minded educators: \$875 manual, \$1775 motorized.

Jerrold showed solid-state modular vhf head ends for multichannel MATV use. Modules for each channel can be plugged in as needed. The channel amplifiers are completely interchangeable providing a system that is highly reliable.

Simple camera control units for desk top or mobile dolly use were shown by Audio Video Industries, Continuous Progress for Education, RCA and Video Systems Inc.

Sylvania demonstrated the ease with which teachers could use its CCTV system by recruiting an all girl crew that immediately turned out quality pictures. Among the specialized products for educational use was an electronic pointer by Raytheon. It consisted of a joystick that could put cross hairs over the area of interest on a tube display.

Harvey's is selling stuff you may not know exists.

There's an information gap in the broadcast and recording fields today. Sometimes we find ourselves distributing an exciting new product that many professionals don't even know exists.

For example, did you know that there's a new boom headset with built-in microphone that's so light you can actually forget you're wearing it? It can pick up two different signals at once. It's interchangeable with any standard boom headset. And if you want one now, Harvey's is the only place you can get it.

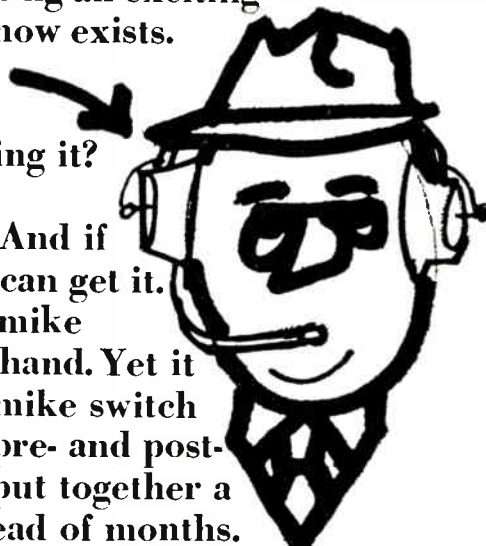

Also, there's now a complete console mike channel so small, you can hold it in your hand. Yet it includes a fader, program equalizer, line-mike switch with input pad, reverb-send channel and pre- and post-echo switch. With a few of them you can put together a complete console in a couple of days instead of months. It's revolutionary—yet, just about the only people who know of it are Harvey customers. Because just about the only place you can get it is Harvey's.



There's much more that's new. We have several new low-cost microphones that sound just as good as the most expensive mikes of a few years ago.

And so on. And so on.

Harvey's is in the habit of finding new equipment and distributing it before anyone else does. Often before anyone else knows about it, in fact. That's why almost every major sound studio and radio station already deals with Harvey's.

Help us close the information gap in the broadcast and recording fields. Call or write Harvey's regularly.

Open an account, if you want, and we'll start sending you our newsletter.

You don't necessarily have to buy anything. We'll just feel a lot better if you, at least, know what exists.

Harvey Radio Co., Inc.

Professional A/V Division, 2 West 45th St., New York, N.Y. 10036 (212) JU 2-1500

By William H. Honan

RADIO STATION WEVD in New York City is looking for a Chinese disk jockey. Applicants should be acquainted with such personalities as Poon Sow Keng (the hottest rock 'n' roll singer today in Hong Kong), be able to report the time, news and temperature in easy-going Cantonese, and quote Confucius in the original. The resulting program may be of limited appeal—beneath the notice, one might guess, of a mass-media adman worth his double martini—and yet, it is chiefly this sort of specialization, or “fractionalization of the market,” as they say in the trade, that accounts for the remarkable sonic boom reverberating from radio these days.

Right now, for example, there are more radios in the United States than people—262,700,000 at the last count. Forty-seven million sets were sold last year alone. Such profusion cannot be attributed merely to teenagers buying transistor radios with which they annoy their parents—although that is a not inconsiderable factor. But parents are buying radios like hot cakes, too. They get them nowadays built into their tractors, hair-dryers, Scotch bottles and even sunglasses. And

All-News All-Music All-Ghetto Radio is a Success*

*Condensed with permission from “The New Sound of Radio,” *New York Times Magazine*, December 3, 1967.

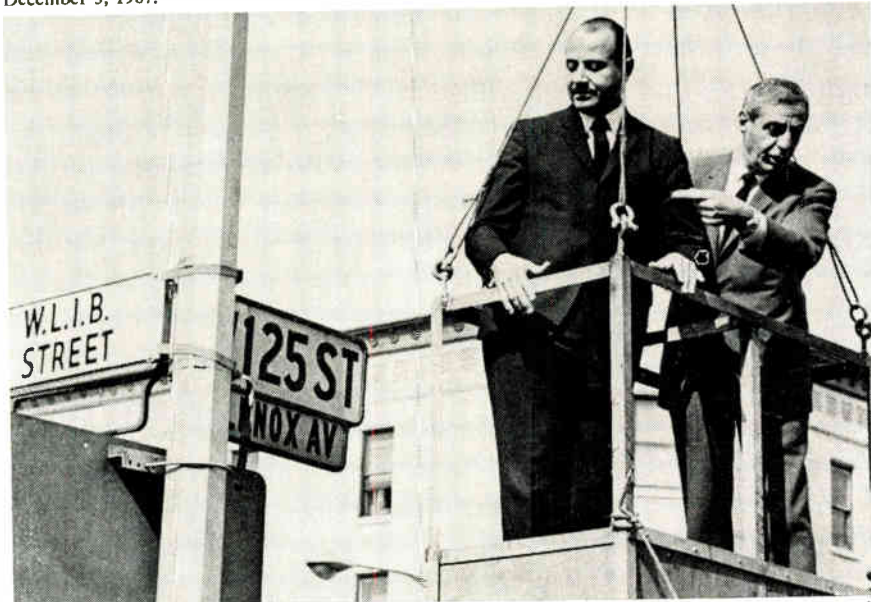

Ethnic Broadcasting—Otherwise, and commonly, known as “ghetto radio,” it is an increasingly important specialization. Here, Manhattan Borough President Percy Sutton (left) officiates at the honorary re-naming of Lenox Ave. as WLIB Street, in honor of that station becoming the first Negro operation ever to win the prestigious Peabody Award. WLIB General Manager Harry Novik points with pride.

the knobs on all these instruments are being clicked and twirled with astonishing frequency.

In fact—and this may be enough to make even Marshall McLuhan gulp with wonder—a recent Trendex survey conducted for the National Broadcasting Company found that more Americans now listen to radio in the course of an average week than watch TV. The audience for individual radio programs, of course, cannot compare with that of the most popular TV shows, but on a cumulative basis the figures indicate that 90.5 percent of the adult population tunes in a radio sometime during the week as compared with 87 percent who flick on television.

The robustness of radio is also illustrated by the fact that the giant advertisers, most notably such bellwethers as the soap and automotive companies which shifted from radio to TV in the early nineteen-fifties, have once again become substantial radio time buyers. Colgate-Palmolive, for example, which was not even listed among the top 100 radio spot advertisers as recently as 1964 was 23d on the list last year. Ford, General Motors and Chrysler were first, second and third, respectively, with a total expenditure last year of \$56-million—up 17 percent over the previous year and up 56 percent over that of the year before.

The explanation for this renaissance of a medium which many condemned to a lingering death as recently as 10 years ago lies, to a great degree, with that sought-after Chinese disk jockey. For, once radio broadcasters began to face up to the fact that television had permanently taken their place as dispenser of general entertainment

for the masses, they began experimenting with new formats and discovered that, collectively, they could recapture their old audience piecemeal by directing strong appeals to specific fractions of the population.

This discovery led to the development of all manner of limited-appeal programs, and the advancing trend is now doing away with even these one-hour or half-hour shows, since the stations themselves are beginning to take on the characteristics of a single, 24-hour program, narrowly addressed to a distinct slice of the population. Such broadcast parochialism is now revolutionizing the industry, with several stations almost every month dropping their old-style eclectic programming in preference for the new "continuous format."

Competition in a city like New York, where no fewer than 63 different a-m and fm stations vie for attention, has naturally pushed specialization to an extreme, and some of the more popular formats appear to have been divided, subdivided and virtually pulled apart with tweezers in order that each station may find a niche (and presumably a distinct audience) it can call its own.

For example, WMCA, WABC, WJRZ and WOR-FM are all what the casual listener might consider standard rock 'n' roll stations, but connoisseurs are aware that WMCA tries to add a local home-town flavor by using such disk jockeys as Joe O'Brien, who has a Yonkers accent; WABC seeks to impart an all-American tone to the proceedings with disk jockeys like Herb Oscar Anderson, who is from Minnesota and full of corn and good cheer; WJRZ restricts itself exclusively to that close relative of rock 'n' roll known as country-Western music, and WOR-FM lays stress on the subdivision known as folk rock, which may include such controversial ballads (which the other stations would never touch) as Phil Ochs's *I Ain't Marchin' Anymore* and Country Joe and the Fish's prickly L.B.J. put-on, *Super Bird*.

Even in lesser cities than New York, however, format specialization has proceeded to a surprising degree. There are as many as 1500 radio stations across the nation substantially if not exclusively devoted to country-Western music, according to the Country Music Association. And the all-talk or telephone-participation format is not only popular in New York City where NBC's Brad Crandall and the insomniac Long John Nebel have large followings, but Philadelphians like to hear themselves gabbing over the telephone with Jack McKinney over WCAU, and nearly everybody in Salina, Kan. (pop. 43,202), listens at one time or another to Mike Cooper on KLSI to catch the latest chatter about the local school merger and to hear Cooper adding his laconic "uh-huh" to a phoned-in beef about how all the rain in June loused up the local wheat crop.

Typical of the trend is a middle-sized city like Peoria, Ill., which now has as many as six radio stations, each with its own distinctive format. WIRL, Peoria's leading outlet, is a "top-40" or predominantly rock 'n' roll station. WXCL, the lo-

cal NBC affiliate, is devoted to country-Western music. WMBD, the CBS affiliate, is strong on conversation and plays "middle-of-the-road" music (Frank Sinatra, Peggy Lee, Vic Damone). WMBD-FM specializes in "potted-palm" fare (schmaltzy renditions of the Warsaw Concerto, and the themes from "Intermezzo" and "Gone With the Wind").

WIVC-FM has female disk jockeys—or "program hostesses," as they are known in Peoria—and plays "adult" pop, jazz and classical music. Finally, WPEO, the Mutual affiliate, having recently tried and then dropped "top-40" and "middle-of-the-road" formats, became a virtually "all-talk" station in January of this year and then in September raided wxcl's country-Western disk jockey—Cal Shrum, an old Gene Autry sidekick—and is now trying to blend the recorded yodelings of assorted farmhands-turned-vocalists with its decidedly right-leaning cast of talkers, whose ranks include Fulton Lewis 3d, the Rev. Carl McIntire and the suave pitchmen of H.L. Hunt's *Life Lines*.

So far has format specialization progressed among radio stations throughout the United States today that local affiliates of the national networks have been ignoring network programming in preference for their own locally originated material. In response to this trend, the ABC radio network has recently announced that it plans to split up its piped fare into four separate subnetworks, each of which will cater to stations with distinctly different formats. There will be one subnetwork for stations with an all-talk or music-and-news format, another for "top-40" stations, one for those with more sophisticated fm formats and another for stations still using the old-style eclectic format. ABC's hope is that its subnetworks will be more congenial to highly specialized stations and will, in addition, make possible more than one ABC affiliate in a given community.

The basic reason for the comeback of radio is that people are listening to the radio again because it is offering them something they want to hear and cannot find elsewhere.

Of New York City's bewildering array of radio stations, three picked more or less at random—WINS, WHOM and WBAI-FM—illustrate the latest types of specialization and to whom these new formats appeal.

In April 1965 WINS, a Westinghouse station, dramatically gave away its rock 'n' roll record library to Fordham University, kissed its disk jockeys good-bye, hired 27 radio newsmen and began broadcasting news for 24 hours a day. Skeptics had said that the WINS anchor men would grow hoarse by early afternoon of the first day, and that if no worse disaster overtook the station, the babbling brook of news would simply run dry, and, on the first really slow day, WINS would be begging to get its records back from Fordham.

Neither of these eventually came to pass. WINS provided enough anchor men so they could spell one another in half-hour shifts. And far from

running out of news, a veritable geyser of gab was churned up by the station's 21 "airmen" covering New York City, by the squad of rewrite men who had access to all the major wire services and by correspondents of the Westinghouse communications network who were sending in "voice cuts" from such far-flung places as Madrid and Saigon.

As time went by, the WINS team of broadcasters developed an original and often rather exciting manner of news presentation, in which the process of news gathering is exposed to the listener in an unfolding drama. In a major news break, for example, the presentation begins with a high-pitched BEEP-BEEP-BEEP-BEEP which, according to high Westinghouse policy, may even interrupt a commercial (but never has). The beeping fades and the voice of the anchor man rises over it with: "Late word has just been received at the WINS newsroom that President Johnson and Premier Kosygin will meet tomorrow in the college town of Glassboro, N.J. Stay tuned for further details as they are received in the WINS newsroom."

Whatever was cut into is then resumed, but pretty soon "Jim McGiffert at the editor's desk," who has been madly pawing through a stack of reference books dumped in front of him, whisks the anchor man a "sidebar" about Glassboro—where it is, its population, principal industry, etc. The next morning, Sid Davis tells about the President's helicopter chugging up off the White House lawn; there is a quick switch to Doug Edelson at the Soviet Mission in New York describing the departure of Kosygin's limousine; then reports from Rod MacLeish, Paul Parker and Jim Gordon in Glassboro shouldering their way through the crowds and finally telling of the arrival of the dignitaries the moment they appear.

The all-news format for radio was originated not by WINS but by Gordon B. McLendon, the flamboyant Texas promoter who was also one of the first to use the "top-40" or "rock-around-the-clock" format. McLendon's station XTRA in Tijuana, Mexico, which broadcasts to Southern California, in 1961 became the first to go on an all-news bender, and was followed three years later by another McLendon property, WNUS in Chicago. (Philadelphia, Washington, Denver and St. Louis now have all-news stations, too).

The WINS format, says General Manager Charles F. Payne, is to "cycle the headlines every 15 minutes, do a time check every 5, weather every 7 and so forth, so when you tune in you're never far away from the bulletins. But in between we have special in-depth reports, a shopping feature, theater reviews, even editorials and sometimes a feature that continues in sections all day long—we call it a 'blitz'—on topics like the poor of New York, the overcrowded air corridors or the coming Broadway season. Furthermore, even the news bulletins are not 'monotonous.' They're changing all the time. Someone once said we're like a newspaper with 48 separate editions every day."

"The key to our format," Payne goes on, "is

being informally informative. What we try to avoid is the old H. V. Kaltenborn pompousness. We want to create the image of the working newsman, the guy who's on the scene."

Although the sound of news would seem to have a universal appeal, WINS's most faithful listeners, according to a recent Politz survey, tend to be those New Yorkers with high incomes, college educations and relatively high-status jobs. Most listeners are between the ages of 25 and 64, teenagers and senior citizens being conspicuously absent. When WINS first shifted to the all-news format, its audience, which had been accustomed to rock 'n' roll, fell off sharply. According to the latest surveys, however, the station has now more than doubled the size of its former audience—a success story which must have been read with interest across town at WCBS, which switched in August to an all-news format, too.

Another increasingly important specialization in contemporary radio is known as ethnic broadcasting, or, less euphemistically, as ghetto radio. There are now, for example, no fewer than three Negro stations broadcasting in New York City. WWRL, by far the most popular of these, anticipates that its annual revenue from advertising will rise above the \$2-million mark this year, having practically quadrupled over the last four years.

WEVD, the formerly all-Yiddish station which now broadcasts in 13 different tongues, including Japanese and Norwegian, say thou 1966 was "the best year ever" in its 40-year history. And *The Wall Street Journal* recently reported that because Pepsi-Cola was the first soft drink to advertise intensively on the local Spanish stations, Pepsi now outsells Coca-Cola two-to-one among New York's 1.5-million Spanish-speaking residents—a state of affairs that Coca-Cola is now trying to rectify by plugging away over "the Spanish Main," as the three stations between 1280 and 1480 kHz are known, with the jingle "*Todo va mejor con Coke*" ("Things go better with Coke").

Typical of the sound and format of ethnic broadcasting is that of WHOM, New York's foremost Spanish station, which is hot-bloodedly Latin. "Language is our most important product," explains Ralph Costantino, WHOM's affable program director, who is himself of Italian extraction but survived the station's changeover in 1957 from Italian to Spanish by virtue of his fluent Spanish. The dialect spoken over WHOM, he says, is Caribbean Spanish, interspersed with plenty of *ay benditos* and *Ave Marias!*, which are characteristic of the Puerto Rican and Cuban idiom one hears on East 125th Street.

So important is the sound of the Spanish language to the station's identity, in Costantino's opinion, that he has a rule of long standing that popular music, which constitutes from 65 percent to 75 percent of the station's programming, must be vocal rather than instrumental. Moreover, with the current unusual exception of The Monkees and The Turtles, vocalists who sing in English are strictly *prohibido*. WHOM even snubbed Frank Sinatra's last big hit, "Strangers in the Night," and

played instead Andy Russell's Spanish rendition "*Estraños en la Noche*," which had more tropical zing.

Baseball games and soap operas—the latter still a great favorite with Spanish-speaking audiences—round out WHOM's regular fare, and they, too, are as popular as they are tempestuous. One of the most avidly followed "soaps" carried on WHOM is called *Collar de Lagrimas* ("Necklace of Tears"), and seems to consist chiefly of organ music and the sound of a woman sobbing, punctuated now and then by gunfire and commercials. (It also has an enormous audience in Cuba, and Fidel Castro will not permit Havana stations to broadcast it while he is making a speech.). The soaps are gradually giving way on WHOM, however, to the jiving sound of the *boogaloo* and *la nueva ola* (rock 'n' roll with a Latin beat), since the younger generation, according to the surveys, is now the dominant group in Spanish Harlem and it would rather twist and wriggle than sniffle and sigh.

So firm is the grip of the ethnic stations on their audiences that a recent Pulse survey shows the Spanish-speaking population, for example, listening to radio for an average of four hours a day, which is almost twice as much time as other Americans devote to the medium. This audience, according to surveys, is profoundly influenced by what it hears, whether commercials, news or comment.

It is particularly regrettable, then, that WHOM has an intellectual content of zero, and offers little that might be considered of genuine public service. (A notable exception among ethnic broadcasters is WLIB, the Harlem Negro station that last year won a Peabody Award—the highest honor in broadcasting—for a telephone-participation program that was believed to have served as a sort of social safety valve by permitting the frank airing of Negro grievances.) The rationale for the low level of programming by WHOM, according to Costantino, is that "most Puerto Ricans who have intellectual capacity are bilingual and thus get their stimulation from English-language sources" (which is a dodge), and that the station did in fact "give free air time to Spanish-speaking deputies of Mayor Lindsay and Cardinal Spellman to appeal for restraint during the summer rioting" (which is true enough, but surely the minimum in terms of social responsibility). A strong case can be made that ethnic radio stations like WHOM, which exploit commercially the linguistic handicap of their listeners, actually serve to perpetuate that handicap, and therefore ought to be charged with providing special counterbalancing educational services.

Noncommercial Change Too

Another highly specialized area of radio broadcasting is occupied by the 350-odd licensed noncommercial stations in the United States which are affiliated with schools, churches, municipalities and foundations. A good many of these have

undergone as much format refinement as any all-news or rock-around-the-clock station on the dial.

Among them is Pacifica Foundation's listener-sponsored WBAI-FM, which is the left-leaning "free-speech" station that was put off the air for 52 hours in September when its transmitter was wrecked by vandalism. An articulate spokesman for WBAI is Larry Josephson, the hip disk jockey. Josephson, a rather corpulent, bearded, 28-year-old computer-programmer by day, has for the last year and a half been conducting a far-out breakfast club for the station, irreverently called *In the Beginning*, which is—in marked contrast to the usual fare at that hour—refreshingly grumpy, lusty and alienated.

Noncommercial stations have specialized just as have the commercial broadcasters, Josephson believes, not only because of the pressures of competition, which naturally affect them less, but in response to "the great diversity of life styles today." Back in the thirties, he says, cultural unity gave rise to relatively undiversified styles in the communication media. But today, in an era of cultural splintering, a great many people find themselves "disfranchised by the mass media" and they begin to seek new styles of experience elsewhere.

WBAI is attractive to at least some of these seekers—no one knows how many since its call letters have never appeared in a general audience survey—because it offers, according to Josephson, programs attuned to the new life styles, programs which are, in his words, "no longer sequential, but random, associative and parallel." Josephson cites as an example of such programming the breakfast club he convenes every weekday morning at 7 A.M. or whenever he gets around to arriving at the station (he is frequently late and sometimes never shows at all), and on which he is likely to say anything that pops into his head—it may be fairly salacious or he may just indulge in a long spate of moaning and groaning.

Josephson points with admiration to his WBAI colleague, Bob Fass, the station's after-midnight disk jockey, who has lately been achieving remarkable effects by playing two records simultaneously—for example, pairing speeches by Timothy Leary and Lyndon B. Johnson about their respective visions; playing the voices of soldiers in a United States Army basic-training course along with a dog-training record, and so forth. Similar effects, Josephson says, were to be found in the dramatization of Christopher Morley's "The Trojan Horse," which juxtaposed cynicism and romanticism, and which the station broadcast, under the direction of Baird Searles, in a four-and-a-half-hour spree on Oct. 8 and 9.

WBAI, like its commercial counterparts, Josephson says, has its very own sound. "Some people say it is the sound of boredom," he begins, adding: "To some extent that's true. Some say it's aggression—a kind of postured hipness. That's true, too. Some say it's amateurishness. Some call it humaneness, or love, or naturalness. It's all of that. Naturalness, especially. For example, when

we're running behind time, we say so. When we make a mistake, we admit it. We don't try to come up with our radio-broadcast *persona grata* intact. When we read news, we try to read it like human beings. I hate WINS. They read everything in the same excited monotone. It isn't human."

A few weeks ago, Josephson took over WBAI's regular book-review program for half an hour, and what he said as well as the manner in which his material was presented pretty well illustrates the WBAI "sound" he was trying to describe.

The announcer, who introduced the program as *Books to Buy, Borrow or Burn*, tripped over a word, and neglected to say who the reviewer was going to be or to give the titles of the books to be discussed. The next voice was that of a newscaster announcing the beginning of World War II on a scratchy old record.

When it was finished, an obviously "live" voice came on the air and explained that the recording was from a broadcast by Edward R. Murrow from London. The live voice went on to say in a very intimate and unradiolike tone that Murrow was "the best broadcaster ever produced by this country." Murrow had also been an intelligent and effective foe of McCarthy, the voice said, but he should not be mistaken for a true liberal because he had condoned execution of the Rosenbergs.

In any case, the voice continued, Murrow was great because he came through on the human level and he made you stop and think. A collection of Murrow's broadcasts, the voice added, had been published by Alfred A. Knopf Inc., in a book called "In Search of Light," which might well be read along with "Due to Circumstances Beyond Our Control" by Fred Friendly, who, as everybody knows, resigned from CBS after the network refused to permit him to drop a rerun of *I Love Lucy* in order to carry the testimony of George F. Kennan before the Senate Foreign Rela-

tions Committee. Taken together, the voice commented, the two books reveal what is good and what is bad about broadcasting in America. "This is Larry Josephson," said the voice and stopped.

There was a long pause—a *very* long pause—and then an old recording of Murrow's voice came on again, this time saying that he had just been with the first wave of U.S. troops to arrive at a concentration camp in central Germany called Buchenwald. His voice trembled perceptibly as he said: "Now let me tell this in the first person." Murrow then described the terrible scene in short, clipped language, remarking at one point: "Men tried to lift me to their shoulders. They could not. They were too weak." And later: "When I came in, they applauded. It sounded like the handclapping of babies."

After describing several other such scenes, Murrow said fervently: "I *pray* you to believe what I have reported about Buchenwald!" He closed by adding: "If I have offended you by this rather mild account of Buchenwald, I am not sorry."

Then the first voice, that of the WBAI announcer, came on once more to say that *Books to Buy, Borrow or Burn* was over, and tripping over a word again, he introduced the next program, which was in French.

Just as radio is now going through a fractionalization previously experienced by the printed media, so television will follow, industry spokesmen agree, especially once the uhf stations begin to catch on. The interesting upshot of all this specialization may then be that the mass media, only recently condemned as purveyors of a bland, regularized sameness, may be counted in the near future as a vigorous force working for cultural diversity.

The level or quality of that diversity, of course, is another question, and that remains to be seen—perhaps to be overseen. ●

WINS Newsman Paul Barker interviews a bank teller who has just been the victim of a hold-up.



BROADCAST EQUIPMENT

Light Tracking Stereo Tone Arm

Model 303 Micro-Trak tone arm has been designed by Gray Research and Development Co. Div., Hartford, Conn., to satisfy professional requirements of present and future light tracking stereo cartridges. Use of new materials permits compromise between the conflicting prerequisites of durability, light weight and low resonance. Basic specifications of

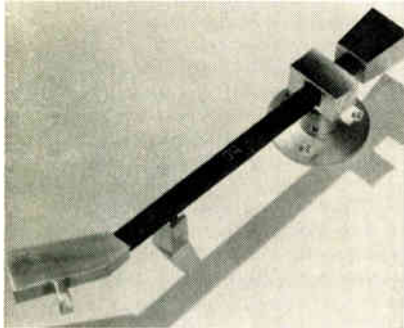

Model 303 are as follows: resonance, less than 10 Hz at 0.5 gram/30 × 10⁻⁶/cm/dyne, dual sapphire bearings in vertical pivot, fluid antiskate mechanism tracks cartridges with stylus pressures down to 0.1 grams. Tone arm measures 12.5 × 8 5/16 × 2 7/8, and is priced at \$72.50.
Circle 100 on Reader Service Card

Lightweight Color Camera

Availability of the Series 1000 color camera has been announced by Cohu Electronics, Inc., San Diego, Calif. Camera has 1) internally generated reference pattern for differential signal registration, 2) sensitivity modulated shading circuits, 3) continuously variable gamma from 0.7 to 1.0 standard C mount to accept 16mm vidicon lens. Solid-state circuits and precision optical system are contained in a compact housing mea-



suring 7 3/4 × 8 × 21 3/4 in., weighing 35 lb. Solid-state plug-in circuits and operating controls are readily accessible behind flip-down panel for ease of operation and maintenance. Camera control is capable of operating camera through 1000 ft of interconnecting cable. Base price: \$26,500, without viewfinder; \$27,500, viewfinder equipped.
Circle 101 on Reader Service Card

Bulk Tape Eraser

An economical hand-held bulk tape eraser has been introduced by the Robins Industries Corp., Flushing, N.Y. Model TM-88 handles any size reel of magnetic recording tape or magnetic stripped movie film. Eraser has momentary switch built into handle for erasing complete reels. Weighing 2 lb, TM-88 operates on 4 A. 110-120 V ac, 50-60 Hz. Eraser is priced at \$17.50.
Circle 102 on Reader Service Card

Digital Clock

Numex CL 624 and CL 612 (24-hr and 12-hr) electro-magnetic digital clocks, made by Numex Corp. of Waltham, Mass., feature differential time correction input control, no mechanical linkages, and magnetic



stepping motor. Clocks project 300 ft Lambert, 1 1/2-in. numerical display. Reference frequency is 60-Hz power, which provides 1-s timing pulses for synchronous motor and photoelectric pickup. Models CL 624 and CL 612 are priced at \$740 each.
Circle 103 on Reader Service Card

TV Control Panel For VTRs/CCTV

The TCP-1 television control panel, designed by Concord Electronics Corp. of Los Angeles, Calif., is designed to meet needs of VTR users for economical special effects capability. Control panel contains built-in switching and controls to title, fade,



flare fade and superimpose images from a two- or three-camera system. TCP-1 may also be used with any multiple camera system employing an external sync generator. Provision is made for tally light, mic, or other desired connections between operator and cameras. Panel includes video inputs for up to three cameras and a video output for connection to videotape recorder. Panel measures 7 1/2 × 5 1/2 × 3 1/2, weighs 3 lb, and is priced at \$150.
Circle 104 on Reader Service Card

Wideband TV Relay Link

Microwave Associates, of Burlington, Mass., has announced development of Model MA-2M solid-state color or black and white wideband TV relay system. System is suitcase size, lightweight and rugged. High resolution images can be relayed from airborne or ground-based transmitters 30 mi or more to corresponding receivers in vehicles or field stations. Solid-state transmitter delivers a minimum power output of 2 W on any of three channel select frequencies. Frequency is stable within 0.05 percent; a/c crystal lock option reduces tolerance to 0.02 percent. Power consumption is 60 W maximum with input of 20 to 32 V dc, 115 V ac, 60 or 400 Hz. Total weight is less than 20 lb, and dimensions are 11 1/2 × 6 3/8 × 7 1/2 in.

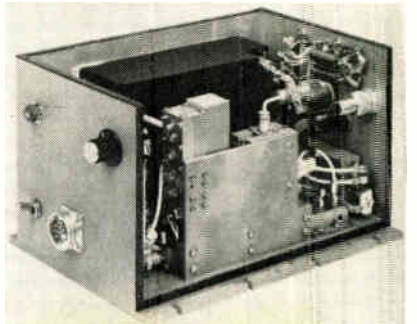



THEY WENT TO VIETNAM FOR A LOCAL STORY.

WTIC-TV, HARTFORD, WANTED IT EXACTLY AS IT WAS—IN COLOR.

According to News Director Tom Eaton, "Color added a new facet to accurate reporting when we sent a news team to Vietnam. People in southern New England saw their sons half a world away—just as our cameramen saw them.

"Reaction was immediate. People deluged us with letters. Large metropolitan dailies and grassroots newspapers reported the interviews with local boys.

And color played a big part."

WTIC News' photographic units, complete with KODAK EKTACHROME Film, sent back "perfectly exposed" footage—enough, in fact, for two complete documentaries plus 75 interviews with men from the WTIC-TV coverage area.

Tom Eaton believes that the difference between color and black-and-white is the difference

between night and day. Since color, expanded WTIC-TV news programming still isn't sufficient to meet sponsor demand.

Kodak has helped WTIC set up their ME-4 process. Kodak supplied the simplified, packaged chemistry. Isn't it time your station switched to color?

Kodak

EASTMAN KODAK COMPANY

ATLANTA: 5315 Peachtree Industrial Blvd., Chamblee, 30005, 404—GL 7-5211; CHICAGO: 1901 West 22nd St., Oak Brook, 60523, 312—654-0200; DALLAS: 6300 Cedar Springs Rd., 75235, 214—FL 1-3221; HOLLYWOOD: 6706 Santa Monica Blvd., 90038, 213—464-6131; NEW YORK: 200 Park Ave., 10017, 212—MU 7-7080; SAN FRANCISCO: 3250 Van Ness Ave., 94119, 415—776-6055



THE ACC-1608 “ON THE RIGHT TRACK”

DO AWAY WITH “TEMPORARY, HALF-FUNCTIONAL” SYSTEMS... THIS 8-TRACK AUDIO CONTROL CONSOLE DOES THE WHOLE JOB!

Up till now you 8-track people have had to make do with baling wire and chewing gum imitations of professional audio control console equipment. *No longer.* Electrodyne has specifically designed the ACC-1608 for your use. The same Electrodyne engineering and quality has been used in the ACC-1608 along with that *little bit more* that continually creeps into our products. For starters we designed the ACC-1608 to completely handle your 8-track recording. There are 16 microphone or line inputs, expandable to 20.

Complete 6 position equalization with echo send and cue on each channel is provided along with independent outputs for 8 channel, 2 channel and monaural. There are 2 stereo pan pots, illuminated pushbutton switches and complete monitor switching and level controls. Wrapping things up are the optional features. You name it, and you can have it! Sure, for a price you say... Try us on price, you'll find *baling wire and chewing gum* are much higher. Let the ACC-1608 get you *on the right track*, all eight of them.

Write or phone for complete literature on the ACC-1608 as well as the complete Electrodyne console and audio components line. Quotations on 12, 16 and 24 track consoles available on request.



ELECTRODYNE

10747 Chandler Blvd., North Hollywood, Calif. 91601
Telephone: area code 213/766-5602 or 213/877-3141
Cable Address: "ELECTRODYNE" North Hollywood, Calif.

Circuit modules are mounted in individually machined housings for protection against damage or rf interference. Fm deviation is 8 MHz peak-to-peak and meets MIL E 5400 environmental specifications for jet aircraft and helicopter use.

Circle 108 on Reader Service Card

Noise Suppressor

A dynamic noise suppressor has been announced by the Winston Research Corp of Los Angeles, Calif. Device contains a dynamic filter and provides for reduction of transmission noise in communication and tape recorder systems. Unit depends upon special characteristics of most signals carrying intelligence and dynamically changes gain for high frequency signals, thereby reducing wideband noise during transmission of recording data. Useful in videotape recorders, telemetry and other communication systems, noise suppressor provides 10- to 12-dB noise reduction. Unit requires no modification of existing equipment and is packaged for standard EIA rack mounting or as a compact airborne



module, operating from 115 V ac, or 12 V, respectively. Suppressor is priced at \$1000.

Circle 106 on Reader Service Card

Four-Tube Camera With Integral Zoom Lens

Designed to produce broadcast 525-line output, 2001 camera, made by



E.M.I. Electronics, Ltd., of London, processes signals from four lead oxide tubes, producing R, G and B for direct application to standard NTSC encoders and to standard RGB color monitors. Measuring 29 × 15 × 15 in. square, including zoom lens, camera uses direct imaging optical system

with lightweight prealigned prism assembly. At 3000° K, with an incident illumination of 100 ft candles and the lens set at f4, signal-to-noise ratio is not less than 40 dB, excluding gamma and aperture corrections. Alternative 10:1 zoom lens packages can be supplied. An 18:1 zoom lens package is also available. Camera weighs 160 lb.

Circle 109 on Reader Service Card

Viewfinder Camera

A high performance viewfinder camera chain, designed for open or closed circuit use in broadcast and educational studios, has been introduced by General Precision Systems, Inc., Pleasantville, N.Y. Called the Precision 1500, camera measures 18¾ × 11¼ × 30½, excluding lens. Camera is priced under \$5000, and weighs about 65 lb. Precision 1500



can be operated as self-contained unit with 2:1 interlace or from internal or external EIA sync generator modules. Specifications include: 30-MHz video bandwidth, 100-line resolution, automatic compensation for 10,000:1 light level variation.

Circle 105 on Reader Service Card

Twin Tape Recorder

Collins Radio of Dallas, Texas, has developed a twin tape system for broadcasters that provides simultaneous record and playback operations. System comprises two solid-state units—the 642E Twin-tape playback unit and the 216D record amplifier, which when combined permit: playback on both cartridges simultaneously, recording on one cartridge while playing the other and dubbing from one cartridge to the other. All Twintape system

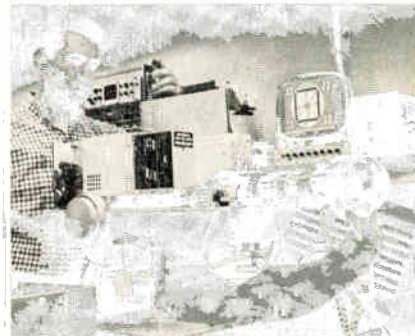
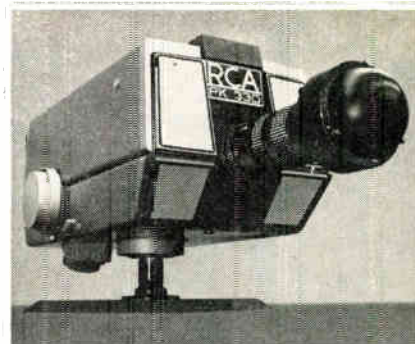
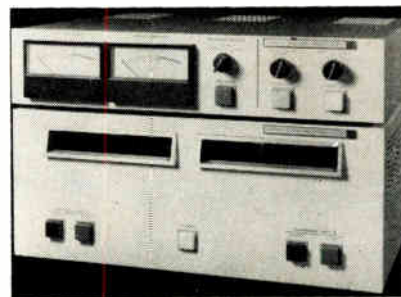

Photo Research introduces an easier, faster, more accurate way to test TV cameras . . .



The SPECTRA TV OPTOLINER

is a high resolution, precision TV camera tester that saves space by eliminating the elaborate test equipment formerly used for this operation. Now being used by RCA in their Burbank production facilities, the Optoliner attaches directly into the camera lens mount and provides microscopic alignment (within 0.002") of the slide mounted test patterns to the center of the camera lens. Ideal for use in production facilities, quality control operations or in standards labs, the Optoliner contains a constant, adjustable light source, and a special meter to indicate the exact illuminance and color temperature falling on the face of the camera tube. For more information on this simplified approach to TV camera testing, write, wire or phone today!

©Trademark of Photo Research Corp.



Karl Freund,
President

PHOTO RESEARCH corp.
"Photometric Equipment for Science and Industry"

837 N. Cahuenga Blvd., Hollywood, Calif. 90038
Telephone: (213) 462-6673 Cable: SPECTRA

Circle 26 on Reader Service Card

SPECIAL COSMICAR[®] LENSES

FOR YOUR SPECIAL CCTV CAMERAS



COSMICAR lenses have improved in quality as CCTV cameras have improved. There is no problem whether your cameras are with built-in an EE mechanism or a viewfinder mechanism.

COSMICAR will make whatever new lenses you need for your CCTV cameras to satisfy your every CCTV purpose.

For example, COSMICAR lenses can be adopted to automatic or rear control system by one hand.

Superb lenses of proven ability from 12.5mm to 1,000mm and Zoom lenses are on sale.

For further details, write to:



COSMICAR OPTICAL CO., LTD.

(Former name: ICHIZUKA OPTICAL CO., LTD.)

568. Shimoochiai, 2-chome, Shinjuku-ku, Tokyo

Cable Address: "MOVIEKINO TOKYO"

Circle 27 on Reader Service Card

EXHIBITS
NEW YORK
COLISEUM

**TECHNICAL
SESSIONS**
NEW YORK
HILTON

Monday through Thursday

PROGRESS IN AN EXPLODING TECHNOLOGY

PROGRESS IN AN EXPLODING TECHNOLOGY

PROGRESS IN AN EXPLODING TECHNOLOGY

PROGRESS IN AN EXPLODING TECHNOLOGY

- 48 GENERAL SESSIONS at the New York Hilton. Hours: 10:00-12:30; 2:00-4:30.
- FOUR FLOORS OF EXHIBITS at the N. Y. Coliseum including over 750 firms. Hours: 10 a.m.-8 p.m. 4 Days.
- GALA ANNUAL BANQUET—Wednesday 7:15 p.m. N. Y. Hilton Grand Ballroom—\$16.00.
- FREE SHUTTLE BUSES between the Hilton and the Coliseum—every few minutes.

- REGISTRATION—Good all days—General Sessions and exhibits. In and out privileges.—IEEE Members \$3.00. Non-members \$6.00. Ladies \$1.00. High School Students \$3.00 if accompanied by an adult—One student per adult; Thursday only—limit of 3 students per adult.
- REG-IDENT CARD speeds request for exhibitors' literature. Ask for one when registering.
- ESCALATORS/EXPRESS ELEVATORS to the Fourth Floor.

IEEE Exhibition MARCH 18-21, 1968

Circle 28 on Reader Service Card

electronic circuits are mounted on plug-in etched-epoxy boards. The 642E may be used alone if recording capabilities are not required. Cue tone oscillators, record level metering, operational controls, and a record amplifier are contained in the 216D. One cue tone is standard with option available for three cue tones. Amplifier may be stacked with playback unit, or rack-mounted with optional adaptor.

Circle 110 on Reader Service Card

Series of CCTV Cameras

A new series of CCTV cameras has been introduced by the Fairchild Space and Defense Systems Division of Fairchild Camera and Instrument Corp., Paramus, N.J. The four-camera TV-177 line is designed on the building block principle. While each of the camera systems is available separately, the basic TV camera can be converted to more advanced con-



figurations as required to meet specific applications requirements. Model TV-177 is a self-contained, crystal-controlled, random interlace unit with 12-MHz bandwidth and 800-line resolution. It has 4000:1 automatic light compensation and adjustable aperture correction. Optional features include rf output, a high-resolution kit to produce 900-line resolution, and 2:1 industrial interlace board. The other cameras, the TVF-177 and TVF-177 RL, incorporate the features of either the basic TC-177 or the TC-177RL models plus a small television viewfinder with optional rear controlled zoom lens.

Circle 111 on Reader Service Card

CCTV Camera Has Internal/External Sync

A new solid-state television camera designed by Concord Electronics Corp., Los Angeles, Calif., for videotape recorders or CCTV applications

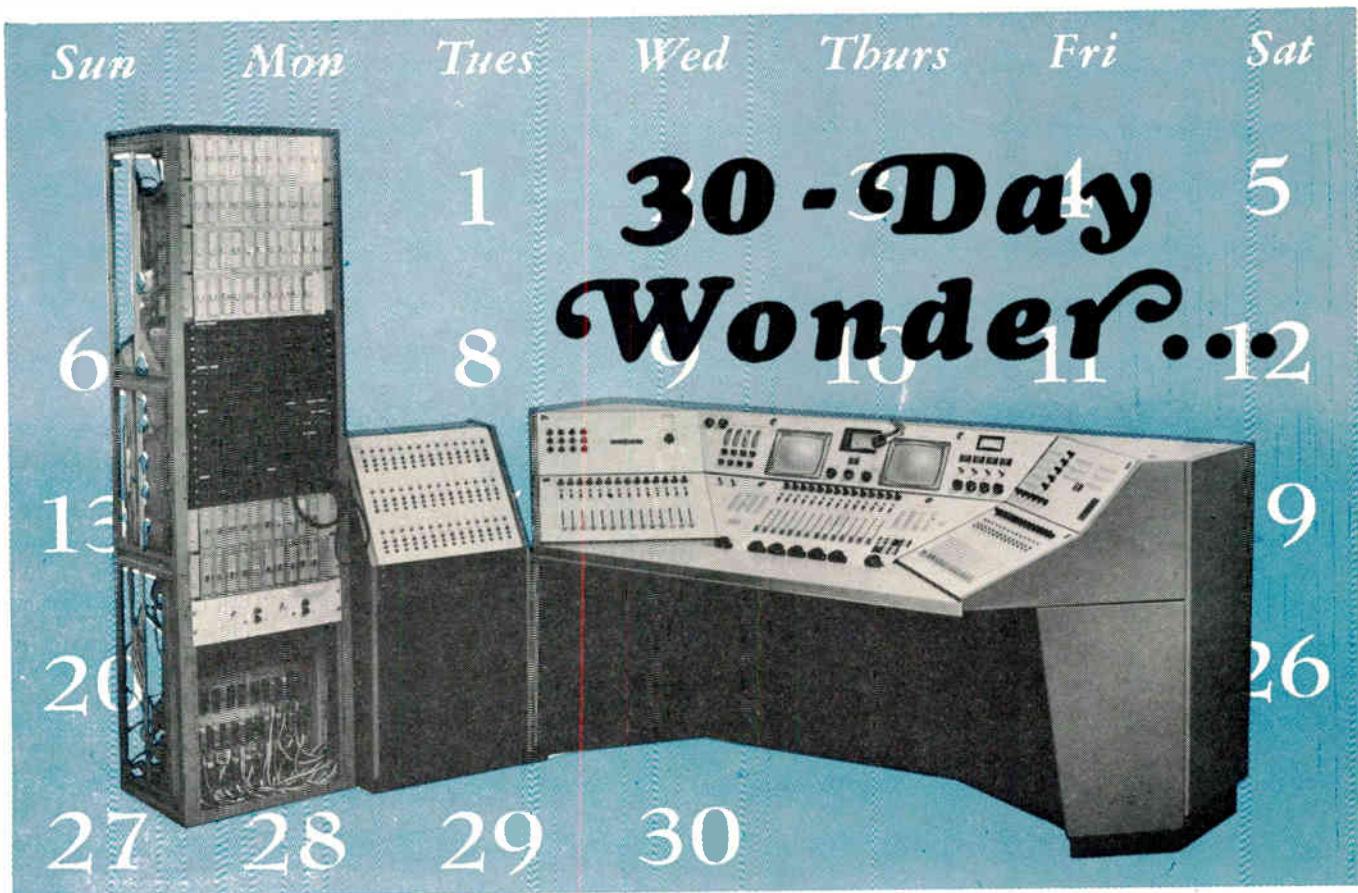

New Fairchild Integra II Remote Control Custom Audio Console!

A major TV network selected FAIRCHILD RECORDING EQUIPMENT CORPORATION, from among several of the largest broadcast equipment manufacturers in this country, to design and construct a 42-input audio mixer console. Not only did FAIRCHILD deliver a remote control mixing console in substantially less than the required time, but the network's audio engineers were so deeply impressed with the INTEGRA II console's performance and compactness that additional consoles were ordered ... the next INTEGRA II console was constructed and delivered in thirty days. These consoles were installed and in operation within a matter of days after delivery.

NO AUDIO IN THE CONSOLE

There is actually no audio in the INTEGRA II console, with the exception of the audio lines assigned to peripheral effects equipment such as effects equalizers, VU meters etc. The INTEGRA II

audio system, by removing the audio from the console area, eliminates the need for audio equipment to be located adjacent to the control area, thereby providing far greater design latitude.

THE SECRET OF FAIRCHILD'S INTEGRA II CONCEPT

The secret of the speed in which FAIRCHILD INTEGRA II consoles are constructed is inherent in the advanced modularized solid state design. By combining several audio functions — amplification, attenuation and switching — in a complete system of plug-in cards, the construction of simple or complex consoles is implemented in short periods of time. In addition, a considerable savings in space and cost is also achieved.

The FAIRCHILD INTEGRA II remote control audio consoles and components are more compact, easier to install and maintain; are far superior in performance and reliability.

IF YOU ARE A PROGRESSIVE BROADCAST OR RECORDING STUDIO, with an eye to the future, look to FAIRCHILD for INTEGRA II consoles or components today. Write for complete details and brochure.

FAIRCHILD RECORDING EQUIPMENT CORP.
10-10 45TH AVENUE - LONG ISLAND CITY, NEW YORK 11101

Circle 29 on Reader Service Card

get the turntable a studio needs
...and rek-o-kut durability, too!



There's hardly an engineer in the broadcast field that hasn't used a Rek-O-Kut turntable in his career. Rek-O-Kut has been building studio turntables for over a quarter century. So you are assured of buying top quality sound reproduction along with the ruggedness and durability that broadcast and commercial installations demand. The rim drive Rek-O-Kut B-12H by Koss Electronics permits slip cueing without sacrificing fidelity. And your Koss/Rek-O-Kut will last and last and last with a minimum of maintenance and repair. Write for complete details on the popular Model B-12H or the 16" studio B-16H today.

specifications:

SPEEDS: 33 $\frac{1}{3}$, 45, 78 rpm. **NOISE LEVEL:** — 59db below 5 cm/sec average recorded level. **MOTOR:** custom-built computer type heavy-duty hysteresis synchronous motor. **45 RPM HUB:** instantaneously removable by hand. **PILOT LIGHT:** neon light acts as an "on/off" indicator. **FINISH:** grey and aluminum. **DECK DIMENSIONS:** 14 x 15 $\frac{1}{16}$ ". Minimum Dimensions: (for cabinet installation) 17 $\frac{3}{4}$ " w. x 16" d. x 3" above deck x 6 $\frac{1}{2}$ " below. **PRICE:** B-12H Turntable \$165 S-320 Tonearm \$34.95. Optional BH Base for audition room \$18.95.



Rek-O-Kut Turntables by
KOSS

Koss Electronics Inc., 2227 N. 31st St., Milwaukee, Wis. 53208
Export Cable: STEREOFONE • Koss-Impetus/2 Via Berna/Lugano, Switzerland

Circle 30 on Reader Service Card



has 2:1 interlace and provides its own sync, or sync for other MTC-18 cameras. Camera also accepts external sync. Light control selector on camera permits either totally automatic or manual adjustment for light conditions. Videotapes with fades, titles, and superimposed images may be created with the addition of TCP-1 television control panel (priced under \$150). MTC-18 measures 5 $\frac{1}{2}$ x 3 x 11 in., and weighs 7 $\frac{1}{2}$ lb. MTC-18 has video resolution of 550 lines, and is priced at \$450.

Circle 112 on Reader Service Card

Ozone-Free Xenon Lamps

The ozone-free Xenolite, Model CXL451-0 xenon lamp is part of a new line of lamps, made by Christie Electric Corp., of Los Angeles, Calif. In addition to ozone-free lamps (450-1600 W), the line includes standard xenon compact-arc lamps (75-6500 W), horizontally operated lamps (300-2000 W), and mercury short-arc lamps (100-500 W). They are available singly or as part of a Xenolite system, including lamphouse with optics, rectifier power supply and igniter. The ozone-free xenon lamps are particularly suited for slide and motion picture projection, TV projection, display systems, trainers, studio and stage lighting. Christie xenon lamps have an average life of 1500 to 2000 hr, are mostly equipped with

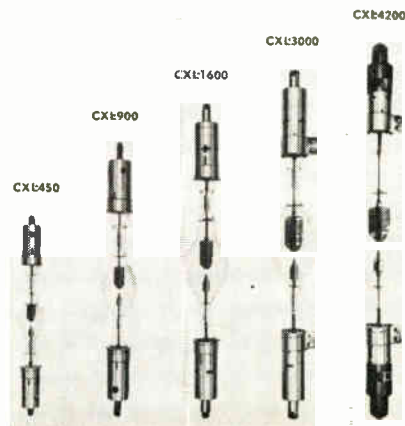

Circle 31 on Reader Service Card ➔

simultaneous record & playback

...plus dubbing

with Collins' new compact Twintape System

Collins' new Twintape System, completely solid-state and available in monaural or stereo models, is the most convenient, flexible, and easy to operate cartridge machine on the market. The Twintape System consists of two units: the 642E Twintape Playback Unit, and the companion 216D Record Amplifier. Combined, these units permit:

- Playback on both cartridges simultaneously.
- Recording on one cartridge while playing the other.
- Dubbing from one cartridge to the other.

Tape transport assemblies in the Playback Unit are easily removed. Rugged, direct-drive capstan motors eliminate flywheels, rubber belts, etc., and produce extremely low wow and flutter. With extra heavy Mu-metal magnetic shields, the unit has very low susceptibility to magnetic pickup of noise. Rear terminal strips provide for optional remote control, automatic sequencing of multiple machines, cue detector contact outputs, etc. Routine maintenance of the Playback Unit may be performed in seconds.

Cue tone oscillators, record level metering, operation controls, and an amplifier are contained in the 216D Record Amplifier. One cue tone is standard, with option for three cue tones. The amplifier may be stacked compactly with the Playback Unit, or rack mounted with an optional adaptor.

All Twintape System electronic circuits are mounted on plug-in, etched epoxy boards.

For a descriptive brochure on this new Twintape System, write or call Broadcast Communication Division, Collins Radio Company, Dallas, Texas 75207. Phone (214) AD 5-9511.



COMMUNICATION / COMPUTATION / CONTROL



Sophisticated programming with one-man operation ...from AMP

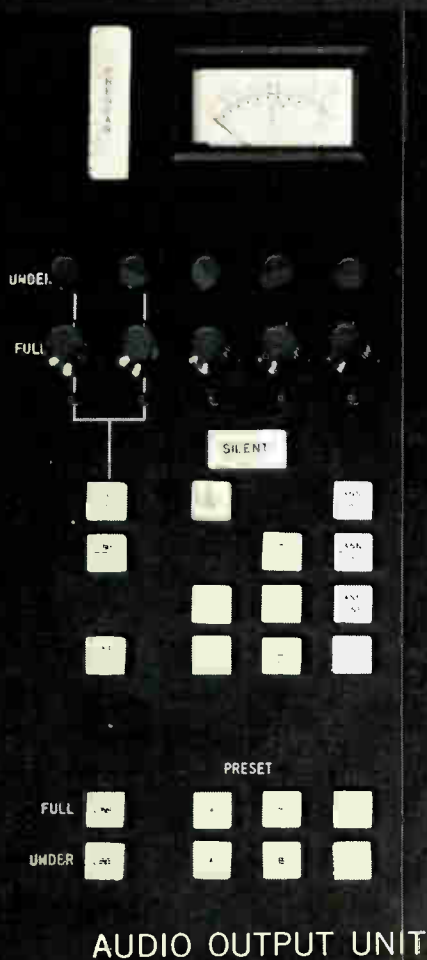

AUDIO OUTPUT UNIT

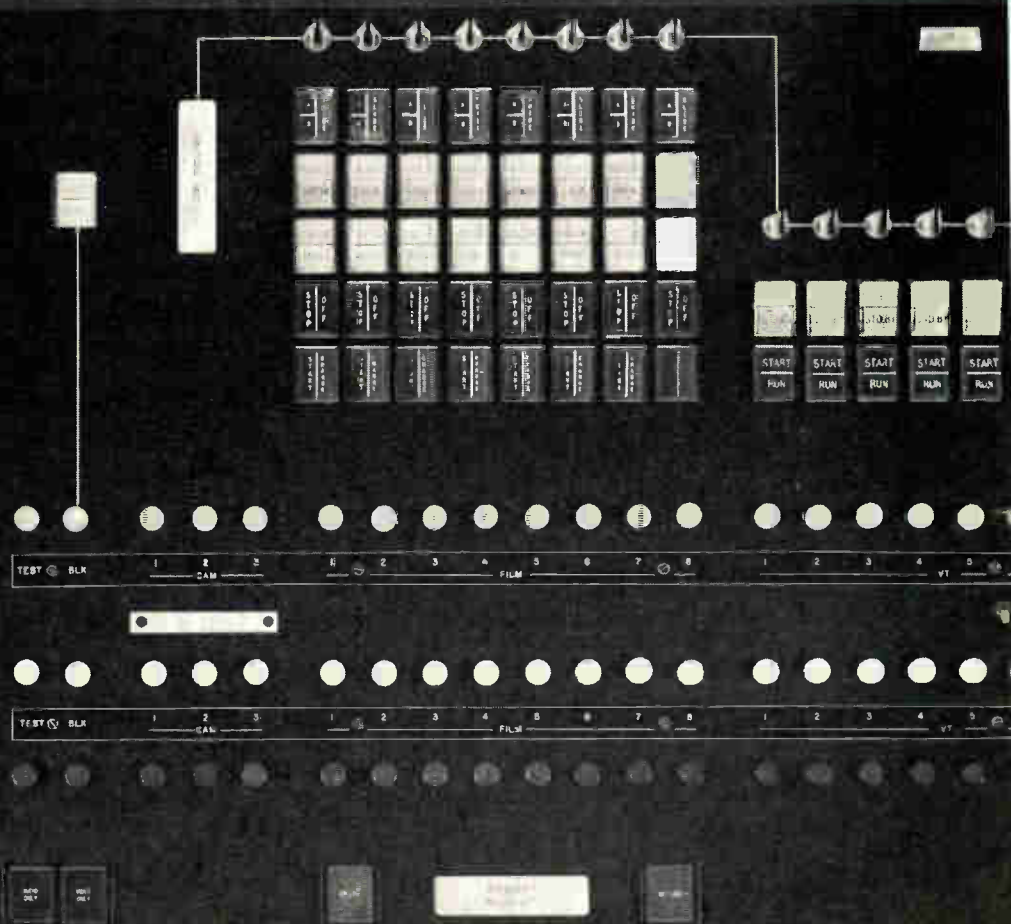

VIDEO SWITCHER

The A-MP* Audio/Video Switching and Control System gives a one-man operation a multi-man appearance. Impossible? No.

It's all done by coupling the newest control techniques with the most imaginative hardware available to the broadcast industry. For example, the master control system shown includes the following elements:

- Video Switcher—a line-preset operation allowing you to preset even mix and matt, coupled with the ability to automate transition rates.
- Audio Output Unit—the only one-event preset unit in the industry. Complete flexibility thru the use of a four-channel mixer that allows you to preset audio-video, announce, plus two additional channels.
- Machine Controls—complete VTR control plus an advanced concept in film island control integrated into the video operation.
- Automation—a 30-event Preset Programmer capable of performing all functions available on the video switcher and audio output unit. In addition, AMP's advanced development has produced the A-MP Automatic Broadcast Programmer—a programmable digital computer featuring a CRT display in broadcaster's language. For full information, write AMP Incorporated, Harrisburg, Pa. 17105.

*Trademark of AMP Incorporated

VISIT US AT BOOTH 308 DURING THE NAB SHOW.

AMP

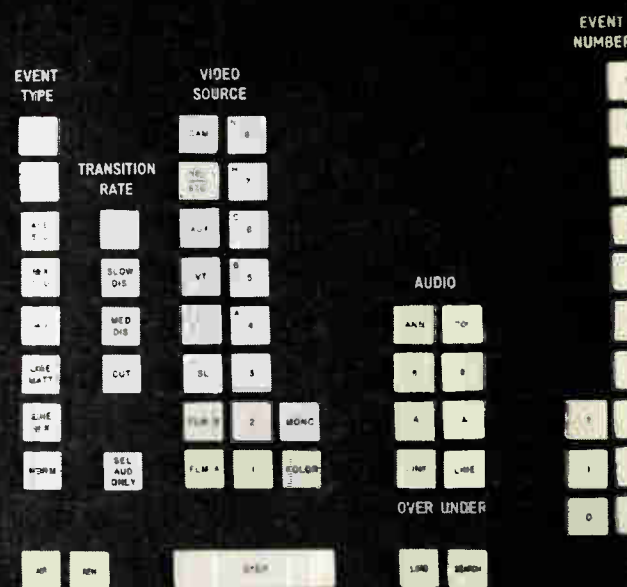
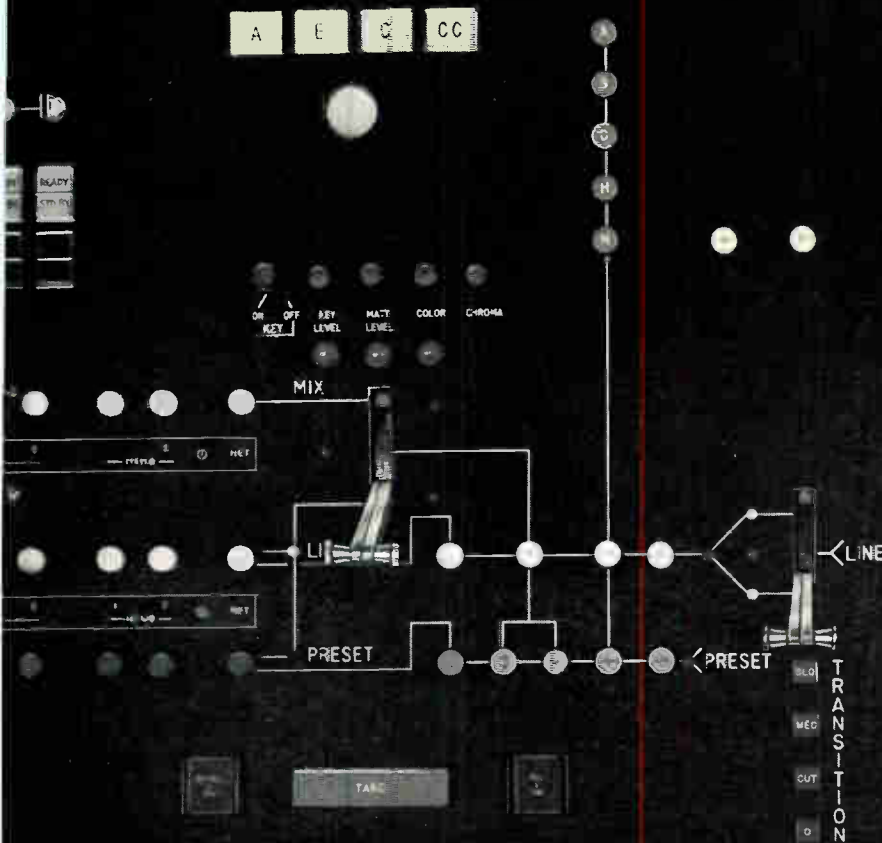

Formal Announcement

ARROW  ELECTRONICS, INC.

is proud to
announce a new
arrival....

AMPEX PROFESSIONAL 4 TRACK RECORDING SYSTEM

FLEXIBILITY allows you to add three channel capability to a monophonic machine by installing two additional panels of electronics, changing heads and head cabling. For the first time, you can build a single channel full track Ampex up to a four channel, four track recorder.

OBSOLETE PROOF allows you to expand without replacement. You can keep pace with the changing requirements of the industry, by using the building block increments of Ampex's new generation in professional audio recorders.

JEWEL BEARING SCRAPE FLUTTER IOLERS minimizes scrape flutter (especially important to production of master tapes).

AUTOMATIC TAPE LIFTERS with electrical and mechanical override ease the tape away from the heads during rewind and fast forward modes.

FAST HEAD CHANGES You can remove a 1/4 inch head assembly and replace with a 1/2 inch head assembly or change from four track to three track operation in a few minutes.

AMPEX ONE YEAR WARRANTY
ON ALL PARTS

AMPEX ONE YEAR WARRANTY ON
ALL PARTS

Now Ampex introduces a new generation of professional audio recorders. Now with transport rigidity previously limited to higher costing machines.

WE HAVE A COMPLETE LINE OF AMPEX PROFESSIONAL RECORDING EQUIPMENT
TAPE DECKS, CONSOLES ETC. IMMEDIATE DELIVERY ASSURED! CALL
OR WRITE MR. HOWARD WINCH, BROADCAST DEPARTMENT, 516-694-6800
212 - JA 6-0300

ARROW  ELECTRONICS, INC.
900 ROUTE 110 • FARMINGDALE, L.I., N.Y. 11735

Circle 33 on Reader Service Card

< Circle 32 on Reader Service Card

integral leads, are ready for instant operation, have practically constant color spectrum throughout their life and irrespective of light intensity variations, and are adjustable over wide range of light output.

Circle 117 on Reader Service Card

Eight-Track Stereo Cartridge Player

Craig 3112 eight-track mobile stereo tape player recently was introduced by Craig Panorama, Inc., of Los Angeles, Calif. Economy-priced unit plays any eight-track cartridge (up to 80 min with twin-pack). Player



has lighted program indicator, volume, balance and tone controls, positive-select lever and built-in noise filters. Wow and flutter are less than 0.3 percent rms. Output power is 8 W (4 W per channel). Signal-to-noise ratio is better than 35 dB. Frequency response at 3 3/4 in./s is 100 Hz to 10 kHz. Channel separation, better than 40 dB. Unit operates on 12V, measures 7 3/4 x 2 7/8 x 8 7/8 in. and weighs 8 lb. Model 3112 is priced at \$59.95.

Circle 113 on Reader Service Card

'Smallest Diameter' CCTV Camera

A significant size reduction in the design of CCTV cameras has been announced by Canoga's RAM Television Products Division, Torrance, Calif. The new camera, Model CH-1270, is the "smallest ever developed using a 1-in. vidicon tube." It measures 2 1/2 in. dia x 9 in., and weighs



February, 1968 — BM/E

Disney's Magic World of Sound... from Altec.

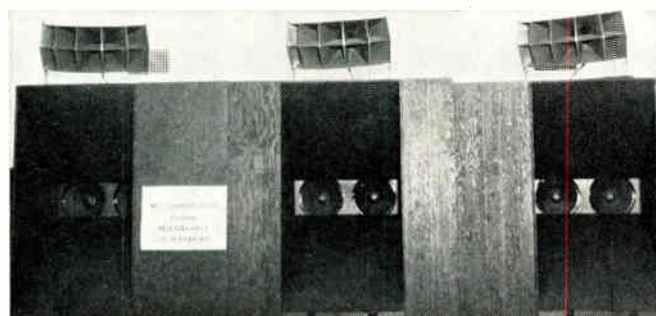
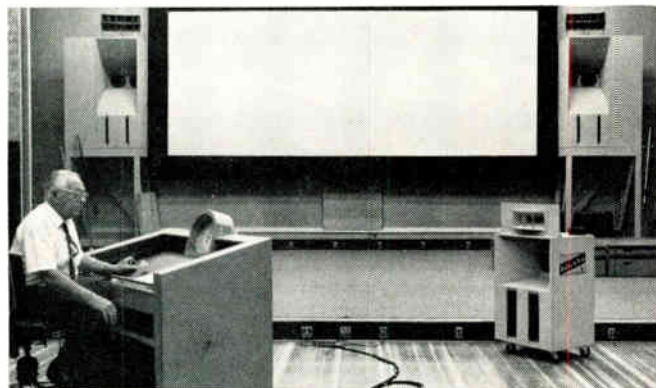

The magic that is Disney is not just a pat formula. It is a form of perfectionism that pervades everything which carries the Disney name. Certainly, there's a Disney look. But just as certainly there's a Disney sound. And that's where we come in.

For example, the new control console at the Disney Studio's orchestra stage is made up of 29 Altec slide-wire attenuators, 7 rotaries, and one 4-gang master. The works are powered by rack-mounted banks of Altec amplifiers. Monitoring in the control room is done in a big way—with three giant Altec A4 "Voice of the Theatre"[®] systems butted together in a single plane of the most powerful, pure sound you can get.

The stage itself uses three more A4's for monitoring, re-recording, and playback. (That's one good way to keep the musicians happy.) Eight caster-mounted A7 "Voice of the Theatre"[®] systems are mobile, may be moved where and as needed.

And that's not all. On the back lot Altec PA equipment provides the paging. Dialog stages at the Studios also use A4's, with Altec's space-saving 844A Monitor Speaker Systems in the compact transfer room. The list could go on, but the point is made.

So who listens when Altec Lansing sounds off at Disney? Everybody, that's who. And if you understand the remarkable expertise of Disney sound engineers, perhaps you should listen too. Let's hear from you.

ALTEC LANSING, A Division of
Ling Altec, Inc., Anaheim,
California 92803

BM/E-2



Circle 34 on Reader Service Card

4-TUBE PERFORMANCE 3-TUBE SIMPLICITY

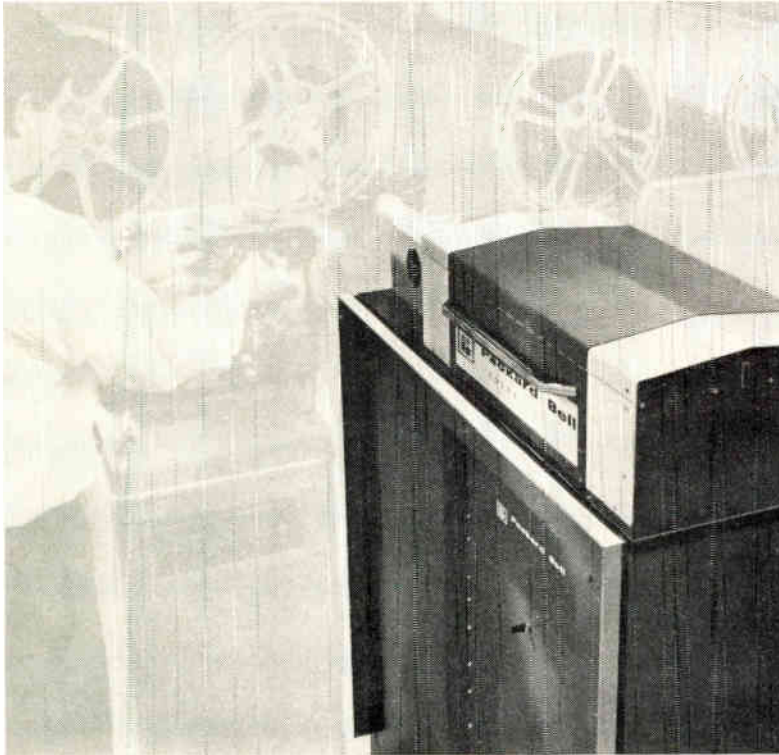

**Only new Packard Bell
Color Camera for film chains combines all
these high-performance features
in one economical package**

Complete matched system—
camera plus optical multiplexer
permits wide projector flexibility.

Full EIA/NTSC compatibility
obtained with optional plug-in
EIA sync modules and encoder.

*Unmatrixed monochromatic
signal* for maximum definition and
contrast.

*Combination of precision fixed
optics and 3-vidicon simplicity*
provides 4-channel standards
of resolution, contrast and ease of
registration.

*Superior sensitivity—150 foot-
lamberts high light-reflectance.*

Write today for full information
and prices. **C86**

Packard Bell



Lawrence & Arnold Drive, Newbury Park, Calif. 91320 • Tel: (805) 498-6601

Circle 35 on Reader Service Card

3 lb. Educational uses include mounting on microscope. Camera features 800-line resolution, all solid-state construction (except for vidicon) plug-in modular design, shock and vibration resistance, full EIA sync per RS-170. **Circle 114 on Reader Service Card**

Adjusting Tools for Communication Gear

A group of precision adjusting tools for relay springs, armatures, rotary switches and telecommunication equipment is available from Jonard Industries Corp., Precision Tools Division, Bronx, N.Y. Tools are spe-

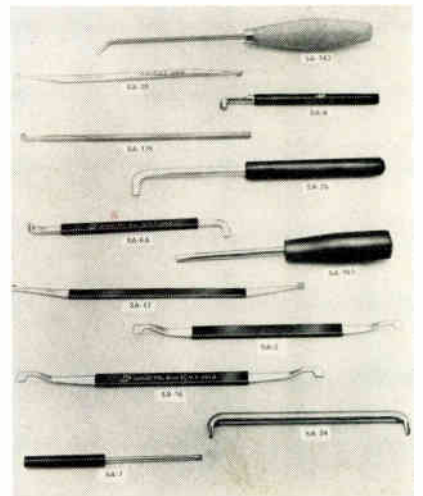

cially designed for adjusting all domestic and foreign type relay spring tension, relay armature back stops, armature arms, etc. Adjuster tips have various shapes and slot openings to accommodate a wide range of relays used in telecommunication and electronic industries.

Circle 116 on Reader Service Card

TV Translator

Rodelco, of Wyandanch, N.Y., announces the development of a complete line of solid-state translators for both vhf and uhf television signals with power output levels to 20 W. Unit shown in photo is Model VHFT.



which is capable of converting vhf TV channels to any other vhf TV channel at a power output of 1 W. Unit has typical noise figure of 2 dB and a 6-MHz bandwidth.

Circle 118 on Reader Service Card

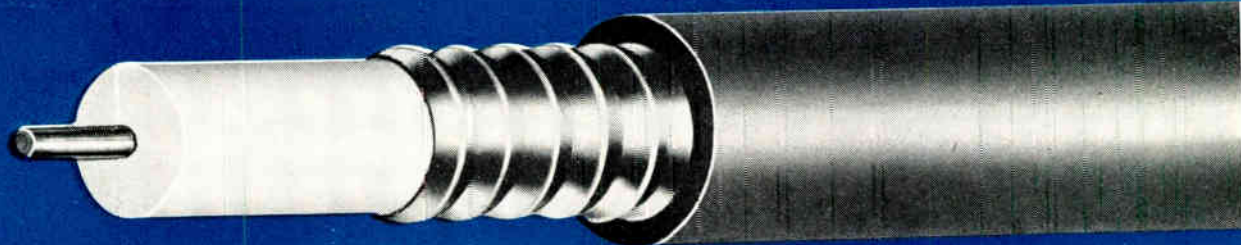

to 300 MHz



and beyond



SUPERIOR CONTINENTAL'S
E-X-T-E-N-D-E-D
SPECTRUM COAXIAL CABLES
for MORE services and MORE revenue.

Controlled impedance uniformity over the extended range provides bandwidth for 14 additional 6 MHz TV channels — with no discontinuity at any point. Now, with this new 84 MHz segment available you can expand your operation to include

- ETV and ITV programming
- CCTV for business and industry
- Data transmission
- Remote control telemetering
- Alert and alarm systems
- Traffic and highway control system

Superior Continental Extended or Full Spectrum Coaxials can also be ordered in IM construction and direct burial types.

Full spectrum coaxials, with no discontinuities to 220 MHz also available.

Write or call for information and prices to:

Superior Sales and Service Division P. O. Box 2327 Hickory, North Carolina 28601 Phone 704/328-2171



**SUPERIOR
CONTINENTAL
CORPORATION**

Circle 36 on Reader Service Card



All Digital Color Sync Generator

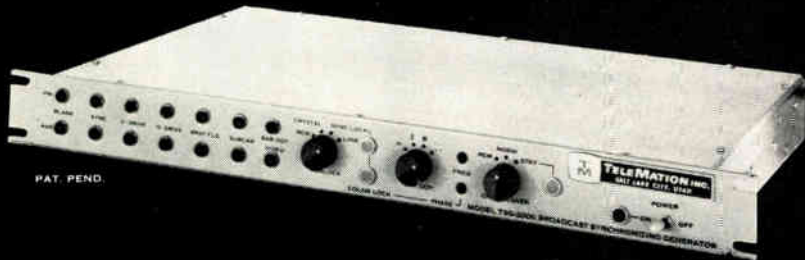

Exclusive Features —

- All pulses and transitions clock derived
- No monostables — no delay lines
- Integrated circuit reliability
- Dual outputs — permit pulse assignment with full standby
- Subcarrier vs. horizontal jitter better than 0.25 nsec.
- Pulse jitter better than 4 nsec throughout frame
- 1 3/4" rack space — including all "Add-In" modules

Add-In Modules —

- Monochrome Genlock
- Bar Dot Generator
- Color Genlock
- Sync Changeover Switch

Monochrome
Model TSG-2000M

\$1,000

Color
Model TSG-2000C

\$1,500

Prices and specifications subject to change without notice.

Television Equipment for Education, Industry and Military . . .

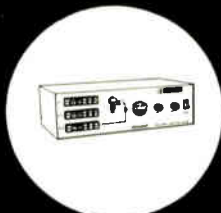

MULTICASTER™



PORTA-SYNC™



TELECTERN™



VR 660 Video Processor



2:1 Interlace Sync Generator

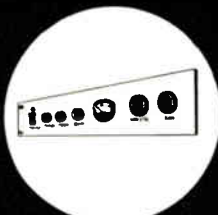

EIA Camera Control

. . . from Telemation — where experience powers pacesetting products!



TELEMATION, INC.

2275 So. West Temple / Salt Lake City, Utah 84115
Telephone (801) 486-7564

Circle 37 on Reader Service Card

NAMES IN THE NEWS

Jerrold Electronics announces the appointments of **Stanley Ogen**, promotion manager for the Community Operations Division; **Frank N. Cooper**, manager of CATV system development; and **David Brody**, manager of the Community Operations Division.



Chase Morsey, Jr.



Frank L. Flemming

The appointment of **Chase Morsey, Jr.**, to the newly-created position of vice president, marketing, RCA, has been announced by President Robert W. Sarnoff.

Visual Electronics Corporation has announced the appointment of **Frank L. Flemming** to the position of chief engineer.

Robert K. King, vice president of Capital Cities Broadcasting Co. and general manager of WKBW-TV, Buffalo, recently announced the appointment of **Don Holland** as WKBW-TV assistant chief engineer.

Kaiser Broadcasting announces that **C. M. "Mike" Cassidy** and **L. McGee**, account executives and **William R. Furnell**, producer-director, have joined KBHK-TV, San Francisco.



William Robinson



Harold "Bud" Mosier

Anaconda Astrodata has announced the appointment of **William Robinson** as southeast regional sales manager.

Harold "Bud" Mosier has been promoted to position chief engineer at Electro-Voice, according to a recent announcement by Robert Ramsey, director of engineering.

Atlanta Constitution Publisher **Ralph McGill** and Moultrie businessman, **Robert B. Wright, Jr.**, have been invited to join the National Citizens Committee for Public Tele-

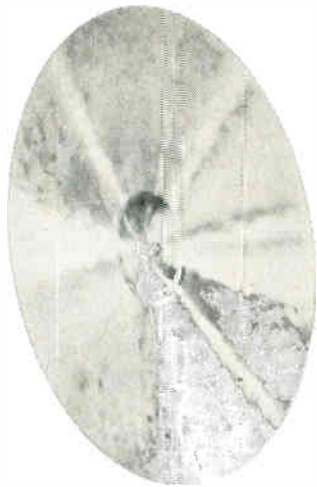

Our new low-noise tape...is all surprises!

From surprisingly soft to surprisingly loud—new Ampex 404 Series low-noise tape can capture more audio reality than low-noise tapes of the past.

Its new small-particle oxide meets or surpasses the most demanding low-noise specifications. Holds inherent tape noise ("hiss") far below the level of your most delicate musical passage. Yet from this same quiet tape comes *greater high frequency response* and *broader undistorted dynamic range*—qualities previously sacrificed in

low-noise tapes. So the silence has more silence. The flute sounds sweeter. *And* the cymbals crash louder, without distortion — on Ampex 404 Series low-noise tape.

Buy the full range of Ampex professional tapes for extra quality: New Ampex 404 Series low-noise tapes for mastering and duplicating. 600 Series for general purpose professional recording. 681 Series lubricated tapes for endless loop cartridges. 291 Series tapes for a/v. Plus others. Send the coupon for up-to-date information.

To: Ampex Corporation, Room 7-14A,
Redwood City, California 94063

- Send me literature on the full line of Ampex professional tapes, including new 404 Series low-noise tape, for
- Professional
 - Master
 - Duplicating
 - Other: _____



NAME _____

ORGANIZATION _____

ADDRESS _____

CITY/STATE/ZIP _____

Career opportunities? Write Box D, Redwood City, Calif. 94064.

AMPEX

Circle 38 on Reader Service Card

World Radio History



**COLOR
SPECTACULAR!**



BIW'S NEW

**TV-85C COLOR TV CONNECTOR
ALIGNS PINS, PROTECTS MATED
PARTS...AUTOMATICALLY**

This new concept in outer sleeve design guarantees positive pin alignment; pins *cannot* be bent or damaged by mismating. The double-sleeve design also prevents injury to mating threads and protects against knocks, drops and abuse from studio rolling stock.

Heavy-duty rubber compression gland provides an effective seal at rear of connector. All pins and sockets on the new TV-85C insert are front release, rear removal, and crimp to cable conductors. Woven cable grip and rugged molded boot provides both bend relief and pull-out protection.

Completely compatible with existing 85 pin connectors used for TV, BIW's new TV-85C connectors are machined from 7075-T6 aluminum, and are precision built for trouble-free performance.

Go BIW all the way — connectors, camera cables (American or European), broadcast panels. Write for details.

Cable concepts grow at...



Boston Insulated Wire & Cable Co.

45 Bay St., Boston, Mass. 02125/141 Nevada St., El Segundo, Calif. 90245
118 Shaw St., Hamilton, Ont./International, 1 Place Ville Marie, Montreal, Que.

Circle 39 on Reader Service Card

World Radio History

vision by its chairman, Thomas P. Hoving.



Richard J. Lutz



Gene Francis

Richard J. Lutz recently became general manager of WHA-TV and the Television Center of University Extension, University of Wisconsin.

Gene Francis, national distributor sales manager for Rohn Manufacturing Co., Peoria, Ill. has been appointed western division sales manager, it was announced recently by R. A. Kleine, vice president.

William A. Schwartz has been appointed station manager of WUAB-TV, Lorain, Ohio, it was announced by John A. Serrao, vice president and general manager of United Artists' office in Cleveland.

Bill J. Ball, editor of the *Neosho Daily News*, has become news director of KBTN Radio and Cable Television, Inc.

Donald B. Davis, manager, Acoustavoicing for Altec Lansing, Calif., has been elected western vice president of the Audio Engineering Society.

Gates Radio announces the promotion of **Lawrence J. Cervone** to the position of vice president and general manager, the recent appointment of **Larry T. Pfister** as district manager, the appointment of **Bob J. Vaughn** as staff mechanical engineer and the promotion of **Eugene O. Edwards** to the new position of general sales manager.

Charles Ferguson, operations manager, WFCR, Amherst, Mass., has been appointed to newly-created position of director of engineering.



Robert A. Munroe



Stanley L. Pearl

Robert A. Munroe of Craftsman Electronic Products, Inc., has been promoted to western regional sales manager.

The election of **Stanley L. Pearl** as president has been announced by Kappa Networks, Inc.

We can get you automated quick as you can say

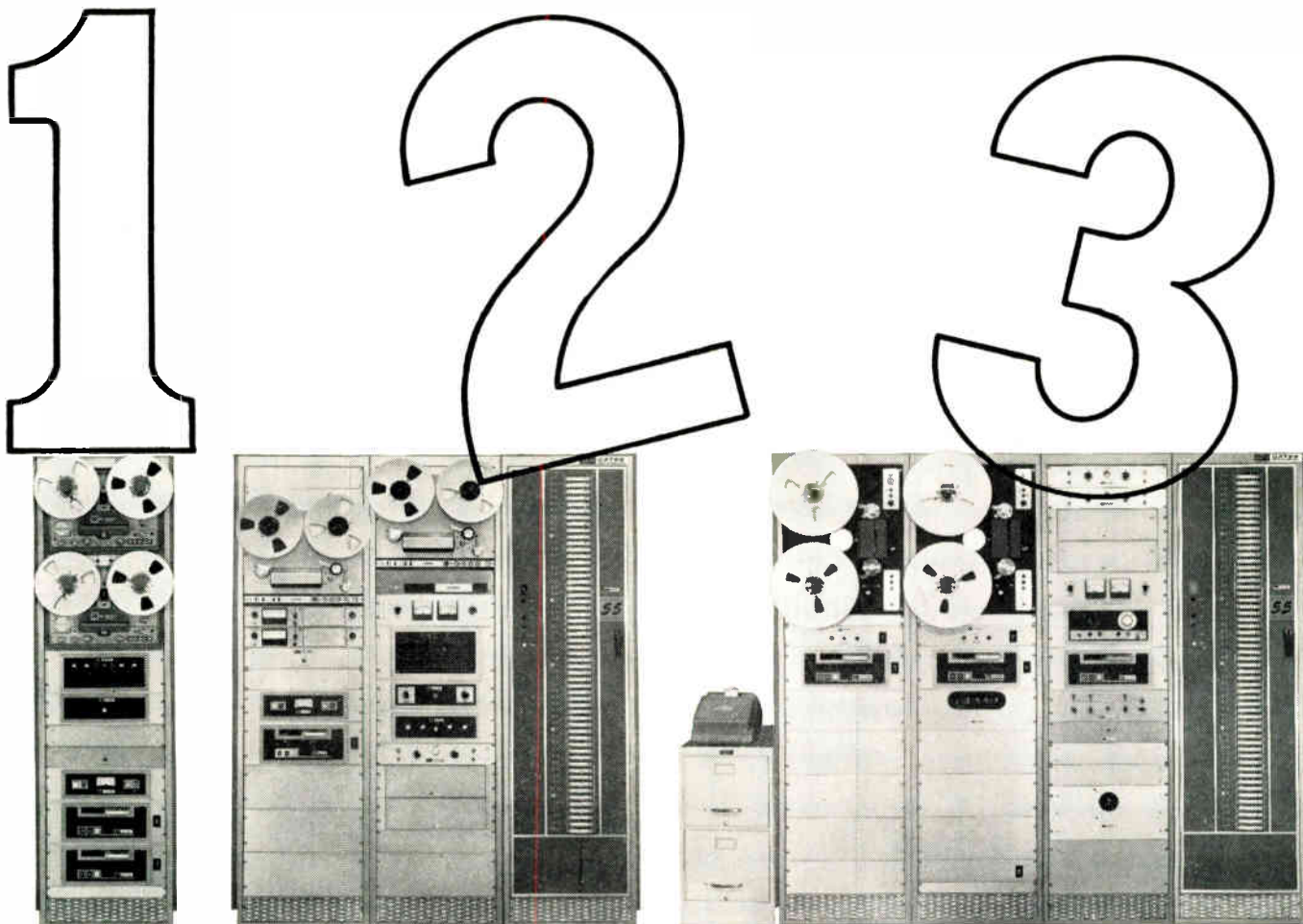

Modern program automation shouldn't be complicated.

Not for the broadcaster.

So we worked out three basic systems on a small-medium-large basis.

And we designed them so each one is easy to modify for specific programming needs.

This gives you the most automation for the least cost. Which is for you?

1. AUTOMATE 244 – A good start if you want selected periods of program automation.
2. AUTOMATE 484 – This one handles some pretty complicated programming. Available with optional network joining and complete remote control.
3. AUTOMATE 1007 – The ultimate in automation – ideal for today's and tomorrow's comprehensive AM/FM program requirements.

And any system can be expanded as you grow.

You'll be amazed at what automation can do for you *right now*.

It's possible that you can be automated for as little as \$65 a week. Let us tell you how.

Just jot down your name, station and address on this ad and mail it to us.

AUTOMATIC TAPE CONTROL DIVISION
1107 East Croxton Avenue
Bloomington, Illinois 61702, U.S.A.

GATES

Gates Radio Company,
Quincy, Illinois

**HARRIS
INTERTYPE
CORPORATION**

Circle 40 on Reader Service Card

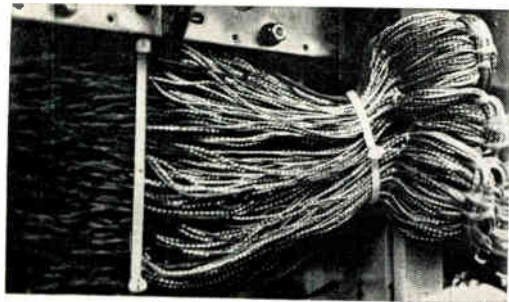

Reduce Costs of Communications Wiring with TY-RAP® Cable Ties

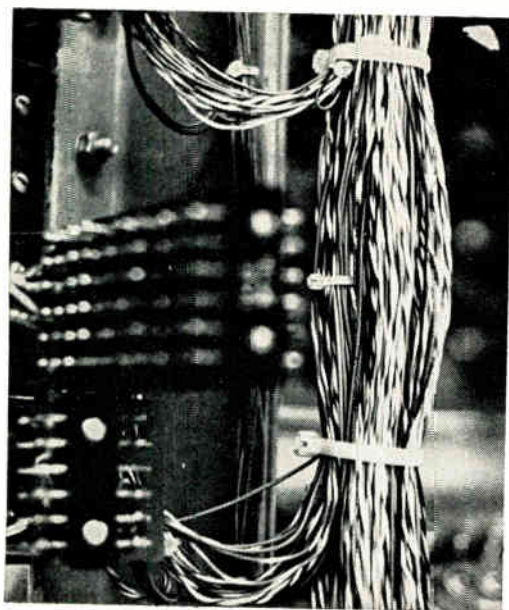

Over the past 6 years, thousands of installers have adopted the modern way to reduce costs and improve appearance in wire bundling. A quick inspection of your facilities will point up the many places where you can save money and gain tying convenience with TY-RAP ties and clamps.

The self-locking TY-RAP ties help reduce the costs of installation — they almost tie themselves. The art of making a neat, reliable tie is built into the product. The tough, nylon gives you a new degree of reliability. The uniformity of the ties enhances the over-all wiring appearance.

You'll be surprised to see the convenience and savings of this modern TY-RAP tying method. Write for samples and literature.

The Thomas & Betts Co., Incorporated • Elizabeth, New Jersey
In Canada, Thomas & Betts Ltd. • Iberville, P.Q.

Sold exclusively through authorized T&B Distributors.



Circle 41 on Reader Service Card

BROADCASTERS SPEAK

Sirs:

For several years we have enjoyed the receipt of *BM/E* at both our installations. It goes without saying that a copy of *BM/E* is certainly well "used" by the time it has made the rounds here . . . first, management grabs each issue, then of course we in engineering will manage to get our hands on the above mentioned publication! We enjoy *BM/E* very much.

As chief engineer of our complex, I make it a point to keep every copy of *BM/E* in our library; however, one of the most important issues has been misplaced.

Would you please send me a back issue? The copy I need is . . . May 1967.

In addition to the above, would you kindly add my name to your mailing list for the following Mactier publications: *EEE* and *Electronic Procurement*?

Thank you very much for your consideration and keep the *BM/E*s coming!

Richard Deese
Chief Engineer
WGRO Radio
Lake City, Florida

Sirs:

Reference: . . . "Three Plans for Receiving Weather Satellite Pictures," which appeared in the November, 1967 issue of *BM/E*. This was an excellent and informative article, but apparently gives the reader the impression that our firm is selling the type of surplus equipment referred to in part 3. I would like to mention that our facsimile recorders are *NOT* military surplus, but are late model commercial recorders that use 100-ft rolls of the . . . electrolytic type recording paper . . . used in all other late model facsimile recorders. Also, many thanks for the publicity that you gave us in this article, as we have sold a number of APT satellite receiving systems as a result.

L. Ray Newsome
Trenton, Mich.

Sirs:

Re: "Cigarette Ad Ruling et alia."
Of the four thousand odd radio stations across the country how many smaller market stations never run cigarette advertising of any kind? Maybe 1000 stations carry cigarette advertising.

If no cigarette advertising is broadcast, need we broadcast public service spots for or against lung cancer?

Then, is it not true that 3000 radio stations have no moral obligation under the so-called Fairness Doctrine to carry the health spots or

Circle 42 on Reader Service Card →

a new concept & performance in coaxial switching

TYPICAL PERFORMANCE CHARACTERISTICS

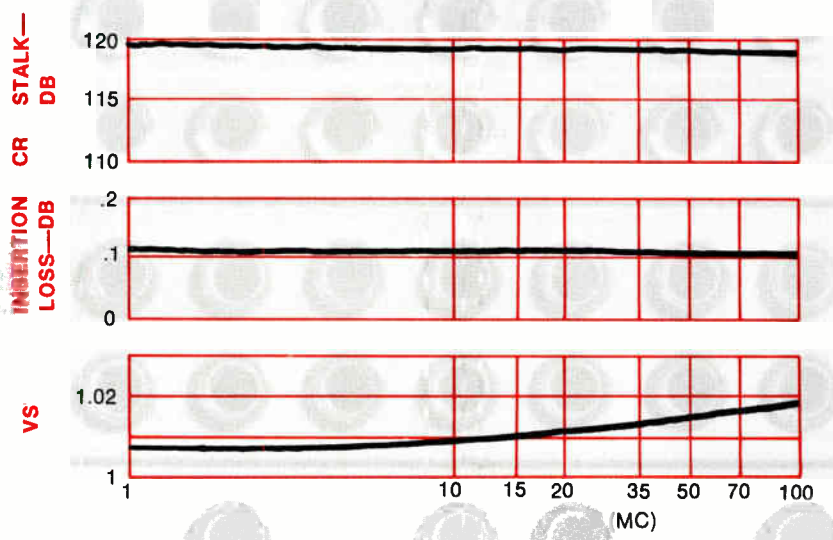

ONLY FROM COOKE Coterm 22T a normal-through coaxial* switching and terminating jack. * Patented

Complete compatibility and Cooke quality combine to make this coaxial switching equipment first choice for TV, radar, communication patching, data handling, etc. Advanced in concept, engineered for the utmost in reliability, it will provide years of dependable, economical service.

COOKE

ENGINEERING COMPANY

735 N. SAINT ASAPH STREET
ALEXANDRIA, VIRGINIA 22314

Test probe permits sampling or testing of normal-through circuit without interruption of signal

The Coterm 22T accepts either standard BNC connectors or Cooke-built quick-disconnect connectors.

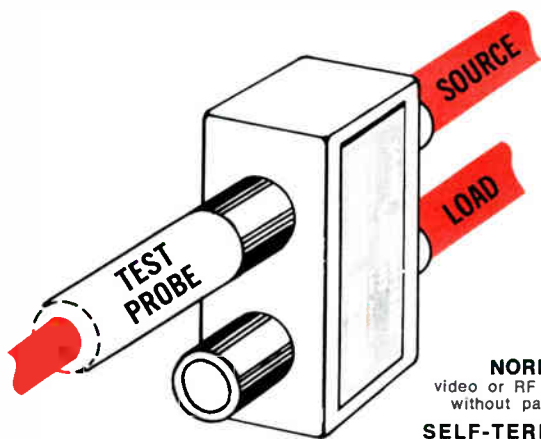

NORMAL-THROUGH
video or RF circuit is provided
without patch cords or plugs.

SELF-TERMINATION OF SOURCE without extra terminating plug
when load side is patched. Patched in circuit feeds load.

TOTALLY FLEXIBLE PATCH FACILITY of extremely
high density possible when patch cords are inserted on both
sides.

COJAX® Model 22B. This normal-through coaxial switching jack is built to the same dimensions and standards as the Coterm Model 22T. It performs all functions except self-termination. It accepts the same equipment as the Coterm so can provide a mixed patch field.

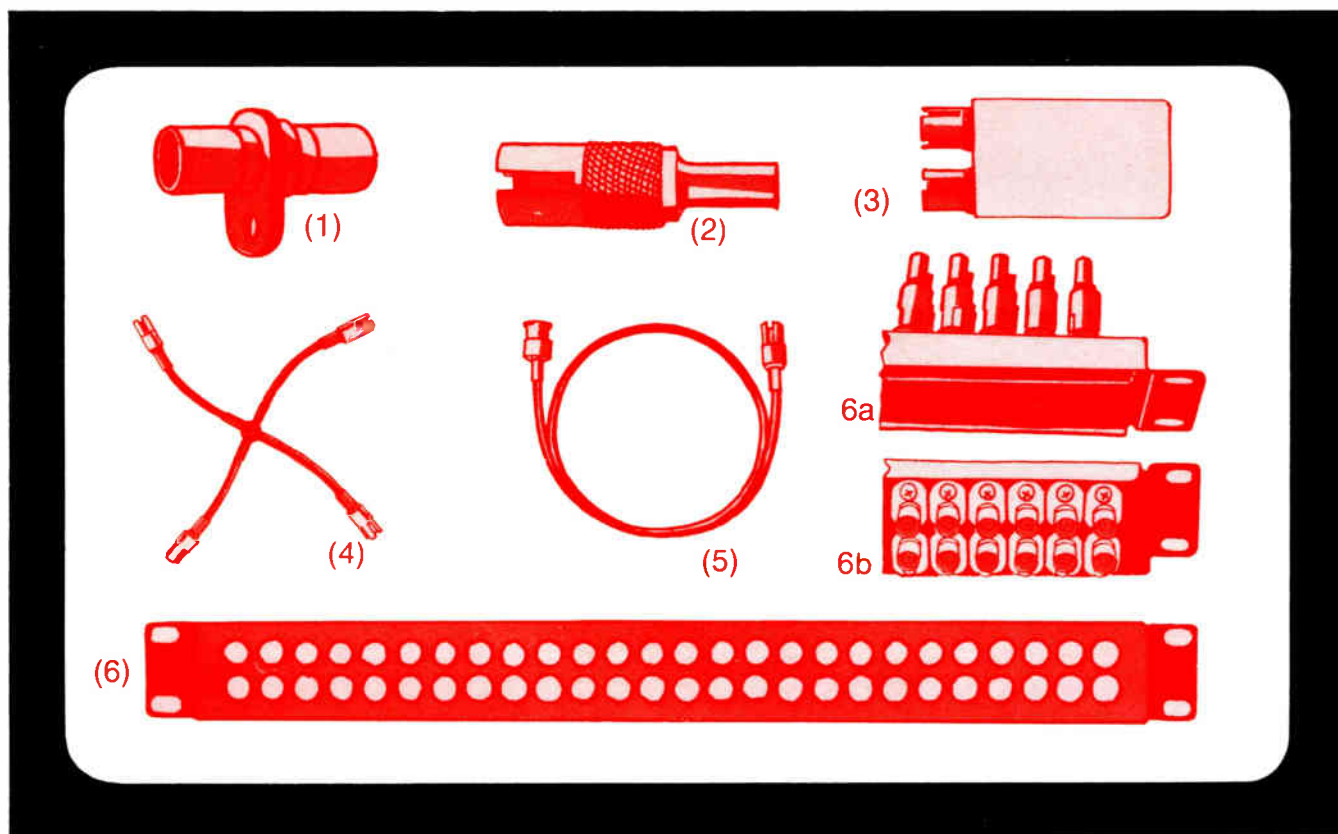
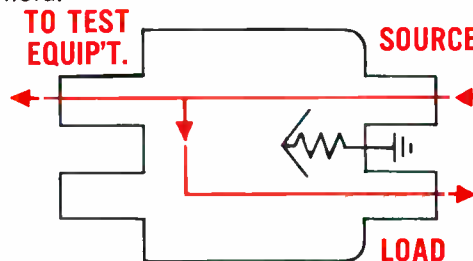

Other Cooke Coaxial Switching Equipment Available (1) Coaxial Patching Jacks. (2) Quick-Disconnect Snap-Lock Connectors*. (3) Quick-Disconnect Normalizing Plugs. (4) Bridging Networks, four and five way (four way shown). (5) Test and Patch Cords. (6) Panels . . . 6a showing permanent cabling, 6b showing Coaxial Patching Jacks, (1) above installed.

For further information write . . .

* Patented

COOKE

ENGINEERING COMPANY

735 N. SAINT ASAPH STREET
ALEXANDRIA, VIRGINIA 22314

Printed in the U.S.A.

200 stations on a common bus

independent of polarity

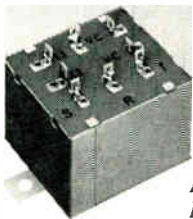

Model 90D
Interphone Amplifier

The Model 90D transistorized interphone amplifier is designed to meet the most stringent audio communications requirements. It replaces the Western Electric Type 101A induction coils commonly used in interphone systems. Its low operating current (30Ma @ 7.5 VDC) permits up to 200 conference connected units. Each unit has terminals for fixed or variable sidetone and level control. Operation is independent of 24 Volt "talk" bus polarity to protect against burnout. The Model 90D operates with a Western Electric Type 52A Telephone Headset or equivalent. Additionally, the 90D is capable of driving a loudspeaker with approximately 45 ohms voice coil impedance.

Bulletin IA967 proves that we build interphone amplifiers like no one else can.



DIVISION OF THOMAS A. EDISON INDUSTRIES
GRENIER FIELD, MANCHESTER, N.H. 03103
(603) 669-0940 • TWX 710-220-1747

Circle 43 on Reader Service Card

< Circle 42 on Reader Service Card

cancer spots? Is THIS in the public interest (*sic*)?

What we're trying to say is, "Fairness Doctrine" and "public interest" are not synonymous in our opinion. And if I carry no cigarette advertising and ergo no lung cancer spots, am I absolved? After all, I'm only following the Fairness Doctrine, because if I have to run the cancer spots, I have to be *fair* to the cigarette industry and run the advertising as well.

Personally, I don't feel that 3000 radio stations across America refusing to run the lung cancer spots are acting "in the public interest" . . . but who can blame them?

Al Kinsall
KEPS Radio
Eagle Pass, Texas

Sirs:

After reading the article "Production Practices—Good & Bad," I feel that a copy for each member of the staff would be nice. We are a strong number two in our market, and with the new look we have taken we are going to be number one soon. Ideas of the type in the article are very helpful to those of us stations that are in the large markets. Please print more of this type of article in your magazine. I usually read any article that pertains to radio as it seems to be a forgotten field. Radio is very important as it can reach more people with more information than any other media.

An article you published earlier this year on news operations prompted our news staff to purchase the book.

Would you please send us 18 copies of the article "Production Practices—Good & Bad," which appeared in the December 1967 issue?

Robert B. Ladd
Chief Engineer
Radio KLWW

Glad you find us helpful, R.L. As the commercial says, "Try harder," and maybe you will be number one! Copies on the way.

Sirs:

Mr. Akerman's article was certainly stimulating; certain points he brought out could evoke emotional discussions and perhaps a fist fight or two at any engineer's meeting.

Without dwelling on the relative advantages and disadvantages of triodes vs tetrodes, let me tell you the story of three transmitters. I believe in the long run that total performance is a determining factor. Transmitter 1 used 4-125A's. It was located in a rural area in the California desert. At the site, line regulation was exceptionally poor (the power company worked closely with us on this) and we would run an air conditioner constantly in the little building. The 4-125A's would fail every six months. Consulting the maintenance logs, one would see these tubes were replaced six months to the week on a long-time basis.



Performing
35
years
behind
the scenes

RCA BROADCAST SERVICE

Broadcasters' repair, modification, and overhaul needs are strictly behind the scenes. And RCA Service Company experts keep on providing *service* to keep all your broadcast equipment operating at peak performance. Take advantage of RCA's experience in AM, FM & TV servicing—on a contract or per-call basis.

Dial either of these offices for full information about fast, dependable RCA service:

Chicago (312) WE 9-6117

Philadelphia (215) HO 7-3300

If you prefer, write:
Technical Products Service

RCA Service Company

A Division of
Radio Corporation of America
Bldg. CHIC-225, Camden, N. J. 08101



Circle 44 on Reader Service Card

Engineering Excellence

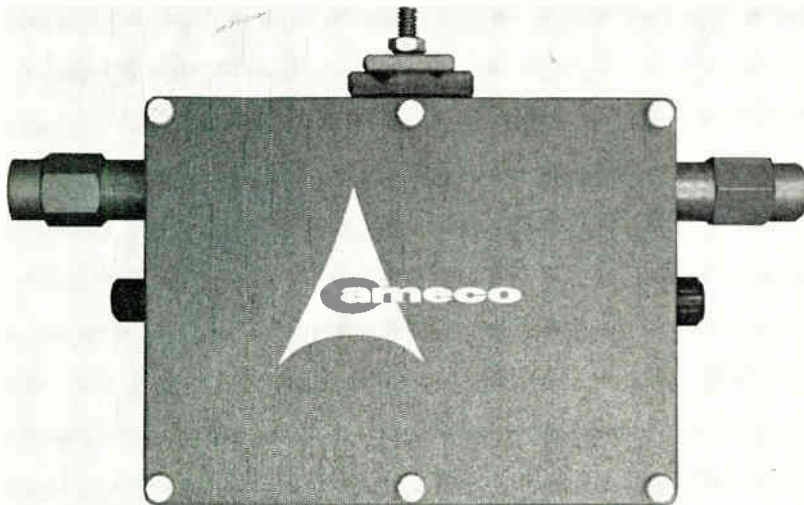

THE AMECO "PACER II" Line Extender

Now you can get Quality Engineering Design in a low-cost line extender—the Ameco "Pacer II". It provides higher output, built-in thermal compensation and lower noise to increase your customer count and give you longer cascades at less cost!

Call Ameco Sales today to order your Quality "Pacer II" Line Extenders. Or, write:

AMECO

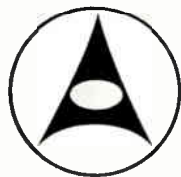

P.O. Box 13741-A • Phoenix, Arizona
85002 • Phone • (602) 262-5500

"Quality Equipment Where it Counts!"

Circle 45 on Reader Service Card

The transmitter manufacturer did not provide a filament voltmeter or any means of regulating filament or plate voltage.

Transmitter 2 used 4-400A's. Its location was in a rural area with slightly better line regulation than at site 1, although during certain periods voltage was quite low. The flashers on the three towers, flashing in phase, would cause interesting movements on the power line meter. These tubes were replaced once a year—and generally did not fail in service.

Transmitter 3 used 833A's. I replace these about once a year. This transmitter has a control and a meter for filament voltage, although on one setting the voltage will only vary from 9.7 to 10 volts. This transmitter will modulate consistently at 100 percent, where the other two would ride at 80 percent and peak around 95 percent. We sound louder, with the same power than another station in town; even on 250 watts at night, we are as loud as they are running 1 kW DA. I am sure it is because we can hang the modulation monitor at 95 percent.

I have had three filament failures on tetrodes and one on triodes.

Of course, in high-frequency work or simplified neutralization, there is nothing like a tetrode. Low driving power has advantages. But I like the 833A from a performance standpoint—I even liked the 829R! How about a word from some beam-power fans—anyone use the 813?

Paul Schuett
Chief Engineer
KWG, Stockton,
California

Sirs:

KLTZ Radio was very pleased to have you feature our Electronic Control Center in your November edition of *BM/E*. We have received many favorable comments since [it was published]. I'm pleased to announce also that my boss-owner-manager of KLTZ, Bill Holter, was delighted. Therefore would it be possible to forward to him about a dozen copies of this edition. Bill KLTZ accordingly if there is any charge. Thank you.

Robert E. Gilbert, C.E.
KLTZ Radio
Glasgow, Mont.

*November BM/Es on the way. R.G.
Glad you liked the treatment.*

Sirs:

I understand that your publication, *BM/E*, is circulated without cost to people engaged in broadcasting. If this is correct, please put my name on your circulation list.

Our center is in the process of establishing an ETV/ITV operation, and I feel that your publication will be of great aid in many ways.

I have one additional request. Is

E E C O O N T I M E

Video Tape Editing and Control System

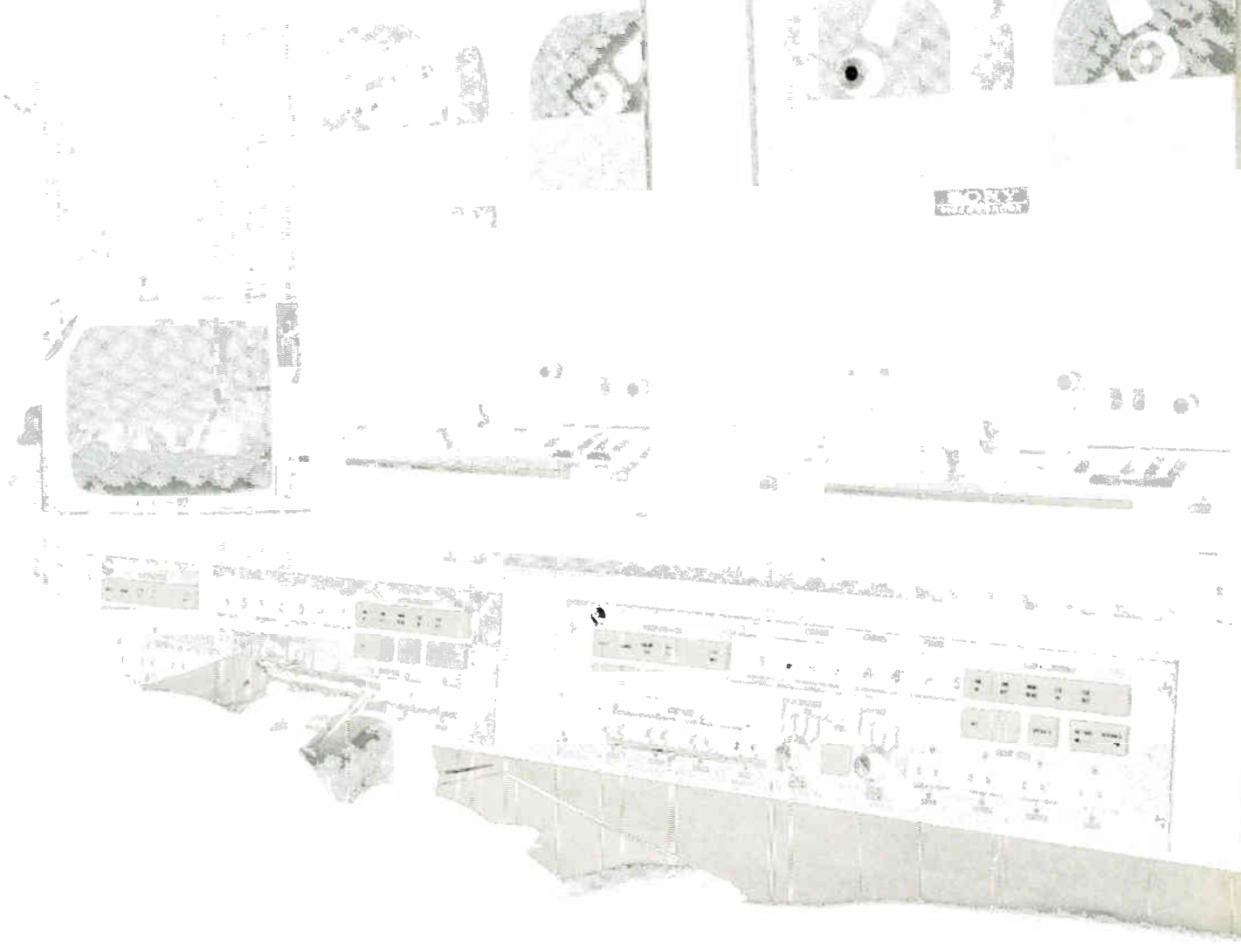

cuts video tape editing costs 75%



EECO's new ON-TIME Video Tape Editing and Control System can now be used with *either* quad-head or helical scan recorders. This means drastic cost reductions — 75%, in many cases — by permitting pre-editing on the helical scan unit, reserving the more costly quad-head machine time for final edit. EECO's ON-TIME pre-editing feature provides a work print and an editing log which allows you to make more than 30 edits per hour on your quad-head recorder. *Edit directly on video tape . . . no tape-to-film and film-to-tape transfers . . . no messy 24 frame-to-30 frame conversion table.* "EECO Time" recorded on the cue track of your video tape lets you find scenes quickly, controls electronic splicing to the precision of one frame, and accurately controls tape transport "stop" and "start" times. Get more information on EECO's money-saving ON-TIME system, and arrange for an early demonstration on your own recorder.



INSTRUMENTS DIVISION

ELECTRONIC ENGINEERING COMPANY OF CALIFORNIA

1601 EAST CHESTNUT AVENUE • SANTA ANA, CALIFORNIA 92701 • (714) 547-5501

Circle 46 on Reader Service Card

World Radio History



CATV SALES

- Openings at several levels exist for capable CATV sales engineers. We also have openings for individuals with a CATV technical background desiring the sales field.
- Excellent growth opportunities in a growing company with rapidly expanding activity in the CATV field.
- To obtain additional information on these salaried opportunities with liberal company benefits, or to arrange an interview, send resume to Larry Peetoom in complete confidence.

CATV DIVISION

AERICAN **E**LECTRONIC **L**ABORATORIES, INC.
RICHARDSON ROAD, COLMAR, PA.

Engineering positions in all areas of endeavor are available at the Colmar facility and in our Washington, D.C., Division in Springfield, Va.

Correspondence: Post Office Box 552, Lansdale, Pennsylvania 19446
Phone: 215-822-2929 TWX: 510-661-4976

AN EQUAL OPPORTUNITY EMPLOYER

Circle 47 on Reader Service Card

R-75 BROADCAST RECORDER / REPRODUCER

Proven best in use by numerous network radio, TV and FM stations!

UNDER *
\$1,000

Brilliant broadcast quality, most compact, most dependable, most easily serviced tape recorder/reproducer in the industry—the new R-75 is uniquely superior! Takes only 8¾" x 19" x 11½" rack space. New advanced solid state lifetime electronics with silicon transistor plug-in amplifiers; cool-running heavy-duty lifetime motors; handles thinnest triple play ¼" tape without breaking or stretching—3600 feet on a 7" reel gives 1½ hrs at 7½ ips (3 hrs @ 3¾ ips) mono or 2 & 3 track stereo! One R-75 and a 7" reel takes the place of two ordinary units!

High level output up to +25 dbm at 600/150 ohms, input transformer bridging 10,000 ohms, single or two speed, remote and automatic operation, slide-out rack mount, motion memory sensor, film sync, many more performance features and full line of accessories.

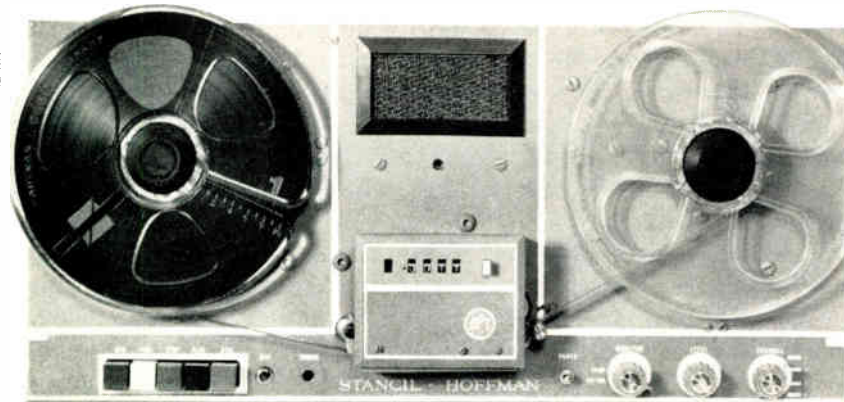

*prices from \$990.00

WRITE FOR SPECIFICATIONS AND PRICE LIST

STANCIL-HOFFMAN CORP.

921 NORTH HIGHLAND, HOLLYWOOD, CALIFORNIA 90038

Circle 48 on Reader Service Card

it possible that you could send, at your leisure, copies of articles pertaining to Educational or Instructional television, that have been featured in *BM/E*? They would be most valuable in our work, and welcomed by others as needed information.

Thank you for your cooperation, and I shall be looking forward to receiving your fine publication.

Thomas W. Levermann
Teacher, Educational TV
Job Corps Center for Women
Omaha, Nebr.

Our Circulation Director says you're on our list, T.L. In addition, we're sending back August issues which contain most of the articles of interest to you.

Sirs:

Again I feel compelled to write you to thank you for the real meaty articles on what other broadcasters are doing in the trade. I might make specific comments on the October issue. Although I'm not particularly concerned with farm broadcasting I was impressed with Ernie Tannen's article on his WDMV. I've heard the station frequently and they are a fine specialized service for an area in need of such a facility. If I may add to his observations that I'm certain many rural stations will watch his formula and no doubt copy it. (By the way Tannen's WEEZ is in Chester Pennsylvania, not Md. This station has specialized in C&W serving a neglected area in Philadelphia radio, and so successfully that a 50 kW has recently changed to Country music.) The article on WTHO and WCLV were also interesting.

I'm looking for more in future issues.

R. Alan Campbell
WDEL-AM-FM
Wilmington, Del.

Sirs:

I have recently started working for radio station WFRB. In looking through the back issues of *BM/E* I find that the May 1967 issue is missing. I would especially like to have this issue because of the article on proof of performance. If you could supply me with this issue it would be greatly appreciated.

Osborne C. Tasker
WFRB-FM
Frostburg, Md.

Somebody must've fallen in love with the May/67 cover, O.T. A replacement issue's on the way.

Sirs:

I have followed *BM/E* since its preview issue several years ago and I have a most complete library of this outstanding publication. From time to time I go back through the issues in search of articles on some subject.

Recently I came across an article called "Conducting A Frequency

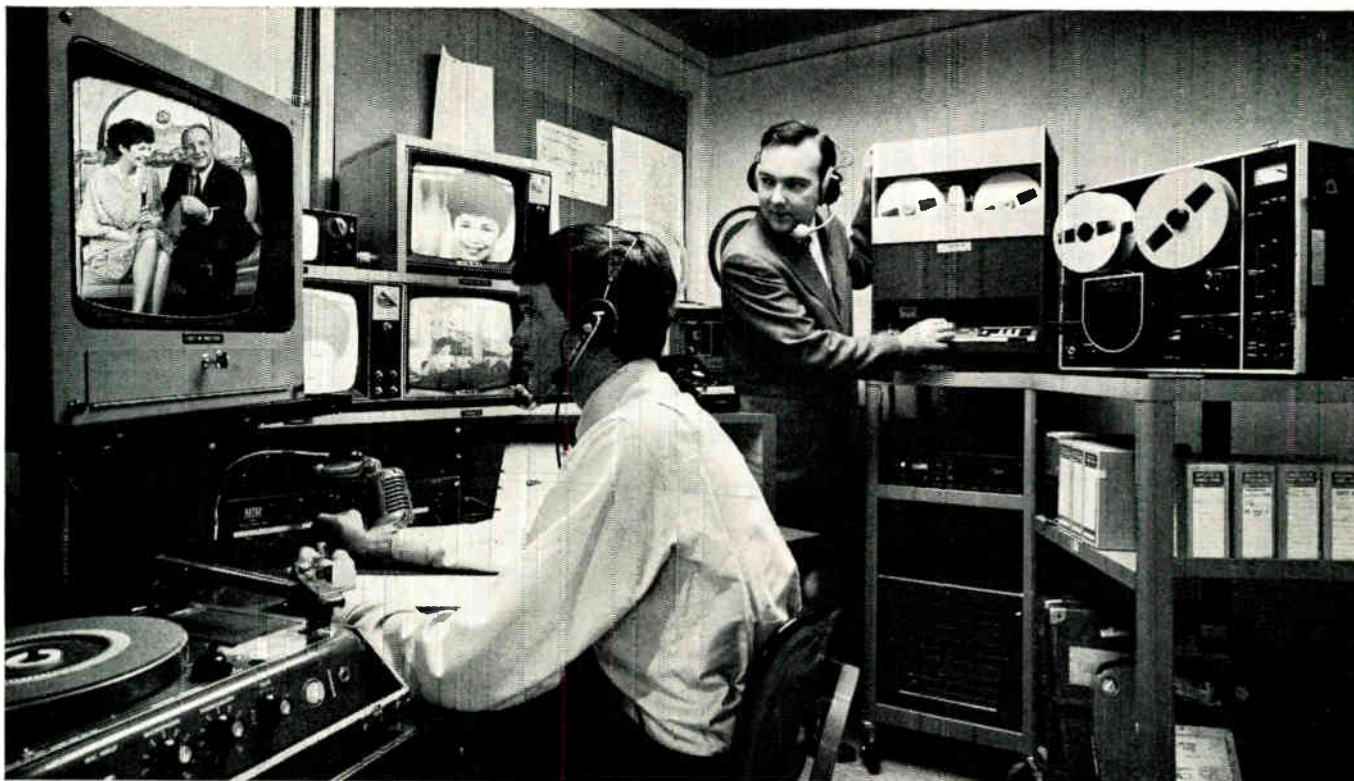

CLOSES THE CIRCUIT

— AT
ROSSMOOR LEISURE WORLD



SONY®

RESEARCH MAKES THE DIFFERENCE
SONY CORPORATION OF AMERICA
INDUSTRIAL DIVISION

516 W. Florence Ave., Inglewood, California 90301

Nestled in a corner of Clubhouse No. 1 at Leisure World, the all-adult community in Laguna Hills, California, is a CATV station that boasts the world's largest single-cable audience.

More than 11,000 subscribers watch Channel 6 as it beams programs of information, education and entertainment over a \$1.5 million cable during its 30 weekly broadcasting hours.

In a studio that is unique in arrangement and design, station producer/director Thom Keith, program coordinator Elizabeth Livingston and technical director Dane Keller handle all station chores. Six Sony monitors are part of the specially-designed console. All taping is done on Sony BV-120U and EV-200 Videocorders.®

"Stars" of the basic programs are residents of the community and members of the administrative staff. Lively ex-actress Hope Sansbury and Director of Community Relations and former songwriter Harry Babbit are regular features on Channel 6. Programming on a variety of subjects is taped for replay and exchanged with Leisure World's sister CATV station in Walnut Creek, California.

Says producer Keith, "We've designed and specified the equipment here specifically to apply to the situation. All anyone needs to become a TV mogul in a station like this are Sony Videocorders and some Sony monitors...and away you go!"

To find out how you can close the circuit on a CATV installation... and make it a profitable operation...write or call us today.

For complete details on this application, ask for APB 105.

Circle 49 on Reader Service Card

Dramatize TV weather

Alden facsimile weather data recorders reproduce pictures direct from satellites . . . all broadcast weather charts and data . . . vividly — permanently — economically.

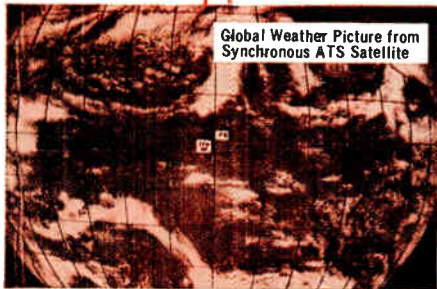

Global Weather Picture from Synchronous ATS Satellite

APT- Satellite cloud pictures from ESSA, NIMBUS, ATS enlarged to 10" x 10" for easier interpretation . . . using one of Alden's complete tracking/receiving systems or via land line from another system.



Weather Charts via radio from United States and international broadcasts.

Weather Charts via land line from U.S. Weather Copy Bureau in handy filing size (8½" x 11").

PLUS . . . remote hard copy reproduction of any weather radar scope presentation via slow scan TV over ordinary telephone lines.

Alden facsimile recorders are rugged and reliable — excellent for land or marine environment. Several models are available to suit space, application, and radio environment including Weather Bureau/Navy/Air Force standard units. If you already have an Alden 18 Weather Chart recorder, consider the Alden 11 Tactical Recorder for back-up . . . adding a second network . . . getting APT pictures. Several operating modes, all using Alfax paper for unlimited storage, tone shade response, permanent printing — and the color gives outstanding results on Television!

Purchase a recorder and build your own system or purchase a complete system from

ALDEN

Tel. (617) 386-4467
ELECTRONIC AND IMPULSE RECORDING EQUIPMENT CO., INC.
Washington Street, Waltham, Massachusetts

(Dept. BB-2)

Send information on the Alden 11 Tactical Recorder and complete Satellite Picture Receiving Systems.

Call me at once. My telephone number _____

NAME _____

COMPANY _____

ADDRESS _____

Circle 50 on Reader Service Card

Search," by Mr. John H. Battison, a consultant from Anapolis, Md. This article was in the November, 1965 issue, and was marked part one. After a thorough search for part two, I determined it was never published. *What happened to it?* The first part was most informative but not having the second part is like waiting for the other shoe to fall when the guy upstairs has only one leg. Thank you for whatever you can do and keep up the good work.

Raymond Meyers
Miami, Fla.

You're right, R.M.! Sorry for the feeling of anxiety, but after Part I was published we decided Part II wasn't necessary.

Sirs:

Thank you for the fine coverage of Grand Valley State College in *BM/E* of August, 1967.

May we order ten (10) additional copies of this issue?

If there are any charges for these please bill them to Grand Valley State College, Audio Video Services.

R.B. Hart
Audio Video Services
Grand Valley State College
Allendale, Mich.

Glad you liked the coverage, R.H. Additional copies are on the way.

Sirs:

In the November issue of *BM/E* reference was made by CFAC Radio Calgary, under "Broadcasters Speak," concerning the September issue of *BM/E*.

When they required 12 copies, I wanted to check my copy to see what I had missed that was so important to them. But alas, no September issue in my file.

Would you, therefore, RUSH via air mail a copy of the September 1967 edition of *BM/E*, please? Rest assured I will honor your costs as soon as received.

Perhaps you may care to suggest to your editorial staff that in a future issue space could be devoted to a short story from us here at 3UL, outlining our unique radio broadcasts. We are the only one of its kind in Australian commercial and noncommercial broadcasting, perhaps in the world for that matter! Is the idea a success? Let's say that we now enjoy a 52% share of the radio audience, in a town of 17,000 located 27 miles east of Warragul.

Sincere best wishes for the continued success of your outstanding magazine, which I believe fills a long overdue gap in the industry.

Colin McL. Cameron
Manager
Radio 3UL

On the way, C.C. Thanks for the offer of the story of your success, and your good wishes.

TULLITO®

SAFETY CLAMP

patented, other patents pending

A Lifesaver for workmen on . . . POLES/TOWERS/TANKS/STACKS/DERRICKS

Locks instantly — absolute safety assured. Fully approved by industrial commissioners and safety engineers.

Write for complete information—
MEYER MACHINE, INC.
P.O. Box 114 • Red Wing, Minn.

Circle 51 on Reader Service Card



VAROTAL VSP

VAROTAL V

VAROTAL XX

The TH Varotal series of lenses comes in several models, each with a number of variations. Color and B & W. Indoor or outdoor use. Servo or manual controls. And each basic optical model is convertible to various camera image formats so that changes in camera technology do not necessarily obsolete the lens. We can now offer these 10:1 lenses for immediate delivery. (Sorry, due to demand there is still a short wait for our 16:1 models).

For more information, call Jim Tennyson at (914) 358-4450.
 Or write Albion, 260 N. Route 303, West Nyack, N.Y. 10994. Telex 137442



Taylor Hobson V.F.L.* lenses

now
in stock

*VARIABLE
 FOCAL LENGTH

(Continued from page 11)

FCC Order Is Remanded

Pointing up the fact that FCC decisions are not always final, a Boston Court of Appeals recently overturned an FCC order requiring Presque Isle TV company to provide pre-release duplication protection to WAGM-TV in Preque Isle. The problem was that cable subscribers get network programs from CHSJ-TV in Canada as much as a week before they are shown on WGAM-TV. However, the cable system operators pointed out that the Canadian station signals are as

strong as WAGM-TV's in the areas involved, therefore people can also see CHSJ-TV with home antennas.

The Court rapped the FCC sharply for rejecting the cable company's statements about relative signal strengths and economic injury, saying "There was no justifiable basis for the Commission's sweeping them aside with a part of one sentence."

New System for Trenton, Maybe St. Louis & Brooklyn

The Teleprompter Corporation has been awarded the cable TV

franchise for Trenton, N.J. Trenton is located within the grade B contour of New York City channels and the grade A contour of Philadelphia channels. A Teleprompter spokesman said that the system will have a potential of 30,000 and they hope to serve 7000 subscribers by the end of their first year.

Teleprompter got a 20 year exclusive franchise in return for promise of payment of 5 percent of the system's gross revenue to the city of Trenton. The franchise also calls for a \$9.95 installation charge and a \$5.00 monthly service charge.

St. Louis took its first step recently toward a CATV system in that city. The Board of Aldermen is presently considering a bill to grant a nonexclusive franchise to St. Louis Cablevision Co., owned by Time-Life Broadcast, Inc. and local investors. According to Sean F. Murphy, manager of the newly formed firm, the system would provide 12 channels including a news-weather-time channel and a channel devoted to community education. Murphy said he expects the system to serve about 90,000 of the 263,000 dwellings in St. Louis within five years after a franchise is granted. This would make it the nation's largest system.

However, even if they get the franchise, St. Louis Cablevision will have to overcome the hurdle of the FCC's top 100 rule.

A novel noncable system has been proposed for Brooklyn, New York, by Bartell Media. Because underground cable conduits are not available in Brooklyn, Bartell wants to send signals in the 42-GHz range direct from his head end to apartment house receiving and distribution systems. Bartell has also applied to the FCC for a permit to test this system.

Spotmaster

Multiple Cartridge Playback Units

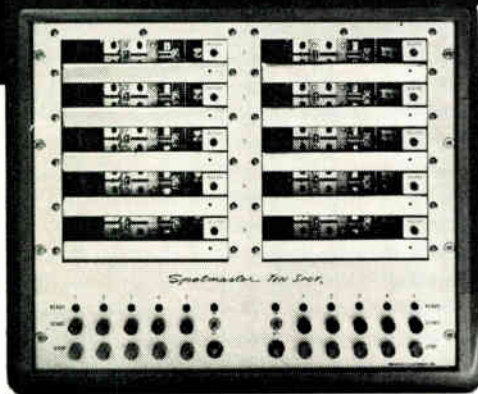

Ten • Spot Model 610B

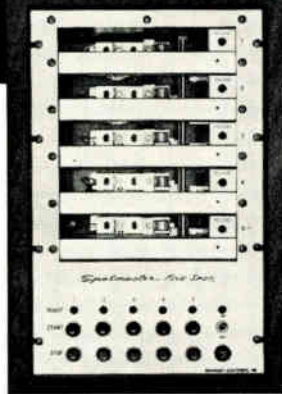

Five • Spot Model 605B

... bringing a new dimension to pushbutton broadcasting

Spotmaster Ten • Spot (holding 10 cartridges) and Five • Spot (holding five) will reproduce any NAB Type A or B cartridge instantly at the push of a button . . . at random or in sequence. They may be operated manually or incorporated into programmed automation systems, using one, two or three NAB standard electronic cueing tones.

The Ten • Spot is designed for 19" rack mounting while the Five • Spot is available either in an attractive walnut-finished case or with a 19" front panel containing a cartridge storage cubicle. Both are backed by Spotmaster's iron-clad full-year guarantee.

For further information about these and other Spotmaster cartridge tape units, call or write today. Remember, Broadcast Electronics is the No. 1 designer/producer of broadcast quality cartridge tape equipment . . . worldwide!

BROADCAST ELECTRONICS, INC.

8810 Brookville Road, Silver Spring, Maryland 20910; Area Code 301, 588-4983



Circle 53 on Reader Service Card



CATV construction equipment has come a long way in 15 years. Ameco's Physical Properties Director Ed Furman shows Bob Hewitt the "Chase & Sanborn lasher" one of the homemade devices Ameco used around the time of its incorporation in 1952. At left is a modern cable lasher.

BUSINESS REPLY MAIL

NO POSTAGE STAMP NECESSARY IF MAILED IN THE UNITED STATES

POSTAGE WILL BE PAID BY

BMIE

BROADCAST MANAGEMENT/ENGINEERING

Mactier Publishing Company
Subscription Department
820 Second Avenue
New York, N.Y. 10017

FIRST CLASS

PERMIT NO. 25039
New York, N.Y.

BUSINESS REPLY MAIL

NO POSTAGE STAMP NECESSARY IF MAILED IN THE UNITED STATES

POSTAGE WILL BE PAID BY

BMIE

BROADCAST MANAGEMENT/ENGINEERING

Mactier Publishing Company
Subscription Department
820 Second Avenue
New York, N.Y. 10017

FIRST CLASS

PERMIT NO. 25039
New York, N.Y.

BUSINESS REPLY MAIL

NO POSTAGE STAMP NECESSARY IF MAILED IN THE UNITED STATES

POSTAGE WILL BE PAID BY

BMIE

BROADCAST MANAGEMENT/ENGINEERING

Mactier Publishing Company
Subscription Department
820 Second Avenue
New York, N.Y. 10017

FIRST CLASS

PERMIT NO. 25039
New York, N.Y.

READER SERVICE CARD

BM/E - Broadcast Management/Engineering

Good until 4/30/68

GET MORE INFORMATION on products, free of charge. Just circle appropriate number below and mail card today.

Tell us what you like or dislike in this issue.

Pages # _____

Comments: _____

Be sure to write your name and address clearly.

1	11	21	31	41	51	61	71	81	91	101	111	121	131	141	151	161	171	181	191	201	211
2	12	22	32	42	52	62	72	82	92	102	112	122	132	142	152	162	172	182	192	202	212
3	13	23	33	43	53	63	73	83	93	103	113	123	133	143	153	163	173	183	193	203	213
4	14	24	34	44	54	64	74	84	94	104	114	124	134	144	154	164	174	184	194	204	214
5	15	25	35	45	55	65	75	85	95	105	115	125	135	145	155	165	175	185	195	205	215
6	16	26	36	46	56	66	76	86	96	106	116	126	136	146	156	166	176	186	196	206	216
7	17	27	37	47	57	67	77	87	97	107	117	127	137	147	157	167	177	187	197	207	217
8	18	28	38	48	58	68	78	88	98	108	118	128	138	148	158	168	178	188	198	208	218
9	19	29	39	49	59	69	79	89	99	109	119	129	139	149	159	169	179	189	199	209	219
10	20	30	40	50	60	70	80	90	100	110	120	130	140	150	160	170	180	190	200	210	220

YOUR NAME AND ADDRESS:

Name: _____

Title _____

Station or Company _____

Street _____

City _____ State _____ Zip _____

The information requested is for Immediate Use Future Use

COMPLIMENTARY SUBSCRIPTION QUALIFICATION CARD

1. I would like to receive BM/E — Broadcast Management/Engineering Yes No

2. I specify purchase Capital Equipment
 approve the purchase of: Replacement Parts
 Services
 None of the above

AM FM TV Station(s)
 CCTV (Educational-Theatrical-Industrial)
 CATV Facility
 Telephone Company
 Government
 Other _____

3. My company is _____

4. I am responsible for Multiple Facility
 Single Facility

5. Your signature _____ Title _____ Date _____

6. The address below is correct

7. For Address Change — Give OLD Address below

NAME _____ TITLE _____

Is this your business address?

Yes No

If not your business address, please give us your business address below so that we can avoid sending duplicate copies.

STATION or CO. _____

STREET _____

CITY, STATE, ZIP _____

Firm Name _____ Business Address _____ City _____ State _____ Zip _____

READER SERVICE CARD

BM/E - Broadcast Management/Engineering

Good until 4/30/68

GET MORE INFORMATION on products, free of charge. Just circle appropriate number below and mail card today.

Tell us what you like or dislike in this issue.

Pages # _____

Comments: _____

Be sure to write your name and address clearly.

1	11	21	31	41	51	61	71	81	91	101	111	121	131	141	151	161	171	181	191	201	211
2	12	22	32	42	52	62	72	82	92	102	112	122	132	142	152	162	172	182	192	202	212
3	13	23	33	43	53	63	73	83	93	103	113	123	133	143	153	163	173	183	193	203	213
4	14	24	34	44	54	64	74	84	94	104	114	124	134	144	154	164	174	184	194	204	214
5	15	25	35	45	55	65	75	85	95	105	115	125	135	145	155	165	175	185	195	205	215
6	16	26	36	46	56	66	76	86	96	106	116	126	136	146	156	166	176	186	196	206	216
7	17	27	37	47	57	67	77	87	97	107	117	127	137	147	157	167	177	187	197	207	217
8	18	28	38	48	58	68	78	88	98	108	118	128	138	148	158	168	178	188	198	208	218
9	19	29	39	49	59	69	79	89	99	109	119	129	139	149	159	169	179	189	199	209	219
10	20	30	40	50	60	70	80	90	100	110	120	130	140	150	160	170	180	190	200	210	220

YOUR NAME AND ADDRESS:

Name: _____

Title _____

Station or Company _____

Street _____

City _____ State _____ Zip _____

The information requested is for Immediate Use Future Use

YOU WON'T FIND A PANIC BUTTON ON A MAGNECORD!



When Magnecord engineered a long list of safety factors into their professional line of tape recorder/reproducers . . . they engineered the emergencies out! A sturdy die-cast mainplate, supporting the transport in every model, insures precise location of internal parts under the roughest operating conditions. Rigid die-cast head mounts eliminate alignment problems. Professional quality hysteresis synchronous

capstan motor and individual reel drive motors are heavy duty models, and the capstan shaft assembly is re-inforced for extra strength and longer life.

While you are taping, safe-guard operating features protect your thinnest tapes. With Magnecord you get top-notch performance and superb fidelity to keep your taping facility operating at maximum capacity, even after years of constant use. Ask a broadcaster who uses one . . . Magnecords are built to take it!

Write now for the full story on the complete line of durable quality Magnecord tape instruments.

Magnecord 8+ Reels now available from Audiotape®. See your local dealer.

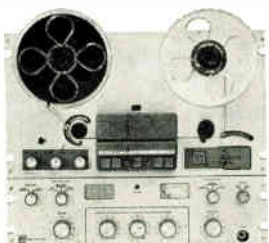
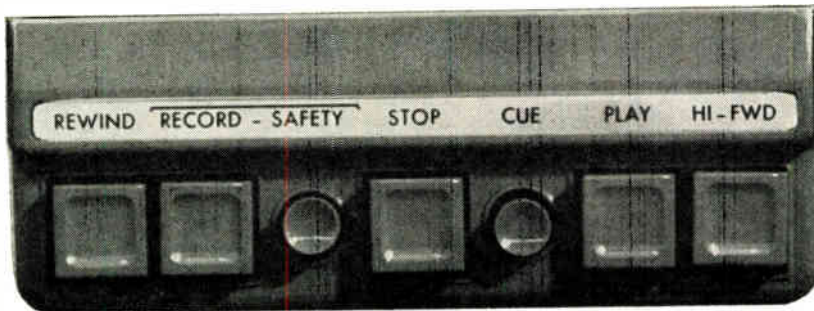

MAGNECORD MODEL 1021
Fully transistorized professional tape recorder / reproducer for monaural operation. For use in main or production control room.

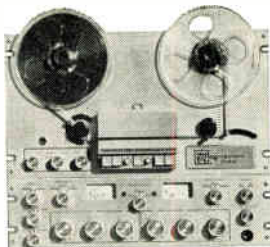

MAGNECORD MODEL 1022
Fully transistorized professional tape recorder / reproducer two channel (stereo) for use in main or production control room.



MAGNECORD MODEL 1028
Professional quality 2 channel (stereo) tape recorder / reproducer for recording master tapes. (10½" reel capacity) Available in ½- or ¼-track.



MAGNECORD MODEL 1048
Professional 2 channel (stereo) recorder/reproducer for use in main studio, production studio or conference recording. (10½" reel capacity) Model 1048 is available in ½- or ¼-track.

MAGNECORD
tape recorders
DIVISION OF THE TELEX CORPORATION
9600 ALDRICH AVENUE SOUTH
MINNEAPOLIS, MINNESOTA 55420

Circle 54 on Reader Service Card

LITERATURE of INTEREST

For additional data, circle No. shown on Reader Service Card.

Coaxial cable—9800 Series—for TV, CCTV, MATV, fm, ETV and other applications is tabulated in 8-page catalog from Alpha Wire. **150**

"Color Television System Planning Guide" includes specifications for Cohu's 1000 Series color camera system and 1900 Series camera control unit. **151**

Color bar generator is described in Data Sheet 6-463 from Cohu. **152**

Videotape recorder—Model VR-1200B from Ampex—has features

and specifications listed in Bulletin V138. **153**

High band VTR—Model VR-2000B—is presented in 8-page, 4-color Bulletin V131 from Ampex. **154**

"Battelle Technical Review," September 1967, contains abstracts of monographs on 51 technical topics from Administration to Welding and joining. **155**

Radio common carrier communications services are presented in brochure from Motorola Communications and Electronics. **156**

Metal plate connectors are the topic of 28-page design manual from Elco. **157**

Wiring system for high-density, quick disconnect applications is presented in 16-page Bulletin 500.1 from Thomas & Betts. **158**

Neon glow lamp description and evaluation is discussed in 8-page illustrated brochure from Thomas & Betts. **159**

Caption scanner and auxiliary equipment are described in date sheet from TV Zoomar. **160**

"TV Basics," vol. 6, from Television Bureau of Advertising of Canada, presents media data and statistics of Canadian television. **161**

Communications test equipment, including wave analyzers; modulation meters and standard signal generators with a-m and fm functions, fm multiplex signal generator and modulator, are presented in 6-page color brochure from London Company. **162**

Interconnection problems encountered with mixers, mics, amplifiers, etc., can be solved by using audio connector adapters such as those described in Data Sheet 171 from Switchcraft. **163**

Audio accessory interconnection adapters are presented in Data Sheet 170 from Switchcraft. **164**

Questions and answers about grip connectors and directional taps are presented in bulletin entitled "Special In-Use Report" from Craftsman. **165**

Semiconductor Buyers Guide from Milo Electronics contains detailed procurement information, engineering data and drawings, prices, etc. Guide is free to qualified personnel. **166**

Strip chart recorder line, including ammeters, voltmeters, milliammeters and microammeters, are presented in 6-page catalog from Ampex. **167**

Signal generator applications, written by three authors, are presented in publication number 5 of "Measure-test" from Marconi Instruments, Ltd. **168**

Zener diode guides from Motorola Semiconductor Products present selection data in two formats. Forty-page guide contains cross reference guide, selector guide, special selections and package dimensions. Condensed selector guide is a wall or desk mountable key to more than 6000 solid-state devices. **169**

"Precision Tools for Electronics, Telephone & Communications" is a 16-page booklet from Jonard Indus-

tries describing standard and custom tools used in communications. **171**

Profit package from Ameco contains issue 34 of "Tech Topics" and "Business Booster." A standardized procedure for checking CATV system performance and effective advertising are the topics. **172**

Tape duplicating hows and whys, Part II, are presented in vol. 4, no. 4, of "Headliner" from Nortronics. **173**

"Pacesetters in Innovation, Fiscal year 1966" contains brief reviews of more than 1000 projects approved under Title III of the Elementary and Secondary Education Act of 1965, authorizing supplementary centers and services for the nation's schools. Book is available from Superintendent of Documents for \$2.50. **174**

Catalog GC-68 from Bird (60 pages) presents full line of rf power measurement instruments and technical data such as load resistor derating curves, vswr nomograph, etc. **175**

"Marconi Instrumentation," vol. 11, no. 1(A), contains 7 interesting technical articles including "Multiple period averaging of a Signal in the Presence of Noise" and "Inductance Measurement at Audio Frequencies." **176**

"Marconi Instrumentation," vol. 11, no. 2(A), 6 interesting technical articles including "Intermodulation in V.H.F. receivers and Signal Generators" and "Mod and Intermod." **177**

Automatic telegraph tone equipment, including a-m tone transmitter and receiver, and frequency shift audio tone transmitter and receiver, are described in brochure from Trepac Corp. of America. **178**

CATV distribution equipment from ColorVue Division of AEL is described in foldout brochure. **179**

Passive repeater brochure featuring specifications and dimensional drawings is available from Microflect Co. **182**

Microwave equipment that converts baseband signals to 70-MHz i-f, frequency modulated signals is described in data sheet from Raytheon. **183**

Line construction material, linemen's equipment, bare and stranded wire and CATV equipment are among items featured in catalog from Pruzan Co. **184**

Transmission and drop line cable for CATV applications is described and depicted in 4-page brochure from Amphenol Cable Division. **189**

CRTs for flying spot scanners and many other types are presented with tabulated specifications in catalog from Thomas Electronics. **190**

Four-way frequency combiner which enables up to four people to converse simultaneously on a four-wire party line (Model B155) is described in data sheet from Lynch Communications Systems. **191**

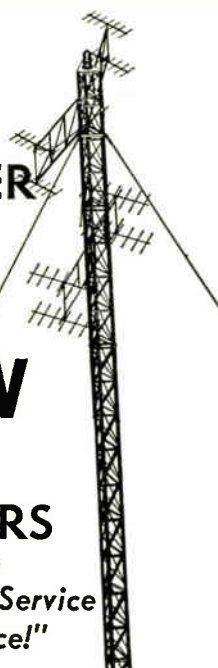

THE
LEADER
IN
CATV
TOWERS

"Quality—Service
and Price!"

Yes, quality, service and price on CATV systems are the reasons for Fort Worth Tower's position as the industry's leading supplier. Experience gained as a pioneer supplier of CATV enables Fort Worth Tower to provide you with a quality product at a price that is reasonable and attractive.

Take advantage of our experience. For assistance in systems planning, engineering and complete systems quotations . . .

CALL OR WRITE TODAY

Fort Worth Tower

COMPANY, INCORPORATED

P. O. Box 8597, Fort Worth, Texas
(817) JE 6-5676

— Associated Companies —
Tommy Moore, Inc.
Big State Engineering, Inc.
Tower Construction Finance, Inc.

Circle 55 on Reader Service Card

CUSTOM LP PRESSINGS

- Fast Service
- High Quality
- Short Run
- Low Cost

We have complete facilities for providing the custom pressings that will enable you to profit from E. T. circulation, sales of LP recordings to local groups, etc. Mono or stereo, 12" and 7". You send us your tapes and label copy—we do the rest.

Write for full information and free manual on custom pressing.

COOK LABORATORIES, INC.

351 Courtland Street • Stamford, Conn. 06906
Phone 203-348-7578

Circle 59 on Reader Service Card



CUSTOM 12" also available in STANDARD 12" or 16"

Who put the "able" in turntable

If you're one of the multitude of QRK users in the U.S. or elsewhere in the world, you own the answer.

If you need another guess . . . it's a three letter word that rhymes with A-OK. (And it is, too!)

When it comes to the cold facts of buying, you needn't guess where the "able" came from. Write us for the addresses of the QRK owners nearest you. Call them, see them. Add their opinion to our information. You, too, will soon "own" the answer to "who put the 'able' in turntable?" QRK . . . naturally!

See your dealer today or call or write us for complete information.



QRK ELECTRONIC PRODUCTS

2125 N. Barton, Fresno, Calif. 93703
Telephone: 209/255-8383 or 209/229-6128

Circle 60 on Reader Service Card

FM AM TRANSMITTERS

AM-5KA 5,000 WATTS

Sola regulated • Five tube types
One-button operation • Less than 2.5% distortion



FM-7.5KA 7,500 WATTS

Uses 4CX300Y driver with field-proven 4CX5000A final • Complete tuning and switching up front • Running-time meter



AM-50KA 50,000 WATTS

Air cooled • Conventional high-level modulation • Motorized tuning control



FM-1KA 1,000 WATTS

Screen DC grounded • 4CX1000K power amplifier, requiring less than 8 watts of drive • 6 tube types • One-button operation



AM-1KA 1,000 WATTS

Sola regulated with built-in dummy load • Automatic recycling • Remote control • Three tube types



STOCK DELIVERY*
COMPLETE EQUIPMENT PACKAGES
CALL OR WRITE
FOR COMPLETE INFORMATION!

*Subject to prior sale

AEL

American Electronic Laboratories, Inc.

BROADCAST EQUIPMENT DIVISION/Colmar, Pa.
Correspondence: P.O. Box 552CL, Lansdale, Pa. 19446
Phone 215/822-2929 • TWX: 510/661-4976

Circle 58 on Reader Service Card

ENGINEERING CASEBOOK

Stereo STL

Here's how one station eliminated its land-line connection for an a-m station and a remotely-located affiliate.

TO PROVIDE the wide bandwidth necessary for stereo broadcasting and to establish the highest degree of reliability, Radio Hanover, Inc., Hanover, Pa., recently completed installation of a 2-channel STL system to control, meter, and program its stereo fm affiliate—WYCR (York-Hanover)—located in the Pidgeon Hills, 5 miles northeast of Hanover.

Studio Equipment

The fm remote control point—

as well as studio facilities—is located in the a-m studio-transmitter building. The heart of the 950-MHz band system is the Moseley PCL-2B STL transmitter, since it is used to transport control, metering, and program data to the fm site. Stereo program material is fed to the STL transmitter, along with a 26-kHz signal from a Moseley SCG-5 control generator. The control generator provides tone signals on command from the PBR-21 studio control unit to turn the fm transmitter on and off, adjust the necessary operating parameters, and to meter the operating parameters remotely. As the block diagram in Fig. 1 shows, the control equipment fits into a stand-

ard 19-in. rack. The STL transmitter is housed in a separate cabinet near the control rack.

At the fm transmitter site, the STL receiver picks up the 950-MHz band signal from the control point. Here, the stereo audio and 26-kHz control signals are separated. The audio is passed through a 15-kHz low-pass filter to remove the 26-kHz element. The control signal with its tone modulation is passed to the SCD-1A 26-kHz detector where the tone signals are removed and fed to the PBR-21 transmitter control unit. At this point the tones activate the appropriate transmitter control circuit or switch to any of the dc sampling voltages coming from

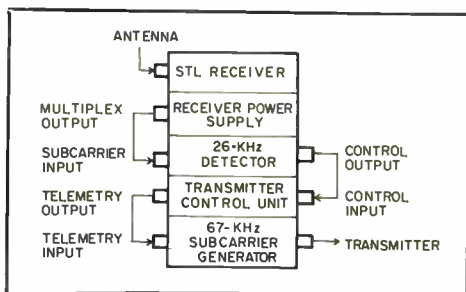

Fig. 1. Studio equipment rack layout.

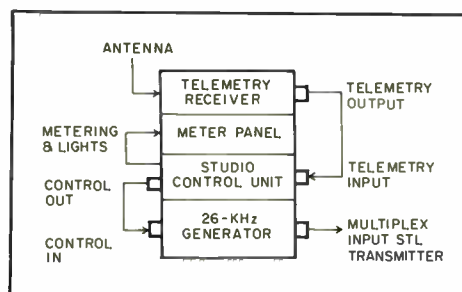

Fig. 2. Remote (transmitter) equipment rack layout.

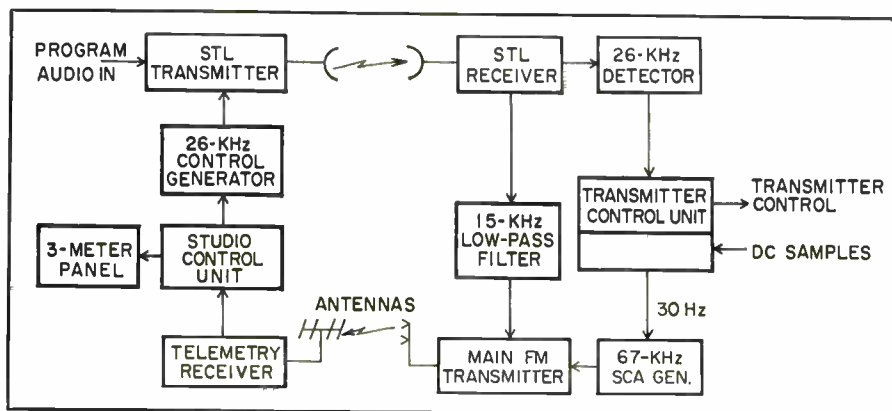

Fig. 3. Block diagram of the complete system.

Mounting and positioning equipment for cameras and space-age instruments



GENERAL PRECISION LABS Closed Circuit TV Camera on PS-34 Pedestal Stand with Model HD head. Model HD head features internal torsion spring to prevent camera dumping during extreme forward and backward tilts.

The PS-34 makes possible an infinite number of applications for mounting and positioning. It has "floating action," which means the actual weight of the camera is perfectly counterbalanced by a sturdy spring—just a touch and the camera automatically "floats" to the level you desire—stays there.

D & S offers the most complete line of stands and tripods. When standard models will not meet the requirement, we design and manufacture special tripods to order. Send us your specs.

For more information write: Dept. BM-F68

DAVIS & SANFORD

24 Pleasant St., New Rochelle, N. Y.

Circle 56 on Reader Service Card

The soundest sound in FM is the new sound of GATES

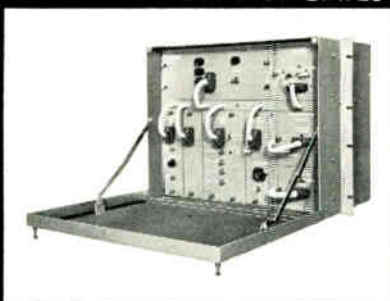

Sorry our DCFM* made your FM transmitter so obsolete

Gates 100% solid-state 10-watt exciter employs *Direct Carrier Frequency Modulation, with 35 dB minimum stereo separation. The TE-1 Exciter is the heart of all new "H" series transmitters—one tube (1 KW), two tube (3, 5, and 10 KW), and three tube (20 KW). All FCC-type accepted, ready for prompt shipment. Phone (217) 222-8202.



GATES

GATES RADIO COMPANY
QUINCY, ILLINOIS 62301, U.S.A.

A subsidiary of Harris-Intertype Corporation

Circle 61 on Reader Service Card

February, 1968 — BM/E

Stereo STL (Continued)

strategic points in the fm transmitter.

Remote metering is accomplished via a 67-kHz subcarrier on the 98.5-MHz main carrier. Dc sampling voltages modulate a telemetering oscillator which in turn modulates the SCG-4 subcarrier generator. As shown in Fig. 2, the transmitter site equipment fits easily into a single 19-in. rack.

Remote Control Functions

Transmitter parameter readings are selected at the remote control point by means of a series of buttons, each representing a particular function. By pushing the desired button on the remote control unit the control generator provides a signal which (via the stereo STL) selects the appropriate dc sampling voltage in the telemetering oscillator. When this action occurs, the telemetering oscillator modulates the subcarrier generator with the transmitter metering information and radiated with the main fm transmitter output. At the studio, a telemetry receiver picks up the fm signal and, after demodulation, feeds the telemetry data to the studio control unit. Metering then appears on the appropriate meter on a 3-meter panel.

Control functions include transmitter ON/OFF, RAISE/LOWER plate and filament voltages. Metering functions include frequency deviation, modulation, plate and filament voltages, transmitter output, and tower lights. A Scala 450 parabolic antenna is used at both the remote control point and at the fm site.

In the WHVR installation the STL and control system affords—apart from improved operation—much more flexibility than did the use of land lines. But even with the increased flexibility, the system is really quite simple, as the block diagram in Fig. 3 indicates. Should it become necessary or expedient, additional metering and control functions are immediately available in the equipment, including a provision to feed an automatic logger. Also, when it is desirable to simulcast a-m and fm programming, the a-m operator simply throws a switch located in the a-m control room.



Leadership presents

the NEW Computer Logic Control Pro 800 Transport



MODEL SX 824

In the league of nimble-fingered tape-handlers there exists a recurrent problem. It has been demonstrated time and again that anyone can ruin a valuable tape by absentmindedly outsmarting the interlock system of an otherwise safe tape recorder.

In answer to this problem and similar problems arising in automated and remote control applications, the CROWN Pro 800 was designed. This recorder has a computer logic system using IC's which prohibit all such destructive operations.

The CROWN computer stores the last command given it in its memory (forgetting all previous commands) and by a continuous knowledge of the operating state of the machine (motion and direction), it takes all the necessary measures and executes the command. This is all done without time-wasting delay mechanisms.

Computer Logic Control brings to you rapid error-free tape handling. It is actually impossible to accidentally break a tape. Call your CROWN dealer NOW!

MOST PERFECT REPRODUCTION

- ⊞ Performance as yet unequalled
- ⊞ Four years proven Solid State circuitry
- ⊞ Extremely low noise electronics

FINEST TAPE HANDLING

- ⊞ Computer smooth operation
- ⊞ True straight line threading
- ⊞ Patented Electro-Magnetic brakes never need adjusting

Write to

Crown International
Box 1000, Dept. BM-2
Elkhart, Indiana 46514

Circle 62 on Reader Service Card

BM/E CLASSIFIED MARKETPLACE

CLASSIFIED ADVERTISING RATES

SITUATIONS WANTED: 15¢ per word; \$2.00 minimum
 HELP WANTED: 20¢ per word; \$2.00 minimum.
 ALL OTHER ADVERTISING: 25¢ per word; \$3.00 minimum.
 BLIND BOX NUMBERS: No extra charge. Send replies to address below.

DISPLAY CLASSIFIED ADVERTISING: \$21.50 per inch 1x; \$20.00 per inch 6x; \$18.50 per inch 12x. Professional Cards \$15.00 12x.
 CASH DISCOUNT: 2% cash discount if remittance accompanies order.
 CLOSING DATE: 5th of the second month preceding issue date.

BM/E, Monterey and Pinola Avenues, Blue Ridge Summit, Pa. 17214 Phone 717/794-2191

BUSINESS OPPORTUNITIES

FRANCHISE DISTRIBUTORSHIPS FOR SEEBURG BACKGROUND MUSIC

We are expanding our distributor territories, and offer to those who qualify franchises for background music, with phone lines, FM Multiplex, or on-premise systems.

Complete details forwarded on request:
 Address:

Joseph F. Hards, Vice Pres.
 SEEBURG MUSIC LIBRARY, INC.
 1500 North Dayton Street
 Chicago, Illinois 60622

Growing CATV system for sale or lease—Southern Kentucky. Excellent return on investment. Reason for selling, relocation of owner. Box 268-10, c/o BM/E, Blue Ridge Summit, Pa. 17214.

POSITIONS WANTED

ATTENTION S.E. FLORIDA!

Managers right hand man available June 1st. Detail man capable of full responsibility for internal affairs. Get back out on the street with a clear conscience. Box 268-28, c/o BM/E, Blue Ridge Summit, Pa. 17214.

Columbia College Student desires full or part-time work on radio station within reasonable commutable distance of Chicago. Draft exempt. School schedule is workable. Experienced and has third class endorsed. Also graduate of Midwestern Broadcasting School. All around ability in field. Excellent sportscaster. Tapes and resume available. Contact Greg Sherlock, Suite 2105 166 E. Superior, Chicago, Illinois 60611.

Top Negro personality, thoroughly trained under actual broadcast conditions in Atlanta's first, finest and foremost broadcasting school. Some experience and will relocate. Military service completed. Leroy Williams, 353A Archerway, N.W. Atlanta, Ga. 30314 or call (404) 753-5358.

Trouble shooter—8 years television experience—including sales and general manager of small ABC affiliate. Unique ability to recover lost business, improve community relations and station image. Box 268-2, c/o BM/E, Blue Ridge Summit, Pa. 17214.

Southeast—Sales manager with announcing and play-by-play experience seeking future management, ownership opportunity. Prefer small market sports-minded station, 33, family, excellent character, college graduate. Box 268-11, c/o BM/E, Blue Ridge Summit, Pa. 17214.

Negro announcer, authoritative newscaster, family man, tight board, non floater, non prima donna. Graduate of New York broadcasting school. Have third class ticket. Box 268-12 c/o BM/E, Blue Ridge Summit, Pa. 17214.

TV News Director—Currently employed in major Calif. market. Young, aggressive, proven administrative ability. Journalism degree. No air work. Will relocate. Box 268-13, c/o BM/E, Blue Ridge Summit, Pa. 17214.

POSITION WANTED (cont'd.)

Well rounded dj-announcer middle of road and rock shows. Authoritative newscaster, draft free, 3rd class. Good commercial delivery, willing to settle. Box 268-4, c/o BM/E, Blue Ridge Summit, Pa. 17214.

Award winning newsmen with degree and second phone. . . . Seeks a permanent position as a News Director or PD. Full details in first letter. PD position preferred. Box 268-5, c/o BM/E, Blue Ridge Summit, Pa. 17214.

On air TV news position wanted, east coast desired. Experienced in newspaper, radio-TV news reporting. Degree. Anywhere in U.S. Box 268-3, c/o BM/E, Blue Ridge Summit, Pa. 17214.

DJ announcer, bright swinging sound, 3rd class endorsed wants to settle, authoritative newscaster, personable not a floater or prima donna. Box 268-6, c/o BM/E, Blue Ridge Summit, Pa. 17214.

Professional sounding beginner. Top broadcasting school student. 3rd class endorsed. Seeks southern California station experience. Box 268-7, c/o BM/E, Blue Ridge Summit, Pa. 17214.

Announcer: Navy Retired—Available February, 3rd Endorsed, Hard Worker, Reliable, Tapes on Request, Les Prough 1316 4th Avenue South, Fort Dodge, Iowa. Call 515-573-4451.

Newscaster-analyst: mature, writer; full-time or part time, day or evening. NJ-NY-Phila., area. Box 268-14, c/o BM/E, Blue Ridge Summit, Pa. 17214.

Announcer, newscaster, bright personality and crisp delivery. Family man, willing to settle, run a tight board. Box 268-15, c/o BM/E, Blue Ridge Summit, Pa. 17214.

Soul jock—3rd endorsed, tight board. Draft exempted. College training, relocate. Box 268-16, c/o BM/E, Blue Ridge Summit, Pa. 17214.

Kovacs-type TV personality/writer. Brilliant. Funny. Reasonable. Box 268-17, c/o BM/E, Blue Ridge Summit, Pa. 17214.

Negro DJ/announcer. Tight board. Middle of road or jazz format. 3rd phone. Will relocate. William McRae, 522 W. 136th St., N.Y.C.

HELP WANTED

W-A-N-T-E-D

BY LARGE EXPANDING CATV
 MULTIPLE OWNER

REGIONAL MANAGERS

SYSTEMS MANAGERS

TECHNICIANS

INSTALLERS

SEND RESUME AND SALARY
 REQUIREMENTS

IN CONFIDENCE TO

Box 268-18, c/o BM/E
 Blue Ridge Summit, Pa. 17214

Combo engineer announcer for an AM FM station in South Florida market of 50,000. Good pay (\$135-\$150 weekly). Good benefits. Best climate. Modern equipment to work with. Engineering background necessary, some announcing required. Send resume and audition tape to Box 268-19, c/o BM/E, Blue Ridge Summit, Pa. 17214.

HELP WANTED (cont'd.)

ENGINEERS—TV—Sunny California. Discover job security, and a new way of life in California. Have top openings for qualified Maintenance Engineers, especially Video Tape and Live Color Video. Send resume or letter to The AMPS Agency—3924 Wilshire Boulevard, Los Angeles, California 90005. 388-3116
 By Broadcasters — for Broadcasters

GO SOUTH, YOUNG MAN! Advance rapidly with the most dynamic CATV operation in the Southeast. JCC's expanding Engineering Department now needs employees who can meet and maintain our high standards in engineering, construction, and maintenance. Urgently need Chief Technicians, Cable Technicians, Field Engineers, and Installers. Your experience and ability will determine your starting salary. All systems are "Go" with Cablevision. Rush complete resume or telephone: Jerry Burge, Director of Engineering, Jefferson-Carolina Corporation, P.O. Box 20348, Greensboro, North Carolina 27420. Telephone: 919/272-5625. Time is money! Airmail is faster! Act now!

Join congenial engineering staff at Kansas ETV station. Immediate opening for TV transmitter-studio operator (no announcing). Must have first phone and energy—chance to advance education. Experience preferred, but your personal potential more important. Contact: Manager, KTWU-Channel 11, Washburn University, Topeka, Kansas 66604.

Ass't chief engineer needed for aggressive UHF station in Nation's Capital area. Must know all types of equipment and be able to take over supervision of engineering department functions. Good salary and opportunity for future advancement. Send resume and references to Box 268-29, c/o BM/E, Blue Ridge Summit, Pa. 17214.

Immediate opening for experienced television engineer with first class license to work with instructional television station. Ability to assume full responsibility for all technical operation of station Dallas, Fort Worth area. Salary open. Send resume to Box 268-1, c/o BM/E, Blue Ridge Summit, Pa. 17214.

First Class Engineer for TV-Radio operation in medium size North Central market. Will train new man. Ability and attitude more important than experience. Latest RCA equipment. Good salary and fringe benefits. Please send resume and photograph to Box 268-20, c/o BM/E, Blue Ridge Summit, Pa. 17214.

Full color station needs engineer with experience and knowledge of RCA tape machine—RCA color camera—also need experienced microwave maintenance engineer first phone requirement—send details to J. W. Robertson, Vice President-Engineering, P.O. Box 1457, Lexington, Kentucky.

IMMEDIATE OPENINGS — Qualify for any of the following positions: Technicians for RCA closed Circuit Television equipment — Camera men — Maintenance men — Video Tape Men — Video Engineers, RCA Rep. 143-08 94th Ave., Jamaica, New York, or (212) 297-4344.

Looking for experience. Live color, color VTR, and color film with new modern equipment. WREX-TV, Rockford, Ill. has an opening for a first class engineer. TV experience desirable but not necessary. Contact Chief Engineer WREX-TV.

WANTED—First Phone licensed engineer to work in South. Must have four to five years experience in TV broadcasting as studio maintenance engineer. Send resume with salary requirements to Box 268-22, c/o BM/E, Blue Ridge Summit, Pa. 17214.

Maintenance Engineer, experienced with cameras and video tape recorders, systems design experience desirable. Contact Frank Beemish, Instructional Resources Center, State University of New York, Stony Brook, Long Island, New York 11790 246-6740 (Area Code 516).

First Class engineers, maintenance background, no board work. Immediate openings. Excellent growth opportunity with independent group. Rush reply by letter to C. Dingmen, WCTC, 385 George St., New Brunswick, N.J.

Opportunity to work in all phases of TV technical operation with color-VHF in beautiful Texas resort city. Box 268-8, c/o BM/E, Blue Ridge Summit, Pa. 17214.

HELP WANTED (cont'd.)

WANTED—Experienced CATV technician to work in South. Send resume with salary requirements to Box 268-21, c/o BM/E, Blue Ridge Summit, Pa. 17214.

If you have a First Class license, experience and ability, and are worth \$150 per week to start, a well-run east coast station would like to hear from you. Box 268-23, c/o BM/E, Blue Ridge Summit, Pa. 17214.

Needed—Experienced combination salesman & announcer. Good future, security, living conditions, hours & pay. Excellent recreation. Southeastern location. Box 268-24, c/o BM/E, Blue Ridge Summit, Pa. 17214.

WANTED—Chief Engineer for 5000 watt night time directional am radio station. Excellent salary, insurance plan. To have complete charge of all engineering. WEGP Radio, Presque Isle, Maine.

Immediate opening for engineer—first phone Television Station, operation—no announcing. Location—Northern Lower Michigan. Box 268-25, c/o BM/E, Blue Ridge Summit, Pa. 17214.

Wanted! Broadcast technicians to enter aircraft electronics. Numerous jobs everywhere. Write: Avionics, Reno/Stead Airport, Reno, Nevada 89506.

"N.M. CATV group desires producer-salesman-announcer; double commissions: "505-437-7258." Box 268-26, c/o BM/E, Blue Ridge Summit, Pa. 17214.

Massachusetts 1 kw station has opening for chief engineer. No announcing. Take full charge of technical operations. Contact manager, WALE, Fall River, Mass. 1-617-674-3535.

Large New England radio and television operation has openings for qualified engineers with first class license. Box 268-27, c/o BM/E, Blue Ridge Summit, Pa. 17214.

"Wanted—1st class engineer-announcer, Radio Station WNKY, Box 248, Neon, Ky.

EQUIPMENT WANTED

**we pay
CASH for TUBES**

Lewispaul Electronics, Inc.
303 West Crescent Avenue
Allendale, New Jersey 07401

I used 5000 watt transmitter in good condition. Specify make, model and dimensions. Chuck Delpderang, Chief Engineer, KOLY, Mobridge, S. D. 57601.

EQUIPMENT FOR SALE

**All types of
Electron Tubes
for
Communications**

**LEWISPAUL
ELECTRONICS**

303 W. Crescent, Allendale, N.J. 07401
(201) 327-7200

Spotmaster cartridge equipment and accessories, Crown tape recorders, QRK, REK-O-KUT, RUSSCO (turn-tables and preamplifiers) Gray and Euphonics tonearms, Metron modulation monitors. Universal audio products, Pultec, Nor-elco-AGK microphones, Fidelipac and Audiopak cartridges. Write for special money saving offers. Audiovox, Box 7067-55, Miami, Fla. 33155.

EQUIPMENT, Audio, Broadcast, Video, Bought-Sold-Traded through our national listing. Contact: The Maze Corporation, Box 6636, Birmingham, Alabama 35210.

EQUIPMENT FOR SALE (cont'd.)

AMPEX authorized Sales and Service. New and used equipment for sale. 48 hour service on most repair including head rebuilding. Other professional equipment also available. ACCURATE SOUND COMPANY, 15 N. Tyler, San Angelo, Texas AC 915 949-1904.

Largest supply of G.E. & Motorola radio and mobile telephone equip. in the U.S. (30-50), (150-174), (450-470), Base, repeater, and dial equip. Dealers invited. Western Mobile Telephone Company, 200 South Anaheim Blvd., Anaheim, Calif. (714) 774-0520.

APT Satellite pictures. Late model Facsimile Receivers, copy direct, or tape record and playback. Ready to go! Lowest price anywhere. Call Ray Newsome person-to-person (313-676-7460) or write Newsome Electronics, Dept. BC, 2670 Pinetree, Trenton, Mich. 48183.

TUBES—Complete Stock From #10 to #89, 1A85 to 38022, OC3 to 11726, and most of the rest. List free. Harold Goldman, 43 Clinton Ave., Rockville Centre, N.Y. 11570—Phone 516-536-6697.

Brand new remote amplifiers, 2 channel remote microphone amplifiers, 2 1/2 inch VU, battery operated, 7 transistors \$95.00 FOB Kokomo. **Greco, Inc.**, 1830 S. Webster, Kokomo, Ind. 46901. Area 317-883-5688.

Ampex AG-350-2 Recorders. Unmounted, condition like new. 3-position head machine, \$1,850. 4-position head machine, \$1,900. J. M. Edelman, M.D., 4550 North Blvd. Baton Rouge, La. 70806. Phone 504-924-6266.

RCA TT-5A, CHANNEL 5 transmitter with sideband filter, WM-12, WM-13 Visual Modulation Converters and Power Supply. No control console. R. E. Oldfield, Southern Colorado State College, Pueblo, Colorado 81005.

Whatever your equipment needs . . . check first with Broadcast Equipment and Supply Co., Box 3141, Bristol, Tennessee.

For sale—McMartin FM monitor TRM 3500 like new, 11 months old. Make offer. Tom Talbot, WJLL, Niagara Falls, N.Y.

Towers, broadcast, microwave, CATV, TV, new and used, phone 224-9922 Tower Maintenance, Inc., 2408 Old St. Rd., Tallahassee, Fla.

Protect your records. Send for our free Lp supply lists. Record Supplies, Hillburn, N.Y. 10931.

GOVERNMENT Surplus Electronic catalog — 25¢. Meshna, Nahant, Mass. 01908.

New & Used tower ground wire available. Bill Angle, Box 55, Greenville, N.C. Tel 752-3040. 6 element circular vertical and horizontal antenna. Price \$2,400.00.

GE FM transmitter, 3kw exceptionally clean, KTFC, Rt. 2, Sioux City, Iowa.

MISCELLANEOUS FOR SALE

SALE ON ELECTRONICS BOOKS! 5 for \$3.98! Guaranteed retail value of \$16.50! Grab Bag of 5 electronics books on testing, test equipment, TV, radio, hi-fi, stereo, etc. Clearance of books which sell for as high as \$4.50 each. Send check or money order to: Grab Bag, Dept. BO7, Box 304, Emmitsburg, Md. 21787.

SIGNS, NAMEPLATES, LABELS, Decals, Badges, Trophies, Plaques. Seton Corp., Dept. BM/E, New Haven, Conn. 06505.

Professional Electronics Projects — \$1 up. Catalog 25¢. PARKS, Box 15265, Seattle, Wash. 98115.

Japanese electronics catalog, \$1.00. Dec. 10639A Riverside Drive, North Hollywood, California 91602.

TECHNICAL SERVICES

AMPEX HEAD ASSEMBLY relapping and replacement head service for all AMPEX professional studio model recorders. Our precision relapping extends head life for maximum use. Brand new shelf stock replacement heads of our manufacture available when relapping not advisable. Prices include thorough assembly cleaning, optical and electrical inspection and complete testing on Ampex equipment. Monaural assembly relapping . . . \$35.00 complete. Monaural assembly replacements \$119.50 complete. "Loaner" assemblies available. For more data, contact LIPPS, Inc., 1630 Euclid St., Santa Monica, Calif. 90404 (213) EX 3-0449.

BROADCAST EQUIPMENT REBUILDERS has moved! Our new address is P.O. Box 276, Hickory, N.C. 28601. B-E-R still offers the same professional service on cartridge rewinding, and all work is fully guaranteed. Write Quin Morrison about your used equipment needs.

TALL TOWERS, Guyed, Self-supporting, Inspections—Registered Engineer, Antenna, Tower repairs and painting, Globe Industrial Contractors, Inc., Henderson, Ky. AC 502-827-1831.

TECHNICAL SERVICES (cont'd)

VIDEO TAPE RECORDER AUDIO HEAD ASSEMBLY SERVICE

Precision relapping of all heads and supporting posts, includes cleaning and testing. AMPEX VTR audio assembly . . . \$75.00 complete. Brand new shelf stock replacement heads of our manufacture available when relapping not advisable. RCA units also serviced. LIPPS, Inc., 1630 Euclid St., Santa Monica, Calif. 90404 (213) EX 3-0449.

CAMBRIDGE CRYSTALS PRECISION FREQUENCY MEASURING SERVICE

SPECIALISTS FOR AM-FM-TV
445 Concord Ave. Phone 876-2810
Cambridge, Mass. 02138

Broadcast maintenance — five inspections \$30.00 week plus hourly. Mailtronics, 109 Pine-tree Drive, Woodbridge, Va.

PROGRAM SERVICES

16mm CATV SOUND PROJECTORS (synchronized for TV) \$650.00

American Diversified Services
Box 975, Kingsport, Tennessee 37662
Phone area 615 239-9301

Background Music Service For FM Multiplex-Wire Line- CATV Systems Magne-Tronics, Inc.

21 East 40th Street, New York, N.Y. 10016

"DEEJAY MANUAL" is a folio of Gags, Ideas, Breaks, Gimmix, Fun for the working deejay. Special \$3.00 with this ad. Write for free "Broadcast Comedy" catalog. Show-Biz Comedy Service (Dept. E) 1735 E 26 St., Brooklyn, New York 11229.

Deejays! 6000 classified gag lines, \$5.00! Comedy catalog free. E. Orrin, Box 679 Boyer Road, Mariposa, Calif. 95338.

Deejays! Monthly gag service exclusive for jocks. "Hollywood Gag Digest" 711 N. Cherokee, Hollywood, Calif. 90038.

CONSULTANTS

VIR JAMES

CONSULTING RADIO ENGINEERS
Applications and Field Engineering
345 Colorado Blvd.
Phone: (Area Code 303) 333-5562
DENVER, COLORADO 80206
Member AFCCCE
TWX 910 931/0514

JANSKY & BAILEY

(Jansky & Bailey Broadcast-Television Department—Atlantic Research Corporation)
Consulting Engineers
1812 K St., N.W.
Wash., D. C. 20006 296-6400
Member AFCCCE

JOHN H. MULLANEY and ASSOCIATES

Suite 71,
1150 Connecticut Ave., N.W.
Washington, D. C. 20036
Phone 202-223-1180
Member AFCCCE

CONSULTANTS (Cont'd)

M. RETTINGER, Consultant on Acoustics, Analysis, Room Design, Noise Reduction. 5007 Haskell Ave., Encino, Calif. Tel: (213) 784-3985.

INSTRUCTION

RON BAILIE

School of Broadcast

+ **Announcing**

+ **Electronics**

+ **Copywriting**

*Where We Produce
Professional Quality
Announcers*

170 Denny Way
Seattle, Wash. 98109
Phone: 206 MU 2-3696

R.E.I.'s famous (5) week course for the First Class Radio Telephone License is the shortest, most effective course in the nation. Over 98% of R.E.I. graduates pass F.C.C. exams for 1st class license. Total tuition \$350.00. Job placement free. Write for brochure Radio Engineering Institute of Electronics, 1336 Main Street, Sarasota, Florida—or 3123 Gillham Road, Kansas City, Missouri—or 809 Caroline Street, Fredericksburg, Virginia.

FCC License in six weeks from the nation's largest license school. Compare reputations and success rates before you invest. Professional announcing training on the nation's only fully school-operated commercial station used solely for training. School locations in Dallas, Atlanta, Chicago, New Orleans and Minneapolis. Write Elkins Institute, 2603 Inwood Road, Dallas, Texas 75235.

FCC License preparation by correspondence. Also, associate degree in electronics by three semesters in correspondence and two semesters in resident classes. Free details on either course. Write: Grantham Desk 7-B, 1505 N. Western Avenue, Hollywood, Calif. 90027.

F.C.C. First phone quickly and easily via new concept in correspondence training. Easy terms. Mid-America Broadcasting Service, P.O. Box 7522, Milwaukee, Wisconsin 53222.

**USE BM/E's CLASSIFIED
MARKETPLACE TO
REACH OVER 21,000
BROADCASTERS!**

Please run the ad attached in BM/E's CLASSIFIED MARKETPLACE in your next:

- 12 issues 6 issues
- 3 issues 1 issues

BM/E, Classified Advertising Department, Monterey & Pinola Avenues, Blue Ridge Summit, Pa. 17214.



ADVERTISERS INDEX

AMP Incorporated66, 67

*Albion Optical Company, Inc. 85

Alden Electronic and Impulse Recording Equipment Co., Inc. 84

*Altec Lansing, A Div. of LVT Ling Altec Inc. 69

Ameco 80

American Electronic Laboratories Inc. 82, 89

Ampex Corp. 73

Arrow Electronics, Inc. 68

Benco Television Corp. 21

Boston Insulated Wire & Cable Co. 74

Broadcast Electronics, Inc. 86

*CBS Laboratories, A Division of Columbia Broadcasting System Inc. ... 5

Central Dynamics Corp. 36

Cleveland Institute of Electronics 22

Collins Radio Co. 65

Conrac26, 27

Cooke Engineering Co.77, 78

Cook Laboratories, Inc. 89

Cosmicar Optical Co., Ltd. 62

Crown International 91

*Daven Division of Thomas A. Edison Industries 79

Davis & Sanford 91

Dynair Electronics, Inc. 18

Eastman Kodak Co. 59

Electrodyne Corp. 60

Electronic Engineering Co. of California 81

Electro-Voice, Inc.Cover 4

Fairchild Recording Equipment Corp. 63

Fort Worth Tower Co., Inc. 88

Gates Radio Co., A Sub. of Harris-Intertype Corp.75, 91

General Electric Co., Visual Communications Products Dept.12, 13

*Harvey Radio Co., Inc. 52

*Hewlett-Packard 3

IEEE Exhibition 62

International Nuclear Corp. Cover 3

International Video Corp.19, 20

Koss Electronics Inc. 64

Langevin 25

McMartin Industries, Inc.10, 11

Magnecord Div. of The Telex Corp. 87

Meyer Machine, Inc. 84

3M Company, Wollensak Television Products 20

Miratel Div., Ball Brothers Research Corp. 17

Packard Bell 70

Philips Broadcast Equipment Corp. 14, 15

Photo Research Corp. 61

QRK Electronic Products 89

RCA Service Co., a Div. of Radio Corp. of America 79

Riker Video Industries, Inc.Cover 2

Sony Corp. of America, Industrial Div. 83

Stancil-Hoffman Corp. 82

Superior Continental Corp., Superior Sales and Service Div. 71

TAB Books 24

Tektronix Inc. 7

TeleMation, Inc. 72

Thomas & Betts Co., Inc., The 76

Tokyo Shibaura Electric Co., Ltd. 35

Toshiba America Inc. 35

Unitrode Corp. 23

Ward Electronic Industries 9

*See ad also in
**BROADCAST EQUIPMENT
BUYERS GUIDE**

ADVERTISING SALES OFFICES

NEW YORK

820 Second Avenue
New York, New York 10017
212-661-0450

New York City & Upper New York
William H. Baldwin

Long Island & Westchester
F. F. "Pete" McAdams

New Jersey
Richard M. Millar

Southeastern States
Charles C. Lenz, Jr.

NEW ENGLAND

41 Stevens Lane
Cohasset, Massachusetts 02025
617-383-0029
Donald B. Kennedy

MIDWEST

612 North Michigan Avenue
Chicago, Illinois 60611
312-642-3774
Charles E. Moodhe
Richard W. Moore

WEST COAST

1245 East Walnut Street
Pasadena, California 91106
213-795-1528
213-684-0590 (Los Angeles)
Lawrence C. Papp
Thomas Boris
Jules E. Thompson Co.
1111 Hearst Building
San Francisco, California 94103
415-362-8547
William Healey

JAPAN

Nippon Keisoku Inc.
P.O. Box 410
Central Tokyo, Japan
Yoshi Yamamoto

Name _____
 Address _____
 Title _____ Company _____
 City _____ State _____ Zip _____

Mail your entry to International Nuclear Corporation, 608 Norris Avenue, Nashville, Tennessee. Decision of the Judges is final, and duplicate prizes cannot (understandably) be awarded. The winner, if any, will receive the secretarial services of Miss International Nuclear for a five day work week.

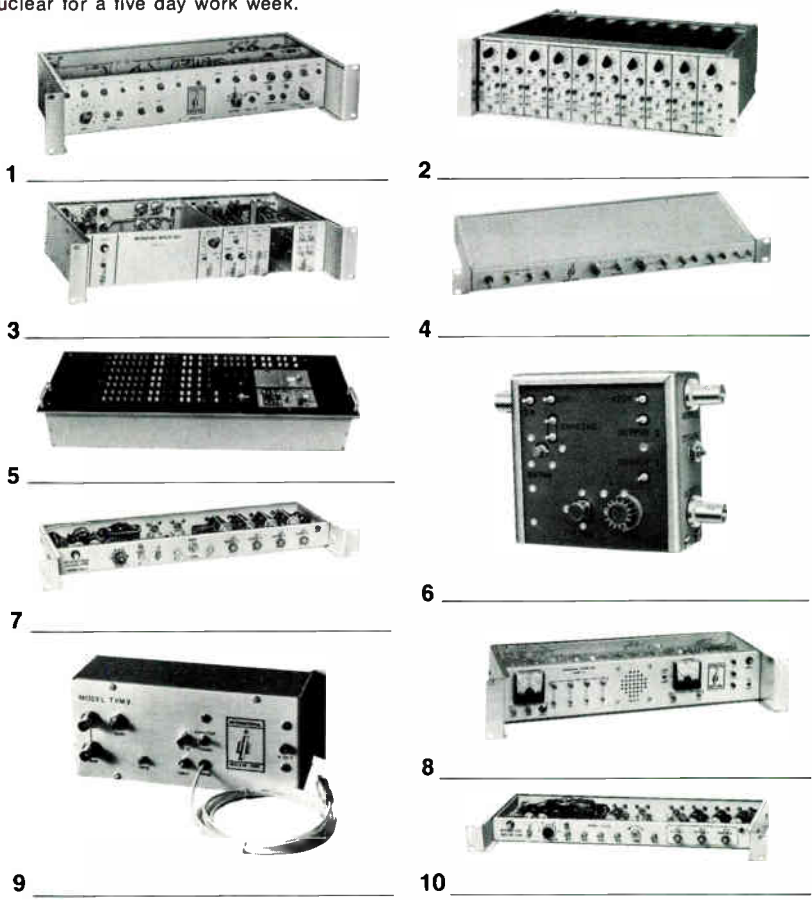

Win Miss International Nuclear for seven fun-filled days.

Here's a nifty contest. Simple rules. If you can name all the International Nuclear products pictured above, we'll send you a neat 8 x 10 glossy picture of Miss International Nuclear (in a plain brown wrapper). We'll even send you one for a good try. If you own one or more of each of the International Nuclear products pictured above, we'll send you Miss International Nuclear . . . to keep as your personal secretary for one glorious week. Offer good until March 15, 1968. Order at least one of everything NOW!



**This was the E-V Model 635.
It started a tradition
of excellence in
dynamic microphones.**



**This is the new
E-V Model 635A.
It's better
in every way!**



Model 635A Dynamic Microphone \$82.00 List. (Normal trade discounts apply.)

ⓔ How can a microphone as good as the E-V Model 635 be made obsolete? By making it better! It wasn't easy. After all, professional sound engineers have depended on the 635 since 1947.

During this time, the 635 earned a reputation for toughness and dependability that was unrivalled by other omnidirectional dynamics. And internal changes through the years have kept the 635 well in the forefront of microphone design.

But now the time has come for an all new 635: the Electro-Voice Model 635A. It's slimmer, for easier hand-held use. Lighter, too. With a slip-in mount (or accessory snap-on Model 311 mount) for maximum versatility on desk or floor stands. The new, stronger steel case re-

duces hum pickup, and offers a matte, satin chromium finish perfect for films or TV.

The new 635A is totally new inside, too—and all for the best. A new four-stage filter keeps "pops" and wind noise out of the sound track, while guarding against dirt and moisture in the microphone, completely eliminating any need for external wind protection. Of course you still get high output (—55db) and smooth, crisp response. And you can still depend on the exclusive E-V Acoustalloy® diaphragm that is guaranteed against failure for life* (it's that tough)!

We expect to see plenty of the "old" 635's in daily use for years. But more and more, the new 635A will take over as the new standard. It's easy to find out

why: just ask your E-V Professional Microphone distributor for a free demonstration in your studio. Or write us today for complete data. We'll be proud to tell you how much better the new Model 635A really is!

*The E-V Professional Microphone Guarantee: All E-V professional microphones are guaranteed UNCONDITIONALLY against malfunction for two years from date of purchase. Within this period, Electro-Voice will repair or replace, at no charge, any microphone exhibiting any malfunction, regardless of cause, including accidental abuse. In addition, all E-V microphones are GUARANTEED FOR LIFE against defects in the original workmanship and materials.

ELECTRO-VOICE, INC., Dept. 281EM
614 Cecil Street, Buchanan, Michigan 49107



Circle 3 on Reader Service Card