

BROADCAST[®]

AN INTERTEC PUBLICATION

ENGINEERING

February 1989/\$3

Dealing with digital technology

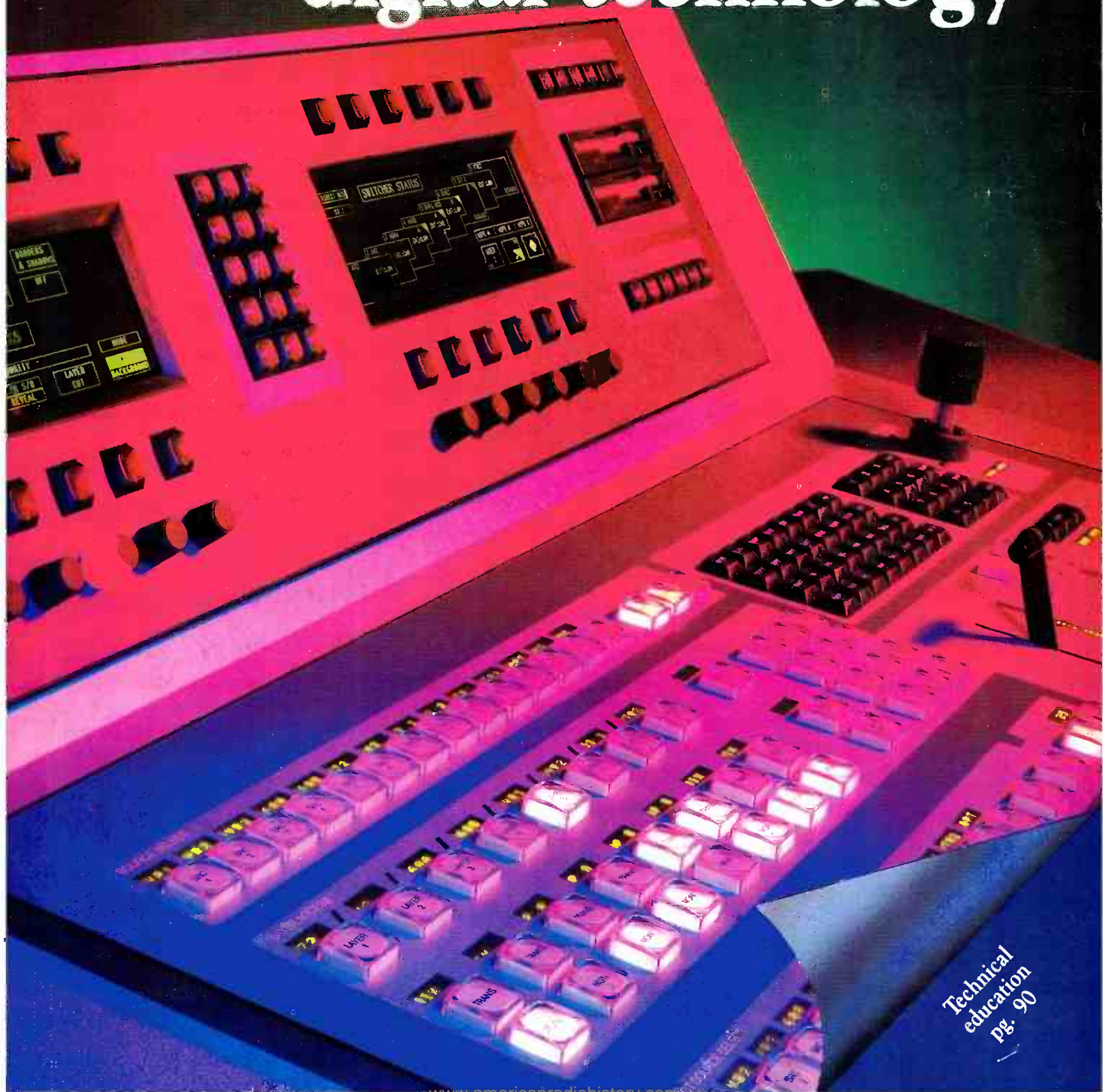

Technical
education
Pg. 90

Regardless of their
politics, Americans believe
in giving each candidate the
right to be heard.

So Democrats
in Atlanta and Republicans
in New Orleans agreed
on the same name.

Shure.

It's no coincidence that when the world is listening, professionals insist on the sound quality and reliability of Shure.

For years, Shure circuitry products and microphones have been a key part of national political conventions, and other major events from the Grammy Awards...to the Olympics.

Providing reliable Shure products is important to us, because performance on your job is so important to you.

For a free copy of our new catalog containing specs on our full line of professional microphones, circuitry products and automatic microphone systems, mail the coupon today. Or call 1-800-257-4873. (In Illinois, 1-800-624-8522).

Photo: SM57 Microphones at 1988 Democratic Convention.

Circle (1) on Reply Card



Yes, please send the new Shure Professional Microphone/Circuitry Products Catalog.

Name _____

Title _____

Company _____

Address _____

City, State, Zip _____

Telephone (____) _____

BE 2/89

SHURE®

The Sound Of The Professionals... Worldwide.

222 Hartrey Avenue, Evanston, IL 60202-3696

the

SOURCE

**A•C•E Encoders . . .
Voted 10,000 times over
as the industry standard.**

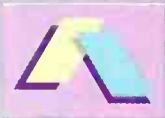

A • C • E

An encoder, which converts the RGB outputs from such sources as character generators or paint systems into composite NTSC, can be the weak link in your system. The addition of an A•C•E encoder to even an inexpensive character generator can produce excellent results.

The 204N offers stable performance and easy installation in a rugged, flexible package. The unit accepts either RGB or CAV (MII or Betacam) inputs and provides six composite outputs. The 204N even offers 32 test signals including full-field and SMPTE color bars, red field and pluge.

With over 10,000 in use worldwide, the Cox encoder is the standard of the industry. The latest version, the 204N, is now sold under the name A•C•E.

Don't compromise your graphics system with an inferior encoder. Insist on the A•C•E 204N.

The 204N Encoder from A•C•E, celebrating their 20th year in the design and manufacture of broadcast television equipment.

Available in the U.S. exclusively from Midwest Communications and backed by Midwest's nationwide service network.



One Sperti Drive
Edgewood, KY 41017
(606) 331-8990

Circle (3) on Reply Card

Contents

February 1989 • Volume 31 • Number 2

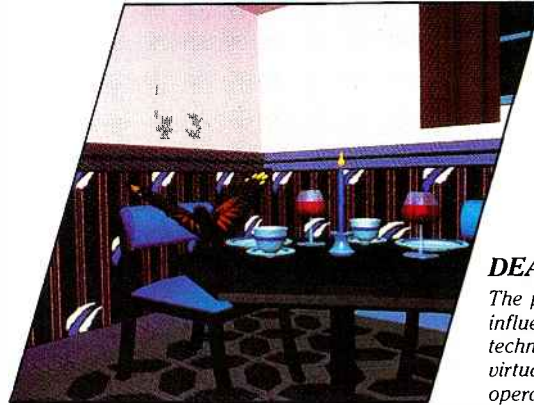

Page 42



Page 58

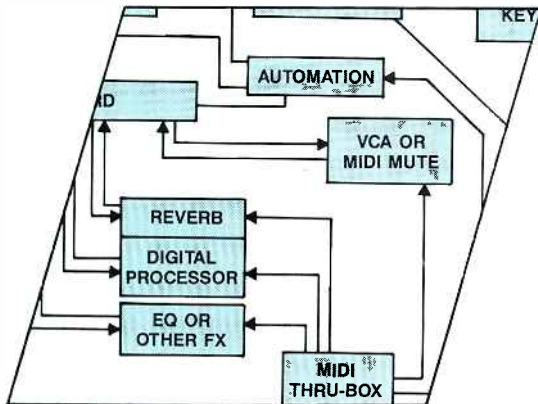

Page 82

BROADCAST ENGINEERING

DEALING WITH DIGITAL TECHNOLOGY:

The products available to radio and TV stations today are influenced in large part by advancements in digital technology. Computer-based hardware has found its way into virtually every area of broadcast and post-production operations — from cameras and audio consoles to transmitters and test equipment. This month, we take a look at some areas of recent development in the application of digital hardware. The following package of articles includes:

- 26 Inside Mathematics Processors**
By Gerry Kaufhold II, SGS-Thomson Microelectronics
Are sum chips better than others?
- 42 State of the Digital Studio**
By Curtis Chan, Centro
"And D-1 and D-2..." Digital formats work in concert.
- 58 Disk Recording and Editing**
By Brad Dick, radio technical editor
Hard disk storage is the key to digital recording and editing.
- 82 MIDI: What's in it for Broadcasters**
By Richard Maddox, Muzak
A new interface standard opens the door to inexpensive digital production techniques.

OTHER FEATURES:

- 90 Technical Education for Broadcast Engineers**
By F. David Harris, P.E., Purdue University Calumet
Becoming a broadcast engineer requires self-study.

ON THE COVER

Digital technology has revolutionized the broadcast industry. The impact of computer-based systems has been felt in radio and TV stations alike. Our cover this month symbolizes the move toward the digital studio. Shown is a digital video switcher (the Abekas A84). Photo courtesy of Abekas Video Systems.

DEPARTMENTS

4	News	96	SBE Update
6	Editorial	98	Applied Technology: Batteries for field applications
8	FCC Update	104	Station-to-Station
10	Strictly TV	107	Field Report: BE Phase Trak 90
12	re: Radio	110	People
14	Satellite Technology	112	Business
16	Circuits	114	New Products
18	Troubleshooting		
20	Management for Engineers		

PROBLEM SOLVERS

How to get perfect camera setups in three minutes—with a single camera or up to 42 cameras. That's right, 42.

Camera setup problems always seem to happen when there's absolutely no time to waste.

That's why Hitachi's setup solution is quick and easy. Our microcomputer Zero Control automatic setup of all three channels is built into every Hitachi SK-970D and SK-97D camera. Zero Control totally eliminates manual adjustment of the G channel.

Now, imagine yourself as the engineer with this setup problem.

You're setting up three cameras to shoot an hour of drama. It has already taken 40 minutes to adjust the G channels and get the

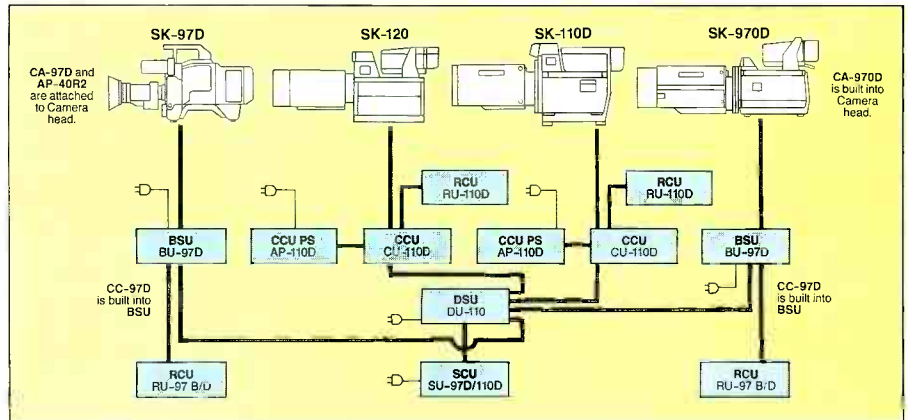

How Hitachi's SU-97D Auto Setup Control achieves simultaneous setups on four different camera models. System can expand to set up and control 42 cameras.

Even better, Hitachi's SU-97D Auto Setup Control Panel can simultaneously and automatically set up as many as 42 cameras. Not only does the SU-97D achieve identical perfect setups on SK-970D and SK-97D cameras, it can also control auto setup of Hitachi SK-110D and SK-120 cameras (see chart).

Another Hitachi exclusive—you can record complete setup and camera adjustment data on a floppy disk, and use the disk to check camera status against

the original setup values. Or, for instant automatic checking of registration and color balance, you can use Hitachi's "Quick Check" switch.

What's your bottom line? You save time and you get perfection. You increase productive time and picture quality.

The world's toughest customers—major networks and major



Rear panel on Hitachi's SK-970D camera. Complete controls for automatic setup and camera operation.

color and registration right. The talent is yawning. The crew is telling jokes. The director is having a fit. Then one of the cameras fails. You bring in another camera and start adjusting G channels again. But you find yourself wishing TV was still black and white.

Stop sweating over G-reference setup. With Hitachi Zero Method automatic setup, no adjustments are required. Just fire up, press the auto setup button and within minutes you're ready to shoot. It's that simple.

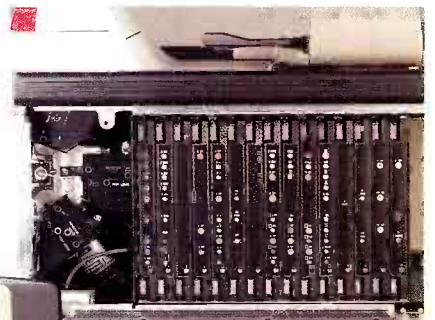

Easy access to plug-in modules for quick service.

independent producers—are our best customers for SK-970D's, SK-97D's and SU-97D's. Isn't it time you called us for a demonstration?

Call now.



Hitachi Denshi America, Ltd.
175 Crossways Park West, Woodbury,
NY 11797 • 516-921-7200 • In Canada,
Call Hitachi Denshi, Ltd. 416-299-5900

Circle (4) on Reply Card

www.americanradiohistory.com

NAB approves FCC's AM technical revisions

The National Association of Broadcasters (NAB) supports the efforts of the Federal Communications Commission (FCC) to improve the technical basis of AM broadcasting, which would prevent future increases in AM interference.

The FCC's proposals consist of four items:

- Improved accuracy in the commission's groundwave and skywave propagation curves.
- Improved methods of calibrating groundwave propagation calculation methods.
- Use of a 25% exclusion principle that includes appropriately weighted adjacent-channel contributors.
- Removal of certain minimum power and city coverage requirements for Class II-S and Class III-S AM stations.

In a filing at the FCC, the NAB urged the commission to implement the proposals

collectively rather than on an individual basis. The NAB also asked the agency to begin a rulemaking proceeding to establish a revised first adjacent-channel protection ratio before adopting its proposals.

SBE announces call for papers

Abstracts are now being accepted for proposed engineering papers for the 1989 **Broadcast Engineering** conference of the Society of Broadcast Engineers (SBE) national convention, Oct. 5-8, in Kansas City, MO. The technical conference will address the needs of engineers and technical managers at radio and TV stations. Sessions are being organized again by John Battison, known for his work at the annual WOSU seminars.

The deadline for submitting outlines is March 31. Those interested in participating in a panel discussion or serving in another capacity should send a letter to Battison.

Only written requests will be honored.

The SBE again will publish the "Proceedings," which will be available at the convention. Authors should be prepared to submit a camera-ready manuscript by June 30. For more information, contact: John Battison, Conference Chairman, 2684 State Route 60, RD #1, Loudonville, OH 44842.

SMPTE: What's new in fiber optics?

The Society of Motion Picture and Television Engineers (SMPTE) Committee on New Television Technology will inform its membership on applications of fiber-optic transmission technology — in particular, analog HDTV, high-speed digital and high-resolution graphics — based on the findings of a new study group.

C. Robert Paulson, Artel Communications Corporation, is chairman of the study group. Participation in the group is open

Continued on page 102

BROADCAST engineering

Editorial and advertising correspondence should be addressed to: P.O. Box 12901, Overland Park, KS 66212-9981 (a suburb of Kansas City, MO); (913) 888-4664. Telex: 42-4156 Intertec OLPK. Circulation correspondence should be sent to the above address, under P.O. Box 12937. RAPIDFAX: (913) 541-6697.

EDITORIAL

Jerry Whitaker, *Editorial Director*
Brad Dick, *Radio Technical Editor*
Carl Bentz, *Technical and Special Projects Editor*
Rick Lehtinen, *TV Technical Editor*
Tom Cook, *Senior Managing Editor*
Paula Janicke, *Staff Editor*
Dawn Hightower, *Associate Editor*
Suzanne Oliver, *Editorial Assistant*
Pamela S. Fleener, *Editorial Assistant*
Pat Blanton, *Directory Editor*

ART

Kristi Sherman, *Graphic Designer*

EDITORIAL CONSULTANTS

Fred Ampel, *Audio*
Nils Conrad Persson, *Electronics*
Ned Soseman, *Video*
Michael Heiss, *Consulting Editor*
Don McCroskey, *Consulting Editor*

BUSINESS

Cameron Bishop, *Group Vice President*
Duane Hefner, *Publisher*
Stephanie Hanaway, *Marketing Director*
Cynthia Baker, *Promotions Coordinator*
Dee Unger, *Advertising Business Manager*
Mary Birnbaum, *Advertising Production Supervisor*
Paula Bourne, *Advertising Coordinator*

ADMINISTRATION

R.J. Hancock, *President*
Chuck Rash, *Corporate Circulation Director*
Jane J. Powell, *Circulation Director*
JoAnn DeSmet, *Circulation Fulfillment Manager*
Barbara Clare, *Reader Correspondent*
Kevin Callahan, *Creative Director*

TECHNICAL CONSULTANTS

Eric Neil Angevine, *Broadcast Acoustics*
John H. Battison, *Antennas/Radiation*
Blair Benson, *TV Technology*
Dennis Ciapura, *Radio Technology*
Dane E. Ericksen, *Systems Design*
Howard T. Head, *European Correspondent*
Wallace Johnson, *FCC/Bdct. Engineering*
John Kean, *Subcarrier Technology*
Donald L. Markley, *Transmission Facilities*
Harry C. Martin, *Legal*
Robert J. Nissen, *Studio/Communications*
Hugh R. Paul, *International Engineering*
Art Schneider, *A.C.E., Post-production*
Elmer Smalling III, *Cable/Satellite Systems*
Vincent Wasilewski, *Communications Law*

MEMBER ORGANIZATIONS

SUSTAINING MEMBERS OF:

- Acoustical Society of America
- Society of Broadcast Engineers
- Society of Motion Picture and TV Engineers

Member,
Association of Business Publishers

Member,
Business Publications
Audit of Circulation



BROADCAST ENGINEERING is edited for corporate management, engineers/technicians and other station management personnel at commercial and educational radio and TV stations, teleproduction studios, recording studios, CATV and CCTV facilities and government agencies. Qualified persons include consulting engineers and dealer/distributors of broadcast equipment.

BROADCAST ENGINEERING (ISSN 0007-1794) is published monthly (except in the fall, when two issues are published) and mailed free to qualified persons within the United States and Canada in occupations described here by Intertec Publishing Corporation, 9221 Quivira Road, Overland Park, KS 66215. Second-class postage paid at Shawnee Mission, KS, and additional mailing offices. POSTMASTER: Send address changes to **Broadcast Engineering**, P.O. Box 12960, Overland Park, KS 66212.

SUBSCRIPTIONS: Non-qualified persons may subscribe at the following rates: United States and Canada; one year, \$25.00. Qualified and non-qualified persons in all other countries; one year, \$30.00 (surface mail); \$108.00 (air mail). Back issue rates, \$5.00, except for the Buyers' Guide/Spec Book, which is \$20.00. Rates include postage. Adjustments necessitated by subscription termination at single copy rate. Allow 6-8 weeks for new subscriptions or for change of address.

Photocopy rights: Permission to photocopy for internal or personal use is granted by Intertec Publishing Corporation for libraries and others registered with Copyright Clearance Center (CCC), provided the base fee of \$2.00 per copy of article is paid directly to CCC, 21 Congress St., Salem, MA 01970. Special requests should be addressed to Cameron Bishop, group vice president. ISSN 0007-1794 \$2.00 + \$0.00.

© 1989. All rights reserved.

Advertising offices listed on page 126.



the **SOURCE**

**The Top of the Line Frame Synchronizers
with the Best Bottom Line in the Business.**



**The DPS-165... Just \$4,990.
or the DPS-165A... \$5,990.**

Get the bottom line on one of today's best values. The DPS-165 and 165A, high quality, full featured frame synchronizers at a price that's about half what you might expect from the competition

And complete with top-of-the-line performance features. Like a 525-line buffered memory to reliably synchronize any monochrome or direct color video feed. Plus auto diagnostic memory, internal test signal generator, and two true RS170A outputs.

Additional standard features include freeze frame/field with field 1 and 2 selectable and an adaptive comb filter on the DPS-165A. A multi-unit remote control is optionally available.

So add some top-of-the-line performance to your bottom line with the addition of a DPS-165 or 165A to your system.

As always backed by Midwest's nationwide service network.

For more technical and sales information contact your nearest Midwest office.



DIGITAL
PROCESSING SYSTEMS INC.

From Midwest Communications –
Exclusive U.S. Distributor.



MIDWEST
Communications Corp.

One Sperti Drive
Edgewood, KY 41017
606-331-8990

Circle (5) on Reply Card

“We’re just here to help”

A guest editorial

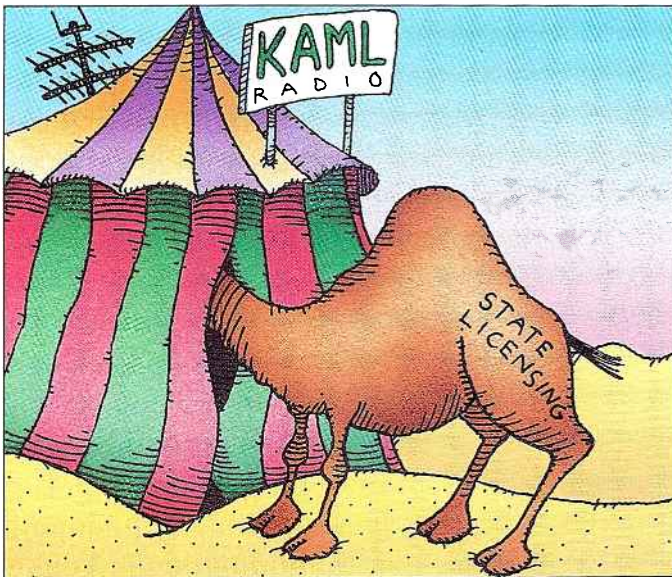

The licensing of broadcast engineers has stirred up a lot of controversy recently. Didn't the FCC deregulate that area more than five years ago? Now, however, it's not the commission that appears interested in requiring you to have a license. It's your state government.

Any attempt by states to regulate or license broadcast engineers is nothing less than a back-door attempt to obtain a measure of control over an industry that is not otherwise within state jurisdiction. Allowing individual states to establish licensing standards for broadcast engineers would create a chaotic, haphazard and conflicting series of regulations.

For instance, would each state recognize the licensing of other states? If one state had a more lenient policy than the others, would broadcast engineers be tempted to apply there, rather than in their home states? If cross-licensing were not approved, how many state licenses might you be required to hold? Imagine having to obtain a driver's license for each state you wanted to drive through.

Will the proposed legislation be limited to broadcasting? Or would cable, teleproduction, industrial and educational activity be included? If such a ridiculous concept is implemented, couldn't it be expanded to include the professional licensing of general managers, camera operators, computer operators or even news anchors? After all, news anchors establish public opinion. Shouldn't they be licensed and insured to make certain that their stories are unbiased? Then there are the equipment sales representatives. We all know that they promote technical equipment and, on occasion, demonstrate and operate the equipment.

There is an Arabian proverb that seems appropriate: "If the camel once gets his nose in the tent, his body will follow." If the door of regulation is opened a crack, it eventually will be forced open wider, permitting regulation in areas never envisioned.

Who's pushing the concept of state licensing? Usually an issue such as this arises when a competing group perceives an opportunity to profit either financially or politically from the change. It's possible that an individual or organization has convinced a member of a particular state legislature that licensing broadcast engineers could generate additional revenue for the state's coffers.

The SBE must take an aggressive stance with the certification program. Each state considering the licensing of broadcast engineers should be notified that an adequate national certification program exists. States must understand that further legislation and regulation would serve only to harm the broadcast industry.

Anyone who thinks that state agencies are better qualified than the SBE to evaluate broadcast engineers is greatly mistaken. When was the last time you saw state or federal regulators do anything better, or cheaper, than it could be done in the private sector? The SBE certification is already in place and operating. Let's not waste time and taxpayers' money trying to reinvent the wheel. Let's allow the SBE to handle broadcast engineer certification, and let's prevent state licensing of broadcast engineers.

William B. Martin
President, Martin Communications
Osage Beach, MO

PARAMETRIC PERFECTION



Introducing the New Orban 642B Parametric Equalizer/Notch Filter

Orban's new 642B Parametric Equalizer/Notch Filter offers unmatched versatility, superb specs, and highly musical equalization in a new generation of our famous and widely-used 622 series. The 642B represents Orban's continuing dedication to the art of creating the "most musical" parametric equalizers through the use of carefully designed, series-connected "constant Q" sections which minimize ringing and stridency.

The 642B's superiority over conventional parametric equalizers is particularly apparent at the extremes of its boost/cut parameter and at narrower bandwidths on difficult program material. In situations like these, the 642B's performance provides consistently satisfying results without complications or unpleasant surprises.

	Band 1	Band 2	Band 3	Band 4
Model 642B (Same in both channels.)	25-500Hz	80-1.6kHz	315-6.3kHz	1-20kHz

Special Application Versions

Model 642B/SP	80-1.6kHz	80-1.6kHz	315-6.3kHz	315-6.3kHz
(Same in both channels. Limited frequency range for speech processing, forensic work, notch filtering/feedback suppression, and similar applications.)				
Model 642B/SPX	Frequency ranges of 642B in channel A; 642B/SP in channel B (For combined full-frequency range broadband shaping and restricted-range narrowband notching.)			

Features include:

- Dual 4-band or mono 8-band configuration selectable by the front-panel Cascade switch
- Each band can be tuned over a 20:1 frequency range; tuning ranges of bands overlap significantly to maximize versatility; +16dB boost/-40dB cut in each band; "Q" variable from about 0.29-5.0
- Vernier frequency control to facilitate fast, precise tuning of sharp notches
- Frequency-selectable 18dB/octave high-pass filter and 12dB/octave proprietary "Automatic Sliding Besselworth"™ low-pass filter to provide full flexibility with maximum musicality
- Noise and distortion specs significantly better than 16-bit digital

Call or write today to discover more about Orban's new, ultra-quiet, 642B Parametric Equalizer/ Notch Filter—a new generation of parametric excellence from the leader in parametric EQ.

Orban Associates Inc.

645 Bryant St., San Francisco, CA 94107
(415) 957-1067 Telex:17-1480 FAX:(415) 957-1070

Circle (6) on Reply Card



Protect your station from PCB problems

By Harry C. Martin

Polychlorinated biphenyls (PCBs) are common in the power transformers of broadcast transmitters and other electronic components manufactured before 1978. As the result of findings that PCBs are highly toxic, Congress directed the Environmental Protection Agency (EPA) in 1976 to take steps to regulate their use and disposal. Broadcasters must be aware of their responsibilities under the EPA regulations. Following is a brief overview.

The EPA's rules set forth procedures to be followed regarding the marketing of PCB items, registrations, leaks, disposal, storage and recordkeeping. Violation of these rules may result in criminal prosecution and large fines.

The most stringent regulations apply to PCB transformers, which are defined as those containing at least 500 parts per million of PCBs. Such PCB transformers:

- May not be used in any way that poses a risk of exposure to food or feed.
- May not be moved to a location in or near a commercial building.
- Must be registered with the local fire department.
- Must be registered with the owner of the building in which the transformer is located and any buildings within 30m of that transformer.
- Must be marked with labels that meet specific design requirements set by the EPA. Labels are commercially available in the various sizes required.
- Must not be stored with combustibles that are less than 5m from the transformer or its enclosure.
- Must be inspected every three months. No two inspections should be less than 30 days apart. Make a log of each inspection and maintenance action, and keep it for three years.

If a PCB transformer:

- **Leaks:** Contain the leak immediately, make daily inspections until it is repaired and begin cleanup as soon as possible. Under no circumstances should cleanup begin more than 48 hours after the leak is discovered.
- **Is involved in a fire-related incident:** Immediately notify the National Response



Center (1-800-424-8802) and your local fire department of the situation. Take all possible measures to protect the water supply from contamination.

- **Is to be disposed of:** PCB transformers and contaminated items must be disposed of in a manner approved by the EPA. In general, liquids and capacitors containing PCBs must be incinerated properly by a licensed facility. Discarded transformers and other PCB articles must be disposed of at an EPA-approved chemical waste landfill. Transportation of PCBs to storage or a disposal site must be licensed in advance and should, under most circumstances, be contracted out to a third party who has the expertise to cope with the contaminated articles under federal and state regulations.

PCBs also may be contained in other electrical components of a transmitter. These components are subject to many of the same regulations regarding marketing, disposal, registration, resale and cleanup.

The "Superfund" law, which provides money for the cleanup of toxic spills and also provides for the recovery of costs from those responsible for the spill, may have a direct impact on stations that have disposed of PCB items or are planning to.

The law says that anyone associated with an eventual spill can be held responsible. This includes owners and operators of a site that requires cleanup, previous owners and operators of the site, anyone who ever has arranged to have waste disposed of at the site in question, and any party involved in the transportation of hazardous materials to the site. Because of these provisions, it is crucial that a station research its waste-disposal procedures carefully to ensure that there is no PCB contamination at the disposal site it is using and that the site is otherwise properly managed.

If you currently are involved in the purchase of a station that may have PCB equipment on the premises, it is important that you make a careful check of the grounds and equipment before committing to the sale. Such an examination might include soil testing, examination of all pre-1980 equipment, a review of the maintenance logs for that equipment and a thorough search for possible past abuses

involving toxic substances on the property. If possible, include a clause in the sales agreement that exonerates you from any future PCB-related problems.

In all cases, careful compliance with the rules and meticulous documentation of all inspections, disposal and research concerning possible toxic materials at your station are the best lines of defense against legal action by the government or private parties.

24-hour ban on indecent broadcasts

In response to a law passed by Congress last fall, the commission has extended its ban on the broadcast of "indecent" material to all hours of the day. Previously, the commission's policy had been to restrict broadcasts of indecent material to times when children were not likely to be in the audience. This so-called safe harbor period had been defined in various FCC enforcement actions as the period between midnight and 6 a.m.

The commission's definition of indecency, which has withstood court scrutiny, is "language or material that, in context, depicts or describes in terms patently offensive, as measured by contemporary community standards for the broadcast medium, sexual or excretory activities or organs."

The new law, as well as the regulations implementing it, are being challenged in court on First Amendment grounds.

Anti-trafficking status quo

The commission has denied the requests of several public interest groups for review of its decision not to reinstate rules that restricted station sales and resales.

These "anti-trafficking" rules generally required a 3-year holding period between sales of a station and did not permit resale for a profit during that time. The rules were eliminated in 1982, but their reinstatement was debated widely by congressional committees and other policymakers during the mid-1980s, particularly after the Metromedia leveraged buyout and other station resale transactions. No consensus ever developed on reinstating the rules, however.

Martin is a partner with the legal firm of Reddy, Begley & Martin, Washington, DC.

Championship Performance.

For a champion, being the best is not enough. You never stop trying to be just a little better. To move the standard a little higher. To make even the most difficult achievements seem easy.

So it is with the Model 300 production system, the recognized world standard. Now in more than 800 installations worldwide, the Model 300 continues to offer you more.

Full integration and centralized control of the Kaleidoscope Digital Effects System puts state

of the art, three-dimensional digital effects at your fingertips. Giving you the world's most advanced and powerful production system. And, the easiest to operate.

When you own a Model 300 with built-in Kaleidoscope Digital Effects System, championship performances are almost effortless.

For details, contact the Grass Valley Group office nearest you.

The Model 300 Production System, integrated with the Kaleidoscope™ Digital Effects System.



THE GRASS VALLEY GROUP INC.

P.O. Box 1114, Grass Valley, CA 95945 USA
Telephone (916) 478-3000
TRT: 160432

OFFICES: New York (201) 845-7988; District of Columbia (301) 662-6313; Atlanta (404) 493-1255; Chicago (219) 264-0931; Minneapolis (612) 483-2594; Dallas/Fort Worth (817) 483-7447; Los Angeles (818) 999-2303; San Francisco (415) 968-6680; GVG International Ltd. (UK) + 44-962-843939; Grass Valley Group Asia (HK) + 852-3-7396632

Circle (7) on Reply Card

Kaleidoscope System Effects shown:
— transparent soft intersecting planes
— drop shadow
— soft border
— Omni-Key™ linear keying
(using Model 300)

A new beginning for HDTV?

By Rick Lehtinen,
TV technical editor

One of the first rules of digital encoding is that you have to use enough samples to do the job. Use any less than a prescribed number, and you introduce errors. But there is nothing that says you can't take all the samples you need and write them in shorthand. Do this, and suddenly you open up tremendous potential for terrestrial TV transmission.

Genesys

One system that does just that is the Genesys system, from Production Services Inc. (PSI), Tucson, AZ. The system can encode a 3MHz auxiliary video signal over an existing 6MHz signal, apparently without disturbing or causing artifacts in the original signal. Developers hope that future incarnations will put a full-bandwidth (30MHz) HDTV signal, or several NTSC signals, and a multitude of top-quality audio channels over an existing NTSC signal without any serious modification to the signal system, switchers or transmitter in a TV station. (The TV transmitter should use IF modulation.) If you think these claims seem sort of incredible, that's natural. Keep an open mind, and read on.

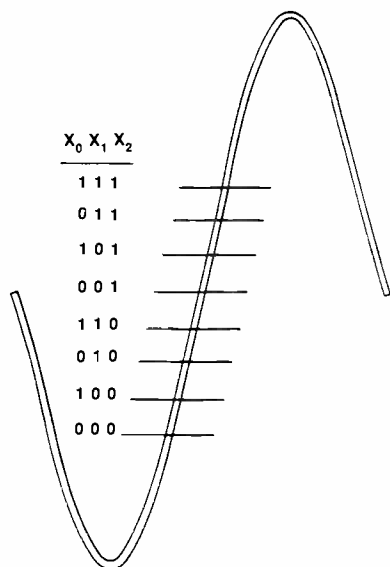

Figure 1. Position of Genesys "bump" on carrier wave conveys three bits. Both rising and falling slopes are used, yielding six bits per cycle.

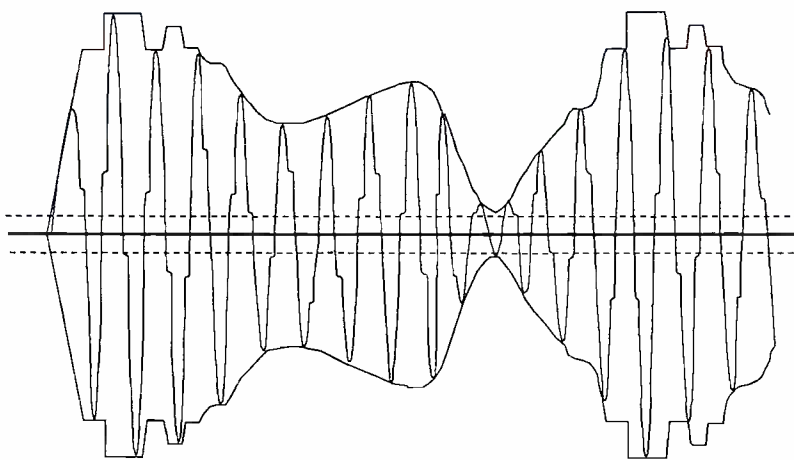
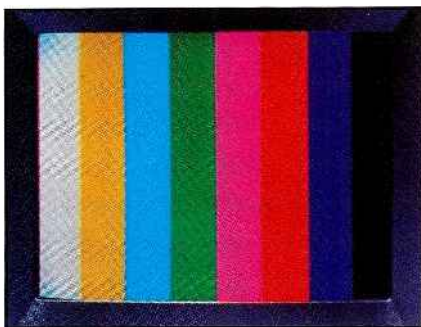

Figure 2. Genesys carrier wave is modulated in normal fashion, in IF-modulated TV transmitters.

Modulation

Historically, a waveform has been modulated by varying its frequency, phase or amplitude. Some waves, such as the color subcarrier signal, were modulated in more ways than one (phase for hue, amplitude for saturation). We generally assume the modulated wave, or carrier, is a sinusoid. It needn't be, however, and by modulating the shape of the carrier wave, we can achieve an additional form of modulation, waveform modulation.

In the Genesys system, the transmitted carrier is given inflections, or bumps, on the rising and falling slope of each cycle. Other parts of the wave are modified to keep its "harmonic signature" (Fourier constituent waves) and rms value close to that of a sinusoid. The position of these bumps conveys six digital (not binary) bits each cycle (see Figure 1). The result is a funny-looking carrier wave that does everything it's supposed to, plus carries extra information.

Extra bits

Of course, six bits doesn't go too far in the binary world. The real power of the Genesys system lies in its ability to tightly compress data into those six non-binary bits. The textbook name for the encoding process is adaptive delta modulation. In Genesys, digital words can be delta or binary, depending on which will resolve

the fastest. This "digital shorthand" increases Genesys throughput.

Transmitted Genesys

Most IF-modulated TV transmitters mix a fixed IF of about 45MHz with whatever local oscillator frequency will add up to the transmitter's assigned output frequency. Genesys premodulates this IF (see Figure 2). Modulation circuitry is common, inexpensive and straightforward.

Receiver compatibility

Receiver compatibility is a key to upgrading the broadcast system. Proponents say Genesys is extremely compatible, because the TV carrier frequency, waveform-modulated or not, is rejected during detection. Genesys encoding, therefore, should be transparent to viewers who don't need it, but allow viewers so equipped to receive whatever kind of HDTV eventually is selected. (Genesys is an open system.) If successful, such an approach would solve many HDTV compatibility problems.

"**STILL . . . THE MOST AFFORDABLE FULLY PROFESSIONAL RECORDER ON THE MARKET.**"

Two new and still affordable versions of the most affordable fully professional recorder on the market join the A807 family—a 1/4" 2-track and a 1/2" 4-track 30 ips High Speed recorder.

Compare features, quality and price! You can't buy a 2-track or 4-track recorder that offers the same level of advanced technology, plus Studer audio performance and renowned Studer quality—at any price.

AGILE AND EASY TO USE

Radio, post-production, or studio—in whatever audio environment you operate—like all A807's, these new versions are fast, full-featured machines for making quick work of your production tasks.

A807 features include: • tape shuttle wheel • reverse play • right hand edit • tape dump • varispeed • multifunction tape timer and autolocator with programmable "soft keys"

• digital setting of audio alignment parameters for 3 tape speeds and 2 tape types • RS 232 port • a wide variety of configurations available now, with more to come in the near future . . .

STUDER AUDIO PERFORMANCE & RELIABILITY

Advanced phase compensated audio-electronics, Dolby HX Pro™, a massive die-cast chassis and headblock . . . these compact recorders are built with the same quality, precision and full-sized Studer sonics that have been synonymous with the Studer name for four decades.

So—if "affordable" is not the first word that comes to mind when you think of Studer—think again.

Then call your authorized dealer and arrange a test drive of the new, affordable High Speed A807's.



**THE 30 IPS
4-TRACK IS HERE!**

STUDER REVOX

Studer Revox America Inc.

1425 Elm Hill Pike • Nashville, TN 37210 • Phone (615) 254-5651

Available from Studer Revox Full-Line Professional Products Dealers. Or contact us directly. **Los Angeles** (818) 780-4234. **New York** (212) 255-4462. **Chicago** (312) 526-1660. **Dallas/Ft. Worth** (817) 861-1861. **Canada** (416) 423-2831.

Circle (8) on Reply Card

www.americanradiohistory.com

Some thoughts about the "good old days"

By John Battison, P.E.

I was involved recently with several AM stations suffering from the ravages of age. Some of these stations were staffed by young station engineers. While working with these capable fellows, I was struck by the contrast between their experience and what was typical many years ago. The comparison leads me to reminisce about some of the changes that have taken place in broadcast engineering training.

Trained engineers

I joined the radio ranks at KMBC-AM (and later, FM) in Kansas City, MO, in 1945. The 5kW station employed several engineers, an RF chief (Ray Moler) and a studio chief (Kenny Krahl). I've forgotten how many audio and RF technicians were employed. In those days, someone had to be on duty at the transmitter at all times. The 30-minute intervals between meter readings required a fairly large number of engineers.

Both chief engineers had been with the station for many years and grew up in the business. Some of the transmitter engineers used their time on duty to improve their technical skills. In fact, many of the men obtained undergraduate degrees while employed at the station. At least one went on to gain a Ph.D.

Learning from others

For me, working under Kenny and Ray was a wonderfully inspiring and instructional introduction to radio engineering. In those days, our work *was* engineering because we were developing technology through everyday operating practice. Solutions to problems that are today covered in textbooks or in technical and manufacturer's literature were not as well-known then. In many cases, the station engineer was forced to find solutions that had not yet been published.

New broadcast technology was being discovered almost daily. High-band FM broadcasting was commencing. Engineers were faced with working not in the 550kHz to 1,600kHz band, but with high frequencies such as 40MHz or even



100MHz. Unexpected oscillations in the PA stages began to occur. Plumbing took the place of nice, convenient coils of wire and direct, simple wire leads. Even when a station bought a new FM transmitter, there was no guarantee that it would work consistently.

I consider myself fortunate to have known such greats as C.M. Jansky, Stewart Baily, Harraden Pratt, George Baily, George Brown, Alan DuMont, Major Armstrong, Commissioner George Stirling and Peter Goldmark. The work of these and other talented individuals made lasting impressions on the radio broadcast engineering profession.

All these men were graduate engineers, holding influential positions in their companies. Few of the old-time greats are working in this industry today. Their places were taken by the youngsters who entered the field in the post-World War II years. This second generation also made its mark on a profession that has more than doubled its rate of growth and technical change every decade or so. The second-generation engineers now have retired or are nearing their time to do so.

Changing regulations

Today's technical and regulatory environment is greatly different from the one faced by the original broadcast engineers. In many cases, new rules represent a lowering of technical standards. Equipment became more reliable, and FCC rules allowed announcers to become *engineers* overnight. New technology made it possible for management to remove many of the safeguards that were required in past years.

Today's technicians learn quickly, are smarter and know more than we old-timers about current equipment. On the other hand, many of these people are less familiar with certain types of broadcast technology. Some of them have never had the opportunity to be trained on equipment by a person thoroughly familiar with its operations.

Proper terminology

You may have noticed my use of the term "technician." I use it to indicate a technical expert. There is continuing

discussion and debate within the industry about the use of the term "engineer" to describe someone who is not registered as a professional engineer. The first-class license never bestowed the title of engineer on its holder. No FCC license ever has.

The engineer appellation has been expanded so much over the years that it has almost lost its meaning. Today we classify garbage collectors as sanitary engineers. Janitors who look after the steam-heating systems are called steam or stationary engineers. Do you really think that the title engineer means much any more? The term technician is growing in usage and application. To my mind, it is an honorable and descriptive term, which is applied increasingly to top professionals in both engineering and medicine. However, we seem to be caught up in a barrage of words about what engineer means.

In fact, the argument has been going on for so long that some of us have forgotten when it started. When I edited the "Journal of the Society of Broadcast Engineers" in the mid-1960s, most issues contained articles or correspondence from members on this topic. (Editor's note: John Battison is the founder and first president of the SBE.)

Nothing was resolved then, and it still isn't today. Now, however, some states seem to be trying to take over jurisdiction of technical workers in the broadcast field. It behooves the SBE to continue its ongoing and strenuous efforts to obtain national recognition of SBE certification as a mark of accomplishment. Under the great leadership of Jim Wulliman and the past SBE presidents, the certification work has continued and prospered. Don't forget that he still needs all the support and encouragement we can provide.

Perhaps now is the time for the SBE to consider establishing a contract engineer certification program. Would the professional certification program suffice? I welcome your comments.

Battison, BE's consultant on antennas and radiation, owns John H. Battison and Associates, a consulting engineering company in Loudonville, OH.

KLYSTRODE[®] TECHNOLOGY SAVES ENERGY.

KHHY CHANNEL 32
ACTION TELEVISION
ANYTOWN, U.S.A.

527

Dec 30 1988 ¹¹⁻²⁴/₁₂₁₀

TO CONSOLIDATED ELECTRIC POWER CO. \$ ^{50,000}/~~100,000~~ %
FIFTY - THOUSAND
ONE HUNDRED THOUSAND & 0/100 Dollars

ANY OFFICE

Your Bank

1234 ANY STREET, ANYTOWN, CA 12345

FOR

ANNUAL POWER BILL

John Mc Tavish

General Manager

⑆000527⑆⑆⑆121000248⑆0158 025684⑆

THANKS EIMAC



varian[®]

eimac san carlos division

Circle (9) on Reply Card

301 Industrial Way / San Carlos, CA 94070 / 415-565-2000

www.americanradiohistory.com

Spread spectrum technology

By Elmer Smalling III



Spread spectrum modulation techniques are becoming popular for satellite and terrestrial communications. *Very small aperture terminal* (VSAT) satellite communications, by which hundreds of asynchronous users share a single transponder, is a logical use of this new technology.

Because *spread spectrum multiple access* (SSMA) communications systems use extremely large bandwidths, they are tolerant of interference. So tolerant, in fact, that a multitude of users can occupy a single channel simultaneously, relying on digital communications techniques and error-correcting codes to sort things out.

CDMA

One spread spectrum technique, which uses an addressing system, is *code division multiple access* (CDMA). This means that the characteristic that separates one signal from all others is not time, as in *time domain multiple access* (TDMA) or frequency, as in *frequency domain multiple access* (FDMA); rather, it is a data address or code. FDMA is inefficient because of the waste of spectrum during periods when no information is transmitted, and TDMA is tricky to decode without using extremely accurate time standards and clocking.

CDMA encoding spreads the spectrum of a carrier because of the addition of address information. If the address is modulated directly on the carrier, the

process is called DS-CDMA or direct-sequence CDMA. If the address is used to continually change the frequency of the carrier, the process is called FH-CDMA or frequency-hopped CDMA. Frequency-hopped CDMA is used primarily by the military for security reasons.

CDMA modulation is a rather simple process: The data signal or bitstream, which is the information to be transmitted, is modulated by a higher-frequency signal consisting of bits of much smaller duration (higher frequency). This higher-frequency modulating signal consists of repeating address information that is detected by the receiver as it examines the entire bandwidth of the CDMA channel.

Because it is many times higher in frequency, the address information will determine the bandwidth required for the channel. Let's say you have a data signal that you wish to feed over a transponder whose center frequency is 4,020MHz. This transponder has a usable bandwidth of 30MHz. Your data signal would be modulated by a 30MHz address signal for transmission.

This signal, in its most basic form (not including error checking or special address routines), is a 30MHz datastream with the address of your station repeating continuously. The bits that form the high-frequency address signal are called chips. In the most common type of spread spectrum modulation, one databit takes the time of eight address chips. If you could listen to the received signal using a filter

to eliminate the FSK data information, you would hear a cacophony of address signals.

Front-end computers and processors have the task of picking out the correct address by matching one in file and keeping the appropriate data signal in coherence. This gets trickier for the front-end processor as more signals are added, and when the noise approaches symbol and crosstalk levels.

VLSI

The equipment required for CDMA signal detection is far more complicated than that used for standard frequency or time domain techniques. LSI (large-scale integration) is important for SSMA. Although the circuitry required for detection is more complicated than that used for older modes of multiple-access transmission, such circuitry can be found in a few ICs rather than on several circuit boards.

Wave of the future?

Even systems as humble as outdoor residence meter reading employ spread spectrum modulation to conserve spectrum space and circuit-power consumption. CDMA will be the predominant spread spectrum type of modulation in the future.

Smalling, BE's consultant on cable/satellite systems, is president of Jenel Systems and Design, Dallas.

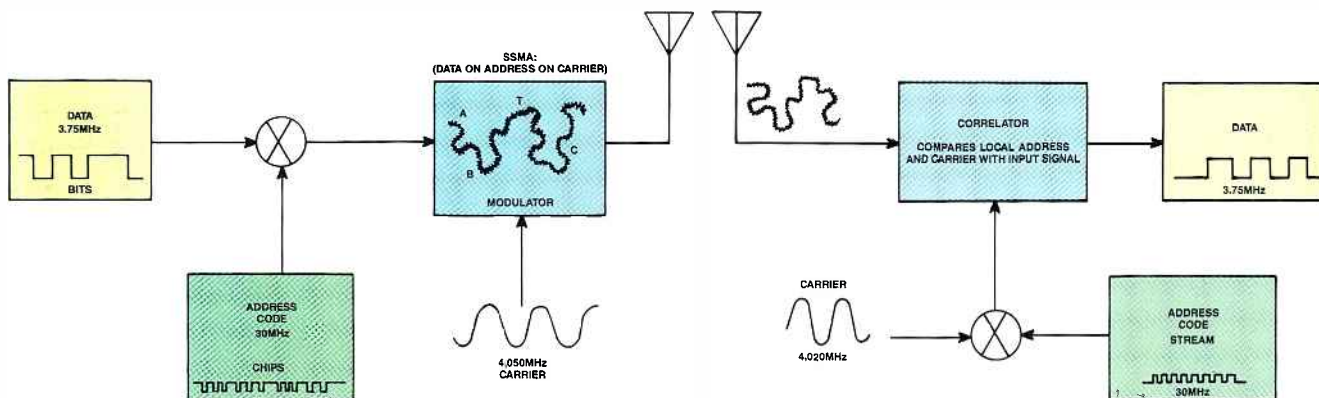

Figure 1. A spread spectrum communication system spreads the datastream with address chips. The correlation detector recovers data at the receiver.

Feature Shock!

Otari's new MX-50. Built around the premise that you can have everything you ever wanted in a two-track tape machine, and still stay within your budget. For example:

The Transport

—DC quartz PLL capstan motor with front panel selection of operating speeds (from either a 15/7.5 or 7.5/3.75 ips speed pair).

—Capstan speed variable by $\pm 7\%$ from the front panel, and by $\pm 50\%$ from SMPTE

time-code external controllers via an Otari-standard 37-pin connector.

—Optional remote control.

The Electronics

—Lighted VU meters with peak-reading LED indicators.

—Transformerless active balanced inputs with XL-type connectors.

—Optional Voice Editing Module (VEM) for twice normal play speed with normal pitch.



A built-in tape timer displays current tape position in hours, minutes, and seconds, and includes a search-to-cue locator with cue point and zero location memories.

Otari's MX-50. For whenever or wherever you need a professional

audio machine at an affordable price.

For more information, call your nearest Otari professional audio dealer, or Otari Corporation at (415) 341-5900.

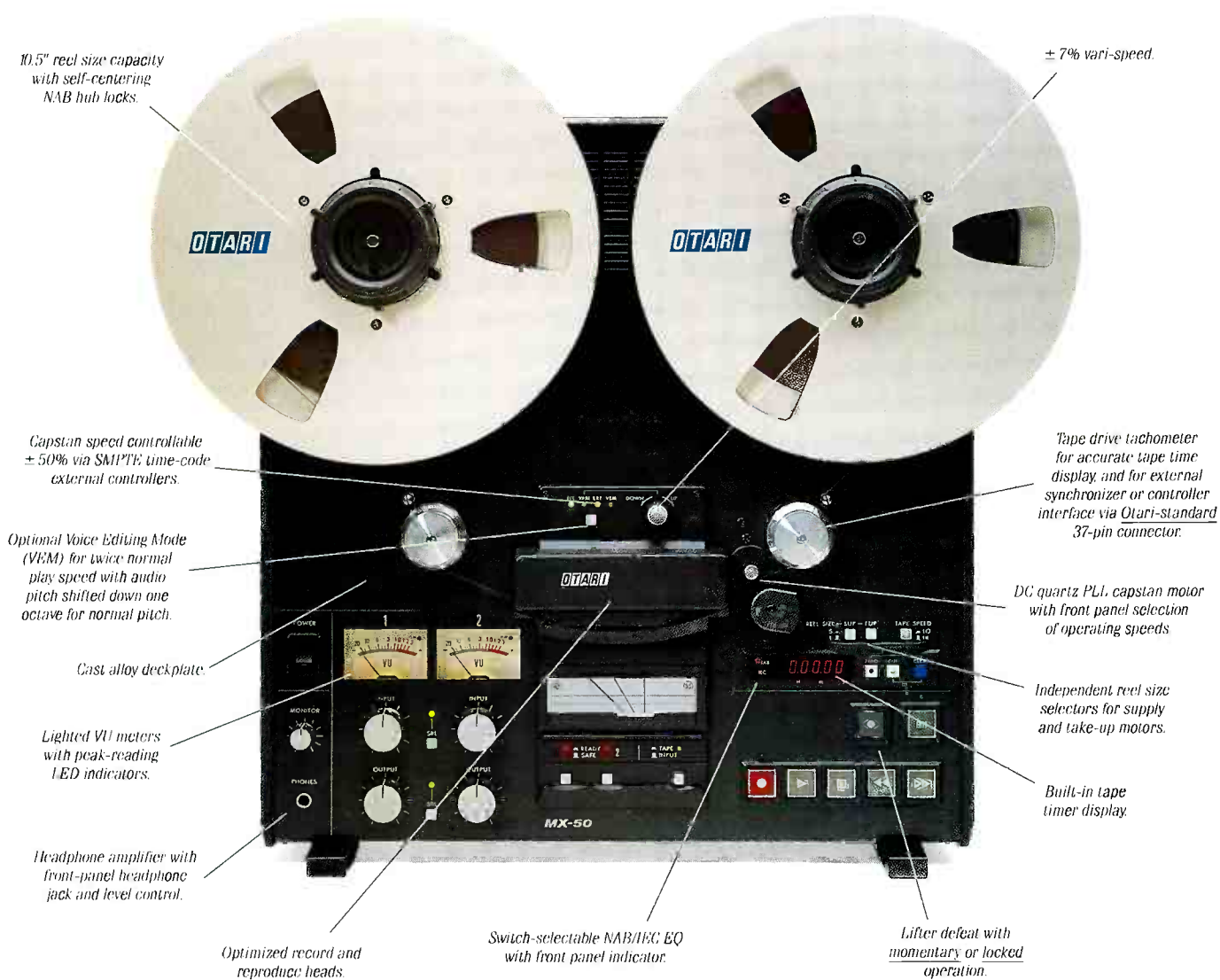

Technology builds on the basic telephone

By Gerry Kaufhold II

Although radio is "wireless," broadcasters know the importance of the telephone system. For remote broadcasts, for remote control and for transmission of news script files and other data, broadcasters often depend on the phone system.

Telcos and businesses constantly are installing upgraded equipment. Fancy PBX systems that can find the least expensive path for a call, voice mail systems that distribute "audio memoranda," automatic call-in vote counters and dial-up message systems all can be useful to broadcasters. Although these new technologies bring exciting possibilities, we must not forget the basics. Let's look at the plain old telephone service (POTS).

Patch panels

Early telephone connections were hand-patched by an operator. Because the wires were open when not connected, early systems used hand-cranked electrical generators to signal operators in the Central Office. When you wanted to make a call, you turned the crank.

The operator's patch panel used connectors that had a metal tip, shielded by an insulator and surrounded by a cylindrical ring. This is where the terms *tip* and *ring* come from in broadcast patch panels.

POTS today

The receive circuit in most telephone systems is similar to the one shown in

Kaufhold is a market development engineer at SGS-Thomson Microelectronics, Phoenix, AZ.

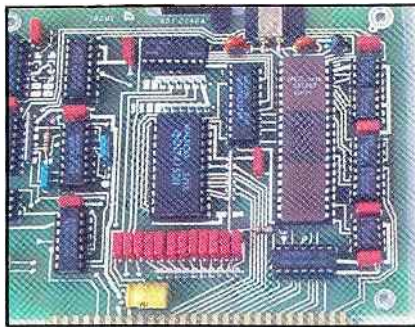

Figure 1. It works along the lines of the system just discussed. When on-hook (disconnected), the telephone draws no currents except the trickle current due to capacitor leakage.

A low-level ac current can be sensed by the Central Office to verify that the line is continuous. This feature was installed as a means for continuity-checking by the Central Office. When the handset is lifted off-hook (connected) a spring-loaded switch shorts the circuit, pulling enough current to energize a relay at the local Central Office.

For devices such as transmitter remote controls and studio transmitter links, the station probably pays a substantial fee to the Regional Bell Operating Company (RBOC) for continuous-duty leased lines. These lines do not detect on- or off-hook, because they are in service around the clock (always off-hook).

Regional differences

The voltage that appears across tip and ring is typically 48Vdc, but different geographic regions have different voltage levels, and polarity might be random.

When a call is placed from the Central Office out to a subscriber, an ac voltage of 60Vrms to 90Vrms is applied at a frequency between 15Hz and 67Hz. This voltage is great enough to energize the bell (ringer) in spite of the series resistor in line with the phone line.

Regardless of local system voltage, note that each device that hangs in parallel across the incoming telephone line must

not degrade the dc line impedance. If you want to measure the dc resistance across a telephone to verify that varistors or other protection devices have not shorted or become low-impedance, always disconnect the phone from the telco line. The resistance when on-hook (hung up) should be high; when off-hook, the resistance should be about 3,000.

Circuit protection

Of course, phones aren't the only devices broadcasters connect to their phone lines. When a solid-state device is being used to sense the ring signal, circuitry must be used to protect the device from transient voltages in the 300V range. The collapsing magnetic fields of electromechanical ringers connected on the line cause inductive kickback voltages to appear randomly throughout the Public Service Telephone Network (PSTN).

Another consideration when connecting equipment to the PSTN is electrostatic discharge (ESD). Because telephone lines often are strung above ground and are made of insulated conducting wire, they act as antennas for ESD and for lightning. In dry regions, it is common to find redundant overvoltage protection devices installed at the connection point to the PSTN.

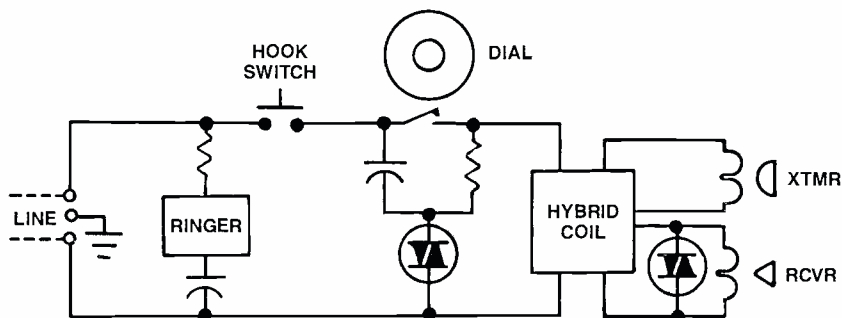

Figure 1. Basic "pots" telephone circuit.



The Audio Processor Classic. And the one that endures.

In the arduous two-year development project that produced the 8100A OPTIMOD-FM®, there was always one overriding principle:

While providing competitive loudness where needed, the processor must have an utterly natural, musical sound that not only attracts an audience, but holds it.

Processing artifacts that cause listener fatigue and tune-outs were simply unacceptable. Loudness at the expense of good sound is never worth the price. (A listener can compensate for loudness by simply adjusting the volume control. But there is *nothing* the listener can do to make a dirty signal sound clean again, except change to another station!)

The development project resulted in a *classic*. The most popular FM processor *ever*. The processor that helped build audience and ratings for thousands of stations. The processor

that was the unchanging, indispensable core of countless customized processing setups. The processor with impeccable quality and rock-solid reliability. And the processor backed up with uniquely responsive Customer Service.

Today, OPTIMOD-FM has evolved into a complete system capable of serving any processing goal, and of fitting into any STL environment, thanks to OPTIMOD-FM's accessories. While other processors have come and gone, OPTIMOD-FM's audio quality has yet to be equaled by anyone, regardless of their bells, whistles, or flashing lights. It's the right choice for any station — because it's the one processor that you won't throw away.

OPTIMOD-FM 8100A/1. The Audio Processor Classic. The one that endures.

Call your Orban Broadcast Dealer for our *new* OPTIMOD-FM brochure, or call us direct.

orban

Orban Associates Inc.

645 Bryant Street, San Francisco, CA 94107 USA

Telex 17-1480 FAX (415) 957-1070

Telephone (415) 957-1067 or (800) 227-4498

Circle (11) on Reply Card

In pursuit of the elusive intermittent

By Roald Steen

Finding intermittent problems with mobile equipment is one of the toughest challenges maintenance engineers face. Consistent faults are repaired more readily. Intermittents often go unrepaired because the engineer may be unable to duplicate the field conditions that are causing the fault.

Major causes for intermittents include:

- RF noise
- Temperature
- Vibration
- Moisture
- Dirt and corrosion

Intermittents can occur in the device or in the external components, or both. Let's look at some suggested repair procedures to track down these elusive problems.

RF noise

Intermittent reception problems may be caused by the vehicle's electrical system. Today's cars and the widespread use of microprocessors and semiconductors can generate noise on many frequencies. If any of the generated frequencies fall on a receiver's tuned image or IF frequency, problems are sure to be noticed. High-amplitude noise may penetrate even the best of receiver shielding.

Electrical noise usually can be traced to two sources: the alternator or the ignition system. An open diode in the alternator system can cause extremely strong radio noise. The vehicle's engine and electrical accessories may operate almost normally despite the open diode. To verify an open diode, connect a short, insulated wire to an oscilloscope's vertical input, and hold the wire near the alternator. Look for extremely strong noise pulses when the engine is running.

The wide spectrum of frequencies that may be present in radio noise can cause unusual problems. In one instance, a unit's receiver could not be unskelched when the vehicle was driven at certain speeds. Replacing the transceiver with a different model made by the same manufacturer solved the problem.

Steen is an electronics instructor and free-lance writer in Woodbury, MN.

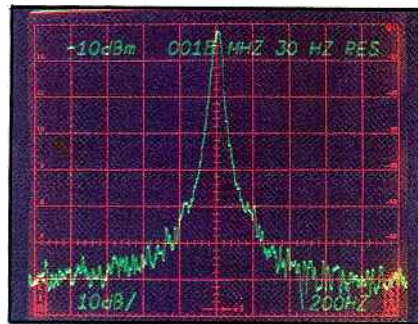

Temperature

Intermittents may be caused by heat, a condition difficult to duplicate in the maintenance shop. A vehicle trunk, where radios often are mounted, may undergo enormous swings in temperature. Trunk temperatures as low as -30°F are not unusual during winter at northern latitudes. During the summer, trunk temperatures may be so high that trunk-mounted equipment are too hot to touch.

The vehicle's exhaust system can add to the heat problem. When a car is moving, exhaust system heat is exchanged with the air that flows around the vehicle. This prevents heat from the exhaust system from radiating into the trunk.

When a vehicle is stationary, the exhaust system heat rises, which can increase the temperature in the trunk. The problem usually occurs during summer when the driver idles the engine to power the air conditioner.

Vibration

Mobile radios are subjected to a wide range of vibration. Some vibration originates from the engine and changes with motor speed. Much more vibration comes from the road, ranging from violent jolts to constant rattles.

These types of intermittents are unlikely to occur when the vehicle is parked in the station parking lot. Hitting the radio (carefully) with the fist can sometimes duplicate the problem. Usually it's best to find out where the unit failed and try to drive over the same path. It sometimes takes a certain type of vibration to trigger the failure.

Never attempt to drive the vehicle while you're looking for the problem. Let someone else drive the car. This leaves you free to poke around or shake the cables as necessary to trigger the intermittent.

Moisture

Pure water is an electrical insulator. However, adding even a little dirt or corrosion changes the insulator into a conductor. In this way, moisture may cause intermittents. On a chilly morning, for example, dew may form inside the radio and on other components, causing a fault. As the air warms, the dew evaporates, and

the intermittent may disappear.

Exposed components such as the antenna are especially vulnerable to moisture. Check inside the antenna mount for moisture and signs of dirt and corrosion. If the connector is corroded, replace it. Be sure any antenna connector or fitting is properly sealed against water.

In cold climates, a vehicle's roof occasionally may be covered with snow. Although snow does not conduct electricity well, it still can cause intermittents. For example, a short UHF antenna may be covered by snow for most of its length. The communication problem will disappear as the snow melts.

Dirt and corrosion

Dirt and corrosion often combine with moisture to cause intermittents. Eliminate these intermittents by thoroughly cleaning connection points and switches. Isopropyl alcohol or special cleaners can be used. Don't use cleaners that leave behind an oily residue. Such cleaners will compound your problems as the oil collects dirt and dust.

Dirt and corrosion may introduce resistance to connection points. The added resistance may not be a problem if low currents are used. However, as the current increases, so does the voltage drop. The lower voltage can cause a variety of problems within radios.

Logs

Because intermittents are sometimes difficult to identify, logs can be a great help. Keep separate logs for the vehicle and for the radio. The logs will reveal whether the problems follow the vehicle or the radio.

Log details of repairs performed. The maintenance engineer can use the logs as a troubleshooting guide. When attempting to make repairs, it's often helpful to know the unit's previous problems. Accurate records also help the maintenance engineer avoid repeating ineffective remedies.

Intermittents are a formidable repair challenge. Following the guidelines presented here can help shorten the time the unit is down. Most important, proper servicing practices can help ensure that failures do not recur. |:-|:-)))))

HOW MUCH MORE WOULD YOU PAY FOR MI COMPONENT QUALITY? HOW ABOUT LESS!

DISCOVER JVC's KR-M800U

If you'd expect to pay a lot to get component picture quality, you're in for a pleasant surprise. JVC's KR-M800U MII editing recorder gives you the editing performance of component video technology at a surprisingly low price.

MII is state-of-the-art component video technology, and it's one of the techniques ever devised to fully reproduce video images. Luminance and chrominance tracks are recorded separately to maintain signal integrity and reduce crosstalk interference. The images are recorded on high-density metal particle tape, giving you a full 90 minutes of the best video you've ever seen. Better performance and greater versatility—That's the MII advantage.

And you don't have to abandon your present format to gain the benefits of MII. In fact, MII enhances your present equipment through Multi-Format Integration.

Shoot in your present format—S, S-VHS, 3/4-in. or any format, transfer your footage to the KR-M800U through JVC's JF-F250U multi-format frame synchronizer/time-base corrector. Now you'll have an edited master in component MII video that is ready for post-production, duplication, or distribution.

Think of the possibilities: record live SNG remotes—MII gives you the power of the 1-in. format at a fraction of the size and cost. Edit news stories and

documentaries—the KR-M800U is a superb cuts-only editing recorder. Insert commercials—the KR-M800U gives you pinpoint precision. Save the quality of animation for generations—shoot in any format you want, but preserve the picture in MII with the KR-M800U.



And this is just the beginning. The KR-M800U has the professional features you'd expect too, including selectable CTCM and component outputs. Y/C 3.58 output for compatibility with S-VHS recorder/players, so you can dub S-VHS tapes from MII component masters without any decoding—

eliminating signal degradation. A 45-pin parallel remote control connector for compatibility with existing parallel editing controllers. High-speed search at 32 times normal speed. Jog control for fast access to edit points. Comprehensive editing functions including preroll, auto edit, edit in/out, trim, go to, and preview/review. Meters for audio and video tracking. RF output for external DOC.

See the MII advantage for yourself. Call 1-800-JVC-5825 and ask for complete details about the KR-M800U. Or we'll set up a demonstration of how MII performance can boost the quality of your video productions.



ALWAYS A STEP AHEAD... TO KEEP YOU A STEP AHEAD.

Circle (12) on Reply Card

www.americanradiohistory.com

Management profiles and personalities

By Walter Borys Jr.

Building on last month's discussion of personalities and management style, let's look at some examples. Using these illustrations, see whether you recognize patterns in your behavior or that of your supervisor.

Different perceptions

Virtually everyone is someone's employee. We all need to ensure that the boss is happy with our performance. However, given the differences in personalities, philosophies, outlooks and values, this can be somewhat of a problem. Let's look at three people, with three different personalities, and how they might view the same problem differently.

John Laidback works in the maintenance shop and is a darned good employee. He is a crack maintenance technician, can repair a camera faster than anyone on the staff and usually ends up doing more work than the other techs. Most important, he's concerned about the quality of the station's air product. John, however, is a bit of a free spirit and a late riser. He just can't seem to make it to work on time. He doesn't consider this a big deal, and he normally works later than would be required to make up the time.

John does have a serious problem, however. His supervisor, Allen Stoneface, is a stickler for rules. He's been with the station for almost 20 years and runs his life in an orderly fashion. He arrives promptly at 8 a.m., wears sensible clothes and always brings a tuna salad sandwich, which he eats promptly at 12:15 p.m. in the employee's lounge. Allen's department is well-run and efficient. Although Allen knows that John does his work, he sees him as disorganized and lackadaisical. According to Allen, "You can't depend on anyone who can't get to work on time." Allen does not consider John a good employee.

Allen's boss, Pete Rusharound, is the dedicated, hard-working type. He always has plenty to do. So much, in fact, that he comes in at 7 a.m. on most days, usually works through lunch, and is lucky to leave

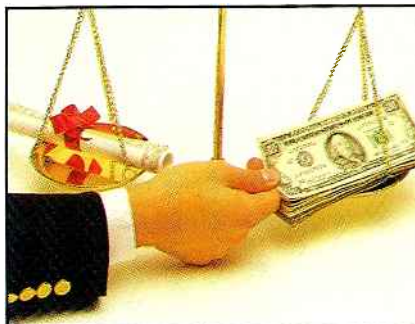

the office by 6:30 p.m. He frequently comes in on Saturdays and often takes work home.

The problem

Pete's not all that crazy about Allen. He knows that he does his job. However, he doesn't think anyone can truly be doing their best if they don't arrive until 8 a.m., then always take a lunch break. He wishes that Allen would stop putting his personal needs ahead of the job and would exhibit more of what he perceives to be old-fashioned dedication and loyalty to the station.

Curiously, Pete thinks that John Laidback is an excellent employee. He knows that John is normally still at work plugging away, long after Stoneface has left for the day. He's sometimes impressed that John can perform so well with such a lackadaisical supervisor.

Each of the three employees in the example appears to be competent, productive and interested in his job. At the same time, each has substantially different views of the world. These differing viewpoints skew the ways in which each views the other. Although these employees are trying their best and performing well, it is probable that they are not receiving the positive strokes, good appraisals or recognition they deserve. This can lead to friction, conflict and reduced productivity.

The supervisor is normally in a position of power. When there is a conflict of values or perceptions, it's likely that the boss already has done something about it in either a direct or indirect manner. The boss may well have conveyed a sense of distrust or disappointment to the employee. Perhaps the employee has received a poor performance appraisal or has been denied a bonus. Simply ignoring an employee or withholding positive comments also sends a clear message. Supervisors often provide indirect, perhaps even unconscious, feedback to employees that reveals their perspective on matters.

Employee's role

Employees, however, are not totally powerless in this situation and often can influence the way the manager perceives their abilities. This ability to influence the

supervisor is the employee's key to resolving this interpersonal conflict.

You are probably already a good employee. You do your job and are respected by your co-workers. However, because of conflicting management styles, perhaps your boss does not think you are doing all that is expected. Resolving this conflict doesn't mean you have to work harder or put in longer hours. The key is to attempt to influence your supervisor's opinion and perception of your value to the organization.

Productive results

John, Pete and Allen tried this technique and were able to successfully resolve their conflicts. For John Laidback, the solution was simple. He was allowed to go to a flexible time schedule to allow him more latitude on his morning starting time. He now comes in some time before 9:30 a.m. and works eight hours from that time. He still puts in plenty of extra hours on his own, but no longer has any starting time conflicts with Stoneface.

After several meetings, Pete Rusharound now understands that Allen Stoneface is an efficient, dedicated and caring employee. Allen has explained that he leads an active social life and cares for his aged parents, which limits the number of extra hours he can work. Pete now knows that these commitments are the reason Allen does not work 60 hours a week, not because he is lazy.

Pete still works too long and too hard. But at least now he admits to himself that he enjoys it that way. He also better understands his other employees and their career needs. He no longer expects Allen and John to approach work exactly as he does.

The key to this strategy is communication between the supervisor and the employee. If you suspect that conflicting management styles are causing problems on the job, it's essential to discuss the matter with your boss in private. Most supervisors will be pleased that you are demonstrating interest, and they probably will gladly provide assistance in solving these problems. Such meetings help reinforce that the employee and supervisor are on the same team. [!:(=)]

Borys is a project manager at the Voice of America, Washington, DC.

NEW FROM ARRAKIS SYSTEMS

10,000 SERIES

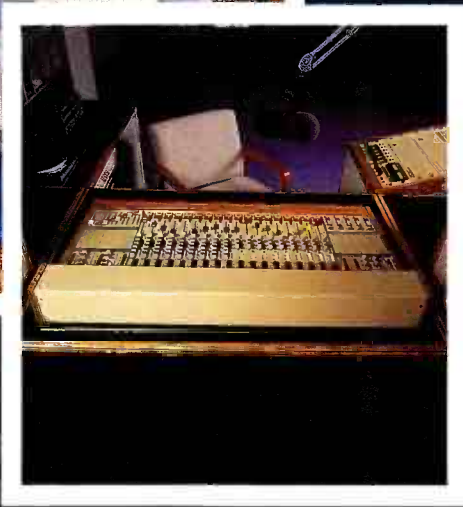
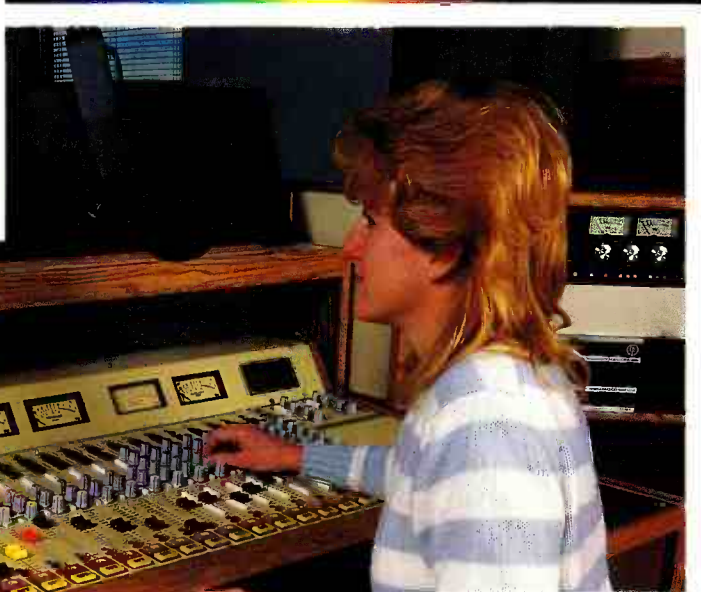

For features, performance, price and reliability,
NOBODY BUILDS CONSOLES LIKE ARRAKIS.

Call (303) 224-2248

Circle (13) on Reply Card

ARRAKIS SYSTEMS INC. 2619 MIDPOINT DRIVE FORT COLLINS, CO 80525



It doesn't seem so long ago that digital equipment arrived in the broadcast station. The first general-purpose CPU was introduced in 1974. At the time, it was considered complex and powerful. The IC contained 5,500 transistors, a fantastic number back then. Today, broadcast equipment uses microprocessors containing more than 275,000 transistors.

Some broadcast engineers first viewed the epoxy-sealed devices with some skepticism. Because they couldn't be pried open to see what was inside, the ICs were considered somewhat magical (even sinister). Engineers were used to being able to examine, test, understand and replace almost any component in the broadcast station. The advent of computer chips changed all that.

Digital technology also changed the face of broadcast maintenance and operations. Analog equipment that often needed adjustment for drifting was replaced by highly stable digital devices. Digital meter displays eliminated the need to interpolate analog meter readings. Equipment operators found that more automated setups and programmed sequences were possible. In general, digital equipment improved the operation of broadcast stations.

One cost of implementing new digital technology is operator and technician training. To help you better understand the technology, this month we examine two rapidly changing areas of broadcast equipment: videographics and digital audio storage.

Author Gerry Kaufhold takes you inside high-level mathematics chips — the engines that make computer graphics systems work. A report on digital studios, by Curtis Chan, discusses how digital machines, routing switchers and production switchers can be integrated into a revenue-generating production system. In "Disk Recording and Editing," Brad Dick explains why the hard disk holds the key to sophisticated digital recording and editing. Richard Maddox examines the low-cost, high-versatility TV and radio production possible through the MIDI interface.

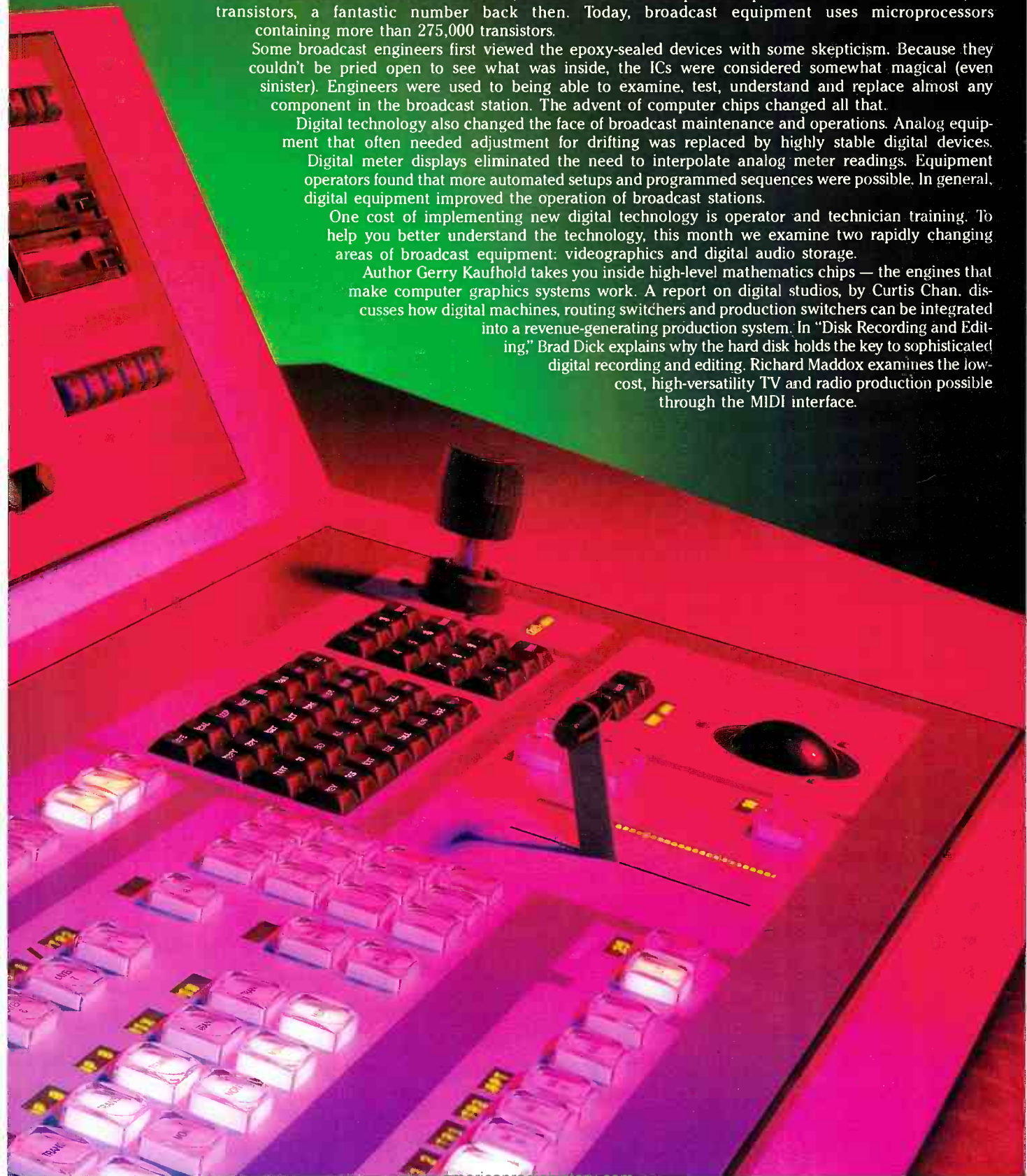



SONY
VO-8800
PORTABLE RECORDER
i matic | SP

SONY
VO-8800
PORTABLE RECORDER
i matic | SP

SONY
VO-9800
VIDEOCASSETTE RECORDER
i matic | SP

SONY
VO-9800
VIDEOCASSETTE RECORDER
i matic | SP

SONY
VO-9850
VIDEOCASSETTE EDITOR-RECORDER
i matic | SP

SONY
VO-9850
VIDEOCASSETTE EDITOR-RECORDER
i matic | SP

YOUR



SHIP JUST CAME IN.

Watching the horizon for more of Type IX?

That's Sony's value line of U-Matic SP™ 3/4-inch video equipment.

Well, the goods are here. And they're not just good. They're great.

There are three new pieces: the VO-9850 Editing Recorder, VO-9800 Recorder/Player, and the VO-8800 Portable Recorder. They will dazzle you with advanced capabilities. And affordable prices.

One innovation is software control. A menu on the screen lets you preset an optional time code and access other machine functions, such as diagnostics, by means of front panel software switches.

The RS-422 serial interface for remote control is bi-directional, so that the edit controller is continually updated on machine status.

Plus longitudinal SMPTE time code, for ±0 frame accuracy. Not to mention the Dolby® C audio noise reduction, with balanced audio XLR connectors.

But see these wonderful new arrivals for yourself. Just call Sony at 1-800-523-SONY.

Sony Communications Products Company, 1600 Queen Anne Road, Teaneck, NJ 07666. © 1989 Sony Corporation of America. Sony and U-Matic SP are trademarks of Sony. Dolby C is a registered trademark of Dolby Laboratories, Inc.

SONY®

PROFESSIONAL VIDEO



Inside mathematics processors

By Gerry Kaufhold II

Are sum chips better than others?

Since the early days of broadcast television, producers and the viewing public have called for creative special effects.

Kaufhold, author of the monthly "Circuits" column, is a market development engineer for SGS-Thomson Microelectronics, Phoenix, AZ.

Special-effects technology has evolved from the original lap-dissolve and scene-wiping switchers to today's digital effects switchers, which perform zoom-in, zoom-out and scene rotation in real time. (Real time means that the effects take place

frame to frame, without interrupting the video signal.)

The related field of computer-generated graphics also has emerged. Even personal computers are now capable of 3-D modeling and photorealistic shading. Integrated

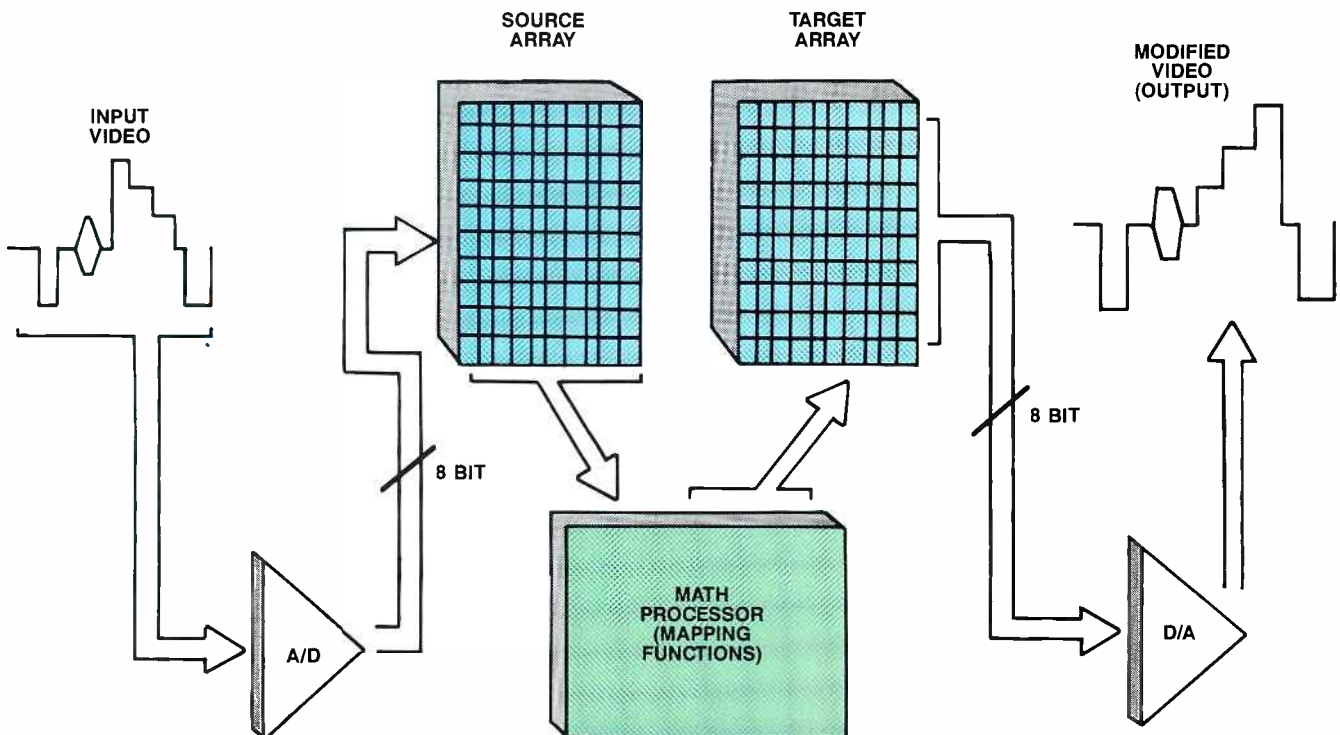

Figure 1. Functional diagram of modern digital video effects system.

ARRAKIS SYSTEMS

5000 SERIES



At A Down-To-Earth Price: 16 Channels, Under \$10,000.

THE FEATURES YOU WANT —

- 16 Modular Stereo Channels.
- Program, Audition and Mono Mixdown Balanced Outputs.
- Telephone Mix-Minus Buss.
- Full Monitoring Facilities.
- Remote Equipment Start/Stop.
- Remote Module Control.
- Standard Digital Clock and Timer.
- Optional EQ and Effects Modules.

THE DEPENDABILITY YOU NEED —

- DC Controlled — No Audio On Pots.
- Rugged Modular Construction.
- Penny & Giles Slide Faders.
- ITT Shadow Switches.
- NE5532 IC Module Design.
- External Regulated Power Supply.
- Superb Audio Performance Specs.
- Most Important, Arrakis Systems Designed-in Ultra Reliability!

For features, performance, price and reliability,

NOBODY BUILDS CONSOLES LIKE ARRAKIS.

Call (303) 224-2248

Circle (13) on Reply Card



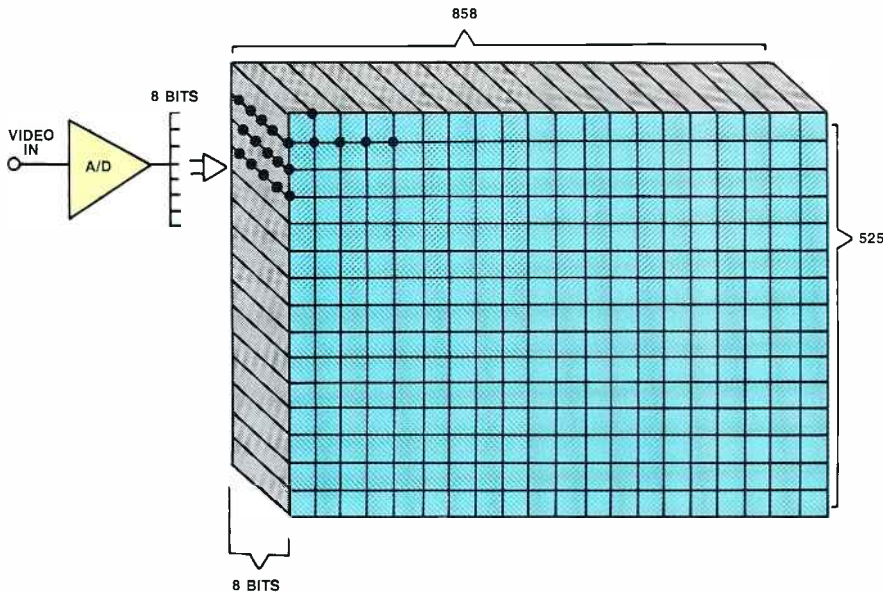

Figure 2. Digitized video is stored in memory arrays before and after matrix processing.

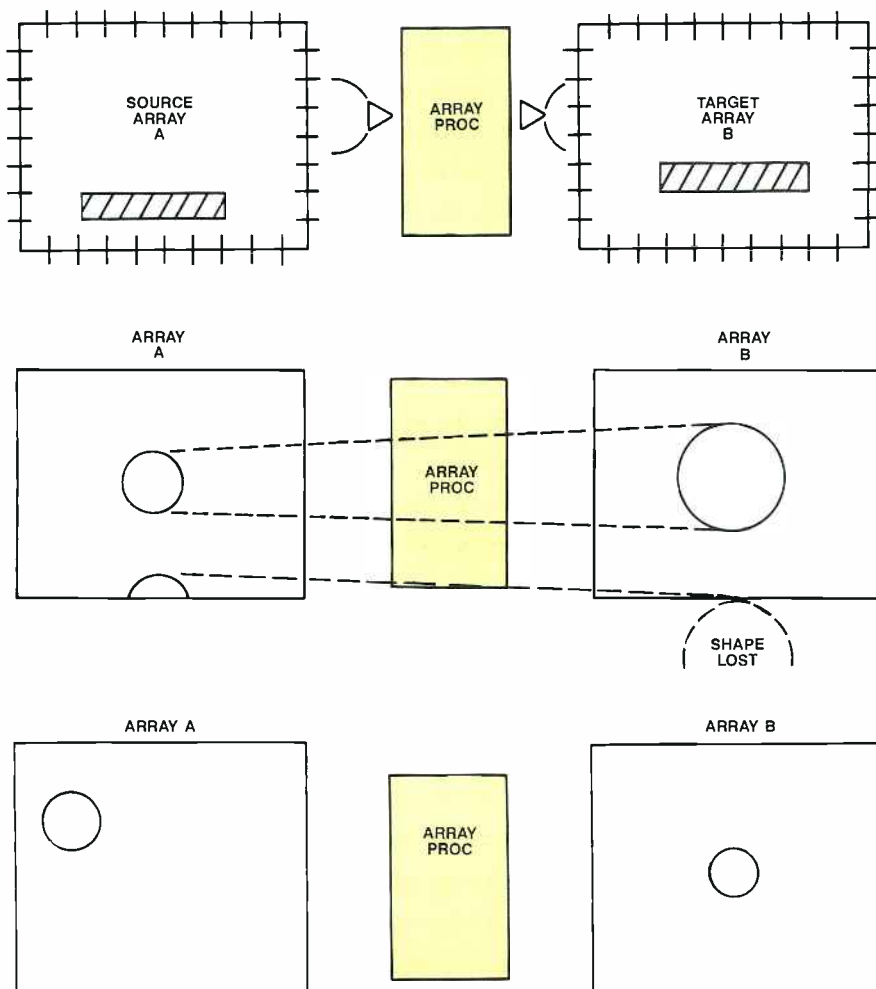

Figure 3. At top, video position transposed using offsets. Zooming and reduction are accomplished, center, via multiplication and division. Combined transposition and zoom can keep images at focal point in spite of size change, as shown at bottom.

circuit manufacturers have developed graphics chips and digital signal-processor chips to manipulate images on video screens. However, computer graphics are generated in "computer time," sometimes taking 30 minutes to create a single complicated frame. Video can't wait that long. This article will show how graphics techniques are used to create special video effects in real time.

NTSC going array

The NTSC video signal, well-known by TV engineers, is defined by the EIA standard RS-170A. The picture begins with the vertical interval blanking pulse, scans 262.5 lines (odd field) horizontally, resets during the next vertical interval, then scans another 262.5 lines (even field). Each field is scanned in approximately 1/60-second. To process one frame (odd plus even field), the signal must be digitized and stored in digital memory circuits.

CCIR 601 standard for digital video (to which D-1 conforms) specifies that the luminance portion of video will be digitized into 8-bit words at a rate of 13.5 million samples per second.¹ This means that a new 8-bit word must scoot into memory every 74ns (0.000 000 074s). To manipulate video in real time, a processed 8-bit word must be output every 74ns as well. This 74ns time constraint dominates the design and performance of digital video switchers.

As a comparison, so-called very fast static RAM memory devices have access times of 20ns. This means that the digital processing in digital video effects units must take place at lightning speed.

The conversion process

Let's look at how a conversion takes place (see Figure 1). The analog video signal starts with the vertical interval blanking pulse, which also resets the memory input pointer in the memory array. Every 74ns, 8-bit representations of the video signal are placed into sequential memory locations. At the end of the frame, the memory can be thought of as a 3-D array storing enough information to re-create the frame. The size of the array is approximately $858 \times 525 \times 8$, or 450kbytes. There are 858 digitized samples per horizontal line of video and 525 horizontal lines. (See Figure 2.)

A typical 21-inch picture tube has about 350,000 phosphor dots for each color. Dividing 350,000 phosphor dots by the 525 horizontal lines of the broadcast picture gives 666 dots per line. This means that the digitized video sample has slightly better resolution than the viewing screen, so the errors incurred by the analog-to-digital (A/D) conversion and subsequent digital-to-analog (D/A) conversion should

Give it your best shot with Ampex.

There are two kinds of videotape companies.

Those who commit all their efforts, resources and research to the video professional.

And those who don't.

Ampex is totally committed to the professional market. Which means we have to be dedicated to providing the best products and service in the business.

Our commitment begins with Ampex Process Management—an advanced quality program that assures you unmatched consistency. So you can count on superior picture quality. Tape after tape, year after year.

And we give you this exceptional dependability in over 100 configurations for commercial and broadcast production to electronic news gathering and corporate training.

And as hardware requirements change and new formats emerge, Ampex research and development ensures that you're always covered for the future.

Ampex's dedication to the professional also includes full technical support, immediate deliveries and the most personal service in the industry.

If Ampex sounds like your kind of videotape company, get in touch with us soon. Because anything less could be just a shot in the dark.

AMPEX

It's your best shot.

Ampex Corporation
Magnetic Tape Division
401 Broadway
Redwood City, CA 94063
(415) 367-3809

Circle (14) on Reply Card



not cause visible distortion to the processed signal.

Once the digitized signal is in the array, it can be operated on, using mapping functions. The source array (the digitized video input) is transformed through a functional block (a math unit) and mapped, point by point, onto the target array (the processed video output). This will be clocked out of the array and will become the video output of the effects device.

The designers of a digital video effects switcher face several major hurdles. The processing operations must be defined, then so highly optimized that they can be executed in the narrow time window of 74ns. Next, the designers must ensure that the output analog signal is free of noticeable distortion. This might include invoking special anti-aliasing math routines.

To prevent picture jitter, caused by time delays in picture processing, the switcher output goes through a recombining circuit that adds the appropriate timing and clamping information. Finally, the output analog signal must be resynchronized with exactly one frame of delay.

Math arrays

Digital video switchers use math to

modify what's on the screen. Because the video is stacked up in arrays, effects devices can use special matrix mathematics — matrix algebra. With it, they can change the position of video on the screen (*transpose*), enlarge or zoom in on images (*multiply*), reduce or zoom out from images (*divide*) and tilt images (*rotate*).

For now, let's consider a 2-D array. A shape in graph A is to be mapped onto graph B (see Figure 3a.) If the operation is transposition, simply add the offset value to each member of graph A, and plot it on graph B.

$$\begin{aligned} \text{New X} &= X + \text{offset} \\ \text{New Y} &= Y + \text{offset} \end{aligned}$$

If the offset is too big, part of the shape will be lost. If the operation is to multiply graph A by a constant, then each member of graph A is multiplied, and the result is mapped onto graph B. (See Figure 3b.)

$$\begin{aligned} \text{New X} &= X \times \text{multiplier} \\ \text{New Y} &= Y \times \text{multiplier} \end{aligned}$$

If the multiplier is too large, some of the shape gets lost. Combining transposition and multiplication lets the operator pick

a focal point and zoom into that point, regardless of where the focal point appears on the screen (see Figure 3c).

$$\begin{aligned} \text{New X} &= \text{multiplier} \times (X + \text{offset}) \\ \text{New Y} &= \text{multiplier} \times (Y + \text{offset}) \end{aligned}$$

If the operation is to divide, then:

$$\begin{aligned} \text{New X} &= X / \text{divisor} \\ \text{New Y} &= Y / \text{divisor} \end{aligned}$$

If the divisor is too large, the picture reduces to a black dot. The most important operation is rotation. The equations that define matrix rotation are:

$$\begin{aligned} \text{New X} &= X \cos + Y \sin \\ \text{New Y} &= Y \cos - X \sin \end{aligned}$$

Fortunately, if the sine and cosine of the rotation angle are known, this operation reduces to four multiplications and a pair of additions/subtractions per point. Combining zoom with tilt has so many steps that special techniques must be used to accomplish the task in the 74ns time frame.

Mathematics coprocessors

To implement matrix algebra operations at high enough speeds for real time digital

AUDIO/VIDEO SIGNAL DISTRIBUTION

No External Control Required • Visual Confirmation
Easy To Program • High Reliability

Introducing the low cost mechanical matrix to switch Audio and Video signals

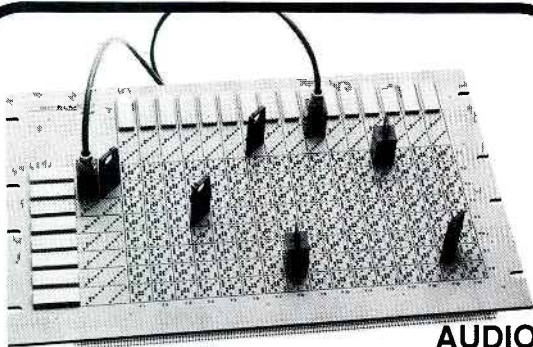

- Low level thru loudspeaker (100v) • Balanced lines (2 pole or 3 pole)
- Shielding (110 DB min. crosstalk) • Cascading (unlimited matrix size)

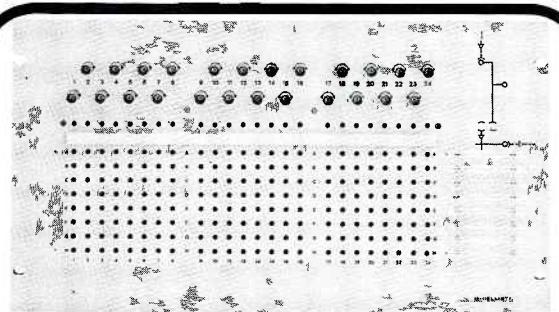

- Switch up to 24 x 24 • Up to 40 MHZ
- Terminated into 75 Ω • Crosstalk @ 5 MHZ - 65 DB

GHIEMMETTI, INC.

5341 Derry Avenue, Unit J, Agoura Hills, California 91301 • Telephone 818-707-1134 • 800-228-1097 • FAX 818-707-1754

Circle (86) on Reply Card

ISN'T IT TIME YOU GOT SERIOUS ABOUT ENG VEHICLES?

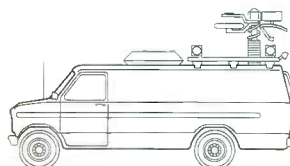
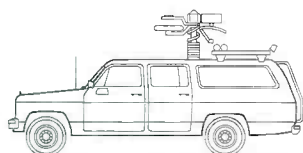
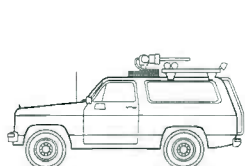

Your ratings are no laughing matter. Staying competitive takes a top news team and a major investment in equipment. They'll both work harder for you in a Centro truck.

Two or four wheel drive, on the road or on the air, Centro trucks offer impressive performance.

Specially engineered air conditioning systems prolong equipment life—and keep your news teams cool and efficient.

Beefy power systems take anything you plug in without complaint.

Welded steel racks are trouble-free and as rugged as roll bars.

And our fit, finish, and ergonomic design are legendary.

But best of all, Centro prices are comparable to trucks that can't begin to match our engineering, craftsmanship and customer support.

So find out how far your news budget can go. Call us today.

Centro. (801) 537-7779.
369 Billy Mitchell Road,
Salt Lake City, Utah 84116.

**Please call me, I'm interested. Circle (15) on Reply Card.
Please send literature. Circle (16) on Reply Card.**



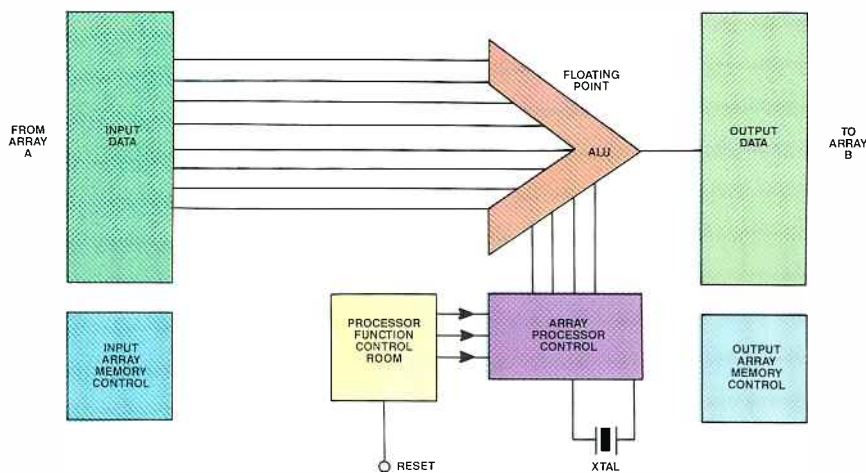

Figure 4. Math processor determines addresses and values for each video pixel.

must use special math coprocessor chips.

As a measure of speed, a complete floating point operation is defined to be one *FLOP*. One million floating point operations per second make up a *megaFLOP*. To perform one complete floating point operation in 74ns, the digital math processor must operate at a speed of more than 20 megaFLOPs to allow time for other operations following the mathematics. It turns out that the mathematics processing power required to perform real time digital video signal processing is pushing the state-of-the-art of mathematics processor design.

In fact, the popular Ampex ADO does not use a math coprocessor, but contains proprietary circuits to execute matrix algebra at the required speed. Some of the newer math coprocessor circuits have the required speed for handling floating point arithmetic, however. The Kaleidoscope by Grass Valley Group uses the Intel 8087 coprocessor in a dedicated circuit for calculating trig functions, and some future equipment may make use of the Texas Instruments TSG 34060 digital signal processor.

A block diagram of a math coprocessor (or digital signal processor) is shown in Figure 4.

Continued on page 36

video signal processing, special circuits must be used.

The video signal originally was digitized and loaded into the memory array as a series of 8-bit words. These 8-bit words carry true analog voltage information. Each bit represents 1/256th of 1V P-P video, or about 3.9mV per bit. Each voltage level can be expressed as a

floating point number. For example, 0.5V = 0.1000 0000 B 0 in binary floating point.

Besides the input video being stored as floating point, the values of sine and cosine will be floating point, and results of division will be floating point. Most computer graphics chips cannot process floating point operations in the 74ns time frame prescribed by CCIR 601. Designers

The only thing it won't test is your tolerance.

Amber 5500: a broadcast-ready, fully programmable audio test system with optional AudioCheck™ PC automation software.

Whether you're testing electronics, tape machines or room acoustics, you want fast, accurate, reliable information — not programming, interfacing or connection headaches.

That's why the Amber 5500 has "broadcast-ready" stereo balanced ins and outs, plus a fully functional front panel so you can run routine bench tests in seconds — without having to hook up a PC.

For PC-automated test routines, the Amber 5500 offers AudioCheck, our powerful PC-based software package. It lets you automate, store and recall transmitter tests, tape deck measurements, console evaluations, any audio measurement you need:

With simple menus, NOT complicated programming.

You can depend on the 5500 everywhere from the studio to the satellite link. Even in high-RFI areas where many other test sets give invalid readings. For a fact-filled 14 page brochure on the broadcast-ready Amber 5500, call 800-361-3697 from anywhere in the USA.

amber

Amber Electro Design Inc. • 3391 Griffith Street
St. Laurent, QC, Canada H4T 1W5
Tel: (514) 735 4105 • Fax: (514) 340 1468

Circle (17) on Reply Card

www.americanradiohistory.com



Broadcast-Ready 5500 Features

- 0.001% (-100 dB) distortion — "digital audio" accuracy
- > +30 dBm power output checks pro-level headroom
- GPIB/IEEE 488 and RS 232 interfaces
- Stores 10 front panel setups in non-volatile memory
- Tests tape recorders and satellite links with asynchronous send & receive signals
- High speed plotting option produces 256-point high resolution swept measurements in seconds
- Effective shielding provides excellent RFI immunity
- Filters & detectors for all international standards
- Optional sum/difference output matrix simplifies stereo tests
- High level stereo balanced ins and outs: 3 switchable impedances

The dawn of Digital Routing flexibility.

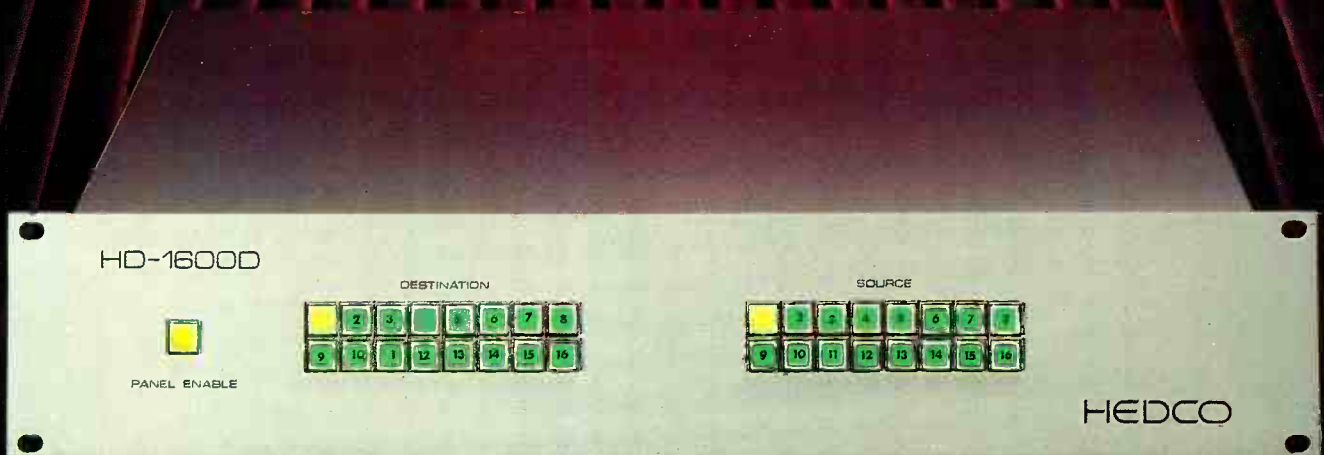

1600 SERIES DATA ROUTER

- True four-wire system (expandable)
- Regenerative operationally transparent Digital Routing (no relays)
- 16 x 16 expandable to 64 x 64
- ANSI/SMPTE 207M-1984
- Operates with companion Video and Audio systems
- Optionally allows switching between RS-232 and RS-422 levels
- Optionally can be configured as an RS-485 Router
- Control is by RS-422/RS-485 X-Y Communication Bus operating as an "exchange" system, optionally system can operate as a traditional system
- Optional RS-232 serial interface

HEDCO

P.O. Box 1985
12520 Loma Rica Dr.
Grass Valley
California 95945 USA
1-800-HEDCO GV (433-2648)
In California 916-273-9524
FAX 916-273-6948

How Good is Our 3rd Generation?



TBC-200 Time Base Corrector

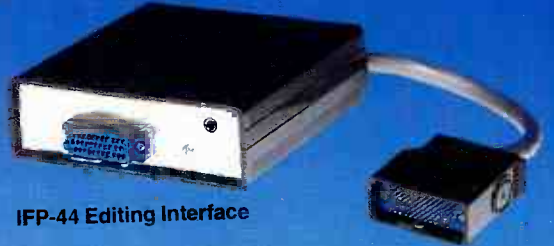

IFP-44 Editing Interface



UTP-1 Signal Transcoder



AG-7400 Portable VCR



AG-7500A Editing VCR



AG-A750 Editing Controller



CCD Cameras



SVHS Video Cassettes

Take a Look at Our 5th!

PERFORMANCE DATA (AG-7500A)

	1st Generation	3rd Generation w/o TBC w/TBC-200		5th Generation w/TBC-200
Horizontal Resolution (Color Mode)	400	370	360	350
S/N Ratio (dB)				
Luminance (Color Mode)	57.2	51.7	52.0	49.0
Chrominance (AM)	51.8	47.5	51.4	44.5
Chrominance (PM)	44.3	40.1	43.8	35.2

Data represents measurements by independent engineering evaluation. VCRs taken at random from inventory.

• Signal Source:	Shibasoku TG-7/1	• Noise Meter:	Rohde & Schwarz UPSF2/UPSF2E2
Luminance:	50 IRE flat field w/burst	Y-S/N:	200 kHz HPF subcarrier trap on
Chroma:	50 IRE w/100 IRE p-p		4.2 MHz, LPF weighted
Resolution:	Monoscope Shibasoku 58A/1	C-S/N:	100 Hz HPF
			500 kHz LPF, unweighted

From the first to the third, even to the 5th generation Panasonic SVHS Pro Series specifications speak for themselves. And they say "outstanding." Here are some of the reasons:

The AG-7500A editing VCR with its new laminated amorphous heads produces superb quality generation after generation.

The AG-A750 editing controller has everything you need for highly accurate single event editing.

And the AG-7400 portable 2-hour VCR is a natural performer in the field.

Our TBC-200 time base corrector has a 16-line

correction window, chroma plus/enhancement, chroma noise reduction and no-roll circuitry. To make multi-generation recordings even better.

The UTP-1 signal transcoder is more than ready to transcode virtually any component signal into any other component signal. Saving you an extra generation.

The IFP-44 editing interface controls Pro Series decks on both the source and edit side. To easily integrate into selected 3/4" systems.

Our CCD Cameras are equally spectacular. And with the Panasonic SVHS Pro Series you not only get outstanding

performance, you also get the added economy of 2-hour operation in the field and in the studio.

The Panasonic SVHS Pro Series. In a word it's outstanding.

For more information on the Panasonic Pro Series, call Panasonic Industrial Company at 1-800-553-7222, or your local Panasonic Professional/Industrial Video dealer.



Panasonic
Professional/Industrial Video

Circle (19) on Reply Card

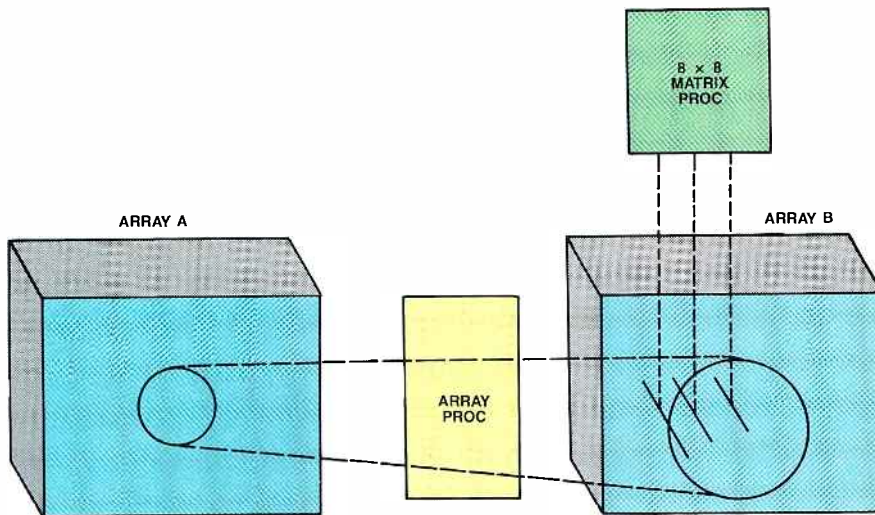

Figure 5. When a pixel is mapped to a non-existent location "between" two screen dots, an interpolation matrix is used to approximate its value by averaging surrounding dots.

Continued from page 32

Addressing

In addition to performing floating point math operations extremely quickly, the chip has to manage the addressing for the source memory array and calculate results that become addresses in the target memory array.

For real time digital video signal processing, the array is 3-dimensional. X and Y values are the address/position pointers into the target (output video) memory array, and the Z value is the 8-bit word that represents the analog voltage value of the digitized input video signal.

Calculating the new X and new Y positions for the selected function is straightforward. The math processor is given the beginning addresses for X and Y and calculates the resultant new X and new Y values as it sequentially walks through the memory space. Out-of-bounds values for new X and new Y are ignored, and the results of floating point operations are rounded off or truncated for the sake of simplicity.

Video value

Coming up with the 8-bit analog voltage value that gets stored in the new location is somewhat complicated. If, for example, the calculated new X and new Y values fall somewhere between two video monitor pixel locations, the processing system must adjust the value of the 8-bit word that gets stored in the new location to prevent a video "glitch."

For the Ampex ADO, this situation is resolved by taking the average of an 8×8 matrix that is centered on the value of the output pixel value. To do this, 64 8-bit additions must be executed and averaged

while the new X and new Y values are being calculated. (See Figure 5.)

Dual-ported memories

Each manufacturer of digital video switchers has a unique and proprietary method for resolving the problems that occur when performing special effects in real time. As mentioned, combining position changes and rotation is difficult. To crunch all the numbers within the time frame permitted usually requires multiple operations to be performed simultaneously.

If two or more math processors are used to provide the necessary numerical processing power, the memory circuitry must be capable of being accessed by more than one processor. Such multiport memories are expensive, especially when they must be fast access memories to keep up with the processing speed of the super fast math coprocessors. Most of these high-speed multiport memories use a combination of CMOS and bipolar technology. This mixed semiconductor technology is known as bipolar CMOS, or BICMOS. Not surprisingly, BICMOS is at the forefront of technology and is still quite expensive.

Pushing the limits

Math coprocessors used for real time digital video special effects must accomplish a lot in extremely short time spans. Recall that digital adder circuits are made up of combinations of AND, OR and INVERT gates. A typical full adder circuit that includes a carry bit and a zero flag bit has nine gates. In high-speed CMOS circuitry, delays within an integrated circuit are 300ps per gate (1/3ns).

Nine gates times 1/3ns per gate equals 3ns for the addition alone. Because digital circuits perform multiplication through

repeated add-shift-add procedures, a 16-bit floating point multiplication could take 48ns, leaving just enough time for memory accessing (20ns) and for the D/A converter to settle before the next operation has to begin.

In addition to performing the mathematics functions fast enough for real time video processing, the math processor has to read data from the memory arrays, as well as read and decode instructions from its own internal ROM program.

Pipelines and parallel paths

The faster the processor chews through numbers, the more chewing it can do in 74ns. This enables the effects device to perform even more complex effects. Digital designers have created ingenious ways to boost throughput on math processors. Two popular methods are pipelining and parallel processing. These can be illustrated with a simple analogy.

Imagine you're in a laundromat. Conventional processing would be to put a load of clothes in the washer, and when it's done, transfer the clothes to the dryer. To speed things up, you would start a new load in the washer as soon as you loaded the dryer, and have a sorted load, detergent and bleach standing ready to dump into the washer as soon as the present load is finished. That's pipelining.

On the other hand, if you could take charge of several washing machines, and have them all running at once, that's parallel processing.

In a crowded laundromat, the problem is getting your quarters from your pocket and into the machine before someone else does. In computers, the problem is getting all the data into and out of memory. If you're not fast enough, you'll have to wait for the next available machine. If your computer memory is slow, it requests the processor to enter a *wait state*, which freezes its operation. Wait states are the nemesis of fast processing.

In pipelining, the computer fetches the next instruction and data while the current instruction is executing. This is called prefetching, which is a standard acceleration tool. Unfortunately, sometimes pipelining architectures fail because the previous instruction is a branch or jump instruction, which invalidates the prefetched instructions and data and causes wait states to occur.

RISCy business

Another idea in vogue is reduced instruction set computers, or RISC. A RISC machine executes one instruction per clock cycle. To achieve this, designers must make use of parallel processing.

Parallel processing requires strict timing adherence, and much forethought must go into designing the flow of procedures so

The hottest number in digital effects

The Abekas A53-D

Cast as the red-hot choice in digital video effects. Thousands of users the world over are relying upon the A53-D for their most demanding post production and on-air effects requirements. Contact Abekas today and find out why.

Abekas

Now Anything is Possible

Abekas Video Systems Inc.
101 Galveston Drive
Redwood City
California 94063
U.S.A.

Tel: 415 369 5111
Telex: 592712
Fax: 415 369 4777

Abekas Video Systems, Ltd.
Portman House,
12 Portman Road,
Reading, Berkshire,
RG3 1EA, England

Tel. 0734-585421
Telex. 847579
Fax. 0734-597267

Abekas Video System Pty Ltd
10/100 Bay Road
Waverton
New South Wales 2060
Australia

Tel: 010 612 957 5559
Fax: 010 612 957 4263

Circle (20) on Reply Card

www.americanradiohistory.com



Puts your signal in it's place!

If you need a quality antenna, you need:
JAMPRO ANTENNAS, INC.
The really experienced one for over 30 years.

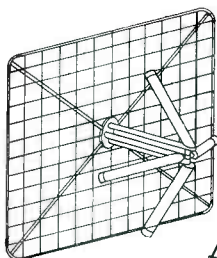

JAHD CP
Arrowhead
Screen Dipole

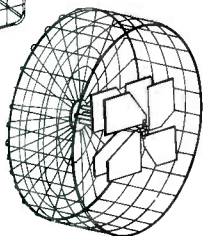

JSDP CP Spiral
Broadband Antenna

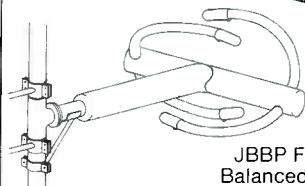

JBPP FM Antenna
Balanced Excitation

JAMPRO is the world leader in custom-designed, directional, CP antennas.

- With over 1600 of our penetrators delivered, more stations have penetrated their market.
 - Our custom-made directional antennas are operating world wide.
 - Full-scale antenna measurements on **JAMPRO's** all-year, all-weather test range.
 - We custom-make tower structures to duplicate your's, for optimum results.
 - Ask about **JAMPRO's** low-power educational packages.
- Give us your requirements and see how fast we produce.

JAMPRO Antennas, Inc.

6939 Power Inn Road
Sacramento, CA 95828
(916) 383-1177 • Telex: 377321
FAX (916) 383-1182

Circle (21) on Reply Card

that none of the parallel processors gets "stuck" waiting for the results of a previous operation to become available.

One technique used to prevent this is called *scoreboarding*. Scoreboarding is a sophisticated technique that allows the processor to determine for itself how it will solve its problems. The list of operations is scanned to determine which can be solved immediately, and which must wait for intermediate results. Then the processor starts chewing through its list in the most efficient order. This ability to autonomously decide which step must come first represents the beginnings of artificial intelligence.

As the computational intensity of digital

video effects increases, expect to hear more about the importance of specialized math processors and other high-performance silicon devices. Parallel processing, in particular, should increase in popularity, because of its increasing use by manufacturers for large computers as well as for superpowerful PCs.

References

1. In equipment based on the CCIR 601 standard, chrominance information is stored and processed separately, but using similar means.

Acknowledgment: The author wishes to thank Jim Duca of Ampex and Peter Symes of Grass Valley Group for assistance in preparing this article.



Digital signal processors

The AT&T DSP-32-C digital signal processor (DSP) is a high-speed, programmable integrated circuit, specially designed to perform matrix operations at a high throughput level. The circuits inside the DSP have been fine-tuned for this application, and the critical path gate-delays have been minimized by creative silicon design.

In many aspects, the DSP is a state-of-the-art microelectronic product. In most of its features, it is similar to other mathematics coprocessors. The main difference between a DSP and a math coprocessor is that the math coprocessor has a more generalized set of features and, therefore, it usually runs slower.

The DSP-32-C has two execution units. One part manages the address functions of reading data from large memory arrays, and the other performs the actual floating point mathematics and error recovery.

The DSP-32-C is capable of 12.5 million instructions per second, or *MIPS*. MIPS do not translate directly into megaFLOPs. The DSP must accomplish a lot of "housekeeping" before it can begin crunching numbers.

Like a microprocessor, a DSP has a program that tells it what to do. The program is stored in ROM. Recall that even fast static rams have access times of 20ns. As a way to speed up instruction timing, the instructions of a program loop will be called into internal registers, so that the DSP can operate without having to read from external memory. The technique of pulling a program loop out of main memory into higher-speed internal registers is called *caching*.

Instructions for the DSP can be tuned to the specific application. At the beginning of the program, the size of the data words and the number of bits of precision for the math routines are specified. For digital video, we would use an 8-bit

data word and 16-bit math. (Note that if two 8-bit words are multiplied, a 16-bit answer results.)

To optimize data throughput, the DSP program will be matched closely to the signals coming in from the data-acquisition module. For example, an interrupt on the DSP goes off when the A/D converter has deposited one byte of information into the source memory. The DSP then grabs the X and Y values of the address of this byte and calculates the new X and new Y address for mapping into target memory.

If the new X and new Y, being floating point numbers, do not fall exactly into a part of the upcoming horizontal scan line, the DSP must perform an interpolation among nearby points and adjust the value stored in new X and new Y to prevent video glitches. As soon as the current item of data has been handled, the DSP updates its address pointers to the next location that will receive a new databyte, then it waits for an interrupt.

Using the compact instructions designed for the DSP, the entire program of *get data, process data, interpolate data, and wait for next data* might require only three instructions. With an instruction cycle speed of 50ns, the DSP-32-C would need 150ns to perform the functions. Unfortunately, the time window for real time video is only 74ns. Thus, although its speed of 12.5 MIPS is faster than that of many general-purpose microprocessors, it cannot perform real time video processing. The DSP-32-C is used by AT&T for slow-scan video (videophone).

Even if they were operated in parallel, the chips still would be limited by their internal floating point speed. The next generation of the device, however, will run at video speeds. Several manufacturers have products in development that will use these chips.



If
Leonardo
Had a
Gallery
the
Mona Lisa
would be
Ageless.

Rank Cintel presents a
Renaissance in long term
image storage:

**GALLERY PICTURE
MANAGEMENT**

Today's electronic artists have an advantage over the Renaissance masters. You can store, manage and archive your graphics and stills on Gallery – the complete picture management system from Rank Cintel.

Gallery is an optical disk 4:2:2 image archive. It digitally interfaces with the world's most popular paint systems. Its powerful database manages your vital images for on-air broadcast or long term storage. In a system designed for future growth.

Gallery image libraries range from single-user workstations to multi-user networks – all accessible by hard wire, telephone, satellite or microwave link.

And because Gallery is 4:2:2 digital, your work remains perfect. **Forever.**

Gallery Picture Management. Because great art is eternal.



Rank Cintel

Circle (22) on Reply Card

Gallery Graphics Center

830 E. Higgins Rd. Schaumburg, IL 60173

Tel: (312) 330-0770 Fax: (312) 330-0799

National Headquarters

704 Executive Blvd. Valley Cottage, N.Y. 10989

Tel: 914-268-8911 Fax: 914-268-5939

Gallery is a trademark of Logica, plc.

Ikegami's remarkable broadcast CCD, the HL-55, features three newly developed $\frac{2}{3}$ " FIT (frame interline transfer) chips, each delivering an industry-first 400,000 plus individual pixels. This insures low FPN (fixed pattern noise), a reduced vertical smear, and enhanced resolution at over 700 TVL and high S/N ratio of 62 dB.

Compact and lightweight (6.81lb with viewfinder), the HL-55 features a six speed electronic shutter for improved dynamic resolution,

high sensitivity (+24dB), a newly developed optical low pass filter for reduction of noise and much more.

Our exclusively designed viewfinder provides complete setting data, a clearer picture than conventional viewfinders, and can add or delete a safe title area box, cross hairs and audio bar graph.

THE HL-55 BROADCAST CHIP CAMERA:

TAKE YOUR BEST SHOT

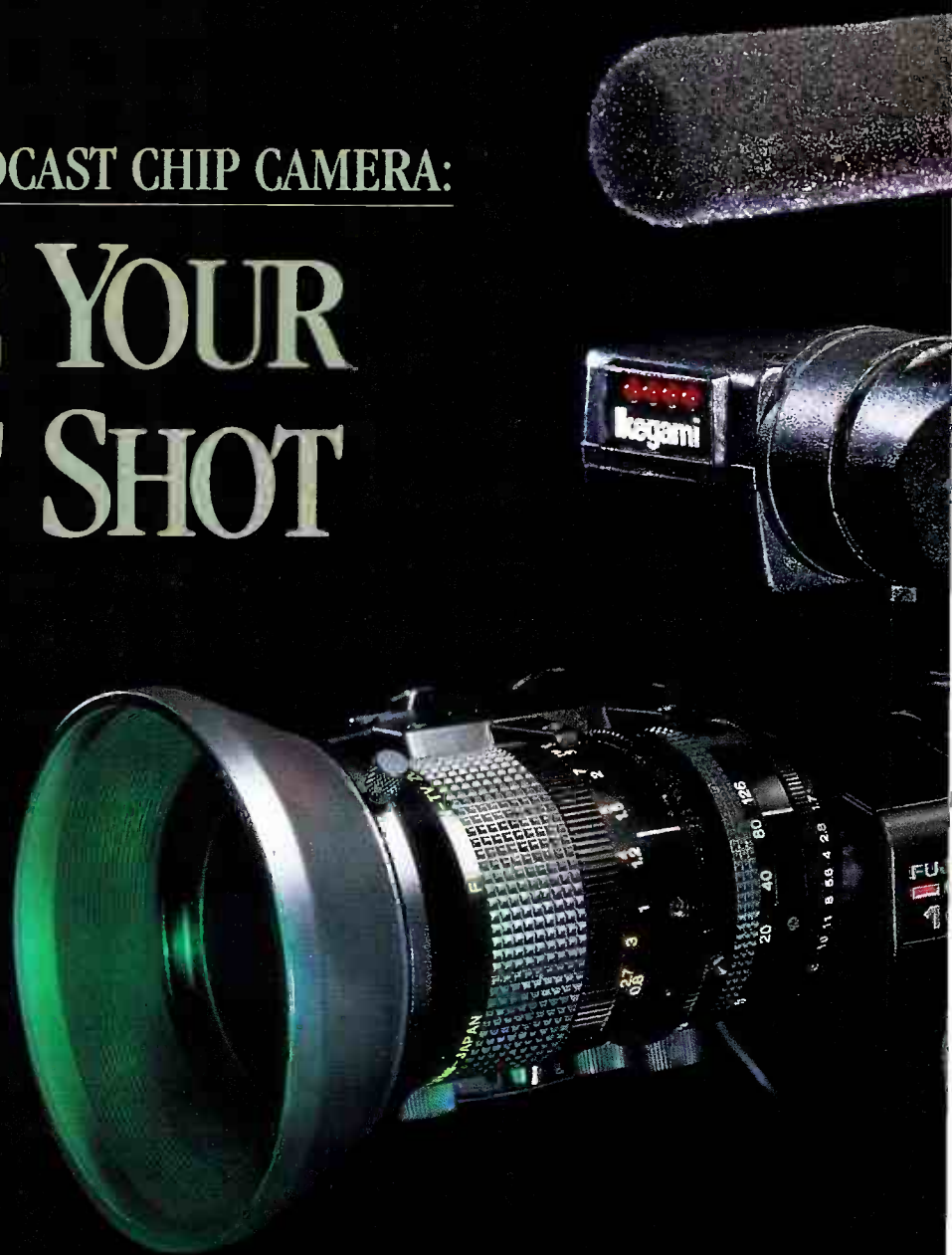

Ikegami

commitment to quality engineering extends beyond performance, right down to the construction of the camera body and boards.

The HL-55 belongs to Ikegami's UNICAM® family of cameras, and is compatible with all HL-95 accessories providing maximum oper-

or studio configuration.

The HL-55 is your guarantee that chip technology won't let you down, unless of course you don't own an Ikegami.

For further information contact your Regional Sales Office or the Ikegami Dealer near you.



Ikegami Electronics (USA), Inc. 37 Brook Avenue, Maywood, NJ 07607
East Coast: (201) 368-9171 West Coast: (213) 534-0050 Southeast: (305) 735-2203
Southwest: (214) 869-2363 Midwest: (312) 834-9774 Hawaii: (808) 946-5955



State of the digital studio

By Curtis Chan

“And D-1 and D-2...” Digital formats work in concert.

The digital studio is no longer an experi-

Chan is vice president of marketing and product development, Centro Corporation, Salt Lake City.

ment, but a revenue-generating reality. Yesterday's embryonic technologies have become expanding product lines from many manufacturers, addressing needs

ranging from production and post-production to broadcast.

The spotlight in the digital video arena has shifted recently from the D-1 standard

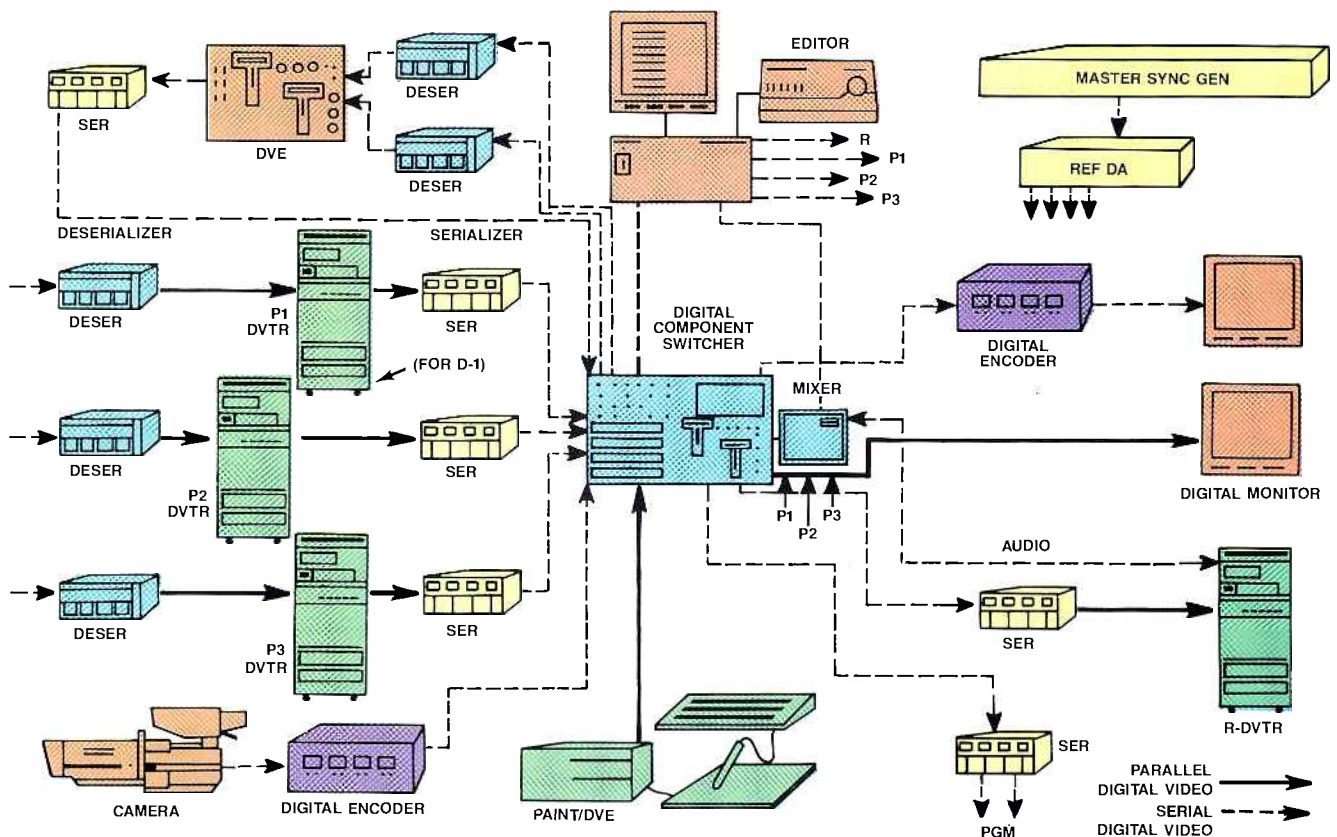

Figure 1. The digital editing facility, showing techniques for incorporating analog, as well as digital, input. Serializers will eventually be 1-chip devices.

It's withstood nineteen years of raps, bops, swings and hits.



Reliability. It's what ITC audio cartridge machines are all about, even after years of pounding and playing. In fact, you'll find many of our original models still in use today. Like this one from KOMA-AM radio in Oklahoma City.

The reason is ITC cartridge machines have always been engineered to withstand heavy-duty use day in and day out. That includes today's latest models. It's reliability like this which has made ITC the undisputed leader in cartridge machines around the world.

And our reputation doesn't just end there. Engineers tell us ITC also offers the undeniably best support in the business. With toll-free technical consultations. Fast turn around on repairs and replacement parts. And our 2-year warranty on factory labor and all parts, including motors, heads and solenoids.

No wonder, then, more stations buy ITC machines than any other brand. And keep coming back for more.

There's an ITC cartridge machine for every need. Including the 99B Master Recorder with the patented ELSA cartridge preparation system. The DELTA Series, the most popular cartridge machine in the last five years. And the economical OMEGA Series offering affordable performance.

To find out more, or for a list of ITC dealers, call International Tapetronics, 3M Broadcasting and Related Products Department toll-free at 1-800-447-0414. (In Illinois and Alaska, call collect, 309-828-1381.)

Tell them you heard about it from a reliable source.



©1988 3M Company

3M

Circle (23) on Reply Card

composite machine should automatically feed the digital machine's composite output, or else automatically route the machine's digital output through a transcoding device.

It is interesting that many facilities are implementing computer-based systems to track and optimize routing operations.

Analog interface

A digital system must interface with the

analog world. This requires digital video codecs. The digital video decoder should be able to accept digital component (SMPTE RP-125/EBU 3246-E) and output RGB, with or without sync, as well as Y, R-Y, B-Y, with or without setup. Similarly, the encoder should accept RGB and Y, R-Y, B-Y and output digital component. The same applies in digital composite encoding and decoding.

It also would be convenient if digital

codecs had inputs and outputs for either serial or parallel digital video. This would eliminate the need for serialization/deserialization conversions if parallel cabling is adequate. The codecs also should be able to retime picture and sync information, using digital processing to minimize degradation.

Synchronization

One of the most critical aspects of a digital production system is system timing. For the present, timing a digital facility is similar to analog facility timing. Normally, the device with the longest path length is taken as the reference device. Delays then are introduced to all other devices to make them coincident with the reference source.

This can be done either by delaying the composite video signal from the source equipment to the zero time point or delaying the reference signals to the source equipment.

In systems with multiple edit suites, source devices may have to feed two or more switchers. In this case, judicious use of auto-delay DAs can correct errors of up to about ± 15 ns. The isophasing DAs, which are equipped with an electrically modifiable delay line, compare their input video to a reference signal and correct their output if it drifts out of time. The isophasing DAs can be located at a critical timing point, such as the input to a switcher, or they can be used as a fan-out device, which keeps all signals properly subcarrier-timed with the zero time point. This prevents constantly having to make drift adjustments or having to trim the timing of video sources.

In cases in which the delay is beyond the range of the DA, timed cables (1.5ns per foot) also can be of benefit by putting the signal in range.

Timing by varying the reference signal fed to video devices usually takes the form of a master sync generator that slaves several source sync generators. The timing of the source sync generator can be varied either according to timing presets, which are programmed in advance, or by a comparator-generated control signal, which samples timing at the time-zero point.

Automatic synchronization systems prevent constantly having to make drift adjustments and trim the timing of video sources. They provide the additional advantages of sync system redundancy, sync hierarchy protection, and the ability for facility growth without major redesign.

A brief comment about component timing is in order. It is imperative that all lines are timed precisely, to avoid interchannel distortion. Color-coded coaxial wires can supplement wire labels as a means of

Continued on page 52

Buying the right case: a crash course.

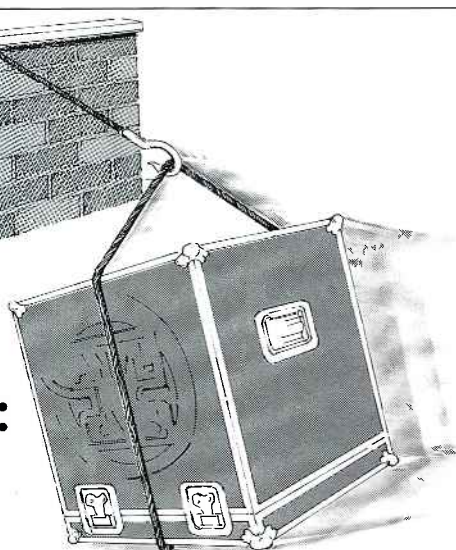

1. Plan for the worst. We're talking real-life baggage handlers here. So take Murphy's Law, multiply by 2, and add a fudge factor.
2. Get an expert evaluation. ANVIL's ATA cases meet or surpass all the shock and vibration criteria in the Air Transport Association's Specification 300, Category 1—the industry's toughest standard for reusable shipping containers.
3. Invest in durable quality. With all you've got invested in your equipment already, isn't it worth the slight additional cost of a genuine ANVIL case, just for the peace of mind?
4. Insist on ease and simplicity. We have thousands of case designs you can order by your equipment's model number. And if we don't already have what you need, we'll make it for you.



800 / 423-4279
CA: 800 / 242-4466
818 / 575-8614

4128 Temple City Boulevard, Rosemead, CA 91770
© 1988, ANVIL Cases

Circle (27) on Reply Card

Professional

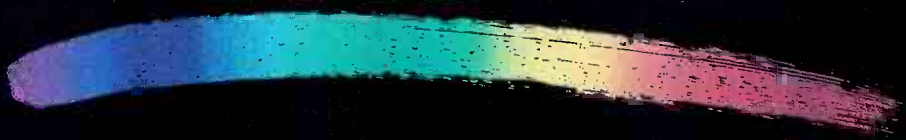

The Telex 6120XLP.
A new audio tape duplicator with
8X speed and tougher specs.



New, tougher specs for a difference you can hear.

Telex is still the leader in high speed duplicating (16X speed) with its famous 6120XL series, providing outstanding audio quality, unlimited expandability and highly profitable production capability. However, if you have higher critical audio needs, the new Telex 6120XLP with 8X speed and XL Life heads should be your choice. For full details and specifications or even a demo tape, call or write to: Telex Communications, Inc., Minneapolis, MN 55420.

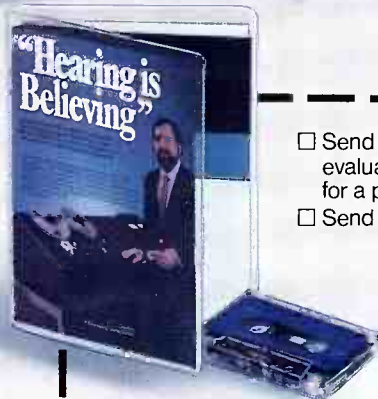

- Send me a free demo cassette for my evaluation— Include my reservation form for a personal demonstration. BE2/89
- Send me literature only at this time.

Telex Communications, Inc.
9600 Aldrich Av. So.
Minneapolis, MN 55420

Name _____

Company _____

Address _____

TELEX®

Circle (28) on Reply Card

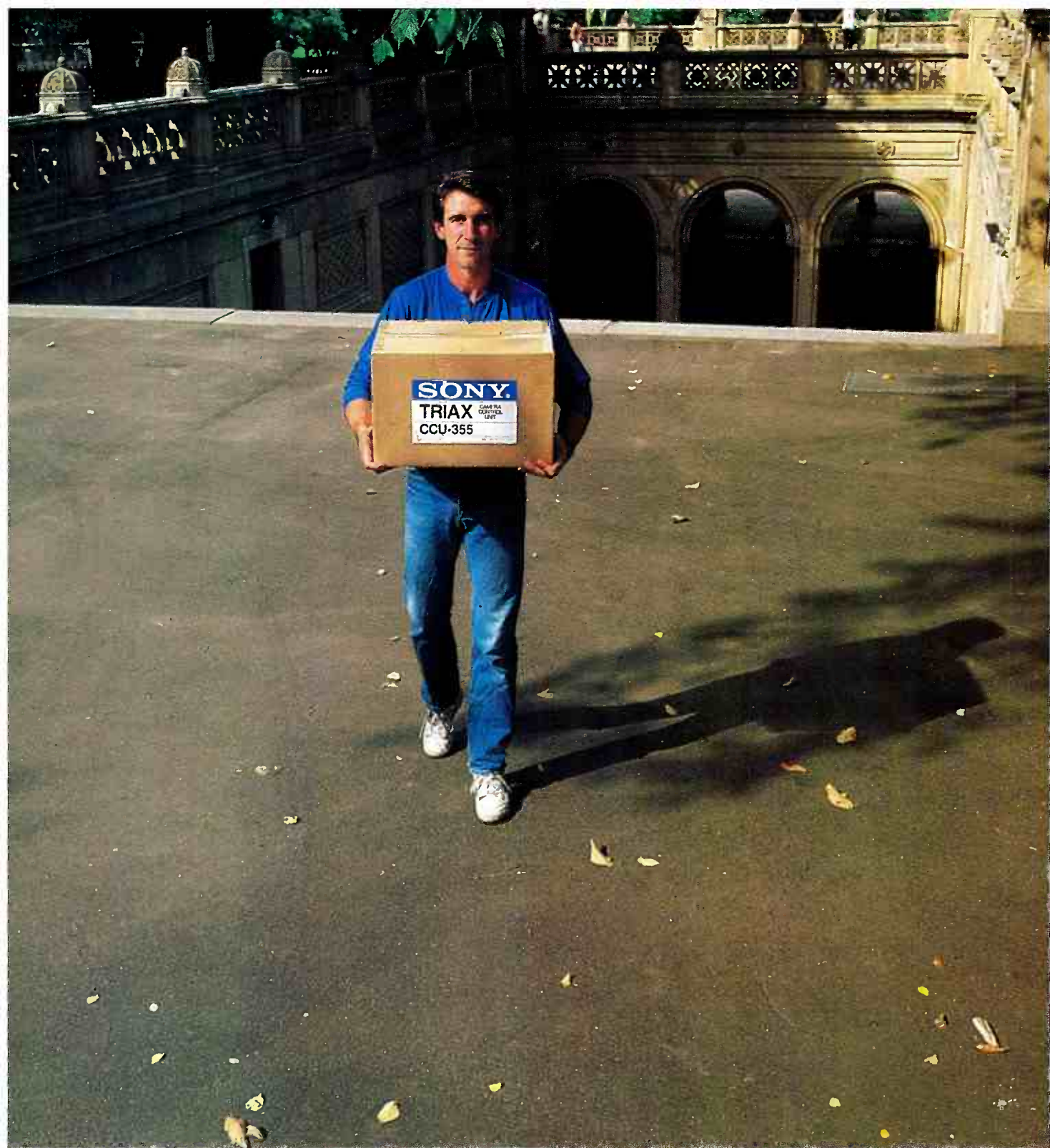

ONE SMALL STEP FOR SONY.

For Sony, it's a small addition to the world's finest line of broadcast cameras. But it means a long jump for EFP.

With the new CCU-355 Control Unit, you can have the freedom of triax while using

the best broadcast portable CCD cameras in the world—the Sony BVP-7 and BVP-50.

Sony has offered leading-edge CCD broadcast camera technology for over two years, bringing you the reliability

and consistent picture quality you expect from Sony—plus the portability and freedom of triax.

No one else sells as many broadcast cameras as Sony. And it's hardly surprising—

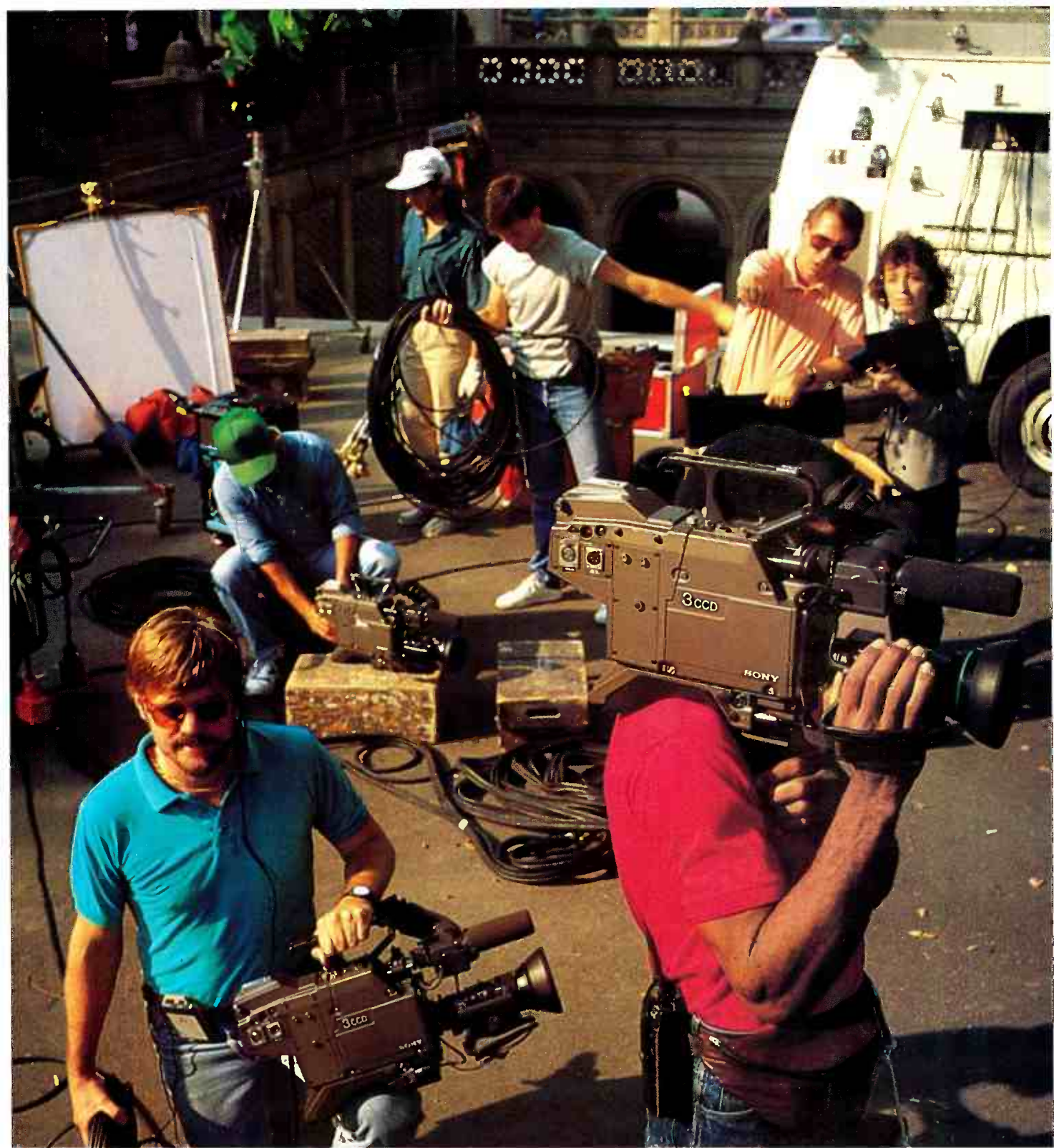

ONE GIANT LEAP FOR EFP.

considering the broad range of leading edge products Sony offers.

So take the plunge into the inherent reliability and stability of solid state technology. Check into the Sony broadcast

portable CCD camera family: the BVP-5, BVP-7 and BVP-50. And the BVW-200 single-unit

camera-recorder. The first step is a demonstration. Just contact your Sony Broadcast Sales Engineer. Or call us at (800) 635-SONY.

SONY®

Sony Communications Products Company, 1600 Queen Anne Road, Teaneck, NJ 07666 © 1988 Sony Corporation of America. Sony is a registered trademark of Sony.

BROADCAST PRODUCTS



IF YOU NEED SATELLITE SERVICES, WE'LL DO EVERYTHING ON EARTH TO HELP

Our six Ku-band Portable Uplinks provide redundant satellite transmission from anywhere on the continent. Downlinks, too. Ku transponder time with occasional or long term leases. Teleconferencing and video production. Conus Master Control provides all necessary coordination. Just pick up the telephone, and no event is beyond your reach. Anywhere. Anytime. For more information, call Todd Hanks or Woody Hubbell, (612) 642-4679.



Conus Satellite Services
a division of Conus Communications
3415 University Avenue
Minneapolis, MN 55414

Circle (29) on Reply Card

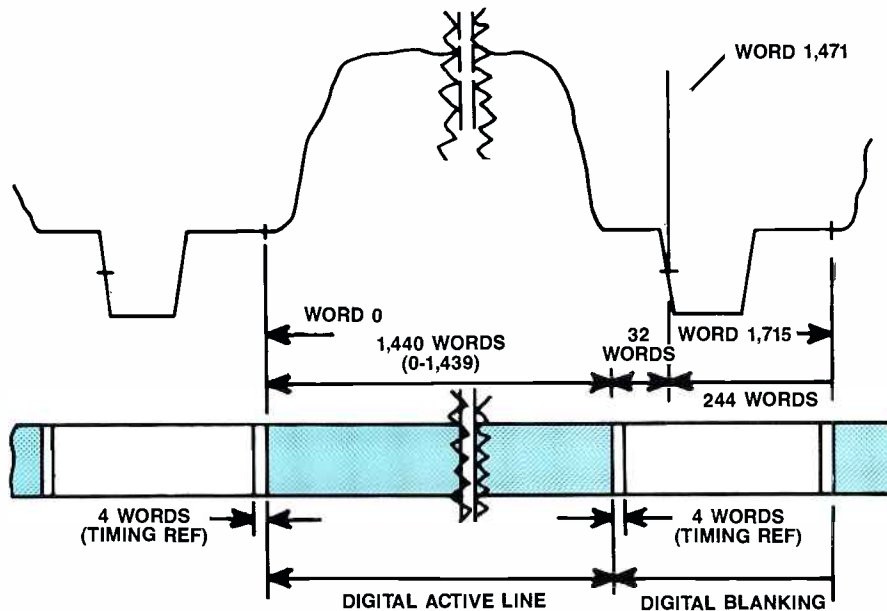

Figure 2. Digital timing signals allow system timing in the digital domain.

Continued from page 48

cable identification in complex systems.

The system timing design of a facility should encompass the patch panel. Digital-ready patch panels incorporate zero-timed ports with recommended patch cord lengths.

As stated, system timing in the digital studio is, for now, a matter of adjusting devices so they are in time when converted to the analog domain, as in a switcher. Some digital formats have timing sync words built in that could allow timing in the digital domain (see Figure 2). In D-1, for instance, the timing word consists of a 3-word preamble. This is followed by a word that indicates even or odd field, whether or not the line is in the vertical interval, and marks the transition between active video and blanking. A new generation of devices that will enable automatic timing, regeneration and equalization probably will be introduced to capitalize on this feature.

The digital switcher

The digital production switcher will play a key role in the overall performance of the system. The digital switcher gives the advantage of multilevel compositing in real time. Single-layer compositing has been used successfully with the availability of the DVTR and the digital disk recorder, but it has two drawbacks. One is that compositing must be done one layer at a time, which increases the time of the production. The other is that many complex productions are dependent upon the spatial relationships between layers, which can be established only when all

the relevant layers can be seen at the same time. The use of a digital production switcher capable of multilevel compositing can eliminate these concerns.

Artifact generation due to multilevel effects processing is a concern in the design of the digital switcher. The process of keying and effects processing requires successive multiplication of digitized video signals by control signals, such as key and wipe waveforms. The interpolation process is also multiplicative, resulting in extra bits of data in the form of fractions. To minimize the effects of rounding, some switcher and graphic device manufacturers are maintaining a 10-bit path throughout all multiplication and combining stages, significantly reducing the artifacts generated.

The digital switcher should have the ability to accept multiple inputs with differing formats and I/O standards. In the case of the component switcher, the ability to accept and output analog composite, analog component and digital component in either serial or parallel form would be convenient. Similarly, the composite digital switcher should accept and output analog composite, as well as digital composite, in either parallel or serial form.

We must maintain image quality from non-digital sources. This can be done through the use of appropriate encoders. For instance, the camera's RGB output can be sent through a digital encoder/serializer. Similarly, all effects devices and monitoring I/Os should be in the digital domain, to preserve image quality.

Input to the switcher also will involve

Now, with Independent Inner/Outer Border Softness Control!

Prodigy™

Experience the genius of Videotek.



You're burning the midnight oil... Final edit's due at 8 a.m.

Be glad you have a Prodigy—the new switcher with more brain-power in a smaller package.

Forget about old two mix/effect systems.

A reliable video switching and special effects system follows the new industry standard—multi-level effects with look-ahead preview. Much more than just another clone, Prodigy raises the standard—offering features no one else does, even on their most expensive systems. Prodigy includes stereo audio-follow-video, editor interface, effects memory and a programmable

downstream keyer.

Have it your way.

Modify Prodigy to suit your style of operation and create memorable performances. Program up to 99 events into Prodigy's 68000 microcomputer, then preview the results instantly. Ten programmable sequences link 80 on-line memory registers, and ten learned operator transitions track your actions over time. With Videotek's exclusive Times Six Plus black burst generator, system timing is virtually automatic.

Who says the grass is greener?

Equally at home in the post-production facility, newsroom or

studio—Prodigy rack-mounts in minutes and its software talks to a wide range of popular editing controllers.

Get your hands on a Prodigy and let the performance begin! For more information or the name of your nearest Prodigy dealer, call Videotek today.



243 Shoemaker Road, Pottstown, Pennsylvania 19464 • (215) 327-2292
TWX 710-653-0125 • FAX (215) 327-9295

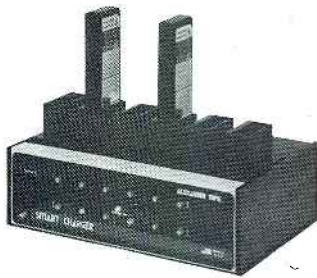

Smart Chargers™

Designed to protect batteries from harmful overcharging.

- Sophisticated negative-voltage-slope charging system...can't overcharge.
- Low trickle charge keeps battery fully charged without overcharging.
- Batteries charged simultaneously.
- Select one, three or six unit model.



**Alexander
Batteries**

By Alexander Manufacturing

Phone: 1-800-247-1821 or 515-423-8955
P.O. Box 1508, Mason City, IA 50401

Circle (31) on Reply Card



Tri-Analyzers™

Analyze batteries while extending life.

- Make sure battery lasts through an important shoot.
- Check batteries for warranty purposes.
- Condition batteries harmed by overcharging or improper discharging.
- Select one, three or six unit model.



**Alexander
Batteries**

By Alexander Manufacturing

Phone: 1-800-247-1821 or 515-423-8955
P.O. Box 1508, Mason City, IA 50401

Circle (32) on Reply Card

the use of cable equalizers and autophasing systems. This is predicated upon the fact that signals sent through long runs of coax will be attenuated and have time-artifact anomalies. Again, it is not inconceivable that these functions can be designed onto PCBs and incorporated into the switcher. At present, judicious use of a master generator and timing modules for each machine affords the user a safety margin in cable-length error when installing the system.

Given the flexibility of source and effects devices depicted in Figure 1, the digital switcher should have the ability to act in either a production or post-production capacity. Features of such a switcher may include:

- Eight to 48 inputs with serial inputs and outputs in accordance with SMPTE and EBU interface standards.
- Internal mixer/effect subsystems capable of handling up to eight picture planes.
- Downstream chroma-keying capable of accepting either digital component or composite with the appropriate translators.
- Downstream digital color correction.
- Automatic phasing of input signals.
- Digital processing providing pattern generation, wipes, keyers, borders, character generation, color background and matting, and framestore.
- Storage and learn capabilities with adjustable transitions along with exponential, log and "S" non-linear transitions.
- On-board diagnostics and computer port for remote testing.

At least in the short term, digital switchers will operationally emulate present analog switchers. The high degree of sophistication available today should make it possible to keep processing, equalization, switching, control, mixing and effects generation transparent to the user.

Equipment, heal thyself

It will not be uncommon for digital switchers to include automatic test systems that will locate faults to a block level. Remote computer interfaces will allow diagnosis by outside computers. Test instruments, in addition to accepting and outputting both digital and analog video, will be controllable by the device under test. In this manner, digital routers and switchers will be able to automatically sweep themselves, reporting problems before failures occur, similar to advanced telecommunications equipment. Furthermore, expect to see greater fault tolerance and software recovery routines that will prolong equipment operation in spite of failures.

Test generators should be able to supply a diversity of signals and syncs, such as RGB plus H-drive, V-drive and tri-level

sync. Similarly, test monitors should be able to accept analog or digital, convert back to analog and be compared with the original source signal.

Format and rate conversion

A final issue is that of format and rate conversion. It is likely that digital video, in current as well as emerging formats, will at some point intermingle. Companies already have addressed this concern and have put products onto the market to do rate conversion. As an example, one company markets two rate converters for both the D-1 and D-2 formats. In the case of the D-1 to D-2 rate converter, the device converts 4:2:2 component digital signals to 4×fsc composite digital video signals. It also encodes Y/R-Y/B-Y to a composite digital NTSC signal, with correct I and Q bandwidths. Similarly, the D-2 to D-1 rate converter changes 4×fsc signals to 4:2:2 signals, as well as from I and Q to Y/R-Y/B-Y.

With the progression of MTS broadcasting and the proliferation of stereo programming, production companies are paying more attention to audio. Presently, audio sweetening is still a separate function, in which audio tracks are sweetened and conformed to the final edited product. This step could be integrated into the video post-production process, and recent equipment introductions seem to point to this trend.

Both the D-1 and D-2 formats use the 48kHz sampling frequency standard, while different digital audio processors sample at frequencies ranging from 30kHz to 50kHz. Luckily, digital audio sampling rate converters are available. Such units will accept sampling frequencies from 30kHz to 50kHz, and output, among others, the 48kHz standard. This keeps the audio in the digital domain, preventing quantization errors and other distortion occurring from excessive analog-to-digital transformations.

A variable-sync unit is used to lock a DATR to video. The unit will lock its internal clock to input video reference and output word sync to vary the speed of the DATR.

Bringing it home

A decade ago, the digital studio was a dream. Standards committees and manufacturers have labored many years to create a standard by which competitive products can be built. Two digital video formats now have emerged, and others are waiting in the wings. Each format and its respective complement of equipment offers unique performance attributes not found in the analog world. By recognizing and implementing these maturing formats, you can bring the digital advantage home to your facility.

[:T=))]]

For Your 601 and D2 Tool Box

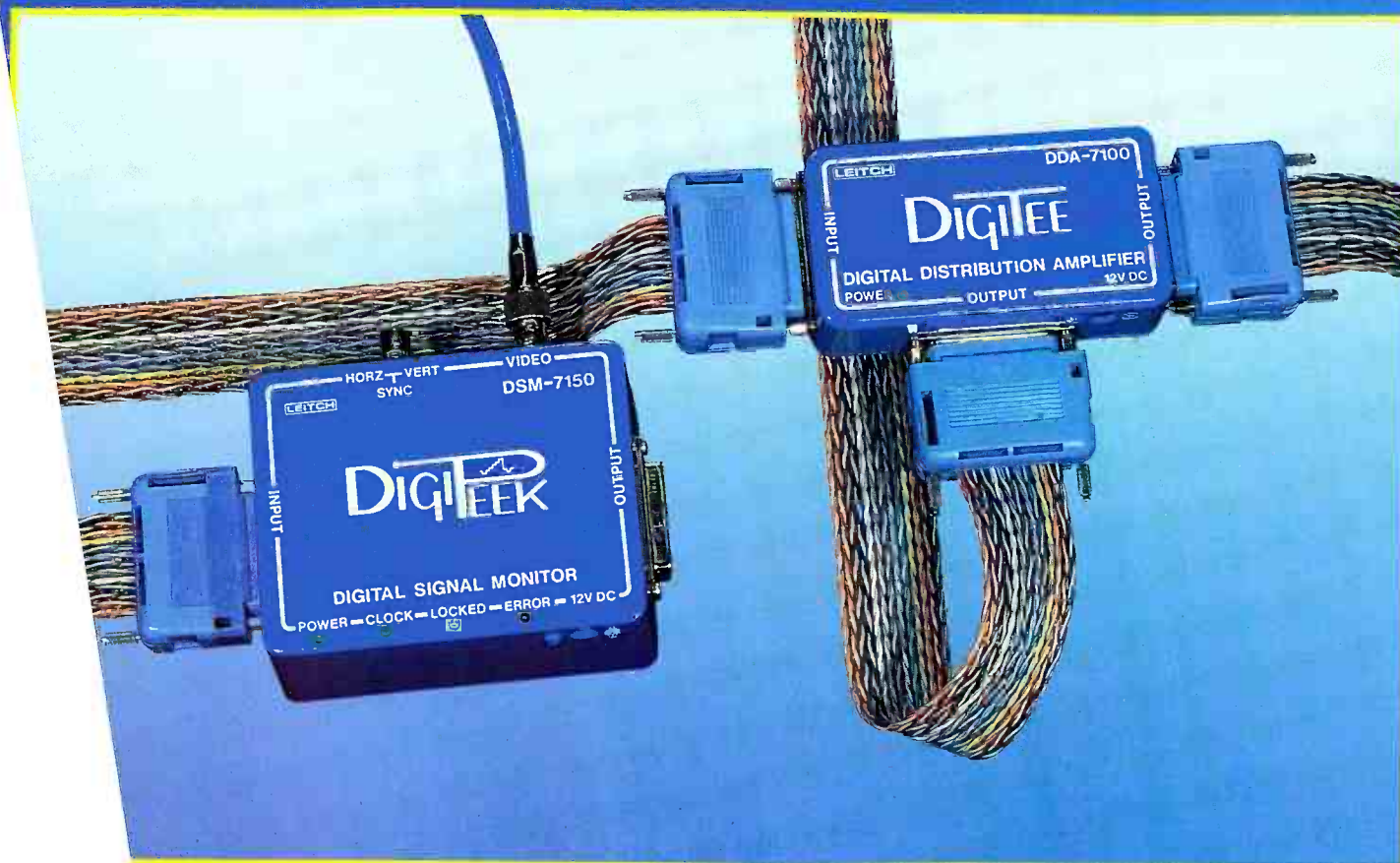

Installation and maintenance of digital equipment is one of the most exciting challenges of this decade. Leitch has developed two new tools specifically designed to simplify your digital installations.

The DigiTee provides compact signal distribution. Since, according to CCIR 601 and D2 specifications, equipment must have terminating inputs, the DigiTee provides a practical equivalent to looping inputs. The DigiTee doubles as a line amplifier for long cable runs by re-synchronizing the full 10 bit data path, yet is small enough for cable troughs.

The DigiPeek's 1 volt composite output and LEDs provides monitoring and status of the digital signal. A re-synchronized digital output permits in-circuit monitoring. The compact DigiPeek is ideally suited for trouble-shooting complex digital systems.

To keep your digital tool box up-to-date, contact your Leitch dealer.

LEITCH

Leitch Video of America, Inc., 825K Greenbrier Circle, Chesapeake VA 23320
Tel: (800) 231-9673 or (804) 424-7920 Fax: (804) 424-0639

Leitch Video International Inc., 10 Dyas Rd., Don Mills, Ont., Canada M3B 1V5
Tel: (800) 387-0233 Fax: (416) 445-0595 Telex: 06 986 241

Circle (33) on Reply Card

Wouldn't it be great if somebody built fully-integrated systems for all your distribution, control, and automation requirements (including digital routing), using standard, expandable equipment?

**SOMEBODY DOES.
UTAH SCIENTIFIC.**

ROUTING

SYSTEMS

ROUTING SYSTEMS. Utah Scientific routing systems perform to the best specs in the industry. Reliability, easy system expansion and long-term stability have been proven in more than 500 installations around the world. Controlling the router is easy with the industry's broadest selection of control panels, computer interface equipment, and automatic control systems, all of which are user reprogrammable to ensure that your system continues to accommodate your changing requirements.

AUTOMATION SYSTEMS. As the need to automate more and more of your facility's operations becomes important, Utah Scientific is ready to help you with a fully integrated system, designed to meet your current needs and expand easily as your requirements grow.

From a simple routing switcher event programmer, to a fully integrated on-air automation system for a broadcast network, Utah Scientific has the products, and the experience, to meet all of your automation needs.

DIGITAL SYSTEMS. Now there's a single-source supplier for all your switching requirements including DIGITAL video. Our new DVS-1 Digital Video Routing Switcher offers 10-bit performance and maximum reliability. Available in a wide variety of configurations, the DVS-1 handles either the D-1 (component) or D-2 (composite) signal format. Of course, like all Utah Scientific products, the DVS-1 can operate as a stand-alone system or be integrated with other components.



DIGITAL

SYSTEMS

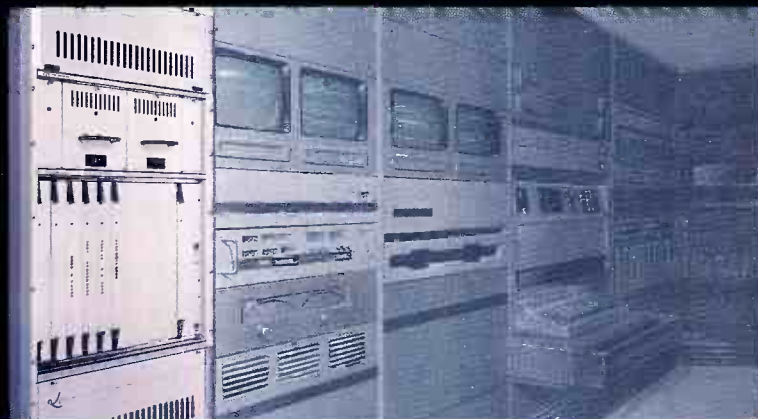

AUTOMATION SYSTEMS



*Somebody
does!*

**US UTAH
SCIENTIFIC**
DYNATECH Broadcast Group

1685 West 2200 South, Salt Lake City, Utah 84119
(801) 973-6840 Toll-Free: 1-800-453-8782

Circle (34) on Reply Card

www.americanradiohistory.com



Disk recording and editing

By Brad Dick, radio technical editor

Hard disk storage is the key to digital recording and editing.

It doesn't take a rocket scientist to recognize that the era of digital recording and editing techniques finally has arrived. No longer confined to film and post-editing suites, today's hard-disk-based systems are now finding application in radio and TV stations.

Some digital audio techniques, such as delay and reverb, have been around for years. However, complete recording and editing systems have become available only recently. Digital techniques that used to be possible only with systems costing \$250,000 now are available for perhaps one-tenth to one-fifth that amount. Although the larger and more sophisticated systems do offer additional features, even personal-computer-based digital editing systems are finding a home in radio and TV stations. As digital editing stations continue to improve and costs are lowered, more stations will move from analog to digital production systems.

Digital benefits

Analog signal processing is a mature technology, and the quality of analog

Photo courtesy of Seagate

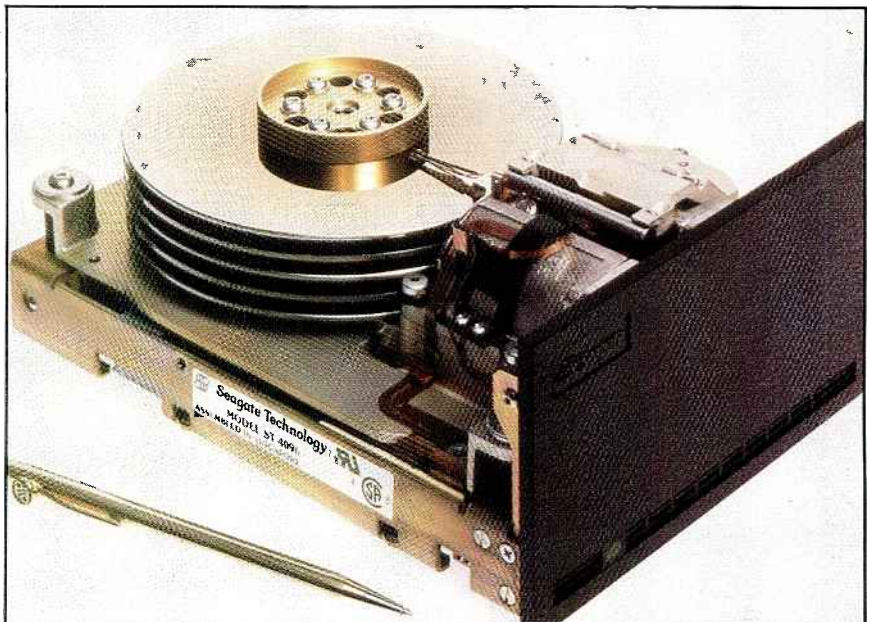



“Auditronics’ 400 gives medium-market KZZP® a major-market sound,”

says Jim Kunowsky, Chief Engineer of Phoenix’ number one hit station. “Our 400 lets us do a lot of fancy promos and commercial production that most stations can’t do in-house. And it’s eight-track record capability with full EQ on every input channel gives us the creative latitude of a recording studio.”

“Yet the Auditronics 400 console is simple enough that the people who use it every day for dubbing from CD to cart for our on-air music find it very easy to use. A big value of the 400 for us is that it can be configured to do everything from simple dubbing to complex original productions with equal ease. Thus, it gives KZZP a whole level of performance above what you normally see in radio production.”

“When the 400 isn’t booked with our own work, we rent the room for a nationally-syndicated high-energy six-hour dance party called Hot Mix. The Hot Mix

producers love the 400 console because even though they don’t use it every day they can be up and running in about ten minutes, which is very time-efficient”.

“While we’re willing to spend money, Nationwide Communications Inc.’s philosophy is that what we spend the money on has to do its job. So far, the Auditronics 400 console is doing its job admirably.”

If you’d like to know more about why Jim Kunowsky likes Auditronics consoles for both on-air and production, call today toll free 1-800-638-0977, or circle reader service number for complete information.



3750 Old Getwell Road, Memphis, Tennessee 38118 • 901-362-1350

Circle (35) on Reply Card
www.americanradiohistory.com

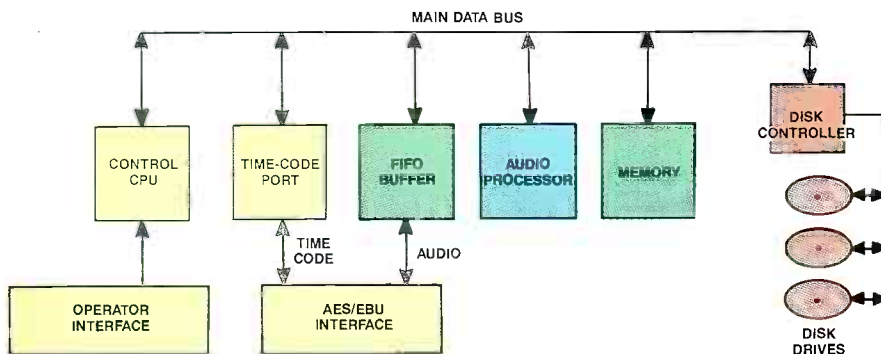

Figure 1. The major components of a digital editing system resemble those of a computer. A key element in both systems is the hard disk storage system.

broadcast signals can be quite good. Even so, digital processing of audio has many unique advantages. At some stations, the advantages offered by digital production systems are not only thought to justify their cost, but also result in new marketing tools.

In the hands of a skilled operator, a digital editing system can produce sophisticated audio effects. Some of these effects, even if they could be accomplished in the analog domain, would be costly and

time-consuming. Today's digital systems offer comprehensive audio processing, including equalization, mixing and dynamics. The precise control offered in the digital domain allows production techniques never before possible.

Rotary storage

The block diagram of a typical digital recording and editing system is shown in Figure 1. Comparing this diagram to that of a computer reveals many similarities.

In fact, many of the circuits used in today's editing systems were developed for the computer industry.

An important key to sophisticated digital editing is the hard disk. Although digital audio processing has been possible for some time, the availability of high-capacity, low-cost disk drives may have been the key to making digital recording and editing cost-effective.

The first hard disk drive was built by IBM in 1953. It contained 50 disks, each measuring 24 inches in diameter. Despite its size, the huge drive stored only 5Mbytes of data. Fortunately, the personal computer industry created such a demand for digital storage that technology and American enterprise improved upon the original idea.

The advent of the personal computer, or PC, was the genesis of today's small disk drives. The PC disk drive became popular in 1980. Early designs boasted a 5Mbyte, 5-inch disk with an access time of 170ms. The drives were expensive too, costing \$1,500. Today, only eight years later, a 20Mbyte drive with a 65ms access time costs less than \$300. Disk drive manufacturers now can produce a hard disk drive for approximately one-tenth of what it would have cost only seven years ago. As



The choice of the professionals...





310B
PROFESSIONAL
PHONO PREAMPLIFIER/EQUALIZER

... Interfaces magnetic phono cartridges for optimum calibration of audio systems. Available with balanced or unbalanced output.



PBR ANNOUNCER'S EARPHONE ...
Ideal for on camera studio work and remote coverage.

The
Dynaphase
30M/SR is a shoulder rest single cup headphone that provides the ultimate in convenience, comfort and superb sound quality. Made to rest on either your left or right shoulder, or shoulder rest can be detached and used as a single cup hand-held monitor.



680EL ... Delivers sound excellence and stands up to backcueing, vibrations and mishandling.

Stanton is the company with a total commitment to quality and reliability—producing products for the Recording Industry, the Broadcast Industry and the Professionals in Audio.



STANTON

THE CHOICE OF THE PROFESSIONALS™

101 Sunnyside Blvd., Plainview, NY 11803



500AL ... For heavy duty on-the-air use with wide tracking force range.

Circle (89) on Reply Card

Ready to Score Another Scoop

Toshiba's Mt-3 Satellite Scoop System makes live coverage of fast-breaking news events routine.

This complete Ku-band system fits in 10 compact, lightweight flight cases that meet IATA carry-on baggage regulations.

Once on site, an array of proven Toshiba design advances facilitate set-up. A 1.8M parabolic antenna with a simplified 360° azimuth rotary mechanism in addition to an easy polarization, 6-segment FRP antenna reflector make set-up short and sweet.

The synthesized exciter minimizes MCPC/SCPC carrier phase noise and provides all-purpose control flexibility. And advanced microprocessor controls assure complete access with all existing international communication satellites.

Toshiba's Mt-3 Satellite Scoop System effectively takes the work and worry out of live news coverage.

The Mt-3 was developed jointly by Toshiba and CBS Engineering and Development.

Satellite Scoop System
Mt-3

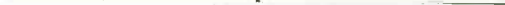

TOSHIBA

TOSHIBA CORPORATION TOKYO JAPAN

ELECTRONIC SYSTEMS DEPARTMENT

1-1, SHIBAURA 1-CHOME, MINATO-KU, TOKYO, 105, JAPAN
TELEX: J22587 TOSHIBA CABLE: TOSHIBA TOKYO PHONE: 457-3246-8

TOSHIBA AMERICA, Inc.

701 WESTCHESTER AVE., SUITE 204W, WHITE PLAINS, N.Y. 10604 TELEPHONE: (914) 949-7750/52/56/58 FACSIMILE: (914) 949-8004

Circle (39) on Reply Card

www.americanradiohistory.com

IT'S A BULL MARKET

The patch panel market, seems to be more bull than business. Late delivery and back orders, compounded by questionable quality, makes hard wiring seem easy. But there is a better way.

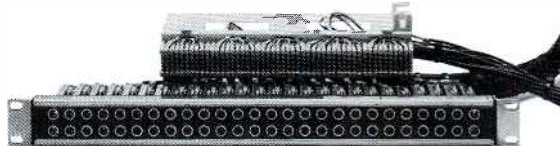

Pre-Wired Patch Panels

For pre-wired patch panels, no one has the edge on Gentner. Our patch panels are hand-wired to your specifications and can be terminated to our stranded-wire Flexblock or any other standard termination. With a wide variety of bay fronts and terminations in stock, you're guaranteed fast delivery. And, that's no bull.

GENTNER
PATCH PANELS

1825 West 2770 South • Salt Lake City, UT 84119 • (801) 975-7200 • FAX (801) 977-0087
© 1988 - Gentner Electronics Corporation
Gentner Electronics Corporation is publically traded over the counter and is listed in the "pink sheets"

Circle (40) on Reply Card



For AM, FM, SCA and TV modulation monitors.

WHEN ACCURACY COUNTS...COUNT ON...

Call (215) 687-5550 or write for more information on Belar AM, FM, Stereo, SCA and TV monitors.



Circle (41) on Reply Card

FREE 44pg Catalog & 80 Audio/Video Applic. 250 PRODUCTS

PWR SUPP. EQ. PHONO, MIC, TRANS. AGN. TAPE, VIDEO, LINE, OSC. / PRESS BOXES Video Audio

1-in/16-out Audio 2-in/18-out Audio 2-in/24-out Audio 4-in/1-out Audio Mixer

Routing Switchers

Video & Audio Dist. Ampls. RGB-Sync. Dist. Ampls.

OPAMP LABS INC (213) 934-3566 1033 N Sycamore Av LOS ANGELES CA, 90038

Circle (101) on Reply Card

PRECISION MAGNETIC TEST TAPES

STL

Standard Tape Laboratory, Inc. 26120 Eden Landing Road #5, Hayward, CA 94545 (415) 786-3546

Circle (76) on Reply Card

Want more information on advertised products? Use the Reader Service Card.

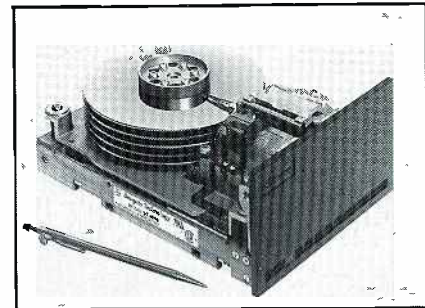

In a high-capacity drive, there may be up to two recording surfaces per platter, each with a read/write head and a common voice-coil actuator.

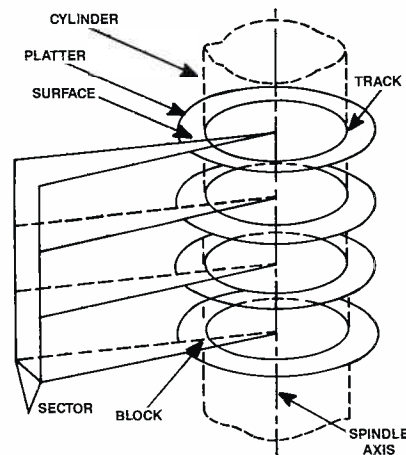

Figure 4. Disk terminology. Tracks are narrow concentric bands that cover the disk surface. Cylinders are the vertical shapes representing all tracks of the same radius. A sector is the angular subdivision of a track. A block is that part of a track within one sector. Each block has a unique cylinder, head and sector address.

permits the heads to fly at the correct height above the disk.

Because of the high relative head-to-disk speed, the last thing you want is for the head to touch the disk. Such an event is known as a head crash or disk crash. If this happens, both the disk and head may be destroyed. Even if the parts are not destroyed, important data could be lost. Fortunately, today's hard disk drives are quite reliable, and head crashes are quite rare.

Assigning space

Engineers unfamiliar with computer technology may be confused by the recording scheme used in disk-based recording systems. Unlike tape, digital storage is

Continued on page 68

UNCOMMON STOCK

If you could solve the lion's share of your equipment needs in one place, you could spend less time running from dealer to dealer, catalog to catalog, and more time running your operation. That's why Gentner Electronics, with over 72 high performance products in stock, is an uncommon company providing innovative solutions to your common problems.

Solutions like the VRC-1000 Remote Control which has allowed countless engineers to monitor and operate their transmitters through any Touch-Tone™ phone. A preprogrammed synthesized voice gives you the parameters, you make the adjustments with the touch of a button. Nothing is simpler or more dependable.

Our Digital Hybrid™ is another example of innovation in our line of telephone interface products. It is an auto-nulling telephone hybrid with precision filtering and noise reduction. It solves your interface problems and uses advanced digital signal processing to analyze, isolate and stop leakage between receive and send signals. This greatly reduces the "hollow" sound that plagues broadcast or teleconferencing applications.

Our Audio Division, with its track record for developing unparalleled products, has taken the sting out of common audio DAs. Our unique flexible Routing Distribution Amplifier has overcome the typical DAs input and output limitations by giving you 8 inputs and 28 outputs. Any

input, or combination of inputs, can be routed to any output. And, with the simple flip of a dip switch, you can reconfigure the RDA to meet changing needs.

Gentner is setting new standards in patch panels, too. Our Versapatch, a chassis-enclosed audio patch panel, is hand-wired to your specifications and can be terminated to our Flexiblock or telco-type '66' punch block. For prewired patch panels, no one has the edge on Gentner. With a wide variety of bay fronts and terminations in stock, you're guaranteed fast delivery.

The bottom line is this—before you place a buy order for your next equipment purchase take a look at what Gentner has to offer. You'll find our uncommon stock is stable, dependable and will pay you dividends for years to come. Gentner Electronics, a sound investment in your future.



VRC 1000



Digital Hybrid



Routing Distribution Amplifier



Versapatch

GENTNER
ELECTRONICS
CORPORATION

P.O. Box 27647 • Salt Lake City, UT 84127-0647
(801) 268-1117 • FAX (801) 265-1394

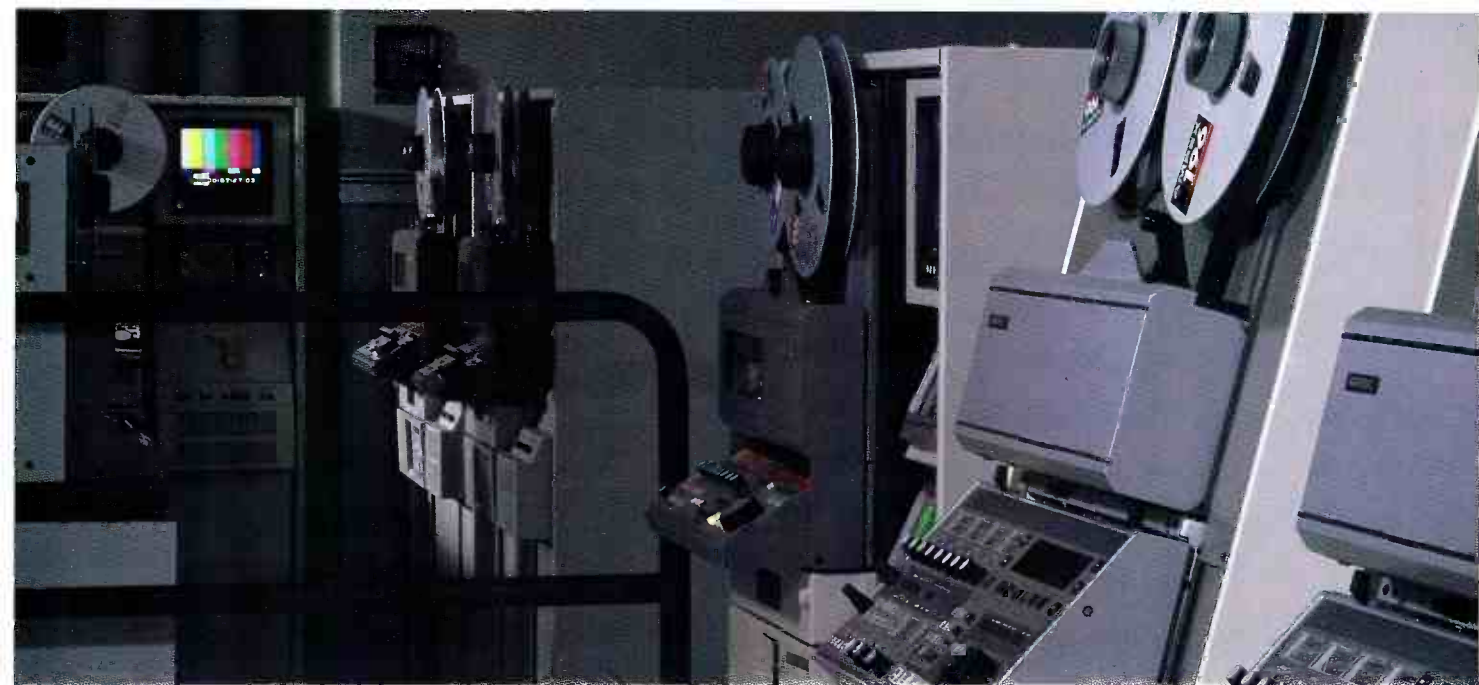

A convincing argument for Type C from a company that invented D2.

We didn't spend five years pioneering the world's first D2 composite digital recorder just to win technology awards—selling D2 machines is one of our top priorities.

But another and even more important priority for us is to make sure that the video professionals we serve have appropriate equipment for their jobs. And that they continue to look to Ampex



"... business more than tripled this year using Type C..."

Bill Stokes,
Bill Stokes Associates

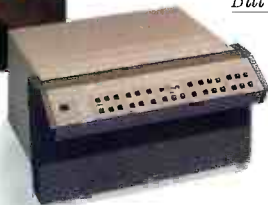

*Ampex Zeus
Advanced
Video Processor*

for the straight story about that equipment and its applications.

A case in point is the question we recently asked several of our customers who purchased Type C *after* we introduced D2.

"With the introduction of D2, why did you purchase Type C?"

We think the answers we got may interest you if you're considering the purchase of *any* video machine.

Bill Stokes (*Bill Stokes Associates* in Dallas), came right to the point. "My business has more than tripled this year, and I'm using Ampex Type C machines. Is there any better reason to buy more? With the new TBC-7 or the Zeus processor they make perfect pictures. Besides, I like the service I get from Ampex."

Jerry McKinzie with *Cycle-Sat Communications Network* in Forest City, Iowa, (a satellite courier,

The VPR-80's Automatic Scan Tracking head and its erase head are both easily removed and replaced with only a screwdriver.

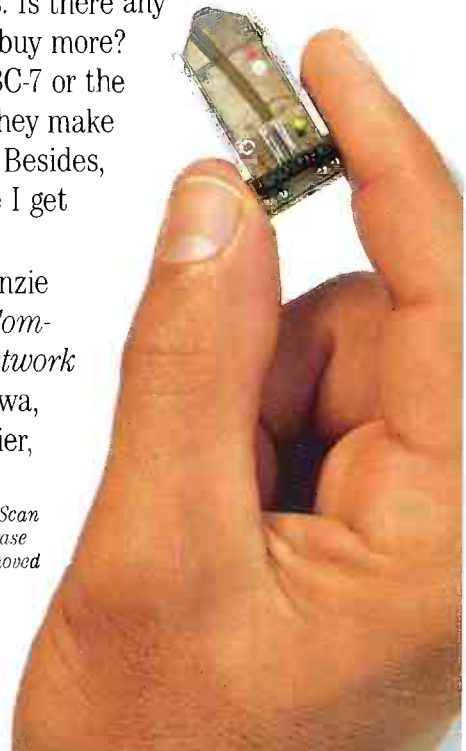



production, and post-production business), thinks it's important to be able to update easily as his business changes. "The hardware and software upgrades Ampex makes in their equipment allow me to keep my facility current, and to always give my customers the newest look. I like that, and my customers demand it."

Darrell Anderson, whose company *Anderson Video* in Los Angeles, recently purchased several



"... Type C business is readily available..."

Darrell Anderson, *Anderson Video*

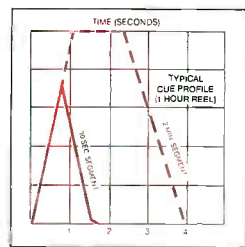

The VPR-3's incomparable acceleration allows a 30 second segment to be re-cued and synchronously played in 2 seconds, using one hour reels.

facility. Type C business is readily available." We were gratified to hear that he, "bought the best Type C machine he could find."

Consider your purchase decision carefully. When the excitement of a new equipment introduction passes, and you've put the pros and cons down on paper, Type C may be exactly the right machine for your application. After all, it's still the world's broadcast interchange and distribution standard.

"... hardware and software upgrades keep my facility current..."

Jerry McKinzie,
Cycle-Sat Communications Network



And it is obviously the perfect choice for facilities that are moving up from 3/4-inch.

We'd like to be involved in your decision-making process, and we're as close as your telephone. Call your nearest Ampex sales engineer at an office listed below or call 1-800-333-1234 for some real help with a difficult decision.

AMPEX

Otari's compact EC-201 SMPTE/EBU time-code reader is a natural for field or studio operation, and it costs only \$525. It offers 1/20 to 60X play-speed reading; 40 hour continuous use on battery power, and re-shaping circuitry on the loop output.

This advanced reader features a full hexadecimal user bits display (with a hold-button for edit logging); a -10 to +10 dBV input range; balanced XLR inputs/outputs, and includes an AC adapter, belt clip, and batteries. It measures 1.5" x 4.2" x 5" and weighs 18 oz.

Contact Otari at (415) 341-5900 for your nearest dealer. From Otari: Technology You Can Trust. Otari Corporation, 378 Vintage Park Drive, Foster City, CA 94404.

OTARI

TIME OUT!

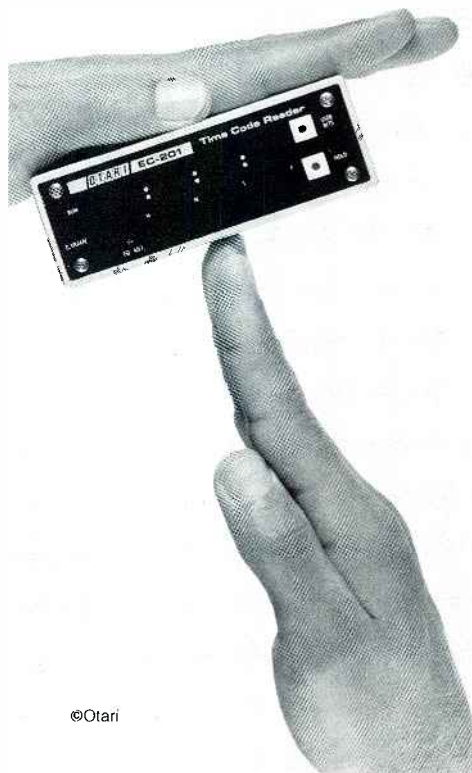

©Otari

Circle (90) on Reply Card

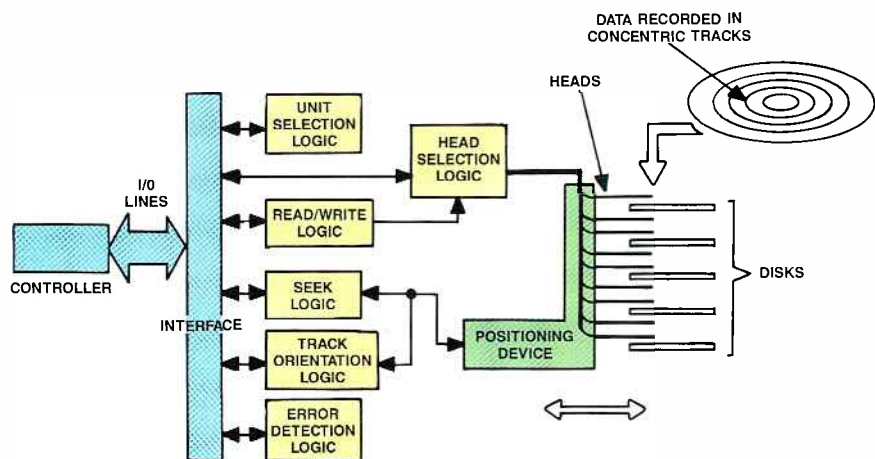

Figure 5. Functional block diagram of a 5-platter drive. All drive activities are directed by the controller.

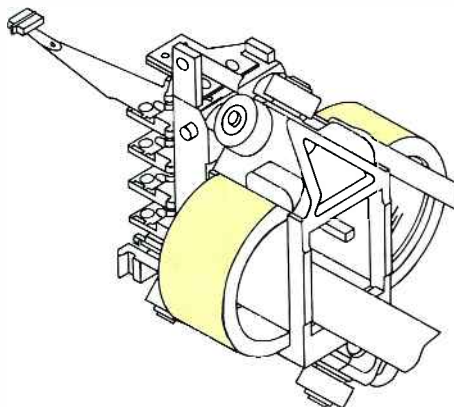

Figure 6. This 5-platter carriage provides one head for each recording surface. Only one head is shown for clarity. The shaded area represents voice-coil wiring.

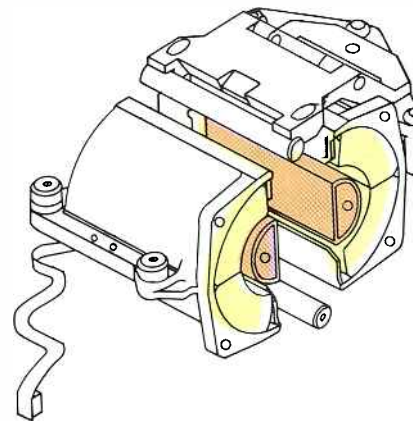

Figure 7. Voice-coil drive. Shaded areas represent the inner and outer magnetic assembly.

Continued from page 64
not assigned space. A stereo editing system does not physically assign space within the drive for each channel of audio.

The audio is stored in blocks of data throughout the disk. A continuous sound needn't be recorded in continuous blocks or sectors. You may have encountered the term *fragmented file* with your computer. This simply means that the blocks of the file are spread throughout the disk, rather than in a continuous form. About all this means to the user is that accessing the data may take more time. This access time becomes important, however, as you will see.

In theory, the hard disk can be divided into as many output channels as desired. However, as the number of output channels increases, the heads must access more and more data almost simultaneously. Even with a large buffer, the seek times

become a factor. With today's systems, a total of eight output channels is considered the practical limit.

Storage capacity also determines the maximum available recording time. Assuming 800Mbytes of storage, more than 138 minutes of monophonic storage is possible. Doubling the number of tracks, from mono to stereo, would reduce the available playing time by half, or 69 minutes.

In a practical sense, multitrack applications seldom require as much storage space as originally thought. Unlike a tape, all the tracks in a hard disk system are not recorded continuously. Some tracks may contain only brief selections or cuts used sporadically in the final mix. A tape machine must allocate an entire track for these effects, thereby requiring more real-time storage space. The disk system must only provide sufficient space to hold all

1953
 1954
 1955
 1956
 1957
 1958
 1959
 1960
 1961
 1962
 1963
 1964
 1965
 1966
 1967
 1968
 1969
 1970
 1971
 1972
 1973
 1974
 1975
 1976
 1977
 1978
 1979
 1980
 1981
 1982
 1983
 1984
 1985
 1986
 1987
 1988
 1989

35 YEARS AGO WE PIONEERED
 THE FIRST TRANSMISSION LINES...

FLEXWELL®

TODAY WE'RE STILL LEADING THE WAY!



Cablewave Systems 6-1/8", 8", 9" and 12" high power Flexwell coaxial cables represent the largest semi-flexible transmission lines of their kind in the world. Produced in continuous lengths, large capacity corrugated copper and aluminum Flexwell cables are designed to meet the high power requirements of medium wave and shortwave international broadcast installations.

The family of Flexwell transmission lines are produced and marketed worldwide by member companies of the Radio Frequency Systems Group. Flexwell corrugated transmission lines range in size from 1/4 inch jumper cable to 12 inch high

power broadcast cable with up to 9 megawatt RF power handling and Flexwell elliptical waveguide from WR42 through WR430.....Cablewave Systems covers the whole spectrum.

For more information on the Flexwell family of RF transmission lines, contact Cablewave Systems division of Radio Frequency Systems Inc. North America, 60 Dodge Avenue, North Haven, CT 06473. (203) 239-3311.



Cablewave Systems®

Circle (44) on Reply Card



How do you get Sony's new digital recorder to work with your analog equipment?

You can slip Sony's new composite digital video recorder right into your current editing suite. With its analog inputs and outputs, it connects directly to your existing equipment.

Yet it does what only digital can do. For example, the Sony DVR-10 composite DTTR gives you more than 20 generations of transparent digital dubbing. And with its write-after-read capability, one

machine can operate simultaneously as both a source and recorder.

The DVR-10 is physically small—half the size of a BVH-2000 recorder—and its price is as compact as its size.



Just plug it in.

And the DVR-10 records four PCM channels of audio, bringing you the same dramatic digital sound you've been hearing on compact discs.

With digital techniques,

you get superior dubbing capability, data error correction, and built-in editing functions.

But see the power of digital for yourself...Contact your Sony Broadcast Sales Engineer. Or call Sony at (800) 635-SONY.

SONY[®]

Sony Communications Products Company, 1600 Queen Anne Road, Teaneck, NJ 07666. ©1988 Sony Corporation of America. Sony is a registered trademark of Sony.

BROADCAST PRODUCTS

Good Reasons To Call RTS When You Need High-Performance Intercom Systems.



Today's disk drives provide high performance at a low cost. This 2-platter drive provides 20 Mbytes of storage.

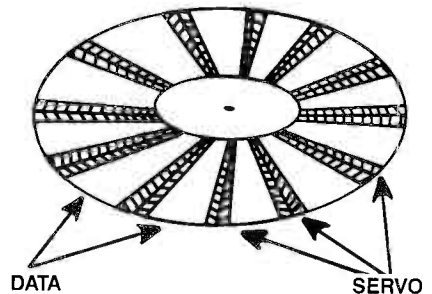

Figure 9. Drives with only one or two platters rely on servo information embedded between the data to control disk movements.

Continued from page 70

tioned by moving the entire assembly in and out of the magnet. The scheme places all the heads over identical tracks on each platter.

Engineers may recognize this design as being similar to a speaker *voice coil*. In fact, drives that use this head-positioning technique are called *voice-coil drives*. The design permits rapid and highly accurate head positioning. Although more expensive than the servo design, voice-coil disk drives are much faster, with access times often less than 16ms.

Servo systems

Finding the desired data on a drive is a complex task. The key is knowing where the heads are positioned currently. This is where the servo system comes into play.

The drive reads to and writes data from the platters under the direction of the controller. These operations cannot be performed randomly. Otherwise, it would be impossible to later recover the recorded data.

A reference map, called servo data, is prerecorded by the manufacturer onto one of the platter's surfaces. In a multiplatter drive, one entire disk surface may be devoted to servo information. The top disk surface in Figure 8 contains the servo information. This technique won't work with single-platter systems. Dedicating an entire platter surface to servo information

Professional intercom systems from RTS—a great way to keep in touch no matter what the application.

Our Series 800 features multi-channel intercom products ranging from sophisticated *microprocessor-assisted* to simple and direct. And our TW Intercom offers a wide array of two-channel system components.

RTS Systems intercom—for all the right reasons. Please call or write for descriptive literature.

PROFESSIONAL INTERCOMMUNICATIONS • PROFESSIONAL AUDIO PRODUCTS

RTS SYSTEMS
INCORPORATED

1100 West Chestnut Street • Burbank, California 91506 • Telephone 818 840 7119 • Telex 194855 • Telefax 818 842 4921

Circle (48) on Reply Card

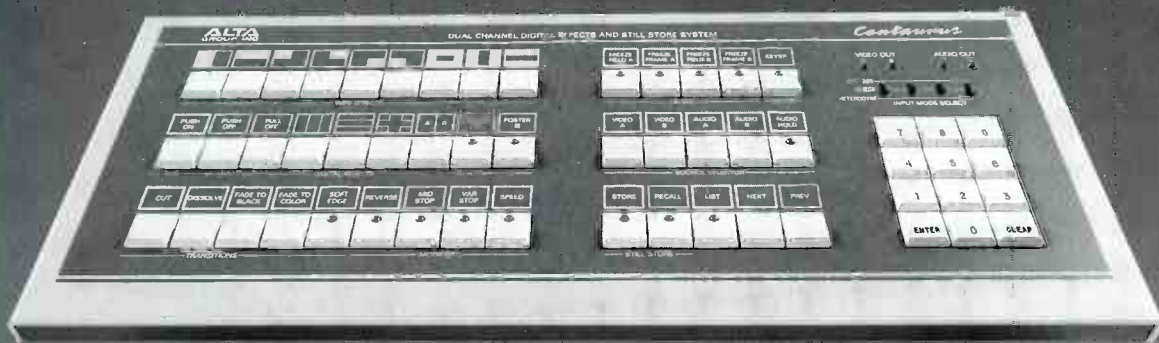

One Still Store Does More Than Just Store Pictures

Simply Storing Pictures Isn't Enough Anymore.

Your still store had better deliver absolutely pristine images and be a multitasking production center, or you're not getting your money's worth.

Can Any Still Store Really Do This?

One can. ALTA's Centaurus. Look at our bandwidth, for example. We don't just meet broadcast specs. We exceed them with high-speed component processing throughput. That means you get the sharpest image possible.

Store More For Your Money!

Now compare Centaurus' storage capacity. All on-line, for instant recall at the lowest cost per picture.

And when your storage requirements grow, we'll grow with you. With additional on-line storage, and a

digital tape cartridge for unlimited off-line storage.

No Other Options Needed!

Our dual synchronizers and TBCs are built right in. So you can work directly with images from tape, camera, microwave and satellite feeds, whatever. All without having to invest in additional equipment.

Becomes a Master of Effects in Minutes!

Put some polish on your productions. Centaurus gives you more effects to work with, on a keyboard that's simple to operate. Plus its built-in switcher and dual TBCs let this still store stand alone, so you won't tie up your entire studio.

How Can This Be?

How can we make a full-featured, dual channel still store for less than the cost of other single-channel systems? Simple. We've been doing it for years. In fact, ALTA engineers were among the pioneers of the digital still store. That's why our warranty is twice as long, and our still store gives you twice the value.

So if you're looking for a still store that does

more than just store pictures, choose the one that does more for your money.

Choose Centaurus.

Specifications	ABEKAS A42	ALTA Centaurus	AMPEX ESS-5	HARRIS ESP II
Bandwidth	4.2 MHz (±0.25 dB)	5.5 MHz (-3 dB)	5.9 MHz (±5 dB)	5.0 MHz (±0.5 dB)
Signal to Noise	52 dB	58 dB	?	56 dB
Storage Capacity*	200 fields 100 frames	250 fields 125 frames	207 fields 207 frames	200 fields 200 frames
Synchronizer	—	Dual	—	Dual
TBC	—	Dual	—	—
Production Effects	1 wipe dissolve —	9 wipes dissolve 7 digital	1 wipe dissolve —	3 wipes dissolve 3 digital
Warranty	1 year	2 years	1 year	1 year
Single Channel	\$19,900	—	—	\$26,333
Dual Channel	\$24,900	\$16,900	\$31,500	\$30,995

*Basic System

Based on available data as of June, 1988.

ALTA
GROUP, INC

535 Race Street, San Jose, CA 95126 • FAX 408-297-1206 • Tel. 408-297-ALTA

Circle (49) on Reply Card

www.americanradiohistory.com

Digital effects

Many digital effects can be accomplished simply by controlling the gain of the desired channels. Cuts, fades, crossfades and other techniques all rely on gain changes.

Gain in the digital domain is controlled by multiplying each sample by some fixed coefficient. If the coefficient is less than one, the gain is reduced. If the coefficient is greater than one, amplification is obtained.

Unfortunately, multiplication in binary circuits is complex, but more important, it is expensive. For these reasons, digital circuit designers often try to reduce the number of multipliers required within a system.

The circuit illustrated below is a simple 2-channel mixer. The two inputs are multiplied by the desired coefficients to control their respective levels, then are added to obtain a mix. This design requires a multiplier for each input channel. By rearranging the circuit, as shown in the top right illustration, one of the multipliers can be eliminated.

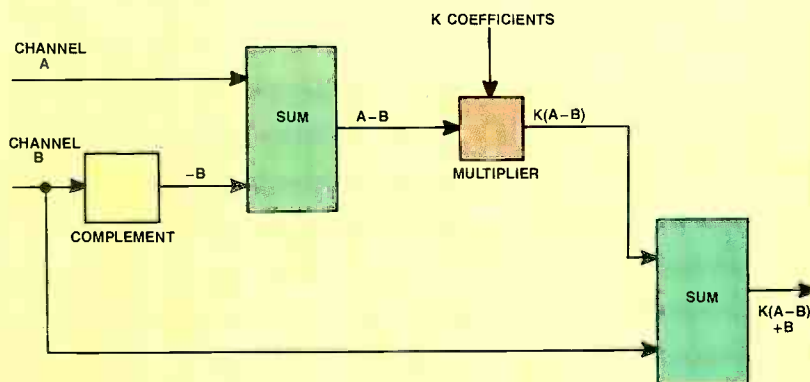

By reconfiguring the circuit, it's possible to eliminate one of the multipliers.

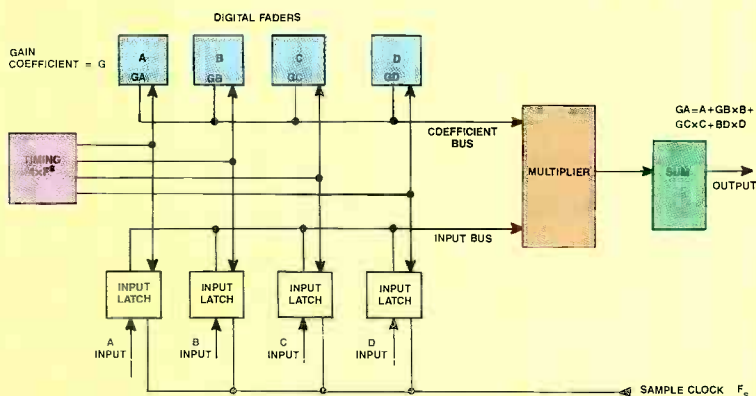

This 4-input mixer relies on time-sharing techniques. This allows one multiplier and accumulator to serve all four inputs.

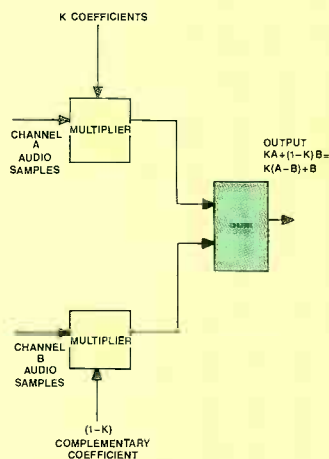

Controlling gain in the digital domain requires the use of multipliers. Note that one multiplier is required for each input channel.

A digital mixer could be implemented with only one multiplier as shown above. Four audio inputs are supplied to the lower input of the multiplier. The desired gain coefficients are supplied by the digital faders to the upper multiplier input.

The timing block operates at four times the sample rate. This permits all

four inputs and corresponding gain coefficients to be processed during one sample period. The multiplier's products are stored in the accumulator for one sample period. At the end of one sample period (four block periods) the accumulator holds the sum of all the products — the digital mix. The process then repeats for the next sample period.

could result in a loss of 50% of the available storage space. These drives embed the servo information between data on the platter surface, as shown in Figure 9.

The servo surface provides three basic types of information: radial head movement, rotational disk position and disk speed. The servo head is mounted on the

same positioner as the data heads. Thus, movements of the servo head across the servo surface correspond exactly to movements of the data heads across the data surfaces. By reading the servo information, it is possible for the controller to precisely and quickly locate the desired data.

Filling the gaps

Because all the heads are mounted on the same carriage, each head is always positioned above the same track. What happens when an audio sample is too long to be contained within a single track? It might be possible to stop the recording process, move the head over one track

Why we called it HARRY

It sometimes seems as if the only thing we *haven't* given Harry is a proper name. But to name it, you've got to define it. We asked five users to help us out. Here's what they said:

"ANIMATION SYSTEM.

I can check the animations as I create them, so I don't waste time. And of course the quality's superb."

"MULTIGENERATIONAL GRAPHICS SYSTEM.

Harry's keyer is superb and I love the transparent Paintbox interface."

"CREATIVE EDITING.

Conventional suites are so frustrating: the drudgery was a creative block. Harry has changed all that."

"DIGITAL EDIT SUITE.

Can I call you back? We've just installed our second Harry and they're both snowed under with work."

"DIGITAL OPTICAL PRINTER. I come from film. Harry lets me work the way I like – with pictures."

A unanimous verdict. No matter what your approach to post-production, here's a faster, more creative and cost-effective solution:

Harry. What's yours called?

Circle (50) on Reply Card

QUANTEL

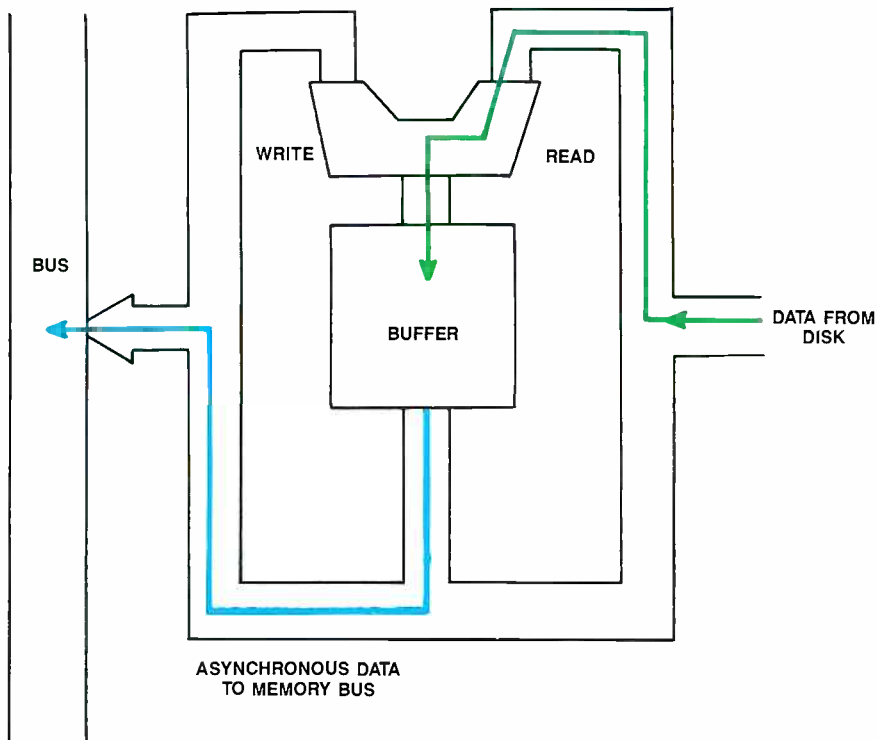

Figure 10. The irregular intervals with which data is processed from the disk head require the use of a buffer. The buffer ensures that the asynchronous circuits are provided with continuous data.

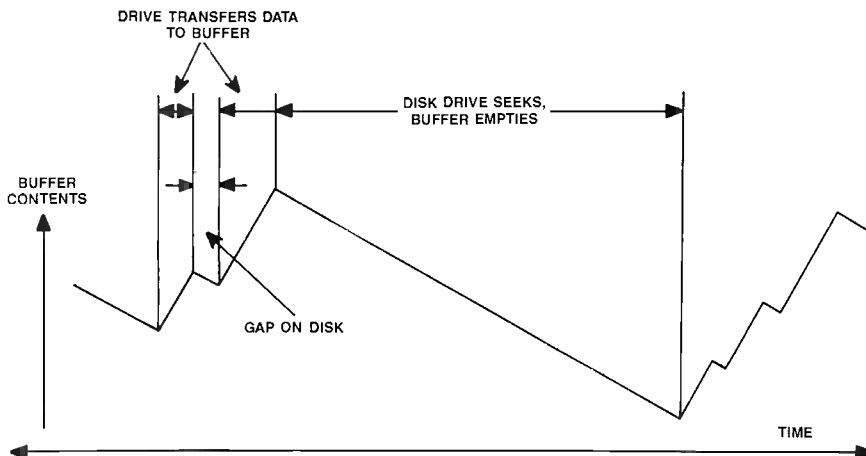

Figure 11. During a read command, the buffer is emptied at a constant rate. The buffer is simultaneously refilled at irregular rates by the disk.

and continue recording. However, this process would create significant delays as the head repositioned itself.

A more efficient scheme is used by the disk drive. Data that exceeds the length of a single track is written not to the next track on the same platter, but to the same track on another platter. This avoids the delay of repositioning the head to another track.

Even with this head-switching tech-

nique, today's disk drives still are not fast enough to process audio on a real-time basis. In addition, because the data is not recorded continuously, gaps in the datastream result when the information is read back from the disk.

Digital audio-processing circuits require that the data be presented on an asynchronous basis — without discontinuity. The solution lies in the use of a RAM buffer between the disk output and the

audio-processing input. Data from the disk is read into a buffer, as shown in Figure 10. The incoming data is processed on a first-in-first-out (FIFO) basis.

The buffer ensures that, no matter how much work the disk drive must do to locate the data, the rate at which data is transferred to the audio-processing section is unaffected. The drive transfers the data in real time to the buffer at intervals determined by the disk and data locations. Any gaps are filled with the stored data from the buffer.

This process is symbolized in Figure 11. After the buffer contains a certain amount of data, the data is output in an asynchronous manner to the memory bus. The CPU monitors the amount of data in the buffer. If the buffer begins to near its capacity, the CPU instructs the disk controller to cease reading data.

As the data is processed out of the buffer, the level is reduced, and the drive is again commanded to retrieve data to fill the buffer.

The reverse process is used to record data back to the drive. During a write instruction, an entire block of data must be provided to the disk at one time. The CPU ensures that the buffer is prefilled before allowing the writing process to begin. As the disk drive skips bad sectors, servo gaps and moves from track to track, the buffer output is halted. Because these operations take place in milliseconds, the editing system's operation is not affected.

Editing in the digital domain

Today's digital editing systems offer so many advantages compared to traditional analog techniques that it is difficult to list all of them. Not only do disk-based editing systems allow almost instant access to recorded material, they also provide creative freedom not available in the analog domain. Most systems permit non-destructive editing. This means that the original files are not destroyed by the editing process. Every edit can be changed or modified without fear of losing the original audio tracks.

Let's see how two audio samples might be edited together. Figure 12 illustrates how audio samples, called files, might be stored on a hard disk. The files might be as short as a single sound, word or effect, or as long as a section of dialogue.

The intent is to edit the end of file A to the beginning of file B. An edit list (sequence of instructions) is produced by first locating the begin and end points of each file. This sequence of instructions forms the basis for the action to be taken by the editing system.

The disk controller first will locate file A and place it in memory. As the edit point approaches, the controller also places blocks of file B into memory. The

MORE THAN CABINETS, WE OFFER SOLUTIONS.

Everything in consoles and racks for the video professional.

We've been designing and building high quality video consoles and racks for over 35 years. So we know the ropes. This experience can save you considerable time and money.

Preassembled, modular units make it easy.

You can choose from hundreds of video consoles, cabinets, racks, desks, EMI/RFI enclosures, and accessories in a wide range of hi-tech colors and styles.

Our consoles and racks are modular for future expansion and everything is preassembled for quick, easy set up.



Modular design provides flexibility.

Free design assistance.

If you like, our team of professional designers can help you design your own custom system.

They'll work with you so you'll get maximum aesthetics, ergonomics, efficiency, durability, and economy.

Quality you can count on.

When you choose Stantron video consoles and racks you're choosing the highest quality.

Our years of experience assures you the very best solution whether it's simply a VTR/VCR rack or an entire room of custom consoles.



A full range of power panels and strips.

Get all the facts.

Fill out the coupon or Reader Reply Card. Or, just give us a call. We'll rush you our new Preplanner and Video Catalog.



Professional design assistance.



Direct your inquires to:

Stantron

Marketing Manager
6900-6918 Beck Ave.
No. Hollywood, CA 91605
Phone: (818) 841-1825 Fax: (818) 841-8892

Console and Rack Preplanner and Video Catalog!

Please rush me your Preplanner and Catalog.

Name _____
Title _____
Company _____
Address _____
City _____ State _____ Zip _____
Phone _____

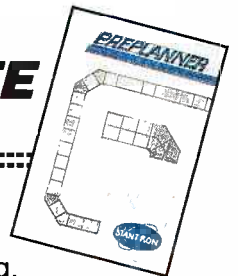

FREE

What's in the Winchester name?

The term "Winchester" has been applied to hard disk drives since their early development, but it's not clear where the name originated.

Two competing explanations cite IBM's use of the term as an interim code name for its model 3340 direct-access storage device, or DASD, introduced in 1973. One theory says the name was based on the device's original "30-30" design, which relied on two 30Mbyte hard disk modules. According to this theory, the drive was named after the famous Winchester 30-30 rifle. The second theory points to IBM's development laboratory located in Winchester, England. This location was responsible for much of the company's research in to hard disk storage devices.

A more American theory also is based on geography. Many of the early third-party hard disk manufacturers were located in Silicon Valley. The manufacturers were located on a street named — you guessed it — Winchester Road.

Perhaps the most plausible answer comes from Ken Haughton, dean of engineering at Santa Clara University, Santa Clara, CA. Haughton named the IBM prototype that later became the model 3340. He indicated that his inspiration was his own Winchester 30-30 rifle.

The term now is applied to any hard disk drive, no matter what size or manufacturer.

combination of fast access times and the buffers permit the drive to perform such seemingly simultaneous tasks. Before the edit point, only file A will output to the audio-processing circuits.

As the edit point approaches, samples of both A and B files are accessed and fed to the audio-processing circuits to create a crossfade. The crossfade becomes the edit. The operator can determine how rapidly the crossfade is performed. Once the desired edit is achieved, the system can record the final result. Until this point, the edit has not been stored, nor has the original data been modified. For a further explanation of how gain is controlled in the digital domain, see the related article, "Digital Effects."

Purchasing considerations

It's probably safe to say that if you've seen a skillful operator using a digital editing system, you want one too. The

results produced on even a medium-priced system seem almost magic. However, before you try to convince the station manager that your station needs a digital workstation, give the matter careful thought.

First, be sure you understand thoroughly what to expect from the editing system. Your application should determine the desired features. For instance, will you need to sync audio to video? Is control over other devices or SMPTE time code important? Are selectable sampling rates important? How many output channels are needed? What types of I/O are required, analog or digital?

Second, consider carefully the human interface or work surface. Some editing systems rely on computerlike or piano-type keyboards. Other systems offer hybrid interfaces consisting of faders, scrub knobs and keyboards. Some workstations rely on touch-screen or graphic-tablet designs. This portion of the system is perhaps more critical to the creative effort than any of the digital processing. Be sure that the operator interface you select is compatible with the abilities and desires of your staff. Don't overlook the comfort factor. Your operators will be spending a lot of time with the system. It's crucial that the operators find the work surface comfortable.

Long-term considerations also are important. Will the hardware selected today be compatible with tomorrow's options? Can portions of a system be upgraded, or will the entire system need to be replaced? Will future software enhancements work on your current system?

Finally, don't overbuy in the beginning. It's unwise to purchase more system than you really need. Instead, buy expandability. It makes economic sense to wait until technology reduces upgrade costs, especially with systems requiring large amounts of RAM storage. The price of the ICs used in RAM has risen dramatically over the past year. Only now are prices beginning to drop. It may be in your best interest to hold off purchasing large amounts of RAM until prices fall.

The digital advantage

Today's engineer is faced with implementing digital technology in many areas. For the past several years, that technology has been directed toward equipment control and business applications. Now the computer age has reached the audio-production area. Although early claims of all-digital on-air playback have not yet been realized, that day may not be too far off.

A few years ago, the advent of digital TV production techniques resulted in a visual battle among stations. It seemed that every station was trying to outdo the

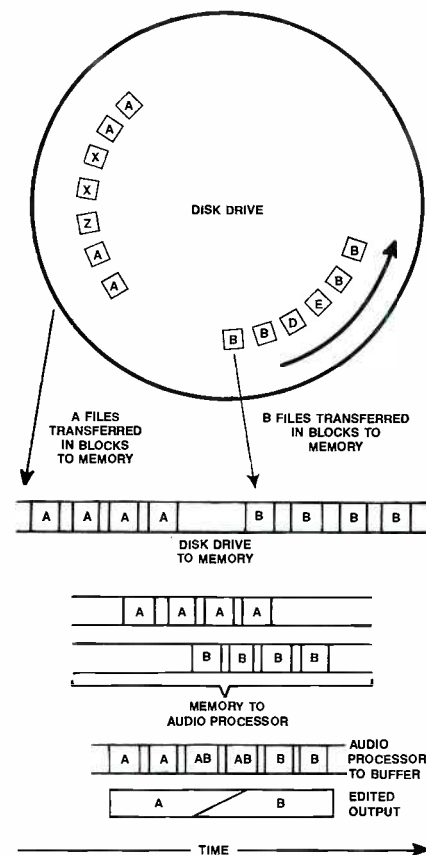

Figure 12. Editing audio samples together. The audio data is stored as files spread throughout the disk. Blocks from files A and B are brought into RAM sequentially. The audio processor, under control of the system software, accesses both files and performs a crossfade between them.

next by using more flying screens and fancy graphics than the next station. It became almost impossible to watch a local commercial or newscast without being overwhelmed with examples of digital production effects.

Could a similar practice develop with audio? Will stations flood the airwaves with examples of digital looping, synthesized sounds and fancy editing just to exhibit their new-technology device? Perhaps not. The stations that use the new technology effectively will be the ones to reap the benefits.

Bibliography

Watkinson, John. "The Art of Digital Audio." Focal Press, London and Boston.

Voelcker, John. "Winchester Disks Reach for a Gigabyte." *IEEE Spectrum*, February 1987.

Editor's note: Special thanks to Rod Revilock, Lexicon, for his assistance with this article. Thanks also to Bruce Cope, Asaca/Shibasoku; Nigel Branwell, Calrec by AMS; Lee Bartolomei, Digital Audio Research; Hugh Heinsdoh, Gentner Electronics; and Ted Pine, New England Digital.

[:~(=))]]



At the top of the charts

digital audio tape, we refined it. The result is Ampex 467, a tape that sets the highest standards for all digital audio applications. And it's available in all open reel and cassette formats, including the 80-minute cassette length.

More top performers record their hits on Ampex tape than any other tape in the world. While opinion may vary on what it takes to make a hit, there's no argument on what it takes to master one.

Ampex hits the top of the charts with Ampex 467 digital mastering tape.

We not only pioneered

AMPEX

Ampex Corporation, Magnetic Tape Division,
401 Broadway, Redwood City, CA 94063, 415/367-3809.

Circle (52) on Reply Card



MIDI: What's in it for broadcasters

By Richard Maddox

A new interface standard opens the door to inexpensive digital production techniques.

It doesn't take a degree in electrical engineering to interface today's digital audio production equipment. Thanks to a relatively new standard called MIDI (musical instrument digital interface), it's now easy to add sophisticated and versatile control functions to your production studio.

Musical interface

The original MIDI specifications were aimed at developing a standard method of interfacing digital synthesizers and musical instruments. The intent was to come up with a common interface similar to the RS-232 used for computers. A key requirement was that the interface be inexpensive and flexible. Manufacturers recognized the importance of such a standard in extending a product's useful sales life.

Similar to RS-232 protocol, the MIDI standard uses a current loop to send logic highs and lows between equipment. A MIDI logic low is represented by a 5mA current at 5Vdc. A logic high is represented by no current flow. A MIDI input (IN) circuit converts the current loop into stan-

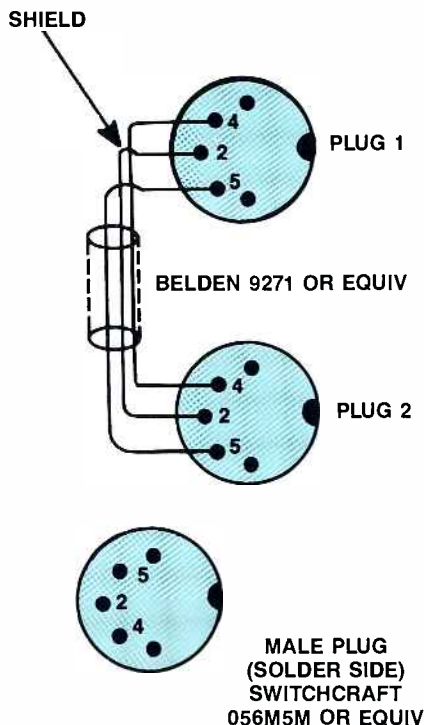

Figure 1. A MIDI cable uses a twisted-pair cable, terminated in a 5-pin DIN connector. Note that the cable shield is tied only to pin No. 2. There is no connection to the connector case.

dard TTL/CMOS logic levels. The MIDI output circuit (OUT) reverses the process, switching the current on and off in response to TTL/CMOS level commands. The rate at which data is transferred in MIDI is 31,250b/s $\pm 1\%$. Because the system uses asynchronous communication, each byte contains 10 bits (eight data and two start/stop).

MIDI hardware

A standard 5-pin DIN connector and shielded-pair cable is used for all MIDI connections. The MIDI standard specifies three types of ports: *MIDI IN*, *MIDI OUT* and *MIDI THRU*. Each port is labeled next to the connector. Almost any type of low-capacitance, low-loss cable can be used to interconnect equipment.

Connector wiring for MIDI plugs is shown in Figure 1. The center pin (No. 2) is connected to the cable shield. This pin is grounded to the chassis only on the MIDI OUT connections. Pin No. 2 on the MIDI IN is floating from the chassis. This provides ground-loop isolation, which is a major MIDI feature. Pins No. 4 and 5 carry the current loop signal. Pins No. 1 and 3 are unused under the MIDI specification. (Note that the Atari ST computer uses pins No. 1 and 3 as a MIDI THRU output, which requires the use of

Maddox is an audio engineer for Muzak, Seattle.

a Y-cord adapter.) Unlike the XLR connection method, all cables use male plugs, and chassis connectors are sockets.

Typical MIDI IN, OUT and THRU circuits are shown in Figure 2. Pins No. 4 and 5 carry the current loop signal among devices. An optical isolator is used on input circuits to translate the MIDI current into TTL/CMOS receive levels. The MIDI OUT circuitry converts the TTL/CMOS logic highs and lows into the proper levels to drive the current loop. MIDI THRU is simply a MIDI OUT circuit that is connected to the output of the MIDI IN optocoupler.

MIDI software

The MIDI software specifications are not as tightly defined as the hardware specifications. This allows manufacturers to add features as new products develop. (Any additions to the software specifications must be approved by an international pair of governing bodies.) The open-architecture approach to software encourages manufacturers to adopt and support the MIDI interface standard without fear of obsolescence.

The serial datastream is sent to all devices connected in the MIDI chain. Much like a computer bus, all devices connected receive all the data. This means that each device must be addressable if the system is to perform properly.

The data signal consists of three parts: *channel messages*, *system messages* and *timing signals*. The datastream is further divided into information packets representing up to 16 separate channels. Data that is specifically directed to one of these 16 channels is preceded by a channel message. The desired channel is awakened to receive and process the data that follows. Typically, a channel message contains both voice and mode data.

Combined with the channel data are system messages. A system common message is received by every component in the chain. The message generally contains status information such as tune request, song select or song position. *System exclusive* (SysEx) messages are generated specifically for use by one device. These messages typically contain specific patch parameter setup information or sample retrieval information.

Timing messages often are referred to as system messages because they fall under the *system real time* classification. These messages contain timing data to be used by sequencers, drum machines and SMPTE-to-MIDI converters to control sound-generating components.

MIDI time code

Only two time provisions originally were designed into the MIDI specification: timing clock pulses (clock) and a song posi-

tion pointer (SPP). The lack of a frame-based clock timing reference proved to be a drawback for broadcast and video post-production applications. Since the early MIDI specifications were developed, software and hardware enhancements have eased the MIDI-to-tape machine interface problem.

The MIDI clock is a time reference — a single-byte word that occurs every 1/24th of a quarter note. The clock was

designed to designate tempo. The SPP is a 3-byte word containing a status byte and two databytes. It's used to identify location within a song (or sequence). Note that neither reference is based on a real-time clock, but rather on the tempo.

Because SMPTE time code is the common method of synchronizing tape machines, it wasn't long before SMPTE-to-MIDI converters began to appear. First-generation converters took the SMPTE

CTE-DP DETAIL PROCESSOR OPTION FOR THE FAROUDJA ENCODER

This option for the Faroudja CTE-2 encoder improves the visibility of small details without excessive enhancement of large outlines.

This device makes use of luminance and chrominance information to correct the lack of resolution due to source softness, especially for saturated colors.

No more blurry reds

The effect resulting from the use of the Detail Processor, combined with the well-known Faroudja comb-filter encoding process is striking. The NTSC image at the output of the CTE-2 is free of cross-color, cross-luminance, noise and grain. The use of the CTE-2 with the DP option delivers a crystal clear, "film-like" image, eliminating all softness and artifacts without introducing unnatural edge effects.

The CTE-2 equipped with the Detail Processor Option is the answer to problems of signal source softness.

Simply the best NTSC.

FAROUDJA LABORATORIES

Faroudja Laboratories Inc.
946 Benicia Avenue
Sunnyvale, California 94086
Telephone 408/245-1492
Telex 278559 MUHA UR
Fax 408/245-3363

Circle (58) on Reply Card

FREE.

TV CAMERA CABLE AND CONNECTORS INFORMATION KIT



Your
one-stop source for
broadcast-quality
camera cable

- Ultra-Flex VTR Cable Assemblies for Sony, Ikegami, Hitachi, & Others
- Slimline studio camera cables
- Waterproof, three-piece high strength connector design
- Customized lengths
- Chassis Mounts
- Quick response to all assembly orders
- Quick repair turn around

Call or write today for your free order kit.

MOHAWK

WIRE & CABLE CORPORATION

9 Mohawk Drive
Leominster, MA 01453
1-800-422-9961
In Massachusetts, 1-800-642-9961

Circle (60) on Reply Card

AEC-1 10x1 V+2A Routing Switcher



Features

- Broadcast Quality
- XPT Memory
- DC Restoration
- Line 10 Switching
- 30 Year MTBF

Options

- 3 Audio Channels
- Serial Interface
- Remote Control
- RGB/Component
- Custom Work

Why pay 30-50% more?

1-800-782-2321

Adrienne Electronics Corporation
11994 MARJON DRIVE, NEVADA CITY, CA 95959
Come see us at NAB!

Circle (61) on Reply Card

A MIDI glossary

Auto-correct: A sequencer function to improve rhythmic accuracy and correct playing or timing errors. Similar to auto-correlation used with tape machines.

Drum machine: A dedicated rhythmic sound generator usually used to emulate drums or percussion instruments.

Edit: To go back through a MIDI file and change parameter. Usually accomplished with a computer and editing software.

MIDI: Musical instrument digital interface. An international specification for interfacing sound-production equipment.

MIDI channel: One of 16 possible addresses used by MIDI components. Allows individual or multiple addressing of components through selected channels.

MIDI clock: A timing signal that uses 24 pulses per quarter note. Used to synchronize the various MIDI components for music performance.

Monophonic: A single-voice instrument (such as a flute or trumpet), or a synthesizer that can play only one note at a time.

Multitimbral: A synthesizer or musical instrument that can produce more than one sound or tone at the same time.

Note on: The simplest MIDI message. Can be used to turn on an oscillator in a synthesizer or start up a playback sequence in a CD or other effects device. It is preceded by a channel message to identify the channel, or a SysEx message for a specific device.

Polyphonic: An instrument (piano, organ, guitar, synthesizer) that can produce multiple voices (notes) with the

same tone at the same time.

Preset: A preprogrammed sound, parameter or timbre.

Sampling: Recording sounds using digital storage. The recorded sound can be played back as is, modified or used as a voice for a keyboard.

Sequencer: A hardware device that records and plays back timing and control information for MIDI devices. Some sequencers are software-based, storing their information on floppy or hard disk.

Step-time: Entering information one segment or step at a time as opposed to entering it in real time. Most often used during editing.

Sync: Internal clock pulses related to the tempo of the music. MIDI uses two types of sync and time code, which is linked to the SMPTE code on a video or audio track. Time code is independent of tempo.

Synthesizer: A musical instrument that uses analog or digital sound generators and modifiers to create common or unique timbres. It is most often in the form of a keyboard controller, but rack-mounted units are available.

SysEx: Short form of system exclusive message, a MIDI word that designates that the information that follows is sent for one specific device only.

VCA: Voltage-controlled amplifier, used to automate volume control in audio mixing boards. Many boards can be modified to accept MIDI VCA control signals.

Voicing program: A software program that allows editing of the parameter of a MIDI device.

||:~(=)))||



No jamming in Inner Mongolia.

Cassette jamming is one of the biggest problems production crews face. Unless they're shooting with Sony Videocassettes. No wonder the producers of a recent documentary shot in Inner Mongolia chose to tape with Sony BCT Series Betacam® cassettes.

The Sony cassettes didn't jam during the entire three weeks of taping, even when covering the nomadic people of Mongolia's grasslands, where temperatures vary from extremely hot to extremely cold.

Not that this surprises those of us at Sony Professional Videotape. After all, we've designed all our products around one basic premise: durability. To be frank, the demanding shooting conditions of Mongolia aren't as tough on our tape as we are.



BCT Betacam cassettes, for instance, combine a high-impact ABS anti-static cassette shell with a base film that's been given Sony's ultrafine carbon-black back coating. All of which ensures more uniform tape transport and superior winding characteristics. Among other things, this kind of runability helps keep Mongolians out of a jam.

No matter which Sony Professional Videotape you're working with, there's one thing you know for sure. Its greatest ability is durability.

Whether it's Betacam, U-matic®, 1" or Digital tape. So take on the world. With Sony Videotape. In Inner Mongolia or in your own studio you need a tape that's tough as Sony. After all, there's no better way to prevent unwanted jam sessions.

SONY
THE ONE AND ONLY.



SONY

Introducing the smallest, lightest broadcast Betacam® camcorder in the world.

The BVW-200 weighs only 15 pounds, including lens, cassette, viewfinder, and lightweight

battery. So you can hold any shot better and longer. Plus, it records for an entire hour on a single NP-1A battery.

But state-of-the-art features are what make the BVW-200

extraordinary by any standard. Betacam SP® format. Advanced CCD technology for higher sensitivity, resolution of 550 lines, and a superior S/N ratio. There's even viewfinder playback.



RAISES TV JOURNALISM TO NEW HEIGHTS.

And all of this fits into a 15-inch length. And a low profile for unobstructed peripheral view. The BVW-200. More compact and maneuverable than any other camcorder before it.

Suddenly, the impossible shot is yours. To find out how the

SONY®

BVW-200 can help your work reach new heights, see your Sony Broadcast Sales Engineer. Or call: (800) 635-SONY.

Sony Communications Products Company, 1600 Queen Anne Road, Teaneck, NJ 07666. © 1989 Sony Corporation of America. Sony, Betacam and Betacam SP are trademarks of Sony.

BROADCAST PRODUCTS

www.americanradiohistory.com

Technical education for broadcast engineers

By F. David Harris, P.E.

Becoming a broadcast engineer requires self-study.

Today's successful broadcast engineer must have a combination of technical, communication and interpersonal skills. It's also important that the engineer be able to continually assimilate new technical knowledge. Obtaining the training to become a broadcast engineer is often difficult. The key to beginning a career in the broadcast engineering field is a good basic education in electronics.

Training programs

Electrical/electronic engineering technology (EET) programs are offered at many colleges and universities. Community and junior colleges offer 2-year programs that lead to an Associate in Applied Science (AAS) degree.

The EET programs at senior colleges and universities are structured in various ways. The most common program arrangement is known as the *two-plus-two* curriculum. This type of program awards an AAS degree after two years of study. A bachelor's degree is awarded after an additional two years of study.

A somewhat less common arrangement is the *integrated 4-year program* that has no exit point after the first two years of study. The integrated programs limit exposure to electronics material until the third and fourth years.

A few universities offer a *plus-two* program. This type of program contains the last two years of a two-plus-two program. The plus-two program is most often found in areas that have several junior colleges offering the AAS degree. Through *articulation agreements* between the area's 2-year feeder colleges and the plus-two institutions, a 4-year education is possible.

This allows the student to attend a local college for two years. Only the last two years require attendance at a university, which may be located some distance away. Through such a plan, a student can reduce the total education expense by living at home during the first two years.

Four-year EET programs require approximately the same amount of core courses as do electrical/electronic engineering (EE) programs. Core curriculums include English and other liberal arts subjects, written and oral communication skills and computer-language classes. The EET programs rely less on mathematics and science courses, but they do require more electronics classes. Virtually all the elec-

tronics courses emphasize laboratory work. An EET curriculum stresses the use of engineering techniques. Electrical engineering curriculums stress the development of these engineering techniques.

Post-secondary vocational programs in electronics exist, and a certificate usually is granted when the program is successfully completed. These non-academic programs seldom emphasize either mathematics or science. They concentrate the student's efforts on electronics training and laboratory experience.

Different emphasis

An electronic engineering curriculum

MATHEMATICS (algebra, trig and calculus).....	12 credits
PHYSICS.....	4 credits
FUNDAMENTALS OF ELECTRICITY AND ELECTRONICS (digital and analog).....	16 credits
ADVANCED ELECTRONICS (digital and analog).....	8 credits
SPECIALIZED ELECTRONIC COURSES.....	12 credits
COMPUTER PROGRAMMING.....	3 credits
DRAFTING.....	3 credits
ENGLISH, SOCIAL STUDIES, ORAL AND WRITTEN COMMUNICATION SKILLS.....	9 credits
TOTAL.....	67 credits

Table 1. A typical 2-year ABET-accredited electrical or electronics engineering technology program might require these courses.

Harris is a professor of electrical engineering technology at Purdue University Calumet, Hammond, IN.

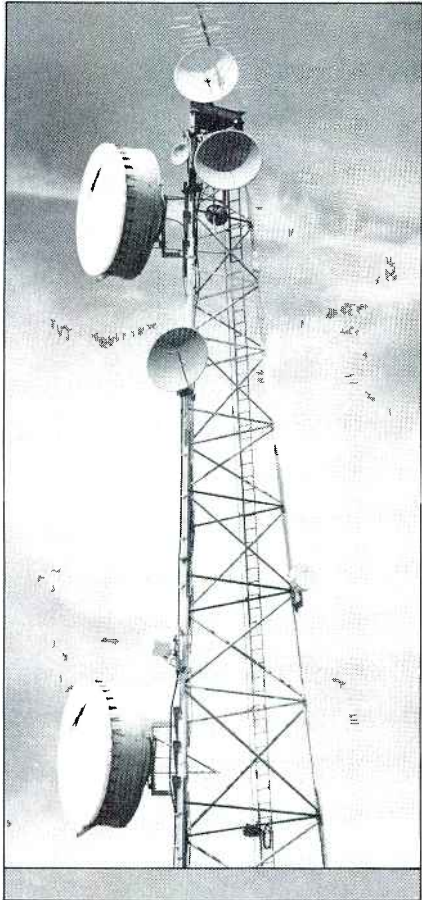

KOVR TV SACRAMENTO, CALIFORNIA

Digital Audio For Your STL . . .

At last . . . a reasonably priced broadcast-quality system to upgrade the audio on your STL path.

VAMP is a system designed to allow the carriage of digital audio, data, or a combination of both, on a wideband subcarrier placed above video in a transmission path.

VAMP is ideal for applications like video or audio STLs, relays and other point-to-point transmission links, as well as satellite distribution of programming. There are numerous audio and data coding techniques available for use with VAMP.

V A M P™

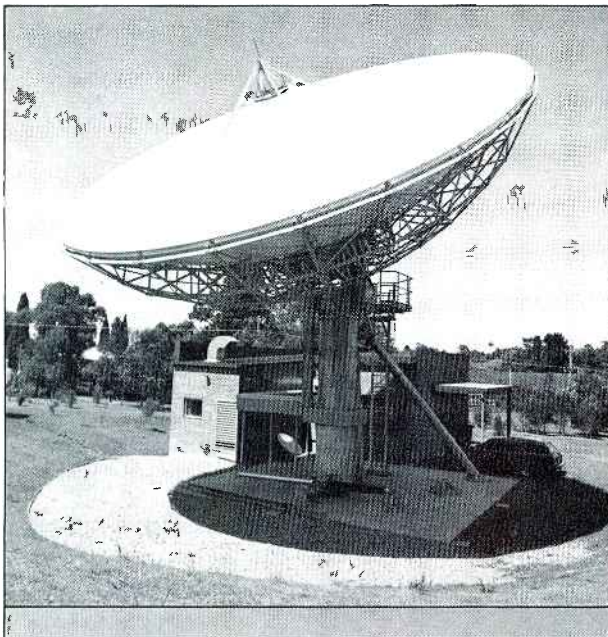

CHANNEL 7 SYDNEY, AUSTRALIA

VAMP equipment costs roughly the same, or less, than conventional subcarrier systems and delivers network-quality performance. It is compatible with many different types of equipment and can easily be integrated into existing transmission systems.

Call for more information about VAMP, or other products from Graham-Patten Systems.

Circle (62) on Reply Card



GRAHAM-PATTEN SYSTEMS, INC.

P.O. BOX 1960, GRASS VALLEY, CA 95945

(916) 273-8412 - FAX (916) 273-7458 - INSIDE CA: (800) 422-6662 - OUTSIDE CA: (800) 547-2489 - TWX 910-333-6065

emphasizes theoretical and analytical studies. Laboratory experience is less important to the student's success. The laboratory instruction stresses the development of skills in scientific methodology rather than hands-on circuit analysis.

In an engineering technology curriculum, the laboratory work is equally important to the theoretical and analytical experiences. These programs develop skills in the use of laboratory and industrial instrumentation. The student is encouraged to practice the design and diagnostic techniques learned in the classroom.

In a vocational curriculum, the hands-on laboratory experience is emphasized. The training is aimed at developing skill in the use of test instruments in troubleshooting and repairing electronic equipment.

Accreditation of programs

ABET (Accreditation Board for Engineering and Technology) is responsible for accrediting EET programs. The board ensures that minimum standards

***The number of jobs
for electronics
technicians is expected
to grow by 50% in the
next decade.***

are met in several areas, such as courses offered, faculty qualifications, instructional quality and institutional support. Programs meeting ABET's standards are required to offer a certain number of credit hours in mathematics, physics, English composition, humanities and oral and written communication courses. In addition, these programs must have appropriate and up-to-date electronics specialty courses. (See Table 1.) These schools are inspected periodically to help ensure that high standards are maintained.

Growth industry

The future for electronics technicians

looks quite good. Some of the fastest-growing areas are office and factory automation, telecommunication systems, microprocessor-based control systems in motor vehicles, industrial instrumentation and consumer products. The number of jobs for electronics technicians is expected to grow by 50% (from 400,000 to 600,000) in the next decade.

A different situation exists in the broadcast industry. Several factors have combined to reduce the need for more broadcast engineers. Deregulation, remote control, program automation and the increased use of contract maintenance will continue to limit job growth. Over the next 10 years, the number of broadcast engineering jobs will grow by approximately 20%, to 33,000.

Each year, 6,000 2-year EET graduates emerge. This may result in only 60,000 graduates to fill the 200,000 jobs that will be created during that 10-year period. The jobs having a larger manual or repair component will be filled with men and women from trade school or vocational high school backgrounds.

From this perspective, it is easy to see



ENCODERS

ACCURATE, RUGGED, RELIABLE, ECONOMICAL



EN 300

- RGB to NTSC or PAL
- Internal or external subcarrier
- Ideal for computers, weather maps, etc.
- Sync-on-green, TTL input options



**EN 350
MULTI FORMAT**

- RGB to BETACAM, MII, YC, NTSC/PAL
- No external pulses required, genlocks to ext. video reference
- 4 µs H phase advance or delay

broadcast video systems ltd.

40 West Wilmot Street, Richmond Hill, Ontario L4B 1H8
 Telephone: (416) 764-1584 Telex: 06-964652 Fax: (416) 764-7438

Circle (100) on Reply Card



Let's Party!



We "Party" in
**Theaters, Concert Halls,
 Schools, Athletic Venues
 Convention Centers . . .**
where ever your application takes us.



**ROH's new 400 Series Party Line
 Intercom System provides clear,
 functional
 communication at an
 affordable price.**



ROH

913 W. 223rd Street
Torrance, CA 90502



Tel: (213) 533-1498
FAX: 213-533-6050

Circle (91) on Reply Card

**Reconfirm your involvement
in the
broadcast industry!
Renew your subscription
today.**

AKG's 568EB. Stand Back.

AKG's C568 short shotgun offers you real directivity in a remarkably small and convenient condenser microphone. Only 10" long, the C568's sensitivity, wide frequency response, durable metal housing, and integrated impedance converter/preamp easily meet the demands of live on-air or recording applications. A perfect balance of pressure gradient and interference principles means the C568 can be up to three times as far from a sound source than normal mics and still yield the same ratio of direct to indirect sound. Used close, it reduces indirect sound levels by 8 dB for improved isolation. So whether it's for ENG, film, theatre or church sound reinforcement, or music applications, AKG's C568 means business. And at half the price of the competition. Just stand back and take a listen.



Focusing on new technology.
77 Selleck St. Stamford, CT 06902
(203) 348-2121

© AKG 1988 *Akustische und Kino-Geräte GmbH, Austria

why few 2-year EET programs emphasize broadcast engineering. Educators recognize the importance of providing training of a more general nature. Students who are well-trained in the area of fundamental electrical concepts can apply their skills in a wide range of applications. Such an approach better prepares the student for changing job and market demands.

Don't criticize the schools for this training philosophy. The electronics industry also has endorsed this approach through joint industry-academy councils and program-advisory boards. Support for this approach is evident in other ways too, such as hiring practices, cooperative education programs, internships and formal, on-the-job training programs for new graduates.

Specialized electronics courses

Today's accredited electronics programs don't include highly specialized electronics courses because there simply isn't time. To best prepare graduates for the work place, the programs must be general in nature. Example courses might emphasize microprocessor technology, power and machinery, instrumentation, process con-

Over the next 10 years, the number of broadcast engineering jobs will grow by approximately 20%.

trol and electronic communications.

Associate-degree electronic communications programs emphasize the design and analysis of basic electronic circuits. AM and FM modulation schemes and basic television usually are covered. An introduction to transmission lines, antennas and propagation also may be included.

Some curriculums offer advanced courses in microwaves, digital communications, antennas and propagation. Such courses are offered only in the last two years of a program. It is rare that broadcast engineering topics are covered thoroughly. Today's job market dictates a more general approach to telecommunications subjects.

Industry training

The proliferation of new electronic technology places changing demands on technical personnel. As the circuits

become more complex, more highly skilled troubleshooting is required. This means that experienced staff members should be offered opportunities to upgrade their skills. The evidence shows that the broadcast industry is well-served by those who maintain their skills.

A recent survey of experienced broadcast engineers, conducted by the author, revealed several important factors. Broadcast engineers read several trade journals and use the material to improve their job skills. Engineers also benefit from the technical presentations at various meetings and conventions. The survey respondents said they would take technical courses to upgrade their skills if such courses were available locally.

Of those who responded, 75% mentioned that specific technical courses are needed by practicing broadcast engineers. The topics they suggested are listed by priority, based on the number of times they were mentioned:

1. Digital electronics
2. Microprocessor fundamentals
3. RF fundamentals
4. Antennas and transmission lines
Basic electronics and broadcast applications
5. Audio
6. Recording techniques
Satellite technology
Computer usage
Mathematics

The challenge

A look at the five certification study guides published by the Society of Broadcast Engineers (SBE) confirms what has been discussed previously. The number of general electronics questions (not specifically related to a broadcast engineering topic) is low. Less than 10% of the questions deal with digital topics.

The remainder of the questions are directed at specific broadcast engineering applications. Even an extremely competent electronic technician would be unlikely to answer them correctly without some practical broadcast experience.

The challenge facing the industry and its professional organizations is how to provide applicable course material. The key is training programs that address the needs of the practicing broadcast engineer.

Short, intensive seminars, commonly offered at conventions and conferences, are quite useful. So, too, are the interactions with equipment suppliers and manufacturers on exhibit floors. Even so, these are only part of the answer.

On-the-job experience is crucial to developing competence in any specialized

area of electronics. This means that broadcast organizations need to provide internships and cooperative education opportunities to electronics students who show an interest in broadcasting. On the other hand, because the number of persons entering the industry is relatively small, providing additional training to current broadcast engineers probably would have a more positive impact.

The Electronic Industries Association (EIA) provides training material for those working with consumer electronics equipment. The SBE should at least explore the

Each year, 6,000 2-year EET graduates emerge. This may result in only 60,000 graduates to fill the 200,000 jobs that will be created during that 10-year period.

possibility of developing broadcast-related course materials. These materials could address the need for individual self-study courses as well as the need for local chapter study groups.

Some of the skills broadcast engineers need can be developed almost anywhere. Computer literacy, analog, digital and microprocessor fundamentals and mathematics skills can be learned in a variety of ways. Broadcast engineers always have been willing to train themselves. The popularity of the "NAB Engineering Handbook" and the (now out-of-print) series of books by Harold E. Ennes attest to the tradition of self-study.

The issue for the broadcast industry is not whether there is a need for further education. Rather, it is finding a source for the necessary training materials.

Bibliography

Accreditation Board for Engineering and Technology, 345 East 47th St., New York, NY 10017-2397.

Selvestra, G. T., and J. M. Lukasiewicz. "A Look at Occupational Employment Trends to the Year 2000." *Monthly Labor Review*, September 1987, Vol. 110 (No. 9), pp. 46-63.

Ellis, Richard A. "Engineering and Engineering Technology Degrees, 1987." *Engineering Education*, May 1988, Vol. 78 (No. 8), pp. 783-792.



TO FIND OUT WHY SONY'S STILL IMAGE SYSTEM CAN WORK FOR YOU, CHECK OUT ITS JOB APPLICATION.



Anyway you look at it, the ProMavica™ Still Image System from Sony can add color, excitement and economy to your visual communication needs.

In an instant, the Sony ProMavica System lets you capture and store full color still images from nearly any video source. Then present, transmit or even print your image of choice.

The Sony ProMavica Still Image System makes it easy. And each component provides the quality and reliability you expect from Sony, the people who invented still image technology.

Capture Images Electronically In An Instant

A miniature 2-inch Mavipak™ disk can capture images from video cameras, VTR's, computer graphic systems or any



device with standard video output. You can even use the innovative ProMavica Still Image Camera to take still pictures electronically of people, products, scenery or events.

Show and Tell Anytime, Anyplace

You can store up to 50 images, with audio, too, on the Mavipak disk for convenient retrieval anytime, anyplace. All you need is the ProMavica Player/Recorder and a monitor. There's even a sturdy portable unit that lets you take your show on the road.

Transmit Color Throughout Your World

What's more, the full color images you see in your office can be sent anywhere in the world over standard telephone lines. In just minutes, the ProMavica Transceiver can deliver high

quality visuals for immediate review, approval, editing, presentation and more.

It's Not a Photograph, It's a Mavigraph Print

For the highest possible color hard copy prints from any still image or video source, look

to the ProMavica Color Video



Printer. Continuous tone Mavigraph® prints are yours in as little as 65 seconds. With vivid color and exceptional clarity for previewing, identifying, publishing or just as a keep-sake. You can even produce full color transparencies for use with overhead projectors.



So for whatever job application, the complete Sony ProMavica Still Image System or any individual component can work for you. To find out more, call 1-800-222-0878 and ask how we can help improve your image.

SONY
STILL IMAGE SYSTEMS

© 1988 Sony Corporation of America. Sony, ProMavica, Mavipak and Mavigraph are trademarks of Sony. Eagle image courtesy of Truevision, Inc.

Circle (54) on Reply Card

www.americanradiohistory.com

Annual convention is in the works

By Bob Van Buhler

Abstracts now are being accepted for proposed engineering papers for the 1989 **Broadcast Engineering** conference, which will be held in conjunction with the SBE National Convention in Kansas City, MO, Oct. 5-8. The technical conference, under the direction of John Battison, will address the practical needs of today's broadcast engineers and technical managers.

If you are interested in presenting a paper, submit an abstract outlining the topic and its importance to the industry. Abstracts should be received by March 31. If you would like to participate in a panel discussion or serve in another capacity, submit a letter to Battison indicating your desire and qualifications. Because of the project's magnitude, only written abstracts and letters of interest can be accepted.

SBE will again publish the conference "Proceedings." Copies will be available at the convention. Authors should be prepared to submit a camera-ready manuscript by June 30. Address all correspondence to: John Battison, Conference Chairman, 2684 State Route 60 RD #1, Loudonville, OH 44842.

Must-attend event

This year's conference will provide training in several new areas. Broadcast technology is changing rapidly. To be successful, today's broadcast engineer needs a wide variety of skills. One of the best places to obtain these skills is at the **BE** conference and SBE convention.

This convention also should prove to be fun. A special effort is being made to plan social activities around the serious business of the convention. If you've found other broadcast conventions to be all work and no play, don't miss this one.

Bob Flanders retires

Bob Flanders, SBE past president and chairman of the admissions committee, is retiring from his position as vice president and director of engineering at Channel 6, WRTV-TV, in Indianapolis. Flanders, who has served as chairman of the admissions



Are you an SBE member?

If not, join the ranks of more than 5,000 broadcast engineering professionals working to improve the industry and their skills. Call today for more information.

SBE National Office
P. O. Box 20450
Indianapolis, IN 46220
317-842-0836

committee since 1975, also will retire from his SBE duties.

He served two terms as SBE president, 1971-1972, and two as vice president, 1969-1970. The society owes him a debt of gratitude for his many years of faithful service and wise counsel. President Jack McKain, the other officers, the board of directors and all SBE members send best wishes and congratulations to Bob as he retires from broadcasting. Flanders will be succeeded at WRTV-TV and on the admissions committee by Dick Pratt.

Certification and AFRN

The Ennes Foundation is developing a cooperative agreement with the Armed Forces Radio Network. Under the arrangement, the skill-training programs of the Armed Forces Radio Network will coincide with SBE certification requirements.

Initially, graduates of Armed Forces Radio and Television Service (AFRTS) entry-level training, conducted at Lowery Air Force Base in Colorado, will receive their certification as SBE broadcast technologists.

A goal is to certify higher skill levels at the corresponding SBE standard certification level. This is not a grandfathering program, but one involving the same requirements any member would face for certification. The certification committee is investigating the compatibility of the training and experience at higher skill levels with SBE requirements. Military on-the-job-training programs incorporate a well-balanced mix of academic training, practical experience and supervisory re-

quirements. These factors help make military-trained individuals prime candidates for future positions as broadcast engineers.

Uplink training program

On Jan. 11, the SBE and NAB announced the establishment of a new broadcast technical seminar to train satellite uplink operators. The announcement was made at the society's winter media luncheon in Washington, DC.

According to Michael Rau, NAB vice president of science and technology, a survey of broadcasters in the top 50 markets indicated a need for such a training program. Most thought it was important for their personnel to be adequately trained on the use of uplink equipment. Most of the stations surveyed planned to send their uplink operators to the seminar.

The training will be geared specifically to the skills needed by the mobile uplink operator. Instruction will be provided on all skills that SNV and other uplink operators should have.

Successful completion of the satellite uplink seminar should prove to be an important credential for uplink engineers and operators. It also may enhance their employability and earnings potential. The society will develop a special class of certification for this new area. Those who complete the course will receive SBE certification.

Additional information on topics and scheduling will be provided soon by the SBE and the NAB. The classes will be held in Washington in March.

President Jack McKain hailed this as an example of the cooperative relationship that SBE has developed with NAB's department of science and technology. He noted the joint training program was possible because it served the needs of both the engineers in the field and management.

Van Buhler is chief engineer for WBAL-AM and WIYY-FM, Baltimore.

'SBE '89'

**October 5-8
Kansas City
Convention Center**

Kansas City—known for its jazz legends, beautiful fountains, great steaks and Harry Truman. And, this year, host to the 1989 SBE National Convention and **Broadcast Engineering** Conference.

The broadcast industry is changing rapidly. To stay ahead today, you need to know where technology is heading. This year, in cooperation with major manufacturers, special hands-on training sessions will be available. It's your chance to be trained by factory

engineers on the equipment your station uses. Other sessions allow you to learn the latest developments important to your job including satellite uplinking, HDTV, engineer licensing and new FCC regulations.

With technical sessions and exhibits specially designed to meet your needs, this is *your show* for '89.

So help us celebrate the silver anniversary of the SBE by attending the 1989 SBE National Convention and **Broadcast Engineering** Conference,

October 5-8. Take in the show, and while you're in Kansas City, take in the sights! ■



KANSAS CITY

Batteries for field applications

By Anton Wilson

A recent survey shows that when an ENG/EFP crew experiences an equipment malfunction, the problem often is the battery. Because of the high reliability level attained with modern video equipment, the batteries represent the weakest link in the portable video chain. Logic dictates that the selection of a battery system is as critical as the choice of a camera/recorder. This does not seem to be the practice, however, and the unfortunate result is numerous field problems traceable to improper selection and incorrect use of batteries.

How can battery problems be eliminated? One way is to analyze the most frequently reported types of battery problems and determine the causes for each. Properly applied, this information can help you create a battery system as reliable as the equipment it powers.

Wrong voltage

If equipment is designed to operate optimally from 13.2V or 14.4V NiCad batteries, what results can you expect when using 12V batteries? The end-of-discharge voltage (EODV) of a 12V battery is 10V, which is less than the minimum voltage requirement for the equipment. The results can be inconsistent performance, loss of capacity and complete failure during cold temperature or "memory" conditions. The survey showed that many people who experienced these problems were powering their cameras and camcorders with 12V batteries.

Would 13.2V or 14.4V versions eliminate the problem? The higher-voltage batteries have EODVs of 11V and 12V, which are above the minimum specification for equipment. They deliver 100% of available capacity under all conditions, and failures due to memory are eliminated for all practical purposes.

Insufficient capacity

A film camera draws significant current only when film is rolling. This translates to a direct relationship between battery capacity and the number of film magazines that can be exposed with a single battery. Video applications are quite



different, however, because a video camera operator can expend an entire battery before rolling a second of tape. There is no clear relationship between battery capacity and the number of cassettes being used.

As a result, battery change interruptions are perceived as being random and unpredictable. The frustration, inconvenience and expense of battery change interruptions can be reduced significantly by selection of a battery with sufficient capacity for the equipment to be powered. The experiences of several hundred video professionals suggest some capacity guidelines.

If you choose a battery that provides two or more hours of run time, you will perceive few, if any, battery change interruptions. A battery rated for at least 1.5 hours of operation will cause a minor, but tolerable, number of interruptions. A battery offering less than 1.5 hours of run time can impede the efficiency of the

operation with frequent and unpredictable interruptions. Batteries rated for less than one hour of continuous operation present an intolerable number of interruptions.

Battery pack construction

Some battery problems reflect characteristic pack designs. Excessive self-discharge, unbalanced batteries and shorted cells are common anomalies produced by mechanical stresses on the cells. Even minor bumps or drops can cause enough internal stress to pinch the thin plate separators, causing separator breakdown. A battery pack made of a group of cells in a shrink-wrap sleeve or plastic box is afforded little physical protection. Although better, a battery belt of soft vinyl or leather may prove insufficient to protect the cells inside.

Before purchasing a battery, consider its construction. High-impact cases, custom-molded to protect the cells inside, offer a higher level of physical security than

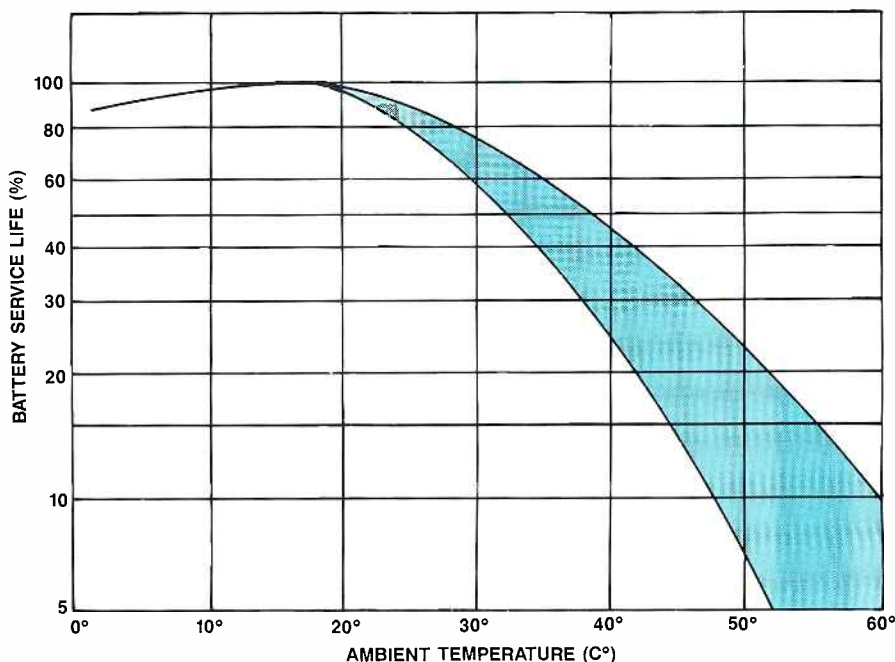

Figure 1. Constant slow charging can raise the internal temperature of a fully charged battery to 45°C to 55°C. At these temperatures, the battery will deliver only 10% to 20% of its normal service life. The battery is thus aging up to 10 times faster than normal.

Wilson is president of Anton/Bauer, Shelton, CT.

INTRODUCING

LOGIC SERIES

TM

MICROPROCESSOR BATTERY/CHARGER SYSTEM



A NEW GENERATION OF TECHNOLOGY

- LONGER LIFE—Logic Series technology can almost double battery life.
- GREATER CAPACITY—Up to 40% more battery runtime per charge.
- UNPRECEDENTED RELIABILITY—Logic Series will consistently deliver 100% of available capacity even under conditions where conventional batteries/chargers may fail.

WRITE FOR COMPLETE DETAILS ON THIS NEW ADVANCED, TECHNOLOGY SYSTEM

antonbauer

*The quality standard
of the video industry.*

Circle (64) on Reply Card

ANTON BAUER, INC. □ ONE CONTROLS DRIVE □ SHELTON, CT 06484 □ (203) 929-1100
www.americanradiohistory.com

Radiation Systems, Inc.

Mark Antennas Division

Antenna Manufacturers
Since 1949

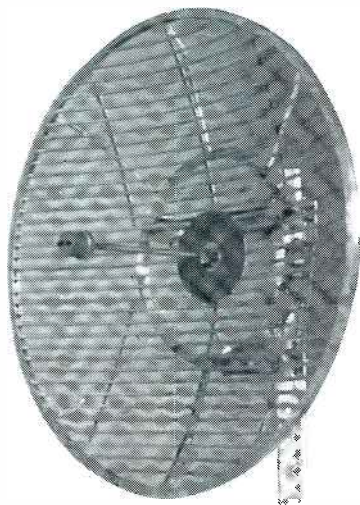

- **Grid Antennas**
- **Affordable**
- **Rugged Construction**
- **Superior Design**
- **High Quality**

2180 South Wolf Road
Des Plaines, Illinois 60018

Tele (312) 298-9420

Fax (312) 635-7946

Circle (65) on Reply Card

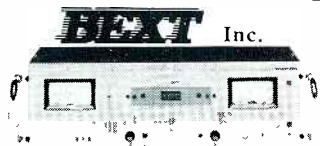

HIGH PERFORMANCE AT AFFORDABLE PRICES

- 1, 10, 20, 30 and 80 W exciters, translators, boosters
- 100, 250, 500 and 1000 W solid state amplifiers
- All front panel programmable broad band
- 800, 1000, 2000, 3000 and 5000 W tube amplifiers
- 2 and 20 W composite STL's
- 24 h. technical support on call

BEXT Inc. Tel (619) 239-8462
739 Fifth Ave. San Diego, CA 92101 U.S.A.
FAX (619) 239-8474 Telex 229882

Circle (66) on Reply Card

shrink-wrap or plain box-type batteries. The ruggedness of other physical components, such as the mounting system and strain relief on cables and connectors, suggests a design that will protect the cells from the normal abuse of ENG/EFP.

In spite of their design, batteries can be damaged through careless handling. Never put loose batteries in the trunk of a vehicle. The sliding impact forces that occur when the vehicle goes around corners are sufficient to cause damage.

Charging

The greatest single influence on battery performance and life is the charging method. An inappropriate charging regimen can cut the life expectancy of a battery to less than one-fifth of its full potential, causing inconsistent performance and substantially reduced capacity. A charger can create battery problems in various ways.

Despite some popular myths, modern NiCad cells accept fast-charge currents well. A fast charge at approximately the "C" rate (1-hour charge) usually results in optimum charge acceptance and maximum performance. A slow charge (overnight) can result in reduced capacity.

A problem begins when the battery — or, more accurately, the first cell — reaches full charge. All sealed NiCad cells have an internal mechanism to absorb a certain amount of overcharge current. The fast-charge current is typically 10 times greater than the maximum overcharge that the cell can absorb safely. Obviously, this extremely high rate of charge must be terminated immediately when the first cell(s) reach full charge. Otherwise, they will be damaged or destroyed. Many premature battery failures and problems can be traced to inaccurate fast-charge termination techniques.

The key to an accurate and safe fast-charge termination system is information. To identify properly the full charge status, the charger must have accurate data concerning the type of battery, number of cells, cell balance and battery temperature.

Rather than choosing a universal "replacement" battery from one manufacturer and a universal charger from another, one solution is to use a dedicated battery/charger system. Such a system uses special sensors and circuits within the battery to feed the necessary data to the charger data for an accurate and safe fast-charge termination. Dependable battery performance and life are difficult to achieve without such a communication system between battery and charger.

Cell imbalance and self-discharge

Accelerated self-discharge is the usual cause of an unbalanced battery. A small

amount of self-discharge, a normal occurrence within a NiCad cell, is typically insignificant in video operations. A new, fully charged NiCad battery retains 85% of full capacity after two weeks on the shelf. (Normal self-discharge is approximately 1% per day at room temperature.) However, a common NiCad ailment called a "high-impedance short" or slow short-circuit can increase the self-discharge rate of individual cells up to 50 times. This affliction may occur naturally within a cell after a period of time, but physical abuse may accelerate the problem.

Let's say a fully charged, 11-cell, 13.2V battery is removed from the charger. Two days later, someone tries to use it on a camera. Unknown to the operator, the battery has two cells suffering from a slow short and, over the two days, the cells have discharged to only 50% of full capacity. The battery runs the camera for only half the expected time and appears to be stone dead when the two slow-short cells are fully depleted. In reality, nine cells retain the other 50% of capacity. However, without the two depleted cells, there is insufficient voltage to operate the camera.

The battery now has nine cells that are 50% charged and two cells that are fully depleted. When the battery is placed on a conventional voltage cutoff (VCO) charger, the charging routine terminates and indicates ready when the nine cells reach 100% charge. However, the two defective cells now have regained only a 50% charge. The battery imbalance remains. Moreover, the imbalance is cumulative, and the battery will appear to have lost capacity each time it is used.

This problem is quite common, but it can be corrected and prevented. First, NiCad batteries can have slow-short cells with self-discharge rates more than 10 times greater than normal and still deliver 95% capacity consistently when used with the proper charging system.

With sensors for each cell within the battery, a dedicated, logic-controlled charger can identify and correct even a severe imbalance automatically during every charge cycle. If such a charger is not available, it is possible to correct imbalances by placing the battery on a slow-only charger (c/10 rate or overnight rate) for 20 to 24 hours. The battery should be removed from the slow charger after 24 hours to prevent accelerated aging due to heat build-up. Although this 24-hour slow charge will correct imbalances, it will not prevent the imbalance from recurring.

Accelerated aging

The most frequent cause of premature battery death is accelerated aging, resulting from continuous slow charging or trickle charging. Once a battery is fully charged, the charger can either turn off

all charge current or continue to deliver a trickle charge. If the charge current is turned off, the battery immediately begins to self-discharge and may develop crippling imbalances. A continuous trickle charge, on the other hand, prevents self-discharge. However, the trickle charge causes the internal cell temperature to rise as high as 115°F.

Heat is the No. 1 killer of NiCad cells, causing accelerated decomposition of the organic components within the cell. A direct relationship exists between elevated temperature and reduced battery life. (See Figure 1.) Specifically, the temperatures generated during trickle charging cause a battery to age from four to eight times faster than normal. A battery that would normally deliver more than two years of service may not last six months if it is subjected to continuous trickle charging.

It's a "Catch 22." Turn off all charge current, and have a partially discharged and unbalanced battery; or maintain slow trickle charging, and simmer the battery to death. The heat from trickle charging is the greater of the two evils and must be avoided.

If your charger does not maintain a trickle, or if you have removed batteries from a trickle-type charger as recommended previously, you run the risk of having batteries that are partially discharged and unbalanced when you need them. This problem can be alleviated by placing batteries on a slow charger the night before they are needed. A fast or quick charger that does not have a balance routine cannot be used for this purpose.

These recommendations do not apply to charging systems that include a proprietary maintenance circuit. The circuit prevents self-discharge with virtually no heat build-up or accelerated aging. The maintenance circuit allows batteries to be left attached to the charger until they are to be used. Even after weeks or months, batteries will be 100% charged, balanced and ready for use without any detrimental effects from accelerated aging.

If batteries are to be out of service for a month or longer, they can be placed in a sealed plastic bag and put in a refrigerator or freezer for storage. Allow batteries stored in this manner to reach room temperature before you open the plastic bag and recharge.

If you are responsible for purchasing or maintaining the battery-operated equipment for ENG/EFP activities at your facility, remember that the success and efficiency of the operation ultimately rest on the dependability of the battery and charging system.

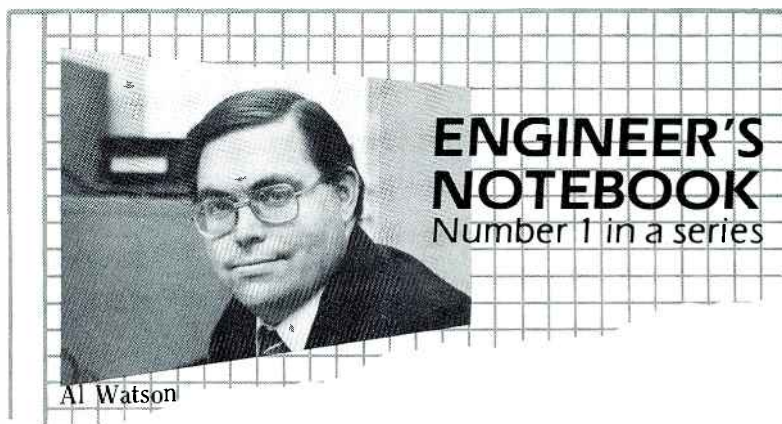

N/DYM™ Technology Comes to Broadcast Microphones

By Alan Watson, Director of Engineering
Electro-Voice, Inc.

Those familiar with the benefits enjoyed by musicians through the new neodymium-magnet microphones have no doubt predicted that the new technology would soon be available in broadcast microphones. And now, with the advent of the Electro-Voice RE45N/D hand-held shotgun microphone, the prediction has come true.

The advantages N/DYM™ technology brings to broadcasting are significant. Above all, it gives us a microphone with the high output previously available only from condenser mics—but without the problems of dead batteries, noises caused by poor ground connections in phantom-powering, humidity damage, static electricity, and poor rf rejection.

The Alnico magnets used in most dynamic mics yield a sensitivity of 6 dB less than would be possible if the steel parts of the magnetic structure could be completely saturated with the field. Increasing the Alnico magnet size does not work since the added size interferes with the acoustic design of the mic. Neodymium magnets, however, are so powerful that the magnet can be far smaller and still provide the "lost" 6 dB of sensitivity.

N/DYM Technology extends far beyond a mere substitution of magnetic material. To maximize the new opportunities, Electro-Voice engineers found that the ideal neodymium magnet shape is one with a thin, wafer-like configuration.

This permitted using a voice coil and attached dome of far larger diameter while reducing the surround—yielding important added advantages for broadcast engineers: a smoother, more evenly contoured pickup pattern with extended high- and low-frequency response and better rejection of unwanted noise from the sides.

For more information, please write to us for the specification sheet and brochure on the RE45N/D—the broadcast industry's first N/DYM dynamic shotgun microphone.

600 Cecil Street • Buchanan, MI 49107 • 616/695-6831
In Canada:
Electro-Voice Div., Gulton Industries (Canada) Ltd.
P.O. Box 520 • Gananoque, Ont. K7G2V1 • 613/382-2141



BROADCAST/PRODUCTION MICROPHONES
Quality-made in the U.S.A. since 1927

Advertisement

Circle (67) on Reply Card

I = (Z =>)))))

News

Continued from page 4

to experts in the TV, communications and computer industries. SMPTE membership is not required. For more information, contact Paulson at 508-562-2100, or Barry Detwiler, SMPTE headquarters, at 914-761-1100.

Among the study group's focuses:

- Existing applications of fiber-optic technology in long distance, metropolitan area and local area networks for transmission of TV, video, audio and ancillary data signals and high-resolution monochrome and RGB color graphic signals.
- Identification and summarization of standards-setting activities in other industry professional associations and societies.
- Standards and practices for circuit and equipment interconnection.
- Existing and potential applications in TV production, post-production, ENG and EFP backhaul, distribution and broadcasting operations.

Another concern facing the group is the need to assess the signal-format conversion implications of the standards now being set for digital recording and the transmission of analog-originated video and audio signals.

Comark ushers in new transmitter era

A Klystron-equipped transmitter has been commissioned into full-time broadcast service by Comark Communications, Colmar, PA, at WIIB-TV 63, Bloomington, IN. A pair of Varian EIMAC 2KDW60LF Klystron power-amplifier tubes (in parallel), driven by two solid-state drivers, are operated in multiplex, enabling the transmitter to achieve 80kW of (peak) RF output power.

The normally supplied sound high-power amplifier, diplexer and RF switching system are eliminated in this configuration, thus decreasing the initial purchase price. The two Klystron power amplifiers' combined ac power consumption was only 70kW at 50% APL and 85kW at black level (including sound power).

Ampex, Abekas clash over patent conflicts

Ampex, Redwood City, CA, has filed suit against Abekas Video Systems, also of Redwood City, for "willful and deliberate" infringement of five Ampex video technology patents. The plaintiff claims that the Abekas A52 and A53-D special effects systems and digital effects combiners, A62

digital disk recorder and A42 video slide projector are in violation of Ampex patents.

Ampex claims to have found patent infringements in Abekas products and offered Abekas a patent license following its sale in 1985 to Carlton Communications. Negotiations continued for more than two years, but Abekas allegedly rejected the license and continued to market the products in question. Co-defendants in the suit include Abekas founders Junaid Sheikh, Bantval Yeshwant Kamath and Phillip Patrick Bennett, all of whom are former Ampex employees.

Abekas denies the allegations. No court date has been set.

By John Blau, European correspondent

NBC joins up with Visnews

NBC has acquired a 37.75% interest in the TV news agency Visnews. The majority stockholder remains the British news agency Reuters, with 51%. The BBC has an 11.25% stake in Visnews.

Clearing a path for the global TV market

The introduction of HDTV to the global TV market will result in estimated sales of \$285 billion, according to Heinz Riesenhuber, head of West Germany's Ministry of Research. European involvement in the debate over high-definition standards is crucial, said Riesenhuber at a press conference on Germany's involvement in HDTV research. Developments in storage and display technologies cannot go unnoticed.

The 4Mbyte storage technology is one of the requirements for true HDTV. Similarly, research continues on producing large LCDs, which will permit flat wallscreens. German companies are among the front-runners in LCD research and development, according to Riesenhuber.

Unlike the Japanese, the European consumer electronic companies would like to see HDTV introduced in two phases. They hope that a first step in their home market will be the purchase of sets with integrated Mac decoders (625-line picture, flicker-free color and digital sound). The second step, full HD-Mac, involves doubling the number of lines for Hi-Vision. Many industry experts believe that this technology will not be available until the middle of the next decade. One of the reasons for the delay is the need to further develop

bandwidth-compression techniques.

Also, a bundle of money is at stake. Project development costs are estimated at almost \$300 billion. More than half this amount is being covered by Europe's consumer electronics industry and broadcasting organizations; the rest of the tab is being picked up by European governments.

1992 is the magic year for the launch of HDTV in Europe. The rush to push HD-Mac production out into the open stems mainly from the timetable of the Committee Consultative Internationale Radio Telecommunication (CCIR), the relevant arm of the International Telecommunications Union, whose aim is to set a world HDTV production standard by 1990. European governments, according to Riesenhuber, have much at stake with HDTV and have pledged full support for the Eureka HDTV project.

Traffic broadcasting to include RDS

A group of West German public service broadcasters have invested about \$14 million to develop a so-called radio data system (RDS). Car owners with RDS radios can travel nationwide and receive traffic information automatically without having to readjust frequencies. The RDS system automatically selects the strongest frequency.

The next step for the 1990s is to develop a "vocoder," which will allow drivers to call up all traffic information by pressing one button without having to interrupt the radio broadcast.

The embattled British TV revolution

Prime Minister Margaret Thatcher has focused her attention on British broadcasting. The government recently promised its "White Book" policy paper to give viewers and listeners a greater choice of TV and radio programs in the 1990s, adding that quality would not be sacrificed. The easing of broadcasting controls is expected to make dozens of new TV channels and several hundred radio stations available to the public.

One of the changes has to do with BBC-TV being financed in the 1990s through subscriptions and sponsors instead of user fees. It will be similar to pay-TV, where viewers pay only for what they see. Another change will provide commercial broadcasters with about 20 new channels for satellite, cable and terrestrial transmission.

The policy paper calls for extended na-
Continued on page 109

TV-Nikkor S15x8.5B **ENG/EFP Lens** **for 2/3-inch TV Cameras** **S13x9B**

Nikon improves TV lens technology

- Compact, lightweight lenses for 3-CCD cameras, with the flexibility to meet any shooting requirement.
- Nikon ED (Extra-low Dispersion) glass for faithful color rendition and minimal tracking/registration errors.
- New anti-reflection coating improves spectrum transmission ratio.
- Highly advanced optical design via CAD for improved corner resolution and high, flat MTF curve.
- 15x zooming ratio – highest among standard ENG/EFP lenses (S15x8.5B).
- Minimum focal length of 8.5mm – widest among standard ENG/EFP lenses (S15x8.5B).



S13x9B
1.1kg
(2.4 lb)

S15x8.5B
1.25kg
(2.76 lb)

Nikon

NIKON CORPORATION

Fuji Bldg., 2-3, Marunouchi 3-chome, Chiyoda-ku, Tokyo 100 Japan

- | | |
|------------------|---|
| U.S.A. ————— | © Nikon Inc.
623 Stewart Avenue, Garden City, New York 11530, U.S.A. |
| Canada ————— | © Nikon Canada Inc.
1366 Aerowood Drive, Mississauga, Ontario, L4W 1C1 Canada |
| Europe ————— | Nikon UK Ltd.
380 Richmond Road Kingston, Surrey KT2 5PR, UK |
| West Germany ——— | Nikon GmbH
Tiefenbroicher Weg 25, 4000 Düsseldorf 30, West Germany |
| Australia ————— | Maxwell Optical Industries Pty Limited
Unit 5, Level B, 100 Harris Street, Pyrmont, N.S.W. 2009, Australia |

Circle (55) on Reply Card

Station-to-station

Installation works in RF environment

By Gil Ludwig

When the news department of KSDK-TV, St. Louis, requested a better public service receiving station in the middle of the "RF heaven" of downtown St. Louis, I knew many obstacles lay ahead. How would it be possible to get commercial-grade reception on six inexpensive receivers; scan more than 100 channels over a 2-state, 50-mile radius; and, worst of all, do all this with an antenna feedline almost 600 feet long?

Because of our downtown location, many undesired signals were present that any antenna gain would automatically pick up. Any strong incoming signals could

Ludwig is engineering supervisor and technical director at KSDK-TV, St. Louis.



overdrive a high-gain amplifier, resulting in intermodulation distortion or non-linear amplification.

Original installation

The existing receiving system used one wideband, multifrequency antenna mounted at rooftop level. It was plagued with severe intermodulation caused by nearby business band, telephone and paging services. Several of these services were located less than half a mile away. Trying to hear a distant station was like trying to talk across town on a pair of low-power hand-helds. Only occasionally could a rural transmission be picked up out of the trash from overloading signals.

The original intent was to build the best

possible broadband omnidirectional multicoupler antenna system, at minimal cost. Yet, with the extreme competition among other news departments at an all-time high, this was the perfect chance to increase the station's visibility through local breaking news stories. Being first on the scene or having exclusive video always speaks well of a news department.

Design process

The first steps were to critically evaluate the RF environment through spectrum analysis and to identify potentially interfering signals. The research revealed many unsuspected sources behind the mixing and first-order images being detected on the scanners. To complicate



Think of it as a REV7

For the past few years, audio professionals have been praising Yamaha's REV7 digital reverb to the skies. So there was incredible pressure to make its successor even better than expected.

Introducing the REV5. Representing a breakthrough in the sound barrier for reverb. And a collective sigh of satisfaction from the overachieving design engineers at Yamaha.

Because not only is the REV5 matured in

capabilities, it's improved in sonic quality as well.

We added more DSP chips to boost the REV5's processing power, creating smoother reverb sounds and multi-effect combinations. Full bandwidth extends reverb to 20 KHz.

In addition to master analog EQ, the REV5 has three-band parametric, programmable digital EQ. So when you make individual EQ settings, they're recalled with each program.

matters, insufficient isolation between the receiver oscillators was causing even more interference. Mutual coupling between scanners often stopped the scan sequence, as though a signal were being received.

We purchased three commercial-grade, high-gain antennas — one each for 42MHz, 155MHz and 460MHz — to replace the original single-element 25MHz-575MHz antenna. A special 40-foot guyed tower was mounted on the 3-story building that houses the KSDK studios. Because St. Louis is known to encounter severe weather, special measures were taken to mount securely all the rooftop equipment. The three antennas were then combined in a multicoupler amplifier, and the 600-foot coax was fed to the

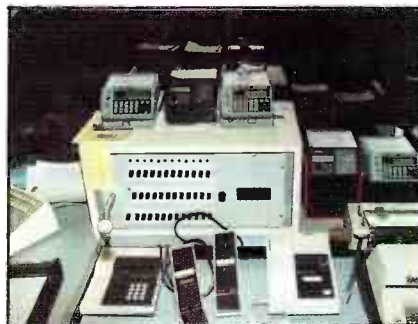

A total of seven receivers, six of which are shown here, places severe demands on any monitoring antenna system. The keys to this installation were careful design and custom amplifiers and filters.

newsroom.

Custom splitter/amplifier

The multicoupler, which was custom-designed for us, has two band-reject filters for 152MHz and 158MHz. The system block diagram is shown in Figure 1. The three antennas are fed into a VHF-low, VHF-high wideband, 2-way power combiner that has a coupling loss of 3.4dB. Two hybrid amplifiers, arranged in a feed-forward configuration, provide a uniform cancellation of all second-, third- and higher-order harmonics. The second-, third- and higher-order intermodulation products typically are reduced by 25dB. The combined VHF output is then amplified in a wideband linear amplifier.



with a sonic boom.

And when you don't have the time to make many decisions, there are 30 preset programs, plus nine unique preset combination programs. Sixty user-memory slots let you save your custom effects.

And even though a lot of the features are new, using the REV5 won't be. Because the format is the same as the REV7 you're used to using.

Check with your friendly Yamaha Professional Audio dealer about the new REV5. Once you hear

it, you may find it difficult to come back down to earth. Yamaha Music Corporation, Professional Audio Division, P.O. Box 6600, Buena Park, CA 90622. In Canada, Yamaha Canada Music Ltd., 135 Milner Avenue, Scarborough, Ontario M1S 3R1.



YAMAHA[®]
Engineering Imagination™

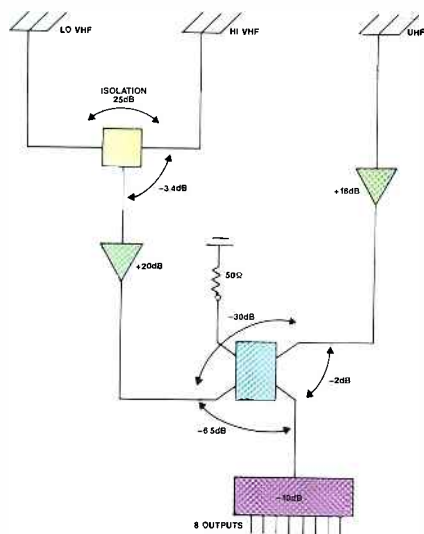
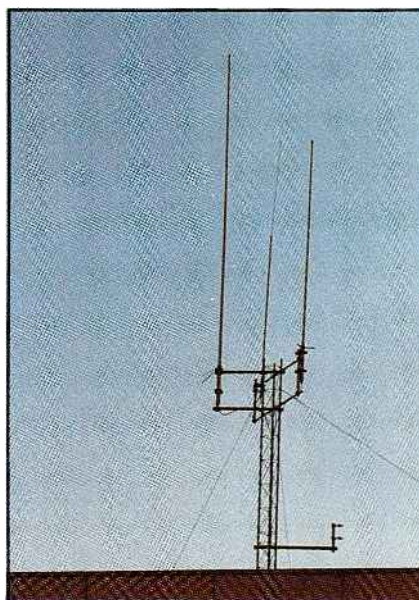

Figure 1. The monitoring system combines two VHF antennas and one UHF antenna into a single feed. A power divider located in the newsroom splits the signal into eight feeds and prevents intercoupling between receivers.



Mounted on a 3-story building, the equipment had to be especially secure because of high-wind conditions common to St. Louis.

and coupling loss of less than 3.5dB. Isolation between the low and high VHF feeds is 25dB. Isolation between the VHF and UHF ports is greater than 20dB. Through-loss (UHF in to out) is 1.75dB, and coupling loss (VHF in to out) is less than 7dB.

The combined signals feed a power divider located at the end of the 600-foot run of coax cable. The divider provides each receiver with a separate, isolated feed. It also prevents any intercoupling between receivers.

The receiving system has been in operation for several months, and I can honestly say that the investment was well worth it. The six receivers in the newsroom and one in the weather center are hearing transmitters that were never heard before. Just as important, the interference, which used to be so common, is gone.

The UHF signal is amplified by a wide-band amplifier operating in a push-pull configuration.

The VHF and UHF outputs are then combined in a 6dB directional coupler with output-to-output isolation of 25dB

1:~:~)))))

Splatter matters

Splatter is a form of radio interference that can drive listeners away from AM radio. It creates distortion in your signal, wastes transmitter power on undesired sidebands and interferes with other stations. Even with an NRSC audio filter, misadjustment of the transmitter or audio processing equipment can still produce an RF spectrum that can exceed NRSC or FCC limitations.

That's why routine monitoring of your station's RF spectrum is a must. But it doesn't mean you'll have to bust your budget on a spectrum analyzer. It just means you need the rugged SM-1 AM Splatter Monitor from Delta Electronics.

For just \$2,150 you can now accurately measure your transmitter's spectral output, monitor transmitter IPM levels and make adjustments to improve clarity. An external audio input helps identify splatter sources.

The Splatter Monitor's unique offset feature tunes spectral segments for closer examination 10 kHz to

100 kHz away from the carrier. Unlike a spectrum analyzer, you can listen to the front panel speaker or your own headphones as you measure splatter levels on the front panel meter. The Splatter Monitor also has an alarm output to drive your remote control.

In this day and age where splatter matters, monitoring it doesn't have to cost you a fortune.

To find out more about the new Delta Splatter Monitor, call (703) 354-3350, or write Delta Electronics, Inc., 5730 General Washington Drive, P.O. Box 11268, Alexandria, VA 22312.

The Above Standard
Industry Standard.

DELTA ELECTRONICS



©1988 Delta Electronics, Inc.

Circle (87) on Reply Card

Broadcast Electronics Phase Trak 90

By Dennis Ciapura

Broadcasters seem to embrace one of two quite different schools of thought regarding audiotape reproduction. Some believe firmly that tape reproduction should be transparent and unprocessed, except perhaps for noise reduction. This group also thinks phase maintenance should be accomplished by head alignment, with source phase being an external issue. Stations with this philosophy sometimes employ a phase-correction device connected to the output of the reel-to-reel decks, which they use to play the commercial masters from agencies. Other stations worry only about in-house phase, either insisting on good masters or using outside material as it's produced.

The other philosophical position suggests that poor audio phase integrity is an unavoidable fact of life. Solving this problem requires the use of a phase-correction device in the program line so that all audio sources are processed.

Although the latest versions of broadcast phase correctors are amazingly effective in differentiating true phase errors from production effects, no design is perfect. One scheme relies on the use of a phase corrector on the output of the tape sources only. This approach, however, may require more phase correctors than the budget of a typical broadcast station allows.

Features

The new Broadcast Electronics Phase Trak 90 cart decks should be attractive to those who desire segregation of the phase-corrected sources. The PT-90 stereo record/play (r/p) and the PT-90 stereo playback units both include built-in non-encoding phase-correction circuitry.

The r/p machine also has a "learn" mode that automatically adjusts the bias, equalization and input sensitivity for up to 10 different tape characteristics. (See Figure 1.) A front-panel display functions both as a timer and as a status display for the various memory features. There is even a built-in test oscillator with eight frequencies spanning 50Hz to 16kHz. Com-

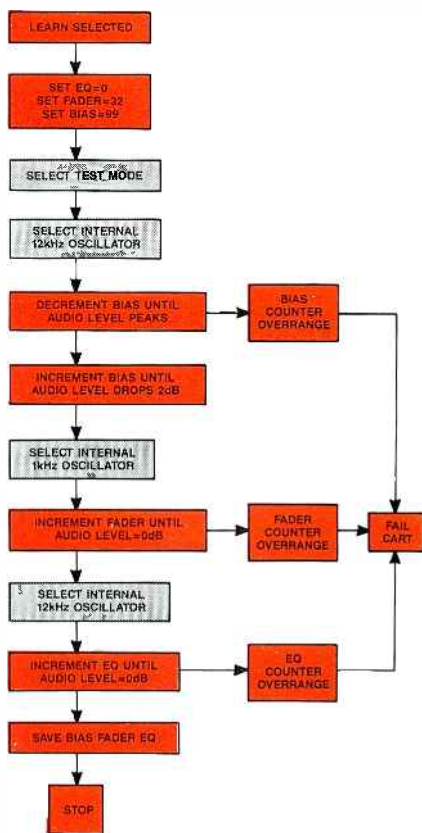
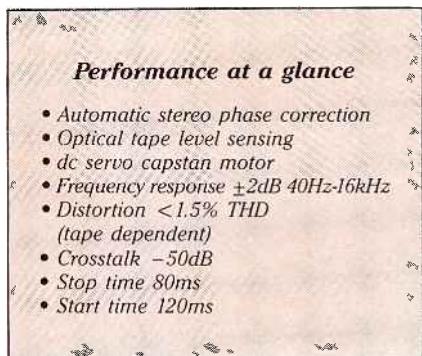
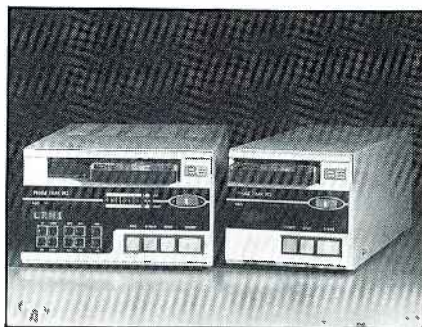

Figure 1. The learn mode allows the machine to store as many as 10 sets of bias, equalization and input sensitivity data for instant recall.

plete electronic alignment can be accomplished from the front panel in either a manual mode or auto mode. In manual

mode, the unit memorizes the settings for each tape type; in the auto mode, the machine does everything, then remembers what it did.

The Phase Trak series of machines also employs the DYNAFEX single-ended noise-reduction system, which effectively reduces the audibility of both source and cart noise. The process is subtle in its operation. Like the phase correction, this feature is defeatable if the user prefers not to use that function or decides not to employ external equipment. A splice finder is included in the r/p machine along with a complete array of cue facilities, including cue erase.

If carts recorded at the elevated 250nWb/m level are marked with the metallic sensor tabs provided, the machine recognizes these carts automatically and adjusts the reproduce gain, thereby maintaining standard levels with a mixture of recorded levels. This feature is useful if spots are recorded on standard carts at 160nWb/m and music is dubbed to premium carts at the elevated level for improved signal-to-noise ratio. It's also possible to use this feature during transition to a higher record-level standard.

Test results

Figure 2 illustrates the machine's playback frequency response. The variation is within ± 1 dB from 50Hz to 16kHz. Phase error with the corrector was nil at 16kHz, which is excellent performance by any standard. Record/play frequency response was first tested with a used, high-performance tape cartridge. Although this may seem to be an unorthodox procedure for an equipment evaluation, using only new tape cartridges does not give realistic results. A used cart is a better indicator of what can be expected from the equipment in a typical broadcast application. After all, how many stations use only new carts?

The r/p results, as shown in Figure 3, were excellent. The tests then were repeated using the automatic alignment function with the same carts, and the results were virtually identical. Distortion was 0.8% at 1,000Hz, 160nWb/m. The 3% distortion threshold was at 12dB above the 160nWb/m operating level, or 8dB above

Ciapura is vice president, technical operations, for Noble Broadcast Group and president of TEKNIMAX Telecommunications, a San Diego-based technical management consulting firm.

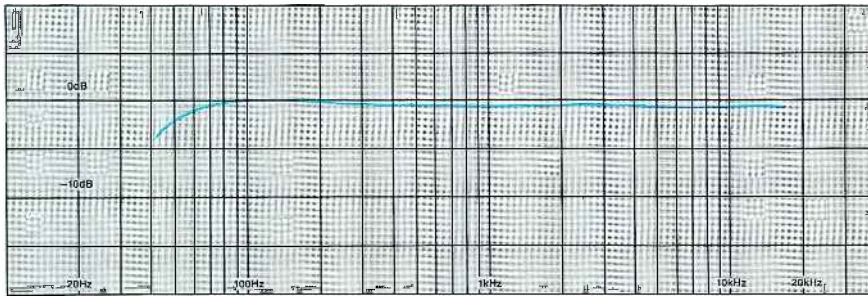
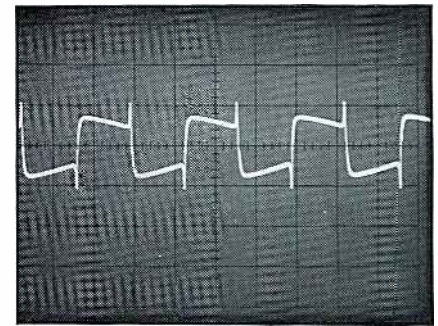

Figure 2. Typical reproduce frequency response from a record/play deck.



Record/play square-wave response measured at 400Hz, 160nWb/m.

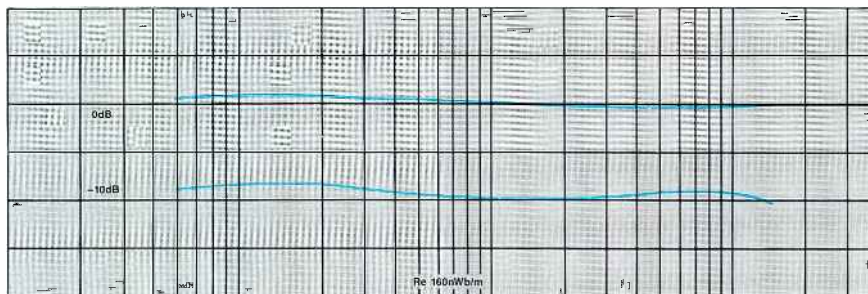

Figure 3. Typical record/play frequency response with a used tape cartridge. The used cartridge provides a more realistic indication of how the deck will perform in actual use.

REFERENCE LEVEL (160nWb/m)	OUTPUT LEVEL
0dB	0dB
-10dB	-10dB
-20dB	-23dB
-30dB	-40dB
-40dB	-55dB

Table 1. The DYNAFEX gain structure provides adequate noise reduction without the need for level matching and encoder/decoders.

250nWb/m.

With the DYNAFEX function, the noise floor settled down to 58dB below the 160nWb/m operating level for a total dynamic range of 70dB. Table 1 shows the DYNAFEX gain structure. Note that it has no significant effect until the output level drops below -20dB. By -40dB, the noise is reduced to approximately the eventual noise floor. This turns out to be an appropriate characteristic for broadcast applications because it won't alter a fade. The circuit offers the additional advantage of reducing overall noise without the need for encoding and level matching.

The square-wave response was 400Hz. There was no sign of ringing from 50Hz to 7,500Hz, at which point the square wave was integrated into a sinusoid as a function of the overall system bandwidth. The moderate tilt and single overshoot are typical of an excellent tape system. Overall, the audio performance of the machines was found to be primarily tape-dependent, as any modern analog tape recorder should be. The phase-correction and noise-reduction circuits did what they were supposed to do, and the automatic alignment and memory features worked flawlessly.

Operational considerations

The mechanical construction quality of a cart machine is as important as the elec-

trical performance, and these machines are well-built. The Phase Lok V head block is especially well-designed and rugged. Although we had to reach pretty far to come up with areas that might be improved, there are a couple of operational details worth mentioning.

The phase correction can be defeated only by moving jumpers on the playback card. The inclusion of a switch on the back of the machine would facilitate head alignment, which must be done with the phase correction off. Also, the cart insertion depth is just deep enough for the top edge of the front-panel opening to block the tension-adjustment screw on at least one brand of carts. Some users may prefer that the front-panel mode buttons that control the memory, cue and auto-alignment functions be located behind a protective cover. Otherwise, the machines appear to be almost bulletproof.

The Phase Trak 90 machines probably are suited ideally to two quite different applications that share the need for a cart machine with integral, non-encoded phase correction. For the small facility with a 1-person engineering department or the contract engineer trying to maintain everything, these machines would be a panacea, even if only the main on-air studio were equipped with playback units. Stations that have larger budgets and are looking for a top-quality machine with all

the automatic features and the ability to phase correct outside sources not under the station's control also will be drawn to the decks.

Editor's note: The field report is an exclusive BE feature for broadcasters. Each report is prepared by the staff of a broadcast station, production facility or consulting firm.

In essence, these reports are prepared by the industry and for the industry. Manufacturer's support is limited to providing loan equipment and to aiding the author if support is requested in some area.

It is the responsibility of Broadcast Engineering to publish the results of any piece tested, positive or negative. No report should be considered an endorsement or disapproval by Broadcast Engineering magazine. [:-7-:-))]]

Frank T. Taylor and **Jeffrey Schneider** have been named to positions with Comprehensive Video Supply, Northvale, NJ. Taylor is product manager for post-production products. He is responsible for development, implementation and technical support of the company's post-production line-up. Schneider was promoted to sales manager of post-production computer products. He will oversee sales of the PC-based Edit Master edit

controller, the PC-2 character generator and other associated software.

Helge H. Wehmeier has been appointed president and CEO of Agfa-Gevaert, Ridgefield Park, NJ. He also has been elected to the board of directors and executive committee of Bayer USA, of which Agfa is a wholly owned subsidiary.

Michael Stewart and **Arnie**

Christensen have been appointed to positions with Aphex Systems, North Hollywood, CA. Stewart is manager of the newly formed systems design group. He is responsible for developing a variety of MIDI-oriented control devices for musicians. Christensen is sales manager.

John Stacey has joined Aston, England, as a graphic designer. He is responsible for the daily font and logo requirements and the graphic demands generated by Aston4/Caption and the "Wallet".

Terence O'Kelly has been promoted to director of national sales for audio-video professional products for BASF Information Systems, Bedford, MA.

Charles W. Kelly has joined Broadcast Electronics, Quincy, IL, as director of international sales. He is responsible for export sales in all areas of the world except Canada.

Charles Felder has been appointed vice president of sales and marketing for BTS Broadcast Television Systems, Salt Lake City. He is responsible for overseeing the direction of the sales force and the marketing plans for the company's product lines.

Christian Tremblay has been appointed product development manager for Central Dynamics, Montreal, Canada.

Michael Montag has been appointed manager. CMX EuroService for CMX, Santa Clara, CA.

George R. Swetland has been appointed marketing manager for EECO/Convergence, Santa Ana, CA. He is responsible for directing sales development and support for all national marketing of the company's post-production editing systems.

Donald Danko has been named Central regional product engineer for For-A, Newton, MA. He is responsible for technical support and quality assurance as well as warranty repair of the company's professional video products.

Vincent J. Hewitt has been appointed president of the display products group for Conrac. Duarte, CA. He is responsible for all operations of the autonomous unit.

Rob Lingle and **Linda Murray** have been promoted to new positions with IDB Communications Group, Los Angeles. Lingle is director of audio-video systems. He is responsible for the future design and

Silence is Golden and less work with telcom c4 for RADIO and TV.



The NR system you just set and forget.

- A product of ANT Telecommunications, Inc.
- No overshooting.
- No pre or post echo.
- No wasting time with lining up — not even for tape exchanges.
- Applications: Cartridge machines, STL, RPU, Reel-to-reels, Cassettes.
- Up to 118dB dynamic range — the widest dynamic range available in any noise reduction system today.
- Over 15,000 channels in use worldwide.
- No breathing or pumping.

telcom c4
Silence by Design

Distributed by:

RAM BROADCAST SYSTEMS INC.

346 W. Colfax Street, Palatine, IL. 60067

New York (516) 832-8080

Chicago (312) 358-3330

Tennessee (615) 689-3030

Circle (69) on Reply Card

expansion of the audio and video control centers at the Los Angeles International Teleport. Murray is director of operations. She is responsible for overseeing all audio operations at the Los Angeles International Teleport and IDB's Program Booking Center. She also will direct all audio, video and data/voice transportable operations for the company.

William Liento Jr., Nicholas Mallis, Jim Smart and **William Johnson** have been appointed to positions with Lee Colortran, Burbank, CA. Liento is senior vice president of sales and marketing. Mallis is senior vice president of operations. He is responsible for all aspects of the manufacturing operations. Smart is general manager of Lee Colortran Canada. He is responsible for managing sales and marketing efforts in Canada as well as overseeing the Canadian operation. Johnson, product manager for luminaires, has expanded duties that include overseeing export sales and custom projects.

Andy Turner, JoAnn Waddell and **Quentin R. Nelson** have been appointed to positions with Magni Systems, Beaverton, OR. Turner is regional sales engineer. He is based at the Chicago branch office and will assume responsibility for sales and local dealer support activities throughout the Midwestern states. Waddell is product marketing manager. Her activities will focus on the marketing and further development of the 4000 series of video graphics encoders. Nelson is Northeast regional sales manager.

Vinod Chitkara and **Ishan Bhawnani** have been appointed to positions with Narda Microwave, Hauppauge, NY. Chitkara is manager of domestic sales. He will oversee all sales activities related to the domestic market for the company's passive and active components. Bhawnani is chief engineer of passive products. He will oversee the engineering of passive products from the design through production stages.

Ted Pine has been promoted to the position of marketing communications manager at New England Digital, White River Junction, VT. Pine is responsible for the management of all the advertising, direct mail and public relations programs. He also will assist in the development of strategic, long-term business programs to strengthen the company's position in the music composition, studio recording, film/video post-production, music publishing and broadcasting markets.

Do you know what's beyond the horizon?

*Somebody
does!*

**US UTAH
SCIENTIFIC**

DYNATECH Broadcast Group

1685 West 2200 South, Salt Lake City, Utah 84119
(801) 973-6840 Toll-Free: 1-800-453-8782

1-[:=)))))

Circle (93) on Reply Card

Paltex acquires EECO/ Convergence video editing division

Paltex Editing & Production Systems, Brentford, UK, has acquired the video editing division of EECO, which includes all inventory, trademarks, designs and software for the Convergence and EECO editing systems. Paltex will manufacture all products at its Tustin, CA, facility. Convergence personnel in the United States

and Europe are being integrated into the organization. Paltex has leased an adjacent building in Tustin to house an expanded engineering/R&D center and to consolidate Paltex and Convergence operations in the United Kingdom into a new international headquarters.

New facilities for ITE

Innovative Television Equipment (ITE), Newbury Park, CA, has moved into a new

facility. The building, at 2550 Azurite Circle, Newbury Park, CA, will allow future growth of the domestic manufacturing operations.

ITE also has opened a Southeastern regional office. The new office will stock ITE equipment and will include a service facility that supports the Eastern regional office located in New Jersey.

KRBK uses M-II format

KRBK-TV, Sacramento, CA, has purchased M-II 1/2-inch video format equipment from Panasonic Broadcast Systems Company (PBSC), Secaucus, NJ. The TV station will be using the format for field production and satellite delay.

Gentner merges RF division into Salt Lake operations

Gentner Electronics, Salt Lake City, has consolidated its San Jose RF Products Division into its Salt Lake City operations. Manufacturing and customer service of RF products will continue from Salt Lake City.

Harrison completes Voice of America order

Harrison Systems, Nashville, TN, has completed the order for 19 consoles for the Voice of America studio renovation project. The consoles were designed to Voice of America's specifications, and used the features and proprietary technology of the company's 790 series broadcast consoles.

Ampex embarks on production program

Ampex Magnetic Tape Division, Redwood City, CA, has begun a project that will lead to production, in high volume, of the metal-particle tapes, thin coatings and thin base films that will form the core of its next generation of magnetic media products. The 2-year program for the state-of-the-art production facility began in January. The program includes a production coating line, a metal-particle mix prep facility, expanded clean rooms, slitters, assembly and packaging equipment, as well as utilities expansion and waste treatment facilities.

AVS wins an Emmy for ADAC

AVS, England, has been awarded a TV engineering Emmy by the National Academy of Television Arts and Sciences for its ADAC standards and formats converter. The converters are distributed in the United States by A.F. Associates.

Barco acquires EMT-Franz

The German company EMT-Franz has become a part of Barco-Industries, Kor-



PROFESSIONAL TECHNOLOGY FOR BROADCASTING

Professional antenna systems for FM and TV broadcasting.

Special requirement antenna systems designed to obtain very directional patterns in FM, VHF and UHF.

High gain, circular polarization FM antenna systems, suitable for any power levels.

Station coaxial accessories.

Manual and automatic patch panels.

FM and TV combining filters.

Cables, connectors for any power rating and any EIA standard.

Custom design and total system engineering including complete in-plant test.

Computer-aided rotating towers for RF spectrum monitoring and checking, complete antenna arrays in any frequency band fed in Dolph Tchebychev system for narrow patterns without spurious lateral lobes.



Comad
COMMUNICATIONS LIMITED

1435 Bonhill Rd., Unit 34,
Mississauga, ON FAX: (416) 676-9176
L5T 1M1 (416) 676-9171 Telex: 06-968570

1-800-387-4991

See us at the NAB Booth 2121 Circle (57) on Reply Card

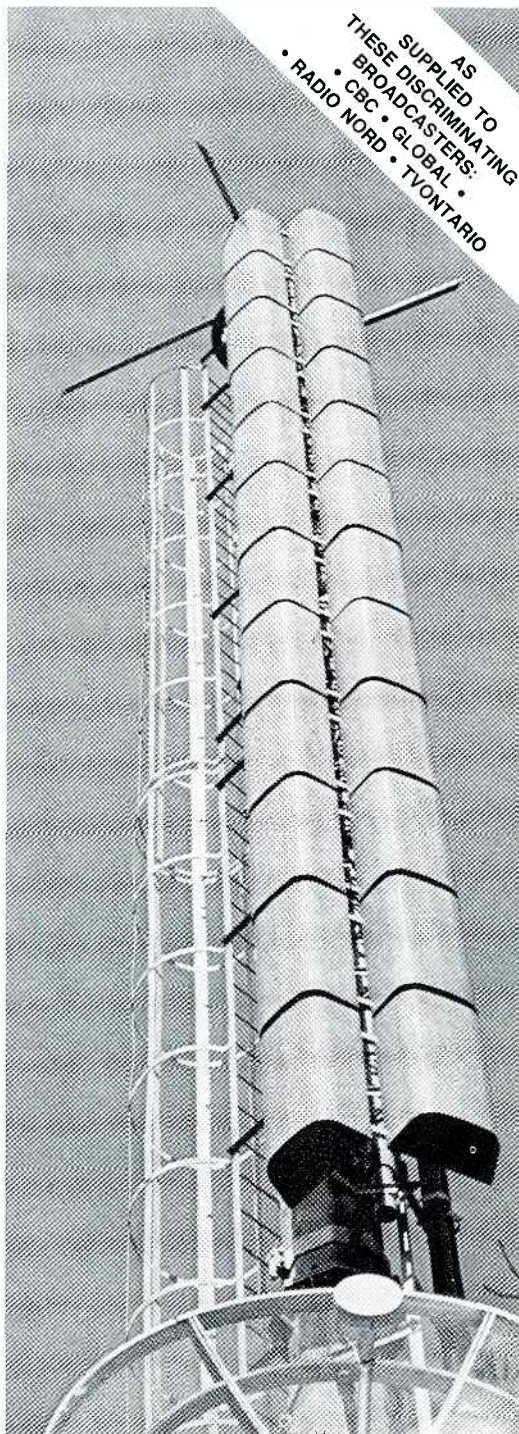

Portable energy case

Frezzolini Electronics has introduced the Frezzi/Pag portable power-packed energy case for professional video, ENG and EFP users. Included in the case are LOK-ON mounting connectors to replace banana jack connectors used by other battery systems. For a limited time, brackets will be supplied with any Frezzi/Pag batteries and charger.



Circle (350) on Reply Card

Time-code generator/reader

Fast Forward Video has introduced the P-1 portable SMPTE time-code reader and generator. Powered by the VCR battery, the unit connects to the camera with a 14-pin cable. The time-code output connector is user-selectable. The generator can be set to run continuously, independent of camera starts and stops, or start and stop with the camera. Jam sync capability is standard.

Circle (351) on Reply Card

Enhanced graphics encoder

Magni Systems has announced Software Control for the model 4004 gen-lockable videographics encoder. The software package provides fades between video and graphics, variable fade rates, luminance keys, color zero keys and videographics cuts to be controlled from the Amiga 2000 with function keys or a mouse. An on-screen display shows the selected settings.

Circle (352) on Reply Card

Video camera boom microphone and VHF wireless system

Nady Systems has introduced the following products:

- The VCM-100 is a sensitive, superdirectional microphone. The supercardioid electret condenser element used in the mic combines wide frequency response with low noise. A single AA battery powers the element. A switch on the mic housing offers the option of normal or long-distance recording. In long-distance mode, extraneous noise is eliminated. Two cords are included: a 3-foot coil cord and shoe-mounting bracket for on-camera use

and a 20-foot straight cord for remote use. A full-length windscreens also is provided.

- The 501 VR wireless system operates on VHF high-band frequencies, with five channels between 170MHz and 216MHz offered as standard. Patented companding circuitry gives the 501 VR a dynamic range of 120dB and full frequency response of 25Hz-20,000Hz. The receiver is housed in a steel case, and is internally powered by a 9V battery or externally powered from any 12V to 35V power source. The receiver includes a "rubber duck" antenna and removable metal belt clip. System transmitters are available in a choice of miniature lavalier transmitter in a body pack or a lightweight, hand-held transmitter.

Circle (353) on Reply Card

Video editing system

M&R Data Services has introduced Symphony System Six, a video editing controller with motion memory and variable-speed capabilities. Two auto assembly modes are featured with global and clock commands for edit list management. Dual and 4-channel audio is supported, as is LAN integration, through Novell SFT Network V2.1.



Circle (354) on Reply Card

Audio processing products

Klark-Teknik has introduced the following products:

- The DN500 dual compressor/expander/limiter features two channels that provide a distortion level less than 0.05% and S/N greater than 94dB from 20Hz-20kHz.

- The DN510 dual noise gate operates as a stereo or dual mono unit with a range of 0 to -90dB and provides front-panel control of all attack, delay, hold and release parameters. THD is less than 0.5% with noise at -104dBm.

- The DN514 quad auto gate and two stereo delays include two auto attack settings for each channel with hold time scaled to the release value.

- The MIDAS XL2 console line with frame sizes of 24, 32 and 40 inputs. A 16-input channel expander connects to existing frames with a single, multipin connector. A submix from any or all of eight

subgroups can be routed to two matrix outputs. An 8-scene automute programming capability includes LED indicators of all essential status buttons. An extensive talkback system includes an interface to standard intercom systems. Four-band EQ with 2-band mid-frequency parametric and bass and treble shelving controls are standard, as are Penny & Giles faders.

Circle (355) on Reply Card

Samplers and software

AKAI Professional has introduced the S950 studio sampler and interface software for the S900 sampler. With a sampling rate of 44.1kHz, the S950 includes an expanded memory to 2.25Mbytes and a high-density disk drive. An optional hard disk interface for connection to a cascade of eight hard drives also provides a CD/DAT interface with 32kHz or 48kHz sampling for DAT applications. Interfaces for the S900 sampler include version V3.1, which allows the use of four Atari hard disk units, and version V3.2 for eight Supra disk drives, which expands the memory capabilities of the IB101A and IB101S interfaces.



Circle (356) on Reply Card

Custom PC systems

Leitch Video has introduced the RacPac AT, a reconfigured AT-compatible PC for mounting in a 19-inch equipment rack. The standard system is 80286-based with 1Mbyte RAM, multifunction card with one serial and one parallel port, sockets for 1.5Mbyte of additional RAM and disk driver card with 20Mbyte hard and 5¼-inch 1.2Mbyte floppy drives. The display adapter includes EGA, CGA, MDA, Hercules or composite monochrome. Options include a 80386 CPU, SCSI controller and RS-422 adapter.

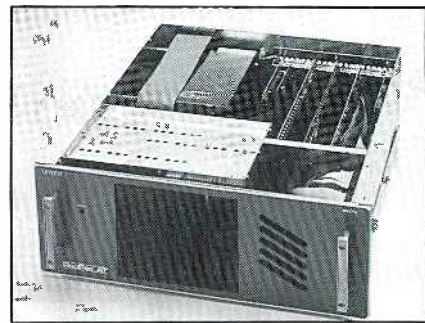

Circle (357) on Reply Card

Receive the latest industry news on key market facts and trends with The S. Klein Newsletter on Computer Graphics

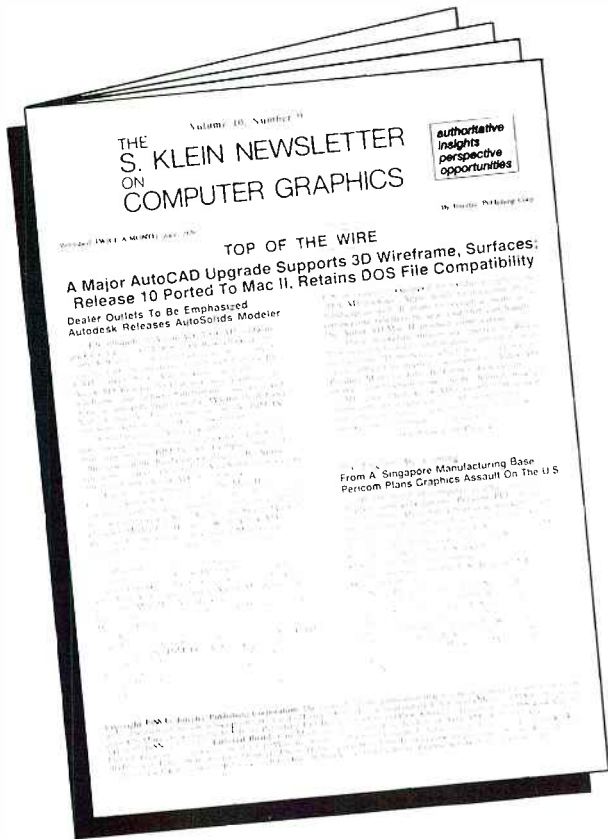

If you need incisive reports on developments in every key area of computer graphics and image processing as they happen—*The S. Klein Newsletter on Computer Graphics* is for you!

Twice a month, *The S. Klein Newsletter* cuts through the clutter to bring you up-to-the-minute news in the computer graphics industry. Through insightful, interpretive reports, you'll learn about the latest developments in:

- Animation & Visual Arts
- Business & Presentation Graphics
- CAD/CAM
- Research & Development
- Databases

You'll be among the first to hear about the latest technology—from hardware and software to systems and services. You'll receive reports on new companies as they are formed . . . applications as they are discovered . . . market trends as they begin . . . and much more!

Get the facts you need for profitable decision making . . . subscribe TODAY!

(Detach here)

THE S. KLEIN NEWSLETTER ON COMPUTER GRAPHICS

YES! I'd like to stay up-to-date on the most important developments, trends and events in the computer graphics industry. Please enter my subscription to The S. Klein Newsletter on Computer Graphics for:

- 1 year, (24 issues), \$253 (For air mail outside U.S./Canada/Mexico, add \$30/year.)
- 2 years, (48 issues), \$406

Enclosed is a check for \$_____

Make check payable to: The S. Klein Newsletter

Bill me.

Please charge to: Mastercard Visa American Express (Circle one)

Account # _____ Exp. Date _____

Signature _____ Date _____

Name _____ Title _____

Company _____ Division _____

Address _____

City _____ State _____ Zip _____

Telephone _____

To begin your subscription, simply call Dan Baker at -800-666-GRAPHICS or fill out the coupon on the right, checking the method of payment you prefer, and mail to:

S. Klein Newsletter
Pertertec Publishing
P.O. Box 12942
Overland Park, KS 66212

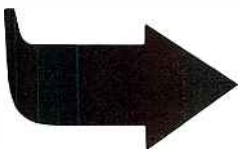

Winsted®

space-saving tape or film **MOVABLE STORAGE SYSTEMS**

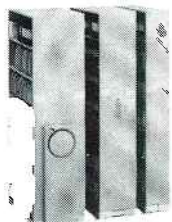

• HIGH CAPACITY SYSTEM

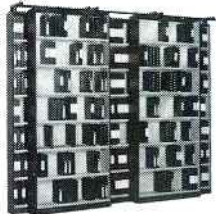

• SUPER DENSITY SYSTEM



• PULL-OUT SYSTEM

Organized, efficient storage for all types of film and videotape. Sliding cabinets move effortlessly on low-profile tracks for easy access and maximum storage capacity in limited space. Available in a variety of designs and sizes, with 5" to 36" depths, to suit your special storage needs. All steel construction.

For Free Full-color FULL LINE CATALOG
Write or call toll-free

800-447-2257

THE WINSTED CORPORATION

10901 Hampshire Ave. So. • Minneapolis, MN 55438

TELEX: 510-601-0887

FAX: 612-944-1546

Circle (98) on Reply Card

Audio processor and interface

Aphex Systems has introduced the following products:

- The model 612 expander/gate features downward expansion with a variable ratio, a level ducker and VCA 1000 voltage-controlled amplifier device.
- The model 124 simplifies interconnection of -10dBV consumer IHF equipment with +4dBm and +8dBm professional audio products.
- The model 120 DA features electronic servo balancing of a high-impedance input and four low-impedance outputs, transformerless circuitry and a flat frequency response suitable for distribution of audio and SMPTE time code.

Circle (359) on Reply Card

Microphones and stereophones

Audio-Technica has announced the following products:

- The TriPoint RD303 incorporates three miniature, permanently polarized condenser cartridges into a single case with separate feeds from each unit. The phantom-powered microphone features a 30Hz-20kHz response.
- The AT4051 externally polarized, transformerless cardioid microphones allow interchangeable head capsules for a wide range of micing applications with a response of 20Hz-20kHz.
- The ATH900 series of stereo earphones includes the ATH909 and ATH911 open-back and the ATH910 closed-back stereophones. They include soft foam earpads for an element-to-ear seal with adjustable headbands.

Circle (360) on Reply Card

FOR
THE
BEST
FOR
LE\$\$
CALL
US
LAST

200 PRODUCT LINES
FOR THE PROFESSIONAL

Toll Free in 50 States
(800) 356-5844

WI: (800) 362-5445
Local: (608) 271-1100
FAX: (608) 273-6336

FULL COMPASS SYSTEMS

6729 Seybold Rd • Madison WI • 53719-1393

Circle (73) on Reply Card

The art of shaping sound.

SONEX is a high-performance acoustical foam that upgrades your studio inexpensively. Ideal for a temporary isolation booth, it can also eliminate slap echo and harsh resonances in the main room or silence noisy tape equipment in the control booth. Write for our color brochure today.

SONEX is manufactured by Illbruck and distributed exclusively to the pro sound market by Alpha Audio.

Alpha Audio®

2049 West Broad Street
Richmond, Virginia 23220 (804) 358-3852

Acoustic Products for the Audio Industry

Circle (74) on Reply Card

NEW FROM I.DEN
**IVT-9B FULL FRAME DIGITAL
TIME BASE CORRECTOR**

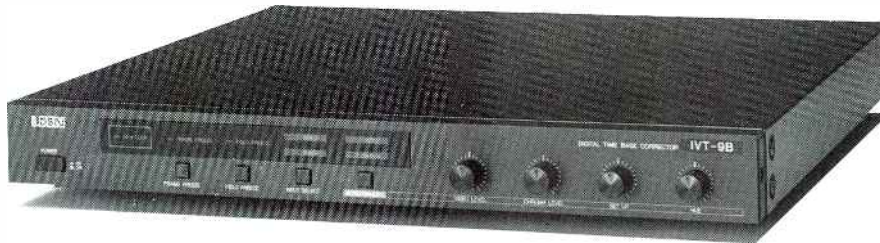

**HANDLES COMPOSITE, COMPONENT (Betacam, MII)*, Y/C688
AND Y/C358 (S-VHS, ED BETA)**

TRANSPARENT TIME BASE CORRECTION

Designed to meet even the most exacting broadcast standards; with its component processing technology - the IVT-9B time base corrects signals with virtual transparency. Operating at 5.5 MHz in Y/C358, Y/C688 and component (Betacam, MII) modes, the IVT-9B can process up to 450 lines of resolution with excellent picture fidelity. Moreover, its full frame of memory enables it to be used even as a low cost frame synchronizer.

INTER-FORMAT FLEXIBILITY

Not only does the IVT-9B solve multi-format headaches, but its input/output flexibility and wide bandwidth allows for system expansion well into the future. In addition to a wide selection of possible inputs, it can also function as a system transcoder from one format to another.

COMPONENT INPUT CAPABILITY

The IVT-9B's component input capability enables it to time base correct signals from portable Betacam and MII VCRs. Additionally, its full frame memory allows it to be used as a component input - composite output frame synchronizer making it especially attractive for field and SNG applications.

SERVICE CONSCIOUS DESIGN

Should anything go wrong with the product and we have done virtually everything to ensure nothing will - the IVT-9B comes in

the same unique four board construction as the popular IVT-9. In the unlikely event that anything should go wrong, the four board design makes for quick fault localization and the consequent board replacement resulting in the shortest possible down time.

USER FRIENDLY AND FEATURE PACKED

The IVT-9B measures one rack unit high with front panel access of Video Level, Chroma, Set Up and Hue adjustment. Its major functions such as frame and field freeze, input select and genlock are highlighted by LEDs on the front panel. Auto-freeze is activated when there is a loss of signal. Furthermore its built-in Automatic Chroma Control (ACC) circuitry helps to eliminate many chroma problems.

LOW COST

With such high performance and flexibility; the IVT-9B, at \$4,950 makes budgetary sense.

SPECIFICATIONS

INPUTS: Y/C358, Y/C688, Composite, Component & Genlock.
OUTPUTS: 2 x Composite, 2 x Y/C358 & Black Burst. SAMPLING
FREQUENCY: 13.5 MHz (4:1:1). QUANTIZATION: Y&C-8bits.
DG/DP: 2%, 2. K FACTOR: Less than 1% (composite 2%),
FREQUENCY RESPONSE: Y/C 5.5 MHz, Composite 3 MHz. S/N
RATIO: 58 dB.

ALSO FROM I.DEN

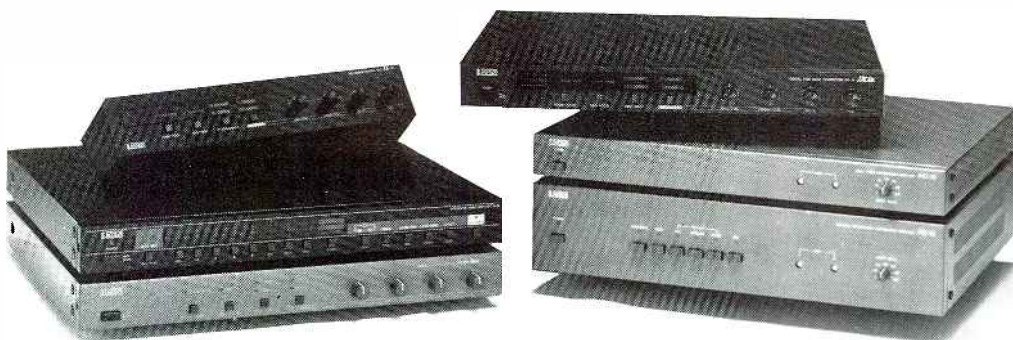

TR-9 Remote Control Unit for IVT-9 Time Base Corrector • IS-80 Integrated CCTV Switcher • IP-10 Image path • IVT-9 Full Frame TBC • IVD-10 S-VHS Distribution Amplifier • IVS-10 S-VHS Transcoding/Distribution Amp

*"Betacam" is a registered trademark of Sony Corporation. MII is a registered trademark of Panasonic Broadcast)



I.DEN VIDEOTRONICS CORPORATION • 9620 CHESAPEAKE DRIVE (SUITE 204), SAN DIEGO, CA 92123
TEL: (619) 492-9239, FAX: (619) 279-2569

Circle (92) on Reply Card

www.americanradiohistory.com

Editing control systems

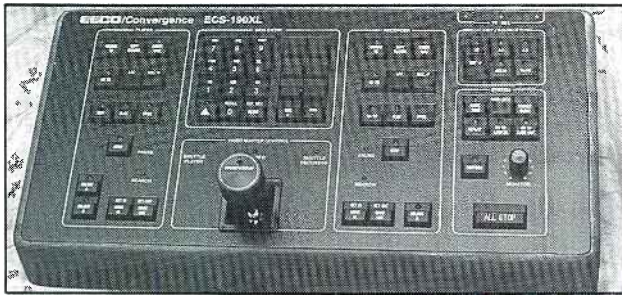

The ECS-190XL

ECSO/Convergence has introduced the ECS-190XL and ECS-195 series of editing controllers. All systems are configured for A/B roll and 3-VTR operation. Joysticks are used for control of tape movement.

- The ECS-190XL features an integral SMPTE time-code reader/generator, sync and color black generator and includes audio editing capability with programmable fades.
- The ECS-195 series supports extensive list management with three levels of non-volatile EDL memory. The 195XL offers 450-event memory and TAG features; the 195+ enhances the list management package with add, delete, replace with or without ripple and sequential/checkerboard auto-assembly. The 195Si boosts the memory to 1,000 events and adds slo-mo and

personalized VTR cue ballistics.

Circle (361) on Reply Card

Standards converter

A.F. Associates has introduced ISIS, an 8-bit, 3-field standards converter with 2-line interpolation. Expansion to 4-field operation is optional.

Signal options include SECAM, PAL-M, PAL-N and RGB/YUV inputs and outputs as well as a CCIR 601 digital interface. Performance options include comb filter decoding, a motion-adaptive temporal aperture, noise reduction and vertical detail enhancement. The unit requires approximately nine inches of a 19-inch equipment rack.

Circle (362) on Reply Card

Recorder with synchronizer

Mitsubishi Pro Audio Group has introduced the X-880 digital audio recorder with CS-1 chase synchronizer. The recorder is a 32-channel system using the ProDigi format and is compatible with previous X-800 series models. It features improved A/D and D/A converters with linear, phase-active analog filters, auto-locator and integral or remotable meter bridge. Options include the CS-1 chase synchronizer to allow 64-track recording with a $\pm 20s$ resolution and the DIF-32 AES/EBU digital interface and IF-SSL-1 analog remote interface linking the recorder to SSL consoles.

Circle (363) on Reply Card

Same Day Transformers!

Our applications engineers help you select the best type for the job from over 70 models in stock, and we'll ship 'em **TODAY!**

jensen transformers
INCORPORATED

10735 Burbank Blvd. • North Hollywood, CA 91601
FAX (818) 763-4574 Phone (213) 876-0059
TELEX 6502919207 MCI UW
(Mon-Thurs, 9am-5pm Pacific time)

Circle (77) on Reply Card

PRECISION MAGNETIC TEST TAPES

STL



Standard Tape Laboratory, Inc.
26120 Eden Landing Road #5, Hayward, CA 94545
(415) 786-3546

Circle (78) on Reply Card

VIDEO SUPPLIES

CABLES • CONNECTORS • CANARE • BELDEN • SWITCHCRAFT • D.A.'S • TIES • BATTERIES • NEUTRIK • 60 INTERFACE BOXES • TAPE • 500 DIFF. TAPE LABELS • GAFFERS TAPE • CASES • PATCH BAYS • LIGHTS • ACOUSTIC FOAM • FORMS • MICROPHONES • SONEK • STANDS • MOUNTS • WIND SCREENS • ZEPPELINS • FIBRE OPTICS • RACKS • DUCT • REELS • TESTERS • FILTERS • CHEMICALS • TOOLS • ON-AIR LIGHTS • DEGAUSSERS • INTERFACE DEVICES • HEADPHONES • CLIPS • SWITCHES • CAM & S/VHS CABLE



MARKERTEK VIDEO SUPPLY
145 Ulster Ave., Saugerties, NY 12477 U.S.A.
TOLL FREE 1-800-522-2025
In NY: 914-246-3036

Circle (79) on Reply Card

Investigate Our Vision!

The CST Series of Townsend UHF Transmitters integrates the art of supervision with the science of information display.

- The industry's first computer-supervised transmitter permits complementary control while maintaining redundant, simple and reliable operation of individual amplifiers.
- EXCLUSIVE - Info-Plex monitors and displays comprehensive information including system status and operating parameters.
- EXCLUSIVE - Info-Plex provides informative graphic flow diagrams of transmitter systems.
- EXCLUSIVE - Unique waveguide to output coupler interface reduces losses, improves reliability. Its simplicity makes klystron installation quick and easy.
- DUALINEAR visual drive amplifier delivers distortion-free amplification and high reliability in a "no single point failure" configuration.

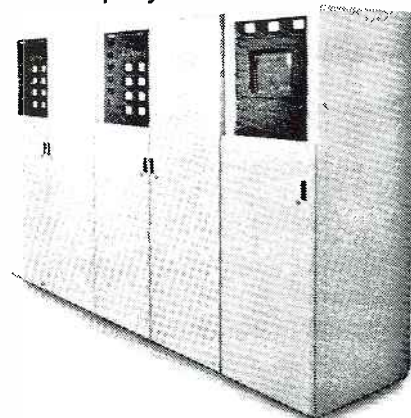

See What We're Becoming
TOWNSEND
BROADCAST SYSTEMS INC.

Townsend Broadcast Systems
(HQ, Mfg., & RF Sales)
79 Mainline Drive
Westfield, MA 01085
413-568-9581

Townsend Broadcast Systems
(Studio Products)
8222 Jamestown Drive
Suite C131
Austin, TX 78758
512-836-6011

In Affiliation with:
Townsend Test and Measurement Group
(Test & Meas. Sales)
8927 J.M. Keynes Drive
Suite 305
Charlotte, NC 28213
704-547-8378

Circle (80) on Reply Card

Low-print audiotape

Ampex Magnetic Tape Division has announced the 478 audio mastering tape for film and video post-production and recording studios. An improved low-print performance provides minimum audible print signals. Other features include a high-speed backcoating process to reduce edge damage and to allow high-speed rewinding of the tape.



Circle (364) on Reply Card

Headsets and shotgun microphone

Beyerdynamic has introduced the following products:

- The DT770/990 studio headsets feature a frequency response of 5Hz-35kHz for reproduction of complex waveforms and extended harmonics. The lightweight designs include a large, low-mass diaphragm. In the DT770, the diaphragm is embedded in a bass-reflex system, and the 990 is a circumaural semi-open air design.

- The MCE86 short shotgun microphone weighs 95g for hand-held, camera mounting or fishpole boom applications. The condenser element with a hypercardioid pattern has a phantom power range from 12Vdc-48Vdc and features a response of 50Hz-18kHz. Two elastic suspension devices are available.

Circle (365) on Reply Card

Time-code equipment

Brabury International has introduced the following products:

- The TCG-201 generator/reader is stored in a leather carrying pouch and allows free-run, record-run, jam-sync and reader modes, selectable from a soft-touch control panel. An LCD display shows time, bits and modes. The unit conforms to EBU specifications.

- The TCI-101 inserter reads time and user bits from 1/30th to 60 times normal play speed in either direction, and it inserts the information into the line driving a video monitor. The display can be positioned on the screen with this freestanding unit that conforms to SMPTE and EBU LTC recommendations.

Circle (366) on Reply Card



**VBB-1 BROADCAST QUALITY
LINE DRIVER**

**EXCEPTIONAL
QUALITY
EXCEPTIONAL
PRICE**

An amplifier in a chip!

Excellent for Component Video

Also available: 1 x 4 DA (featuring VBB-1) — Ideal for HDTV

415-792-8684
415-361-1253 Message Ctr.



ADVANCED VIDEO ASSOCIATES
400 Walnut St., Ste. 101, Redwood City, CA 94063

Circle (99) on Reply Card

AES

brings you the
world of audio

JOIN
PARTICIPATE

Call:
212-661-8528

AMIGA

IS THE COMPUTER FOR VIDEO
GRAPHICS & ANIMATION!!!

INFOTRONICS

IS THE SOURCE
FOR AMIGA VIDEO SYSTEMS.

INFOTRONICS, INC.

P.O. BOX 935
WOODBURY, CT 06798
203-263-5350

Circle (102) on Reply Card

MODEL
CX-2

ONE-STEP

COAXIAL CABLE STRIPPER

Fast consistent cable preparation is easy with the CX-2 Motorized Coaxial Cable Stripper. Prepares a 3-level strip in a single action for any connector configuration. Strips cables from .100 to .430" diameter. Twenty years proven use by leading networks and independent stations. Also available is the CX-1 hand-operated mechanical Co-ax stripper with similar capabilities. Call us for complete descriptive literature.

**WESTERN ELECTRONIC
PRODUCTS CO.**

951-G Calleamanecer, San Clemente, Calif. 92672
Telephone: (714) 492-4677

Circle (46) on Reply Card

Macrokey generator

Black Sand Digital has announced the BSD-901 macrokey generator for use with the Sony BVE-900 video editing controller. The plug-in device is powered from the editing system and stores sequences to 254 keystrokes for recall by each soft key. An LED indicator alerts the operator to the learn and do modes. Learn sequences are executed as they are learned, to eliminate errors in programming.

Circle (368) on Reply Card

Standards converter systems

Merlin, Snell & Wilcox has introduced six new standards converter systems:

- The ME-2001 accepts different HDTV signals and converts to NTSC, PAL or SECAM.
- The ME-9900 universal 4-field converter works with all world standards.
- The ME-9930 is a 4-field converter that converts the three most common standards.
- The ME-8000 series includes transparent conversion using improved motion interpolation algorithms in the ME-8100 single-in, single-out and the ME-8800 full-feature, all-standards system. In addition, 4-field upgrade kits are available for the existing ME-800 series of universal standards converter systems.

Circle (369) on Reply Card

Video graphics equipment

The Chyron Group has announced the Aurora AU/250 videographic system. The system features full-color paint, animation and 3-D capabilities with an 80386 microprocessor for improved processing speed and an SCSI peripheral interface.



Circle (370) on Reply Card

Do you need a full-bore 'on-air' Character Generator?

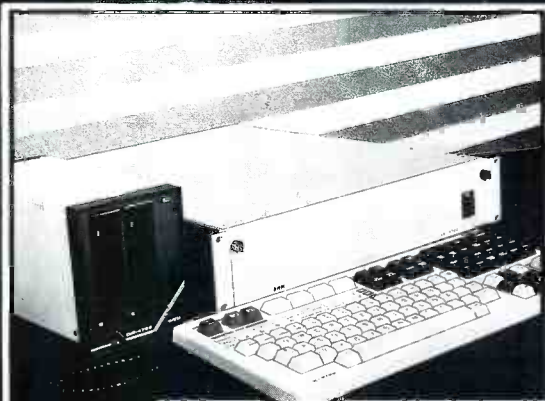

The CG4722
Quality & Speed

Loaded with all the usual features you'd expect in a broadcast quality CG plus as standard

- Font and logo composer
- Auto subtitler from time code pulses
- DSK • SPG • Friendly and fast keyboard
- NTSC Encoder or RGB/YUV
- SMPTE time code reader/auto subtitling
- Dual 3 1/2" disc drives
- Remote keyboard facility
- Space saving electronics and
- Full diagnostics capability

 **PESA**
• Grupo INISEL

Pesa America, Inc., 6073 N.W. 167 Street, Suite C-4, Miami, Florida 33015.
Telephone (305) 556-9638. Telex 6712435. Fax (305) 556 5536.

Circle (84) on Reply Card

Intercom systems

Diless has introduced ProCom, a full-duplex intercommunication system. Each station is equipped with a push-button dial, allowing all users to establish the desired connection at the touch of one button. Any station may be used as belt pack or table-mounted units with interconnection through a standard 3-core microphone cable.

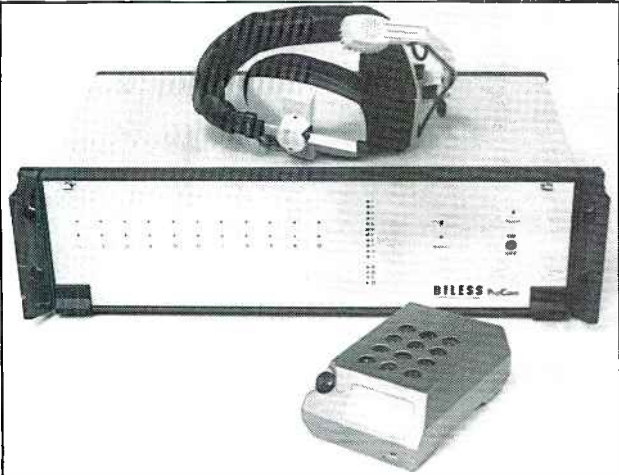

Circle (372) on Reply Card

Framestore, decoder and test unit

GML has introduced the following products:

- The TIM provides two independent channels of infinite-window digital time base correction with field and frame freeze capability for PAL 625/50 color signals.
- The PCD-500 PAL-to-component decoder provides simultaneous outputs of YUV components, RGB plus sync and S-VHS with a digital interface conforming to CCIR-601 as a plug-in option.
- The MTG-205 generator produces CCIR-601 digital component, YUV component and composite outputs selected from an LCD menu display and function keys. The unit includes gen-locking to an external sync source.

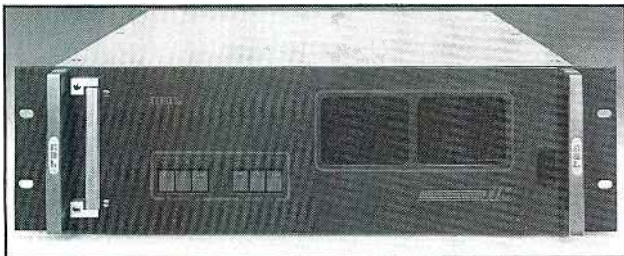

Circle (373) on Reply Card

Digital audio production center

Digital Audio Research has introduced 2- and 8-channel configurations of SoundStation II, a second-generation digital audio recorder and production center. Features include stereo time warp, an animated playback display, punch-in/record, long crossfades and full-chase synchronization. Inputs and outputs can be analog or digital with optional 18-bit A/D and D/A, AES/EBU digital interfacing and 1610/30 digital interface. Winchester or optical WORM disk drives may be used with the system.

Circle (374) on Reply Card

Solve your intercom interface problems forever.

CLEAR-COM

TW-12B

System Interface



** Interfaces: Clear-Com to RTS*

RTS to Clear-Com

Clear-Com to Clear-Com

even RTS to RTS

** Easy, fast, accurate nulling - up to 40dB!*

** Matches system levels - even between incorrect or multiple terminations!*

** Transformer isolated/opto-coupled to eliminate ground loop hum, buzz and noise!*

Call Clear-Com or your local dealer for details



945 Camelia St.
Berkeley, CA 94710
415/527-6666

Circle (83) on Reply Card

STOP GROUND-LOOP HUM!

VIDEO HUM STOP COIL...HSC 2

Will ELIMINATE HUM and other INTERFERENCE in Video Lines caused by differences in Ground Potential.

- Rack Mountable.
- FLAT-DC to 6.5 MHz.
- No low-Freq or Hi-Freq. Roll-off.
- No Differential Phase Distortion.
- No Differential Gain Distortion.
- No Envelope Delay.
- Passive Device - Failure Free-Low Price.
- Small Compact Package 4" x 4" x 2-1/4".

ELIMINATES HUM AND INTERFERENCE:

IN STUDIO

- Between Buildings
- On long runs in Buildings
- Between Studio and Transmitter
- On Incoming Circuits
- On Outgoing Circuits

IN FIELD

- Betw. Remote Truck and Telco
- Betw. Remote Truck and Microwave
- For Intertruck Hookup
- For VTR Units
- For Monitoring Lines

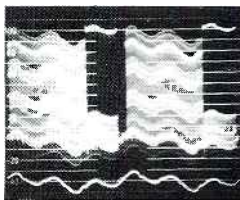

NEW!

**\$190
F. O. B.
N.Y.**

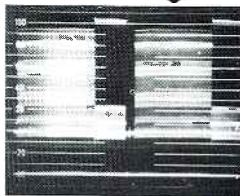

Steadicam accessories

Cinema Products has introduced a series of accessories for the Steadicam. A telescoping balance kit enables easier adjustment of the camera mount in high and low modes with a telescoping support post for expansion or contraction of the main post. A side-to-side balancing camera base plate moves the camera by turning a knob. Also included is a fore/aft/rotating balance control and a dovetail plate for front-to-back movement of the electronics module.

Circle (375) on Reply Card

Video and pulse delay lines and video filters

Broadcast Video Systems has introduced the MINIBOX series of lumped, switched and pinnable video and pulse delay lines and video filters housed in a 3" x 3" x 7/8" metal case. The unit may be freestanding or rack-mounted.

Circle (376) on Reply Card

Patchbays and utility plugs

Connectronics has introduced the J-Bay and X-Bay patchbay systems and a series of Bodge plugs. J-Bay circuit card patchbays use a 1/4-inch jack in the front panel with a 1/4-inch jack, phono or hardwire options at the back. Twenty-two pairs of sockets can be balanced or unbalanced and used in normaled, half-normaled, listen or isolated modes. X-Bay XLR systems can be reconfigured to take a variety of sockets from BNC, MIDI, UHF and F.

XLR-based Bodge plugs have three spring-loaded terminals at one end with a 3-pin male or female XLR connector at the other. The terminals allow connections to be made for temporary, test or experimental equipment hookups.

Circle (377) on Reply Card

MIDI and video interfaces

Integrated Media Systems has introduced an audio interface for use with Abekas A-60, A-62 and A-64 digital videodisc recorders, which adds fully integrated audio. The interface also offers audio I/O for digital videotape recorders and analog outputs for standard ATR and VTR decks as well as AES/EBU, R-DAT and Sony PCM equipment. A track-ball control permits instant random access of sound and auto-bouncing where audio always follows video.

Circle (378) on Reply Card

Portable microwave transmitter

RF Technology has introduced the RF-223B miniature portable microwave transmitter. It is available in any 250MHz segment of the band (1.7GHz-2.7GHz), with the RF power output switchable (12/3W at 2GHz and 10/3W at 2.5GHz). A special "Goldline" version of the transmitter also is available that will cover both 2GHz and 2.5GHz ENG frequency bands in a single unit.

Other standard features include dual, high-quality audio channel with line-/mic-level switching, LPF video input, remote-control capability, wideband (10MHz), narrowband video, base-band switching and 12Vdc operation.

Circle (379) on Reply Card

Available on
10 day free trial

AUDIO-VIDEO ENGINEERING COMPANY
65 Nancy Blvd., Merrick, N.Y. 11566
Tel. (516) 546-4239

Circle (81) on Reply Card

NEW PORTA-BRACE CARRY-ON CASE



► A breakthrough in carry-on camera luggage, the new Porta-Brace Carry-On Case meets FAA suggested size limitations. The case is slim, durable, easy to carry and suprisingly handsome. Some cameras fit under-seat others overhead.

Supplied for certain popular cameras only. Call for prices and availability.



K&H Products, Ltd.

Box 246
North Bennington
Vermont 05257

PHONE 802-442-8171
FAX 802-442-9118

Circle (82) on Reply Card

Professional services

VIR JAMES P.C.
CONSULTING ENGINEERS
Applications and Field Engineering
Computerized Frequency Surveys
3137 W. Kentucky Ave. — 80219
(303) 937-1900
DENVER, COLORADO
Member AFCCE & NAB

**PRO VIDEO & FILM
EQUIPMENT GROUP**
SPECIALISTS IN USED & NEW
WE BUY-SELL-TRADE-CONSIGN
FREE CATALOG ON REQUEST
(214) 869-0011 DALLAS

EVANS ASSOCIATES
CONSULTING TELECOMMUNICATIONS ENGINEERS
AM-FM-TV-CATV-ITFS-LPTV SATELLITE
216 N. Green Bay Road
Thiensville, Wisconsin 53092
Phone: (414) 242-6000 Member AFCCE

FCC ON-LINE DATABASE
dataworld[®]
Allocation/Terrain Studies
AM • FM • TV • LPTV • ITFS
P.O. Box 30730
Bethesda, MD 20814
(301) 652-8822 1-800-368-5754

**D. L. MARKLEY
& Associates, Inc.**
CONSULTING ENGINEERS
2401 West Moss Ave.
Peoria, Illinois 61604
(309) 673-7511
Member AFCCE

K. BLAIR BENSON
Consultant
Television Technology
23 Park Lane
Norwalk, CT 06854
203-838-9049

TEKNIMAX
TELECOMMUNICATIONS
DENNIS R. CIAPURA
PRESIDENT
11385 FORESTVIEW LN.
SAN DIEGO, CA 92131 (619) 695-2429

SMITH and POWSTENKO
Broadcasting and Telecommunications
Consultants
2033 M Street N.W., Suite 600
Washington, D. C. 20036
(202) 293-7742

Robert J. Nissen
THE NISSEN GROUP, INC.
Communications Technology Consultants
32 Ridge Drive • Port Washington, New York 11050
(516) 944-5477

COMMUNICATIONS INC.
• Radio and Television System Design
• Transmitter and Studio Installation
• Microwave and Satellite Engineering
and Installation
201-746-9307 12 North Willow St.
Montclair, NJ 07042

JOHN H. BATTISON P.E.
CONSULTING BROADCAST ENGINEER,
FCC APPLICATIONS AM, FM, TV, LPTV
Antenna Design, Proofs, Fieldwork
890 Clubview Blvd. North
Columbus, Ohio 43085
614/888-3364

ERIC NEIL ANGEVINE, P.E.
consultant in acoustics
specializing in broadcast studio acoustics
910 Lakeridge Drive Stillwater, OK 74075
405-744-6444 405-372-3949

AMERICAN LASER SYSTEMS, INC.
751 S. Kellogg Ave
GOLETA, CA 93117 USA
ENG • STL LINKS • SPORTING EVENTS
Solutions to LICENSE-FREE, short range
video/audio transmissions via infrared
atmospheric links
LORRAINE SHALLENBERGER 805/967-0423
MARKETING MANAGER FAX 805/683-4382

MAILING LABELS
AM, FM & TV
CALL
dataworld[®]
1-800-368-5754

PATCHPRINTS VIDEO TIE LINES
In 1 2 3 4 Aux
Custom Patch Bay Labeling
By
PATCH BAY DESIGNATION COMPANY
Div. of Glendale Rubber Stamp & Printing Co., Inc.
P.O. Box 6278, Glendale, CA 91205 Telephone
4742 San Fernando Road (818) 241-5585
Glendale, CA 91204 FAX (818) 507-5050

East Coast Video Systems
ON-LINE... IN-TIME
A full service company providing... Servicing...
• Consultation • Cable Systems
• Engineering & Design • Corporate Facilities
• Installations • Broadcast Facilities
• Training • Teleproduction Facilities
178 Casterline Road • Denville, NJ 07834 • (212) 431-7453

Consultation Services
Lightning • Power Conditioning • Grounding
Over 40 years experience. work guaranteed
Roy Carpenter
President
Lightning Eliminators and Consultants
13007 Lakeland Rd. Santa Fe Springs, CA 90670
t2131 946-6886 TVIX 910 586-1381

Franklyn R. Beamish & Co.
Engineering for the Video, Motion Picture & Recording Industries
VIDEO POST, BROADCASTING, CONFERENCE CTRS, THEATERS, RECORDING
FACILITIES AND SYSTEMS DESIGN & IMPLEMENTATION
ANALOG & DIGITAL VIDEO, AUDIO, HDTV
ARCHITECTURAL ENGINEERING
ELECTRICAL, HVAC, ACOUSTICAL
574 Sunrise Highway, Baldwin, NY 11510 516/867-8510

Why not run your business card here?
Only \$65 per insertion.
Frequency discounts available.
Call 913/888-4664

UNUSED
CALL LETTERS
CALL
dataworld[®]
1-800-368-5754

Got a hurt Miller? We can restore it to factory original specifications.
MILLER FACTORY SERVICE
• Economical • Thorough
• Fast • Guaranteed
MILLER FLUID HEADS (USA) INC.
410 Garibaldi Avenue Telephone (201) 473-9592
Lodi, New Jersey 07644 FAX (201) 473-9693

Why not run your business card here?
Only \$65 per insertion.
Frequency discounts available.
Call 913/888-4664

Hall Electronics
Broadcast Equipment & Components
• We buy and sell quality used radio broadcast equipment with 30 day warranties & economical prices.
• SEND FOR FREE FLYER!
P.O. Box 7732
Charlottesville, Va. 22906
(804) 977-1100

**MAILING LABELS
AM, FM, TV**
• Personalized to GM, PD, CE
• Accurate
• \$55 per thousand
StationBase
Call (602) 899-8916
1840 E. Warner Rd., #A105-235 Tempe, AZ 85284

BRYSTON

Amplifiers and Control Preamplifiers Dedicated to the Broadcast and Video Production Industries



Model 2B-LP Pro. Modular construction ensures total independence.

Bryston approaches the broadcast and video production industry requirements for high quality, musically accurate, and reliable power amplifiers with the same integrity and commitment to excellence that has earned Bryston its leading position in the professional power amplifier industry for the past 15 years.



Model BP-5 provides all the switching input flexibility that the professional industry demands.

Whether your requirements are for, 50 watts, 800 watts or anything in between Bryston amplifiers can satisfy your every power need. Standard features include such things as dual power supplies, completely independent stereo channels, balanced

XLR connectors, clipping indicators, gain controls, rack mounting, and bridgeable switching.

When a highly versatile and reliable control preamplifier is needed, then the Bryston, BP-1, BP-4 or BP-5 provides all the flexibility required by the professional broadcast and video production industries. Features include such things as balanced XLR connector, cartridge load adjustment, high overload threshold, 1 space rack mount and fully discrete gain blocks. For further information contact:

Bryston Vermont
R.F.D #4, Berlin, Montpelier, Vermont
05602 (802) 223-6159

TRANSMITTER HIGH BAND better on channel G (FFC), CCir system M, output power between 17kw and 34kw, with single on parallel operation. Contact Massad at (212) 475-0667. 2-88-11

WE PLACE ENGINEERS

ALL CATEGORIES FOR TV, PRODUCTION, VIDEO, CATV (EXCLUDING OPERATORS)

America's Leading Source for a Decade
ITV STATIONS, PRODUCTION FACILITIES, CORP. TV, MFG, CATV

For information phone or write Mark Kornish



key systems

479 Northampton Street
Kingston, PA 18704

Employer
Paid Fees

(717) 283-1041

HELP WANTED

IMMEDIATE OPENING for Broadcast Maintenance Engineer at ABC affiliate on the Texas Gulf Coast. Must have at least five years experience and SBE Certification. Experience in VHF transmitter and studio equipment, including one-inch tape and digital systems required. Send resume to: Fred Hoffmann, Texas Television, Inc., P.O. Box 6669, Corpus Christi, TX 78466-6669. E.O.E. 02-89-11

TELEVISION MAINTENANCE ENGINEER Lifetime Television seeks an experienced Maintenance Engineer for its new broadcast facility in Astoria, Queens, New York. Knowledge of Sony 1", 3/4", Beta SP and Betacart desired. Familiarity with G.V.G. Switchers, Editors and FX a plus. Position will involve custom construction and routine maintenance. Available to work evenings. Salary commensurate with experience. Send resume with salary history to: Lifetime Television, 36-12 35th Avenue, Astoria, N.Y. 11106. Attn: Personnel Department. 02-89-11

CHIEF ENGINEER Farmington, New Mexico, VHF network affiliate. Minimum of 5 years hands-on experience with studio and transmitter equipment. Familiar with FCC technical rules and regulations. FCC general license required. Salary commensurate with experience. Send resume to F. Bibeau, KOB-TV, Inc., P.O. Box 1351, Albuquerque, N.M. 87103, EOE M/F 02-89-11

Circle (103) on Reply Card

Classified

Advertising rates in Classified Section are \$1.50 per word, each insertion, and must be accompanied by payment to insure publication.

Each initial or abbreviation counts a full word. Minimum classified charge, \$35.00.

For ads on which replies are sent to us for forwarding (blind ads), there is an additional charge of \$40.00 per insertion, to cover department number, processing of replies, and mailing costs.

Classified columns are not open to advertising of any products regularly produced by manufacturers unless used and no longer owned by the manufacturer or distributor.

TURN YOUR IBM-PC INTO A TELEPROMPTER PC-PROMPT works with your favorite word processor to create smooth scrolling large text. Speed, size, and colors are adjustable. Remote control, camera mounted display and battery powered system for remote shoots are available. PC-PROMPT only \$495. Call Blue Feather Co. (608) 527-5077. 02-89-11

FOR SALE

FOR SALE: Quantel DVM-8000 Mirage - \$295,000; NECEFLEX/OPTIFLEX 2 Ch.; Rot & Persp. - \$33,000; Complete Bosch FDL60B/BVH-2500/GVG100/BVV800 Transfer Suite - \$330,000; Sony BVH-2500 (NEW) full Bridge & Loaded - \$43,000; Chyron RGU-2 Char. Gen. 1 CH.; Encoder; Font Compose - \$10,000; Quantel DPE-5000 Digital Effects - \$9,000; Ikegami HL95/BVV-1A Pkg. w/13X Lens - \$26,500. MICOR VIDEO EQUIPMENT SALES, 312-663-0025 *FAX 312-663-0710, INTERNATIONAL BROKERS OF BROADCAST VIDEO/AUDIO/FILM EQUIPMENT 02-89-11

FOR SALE: Many Ikegami Cameras - HL-79EAL's from \$22,000; HL95's from \$22,000; HL-79D's from \$11,500; ITC-730A's from \$4,500 - Sony BVV-110's (NO ACCESSORIES) - \$1,500; Sony BVW-10 Betacams from \$9,500. MICRO VIDEO EQUIPMENT SALES, 312-663-0025 *FAX 312-663-0710, INTERNATIONAL BROKERS OF BROADCAST VIDEO/AUDIO/FILM EQUIPMENT 02-89-11

FOR SALE: 360 ft. Truscon guyed tower, 48 inch face, solid rod, with lighting, guys, base insulator and 60 ft. pole. Bill Glasser, WHBC Radio, Canton, OH (216) 456-7166. 02-89-21

HIGHEST PRICES for 112 Phase Monitors, vacuum capacitors and clean, one kw or greater powered AM and FM Transmitters. All duty and transportation paid. Surplus Equipment Sales, 2 Throncliffe Park Dr., Unit 28, Toronto, Canada M4H 1H2, 416-421-5631. 3-86-tfn

TRAINING

FCC GENERAL RADIOTELEPHONE operators license through cassette recorded lessons at home plus one week seminar in Boston, Washington, Detroit or Philadelphia. Our twentieth year teaching FCC license courses. Bob Johnson Radio License Preparation, 1201 Ninth, Manhattan Beach, Calif. 90266. Telephone (213) 379-4461. 8-81-tfn

NAPA VALLEY COLLEGE offers a 2-year telecommunication program with emphasis in 1-Inch "C" format, T.B.C.S., component and digital video. Call or write Gary Vann, (707) 253-3258 Napa Valley College, Napa, California 12-88-91

SERVICES

AUDIO AUTOMATION: Computer controlled, 8-CD changers, music and commercial program software, hard disc for commercials. Complete: \$6900. BGM INTERNATIONAL, (904) 438-8054. 7-71-tfn

TRANSMITTER TUBE REBUILDING SINCE 1941: 3CX2500, 4CX5000, 4CX15000 and many others. Write for details. FREELAND PRODUCTS INC., Rt. 7, Box 628, Covington, LA 70433. (504) 893-1243 or (800) 624-7626. 6-79-tfn



TELEVISION ENGINEERS

Turner Broadcasting Systems, the leading News, Sports and Entertainment system in satellite communications, has career opportunities for engineers with broadcast maintenance experience. These positions demand an extensive background in television engineering and at least two years of training in electronics technology. Turner Broadcasting System offers and excellent benefit and compensation program. Send resumes to:

Mr. Jim Brown, Engineer
Turner Broadcasting System, Inc.
One CNN Center
P.O. Box 105366
Atlanta, Georgia 30348-5366
404-827-1638

TBS is an equal opportunity employer.

ATTENTION: WOMEN WHO SOUGHT EMPLOYMENT WITH THE VOICE OF AMERICA (VOA), THE UNITED STATES INFORMATION AGENCY (USIA), OR THE UNITED STATES INTERNATIONAL COMMUNICATION AGENCY (USICA) BETWEEN OCTOBER 8, 1974 AND NOVEMBER 16, 1984.

**YOU MAY BE A VICTIM OF SEX DISCRIMINATION
ENTITLED TO A MONETARY AWARD AND A POSITION WITH THE AGENCY.**

UNITED STATES DISTRICT COURT FOR THE DISTRICT OF COLUMBIA

CAROLEE BRADY HARTMAN, et al.,
Plaintiffs,

v.

CHARLES Z. WICK,
Defendant

Civil Action No. 77-2019
Judge Charles R. Richey

PUBLIC NOTICE

On November 16, 1984, the United States District Court for the District of Columbia found in this class action lawsuit that the United States Information Agency (USIA or the Agency), including the Voice of America (VOA), is liable for sex discrimination against female applicants for the following positions at the Agency. The USIA was also formerly known as the United States International Communication Agency (USICA). On January 19, 1988, the Court issued its opinion ordering relief in a variety of forms to potential class members. Accordingly, this case is now in the remedial phase.

JOBS COVERED

Specifically, the Court has found that the Agency has discriminated against women in hiring in the following jobs:

- Electronic Technician (Occupational Series 856)
- Foreign Language Broadcaster (Occupational Series 1048)
- International Radio Broadcaster (Other) (Occupational Series 1001)
- International Radio Broadcaster (English) (Occupational Series 1001)
- Production Specialist (Occupational Series 1071)
- Writer/Editor (Occupational Series 1082)
- Foreign Information Specialist/Foreign Affairs Specialist/Foreign Service Information Officer/Foreign Service Officer (Occupational Series 1085 and 130)
- Radio Broadcast Technician (Occupational Series 3940)

WHO IS INCLUDED

All women who sought employment with the Agency in any of the jobs listed above between October 8, 1974 and November 16, 1984 and were not hired may be eligible for relief. Also included are those women who were discouraged from applying for these positions during that time period. Even those women subsequently hired by the Agency in some capacity may be entitled to participate in the remedial phase of this case.

Women who sought employment with the Agency as Foreign Service Officers or Foreign Service Information Officers may be eligible for different kinds of relief depending upon the date of application and whether they sought employment at the entry level or mid-level. Women who sought employment with the Agency as entry level Foreign Service Officers or Foreign Service Information Officers in the years 1974-1977 must use the procedure outlined below. Women who sought employment with the Agency as mid-level Foreign Service Officers or Foreign Service Information Officers in the years 1974-1984 must also use the procedure outlined below. However, women who sought employment with the Agency as entry level Foreign Service Officers or Foreign Service Information Officers in the years 1978-1984 cannot use the procedure outlined below, since the Court has ordered an alternative form of relief for them and selected women in this group will be notified individually as to their rights.

RELIEF AVAILABLE AND HOW TO OBTAIN IT

Relief available to class members may include a monetary award and/or priority consideration for a current position with the Agency. If you think you may be entitled to relief, you must obtain a claim form, complete it fully, and return it to counsel for the plaintiff class, Bruce A. Fredrickson, Esq., Webster & Fredrickson, 1819 H Street, N.W., Suite 300, Washington, D.C. 20006 (202/659-8515), postmarked no later than July 15, 1988.

You may obtain a claim form in person and/or in writing from several sources: counsel for the plaintiff class, whose address is listed above; in person from USIA, Front Lobby, 301 4th Street, S.W., Washington, D.C. (8:15am - 5:00pm); Office of Personnel Management (OPM), Federal Job Information Center (First Floor, Room 1425), 1900 E Street, N.W., Washington, D.C. (8:30am - 2:30pm); or from area OPM offices throughout the country; in writing, VOA-Hartman, P.O. Box 400, Washington, D.C. 20044. You should carefully consider all questions on the claim form, sign it, and return it to counsel for the plaintiffs. Do not, under any circumstances, return the claim form to the Judge, the Court or the Clerk of the Court. The Judge, the Court and the Clerk of the Court will not accept the claim forms and will not forward claim forms to plaintiffs' counsel.

PROCESSING OF CLAIMS

The process for handling claims has not been finally decided. Thus far, the Court has ordered that responding class members demonstrate their potential entitlement to relief at an individual hearing to be scheduled at a later date. However, the Court has reserved the right to reconsider this procedure in the event the number of claims filed makes this approach unmanageable.

Should individual hearings be used, you will be fully informed as to the date and time of your hearing. Moreover, you will be entitled to legal representation by counsel for the plaintiff class or his designee at no cost to you. Legal counsel will discuss your claim with you prior to your hearing, help you prepare your case and represent you at your hearing. You may, of course, retain your own attorney to represent you, if you so desire.

At the individual hearing, you will be asked to demonstrate your potential entitlement to relief by showing that you applied for one or more of the covered positions during the period October 8, 1974 and November 16, 1984 and that you were rejected, or that you were discouraged from applying. Evidence may be required in the form of testimony, documents, or both. Once you have demonstrated these facts, USIA is required to prove, by clear and convincing evidence, that you were not hired for each position for which you applied for a legitimate, non-discriminatory reason, such as failure to possess requisite qualifications. Should USIA make such a showing, you would then be entitled to demonstrate that the Agency's reason is merely a cover for sex discrimination or unworthy of belief.

Following the hearing, the Presiding Official will decide whether you are entitled to relief and, if so, what relief is appropriate. You may be entitled to wages and benefits you would have earned if you had been hired (back pay) from the date of your rejection until the date relief is approved. Under the law, back pay is offset by earnings you may have had during the period. In addition, you may be found to be entitled to front pay (that is, compensation into the future until an appropriate position is afforded you). Similarly, you may be found to be entitled to priority consideration for employment with the Agency. If hired, you may further be entitled to retroactive seniority with the associated benefits and the value of any promotions you would likely have had if you had not suffered discrimination.

REQUIRED STEPS TO FILE YOUR CLAIM

To participate in the remedial phase, you must fully complete the claim form and return it, POSTMARKED NO LATER THAN July 15, 1988, to counsel for the plaintiff class. Your failure to do so will result in your losing all rights you may have in this lawsuit. If you have questions about your rights or procedures available to you, you may contact counsel for the plaintiff class:

Bruce A. Fredrickson
Webster & Fredrickson
1819 H Street, N.W., Suite 300
Washington, D.C. 20006
(202/659-8515)

October 4, 1988

Date

/s/ Judge Charles R. Richey

United States District Court
Judge Charles R. Richey

RF SERVICE ENGINEER

One of the nation's premier telecommunications companies currently seeks an RF Service Engineer to provide customer and engineering support to sales staff and RF field service for TV transmitters.

Based in Dallas, this individual will be responsible for installing TV transmitters; checking performance and repairing RF products; answering customer inquiries; interfacing with vendors to make orders; and preparing drawings and documents. This position

requires three years of related experience and the willingness to travel 50%.

If you meet these qualifications, send your resume and salary history to: Stackig, Sanderson & White, Dept. LR, 7680 Old Springhouse Road, McLean, VA 22102. We are the advertising agency for this client, not an employment agency. No fees are involved. No phone calls please. Our client is an equal opportunity employer.

SALES REPRESENTATIVES and Equipment Suppliers: World famous Telenorma Clocks...Analog and Digital with silent movements are available for distribution in the U.S.A. Contact: Time Service Systems Inc., 30 East Beaver Creek Rd. #117, Richmond Hill, Ontario, Canada L4B 1J2, Tel: (416) 764-7720 02-89-1t

TV TRANSMITTER MAINTENANCE ENGINEER Fox Television, WFXT, Boston is seeking a qualified transmitter engineer with strong background in RF. Previous experience with RCA-TTU110 UHF transmitter and studio equipment preferred. FCC lic. or SBE certification required. Send resume/references to: Moses Primo, C.E., WFXT-TV, 100 2nd Ave., Needham, MA 02194. EQUAL OPPORTUNITY EMPLOYER. 02-89-1t

Electronics

TV STATION ENGINEER

Illinois Institute of Technology's instructional television fixed service has an outstanding opportunity available with an opportunity for advancement in the near future.

Work will involve a variety of technical tasks required to maintain operations at a highly professional level. Will perform necessary testing, installation, operation and maintenance of TV transmitter, studio, video recording equipment, satellite downlink and uplink equipment and enter components in the IIT/V system.

Requirements include FCC license and 3-4 years experience as a Television Engineer. Bachelor degree preferred.

Attractive salary and benefits, including tuition in an outstanding research university. Apply to:

Manager, Employment
ILLINOIS INSTITUTE
OF TECHNOLOGY
IIT CENTER

Chicago, Illinois 60616

Affirmative Action/Equal Opportunity Employer

M/F

2-89-1t

ENGINEER BROADCASTING/CABLE TV SYSTEMS OVERSEAS CONTRACT ASSIGNMENTS

Tridents' European branch based in Holland has urgent assignments for Professional Engineers for 2-3 year contracts in Madrid, Spain. Excellent rates and package.

Must have 5 years' experience and be competent in the following areas:

- Broadcasting/Cable TV Systems
- Transmitter and Transpowers
- Signal Dumping and Amplification
- Cable Installation
- Specification/Selection of Networks
- Microprocessor H/W and S/W design and development

Please send your resume to:

Trident Computer Services Inc.
33 Boston Post Road
Suite 250
Marlborough, Massachusetts 01752
or phone 1-800-344-4827

TRIDENT
COMPUTER SERVICES INC.

SOUTH FLORIDA OFFICE of Midwest Communications Corp., the nations largest Video Equipment/Systems Dealer seeks well qualified and experienced video service technicians to work in our service shop. Systems experience a plus. Send resume with salary history to: 8875 N.W. 23rd Street, Miami, Florida 33172 02-89-1t

TRANSMITTER/STUDIO ENGINEER needed for Worcester, Massachusetts UHF television station. Strong background in UHF transmitters. Also, studio maintenance background helpful. Contact Fran Vaccari, Chief Engineer, WHLL-TV, 617-799-2727. 7-88-1fn

CHIEF TELEVISION ENGINEER Outstanding opportunity for Chief Engineer to make an impact as a member of our creative team as we design and implement a statewide television system, using fiberoptic, ITFS and standard microwave technologies. Chief will play an integral part in the design, construction and equipping of a video production/operations facility designed to broadcast standards and scheduled for completion next year. You will supervise engineering for multi-camera production and ITFS operations, and oversee equipment specifications, installation and maintenance. Salary competitive with industry standards. Attractive benefit package. Requires at least 3 years television engineering experience, including maintenance and staff supervision, design of television systems and knowledge of digital, microwave and satellite technologies. For more information, call Fred Hurst, Operations Manager, Maine Interactive Television System, (207) 622-7131. To apply, send resume and letter of application to: Fred Hurst, Interactive Television, University of Maine at Augusta, Augusta, Maine 04330. Screening of applicants will begin March 1, 1989. THE UNIVERSITY OF MAINE IS AN AFFIRMATIVE ACTION/EQUAL OPPORTUNITY EMPLOYER. 02-89-1t

Advertising sales offices

SANTA MONICA, CALIFORNIA

Herbert A. Schiff
Telephone: (213) 393-9285
Telefax: 213/393-2381

Jason Perlman
Telephone: (213) 458-9987
Telefax: 213/393-2381

Chris Woodbury-Leonard
Telephone: (213) 451-8695
Telefax: 213/393-2381

Schiff & Associates
501 Santa Monica Blvd., Ste. 504
Santa Monica, CA 90401

TOKYO, JAPAN

Mashy Yoshikawa
Orient Echo, Inc.
1101 Grand Maison
Shimomiyabi-Cho, 2-18
Shinjuku-ku, Tokyo 162, Japan
Telephone: (03) 235-5961
Telex: J-33376 MYORIENT

CHICAGO, ILLINOIS

Vytas Urbonas
Telephone: (312) 435-2361
Telefax: (312) 922-1408
55 East Jackson
Ste. 1100
Chicago, IL 60604

NEW YORK, NEW YORK

Diane Gottlieb-Klusner
Telephone: (212) 702-3404
Telefax: (212) 702-7802
David W. Frankel
Telephone: (212) 702-3405
Telefax: (212) 702-7802
866 Third Ave.
New York, NY 10022

OXFORD, ENGLAND

Nicholas McGeachin
Intertec Publishing Corp.
Roseleigh House
New Street
Deddington
Oxford OX5 4SP
England
Telephone: (0869) 38794
Telefax: (0869) 38040
Telex: 837469 BES G

FREWVILLE, AUSTRALIA

John Williamson
Hastwell, Williamson, Rep. Pty. Ltd.
109 Conyngham Street
Frewville 5063
South Australia
Phone: 799-522
FAX: 08 79 9522
Telex: AA87113 HANDM

INTERTEC
PUBLISHING CORPORATION
©1989. All rights reserved.

Ad index

	Page Number	Reader Service Number	Advertiser Hotline		Page Number	Reader Service Number	Advertiser Hotline
Abekas Video Systems	37	20	415/571-1711	Markertek Video Supply	118	79	800/522-2025
Adrienne Electronics Corp.	86	61	800/782-2321	Microwave Development Laboratories, Inc.	70	85	
Advanced Video Associates	119	99	415/792-8684	Midwest Communications Corp.	1	3	800/543-1584
ADX Systems USA	46	72	800/444-4ADX	Midwest Communications Corp.	5	5	800/543-1584
AKG Acoustics, Inc.	93		203/348-2121	Mohawk Wire & Cable	86	60	800/422-9961
Alexander Mfg. Co.	54	31,32	800/247-1821	Nikon Corporation	103	55	
Alpha Audio	116	74	804/358-3852	Opamp Labs, Inc.	64	101	213/934-3566
Alta Group, Inc.	75	49	408/297-2582	Orban Associates, Inc.	7	6	800/227-4498
Amber Electro Design Inc.	32	17	800/361-3697	Orban Associates, Inc.	17	11	800/227-4498
Amek Systems and Controls Ltd.	71	47	818/508-9788	Otari Corp.	15	10	415/341-5900
Ampex Corp. (AVSD)	66-67	43	415/367-2911	Otari Corp.	68	90	415/341-5900
Ampex Corp. (MTD)	29	14	415/367-2911	Panasonic Pro Industrial Video	34-35	19	800/553-7222
Ampex Corp. (MTD)	81	52	415/367-2911	Pesa Electronica S.A.	120	84	
Anton/Bauer Inc.	99	64	203/929-1100	Pinnacle Systems, Inc.	113	70	408/970-9787
Anvil Cases, Inc.	48	27	818/575-8614	Polyline Corp.	62	37	312/297-0955
Arrakis Systems, Inc.	21	13	303/224-2248	Quantel Ltd.	77	50	
Arrakis Systems, Inc.	27	13	303/224-2248	Radiation Systems, Inc.	100	65	
Audio-Video Engineering Co.	122	81	515/546-4239	Ram Broadcast Systems, Inc.	110	69	516/832-8080
Audiotronics, Inc.	59	35	901/362-1350	Rank Cintel Inc.	39	22	914/268-8911
Belar Electronics Laboratory, Inc.	64	41	215/687-5550	Research Technology Inc.	44	24	800/851-4028
Benchmark Media Systems	62	38	315/452-0400	ROH	92	91	800/262-4671
Berc	61	36	818/841-3000	RTS Systems, Inc.	74	48	818/843-7022
BEXT Inc.	100	66	619/239-8462	Shure Brothers, Inc.	IFC	1	312/866-2553
Broadcast Supply West	85	59	800/426-8434	Sony Communication Prod/Broadcast Div.	50-51		800/635-SONY
Broadcasts Video Systems, Ltd.	92	100	416/764-1584	Sony Communication Prod/Broadcast Div.	72-73		800/635-SONY
Bryston Vermont	124	103	802/223-6159	Sony Communication Prod/Broadcast Div.	88-89		800-635-SONY
BTS Broadcast Television Systems	47	26	801/972-8000	Sony Communication Prod/Pro Video	24-25		800/653-SONY
Cablewave Systems	69	44	203/239-3311	Sony Corporation/ Pro Mavica	95	54	800/222-0878
Centro Corp.	31	15,16	619/560-1578	Sony Mag. Tape Div.	87		201/930-7669
Clear-Com Intercom Systems	121	83	415/861-6666	Standard Tape Laboratory, Inc.	64	76	415/786-3546
Comad Communications	112	57	800/387-4991	Stanton Magnetics	60	89	516/349-0235
Conus Communications	52	29	612/642-4679	Stantron/Unit of Zero Corp.	79	96,97	800/821-0019
Crosspoint Latch Corp.	128	94	201/688-1510	Studer Revox America, Inc.	11	8	615/254-5651
Delta Electronics	106	87	703/354-3350	Tascam Div. TEAC Corp of America	45	25	213/726-0303
Di-Tech, Inc.	IBC	2	516/667-6300	Telex Communications, Inc.	49	28	612/887-5550
Electro-Voice, Inc.	101	67	616/695-6831	Telex Communications, Inc.	109	68	612/887-5550
Faroudja Laboratories, Inc.	83	58	408/245-1492	Toshiba Corp.	63	39	914/273-1750
Full Compass Systems	116	73	800/356-5844	Townsend Broadcast Systems	118	80	413/568-9581
Gentner Electronics Corp.	64	40	801/268-1117	Utah Scientific, Inc.	56-57	34	800/453-8782
Gentner Electronics Corp.	65	42	801/268-1117	Utah Scientific, Inc.	111	93	800/453-8782
Ghielmetti	30	86	818/707-1134	Varian	13	9	415/592-1221
Graham-Patten Systems, Inc.	91	62	800/547-2489	Videotek, Inc.	53	30	602/997-7523
Grass Valley Group, Inc.	9	7	916/273-8421	Ward-Beck Systems Ltd.	BC		416/438-6550
Hedco	33	18	800/433-2648	Western Electronic Products Co.	119	46	714/492-4677
Hitachi Denshi America Ltd.	3	4	800/645-7510	Winsted Corp.	116	98	800/447-2257
I-Den Videotronics Corp.	117	92		Yamaha International Corp.	104-105	56	
Ikegami Electronics, Inc.	40-41		201/368-9171				
Infotronics	119	102	203/263-5350				
Jampro Antennas, Inc.	38	21	916/383-1177				
Jensen Transformers, Inc.	118	77	213/876-0059				
JVC Professional Products Co.	19	12	800/582-5825				
K&H Products Ltd.	122	82	802/442-8171				
Leitch Video of America, Inc.	55	33	804/424-7290				
3M Broadcast & Related Products	43	23	800/328-1684				

6129



A GENERATION AHEAD OF ITS TIME

**SIX LEVELS OF VIDEO
IN TWO MIX EFFECTS SYSTEMS
FOR FEWER TAPE GENERATIONS
IN EDITING**

from
\$10,995

**SURPASSES EVERYTHING
IN ITS CLASS AND BEYOND
NOTHING ELSE EVEN COMES CLOSE**

A demonstration tape is available for only \$15.

UNMATCHED ELECTRICAL SPECIFICATIONS

STANDARD FEATURES

TWO MIX EFFECTS SYSTEMS
FOUR LEVELS OF KEYS OVER BACKGROUND
800 EVENT MEMORY
32 PATTERN GENERATOR
TWO PROGRAMMABLE FADER ARMS
RGB CHROMA KEYS
THREE COLORIZERS
FIVE FRAME ACCURATE TRANSITIONS
LINEAR KEYS
THREE COLORIZERS

OPTIONS

SECOND CHROMA KEYS
SECOND DSK WITH OUTLINE AND DROP SHADOW
16 INPUTS WITH SHIFT KEY
SECOND 32 PATTERN GENERATOR
SERIAL OR PARALLEL EDITOR INTERFACE
NEXT EVENT PREVIEW

ACCESSORIES

STEREO AUDIO FOLLOW MIXER

CROSSPOINT LATCH CORP.

95 PROGRESS STREET • UNION, N.J. 07083 USA
Country Code 1 • (201) 688-1510 • Telex 132850 • FAX (201) 688-8094

CROSSPOINT LATCH CORP.

FINANCING AVAILABLE (SUBJECT TO CREDIT APPROVAL)

Circle (94) on Reply Card

ACTION CARD

IMPORTANT: Do you wish to receive or continue to receive your free subscription? Yes No

Your signature is required _____ Date _____

Please answer all the following questions. Please print or type:

Name _____

Title _____

Company _____

Co. Address _____

City _____ State _____ Zip _____

Phone (_____) _____

For address change or literature request, place peel-off label from cover here

FREE LITERATURE REQUEST

For Issue of February 1989 Use until June 1989

(After this date, please contact supplier directly.)

FASTER ACTION!

If you have immediate interest in any products in this issue, write in the number(s) below and check all the appropriate boxes.

I am interested in these items ▼	Immediate Need	Have Sales-person Call	Name Nearest Dealer	Send Literature	For Future Reference
	<input checked="" type="checkbox"/>	<input checked="" type="checkbox"/>	<input checked="" type="checkbox"/>	<input checked="" type="checkbox"/>	<input checked="" type="checkbox"/>
#					
#					
#					
#					

Circle reader service numbers below for more information

1	17	33	49	65	81	97	113	129	145	161	177	193	209	225	241	257	273	289	305	321	337	353	369	385	401	417	433	449	465	481	497	513	529	545	561	577	593
2	18	34	50	66	82	98	114	130	146	162	178	194	210	226	242	258	274	290	306	322	338	354	370	386	402	418	434	450	466	482	498	514	530	546	562	578	594
3	19	35	51	67	83	99	115	131	147	163	179	195	211	227	243	259	275	291	307	323	339	355	371	387	403	419	435	451	467	483	499	515	531	547	563	579	595
4	20	36	52	68	84	100	116	132	148	164	180	196	212	228	244	260	276	292	308	324	340	356	372	388	404	420	436	452	468	484	500	516	532	548	564	580	596
5	21	37	53	69	85	101	117	133	149	165	181	197	213	229	245	261	277	293	309	325	341	357	373	389	405	421	437	453	469	485	501	517	533	549	565	581	597
6	22	38	54	70	86	102	118	134	150	166	182	198	214	230	246	262	278	294	310	326	342	358	374	390	406	422	438	454	470	486	502	518	534	550	566	582	598
7	23	39	55	71	87	103	119	135	151	167	183	199	215	231	247	263	279	295	311	327	343	359	375	391	407	423	439	455	471	487	503	519	535	551	567	583	599
8	24	40	56	72	88	104	120	136	152	168	184	200	216	232	248	264	280	296	312	328	344	360	376	392	408	424	440	456	472	488	504	520	536	552	568	584	600
9	25	41	57	73	89	105	121	137	153	169	185	201	217	233	249	265	281	297	313	329	345	361	377	393	409	425	441	457	473	489	505	521	537	553	569	585	601
10	26	42	58	74	90	106	122	138	154	170	186	202	218	234	250	266	282	298	314	330	346	362	378	394	410	426	442	458	474	490	506	522	538	554	570	586	602
11	27	43	59	75	91	107	123	139	155	171	187	203	219	235	251	267	283	299	315	331	347	363	379	395	411	427	443	459	475	491	507	523	539	555	571	587	603
12	28	44	60	76	92	108	124	140	156	172	188	204	220	236	252	268	284	300	316	332	348	364	380	396	412	428	444	460	476	492	508	524	540	556	572	588	604
13	29	45	61	77	93	109	125	141	157	173	189	205	221	237	253	269	285	301	317	333	349	365	381	397	413	429	445	461	477	493	509	525	541	557	573	589	605
14	30	46	62	78	94	110	126	142	158	174	190	206	222	238	254	270	286	302	318	334	350	366	382	398	414	430	446	462	478	494	510	526	542	558	574	590	606
15	31	47	63	79	95	111	127	143	159	175	191	207	223	239	255	271	287	303	319	335	351	367	383	399	415	431	447	463	479	495	511	527	543	559	575	591	607
16	32	48	64	80	96	112	128	144	160	176	192	208	224	240	256	272	288	304	320	336	352	368	384	400	416	432	448	464	480	496	512	528	544	560	576	592	608

Use this form to...

- Apply for or renew your FREE subscription
- Request FREE literature on items in this issue
- Submit change of address

(Check all that apply)

ALL INFORMATION MUST BE PROVIDED!

1. Which statement best describes your role in the purchase of equipment components and accessories?

- A Make final decision to buy a specific make or model.
- B Specify or make recommendation on make or model.
- C Have no part in buying or specifying.

2. What is your annual budget for equipment purchases? (check only one):

- A Less than \$25,000
- B \$25,000 to \$49,999
- C \$50,000 to \$99,999
- D \$100,000 to \$249,999
- E Over \$250,000

3. Please check the ONE type of facility or operation that best describes your business classification.

- 19 Low Power TV Station
- 20 TV Station
- 21 AM Station
- 22 FM Station
- 23 AM & FM Station
- 24 TV & AM Station
- 25 TV & FM Station
- 26 TV, AM & FM Station
- 27 CATV Facility
- 28 Non-Broadcast TV including Closed Circuit TV (CCTV)
- 29 Recording Studio
- 30 Teleproduction Facility
- 31 Microwave, Relay Station or Satellite Company
- 32 Government
- 33 Consultant (Engineering or Management)
- 34 Dealer, Distributor or Manufacturer
- 35 Other _____

(Please specify)

4. If you checked 20 through 26 above, which of the following best describes your over-the-air station? (check only one):

- A Commercial
- B Educational
- C Religious
- D Campus Low Frequency
- E Community
- F Municipally Owned

5. Which of the following best describes your title? Write the number in the box (select one number only):

- A **Company Management** — (1) Chairman of the Board, (2) President, (3) Owner, (4) Partner, (5) Director, (6) Vice President, (7) General Manager (other than in charge of Engineering or Station Operations Mgt.), (8) Other Corp./ Financial Officials.
- B **Technical Management & Engineering** — (9) Technical Director/Mgr., (10) Chief Engineer, (11) Other Engineering or Technical Titles.
- C **Operations & Station Management/Production & Programming** — (12) VP Operations, (13) Operation Mgr./ Director, (14) Station Mgr., (15) Production Mgr., (16) Program Mgr., (17) News Director, (18) Other Operations Title.
- D **Other:** Specify _____

6. What is the ADI rank of your station?

- A Top 20
- B 21 to 50
- C 51 to 100
- D Over 100

Which one advertisement in this issue was of most interest to you?

Advertiser's name _____ Circle No. _____

Your comments on this issue:

NO ENVELOPE NECESSARY
FOLD—TAPE—STAMP—MAIL



Place
First Class
Postage Stamp
Here

BROADCAST[®] engineering

P.O. BOX 12902
OVERLAND PARK, KANSAS 66212-0902

Circulation Department



ACTION CARD

IMPORTANT: Do you wish to receive or continue to receive your free subscription? Yes No

Your signature is required _____ Date _____

Please answer all the following questions. Please print or type:

Name _____

Title _____

Company _____

Co. Address _____

City _____ State _____ Zip _____

Phone (_____) _____

For address change or literature request, place peel-off label from cover here

FREE LITERATURE REQUEST

For Issue of February 1989 Use until June 1989

(After this date, please contact supplier directly.)

FASTER ACTION!

If you have immediate interest in any products in this issue, write in the number(s) below and check all the appropriate boxes.

I am interested in these items ↓	✓	✓	✓	✓	✓
#					
#					
#					
#					

Circle reader service numbers below for more information

1	17	33	49	65	81	97	113	129	145	161	177	193	209	225	241	257	273	289	305	321	337	353	369	385	401	417	433	449	465	481	497	513	529	545	561	577	593
2	18	34	50	66	82	98	114	130	146	162	178	194	210	226	242	258	274	290	306	322	338	354	370	386	402	418	434	450	466	482	498	514	530	546	562	578	594
3	19	35	51	67	83	99	115	131	147	163	179	195	211	227	243	259	275	291	307	323	339	355	371	387	403	419	435	451	467	483	499	515	531	547	563	579	595
4	20	36	52	68	84	100	116	132	148	164	180	196	212	228	244	260	276	292	308	324	340	356	372	388	404	420	436	452	468	484	500	516	532	548	564	580	596
5	21	37	53	69	85	101	117	133	149	165	181	197	213	229	245	261	277	293	309	325	341	357	373	389	405	421	437	453	469	485	501	517	533	549	565	581	597
6	22	38	54	70	86	102	118	134	150	166	182	198	214	230	246	262	278	294	310	326	342	358	374	390	406	422	438	454	470	486	502	518	534	550	566	582	598
7	23	39	55	71	87	103	119	135	151	167	183	199	215	231	247	263	279	295	311	327	343	359	375	391	407	423	439	455	471	487	503	519	535	551	567	583	599
8	24	40	56	72	88	104	120	136	152	168	184	200	216	232	248	264	280	296	312	328	344	360	376	392	408	424	440	456	472	488	504	520	536	552	568	584	600
9	25	41	57	73	89	105	121	137	153	169	185	201	217	233	249	265	281	297	313	329	345	361	377	393	409	425	441	457	473	489	505	521	537	553	569	585	601
10	26	42	58	74	90	106	122	138	154	170	186	202	218	234	250	266	282	298	314	330	346	362	378	394	410	426	442	458	474	490	506	522	538	554	570	586	602
11	27	43	59	75	91	107	123	139	155	171	187	203	219	235	251	267	283	299	315	331	347	363	379	395	411	427	443	459	475	491	507	523	539	555	571	587	603
12	28	44	60	76	92	108	124	140	156	172	188	204	220	236	252	268	284	300	316	332	348	364	380	396	412	428	444	460	476	492	508	524	540	556	572	588	604
13	29	45	61	77	93	109	125	141	157	173	189	205	221	237	253	269	285	301	317	333	349	365	381	397	413	429	445	461	477	493	509	525	541	557	573	589	605
14	30	46	62	78	94	110	126	142	158	174	190	206	222	238	254	270	286	302	318	334	350	366	382	398	414	430	446	462	478	494	510	526	542	558	574	590	606
15	31	47	63	79	95	111	127	143	159	175	191	207	223	239	255	271	287	303	319	335	351	367	383	399	415	431	447	463	479	495	511	527	543	559	575	591	607
16	32	48	64	80	96	112	128	144	160	176	192	208	224	240	256	272	288	304	320	336	352	368	384	400	416	432	448	464	480	496	512	528	544	560	576	592	608

Use this form to...

- Apply for or renew your FREE subscription
- Request FREE literature on items in this issue
- Submit change of address

(Check all that apply)

ALL INFORMATION MUST BE PROVIDED!

1. Which statement best describes your role in the purchase of equipment components and accessories?
 - A Make final decision to buy a specific make or model.
 - B Specify or make recommendation on make or model.
 - C Have no part in buying or specifying.
2. What is your annual budget for equipment purchases? (check only one):
 - A Less than \$25,000
 - B \$25,000 to \$49,999
 - C \$50,000 to \$99,999
 - D \$100,000 to \$249,999
 - E Over \$250,000
3. Please check the ONE type of facility or operation that best describes your business classification.

19 <input type="checkbox"/> Low Power TV Station	28 <input type="checkbox"/> Non-Broadcast TV including Closed Circuit TV (CCTV)
20 <input type="checkbox"/> TV Station	29 <input type="checkbox"/> Recording Studio
21 <input type="checkbox"/> AM Station	30 <input type="checkbox"/> Teleproduction Facility
22 <input type="checkbox"/> FM Station	31 <input type="checkbox"/> Microwave, Relay Station or Satellite Company
23 <input type="checkbox"/> AM & FM Station	32 <input type="checkbox"/> Government
24 <input type="checkbox"/> TV & AM Station	33 <input type="checkbox"/> Consultant (Engineering or Management)
25 <input type="checkbox"/> TV & FM Station	34 <input type="checkbox"/> Dealer, Distributor or Manufacturer
26 <input type="checkbox"/> TV, AM & FM Station	
27 <input type="checkbox"/> CATV Facility	35 <input type="checkbox"/> Other _____

(Please specify)
4. If you checked 20 through 26 above, which of the following best describes your over-the-air station? (check only one):

A <input type="checkbox"/> Commercial	D <input type="checkbox"/> Campus Low Frequency
B <input type="checkbox"/> Educational	E <input type="checkbox"/> Community
C <input type="checkbox"/> Religious	F <input type="checkbox"/> Municipally Owned
5. Which of the following best describes your title? Write the number in the box (select one number only):
 - A **Company Management** — (1) Chairman of the Board, (2) President, (3) Owner, (4) Partner, (5) Director, (6) Vice President, (7) General Manager (other than in charge of Engineering or Station Operations Mgt.), (8) Other Corp./Financial Officials.
 - B **Technical Management & Engineering** — (9) Technical Director/Mgr., (10) Chief Engineer, (11) Other Engineering or Technical Titles.
 - C **Operations & Station Management/Production & Programming** — (12) VP Operations, (13) Operation Mgr./Director, (14) Station Mgr., (15) Production Mgr., (16) Program Mgr., (17) News Director, (18) Other Operations Title.
 - D **Other:** Specify _____
6. What is the ADI rank of your station?
 - A Top 20
 - B 21 to 50
 - C 51 to 100
 - D Over 100

Which one advertisement in this issue was of most interest to you?

Advertiser's name _____ Circle No. _____

Your comments on this issue:

NO ENVELOPE NECESSARY
FOLD—TAPE—STAMP—MAIL



Place
First Class
Postage Stamp
Here

BROADCAST[®] engineering

P.O. BOX 12902
OVERLAND PARK, KANSAS 66212-0902

Circulation Department





DI TECH'S VIRTUAL MATRIX MAKES OTHER ROUTERS VIRTUALLY PASSÉ



Model 5861
64x32 Video Switcher

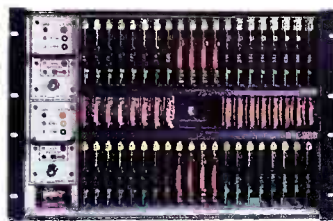

Model 5862
64x32 Audio Switcher

Routing switchers are simple and efficient when all you need is a full AFV matrix. If you try reserving a few video only or audio only crosspoints, however, they can quickly become very clumsy and awkward. Now, you could play games moving switch cards around, tie up "spare" inputs with terminators, or rewire your router frames. But there is a better way.

Di-Tech's *virtual matrix* control system, Model 9002, maintains a software map of your router's hardware connections. This makes it easy to define single level crosspoints *anywhere* in a matrix, as well as preset breakaway switches. Special purpose routing – such as time code, RS422 or RGB – can be smoothly integrated into an 8 level master grid at any time.

Prepare for tomorrow with the company that can do it all today...Di-Tech.



di-tech inc.

48 Jeffryn Boulevard, Deer Park, New York 11729
(516) 667-6300, Telex No. 971806, FAX (516) 595-1012

Circle (2) on Reply Card

Routing switchers are simple and efficient when all you need is a full AFV matrix. If you try reserving a few video only or audio only crosspoints, however, they can quickly become very clumsy and awkward. Now, you could play games moving switch cards around, tie up "spare" inputs with terminators, or rewire your router frames. But there is a better way.



The ST Series by Ward-Beck. Television's first true Stereo Console!

Ward-Beck proudly introduces the first purebred
Stereo Television Console.

This is no ordinary mixing board modified and adapted for stereo TV. The ST Series has been designed, without compromise, from the ground up to give television broadcasters full stereo facilities.

The ST evolved from extensive consultation with end-users, resulting in a microprocessor controlled system incorporating totally new circuitry, new module designs, and a unique console profile for enhanced operational simplicity.

The ST3642 has ample capacity for major production facilities, while the ST2442 is ideal for on-air and smaller production applications.

The ST Series... Legendary Ward-Beck quality, competitively priced, for every television market!



First by Design.

Ward-Beck Systems Ltd.,
841 Progress Avenue, Scarborough, Ontario, Canada M1H 2X4.
Tel: (416) 438-6550 Tlx: 065-25399.