

The LPTV Report

News and Strategies for Community Television Broadcasting

NAB '92

Vol. 7, Issue 3 • March 1992

\$5.00

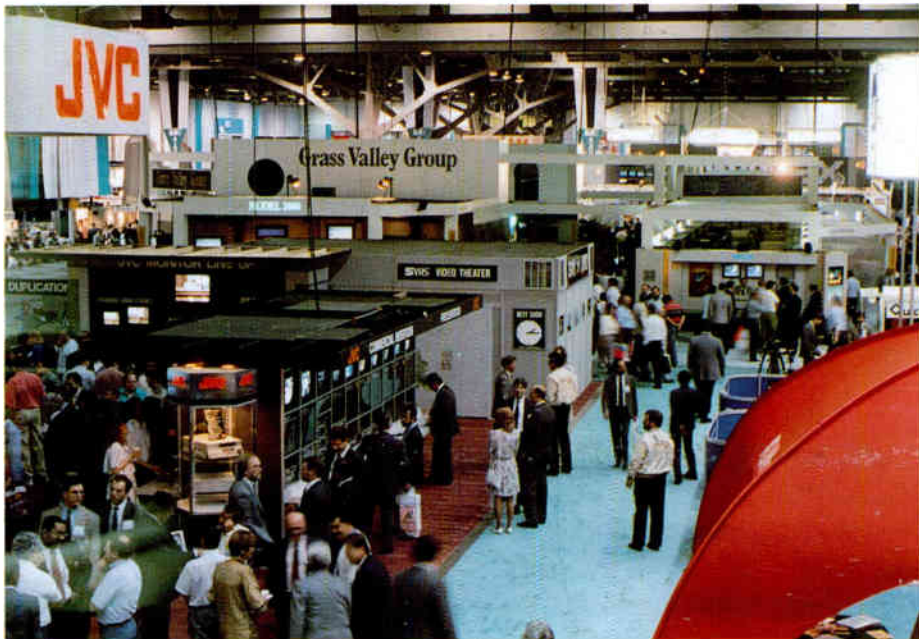

The NAB floor is a busy place. Bring your walking shoes.

“Working With The Competition” To Be LPTV Panel Theme

Again this year, the NAB Convention will host a gathering for LPTV broadcasters and those interested in community television. The session — entitled **Community Television Comes of Age** — will explore the many ways community broadcasters and full power stations can work together to benefit themselves and their communities.

The meeting is being organized by Community Broadcasters Association vice president Woody Jenkins of TV 19 in Baton Rouge. Invited speakers include Roy Stewart, chief of the FCC's Mass Media Bureau; Peter Tannenwald, CBA general counsel; and community broadcasters Robert Raff and D. J. Everett.

The 1½-hour session is scheduled for Wednesday, April 15, at 2 p.m. in Room N242 of the Las Vegas Convention Center. It is open to anyone involved in LPTV or interested knowing more about it. Full power TV broadcasters are especially welcome.

Other NAB sessions are highlighted below. For detailed information — and times and places — see the NAB session and exhibit guide, available at the registration desk.

...

Zenith Electronics chairman Jerry Pearlman will be the keynote speaker at the opening ceremonies of **HDTV World** on Monday, April 13. Pearlman will discuss some of the key issues raised by

continued on page 16

The 1992 NAB Walk-Through

A Community Broadcaster's Guide To Exhibits

—compiled by Jacquelyn Biel and Anne C. Rosenberger

The 1992 Convention of the National Association of Broadcasters, scheduled for April 12-16 in Las Vegas, once again promises to be informative, exciting, and ... exhausting. At least if you're not in good physical condition, that is.

More than 700 exhibits at the massive Las Vegas Convention Center mean a ten-mile trek for anyone committed to seeing all of them. To make your job easier, we've compiled a guide to those exhibitors with products for the community television and LPTV broadcaster. They're presented below in alphabetical order, with a summary of the items to be displayed.

But words can't do justice to the color and variety and sheer engineering exuberance of the NAB show. So remember your Reeboks...and get ready for a hike.

continued on page 6

WorldRadioHistory

LPTV Report
P.O. Box 25510
Milwaukee, Wisconsin 53225-0510
ADDRESS CORRECTION REQUESTED

MCOO-0388-SB
FRED MCCORMACK
PO BOX 17860
ST PAUL, MN 55117-7860

DATED MATERIAL

BULK RATE
U. S. POSTAGE
PAID
Manchester, N.H.
Permit No. 1926

AFFORDABLE AUTOMATION

STOP BY
BOOTH # 15182 AT

NAB 92

FOR A DEMONSTRATION
OF THE ACTIVE
BROADCASTING SYSTEM

ADTEC PRODUCTIONS, INC.
NASHVILLE, TN.
1-615-228-7503

Circle (149) on ACTION CARD



In Our View

As you know, the House telecommunications subcommittee will soon consider a new cable re-regulation bill, the counterpart to S.12 which passed the Senate this January. The bill, sponsored by subcommittee chairman Edward Markey (D-MA), is also expected to reach the full Energy and Commerce Committee for markup very soon.

At this writing, reports are that Markey's new bill will be closer to the Senate's S.12 and much tougher on cable than last year's H.R.1303, which he also sponsored. Markey's bill is unlikely, however, to include language guaranteeing cable carriage for LPTV stations. So Rep. Jim Slattery (D-KS) is planning to introduce an amendment during markup that will mandate cable carriage for LPTV stations airing a minimum number of hours of local programming each week and meeting certain other requirements (see **LPTV Report**, August 1991, page 21).

The amendment is virtually identical to the amendment to S.12 introduced by Sen. Wendell Ford (D-KY) last May. Community Broadcasters Association board member Robert Raff of TV 6 in Junction City, KS is leading the effort to support Slattery.

It is doubtful that Markey's bill will have reached the full Commerce Committee by the time you read this, so you still have time to write or call your Representative and urge that he or she support Slattery's amendment.

The amendment has a good chance of passing committee. First, there is the Senate precedent. The Ford amendment was passed unanimously by the Senate Commerce Committee last May. Then, just this past January, the entire Senate passed

S.12 — by a vote of 73 to 18.

Secondly, it is very difficult to argue against local programming, which is what the NAB or any other group would have to do to defeat this amendment.

To bring you up to speed on the history behind the current House effort:

H.R. 1303, introduced by Markey in 1991, was basically a watered-down version of an earlier Senate bill — S.1880. That bill died in October 1990 when Congress recessed before it could be voted on by the full Senate.

But House Republicans opposed Markey's 1303 as too hard on the cable industry. And last summer, Commerce Committee chairman John Dingell (D-MI), seeking a consensus among the Committee before risking a full House vote, insisted that Markey rework it. The goal this time around was to advance "as uncontroversial a bill as possible," according to Markey's communications assistant, Larry Irving.

John Kompas, the CBA board member in charge of government relations, says that now the Republican stance appears to be softening, an indication that House Republicans are following the Senate's lead in supporting what is essentially a pro-consumer bill. In other words, the earlier opposition to harsh re-regulation may be withering in the face of re-election campaigns.

President Bush, especially, has moderated his position on consumer issues; earlier, he had threatened to veto any cable re-regulation that came to his desk. But if things go as Kompas expects, the final version will pass the House, and the final, reconciled bill will reach the President just before the November elections — when an anti-consumer stance on his part would be political suicide.

There are other efforts, of course. Ranking minority subcommittee member Matthew Rinaldo (R-NJ) may still be pushing for a more cable-friendly version modelled after the defeated Senate bill offered by Bob Packwood (R-OR). And Rep. Dennis Eckert (D-OH) has offered his own must carry bill, H.R.3380, which he has

agreed to amend to include LPTV stations if that bill becomes the House vehicle.

But the Markey bill will probably be the one that gets the go-ahead. So now is the time, once again, to write or call your Representative to express your support of Slattery's LPTV amendment. There is no formal opposition to this. We have a clear field. But we need to lobby hard.

If you need more information, or a sample letter, call Kompas at (414) 781-0188. We've proven several times before what we can accomplish by working together. Now it's time to do it again.

FCC's Gender Preference Overturned

The U.S. Court of Appeals in Washington has struck down the preference women receive when applying for broadcast licenses.

The February opinion was written for the three-judge panel by newly confirmed Supreme Court Justice Clarence Thomas, who was a member of the Appeals Court before joining the Supreme Court last October. Thomas and Appeals Court Justice James Buckley argued that the gender preference violated the equal protection clause of the Fifth Amendment. Judge Abner Mikva dissented, saying that the majority ruling could not be reconciled with the minority preferences that the same court had upheld in a 1990 ruling.

Thomas argued, and Buckley concurred, that there was no clear correlation between gender and programming diversity — the FCC had defended the preference as a means of achieving diversity — and that therefore the government could not treat males and females differently.

The case began when Jerome Lamprecht and three others applied for the same FM frequency in Middleton, MD. The station was awarded to a female applicant based in part upon the extra gender preference points she brought to the comparative hearing. Lamprecht appealed the decision, and after the FCC affirmed it, he went to court.

Lamprecht's attorney — Michael Carver of Shaw, Pittman, Potts & Trowbridge — told *Broadcasting* magazine (February 24, 1991) that the case marked the first time that a Congressionally-sanctioned affirmative action program had been struck down by the courts. The FCC may appeal the ruling to the Supreme Court, but the outcome would be doubtful in light of the fact that the Supreme Court is now dominated by conservatives.

The gender preference does not apply in the LPTV service where multiple applications for the same frequency are settled by lottery, not by comparative hearing. Minorities, but not women, are given preference points in LPTV and TV translator lotteries.

The LPTV Report

5235 North 124th Street, Butler, WI 53007
(414) 781-0188
FAX: (414) 781-5313

Jacquelyn Biel: *Editor & Publisher*
Katie Reynolds: *Account Executive*
Anne C. Rosenberger: *Staff Writer*
Bernadette Klitzka: *Administrative Secretary*
Julie Gottfried: *Sales Assistant*
John Kompas: *Marketing Consultant*

Columnists: John H. Battison, P.E., Peter Tannenwald, Joe Tilton

Guest Contributor: Earl Jamgochian

Typography: Graphic Innovations
Layout: Debi Muraro, Graphic Innovations

Printing: Cummings Printing Co.
Printing Coordinator: Don Beleski,
Cummings Printing Co.

* * * * *

Advertising Sales:

Katie Reynolds
(414) 781-0188 FAX: (414) 781-5313
Affiliations: **CBA**

The LPTV Report is an official information channel of the Community Broadcasters Association.

Community Broadcast Publishers, Inc.

S.E. Bradt: *President & Chief Executive Officer*
Richard P. Wiederhold: *Vice President & Treasurer*

The LPTV Report, ISSN 0892-5585, is published monthly by Community Broadcast Publishers, Inc. 5235 North 124th Street, Butler, WI 53007, or P.O. Box 25510, Milwaukee, WI 53225-0510. © Copyright 1992 by Community Broadcast Publishers, Inc. All rights reserved.
Subscription price: 1 year, \$35.00; 2 years, \$55.00. Outside USA: 1 year, \$43.00; 2 years, \$71.00.
Back Issues: \$5.00 each. POSTMASTER: Please send address changes to: The LPTV Report, P.O. Box 25510, Milwaukee, WI 53225-0510.

Panasonic

NAB '92 A SHARE A VISION.



D

Today's expanding vision of video technology includes CCIR 601 component digital, composite digital, component analog, composite analog... with proposals for several Advanced Television Systems and HDTV. Not to mention overlapping video markets from desktop to prime time; from personal to global video.

To satisfy these diverse demands—today and tomorrow—Panasonic has a vision of video recording systems that deliver the right level of performance at each production stage in analog and digital, in composite and component.

These systems all feature RS-232C or RS-422 Serial Digital Control interfaces; expanded interconnectivity, so signals pass between terminal equipment at the highest quality levels; superb digital interfaces between analog and digital, or from component digital to composite digital; and a family of videotape cameras offering digital signal processing for every format.

Panasonic has implemented this vision with its 1/2-inch videotape technology in S-VHS, MII and D-3 videotape recording systems: a vision which includes enhanced MII videotape recorders; small format component digital recording and even HDTV.

Visit Panasonic at Booth 18019. And share the vision.

Panasonic
Broadcast & Television Systems Group

For more information call: 1-800-524-0864
One Panasonic Way, Secaucus, NJ 07094

Circle (45) on ACTION CARD

Get Control of Time ..



Real Time Event Sequencer

CRL is proud to introduce our new **Real Time Event Sequencer**. This one rack height unit is a seven day programmable event sequencer. Any combination of eight or one of 255 outputs can be controlled via a rear panel connector. This unit can store up to 200 events. The outputs are selectable either to latch on, or provide half or one second contact closures. Programming is done via a simkey pad, and is

displayed on a back-lit LCD. Security key lock and battery backup included. To control time more easily, write, FAX, or phone:



Circuit Research Labs, Inc.

2522 West Geneva Drive
Tempe, Arizona 85282-3192 U.S.A.
(800) 535-7648 (602) 438-0888 FAX 438-8227
Bulletin Board System (602) 438-0459 Telex: 350464

Circle (161) on ACTION CARD

NAB Walk-Through

continued from front page

(P.S. For a handy reference to exhibitors' booth numbers, or to order information directly from the companies, see page 25.)

Acoustical Solutions, Inc. (Booth 12901-02): Acoustical Solutions will be exhibiting a full line of acoustical material for sound and noise control, including the new Alpha portable isolation booth for in-house or on-location production work.

Established products on display will include Alpha Pyramid, Alpha Wedge, and Sonex acoustical foam, Soundtex acoustical wall fabric, fabric-covered fiberglass acoustical panels, and Audio Seal acoustical blankets and sound barrier materials.

Acrodyne (Booth 15712): Several high performance LPTV transmitters and TV translators will be on display, including the TLU/IKS solid state 1 kW UHF TV transmitter with four slide-out 250-watt amplifiers; the TLU/IKACE Tetrode 1 kW UHF TV transmitter equipped with a Burle 9017 tetrode with a 10,000-15,000 hour life expectancy; and the TLU/100SE solid state 100-watt UHF TV translator convection-cooled system.

Acrodyne will also display a solid state 100-watt system and a high power, high efficiency UHF TV transmitter for 30 kW output.

Adtec Productions (Booth 15182): Adtec will be exhibiting the Active broadcasting system featuring the Active 64-16 microprocessor-based video controller. This unit is capable of automating the playback and switching of up to 16 VCR's on up to five channels. There is no need for a terminal or PC.

Alan Dick & Co., Inc. (Booth 19258): Alan Dick & Co. offers a line of LPTV transmitting antennas of the slotted cylinder design, similar to their higher power UHF transmitting antennas. The CBA Series antennas are designed to be side mounted to a tower or support structure, and each unit is enclosed in a radome to protect it from the elements. Circularly polarized and top mount antennas are also available.

Ampex Corporation (Booth 17101, S204): This will be the first NAB showing of the ADO 500® digital effects system that combines a new 3-D page turn, warps, and image processing effects into an affordable system.



The Ampex ADO® 500 digital effects system.

Established products will include the complete Ampex family of video products developed for broadcast, post-production, and corporate/industrial applications, as well as mass-storage tape drives and automated library systems.

Andrew Corporation (Booth 16646): Andrew will be showing its line of AL8 and ALP Series transmitting antennas for LPTV broadcast, as well as several of its satellite dishes, including the ESA 3.7 meter APT transportable TRIFOLD™ antenna.



The new EASIAx® cable prep tool from Andrew.

Also on display will be a variety of antenna accessories including HELIAX® coaxial cables and waveguides, the Dryline® series of pressurization equipment, and the new EASIAx® cable prep tool for 7/8" foam cable.

Antenna Technology Corporation (Booth 13725-26): A full line of satellite earth stations and related electronic components will be shown at Antenna Technology's booth. Among them will be the Simulsat Multibeam antenna, capable of receiving up to 35 satellites within a 70° arc, simultaneously at C and Ku band. The Simulsat is available in 3, 5, and 7 meter equivalent sizes.



The Simulsat earth station from Antenna Technology.

Also on display will be parabolic antennas from 1.8 to 32 meters, an L band satellite switching system introduced at last year's NAB, and the new Vanguard Instruments VI 2.0 high-precision multi-function satellite analyzer, receiver, and monitor.

Anton Bauer, Inc. (Booth 13418-20): Anton Bauer will be introducing several new products this year — the Logic Series® digital battery system; the Ultralight® 2, a low voltage on-camera light; the Automatique™, an optional on-camera light control circuit; the MP-4D — Logic Series® microprocessor 4-position sequencing fast charger; and the DM-4, a discharge module/battery evaluator.



Assorted accessory belts from Anton Bauer.

Established products will include Logic Series® camera batteries and microprocessor chargers, Ultralight® accessory lighting systems, the Gold Mount® battery bracket system, Universal Battery belts and accessories, and D.C. power supplies.

Autogram Corporation (Booth 4525-27): Two new products will be shown at the Autogram booth. The first is the Pacemaker PM-1644, the newest addition to the Pacemaker audio board series. The PM-1644 features 16 faders and 44 stereo inputs, five VU meters, and such standard Autogram features as front panel engraving, all aluminum "bullet-proof" construction, and easy access for maintenance. Also on display will be the Mini-Max 8 audio board with 8 channels, 16 stereo inputs, and 4 LED VU meters.

AVCOM (Booth 12903): AVCOM will be introducing a new network and spectrum analyzer, model NASA-1000A, that covers frequencies from 1-1000 MHz in one sweep.

AVCOM will also be displaying its line of portable spectrum analyzers, its PTR-25A portable test receiver, microwave signal generators, satellite receivers, portable microwave links, and microwave accessories.

Barco, Inc. (Booth 18804): Barco is showing several modulators and demodulators for the LPTV and cable markets.

The first, the VSBM 200 TV modulator, features remote controlled, automatic substitution (which becomes operational when a standard program source is missing); a SAW filter; state-of-the-art electronics; and a crystal controlled output converter that can be specified for any channel or frequency from 47-860 MHz.

A universal demodulator, the VSD 10, features a hyperband tuner; numbered program selection; LCD readouts of program, channel, frequency, and transmission standard; stereo and bilingual sound demodulation; and a PLL tuning system.

The VSD 1000 TV demodulator for ca-

ble headends and television transmitter sites also features a SAW filter, a quartz-controlled input converter that can be specified for any channel or frequency, and an input synthesizer covering the complete frequency range.

Finally the VSBM 1000 TV modulator is a professional modulator that converts baseband video and audio into high quality RF output. It can be upgraded to a stereo/dual sound modulator by adding the appropriate boards. The professional SAW filter and extreme stability make it ideal for adjacent channel applications.



It's a fact. Today's broadcast environment hasn't room for "near misses." Survival hinges on: (1) getting a powerful signal right on target, (2) minimizing costs, and (3) using reliable equipment — backed by in-depth support.

That's exactly why more and more broadcasters rely on Antenna Concepts for the technologies and commitment that mean clearer images, economical pattern-to-market matching, responsiveness to special design needs, and ongoing assistance, easily accessed.

Call or write for details; visit us at Booth #10662 at the NAB Show in Las Vegas April 12-16. And begin building a secure future in the air.

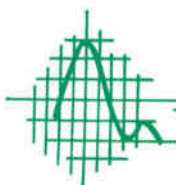

ANTENNA CONCEPTS INC.

3234 Saddlehill Court ▲ Placerville, CA 95667
Phone: 916-621-2015 or FAX: 916-622-3274

Circle (181) on ACTION CARD

Affordable Automation

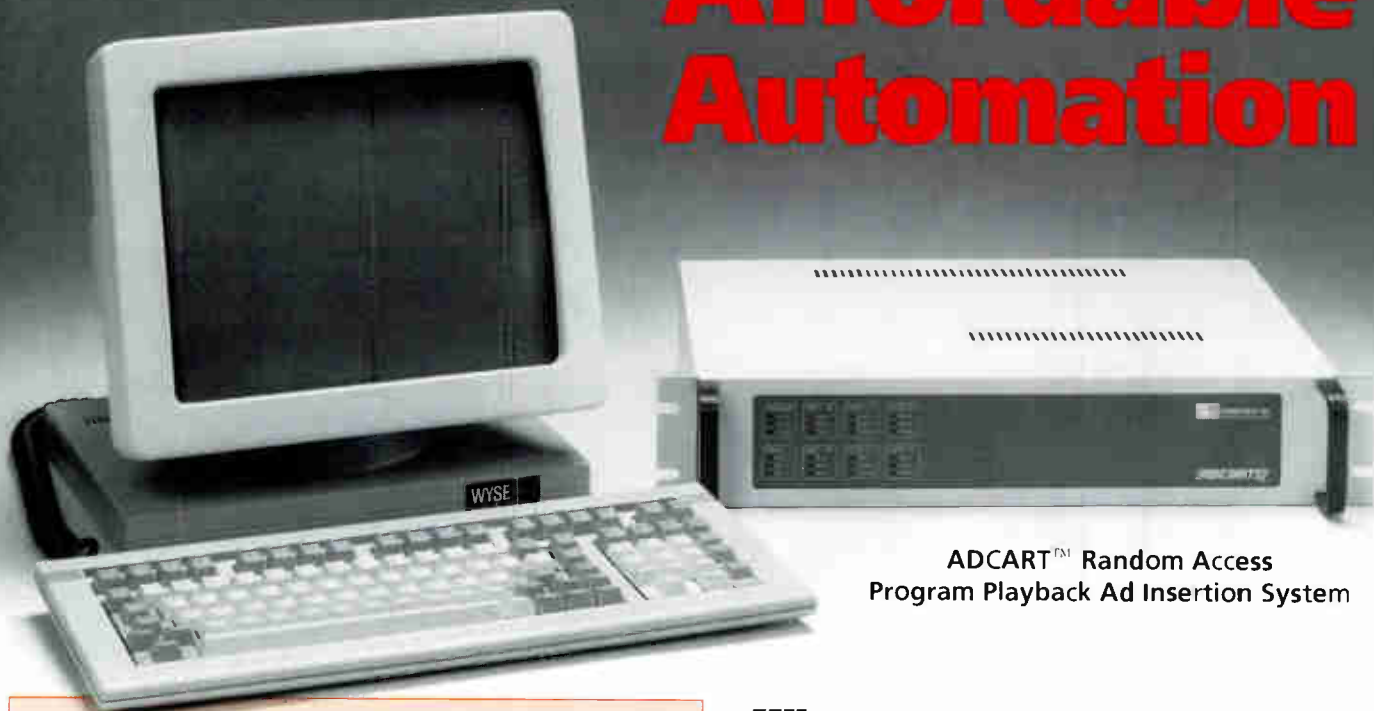

ADCART™ Random Access
Program Playback Ad Insertion System

Automation with ADCART™

- Controls up to four audio/video sources (VCRs, character generators, satellite or live video feeds) for automatic playback or insertion into one or two channels.
- Provides external control of up to eight VCRs for automatic recording on a time-scheduled basis. Allows you to record up to 16 hours of satellite programming, continuously!
- Full screen terminal simplifies scheduling, system status monitoring and machine control.
- Schedule processor holds up to 16 complete schedules per channel.
- Performs broadcast-quality audio/video switching from VCRs or other A/V sources to network.
- Constant video quality monitoring with automatic failure bypass assures the highest on-air signal quality.
- Logs and verifies events, plus prints a variety of detailed reports.

When you're managing program playback from a variety of sources 24 hours a day, and seeking additional revenue through local ad insertion, you need extremely reliable, high quality equipment that does the job. Easily, efficiently, and cost-effectively, with minimal operator involvement. ***You need to automate.***

Channelmatic is the LPTV automation system leader. We've been in the business 17 years, with field-proven products that are actively controlling 7,000 LPTV and CATV channels on-line, nationwide.

Call, Fax or write for more information and a free system quotation.



CHANNELMATIC

821 Tavern Road, Dept. CIG, Alpine, California 91901
Telephone (619) 445-2691 • FAX (619) 445-3293 • (800) 766-7171

Revolutionizing television automation.

AD INSERTION... TAPE COMPILING/EDITING... PROGRAM PLAYBACK... A/V SWITCHING, DISTRIBUTION AND CONTROL

Circle (6) on ACTION CARD

Benchmark Media Systems, Inc. (Booth 11301): Benchmark's new products include the MP-1, a 1-in/2-out mic-preamplifier for the MF-1 MicroFrame series and for the SYSTEM 100; the RS-414, a 4-in/4-out router/switcher module; the PS-302, a slide-in power supply module; the MF-300, a newly modified 12-module frame; the DA-101A, a newly revised mono audio amplifier; and the LLD-101 long lines driver, and newly connectorized back panels for the System 1000.

Established products to be displayed include the MF-1 and LA-1 microframes, and — from the SYSTEM 1000 series — the DA-102 amplifier, the ALM-110 alarm board, and the MPS-400 and MPS-420 4-channel pre-mics.

BEXT, Inc. (Booth 3918): BEXT will be displaying a number of items, including the NS-1000S and NS-100 TV amplifiers, the TC-280 UHF exciter, the LC-STL and SD-STL composite aural STL systems, the HPT-FM transmitter/translator, and the P2/P10, PTX-30, and PTX-80 programmable FM exciters. Also included are the PJ-250, PJ-501, and T-2000 FM amplifiers.

beyerdynamic (Booth 12230): beyerdynamic will be showing its full line of headsets and microphones, including the new DT-190 Series Headset/Microphone. This new lightweight unit combines excellent ambient noise isolation with studio monitor quality earphones and an upgraded dynamic microphone.

Also on display will be the M424, a miniature supercardioid dynamic mic for broadcast or recording applications, and the U700 UHF wireless microphone system. The U700 series can accommodate up to 12 channels within the bandwidth of one TV channel. It is available in either a hand-held or a body-pack transmitter version.

And for remote crews, there is the new TE 170, a miniature VHF microphone receiver designed to be mounted on video cameras for on-location and field production applications. The TE 170 features user adjustable headphone and earphone gain and LED lights to indicate reception and battery condition.

Bi-Directional Microwave Systems (Booth 15570): Bi-Directional Microwave will be showing portable and fixed (STL) wideband radios capable of high-definition Y/C or S-VHS transfer. The phase lock looped video format equals the performance of satellite uplinks. FM modulation with pre-emphasis and refined low pass filtering maintain an excellent signal-to-noise ratio within a 25 MHz bandwidth.

The system response is linear (flat) from 12 through 15 MHz for analog carriers. HDTV signals can be transferred from one point to another through free space or fiber optic cable through the studio

and out for broadcast with only slight modifications to existing equipment.

Broadcast Microwave Services, Inc. (Booth 12301-04): BMS will be exhibiting the BMA-3000 antenna pedestal system, the TAA-101 helicopter antenna system, the TBT-50 transmitter, the BMT-26P portable transmitter, the TBR-300 and BMR-2KP portable receivers, the TBR-200 rackmount receiver, and TAA-500 rackmount controller.

BMS will also display the BMA-3000 antenna pedestal and their line of easily installed portable microwave transmitters and receivers.

Cablewave Systems (Booth 1924): New products being displayed include the PAT truncated series microwave parabolic antennas which come in 6' and 8' sizes with a range between 6.875 and 7.125 GHz; RF precision connectors; and rigid line expansion components. Cablewave will also be exhibiting the Flexwell™ E30 elliptical waveguide with 7/8" EIA transition for ITFS and MMDS, as well as new additions to the Flexwell coaxial cable line.

Established products on display will include circularly polarized FM antennas, Bogner® low and medium power UHF-VHF TV antennas, MMDS/ITFS/MDS TV antennas; mounting hardware; dehydrators; and accessories.



The LX-100 from Canon.

Canon (Booth 15719): Canon will be featuring the LX-100 hi-band 8 mm camcorder and the Canobeam infrared laser beam transmission system. Established products to be displayed include telephoto, standard, wide angle, ENG/EF, and studio/field zoom lenses, the U-4 remote pan and tilt camera, the MC 300 pedestal, the TR 90 tripod, and an assortment of teleconferencing lenses.

Channelmatic (Booth 17430): Channelmatic provides TV automation for every budget and offers a full range of ad insertion equipment. Among other items on display will be the CompEdit automated tape compiler/editor, as well as a variety of automated program playback systems, A/V switchers and DA's, clock controllers, and time/tone switchers. More than 200 automation products and accessories are available.

Circuit Research Labs (Booth 4208): New this year is a real time event sequencer that controls up to 8 outputs or devices and can store up to 200 events over a 7-day clock.

A complete line of signal processing equipment for the TV market — including a tri-band gain controller, an MTS generator, and a monaural TV processor system — will also be on display.

Coaxial Dynamics, Inc. (Booth 12905): Coaxial Dynamics is a leading manufacturer of precision equipment for measurement and termination of RF power, as well as custom designed OEM RF filters and directional power detectors. Several models of wattmeters and loads are available for power ranges from 0.1 watt to 100,000 watts. The company also offers a complete line of terminating loads — dry from 5-500 watts, liquid dielectric from 600 watts to 10 kW, and water-cooled and heat exchanger models from 10 kW to 100 kW.

continued on page 17

EBS EQUIPMENT

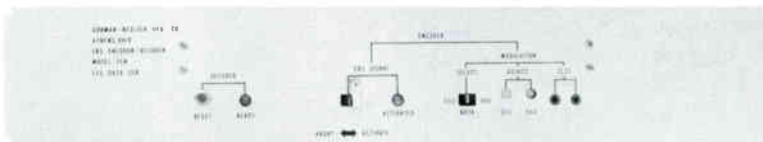

	Price
Model CEB Encoder-Decoder	\$540.00
Model CE Encoder	375.00
Model CE Stereo Encoder	405.00
Model CD Decoder	320.00
Encoder FCC Type Accepted decoder FCC Certified	
Exceeds FCC Specifications	
Receiver can be supplied to drive Decoder	\$100

Required for L.P.T.V.

All interconnections to the EBS equipment are made through a barrier terminal block. No special connectors necessary. In stock—available for immediate delivery.

GORMAN REDLICH MFG. CO.
257 W. UNION STREET • ATHENS, OHIO 45701 • (614) 593-3150



LPTV and the LAW

—by Peter Tannenwald

What The New Video Dialtone Proceeding Is All About

Because of their entrenched monopoly position in voice communications, telephone companies have in the past been barred by the government from providing video programming services. The telcos, as is to be expected, have not been content to remain shackled and have steadily pressured for relief from the restrictions.

But now that the cable television industry has grown strong—and is itself a monopoly in the eyes of some people — the government is starting to think that maybe the telephone companies should be allowed to try their hand at video services. The rationale is that the phone companies would provide a counterbalance to the economic power of the cable industry.

The FCC's "video dialtone" proceeding is intended to be the first step in allowing telephone companies to compete with cable TV systems.

Four Steps to New Video Services

There are four aspects to the FCC's actions. The first is a policy decision, already made, that no matter what video services telcos are allowed to provide, neither the telcos nor their customers will require local franchises. Since cable TV systems must have local franchises, cable operators are obviously unhappy about more relaxed treatment for potential competitors. Municipal authorities, which grant franchises, are not pleased either. We can expect continued litigation over the local franchise issue.

Second, the FCC has decided that there should be no restriction on the provision of cable TV services by interexchange telephone carriers — more commonly known as long distance companies. The main thrust of this decision is to remove any restriction on AT&T's providing cable TV services. But it frees MCI, Sprint, and other interexchange carriers as well.

The two remaining steps have not yet been adopted. One is a proposal to allow local telephone companies (in other words, the Regional Bell Operating Companies, GTE, United, and other smaller independents) to provide video dialtone service in their telephone service areas. Telcos would be allowed to provide video services *other than* programming to the general public, as well as transmission

service for programming provided by third parties.

The final idea is only at the inquiry stage at this time, which means that questions are being asked without any formal proposals yet. It would let telcos go all the way and provide video programming services themselves directly to the public.

Two Types of Dialtone Service Considered

What does the FCC mean by "dialtone"? The idea is to expand video services beyond what cable systems now offer to include switched services. With present cable technology, all the cable system's offerings are distributed throughout the entire cable system at all times. A subscriber selects what he or she will watch by tuning to a particular frequency or selecting one of two cables entering the home. Signals are separated by frequency, so the capacity of the system depends on its total bandwidth capacity.

Switched services are like your voice telephone. You have one dedicated line from your home to the telco central office. At the central office, a switch connects your line to another line that goes to the place you are calling. Once the circuit is established, you have a dedicated line between your telephone and the one on the

Limit Phone Companies To Video Transmission, Says NAB

In comments filed recently in the FCC's "video dialtone" proceeding, the National Association of Broadcasters said that telephone companies should be allowed to transmit programming, but not to own or package it or buy cable systems.

The safeguards would give consumers a "wide diversity" of competitively priced programming and broadcasters fair access to a second wired transmission service into the home. But they would prevent telephone companies from engaging in anti-competitive behavior by forbidding them to select, market, or originate programs. CBP

other end of the conversation. This line carries only one conversation — yours.

Likewise, switched video service would give you only a limited bandwidth circuit between your home and a central location, where a switch would connect you to the video source you wish to access. While the circuit into your home might carry only one or a few signals, you would have access to more than you do today, because the central office switch could connect you to any number of program sources.

Two Gateway Concepts

The FCC has tentatively concluded that telcos should offer a two-level gateway to video services. When you first turned your television on, you would be connected to an electronic platform that opened to a broad network of services provided by many different vendors. Some services might be television programming; others would be information services and databases. By touching a keypad or some other device, you would "dial" the service you want to reach, and the central office would connect you. The initial platform would be provided on a common carrier basis, and the telco would be forbidden from discriminating among its customers.

One of the options you could "dial up" would be a video service menu provided by the telco itself. The telco could offer anything it wanted to on the video service menu — except for video programming. Text and database services, and anything else other than programming, could be furnished.

The second gateway concept is a single advanced gateway, where consumers would access non-programming services from other vendors at a single level. Only the switching and transport of signals would be regulated as common carriage.

Turn About is Fair Play

Whether or not to allow local telephone companies to provide video services remains controversial and will be debated at length both at the FCC and before the Congress. If the present rules are relaxed — as many people think they will be, sooner or later — don't be surprised if your local cable system tries to add telephone service to its offerings. Some have already tried it. In fact, the idea of local telephone competition is already being discussed by the state regulators that have the power to control it.

Why not watch TV on your telephone and make a phone call on your TV? That's what competition is supposed to be all about.

Peter Tannenwald is a partner in the Washington, DC law firm of Arent, Fox, Kintner, Plotkin & Kahn. He is general counsel to the Community Broadcasters Association. CBP

Phase Out "Unfilterable" Off Air Interference To CATV/Broadcast/Mobile

Suppress Unwanted Receptions Too Close To Desired Signals For Filters:
Co-Channel • Ghosting • Harmonics • Wideband Noise • UHF-TV Sidebands • Adjacent FM

Choose the correct model 2903 "Phase Canceler", hook it up with a second antenna and cancel the unwanted reception at your radio receiver or CATV, SMATV or In-House TV System processor. No matter how close the bad signal is to the desired: *Even if at the same frequency!*

Standard Models available for bands 54-890 MHz. Special models feasible into microwave (for 4 GHz wideband interference, for example).

Standard models 1 week or less - overnight for your emergencies. Special models 30 days or sooner.

"We Make Filters In A Hurry For Customers In trouble!"

Does it really work? Hundreds in use since 1976 - sold with a **Money Back Guarantee!** We'll put you in touch with users with your problem.

Free Application Handbook & Catalog **Phase Canceler/90** gives set up and operating details - and we back you up with **Free** telephone assistance.

- Theory of Operation
- Detailed Set-Ups
- Detailed Operating Instructions
- Application to CATV
- Application to Co-Located Radio transmitter/receiver
- Application to TVRO
- Wideband Interference



**Phase Canceler/90
Get Your Copy Today!**

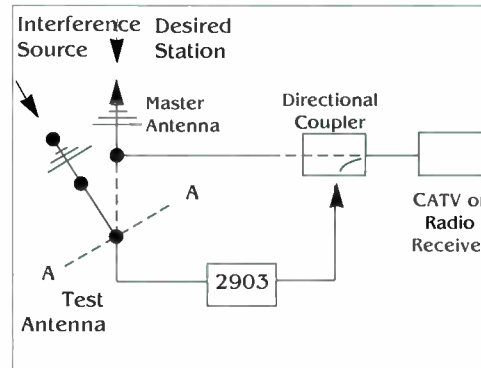

Phase Canceler applied to suppressing interference at CATV systems or radio receiving sites with distant interference source.



Model#
 2903-2/6
 2903-FM
 2903-A/I
 2903-7/13
 2903-UL
 2903-UH

Operating Band (MHz)
 54-88
 88-108
 120-174
 174-216
 470-680
 680-890

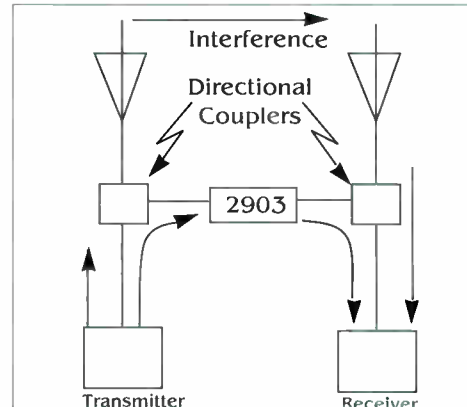

Phase canceler suppressing interference at duplex transmitter/receiver systems: strong co-located transmitter signal is the problem.



Set up for suppressing wideband (digital) TI on 4 GHz TVRO.

Filters For All Electronic Needs: CATV, SMATV, In-House TV/LAN, Satellite, LPTV, FM/TV Broadcast, Mobile Radio, Microwave TV (ITFS/MMDS), RF/MW Communications, Radar, Navigation, Electronic Warfare, Medical/Physics Research

Microwave Filter Company, Inc. • 6743 Kinne Street • East Syracuse, NY 13057
Toll Free(US/CAN): 1-800-448-1666•Collect(NY/AK/HI): 315-437-3953•FAX: 315-463-1467•Telex: 249-613

How Good Is Your Station's Programming?

And Who Is There To Help?



SHOWPLACE
HAL PONTIUS & ASSOCIATES
 1962 N. Bissell • Chicago, IL 60614
 (312) 472-8828 FAX 929-1108

Circle (180) on ACTION CARD

BON MOT

Facing the terrible absurdity of ourselves is always jolting.

Opus

Will TV Answer Fly?

Technology Works But Economics Questionable, Say Detractors

—by Anne C. Rosenberger

Television, a two-way communication tool.

It has been promised before and has never gotten off the ground.

But the people at TV Answer believe they will be the ones to finally deliver a viable interactive video data service (IVDS) — without cable or telephone hookup.

With TV Answer's new technology, say its designers, viewers will be able to pay bills, make bank deposits, order merchandise advertised on TV, and perform other interactive functions, as well as view normal television programming.

And on January 16 this year, the FCC put its stamp of approval on the project by allocating one megahertz of spectrum — between 218 MHz and 219 MHz — to IVDS. This decision essentially created a new wireless broadcast industry. Previously, companies wanting to exploit interactive television technology have been unable to provide wireless service because they were barred from using the airwaves for their transmissions.

How Does It Work? What Does It Do?

TV Answer's system uses radio waves to transmit signals between users' home units and local cell sites. The cell sites deliver the signals to a satellite, which relays them back down to TV Answer headquarters and from there to "service providers" — program originators or ad-

TV Answer sends video in much the same way that cellular telephone systems send voice signals.

vertisers. The system is similar in structure to a cellular telephone network.

Although the system is high tech, its operation and uses are actually quite mundane. The TV Answer remote control device functions as a universal remote, allowing viewers to operate their TV sets, VCR's, satellite or cable converters, and stereo equipment, as well as to communicate with providers via the interactive TV Answer programs.

As for practical applications — a commercial announcement on a regular TV program would be accompanied by a prompt, allowing the viewer to order the product being advertised by "zapping" the screen with the remote. Payment would be made via the viewers' credit card whose numbers would be programmed into the in-home unit, and accessed through a personal identification number or "PIN" code. Banking, bill-paying, and other personal financial transactions could be accomplished in a similar fashion. And certain channels and types of programming could be put "off-limits" to young viewers through use of a PIN.

Program information would be streamlined. All of the possible channel choices would be organized by type and accessible through the remote: networks, news and information, sports, premium channels, music, education, religion, and home shopping. And program listings could be downloaded at any time from the central control facility. In other words, your TV program guide would appear on your screen, and you'd be able to choose programs simply by zapping the listing with the remote.

TV Answer claims that broadcasters will be able to conduct ratings polls instantly for all types of programming, providing data at rates much lower than the ratings companies charge. And TV advertising for the first time can be used as a "point of purchase" device, allowing stations, agencies, and clients to monitor exactly what's working and when.

The company also says that the TV Answer technology will decrease channel hopping by actively involving the audience, thus increasing audience attention span and, potentially, audience size. Programming effectiveness can also be improved, especially for educational and children's programming. And because TV Answer is independent of telephone or cable hookup, it can be deployed in any environment where broadcast signals can be sent and received.

Benefits For Broadcasters?

Can TV Answer be used to improve the revenues of existing television broadcast-

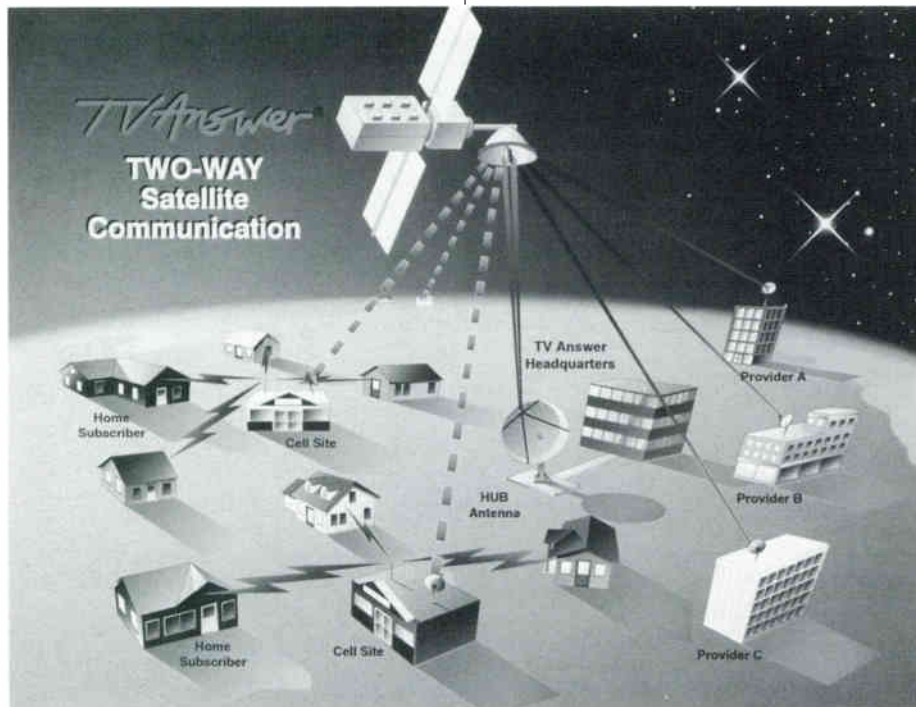

ers? Connecticut community broadcaster and computer systems expert Robert Knapp said he could not see "any direct benefits for broadcasters.

"The technology would be ideal for some of the cable programmers who have to rely now on telephone lines for their interactive programs," Knapp says. He thinks that cable pay-per-view and home-shopping television would be the vanguard users of the cellular system, which would be faster and wouldn't overload as easily as phone lines.

Bob Truscott, an RF engineer and president of Truscott Broadcast Services in Bolingbrook, IL, also doubts its usefulness for broadcasters. "It's not really a broadcast technology as we know it. It uses a different piece of the spectrum which has to be applied for independently. You couldn't just start airing this stuff over your existing station."

Neither is everyone convinced that IVDS will not in some way compromise privacy. Knapp is concerned about credit card and bank account numbers "whizzing" over air waves. Even though he's sure that the numbers would be encoded in some way, he's equally certain that someone will be able to break that code.

The National Association of Broadcasters has also expressed concern that individuals' privacy rights could be threat-

ened by the new technology. Although it did not believe that TV Answer intended to misuse the technology, NAB said in comments to the FCC during the IVDS proposed rule making proceeding, "An information pipeline from the home television set can be spun into scenarios of 'big brother' data collection and nefarious intrusion into private home life."

Prototype Successful

A prototype TV Answer system operated from 1987-1989 in Fairfax County, VA under an experimental license granted by the FCC. The test involved more than 600 volunteers who were given sender/receiver units so they could participate in interactive programming 24 hours a day. Programming included public opinion polls, news polls, and entertainment. Viewers answered questions, rated music videos, and participated in contests.

L. Sanders Smith, TV Answer's vice president of video products, said that the prototype system was designed primarily to test the system's engineering. There was no hook-up to advertisers.

Cost

There is no initial set-up cost for broadcasters, according to Smith. Rather, TV

Answer will charge broadcasters (or their program clients) a fee per transaction, much in the same way that credit card companies take a cut from the retailer who accepts the card as payment. The only possible starting expense that Smith sees for broadcasters is a VSAT dish for about \$20,000. But the dish would be necessary only in the case of large numbers of transmissions.

Right now, Smith says that TV Answer is in the process of talking with retailers, banks, and other "back-end providers." In order to provide the services that TV Answer offers, these providers will have to set up a service bureau to receive and process transmissions.

TV Answer has not yet approached potential consumers. According to Smith, it's still too early; but when the time comes, the consumer will buy the in-home box through a retail store at a cost of around \$400 to \$600.

TV Answer intends to license its interactive technology and to operate systems. The company has spent more than \$50 million and projects that it will have between 1.5 and 4 million users by the end of the first year of operation. In the first step of its initial \$13.5 million contract with Hughes Network Systems, TV Answer has installed its central satellite earth station in Reston, VA. Their goal is to inter-

THE ULTIMATE PERFORMERS!

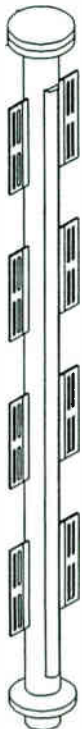

Traveling Wave UHF Slot Antenna

for Performance and Reliability
Designed Specifically for Low Power TV

- Lightweight rugged aluminum construction
- Radom-covered slots need no pressurization
- Select from seven standard patterns
- Custom patterns available
- Ice Shield optional
- Beam tilt and null fill optional
- VSWR 1.1:1 or better
- Side mount brackets included
- Delivery time 30 to 60 days
- Input power 1Kw 7/8" standard
- Competitive pricing

3dbm

3dbm, a recognized leader in specialized military ground and airborne systems for over 25 years, introduces the Model 800, Solid-State, Low Power Television Transmitter. The Model 800 utilizes the latest in state-of-the-art, solid state technology. It accepts video and audio inputs from virtually any source, and transmits at any standard UHF or VHF channel.

STANDARD FEATURES

- 5 to 1000 Watts Transmit Power
- 2 Video Inputs • 3 Audio Inputs
- Automatic Station Identification
- Automatic VSWR Shutdown Protection
- Integral Output Isolator Protection
- Modular Plug-In Design
- Internal Monitoring of Power Supply and Amplifier Performance
- Local Control and Monitoring Facilities
- Integral Redundant Forced Air Cooling
- Redundant Power Supplies and Power Amplifier Assemblies
- Graceful Degradation in the event of Power Amplifier Module failure
- Internal monitoring and compensation of Exciter, Amplifiers and Power Supplies to ensure uninterrupted broadcasting

Solid State Transmitter

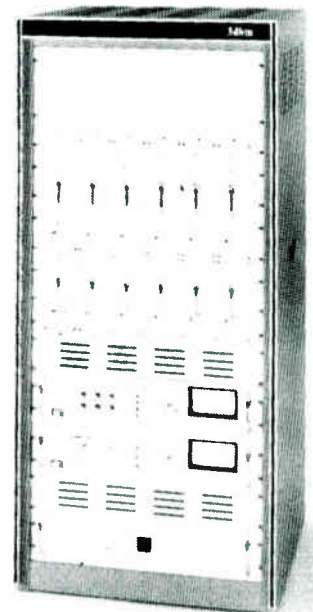

For Complete Information Contact Jimmie Joynt at 800-279-3326 • Sales Office POB 25966, Colorado Springs, CO 80936

connect up to 2,800 cell sites (at \$30,000 per site) in the first year and up to 30,000 sites in five or six years.

Longevity

As with any new technology, there is the question of how long before TV Answer is replaced with something bigger and better. Robert Knapp feels that once fiber optics' full potential is reached, TV Answer's technology will become obsolete, and he believes that day will not be long in coming. Therefore, as a potential investor, he's decided not to throw money at the system. As Knapp says, "I'll stick to the telephone."

The January 20, 1992 issue of *Broadcasting* reports that Commissioner Andrew Barrett also questions the longevity of the system and wonders why TV Answer would "spend the massive amount of time [and money] lobbying...for a service that for all practical purposes can be provided now" through fiber optics or basic cable.

In response, Smith says that independent experts have stated that it will be 15 to 20 years and \$50 billion before fiber optic cable reaches everyone. And in Smith's estimation, 15 to 20 highly active years isn't bad. Secondly, although Smith believes that fiber optics will certainly be powerful enough for interactive television, he says that right now all its developers are talking about is pumping more and more information into homes. "They're not even discussing two-way possibilities," he says.

Licensing

As in the cellular telephone service, individual users do not need licenses, but base stations will. To ensure competition, the FCC wants to issue two licenses per geographical market.

The agency expects to begin accepting applications for IVDS licenses sometime between March and June, using an expedited lottery procedure. A \$1,400 application fee will be charged. The first licenses could be awarded as soon as late 1992, with the first service expected to reach consumers soon thereafter.

Licensees will have to build 10% of their operation by the first year, 30% by the third, and 50% by the fifth — or lose their license. FCC rules also prohibit the transfer of a license until 50% of an operation is built.

In addition, IVDS transmissions will be secondary to Channel 13 television transmissions, up to five miles beyond the Grade B contour. To reduce the chance of interference, the FCC requires that individual transmissions be automatically reduced to the minimum level necessary to achieve reliable communication with the nearest base station. 



Little Things (In LPTV) Can Mean A Lot

Technical Talks

—by John H. Battison, P.E.

Over the years I have inspected a lot of television stations, both full power and community (LPTV) operations. Generally the larger the station, the more observant the personnel of the small things in the operation.

By small things I mean *anything* that affects the station's operation, and hence its success. Small things range from letting dirt and dust remain in operating — or any other — areas, to ignoring electronic signals that tell the alert observer that something is not right. Small things can be anything that does not quite agree with normal operations, or even just "doesn't feel right"! So-called gut feelings can often be very helpful in keeping electronic equipment operating properly.

I'm still harping on levels — those seemingly arbitrary readings that monitors and meters demand be maintained. Let's look at a simple video level — one that is very frequently over-looked, and can be a cause of unexplained transmitter outage.

Detector Circuits

The design of most LPTV transmitters is based on that of the original TV translator which switched itself off when the primary TV station closed down. It also turned itself on again when the main TV station came back on the air. How does the transmitter do this?

There is a simple detector circuit in the modulator that detects the presence of video. If it is not there, or is too low, the transmitter turns off. In fact, this is a feature of most LPTV transmitters so that they cannot be operated without video input. Sometimes that can be a nuisance when one needs to test without modulation. But it can be simply bypassed.

Now, not all LPTV transmitters contain this feature, but the betting is good that yours does. Let's suppose that your video waveform monitor shows less than 100 IRE units. The result will be that your received picture will tend to be snowy or washed out because the transmitter is not sending out as much power as it should. If you spend a few moments watching your own station's monitor, you may observe that the incoming signal from your satellite dish is quite a bit lower than 100 IRE

units. And yet the next program may come in at quite a lot over 100 IRE units.

Ride the Gain

In far too many stations that I've seen, no one seems to watch these levels, or even to care. If they do have waveform monitors, the odds are that at any given moment the video level is not 100 (this ignores the obvious instantaneous variations). If you don't have someone "riding gain" on the video signal, these variations will affect your received picture.

Depending on the transmitter in use, and its adjustment, any video level less than 40 IRE units will probably cause the transmitter to shut down. So you will have an unexplained outage. With some transmitters, after this happens a few times the protective circuits cause a permanent shutdown. This means that someone has to go out to the transmitter to turn it on again. This may mean a short walk, or a long climb to a remote rooftop transmitter.

"Yes, but what about AGC amplifiers?" someone will ask.

Far too many LPTV stations do not have AGC amplifiers. The output from the switcher goes straight into the transmitter, or (what is worse) into a line going to the transmitter. And the other end of the line is connected straight into the modulator input terminals.

Along this line many things can happen. There may be frequency selective attenuation which can cause odd video details to drop out. There will be attenuation so that the signal reaching the transmitter is less than that going into the line. Noise and interference can be introduced. Almost anything can happen — and it often does.

A simple AGC amplifier alone will take care of video levels, but a processing amplifier will take care of a lot more, and can help clean up a messy signal. If funds are low, but video problems persist, try to find a used AGC/processing amplifier so that your video level is at least maintained and you can remove unexpected sources of transmitter dropout.

Video Hum

Many LPTV broadcasters complain about video hum. The signal looks fine at the switcher output, but when it is viewed over the air there is a hum bar, or even worse. This sort of thing is more likely to occur during the early days of construction and start-up, than once regular operation has commenced. But it can, and often does, suddenly occur during normal operation.

The most frequent cause is either lack of ground connections, or too many. Like audio, video signals are very susceptible to the generation of hum signals along their lines when there is a different potential (or voltage) at each end of the cable

carrying the signal. This sort of thing can happen over a short four- or five-foot studio run, or over a line that is many times longer. If the line goes from a studio building that is connected to a specific ground point at the power line input (which is often not good) to a tower that does not have a good ground and that may even have resistance in the ground path back to the studio, conditions are ripe for hum generation. Any time that a current passes through a resistance, a voltage is generated. This generated voltage shows up as hum.

Fortunately this is generally taken of quite easily by use of a hum bucking transformer. If the transformer is connected according to the instructions, the hum generally vanishes.

Watch Out For Smoke

Another "small" thing that has generated a tremendous amount of argument is cigarette smoke. Health considerations aside, smoke is the worst thing that can happen to video equipment. It very quickly settles in a thin film over camera lenses, contacts, and the very important VCR heads. Smoke gets onto video tape and causes loss of detail, and — in bad cases — sync loss.

Unfortunately, many VCR operating areas are not kept as surgically clean as I feel is required. Full power stations have specially air-conditioned and climate-controlled areas. Smoking is strictly forbidden.

Dirt and smoke deposits are the enemies of VCR's. The VCR heads are precision pieces of equipment with very small gaps and precise tolerances. The presence of even a minute piece of dirt can

ruin a head, and smoke deposit build-up can bridge gaps, reduce head-to-tape contact, and cause multitudes of video problems. If your station has a NO SMOKING policy, it should be strictly enforced.

**Achieve Practical Solutions
 to STL Requirements**

**High-Reliability and Low-Cost:
 Links Starting at \$6200**

**See us at NAB
 Booth #13901**

For High-Quality Video,
 Connect with
Microwave Radio Corporation.

*Discover how Microwave
 Radio Corporation offers
 you practical, quality
 wireless interconnections.*

Connect with us today:

TEL: (508) 250-1110

FAX: (508) 256-5215

**Microwave Radio Corporation
 20 Alpha Road
 Chelmsford, MA 01824-4168**

**Fixed and Portable Microwave
 Systems from 1.7 to 40 GHz**

**The Leading Supplier for TV
 and Video Applications**

 **MICROWAVE
 RADIO** corporation
 The Microwave Connection

Circle (134) on ACTION CARD

If you don't have a NO SMOKING policy in your video areas, you are asking for video problems.

John H. Battison, P.E. is a consulting engineer with offices in Loudonville, OH. CBP

LPTV Chief Wins National Government Poster Contest



LPTV's fearless leader at the FCC, Keith Larson, regarded by his peers as an efficient administrator and a smart engineer, has now displayed new talents in the graphic arts, capturing the top prize in a government-sponsored contest with a poster he designed for last fall's Combined Federal Campaign.

Larson won first place in the poster division for "Radiate Good Will," a motivational poster depicting television screens showing scenes of needy and handicapped individuals.

Said Larson, "My theme, 'Radiate Good Will,' reflects what we do here at the FCC — authorize the stations that radiate into our living rooms the graphic plight of the needy. By contributing to the CFC, FCC employees effectively close the circle."

The TV screens, topped by rooftop an-

tennas, surround a star-like representation of radiating signals. At the bottom left corner are the words, "FEDERAL COMMUNICATIONS COMMISSION 1991 COMBINED FEDERAL CAMPAIGN"; at the bottom right, "The need is great. Support the CFC and signal that YOU CARE!" Larson designed the poster and did his own art work.

The Combined Federal Campaign is the federal employees' version of United Way. FCC chairman Al Sikes headed the FCC campaign. Video Services Division chief Barbara Kreisman was vice-chairperson, leading the FCC to the "Winners' Circle" of top contributors among government agencies.

Larson said he enjoyed his excursion into the world of art; "however, I don't think I'm quite ready for a career change just yet."

Besides, there's also music. Larson plays a mean piano. CBP

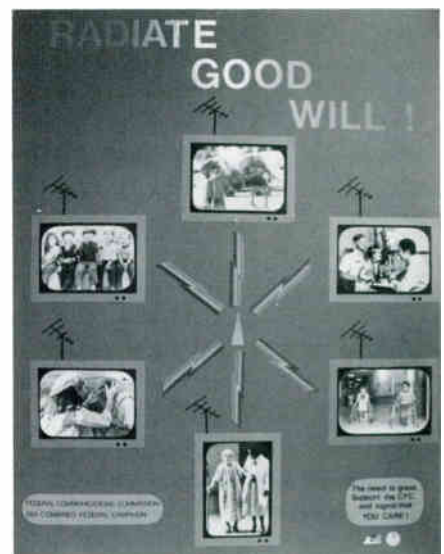

★ FREE ★ PROGRAMS for LPTV Stations

T.A.N. proudly presents

★ The Country Store

A unique shop-at-home show.
All handmade, handcrafted
items made in the USA. Plus
entertainment • music • humor.

★ The National Country Music Jamboree

1 hour format — invites people
from all over the USA to come and
perform. Comedy — Music —
REAL PEOPLE.

★ All New —
Tappings Done Weekly
Uplink feed or tapes available.



For Information & Demos
Call 1-800-222-8937 or
Write T.A.N. • P.O. Box 193
Harrington, ME 04643

Circle (165) on ACTION CARD

News Salaries At A Standstill, Says RTNDA

Average salaries for most radio and television news jobs stood still last year, according to a survey done for the Radio-Television News Directors Association.

Reporters, producers, anchors, and news directors were making roughly the same pay in the summer of 1991 as they were a year earlier — despite an increase in the consumer price index, which rose 4.7% during the period.

The average TV news director's salary was \$45,000. Medians ranged from \$32,000 in the 60 smallest markets to \$105,000 at network affiliates in the 25 largest markets.

Radio news directors had a median salary of \$17,800, \$400 less than in 1990. Medians ranged from \$13,750 in markets of less than 50,000 people to \$35,000 in markets of a million or more.

The survey was conducted last summer for RTNDA by Vernon Stone, professor of journalism at the University of Missouri.

BON MOT

God gave us two ends — one to sit on and one to think with. Heads you win. Tails you lose.

Toni Needham

Sessions

continued from front page
recent developments in advanced television.

Zenith's all-digital HDTV system, developed in conjunction with AT&T, is one of the systems now being considered for adoption as the U.S. standard sometime in 1993.

HDTV World will host the first over-the-air live broadcast demonstration of HDTV technology when the Digicipher HDTV system, another contender, begins broadcasting via microwave link from the Convention Center to the Hilton Hotel. The Digicipher system was developed by General Instrument Corporation in partnership with the Massachusetts Institute of Technology.

Also at HDTV World will be a Technical Conference at which more than 65 papers will be presented focusing on the technical, political, and artistic issues raised by HDTV development. Topics will include HDTV production techniques, programming, advanced television equipment, and an HDTV tutorial.

The Conference proceedings will be compiled and sold at the convention at \$50 for NAB members and \$75 for non-members.

• • •

Radio broadcasters looking to tap into the \$207 billion Hispanic consumer market will benefit from a session that will join Hispanic broadcasters with top broadcast ratings and research executives in a discussion of trends among Spanish speaking consumers. The session, to be conducted in both Spanish and English, is scheduled for Tuesday, April 15.

• • •

A special session scheduled for April 14 will explore the changing partnership between TV networks and their local affiliates. Top executives from ABC, CBS, NBC, and FOX will square off with leaders from the local affiliate groups in one of several similar sessions focusing on broadcast TV's future.

Among the topics to be covered are: How will retransmission consent legislation affect stations' relationships with their networks? How will the removal of network/cable cross-ownership restrictions affect local broadcast affiliates? Will today's digital compression technology turn local stations into multi-channel video providers? How will the economics of today's broadcast marketplace change tomorrow's programming options?

• • •

Two special sessions for small market radio managers will offer tips on sales, marketing, and management in a small market station. **The Best of the Best Small Market Promotions** will showcase

money-making ideas from the winners of a recent Best of the Best promotion contest.

Selling Without Numbers will present street-tested techniques that sell advertising without dominant audience numbers, signals, or facilities. Selling without numbers means selling ideas, custom local research, and quality — regardless of the competition.

Working Leaner Means Greener will show station managers how to cut costs without sacrificing quality, and **A Cache of Collection Ideas** will present specific strategies for collecting advertising bills faster and more effectively.

Finally, **How to Work Effectively With Your Local Banker** will show managers how to develop a strong relationship with a banker so that the bank is there when the crisis is.

The sessions are geared to small market radio managers, but community television broadcasters will find that many of the ideas can be used in their businesses as well. See the NAB program schedule for times and places.

• • •

A Sports & Events Marketing Day is scheduled for April 14 and will feature five sessions that break down event marketing into a nuts and bolts, how-to exercise. **Sponsorship Proposals that Clinch the Deal** will offer specific writing and presentation techniques to help make sponsorship proposals stand out from the rest. The session will be led by Larry Zarin whose Team Z Enterprises boasts such clients as MTV Networks, *Rolling Stone*, and General Foods.

Sports Marketing Money-Makers will go beyond on-air sports coverage to show managers how combining calendars, sports hotlines, newsletters, team-related events, and other projects can increase station revenue.

Do's and Taboos of Small Market Event Marketing will share specific promotional events that are proven winners, as well as dud promotions to be avoided at all costs. Attendees will learn techniques and strategies to make events easier to conduct and more effective.

Parlaying National Sports Events Into Local Dollars will outline how to make money on sports events that are not based in a station's home community. Attendees will hear tips on creating local tie-ins to national sports events.

And to shore up a station's legal protection, **Sports & Events Marketing — Liability & Rights** will help managers learn more about obtaining rights, protecting a station against liability problems, understanding the value of trademarks, and other legal points.

These are just a few of the dozens of sessions scheduled at this year's NAB. For full information, see the NAB program available at the registration desk. 

NAB Walk-Through

continued from page 9

Comprehensive Video Supply (Booth 12438): Comprehensive Video will be introducing version 4.0 of their PC-based Edit Master video editing controller; a multi-source edit controller for the Amiga computer; the RS-422 data convertor; an affordable, easy-to-set-up, laptop-computer-based speech prompter; a compact time-code reader/generator; and a composite version of their low-priced NTSC chroma keyer.

Established products on display will include the Edit Master for Macintosh; PC software for videotape logging, script writing, and teleprompting; an assortment of video and audio switchers, mixers, and distribution amplifiers; and a cross section of the 3000+ products offered in the 1992 edition of Comprehensive's "Complete Book of Professional Video Accessories."

Computer Prompting Corporation (Booth 17075): CPC is featuring the CPC-500 CaptionMaker, the first high quality, low cost, PC-based, closed captioning system available. The CPC-500 CaptionMaker consists of IBM PC compatible software — used with a Line 21 Encoder or Line 21 Video Decoder — and two VCR's to close or open caption video tapes and do limited real-time captioning. A free demo video is available.

COMTEK (Booth 11127-28): COMTEK manufactures a full line of wireless communication systems in both high and low VHF frequencies. Featured products include the M-182 handheld wireless microphone, the miniature MRC-82 camera companion wireless microphone receiver, and the PRO-82 hi-fidelity personal receiver. Wireless microphone systems include handheld and lavalier transmitters with studio and field receivers. Personal communication systems include full duplex PL and cuing systems, and personal receivers for off-air monitoring of TV channels 2-13. The M-72 base station and the new PRO-82 personal receiver offer wireless convenience for IFB systems. And for inconspicuous cuing, COMTEK offers totally wireless ear canal earphones.

Dataworld (Booth 1626): Dataworld, now in its 21st year of service to the broadcast industry, maintains comprehensive databases and computational programs for AM, FM, TV, LPTV, and wireless cable. These include directories, allocation and interference studies, 1990 Census population counting, FCC flag service, terrain elevation retrieval, FM and TV area-to-locate studies, AM daytime and nighttime channel studies using the new AM rules, tower location studies, and unused call sign listings.

continued

See us at NAB '92
Booth #19924
Las Vegas, April 13-16, 1992

Video Processing, Amplified!



The VPA-330N's internal controls prevent inadvertent adjustments, while the VPA-331N features front panel controls and auxiliary video input.

Both Video Processing Amplifiers offer:

- ✓ Front panel SCH indication
- ✓ H&V blanking width adjustable
- ✓ Soft & gated hard black clip
- ✓ Video & chroma gain control
- ✓ Selectable VITS deletion
- ✓ Optional differential input
- ✓ Optional equalizing input
- ✓ Video & chroma AGC
- ✓ Hard or soft clamping
- ✓ Soft & hard white clip
- ✓ Fade to black
- ✓ Total bypass
- ✓ Optional remote control panels

For more information, call Toll Free:
In U.S.A.: 1-800-231-9673 In Canada: 1-800-387-0233

LEITCH

HEDCO

Leitch Incorporated/HEDCO
920 Corporate Lane, Chesapeake, VA 23320, U.S.A.
Telephone: (800) 231-9673 or (804) 548-2300 Fax: (804) 548-4088

Leitch Video International Inc.
220 Duncan Mill Rd., Suite 301, Don Mills, Ontario, Canada M3B 3J5
Telephone: (800) 387-0233 or (416) 445-9640 Fax: (416) 445-0595

Circle (128) on ACTION CARD

Dataworld also offers maps depicting zip codes, coverage, population density, power density, terrain shadowing, and received signal level, as well as on-line, 24-hour 300 to 9600 bps remote access with no connect or CPU charges.

Decision, Inc. (Booth 2100): Decision, Inc. will be featuring the Broadcast System III. The system is portable and runs on any MS-DOS, OS/2, UNIX system. Software includes traffic, scheduling, A/R and logging, with additional modules available. All reports and manuals can be displayed and searched on-screen. Remote access and modem support are also available.

Di-Tech Inc. (Booth 13107): Di-Tech will be exhibiting Model 5430-1, a stereo routing switcher with a 16 x 1 matrix and Model 5434, a stereo routing switcher with a 12 x 4 matrix. Also on display will be audio/video/pulse distribution amplifiers, video equalizers, audio monitor amplifiers, and video detectors.

Dielectric Communications (Booth 1708): Dielectric Communications is showing their popular "flagpole" antenna featuring an enclosed radome and optional ice shield. Circular polarization and customized patterns are available as are a top mount version and custom brackets. The result is optimal coverage and minimum picture distortion.

Also on display will be the company's 7/8" coaxial switch designed to provide fast, reliable switching of coaxial transmission line systems.

Digital Creations/Progressive Image Technology (Booth 19682): Digital Creations will be featuring the Kitchen Sync dual time base corrector which operates on a single PC or Amiga compatible card with both S-VHS and composite input and output, full frame and field freeze, and several other built-in features. The unit starts at \$1,895 for the PC card version.

Also featured will be the DCTV, an NTSC paint system for the Amiga 500, 2000, 7500, and 3000. The DCTV, which lists at \$499.95, is both a digitizer and a display device.

DYNAIR Electronics, Inc. (Booth 16706): New products on display will be DYNAIR's Series 400 RS-250C short haul video links for distances up to six miles. The links feature stereo audio. Also new is the Control Communications Line Distributor for the DYNASTY router.

Product upgrades include the MP9230 System Controller with enhanced graphic display, logical windows-style operator interface, eight-level control, and disk storage; the MiniStar control panel preview option which allows signal preview before take, for error-free switching; and the Se-

ries 400 Video high performance fiber links for applications up to 9.3 miles.

Dynatech Video Group (Booth 18046): The Dynatech team, which has changed its name to Dynatech Video Group, will be showing a wide range of products from each of its companies.

Utah Scientific's Total Automation System and NewStar II for traditional broadcast applications will be on display. Also of note will be a series of new digital products: the Colorgraphics DP digital graphics systems, the Quanta Delta digital character generators, the Alpha Image and Utah Scientific digital routing switchers, da Vinci's new 8:8:8 digital color corrector, a new component digital production switcher and digital standards converters from Alpha Image, and the Calaway CE-400 on-line editor.

Also on display will be a variety of Hi-8 and S-VHS format products from The Alta Group.

Echolab (Booths 13733-36): Echolab will be showing their line of special effects generators and switchers, all with linear keyers. The switchers feature 6 inputs and 10 outputs and come with or without memory. Also on display will be a mouse-driven digital effects processor that employs icons.

EMCEE (Booth 16728): EMCEE will be showing the new TTU1000EE solid state 1 kW UHF broadcast transmitter, along with 100-watt solid state VHF and UHF linear amplifiers. Also on display will be a their line of MMDS equipment, including the TTS20HS 20-watt solid state frequency agile transmitter with all-modular construction; the TSA50, a 50-watt linear amp for upgrading the TTS20 and TT-S10HS to 50 watts; and the MC2127 MMDS downconverter. New at this year's show is an exclusive EMCEE "Site Lock" system designed to reduce co-channel interference problems.

ESE (Booth 13701-02): New products from ESE include the ES-219 four output RS-170A black burst generator (\$195), the ES-2695 SMPTE time code to ESE time code converter (\$500), the ES-2743A ESE time code to ESE time code converter (\$1,350), the ES-233 video fade-to-black interface (\$395), the ES-215 rackmounted audio level indicators (\$138), and the ES-236 digital audio distribution amplifier. ESE will also be displaying all of its standard products.

Fast Forward Video, Inc. (Booth 11541): Fast Forward Video manufactures high-performance, low-cost time code equipment. The P-units incorporate low power LCD displays so that the units can be powered by a camera/deck; the F-units are AC powered rack units.

Featured at the show will be the P-1 with LTC R/G, drop/non-drop, and jam

sync; the P-2 with LTC R/G, drop/non-drop, character inserter, MTC, RS-232 serial control, and jam sync; the F-22 with LTC R/G, drop/non-drop, window dub, MTC, user bits, jam sync, and regenerate; and the F-30 which is the same as the F-22 with an added RS-422 serial port, GPI output, EBU 25-frame, balanced audio, and color framing.

Feral Industries (Booth 16406): Feral Industries will be introducing the C-100 time base corrector/synchronizer featuring multiple input selection. The \$2,495 unit operates in both NTSC and PAL video formats, and transcodes composite to S-VHS.

Established items will include the 6119 and 6119Y/C production switchers, the Hamlet Video International combination waveform/vectorscope, the Video International Standards converter, and the YEM Scan converters.

Fidelipac (Booth 1920): Fidelipac's new Dynamax DCR-1000 series digital audio cartridge machines will be on display. Also new is the MX series modular console featuring 8 to 12 mixers in both rotary and slide fader versions.

The Broadcast Audio Division of Fidelipac produces a wide range of modular audio consoles for on-air and production studios.

G&M Power Products (Booth 16427): G&M markets portable power supplies for the video broadcasting and film markets. Their product line includes Anton Bauer power systems, BP-90's manufactured in both NICAD and Lithium versions, and NPIA's and NPIB's alkaline and Walkie Talkie batteries. The company also provides power supplies for transmitters and remote locations.

Gorman-Redlich (Booth 4224): Gorman-Redlich will be showing Emergency Broadcast System encoders and decoders, as well as weather radios. The Model CEB encoder/decoder is a complete two-frequency EBS system that meets all FCC requirements. The Model CE encoder and Model CD decoder will also be on exhibit.

The Model CRW is a highly sensitive and selective receiver for National Weather Service transmissions. It will automatically record weather forecasts and emergency alert messages, and its three channels make it possible to market your audio for commercial services.

Ikegami Electronics (Booth 18558): Ikegami will be exhibiting many new products — the HK-343 2/3" field/studio camera, the HC-340, HL-43, HL-57 Digital, and HL-V57 Digital Camcorder 2/3" portable chip cameras; the 18 (600 lines), 20 (700 lines), and 30 (900 lines) series of TV monitors; and a composite digital compression/transmission system.

Established products on display will include field/studio cameras, portable chip cameras, 3-D equipment, HDTV equipment and monitors, RF equipment, and projection equipment.

ITS Corporation (Booth 12136): ITS will be featuring the ITS-235A and the ITS-1240 air-cooled, single Tetrode UHF transmitters. Both transmitters use the Thomson TH382 air-cooled Tetrode that provides 10 kW of visual amplification.

Established products on display will include two different 1 kW transmitters: the ITS-230A tube and the ITS-1230 solid state. The ITS-20A UHF exciter package will also be shown.

James Grunder & Assoc., Inc. (Booth 16406): See Feral Industries.

JVC Professional Products Company (Booth 16756): JVC will introduce what has been termed the most comprehensive S-VHS editing recorder in the industry — the BR-S822U. Key editing features include an optional Y-688 dub for easy interface with other editing equipment; a built-in 9-pin serial remote interface and a plug-in TBC with component outputs, allowing a direct feed to Betacam and MII.



JVC's new KY-17B 3-CCD camera.

To accompany the BR-S822U, JVC will also be introducing a complete line of new products — broadcast and video cameras, recorders, duplicators, editing equipment, and audio systems. New cameras will include the KY-17B and KY-17FIT, both featuring the latest in CCD technology, improved sensitivity, and drastically reduced vertical smear.

Of course, there will be a full range of established products also on display, including the S-VHS KM-D600U digital special effects unit with dual channel time base corrector.

Laird Telemedia (Booth 16360): On display at the Laird Telemedia booth will be the CKM-4 Series multi-layer keyers, the SE-Legend line of character generators, the K-120 keyer, the K-110 keyer, the CG-7000 character generator, the 1400 Series character generators, and the VC-2000 video corrector.

Leader Instruments Corporation (Booth 11701-04): Products to be shown include a portable broadcast/cable signal



Leader's Model 951 signal level meter.

level meter, a high-resolution RGB generator, an attache-case size 100 MHz oscilloscope, a digital video generator, a digital/analog waveform monitor, a 2.7 GHz synthesized/programmable signal generator, and a stereo monitor featuring auto alarm of L or R phase reversal.

Leitch/HEDCO (Booth 19924): The 100 MHz 16Xplus HEDCO router will join the D2TSG-1302N test signal generator and the D2PSG-1302N sync pulse generator at the Leitch/HEDCO booth. The 16Xplus is an economical, versatile router built on a modular concept. It allows 100 MHz of video and stereo audio in a one-rack-unit frame or 100 MHz of RGB video and stereo audio in two rack units.



The TSG-1302N test signal generator from Leitch.

The 16 x 1 video board can be increased to 32 x 1 or 62 x 1 in the one-and two-rack-unit frames, respectively.

The D2TSG-1302N is a low-cost, modular unit that provides a wide range of test signals, front panel control, balanced stereo tone, and serial/parallel remote control capability. The D2SPG-1302N sync pulse generator has a high stability internal sync generator; independent timing for pulses, black, and test signals; and adjustable blanking width and burst flag position.

Lenco Electronics, Inc. (Booth 12663, 12763): Lenco Electronics will be exhibiting sync generators, audio and video distribution amplifiers, audio power amplifiers, NTSC encoders, decoders, video processing amplifiers, video test equipment, system timing, and SC/H timing and phase instruments.

Listec Video (Booth 16719): Among the products Listec will be showing is the A-6000 Series PC Prompter Program featuring simultaneous edit and prompt in full color from a single, triple split-screen display. Scripts can be created from within the program or imported as ASCII text. Mouse, trackball, or keyboards control speed, next story, previous story, story restart, and story pause. *continued*

Eagle-Lion Video Presents HOLLYWOOD CLASSICS

Purchase from
an impressive library of over 1500 classic movies,
now available at VERY affordable prices.
Create your own movie library, with no limits on number of airings.

Award winning features include:

- John Wayne
- Cary Grant
- Jimmy Stewart
- Frank Sinatra
- Glen Ford
- Kirk Douglas
- Abbott and Costello
- Humphrey Bogart
- Charles Laughton
- Ronald Reagan
- Audrey Hepburn
- Walter Matthau
- Elizabeth Taylor
- James Cagney



FOR A COMPLETE CATALOG, CALL (619) 281-9975 or write:
Eagle-Lion Video, 4569 Mission Gorge Place, Suite G, San Diego, CA 92120

Circle (96) on ACTION CARD

Sony Tape™

**ALL SONY TAPE FORMATS AVAILABLE TO LPTV'S
AT "BIG STATION" PRICES!!**

Complete Post Production of station I.D. packages
DVE — Stillstore — Paint — Logo Compose — Great prices

Call 1-800-444-EDIT (3348)



Trident Productions, Inc.

Charleston, SC



Circle (165) on ACTION CARD

Prompters to be shown include the A-4250 Shoebox Mini-Prompter, the A2012P Portable Field/Studio 12" On-Camera Prompter, and the A-5501 SCROLLBOX-PLUS Electronic Prompter.

Manhattan Production Music (Booth 5122): Manhattan Production Music will be premiering the 5CD Audiophile Sound Effects series, a new library featuring 495 popular sound effects for radio and TV, recorded digitally with more than 128 times over sampling. Also featured will be MPM's music library, which currently consists of 38 CD's, including two new releases — MPM 37 Weekend Update, featuring news themes, and MPM 38 Bumper to Bumper, featuring 99 different short bumpers and stingers.

MATCO (Booth 16379-80): MATCO will be featuring four automated playback systems. The new MATCO MA-204A is the old MA-204 with a new front panel, internal routing switcher, and software features. The new unit — more economical than the 204 — lists at \$4,200.

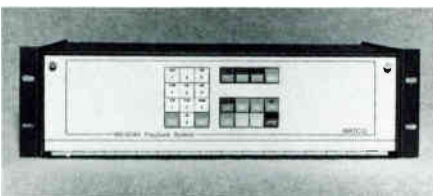

The MATCO MA-204A.

Also featured will be the MA-201, a low cost, single output, internal 8 x 1 AFV stereo router with 77 day 700 event programming; the MA-300, a real time tape duplication control system; and the MA-270, an off air logging system.

Microwave Radio Corporation (Booth 13901): Microwave Radio, a leading manufacturer of microwave radio systems, will be featuring the ProStar™ series of portable transmitters, receivers, and amplifiers. Also to be exhibited are the ProScan™ 2 and MicroScan™2 7 GHz antennas; the Megahorn™ and DiscRod

antennas; and TouchStar, BB-4, and PC-100 antenna control systems.

FLR and FLH series transmitters and receivers, PAC series modulators/demodulators, the IF modem, the Digi-Pro™ digital audio system, and the MR-23VX 23, MR-23CX 23, and the Micro-Link™ III 18 GHz microwave radio systems will also be on display.



Microwave Radio's ProStar 2T2 WB 2 GHz wideband microwave transmitter with Megahorn antenna.

Miller Fluid Heads Inc. (Booth 16101): Miller Fluid Heads will exhibit and demonstrate its complete range of pan and tilt fluid heads, tripods, camera support systems, and camera support accessories for TV and film production.

Of particular interest to LPTV broadcasters is Miller's new range of single and 2-stage "Leg Angle Lock" tripods and the economical Miller studio pedestal systems.

Moseley (Booth 3424): Moseley will be displaying the MRC 1620 transmitter remote control system. Using Task Master 20™ software, one broadcast user is controlling more than a hundred sites from two PC's located in southern California. The cost-effective software permits phone access to the transmitter site on a scheduled and emergency basis.

Nikon Electronic Imaging (Booth 18172): Nikon Electronic Imaging is exhibiting its S15 x 8.5B II lens, introduced just this past December. The lens is an enhanced version of the company's

S15 x 8.5 Nikkor lens for 2/3" CCD cameras. The \$6,600 list price lens features a wide zoom ratio and minimum object distance of .8 meters, along with a zoom speed adjustment switch and a removable servo housing.



The Nikon S19 x 8 ENG lens.

Also on display will be Nikon's FW-ENG and F-ENG converters, as well as ENG accessories such as filters and zoom controls, and the new HDTV Series zoom and fixed lenses.

NOVA Systems (Booth 13943, 14043, 14143): NOVA will be featuring the NOVA-Mate™ TBC for computer plug-in, stand alone or NOVAFrame, the NOVA Ncoder, the NOVA Dcoder, the NOVA Xcoder, and a new video signal processing system.

Established products on display will include the NOVA 950 TBC, the NOV-ASync™, the NOVA 920SP and the NOVA 810 TBC's.

Panasonic (Booth 18019): One of the many new products to be introduced by Panasonic will be the M.A.R.C. Cassette Library system with its wide range of custom application software. Available in 100, 450, 800, and 1,200 cassette sizes, the M.A.R.C. uses either the cost-effective MII or the new D3 composite digital format.

The company's multi-station system allows programming and spots for more than one station to be prepared and controlled from a common control room using a common library system. It will accommodate either common program material with different break material of both different program and different break material.

Also to be exhibited will be the company's full line of S-VHS products for television studio and ENG applications.

PESA Chyron Group (Booth 19306): Some highlights from the PESA Chyron Group include the RM4000 100 MHz routing switcher with 6600 EX self-contained controller board; the MAX! >, a dual channel capable, full color, fully anti-aliased character and graphics generator; and the Aurora Systems AU/280 Commander 32-bit 4:4:4:4 paint and animation system.

Established products on display include the Chyron Infiniti! and the AU/240 and AU/250GT paint and animation systems, as well as the CMX OMNI 1000 from

CMX Editing Systems. The OMNI 1000 can control all of the equipment in the post-production suite through direct interfacing and networking.

Prime Image (Booth 16966): Prime Image will introduce the TBC-PCB, a new plug-in time base corrector/synchronizer board. The unit is a single-channel, 525-line window device and is compatible with Betacam, Betacam SP, MII, U-Matic, U-Matic SP, Hi-8, ED Beta, VHS, and S-VHS tape formats. List price is \$850. Also new are the NTSC-10 x 10 SYNC — a 10 MHz bandwidth, 10 bit, very wide band direct synchronizer; and the NTSC and PAL-TWO, Model 2X, a dual channel time base corrector/synchronizer based on the 601 standard.

Established products on display will be the PAL-6.5P series (Model 6500) and the NTSC-EXCEL 6.5 series (Model 600) time base correctors/synchronizers, as well as the NTSC-ACCESS (Model 500), an electronic still store with transcoding.

QSI Systems, Inc. (Booth 16633-35): QSI will be featuring the Model 8000 image generator, a self-contained graphics editor. The 8000 features mouse-controlled editing; 2X, 4X, and 8X hardware magnification; pixel by pixel editing; a 512-color palette; and more.

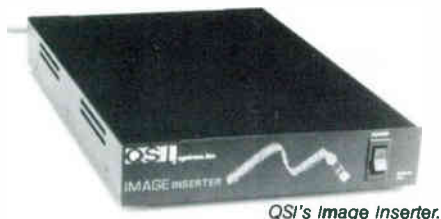

QSI's Image Inserter.

Also featured will be the Model 800 image inserter for in-video display of any image over any RS170/RS170A video source. The 800 is a fully self-contained NTSC graphic inserter that produces a full color insert with a pixel resolution of 760 x 480 and adjustments over chroma phase and gain.

Register Data Systems (Booth 2206): RDS™ offers a complete line of sales/traffic/billing/accounting computer systems for broadcasters with any size station in any size market. The Digital Audio Division of RDS™ offers the DigiCorder™ digital audio system, providing instant access to any audio, with CD quality.

RF Technology, Inc. (Booth 16115): The RF-18GT and RF-23GT microwave systems from RF Technology represent state-of-the-art short haul microwave. Features include full RS-250C performance, 70 dB dynamic range, and a unique linearized AGC for easy installation and antenna alignment.

To complement its D Series product line, the company is introducing the RF-1300/1302D 13 GHz portable. Both units are capable of 600 MHz agility. The

transmitter supplies a full 1.5 watts for RF power, which — when operated into the low noise receiver — provides unparalleled system gain.

RTI (Booth 14046): RTI will be exhibiting the new TapeChek® Pro Line 4100, a new Betacam SP tape recycling and rejuvenation system featuring a new CCD-based defect detection system. Also new are the TapeChek® 490M videotape cleaner and inspector for MII format users and the TapeChek® XCL high-speed VHS videotape cleaner/conditioner/rewinder.

Scala Electronic Corporation (Booth 15715): Scala will be exhibiting a complete range of antennas for VHF and UHF LPTV systems, including transmit antennas, monitoring antennas, and accessories.

Scala offers more than 38 years of experience in the design, manufacture, and application of professional antennas for LPTV systems.

Shure Brothers (Booth 11901): Shure will be exhibiting its line of professional audio equipment featuring the FP410 portable automatic mixer, the VP64 ENG handheld interview microphone, the VP88 MS stereo condenser microphone, and the Shure L Series wireless microphone systems.

Sony — Professional Tape Division (Booth 11711): Sony will be introducing the metal Betacam-SP BCT-MA series, the D2 series formulation that was previewed at SMPTE, the Pro S-VHS MQST series, the Pro DAT Plus PDP series, the digital audio U-matic MDU series, the improved Pro Hi-8 HMPX and HMAX, and the D1 and D2 large-size case approved for shipping.

The metal Betacam SBT professional series will also be on display.

Stantron, Zero (Booth 16401-04): Zero Stantron will display its full line of all-welded pre-assembled video consoles, equipment racks, modular work stations, mobile VTR racks, dubbing racks, TV/VTR editing consoles, rack slide kits, fast rack enclosures, and accessories.



An assortment of cases from Star Case.

Star Case (Booth 11113-11114): Star Case will be featuring several design concepts in its Ultra, Super, ATA, and Carry Star product lines. Visitors to the Star Case booth will receive a free copy of the Custom Reference Guide to help eliminate the mystery often associated with custom case design. *continued on page 24*

WorldRadioHistory

THE LEADER IS AT IT AGAIN!

State-of-the-art technology and JAMPRO continue to grow together . . .

We were on the cutting edge when we developed the first circular polarized television antenna . . . and that tradition continues today in our Low Power series TV systems.

JAMPRO offers the LPTV broadcaster a wide variety of competitively priced antennas, all of which contain the technology and experience of a company that has been the leader in the industry for over 35 years.

FOR THE MOST COMPETITIVELY PRICED QUALITY LPTV ANTENNAS CALL

(916) 383-1177
Fax (916) 383-1182



6340 Sky Creek
Sacramento, CA 95828

See us at NAB
Booth #3824

Circle (154) on ACTION CARD

LPTV Report / March 1992 / 21

Supplier Solo

The Paltex EDDi Opens New Windows In Desktop Video

—by Earl Jamgochian

Since its advent nearly two decades ago, computer-controlled videotape editing — or more appropriately, video post-production — has remained a relatively complex and expensive process. Advances in technology have slowly brought down the cost of the necessary hardware — video editor, video switcher, audio mixer, and character generator; but the complexity remains, and the costs are still much too high for the vast majority of the video industry.

Until now, the greatest single reason for the high cost of video equipment has been that manufacturers have had to develop their own computer hardware to support the specialized software that makes these systems work. However, the same technologies that have made desktop publishing a household term — the introduction of powerful, inexpensive personal computer hardware and the development of Graphical User Interfaces

like Microsoft®'s Windows™ — have now been applied to video production by PALTEX International.

PALTEX has recently introduced a revolutionary new Desktop Video Production Center, called EDDi™, that works within a standard AT-class (286 or greater microprocessor) PC-compatible computer operating under the popular Windows environment.

By taking advantage of the "cursor and keyboard" functions common to all Windows-based software packages, users familiar with icon-based systems will find that learning to use EDDi is straightforward and quick. With the multi-tasking capabilities of Windows, users are free to switch at will between the EDDi Production Center and any of the hundreds of available Windows-based software packages. In fact, EDDi can be left operating in the background while another software application is brought to the system's foreground for use.

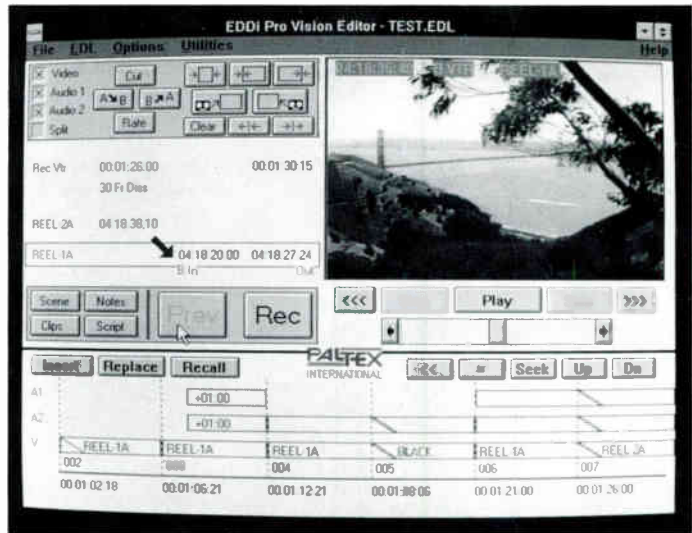

A screen menu from the Paltex EDDi Provision™ Editor.

parallel remote VTR's is possible with the optional PALTEX SID™ Serial Interface Device; interfacing to Control-L, Control-S, and new-generation RS-232 VTR's will be released later in 1992. PALTEX's dozen years' experience with tape transport control ensures that edit accuracy and VTR synchronization are limited only by the attributes of the VTR's in use.

Features common to all EDDi models include:

- 999-line edit decision list (EDL) memory;
- Edit List Management with Stage-1 Auto-Clean;
- Graphical or traditional EDL display;
- "Click and drag" edit point transfer;
- Backspace preview;
- Automatic match-frame calculation;
- Animation mode;
- Sequential auto-assembly;
- Multiple General Purpose Interface (GPI) triggers;
- Extensive, context-relevant HELP system.

EDDiSwitch™ Video Switcher: Designed by PALTEX's Advance Research facility, EDDiSwitch is an 8-crosspoint switcher that features seven video inputs, two outputs, and a built-in Color Black generator. Priced at \$1,900, EDDiSwitch fulfills both the needs of off-line edit decision list generation (i.e., the development of a properly timed EDL and video rough cut) and those of a production switcher for final-cut editing (fades from and to black, and cuts and dissolves between sources). The switcher can be operated manually by a pull-down control panel, or automatically by the EDDi video tape editor.

EDDiMix™ Audio Mixer: EDDiMix, a \$1,500 accessory to the EDDiSwitch video switcher, is an innovative 8-channel stereo audio mixer that plugs into a con-

Custom Loaded Videocassettes

- All NEW Tape
- All Major Brands
- 3/4", VHS or Betacam
- Any Length
- Shelf Cases-Sleeves
- Packaging & Fulfillment

**Excellent Service
Great Prices**

CoarcVideo™

(800) 888-4451

PO Box 2 • Route 217
Mellenville, NY 12544
FAX (518) 672-4048

Circle (28) on ACTION CARD

The EDDi System

The EDDi system is available in four different configurations to fit the needs and experience levels of its users:

- EDDi™, capable of controlling two VTR's and developing a true A/B-roll edit decision list for later on-line editing;
- EDDi Pro™, with full A/B-roll VTR and internal or external RS-422 switcher control;
- EDDi vision™, a 2-VTR system with PALTEX's unique vision Video Overlay system, which puts full motion, real-time video on the user's PC display and adds a powerful video database system and a full-screen pictorial editor;
- EDDi Pro vision™, like EDDi vision but with A/B-roll VTR capability and internal or external RS-422 switcher control.

Components of the System

EDDi™ Video Tape Editor: The EDDi Video Tape Editor is the platform upon which the rest of the EDDi Desktop Video Production Center is built. Utilizing a new, proprietary control design, EDDi communicates with most popular serial remote VTR's (S-VHS, 3/4" U, Betacam, M-II, and 1" Type C) and various RS-422 serial switchers, through a small external interface box connected to one of the host PC's COM (serial communication) ports.

In addition, control of many common

The perfect marriage... You and BE-TV.

PROGRAMMING SCHEDULE							
SUGGESTED AIRING TIME	SUNDAY	MONDAY	TUESDAY	WEDNESDAY	THURSDAY	FRIDAY	SATURDAY
	7:00 p.m.	SPORTS REVIEW	THIS WEEK IN SPORTS	QUICK GARDEN ROMANCE and ROSES	OUTDOOR TRADITION MYSTERY FORUM	GOOD OL BOYS WESTERN THEATER	ANTIQUE CARS BACK STAGE PASS
8:00	CRAFT CORNER DO IT YOURSELF	THE BIG PICTURE	ROMANCE THEATRE	MYSTERY THEATRE	SCI FI THEATRE		SCARY THEATRE
9:00	BYTES and PC's	OLD FAVORITES THEATRE	PSYCHIC VOYAGES	JUSTICE		MIND PROBE	FUNNY BUSINESS
10:00	JAZZ and BLUES THEN and NOW						
11:00		RERUN ACTION THEATRE	RERUN OLD FAVORITES THEATRE	RERUN ROMANCE THEATRE	RERUN MYSTERY THEATRE		SCARY THEATRE
12:00	ACTION THEATRE	RERUN ACTION THEATRE	RERUN OLD FAVORITES THEATRE	RERUN ROMANCE THEATRE	RERUN MYSTERY THEATRE		
1:00 a.m.							

BE-TV
 P.O. Box 413671 • Kansas City, MO 64141 • (816) 842-BETV FAX: (816) 842-6313

Circle (196) on ACTION CARD

necter on the switcher's printed circuit board. A positionable, pull-down menu provides simple, scroll-bar control of audio levels and channel assignments. Users may choose between audio-follow-video and break-away source selection and mixing.

EDDiText™ High-Resolution Character Generator: The third component of the EDDi system, the \$2,800 EDDiText, is a high-resolution video character generator. Pull-down menus provide quick and easy access to typeface selection, font size, drop shadow and borders, character color, and other CG essentials. When used with PALTEX's EDDi *vision*™ series, composed text is automatically keyed over the on-screen video window.

SceneManager™ Video Database System: Standard equipment with the EDDi *vision*™ series, and an available option for the rest of the EDDi line, SceneManager allows system users to view their footage on EDDi's PC display; mark and "grab" desired key-frames with the click of a mouse button; and create a time-code related video database for each video project.

SceneManager also provides for direct control of the source VTR from its display menu. Since a key-frame is not always the scene's first frame, SceneManager provides the ability to mark time code points

other than that of the image displayed. Once grabbed and saved, script notes may be written and appended to each image, creating a time-relevant database of all key images on each source reel.

EDDiView™ Pictorial Editor: Completing the *vision*™ series is EDDiView, a full-screen pictorial extension of the EDDi Video Tape Editor. EDDiView utilizes the power of the *vision* Video Overlay system to provide full-screen Source and Record video output, then adds superimposed controls for VTR transport operation, time code "marks" selection, video and audio channel designations, and edit preview and perform. EDDiView is perfect for visual editors who like to keep the mathematics and mechanics of videotape editing in the background.

System Configurations

The EDDi Desktop Video Production Center is available as a user-installed software/hardware package, with prices ranging from \$1,500 for the basic 2-VTR (cuts-only) EDDi to \$5,000 for the 3-VTR EDDi Pro *vision*. A complete Desktop Video Production system, ready for installation in the user's PC, carries a maximum price of \$11,300.

For users without the requisite PC hardware, PALTEX International also markets a fully configured "turnkey" production

system, complete with a unique black PC-compatible with 33 MHz 80386 microprocessor, 4 Mb RAM, a 120-Mb fixed disk, and 1.2 Mb and 1.44 Mb floppy disk drives. The turnkey system also includes a color-coordinated mouse and keyboard as well as a 14" high-resolution multi-sync monitor. Prices for these complete systems range from \$7,300 to a maximum of \$14,500.

In summary, the EDDi Production Center defines "desktop video": The marriage of a cost-effective video production system with readily-available computer hardware and an established operating environment. Add the ability to use the system's hardware for other purposes, and the economics of personal video production make sense for the first time. For the video professional of the '90's, PALTEX International's EDDi makes computers and video work together.

Earl Jamgochian was graduated from the School of Cinema at the University of Southern California with a degree in Film Production. After 15 years working professionally as a film and video editor, camera operator, and still photographer, he is now marketing manager for PALTEX International, a leading manufacturer of broadcast and professional video post-production equipment.



Pre-Owned Visual Communications Equipment

With the best prices and greatest value for your dollar, our equipment is backed by a vast network of professional dealers. To reinforce this, we offer warranties and provide authorized service centers across the country for your convenience.

Whether your need to sell equipment or purchase pre-owned equipment, VCR can help you by working within your budget . . . on your terms.

Our inventory changes daily, so don't delay . . . the equipment that is perfect for you may be gone tomorrow.



2368 Schuetz Road
St. Louis, MO 63146
1-800-745-8272
FAX 1-800-488-8779

VISUAL COMMUNICATIONS
REPLAY CORPORATION

Circle (171) on ACTION CARD

NAB Walk-Through

continued from page 21

TEKNO, Inc. (Booth 20073): TEKNO will be introducing the Balcar high performance Fluxlite, a heatless, low power, continuous light source, for TV/movie and electronic imaging lighting.

Tektronix Television Division (Booth 18032): Tektronix will be featuring the VM 700A-option 21 automated camera measurement set for CCD defects, fixed-pattern noise, color imagery, and frequency response. The new VS210 NTSC video synchronizer will also be shown along with a new service agreement. Many of Tektronix's established products will also be on display.

Television Technology Corporation (Booth 15725): This year marks TTC's 25th year of service to the LPTV and translator market. At NAB '92, the company will be featuring the XLS series solid-state transmitters and translators. A new dual-input option for the XLS-1000 will be shown for the first time.

The XLS-1000's intelligent controller monitors its performance to maintain a solid, stable output up to full rated power. The controller automatically compensates for over-temperature conditions, high VSWR, device failure, and more — thereby protecting itself while remaining on-air.

The XLS-100 companion to the XLS-1000 will also be shown, along with



The XLS100 solid state 100-watt transmitter from TTC.

the XLS-100 100-watt transmitter, the XL-1000 tube type 1 kW transmitter, and the TVF-10 VHF transmitter.

Texscan MSI (Booth 15682-83): Texscan will be exhibiting the new Spectra-Gen Z series character generators, the M series shared network control system for automated commercial insertion, and the CSS-MINI Plus automated tape playback system.

Ultimatte Corporation (Booth 12529): Ultimatte will be introducing three new products at this year's show. The first is the Ultimatte 45, designed for the mid-sized production and post-production market. The device produces Ultimatte composites and incorporates the new MATTE SHADING process which overcomes problems of poor blue screens, has built-in transcoders and sophisticated flare suppression circuitry, and is menu-driven for easy operation.

continued on page 34

What's Going On

March 12-15, 1992. National Federation of Community Broadcasters Annual Conference. Seattle, WA. Contact: Wendy Muzzy, (202) 393-2355.

March 20-22, 1992. National Association of College Broadcasters Fourth Annual Western Conference. University of Southern California, Los Angeles, CA. Contact: (401) 863-2225.

April 4, 1992. National Association of College Broadcasters Third Annual Mid-Atlantic Regional Conference. Luzerne County Community College, Nanticoke, PA. Contact: (401) 863-2225 or (717) 821-0932.

April 10-12, 1992. Television Bureau of Advertising 37th Annual Meeting. Las Vegas, NV. 1993 Convention, March 15-17, New Orleans, LA. Contact: (212) 486-1111.

April 11, 1992. National Association of College Broadcasters Second Annual Southern Regional Conference. Middle Tennessee State University, Murfreesboro, TN. Contact: (401) 863-2225.

April 11-13, 1992. Broadcast Education Associations 38th Annual Convention. Las Vegas, NV. Contact: (202) 429-5355.

April 12-16, 1992. National Association of Broadcasters Annual Convention and Broadcast Engineering Conference. Las Vegas, NV. 1993 Convention, April 19-22, Las Vegas. 1994 Convention, March 22-25, Las Vegas. Contact: (202) 775-3527.

April 22-24, 1992. Broadcast Cable Financial Management Association/Broadcast Cable Credit Association Annual Conference. The New York Hilton, New York City. 1993 Conference, April 28-30, Lake Buena Vista, FL. 1994 Conference, April 20-22, Town & Country Hotel, San Diego, CA. Contact: Cathy Lynch, (708) 296-0200.

May 3-6, 1992. National Cable Television Association Annual Convention. Dallas, TX. 1993 Convention, June 6-9, San Francisco, CA. Contact: (202) 775-3669.

May 14-16, 1992. National Translator Association Annual Technical Seminar. Salt Lake Hilton Hotel, Salt Lake City, UT. Contact: Darwin Hillberry, Presi-

dent, (307) 856-6827 or Gary Robinson, Seminar Chairman, (801) 575-7531.

May 27-30, 1992. American Women in Radio & Television 41st Annual Convention. Phoenix, AZ. Contact: (202) 429-5102.

June 14-17, 1992. Broadcast Promotion and Marketing Executives & Broadcast Designers Association Annual Conference & Expo. Seattle, WA. 1993 Convention, June 13-16, 1993, Orlando, FL. 1994 Convention, June 10-13, New Orleans, LA. 1995 Convention, June 7-10, Washington, DC. Contact: (213) 465-3777.

July 26-28, 1992. Wireless Cable Association International '92 Convention. Marriott Orlando World Center Hotel, Orlando, FL. Contact: Robert L. Schmidt, President, (202) 452-7823.

September 9-12, 1992. National Association of Broadcasters Annual Radio Convention. New Orleans, LA. 1993 Convention, September 8-11, Dallas, TX. 1994 Convention, September 7-10, Los Angeles, CA. 1995 Convention, September 6-9, New Orleans, LA. Contact: (202) 429-5356.

September 23-26, 1992. Radio-Television News Directors Association Annual Convention. San Antonio, TX. 1993 Convention, September 29-October 2, Miami Beach, FL. Contact: (202) 659-6510.

October 1992. Women in Communications, Inc. National Professional Conference. Chicago, IL. Dates to be announced. Contact: (703) 528-4200.

October 14-17, 1992. Society of Broadcast Engineers National Convention. San Jose, CA. 1993 Convention, October 13-16, Richmond, VA. Contact: (317) 842-0836.

October 11-13, 1992. Association of National Advertisers, Inc. 83rd Annual Meeting & Business Conference. Hot Springs, VA. 1993 Convention, October 17-19, Palm Beach, FL. Contact: (212) 697-5950.

November 10-14, 1992. Society of Motion Picture and Television Engineers Annual Conference. Toronto. Contact: Ann Cocchia, (914) 761-1100.

November 12-15, 1992. National Association of Farm Broadcasters Annual Meeting. Kansas City, MO. Contact: (612) 224-0508.

November 1992. Community Broadcasters Association LPTV Conference & Exposition. Las Vegas, NV. Contact: Eddie Barker, (800) 225-8183.

Panasonic

Professional/Industrial Video

S-VHS

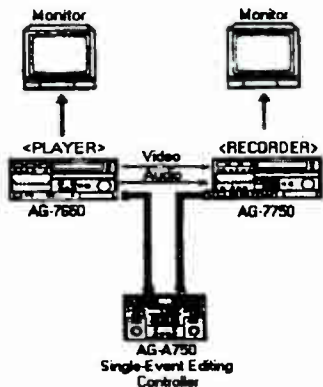

Video Editing Package

- CT-1382Y 13" Color S-VHS Monitors w/420 lines resolution
- AG-7650 S-VHS Source Player
- AG-7750 S-VHS Editing VCR
 - Built-in Digital TBC -Jog/Shuttle Dial -4 Channel Audio
- AG-A750 Edit Controller -Full Function, Single-Event Editing

Call us for information about this system, MII format, video accessories and tapes.

SHOWCASE

• ATLANTA •
404-325-7676
800-736-1976

Ask about our single-frame animation service.

AMIGA

Commodore

- SYSTEMS •
- SERVICE •
- SOFTWARE •

Circle (158) on ACTION CARD

NAB '92 Selected Exhibits

For more information on the products and services exhibited at this show, circle the appropriate numbers on the ACTION CARD bound in this magazine and send it in.

Company	Action Card Number	Booth Number
Acoustical Solutions, Inc.	4	12901-02
Acrodyne	5	15712
Adtec Productions	9	15182
Alan Dick & Co., Inc.	11	19258
Ampex Corporation	12	17101, S204
Andrew Corporation	13	16646
Antenna Technology Corporation	15	13725-26
Anton Bauer, Inc.	16	13418-20
Autogram Corporation	20	4525-27
AVCOM	21	12903
Barco, Inc.	22	18804
Benchmark Media Systems, Inc.	23	11301
BEXT, Inc.	24	3918
beyerdynamic	27	2230
Bi-Directional Microwave	31	15570
Broadcast Microwave Services, Inc.	34	12301-04
Cablewave Systems	35	1924
Canon	36	15719
Channelmatic	37	17430
Circuit Research Labs	38	4208
Coaxial Dynamics, Inc.	39	12905
Comprehensive Video Supply	41	12438
Computer Prompting Corporation	42	17075
COMTEK	43	11127-28
Dataworld	44	1626
Decision, Inc.	46	2100
Di-Tech Inc.	49	13107
Dielectric Communications	50	1708
Digital Creations/Progressive Image Technology	51	19682
DYNAIR Electronics, Inc.	52	16706
Dynatech Video Group	53	18046
Echolab	55	13733-36
EMCEE	56	16728
ESE	57	13701-02
Fast Forward Video, Inc.	58	11541
Feral Industries	59	16406
Fidelipac	60	1920
G&M Power Products	61	16427
Gorman-Redlich	63	4224
Ikegami Electronics	64	18558
ITS Corporation	65	12136
James Grunder & Assoc., Inc.	66	16406
JVC Professional Products Company	67	16756
Laird Telemedia	68	16360
Leader Instruments Corporation	69	11701-04
Leitch/HEDCO	70	19924
Lenco Electronics, Inc.	71	12663, 12763
Listec Video	74	16719
Manhattan Production Music	72	5122
MATCO	73	16379-80
Microwave Radio Corporation	76	13901
Miller Fluid Heads Inc.	77	16101
Moseley	78	3424
Nikon Electronic Imaging	82	18172
NOVA Systems	84	13943, 14043, 14143
Panasonic	85	18019
PESA Chyron Group	86	19306
Prime Image	89	16966
QSI Systems, Inc.	91	16633-35
Register Data Systems	92	2206
RF Technology, Inc.	93	16115
RTI	96	14046
Scala Electronic Corporation	97	15715
Shure Brothers	98	11901
Sony — Professional Tape Division	99	11711
Stantron, Zero	101	16401-04
Star Case	102	11113-11114
TEKNO, Inc.	103	20073
Tektronix Television Division	105	18032
Television Technology Corporation	107	15725
Texscan MSI	109	15682-83
Ultimate Corporation	110	12529
Video Accessory Corporation	111	16639
Video Data Systems	112	15684
Walter Brewer Corporation	113	12348

...at the FCC

NEW LPTV LICENSES

The following LPTV stations received licenses on the dates shown. Station call sign, location, and the name of the licensee are also given.

K34DF Redding, CA. Northern California Conference Association, 1/22/92.
W12CL Windsor Locks, CT. John Andrew Thompson, 1/21/92.
W48AV Detroit, MI. Glenn R. and Karin A. Plummer, 1/15/92.
W35AR Smithfield/Selma, NC. Waters & Brock Communications, Inc., 12/12/91.
W51BN White Lake, NY. John Mester tr/as Mester TV, 1/21/92.
K59EE Woodward, OK. Shaffer Translator, Inc., 1/29/92.
W68CE Shickshinny, PA. Joseph S. and Irene F. Gans, 1/22/92.
W68CG Nashville, TN. South Central Communications Corporation, 1/21/92.
K46CM Beaumont, TX. Faith That Pleases God Church Corporation, 11/12/91.

LPTV LICENSE RENEWALS

The following LPTV stations received license renewals on the dates shown. Station call sign, location, and the name of the licensee are also given.

K10LO Tygee Valley, ID. Stump Tygee Translator Station, 1/24/92.
K09OP Brownlee/Halfway, OR. Idaho Power Company, 1/28/92.
K30BN Coos Bay, OR. California Oregon Broadcasting, Inc., 1/28/92.
K36BX Coos Bay, OR. California Oregon Broadcasting, Inc., 1/28/92.
K63DO Coos Bay, OR. Metro Com of Oregon, Inc., 1/28/92.
K25AS Eugene, OR. Metrocom of Oregon, Inc., 1/28/92.
K57EL Eugene, OR. California Oregon Broadcasting, Inc., 1/28/92.
K59DJ Eugene/Springfield, OR. His Word Broadcasting Company, 1/28/92.
K65ER Eugene/Springfield, OR. Metro Com of Oregon, Inc., 1/28/92.
K38CP Grants Pass, OR. California Oregon Broadcasting, Inc., 1/28/92.
K65EJ Grants Pass, OR. Better Life Television, 1/28/92.
K04AE Long Creek, OR. F. L. C. R. Community TV, 1/28/92.
K06AB Long Creek, OR. F. L. C. R. Community TV, 1/28/92.
K09AE Long Creek, OR. F. L. C. R. Community TV, 1/28/92.
K11AH Long Creek, OR. F. L. C. R. Community TV, 1/28/92.
K62DN Medford, OR. Better Life Television, 1/28/92.
K63DA Milton/Freewater, OR. Citizens TV, Inc., 1/28/92.
K62DR Roseburg, OR. California Oregon Broadcasting, Inc., 1/28/92.
K52DE Salem, OR. Columbia River Television, Inc., 1/28/92.
K61CC Salem, OR. Northwest Christian Broadcasting, 1/28/92.
K42BR Terrebonne/Bend, OR. Rodney S. Johnson, 1/28/92.
K48BL Terrebonne/Bend, OR. Rodney S. Johnson, 1/28/92.
K03AX Umatilla River Valley, OR. Umatilla River TV Association, Inc., 1/28/92.
K29AX Winston, OR. John A. Zwart, 1/28/92.
K44CK Chelan, WA. KAYU-TV Partners, Ltd., 12/17/91.
K09UP Colville, WA. KAYU-TV Partners, Ltd., 12/17/91.

K03EJ Curlew/Malo, WA. Franson Peak Television Association, Inc., 12/17/91.
K09MP Curlew/Malo, WA. Franson Peak Television Association, Inc., 12/17/91.
K11NB Curlew/Malo, WA. Franson Peak Television Association, Inc., 12/17/91.
K13NV Curlew/Malo, WA. Franson Peak Television Association, Inc., 12/17/91.
K35BJ Ellusford/Oroville, WA. Okanogan Television, Inc., 12/17/91.
K11EY Grant County Airport, WA. Peoples TV Association, Inc., 12/17/91.
K13EP Moses Lake/Larson, WA. Peoples TV Association, Inc., 12/17/91.
K08CN Moses Lake/Ephrate, WA. Peoples TV Association, Inc., 12/17/91.
K55DJ Moses Lake/Warden, WA. Peoples TV Association, Inc., 12/17/91.
K58BL Moses Lake/Warden, WA. Peoples TV Association, Inc., 12/17/91.
K64CZ Moses Lake, WA. Peoples TV Association, 12/17/91.
K68BV Moses Lake/Warden, WA. Peoples TV Association, Inc., 12/17/91.
K31AH Omak/Okanogan, WA. Okanogan Television, Inc. 12/17/91.
K60AE Soap Lake/Ephrate, WA. Peoples TV Association, Inc., 12/17/91.
K52AF Moses Lake/Warden, WA. Peoples TV Association, Inc., 12/17/91.
K53CY Yakima, WA. KAYU-TV Partners, Ltd., 12/17/91.

NEW LPTV CONSTRUCTION PERMITS

The following parties received LPTV construction permits on the dates shown. Station call sign and location are also given.

W66BY Gulf Shores/Foley, AL. Christian Brotherhood Broadcasting, 1/6/92.
W12CP Mobile, AL/Pensacola, FL. Christian Brotherhood Broadcasting, 12/10/91.
W50BI Mobile, AL. Robert T. James, 1/30/92.
K55GE Little Rock, AR. Cyril H. Miller, Jr., 12/17/91.
K48DY Coalinga, CA. Gary Cocola, 1/30/92.
K02OH Fresno, CA. Dr. W. R. Portee, 1/23/92.
K25DW Sacramento, CA. Kidd Communications, 1/29/92.
K40DP Las Animas, CO. Full Gospel Outreach, Inc., 1/29/92.
W10CG Hartford, CT. Harvard Broadcasting, Inc., 1/29/92.
W67CL Jacksonville, FL. Christina M. Berry, 1/23/92.
W43BD MacClenny, FL. Henry J. McGinnis, 1/6/92.
W20AY Melbourne, FL. David Kennedy Ross, 12/16/91.
W35BD Albany, GA. Jesse Boone, Sr., 12/17/91.
W42BO Waycross, GA. Carl L. Gillis, Jr., 12/10/91.
K39DF Council Bluffs, IA. Douglas Sheldahl, 1/28/92.
K67FL Spencer, IA. Mountain TV Network, Inc., 12/16/91.
K31DE Boise/Nampa/Caldwell, ID. Brian A. Gould, 12/10/91.
K48DX Sandpoint, ID. KHQ, Inc., 1/22/92.
W07CW Lincoln, IL. L & M Broadcasting Company, Inc., 1/6/92.
W09CA Lincoln, IL. L & M Broadcasting Company, Inc., 1/6/92.
K49DE Lafayette, LA. Acadiana Christian Broadcasters, 1/30/92.
W40AV Lafayette, LA. Family Vision, Inc., 1/6/92.
K45DI Mermentau, LA. R. B. Sheldahl, 1/15/92.
W09CB Carmel, ME. Howard L. Soule, dba TV-9, 1/15/92.
W14BO Medway, ME. Craig Ministries, Inc., 12/16/91.

W67CP Waterville, ME. Bangor Communications, Inc., 1/28/92.
K23DF Appleton, MN. Prairieview TV, Inc., 12/19/91.
K24DF Lebanon, MO. New Life Evangelistic Center, Inc., 12/10/91.
K05JM Springfield, MO. Ed Stites, 12/24/91.
K02OF Bozeman, MT. Murray Duffy, 12/17/91.
K59EQ Kalispell, MT. CTN Missoula, Inc., 1/6/92.
W18BB Elizabeth City, NC. Elizabeth City State University, 1/22/92.
W46BV Elizabeth City, NC. Elizabeth City State University, 1/22/92.
K23CY Farmington, NM. John W. Lee, 1/31/92.
W61CA Buffalo, NY. Craig L. Fox, 12/17/91.
W27BI Plattsburgh, NY. Susan Clarke, 1/28/92.
W25BQ Defiance, OH. Wolfe Communications, Inc., 1/28/92.
K50DF Glencoe, OK. Mike Veldman, 12/17/91.
K31DF Lawton, OK. Lawton LPTV, Inc., 12/17/91.
K19DB Stillwater, OK. Ron Buck, 1/6/92.
K20DQ Sulphur, OK. William G. Mayo, 1/29/92.
W40AT Meadville, PA. A. D. Glover, 12/24/91.
W47BK Charleston, SC. Jeffrey L. Hamilton, 1/6/92.
K32DK Watertown, SD. Jeffco Broadcasting, 1/15/92.
K20DO Abilene, TX. Joanna Levin, 1/22/92.
K25EK Fredericksburg, TX. Perspective Communications, Inc., 12/10/91.
K45DN Kerrville, TX. River City Broadcasting, L.P., 12/10/91.
K47DZ Kerrville, TX. William G. Stacy, III, 1/22/92.
K31DG Killeen, TX. Killeen Christian Broadcasting Corporation, 1/30/92.
K48DS San Antonio, TX. San Antonio College, 1/22/92.
K07VC Victoria, TX. Ed Stites, 12/24/91.
K20DN Wichita Falls, TX. Rod Payne, 1/29/92.
K58ED Salt Lake City, UT. John Okita, 1/22/92.
W59CE Hampton, VA. WAVY Television, Inc., 1/23/92.
W38BM Charlotte Amalie, VI. Kelly Guglielmi, 1/6/92.
W62BY Monkton, VT. Vermont Wireless Cooperative, 12/17/91.
W64BP Monkton, VT. Vermont Wireless Cooperative, 12/17/91.
W66BX Monkton, VT. Vermont Wireless Cooperative, 12/17/91.
W68CK Monkton, VT. Vermont Wireless Cooperative, 12/17/91.
K32DD Colville, WA. Mountain TV Network, Inc., 12/24/91.
K29CP Point Roberts, WA. Concorde Ventures, Ltd., 1/28/92.
K54DU Richland, WA. Gloria Black, 1/22/92.
W61CB Stevens Point, WI. Northland Television, Inc., 12/19/91.
W55BY Waupaca, WI. Renee S. Garner, 1/6/92.

ASSIGNMENTS AND TRANSFERS

K33DJ Carmel, CA. Voluntary assignment of permit granted from Peninsula Communications, Inc. to Polar Broadcasting, Inc. on 1/30/92.
K69FX Carmel, CA. Voluntary assignment of permit granted from Peninsula Communications, Inc. to Polar Broadcasting, Inc. on 1/17/92.
K66CQ O'Neals, CA. Voluntary assignment of license granted from K. Sandoval Burke to Gary Cocola on 1/21/92.
W46BM Melbourne/Fellsmere, FL. Voluntary assignment of permit granted from Treasure Coast Educational Broadcasting, Inc. to Jacksonville Educators Broadcasting, Inc. on 1/22/92.
W68CF Tampa, FL. Voluntary assignment of license granted from WJUK-TV, Inc. to WSSM-TV, Inc. on 12/24/91.
W47BG West Palm Beach, FL. Voluntary assignment of permit granted from Treasure Coast Educational Broadcasting, Inc. to Jacksonville Educators Broadcasting, Inc. on 1/22/92.
W57BL Schaumburg, IL. Voluntary assignment of permit granted from Television Interests Company to Television Interests Company, Inc. on 1/13/92.
W51BU Indianapolis, IN. Voluntary assignment of permit granted from Television Interests Company

Classifieds

FOR SALE

HOT MUSIC: Buy-out library albums, station ID's and jingles from MusiCrafters. Call (215) 368-TUNE for a free demo and catalog.

For Sale: Panasonic S-VHS editor AG-A750; (3) Panasonic S-VHS 7100's; Quanta character generator; production van; microwave system; Vid Tech RS10A; Adcart 22. Contact Dave McCormick or Bob Moore at (419) 534-4848.

High-powered CP for sale: W29AU Coral Bay, Virgin Islands (60 kW ERP). Call (602) 582-6550, Charlene.

Used broadcast and studio equipment. Scala TV08 VHF antenna, Sony 3/4" players, portable 3/4" recorder, monitors, audio mixers, CG, special effects generator, and more. For complete list and prices, call (813) 371-0024.

WANTED TO BUY

LPTV station in south Florida area. Call or write M. Greenberg, c/o Silvercup Studios, 42-25 21st St., Long Island City, NY 11101, Dept. T, (212) 349-9600.

SERVICES OFFERED

Consulting. Manager highlighted in WSJ article on LPTV available for consulting. More than 8 years experience managing profitable LPTV's. For rates, contact Ken Shapiro at (312) 951-0871 or at 1636 N. Wells St., Chicago, IL 60614.

LPTV mailing labels. Reach all LPTV licensees, CP holders, applicants. Accurate, up-to-date marketing lists in your choice of format. Call Katie Reynolds at (414) 781-0188.

BUSINESS OPPORTUNITIES

Need your rate card for infomercial time. FAX to (702) 891-0415 with coverage map and programming. Telephone: (702) 597-1829, Arch Communications.

Broadcasting Systems, Inc.
Turnkey LPTV Construction
21617 North Ninth Avenue,
Suites 105 & 106
Phoenix, AZ 85027
(602) 582-6550
FAX (602) 582-8229

ARCOR BROADCAST PRODUCTS INC.
ARCOR stocks product for . . .
Audio Applications:
• Audio Cable
• Multi Channel Cable
• Microphone Cable
Video Applications:
• Precision RG59/U
• Precision 75 Ohm Video
• Camera Cables
1821 Elmdale Avenue
Glenview, IL 60025
708 724-7820
FAX 708 724-7833

Arent, Fox, Kintner, Plotkin & Kahn
Washington Square 1050 Connecticut Avenue, N.W.
Washington, D.C. 20036-5339
General Counsel to the
Community Broadcasters Association
Telephone (202) 857-6000 Telex WU 892672 Telecopier (202) 857-6395

SITUATIONS WANTED

Multi-talented LPTV manager seeks consulting assignments or management position. Diversified experience since 1987 encompassing consulting, founding, equipping, operating LPTV stations with "zero" budgets. Adept at site/coverage planning, obtaining legal/engineering counsel, FCC procedures, equipment selection/purchase, and Sony 3/4" production. Produced daily live variety interview programs. Did everything. John Broomall, (404) 974-8924.

CLASSIFIED RATES: All classified ads are payable in advance. When placing an ad, indicate the exact category you desire: *Help Wanted, Situations Wanted, Business Opportunities, Services Offered, Wanted to Buy, For Sale, Miscellaneous.* The publisher reserves the right to abbreviate, alter, or reject any copy.

Classified advertising is sold at the rate of 60¢/word. There is a \$20.00 minimum charge for each ad. Count each abbreviation, initial, single figure, or group of figures or letters as one word each. Symbols such as mm, C.O.D., P.O., etc. count as one word each. Telephone numbers with area codes, and ZIP codes, count as one word each.

Business Card ad rates are \$50.00 per insertion for each column inch. Rate is discounted to \$45.00 per inch for three or more insertions. Classified Display rates are \$50.00 per column inch.

To place your order, call Jackie Biel
at (414) 781-0188.
We now accept VISA/MASTERCARD orders.



SMITH and POWSTENKO
Broadcasting and Telecommunications
Consultants
1233 20th Street N.W., Suite 502
Washington, D.C. 20036
(202) 293-7742

ROBERT E. WINN
Director, Product Management
Antenna Operations
DIELECTRIC
GS
479 GIBBSBORO-MARLTON RD. PHONE 609-435-3200 EXT. 108
VOORHEES, NJ 08043 FAX 609-435-3204

ROBERT G. TRUSCOTT
President
TRUSCOTT BROADCAST SERVICES, INC.
TV Engineering Consultants
LPTV • Full Power • Microwave
Construction • Maintenance Contracts
618 Feather Sound Dr. Phone: 708-972-9658
Bolingbrook, IL 60440 Fax: 708-972-9648

JOHN H. BATTISON, P.E.
& ASSOCIATES
Consulting Low Power TV Engineers
2684 State Route 60, RD #1
Loudonville, Ohio 44842
Applications, Licensing, Turnkey
(419) 994-3849

JOB-HUNTERS EMPLOYERS
Looking for a job in television? Need someone for that hard-to-fill position? Use **The LPTV Report** classifieds.
Employers, list your openings for only **\$10 a month**, a savings of as much as \$20 off the regular classified rates.
Job-seekers, advertise **FREE**.
Ads are limited to 50 words. Please send payment with your order. Ads will run once, unless renewed in writing.
Send your ad copy (and payment, if appropriate) to Katie Reynolds, *The LPTV Report*, P.O. Box 25510, Milwaukee, WI 53225.

Just Getting Started?
So were we seven years ago. Since then, we've founded six LPTV stations. Some say WBTR-TV, Channel 19 here in Baton Rouge is one of best in country — winner of 7 CBA awards, rated by Arbitron and Nielsen, reaching 190,000 HH's, including 120,000 on cable, and making impact on our city. Along the way, we've learned about equipment, programming, sales, and operations. We conduct an intensive, personalized day-and-a-half training seminar and tour at WBTR-TV that could revolutionize your understanding of this business, save you money and help avoid pitfalls. Call Woody Jenkins, Gen. Mgr., WBTR-TV (504) 928-3146 or FAX 923-2822. B.A. in advertising, J.D. from LSU, 27 years' media experience, LSU J-School Hall of Fame, Vice Pres., CBA.

NEW - REBUILT TRANSMITTERS
1w - 1kw
LPTV - TV - FM TRANSLATORS
SELL - BUY - TRADE
REPAIR SERVICE
DARWIN HILLBERRY
113 SO. 2ND EAST
RIVERTON, WYOMING 82501 307-856-3322

EMMY AWARD WINNER
Bishop Fulton J. Sheen
Life is Worth Living
• 31 classic programs
• 3 minutes for your commercials
• 2 minutes for ours
• Low program fee
• Earn commission on tape sales
Call for information 1-800-732-2011
Sheen Productions, Inc.
23 E. Main Street • Victor, New York 14564

LPTV Distribution by State and Territory

February 6, 1992

	Licenses	CPs
ALABAMA	11	30
ALASKA	222	10
ARIZONA	32	31
ARKANSAS	10	27
CALIFORNIA	54	90
COLORADO	21	34
CONNECTICUT	3	5
DELAWARE	1	1
WASHINGTON, DC	2	0
FLORIDA	50	130
GEORGIA	22	35
HAWAII	4	33
IDAHO	20	30
ILLINOIS	15	37
INDIANA	16	28
IOWA	13	32
KANSAS	11	27
KENTUCKY	13	32
LOUISIANA	19	38
MAINE	8	21
MARYLAND	2	7
MASSACHUSETTS	8	12
MICHIGAN	13	23
MINNESOTA	51	42
MISSISSIPPI	12	22
MISSOURI	21	30
MONTANA	31	49
NEBRASKA	4	9
NEVADA	22	16
NEW HAMPSHIRE	3	4
NEW JERSEY	3	14
NEW MEXICO	17	35
NEW YORK	32	46
NORTH CAROLINA	15	31
NORTH DAKOTA	9	15
OHIO	23	44
OKLAHOMA	24	34
OREGON	28	29
PENNSYLVANIA	18	58
RHODE ISLAND	0	2
SOUTH CAROLINA	3	22
SOUTH DAKOTA	8	17
TENNESSEE	32	34
TEXAS	67	110
UTAH	22	6
VERMONT	1	16
VIRGINIA	9	28
WASHINGTON	19	26
WEST VIRGINIA	2	8
WISCONSIN	17	17
WYOMING	26	16
GUAM	1	0
PUERTO RICO	7	6
VIRGIN ISLANDS	1	3

TOTALS: Licenses: 1,098
Construction Permits: 1,502

to Television Interests Company, Inc. on 1/13/92.
K15BQ Topeka, KS. Voluntary assignment of license granted from Deanna Hinojosa to Capitol City Broadcasting Corporation on 1/15/92.
W46BE Murray, KY. Involuntary assignment of license granted from Keith Stubblefield to Joe Pat James, Receiver, on 1/16/92.
W54AE Paducah, KY. Voluntary assignment of license granted from Family Video Entertainment Corporation to Tri-State Christian TV, Inc. on 1/7/92.
W36BD Detroit, MI. Voluntary assignment of permit granted from Telethon Television Company to Telethon Television Company, Inc. on 1/13/92.
K26CR Kansas City, MO. Voluntary assignment of license granted from Janet Jacobsen to North Central LPTV, Inc. on 12/24/91.
K26CR Kansas City, MO. Voluntary assignment of license granted from Janet Jacobsen to North Central LPTV, Inc. on 1/28/92.
K29CF Kansas City, MO. Voluntary assignment of permit granted from Triangle Television Company to Triangle Television Company, Inc. on 1/17/92.
K35CT Overland Park, MO. Voluntary assignment of permit granted from Triangle Television Company to Triangle Television Company, Inc. on 1/21/92.
K07UR Raytown, MO. Voluntary assignment of permit granted from Triangle Television Company to Triangle Television Company, Inc. on 1/21/92.
K40CY St. Ann, MO. Voluntary assignment of permit granted from Television Interests Company to Television Interests Company, Inc. on 1/13/92.
K42DB St. Louis, MO. Voluntary assignment of permit granted from Triangle Television Company to Triangle Television Company, Inc. on 1/21/92.
K68DS St. Louis, MO. Voluntary assignment of permit granted from Triangle Television Company to Triangle Television Company, Inc. on 1/21/92.
W25BR Charlotte, NC. Voluntary assignment of permit granted from Triangle Television Company to Triangle Television Company, Inc. on 1/21/92.
W20AT Roanoke Rapids, NC. Voluntary assignment of license granted from Donald Frank White to Moran Communications, Inc. on 1/21/92.
K68DR Albuquerque, NM. Voluntary assignment of permit granted from Breckenridge Broadcasting Company to Breckenridge Broadcasting Company, Inc. on 1/13/92.
W28BC Massena, NY. Voluntary assignment of license granted from Watertown Television Corporation to Watertown Television Corporation, Debtor-In-Possession, on 1/16/92.
W67CN Rochester, NY. Voluntary assignment of permit granted from Television Interests Company to Television Interests Company, Inc. on 1/13/92.
W25AB Watertown, NY. Voluntary assignment of license granted from Watertown Television Corporation to Watertown Television Corporation, Debtor-In-Possession, on 1/16/92.
W53AX Cleveland, OH. Voluntary assignment of permit granted from Breckenridge Broadcasting Company to Breckenridge Broadcasting Company, Inc. on 1/13/92.
W47BE Seven Hills, OH. Voluntary assignment of permit granted from Breckenridge Broadcasting Company to Breckenridge Broadcasting Company, Inc. on 1/13/92.
K02NS Oklahoma City, OK. Voluntary assignment of permit granted from Breckenridge Broadcasting Company to Breckenridge Broadcasting Company, Inc. on 1/13/92.
K04NZ Tulsa, OK. Voluntary assignment of license granted from Harry V. Tootle to Gerald W. Brothers on 1/6/92.
K36CS Tulsa, OK. Voluntary assignment of permit granted from Linda K. Trumbly to Mike Simons on 1/9/92.
W66BM Quebradillas, PR. Voluntary assignment of license granted from Jose J. Arquaga tr/as Arquaga Broadcasting Group to Nelly Quiles on 1/17/92.
W15BB San Juan, PR. Voluntary assignment of permit granted from Jose J. Arquaga tr/as Arquaga Broadcasting Group to Nelly Quiles on 1/17/92.
W28BD Franklin/Columbia, TN. Voluntary assignment of permit granted from Lorianne Crook-Owens to Alice Jackson on 1/31/92.

W56CM Knoxville, TN. Voluntary assignment of license granted from Robert H. Shreffler to Southeast LPTV, Inc. on 1/28/92.
K57FH College Station, TX. Voluntary assignment of construction permit granted from Pueblo Broadcasting Corporation to Trinity Broadcasting Network on 12/16/91.
K55FV Houston, TX. Voluntary assignment of permit granted from Breckenridge Broadcasting Company to Breckenridge Broadcasting Company, Inc. on 1/13/92.
K62DY Victoria, TX. Voluntary assignment of construction permit granted from Pueblo Broadcasting Corporation to Trinity Broadcasting Network on 12/16/91.
K35BJ Ellusford/Oroville, WA. Voluntary assignment of license granted from Okanogan Television, Inc. to KAYU-TV Partners, Ltd. on 12/18/91.
K31AH Omak/Okanogan, WA. Voluntary assignment of license granted from Okanogan Television, Inc. to KAYU-TV Partners, Ltd. on 12/18/91.
K58DP Seattle, WA. Voluntary assignment of permit granted from Breckenridge Broadcasting Company to Breckenridge Broadcasting Company, Inc. on 1/13/92.

CHANNEL CHANGES

K49DD Sacramento, CA. Kidd Communications. Channel change granted from 25 to 49 on 1/29/92.
K51DY Santa Barbara, CA. Costa De Oro Television, Inc. Channel change granted from K36CD to K51DY on 12/9/91.
K27DU Pueblo, CO. Lomas De Oro Broadcasting Corporation. Channel change granted from 26 to 27 on 10/25/91.
K21DQ Baton Rouge, LA. Great Oaks Broadcasting Corporation, channel change granted from 65 to 21 on 1/8/92.
W25BR Charlotte, NC. Triangle Television Company. Channel change granted from 26 to 25 on 1/13/92.
W66BT Statesville, NC. Trinity Broadcasting Network. Channel change granted from 69 to 66 on 10/24/91.
K44DL Lovington, NM. Prime Time Christian Broadcasting, Inc. Channel change granted to channel 44 on 10/29/91.
K18DP Lovelock, NV. Pershing County Nevada TV District. Channel change granted from K14AK to K18DP on 11/5/91.
W49BF Syracuse, NY. Craig L. Fox. Channel change granted from W35AQ to W49AF on 12/2/91.
W25BO Ladysmith, VA. Caroline Community Broadcasting, Inc. Channel change granted from 40 to 25 on 10/25/91.
K24CU Colville, WA. Mountain TV Network, Inc. Channel change granted from K52DC to K24CU on 10/20/91.

CANCELLATIONS

The following construction permits were cancelled and their call signs deleted on the dates shown.
W13CF Atmore, AL. Eddie L. Tullis, 12/31/91.
W51BL Birmingham, AL. Channel 17 Associates, Ltd., 12/31/91.
W11CG Decatur, AL. Richard W. Baker, 1/31/92.
K10NO Batesville, AR. Arkansas Rural TV Co-op Company, 2/3/92.
K13VZ Camden, AR. Arkansas Rural TV Co-op Company, 1/31/92.
K05JI El Dorado, AR. Arkansas Rural TV Co-op Company, 2/3/92.
K18CZ Harrison, AR. Mountain TV Network, Inc., 12/31/91.
K22BZ Little Rock, AR. Catch 22 Broadcasting, Inc., 1/31/92.
K32CM Lake Havasu City, AZ. Dennis Macey, 1/31/92.
K39CS Barstow, CA. Katherine Estes Wilkerson, 12/31/91.
K50CL Belridge, CA. Belridge Elementary School District, 2/5/92.
K23CQ Ventura, CA. Laurence Windsor, 12/31/91.
K61FC Denver/Evergreen, CO. Lansman & Schatz Partners, 1/31/92.

continued

FCC Orders Applicants To Certify Eligibility Under Drug Act

Applicants for almost all types of FCC licenses will have to certify that they are eligible for the license under the provisions of the Anti-Drug Abuse Act of 1988, according to new FCC rules that took effect February 3.

A person convicted of a drug crime may not receive an FCC license if the sentencing judge has specifically declared him or her ineligible either for federal benefits generally or for FCC licenses in particular.

The new rules cover all construction permits, operating licenses, modifications, extensions, special temporary authorities, renewals, assignments, transfers, or other applications. The only exceptions are services, such as the Amateur Radio Service, that do not require individual licenses for users.

An applicant's signature on older application forms will be understood to include the certification, unless the applicant states otherwise. Forms printed after February 3 will include the certification question. The FCC plans to check applications against a General Services Administration master list of persons barred by judges from receiving federal benefits.

W04CL Fort Pierce, FL. Stephen G. Watford, 1/31/92.
 W08DA Fort Pierce, FL. Jerry E. Coone, 1/31/92.
 W59BX Stuart, FL. CW/S Partners, 1/31/92.
 K23CT Kailua, HI. Alegria Broadcasting Corporation, 1/31/92.
 K45CW Cedar Falls, IA. Great American Broadcasting Company, 10/31/91.
 K66DS Cedar Rapids, IA. Gaylord Broadcasting Company, 2/3/92.
 K10NM Davenport, IA. Richard D. Martin, 1/31/92.
 K45DG Des Moines, IA. Janet Jacobsen, 1/31/92.
 K23CS McArthur, ID. Mountain TV Network, Inc., 12/31/91.
 K17CQ Weiser, ID. Mountain TV Network, Inc., 12/13/91.
 W51BO Belvidere, IL. Belvidere Daily Republican, 1/31/92.
 W59BZ Belvidere, IL. Belvidere Daily Republican, 1/31/92.
 W06BN Mattoon, IL. The Cromwell Group, Inc. of Illinois, 12/13/91.
 W12CB Fort Wayne, IN. HSN Broadcasting-LPTV, Inc., 12/13/91.
 K45CF Winfield, KS. Winfield Publishing Company, Inc., 12/31/91.
 W20AX Glasgow, KY. Brightness Ministries, Inc., 1/31/92.
 W06BO Lexington, KY. Veal Pennington, 2/6/92.
 K30DH Bogalusa/Washington, LA. Mountain TV Network, Inc., 12/31/91.
 W13CG Gonzales, LA. Great Oaks Broadcasting Corporation, 12/13/91.
 K07UT Morgan City, LA. Great Oaks Broadcasting Corporation, 12/31/91.
 K07UV Shreveport, LA. Jeremy D. Lansman, 1/31/92.
 W54BJ Slidell, LA. Gerald Brothers, Jr., 1/31/92.
 W22BA Cape Cod, MA. J. J. Frost & L. Morrison, 12/13/91.

W30AO Marblehead, MA. William Gerry, 1/31/92.
 W61BS Mechanicsville, MD. Satellite Video Broadcasting Company, 12/13/91.
 W22AW Bangor, ME. D. Lee Caron, 2/3/92.
 W61BH Portland, ME. Figgie Communications, Inc., 1/30/92.
 K51DO Donnelly, MN. Televue Systems of Minnesota, Inc., 2/3/92.
 K21AK Morris, MN. Televue Systems of Minnesota, Inc., 2/5/92.
 K16CI Thief River Falls, MN. Hubbard Broadcasting, Inc., 1/31/92.
 K34DG Willmar, MN. UHF Television, Inc., 2/3/92.
 K38CV Willmar, MN. UHF Television, Inc., 2/3/92.
 W05BK Charlotte, NC. Gordon B. Madlock, 1/27/92.
 W28AC Charlotte, NC. Michael B. Ginter, 1/30/92.
 W29AX Greensboro, NC. Silvia M. Landin, 1/31/92.
 K42CW Bismarck, ND. Richard A. Warren, 10/30/91.
 K28DI Austin, NV. Austin Television Association, 12/13/91.
 K29CD Lake Tahoe, NV. Mark S. Severence, 12/13/91.
 K63EF Las Vegas, NV. Gerald D. Kamp, 1/31/92.
 W29AL Albany, NY. American Christian Television System, 12/13/91.
 W27BE Cincinnati, OH. James Worrall, 1/31/92.
 W25BH St. Marys, OH. Western Buckeye Broadcasting Company, 12/31/91.
 K22CV Durant, OK. Betty Margaret Wheeler, 12/31/91.
 K24CJ Durant, OK. Betty Margaret Wheeler, 12/31/91.
 K30CT Durant, OK. Betty Margaret Wheeler, 12/31/91.
 K32CN Durant, OK. Betty Margaret Wheeler, 12/31/91.

continued

MMDS Starts Here



Bill Betts
Mid West & Canada

Bethanne Bonita
Parts Representative

Jack Long
S.W. & California

Rich Fiore
East Coast & Carib.

Chuck Ray
Northwest & South Central

Eli Vardy
Mexico/So. America

Please Call 1-800-233-6193
EMCEE Broadcast Products, Inc., White Haven PA., 18661

Come see us at NAB ! Booth 16728

Circle (1) on ACTION CARD

WorldRadioHistory

Tom -

While you're at the NAB, check out Cablewave Systems. They have some exciting new products like Truncated STL antennas and FLEXWELL[®] E30 Elliptical Waveguide with 7/8" EIA Transition for ITFS/MMDS service. They've added some new items to their FLEXWELL coaxial cable product line and enhanced their line of BOGNER[®] medium and low power broadcast antennas. Their innovative engineering and product quality can't be beat. Cablewave Systems is right on the mark.

But don't take my word for it. Find out for yourself.

Remember - booth # 1924 at the NAB.

Dave



Radio Frequency Systems, Inc.
Cablewave Systems Division

Cablewave Systems

60 Dodge Ave.
North Haven, CT 06473
TEL (203) 239-3311
FAX (203) 234-7718

K61EZ Lawton, OK. BSP Broadcasting, Inc., 12/31/91.
 W46AM Lebanon, PA. Lebanon Broadcasting Company, 11/14/91.
 K22DF Rapid City, SD. J. Jacobsen, dba Jeffco Broadcasting, 12/31/91.
 W59BW Memphis, TN. Richard A. Warren, 10/30/91.
 W63OL Memphis, TN. Janet Jacobsen, 1/31/92.
 K31CQ Blanco, TX. KXAN, Inc., 2/5/92.
 K35DA Corpus Christi, TX. David A. Davila, 1/31/92.
 K62DX Jasper, TX. Mountain TV Network, Inc., 12/31/91.
 K27DP Taylor, TX. KXAN, Inc., 2/5/92.
 K48DJ Wichita Falls, TX. BSP Broadcasting, Inc., 12/31/91.
 K50CU Ogden, UT. First National Broadcasting Corporation, 1/31/92.
 W58BS Ruckersville, VA. Ridge Broadcasting Corporation, 2/3/92.

LPTV LOTTERY WINNERS

The following are tentative selectees of the LPTV/translator lottery held on December 11, 1991. If no petitions to deny the selectees are filed, and if they are otherwise qualified, they will be granted construction permits.

Ch. 50 Mobile, AL. Robert T. James.
 Ch. 62 Sanford, AL. Destin Community Television.
 Ch. 59 Springdale, AR. Pharis Broadcasting, Inc.
 Ch. 24 Bullhead City, AZ. MW TV, Inc.
 Ch. 65 Bullhead City, AZ. Richard D. Tatham.
 Ch. 19 Phoenix, AZ. Jeffrey J. Jacobsen.
 Ch. 39 Bridgeport, CA. Mono County Office of Education.
 Ch. 15 Fresno, CA. Park Broadcasting Company.
 Ch. 21 Sacramento, CA. National Minority TV, Inc.
 Ch. 20 San Luis Obispo, CA. J. Christian Damon.
 Ch. 32 Smith River, CA. Fortuna Economic Development Corporation.
 Ch. 38 Torrance, CA. Robert Rathe.
 Ch. 69 Visalia, CA. Eduardo & Rosa Maria Caballero.
 Ch. 24 Pueblo, CO. David M. Drucker.
 Ch. 26 Ft. Walton Beach, FL. Channel 44, Ltd.
 Ch. 44 Kaneohe, HI. KFVE Joint Venture.
 Ch. 23 Des Moines, IA. R. B. Sheldahl.
 Ch. 27 Des Moines, IA. Joseph Alfred Smith.
 Ch. 51 Grand Forks, ID. Barbara Dille.
 Ch. 33 Nampa/Caldwell, ID. Brian A. Gould.
 Ch. 46 Salmon, ID. Ambassador Media Corporation.
 Ch. 50 Carmel, IN. KEE Properties, Inc.
 Ch. 54 Evansville, IN. Randolph Victor Bell.
 Ch. 67 Wichita, KS. Brian N. Benschoter.

Ch. 60 Shepherdsville, KY. Valuevision International, Inc.
 Ch. 49 Lafayette, LA. Acadiana Christian Broadcasters.
 Ch. 52 Shreveport, LA. The Act of Faith Community, Inc.
 Ch. 42 Biddeford, ME. Kennebec Valley Television, Inc.
 Ch. 45 Cape Girardeau, MO. New Life World Outreach Center.
 Ch. 49 Springfield, MO. Pictures & Sound, Inc.
 Ch. 62 Jackson, MS. Great Oaks Broadcasting Corporation.
 Ch. 56 Durham, NC. Victory Communications, Inc.
 Ch. 34 Omaha, NE. Catherine A. Hill.
 Ch. 30 South Effingham, NH. James Rutherford.
 Ch. 9 Albuquerque, NM. Robert F. Porter.
 Ch. 17 Albuquerque, NM. Max A. Trevino.
 Ch. 29 Clovis, NM. Ramar Communications, Inc.
 Ch. 47 Hobbs, NM. Ramar Communications, Inc.
 Ch. 30 Las Cruces, NM. Ralph Orduno.
 Ch. 59 Las Vegas, NV. Adam Laird Marko.
 Ch. 69 Buffalo, NY. Craig L. Fox.
 Ch. 39 Hamburg, NY. Southtown Christian Center, Inc.
 Ch. 17 Manhattan, NY. Trintab Productions, Inc.
 Ch. 47 Rochester, NY. Global Broadcasting.
 Ch. 19 Durant, OK. Betty Margaret Wheeler.
 Ch. 2 Norman, OK. Gerald Brothers.
 Ch. 15 Bend, OR. A. B. Herman.
 Ch. 41 Eugene, OR. A. B. Herman.
 Ch. 18 Redmond/Prineville, OR. A. B. Herman.
 Ch. 40 Huron, SD. Crossroads Communications Company.
 Ch. 53 Sioux Falls, SD. Siouxland Christian Broadcasting.
 Ch. 57 Memphis, TN. Bert V. Groves, Jr.
 Ch. 67 Memphis, TN. George S. Flinn, Jr.
 Ch. 20 Amarillo, TX. National Minority TV, Inc.
 Ch. 39 Corpus Christi, TX. James D. Morgan.
 Ch. 41 Corpus Christi, TX. Jeffrey L. Hamilton.
 Ch. 46 Dallas, TX. HSN Silver King Broadcasting Company, Inc.
 Ch. 31 Killeen, TX. Killeen Christian Broadcasting Corporation.
 Ch. 46 Lubbock, TX. Ray Moran.
 Ch. 46 Port Isabel, TX. Perspective Communications, Inc.
 Ch. 69 San Antonio, TX. Simon, Inc.
 Ch. 33 San Angelo, TX. Perspective Communications, Inc.
 Ch. 27 San Antonio, TX. Inspiration TV of Southern Oregon.
 Ch. 58 Salt Lake City, UT. John Okita.
 Ch. 45 Richmond, VA. Charles W. Williams.
 Ch. 19 Virginia Beach, VA. Laura M. Beverage.
 Ch. 34 Spokane, WA. Browne Mountain Television.
 Ch. 63 Spokane, WA. Browne Mountain Television.
 Ch. 18 Ruidoso, NM. John Myrl Warren. CBP

Station Shorts

—by Anne C. Rosenberger

Elementary school kids in Davies County, KY are learning Spanish, courtesy of Owensboro Community College which began broadcasting live classes in February over their community station, W12BJ.

The instructor, Senora Roddy Woodward, offers 15-minute lessons Monday through Thursday at 8 a.m. from the OCC studio. Cordless telephones in the classrooms allow teachers and students to interact with Woodward.



W49AY, a religious community station run by the Glen Iris Baptist School in Birmingham, AL, has begun airing local church services every Sunday morning according to Ron Hass, a manager at the station. Along with other local programming, the station features "Woman's Perspective," a daily half-hour telecast featuring interviews with Birmingham area residents. The show is hosted by retired university professor Marie Blackwell.



At 7 p.m. TV 40 in Carlisle, PA rebroadcasts the 6 p.m. news from ABC affiliate WHTM in Harrisburg, PA. According to station manager Jeff Manotti, the rebroadcasts have been very successful. Although TV 40 cannot sell spots within the news program, they can cover a WHTM promo with a promo of their own, and they can sell the news adjacencies. Those spots sold out from August through the middle of January due in part to a special introductory offer of \$10 a spot.

Have you or your station made the news recently? Share your experience with other community broadcasters. Call Anne Rosenberger at (414) 781-0188 or send your news clip to Anne at The LPTV Report, P.O. Box 25510, Milwaukee, WI 53225. CBP

INDEX TO ADVERTISERS

Use this handy chart to find the ad you're looking for. Then fill out the **ACTION CARD** bound in this magazine for **FAST** answers to all your questions.

COMPANY	PAGE	ACTION CARD NUMBER	ADVERTISER FACT LINE	PAGE	ACTION CARD NUMBER	ADVERTISER FACT LINE
3 dbm/SWR	13	75	(800) 279-3326 ITS Corporation	36	123	(412) 941-1500
Acrodyne Industries, Inc.	29	18	(800) 523-2596 Jampro Antennas	21	154	(916) 383-1177
Adtec Productions	1	149	(615) 865-8707 Leitch/HEDCO	17	128	(800) 387-0233
Andrew Corporation	35	79	(800) 255-1479 Microdyne Corporation	33	100	(800) 441-9084
Antenna Concepts	7	181	(916) 621-2015 Microwave Filter	11	172	(800) 448-1666
Auction Network, The (TAN)	16	165	(207) 483-6686 Microwave Radio Corporation	15	134	(508) 250-1110
BE-TV	23	196	(816) 452-3346 Panasonic Broadcast & Television Systems	4-5	45	(800) 524-0864
Cablewave Systems	31	32	(203) 239-3311 Showcase	25	158	(800) 736-1976
Channelmatic	8	6	(800) 766-7171 Showplace	12	180	(312) 472-8828
Circuit Research Labs	6	161	(602) 438-0888 Television Technology Corporation	34	7	(303) 665-8000
Coarc Video	22	28	(518) 672-7202 Texscan MSI	2	26	(800) 367-6011
Eagle-Lion Video	19	96	(619) 281-9975 Trident Productions, Inc.	20	165	(800) 955-5660
EMCEE Broadcast Products	30	1	(800) 233-6193 Visual Communications Replay	24	171	(800) 745-8272
Gorman-Redlich	9	62	(614) 593-3150			



“We needed a professional, satellite receiving system with the flexibility to access all available programming.”

*Brad Dobbs, Vice President of Operations,
TV 43, Waukesha, Wisconsin*

“So we chose VistaLink™. An automated satellite receiving system from Microdyne.

VistaLink is preprogrammable, letting me access any satellite and any transponder. Any time.

Plus, I have the option of operating VistaLink remotely. That way I can set the receiver and antenna without even leaving the station.”

VistaLink is a proven system backed by Microdyne. A pioneer in satellite technology with thousands of satellite receiving installations around the world.

For complete information on VistaLink and how Microdyne can help your LPTV business, call toll-free (800) 441-9084. Or write Microdyne Corporation, 491 Oak Road, Ocala, FL 32672.

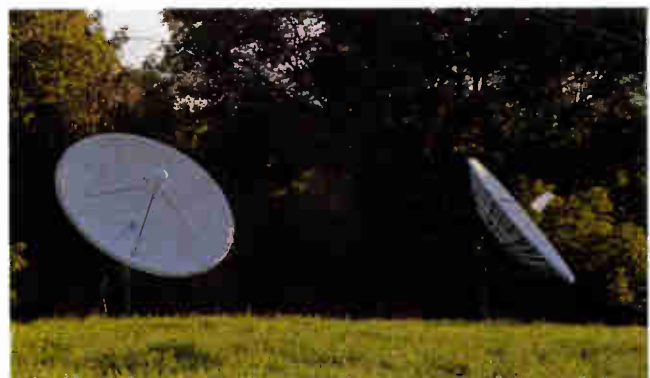

At TV 43, primary programming is received on a fixed Microdyne antenna. The VistaLink antenna rotates to receive programming from other satellites.

The VistaLink system lets you receive any satellite—any program, transponder format, or frequency—as easily as you operate a VCR.



WorldRadioHistory

Circle (100) on ACTION CARD

Microdyne
Excellence in Communications Technology

NAB Walk-Through

continued from page 24

The company will also be displaying its new computer graphics interface for the Ultimatte Memory Head. When used in conjunction with Ultimatte, the graphics interface allows live action to be composited into computer generated backgrounds and permits camera moves such as pans, tilts, zooms, and focus pulls to take place with the foreground and background locked together.

Finally, a new System-6 Transcoder 4:4, a two-channel bi-directional transcoder with two completely independent channels allows the Ultimatte System-6 to be used with any component recorder.

Video Accessory Corporation (Booth 16639): To be introduced at NAB is the VB/VDA Video Brick video distribution

amplifier featuring four 100 MHz outputs and differential or single-ended operation in a shirt pocket-size package. Also new is the HN/VDA Hum-Nulling video distribution amplifier with six wideband outputs and hum nulling adjustment.

Established products include black burst, color sync, genlockable color sync, and pattern generators; as well as clamping video distribution amplifiers and audio distribution amplifiers.

Video Data Systems (Booth 15684): The products Video Data Systems will be exhibiting include the LAPS laser auto promotion system for insertion of full motion video promos of pay and pay-per-view programming, and the Laser Cine Machine automated playback system incorporating laser discs and VCR's for pay-per-view programming.

Also on display will be the System 800

crawl inserter; the System 900 insertion system; the System 810 page titler for message, logo, or identification; the System 2000 automated information display system; and the System 830 color billboard.

Walter Brewer Corporation (Booth 12348): Walter Brewer specializes in the design, engineering, equipping, and installation of studio and location lighting systems for broadcast and production applications. The company specializes in turnkey systems but also offers a full range of equipment on an individual basis. Categories of equipment available include fixed and moveable grids, grid hardware, power distribution, fixtures and accessories, dimming and control, cycloramas, curtains and curtain track systems, and grip and gaffer tools and supplies. CSP

The Community Leader

Presenting another great innovation from TTC:

The XLS1000 Solid State 1 kW Transmitter:

Just what you would expect from the global leader in Community Broadcast Television.

TTC's Exclusive Solid State Design reduces power consumption, improves reliability and significantly lowers your operating costs.

Diagnostic and Control Intelligence continually self-corrects and compensates for adversities to insure you stay on the air.

The Most Extensive Remote Control in the industry lets you monitor and control 65 different operating parameters from anywhere in the world!

*To put the leader in your community call Jim Burns
(303) 665-8000, ext. 456.*

A Global Force In Broadcast Transmission Technology

TTC

650 S. Taylor Ave. Louisville, CO 80027

Visit TTC at NAB Booth #15725

Circle (7) on ACTION CARD

**This is an
Insurance
Policy**



**So
is
This**



ANDREW

Andrew Corporation
10500 W. 153rd Street
Orland Park, IL 60462
1-800-255-1479

Outstanding quality and performance are built into all Andrew products. The ALP-series™ LPTV antenna maximizes market coverage, and insures long-term system reliability.

Available from leading OEM's and System Integrators Worldwide

Ask About AndrewSM

Circle (70) on ACTION CARD

Reliability is ...

More than Solid State alone!

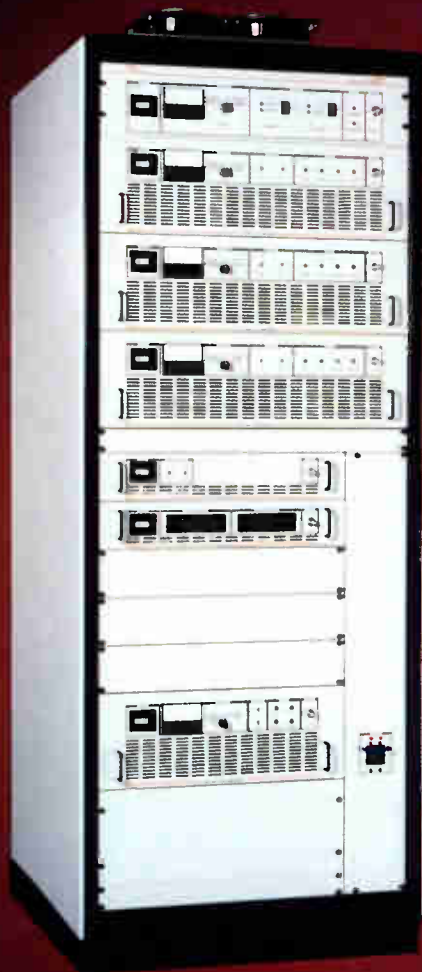

ITS-1230
1kW UHF Solid State Transmitter

Reliability is staying on the air - Parallel amplifier stages *from exciter to output* . . . redundancy extends to integral power supplies and cooling fans as well. For remote sites, a second exciter with auto-switcher can be added.

Reliability is ease of maintenance - Advanced Multi-level diagnostics and our proven 24-hour-a-day telephone support make this a reality.

Reliability is outstanding value - True Broadcast quality and features at a competitive price!

For more information on the ITS-1230, or our other LPTV transmitters and translators from 10 Watts to 2 KW, call (412) 941-1500 for the name of the **ITS** Representative in your area.

ITS
information
transmission
systems
CORPORATION

Visibly Better Technology

375 Valley Brook Rd., McMurray, PA 15317-3345

Circle (123) on ACTION CARD