

# The LPTV Report

News and Features for the Community Television Industry

Vol. 2 Issue 4

A Kompas/Biel Publication

April 1987

Trial Copy  
Subscribe Today!

## AN NAB PREVIEW

### *The LPTV Broadcaster's Guide to NAB Exhibits*

For the first time since the optimistic days of LPTV's inauguration, NAB exhibitors are truly trying to address the needs and, maybe more important, the pocket-books of LPTV broadcasters. This year's show is immense, and full of delectable toys as well as essentials. Because we knew many of you will be in Dallas for only one or two days, we thought we'd map out a brief guide to the exhibit floor, pointing out products and companies that have specific applications for LPTV.

We tried to concentrate our efforts on those companies that have expressly addressed the LPTV market with products or pricing. One response we note here — surely a first for television — is the new movement toward manufacturer-sponsored payment plans. Chyron, ITE/3M, and EMCEE, for example, have all instituted financing programs; and Riviera Broadcast Leasing has a special package just for LPTV people.

If you need a quick getting-around guide, pick up a map to the exhibit floor at the registration booths. (We're sorry ... we couldn't make room for the map here.) With that, and our product-by-product summary below, you should have no trouble making your hours at NAB pleasant and productive.

### CAMERAS AND ACCESSORIES

Of course, if you're in the market for cameras—and what television broadcaster isn't at NAB?—you've got to hit the "big-

gies": **Hitachi** (Booth 3160), **Ikegami** (Booth 3150), **JVC** (especially the KY Series, Booth 3180), and **Sony**—the M3 is the choice of some 20% of LPTV broadcasters (Booth 3100).

While you're at it though, you might take a look at **Pro Battery's** display (Booth 2761). They make rechargeable nickel/cadmium battery packs for ENG/EFP applications—including the PB-14 on-board camera battery system, the PB-90 VTR/camera battery, and the PB-N-1 for the Sony 6800 series recorders.

In Booth 2710, take a look at **Comprompter's** Totaprompter, the first fully electronic portable prompter, available in low-cost versions for both Apple and IBM systems. The IBM-based system will be introduced at NAB, so do stop in for a look.

### RECORDERS

You'll be looking at recorders, too, so don't miss the **JVC** CR Series (Booth 3180) or the **Sony** VO-5800's (Booth 3100). You might also check out the **Panasonic** NV Series recorders at Booth 3116. Then take a trip over to **The ALTA Group's** Booth 2502 and review the Pyxis—a digital production system for audio-video effects switching and A/B roll editing. The moderately-priced Pyxis offers 22 different production effects, including cut, wipe, fade, dissolve, posterize, and editor interface. Also at ALTA's booth is **Vid Video's**

*continued on page 10*

## HOW TO BUILD A NETWORK

### *An Interview With Woods Communications' Wayne Register*

One of the ideas that made immediate sense to early LPTV entrepreneurs was that of LPTV networks, chains of stations sharing programming and administrative costs, yet providing responsive and original local broadcasting to their separate communities. Charles Woods LPTV is one such network.



*Wayne Register*

Charles Woods LPTV is part of Woods Communications, which owns long-standing ABC and CBS affiliates in Alabama, Texas, Missouri, Indiana, and Louisiana, as well as six 100,000-watt FM radio stations around the country.

The Woods LPTV Network presently comprises nine stations: one each in Milwaukee, Chicago, Atlanta, and Evansville.

*continued on page 6*

## Inside

12 New Stations Licensed.  
See "At the FCC" . . . . . 22

Technical Columnist  
Debuts. . . . . 14

The New Window and  
Displacement Rules . . . . . 4

LPTV Report  
P.O. Box 25510  
Milwaukee, Wisconsin 53225-0510

ADDRESS CORRECTION REQUESTED

Bulk Rate  
U.S. Postage  
**PAID**  
Milwaukee, WI  
Permit No. 3412

# EMCEE

## The High Point in High Tech

EMCEE gets your LPTV system off the ground with the newest in high technology.

From transmitters to turnkey systems, EMCEE provides the products and services you need for your LPTV station.

From one to 5000, we fill every watt with power—and transmit your signal through the most reliable and technically advanced broadcast equipment ...all provided by EMCEE.

Our 26 years of tower installation experience and our

turnkey capabilities mean that your station comes in loud and clear...with EMCEE Broadcast Products.

Reach the high point in high tech:  
Visit the EMCEE NAB Booth 3032  
March 28-31, 1987



# EMCEE

#### EMCEE BROADCAST PRODUCTS

Div. of Electronics, Missiles & Communications, Inc. White Haven, Pa. 18661 FAX (717) 443-9257  
Call Toll-free: 1-800-233-6193 • (In PA: 717-443-9575) • TWX: 510-655-7088 • Ans: EMCEE WHHV



## In Our View

LPTV is on the threshold of a renaissance. Or, if you consider that too grand a term, a rebirth. We have survived the winter of the past four years and are springing up like new grass all over the country.

License applications are increasing steadily, and the unofficial word is out that we may shortly see months in which 15 to 20 new stations sign on the air. Assignment applications are also up. The people that have called our offices seeking information about CP's to buy and build number in the dozens. Several parties are actively seeking not one, but multiple, LPTV properties.

There is certainly nothing cold about the passion with which the people at these small stations value their work. And there's nothing vain or assuming about the way they respond to their viewers.

One common denominator: small TV stations actively and consistently reach out to the people who watch them. In these pages we have profiled several stations that have discovered the immense value of regular communication with their viewers. Call-ins, contests, giveaways, active visibility at every possible community event, constant solicitation of their viewers' opinions and desires. In much the same manner, contemporary radio achieves a camaraderie with listeners never seen in the days of the big radio networks. Many viewers—of both commercial and public LPTV stations—genuinely feel that they have a voice in programming decisions—through their

responses to informal surveys or through participation in formal programming committees. LPTV is inaugurating a *personalized* television that we have never seen before.

Also contributing to this new, more personal, broadcasting is the *local* programming emphasis that we have found in every station with production capability. It's no news to broadcasters that *local* news draws the largest audiences, and therefore the highest ad dollars, of any programming. It's no news either that the American people have returned, after the heyday of mass media in the 50's, to the desire to see *their own lives* reflected in the media that serve them.

Big TV has rarely welcomed viewers into more than their vestibules. LPTV stations everywhere have opened their offices and their studios, not only to interested observers, but to users. Teenagers take on the city fathers in their own magazine shows; veterinarians perform weekly miracles on ailing dogs and cats—to the great relief of worried young own-

## Kudos

To W55AS, MILWAUKEE, WI:

W55AS-TV is doing a very good job in selling mail order records for our client, Suffolk Marketing. In fact, *All Time Gospel Favorites*, a contemporary black gospel record collection, has sold consistently well for over 6 months.

W55AS-TV does as well as many high-power stations! Keep up the good work!

Gary Stillman  
Malcolm E. Smith Advertising, Inc.

(If you've received kudos you'd like us to print, just send them to *The LPTV Report*, P.O. Box 25510, Milwaukee, WI 53225-0510.)

ers; Uncle Jake and Aunt Tilly delight the golden-agers with a regular rendition of accordion duets. One new station plans to open a glass-enclosed studio in a shopping center, so that shoppers can see actual productions in the making. Another regularly tours the town with a big screen TV mounted on its remote truck for the enjoyment of passers by.

What this all adds up to is a sense of participation among the viewers, a feeling that the TV station is *their* station. Instead of the exalted allure of a major network, there is warmth, accessibility, and a genuine feeling of *involvement*.

It's a most powerful tool. Nobody, but nobody, can top the viewer loyalty that's built this way.

And viewers mean advertisers. Listen to these comments:

"We're getting a *great* response from the business community!" "Our revenues are five times what they were last year at this time." "We just had to expand our production department. We couldn't keep up with the demand." "We signed up 79 advertisers before we even went on the air."

Of course there are challenges to meet and obstacles to be overcome—cable carriage, displacement, affordable programming, audience measurement, power levels. There have been and will continue to be failures—many of them casualties of LPTV's growing pains, some of them simply the result of poor timing or bad management. But those that are building and growing are demonstrating everywhere that a consuming desire to serve the community, to speak—and listen—to the individual, to care about Aunt Tilly and Uncle Jake, Esperanza and Carlos, Ranelle and Yuen, is the key to successful LPTV broadcasting.

## Comments Sought in Fairness Doctrine Proceeding

The FCC has issued a *Notice of Inquiry* in response to a Congressional directive "to consider alternative means of administration and enforcement of the Fairness Doctrine and to report to the Congress by September 30, 1987."

The Fairness Doctrine requires broadcast licensees to cover controversial issues of public importance and to provide a reasonable opportunity for those with opposing viewpoints to present their side of such issues.

In 1985, the Commission concluded that the Fairness Doctrine no longer served the public interest, because it no longer effectively protected the public's right of access to diverse viewpoints on controversial matters. In fact, the Commission found that, in actual operation, the Fairness Doc-

trine "chills" or inhibits the presentation of those issues.

Cited as one example of such "chilling" was the corollary *Cullman* doctrine, which states that when controversial issues of public importance are presented during a sponsored program, and the broadcaster is unable to obtain paid sponsorship for the presentation of opposing viewpoints, he or she must either provide free time for that purpose or present the opposing viewpoints in the station's own programming.

While the Commission did not set forth specific proposals, it did invite comments on the following: 1) abandoning the existing case-by-case enforcement of Fairness Doctrine complaints in favor of a process under which a station's compliance with

the Doctrine would be examined solely at license renewal time; 2) placing an experimental moratorium on enforcement; 3) using a market-wide approach to enforcement; and 4) replacing the Doctrine with an "access time" requirement. The access concept would require broadcasters to set aside a discrete period of time for regular discussion of controversial issues by interested parties.

Comments are invited on these proposals or any others that commenters believe should be addressed, as long as they further the underlying goal of the Fairness Doctrine.

Comments are due April 13, 1987; reply comments are due May 13. For further information, contact Barbara Kreisman at (202) 632-7792.

## It's always a Take with Pro Batteries!



Now with Pro you can eliminate costly retakes due to battery failure. Designed to power any video system, the rigidly tested Pro Batteries provide you with maximum run-time and will fit any production budget. What's more, they're backed by a one year money-back guarantee.

So go for the sure take. Go with a Pro!



**Pro Battery Co., Inc.**  
3941 Oakcliff Industrial Ct.  
Atlanta, Georgia 30340  
(800) 451-7171 • (404) 449-5900

### Kompas/Biel & Associates, Inc.

S.E. Bradt, *Chairman of the Board*  
John Kompas, *President and  
Chief Executive Officer*  
Jacquelyn Biel, *Executive Vice President*  
Michael J. Dwyer, *Secretary*  
Richard P. Wiederhold, *Vice President—  
Finance and Treasurer*

### The LPTV Report

4434 Glenway  
Wauwatosa, WI 53225-4449  
(414) 462-7010

John Kompas, *Publisher*  
Jacquelyn Biel, *Editor*  
Shelley Gall, *Executive Assistant*

*Guest Columnists:* John Battison, John D. Luellwitz, Lee Shoblom, Peter Tannenwald.  
*Guest Contributor:* Kris Harvey

*Advertising Sales:*

### Kompas/Biel & Associates, Inc.

P.O. Box 25510  
Milwaukee, WI 53225-0510  
(414) 462-7010

**Affiliations:** CBA The LPTV Report is the official information channel of the Community Broadcasters Association.

The LPTV Report, ISSN 0892-5585, is published monthly by Kompas/Biel & Associates, Inc., 4434 Glenway, Wauwatosa, WI 53225-4449, or P.O. Box 25510, Milwaukee, WI 53225-0510. © Copyright 1987 by Kompas/Biel & Associates, Inc. All rights reserved.

Subscription price: 1 year, \$25.00; 2 years, \$45.00. Outside USA: 1 year, \$31.00; 2 years, \$57.00. POSTMASTER: Please send address changes to: THE LPTV Report, P.O. Box 25510, Milwaukee, WI 53225-0510.



## LPTV and the LAW

What the New Application and Displacement Rules Mean for You

—by Peter Tannenwald

On February 27, 1987, the Commission released its *Report and Order* in MM Docket No. 86-286, announcing new filing procedures for LPTV applications, and new measures for the relief of displaced LPTV stations. The rules, which are effective April 13 of this year, authorize filing "windows" for LPTV applications. The date of the first window has not yet been announced.

The new rules also provide limited relief for LPTV and translator stations displaced by full power television or land mobile radio allocations, and interference to cable TV headends and ITFS/MDS converters.

The Commission's main purpose in adopting new rules was to avoid another avalanche of paper like the one that literally flooded its halls when over 25,000 LPTV applications were filed in 1983. Two approaches to limiting the number of filings were considered: 1) authorizing windows one at a time for narrow geographic areas, and 2) imposing a cap on the number of applications that any one party could file during a single window. The FCC chose the latter approach, because it found that the main cause of the 1983 logjam was multiple filings by single applicants: some 75% of all the applications were filed by only 10% of the applicants.

Thus, future filing windows will continue to be nationwide (although Alaska is treated separately), but a ceiling of five will be placed on the number of applications in which a single applicant may participate.

### Ownership Limits Are Stringent

"Participation" by a single applicant means being involved in any way: applying as an individual; being a general or a limited partner in a partnership applicant; or serving as an officer or director, or holding 1% or more of the stock, of a corporate applicant. Full ownership information—including names, addresses, and telephone numbers for all parties—will be required in the application.

(These standards for what constitutes "participation" are much more stringent than the standards applied to applicants for full power broadcast stations, where non-participating limited partners and owners of small stock interests are sometimes disregarded.)

While the Commission does not deal explicitly with the subject in the *Report and*

*Order*, past precedent in other broadcast services indicates that family relationships are likely to be examined closely. In general, a husband and wife are considered to be a single party, as are minor children and a parent. Adult children are generally presumed to be independent of their parents and of other adult siblings, but questions may be raised where a parent or sibling provides financial assistance to an applicant. As you prepare your application, be sure to consider these problem areas.

Translator applications will continue to be treated the same way LPTV applications are, despite continued attempts by translator interests to obtain preferred processing, particularly in the case of state networks of public television stations.

### New Displacement Rules

The second point addressed in the *Report and Order* is the "bumpability" issue, wherein authorized LPTV or translator stations—because of their secondary status—can be displaced by full power TV or land mobile allocations. In the past, any request to change an LPTV channel for any reason has been treated as a "major change" application, requiring the applicant to wait for a filing window and then face competing applications and, usually, a lottery. Because the risk of losing the lottery is substantial, the survival of the LPTV station is threatened.

Under the new rules, a displaced LPTV station may apply for another channel without facing competing applications, but only if the new channel is completely vacant, and only if operation on that channel would not cause interference to any existing station or pending application.

Unfortunately, this inability to prevail automatically over pending applications represents a serious setback for LPTV stations threatened with displacement. But the Commission was evidently not willing to tackle the legal issues that might be raised were it to dismiss legitimately filed applications in favor of an incumbent licensee.

### "Displacement" Strictly Defined

Assuming that a truly vacant channel can be found, the "displacement" that entitles an LPTV station seeking a channel change to file outside of a window will generally be deemed to occur only after the service receiving interference has al-

ready been authorized. In other words, if a full power TV channel allotment is made or an application filed, an LPTV operating on that channel normally will not be permitted to apply to move to another channel until the full power construction permit is actually awarded. The announcement of a full power channel allotment in a rule making, or the filing of a TV application, will not be sufficient.

However, all LPTV's and translators operating on Channels 70-83 automatically qualify as displaced, regardless of whether or not interference to land mobile operations occurs in practice. Also, in response to one of the Comments filed, the FCC extended displacement relief to those LPTV stations or translators experiencing interference problems with cable TV headends and ITFS and MDS converters.

Once displacement occurs, an LPTV station may apply to change channels without waiting for a filing window. Moreover, some leeway will be afforded in the present rule, which forbids LPTV's from filing for any modifications that would involve an extension of their service area. Thus, displaced LPTV's, while changing channels, may also modify their transmission facilities, as long as they do not move their transmitter sites more than 10 miles. Switches between VHF and UHF bands will be permitted.

This relief does not apply, however, to

LPTV's that are not displaced but seek to modify their facilities because of inadequate coverage, loss of transmitter site, or other reasons. Unless they file during a window and take their chances in a lottery, they may not change channels, move their transmitter by more than 200 meters, increase power, or extend their signal coverage area.

Note that an application by a displaced station that is filed during a window will not automatically prevail over any other application filed during that window. Thus to be sure of being free from competition, displaced stations must file as soon as they can, and before the opening of the next window, after they become eligible for displaced treatment.

#### Two Applicants, One Channel

There may be situations where two or more displaced LPTV's seek to move to the same vacant channel. In that case, a first-come-first-served rule will apply, and the earlier filed application will be granted. There will be no relief from the "letter-perfect" standard for applications by displaced stations, so in order to be sure of obtaining a new channel, an application will have to be both first and perfect.

If a displaced station is unable to find a vacant channel for which to apply, it can obtain special temporary authority (STA)

to operate on a currently unused channel, despite the fact that applications may be pending for that channel. Many stations that have already been displaced are operating under STA's. However, in cases where other applications are pending for the STA channel, the new rules offer no permanent relief. The displaced station must compete against other applicants in a lottery and will be given no preferred status.

#### Preparing for the Window

As you get ready for the next filing window, remember the five-application limit, and choose your markets carefully. Also, remember that there will be a \$375 filing fee per application.

Lastly, the FCC's order adopting filing fees announced that all "window" filings will be made at a special location in Pittsburgh, and not in Washington. We are awaiting a final announcement as to whether only non-broadcast window filings will be handled in Pittsburgh or whether LPTV applications will also have to be sent there. So before you file, be sure to find out the correct location to deliver your application. K/B

*Peter Tannenwald is a partner in the Washington, DC law firm of Arent, Fox, Kintner, Plotkin & Kahn. He is general counsel to the Community Broadcasters Association.*

# Hear the great wireless sound.

## Consider the size advantages...

Cetec Vega's R-33 PRO PLUS wireless microphone receiver mounts inconspicuously on a camera. Or on a tiny corner of your sound cart. Or in your pocket. Or on your belt, providing you with program-quality headset audio.

With the R-33 you have a wide choice of transmitters...any Cetec Vega DYNEX® II bodypack or handheld. A full complement of useful accessories is included.

The R-33 provides 8 hours of operation on a single 9-volt battery. Audio is studio-quality (e.g., over 100 dB S/N).

All this, in a rugged package less than 12 ounces, and only 3/4 x 3-1/4 x 5-5/8 inches (HWD). Available in two colors... PRO Brown/Cream or Camera Black.

 **Cetec Vega**

... the professional's wireless  
9900 Baldwin Place  
El Monte, CA 91731-2204  
(818) 442-0782



## Interview

continued from front page

IN; and five in Florida—Orlando, Ocala, Lake City, Gainesville, and Naples. Headquarters station W08BY is located in the Marc Plaza, a grand old Milwaukee hotel whose upper floors have been converted into elegant, upscale office suites. It was here that we visited Wayne Register, general manager of Woods Communications' LPTV Division, to find out more about his plans for this new kind of broadcasting.

Register is a soft-spoken Southerner with a quick business canniness and an obvious and unaffected decency. He is bullish about LPTV, especially about the opportunities it offers to small advertisers left out by pricey big stations, and to the hundreds of segments of American society whose special concerns and tastes cannot economically claim a place in the programming plans of the major networks. Here is what he told us.

• • •

**LPTV Report:** *Although he was not among the original applicants for LPTV stations, lately Charles Woods has been aggressively buying LPTV construction permits. Wayne, would you describe the markets that you're targeting, and why you're targeting them?*

**Register:** Well, for this first series of stations, we're targeting the largest markets—the larger towns, the larger cities. They're more attractive to our ad-

vertisers. Our Channel 13 in Chicago, for example, reaches two million people. Atlanta is also a big market.

Our construction plan starts here with our base station in Milwaukee. Chicago will be staffed next. Then Atlanta, then Orlando, Naples, and Ft. Myers.

One of our strategies is to work stations in pairs. Milwaukee and Chicago are close together geographically, so we can do a lot of things out of Milwaukee for Chicago, and vice versa. The same is true for Orlando; it's only about 40 miles away from Ocala. So they work together, even though Ocala is a lot smaller than Orlando is.

Ocala is a good market in its own right though. It's one of the fastest growing cities in America. It's a resort city, a retirement city. Its leadership is some of the best in the nation—very progressive, looking to the future, not just making plans for today.

• • •

**LPTV Report:** *Wayne, your programming here in Milwaukee centers around music videos. Is this true for all of your stations?*

**Register:** Videos are, in my opinion, a good way to start. They may not be the complete answer though. We don't know the future of music videos. We hope they will be around for a long time but you can never rest assured that any programming will continue to be popular forever.

**LPTV Report:** *How is your music video format different from Hit Video USA, MTV, or some of the other music video satellite services?*

**Register:** Well, basically, ours is different because we localize it. We play Milwaukee music—what Milwaukee wants to hear. We're making announcements about Milwaukee. We're doing Milwaukee concerts. We're doing profiles of Milwaukee musicians. And we do a variety of programming. We do rhythm & blues, we do rock, we do heavy metal in the afternoons for the kids, we do pop.

We feel like we offer something for everybody, and we know from the phone calls we get that it's not just the kids who are watching. Housewives watch during the daytime. The after-school hours are controlled by the kids. Then we have the adult audience until 10 or 11 p.m. In Milwaukee we serve two major universities as well as several smaller colleges, so we have a strong young adult audience.

We also get involved locally in other ways. A couple of the local radio stations—WMIL, a country station and WAWA, which is basically soul—come over here every week to host their own programs. The viewers love it.

We're planning to diversify our programming to give the community something different, and we'll be announcing those plans soon. We're in negotiations right now with several programmers. But we won't get too far away from our music.

We have meetings every day of the week to discuss how we can do something better or different, how we can do new local programming.

# Filters For Broadcast Television

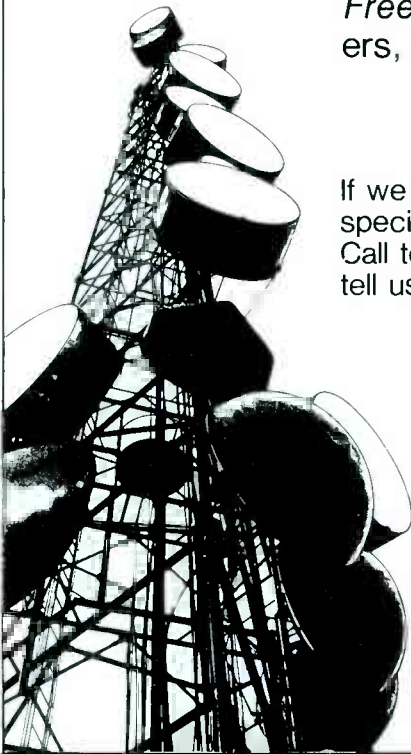

Free catalog BTV/85 contains bandpass filters, traps, diplexers, channel combiners and custom filter networks for:

- LPTV
- UHF
- ITFS
- MDS

If we don't have the exact filter you need, we'll custom make it to your specifications (which is how we've developed over half our products). Call toll free or return the coupon below to get your **FREE** catalog or to tell us about your special problem.

Return Coupon To The Attention Of Jay LaBarge

Name _____				Title _____			
Company _____							
Address _____							
City _____		State _____		Zip _____		Telephone# _____	
<input type="checkbox"/> Send me free catalog				<input type="checkbox"/> I have an immediate requirement - have an engineer contact me.			

Microwave Filter Co., Inc. • 6743 Kinne St. • E. Syracuse, NY 13057 • Toll Free: 1-800-448-1666 • Collect: 315-437-3953 • TELEX: 249-613

# Showstopper!

Digital Picture Freeze & "Infinite Window" TBC/Synchronizer

4x1 Audio & Video  
Switcher... Built In!

H & V Image  
Enhancement

D.O.C.

Meets Broadcast  
RS170 Video  
Specifications



Digital Video Effects

- Mosiac
- Freeze
- Posterization
- Colorization
- Picture Strobe

## Cygnus

Video Production System

**\$4990.** List Price

Phone or write for full particulars

The ALTA Group, Inc. 535 Race Street, Suite 230 San Jose, CA 95126 (408) 297-2582

**ALTA**  
GROUP, INC

**LPTV Report:** You had to grow into all this local programming, didn't you?

**Register:** Yes, we took it easy at first. We started out with one VJ for a four-hour show. Then we put VJ's on the air eight hours a day. Then we went to 12 hours. Now we're up to 20 hours of local VJ's on the air, and we use satellite programming for only four hours each night—between 2 and 6 a.m. Within the next few weeks, we'll be locally originating 24 hours a day.

The local approach has been extremely successful for us. Our phones ring 400-500 times a day. The peak periods are afternoon and night, when the kids are home. Recently, we had to add four new lines, just to handle the telephones!

**LPTV Report:** Do you have any problem getting music videos to air, in light of the fact that MTV has exclusive agreements with a number of the major record companies and there is a fair amount of hot competition for these things.

**Register:** We work with the record companies. We negotiate with them. We can offer them something that MTV can't: we have local promotions; we give their record albums away over the air; we run little call-ins; we give out tickets to clubs. The record companies realize that we can help them as much as they help us.

**LPTV Report:** So they're open to negotiating with you?

**Register:** They're very open. They've got a product for sale and we're an outlet, just like a radio station, for their product.

They hope that, in the end, our viewers will go out and buy their records.

**LPTV Report:** Can you describe some of the local feature programming you do?

**Register:** Well, we do profiles of local artists. We interview the national artists when they come to town, and that's a lot. You know, Milwaukee is probably one of the best cities in the world for entertainment. If you like sports, you can find almost any kind of sports you want. There's any kind of music you want to hear—pop, rock, country, classical, jazz. I saw Ricky Scaggs at breakfast one morning right here at the Marc Plaza. Not to mention Liberace. Milwaukee was Liberace's home town. When he was in town he stayed in a suite just down the hall from our studio.

We don't have any trouble finding stars to profile on Channel 8.

**LPTV Report:** I'm curious about the kind of investments you've made. What does it cost to put a Milwaukee station up, a Chicago station? How deep is the commitment on Woods' part?

**Register:** First of all, you have to consider how much it costs to put an LPTV station on the air anywhere. Probably half a million dollars right off the bat. Then you start looking at personnel—you can figure \$200,000/year for expenses and personnel. So you're looking at close to a million dollars for the first year investment.

**LPTV Report:** Is that because Milwaukee is a major market? Would you pay less in smaller markets?

**Register:** No. You'd pay the same amount for equipment, for employees. If they're doing the job, you've got to pay them. Otherwise you'd be doing it yourself!

**LPTV Report:** You've just made a big investment in new production equipment for Channel 8. Could you elaborate on that, please?

**Register:** Yes. When we were on the air only eight hours a day, we had plenty of time to do production. As we grew, we outgrew our production department. So we decided to upgrade our facilities and we made a large investment in A/B editing systems, switchers, the whole nine yards.

• • •

**LPTV Report:** Let me ask you about marketing. How have you gone about marketing your station here in Milwaukee? And what has been the response to that?

**Register:** We've done some newspaper ads. There have been a number of news articles about LPTV that have featured us. We've done some radio. We're trying to do a lot of self-promotion.

We've been received extremely well, especially in the last six months—the station's been on a little over a year. When we started, nobody had ever heard of us. Now Channel 8 is a recognized name in Milwaukee.

**LPTV Report:** How is your relationship with the Milwaukee full power stations?

**Register:** We contact them if we need a

# DON'T FRET!



30  
YEARS  
OF  
EXPERIENCE  
SPEAKS FOR  
ITSELF —

## MODERN TV

IS A NAME  
YOU CAN  
DEPEND ON!!!

We offer a wide selection of titles available in a variety of formats and running times and the only cost to you is the cost for the return postage.

For more information,  
contact:



5000 Park Street North  
St. Petersburg, FL 33709  
Toll Free (800) 237-8913

For your copy of the 30th Anniversary Edition of the MODERN TV CATALOG, please fill in the coupon below and return to:

MODERN TV  
5000 Park Street North  
St. Petersburg, FL 33709

Name \_\_\_\_\_  
Address \_\_\_\_\_  
City \_\_\_\_\_ State \_\_\_\_\_ Zip \_\_\_\_\_  
Station Call Letters \_\_\_\_\_  
Phone Number \_\_\_\_\_



VJ's Guy Richards and Sue Quinn in TV 8's master control. A guest is in the background.

dub of their commercials. What makes us happy is that they ask for dubs of ours!

**LPTV Report:** *Would you talk about the business side of Channel 8? How are you doing?*

**Register:** We're doing extremely well. Better than I projected. Our revenue has grown 600% over last year's.

Our advertisers have had a lot of success with us. One pest control firm advertises only on Channel 8, and their business has increased to the point where they had to buy another truck. So that's positive.

One thing we don't do is we don't classify advertisers into big or small. Every one of them is big to us. We do everything from pizza to clubs to the telephone company.

**LPTV Report:** *Have any of your advertisers used television before, or are you introducing them to the concept?*

**Register:** Most of them—such as specialty shops—have never even thought about advertising on television because they couldn't afford it. So this is a first time situation for them. Most of them are very pleased to have TV advertising available. They can reach a market that they haven't been able to reach before except through print.

**LPTV Report:** *Could you give us some idea of how you promote Channel 8?*

**Register:** We do a lot of things. This year alone, we've given away trips to the Bahamas, diamond rings, a truckload of record albums, and of course T-shirts and other promotional items like that.

Our VJ's guest host dances and parties and other local events. We get them out into the community as much as possible.

Actually, they're getting pretty famous! They get marriage proposals daily when they're on the air.

**LPTV Report:** *What do you look for when you hire a VJ?*

**Register:** We try to use good judgment. We look at their background: is this the kind of person that we want in our organization? We don't necessarily look for experience. Some of the best VJ's we've had have never been in radio or TV before. On the other hand, some of the best ones we've had have had that background. It depends on the person.

**LPTV Report:** *Milwaukee is cabled by Warner which has traditionally been reluctant to carry LPTV. Can you tell us how you negotiated cable carriage with them?*

**Register:** First, you have to have a positive attitude. Hostility doesn't get anybody anywhere. Business is business, and negotiation is the only way to do business. You may not get what you want, but at least you can leave friends.

We tried to go in with a good attitude and show Warner that we were going to do something positive for them. We believe that since Warner has been carrying us, they've gained subscribers—people who have subscribed just because we're being carried.

**LPTV Report:** *How long did it take to conclude negotiations with Warner?*

**Register:** We've been talking to them the entire time we've been on the air. But I started negotiating in earnest about two or three months before we made a deal.

**LPTV Report:** *What about the suburban cable systems?*

### Equipment System: W08BY, Milwaukee, Wisconsin

- Acrodyne T-210 transmitter
- Scala HDCA-5EB antenna
- Scientific Atlanta 9000 receive dish
- Scientific Atlanta 6650 satellite tuner
- 2 Sharp XC-A1 cameras
- Sharp XC-900 camera
- 2 Sharp XM-1300 video monitors
- 2 Sony VP-5000 video tape players
- Sony VO-5600 video tape recorder
- Sony VO-5800 video tape recorder
- Sony VO-5850 editing VTR
- Sony VO-4800 field VTR
- Sony RM-440 controller
- ALTA Group Pyxis video production system
- Grass Valley TEN-X switcher
- Fortel CCD-HP time base corrector
- Harris AC-20AS frame stor
- Quanta QCG-400SD character generator
- Grass Valley 3256A-3 sync generator
- Grass Valley 8501 and 3240 distribution amplifiers
- E/V 8212 audio board
- 2 Broadcast Electronics 3300 cart machines
- E/V RE-20 microphones
- Lowel Omni lighting kit



**Register:** We haven't started pushing for that yet, but we will be in negotiations with all of them.

**LPTV Report:** *What about Chicago?*

**Register:** Chicago is not a cabled city. We feel that cable will not be a factor in that town.

**LPTV Report:** *What about Atlanta?*

**Register:** We haven't begun to concentrate our whole effort on developing Atlanta. We want to finish Milwaukee and Chicago first. But when we do, we definitely will negotiate. Atlanta is about 88% cabled. If you're not on cable in Atlanta, you're not watched.

Orlando is the same as Atlanta. Penetration is high. In Ocala, carriage would definitely be a help. Cable penetration is in the neighborhood of 40% in Ocala.

• • •

**LPTV Report:** *What is the level of commitment to LPTV on the part of Woods Communications?*

**Register:** Totally committed. Totally committed. We feel that there's a future in LPTV. We feel that neighborhood broadcasting is what TV started out to be. Where in Milwaukee but on the LPTV stations can most of the civic clubs get recognized? The big TV stations have gotten so commercial, they simply don't have time to cover all the local events. On the other hand, we've got time for those people. We've got time to put them on the air.

**LPTV Report:** *Tell me what you see in the future for Charles Woods LPTV.*

**Register:** A network of stations — perhaps tied together with satellite uplinks and downlinks—serving our respective cities in a local way.

**LPTV Report:** *How big do you want your network?*

**Register:** Well . . . CBS has some 200 affiliates, right?

• • •

**LPTV Report:** *Wayne, from your perspective, what is the future of LPTV?*

**Register:** The future of LPTV is excellent. You'll get out of it what you put into it. I see LPTV turning around drastically for us, because we are committed to it. The City of Milwaukee is going to be a lot better because of us.

I think that the next five years will be survival years for LPTV. Unfortunately, some people may not survive.

**LPTV Report:** *Why?*

**Register:** Lack of programming. Unless things change, the lack of cable carriage. The lack of committed people who are able to lose some money for some years to see the service take root.

In some ways, you can compare LPTV to the early days of FM radio. Nobody thought FM would work. No one wanted to invest in it. Now, in the 1980's, FM is the dominant factor in radio. AM radio stations are going out of business, they're going off the air. There's just no demand for AM anymore. We feel that it's going to be the same way with LPTV. LPTV will be the dominant force in television.

K/B

# kWU



## There are only two reasons to buy an Acrodyne TV transmitter.

### Putting you on the air. And keeping you there.

These are Acrodyne's top priorities. That's why we can give you more than just a few reasons to buy our state-of-the-art TV transmitters, known worldwide for their dependability:

- A modular upconverter featuring broadband amplifiers, synthesized L.O. and phase-locked VCO
- Extensive built-in diagnostics and metering
- IF modulation and low level diplexing
- Single (Class A) solid-state, broadband driver module
- Overall AGC
- Single Thomson 347 tetrode

All this plus application and custom engineering, installation and start-up help are your assurance that all your broadcasting requirements will be met. Write or call Acrodyne today at 1-800-523-2596 or 1-215-542-7000 for more information on our TRU/1KAC and TLU/1KAC 1 kW UHF TV transmitter/translators or any of our TV transmitter products and services.

Global Dependability

## ACRODYNE

Acrodyne Industries, Inc.  
516 Township Line Road  
Blue Bell, Pennsylvania 19422  
215/542-7000 800/523-2596  
Telex: 846358

# TELEVISION *Bingo!*

Complete "Ready to Air" Package  
**\$1995 tv**

- **Oldest Promotion in the Industry**  
Over 33 years . . . 1400 plus stations.
- **Gets Double Rate Card Rate**  
A complete promotional package providing sponsors the "extras" that command extra dollars.
- **Increase Ratings**  
A proven leader in all markets.
- **Tremendous Sponsor Foot Traffic**  
Proves the effectiveness of your station with tangible sponsor results.
- **Continuous Renewals**  
Sponsors and listeners demand it.

**OUR BUSINESS IS IMPROVING YOURS**  
©Copyright 1986, World Wide Bingo, Inc.



**WORLD WIDE  
BINGO, INC.**

PO Box 2311  
Littleton, CO 80161  
(303) 795-3288

## NAB Exhibits

*continued from front page*

low-cost Shuttle 1B which works with the Pyxis and Sony's RM-440 to roll a "B" VTR with the normal edit cycle.

### RF AND TOWER EQUIPMENT

Are you just starting to get your station up? You'll want to see **Television Technology Corporation's** transmitters (Booth 3580)—available from 1 to 1,000 watts in both UHF and VHF. Also offering transmitters are **PESA Electronica** (Booth 3417), and **Acrodyne** (Booth 3521), which is showing their new, lower-cost, Freedom transmitter line.

You'll want to see **EMCEE's** transmitters in Booth 3032, a 1-kW unit and two 10-watt units, one UHF and one VHF. EMCEE also offers antennas on an OEM basis. And, as we mentioned before, they've developed some financing and leasing packages which you'll want to check into.

Also, check out **Townsend's** TE-3 (in Booth 3305-3306), the new VHF and UHF TV exciter with new circuitry, control, and chassis; and the TM100 transmitter input and monitoring system.

For antennas, co-axial transmission line, and downlinks, see **Andrew Corporation** in Booth 3098. Then hike down to Booth 3406 for **Bogner's** high V and U antennas, available in omni-directional or directional, as well as multi-channel, versions.

You'll want to look at **Rohn** (Booth 2449), both for their towers and also for their transmitter shelters; isolation transformers from **Shively** (Booth 2442) — especially the Model 2320 which is designed specifically for LPTV; and the special purpose surge protectors for LPTV applications from **L.E.A. Dynatech** (Booth 3332).

### LIGHTS AND SETS

For lighting—both portable and studio—see **Lowel-Light** (Booth 2600) and **The Keylite PSI Group** (Booth 2789).

Modular studio set designs from **Uni-Set** are on display in Booth 2806. (Ask to see the miniature set modules—a handy way to experiment with different sets for different applications.)

### CHARACTER GENERATORS AND GRAPHICS SYSTEMS

The big name here, of course, is **Quanta**, whose QCG Series, along with the Microgen, led with over a third of the LPTV market in our January issue's Equipment Survey. They'll be in Booth 3128 displaying three new CG's especially for LPTV: the Microgen Plus, with four standard face dials in both upper and lower case and resolution to 50 nanoseconds; the QCG-34, with four standard face dials, instant sizing, 48 sizes, single or dual disk drives, and resolution to 18 ns; and the QCG-38 with eight face dials, 30 graphic symbols, and 18 ns resolution proportional to character size, a feature which makes for very fine resolution.

In Booth 3072, there is **Chyron's** VP-2 and the Chameleon paint system, which together can mix graphics with character generation for results not formerly possible in this equipment price range. While you're there, be sure to ask about Chyron's new "Earns-Its-Own Payments Plans," three pay-as-you-grow ways to afford quality Chyron products.



*Chyron's VP-2 character generator and the new Chameleon paint system.*

**Robert Bosch** (Booth 1340) is showing four graphics systems, including the FGS-4000, an animation unit that provides interactive manipulation of two-dimensional and 3D objects in a 3D presentation.

And you might take a look at **Laird Telemedia's** CG's and multiplexers in Booth 3474, and **D.E.L. Compu-Cable's** Spectra-View Character/Graphics Generator (Booth 2551).

Lastly, the **Grass Valley Group** (Booth 3112) is introducing the Dubner Computer System, a new, character generator with Grass Valley quality for under \$10,000.

### AUTOMATION SYSTEMS

Take a trip over to **Townsend Broadcast Systems** (Booth 3305-3306), and check out the new DC-80, an automatic, digitally controlled, video cart machine system. Pre-programmed station breaks are now simple to accomplish, and operator errors are virtually eliminated. Also check out the DC-800. This is an automation system capable of running an entire TV technical operation — programs and commercials — for eight hours, with no operator intervention.

Then there's the **Channelmatic** (Booth 2548) automatic playback sequencer for up to 10 VCR's; their "Broadcaster I", an automatic video cassette changer for up to 15 cassettes; and the star attraction, the "Li'l Money Maker", a low cost ad insertion system.

There's the economical BCS Controller by **CCI** (Booth 2484), capable of commanding up to eight tape machines and two alternative video/audio sources.

Lastly, **Alamar Electronics** (Booth 3561) is showing the "Auto-Cart", a single-channel automation system that controls from 1 to 32 multi-format VTR's and one strip switcher; and the "Copy-Cart", a net delay record/playback automation system.

### AUDIO

For your audio needs, stop by **ADM Technology** (Booth 3266) for a look at their new RM-1083 rack mount audio mixer, a mixer with specific application to LPTV.

**International Tapetronics Corporation / 3M** (Booth 3052) is showing, for the first time at NAB, the DCM-I Dynamic Cartridge Monitor, which, used in conjunction with your cart machine system, identifies worn-out or problem tapes before they can fail on the air. ITE/3M is also announcing at NAB a generous trade-in program and new extended payment plans which will make it easier for broadcasters to fill their equipment needs.

Also check out **Cetec Vega's** VECTA VS-1 wireless mic system in Booth 3394, and of course **Shure's** audio mixers and microphones in Booth 3320.

### TIME BASE CORRECTORS

At **Fortel's** Booth 3044, you can see the DHP-525, a good, basic TBC for the Sony 5000 Series VTR, as well as most others. Priced under \$6,000, its many features

include full frame, freeze frame, and freeze field. (While you're there, you can preview the new CC-1 Color Corrector.)

Also take a look at the **ALTA Group's** Cygnus (Booth 2502), a video effects generator, time base corrector, and four input audio/video routing switcher.

## SWITCHERS

**Grass Valley** (Booth 3112) is showing the Model 100-N production switcher, the 8560 Series audio distribution amplifiers, and the 9550, a changeover switcher for the 9500 Series sync generators. Also being unveiled for the first time at NAB is the TEN-20 and 20-TEN routing switcher—a new, low-cost routing switcher system featuring audio only, video only, or video and multiple audio, 10×20 out and 20×10 out.



Grass Valley Group's Model 100CV Component Color Video Switcher.

Then stop in at **Channematic** (Booth 2548) for a look at a very low-cost 8×1 switcher, and also their 10×1 switcher.

**Robert Bosch** (Booth 1340) is showing the R51ME Compact Production Switcher with 10 inputs plus 2 title inputs; its big brother, the R102ME (16 or 24 inputs plus 5 title inputs); the MCS-2000 Master Control Switcher which offers more functions than traditional switchers; and the TVS/TAS-2000 Video/Audio Distribution Switching System.

## DISTRIBUTION AMPLIFIERS

**Channematic** (Booth 2548) is displaying audio and video DA's, as well as a sync stripping pulse DA.

**Robert Bosch** (Booth 1340) is introducing at NAB the BVA-350 Wideband Video Distribution Amplifier, as well as the BAA-350 Audio DA with one input and 6-12 outputs. They are also showing their LDH line of high quality picture monitors.

## TEST EQUIPMENT

For test equipment, you'll have to stop at **Tektronix** (Booth 3214) and take a look at the 1705 spectrum monitor for newsgathering operations, the 1700 Series waveform monitors and vectorscopes, and the 1480-F30 noise measurement kit.

# VID VIDEO

## ZERO FRAME OFFSET ADDRESS TRACK MODIFICATION

- Update all VO-5850, VO-5800, VO-5600, VP-5000, VO-5630 and VO-6800 with SMPTE time code
- Allows third channel time code
- BVU-800 compatible
- 2¼ H head switch plus LED
- Installation kits available



### SHUTTLE I

- Adds shuttle knob to VP-5000/VO-5600, VP-5030 and VO-5630P
- Variable speed—0 to 5X in forward and reverse
- Control track readout
- Preroll

### INTRODUCING SHUTTLE-IB

- All the features of the SHUTTLE I PLUS
- A/B roll editing with Sony RM-440
- GPI programmable switch triggers PYXIS effects
- No additional interface cable required

### SHUTTLE II INTERFACE

- Use VP-5000/VO-5600 with: RM-440, ECS-90, ECS-204, PALTEX ABNER
- Saves \$2000 per playback VTR
- Variable speed—0 to 5X in forward and reverse, and BUMP commands from edit controller

Contact: **Russell W. Glenn**  
President

Former Sony Broadcast Instructor  
3919A W. Magnolia Blvd., Burbank, CA 91505  
(800) 826-2035 In California (818) 845-1515

You might also drool a bit over Tektronix's new component equipment and the new automated video measurement units being introduced at NAB.

At **Videotek** (Booth 3316), you can see the TVM 620, a new waveform monitor and vectorscope combo; the DM-140S, a new 140-channel stereo demodulator; and the Times Six standalone blackburst generators. Also at Videotek is the AVM-19s, a new 19" rack mount color monitor with audio.

Finally, don't forget to stop in at **Leader Instruments** (Booth 2763) for a look at the LVS-5850B vectorscope.

## DATA MANAGEMENT SYSTEMS

**Alamar Electronics** (Booth 3561) is showing three computerized data systems—The Media Manager, for cataloging film and tape; the Schedule Manager, an integrated traffic package for generating daily logs; and the Traffic Manager. All three Manager systems interface with Alamar's MC-1050, a multi-channel automation system handling multiple spot tapes.

**Generic Computer Systems** (Booth 2818) offers computerized traffic and billing systems designed especially for LPTV. Geared for either IBM or Apple hardware, the Generic systems are economical too—easy monthly payment plans are available.

*continued on page 12*

## LPTV'ers We Know Your Market

**IBMisLOG \$3500**  
**APPLELOG \$2600**

Generic Computer Systems knows that our computerized traffic and billing systems are exactly what you have been looking for. Why? We know small market radio. We're broadcasters too, and we know that LPTV and small market radio think alike. We have geared the IBMisLOG and APPLELOG systems to your home-grown marketing approach. Generic Computer Systems knows your marketing appeal emphasizes local happenings and local coverage as you identify with your community. We allow easy monthly payments and, like you, we are open seven days a week for service.

**Let Generic improve your efficiency and end the drudgery of creating logs and generating bills — it will be the best generic investment you'll make.**

*Affordably yours,*

**Joel W. Rosenblum**  
412-283-1500

**GENERIC**

**Computer Systems**  
357 North Main St., Butler, PA 16001

### Selected Booths, by Company

Acrodyne	#3521
ADM Technology	#3266
Alamar Electronics	#3561
ALTA Group	#2502
Andrew Corporation	#3098
Bogner Antenna	#3406
CCI	#2484
Cetec Vega	#3394
Channelmatic	#2548
Chyron	#3072
Comprompter	#2710
D.E.L. Compu-Cable	#2551
EMCEE	#3032
ESE	#3470
Fortel	#3044
Generic Computer Systems	#2818
Gorman-Redlich	#2715
Grass Valley Group	#3112
Hitachi	#3160
Ikegami	#3150
ITE/3M	#3052
JVC	#3180
K & H Products	#2532
Keylite PSI	#2789
L.E.A. Dynatech	#3332
Laird Telemedia	#3474
Leader	#2763
Lowel-Light	#2600
The Management	#2512
Panasonic	#3116
PESA Electronica	#3417
Pro Battery	#2761
PSNI	#2486
Quanta	#3128
Quickset	#3380
Riviera Broadcast Leasing	#2793
Robert Bosch	#1340
Rohn	#2449
Shively	#2442
Shure	#3320
Sony	#3100
Tektronix	#3214
Television Technology Corp.	#3580
Townsend Broadcast Systems	#3305-3306
Uni-Set	#2806
Videotek	#3316

### Nab Exhibits

continued from page 11

Finally, **The Management** (Booth 2512) is showing their EZ LOG, complete software for traffic, A/R billing, affidavits, aging, and sales reports. The entire system, which runs on IBM-PC or compatible hardware, is available for \$495.

#### GENERAL

As you're strolling through the exhibits, do stop in to visit Jim Gorman at **Gorman-Redlich** (Booth 2715), who supplies Emergency Broadcast System encoders, decoders, and encoders-decoders, as well as NOAA weather radios. You need them; Jim's got them.

Also check out the clocks and timers from **ESF** (Booth 3470).

Then look at **Quickset** (Booth 3380) for their line of tripods, especially the economically priced and light-weight Rainbow Pro with its multi-purpose mounting plate. The Rainbow Pro is a reliable, stable support for virtually any tripod application. Quickset also offers fluid heads, a dolly, and a geared elevator column.

And don't forget to visit **K & H Products** in Booth 2532. They make carrying cases for cameras, VTR's, and accessories.

Where are you going to get it all? See John Grozik in Booth 2486 who will introduce you to the affiliate dealers in the **Professional Systems Network**, all of whom have committed themselves to excellent customer service after the sale and are geared to do LPTV turn-keys.

And finally, how are you going to pay for it? Not to worry. **Riviera Broadcast Leasing** has developed a new equipment leasing package designed to allow LPTV stations to acquire high-quality equipment at affordable terms. Riviera is in Booth 2793.

Happy hunting!

K/B

### Selected Booths, by Number

Robert Bosch	#1340
Shively	#2442
Rohn	#2449
CCI	#2484
PSNI	#2486
ALTA Group	#2502
The Management	#2512
K & H Products	#2532
Channelmatic	#2548
D.E.L. Compu-Cable	#2551
Lowel-Light	#2600
Comprompter	#2710
Gorman-Redlich	#2715
Pro Battery	#2761
Leader	#2763
Keylite PSI	#2789
Riviera Broadcast Leasing	#2793
Uni-Set	#2806
Generic Computer Systems	#2818
EMCEE	#3032
Fortel	#3044
ITE/3M	#3052
Chyron	#3072
Andrew Corporation	#3098
Sony	#3100
Grass Valley Group	#3112
Panasonic	#3116
Quanta	#3128
Ikegami	#3150
Hitachi	#3160
JVC	#3180
Tektronix	#3214
ADM Technology	#3266
Videotek	#3316
Shure	#3320
L.E.A. Dynatech	#3332
Quickset	#3380
Cetec Vega	#3394
Bogner Antenna	#3406
PESA Electronica	#3417
ESE	#3470
Laird Telemedia	#3474
Acrodyne	#3521
Alamar Electronics	#3561
Television Technology Corp.	#3580
Townsend Broadcast Systems	#3305-3306



# LINES

VIDEO SYSTEMS

219 South Jefferson/Springfield, MO 65806  
1-800-641-4674

## PACKED FOR ACTION

The minute you get that (CP) construction permit, you're marked. Every video equipment salesman in the book will be on your doorstep pitching the latest state-of-the-art equipment. But who's going to show you what to do with all that stuff when it arrives?

#### WE WILL.

When you purchase a Lines Video System you get more than just state-of-the-art equipment. You get our professional team of video specialists. The right equipment you need for a low power TV station, a remote production van, or a production studio. The right team of professionals to show you how to put each piece through its paces. We'll teach you system installation and operation, production editing, special effects, and everything else you need to know to put your investment in the black. So when your advertisers ask for miracles, you'll know how to produce them.

Why just settle for a truck load of equipment when you can also have a plane load of professionals? Call Lines Video Systems and turn a turn key operation into one that turns a profit.

## LPTV Distribution by State and Territory March 1987

	Licenses	CPs*
ALABAMA	4	19
ALASKA	10	32
ARIZONA	5	30
ARKANSAS	3	39
CALIFORNIA	21	39
COLORADO	9	58
CONNECTICUT	0	1
DELAWARE	0	3
WASHINGTON, DC	0	1
FLORIDA	11	49
GEORGIA	2	33
HAWAII	1	7
IDAHO	4	42
ILLINOIS	2	11
INDIANA	2	21
IOWA	4	28
KANSAS	3	81
KENTUCKY	3	10
LOUISIANA	2	22
MAINE	2	9
MARYLAND	1	3
MASSACHUSETTS	2	7
MICHIGAN	2	28
MINNESOTA	13	46
MISSISSIPPI	5	31
MISSOURI	3	50
MONTANA	11	113
NEBRASKA	2	72
NEVADA	8	46
NEW HAMPSHIRE	0	2
NEW JERSEY	1	5
NEW MEXICO	6	48
NEW YORK	5	23
NORTH CAROLINA	1	17
NORTH DAKOTA	1	59
OHIO	2	14
OKLAHOMA	8	52
OREGON	12	54
PENNSYLVANIA	1	14
RHODE ISLAND	0	1
SOUTH CAROLINA	0	7
SOUTH DAKOTA	0	62
TENNESSEE	4	29
TEXAS	15	101
UTAH	13	58
VERMONT	0	4
VIRGINIA	3	15
WASHINGTON	4	34
WEST VIRGINIA	0	2
WISCONSIN	9	15
WYOMING	16	45
GUAM	0	1
PUERTO RICO	1	0
VIRGIN ISLANDS	0	1

In addition to the stations listed above, ALASKA operates a 241- station LPTV educational network.

\*Construction Permits

Source: Kompas/Biel & Associates, Inc.

## Bogner—20 years, over 1000 TV transmitting antennas and still climbing!

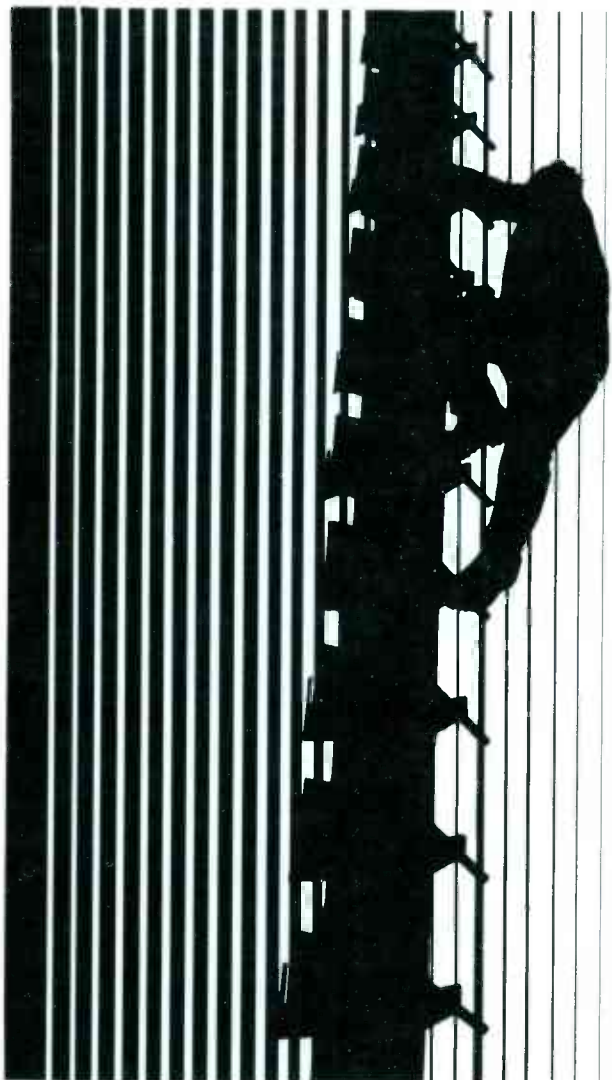

In the twenty years since we innovated a remarkable slot array design we have succeeded to a leadership role in TV broadcast antennas. We had to be better than the competition. We still are.

Today there are over 1000 Bogner TV transmitting antennas in use, more than from any other single manufacturer. Antennas with a long history of trouble-free performance and unequalled coverage.

Bogner antennas come in every power range and with the largest number of standard patterns in the industry. In addition, Bogner offers hundreds of custom patterns plus special designs to meet particular requirements.

Find out more. Call or write: Bogner Broadcast Equipment Corp., 401 Railroad Avenue, Westbury, New York 11590, (516) 997-7800.

When you need us  
we'll be there.

**BOGNER**  
WE MAKE THEM SMARTER

### EBS EQUIPMENT



Model CEB Encoder-Decoder  
Model CE Encoder  
Model CD Decoder

**Required for L.P.T.V.**

Encoder FCC Type Accepted Decoder FCC Certified  
Exceeds FCC Specifications  
Receiver can be supplied to drive Decoder

Price  
**\$475.00**  
**330.00**  
**280.00**

**\$100.00**

All interconnections to the EBS equipment are made through a barrier terminal block. No special connectors necessary. In stock—available for immediate delivery.

**GORMAN REDLICH MFG. CO.**

6 CURTIS STREET • ATHENS, OHIO 45701 • (614) 593-3150

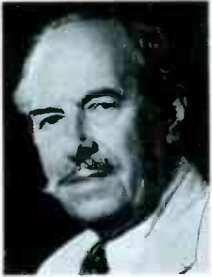

## Technical Talks

—by **John Battison**

Good day to you.

This is the first in a series of brief talks about the technology of LPTV station operation. These talks will not be deeply technical unless you, the reader, want them to be. Questions sent to me will be answered here if they are of sufficient general interest or if they are intriguing enough for special attention. I would also appreciate suggestions for special topics.

• • •

A recent issue of this magazine carried a story about Channel 22 in Bucyrus, Ohio, for which I was the consulting engineer. There were many problems that Bill Allonas had to solve. As the first, and most successful, LPTV station operator in Ohio, he had to be very innovative to keep technical costs down.

Allonas did not make the mistake of rushing out and buying lots of flashy large TV station equipment. Instead, he used his experience in the radio/TV consumer field and bought as much good quality consumer material as he needed. He kept his eye on the most important thing, however; he insisted on top quality video transmission. This helped him immensely in competing with the cable TV in Bucyrus—which carried signals from full service TV stations in major markets.

Allonas also saved money another way. When he put his Channel 54 on the air, I specified a Bogner BU type antenna to be mounted atop the existing Channel 22 BU antenna. But instead of buying a new unit, Allonas got a used one and sent it to Bogner for refurbishing. This saved him about \$10,000.

One piece of advice: There is always the temptation to pick up a used antenna and "save money" by putting it straight into service. Don't do it!—unless the unit is a simple Yagi type that can be eyeballed and any obvious damage rectified by your own engineer. The cost of putting up and pulling down an antenna twice can more than eat up the money saved on a used one.

• • •

There is a lot of talk about the merits of VHF versus UHF LPTV, and low band VHF versus high band VHF. However, a great deal depends on the local topographical conditions and the facilities that have been authorized. The distribution of the viewing audience may also be a factor; for instance, if the viewers are concentrated in one particular area, a directional rather than a non-directional antenna may be in order. For the most part, though, I feel that the old "stigma" of UHF is now well behind us, and that in many ways UHF is preferable to VHF.

In most cases, more power can be radiated with UHF, allowing high transmitting antenna gain\* with small structures. Also, a viewer's receiving antenna can be

### About the Author

Who is John Battison? If you're in television engineering, you know; or if you don't, you should. But those of you new to TV, or in less technical areas, may not have heard yet of this gentleman who is one of the pioneers of television technology.

Battison's career is varied and follows the history of television. He began with ABC in the 40's, building their flagship station—WJZ, now WABC—in New York City, and following that with other ABC stations in major cities around the country. In 1946, he worked at CBS with the late Dr. Peter Goldmark developing color television technology.

For many years, Battison practiced as a consulting engineer in Washington, DC. Among his clients were Bing Crosby and several foreign governments, including Lebanon, for whom he developed the national television system. He founded the Society of Broadcast Engineers and has written fifteen books and more than 360 technical articles for both international and U.S. technical journals.

In 1978 he joined the faculty of Ohio State University where his main responsibilities were overseeing the university's radio and television stations, and where he developed the Battison Technical Seminars, familiar to SBE members. He has also owned stations—KAVE, Channel 6, in Carlsbad, New Mexico, and a Carlsbad radio station.

After retiring from Ohio State last October, Battison set up a consulting engineering practice in Columbus Ohio, where he has since done much work in LPTV.

Welcome to *The LPTV Report*, John!

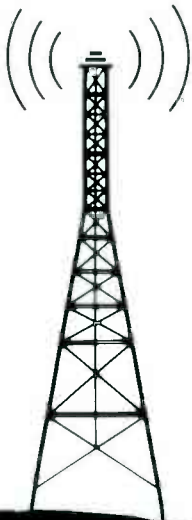

## LPTV Filing Window to Open Soon

Within the next few months, the Federal Communications Commission will announce the opening of a "window" for new and major change LPTV applications. The selection process favors minorities. No cross-ownership restrictions.

Applications **must** be letter-perfect upon submittal; corrections and re-submittals will not be allowed.

For **guaranteed** application preparation, call Kompas/Biel & Associates, the full-service consultants to LPTV.

*LPTV market analysis, engineering, and business planning also available.*

**For more information, call  
1-414-462-7010**

**Kompas/Biel & Associates, Inc.**  
P.O. Box 25510 • Milwaukee, WI 53225

smaller and higher, with more gain and directivity.\*\*

In smaller markets where your station may be the only UHF in town, it is important to mount your antenna on the most suitable VHF tower, rather than on, say, an FM tower in the opposite direction. Your viewers' antennas will all be oriented toward the VHF towers and, consequently, toward your U.

Remember that some viewers will not have UHF antennas. Others will have installed combination VHF/UHF antennas. Still others may be able to add a two-bay "bow tie" antenna, or use the UHF "Loops" that came with their TV sets.

On the other hand, if your market already has UHF stations, the logical thing is to locate on a UHF tower. If all the U's use the same tower, you will inherit the existing UHF-oriented antennas when you go on the air.

I can hear readers saying, "Yes, that's fine, but our CP's are for a different location. We can't just move to a new site."

That is more of a problem. But provided that your new antenna location does not produce service to an area not already in your service contour, you can file for a minor change and get it granted reasonably quickly.\*\*\* Every case is different and should be considered carefully by your chief engineer, with a small assist from a consulting engineer if necessary.

#### **NEXT MONTH: "Service" Contours and What They Mean**

\*Gain: A technical term used for the amplification of the signal produced by the antenna. In general, the more elements ("fishbones") in the antenna, the higher the gain.

\*\*Directivity: The ability of an antenna to concentrate its "pick-up", or signal, along a narrow beam in a given direction.

\*\*\*Ed. Note: For more on moving your site, see Richard D. Bogner's "Moving Your Antenna? Don't Lose Coverage" in the September 1986 LPTV Report. K/B

*John H. Battison, P.E. is president of John H. Battison & Associates, Consulting Radio Engineers, in Columbus, OH.*

## **EBS Script Change**

Broadcast stations now have the option, during their weekly Emergency Broadcast System announcements, of mentioning the types of emergencies likely to occur in their area.

This should be done in the third sentence of the second broadcast announcement: "... If this had been an actual emergency (optional—stations may mention the types of emergencies, such as earthquakes, likely to occur in their area), the attention signal you just heard would have been followed by official information, news, or instructions. . . ." K/B

## **FCC Requests Comments on New TV Booster Service**

In a *Notice of Proposed Rulemaking* regarding amending the rules relating to FM booster stations, the Commission has also proposed establishing a television broadcast station booster service.

Under the proposed rules, the licensee of a full power television station would be allowed to operate booster stations on the same channel as the full power station within that station's Grade B contour. The intention is to allow a full power licensee to achieve coverage of all areas within its predicted Grade B contour, specifically those areas unable presently to receive the signal directly over the air because of terrain blockage. The Commission stated that the boosters will not be permitted to operate as point-to-point relay systems.

The operating power and location of television boosters would be limited only to the extent that they not provide Grade B or higher level service beyond the predicted Grade B contour of the primary TV station, or increase interference to other TV stations. They would be treated as on-channel translators and would be required to abide by the interference standards applicable to all TV translators. Initially, the

Commission would authorize these stations only at low power levels, like the present TV translators and LPTV stations.

Because such a booster would be a technical extension of the television station being rebroadcast, ownership would be limited to the licensee or permittee of the rebroadcasting station. Also, applications for the boosters would be exempt from the competitive applications process.

The Commission requests comments on 1) the feasibility of the proposed TV booster service, especially in regard to the interference protection issues, 2) whether the proposed technical regulations are adequate, particularly the suggestion that booster applications state the measures that will be taken to insure that operation of the booster would not degrade areas of service from the primary station, and 3) the proposal to limit ownership of TV boosters to the licensees of the stations they rebroadcast.

Comments are due April 10, 1987; reply comments are due April 27. For further information, contact Marcia Glauberman at (202) 632-6302. K/B

### **NEW! COMPACT MOBILE MULTIPLEXER II**

THE FILM CHAIN WITHOUT A DEDICATED CAMERA

SUPERIMPOSE-DISSOLVE IMAGES FROM TWO SLIDE PROJECTORS AND ONE 16MM PROJECTOR FOR REAL TIME VIDEO OR VIDEO TAPING



- Your video camera with normal zoom lens can be tripod mounted and easily aligned in seconds.
- Small footprint. Unit fits standard 18" X 24" table.
- ✓ Write or call for free technical details.

**BUHL**  
OPTICAL COMPANY

1009 BEECH AVE., PITTSBURGH, PA 15233  
● 412-321-0076 ● 800-245-4574



# Checks & Balances

## Coping With Growing Pains

Growth Can Be Painful If You're Not Prepared

—by John D. Luellwitz

Economic theory and the real world seem to meet rarely. But when they do, the meeting can be both enlightening and frightening. One fairly common intersection of the realm of theory and the world of action occurs when a business passes out of what economists call a "relevant range of production."

To the economist, a relevant range of production is the level of production below which fixed costs remain reasonably constant. Moving beyond that level—that is, adding production capacity by acquiring or developing additional resources—readjusts fixed costs and creates what can be regarded as growing pains.

Whatever you call it, a shift from one relevant range of production to another can create painful problems. The diseconomies of scale can be devastating to your profit picture if you do not anticipate and resolve them before they begin to affect your station.

### Diagnosing Growing Pains

Growing pains come in many varieties, and not all elements of a business will experience these pains at the same time. Consequently, your station may be strained in different areas with each significant increase in sales volume. To an economist, that would indicate a business with fairly narrow relevant production ranges, each with a different resource defining its upper limit.

The resource lacks that can restrict profitable growth are numerous, but the most common are 1) the lack of trained personnel; 2) the lack of adequate internal accounting, data processing, or customer service systems; and 3) the lack of production equipment. The growing pains caused by these and other resources can surface in many ways:

**Cash Shortages.** A company's growth can be measured in two areas—revenue growth and asset growth. If sales are allowed to grow uncontrolled, they may outrun your station's ability to finance addi-

tional assets such as programming or production equipment. As a result, new programming and equipment is funded out of the company's operating cash flow and your station never seems to have enough cash to pay its bills, although sales and profits are increasing. If this situation is allowed to continue unchecked, suppliers may eventually refuse to ship to you, and both sales and profits will drop dramatically.

**Dissatisfied Customers.** The quality of your local production, especially ad production, or of your customer service may suffer as your station's business expands. Once a customer's confidence in you is lost, it can be very difficult to regain.

**Lower Profits.** In some situations, when you increase production capacity by adding people or by increasing your investment in fixed assets, your station's break-even point rises. When the additional growth profit generated by the sales increase is not sufficient to cover the new fixed costs created by the increase in capacity, lower operating profits will result.

# MPA

## DISK BASED GRAPHIC GENERATORS VISTA 90 ROM BASED CHARACTER GENERATORS

### DISK BASED GRAPHIC GENERATORS

- VISTA 90 SINGLE CHANNEL GRAPHIC GENERATORS  
Model VISTA 90/SF includes — 2 (512K) flexible disk drives  
Model VISTA 90/SH includes — 1 (20M) hard disk drive  
— 1 (512K) flexible disk drive
- VISTA 90 TWO CHANNEL GRAPHIC GENERATORS  
Model VISTA 90/DF includes — 2 (512K) flexible disk drives  
Model VISTA 90/BH includes — 1 (20M) hard disk drive  
— 1 (512K) flexible disk drive

### VISTA 90 ROM BASED CHARACTER GENERATORS

#### FEATURES

- FONTS — 64 Line Universal Special Style Font  
— 32 Line Universal May be Custom Ordered  
— 16 Line Universal
- Sloped or Non Sloped Letters
- Store/Recall up to 8 Pages of Text
- Roll/Crawl up to 8 Pages of Text
- All Other Vista 90 Features Except Disk Functions
- Computer (RS232C) Interface
- PC Type Keyboard

NOTE: ALL VISTA 90 SYSTEMS ARE UPWARD/DOWNWARD COMPATIBLE

- The Basic Vista 90/RM ROM Based Character Generator is readily upgraded to a single channel Vista 90/SF/SH graphics system by adding the **Disk Drive Accessory Kit**.
- The single channel Vista 90/SF/SH graphic system is readily upgraded to a dual channel Vista 90/DF/BH graphic system by adding the **Channel Expansion Kit**.
- Single or dual channel Vista 90 graphic systems can be expanded to a full blown artwork composition system by adding the **Keyboard/Camera Compose Artwork Composition Kit**.

\*PRICES ARE FROM \$8500. U.S.

\*\*CUSTOM CHARACTER GENERATORS AND GRAPHIC SYSTEMS FOR SPECIAL APPLICATIONS MAY BE BUILT UPON REQUEST



Advanced All Solid State  
Software Controlled  
Systems



Features for  
Broadcast Application



Charts and  
Illustrations

MPB Technologies Inc., 1725 Trans Canada Highway, Dorval, Québec H9P 1J1 Canada, Tel.: (514) 683-1490 TLX: 05-823509



# TTC

## TELEVISION TECHNOLOGY CORPORATION

*"Leader in LPTV Transmitters"*



### XL1000MU Kilowatt Transmitter

State-of-the Art, Dependable, Rugged Construction. Low AC Power Consumption — Compare us to others. Typical Tube Life — two years. Ask us how we do it. Experience — Over one hundred in operation worldwide.

*Also available* — VHF, UHF & FM Translators/Transmitters  
one watt to one thousand watts

Phone 303-465-4141 Telex 910-938-0396 TTC ARDA Fax 303-469-9728  
P.O. Box 1385 2360 Industrial Lane, Broomfield, CO 80020

There are few things more frustrating than realizing that even though sales go up, there is less profit to show for the effort.

#### **What's the Best Treatment?**

Planning can minimize the impact of growing pains. To achieve profitable growth, you must first identify areas where expansion may create bottlenecks in the flow of services to your customers and viewers. From an economist's point of view, this exercise involves identifying the resources that define the upper boundary of any given relevant production range.

The task is not easy. It may be one thing to identify the theoretical capacity of your production department, but determining the actual point at which the production of one more tape will create more problems than benefits is very difficult and requires a thorough knowledge of the entire production process. You can have even more difficulty determining the number of invoices your accounting people can process or how many phone calls the customer service group can handle each day. And the problems are compounded if, as is the case with many LPTV operations, everybody wears at least a couple of hats.

#### **Employees May Have Insights**

In spite of these difficulties, you must determine what the capacity of each major business operation is before it is

reached. The people who work within each operation may be the best judges of capacity.

Without the ability to anticipate bottlenecks, you will be unable to expand in an orderly fashion, thereby setting the stage for periodic chaos that makes life difficult for customers, employees, and management alike. A plan for growth, which can smooth the wrinkles associated with expansion, may include identifying potential sources of additional financing or formalizing the employee training program so productive workers can be developed in a shorter time.

Once the potential bottlenecks are defined and contingency plans are made, a monitoring process should be put into place. This process will alert you when the station approaches capacity on any one of its critical operations. Implementing a contingency plan will almost always require some lead time. Without this lead time, the plan may be useless and you will find your actions being controlled by your station's growth, rather than the other way around. K/B

*John D. Luellwitz is a manager in the Entrepreneurial Services Group of the Milwaukee office of Arthur Young. Arthur Young, the international accounting, tax, and management consulting firm, has offices in 90 U.S. cities and 280 other cities worldwide.*

## METEOROLOGICAL INSTRUMENTATION

Solar radiation  
Wind speed  
Wind direction  
Temperature  
Humidity  
Rainfall  
Barometric pressure  
Portable  
DC Systems  
Recorders  
Controllers  
Sensors  
Analog & Digital  
Instruments

**Computer compatible.**  
**Made in U.S.A.**

Call for prompt delivery and moderate prices, or write us about your problem.  
(214) 631-2490.



**Texas Electronics, Inc.**  
P. O. Box 7225, Dallas, TX 75209

# URGENT! Important Message for LPTV and CP Holders:



4-021383S056002 2/25/87 ICS IPMMTZZ CSP NYAD  
1 12753606 MGM TDMT NEW YORK-OS NY 02-25 0315P EST

Dear LPTV and CP Holders

Channel America is a serious, committed, long term player in LPTV. We have the concept, format and resources necessary. We now seek LPTV properties in top 100 markets, prior to the FCC window and our initial public offering. We believe that we can offer CP holders a variety of alternatives that provide near and long term rewards without infringing on FCC regulations. Our offers require no further investment on your part, yet give you a participation in our future. All calls handled through special hotline with total confidentiality. One LPTV per market. Must act immediately.

David Post

Chairman

Channel America

**Hotline: 212-421-1449 or 212-421-7179**

8AM to 7PM Monday through Saturday

15:31 EST

MGMCOMP

## After NATPE (Programming Deals will Never be the Same!)

—by Kris Harvey

Whatever my original expectations of the 1987 NATPE Convention in January, they were surpassed completely by this four-star, worthwhile show.

There were over 200 exhibits at NATPE, and I visited at least 150 of them. I saw and met stars like Oprah Winfrey, Jack Ritter, Tony Danza, Dr. Ruth, and Hulk Hogan. I ate mounds of free shrimp cocktail, and even though I don't care much for caviar, I was impressed to discover it in the convention booths for breakfast.

Although I missed my flight and lost my luggage, once I got to New Orleans, I found myself sharing an airport limo with Mark Osmundson from Marshalltown, IA who was down to seek programming for his newly signed-on LPTV station. I exchanged my "spud-talk" for his "corn-conversation," and both of us compared programming notes until the convention was over.

The syndicators generally gave me three kinds of attention: Day 1 was icy cold (I visited only the smaller booths); Day 2 was lukewarm (Bravo! I threw in a few

larger ones); Day 3—Well done! (The biggies were asking me to talk to them.)

Programming, and the lack of it, seems to be the toughest problem of all for LPTV stations. We at K49AZ-TV felt that we had already secured half of the barter programming available to us. However, because of our market area and the latest Nielsen surveys (for which we attained full reportability), we found programming sources galore at NATPE. But I had to be there, face-to-face, to acquire it.

Finding good programming, either cash or barter, is a full time job. I have found that your attitude has a lot to do with your success. Begging for programming like an underdog doesn't compare with coming in from the point of view that any and all companies *should* barter with you. We all realize the quandary we're in: We can't get the numbers without good programming, and we can't get good programming without the numbers. Our big job is to convince the syndicators that we are worth the gamble.

Securing programming for a TV station is far more complex than buying a music service for radio (which is where my back-

ground is). The industry lingo alone is enough to make you feel inadequate. If I had to do it all over again, I wouldn't have started Channel 49 until I had found a helpful, successful TV station on the other side of the country who was willing to let me live with them for a week.

*Broadcasting* recently published a complete list of all the exhibitors at NATPE. If you want to improve your programming, I'd suggest that you call every one of them. Almost all syndicators have some barter shows. If they aren't yet cleared in your market, you may find some golden opportunities.

No, these guys won't treat you like a long-lost brother, but they're only human. To quote Dale Carnegie, you must "appeal to their nobler motives." Eventually they'll capitulate. They did for me.

Good luck! And do plan to attend next year's NATPE in Houston. What you'll learn there will be well worth the price of admission.

K/H

*Kris Harvey is vice president and general manager of K49AZ in Twin Falls, ID.*



# cba Comment

—by Lee Shoblom

This month, our column will be read by a lot of new people. It's our NAB Convention issue, and a multitude of extra copies were printed for hand-out in Dallas. For those of you reading this publication for the first time, we welcome you to the world of LPTV—low power television, or "Community Television," a term that many of us prefer.

We are part of a bright new industry, an industry brought about by the FCC when they created the first new broadcast service in over 20 years. There are almost 300 of us on the air now, in communities large and small, in every state of the union. Some of us are very limited in our scope—modified translators really. But others of us are fully configured operations, looking every bit like any traditional television station anywhere.

The LPTV service was created by the FCC to bring new voices into the broadcast fraternity—minorities, women, and many other groups and individuals who feel they have something to contribute to their communities. It has been a rocky road these past five years, and many people, both in and out of the broadcast world, were ready to hang wreaths on us long ago. Some still are. We were plagued with "get rich quick" schemers, and "consultants" who wanted to help themselves more than the infant industry. Thousands upon thousands of faulty applications were filed by paper mills who took our money and ran.

Thankfully, these types have departed, and the serious players are now taking the stage. Everywhere, expiring construction permits have been purchased and activated. Instead of a plethora of failure stories, we have a multitude of success stories. We have music video stations, religious stations, all news stations, ethnic stations. We have traditional TV programming and we have programming resembling "radio with pictures." The real key to our success is our responsiveness to our communities; we are bringing local TV, in ways never before possible, to areas

never before touched by television. We are innovators

If you are a radio broadcaster, consider this: many radio operators are picking up expiring LPTV construction permits in their towns. There's no FCC restriction against radio people owning LPTV stations, as there is with traditional TV. Radio people already have the buildings, towers, personnel, contacts, and sales momentum to make the TV transition extremely smooth. If you're interested, check with some of us here at the convention at the LPTV session at 2 p.m. on Sunday in room S-411 of the South Meeting Hall. Or contact us here at the magazine. We're very aware of the construction permits available in your area. Who knows? You just might be able to skip the whole lottery process and become a fellow broadcast pioneer rather quickly.

When you do (here comes the pitch), we really need you as a member of the Community Broadcasters Association. As in anything else, in unity there is strength. Every issue of this magazine highlights more breakthroughs in areas helpful to LPTV people. But these legislative and regulatory victories don't come cheaply. They come through a lot of stumping in Washington, a lot of phone calls, and a lot of lobbying of all sorts.

Breakthroughs are also happening in programming. Consortiums are being put together and ways are being found to supply good programming to everyone at prices we all can afford.

It's all coming together. It's all working. But we need to have everyone in this business with us. We need station members and we need supplier members. We need your ideas. We need your financial support in the form of dues. We need your moral support.

Believe me, you will personally benefit from your association with the CBA. Enjoy! And **SUCCESS!** K/B

*Lee Shoblom is owner and general manager of LPTV 45 in Lake Havasu City, AZ. He is chairman of the Community Broadcasters Association.*

## Video Images Moves Offices

Video Images, Inc., a Wisconsin video systems dealer, has announced the relocation of its corporate headquarters to 285 North Janacek Road, Waukesha, WI. Branch offices are located in Madison, WI and Elk Grove Village, IL.

The new headquarters features a seminar and product demonstration studio and a larger installation department for remote truck modifications, prefabrications, and pre-delivery testing of television control rooms and editing suites. K/B

**BRIAN K. SMITH  
AND  
ROGER M. TEETER  
ARE**

**DALLAS  
BOUND !**

MARCH 28th and 29th

**FAMILY  
CHILDRENS  
FEATURES  
SHORTS  
CARTOONS  
GRAPHICS**

**BKS  
PRODUCTIONS INC.**

(404) 688-8674  
SUITE 300-G  
542 CHURCH ST.  
DECATUR, GA. 30030

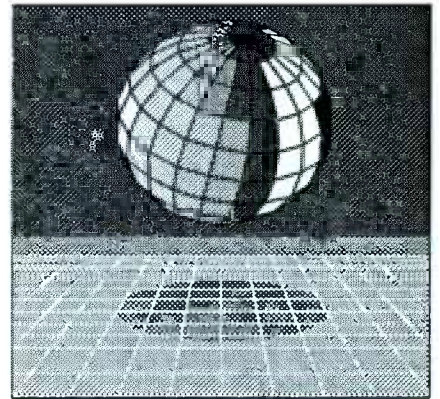

## Tomorrow's World Starts Today at TRA

Tomorrow's LPTV & FM stations are being planned today by the experts at TRA. Winning FCC application preparation. Call or write today for free info package:

**TRA Communications  
Consultants**

3590 S. 60th Ave., Suite 9  
Hollywood, FL 33023  
(305) 981-8480

# Classifieds

## WANTED

**LPTV Construction Permits or Licenses.** If you have an LPTV license or CP for sale, we have interested buyers. Confidentiality assured. John Kompas, Kompas/Biel & Associates, Inc., (414) 462-7010.

**Translator** and parts, subscription equipment, (315) 677-3404.

## FOR SALE

**LPTV Construction Permit.** Medium-size Great Lakes university town. No other local TV. (414) 462-7010.

**SHOOK ELECTRONICS USA, INC.** builds mobile television systems for independent producers and stations. Licensed engineering. 8-year track record of successes. CALL JIM BECKMAN FOR DETAILS, (512) 653-6761.

**LPTV Construction Permit** for large California city. Excellent opportunity. Please respond to (415) 724-1110 or P.O. Box 1122, Lafayette, CA 94549.

**\$495 COMPUTER TRAFFIC SYSTEM. EZ LOG:** Complete Traffic, A/R Billing, Affidavits, Aging and Sales Report software. For any IBM-PC or compatible computer. Immediate delivery. Complete hardware/software systems available. Call (817) 441-8532 for print-out package. The Management, Box T, Aledo, TX 76008.

*John H. Ballison & Associates*  
CONSULTING RADIO ENGINEERS

JOHN H. BALLISON P.E. 890 CLUBVIEW BOULEVARD NORTH  
COLUMBUS, OHIO 614/888-3364

FCC ON-LINE DATABASE

**dataworld**<sup>®</sup>

Allocation/Terrain Studies  
AM • FM • TV • LPTV • ITFS  
4827 Rugby Ave. Suite 200  
Bethesda MD 20814  
(301) 652-8822 1-800-368-5754

All classified ads are payable in advance. When placing an ad, indicate the exact category you desire: *Help Wanted, Situations Wanted, Services Offered, Wanted to Buy, For Sale, Miscellaneous.* The publisher reserves the right to abbreviate, alter, or reject any copy.

Classified advertising is sold at the rate of 50¢/word. There is a \$15.00 minimum charge for each ad. Count each abbreviation, initial, single figure, or group of figures or letters as one word each. Symbols such as *mm, C.O.D., P.O., etc.,* count as one word each. Telephone numbers with area codes, and ZIP codes, count as one word each.

For Classified Display rates, call John Kompas at (414) 462-7010.

# Supplier Side

**LAKE Compuframes, Inc.** announces the release of an innovative Storyboarding System that makes pre-production, production, and post-production more efficient and less costly than other storyboard systems do.

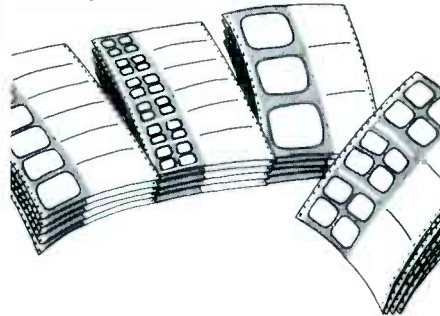

LAKE Compuframes continuous-form storyboards.

The Compuframes<sup>®</sup> System can be used with any word-processing program that offers pagination, margin definition, forced page breaks, and header insertion. You can format the word processor to print your script, as well as visual and audio directions, in prescribed slots on the storyboards. You can also direct it to insert frame numbers automatically.

Visuals can be drawn, frame by frame, into TV screen grids that correspond to text frames. Alternatively, computer generated graphics can be inserted directly into the screens as the script prints out.

Make a mistake? Just place a pressure-sensitive replacement screen over the original visual and start again.

The Compuframes pin-feed, continuous-form storyboards tear down to standard 8 1/2 x 11" sheets and are available in four formats: 6 frames per page or 3 frames per page, with either single or 4-way split frames. A box of 500 sheets is priced at \$49.98, 2,500 sheets at \$195.25. Replacement labels are \$19.98 per 100.

Contact: LAKE Compuframes, Inc.  
P.O. Box 890  
Briarcliff Manor, NY 10510  
(914) 941-1998

**BEACON Software, Inc.** has introduced AUTOPROMPTER+, a microcomputer-based teleprompter program for the Apple II Series computers and compatibles (64K minimum). AUTOPROMPTER+ is a full-featured, menu-driven program which supports video or paper-based portable or camera-mounted prompter systems and offers a wide range of features for text entry and electronic teleprompting. A story management option has been especially designed for television stations, cable systems. LPTV stations, radio, video or

## LUNAR'S Television Translator and Transverter Systems . . .

. . . for providing economical coverage  
to those areas unable to receive normal TV  
signals due to topographical limitations.

Many years of consistent quality control and product innovation have resulted in Lunar manufacturing the finest line of linearized amplifiers, low noise preamplifiers, frequency translating modules as well as other VHF and UHF accessories.

Complete turnkey systems include: TVRO; TV retransmission systems for NTSC, PAL or SECAM at VHF, UHF or Superband with encoded multichannel capability also available; SMATV; complete system engineering design, installation and training assistance; follow-up maintenance programs; total system upgrades; telecommunication networks integrated within re-broadcast systems; S-band systems for Arabsat and Insat are also available.



1W VHF - VHF Transverter



INDUSTRIES, INC.  
**LUNAR**

COMMUNICATIONS & SYSTEMS DIVISION

7930 Arjons Drive San Diego, CA 92126 (619) 549-9555 Telex 181747

# UNCOMPROMISING

- AM Voltage Rating – 10 KV
- Low Insertion Loss
- Low VSWR
- Protected against Lightning Damage

This is the only AM/LPTV isolation unit designed specifically for LPTV. Our AM voltage rating of 10 KV exceeds most models currently available, which were originally created for the translator market. Why settle for less, call today and see what the right equipment can do for you.

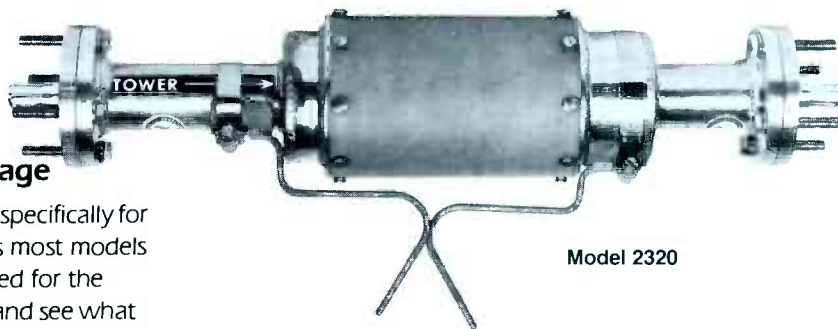

Model 2320

## Shively Labs

a division of Howell Laboratories, Inc.

51 Harrison Road

Bridgton, ME 04009 (207) 647-3327 TWX 710-223-8910 Shively BRGT FAX (207) 647-8273

**Shively Labs AM/LPTV Isolation Units  
Designed Exclusively for LPTV**

audio production houses, and broadcasting schools.

AUTOPROMPTER+ features include smooth scrolling text (up or down) in large, specially designed letters; adjustable scrolling rates; on-line help screens; highlighting and underlining; a built-in word processor for speedy script entry; and screen reverse for mirror-mounted prompters. List price is \$475.00.

Contact: BEACON Software  
P.O. Box 23422  
Milwaukee, WI 53223  
(414) 355-4460

Miller Fluid Heads (USA), Inc., offers the Miller 20 Fluid Head and the "System 20" head/tripod combination.

Designed especially for the new, lightweight, professional video cameras, the Miller 20 features full fluid pan and tilt control, a counterbalance, and a sliding camera platform system with a quick-release plate and integrated claw-ball leveling. It handles camera payloads of up to 20 pounds.

Complementing the lightweight Miller 20 is the new Compact Tripod. The Compact Tripod weighs less than 10 pounds, including its integrated above-ground spreader. Features include a high-strength, black-anodized tubular aluminum design, and new leg locks with protection against over-tightening.

Contact: Miller Fluid Heads (USA), Inc.  
2819 West Olive Avenue  
Burbank, CA 91505  
(818) 841-6262



The Jan-Al Pro Rack.

Jan-Al Innerprizes has introduced the Pro Rack, an innovative EIA rack system that brings an expensive high-tech look to a low-cost cabinet. Built in accordance with European design principles, it organizes electronic equipment into a professional unit.

The Pro Rack can be assembled with a screwdriver in 15 minutes and can be expanded by replacing the side panels. It is available in 7, 13, and 20 spaces.

Constructed of 3/4" multi-ply hardwood, it has a scratch-resistant, water-resistant finish. Standard features include medium duty handles with a comfortable grip, and a steel rack rail with 18" of rackable depth. Accessories include casters (the bottom panel is pre-drilled), rear rack rail, mounting hardware, and a Rhino (ATA) flight case.

The Pro Rack is available through authorized dealers.

Contact: Jan Michael Alejandro  
Jan-Al Innerprizes  
4452 East Washington Blvd.  
Los Angeles, CA 90023  
(213) 260-7212  
(213) 669-0550

Electronics Diversified, Inc., a manufacturer of performance and architectural lighting control equipment, introduces the Litestar II Memory Controller.

The new Litestar II allows up to 1000 dimmers to be controlled by 120 control channels. Features include 100 memories, ten full inhibiting submasters, two electronic crossfaders, and one manual cross-fader.

Output is USITT standard serial digital, with analog backup. Options include a high speed printer and hand-held remote.

Contact: Electronics Diversified, Inc.  
1675 NW 216th Avenue  
Hillsboro, OR 97124  
(503) 645-5533

K/B



The Litestar II by Electronics Diversified, Inc.

# Enter the ViP Aura

Lowel's ViP trio of tiny halogen lights switch from stands to clamps to hands to cameras to walls, in high style—and they travel everywhere in first class kits.

The 120/220 volt V-light provides 500 watts; the 12 volt i-light, 55 and 100; the 12/30/120 volt Pro, up to 250 watts. Broad illumination, refined fill, classic spot-flood lighting are at your command.

An elegant array of shared accessories, including many Tota-light® devices, makes the system a truly light investment. Lowel ViP treatment. You and your subjects will glow in it.

Lowel-Light Manufacturing, Inc.  
475 Tenth Avenue  
New York, NY 10018-1197  
212 947-0950

**lowel**®



## ...at the FCC

### NEW LPTV LICENSES

The following LPTV stations received licenses on the dates shown. Station call sign, location, and name of licensee are also given.

- K48BL Terrebonne-Bend, etc., OR. Rodney S. Johnson, 1/16/87.
- K44AW Rural West Riverton, WY. Riverton Fremont TV Club, Inc., 2/13/87.
- K48BM Jackson, WY. Ambassador Media Corporation, 2/13/87.
- K08GO Riverton/Arapahoe, WY. Riverton Fremont TV Club, Inc., 2/13/87.
- K34AV Fresno, CA. Family Television, Inc., 2/13/87.
- W12BF Crystal River, FL. West Florida Television, Ltd., 2/13/87.
- K39AS Marshalltown, IA. MTN Broadcasting, Inc., 2/13/87.
- W16AE Cresaptown, MD. Trinity Broadcasting Network, Inc., 2/13/87.
- K56CA St. Louis, MO. St. Louis Metropolitan Baptist Association, 2/13/87.
- W11BC Williamsport, PA. Trinity Broadcasting Network, Inc., 2/13/87.
- W67BD Chattanooga, TN. Sur Este Broadcasting Corporation, 2/13/87.
- K14BF Wenatchee, WA. Wescoast Broadcasting Company, 2/13/87.

### ASSIGNMENTS AND TRANSFERS

- W69BL Roanoke, VA. Assignment of permit granted from Media Properties to Lorin A. Costanzo on 12/17/86 (late report).
- K58CM Duluth, MN. Assignment of permit granted from George Fritzingler to Trinity Broadcasting Network, Inc. on 1/16/87.
- W28AC Charlotte, NC. Assignment of permit granted from Media Properties to Michael Gliner on 1/16/87.

### LPTV LOTTERY WINNERS

The following are tentative selectees of the LPTV/translator lottery held on January 30, 1987. If no petitions to deny the selectees are filed, and if the selectees are otherwise qualified, they will be granted construction permits.

- Ch. 66, Florence, AL. American Translator Development Co.
- Ch. 28, Cortez, CO. Arnold Salazar.
- Ch. 38, Pueblo, CO. Elizabeth A. Terrell.
- Ch. 21, Perry, FL. Evarista Romero.
- Ch. 25, Fort Lauderdale, FL. Community Service Television Company.
- Ch. 9, Panama City, FL. Brooks Broadcasting, Inc.
- Ch. 61, Tallahassee, FL. Mrs. Judith Ann Acevedo.

- Ch. 34, Savannah, GA. M & M Communications.
- Ch. 64, Dubuque, IA. Black Media Associates.
- Ch. 22, Waukegan, IL. Mar-Kap Broadcasting.
- Ch. 29, West Chicago, IL. Minority Communications, Inc.
- Ch. 42, Wichita, KS. Cherokee Network.
- Ch. 61, Haughton, LA. K. Sandoval Burke.
- Ch. 39, Morgan City, LA. Ginger A. Price.
- Ch. 52, Flint, MI. Media Properties.
- Ch. 68, Kansas City, MO. Mark L. Wodlinger.
- Ch. 23, Page, NE. Mountain TV Network, Inc.
- Ch. 33, Taos, NM. Taos Community TV, Inc.
- Ch. 66, Las Cruces, NM. Central California Broadcasters, Inc.
- Ch. 33, Reno, NV. Island Television Corporation.
- Ch. 50, Las Vegas, NV. Marcia L. Crittendon.
- Ch. 43, Jamestown, NY. Ogden Cable Corporation.
- Ch. 55, Albany, NY. Debra M. Kamp.
- Ch. 30, Syracuse, NY. Connecticut Home Theatre.
- Ch. 67, Marietta, OH. Community Broadcasting Corporation, Inc.
- Ch. 50, Athens, OH. The Messenger Publishing Company.
- Ch. 57, Coos Bay, OR. Jo Ann's Balloon Boutique, Inc.
- Ch. 11, Myrtle Beach, SC. Television Unlimited.
- Ch. 45, Greenville, SC. Barbara Dilley.
- Ch. 58, Nashville, TN. Classic Video Systems.
- Ch. 33, Union City, TN. O. L. Turner.
- Ch. 32, Eagle Pass, TX. Mountain TV Network, Inc.
- Ch. 44, Eagle Pass, TX. Mountain TV Network, Inc.
- Ch. 14, San Antonio, TX. National Black Media Coalition.
- Ch. 51, Clarendon, TX. Donley County UHF TV, Inc.
- Ch. 20, Kerrville, TX. K. Sandoval Burke.
- Ch. 30, Pullman, WA. Janet Roberts.
- Ch. 59, Charleston, WV. Evangelina Garcia Garza.
- Ch. 18, Kemmerer, WY. Mountain TV Network, Inc.

### NEW LPTV CONSTRUCTION PERMITS

The following parties received LPTV construction permits on the dates shown. Station call sign and location are also given.

- W30AI Birmingham, AL. Donnie F. Tucker, 1/27/87.

W11BL Huntsville, AL. Janet Roberts, 1/30/87.

K22AY Kingman, AZ. Mountain TV Network, Inc., 1/24/86 (late report).

K04NJ Fresno, CA. CBC TV, 1/28/87.

K29BE Springfield, etc., CO. Mountain TV Network, Inc. 1/28/87.

W54AH Sebring, FL. New Florida Broadcasting Company, 1/27/87.

K18BP Lewiston, ID. Lawrence P. O'Shaughnessy, 1/30/87.

W24AI Michigan City, IN. BTV Associates, 1/30/87.

K27BS Hayes, KS. Telemedia, Inc., 2/13/87.

K50BP Gorham, KS. Wireless Cable Broadcasting Company, 1/27/87.

W63AZ Portland, ME. Elizabeth E. Terrell, 1/30/87.

K65DB Bethany, MO. Mountain TV Network, Inc., 1/24/86 (late report).

K51BN Lebanon, MO. Mountain TV Network, Inc., 1/24/86 (late report).

K33AV Bethany, MO. Mountain TV Network, Inc., 1/24/86 (late report).

K18BN Glasgow, MT. Matlock Communications, Inc., 1/16/87.

K28BP Enid, OK. Evangelina Garcia Garza, 1/30/87.

K58CO Portland, OR. Focus Translators, Inc., 1/30/87.

K23BN Coos Bay, OR. Family Television, Inc., 1/30/87.

W50AJ Jackson, TN. Owen Broadcasting Enterprises, 1/16/87.

K38BP Mt. Pleasant, TX. F. V. P. Network, Inc., 10/24/86 (late report).

K17AX Alpine, etc., TX. Mountain TV Network, Inc., 5/16/86 (late report).

K20BK Amarillo, TX. The Hunter Partnership, 1/30/87.

W54AI Windsor, etc., VT. Media Consulting Corporation, 1/27/87.

K68CJ Spokane, WA. Quanta Communications, 1/29/87.

W08CK Madison, WI. The Identity Institute, 1/30/87.

K56DG Green Bay, WI. Jose A. Rosado, 1/30/87.

K22BK Rock Springs, WY. Jeffco Broadcasting, 1/16/87. K/B

## "Perry Mason," "Star Trek" to Air in Twin Falls

Kris Harvey, general manager of K49AZ, Twin Falls, ID has contracted with Viacom International for 76 episodes of "Perry Mason." The episodes, all in 3/4" format, have never before been aired on television. The all-cash deal calls for a \$3,000 total payment over four months.

Channel 49 has also bought a package of 25 color classic horror films from Majestic. The contract specifies unlimited runs for three years at \$50/title/year.

Buena Vista, distributor of the Disney movies, has contracted with Channel 49 for 25 films, including *Mary Poppins*, *Zorro*, and 20,000 *Leagues Under the Sea*. Payment is on a barter basis.

Also on barter is a series package from Paramount Pictures, including "Friday the 13th," "Marblehead Manor," and "Star Trek: The Next Generation." K/B

## Passink Builds Production Studio

Paul Passink, owner and manager of W33AB in Concord, VA, has signed with the ACTS Network and is building a studio for local advertising production.

Channel 33 was originally a subscription station offering SelecTV. Passink said he switched to ACTS because of the potential for local ad sales. K/B

## Hit Video USA Names Sales Manager

Nora M. Garcia has been named sales manager of Hit Video USA, the Houston-based, 24-hour music video programming service, and its LPTV affiliate, K05HU.

Garcia's background includes freelance public relations in New York City and a stint as an account executive for a Madison Avenue ad agency. K/B

# STOP SHOPPING!

Thirty years of manufacturing expertise offers you the security of proven reliability and high quality.

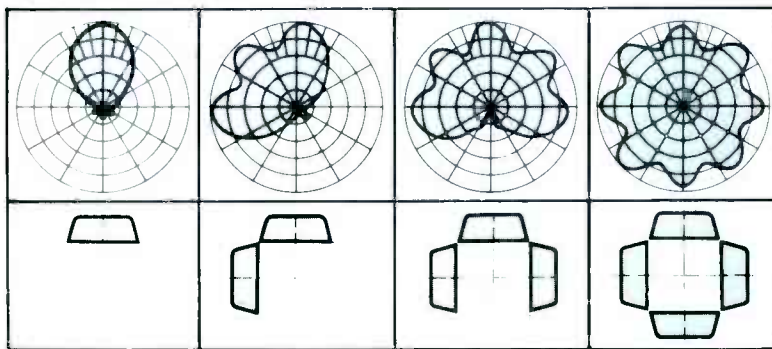
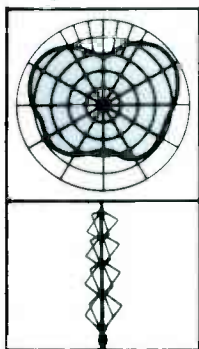

FOR ALL YOUR LPTV ANTENNA REQUIREMENTS... **CALL NOW!**

# Lindsay

Join the thousands of satisfied customers who chose *Lindsay*.

**LINDSAY SPECIALTY PRODUCTS LIMITED**  
50 Mary Street, Lindsay, Ontario, Canada, K9V 4S7  
Telephone (705) 324-2196      Telex: 0-6962-860

# TOWNSEND

## Low Power Television Transmission Systems

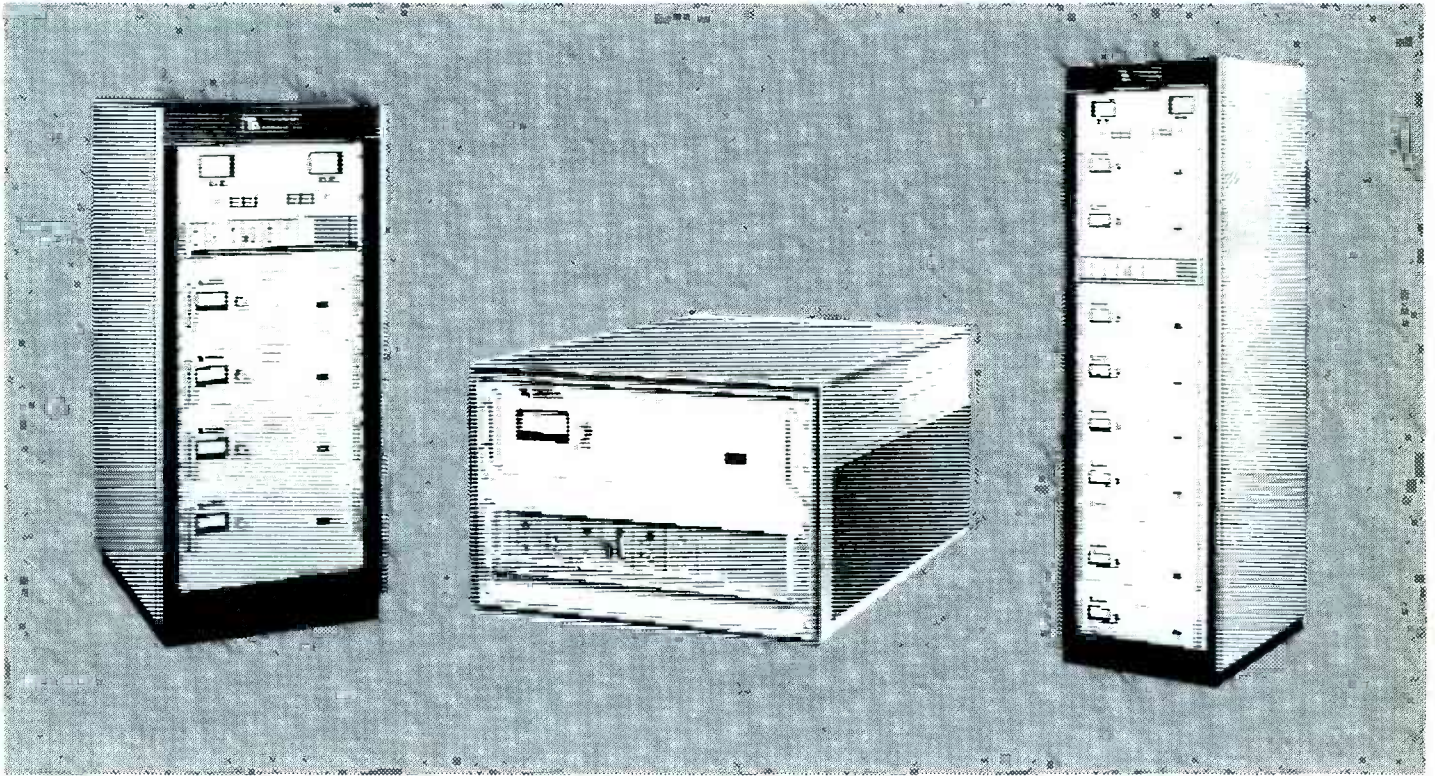

## TRANSMITTERS • TRANSPOSERS ANTENNAS • ACCESSORIES

- Solid state to the highest power level consistent with availability of solid state devices.
- Broadband design solid state stages require no tuning.
- Exciters providing I.F. modulation with SAW filters.
- Compact, but not to the extent of making ventilation of the equipment marginal, or of hampering serviceability.
- Readily available components of standard manufacture.
- Complete metering.
- A single tetrode to be employed exclusively for UHF transmitters of 1000 watts and over. The tetrode used has proven itself to be the means of accomplishing fine performance at lowest possible cost.

\*Systems D, I, K, K', L, M, and N are also available.



**TOWNSEND**  
The Television Transmission Specialists

79 MAINLINE DRIVE, WESTFIELD, MASSACHUSETTS 01085 • (413) 568-9581 • TWX#710-356-1521



# The LPTV Report

News and Features for the Community Television Industry

Vol. 2, Issue 9

A Kompas/Biel Publication

October 1987

**Trial Copy**  
Subscribe Today!

## LPTV-4 Rides Radio Market In Kentucky's Heartland

—by Jacquelyn Biel

About 30 miles east northeast of Mammoth Cave (as the crow flies) lies Campbellsville, KY, home of Heartland Communications' W04BP, which has just celebrated its first birthday on the air. Serving a city of about 9,000, and a county of some 22,000 people, LPTV-4 broadcasts from 6 a.m. to midnight every day with a mix of Tempo Television and Country Music TV, periodic University of Louisville football and basketball games, and a twice daily half-hour of local news.

The market is aggressive and growing, says Jim Jackson, the station's vice president and general manager. Most of the

surrounding area is farm country, but Taylor County is a regional employment center—Fruit of the Loom's main plant is in Campbellsville—and there is a lively retail trade.

Jackson believes in the value of local production, especially in a town like Campbellsville. "I think it's essential to be really involved in the community—to show local faces and sights on the air. Sometimes, we'll just take the cameras out, shoot a lot of video, and then air it with some music in the background. People get a real thrill out of seeing themselves and their kids on the screen."

*continued on page 5*

## TV-55, St. George, UT, Signs On With Emmys

Michael Russell, a former producer/director at KSL-TV in Salt Lake City, has joined the ranks of LPTV owners, signing K55DL on the air in St. George, UT. Airing 17 hours a day, Russell programs packages from Orbis, films from Lorimar and ITN, and various Fox Network offerings, including the recent Farm Aid concerts and Emmy Awards.

"Some of the stuff from Fox comes in on translator from Salt Lake City. I just air mine an hour earlier and get all the viewers first," said Russell of his approach to the area's competition.

Russell also does a variety of local productions—"A lot of local programming is really the key to success in LPTV," he asserts—Little League games with kids as commentators, the Senior Olympics, parades, the city council. And drawing on his professional experience at KSL, Russell is planning a telethon to raise money for St. George's Southwest Symphony.

Russell believes that quality is important in the successful operation of an LPTV facility. "You can't accurately represent good programming without good equipment," he insists. "For example, the time delays we needed to do for the Emmy's took six machines. For ads and remotes, we have a completely equipped mobile van."

Russell expands his Channel 55 coverage by translating via K45AI, a second LPTV serving Mesquite, UT. And he is buying a Cedar City translator that will increase his coverage from the present 35,000 viewers to more than 100,000.



News anchor Mary Blakeman and weatherman Steve Jenkins on the News-line 4 set.

**TTC**

**When you go into  
low power television...  
go in strong  
with TTC transmitters.**

Television Technology Corporation offers a full line of outstanding low power television transmitter/translators.

**The quality is TTC.**  
TELEVISION TECHNOLOGY CORPORATION

[See the TTC ad on page 17 for details]

LPTV Report  
P.O. Box 25510  
Milwaukee, Wisconsin 53225-0510

**ADDRESS CORRECTION REQUESTED**

WLLM-TV  
JOHN R. POWLEY  
1536 LOGAN AVENUE  
ALTOONA, PA 16603

Bulk Rate  
U.S. Postage  
**PAID**  
Milwaukee, WI  
Permit No. 3412

# WANTED

## LPTV

### LICENSES & CONST. PERMITS

(PURCHASE OR LEASE)

### IN THE FOLLOWING MAJOR MARKETS, SURROUNDING AREAS & STATES

ALABAMA Birmingham	Orlando Tampa West Palm Beach	Flint Monroe Oakland County	OREGON Eugene Portland Salem
ARIZONA Phoenix	GEORGIA Atlanta Columbus Savannah	MINNESOTA Minneapolis St. Paul	PENNSYLVANIA Philadelphia Pittsburgh
CALIFORNIA Bakersfield Eureka Fresno Los Angeles Monterey Sacramento Salinas San Diego San Francisco San Jose Santa Barbara Santa Rosa Stockton Visalia	IDAHO Boise	MISSISSIPPI Jackson	SOUTH CAROLINA Columbia
	IOWA Cedar Rapids Des Moines Davenport Sioux City	MONTANA Billings	SOUTH DAKOTA Sioux Falls Rapid City
COLORADO Denver	KENTUCKY Lexington Louisville	NEBRASKA Omaha	TEXAS Dallas Fort Worth Houston San Antonio
D.C. Washington	LOUISIANA Alexandria New Orleans Shreveport	NEW MEXICO Albuquerque Santa Fe	UTAH Salt Lake City
FLORIDA Fort Pierce Jacksonville Miami	MARYLAND Baltimore	NORTH CAROLINA Charlotte	WASHINGTON Seattle Spokane
	MICHIGAN Ann Arbor Detroit	NORTH DAKOTA Bismark Fargo	
		OHIO Cincinnati Cleveland Columbus	

**NOTE: IF YOU HAVE AN LPTV LICENSE OR C.P. OR  
ARE A PARTICIPANT IN A  
LOTTERY FOR ANY OF THE ABOVE MARKETS  
PLEASE CONTACT US TODAY!**

Please Send:

- \*Sale or Lease price quotes
- \*Copy of coverage map,  
construction permit & application

To: Steve Peters  
Video Jukebox Network Inc.  
3550 Biscayne Blvd., Suite #711  
Miami, Florida 33137

**For Details Call: (305) 573-6122**



## In Our View

The National Cable Television Association recently commended a number of local cable origination channels from around the country for their children's productions, many of the programs featuring the kids themselves as producers, or even hosts.

- "Room 13-19," a magazine show done by Syracuse NewChannels in Syracuse, NY spotlights the achievements of kids between the ages of 13 and 19.

- American Cablevision of Indianapolis offers "The Filling Station," which dramatizes popular non-denominational Bible verses and basic Biblical values with music and animation.

- TCI's Dubuque, IA system features "The Stay Safe Spots," a series of skits that teach kids how to be safe around strangers. The series was produced with the assistance of the Dubuque police department and the Girl Scouts.

- "Dial A Teacher," for students who need help with their math homework, is offered on Media General Cable in Fairfax County, VA.

- Cox Cable of Omaha, in conjunction with the Omaha Opera Company, presented a scaled down version of "Porgy and Bess" for grade school audiences.

- "Music and Me" introduces grade school kids to orchestral music on Continental Cablevision's Springfield, MA system.

- Viacom Cablevision of Cleveland produces "Cleveland's Kids and Company," a video magazine filmed on location that highlights outstanding students and their activities.

Although LPTV is a youthful service and the stations doing local production still number under 200, similarly useful and responsive local children's programming is being aired by LPTV operators who have found that the way to viewers' hearts is through their kids:

- "Gramma's Gang," a production of W07BN in Bruce, MS, features one of the town's grandmas and the antics of her handmade puppets.

- W18AE in Killington, VT opens its studios to Killington's grade school students, who produce a weekly news show. Every week a different grade is responsible for the reporting.

- Milwaukee's W08BY programs music videos interspersed frequently with local production. A large share of the audience is teenagers, who squeal through interviews with visiting rock stars and boogie to the beat of local bands, many of whom

get their first city-wide exposure on Channel 8.

- Ron Koplinger, an operator at W20AB in Olean, NY, does the daily "Ranger Ron Show," a children's variety hour.

- Last November, high school students in Tonopah, NV did a half-hour documentary on date rape. It was one episode of a weekly series produced by the students, who also are responsible for other local programs aired on K17AH—from PSA's to interviews to specials.

The possibilities for locally produced programming that appeals to kids are endless. What about a children's craft show on the order of adult cooking or woodworking programs. The kindergarten teacher would be happy to suggest projects, local seniors would get a kick out of hosting the show, and toy and hobby stores would jump to sponsor it.

My son, Wyatt, recently talked us into getting him a B-B gun. Both he and we would have welcomed a program about marksmanship and safety, in language and concepts appropriate for a ten-year-old. For that matter, programs geared to the young hunter or fishing enthusiast might go over well with both the kids and the local sporting goods store.

How about a kids' swap corner, a business show for kids (sponsored by your accountants), fifteen minutes a week devoted to an introduction to careers (take your cameras out and interview the cement truck driver, the doctor, the newspaper editor, the garage mechanic).

If your town hosts a professional sports team, invite the players to speak to local youth at your studios—and broadcast the whole thing live. Or take a tip from K55DL in St. George, UT (see this issue, page 1) which airs Little League games, with the kids themselves as commentators.

Kids are wonderful PR reps simply because very few people can resist them. Program to the kids in your market, let them into your studios, even let them do a bit of production. Chances are that both your advertisers and your adult viewers will applaud you. You can take it from there.

K/B

*Jackie Piel*

## Our Readers' Comments

In my opinion, the LPTV industry is in a limbo right now as far as syndicated programming or national advertising is concerned. We can expect no help from anyone but ourselves, at least until someone comes up with an acceptable ratings system.

It appears, from my recent discussions with Arbitron and A. C. Nielsen, that we can expect nothing from them in the future. This means a lot of headaches in securing programming and a near hopeless chance for attracting national advertisers.

I support the CBA's goal of creating a programming cooperative for the industry. As most of you are aware, numbers make the difference when trying to sell any product. I think a cooperative is a sound objective but, again, it takes help—help only we, ourselves, can give it. It won't work without us.

A programming co-op certainly is worth a try. I urge other LPTV operators to support the CBA's efforts to make things better for all of us.

Jim Conlon, General Manager  
W30AJ, Inc.  
Syracuse, NY

K/B

### COMPUTER GENERATED GRAPHICS

Custom & Stock  
LOGOS & DATERS  
and much more.....

ALSO:

### QUALITY ORIGINAL PROGRAMMING

★ Children's

★ Family

For the most reasonable rates around

Contact:

**BKS** Productions Inc.  
(404) 688-8674

SUITE 300-G  
542 CHURCH STREET  
DECATUR, GA. 30030

## Kompas/Biel & Associates, Inc.

S.E. Bradt, *Chairman of the Board*

John Kompas, *President and  
Chief Executive Officer*

Jacquelyn Biel, *Executive Vice President and  
Secretary*

Richard P. Wiederhold, *Vice President—  
Finance and Treasurer*

### The LPTV Report

4434 Glenway  
Wauwatosa, WI 53225-4449  
(414) 462-7010

John Kompas, *Publisher*  
Jacquelyn Biel, *Editor*  
Shelley Gall, *Executive Assistant*  
Catherine Berse, *Marketing Coordinator*

*Columnists:* John H. Battison, Lee  
Shoblom, Peter Tannenwald.

*Advertising Sales:*

**Kompas/Biel & Associates, Inc.**  
P.O. Box 25510  
Milwaukee, WI 53225-0510  
(414) 462-7010

**Affiliations:** **CBA** *The LPTV Report* is the  
official information channel of the Commu-  
nity Broadcasters Association.

*The LPTV Report*, ISSN 0892-5585, is published  
monthly by Kompas/Biel & Associates, Inc., 4434  
Glenway, Wauwatosa, WI 53225-4449, or P.O. Box  
25510, Milwaukee, WI 53225-0510. © Copyright  
1987 by Kompas/Biel & Associates, Inc. All rights  
reserved.

Subscription price: 1 year, \$25.00; 2 years,  
\$45.00. Outside USA: 1 year, \$31.00; 2 years,  
\$57.00. POSTMASTER: Please send address  
changes to: *The LPTV Report*, P.O. Box 25510,  
Milwaukee, WI 53225-0510.



### Catherine Berse Joins The LPTV Report

Catherine Berse, a 1986 University of  
Wisconsin graduate with a degree in  
Communications and Advertising, has  
joined *The LPTV Report* as marketing co-  
ordinator.

Berse comes to *The LPTV Report* from  
WPWR-TV, an indy in Aurora, IL where  
she was a master control and tape opera-  
tor. She will be in charge of circulation  
and will assist in marketing and ad sales.

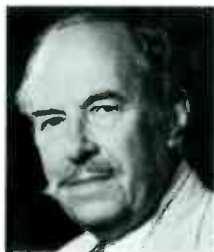

## Technical Talks

—by **John H. Battison**

In previous columns I discussed gain,  
transmission lines, contours, and cover-  
age. This month I want to continue on the  
subject of coverage...for it is coverage  
that counts.

In general, coverage can be obtained,  
or controlled, in two ways: 1) a combina-  
tion of power and antenna pattern and  
height, or 2) exposure on a cable system.  
What is left of the must-carry rules does  
not apply to LPTV (in fact, it never did).  
However, there is nothing to prevent the  
astute LPTV licensee from gaining access  
to cable subscribers, provided that there  
is room on the system and the cable op-  
erator is agreeable. As cable technology  
progresses, cable capacities are contin-  
ually increasing, and in some areas cable  
operators will welcome LPTV with open  
arms. We shall deal with that later.

Let's look at coverage first. The shape,  
and size and area, of your "service con-  
tour" are governed by your antenna's  
ERP (effective radiated power), the  
height of the center of radiation (from the  
antenna) above the *average elevation* of  
each radial, and the actual radiation pat-  
tern of the antenna.

If your station is one of the original  
construction permits authorized and you  
bought it from its original owner, very  
likely it does not produce optimum cover-  
age. In the early days of LPTV availability,  
many applicants, in a hurry to file their  
applications, put together a legally and  
technically correct presentation with a  
simple non-directional, and probably low  
gain, antenna. The whole application was  
grantable, but it did not do anything like  
the best possible job.

Unlike the case with FM, the FCC does  
not require that LPTV applicants show  
the terrain (ground) elevations along each  
radial. Furthermore, it does not require  
the applicant to calculate the total an-  
tenna height above average terrain for  
the application. Thus many of the original  
so-called "coverage contours" were  
merely educated guesses and did not  
necessarily have any relationship to real-  
ity. I can recall several applications whose  
alleged "protected contours" (the FCC's  
specified contours) were several times  
greater than the actual contours turned  
out to be. When the stations were built,  
coverage was nothing like the promise.

This is not necessarily dishonesty on  
the part of the original applicant; it is  
more a lack of knowledge of TV propaga-  
tion and engineering requirements. Ap-  
plications prepared by well-known, pro-  
fessionally registered consulting  
engineers contained these data; but  
many of the fly-by-night "amateur engi-  
neers" gave only minimal information  
which was often very misleading.

Sometimes the antenna location was  
determined for expediency, rather than  
technical desirability. For instance, a con-  
venient tower on the edge of town might  
have been chosen because of quick avail-  
ability. The fact that half the non-  
directional signal went to wide open  
spaces populated only by jackrabbits was  
ignored. A simple change to a directional  
antenna could double the number of  
people able to receive the signal.

Take the above situation and work out a  
better combination of antenna height  
and power, and the station can become  
quite viable financially. This is the type of  
situation where the consulting engineer's  
experience becomes invaluable.

Another factor has to be considered.  
Because many original applications did  
not require the examination of radial ter-  
rain data—that is, the varying heights of  
the ground along each radial—there are  
many LPTV stations today that cannot  
provide service to desirable areas be-  
cause they are behind hills whose exist-  
ence was not considered during the ap-  
plication process.

In cases such as the above, there are  
two alternatives. One is to raise the an-  
tenna. This could be easy, if the antenna  
has been placed low on a tall tower. Or it  
could be very expensive if existing tall  
tower facilities are not available. The sec-  
ond alternative is to move the antenna to  
a more suitable location. This involves  
studying a topographic map and prepar-  
ing terrain profiles for each radial to en-  
sure that there are no pockets of low or  
inadequate signal.

At the same time that the antenna  
move is being considered, the ERP  
should be examined together with the  
antenna radiation pattern to determine  
whether a power increase and/or a  
change in radiation pattern is advisable.  
Since the early days of LPTV applica-  
tions, better means of determining pro-  
tection requirements to other stations  
(generally full service TV stations) have  
become available. Many times a pattern  
with significant radiation in certain desir-  
able directions can be provided at very  
little cost. This can often mean a signifi-  
cant improvement in viewer acceptance.

Space is running out. This topic will be  
continued next month with some exam-  
ples of coverage improvement. K/B

*John H. Battison, P.E. is president of John  
H. Battison & Associates, Consulting Ra-  
dio Engineers, in Columbus, OH.*

# Campbellsville's TV-4

continued from front page

## Local Politics Big With Viewers

One of the more important pastimes in Campbellsville is local politics, and Channel 4 covers all the elections and meetings—as well as such events as the Rotary Club auction and the town's big Annual 4th of July Celebration. Just being there with the van and the cameras is many times promotion enough for Jackson and his crew, but jackets and sweat-shirts bearing the Channel 4 colors and logo help to reinforce the image of a lively, active news team. And to encourage his viewers to watch the local features, Jackson showers the town with printed cards listing the local programs and their air times.

Channel 4 is carried on two area cable systems—Telescripps, a TCI system, and Cumberland Valley Cable. Jackson supplied the Cumberland System with an antenna and a modulator to insure a clear signal, but he pays no carriage fee. Relations are friendly—"We give them local programming, they extend our reach."

The station's only other media competition comes from Campbellsville's WGRB, a UHF TV that does no local production—and Heartland Communications' own AM and FM stations, which Jackson uses to promote the LPTV. The AM, for example, runs a "Newsline 4 Trivia"; listeners who can answer questions about the previous night's TV news win a small prize. And the three-night Rotary auction was simulcast on the AM and Channel 4. "It proved to the business community once and for all that people watched Channel 4," said Jackson. "We got at least one long-term ad contract out of it."

Many of the radios' administrative people also work with the LPTV, and even on-air personalities are shared: Mary

Blakeman, the TV news anchor, does the afternoon radio news; the morning radio news and the TV weather are both done by Steve Jenkins. Sports anchor Tom McClendon, engineer Mike Graham, and sales manager Marti Hazel similarly split their time between the radios and the TV.

## Memorable Spots Help Sales

"What we really need right now," says Jackson, "is a full-time ad salesperson for the TV." He feels that a serious push on TV advertising could be quite successful now that the station has achieved some recognition in the community. "We have banks, car dealers, restaurants, a drug-



Heartland Communications' satellite dishes: S/A 9000 and S/A 9630.

store, a building materials firm. We're getting more and more advertisers all the time."

Jackson credits producer/director Janet Graham with the success of the ads. "She's very talented, very creative. She's done some super spots. The whole idea is to make the commercials as interesting as possible so that viewers remember them and then mention them to the advertiser. Janet's very good at that."

As for rates, he charges \$5 to \$12 for

Tempo spots, \$50/spot during the local news. "We don't move on the rate—even though the UHF sells them for \$5 and \$6. We're making some money—not a lot—but we're in the black with the station."

Expenses right now hover around \$4,000/month—due in large part to the fact that much overhead is covered by the radio operations. And because all the equipment—some \$93,000—was bought from cash flow, there is no debt to service.

"I think it's important for anyone entering this industry to keep in mind that it is LPTV, not high power television," Jackson advises. "You shouldn't invest millions—not if you want to make a profit." He admits he would like to get more equipment—"...a Chyron, a TBC, an effects bank," but he also asserts that Channel 4 "looks better than WGRB."

Right now Jackson is using consumer grade 8 mm digital cameras that he traded for at a Campbellsville video supply store. He shoots in 8 mm and then dubs at the studio to 3/4", a procedure that results in quality that is "superior, if you keep the dubbing to three or four generations." All audio is in stereo, which added an extra \$2,000 to the build but which has paid off in the satisfaction of Channel 4 viewers, especially the CMT regulars.

What would he do differently if he were building his station today? "Well, I might want to go with a UHF channel. On the V we're susceptible to interference from the cable headend power lines that run right in front of the station." Otherwise Jackson is pretty satisfied. "You have to figure on several lean years before you can make a real profit. You have to be very aggressive in getting good programming. But on the whole I think everything has worked out real well for us. Nobody thinks we're less valuable to the community because we're an LPTV. We do a good job and the town likes us."

And that, folks, is what really counts.

## EQUIPMENT LIST — W04BP, Campbellsville, KY

- Sony VO-5800 Video Recorder
- Sony VO-5850 Editing Recorder
- Sony RM-440 Editing Controller
- 2 Sony VO-5600 Video Recorders
- 2 Sony Trinitron CVM 1270 Color Monitors
- NEC C12-202A Color Monitor
- Tektronix 528 Waveform Monitor
- Quantel TBC 2000
- Scientific Atlanta 9320-80
- Scientific Atlanta 9000, 2.8 M receive dish
- Scientific Atlanta Z-500 Dish Control
- Scientific Atlanta 9630 Receiver
- TTC LPTV Transmitter, TVF-10 (CH4)
- Drake 2202 Satellite Receiver
- Drake LNB, 2501
- 6 Panasonic TR-930U and TR-932 Monitors
- Videotek RS-10A/24 Routing Switcher
- Ikegami HL-77A Camera
- Sony ECM-50 Lavalier Mic
- Electrovoice CO-90 Lavalier Mic
- Tektronics 1720 Vectorscope
- 2 Videotek VDA-16 Distribution Amps
- Panasonic WJ-200RB Switcher
- Videotek VSG-200 Sync Generator
- Sony CCD V8AFu/B Portable Video Camera
- Channelmatic Commercial Inserter
- Channelmatic ATG-202A-DT VCR Tone Generator
- Channelmatic CTD-3104A Tone Decoder
- Channelmatic SSS-3005A Seq. Selector Switch
- Fujinon A 12 x 10 120mm lens
- Lowel 1500 Soft Light 2
- Scientific Atlanta 6380 BTSC Stereo Encoder
- Scientific Atlanta 6350 Modulator
- Quanta QCG 300/SD Character Generator

# Shopping For A Downlink? Browse Before You Buy

Virtually all LPTV operations use satellite programming of one sort or another. A good dish and receiver system is essential to such operations, and the system's ability to capture a quality signal from the bird can mean the difference between satisfied and loyal viewers or a telephone line clogged with complaints.

If you're a new construction permit holder, you're probably thinking seriously of acquiring some satellite reception capability. Below is a brief review of some representative manufacturers and their products. Of course, there is much we cannot cover here. But the following paragraphs should give you an idea of what to look for and what is available in this complex technology.

## RECEIVING ANTENNAS

COMTECH manufactures 3.0 and 3.8 meter antennas that provide quality and performance at an affordable price. Both sizes feature single-pole mounts for inexpensive installation. And each antenna is engineered to a near-perfect parabola. This, combined with a high-efficiency



COMTECH's 5.0 meter polar mount satellite receiving antenna.

feed horn, produces high gain and good sidelobe performance.

The 3.8 meter antenna features an extremely efficient 42.9 dB gain. The El/Az (elevation-over-azimuth) mount permits 360° azimuth adjustment and eliminates the need for costly foundation alignment. Using the elevation jack, an operator can smoothly and easily adjust the antenna's elevation from 0° to 70°.

The system is polar-mounted and is available in both manual and motorized versions.

• • •

Scientific Atlanta's Satellite Communications Division manufactures a 4.5 meter antenna with standard El/Az mount. The antenna is designed for a wide range of applications in the C- and Ku-Bands and, according to the company, is especially well suited for LPTV operations.

The parabolic reflector is made of twelve precision stretch-stamped steel panels for consistent surface accuracy. The panels are uniform and completely interchangeable for convenient handling, lower shipping costs, and easy installation. After a foundation has been prepared, two people can install the antenna in less than one day. No special tools are required, and no part weighs more than 140 pounds.

The El/Az mount provides continuous coverage of the satellite arc from any location in the contiguous United States. Pointing is rapid and accurate. Complete 360° azimuth coverage eliminates the need to align the foundation and makes installation easy.

As an alternative to a concrete slab foundation, Scientific Atlanta offers an economical pier foundation kit. The pier



Scientific Atlanta's 4.5 meter receiving antenna.

foundation, which is designed to accommodate steady 110 mph windloads, comprises three cast pier inserts. A steel framework bolts the inserts into a triangle which is lowered into three augured holes containing prepared re-bar cages. The holes are then filled with concrete. Installing the pier foundation is faster and cheaper than pouring a concrete slab foundation.

• • •

Channel Master manufactures a dual feed satellite antenna system specifically designed for commercial applications. Three sizes are available—3 meter, 3.5 meter, and 4.3 meter. The antennas are precision-formed of maintenance free fiberglass. Each features a heavy-duty polar axis mount.

• • •

Microdyne Corporation manufactures a complete line of fixed and motorized antennas, ranging in size from 1.2 meters

## UNCOMPROMISING

- AM Voltage Rating – 10 KV
- Low Insertion Loss
- Low VSWR
- Protected against Lightning Damage

This is the only AM/LPTV isolation unit designed specifically for LPTV. Our AM voltage rating of 10 KV exceeds most models currently available, which were originally created for the translator market. Why settle for less, call today and see what the right equipment can do for you.

### Shively Labs

a division of Howell Laboratories, Inc.

51 Harrison Road

Bridgton, ME 04009 (207) 647-3327 TWX 710-223-8910 Shively BRGT FAX (207) 647-8273

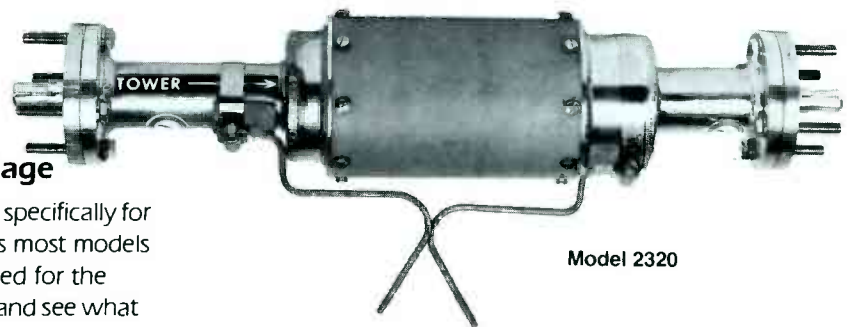

Model 2320

**Shively Labs AM/LPTV Isolation Units  
Designed Exclusively for LPTV**

# COVER YOUR MARKET WITH THE BEST POSSIBLE SIGNAL!

Utilizing Bogner Slot Array Antennas with over 15 standard patterns to choose from . . . Install a 1000 watt transmitter, select our 8, 16 or 24 bay model antenna and you can broadcast 20KW, 30KW, 60KW and even 100KW ERP!

**CALL  
TODAY**

**Kidd**  
COMMUNICATIONS

**916-961-5433**

OR WRITE: 4096 Bridge Street, Suite 4 • Fair Oaks, CA 95628

TALK TO US! . . . We have the knowledge and experience to provide you with a complete transmitting system best suited to your needs!

**FREE CATALOG!**

to 7 meters and suitable for both C-band or Ku-band applications. The 3 and 3.66 meter antennas are specially designed for broadcast quality reception, and the E/Az mount design means easy alignment and stable support in even the worst environmental conditions. Both antennas are available in either single or dual polarization feeds. The 5 and 7-meter antennas meet FCC requirements for 2° spacing at either C- or Ku-band frequencies.

All of Microdyne's antennas feature precision-molded fiberglass reflectors, prime focus feeds, superior sidelobe performance, and high gains.

## RECEIVERS

**R. L. Drake** offers the ESR-2240, a 19-inch rack mountable, commercial earth station receiver with a high level of IF (intermediate frequency) signal processing for professional quality video signals. Its features include block downconversion with Drake's BDC-24 weatherproof block downconverter or LNB; dual signal inputs with either automatic or manual polarity changeover for dual feed installations; a SAW filter for maximum adjacent channel and interference rejection with minimal signal distortion; and optional dual audio output for control tones or second audio subcarrier output.

The front panel of the ESR-2240 is designed for easy use. It includes button selectors for transponders and subcarriers, wide or narrow IF filtering for maximum sensitivity, signal strength metering, a video invert switch, and an audio moni-



R. L. Drake's ESR-2240 receiver.

tor with front panel speaker and volume control.

The receiver, priced at \$899, installs easily and comes with a 1-year limited warranty.

• • •

**AVCOM** makes two commercial satellite receivers suitable for LPTV applications—the COM-20T and the COM-66T. The COM-20T, together with the AVCOM RDC-20/RDC-21 remote downconverters, is an economical and reliable receiver system. Microwave oscillator technology insures that the downconverters remain highly stable over temperature extremes. The COM-20T features excellent threshold performance, selectable audio IF bandwidth—for those "special" narrow band subcarriers, and a signal strength meter sensitive to 1/10 dB. Also standard are rack mounting and tunable audio covering all subcarrier frequencies. Options include an internal downconverter and remote video polarity control.

The COM-66T, used with the BDC-60 block downconverter, is a dual conversion receiving system in a 3" rack mount configuration. As with the 20T, highly stable microwave oscillators eliminate frequency drift and allow operation over wide temperature ranges. The 270-770 MHz block downconversion frequency means that complex and versatile systems can be configured using low cost cable and components. Special threshold extension circuitry offers superior video quality with small aperture antennas.

Standard features include tunable audio with wide and narrow audio IF filters, vertical/horizontal output for automatic polarity switching, a normal or inverted video switch, and precise signal strength metering. The flexible downconverter



The AVCOM 66-T.

makes it possible to use any degree and brand of LNA.

Options for the 66T include automatic polarity switching, threshold peaking, and a remote video polarity switch.

• • •

**Microdyne** makes competitively priced receivers for either LNA or LNC/LNB systems, giving the LPTV operator a choice of available technologies.

LNA type receivers currently in Microdyne's line include the 1100 LPR and its remote control version, the 1100 LPR(R). Standard features on the 1100-LPR include dual video outputs, single knob front panel channel selector for easy tuning, and front panel adjustable video and audio gain.

The 1100-BKR provides broadcast quality LNB video reception for both C- and Ku-band applications. Four selectable IF bandwidths provide the operator with immediate access to any accessible C-band or Ku-band transponder. The 1100-BKR comes standard with two tunable audio subcarrier demodulators and is equipped with circuitry that can handle audio deviation.

The 100 CKR is Microdyne's newest commercial grade video receiver, designed to handle an input of 950-1450 MHz from an LNB. The single receiver can be used for either C- or Ku-band reception.

Finally, Microdyne has just introduced the Microdyne Automated Terminal, or MAT. Designed for total compatibility with all domestic satellite transmission

*continued on page 12*

## LPTV Distribution by State and Territory

### October 1987

	Licenses	CPs*
ALABAMA	4	24
ALASKA	12	37
ARIZONA	9	41
ARKANSAS	3	45
CALIFORNIA	27	49
COLORADO	11	62
CONNECTICUT	0	2
DELAWARE	1	2
WASHINGTON, DC	0	1
FLORIDA	15	72
GEORGIA	4	47
HAWAII	1	9
IDAHO	5	47
ILLINOIS	3	20
INDIANA	5	23
IOWA	4	44
KANSAS	5	97
KENTUCKY	3	12
LOUISIANA	3	34
MAINE	4	11
MARYLAND	1	4
MASSACHUSETTS	3	7
MICHIGAN	3	31
MINNESOTA	15	56
MISSISSIPPI	7	32
MISSOURI	4	73
MONTANA	12	129
NEBRASKA	3	76
NEVADA	16	48
NEW HAMPSHIRE	0	3
NEW JERSEY	2	4
NEW MEXICO	9	66
NEW YORK	12	28
NORTH CAROLINA	1	28
NORTH DAKOTA	2	65
OHIO	3	23
OKLAHOMA	10	64
OREGON	14	73
PENNSYLVANIA	4	16
RHODE ISLAND	0	1
SOUTH CAROLINA	0	14
SOUTH DAKOTA	1	73
TENNESSEE	6	35
TEXAS	26	129
UTAH	14	61
VERMONT	1	5
VIRGINIA	3	28
WASHINGTON	6	40
WEST VIRGINIA	0	4
WISCONSIN	9	37
WYOMING	18	58
GUAM	0	1
PUERTO RICO	1	3
VIRGIN ISLANDS	0	2

TOTALS: Licenses: 325  
Construction Permits: 1,996

In addition to the stations listed above, ALASKA operates a 241-station LPTV educational network.

\*Construction Permits

Source: *Kompas/Biel & Associates, Inc.*



—by Lee Shoblom

## CBA Comment

Are you a radio broadcaster in a town where an LPTV permit is expiring? Grab it!

In my judgment, running an AM/FM/LPTV operation really is the best of all possible worlds. For example, I'm able to attend a radio convention like the recent NAB gathering in Anaheim and talk knowledgeably about AM improvement, FMX technology, and all other radio matters—technical, programming, regulatory, legislative—and then I can creep around the halls and sessions and share the chit-chat about LPTV from radio people now adding pictures to their operations.

Then I can go to a full-blown, high power television activity like the September NAB "100 Plus" small market TV gathering in Washington and dazzle anyone within earshot with my recitations of the numbers of LPTV grants, station sign-ons, and successful operations across the land.

Incidentally, the 100-plus markets have a lot more in common with successful LPTV stations than do their big city counterparts with staffs of 150 people or more. In fact, many of the small market, high power operations are literally identical to some of the LPTV's, with the single exception of the type of license. They're out there scratching for quality programming, good people, and advertising money just as we are.

However, in every department, their costs are higher than ours. They must operate under much stricter FCC rules and regulations than the relatively regulation-free LPTV stations do. So it's a real plus to be able to double up with a combination radio/LPTV operation. Staff can be shared, as well as equipment, tow-

ers, buildings, vehicles, news sources, and advertising contacts.

And if you want to talk money, it's a real revelation how easy it is to get customers who do absolutely nothing on radio to advertise on your television station. Whether it's the magic of the flickering tube, the ego trip they get seeing themselves or their businesses on TV, or a simple desire to show a picture of their product, the motivation to use TV advertising is a strong one. Advertisers like realtors and restaurants want to show viewers that home or that table-side chef, carving the Chateaubriand. Interestingly enough, once they're on TV, it's relatively easy to get advertisers to use radio as part of a combo buy.

Speaking from experience, I can assure you that adding an LPTV doesn't draw much from your radio operation; indeed, it seems to enhance and stimulate activity in both businesses—a nice situation, to say the least. I've mentioned in this column that several members of your new CBA Board are combo owners. I feel this reflects the stability that has come to our new industry. The radio people wouldn't be interested if they didn't see potential.

The standalone LPTV will always be the mainstay of this business. It is, after all, what the service is about, to introduce new voices—minorities, specialty groups—to broadcasting. But when LPTV construction permits are expiring, for whatever reason, I think it's great that successful radio broadcasters are jumping in and activating them. It's good for them, and it's good for the industry.

Think about it, and thanks for listening.

*Lee Shoblom is owner and general manager of K45AJ in Lake Havasu City, AZ. He is chairman of the Community Broadcasters Association.*

K/3

## K39AS, Marshalltown, IA, Greets Vice President Bush At Vets' Gathering

Vice President George Bush visited Marshalltown, IA in late September to help celebrate the 100th anniversary of the Iowa Veterans' Home. Highlighting the festivities was a detailed re-enactment of a Civil War battle, complete with authentic uniforms, guns, horses, cannon, wagons, and battle plans. The 400 actors built a bridge and then blew it

up, and planted exploding ground charges to simulate cannon hits.

K39AS was on the scene to record Bush's speech and videotape the battle. A documentary of the event will be made for possible distribution to other LPTV stations, said Mark Osmundson, the station's president and general manager.



**Announcing the Pro Series  
S-VHS video production  
system—by any standard  
of measurement in  
a class by itself.**

**Panasonic**





# The Panasonic Pro Series 400-line high-resolution video production system.

In this S-VHS System, dot interference has been completely eliminated. The luminance and chrominance signals are output separately. This gives S-VHS video signals extremely clear color gradations and truly brilliant colors. All this—without sacrificing upward compatibility with standard VHS.



# Improved Cost/Performance.

VCR FORMAT COMPARISON*			
Edit VCR	VHS	3/4	Pro Series
List Price \$	4,400	8,000	5,900
Max Rec Time (Min)	120	60	120
ENG Rec Time (Min)	120	20	120
Tape Cost \$	9	40 Studio 30 ENG	20
Resolution In Color Mode	240 +	260 +	400 +
S/N (In color mode)	45dB +	46dB +	47dB +

## Equipment:

Upgrade your system even as you cut your costs: lower equipment/operating costs. Higher 400-line resolution.

## System Simplification:

Typical 3/4" 2-hour playback system—costly, complicated components.

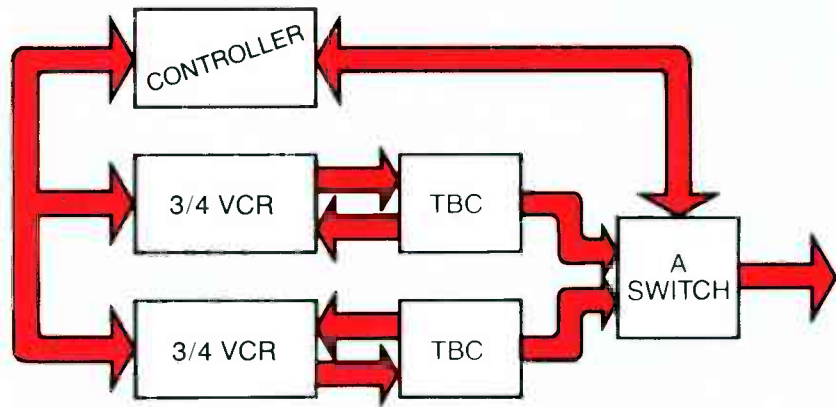

Panasonic Pro-Series S-VHS 2-hour playback system—requires no controller, only 1 TBC, only 1 VCR.

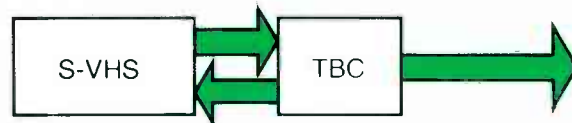

## Lower Tape Running Costs:

It takes six 3/4" 20-minute cassettes to equal the ENG recording time of one S-VHS cassette.

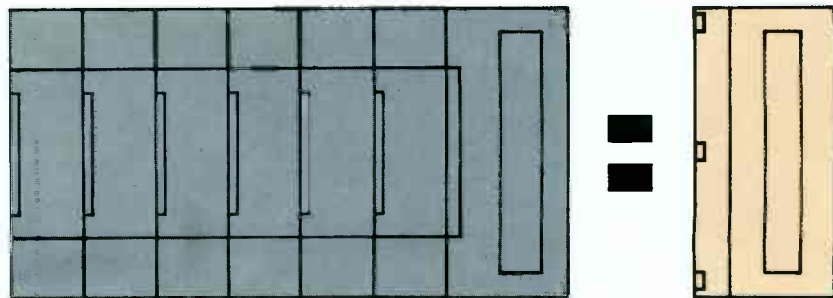

# Panasonic

Professional/Industrial Video

\*Based on  
Panasonic Edit Machines

## Downlink Shopping

continued from page 7

formats, both C-band and Ku-band, MAT is the first fully automated satellite earth terminal. It is user-friendly and easily controlled through a touch-activated keypad. Or it may be programmed in advance to automatically re-orient itself at a specified time and to activate video recorders or other electronic equipment.

• • •

The modular construction of **Scientific Atlanta's** 7500 receiver means easy maintenance. All circuit functions except the downconverter plug in from the top of the receiver; and the downconverter is removable from the front panel.

Front panel keyboard and display control allows the operator to enter a frequency or transponder number directly, step numbers up or down, or select one of six user-programmable memory channels. All status and tuning information is available at a glance.

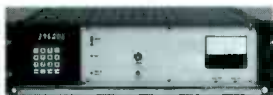

Scientific Atlanta's 7500 video receiver.

Other features include a standard S/A bus monitor and control interface, provisions for four audio subcarriers, and a threshold extension video demodulator for improved performance at lower signal levels.

K/B

## TELEVISION Bingo!

Complete "Ready to Air" Package  
**\$1995 tv**

• **Oldest Promotion in the Industry**  
Over 33 years ... 1400 plus stations.

• **Gets Double Rate Card Rate**  
A complete promotional package providing sponsors the "extras" that command extra dollars.

• **Increase Ratings**  
A proven leader in all markets.

• **Tremendous Sponsor Foot Traffic**  
Proves the effectiveness of your station with tangible sponsor results.

• **Continuous Renewals**  
Sponsors and listeners demand it.

**OUR BUSINESS IS IMPROVING YOURS**

©Copyright 1986, World Wide Bingo, Inc.



**WORLD WIDE  
BINGO, INC.**

PO Box 2311  
Littleton, CO 80161  
(303) 795-3288

## Satellites and LPTV: A Bit of History, Some Definitions, and a Little Advice

—by **John H. Battison**

When LPTV was first authorized, applicants were concerned with all the technicalities of getting their systems on the air, and not much thought was given to programming. As the service has come of age, however, and the LPTV stations on the air number in the hundreds, many operators have discovered the benefits of programming from the satellites.

Although everyone knows about satellites, not many people really know how they work. So let's take a look at some general concepts.

### Frequency

First we'll talk about frequency (or "alphabands"—to use a word I've coined to reflect the use of the alphabet in satellite terminology). The first satellites were, and still are, in the "C" band, which is (for our purposes) frequencies ranging from about 3500 MHz to about 4000 MHz. These frequencies are in the neighborhood of five times those of UHF television. Another way of expressing the same range is 3.5 to 4 "Gigacycles." In most cases, such frequencies still require fairly large receiving antennas.

There are also sources of interference to C-band transmissions. Long distance telephone services, for example, use the C-band for terrestrial, or earthbound, communications. The systems employ microwave links, with towers bearing drum-like antennas spaced about twenty miles apart. These earthbound beams carry hundreds of signals along their routes.

Microwave beams are relatively narrow and focussed like a searchlight. However, because of scattering due to atmospheric diffraction, some of these signals will occasionally appear some distance off of

their planned paths. Sometimes, too, the paths of these beams run near a satellite receiving antenna and appear in the picture as a herringbone or similar interference pattern. In extreme cases, the undesired signal may actually override the desired signal and ruin reception.

Occasionally, also, unusual atmospheric conditions cause reflections and refractions that make normally harmless signals troublesome.

### Licensing

When satellites first began to be used for communications, the FCC required that the receivers be licensed. Licensing ensured that no one later could erect an adjacent system that interfered with the original user's reception. It involved performing a special interference study to show that none of the local terrestrial signals would cause interference to the satellite signal. Once this was done, and the receiver licensed, it was protected against interference from new installations.

However, as time passed, and as more and more people used the satellite service, the FCC decided to drop the licensing requirement and let the risk of future interference rest with the user. In other words, there was no protection.

That is the situation today, and consequently, most, if not all, LPTV stations have unlicensed receiving antennas. In most cases they have no problems. However, there is the danger that a communications company may someday build a terrestrial system that impinges on their receivers.

Also, as time passed and technology was refined, the original requirement that dishes measure 30 feet in diameter was

### WHERE TO CALL

**AVCOM of Virginia, Inc.**  
500 Southlake Blvd.  
Richmond, VA 23236  
(804) 794-2500

**Channel Master**  
Division of Avnet, Inc.  
Industrial Park Drive  
P.O. Box 1416  
Smithfield, NC 27577  
(919) 934-9711

**COMTECH Systems, Inc.**  
Antenna Division  
3100 Communications Road  
St. Cloud, FL 32769  
(305) 892-6111

**Microdyne Corporation**  
P.O. Box 7213  
491 Oak Road  
Ocala, FL 32672-0213  
(904) 687-4633

**R. L. Drake Company**  
P.O. Box 112  
Miamisburg, OH 45342  
(513) 866-2421

**Scientific Atlanta, Inc.**  
3845 Pleasantdale Road  
Atlanta, GA 30340  
(404) 441-4000

dropped. Receivers have become more sensitive, with lower noise levels and better ability to reject interference. As a result, many measure only five to nine feet in diameter.

#### Ku-Band

C-band satellites are spaced 4° apart in an arc lying above North America. As these satellites became more and more popular, the available space in the arc began to fill up. And so, because of the lack of space as well as the need for smaller antennas, both receiving and transmitting, plans were developed to move to the "Ku" band, which is in the 12-13 Gigahertz range. (Incidentally, these mysterious letter bands were originally top secret; during World War II, letters were used to designate the various radar bands, and their use has resurfaced with the introduction of satellite technology.)

In electronics, any improvement in one direction generally imposes a limit in another. In the case of Ku-band, the uplink transmitter can utilize much narrower beam widths, and satellites can be spaced only 2° apart instead of 4°. Also, because of the much higher frequency, Ku-band receiving antennas have more "gain" (amplification) and can be very small compared with those for C-band. A three- or four-foot receiving antenna is often suitable for Ku-band reception. Similarly, the satellites, themselves, can use lower transmitter power because the antenna gain makes up for it.

However, the narrower beams mean that the Ku-band receiving antenna must be very firmly anchored; otherwise high winds or vibration can cause picture variation as the antenna moves. Also, Ku-band antennas are smaller and less noticeable, and they fit into areas where a "C" antenna might not fit. But they require greater attention to detail in manufacture, and the inside of the dish must be highly polished and very smooth. Any rivetheads or other irregularities can cause unwanted reflections in the picture.

#### Location

One short word on placing your antenna properly. In general, a ground receiver that can "see" the bird will obtain a usable signal, provided that foliage or buildings do not get in the way. Ground antennas should be located away from parking areas where vehicles can block line of sight, or in extreme cases, produce interference.

*John H. Battison, P.E. is president of John H. Battison & Associates, Consulting Radio Engineers, in Columbus, OH. He is a regular contributing columnist to **The LPTV Report**.*

K/B

## Bogner—20 years, over 1000 TV transmitting antennas and still climbing!

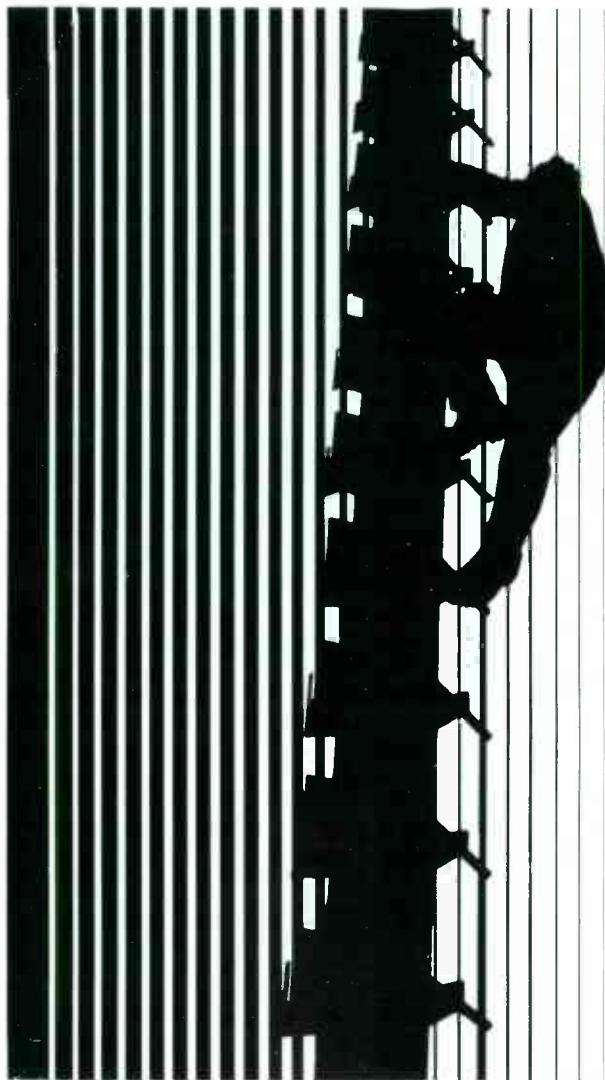

In the twenty years since we innovated a remarkable slot array design we have succeeded to a leadership role in TV broadcast antennas. We had to be better than the competition. We still are.

Today there are over 1000 Bogner TV transmitting antennas in use, more than from any other single manufacturer. Antennas with a long history of trouble-free performance and unequalled coverage.

Bogner antennas come in every power range and with the largest number of standard patterns in the industry. In addition, Bogner offers hundreds of custom patterns plus special designs to meet particular requirements.

Find out more. Call or write: Bogner Broadcast Equipment Corp., 603 Cantiague Rock Road, Westbury, New York 11590, (516) 997-7800.

When you need us  
we'll be there.

**BOGNER**  
WE MAKE THEM SMARTER

### Pittsburgh's LPTV-63 Adds ABC Soap

Nancy Hahn, president and general manager of W63AU, a Pittsburgh LPTV on the air since May, has just contracted with ABC for "Ryan's Hope" and "Business World," neither of which are currently being aired in Pittsburgh. The programming joins classic films from Lloyd Daniels, foreign films and sports from

ITN, and a variety of local features.

Hahn also announced that as of September 28, Channel 63 is being carried on Pittsburgh's TCI cable system. The move adds TCI's 90,000 subscribers to Channel 63's present 500,000 broadcast viewers.

K/B

### Woodstock's Channel 10 Gets Wendy's

W10AZ in Woodstock, VA has just added Wendy's to its spot schedule. TV-10 contracted with G. K. Foods, the franchisee for 14 Wendy's restaurants in Northern and Central Virginia, for a 13-

week run of five spots per day.

Said Art Stampler, president and GM of TV-10, "We're most pleased to have been selected by G. K. Foods. They chose us for our reach and viewer response."

K/B



# LPTV and the LAW

## Obscenity And Indecency On The Airwaves

—by Peter Tannenwald

Last April, the FCC announced that it would be strengthening its enforcement of Section 1464 of the U.S. Criminal Code, which prohibits the broadcast of "obscene, indecent, or profane" material. This statutory restriction goes beyond the limits placed on the print media. In print, only obscenity is forbidden; but on the air, indecency and profanity are barred as well. The Supreme Court has upheld the broadcasting statute as constitutional under the First Amendment, even though it distinguishes broadcasters from books and newspapers and even though the concepts of "indecency" and "profanity" are vaguer and more difficult to define than "obscenity."

It is important for LPTV operators to understand these concepts, because LPTV stations are fully subject to the statute. Even if an LPTV operator does not

originate any questionable programming, motion pictures taken from program sources that normally supply services like cable—which is available only to persons who specifically request it—may violate the FCC's decency standards for free, over-the-air broadcasting, which is available to all.

The obscenity/indecency statute may be enforced not only by the FCC but also by the Justice Department, because it is a criminal statute. However, over the years, the FCC has tended to be more active than Justice in this area, at least as far as broadcasting is concerned, so this column will focus on the FCC's view of the statute.

### Obscenity and Indecency: Definitions

Prior to its 1975 ruling in the *Pacifica Foundation* case, the FCC treated "obscen-

ity" and "indecency" as the same, following the Supreme Court's definition of obscenity: (1) material that the average person, applying contemporary community standards, would find, as a whole, appeals to prurient interests; (2) material that depicts or describes, in a patently offensive way, sexual conduct specifically defined by the applicable state law; and (3) material that, taken as a whole, lacks serious literary, artistic, political, or scientific value. In the *Pacifica* case, the FCC redefined "indecency" as language or material "that describes in terms patently offensive as measured by contemporary community standards for the broadcast medium, sexual or excretory activities or organs."

The *Pacifica* case involved the mid-afternoon radio broadcast of a recorded humorous monologue by comedian

# STOP SHOPPING!

Thirty years of manufacturing expertise offers you the security of proven reliability and high quality.

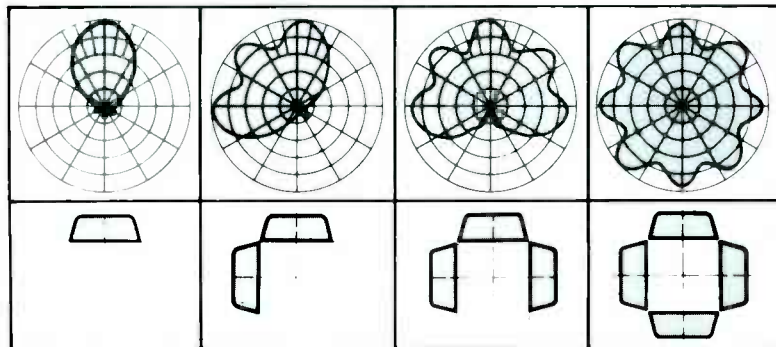
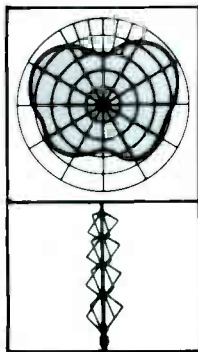

FOR ALL YOUR LPTV ANTENNA REQUIREMENTS... **CALL NOW!**

# Lindsay

Join the thousands of satisfied customers who chose *Lindsay*.

**LINDSAY SPECIALTY PRODUCTS LIMITED**  
50 Mary Street, Lindsay, Ontario, Canada, K9V 4S7  
Telephone (705) 324-2196 Telex: 0-6962-860  
FAX 705-324-5474

George Carlin. The subject of the monologue was "seven dirty words" that Carlin said could not be used on the radio. After that case, the FCC's enforcement of the indecency law was limited to the deliberate and repetitive use of those specific seven words prior to 10 p.m., the hours when children were considered likely to be in the audience.

The FCC has now declared that it will no longer limit enforcement to the seven dirty words, or to hours before 10:00 p.m. Rather, any material that describes sexual or excretory functions or organs will be suspect, no matter when it is broadcast, if it is found to be patently offensive; and offensiveness will be measured by contemporary community standards applicable to broadcasting, not to other media.

As to the time of broadcast, a station broadcasting indecent material must be prepared to show, with ratings or other audience surveys, that there is no reasonable risk that minor children are in the audience in the market as a whole, not just the audience of the individual station. And even if there are no children in the audience, the program must be preceded by a warning that offensive material may follow.

#### Cases on Trial

Four cases were before the FCC on April 16:

1. KPFK-FM, Los Angeles, broadcast excerpts at 10 p.m. from a play entitled "Jerker," including an explicit description of sexual activities between two men. The FCC was kind enough to publish quotations in its *Opinion*, and they would certainly raise most people's eyebrows. The material was found to be not only clearly indecent but also likely obscene, so the case was referred to the Justice Department for possible criminal prosecution.

2. KCSB-FM, Philadelphia, broadcast the highly publicized Howard Stern show during morning drive time. Stern's comments intentionally included sexual innuendo and double entendre, but the FCC said that the remarks went beyond off-color references and dwelled on sexual and excretory subjects in a titillating fashion that was patently offensive, at a time when children were clearly in the audience. Since the FCC was admittedly announcing a new enforcement standard, it only issued a warning to the station.

3. KCSB-FM, a student-operated non-commercial station in Santa Barbara, CA, broadcast a song entitled "Makin' Bacon," which included lyrics referring to sexual organs and activities in a manner which it would be hard to argue was not offensive to most people. Even though the broadcast occurred after 10:00 p.m., the FCC found, through a ratings survey, that children were in the market audience at the actual time of broadcast.

Again a warning was issued.

4. David Hildebrand, an Amateur Operator, transmitted repeated expletives over an Amateur radio repeater. He not only used the words from the Carlin monologue, but also joked explicitly about sex with young children. This conduct was found to be willful and repeated, as well as unlawful because the Amateur radio bands are widely shared, and children are encouraged to become Amateurs. Hildebrand was censured and would have been fined had not a legal technicality barred the FCC from assessing a fine in this particular case.

#### Be Careful!

The FCC's new standards are strict enough, yet vague enough, that some broadcasters will likely test their limits in future cases. But unless you are in the mood for a long, hard legal fight, it would be prudent to recognize that the FCC is not likely to back down on this issue easily, unless forced to do so by the courts. The new policy is the product of the increasingly conservative political atmosphere in Washington, as well as pressure from Congress. With this outside support, the FCC Commissioners will probably stick to their guns.

So in reviewing programming for your station, beware of indecency. Avoid repeated use of specific sexual or excretory words or phrases. Simple expletives, without descriptions of sexual or excretory conduct, will be a problem only if they are deliberate and repeated. If a broadcast goes beyond the use of expletives, then the context in which the language is used will be an important factor in evaluating it.

What's next? So far, the FCC has focused on obscenity and indecency, and has not discussed profanity, the third part of the statute. To the extent that "profanity" may be different from indecency, that difference will probably not be the subject of legal proceedings until the indecency standard is tested further in court. So unless you want to go to the front line in defense of the First Amendment (which broadcasters should do in some cases to preserve our free society), be very careful before you broadcast material which you think will be offensive to a substantial part of your audience. If you want to broadcast such material, at least precede it with a strong warning and restrict it to very late night hours when you are sure there are no children in the audience. And if you are not sure about the material, checking with a lawyer first would be good preventive medicine. **K/B**

*Peter Tannenwald is a partner in the Washington, DC law firm of Arent, Fox, Kintner, Plotkin & Kahn. He is general counsel to the Community Broadcasters Association.*



## ViPs Make Connections

Because ViPs are well<sup>®</sup>connected, they switch from stands to clamps, to cameras, to ceiling grids, to doors and walls. At your fingertips.



The ViP trio.  
For just the light touch.

# lowel<sup>®</sup>

Lowel-Light Mfg., Inc., NY, NY  
10018-1197, 212-947-0950

# Classifieds

## WANTED TO BUY

**LPTV construction permits or licenses.** If you have an LPTV license or GP for sale, we have interested buyers. Confidentiality assured. John Kompas, Kompas/Biel & Associates, Inc., (414) 462-7010.

**USED TRANSMITTERS AND ANTENNAS.** We will buy your used Bogner/Scala antennas, UHF & VHF transmitters and transmission line. Video/audio microwave transmitters and studio equipment also wanted. Call us first, before you buy new equipment, for maximum trade-in value! KIDD COMMUNICATIONS, (916) 961-6411.

## FOR SALE

**COMPLETE RF TRANSMITTING SYSTEMS,** Bogner antennas, Television Technology transmitters, Cablewave low loss transmission line. We welcome your trade-ins. Buy from the knowledgeable company that has the ability to deliver promptly! KIDD COMMUNICATIONS, (916) 961-5433.

FCC ON-LINE DATABASE  
**dataworld**<sup>®</sup>  
Allocation/Terrain Studies  
AM • FM • TV • LPTV • ITFS  
4827 Rugby Ave. Suite 200  
Bethesda, MD 20814  
(301) 652-8822 1-800-368-5754

*John H. Battison & Associates*  
CONSULTING RADIO ENGINEERS  
  
JOHN H. BATTISON P.E. 890 CLUBVIEW BOULEVARD NORTH  
COLUMBUS, OHIO 614/888-3364

**JM**  
JAMES MARTIN & ASSOCIATES  
**LPTV BROADCAST**  
ACQUISITION • DIVESTITURE  
FINANCING • APPRAISAL  
James Martin  
Suite 1000, 65 E. State St.  
Columbus, Ohio 43215  
(614) 889-9747

**CLASSIFIED RATES:** All classified ads are payable in advance. When placing an ad, indicate the exact category you desire: *Help Wanted, Situations Wanted, Services Offered, Wanted to Buy, For Sale, Miscellaneous.* The publisher reserves the right to abbreviate, alter, or reject any copy.

Classified advertising is sold at the rate of 50¢/word. There is a \$15.00 minimum charge for each ad. Count each abbreviation, initial, single figure, or group of figures or letters as one word each. Symbols such as *mm, C.O.D., P.O., etc.,* count as one word each. Telephone numbers with area codes, and ZIP codes, count as one word each.

Business Card ad rates are \$35.00 per insertion. For Classified Display rates, call John Kompas at (414) 462-7010.

## Oops!

We inadvertently omitted contact information for Texscan MSI in last month's Character Generator Review. Here it is:

### Texscan MSI

124 North Charles Lindbergh Drive  
Salt Lake City, UT 84116  
(801) 359-0077

We apologize, Texscan!

# ...at the FCC

## NEW LPTV LICENSES

The following parties received LPTV licenses on the dates shown. Station call sign and location are also given.

- W25AB Watertown, NY. Moreland Broadcast Associates, 8/17/87.
- K17AH Tonopah, NV. Nye County, 8/25/87.
- K58CS Erick, OK. Northfolk TV Translator System, 8/25/87.
- K29AD Corsicana, TX. Navarro College, 8/25/87.
- K051A Huntsville, TX. International Broadcasting Network, Inc., 8/25/87.
- W10AX Jacksonville, FL. Figgie Communications, 8/25/87.
- W59AZ Grand Rapids, MI. International Union, UAW, LPTV Project, 8/25/87.
- W05AX Cape May, NJ. Carter Broadcasting Corporation, 8/25/87.
- K36AX Hilltop, AZ. Group Seven Communications, Inc., 8/25/87.

## LPTV LICENSE RENEWALS

- K25AD Sterling, Fleming, CO. Board of Logan County Commissioners, 9/9/87.
- K43AI Farmington, NM. Regents of the University of New Mexico, 9/9/87.
- K69DG Duncan, AZ. Southern Greenlee County TV Association, Inc., 9/9/87.
- K55DM Duncan, AZ. Southern Greenlee County TV Association, Inc., 9/9/87.
- K32AL Marysvale, UT. University of Utah, 9/9/87.

## ASSIGNMENTS AND TRANSFERS

- K21AZ Telluride, CO. Voluntary assignment of permit granted from American Translator Development, Inc. to Howard D. Berkley, III on 4/3/87 (late report).
- K40AS Topeka, KS. Voluntary assignment of permit granted from Low Power Technology, Inc. to Howard D. Berkley, III on 4/3/87 (late report).
- K32AM Kansas City, MO. Voluntary assignment of permit granted from Low Power Technology, Inc. to Howard D. Berkley, III on 4/3/87 (late report).
- K45BC Mitchell, SD. Voluntary assignment of permit granted from Low Power Technology, Inc. to Howard D. Berkley, III on 4/3/87 (late report).
- W12BK South Bend, IN. Assignment of license granted from Ideal American Television, Inc. to Weigel Broadcasting Company on 8/21/87.
- K61CA Phoenix, AZ. Voluntary assignment of permit granted from Community Television Network of Phoenix, Inc. to KUSK, Inc. on 9/1/87.
- W59BI Inverness, FL. Voluntary assignment of permit granted from Impact Television Group, Inc. to Video Marketing Network, Inc. on 9/1/87.
- W28AF Columbus, IN. Voluntary assignment of permit granted from Impact Television Group, Inc. to Video Marketing Network, Inc. on 9/1/87.
- W48AM Columbus, MS. Voluntary assignment of permit granted from Impact Television Group, Inc. to Video Marketing Network, Inc. on 9/1/87.
- W44AH Milan, TX. Voluntary assignment of permit granted from Impact Television Group, Inc. to Video Marketing Network, Inc. on 9/1/87.
- W55AW Savannah, GA. Voluntary assignment of permit granted from Neighborhood TV Company, Inc. to Channel America LPTV Holdings, Inc. on 9/2/87.
- W26AB Detroit, MI. Voluntary assignment of permit granted from Neighborhood TV Company, Inc. to Channel America LPTV Holdings, Inc. on 9/2/87.
- K67CV Lincoln, NE. Voluntary assignment of permit granted from Neighborhood TV Company, Inc. to Channel America LPTV Holdings, Inc. on 9/2/87.
- W34AF Atlantic City, NJ. Voluntary assignment of permit granted from Neighborhood TV Company, Inc. to Channel America LPTV Holdings, Inc. on 9/2/87.
- W14AE Syracuse, NY. Assignment of license granted from Neighborhood TV Company, Inc. to Channel America LPTV Holdings, Inc. on 9/2/87.

K67DV Salt Lake City, UT. Voluntary assignment of permit granted from Neighborhood TV Company, Inc. to Channel America LPTV Holdings, Inc. on 9/2/87.

W55AT Huntington, WV. Assignment of license granted from Neighborhood TV Company, Inc. to Channel America LPTV Holdings, Inc. on 9/2/87.

## CHANNEL CHANGES

- K18BV May & Fort Supply, OK. Gage Translators, Inc. Channel change granted from 7 to 18 on 8/25/87.
- K22BR Gage, OK. Gage Translators, Inc. Channel change granted from 13 to 22 on 8/25/87.
- K28BT Alexandria, MN. Selective TV, Inc. Channel change granted from 42 to 28 on 9/16/87.
- W64BB Jackson, MS. Sue Este Broadcasting Corporation. Channel change granted from 56 to 64 on 9/16/87.
- W36AK Nashville, TN. Trinity Broadcasting Network, Inc. Channel change granted from 50 to 36 on 9/16/87.
- K42CC Sioux Falls, SD. Localvision. Channel change granted from 34 to 42 on 9/16/87.

## NEW LPTV CONSTRUCTION PERMITS

The following parties received LPTV construction permits on the dates shown. Station call sign and location are also given.

- K46BP Prairie City, MO. Mountain TV Network, Inc., 8/24/87.
- W39AO Traffic, VA. Thelma W. Anglin, 8/24/87.
- K25BW Galvin, WA. Artesian Minority Broadcasters, Inc., 8/24/87.
- K56DH Port Angeles, WA. Mountain TV Network, Inc., 8/24/87.
- W50AO Green Bay, WI. State of Wisconsin, Educational Communications Board, 8/24/87.
- K66CT Stevens Point, WI. Midwest Radio Television, Inc., 8/24/87.
- K65DO Sheboygan, WI. Impact Television Group, Inc., 8/24/87.
- W67BL Charleston, WV. Residential Entertainment, Inc., 8/24/87.
- K19BL Rawlins, WY. Mountain TV Network, Inc., 8/24/87.
- K27BY Green River, WY. Telecrafter Corporation, 8/24/87.
- K47CA Gillette, WY. American Lo-Power TV Network, Inc., 8/24/87.
- K14GY San Antonio, TX. Gwendolyn May, 8/24/87.
- K19BM Ingram, TX. Jack Clarke, III, 8/24/87.
- K43BQ Bay City, TX. Mountain TV Network, Inc., 8/24/87.
- K14GX Beeville, TX. Mountain TV Network, Inc., 8/24/87.
- K27BV Kerrville, TX. Eddie Robinson, 8/24/87.
- K54CG Odessa, TX. Todd & Fugit, 8/24/87.
- K11SH Nacogdoches, TX. Texan Broadcasting Co., Inc., 8/24/87.
- K02NG Alpine, TX. Jeffrey Nightbyrd, 8/24/87.
- W52AK Charleston, SC. James and Hope Smith, 8/24/87.
- K41BQ Clark, SD. Hometown TV, Inc., 8/24/87.
- K48BU Sisseton, etc., SD. Mountain TV Network, Inc., 8/24/87.
- K62CN Yankton, SD. Localvision, 8/24/87.
- W49AM Crossville, TN. Blacks Desiring Media, Inc., 8/24/87.
- K33BM Santa Rosa, etc., NM. Mountain TV Network, Inc., 8/24/87.
- K21BR Chama, NM. Mountain TV Network, Inc., 8/24/87.
- K39BQ Carson City, NV. Constance David, 8/24/87.
- K46BM Las Vegas, NV. Journal Communications, Inc., 8/24/87.
- W25AK Olean, NY. Olean Television Station, 8/24/87.
- W56BR Dayton, OH. LPTV, Inc., 8/24/87.
- W39AQ Marion, OH. Charles Hutchinson and Richard Riggs, 8/24/87.
- W12BS Lakewood, OH. Karen Klaus, 8/24/87.
- K58CI Grainola, OK. Scripps-Howard Broadcasting Company, 8/24/87.
- K69EK Oklahoma City, OK. Clear Channel Communications, Inc., 8/24/87.



K26BP Guymon, OK. Donrey, Inc., 8/24/87.  
 K54CH Klamath Falls, OR. Blacks Desiring Media, Inc., 8/24/87.  
 K33BP Klamath Falls, OR. Blacks Desiring Media, Inc., 8/24/87.  
 K53CG The Dalles, OR. Russell Communications, 8/24/87.  
 W26AG Presque Isle, ME. American Lo-Power TV Network, Inc., 8/24/87.  
 K18BQ International Falls, MN. Mountain TV Network, Inc., 8/24/87.  
 K36BN International Falls, MN. Mountain TV Network, Inc., 8/24/87.  
 K26BX International Falls, MN. Mountain TV Network, Inc., 8/24/87.  
 K56DE Bay Lake, MN. Mountain TV Network, Inc., 8/24/87.  
 K58CL Bay Lake, MN. Mountain TV Network, Inc., 8/24/87.  
 K44BR Joplin, MO. American Christian TV System, Inc., 8/24/87.  
 K26BS Poplar Bluff, MO. Telemedia, Inc., 8/24/87.  
 K31BH Poplar Bluff, MO. Telemedia, Inc., 8/24/87.  
 K46BP Prairie City, MO. Mountain TV Network, Inc., 8/24/87.  
 K48BT Osage Beach, MO. News Tribune Company, Inc., 8/24/87.  
 K34BS Baker, MT. Mountain TV Network, Inc., 8/24/87.  
 K42CA Dillon, MT. Mountain TV Network, Inc., 8/24/87.  
 K02NK Bozeman, MT. Women's LPTV Network, 8/24/87.  
 W47AI Manteo, NC. Jennifer J. Frost & Lilius J. Morrison, 8/24/87.  
 W26AH Manteo, NC. CMM, Inc., 8/24/87.  
 K45BO Junction City, KS. Mountain TV Network, Inc., 8/24/87.  
 K27BT Gove, KS. Mountain TV Network, Inc., 8/24/87.

K20BM Liberal, KS. Crossroads Communications Corporation, 8/24/87.  
 K67DX Shreveport, LA. Broadcast Data Corporation, 8/24/87.  
 K49BS Leesville, LA. Mountain TV Network, Inc., 8/24/87.  
 K13VD Jennings, LA. Jennings Broadcasting Company, Inc., 8/24/87.  
 K26BW Luana, IA. Mountain TV Network, Inc., 8/24/87.  
 K60DK Storm Lake, IA. Mountain TV Network, Inc., 8/24/87.  
 K49BQ Denison, IA. Mountain TV Network, Inc., 8/24/87.  
 W29AG West Chicago, IL. Minority Communications, Inc., 8/24/87.  
 W41AL Streator, IL. Linda D. Clevenger, 8/24/87.  
 W63AY Vandalia, IL. Pepsi-Cola Bottling Company of Alton, Inc., 8/24/87.  
 W24AG Bedford, IN. Schurz Communications, Inc., 8/24/87.  
 K48CC Jonesboro, AR. Mountain TV Network, Inc., 8/24/87.  
 K14HC Prescott, AZ. Global Village Video Resource Center, Inc., 8/24/87.  
 K39BH Prescott, AZ. Mountain TV Network, Inc., 8/24/87.  
 K42BY Lamar, CO. Mountain TV Network, Inc., 8/24/87.  
 K16BE Buena Vista, CO. Mountain TV Network, Inc., 8/24/87.  
 K58CR Limon, CO. Mountain TV Network, Inc., 8/24/87.  
 W42AM Daytona Beach, FL. ATN of Daytona Beach, 8/24/87.  
 W45AH Savannah, GA. Boxes Trees, Inc., 8/24/87.  
 W34AM Perry, FL. Kenneth B. Darby, 8/25/87.  
 K64CR San Antonio, TX. Catholic Views Broadcasts, Inc., 8/25/87.  
 K52BW Pampa, TX. Blacks Desiring Media, Inc., 8/25/87.

K20BS Big Spring, TX. Heidi A. Terrill, 8/25/87.  
 K62CO Spokane, WA. Classic Video Systems, 8/25/87.  
 W50AP Steubenville, OH. Kennebec Valley Television, 8/25/87.  
 W69BR Mayaguez, PR. Sevenoaks Company, 8/25/87.  
 W67BN Mayaguez, PR. Sevenoaks Company, 8/25/87.  
 W49AR Georgetown, SC. Impact Television Group, Inc., 8/25/87.  
 W64BA Knoxville, TN. Sur Este Broadcasting Corporation, 8/25/87.  
 W33AL Brunswick, GA. Christian Renewal Ministries, 8/25/87.  
 K16BF Teterville, KS. Mountain TV Network, Inc., 8/25/87.  
 K55EX New Orleans, LA. Sur Este Broadcasting Corporation, 8/25/87.  
 K25BX Scobey, MT. Blacks Desiring Media, Inc., 8/25/87.  
 W59BL Charleston, WV. Elizabeth E. Terrell, 8/31/87.  
 W34AL Fond du Lac, WI. Daniel F. Finnane, 8/31/87.  
 K61DY Houston, TX. Satori Broadcasting Corporation, 8/31/87.  
 K21BU Ingram, TX. Jack Clarke, III, 8/31/87.  
 K69ER Amarillo, TX. Russell Communications, 8/31/87.  
 K29BJ Beaver, OK. Mountain TV Network, Inc., 8/31/87.  
 K63DO Coos Bay, OR. Localvision, 8/31/87.  
 K29BL Klamath Falls, OR. LPTV Services, Inc., 8/31/87.  
 K63DN Reno, NV. Generic Television, 8/31/87.  
 K52CB Salina, KS. Mountain TV Network, Inc., 8/31/87.  
 K41BY Liberal, KS. Crossroads Communications Corporation, 8/31/87.  
 K64CU Bogalusa, LA. Bogalusa Daily News, Inc., 8/31/87.

*continued*

**TTC**

XL 1000U 1000 Watt  
 XL 100U 100 Watt

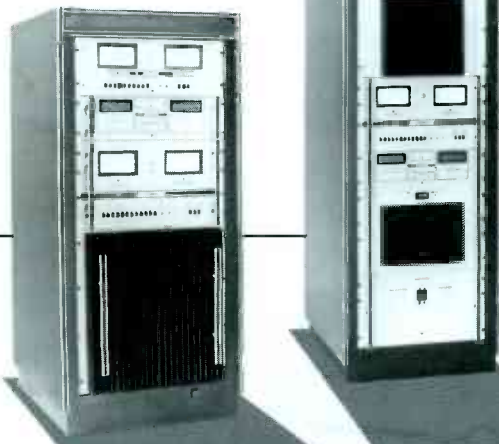

**When you go into low power television...  
 go in strong with TTC transmitters.**

**TTC offers a full line of outstanding television transmitter/translators:**

- **XL 100U**—For 100 Watt UHF TV, the XL 100U is 100% solid state designed for unattended operation in remote and hostile environments.
- **XL 1000U**—Long term reliability, performance, and advanced capabilities make the XL 1000U the best selling 1000 Watt UHF transmitter in the world. It can be used as a translator with VHF or UHF input, or as a transmitter for use with satellite, microwave or audio/video input.
- **XL 10U and XL 20U**—These "power flexible" 10 Watt and 20 Watt units are TTC's most affordable, featuring VHF, UHF, or modulator input.

- **Compact design**
- **Full VSWR protection**
- **Low power consumption**



XL 20U 20 Watt

**The quality is TTC.**  
 TELEVISION TECHNOLOGY CORPORATION

For free product literature or additional information, call or write:  
 P.O. Box 1385 • Broomfield, CO 80020 • (303) 465-4141

**MEDIA BROKERS • APPRAISERS**

**Put my over 30 years of service  
to work for you ...**

**Wanted: LPTV construction permits for  
top 50 markets. Buyers waiting.**



**BURT SHERWOOD INC**

**3125 Maple Leaf Dr. • Glenview, IL 60025 312•272•4970**

- K14HE New Orleans, LA. JLR Broadcasting, 8/31/87.
- K44BZ Springfield, MO. American Christian TV System, Inc., 8/31/87.
- W29AJ Vidalia, GA. Conner Communications, 8/31/87.
- W50AQ Athens, GA. LPTV America, 8/31/87.
- K32BU Hilo, HI. Kim Mooney, 8/31/87.
- K64CS Dubuque, IA. Black Media Associates, 8/31/87.
- K46BT Storm Lake, IA. Millard V. Oakley, 8/31/87.
- K51CD Junction City, KS. Mountain TV Network, Inc., 8/31/87.
- K47CK Jonesboro, AR. CMM, Inc., 8/31/87.
- K44CD Arroyo Grande, CA. Mountain to Valley Broadcasting, 8/31/87.
- K15CB Glenwood Springs, CO. Black Women's Network of New Jersey, Inc., 8/31/87.
- W21AJ Live Oak, FL. Jennifer J. Frost & Lilius J. Morrison, 8/31/87.
- W11BM Orlando, FL. National Black Media Coalition, 8/31/87.
- W05BF Chipley, FL. Pentacom Broadcasting Corporation, 8/31/87.
- W25AL Oakland Park, FL. Taft Television and Radio Company, Inc., 9/21/87.
- K59DG New Orleans, LA. Communicators of New Orleans, 9/21/87.
- K26CC Brookings, SD. Williams Broadcasting, 9/21/87.
- K21BV Cody, WY. Freda A. Brown, 9/21/87.

**LPTV LOTTERY WINNERS**

The following are the tentative selectees of the LPTV/translator lottery held on September 18, 1987. If no petitions to deny the selectees are filed, and if they are otherwise qualified, construction permits will be awarded.

- Ch. 50, Fort Dodge, IA. Cherokee Network.
- Ch. 56, Storm Lake, IA. Millard V. Oakley.
- Ch. 65, Topeka, KS. Quanta Communications.
- Ch. 61, Montgomery, AL. Brooks Broadcasting, Inc.
- Ch. 36, Hilo, HI. Jan Girard.
- Ch. 38, Kaim, HI. Mountain TV Network, Inc.
- Ch. 33, Hyannis, MA. Local Communications.
- Ch. 34, New Bedford, MA. Katy Communications, Inc.
- Ch. 57, Clinton, NC. Destin Community Television.
- Ch. 27, Wolf Point, MT. Matlock Communications, Inc.
- Ch. 65, Southern Pines, NC. Black Media Associates.
- Ch. 33, Union City, TN. Futures TV, Inc.
- Ch. 39, Hobbs, NM. Black Media Associates.
- Ch. 11, Myrtle Beach, SC. Pearl Television Associates.
- Ch. 22, Fairbanks, AK. Jamal TV.
- Ch. 27, Fairbanks, AK. Lawscow Broadcasting Group.
- Ch. 45, Cedar Rapids, IA. Elbyvision.
- Ch. 34, Bozeman, MT. Generic Television.

**Supplier Side**

**Pinnacle Systems, Inc.** has just introduced the Super V-1000 Desktop Video WorkStation, an effects generator designed specifically for compatibility with the new S-VHS video format. Ajay Chopra, Pinnacle's president and CEO, said that the new WorkStation "is the equivalent of the personal computer for the video production environment."

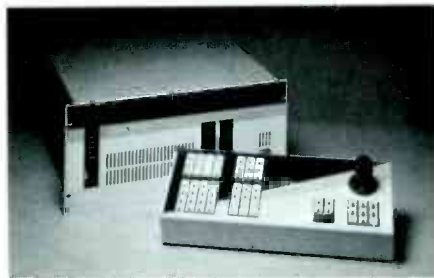

*The new S-VHS compatible Super V-1000 from Pinnacle.*

"The arrival of the S-VHS format, and its clear position in the marketplace, is timely," he added. "The 3/4" format costs considerably more, and other half-inch formats simply do not have the horsepower to allow this combination of quality and superior performance at this price level.... S-VHS is the catalyst that will create extraordinary production opportunities."

The Super V-1000 line of products is designed to "plug and play" with any equipment supporting the new S-VHS format. All Super V-1000 products support direct connections for Y/C (3.58) In and Y/C (3.58) Out, and Composite Out.

Standard features include variable smooth placements; variable cropping from any and all sides; variable size borders of any color; pushes and pulls in eight directions; wipes, in and out, in 15 directions; cuts; posterize; tint; negative; horizontal and vertical invert; and GPI In and Out. All transitions can have variable duration. Additionally, effects may be combined. For example, a cropped pic-

ture may be posterized and tinted, then pushed off diagonally.

A unique feature is a second, visible digital storage buffer called the background buffer. A user with a simple cut-only editing system can give productions an "A/B look" using a frozen image stored in the buffer along with any of the system's standard transitions.

The Super V-1000 with standard features is priced at \$13,900. It can be upgraded with an optional Enhanced Effects package, or it can be configured as a fully IBM-AT hardware and software compatible computer, thus giving access to all IBM-AT and compatible software and hardware for professional video applications.

*Contact:* Ajay Chopra  
President  
Pinnacle Systems, Inc.  
2380 Walsh Avenue  
Santa Clara, CA 95051  
(408) 970-9787

**Charisma/Visual Motion** has produced seven new theme libraries of computer-generated special effects for broadcast, cable, industrial, and advertising use. Created by Academy Award winning designers on the Caesar/System Four, the new libraries include movie titles, coming attractions, textured backgrounds, sports images, hi-tech, and music images.

The license generally runs for 18 months, although longer terms are available. Pricing is according to use and market size.

All effects run from 30 seconds to three minutes. Shot on super black, they are completely keyable.

*Contact:* Michael A. Feldman  
Charisma/Visual Motion  
32 East 57th Street, 20th Floor  
New York, NY 10022  
(212) 832-3020

For the do-it-yourselfers in your audience, especially the growing number of female home improvement enthusiasts, why not try "The Do-It-Yourself Show" from **DIY Video Corporation**. This weekly program, a record-breaking series on PBS, "aims to satisfy the public's voracious appetite for practical, usable infor-



*Les Cizek and Avian Rogers of "The Do-It-Yourself Show."*

mation on home improvement," according to DIY's president, Robert Roskind.

Unlike most other do-it-yourself programs, which merely sketch out a home-improvement project, "The Do-It-Yourself Show" gives viewers ample information to complete a job, as well as the confidence necessary to attempt projects on their own. Each week, the show's hosts tackle a new project, taking the viewer step-by-step from start to finish. Among the topics covered in the series are woodworking—building bookcases, tables, cabinets—and remodeling projects such as exterior and interior painting, carpet installation, fence building, and putting in plumbing and electrical wiring.

The hosts—Avian Rogers and Les Cizek—are seasoned home improvement experts. Rogers is a licensed cabinet-maker—and a woman. She appeals to the nearly 50% of all do-it-yourselfers who are female.

"The Do-It-Yourself Show" is available on a barter basis with 3 1/2 minutes of ad time available to the station.

Contact: Robert Roskind  
President  
DIY Video Corporation  
5250 Seventy-Seven Center Drive  
Suite 340  
Charlotte, NC 28217  
(704) 523-4001



One of the Presidential Series from American Mobile Office.

Need a transmitter building...or an office? **American Mobile Office, Inc.** may have just what you're looking for.

The economical Guardian Series compact buildings can be installed with a forklift and are suitable for either inside or outside use. The Classic Series offers strength and durability. Steel siding combined with heavy fiberglass insulation, 5/16" vinyl covered gypsum wall panels, and 5/8" plywood decking provide a sound-deadening, comfortable environment. The Fire Guard Series, for use in more hazardous areas, complies with recognized local fire codes and meets or exceeds known plant codes.

The company also offers the Presidential Series of ruggedly built office structures. Ranging in size from 8 x 20' to 12 x 60', these units feature heavy duty steel frames, gas or electric forced air heat or baseboard heating, copper wiring, double tube fluorescent lights, and a host of options such as air conditioning, shower stalls, custom paneling, and furnishings. Sales, rentals, and leases are available.

Contact: Janet Erickson  
Sales Coordinator  
American Mobile Office, Inc.  
P.O. Box 279  
Monee, IL 60449-0279  
(312) 534-4466  
or P.O. Box 323  
West Chester, OH 45069  
(513) 777-5200  
Outside IL: 1-800-323-7614

K/B

BON MOT

"...three species of liberty...are essential to the happiness of social life—religious, domestic, and civil...."

John Milton, Second Defense of the English People

## ITS CORPORATION

### The Closer You Look The Better We Look

At ITS, we've been designing and producing quality modulators and full service transmitters for years. Our products are widely known for their superior engineering, quality construction, and reasonable cost.

Our low power transmitters and translators offer many features that are either costly options or simply not available on other brands — without compromising performance, quality, or price.

Along with these superior products, we offer top-notch field support. Over 100 full service customers value this service — we think you will, too.

If you'll look closely and compare, you'll agree that ITS looks better and better.

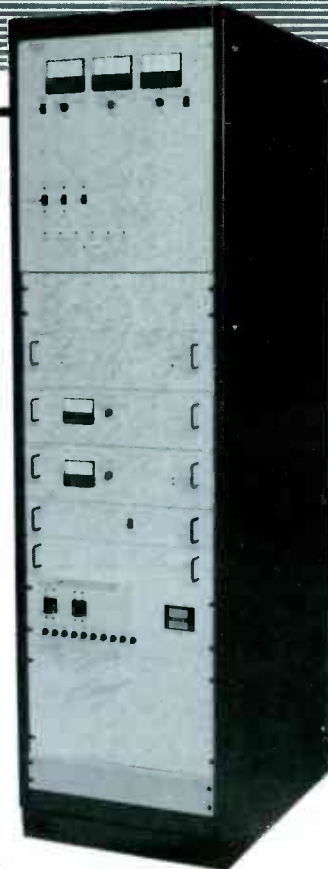

### ITS-230 1kW UHF Transmitter

**PERFORMANCE:** standard broadcast (*not cable TV*) modulator/processor is FCC type accepted under both part 74 (LPTV) and part 73 (full service).

**FEATURES:** many full service features such as IF processing, stereo aural, interactive control circuits, and extensive remote control are standard.

**QUALITY:** totally designed and manufactured by ITS.

**OPERATING COSTS:** Low power consumption and designed for easy maintenance - final amplifier uses RCA 9017 tetrode (approximate replacement cost \$1,900).

**PRICE:** very competitive.

ITS CORPORATION • 375 VALLEY BROOK ROAD • McMURRAY, PA 15317 • (412) 941-1500

# 5...4...3...2...1...

**ON THE  
AIR**

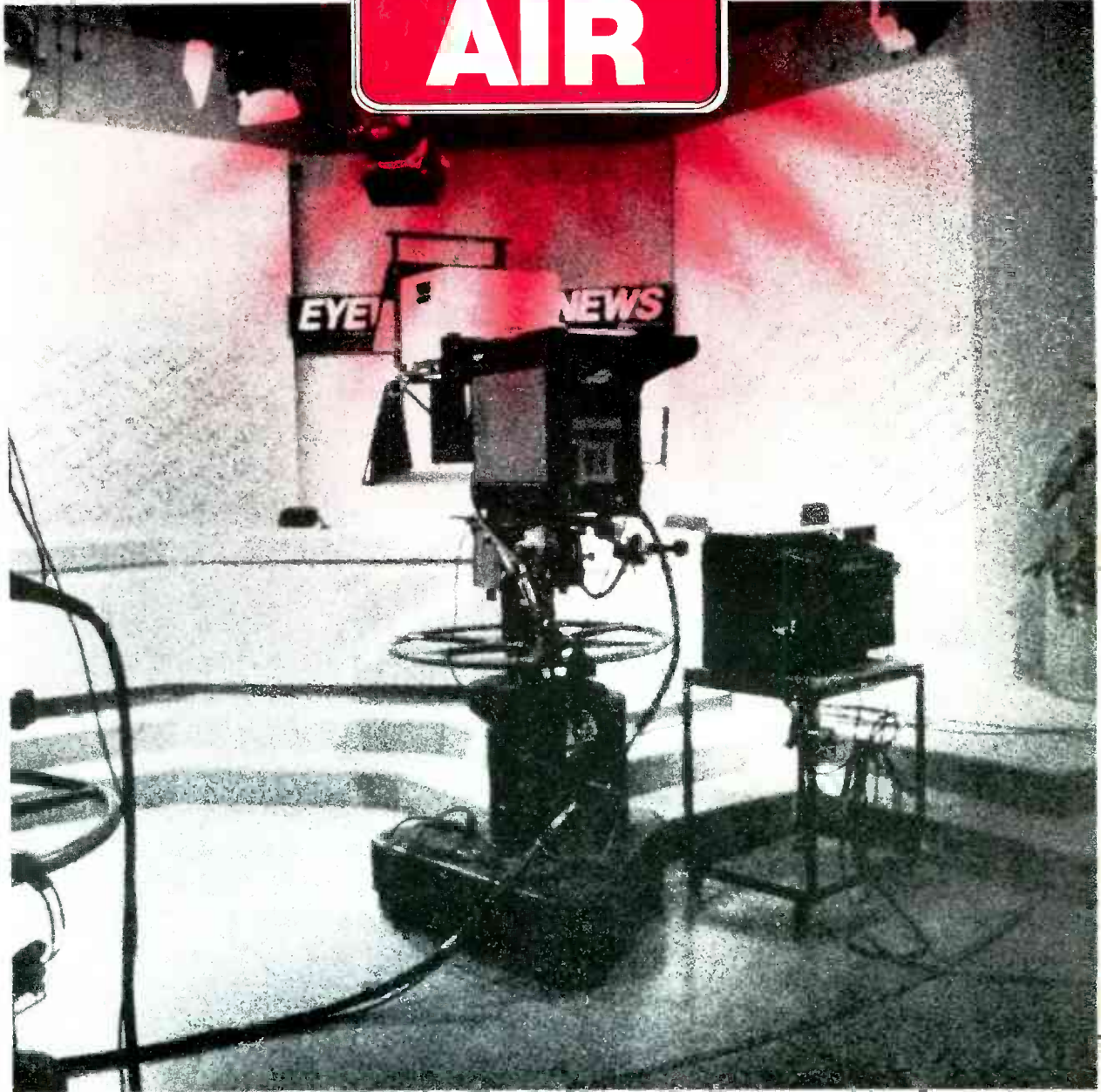

## You're on the air!

And your dream's come true.

Your LPTV station is sending out a signal, loud and clear. Every hour of planning and every piece of equipment is backing that signal, because EMCEE is backing them: site selection, satellite earth station, transmitter, transmitting antennas and line, towers, translators. . . even a complete studio package of cameras, lighting, video switcher, audio console and more.

EMCEE's 27 years of experience in low power television guarantee the best equipment, installation, service,

maintenance, training and parts.

You wouldn't entrust your dream to just anybody. EMCEE is on the air with you.

EMCEE BROADCAST PRODUCTS,  
Div. of Electronics, Missiles &  
Communications, Inc.  
White Haven, Pa. 18661  
FAX (717) 443-9257  
Call Toll-free: 1-800-233-6193  
(In PA: 717-443-9575)  
TWX: 510-655-7088  
Ans: EMCEE WHHV

**EMCEE**

*advanced technology  
systems excellence*