

Radio Guide

www.radio-guide.com

Digital Issue Now On-Line

May-June 2020 – Vol. 28, No. 3

From Rock Studios to Radio – Audio Pioneer Jim Wood Explains



Inovonics' Evolution of Audio Processors for Radio

*****AUTO**ALL FOR ADC 913
 K.M. RICHARDS
 820 P3
 K.M. RICHARDS PROGRAMMING SVC.
 PO BOX 7427
 VAN NUYS CA 91409-7427
 1 408

PRSRAT STD
 U.S. POSTAGE
 PAID
 PERMIT NO. 410
 BEAVER DAM WI

AARON 650
 FM REBROADCAST RECEIVER

For Challenging Reception Scenarios.

New! Best Protection For Less Cost.



P.O. Box 69456
Odessa, TX 79769
432-943-2588
www.jammin947.com

The new *Series 200* is rated at
200,000 surge-amps per phase.

Hi Hank,

About a year ago I installed a Power Clamp TVSS surge suppressor unit at our AM transmitter site. We were upgrading from 5kW to 12kW and I wanted to protect the new transmitter from "dirty power". We're located in the middle of an oil field about 8 miles out of town, and I replace about 30 MOSFETs each year in our 5kW solid state transmitter.

After reading a testimonial from someone who experienced similar problems, I made sure that a Power Clamp was included in the budget. Now, with 13 months since PowerClamp's installation, I have not had to replace one. The box of MOSFETs is collecting dust.

We recently bought an unbuilt FM station and guess what I ordered for that transmitter site?

PowerClamp has kept us on the air and reduced our maintenance costs.

Thanks for an effective solution!

Bob Souza,

Managing Partner

KCKM 1330 - 12,000 Watts
Monahans, TX 79756



**Stay On The Air
with PowerClamp
Surge Protection!**

Prevent transmitter failure!

The new PowerClamp *Series 200* surge suppressors reduce AC spikes and surges that damage transmitters. They clamp many transients to within a few volts of the AC waveform, preventing shutdown, tripped breakers, and blown power supplies.

PowerClamp *Series 200* features automatic *Sine Wave Tracking*, on-board LED fuse status LEDs, and a Remote Status option. The superb protection of our original Series 10 TVSS, but for 25% less cost.

For details, contact any Henry Engineering / PowerClamp dealer
or visit www.henryeng.com/powerclamp/

Tel: 562-493-3589

World Radio History



Accuracy, Peace of Mind and Reliability

These are at Least Three Reasons Why the DPS-100D Series Power Meter has Become the Choice of Broadcasters Worldwide



No other power meter on the market meets the stringent and changing requirements like BDI's DPS-100D Series True RMS Power Meters. FM broadcasters, television broadcasters and now AM all digital broadcasters can take advantage of the DPS-100D Series feature set including 40 dB dynamic range, measurement of analog FM and IBOC simultaneously, measurement of multiple carriers simultaneously for master antenna applications and much more. With BDI's exclusive 3-Strike™ VSWR protection algorithm your system is protected from damage. The DPS-100D interfaces directly to our SWP-200 series motorized switch controllers, SWP-300 remote controls and our SWP-206 master antenna monitor system. Email alerts, SNMP IP interface and a host of other features make the DPS-100D series unmatched in flexibility and ease of use.

bdi ... Serving the Broadcast Industry for 35 years

Tel. (914) 737-5032 www.broadcast-devices.com

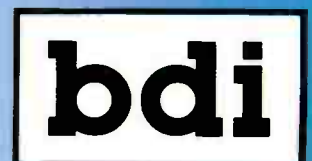

Radio Guide

Contents

May-June 2020

Cover Story	6
<i>From Rock Studios to Radio – by Audio Pioneer Jim Wood</i>	
Studio Site	8
<i>Virtual Virtuosity</i>	
Chief Engineer	10
<i>We've Come A Long Way, Baby!</i>	
FCC Focus	12
<i>Unwired Networks and Political Advertising</i>	
Links and Lines	14
<i>Vacuuming Line or Purging?</i>	
Power Principles	16
<i>Upgrading Your Generator</i>	
Tool Guide	18
<i>Supporting Good Cable Management – and Much More</i>	
Tower Topics	20
<i>To Cell or Not to Cell</i>	
IT Guide	22
<i>The Linux Connection & A Summer Storm</i>	
Station Stories	26
<i>Mystery of Radio</i>	
Engineering Perspective	30
<i>Find or Create?</i>	

Shop Talk	34
<i>Misc. Tech-Tips and Thoughts</i>	
Small Market Guide	38
<i>The Ides of March Brings the Virus to Small Marketville</i>	
Practical Tech	40
<i>Printed Circuit Boards from ExpressPCB</i>	
Tips From the Field	42
<i>Don't Drag 'Em ... Roll 'Em</i>	
Service Guide	44 & 45
<i>Radio Equipment, Products, and Services</i>	
Broadcast Reflections	46
<i>Looking Back</i>	
Final Stage	47
<i>Convention, and Event Register and Advertiser Information</i>	

Radio Guide

Volume 28 – Issue 3

Radio Guide Website: www.radio-guide.com
 Classified Ads: www.radio-classifieds.com

PO Box 20975, Sedona, AZ 86341

Phone: 928-284-3700 • Fax: 866-728-5764

Ray Topp (publisher & editor) – radio@rconnect.com

Radio Guide, ISSN 1061-7027, is published bi-monthly, six times a year, by Media Magazines Inc., PO Box 20975, Sedona, AZ 86341. Radio Guide is copyright 2020, Media Magazines Inc., and may not be copied, reproduced, or stored in any format, without the written permission of the publisher.

In This Issue

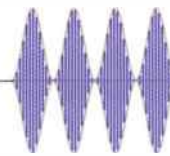

Critical Content for Radio

Cover Story – by Jim Wood (page 6)

From Rock Studios to Radio: "But the music business was somewhat flakey in the early '70s. Broadcasting, on the other hand, operated under some degree of government oversight and enjoyed a more professional reputation. After receiving a fair number of bad checks, Inovonics shifted its marketing thrust from studio recording to the audio needs of broadcasters."

Chief Engineer – by Scott Schmeling (page 10)

We've Come a Long Way Baby: "The station's equipment appeared to be a basic Gates (later Harris, now Gates-Air) package – we had a Gates Gatesway console, two Gates 12-inch turntables. The station was built before cart machines were in common use, so the commercials were played from 3-inch tape reels on a pair of Magnecord PT-6 reel-to-reel tape machines. You can imagine our excitement when the first cart machine arrived. It was a Gates Cartritape II cart machine (only one for the time being)."

FCC Focus – by Gregg Skall (page 12)

Unwired Networks and Political Broadcasting: "A network supplying political advertising messages without prior approval impinges on a licensee's ability to maintain control over its station. FCC rules require that the licensee maintain full authority over station policies, programming and operation of the station. This includes, without limitation, the right to decide whether to accept or reject any programming or advertisements and to preempt any program. Therefore, except for candidate ads, the licensee must have the opportunity to make decisions that have the potential for controversy, including political issue advertisements, allowing it to be aired."



Available in stock from
 Broadcast Depot, Call: 800-313-7592
www.devabroadcast.com



Price: \$3200



Price: \$2350



Price: \$1950



Price: \$2100

Modulation Monitors • Rebroadcast Receivers • RBDS Encoders • Broadcast Tools

9 THINGS

YOU DIDN'T KNOW ABOUT **GV**

- ✓ Cool operation for long life & reliability
- ✓ Field-serviceable RF power modules
- ✓ More power FETS for more power headroom
- ✓ Full cabinet design for easy service
- ✓ Positive pressure airflow for better heat transfer
- ✓ Cold start to full power in seconds
- ✓ ON-Air fan replacement
- ✓ Outstanding reliability based on 1,800+ installs
- ✓ HD Spectrum/Efficiency Optimizer for pristine signal quality & high efficiency



PLUS

FOR A LIMITED TIME
100 month Warranty and **FREE** 2nd back-up Exciter*
Call your Nautel Rep today – **877-628-8350**

Worry-Free
Transmission



Because
Radio
Matters

* • Orders must be placed by July 31, 2020
• Offer cannot be combined with other promotions
• Canada & USA only
• Other restrictions apply

nautel

World Radio History

From Rock Studios to Radio Audio Pioneer Jim Wood Explains

by Jim Wood – Founder of Inovonics

Audio cassettes were just beginning to challenge vinyl records and Top-40 radio was switching from AM to FM when Inovonics got its start in 1972. In the beginning we were not a broadcast-oriented manufacturer. The founding partners came from a background in audio recording with close ties to the music business, record companies and recording studios.

But the music business was somewhat flakey in the early '70s. Broadcasting, on the other hand, operated under some degree of government oversight and enjoyed a more professional reputation. After receiving a fair number of bad checks, Inovonics shifted its marketing thrust from studio recording to the audio needs of broadcasters.

Although the company's initial products were related to analog tape recording, which continued as a bread-and-butter product area for many years, the commencement of the Loudness Wars in radio sparked interest in developing simple, yet effective, dynamics processors ... compressors and limiters, as they were generically called back then.

Not too surprisingly, given the founders' background, the company's first processing product, the Model 201 Average and Peak Responding Limiter, was more at home in a recording studio environment. It did develop a cult following of sorts, and many are still in use. They can occasionally be found on eBay at the highly inflated prices typical of vintage studio outboard gear.

Broadcasters in the mid-1970s were eager for more aggressive audio processing. The Inovonics 201 was demoted by a leading Los Angeles group station, which, thankfully, gave Inovonics its initial, eye-opening lesson in what airchain audio processing was all about. This spurred development of a true broadcast processor, the 220 Audio Level Optimizer. The 220 could provide asymmetrical limiting for AM, and also featured an independent plug-in card to lend the independent high frequency limiting function essential to FM.

At about this same time, processing trendsetter Mike Dorrrough was gaining a reputation with his 3-band Discriminate Audio Processor, the "DAP." His unit ushered-in the concept of multiband processing for broadcast – dividing the audio spectrum into frequency-discriminate bands with attack and release timing optimized within each. The DAP concept was introduced to Inovonics by a fellow who sold the Dorrrough DAP, but was frustrated by delayed deliveries of the popular product. "Can you build one of those?" he asked. "Sure we can," was our reply.

Whoops!

Although not quite a disaster, Inovonics' first Multiband Audio Processor, or "MAP," proved a lesson in how *not* to approach a challenge. It was a very quick, seat-of-the-pants

design that, frankly, sounded horrible. "We sound like a shortwave station," one user said.

With that lesson under our belt and egg on our face, the MAP was superseded in short order by the MAP-II, a more thoughtful design that enjoyed certain popularity for several years. It used much the same packaging as its predecessor, but differed enough to not be confused with its older, evil sibling. Although intended as a monaural processor for AM, two units could be, and frequently were, interconnected for stereo by FM stations that strove to emulate that "big AM sound."

By the early 1980s, Bob Orban's Optimod 8100 was quickly becoming the de-facto standard for FM airchain processing. Not unlike our previous experience with Mike Dorrrough's DAP popularity, we were encouraged by our distributors to develop something equivalent to the Optimod. The Inovonics 250, a stereo 5-band processor, grew from this prompting, although we chose not to include the FM stereo generator. A mistake, as Bob's integrating the stereo-gen with his processing was the key to the Optimod's success.

Our reasoning in making a standalone stereo multiband processor was an attempt to be all things to all people. At this point stereo-AM was being pursued as a means for AM broadcasters to rein-in the exodus of music programming to the FM band. Several stereo-AM technologies were proposed, but in the end Motorola's C-QUAM technology prevailed in the marketplace. The Inovonics 250 had plug-in limiter card sets; a pair for FM and a sum-and-difference processing pair for stereo-AM. Sadly, stereo-AM fizzled fairly quickly, with few adopters and little impetus for receiver manufacturers to get behind the technology.

Nevertheless, as an FM processing also-ran, the Inovonics 250 performed quite well, with a high level of popularity among European broadcasters. In 1980s Europe, ultimate loudness took a back seat to preserving the artistic intent of music broadcasts. The "nice-sounding" 250 had processing setups that could be run by a scheduler and could even be computer-controlled ... in 1984! (We used a Commodore 64 for this at the NAB show.) The 250 remained in our catalog until we embraced digital technology in the early 2000s.



DAVID IV 719N

The Inovonics DAVIDs

Broadcasters recognized the benefit of incorporating the stereo generator with audio processing, and the "one box solution" quickly dominated the market. Inovonics responded with a modestly priced product that competed surprisingly well with the more expensive alternatives. We called it the "DAVID," as in David vs. Goliath. Three generations of DAVIDs progressed over a period of about 15 years. The appeal of the DAVID had to do with its comparatively low cost and the ease with which it could be installed and set up by nearly anyone at the station. There were few front-panel knobs, and factory limits on control ranges made it difficult to get a really bad sound regardless of how aggressively the DAVID was adjusted.

Entering the Digital Age

Inovonics was not at the forefront of digital audio processing, but writing on the wall ultimately compelled us to move in that direction.

Our first foray into the realm of ones and zeroes took us out-of-house for product design. Many companies experience ongoing successes with contract-design firms, but our experiences with the development of the Omega_FM processor were mixed.

It's especially important to have a product concept firmly in mind before that product is finalized. In the case of the Omega_FM, Inovonics accepted an existing processor design, lock, stock and barrel. It was a novel concept, running a proprietary operating system on an industrial-grade "embedded" single-board computer. While Inovonics' analog designs consistently used common and readily available component parts, with the Omega_FM we were now at the mercy of the fast-moving computer industry and rapid obsolescence of component parts.

Although our Omega_FM was a comprehensive and versatile processor/stereo-gen capable of phenomenal performance, the plethora of controls over processing parameters relegated its setup to station engineering staff who knew their stuff. This was not a product for PDs and owners. We promised ourselves that all future Inovonics products would be thoughtfully conceptualized, designed and built – in-house.

Getting a Grip on DSP

Our first at-home experiments with Digital Signal Processing met with surprising success. We hired a bright, recent-graduate double-E codewriter "on spec." The new guy didn't know broadcasting well, and the rest of us were newcomers to DSP and its language. But by conversing in analogies and oversimplifications, an elementary AGC/Compressor/Limiter came together in literally a matter of hours.

The design was refined over time and became our Model 261, replacing a similar analog "utility processor," the 260. A few weeks later we added independent high frequency limiting to extend the processor's applicability to FM broadcasting. It actually sounded quite good for a first effort and drove us to learn, know and use DSP for nearly everything afterward.

Where We Are Today

On the heels of the seminal Inovonics 261, we undertook development of a bigger and better FM airchain processor. HD Radio was becoming firmly entrenched at the onset of the project, so the new product became a dual-path FM and FM/HD box, complete with the necessary diversity delay that the HD Radio system defines. We brought the new box into the DAVID fold, naming it DAVID-IV. In the concept phase we relied heavily on friends in the broadcast industry, as well as people in the music field and a panel of critical listeners. This one we were going to do the right way from the start.

The DAVID-IV was launched in 2011. With several firmware updates, it remains our flagship processor to this day. An upcoming hardware/firmware upgrade will bring it full Webpage-driven networking access.

As a supplement to the DAVID-IV, a series of cost-effective, all-digital half-rack NOVIA processors has recently been added to the line. These are compact, full-function units with Web-enabled control and remote listening capability. These come in specific versions for FM (with integral RDS), AM and production studio applications.

Audio processing is only one facet of the Inovonics product line. Modulation monitors, off-air rebroadcast receivers, SiteStreamers™ and RDS encoders round out the catalog, with a sprinkling of incidental Toolbox accessories that are categories unto themselves. A diversity of products allows us to be of greater service to the industry. And with audio processing, as with most of our other products, our goal has always been to embrace simplicity in design, consistent with achieving the desired result. – Radio Guide

Work from Home

We can help your on air talent broadcast remotely...

We have the solutions to keep you on-air.

Bridge-IT

Via



Our remote broadcast solution that makes it simpler to go live than ever before



Our cost effective Bridge-IT Pro and Bridge-IT XTRA

Visit www.tieline.com/solutions/

Report-IT



Our Smartphone Solution

Tieline 
The Codec Company

317-845-8000 | sales@tieline.com | tieline.com

Studio Site

Virtual Virtuosity

From staff meetings to interviews, you can do more with less.

by George Zahn

I know that doing more with less has been the bane of many a radio professional. As staff are cut, some are not replaced and the work falls on the remaining team. That's not the point of this discussion. I'm talking about doing more with less *contact* and the fact that it could become a new broadcast norm.

That's also not to say "the new normal." Most of us won't feel right until we get back to as much of the old normal as possible, but I have to admit that weeks of audio emanating from homes is "dumbing" down what's acceptable as far as audio voice quality.

In Cincinnati alone, numerous TV weather and sports reporters are simply filing from home offices or dens, or doing stand ups right near their homes to get an outdoor image. TV interviews and specials, even on the network, are done through video conferencing and what was once the domain of good studio quality sound, or at least natural background sound in the field, has been replaced with boxy sounding rooms that were never made to be broadcast friendly.

Getting the Picture

Coming through communications academia as a student and later a university teacher, I always lamented the fact that audio was the stepchild to video on TV. All you have to do is listen for the local TV audio, many times in news and remotes, with distorted audio that is far too common in some markets. The motto seems to be: Get the picture on the air, and the audio quality is secondary at best.

Well, we're radio where audio rules, and it pains me to think that during prolonged times in which we cannot have personal contact, press conferences, post game interviews, or regular interviews that we have counted on, we may have to settle for video conferencing as a fallback, or eventually a mainstay. Can our ears get used to it? I wouldn't say for basic announcers or show hosts it would be acceptable, but for guests and sidekicks, we may have to make it work. Will our ears get trained to "ignore" non-studio quality? Time will tell.

As Covid-19 and social distancing are affecting different communities and states in different ways, we should be looking at video conferencing as an option for everything from staff meetings to interviews, and more. Our studios happen to be in the same building with a retirement community, so we're not getting a lot of extra guests in anytime soon. Hopefully your station is in a less precarious situation.

Have staff working from home? See some past columns on using old laptops as digital work stations, and you can even have home-bound or isolated talent still cut good stuff and send it in via e-mail, hightail, or cloud drive as a high quality mp3. That's a good alternative to videoconferencing for basic production, but not for interaction and interviews.

This is where video conferencing is coming to the fore, as we remain to a lesser or greater degree isolated. So for many of us, we have to decide between the evils of phone quality or the villainy of computer microphones and acoustically imperfect rooms. Some would argue a good land line for a phone interview may be best as it does not have some of the extra digital latency that is more common on cell phones and over Internet conferencing.

"Record" Keeping

One attractive aspect of video conferencing options is that many offer recording of an on-line meeting. In the case of the video conference I use, immediately after the meeting is closed, the software converts the meeting into an mp4 video file and a separate m4a audio file, which I can convert easily and edit in Adobe Audition. If the content is long-form and vital, I may even choose to tighten digital pauses or even equalize the audio for use on air.

I started just experimenting with video conferencing by creating a weekly listener off-air interface with no intention to broadcast the content, but I could just as easily connect with an interviewee for news content or an extended interview. I have been playing with Zoom.us which has been fairly intuitive and user friendly. The free version allows one host (the interviewer) and multiple participants (you may only need one for a standard interview or more as I'll explain later), and the sessions are capped on the free version at 40 minutes.

Our station has invested in a one-month upgrade in order to do a virtual Consumer Forum that we do with a live audience annually. Once each year, dignitaries such as reps from the Ohio Attorney General's Office, the FBI, and many other agencies join us live with an auditorium audience. That cannot happen this year due to travel and group size restrictions. This normally results in a ninety-minute broadcast.

A "Mute" Point

For a small, one-month investment (about \$15), I have upgraded from the 40 minutes limit to virtually unlimited time to record the panel that will number nine participants this year. The event is due to record a few days after this article's deadline, and it will be my first extended experience with doing video conferencing for later edit and broadcast. Trying to get all nine panelists at once by phone would be a nightmare, and the fact that many video conferencing options allow each participant to mute until they have to speak is a great feature, given the latency involved when using multiple computers, each potentially connecting at different rates and qualities. In Zoom, you can mute your microphone, and simply press the space bar on the keyboard as a "Push to Talk" button.

There are so many options when it comes to video conferencing. Among them are Cisco Webex, Blue Jeans Meetings, Zoom, Google Meet, Intermedia AnyMeeting, Microsoft Teams, Join Me, Ring Central, ClickMeeting, Zoho Meeting and Go To Meeting, to name a few. Each offers a wide array of pluses and minuses and will vary in fit by whether you're doing a 5 minute news interview, extended one-on-one discussion, a forum or panel talk, or a board or staff meeting.

One colleague said recently, "Until Covid, I had never heard of video conferencing. Now I don't know how I'd survive without it." There is apparently no single best option for every broadcaster. I'd suggest checking a few and looking at free versus paid versions of each, then pick one and dive in. Start with something non-critical at first and build your skills.

There are plenty of "bells and whistles" that you may or may not find important in the different options.

As a broadcaster, ease of use and familiarity was important to me over security. Given that the people you want to connect with need to use an interface, you want to make sure it's not too complex. Despite reports of Zoom Bombing (people hacking in and joining Zoom chats), I figured that what I was doing was not going directly on the air, therefore I could control the end product. By the way, Zoom has just acquired a company they claim will help them with security issues moving forward.

This is not meant to be an endorsement of Zoom. The companies listed above will have different features and price ranges that may be more attractive. Some of the features you may need to consider are how many "hosts" and "participants" are allowed under whatever price tier you choose (free choices will always have more limited options), ability to record the session (vital for later audio broadcast or even as video stream on-line if you wish), ability to share a screen from a computer or create an all-participant community whiteboard (usually more useful for meetings).

You may also have options that allow for strictly phone audio interface or even Voice over Internet Protocol (VoIP). The key is getting dependable audio, and while it will not be perfect studio quality, it may be passable enough if the only other option is to not get the interview, or to do it by phone.

Get (It) Together

If you're looking beyond the use for interviews, video conferencing can be used for listener interaction, local and regional staff meetings and more. The above mentioned whiteboards and screen shares come in more handy on sales presentations and staff meetings, and some services may charge more for advanced options. We are looking into adding a trivia question or two to our weekly listener video chats, and there are some inexpensive paid services that allow for more glitzy presentation, although many create graphics in software such as PowerPoint and share their screen during the video conference.

One tip that really helps if you're doing a listener chat: It's vital to have a meeting leader to keep things moving, fill dead spaces when no one might be talking, and ring lead to make sure no one is monopolizing the conversation and to prompt quieter participants who may be nudged out by more talkative folks. It's important as a meeting leader to listen and be ready to react and steer the conversation at the moments it needs to be better directed.

I was a bit concerned as our regular community chat leader and also as the manager of my station that I'd get people just coming on complaining about mundane programming issues or changes. I can say a month into this experiment that I haven't had one participant in that category. It's been a novel (bad choice of words) opportunity to promote upcoming shows, ask opinions, and break down the wall that might stand between listener and broadcaster.

As we fight to flatten the Covid curve, consider the rising curve of who's using video conferencing. One company told me in mid-May, "Pre-Covid, we had 10 million participants in a week. Now we're at 300 million." If you're using video conferencing, let me know your tips and success stories, and I may be able to share ideas in future columns.

George Zahn is a Peabody Award winning radio producer and Station Manager for WMKV-FM at Maple Knoll Communities in Springdale, Ohio. He is a regular contributor to Radio Guide and welcomes your feedback. Share your stories with others by sending ideas and comments to: gzahn@mkcommunities.org

**“This is the
dawning of
the Age of
Asparagus.”**



**Make misheard lyrics a thing of the past.
Process with Omnia.**



Chief Engineer

We've Come a Long Way Baby!

by Scott Schmeling

We are nearly half-way through 2020. I think I can safely say we've never experienced anything like this before. I originally wrote this for the January/February issue of *Radio Guide*. Then the Novel Coronavirus Pandemic came to our shores. Hopefully the pandemic's curve will be leveling soon as businesses reopen and we all work to find the *new normal*.

In this issue, I'd like to take a look back a few decades. Show of hands ... how many of you readers know what I'm paraphrasing in the title, "*We've Come A Long Way Baby?*" (No Googling!). In the summer of 1968, Virginia Slims cigarettes were introduced. They were narrower and longer than standard cigarettes and they were marketed to women with the pitch line, "You've come a long way, baby!" If you remember that, this will probably be a trip down memory lane. We're going to look at changes in the industry – how things have evolved, and maybe a glimpse into the future.

The "radio bug" bit me early in life. I was in 9th grade (1964) when I got my first job in radio as an announcer. Between you and me, I had been "hanging around" the station and got kicked out so many times that they finally decided to give me a job. (That's the short version of the story.)

The station was KSDR, a Daytime AM in Watertown, South Dakota. – a Daytime AM station signed on at sunrise and signed off at sunset. At the time, this station did not have Presunrise Authority, which would have allowed signing on at lower power prior to sunrise. That meant, for instance, in December (radio's biggest month for ad sales thanks to Christmas) the station signed on at 7:15 a.m. and off at 4:45 p.m., as I recall.

My first job was as an announcer (a DJ, as it were). Back then, you needed a license to turn the transmitter on or off and take meter readings. We also were required to take transmitter

meter readings every *half hour*. My first FCC permit was the Restricted Radiotelephone Operator Permit. As I recall, I filled out the form, mailed it in, and watched the mailbox. It wasn't good for much, but I was



A (young) Scott at KSDR

proud as could be of it. Later I studied, took the test, and received my Third Class Radiotelephone Operator Permit – with Broadcast Endorsement. *That* was what I needed to work at a radio station. Yes – you needed a license back then.

A few years later, the new owners of KSDR recognized my technical aptitude and my desire to become the station's Chief Engineer. After graduating from high school in 1968, I attended a special school in Minneapolis to get my First Class Radiotelephone Operator Permit. At the time, that was required to work on broadcast transmitters. And every station was *required*

to have a "First Class Operator" on staff as Chief Engineer. Quite honestly, this school taught the *test*, so there were some gaps in my technical knowledge. Hopefully I've filled in at least part of that knowledge gap with on-the-job training.

The station's equipment appeared to be a basic Gates (later Harris, now Gates-Air) package – we had a Gates Gatesway console, two Gates 12-inch turntables. The station was built before cart machines were in common use, so the commercials were played from 3-inch tape reels on a pair of Magnecord PT-6 reel-to-reel tape machines. You can imagine our excitement when the first cart machine arrived. It was a Gates Carritape II cart machine (only one for the time being).



Gates Gatesway Console

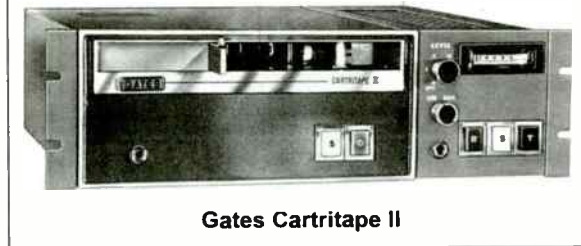

Gates Carritape II

The transmitter was also built by Gates. It was a BC-1T, 1000 watt AM transmitter. I remember how the warm glow of those four 833A vacuum tubes would light up the transmitter room. The transmitter even had a built-in dummy load, and when the dummy load was switched in, there was a red light bulb that would flash as a reminder you were on the dummy – not the antenna. I never forgot to put the transmitter back on the antenna. I *did*, however, forget to put the switch back in REMOTE once (and *only* once)!

Some of the previous paragraphs have included some terms that may be foreign to some of our younger readers. If you walk through most radio stations today you will most likely *not* find a turntable, any reel-to-reel equipment, or any cart machines. All used to be standard equipment in every radio station.

But standards have changed. Commercial delivery has also changed over the years. The standard switched from reel-to-reel tapes to endless loop tape cartridges (carts), which remained the standard for decades.

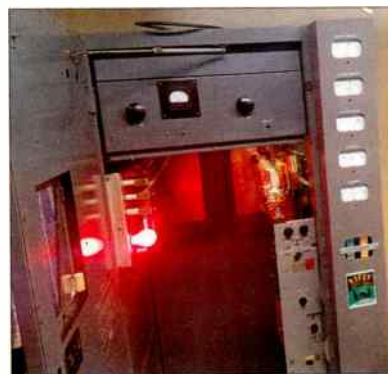

Gates BC-1T 1000 W AM Transmitter

Likewise, the way we play music has also evolved. Turntables and vinyl records used to be the standard. Later it was not uncommon for stations to transfer their music from vinyl records to carts. In the mid 80's vinyl was being replaced by CD's. Many stations jumped on this new technology by adding CD players to their equipment (but kept the turntables). Cart machines, of course, were also retained.

Turntables, tape and cart machines required a fair amount of maintenance attention. I used to carry a service kit with me that included test tapes for both cart and reel machines, long wooden-handled cotton swabs, head demagnetizer and various other alignment tools. A fairly major chunk of my time was spent maintaining tape machines. Whether it was simply cleaning the heads and pinch rollers and lubricating the mechanisms or adjusting equalization I had to carry what I would need.

Turntable maintenance was usually limited to replacing the stylus, possibly adjusting the tone arm (remember "cue-burn?"), and in some cases replacing tubes in a pre-amp.

But the big evolution (maybe even *revolution*) came in the second half of the 1980's when computers expanded their presence at the radio station from traffic and possibly word processing to audio recording and playback. With the "infiltration" of computers for audio play-out in the control room, gone are cart machines, reel machines, and turntables. The computer (with a high-quality sound card) replaced them all.

Syndicated programs used to be shipped to radio stations on either vinyl discs or reel-to-reel tapes. How many of you remember waiting for the American Top 40 discs to arrive? Later, more and more programs would be delivered by satellite. Now it's a combination of satellite and download.

Our job as Engineers has certainly changed over the decades. Generally speaking, we no longer have turntables, or cart or reel machines to maintain. But that doesn't mean we have spare time (whatever that is) on our hands!

It seems every day there are more computers in the system. And they're doing more and more. Downloading programs (or having them "pushed" to you) from the Internet is taking the place of some satellite feeds.

As the computer network grows, so does the need to manage that network. In addition, there is more need for remote access to the system – whether it be for Programming (running a remote from somewhere or broadcasting from home during the pandemic) or for Engineering – troubleshooting a problem or confirming things are running the way they should.

With the growth of your computer network, security becomes a major concern. With more and more computers on your network with exposure to the outside world, come more and more potential security issues.

As I stated in the beginning, I've been working in radio since 1964, and Engineering since 1968. I've only scratched the surface on the changes (evolution) I've seen over those 50-plus years (Holy Moley ... that means I've been doing this for *half a century!*) Until recently, I've been a "one man shop." The company has been growing and we recently hired another engineer. Keith has been working on enhancing our network and security as well as some other projects. Hopefully, he can teach this old dog some new tricks!

I hope you are staying safe and healthy, everyone. Take care of yourselves ... and until next time – Keep it between 90 and 105!

Scott Schmeling is the Chief Engineer for Minnesota Valley Broadcasting. He can be reached via email at scottschmeling@radiomankato.com



Broadcasters General Store

Family Owned & Operated Since 1979

352-622-7700

www.BGS.cc



Brand Your Station



RDS MESSAGING

RDS ENCODING, DECODING, RECEIVERS, & SIGN DRIVERS

- Advanced Dynamic RDS Encoding
- Supports automated playout systems
- Monitor & log your FM/RDS broadcast
- Decode & display RDS data
- RDS Receiver & Sign Driver
- Remote scheduler

EASY as SNMP!



Interface to SNMP Remote Controls with a Single CAT 5 Connection

SWP-200 Series RF Switch Controllers and SWP-300 Site Controllers with Direct Interface to all RF Switches on the Market and BDI's DPS-100D Series RF Power Meters

ALL NOW WITH SNMP CAPABILITY!



The DPS-100D Series RF Power Meters and Companion RMD-100

Rock Mount Remote Meter Display

Tel. (914) 737-5032

sales@broadcast-devices.com

www.broadcast-devices.com



Guest Interviews Don't have to be Complicated.

Quality Interviews, Simple Setup.



COMREX

PODCAST PROTM BY ACCU-LITE[®]



Broadcast quality for a podcaster's budget!

* Includes: mic boom, c-clamp, cable with male & female XLR connectors. Microphone not included.

PN: ALMBP1

www.accu-lite.com
www.ocwhite.com



Unwired Networks and Political Broadcasting

by Gregg P. Skall – Womble Bond Dickinson (US) LLP

Question 1: Do you run programming from any national or statewide unwired network?

Question 2: Does your network run political advertising?

If you answered *yes*, you have work to do!

Did you know that your station is subject to the very same FCC political rules that would apply as if you sold the advertising yourself. Special issues arise when a station runs network fed political advertising from legally qualified candidates or third party political advertisers and push the ads to local affiliates.

That means that:

- You *must* have the same documentation for your on-line public file; it must be provided by the network.
- That documentation *must* be posted in your political file immediately.
- You *must* be able to review issue/PAC advertising messaging in advance of airing.
- You have the *right* to refuse to air issue/PAC advertising,
- If you are unable to receive the appropriate information from the network in a timely fashion and you air the messages, you could be subject to *fines and other penalties*.

Here Are the Specific Details:

The 2020 election year is shaping up like no other any person alive can remember. SmithGeiger recently reported that, since the start of the COVID-19 pandemic, live TV, local and national news is up around 40 percent and some state broadcaster associations confirm that increased political advertising is coming through regional unwired networks to local stations.

– Importance of Licensee Prior Approval:

A network supplying political advertising messages without prior approval impinges on a licensee's ability to maintain control over its station. FCC rules require that the licensee maintain full authority over station policies, programming and operation of the station. This includes, without limitation, the right to decide whether to accept or reject any programming or advertisements and to preempt any program. Therefore, except for candidate ads, the licensee must have the opportunity to make decisions that have the potential for controversy, including political issue advertisements.

Also, the licensee must have the information required to be placed in its on-line public file. There is no exception for network placed ads. Therefore, it is critical that each affiliate be provided the necessary public file information prior to allowing it to be aired.

Network placements may contain a positive "use" by a legally qualified candidate. When this happens, the affiliate may not edit or censor the ad and must accept demands for equal opportunities from opposing candidates. Stations need to know in advance whether running the network feed will result in demands for equal opportunities to opposing candidates. Business and regulatory consequences must be planned for.

– Equal Opportunities and Lowest Unit Charge:

The network and the station should have an agreement between them as to who has the responsibility to honor equal opportunities obligations. Now is the time for affiliates to

review network affiliation agreements to determine what rights an affiliate has to require the network to accept that responsibility and to bargain for any desired changes. If it falls on the affiliate, note that the FCC's "network exception" policy relieves the affiliate of the requirement to offer its own lowest unit rate to an opposing candidate. Rather, the network has the obligation to offer its lowest unit rate, and to the opposing candidate as well.

Under the FCC regulatory scheme, when a network sells time to a legally qualified candidate, it is acting as the affiliate's surrogate, so while the network may arrange for this, and its time is sold at the "network rate," it remains the obligation of each individual station licensee to assure that timely requests for equal opportunities by an opposing candidate are honored.

– The Public File

When a network sells political time it is also the station's responsibility to assure that it places in its on-line public file all the information required of it by the FCC rules.

– Issue Advertising

Possibly the hottest area for political advertising over the next six months will be political issue advertising. The most active area is likely to be funding for political action committees (PACs) which are not subject to most of the FEC restrictions imposed on federal candidates and their authorized committees.

The FCC requires that detailed information on issue-oriented advertising be placed in the station's political on-line public file. This election may be the first time many broadcasters will be dealing with some new requirements. Because each broadcast licensee must remain in compliance with FCC rules, it is critical to obtain information on issue-oriented advertising from a network that places political advertising on its station. The NAB has revised its forms to cover this requirement in its new PB-19 form package. NAB members should require its use and ensure that networks supply the information prior to sending any candidate or other message containing political matter to the station, enabling the station to comply with its FCC political file obligations.

For any message that communicates "Political Matter of National Importance" the station must provide the following information in its political file:

For each request, all political matters of national importance mentioned in the ad, including names of all legally qualified candidates and the offices to which they are seeking election, all elections for federal office (with or without a candidate name), and all "national legislative issues of public importance" referred to in the communication.

The FCC will defer to the licensee good faith efforts to identify and include all political matters in its file. It will consider context in deciding what constitutes "Political Matter of National Importance," but at a minimum, a message that includes, (a) any references to legally qualified candidates for Federal office (this refers only to federal candidates, although some ads concerning state and local candidates may qualify as raising "political matters of national importance"); (b) any reference to a federal office (for example "our next Senator" or "our person in Washington") or (c) discussion of a "national legislative issue of public importance" would be included.

While a "Political Matter of National Importance" includes any matter that is the subject of controversy or discussion at the national level, a "national legislative issue of public importance" is narrower and includes issues that are the subject of federal legislation that have been introduced and are pending in Congress at the time the request for airtime is made.

– **Regarding a National Issue of Legislative Importance, the station must place in its public file:**

1. Whether the request to purchase broadcast time is accepted or rejected by the licensee;
2. The rate charge for the broadcast time;
3. The date and time aired;
4. The class of time purchased;
5. The name of the candidate to which the communication refers, the office the candidate is seeking and the election to which the communication refers (if relevant);
6. The issue or issues to which the communication refers (*NOTE: All issues discussed must be listed*);
7. For a request made by, or on behalf of candidate, the name of the candidate, the authorized committee of the candidate, and the treasurer of such committee;
8. In the case of any other request, the name of the person purchasing the time, the name, address and phone number of a contact person for such person, and a list of the Chief Executive Officers or members of the Executive Committee or of the Board of Directors for such person.

– **Importantly, for each ad that references a Political Matter of National Importance, whether or not it is designed or placed for a candidate PAC, must include:**

1. The names of all candidates for federal office referenced in the broadcast message;
2. The respective offices to which all such candidates are seeking election;
3. All elections referenced in the broadcast message;
4. All National Legislative Issues of Public Importance.

Finally, whenever a station broadcasts any political matter or a matter involving a controversial issue of public importance paid or furnished by an entity, the station must obtain a list of the Chief Executive Officers or members of the Executive Committee or the Board of Directors and make it available in its on-line public inspection file.

Whenever the station has a reasonable basis for believing that sponsor information appears to be incomplete, it must inquire further. That obligation can be satisfied by a single further inquiry to either the sponsoring organization or the third party time buyer. *But it must make the inquiry.* The response should be obtained in writing and maintained as evidence of its effort should a later inquiry be made.

Conclusion

There are reports that some unwired networks are including political advertising subject to FCC rules in their network feeds to affiliates but have refused to allow pre-clearance rights to stations or to provide the information required for their on-line public files. Acceding to this arrangement should be rejected by affiliates of that network as it could result in a serious violation of the FCC's rules subjecting the affiliate to a severe FCC sanction.

Provided for general information purposes only and should not be relied upon as legal advice pertaining to any specific factual situation. Legal decisions should be made only after proper consultation with a legal professional of your choosing.

Gregg Skall is a partner of the law firm Womble Bond Dickinson (US) LLP. He frequently lectures on FCC rules and regulations, represents several state broadcaster associations and individual broadcasters and other parties before the Federal Communications Commission in their commercial business dealings.

Control Your AoIP Universe



QUASAR

by **AXIA**

Application-specific controls. Customizable Source profiles. Metering where you need it. User-assignable buttons. All cosmically connecting with networked sources near and far.

Finally, you have the power to create the most brilliant content in the AoIP universe. Harness It.

**To experience
limitless production
possibilities,
contact us today.**

 **Telos
Alliance®**

Vacuumping Line or Purging?

by Gary Minker

This topic is one of those things that tries to tell me that some people still think that it's 1930. Purge, or Vacuum. This is a topic that I have steered clear of for many years in my series of "Don't Do That" articles, though I maintain a vehement stance. It has come to a point with the Re-Pack that one of my customers sent me a PDF of a set of instructions on how to remove moisture from a brand new antenna system using an air conditioning Vacuum Pump along with a gaggle of dangerous caveats. This hideous primer was written by a major manufacturer and I was appalled.



Vacuum Pump

My customer wanted to know if this was safe, and not tantamount to a bad joke

The ubiquitous, generic Refrigeration Vacuum Pump should only be used for one purpose. This purpose is pumping down your gas based cooling system where pulling a negative pressure of 24 to 30 inches of Mercury can be tolerated with a positive goal in sight.

A vacuum level of -30 inches of Mercury is relative to about -15 psi. Yes, vacuum is often expressed in inches of mercury and many people do not know how it relates to pressure, so now you know. Most pressurized RF systems are meant to run at between 5 psi and 15 psi. Elliptical Waveguide is operated at 3 psi and rectangular WR series high power Waveguide often runs at 0.5 psi maximum with a high precision regulator. This vacuuming primer that was sent to me is vague to say the least, but it insinuates that "systems," which might mean Heliac, and it might mean Rigid, should be vacuumed down to -28 to -30 inches of Mercury and held there for some length of time that is unspecified, at which time great caution should be observed not to allow air of any kind back in to the system, and dry Nitrogen should be introduced up to a suitable and still unspecified pressure.

Yes, I am paraphrasing a bit to keep from being verbose, but you get the gist.

Vacuumping a line exposes your new system to a host of destructive issues. This equipment is *not* built to withstand negative internal vacuum environments. This equipment *is* built to withstand positive internal pressure environments. The typical RF system is designed to operate between 5 psi and 15 psi positive pressure. Cylindrical objects such as tubing, and other components are designed for positive pressure. These same objects, when subjected to the stresses of a negative pressure or vacuum environment, can warp, deform, or damage welds.

Insulators in most RF systems are designed to be captured in a positive pressure environment. Placing a vacuum on insulators that breach conductors to the outside, such as arm feed or coax feed eggs, can be dislodged, or have their seals sucked inward which will

cause a permanent leak to be inflicted on the components. If damaged gaskets are the worst that happened, good on ya, but you also risk damaging the insulators. Warped insulators and breached seals are a permanent damage point. Gasketed EIA O-rings in flanges subjected to high vacuum levels can be sucked in past their capture groove and any Silicon Grease that is there can be sucked into the line. If a "O" ring is damaged or sucked in to the line and cracked or torn, the Silicon Grease on that "O" ring can corrupt the associated Teflon components or the associated bullet anchor inner. Aside from a new leak, this can set up an arc path going forward that could fail at any time, short or long term, resulting in an inspirational burnt offering.

This document that is skulking around the Internet has a huge number of dangerous caveats in it. Compared to the widely accepted Nitrogen Purge method which has been overwhelmingly popular, and has no dangerous caveats, the simple question is: *Why Risk It?* Nitrogen comes in two basic styles: Liquid Dewar and High pres-

sure gas. The Liquid Dewar is about 22 H type bottles in quantity. You order the high pressure version which operates at a fitting level of about 250 psi – this pressure will still operate a conventional regulator. This is obviously a lot of gas and will purge even the largest Television installation, multiple times over. Nitrogen generators can be wonderful and of course standard bottles are the old standby.

The theory of atomizing moisture down to a micron level in a vacuum environment works great for refrigeration equipment, where the materials are robust and designed to operate at pressure and vacuum levels that are wildly fluctuating and dramatic. RF systems are not designed like this.

Purging RF systems depends on the ability to dump the moisture laden gas from inside of the system. Self purging Pop Off valves come in dozens of configurations. They are all spring loaded and made of resilient

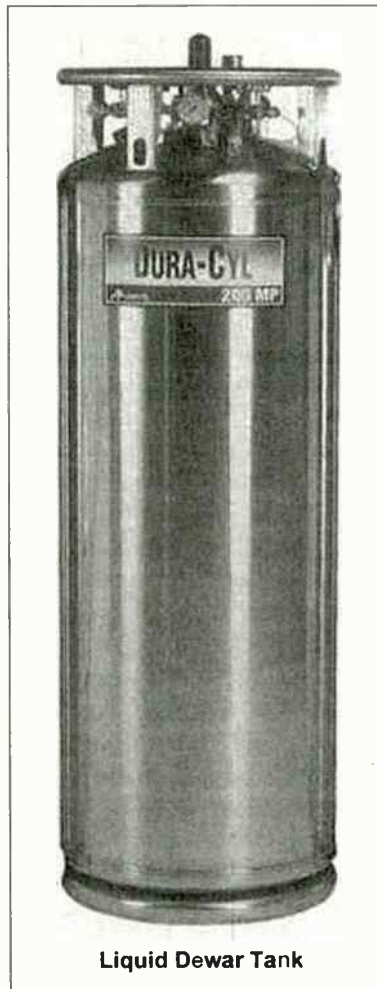

Liquid Dewar Tank

materials such as Brass or Stainless Steel. These nifty labor saving devices eliminate the need for a tower climber and allow you to purge your system at will, any time you desire. These poppers are ordered with specific "crack open" pressure levels that range from 1 psi to 200 psi. If your Nitrogen gets stinky, just purge it. Poppers are available with rain hats that keep contaminants out of the seals and the seal types are also selectable.

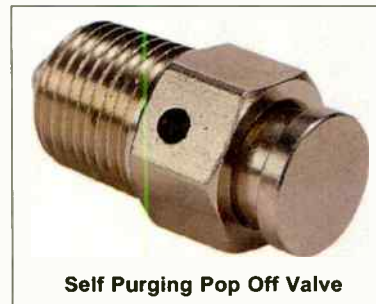

Self Purging Pop Off Valve

What is also interesting is that this vacuuming article, though written by a major manufacturer, also admits that they build this equipment – but it is often delivered tarnished or dirty inside, which necessitates the need for cleaning of the equipment prior to use. While many of the "un-washed" still use alcohol instead of a more effective nasty chemical, this alcohol vapor is not something that you want to run through the vacuum pump oil either. This cleaning also is affected by their vacuum method. I find all of this very strange. While they mention that oxides of copper are non-conductive, they gloss over the silver oxide issue.

While performing their procedure for vacuuming, they are quick to warn the reader that any failure of the procedure can come with (unmentioned) "serious" consequences.

I am particularly fond of the warning that says that if the vacuum level of -24 inches of Mercury can not be achieved, there must be a leak that the prior pressurization test failed to show ... or maybe you just sucked in a gasket and now good luck finding that little devil.

Why mess with success. If you follow my articles, you will see that I have successfully dried out tens of thousands of feet of Heliac and Rigid line over the years, from every malady from old cracked neoprene gaskets to lead poisoning. The Videos page of my web site has some of the water works highlights on it:

<http://www.radioworksrfconsulting.com/videos.htm>

If purging with heated high volume manifold fed air, followed up with a popper-based nitrogen purge is so successful drying up the tadpole pond from a high calibre round, why on earth would you risk utter catastrophe and damage by pulling a vacuum on your new system. That ranks right up there with flooding the system with greasy Freon based refrigerant, to use a leak detector to find your leak instead of bubbles or an Ultrasonic Leak Detector.

Gary Minker owns Radio Works R.F. Consulting Email him at: gary@RadioWorksRFConsulting.com or call 561-346-8494. Find Gary on the web at www.RadioWorksRFConsulting.com



AM WORKS!

Orban's XPN-AM processor makes
GREAT AM!

"I don't know what magic Bob Orban developed for AM processing, but it IS magical."

-Tom Read, Owner, ACN, KTBI, KTRW, KYAK

Call SCMS to Schedule an
XPN-AM Demo
TODAY!



www.scmsinc.com

1-800-438-6040 | sales@scmsinc.com

Broadcast Equipment Solutions | 19 reps across the U.S. and Latin America



Power Principles

Upgrading Your Generator

by Wiely Boswell

At some point every station will need to install a backup generator or perform a generator upgrade. So whether it's a brand new install or upgrade as we did, there is a lot to consider. A studio and a transmitter location are similar but a transmitter site typically requires more power and three phase service. First you have to determine the desired emergency backed up loads to calculate the minimum size in kW of the generator. Will it be the entire building or just an emergency sub panel? You next decide how much extra overhead you need for HVAC starting surge and any expansion in the future. Multiple HVACs may require staggered start delays. Then you also have to derate the generator kW output if propane or natural gas is the fuel source selected.

During installation in a new building, it is the easiest to wire in an emergency sub panel to be fed by a large breaker in the main panel routed through an emergency transfer switch. The other option is to support the entire building load at the service entrance. Extra requirements exist for a transfer switch that is located outside at the entrance. Of course local electrical codes will vary and need to be followed. A reputable electrical contractor will know all the local standards and we learned how our old generator was not in compliance. It was too close to the building wall (It needs to be a two hour rated wall.) and in addition a window was too close as well. Fresh air intakes to the building also need to be away from the generator's exhaust. A new location was chosen that allowed the new generator to meet code and the existing generator did not have to be moved out of the way during the install.



Portable generator under tent.

The biggest concern was that during rewiring the power was down at several points in the procedure. A well thought out plan was needed. This meant UPS units were going to be put to the test. If outage time is more than 10 minutes (and hard to predict) external generator(s) may be needed using extension cords to keep up the UPS(es). They typically do not last long, especially when loaded down. You might even need to change batteries. The amperage drawn on the batteries is huge even with just a medium load. The next issue can be a rejection of generator power by the UPS. The UPS considers the power as "dirty." On APC brand UPS units there is a sensitivity adjustment. It is either a screen setting or a button in the rear of the unit. There is a green LED next to a recessed button which is dark for max, bright green for med sensitivity, and dim green for "tolerate" dirty power.

Waveforms can get rather distorted from a generator. A 240 Volt generator needs to have 120 Volt loads as balanced as possible to put out clean waveforms. So again, a generator source must be tested to verify the UPS lets the line take over from battery.

A common source for small to medium systems is natural gas – the engine runs clean and you rarely see the service interrupted. If it is planned to be fail-safe it needs a backup source such as propane. A large tree being blown over or an earthquake are examples of disasters that can take out gas lines. Natural gas systems run on a series of regulators similar to transformers on a power grid. The pressures delivered are typically very low and are regulated to <1 PSI in most applications, yet on the street it is closer to 50 PSI. A special 2 pound meter/regulator is indicated by a red face in the meter. If you need to have a 2 lb meter to support a large generator you would be required to have sub regulators on appliances inside the building – similar to a 440 VAC power distribution in an industrial situation requiring step down transformers. The pressures are so low that gas line size and length will adversely affect gas flow. So before they disconnect your old generator and move to a larger unit, you need to be sure gas flow will be adequate.

There is a test point on the generator near the gas solenoid and regulator. You will hear the term "inches of water column" referencing the gas pressure. Seven inches of water column is approximately 1/4 PSI. In our case the pressure was just above the minimum required of 5 inches but, while running, the pressure started cycling up and down being starved for gas. The original 15 kW generator had a 1/2-inch copper line about 20 feet long. The new 25 kW generator went up to 3/4-inch galvanized and after the pressure fluctuation issue it was increased to 1-1/4 inch. You will also hear BTU demand mentioned as line size is determined and our new generator is in the 325K range. So again, if your layout and generator requires a large BTU gas supply you may be looking at a special gas service meter and regulators added to all inside appliances.

On a new install you need to plan room for the transfer switch. It is a large heavy box to mount and ours is 2x3x1, feet deep. Holes are cut in the enclosure as required to run conduit. Besides the main power run from the generator, you will need a separate 120 VAC circuit to supply power to the battery charger/block heater and another conduit for between two and six or more control wires or perhaps a fiber LAN cable. Our biggest delay ended up being the scheduling by the manufacturer's approved vendor to test and certify installation – it is required for warranty coverage. They wanted a filled out, detailed form on installation before they would even schedule turn-up. They do not want to waste time showing up with something missing.

The outside controller is quite sophisticated and the first thing that happens is a laptop with proprietary software gets hooked up with a serial cable.



Expensive controllers offer wireless access for monitoring. The tech then determines what your normal line voltage is and sets the output voltage of the generator to match. This helps to minimize any transfer glitch. The indoor electronics controls the synchronous switch zero crossing, back to line power, after an active run/switch event. There are a lot of settings such as: cool down timer; generator windings need to cool after a run. Minimum run time; ensures generator runs long enough for the engine to heat up and have cooling thermostat open up and have coolant flow through the radiator. Return to utility; after power fail and restore sets how long before you switch back to utility. If it took a power interruption once there may be another one coming, so wait to revert. A signal before transfer timer; allows adjustable time to signal an elevator for example to get a car to the next floor. There is a switch option to allow transfer load during the exercise routine.



So in summary, to save time with no permanent generator backup you need to know what is required for scheduling factory service turn-up and training. Make sure gas pressure is correctly calculated. Plan for all service interruptions during install. Have a portable generator plan in place and test your UPS systems for generator operation. Might be time to swap UPS batteries.

Wiely Boswell is Chief Engineer of Faith Broadcasting, Montgomery, AL; CBRE, CBNE, and SBE 118 Chairman. He may be contacted at: Wiely@faithradio.org

50 YEARS OF
ENGINEERING
THE FUTURE.



PROJECT SHOWCASE

Connoisseur Media

<https://bit.ly/WatchConnoisseurMedia>



6 stations. 10 consoles. 1 AoIP network.

Welcome to the radio renaissance. Virtual Radio. Visual Radio. Combined plants where radio and TV converge seamlessly. It's a new era of excitement, innovation and imagination, where leading-edge design and IP technologies push boundaries and expand horizons.

Lawo's radio consoles and Power Core units bring a wind of change to radio stations all over the US. Tired of a console that feels like licking the spark plug and hoping that nothing explodes? Meet a "nice and precise" radio solution with endless flexibility. Over a single IP network.

Meet Lawo's IP solutions – Advanced German Engineering with Expert Lawo USA Support!



www.lawo.com
World Radio History

Tool Guide

Supporting Good Cable Management

... and Much More

by Jim Turvaville

Anyone who knows me for very long will find out that I've never been accused of being an early adopter kind of guy, especially when new tech comes along that pushes that comfort envelope a bit. I tend to stay a bit behind on innovations that affect my life – my cell phone is always at least two versions behind the newest one on the shelf, and upgrading software to the newest version when the one I'm using is working just fine has never quite got through to me.

There are those who can say that the same can be said about my progression to cable management techniques. I discovered the Zip Tie early in the 1980's when they became more commercially available, and my love affair with those little plastic ties remains to this day. I have been guilty of combining several of them into various configurations to make just about anything hold onto just about anything else – even at 75 mph on the roof of my Trailblazer. I can bundle audio cables with the best of them, and make them look as pretty as anyone can, with the right size and number of Zip Ties. Oh, but then those pesky Cat-5 cables came along, and were accompanied with “warnings” to *not* use Zip Ties to bundle them together. What? Is there *anything* that my sacred Zip Ties might not be appropriate to bundle? That would be sacrilege at best. So I kept my peeve to myself and just quietly ignored the “new crowd” of people who bundled Cat-5 cables with that fuzzy sided stuff.

It was a very kind and patient IT guy who worked for me at Corporate who began to whittle away at my crusty old shell, and slowly forced me to face my fears of new cable management materials head on, and eventually even make a Velcro® fan out of me. While I still cherish my variety of Zip Ties which grace my tool bag, there are also at least a couple of rolls of the black fuzzy stuff which have found a place in my life.

A History Lesson

The Velcro® brand of hook and loop was invented by a man named George de Mestral back in the 1940's. Yeah, hard to believe it's been that long ago. But while he was hunting in the Jura Mountains in Switzerland. Mr. de Mestral, who was a Swiss engineer, realized that the tiny hooks of the cockleburs were stuck on his pants and in his dog's fur and wondered how they attached themselves. Under the scrutiny of the microscope, he observed the hooks engaging the loops in the fabric of his pants, and an idea was born. De Mestral, along with help from friends in the weaving business, finally duplicated mother nature's hook and loop fastener in the manufacturing plant. The result of his new invention was Velcro® Brand hook and loop fasteners, from the French words for velvet “velour,” and hook, “crochet.” The patent for the product expired in 1979, and mass production began on a variety of products which imitated the original invention. Of course, overseas manufacturing also increased in the decades which followed until the material is commonly available in large quantity at miniscule costs these days.

My personal favorite source of Hook and Loop Cable Strap material is my Harbor Freight store – the 35 foot roll of 3/4-inch wide material is all of \$7.00 every day there, and at least a couple of them grace my tool bags at all times. Unless I'm needing to bundle large cables, I typically will cut the material in half lengthwise, to have a 3/8-inch wide piece which will not only stretch well and tight over a cable bundle, it will also bundle very small cables of 1/4-inch or less in total diameter tightly together. But that 3/4-inch width also gives me a lot of creative flexibility for its use, in ways that might be considered less than typical. Let me share a few.

One of my very first uses other than cable management was to keep my soldering iron from getting tangled in the tool box. By wrapping a piece of the material with the hook side out over the handle, a cable wrapped with the loop side out will stick to it and keep everything all neat. I wrap my roll of solder with the material to keep it from unraveling in the tool box as well, as it is wider than the 3/4-inch and lets the solder come out for use without being free to unravel.



After that initial revelatory use, I figured it should also be helpful in other parts of the tool box. When it came to boxed and open ended wrenches, as well as socket sets, I found the hook and loop material very beneficial in organization. I separate SAE and Metric wrenches in order by size, and loop a piece through the box ends to keep them organized and easy to find the needed size. I've been known to leave the box ends banded together for quick use of the open end for a single purpose.



And finally in the tool and parts category, I like to carry these small parts boxes which often are included when one buys new tool bags. However, their downfall has always been the likelihood of spilling the contents in the tool bag should they come open. Hook and loop material to the rescue (Figure 3), a single band or two at opposing directions will keep the container safely sealed even with the roughest of tool bag handling.

A related use I have found for the hook and loop material also involves one of my favorite large storage solutions – the rubberized plastic containers with snap on lids (Figure 4). I have well over a dozen with a variety of things for short and long term storage. One of the difficulties in using those containers for day to day transport is that the lids do not snap

sufficiently secure to prevent spillage should they get tossed about or rolled over on their side. By cutting a slot about 1 inch long and 1/8 inch wide, I found that I can slip that 3/4-inch wide material in a complete loop and secure each end closed. This figure happens to be one of my sound cable totes for our portable sound system, and being able to secure the lids in this manner has saved lots of headaches.

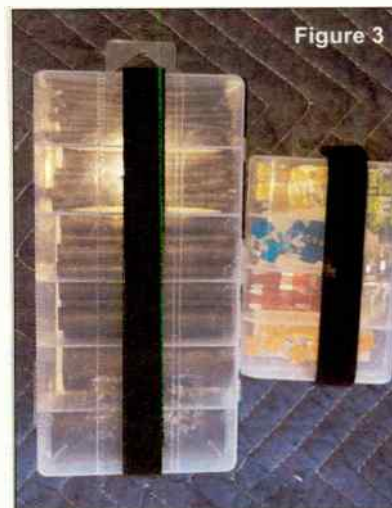

Figure 3

Of course, cable management often leads to small equipment management with hook and loop material. (Figure 5) While I have used double sided tape for a power block and a small network switch, that gets messy to work with later and

the hook and loop material can be easier and quicker for maintenance needs. I've also screwed or stapled the material to a wall and used it as the primary means of attaching small devices.

And my final epiphany is that the hook side of the material sticks to more than just the corresponding loop material. I have short nap carpet in my office and it sticks very well to hold cable bundles. I not only bundle the cables with the loop side out so they stick directly to the carpet, but a strap every few feet adds more neatness. (Figure 6) This also works in my work truck, as the headliner is sufficiently similar to the loop material that I can stick things to my ceiling using the hook side. That's a bit odd, but then – so am I.



Figure 4

The next time you have an attachment opportunity step back and think outside the box, it might be that the hook and loop roll is your best answer.

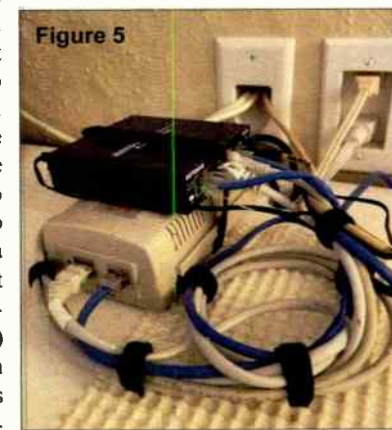

Figure 5



Figure 6

Jim “Turbo” Turvaville is semi-retired from 40 years in full-time Radio Engineering and lives in Rural Wheeler County Texas in a “tiny house” where he maintains a small clientele of stations under his Turbo Technical Services (www.jimturbo.net) operation providing FCC application preparation and field work.



SMARTS
Broadcast Systems

(800) 747-6278

www.smartsbroadcast.com

sales@smartsbroadcast.com

Skylla

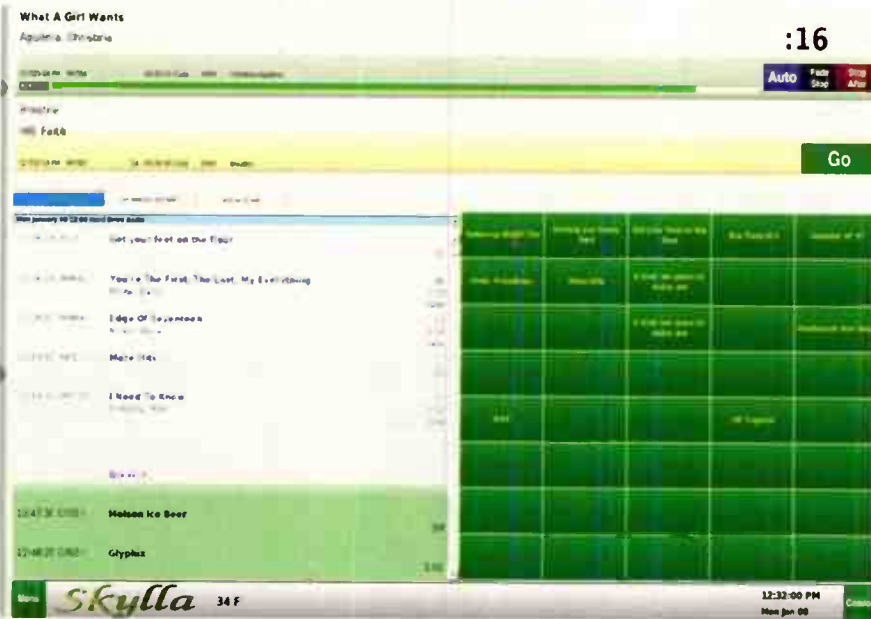

Skylla's **Smart** Features:

Smart Special Events like ballgames, national and local.

Smart Satellite support, complete with incoming RBDS data, announcers, clocks, break-tracking, and automatic break fill.

Smart Automatic Downloads of audio from the Internet.

Smart Automatic Unattended Recording by time, closure, or both.

Smart Voice Tracking allowing people to voice track at the same time to the same log, both at the station and remotely. Also allows voice tracking to future yet-to-be-merged playlists.

Smart Design. For uptime and reliability: Linux. For data safety: RAID and machine-to-machine backups of audio and data.

SkyllaPad



Simplify local sports broadcasts.

With features found only on SkyllaPad, broadcasting remote sporting events has never been easier.

You supply audio, SkyllaPad supplies control. With the touch of a button on a Smartphone, tablet, or laptop, you're on the air and in charge of your remote.

SecGen

Traffic & billing software designed for you.

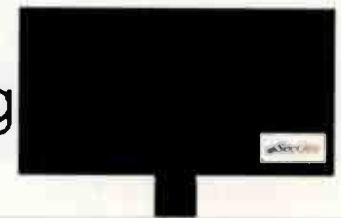

SecGen, the second generation of our original Smarts program, lets you define the setup by matching the program to your station's formats and breaks. Combined with the ability for single user, multi user, and remote user, SecGen can be customized to fit your needs.



SMARTS
Broadcast Systems

Tower Topics

To Cell or Not to Cell

by Steve Callahan

Everyone's got one and in some cases more than one. I'll bet you have one within arm's reach right now and you wouldn't be caught dead without it. I'm talking about your cell phone. Remember when your first cell phone was permanently attached to your car and then it later became portable and needed a lunchbox-sized bag for the electronics? The public's thirst for bandwidth these days seems insatiable.

Cell phones and broadcasting once had one thing in common ... the need for towers. I once managed a tower site with an FM at the top and \$360,000 worth of rental business per year. I had several cell phone carriers at \$6,000 per month, along with two way radios and, believe it or not, pagers! Where one cell operator went, the rest were sure to follow. You just made sure that the last man in performed an intermod study and a structural analysis of the tower and then you cashed the check every month. The radio station liked the cash influx because it was "non-broadcast revenue" and not to be counted to calculate the yearly music licensing fee. Yes, life was simple in the good old days of not too long ago.



A Very Busy Cell Tower

Then cell companies started merging with each other and they found that they didn't need as many towers as they did before. They started putting up their own monopole towers and developing co-habitation agreements with other cell carriers. Technology advanced so that small or micro cell technology could pinpoint coverage utilizing small cell sites on rooftops, church steeples or even individual telephone poles.

For the longest time, the site survey folks that the big cell companies employed were told to stay far away from any AM radio towers. They had to because the FCC rules dictated that any tower construction within a certain distance of a non-directional or directional station had to consider the negative effects of the new tower on the stations coverage. That meant pre and post construction field strength measurements. That was an expense that the cell carriers wanted to avoid – and don't even think of co-locating a cell site on an AM tower because that meant mounting on an RF "hot" tower and that was something that many cell operators thought was impossible.

I worked at a directional AM station where the antenna monitor parameters, which normally were rock solid, suddenly were out of tolerance. I noticed that a cell operator had built a cell site on a smoke stack across the street from the AM transmitter site. Normally a cell operator in those days would have to notify an AM station within two kilometers of pending construction so that a preliminary study of the monitor points could be done and logged. This company felt that since there wasn't going to be any tower construction, they didn't need to pre-notify me. They didn't realize that 24 vertical coaxial cable runs, that were coincidentally almost the same height as my towers, were tall would cause problems.

Just as detuning on a structure is a good thing, taking a detuning network off of a structure is an equally bad thing. At this same AM directional there was a self-supported cable TV relay tower less than a mile away that was well known to the AM station. It was equipped with a detuning skirt which was basically a folded unipole network of three vertical wires, one on each leg, feeding into a box at the tower base with an inductor and a variable vacuum capacitor. The cap was tuned to shunt all of the RF energy to ground rather than reflect it back to the AM station where it would act like another tower in the array.

One day, those rock steady antenna monitor readings were way off and I noticed that the cable TV relay tower was in the process of being dismantled and that my detuning network was now in a heap at the base of the tower. The tower crew hadn't a clue what it was or who it belonged to. There was nothing I could do but wait the week or so it took for them to pull the tower and relocate it to another part of the state far from my AM station.



A Detuned Communications Tower

At another AM directional site, I got a call one morning from the foreman of a tower crew who asked me if I could turn the AM station off because his crew was getting RF arcs on a cell site that they were constructing. Seems he was constructing a monopole about a mile from a 10 kW AM directional and he was smack dab in the major lobe. I asked if he had done the required pre-notification to the AM station and he responded by saying, "Consider this call your pre-notification."

However, the pendulum has started to swing in the other direction. The FCC has rewritten the requirement for AM station notification especially in the light of more common use of the Method of Moments procedure for determining potential interference sources in the area of AM directional stations.

Additionally, many AM stations use towers that are under 300 feet tall which is perfect for a cell site. Existing AM towers are often close to a community and they have been in place for many years and are accepted by abutters. Every AM station I know could use some non-broadcast revenue these days.

I've visited a directional tower site that has a cell tower on the same property as the AM and a public service communications tower just over the property line. The cell tower is owned by a major tower group and the communications tower was recently built by the community to link their Police, Fire and Public Works departments. Both of the towers have detuning networks installed that have been tuned properly. However, every time there are changes or additions, or subtractions, to anything on the two towers, the detuning skirts have to be readjusted and any energy reflected by the two towers has to be nulled out.



Box with detuning coils for antennas on AM tower.

There are several ways that a cell operator can locate on an AM tower. If a station utilizes a folded unipole skirt, then the co-location should be relatively simple as long as the tower will support the cell sector frames which can be quite heavy. Isocouplers were used to bridge the insulated tower base as until cell technology advanced to putting the radio heads up on the tower and using a hybrid fiber and coax cable to power them. I'm working on one station that is utilizing an isolation coil much like a tower lighting choke but only bigger to get the DC power up the tower.

I once built an 1000 Watt AM station that was in a flood plain and required some special attention. The tower and transmitter were built on a berm above the high water mark. It also utilized a six wire, above ground, radial system of 10 foot tall telephone poles, supporting just six ground wires. The tower was equipped with a slant wire feed system which was relatively common in the early days of radio. They succeeded in proving to the FCC that the antenna system was as efficient as a more common shunt feed. That tower now has several cell carriers on it.

Where there's a potential income to a struggling AM station, there's a way to get the job done.

Steve Callahan, CBRE, AMD, is a member of the engineering staff at Entercom Boston. Email at: wvbf1530@yahoo.com

ARC-talk-Blue

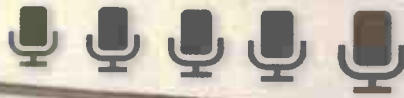

5 Mic channels with dual Conferencing Bluetooth Phone interfaces

- Eight channels
- Stereo Program output
- 5 mic, 1 stereo line, 1 PC, & 2 Bluetooth inputs
- USB interface for play and record from a PC
- 2 Bluetooth interfaces for Two Cell Phone callers ...or... stream audio from any Bluetooth Audio device



Easy access connectors for Fast installation...



- Fast, easy installation:
- RCA's for unbalanced IO.
 - Cat5s for balanced inputs.
 - XLRs for mics & Program output

NO Hybrids needed

Mic Mixers Reinvented !!!

Powerful, compact, portable, and not needing a land line to take incoming calls, the 'ARC-talk-Blue' is ideal for applications that require a mic mixer with bluetooth sources or bluetooth telephone caller interface. The revolutionary console features 5 high quality mic channels plus phantom power. Channels 6 & 7 on the console can be paired to any Bluetooth enabled audio device such as your Cell phone, MP3 player, MP3 recorder, editor, and more. Each 'Blue' channel features a button you push to connect an incoming caller and push again to disconnect from the caller. The channel One mic features 'Talk' buttons to talk to each Blue caller off line. No external hybrids are needed. OR, you can pair any Bluetooth enabled audio device such as an Ipad, Tablet device, or MP3 player and stream full bandwidth, high quality stereo (A2DP) audio into the console. The 'ARC-talk-Blue' also features a built in USB PC sound card on channel 8 so that you can play audio from your PC while recording the console Program output with your favorite software. Once again, Arrakis is 'The Leader' in Radio console evolution. Follow the Leader and visit our website today.

list price **\$1,149**

...the Bluetooth phone interfaces work with BOTH cell phones and Bluetooth headset enabled land lines.

www.arrakis-systems.com

970.461.0730

ARC-15 advanced Radio console

1 Mic, 4 Mic-line, 10 line channels with optional Bluetooth Phone interface



Easy access connectors for Fast installation...

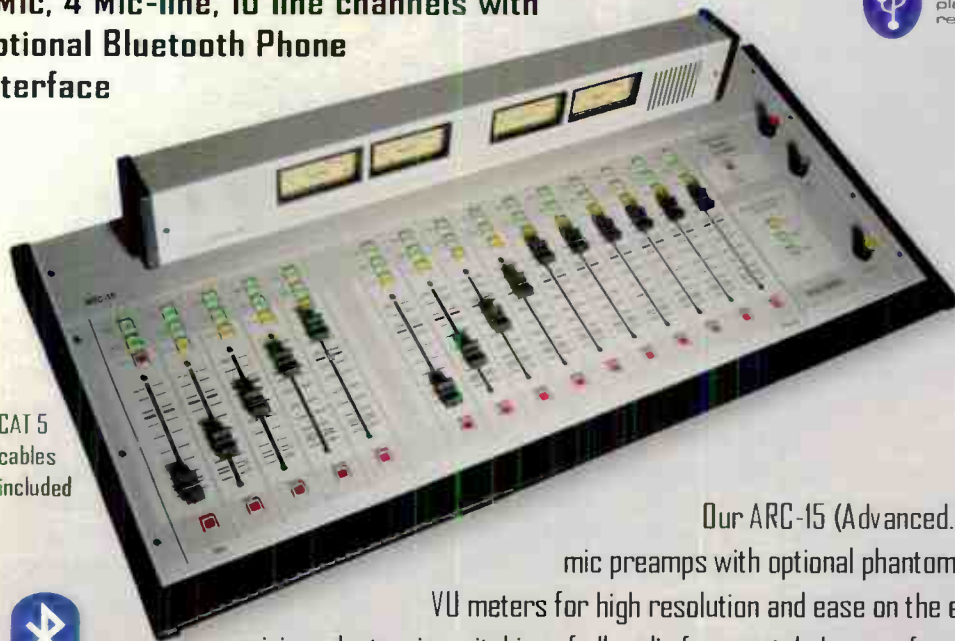

CAT 5 cables included



optional Bluetooth



BOTH balanced and unbalanced Outputs

RJ45 balanced inputs WITH cables supplied

XLR connectors for ALL mic inputs

NO compromise, take no prisoners design !

Our ARC-15 (Advanced Radio Console) is called advanced for many reasons: 15 input channels, 5 assignable mic preamps with optional phantom power, Telco interface, PC USB sound card built in with free Radio software, analog VU meters for high resolution and ease on the eyes, socketed ICs for ease of repair, RJ45 connectors with cables included for fast wiring, electronic switching of all audio for crystal clear performance, LED lamps for highest reliability, optional Bluetooth interface and much more.

list price **\$3,999**

...the Bluetooth phone interfaces work with BOTH cell phones and Bluetooth headset enabled land lines.

www.arrakis-systems.com

970.461.0730

The Linux Connection

Getting Around "Windows Frustration Syndrome" – continued

by Tommy Gray – CPBE, CBNE

For the past many months, I have been writing columns here regarding the transformation of certain Windows™ computers to a free and very powerful operating system called Linux Mint Cinnamon. I have explored and compared office applications, business and accounting applications, and several other things like security camera apps. From my readers I have been receiving requests for a few other items as well, that I will cover in the upcoming issues. More recently I have been trying out CAD programs. I have an older version of AutoCAD™ that I have used for many years, and was wanting to find a Linux based app to use in that regard since when I went over to Cinnamon, I have rarely even turned on a Windows computer.

Now I don't do a lot of CAD drawing anymore but I still like to have something good to use. If you have been following my column, you know that we use a suite of office apps called "Libreoffice." It is a very powerful set of programs that comes already installed and working when you install Linux Mint Cinnamon. As a part of the Libreoffice suite, I found a really great CAD program called, as you might guess, "LibreCAD." Its native file format is the .DXF file format that is used by a great many CAD programs, including AutoCAD. Some open source or free programs will save in that format, but you have to export the file then in .DXF. It is the default filetype for LibreCAD. LibreCAD can also save or export a file in many other filetypes as well. It is not limited, as are some programs, to its own proprietary type. Information on this free part of the Libre Programs, can be found at www.librecad.org

Here is a sample screen shot from the LibreCAD website:

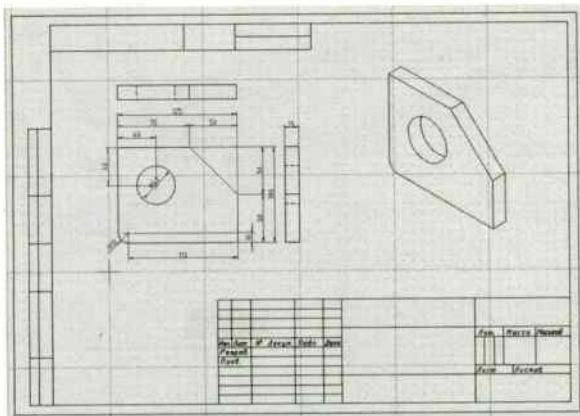

If you already have installed Linux Mint Cinnamon, all you have to do is to go into the software manager and install it. In addition to the things that come by default with the program, there are many parts libraries available to add onto your LibreCAD install for specialized things like electronics, electrical, architectural, etc. The link below is a link that has a few downloads available. I would suggest that you get these soon as this is a WIKI that may be replaced. However, if it is gone when you try you can still do a

web search and find them as the files will not go away, just the download location. Here is the URL for the WIKI containing the downloads.

https://wiki.librecad.org/index.php/Part_Libraries

I will explore some of the tools that we as engineers might use in the next installment.

Summer Storms!

Well, as with most parts of the country, ours has been experiencing spring/summer storms. The associated tornadoes have been popping up all around the area. Now we are not in an area where we are inundated with them like some parts of the nation, but we still get our high winds, heavy rain, and sometimes hail. Just a couple of weeks ago, I got a call early in the morning from a station manager, that one of our primary stations had lost the tower in the overnight storm. This is a station that I am not on the call list for the remote control – as the GM is an engineer of sorts and takes the calls, and then in turn lets me know if one of our crews needs to respond.



Tower folded over tenant building.

This particular morning, he informed me that the rental tower had fallen. A couple of us went to the site to inspect and sure enough, the angle iron tower that had been there for a good many years was in a pile of rubble on the ground. There are two buildings on the site and ours is the largest of the two and at the front of the property. My first thought was that we had a building with pieces of fallen tower sticking through the roof. The GM had beat me to the site and when he arrived, the transmitter was still running though the plates had kicked off due to the VSWR. Much to my surprise however, when I arrived on site, our facility was intact and completely undamaged. Only another tenant's building

in the rear of the site had sustained minor damage. The tower had basically folded itself over that building just damaging the outer edges of the roof structure.

I then went in and turned off all the equipment and killed the power to the facility to protect everything. Then I took some pictures and looked everything over. Below I have a few pictures of what an angle iron tower looks like when it is hit by tornado-like twisting winds that exceed its structural capability. Now I have my own opinion as to why it did not survive, as it should have been able to handle the winds that we had, but for legal reasons I will keep my opinion to myself!

Here are some pictures of the remains of the KNBB-FM Tower. What you can't see is the 6-bay FM antenna buried in the dirt and grass. The Tower fell right on top of the antenna.

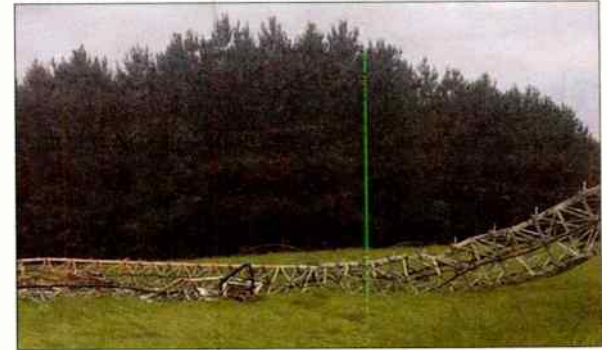

Tower remains lying in the field.

Right now, everyone is working to try to get a new tower erected and to get the station back on the air. Since the group had four stations in the market, and one of them was a station that was carrying a less profitable format, they swapped the programming over to it.



Remains of the base – nothing but twisted steel.

At this point at least the programming from the station that lost the tower, is still serving its desired audience, though at a lesser power and a different frequency. A few area newspapers ran the story for the station, outlining the frequency change, and they inundated social media with the news – so far things seem to be going OK for them. We engineers are now waiting for some steel to hang a new antenna and line on, and to get the station back to what it used to be. It was a great station and will be again soon hopefully.

Until next time ...

Tommy Gray is a semi-retired veteran broadcast engineer currently staying busy doing engineering in the gulf south, through "Broadcast Engineering & Technology LLC," a Louisiana based Consulting and Contract Engineering Firm, serving the US. www.BEandT.com

Open the door to *your* possibilities!



ON THE AIR

Powerful, state-of-the-art automation with the flexibility to grow with you...

- The power of OPX in one stand-alone computer
- Easy to learn
- The power to handle the largest audio libraries
- Satellite and live programming
- Additional stations
- Remote voicetracking
- Remote control



Call (888) 274-8721
(888) BSI-USA-1
or email us at sales@bsiusa.com

OPX ONE

PTEK

FM

Transmitters

YOUR MESSAGE MATTERS

PTEK DELIVERS

ALL PTEK TRANSMITTERS FEATURE:

- Wide range input 88 to 264 VAC
- Frequency agile from 87.7 to 108 MHz
- True proportional (VSWR) fold back
- Direct Digital Synthesis exciter with great sonic performance
- Built-in stereo generator (includes composite & SCA inputs)
- Built-in programmable FSK ID
- Front panel metering
- Remote control interface with analog and serial I/O
- Compact, Rack mountable Chassis
- Designed, manufactured & supported in the USA

FEATURING:

ES SERIES

- 300 Watt
- 500 Watt
- 1200 Watt

PS SERIES

- 2 kW
- 2.5 kW
- 3 kW
- 3.5 kW
- 4 kW
- 4.5 kW



ES Series 300-1050 Watt



PS Series 2-3.5 kW



PS Series 4-4.5 kW

ES Series Transmitters range from 300W to 1.2kW

The FM300ES is FCC type certified for use on LPFM stations. The ES Series is conveniently designed to be used as an exciter or a stand alone, low power transmitter. Optional internal Webserver available for the ES300 & ES500. Other models supported soon.

PS Series Transmitters range from 2kW to 5kW

PS SERIES KEY FEATURES:

- Very low cost to purchase
- Low operating cost (reduced power consumption)
- Super High efficiency (80%) LDMOS technology power amplifiers
- Reduced cooling requirements
- Compact and lightweight for ease of installation
- Digital front panel metering & controls
- Spacious design with major components accessible by removing top cover
- 1,500 Watt Hot Pluggable Switching Power Supplies



FM BROADCAST TRANSMITTERS

www.ptekpower.com

Ph: 888.889.2958

111 N Vista Rd, Suite 3E, Spokane Valley WA 99212

World Radio History

Sicon-8 Internet & Voice Remote Control



The CircuitWerkes Sicon-8 Remote Monitor & Control

- Uses Dial-up, Internet Web server or free Siconcontroller Software!
- 8 channels of metering, status and control (expandable to 32) and up to 5 alarms per channel.
- No accessories necessary to control your site right out of the box.
- Auto-ranging, auto-calibrating meters make setup a snap.
- Includes: Function scheduler, auto-logging & alarm reporting.



Internal Web Server



Free Siconcontroller Software

The Sicon-8 lets you control your site via Internet with its internal Web server, via telephone, auto-answering cell phone or with our free software. Setup is a breeze using the Siconcontroller software that also includes scripting, e-mail alerts, multi-site management, virtual metering & much more!

Web-Based Remote Controls w/Streaming Audio Option

Introducing the SiteSentry4 (4 channel remote control), SiteSentry2 (2 channel remote control) & WAM-2 audio monitor

- Web enabled remote controls with 6 relay outputs & 2 status inputs on all units.
- All units detect Stereo or Dual Mono Silence (independantly adjustable channels).
- User-programmed relays (DPDT) close automatically or via Web control
- All products include onboard temperature sensor
- Internal logging with onboard e-mailing.
- Supports DDNS services and Netbios names
- Upgradable firmware. Keep your product current with downloadable updates!
- Streaming audio option encodes Ogg-Vorbis & decodes mp3 or Ogg-Vorbis.



Remote Broadcasting Solutions

Discover more online at www.circuitwerkes.com



MicTel Mic/Line to Telephone Interface

- Outputs & Inputs for telephone handset, cellular phone or balanced line level at up to +10dBm.
- Operates up to 36+ hours on two 9V alkaline batteries.
- High quality, user-switchable, internal limiter prevents clipping.
- External power input with silent, auto-switching battery backup.
- Individual gain controls for send, receive & headphones levels.

Unattended Dial-Up Broadcasts with the DR-10

- The DR-10 is a Dial-Up remote control with balanced, telephone audio input & output that can control many automation systems or your audio console for unattended remote broadcasts.
- Our Silencer™ option removes control tones from the audio path.
- Use the DPDT relays to insert the phone audio directly into the program path when necessary, especially for emergencies.



TelTap Pocket-Sized Manual Telephone Coupler

- Can be used as a phone tap or a passive manual telephone coupler.
- Send or receive telephone audio.
- Compact size & low cost makes the TelTap a great addition to your remote kit for main or backup capabilities.

Lots More CircuitWerkes Problem Solvers

- Transcon-16 - Move up to 16 contact closures from room to room over an audio cable
- DT-232 - Turns DTMF sequences into user-programmed serial outputs & action steps
- FSK Encoders, decoders, transceivers and contact-to-FSK encoders/decoders.
- SUB-03 Subaudible tone decoder and SEN-6 Subaudible encoder.
- HC-3 telephone autocoupler and AC-12 rack of autocouplers
- DTMF-16 and DS-8 DTMF tone decoders.

Find Full product info & downloadable manuals online at www.circuitwerkes.com. 352-335-6555

Mystery of Radio

by Dave Dunsmoor

Do you recall when you first began listening to radio with some interest, when it became something you actually noticed? Where were you, how old were you, and what was the program material ... do you recall? I must have been around five, sitting on the floor in a small house in south Eugene Oregon when I recall actually listening to something on the radio for the first time. It was Amos 'n Andy I think, anyway, one of the characters had a very gravelly voice. Who are they, and where are they, and are they real I wondered.

It's time for some nostalgia now. It hasn't actually happened yet, but I can just imagine the conversation starting something like this: "Grandpa, why do you listen to that noisy radio, instead of iTunes? My cellphone is quiet, and smaller and fits in my pocket and I can listen to whatever I want whenever I feel like it!"

Well, all that is true, so I guess that's a legitimate enough question, actually. So why is it that I prefer radio over iTunes, Spotify, and the rest of those customizable sources of sound entertainment? Or even why do I find radio to be preferable to television even? I think that it is, on the surface anyway, a generational preference. I was brought up with radio, mostly due to listening to the AM radio in the car late at night while riding with dad on one of his trips somewhere. I was intrigued by those red lights off in the distance, while wondering how does this work, and what do those lighted towers have to do with me being able to listen to "Gunsmoke" here in the car? How is it that I can hear stations from Detroit, New Orleans,

Sacramento and many unknown location at night? It was all very mysterious back then, over a half century ago, and really, it still is, but sometimes, for different reasons.

I was (somewhat) familiar with amplifiers, and speakers, and the fact that wire connects the two together, having strung wire down the hallway to my room from the front room "stereo" when I was about 12 or so. I had no idea what I was doing really, but just that it worked when I finished. I could lay back and listen to whatever was on the radio instead of formally sitting in the living room with all the distractions there. So when I first set foot inside a radio station, having accepted the job of "engineer," it was more of the same: turntables, tape decks, amplifiers, speakers and the transmitter, all connected together with more wires. It all was quite a bit more complex than my hallway construction project, and a bit unnerving as well, but the concept was essentially the same.

So what started out as a few hours a week, watching over an aging AM transmitter (Gates BC-5P), running daytime only programming, soon moved into 24 hour operation. Then came the satellite receivers, and the necessity to have that audio accessible to the control operator, sometimes from such a remote location as the transmitter site itself. And being essentially a one-man shop, ingenuity was an important necessity here. I did have a mentor for a few years (John Valker - WØGH, now silent key), and he was often available for questions, sometimes late night questions, and this was

much appreciated. Next came the automatically switched programming and a variety of mechanical methods for advertising insertions, and sometimes these resembled a Rube Goldberg contraption. I wish now that I had a photo of the old SMC carousel which was my first introduction into "automation" – three racks of seemingly constant electro-mechanical moving mysteries! I didn't even own a cellphone at the time, and never thought of actually taking a picture of it.

And it seems that all the messing around with these contraptions was required to be done during the late night hours, and who was there for company? Yes, the voice on the radio (and the overly done coffee)! Late night programming was, and generally still is, a talk show of one sort or another. I often listened to Larry King, Bruce Williams, and Sally Jessie Raphael from years past, when working late, and the current big name, Coast to Coast AM. And there ya go, that's AM radio.

So what is it that I like about radio, and particularly AM radio? And why is it that AM radio is so often noisy, and why can't it "behave itself," be and nice and quiet like my grandkids "iThingys," or FM radio even? And really, is that such a problem? Let's start with this: AM was the original version of radio and is the easiest to receive. When I was about 10 years old, I received one of those little "spaceship" style crystal receivers, for a birthday I suppose. That little gadget provided a lot of entertainment, but it was a real puzzlement to me, and I recall quite clearly snapping the little "alligator clip" onto various pieces of metal around the house looking for something that was a suitable antenna, and wondering why one worked and another didn't. It was fun as well as instructional, and I did occasionally find something to listen to but it was quite susceptible to noise, and many people seem to find that noise objectionable.

But I don't usually concern myself too much with noise when listening to radio – I look deeper into the experience. As an example, I can drive for many miles across western

(Continued on Page 28)

Why Not Switch to



Complete FM / TV Product Line

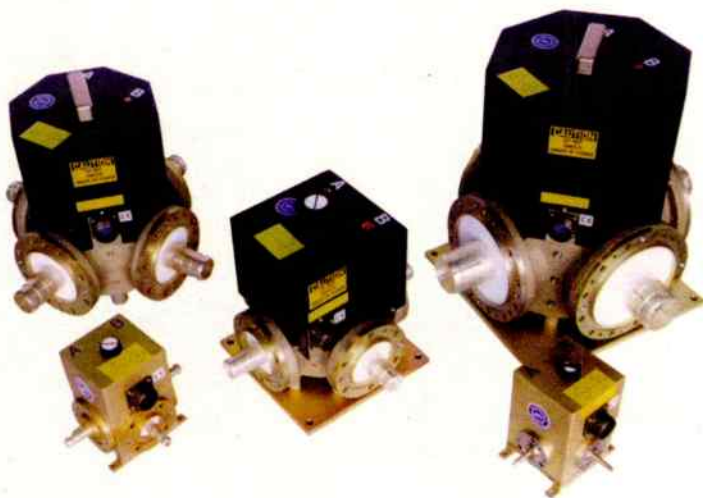

Coax switches available in
Type-N and 7/16 DIN and
7/8" through 6-1/8"

- Antennas
- Splitters
- Notch Filters
- Harmonic Filters
- Power combiners
- Channel combiners
- N +1 Switching Matrix

Control panels available.

A subsidiary of **MEGA** RF Solutions

www.megaind.com

Toll Free: 800-545-0608 | www.mcibroadcast.com

One Receiver to Tune Them All

**Powerful, Versatile,
Rock Solid
Dependability!**

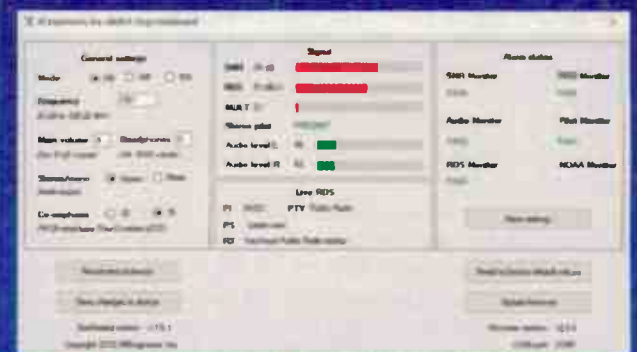

- AM / FM / NOAA Weather Receiver & Real-Time RDS Decoder
- Industrial Grade: Built to be used 24/7/365
- Unbalanced Headphone Output
- Balanced Speaker Output
 - Analog Standard, AES3 Optional
- Extensive Monitoring & Alarm System
- User API Makes Automation Easy
- Modular Design for easy reconfiguration
- Tamper Resistant Settings

For Full Information Visit
www.rfengineers.com



**Contact your favorite
dealer to order today!**



Mystery of Radio

– Continued from Page 26 –

North Dakota and eastern Montana while listening to one of my favorite Canadian stations, CBC 540. And the reason I select that particular station is because they tend to focus on and discuss interesting subjects that the U.S. stations typically do not, and they spend time on each topic, similar to NPR here in the US. Finally, the signal covers a large area which means it's available for several hours before becoming too distant to decipher. Good coverage and interesting content, two features which I believe are important for gaining and keeping listeners.

When I'm traveling across the country, I often want to know what the weather is likely to be ahead. In the summer, out on the prairies, I can usually see a problem miles (and hours) ahead of me, but at night, in the winter on unfamiliar roads, local stations usually are good for that kind of informative chatter between the ads and artists.

When traveling to the west coast, through the mountains, and during winter trips especially, I like to hear of weather and road conditions ahead. I like listening to the local announcers, their style – some seem to be nervous and "unpolished," others are laid back and relaxed, and listening to them is like visiting with a friend at a family picnic. This is where the local AM stations are entertaining, instructional and informative.

When traveling late at night, I still really enjoy "dialing around" to see what stations I can find and trying to determine where they are, and then as they fade in and out, imagining just what the ionosphere is doing between here and there to affect what I'm hearing. Yeah, I'm not your common listener, that's certain. I like hunting for the obscure, unknown (to me anyway) stations as well as the big signals.



**Very Large Storm in Western South Dakota
Best to Avoid This One!**

KFBK, Sacramento is one of my favorites, again due to it's great coverage – that, and it carries my all time favorite talk show, Coast to Coast AM. When returning home after a day of exploring the coast or the mountains with the grandkids, when everyone is asleep, it is a familiar companion, like listening to Bruce Williams all those years ago doing some late night duties. We were driving on Highway 2 East, out of Glacier National Park some years ago, and I was able to listen to it as far as Havre, Montana. That is clearly out of it's expected coverage area, but that is part of the fun and attraction of AM radio, That, and I don't have to continuously watch something, I can listen and use my imagination instead of being compelled to continuously watch a screen to get the story, and I think that this is an aspect of radio most people don't consciously appreciate.

KWAL (Wallace, ID) was another of my favorites. Not because of the programming so much, but because of the location. It was the only station I could hear for many miles through northern Idaho, and I was fascinated by the two tower array straddling I-90, in a very rocky valley in Osburn, Idaho. The north tower was sandwiched between the highway and a fast running stream, with just enough room between the



KFBK's Nighttime Coverage Map

interstate and the stream for an access road and the tower. So where were the radials, and how did they possibly plow 'em in, I wondered? I stopped to see if anyone was at the studio, some years ago when I noticed that the north tower was missing. I found the owner who told me the story of a young man who had unintentionally snagged one of the guys with his truck, and dropped the tower. He didn't know whether it would be replaced.

I checked radio-locator.com as I write this, and it's sad to report that KWAL is no longer listed. There has been a lot of speculation on the future of AM radio, and I'm afraid this is going to continue to be part of it.

Dave is mostly retired, and does backup engineering for Air-1 and I-heart Media as requested. He can be reached at: mrfixit@min.midco.net

Kintronic



Labs

Solutions for ALL FM Installations

Introducing Two New Products



FM Combiners

**Model FMC-1.5 Isocoupler
for low-loss isolation
solution**



**LAB4.50 Automatic Dehydrator
with 165,000 hour MTBF**



**Full line of Isocoils
for co-locating 1
or more FM
Translators on
AM tower**



**DL-25K-FM
FM Dummy Load
25kW
VSWR: 1:15:1**

ADDRESS: P.O. Box 845, Bristol, TN 37621

PHONE: 1-423-878-3141

EMAIL: ktl@kintronic.com



OLD SCHOOL.

Flexiva™ FMXi 4g



HIGHER EDUCATION.

Flexiva™ FMXi 4g

HD Radio® Embedded
Exporter/Importer

- Integrated Diversity Delay
- Dynamic Time & Audio Correction
- Integrated Audio & PAD Monitoring
- No Fans or Moving Parts
- Full Support of SFN
- Fast Bootup Time
- Simplified Artist Experience Setup
- No Windows Operating System

gatesair.com/fmxi4g

gatesair.com/v-events

GATESAIRCONNECT
VIRTUAL
events



No one delivers greater performance and network analytics for your IP audio and data streams



Intraplex® IP Link 100 · 100p · 200 · 200A · MPXp

- Multi-stream encoding lowers channel costs
- Rock-solid, reliable Intraplex connectivity
- Real-time network diagnostics with LiveLook

Highly integrated codecs for next-generation, multichannel radio networks



gatesair.com/codecs



Intraplex Ascent platform for scalable, multichannel SRT audio/video over IP, available as either a 1RU server or a software-only solution

Find or Create?

by Sam Wallington

Because of my interest in motorcycles, I stumbled across a YouTube channel by a guy who repairs motorcycles, cars, and houses. I am becoming addicted to watching his videos, because he reminds me of broadcast engineers: He does good work, often spending little or no money as he resolves problem after problem. A number of these videos have covered taking junk motorcycles and other stuff he bought for next-to-nothing (and sometimes nothing) to full working order for far less money than buying new, or even new parts.

Curious about my addiction to his channel, I have been thinking about why it interests me and how it connects to radio and engineering. Here is my list, in no particular order:

- He does not let fear stop him, fairly regularly saying, "I have never done this before..." as he dives in.
- He keeps his sense of humor. When discovering a previously unknown problem, it is more of an "ah-ha!" moment than a point of frustration. On the rare occasion when he gets frustrated, he steps away until his head is clear again.
- He keeps it clean. Some might think I am too conservative, but the cultural increase in swear words bothers me (and, honestly, those words lose their impact when they are overused).

- He uses scraps plus his brains to create replacements for broken parts. Rather than spend a money on a new part, he will often spend a little time to hand-craft a replacement out of what would otherwise be trash. The replacement is often better, or more elegant, than the original (and yes, sometimes it is just a Band-Aid until the real part arrives).

- He prioritizes well. For example, he might start by determining if an engine is seized. If not seized, does it have compression? If so, does it have lubricant, fuel, oil, air, and spark? If so, will it start? And so on. By looking at the most important things first, he saves much time and effort, and can focus on the critical rather than getting overwhelmed by the number of problems.

- He keeps his family first. Many video segments are shot by his wife, and his young son often helps put things together or take them apart. It is clear there is a lot of love and laughter in their relationships.

True, he could go on-line and order brand new parts for every problem he finds (and he occasionally does, especially on high-precision components like pistons or valves), but the videos would be much less interesting if he did. Plus, I think some of the joy would be missing.

Early in my broadcast career, I often worked for stations with little or no money to spend on engineering.

Sometimes lack of money created problems (it is *very* smart to pay your contract engineers on time!), but often it just became a fun challenge to see how creative I could be. Honestly, this is one of the best parts of being a broadcast engineer – seeing if we can make something work using "nothing."

I once worked with a guy regularly introduced me as the greatest radio engineer ever (he was wrong by a mile, but I never seemed to be able to correct his thinking). Why did he think that of me? Because once on a remote mountain with no tools and no parts, I had repaired a transmitter using my multi-tool and a paperclip found in the truck's glovebox. The repair was my interview, resume, and doctorate as far as he was concerned. From then on, I could do no wrong. Of course, the truth is all good broadcast engineers would and could have fixed the transmitter using the same resources.

Being creative with problem-solving adds a sense of play which can be fun for others. One time I was using "nothing" to fix a recalcitrant remote-control system. I do not remember what was broken, but I remember joking around with the station's board operator while I fixed it, giving an exaggerated, "Oh! That's a problem" commentary when I uncovered some new issue on the way to the unit working again.

Same thing with a problem in a control room. Enjoying banter with a DJ, while you have their console torn apart mid-show for the fourth time in a week, can be cathartic for both parties. It is not being flip-pant; it is just fun conversation. Plus, it helps them to see your confidence that all will soon be well.

(Continued on Page 32)

Coaxial Dynamics A CDI INDUSTRIES, INC. COMPANY SPECIALISTS IN RF TEST EQUIPMENT & COMPONENTS

COAXIAL DYNAMICS has been a leading manufacturer of precision equipment for the measurement and termination of RF Power since 1969. Our equipment is used by engineers in a wide variety of applications throughout the world.

Our products include:

- Directional Wattmeters for both Analog & Digital applications from 1 W to 100 kW and from 2 MHz to 2.3 GHz.
- Wattchman RF Monitor/Alarm Systems.
- Line Sections & Plug-In Elements.
- RF Loads - Dry, Oil, Water, and Air designs up to 200 kW.
- Low Pass Filters & Power Sensors.

6800 Lake Abram Drive, Middleburg Hts., Ohio 44130, USA
440-243-1100 • Toll Free: 1-800-COAXIAL • Fax: 440-243-1101
E-Mail: sales@coaxial.com • Web Site: www.coaxial.com

- **Broadcast Equipment** •
Wattchman - High Power Wattmeters - Elements
- **Line Sections & Meters** •
- **Termination Loads** •
Dry - Oil - Water - Air



mixIT

The Affordable Touchscreen Console

- AES67, Ravenna, Livewire™ AoIP built in
- Optional Dante® AoIP coming soon
- Mic In, Analog & Digital I/O
- EQ, Dynamics and Mix-Minus

6 Faders - \$4800

12 Faders - \$5800



Logitek

Networked Audio Consoles

Learn more at logitekaudio.com or call 800.231.5870

Find or Create?

– Continued from Page 30 –

Thinking about all this, I wondered if we have almost fully transitioned into a “find” culture instead of a “create” one. We need information? We find it on Google. We need a part? We find it on Amazon. Getting information used to involve lots of thinking and research at the library or talking to experts, and creating or obtaining necessary parts used to require thinking and playing around with different ideas. For many years, America was a “create” culture. Need a house? Clear some trees, level some land, and use the trees to build the house. The car quit working? Use tools to make a replacement part (and sometimes to make the necessary tools). Do you think perhaps people are beginning to forget how to create because it is just so easy to find?

A challenge with the “find” mentality is it becomes too easy to tell the Program Director, “Sorry, the part won’t be here until Thursday,” while the station limps along. Maybe this is caused by habit or by laziness, but I suspect more might be caused by lack of knowledge.

I remember a particular broken AM transmitter. After troubleshooting the fault down to a low-current zener diode, I was ready to throw in the towel while I waited for the part. When I told my mentor, he asked me if I had any regular diodes, which I did. He then instructed me to solder together a bunch of diodes in series, then install them backwards in place of the bad

zener. Doing so used their cumulative reverse breakdown voltage to emulate the zener. Funny, my electronics degree had explained diodes, but no one had ever explained about a zener simply being a normal diode with a carefully designed reverse breakdown voltage. Since my diodes were not specifically calibrated, I did a quick test with a multi-meter to make sure I had enough to approximate the desired voltage, and then hooked them into the circuit. It was physically ugly, with a big arc of diodes sticking up from the circuit board, but the station was back on the air even though I did not have the “right” part.

How is knowledge like that gained? My degree had not prepared me (since they were teaching how to use diodes in properly design circuits, not how to kludge a repair out of what I had on hand). Easiest, perhaps, is the way I learned it: have a mentor teach you the tricks of the real world. Otherwise, learning mostly requires thinking hard. If we understand the principles of diodes, we can deduce the creation of a zener – if we think about it. I cannot count how many times we looked at a forward-reverse diode conduction graph during various classes, but I never did more than memorize what I needed to pass the test. I did not understand it until the AM transmitter education.

Another time I was on a mountain top drilling holes in a new bracket so I could re-mount a station’s transmit antenna. I was foolish and thought my cordless drill would make it through the job with the charged batteries I brought, but alas, half-way through the job the batteries died. Hoping to not leave the station off air for another two hours while I drove to get a corded drill (no, I did not even bring the charger!), I started looking around the site

for options (better to start thinking too late rather than never). My drill bit was still good. I just needed a way to turn it and put some force behind it. Lying around the site were a faded aluminum soda can, a copper bolt-style ground-rod clamp, and some miscellaneous nuts, bolts, and washers probably dropped by a tower crew sometime in the past. In the truck I found one of those X-shaped lug wrenches. Ah hah! I used the ground clamp to secure the drill bit to one arm of the lug wrench, then crushed the soda can down to a disk shape. I put the drill bit tip where I wanted the hole, put the crushed can on the top arm of the lug wrench and push down on that with one hand. With the other hand, I could rotate the lug wrench and therefore the drill bit. 20 minutes later, the holes were drilled and we began to re-hang the antenna. Not a great tool, but it worked for what I needed.

Even if your job is not engineering-related, it is still possible to create rather than find. Maybe skip the 63rd management book and sit down with team members to talk about what is really happening and design a plan to address the challenges. Perhaps take a walk outside to think through innovative ways to make that next production really sparkle.

The YouTube channel I have been watching has inspired me by reminding me it is not necessary to always do things “correctly.” Next time I might just get creative instead of rushing off to Amazon. Are you willing to join me? It might be fun and we might learn something new.

Sam Wallington is VP of Operations and Engineering for Educational Media Foundation, and has 36 years of experience in broadcast engineering. He can be reached at swallington@kloveair1.com

Quality FM & TV Antenna Systems

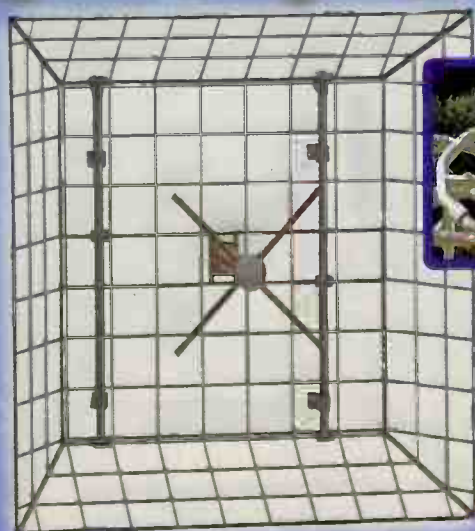

FM PANEL



POWER-TILLER



POWER-TILLER WITH RADOME

PSI is dedicated to designing and manufacturing the highest quality product. Working diligently with station engineers, consultants and outside vendors ensures that each project is completed to the customer's satisfaction.

Wide range of antenna models are available at all power levels, directional and non-directional, multi-station and more.

Additional products include..

- Transmission Line
- Combiners
- Filters
- Turnkey Systems

SLANT-V
DIRECTIONAL

PSI ψ

Propagation Systems, Inc.

Phone: (814) 472 - 5540

Email: sales@psibroadcast.com

Fax: (814) 472 - 5676

www.psibroadcast.com

MONITOR REMOTELY FROM
HUNDREDS OF MILES AWAY
using just your smartphone.

SOFIA 568

HD Radio SiteStreamer+™

ALSO AVAILABLE

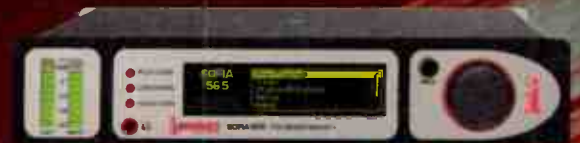

SOFIA 565 FM SiteStreamer+



SOFIA 567 AM SiteStreamer+



The new SOFIA 568 HD Radio SiteStreamer+ takes it up a notch combining remote off-air monitoring with a host of features to ensure that you are the first to know when there is a problem. You've got the tool to listen to the off-air programming and confirm that Artist Experience graphics are displaying correctly.

It's a SiteStreamer PLUS.

The elite SOFIA SiteStreamer+™ (plus) adds new features to the SiteStreamer product line.

- Internet listening stream for up to 10 listeners
- Displays HD Radio Artist Experience graphics and station graphics on Web interface
- Adjustable Audio Outputs in L/R Analog, AES digital, and Dante AES67 AoIP
- Monitor multiple transmissions sequentially with StationRotation™
- Alarms & notifications sent via email or SMS messaging
- Remotely monitor fulltime off-air FM and HD Radio signals
- Easy set up and operation; full SNMP support



www.inovonicsbroadcast.com
sales@inovonicsbroadcast.com
831-458-0552

WHY INOVONICS?

- Quality Solutions. Competitive Prices.
- Quick to install. Easy to Program
- Three-year Factory Warranty.
- Quality after sales service.



Misc. Tech-Tips and Thoughts

I always enjoy getting emails from my readers. Some of you have made some very interesting and helpful comments. If you have something positive to contribute, I would love to hear from you. If you have some helpful technical advice or words of wisdom, please contact me at stuzeneu@sbe.org. Your help will be appreciated by the readers, and I would appreciate it as well.

Email from Readers

In a previous column I wrote about the Rivendell audio play-out system. I mentioned that you would need a high end audio card to get the maximum amount of features working.

Scott Todd from KLOVE-Air 1 questioned the need for sound cards. Scott wrote: *Do we even need sound cards anymore? Why not go with AES-3 or AES-67 for the output, or doesn't Rivendell do that?*

You are right, Scott; in the digital domain, we don't need sound cards. However, there are still a lot of analog stations in the country, and I should have mentioned that sound cards should be used in that scenario.

Here's another email from a reader who responded to a mystery photo I included in the Mar/Apr-2020 edition of Shop Talk. The photo showed a device attached to a tower. While I had my strong suspicions as to what the item in the photo was, Stu Tell, of Mason City, Iowa, shares his thoughts as to what that mystery item is:

Hi Steve!

Yes sir, that Figure-1 [Mar/Apr-2020 Radio Guide] you were wondering about is a picture of an FM isolation transformer made, I believe, by ERI.

You know all about why they are used I am sure. With an isolation transformer/isolation coupler/trombone or Bazooka section, you can connect a grounded transmission line across the base of a hot AM tower. That one is for FM, but they made smaller ones too, about the size of soup cans, for Marti or Mosely RPU systems as well as for TSL and STL systems. There are other less popular methods (OK, "old school" methods) to run a transmission line across an insulated AM tower. They are known as 1/4 wave isolation transformers or "sections." And there are the ones sometimes called "trombones." The transmission line is simply ran across the base of the hot AM tower, grounded at the bottom, then ran up the tower on insulated stand offs for a 1/4 wave up at the AM frequency. At that point the outside of the transmission line is once again grounded, but now to the tower, and then the transmission line is attached directly to the tower for the rest of the run up to the FM/STL/RPU antenna. Since it's a 1/4 wavelength long, the point the line grounds on the tower looks like an open to the AM RF. At the transmission line ground at the bottom of the tower, sometimes a vacuum variable capacitor is added in series to the ground and adjusted to

increase the isolation of the newly added transmission line. A Bazooka section I think works the same way, only it runs horizontally along the ground from the bottom of the tower back to the transmitter building. I have never seen the horizontal run type though. I just remember old guys talking about them. (Funny ... I am the old guy now!)

Of course some would say the ultimate solution to all this is just ground the tower and add a wire skirt for the AM. If you add multiple lines I think that is true. Except up north where I live, wire skirts don't work very well as they can get torn up and break during ice storms in the winter. The solution to that in my opinion is to build them utility company style with two wires twisted with each other.

Keep up the good work in Radio Guide. I always look forward to reading Shop Talk!

Best regards,

Stu Tell, Mason City, Iowa

Thanks, Stu, I appreciate your email about the isolation transformer. Thanks also for your kind words about Shop Talk. It's encouraging to know other engineers get something out of reading my column.

Another engineer by the name of Shawn Baker responded to our mystery photo:

"I noticed the photo included with shop talk in radio guide because I not only recognize the component but the location in the photo. That is the isocoupler used at KELE. The purpose is to feed an FM coax onto hot am tower. They typically involve an RF transformer resonant at the FM frequency being broadcast but involve an air gap wide enough that the AM being broadcast on the tower cannot feed back down the coax. So it is a filter that passes a particular FM frequency in the 88-108mhz band but blocks AM band signal. This is necessary because the entire tower at AM sites is typically the radiating element.

(Continued on Page 36)

AES Switching Made Easy



AES Switcher Sentinel® 2+1

The AES Switcher Sentinel 2+1 is a web-enabled three channel AES/EBU silence monitor combined with an integrated 3x1 AES switcher. It is designed to monitor two AES audio sources and one analog to digital (ADC) audio source. When silence is detected on the primary AES input it can automatically switch to the back-up

AES input or the backup ADC input via mechanical latching relays. The AES Switcher Sentinel 2+1 can be configured and monitored locally and/or remotely over any IP network, including private networks, IP-based industrial control networks, and the Internet. Supports SMTP (Gmail, etc.) and SNMP.



Broadcast Tools is a Veteran Owned Business
Designed, Assembled and Supported
in WA State, USA.
www.broadcasttools.com



BROADCAST
t o o l s
PROBLEM SOLVED

StudioHub

From Angry Audio



We heard you. When you found out that StudioHub™ was gone, you took it pretty hard. After all, it's not every day that one of your favorite brands bites the dust. You weren't happy, and you raised a ruckus from Seattle to D.C.

Well, here's some news that'll make your day. StudioHub is back! All the products you love — cabling, adapters, amplifiers and control panels — and have come to depend on. It's back from the dead, courtesy of the folks at Angry Audio. You're welcome!



Adapters

Audio over CAT-5. StudioHub is the original broadcast adapter.



Cables

High-performance shielded CAT-5 patch cables in nearly every length.



Dongles, Splitters, & Couplers

DSUB to RJ45 converters, level pads, splitters and much more.



Hubs & Patch Panels

Breakout boxes, patch panels and punch blocks.



MatchJacks & DA

Audio balancers, converters and distribution amps powered by StudioHub.



Packages & Harnesses

Prepackaged cable and adapter kits for studio-sized projects.



Power Supplies

Exclusive power injection system enables CAT-5 cables to deliver audio plus power.



Panels

Headphone amps, mic preamps, buttons and jacks. There's a panel for everything.



Mounts

Put your panels in their place with our bezels and mounting systems.





Misc. Tech-Tips and Thoughts

– Continued from Page 34 –

The AM tower at this location is base fed meaning it is set on an insulator and all the guy wires have insulators so the tower is electrically floating. The AM signal is matched through a matching network in the steel box visible in your photo and feed to the bottom of the tower steel. The problem is anything crossing the bottom of the tower to ground effectively shorts out the AM signal. That is why the isocoupler is used to isolate the coax at the AM frequencies when adding an FM or other broadcast antenna. There are also isocouplers for higher frequencies, made of tightly wrapped coils of coax. The high frequency passes through the wound coax with no effect other than attenuation losses but the low AM frequency sees the loops as an inductor effectively blocking the low frequency from passing.

– Shawn Baker”

Affordable VNA

If you have a desire to do some technical measurements but have been hesitant to shell out the thousands of dollars needed for test equipment, I have some good news for you. A while ago a fellow engineer wanted to “sweep” his transmission line, but didn’t have the funds to purchase one of those expensive network analyzers. He did some looking around and discovered the VNA 2180 by Array Solutions. At a cost of under a thousand dollars, the VNA 2180 is small and feature-packed. There are some accessories you can purchase to have a complete system, but the price will still be within most engineers’ budgets. The VNA 2180 works with

your laptop and is an affordable piece of test equipment. Visit their site here: <https://www.arrayolutions.com/index.php?route=common/home>



EAS Security

In recent weeks there has been an increased interest in keeping EAS boxes secure. We have all read or heard about the incidents where these units have been hacked. Two years ago, an EAS box was hacked and a false alert issued, notifying listeners of an ICBM missile attack that turned out to be a false alarm.

Lisa M. Fowlkes, Chief, Public Safety and Homeland Security Bureau with the Federal Communications Commission, issued this notice:

EAS Participant:

We are aware of various reported instances of EAS equipment connected to the Internet with weak or otherwise inadequate network security and/or unsecure device setting configurations that potentially leave them vulnerable to IP-based attacks. We remind EAS Participants that if EAS equipment lacks basic security maintenance, it can be vulnerable to disabling or exploitive attacks.

EAS Participants should take action to secure their EAS equipment. It is advisable, for example, to ensure that default passwords have been changed, equipment is updated with current security patches, and EAS equipment is secured behind properly configured firewalls and other defensive measures. The Commission’s Communications Security, Reliability, and Interoperability Council IV (CSRIC IV) has developed several security best practices

for EAS Participants, and we encourage all EAS Participants to review them and implement those that apply to their situation. These best practices are referenced in the Communications Security, Reliability and Interoperability Council IV, Working Group 3, Emergency Alert System (EAS) Subcommittee, Final Report (March 2015), available at the following link:

https://transition.fcc.gov/pshs/advisory/csric4/CSRIC_IV_WG3-EAS_SECURITY_FINAL_011316.pdf

and are listed in detail in the Communications Security, Reliability and Interoperability Council IV, Working Group 3, Emergency Alert System (EAS) Subcommittee, Initial Report (May 2014) at the following link:

https://transition.fcc.gov/pshs/advisory/csric4/CSRIC_IV_WG3-EAS_SECURITY_INITIAL_REPORT_062014.pdf

All EAS equipment manufacturer models are included in this advisory.

If there are any questions regarding the security of EAS equipment, we encourage EAS Participants to contact their EAS equipment manufacturers.

We appreciate your efforts to make the EAS a vital, beneficial and secure national platform for the distribution of alerts that save lives and property.

Thank you,

Lisa M. Fowlkes

Chief, Public Safety and Homeland Security Bureau
Federal Communications Commission

The thoughts, ideas and opinions in this column are my own, and do not necessarily reflect the views of Radio Guide or its publisher.

Steve Tuzeneu, CBT, is a staff engineer with the Bible Broadcasting Network in Charlotte, NC. He is a member of the SBE, and an extra class radio amateur. Steve may be reached at: stuzeneu@sbe.org

ALTRONIC RESEARCH INC.

Performance By Design

RF DUMMY LOADS for ALL YOUR APPLICATIONS

- AIR-COOLED
- HDTV
- HD
- WATER-COOLED

ALTRONIC RESEARCH INC.

P.O. Box 249 Yellville, Arkansas 72687 870-449-4093 Fax: 870-449-6000
E-mail: info@altronic.com Web Site: <http://www.altronic.com>



Studio Items Inc



Mic Booms
On-Air Lights
Speaker Mounts
www.studioitems.com

TORPEY TIME

(The Good Time People)



Clocks
Up/Down Timers
www.ram68.com

Dixon Systems



News Mixers
Line Matchers
www.ram68.com



RAM Systems



Broadcast Furniture
Sound Absorption Panels
www.ram68.com

DIGITAL AUDIO SWITCHING



THE LOGICAL WAY 3-DRX

Automatically switches between two AES digital audio signals or a stereo analog signal. Analyzes digital signal errors (CRC, bit, framing, etc.) and checks for loss of audio on the digital signal. User programmable.

TITUS
TECHNOLOGICAL
LABORATORIES

860-633-5472

WWW.TITUSLABS.COM

Small Market Guide

The Ides of March Brings the Virus to Small Marketville

by Roger Paskvan

It was a typical day in small market. Spring was in the air and we all were contemplating the increase in ad revenue from upcoming fishing, boating and the spring fishing opener. It was the beginning of March, as a matter of fact, the "Ides of March," was very close.

Ides were simply ancient markers used to reference dates in relation to lunar moon phases. Ides simply referred to the first full moon of a given month, which usually fell between the 13th and 15th. Yet when heroes in movies, books and television shows are faced with the Ides of March, it's always a bad omen. Well, almost the very next day, news of the Coronavirus becoming a pandemic was about to become a major reality in our small town in northern Minnesota.

In the beginning it didn't seem like a big deal. Most of us viewed this as something that happened to big cities. Well things got worse and the virus began to show up everywhere. Minnesota and the Dakotas seemed to be spared until one day, the first cases started to creep into our state. First it was around the twin cities, then a few cases in adjacent towns. Our area was still clear and business as usual continued. Our newscasts were dominated by hundreds of deaths. The situation became grim with people calling the station for advice – the beginning of public panic. Soon news that President Trump blocked most visitors from Europe, China and other nations from coming into the USA. Later that week, Trump declared a national emergency. It was March 13, the beginning of the ides of March, the full moon.

The next morning, one of our sales persons, whose mom works at the local hospital, walked into my office and said, it's here – we got our first case of coronavirus in town. The situation now took on a new meaning. This disease was now a reality in small market. I could see the fear in her eyes.

The Governor soon mandated closures and many businesses were forced to close their doors. The next few weeks could only be described as a page out of some bad movie, like Chernobyl. It was an eerie feeling to be outside. There were no people on the streets, everything was shut down. No shopping, no restaurants, the town was in suspended animation. Next came the cancellations from all our faithful advertisers. The phone kept ringing but the wording stayed the same, "cancel all advertising until further notice." Sales dropped by 70% in less than a month. This was not good for any business.

The reports got grim and the death totals increased. Everyone was stocking up on food and bedding down for the long haul. It's funny, the hardest thing to find was toilet paper. Every store was out; limit one to a customer on every shelf. The essential businesses remained open like

food and hardware but many were forced to close. Fortunately, radio was essential and we had to stay on the air to provide a community service.

All the theaters were closed so our station came up with the idea of running radio plays three times a day. It worked quite well, and brought in some revenue, plus made the locals happy. It was like 1930 radio, all over again.

The radio business was suffering but our bills stayed the same. REA (electric bill) still wanted to be paid in full every month along with ASCAP etc. Payroll became critical and for the first time in 27 years the thought of no paycheck could be a real situation. The president's PPP program came to the rescue. Our company applied for both the PPP and an SBA loan to carry us for the next few months.

Our manager came up with a half-staff idea that worked out quite well. The thinking was to have two crews, one at the station and the other working from home. If anyone got sick with the virus, that whole crew would stay at home and the standby crew now came into work. It was a brilliant idea, and fortunately no one got sick so we just alternated crews each week.

According to Fox news, in just a few weeks, the pandemic put nearly 10 million Americans out of work, including a staggering 6.6 million people who applied for unemployment benefits in the last week of March. By the end of April, the Coronavirus pandemic had killed more than 200,000 people and sickened more than 2.8 million worldwide.

As of this writing, there are still only two documented cases in our small town and only three cases in the entire county.

Will this ever end?

Roger Paskvan is a Professor of Mass Communications at Bemidji State University, Bemidji, MN. You may contact him at: rpaskvan@bemidjistate.edu

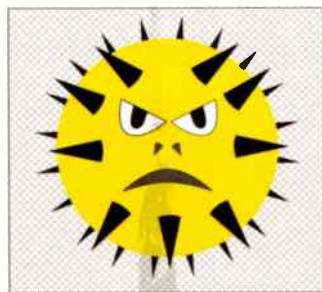

davicom

SERIES CORTEX



Take Your Remote Site Intelligence to the Next Level

Monitor, Control and Automate Your Transmitter Site

- Completely Customizable HTML 5 GUI
- Powerful SNMP Manager & Modbus Master
- Smartphone Application Dav2You

Working remotely has never been easier with a remote site management system



cortex.davicom.com



T. 1 877 282-3380 | dvsales@davicom.com

WALLTIME

NTP Clock & Notification System

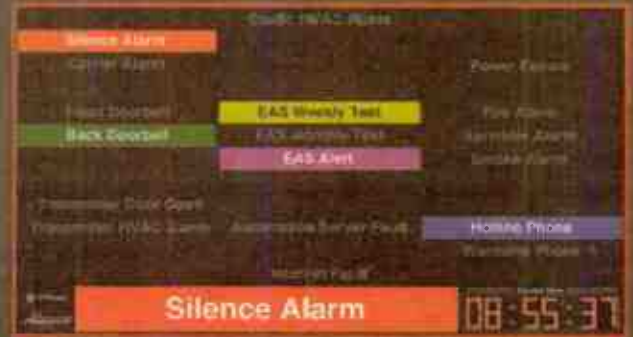

\$295



- Display Styles with Analog and Digital Clocks, Multiple Time Zones, Notifications & Alerts
- Built-in NTP Client & Server
- Widgets for On Air Light, Segment Counters, Status Notifications, Livewire Audio Meters and More
- Customize with Your Logos
- Supports Livewire, WheatNet & Ethernet GPIO Interfaces

www.paravelsystems.com

(877) 44-PARAVEL
(877) 447-2728



Antenna Sizes Available
1.8m to 5.0m

DH Sectional C/Ku Band Antennas Available:

1.8m ~ 2.4m ~ 2.7m ~ 3.0m
3.7m ~ 4.2m ~ 4.5m ~ 5.0m

Mount Options:

Fixed Az-El, Polar Tracking, Horizon to Horizon,
Fixed & Dual-Powered Gibraltar Az-El
Dual-Powered Gemini Az-El

Options:

Hot Dip Galvanizing, Electronics, Cabling, Filters, De-icing,
Non-Penetrating Roof Mounts & Concrete Template Kits

For More Information: dhsat@mhtc.net

**DH Satellite
Leading the Industry**

Outperforming the rest for over 35 years!
Our 3.7m 4-piece sectional antenna with computer
generated ribs has been the industry standard
FOR DECADES!

Superior Quality Quick Delivery
Inexpensive Shipping & Simple Installation
Low Maintenance 10,000's Installed Globally

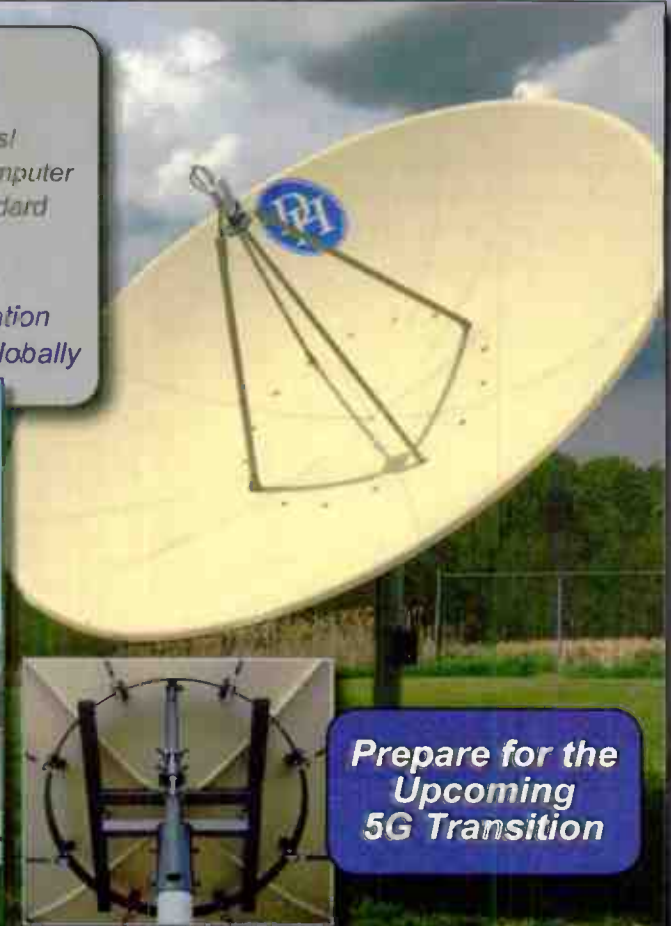
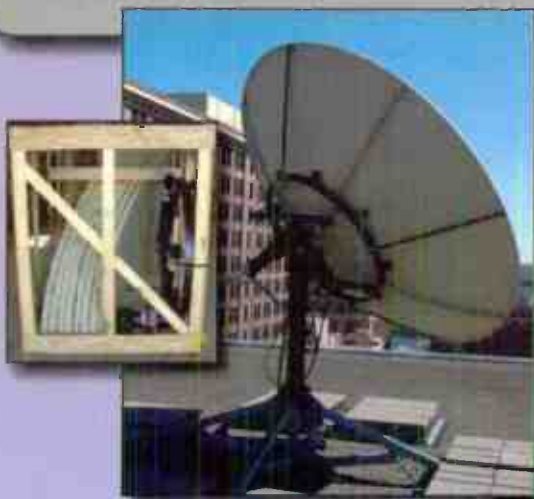

Prepare for the
Upcoming
5G Transition

DHSatellite.com ~ 800-627-9443

Printed Circuit Boards from ExpressPCB

by Bob Reite, CBT

In the Old Days

If one wanted a custom printed circuit board not all that long ago, one had to get blank copper boards and lay out traces with a special pen who's ink would resist the ferric chloride etching solution. After thirty minutes later or so in the etching bath, you would hopefully have the pattern you wanted with no missing traces. Then the holes had to be drilled. The final product would have no solder mask or legends, you had to keep track of what went where from your layout documentation, and be careful while soldering components in place to avoid solder bridges. Doing a double layer board would be challenging to say the least and you would have to rely on component leads to connect the traces between the top and bottom layers.

Draw Your Schematic

Today, it is a lot easier. Begin by downloading and installing the free ExpressPCB software. There are now two versions of the software. ExpressPCB Classic allows for two to four layers, silkscreen legends for the top layer and a schematic link to the layout. ExpressPCB Plus adds the ability to design boards with up to six layers and have a silkscreen legend added to the bottom side. Once the software is installed, use the built in schematic drawing program to create the design. Common components such as capacitors, resistors, transistors and ICs are available in the Library. There is provision to create and save custom components not shown, such as the mag latch relay and the 14 position connector shown in my example below. Try to draw your schematic placing components like they will be placed on the actual circuit board to minimize wires crossing over, although since there is no extra cost in producing a two layer board, crossovers can be accomplished on the top layer, as well as by using components.

Lay Out the Board

Once the schematic is drawn, open the ExpressPCB Layout program. Upon starting the program, you will be asked if you are producing a two or four layer board and for default vias trace and pad clearances. The defaults shown are adequate for most purposes. The program also starts with a default board size of 3.8 by 2.5 inches. This size is the best value as you get three boards of this size for \$80.00 including shipping. If you do not require plating, silk screen or solder mask, the price drops to \$60.00. Other sizes up to 12 by 14 inches can be ordered with the cost proportional to the size and number of holes required.

Similar to the schematic capture, the board layout program has a library of common components, organized by type and lead spacing. ICs are by type of package and number of leads. Custom components are created by drawing lines and placing pads and linking them together. One must be careful to number the pads the same as the corresponding custom component in the schematic capture program.

Place the components on the board. The components can be rotated as needed so as to have diodes facing the correct direction. It is good practice to have pin one of DIP and SSOT packages facing all the same direction to minimize the chances of mistakes during assembly. Normally all components all go on the top side. However in my example, I placed surface mount capacitors on the bottom side to place the power supply bypass capacitors for the op amp as close to the leads as possible.

Decide now if you want a ground plane on the board or not. This will make a difference in the interconnections. The ground plane does not need to occupy the whole surface of the board, it can be drawn to only include part of the board. It is even possible to have two isolated ground planes.

Next link the schematic to the board from the file menu. Hopefully you gave the board layout the same name as the schematic so that you can find it easily. Next click the "Highlight Net Connections" icon then use the arrows near the top right of the window to step through the list. You will see blue dots indicating the components that need to be connected together. If you get an error message stating that a component cannot be found, check both the schematic and board layout for the missing item.

If you have added a ground plane to your layout, when you get to the grounded connection on the net list, right click on the to be grounded connection and choose "Bottom layer pad shape" (assuming that your ground plane is on the bottom layer) and choose "Thermal pad to filled plane." This will make it easier to solder. If you know that it is going to be a high current connection, or that this point in the circuit needs to have extremely low inductance, then choose "solid pad to filled plane."

After you have gone through the net list, check through it again for missed connections. Also check that you do not have traces crossing each other that should not be connected. Use a resistor or capacitor for crossings, although if you can't get that to work out, you can use a trace

on the top layer with a via at each end to make the connection.

Now add the printing that you want on the top silk screen. Identify the function of any trim pots that you have. Identify what any wire connections are for. You may want to hide the arbitrary Wx legends that were used to link the board layout to the schematic as I do – use the "set component properties" to do this. Likewise some builders like to hide the arbitrary resistor and capacitor numbers, replacing them with the actual component values.

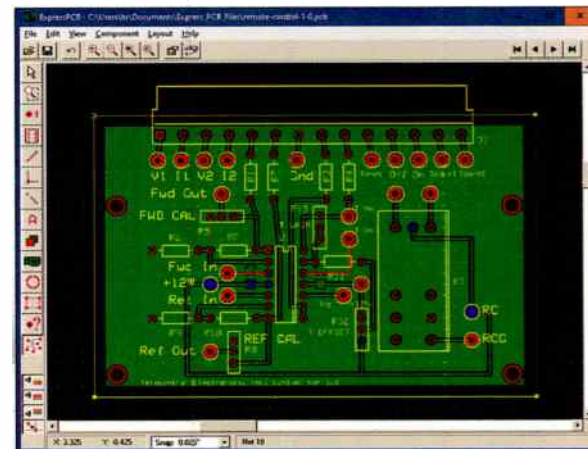

Final Checks Before Ordering

It is most important to check everything before submitting the design for production. ExpressPCB will *not* check your work for errors. Whatever you submit is what will be produced, even if you have traces shorting each other out, components placed too close to fit, or whatever. If you have not already done so, obtain all the physical components that will actually be installed on the board. More than once I have had so called "1/4 Watt resistors" that were different lengths. Of course you can lay out the board for the largest size, and the smaller one will work and I've stood resistors on end to get them to work if they turned out to be too long, but if you are going to be making a custom board it's nice to have everything fit neatly.

I print out the design on 90# card stock using the "Silkscreen pads and text on top layer" printing option. I then poke holes in the card stock with a sharp pin and insert the through hole components as if it were an actual circuit board. This will tell you right away if you have components too close to fit comfortably or that you designed your custom components incorrectly. Keep heat producing components such as resistors over one Watt and TO-220 devices away from electrolytic capacitors to extend the life of these components. Once you are absolutely sure that everything is correct, then go to *Layout > Order Boards* and choose your options – then place the order direct from the layout program. In less than a week, you will have your completed boards ready to stuff.

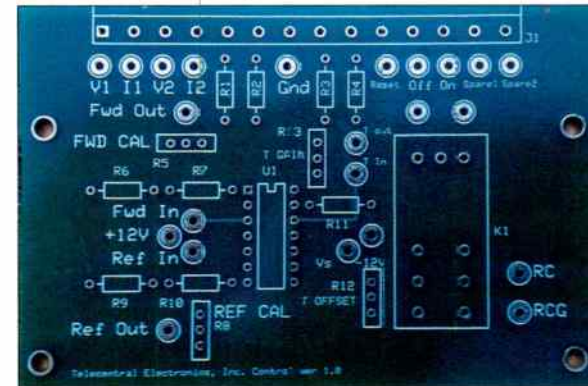

Bob Reite operates his contract engineering firm, Telecentral Electronics, Inc. servicing radio stations in Pennsylvania and New York state and may be contacted at br@telcen.com

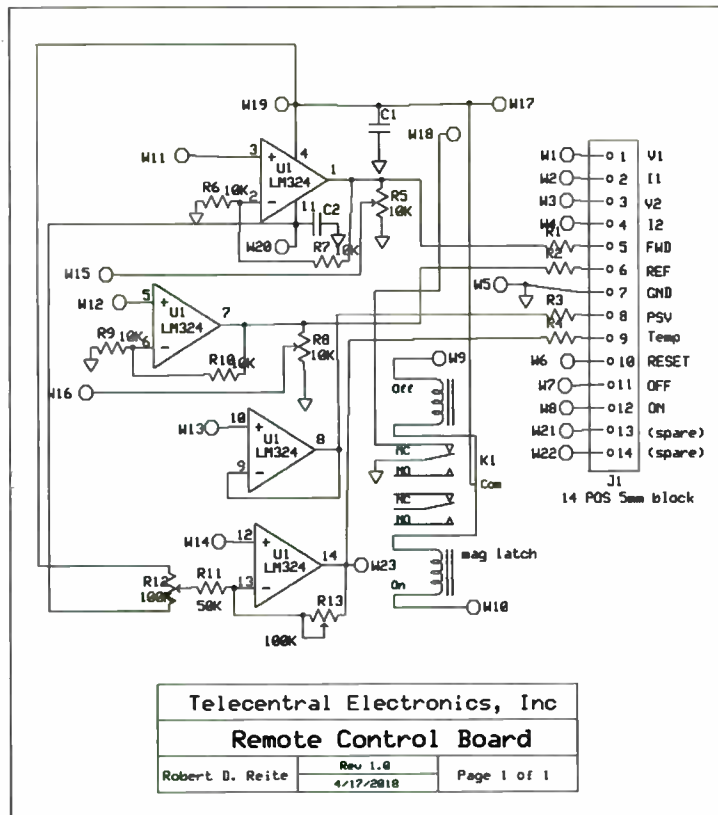

WORKING REMOTELY? Take complete control of your station with WebDAD.



ENCO.com/VirtualDemo

800-ENCO-SYS

sales@enco.com

fuhgeddaboudit!

Admit it; you'd love to forget all about your FM antenna. You'd be perfectly happy if it were to spend decades out of sight, out of mind, and out of your budget. You just want it to work; day in, and day out.

We understand.

Shively designs antenna systems to work flawlessly. Year after year. At any site. Under any conditions. For any power level. Happily, in the background.

FM First.

This was Ed Shively's vision in 1963, when he founded the company; and over 50 years later, we're still doing our best to be absolutely forgettable.

Shively Labs®

A Division of Howell Laboratories, Inc.

Bridgton, Maine 04009 USA

Call Toll-Free: (888) SHIVELY

Or visit us on the Web at: www.shively.com

- An Employee-Owned Company since 1995 -

Tips From the Field

Don't Drag 'Em ... Roll 'Em

Replacing an old tube transmitter with a new solid-state one can be much easier if you follow these tips.

First equip yourself with a bucket full of 1-inch steel pipes – maybe about 24 inches long. After removing all connections to the old transmitter, slip a couple of those rollers under the front edge. This will remove most of the floor friction and make it possible for one person to push the transmitter from the back. The old transmitter can then be rolled into narrow hallways, or other places by re-orienting the rollers – then rolled it into a back room, clearing the way for the new transmitter to be rolled into place the same way. On flat floors, it is extremely easy. There are just a few simple laws of physics to keep in mind.



1. As the object moves along the floor, the roller is also moving along the floor, as well as toward the rear of the object. Eventually, the rollers will be further back and the majority of the weight will be shifted to the leading side of the roller[s]. Just before this happens, additional rollers must be placed at the front, or the object will tilt forward and friction will be opposing any further movement.

2. Eventually, the rollers will come out the rear. So it is good to have at least three sets of rollers in order to have one (preferably two) sets under the object at all times.

3. When turning a corner, you can either completely clear the corner, then rotate the rollers under the object by 90 degrees, or place the leading rollers at a 30-45 degree angle and watch the object turn the corner with ease.



Notice the object turns the same as a car when the front wheels are turned to one side or the other.

4. So far, the discussion has assumed the object is being moved over a flat floor. Moving up or down an incline is more tricky. In such cases, a professional moving company might be the wise choice.

Although the steel rollers work very well, Sched-40 PVC pipe can also move most objects with no problems. And if you have a work truck, it's easy enough to keep a few in the back. It can make it much easier to move a heavy items in or out of the back.

Other items that can help you move heavy gear are: a furniture dolly, a J-Bar, and a pallet jack. They are all simple but effective tools.

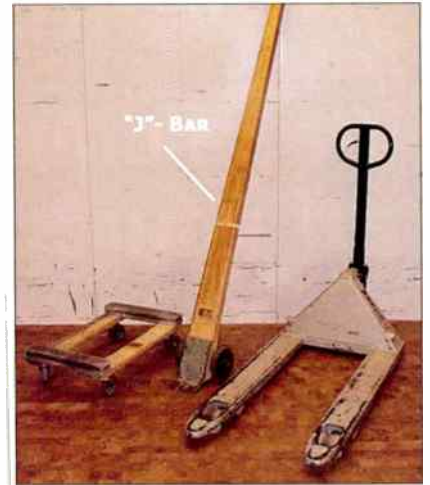

Furniture Dolly, J-Bar, Pallet Jack

Do You Have Tech Tips?



Email to: radioguide@earthlink.net



The most trusted Nautel dealer for 35 years

Contact your local RF Specialties office for more information

rfspecialties.com



ECONCO

Rebuilt Power Tubes



Approximately One Half the Cost of New

3,000 Hour Unconditional Guarantee

Call for Your Quotation



Phone: 530-662-7553 • Fax: 530-666-7760
Toll Free: 800-532-6626

www.econco.com

1318 Commerce Ave, Woodland, CA 95776

TRANSCOM CORPORATION

Serving the Broadcast Industry Since 1978

Visit Our Website – www.fmamtv.com

Send your e-mail requests to: transcom@fmamtv.com

Fine Used AM & FM Transmitters & New Equipment

AM	1 kW	2005	NautelJ1000
	5 kW	2015	GateAir DAX5
	5 kW	2004	GateAir DAX5
	6 kW	2016	Nautel XR6
	12 kW	2001	Nautel XL12
	50 kW	1999	Harris DX50
	50 kW	2006	Harris 3DX50

Please see our current listings on our website.

FM	55 W	2000	Harris DIGIT™ CD
	3.5 kW	1985	BE FM3.5A
	10.0 kW	2009	Nautel NV10 - Solid State
	10.0 kW	2005	BE FM10S - Solid State
	20.0 kW	2005	BE 20T
	25.0 kW	2004	Harris HT25CD

Please see our current listings on our website.

Special	10.0 kW	1995	CCA AM10000HF
	1 kW	2018	Radio Partes 1000

Used Misc. Equipment:

Bird Model 8932, 10kW Air-Cooled RF Load

Exciters:

Harris DIGIT™ - New 30W Synthesized



Please go to our website for updated listings. Retuning and testing available – call for quote!

OMB STL systems for radio, complete with antenna and cable for under \$5,000!

PO Box 26744, Elkins Park, PA 19027
800-441-8454 • 215-938-7304 • Fax: 215-938-7361

NiCOM

HELPING YOU SEND CLEAR SIGNALS SINCE 1997

AMERICAN



MADE



FM & TV TRANSMITTERS



STL SYSTEMS

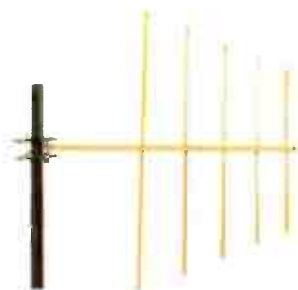

FM & TV ANTENNAS

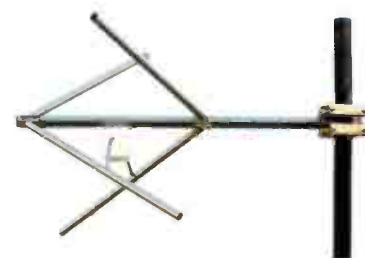

619.671.9500

NICOMUSA.COM



The HIGH EFFICIENCY BROADBAND ANTENNA



(877) HEBA-4-US (781) 275-1147
www.worldwideantennasystems.com

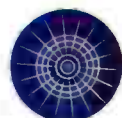

WORLD WIDE
ANTENNA SYSTEMS

THE FUTURE OF BROADCASTING IS

BRIGHT WHITE



All the features you want in the new line of transmitters from the company you can trust

Call Bext today to learn more about the many built-in features of the new XD White Line of Transmitters

BEXT

888 239 8462

bext.com



The Leader in Broadcast Engineering Software!

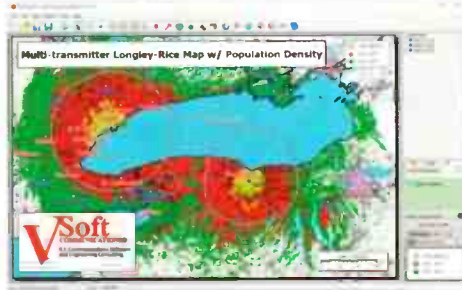

• Create stunning "real-world" coverage maps, interference studies, and population reports with Probe 5™

• Find STL broadcast auxiliary and Part 101 microwave frequencies and generate PCN letters with Microwave Pro™

• AM Pro 2™, used daily by FCC engineers, performs skywave and groundwave allocation studies and AM coverage mapping

• Map FM stations and find upgrade possibilities using FCC minimum separations and contour-to-contour methods with FMCommander™

www.V-Soft.com - info@v-soft.com - 1-800-743-3684

Bay Country Broadcast Equipment

Buy • Sell • Trade

Your #1 Source for Quality Used Radio Broadcast Equipment

View our latest list of equipment on-line at:

www.baycountry.com

(Website Updated Daily)

All equipment sold with a 15 day return guarantee.

Turn Your Excess Gear Into Cash

Send your list to us and we will respond with our offer promptly.

We only buy good working equipment with traceable serial numbers.

Send Your List Today – sales@baycountry.com -or- Fax 443-596-0212



E-mail: sales@baycountry.com

877-722-1031 (Toll Free) 443-596-0212 (Fax)

7117 Olivia Rd, Baltimore, MD 21220

ICE KRACKERS®

The Solution Since 1979

NEED ICE DAMAGE PROTECTION FOR YOUR TOWER?

With the higher levels of atmospheric moisture, we may have very high snow and ice levels this year. Be prepared with Ice Crackers®.

Protect your tower site investment by protecting your anchor hardware and dampers with an inexpensive Ice Cracker.

Ice Crackers are galvanized and supplied with all mounting hardware and can be installed within minutes.

The average cost for equipping Ice Crackers at the tower is about \$500.

Contact us for a quote:
icecrackers@comcast.net
icecrackers.com

800-747-8921



AM-FM Transmitters

Pre-Owned – Tuned and Tested to Your Frequency

www.Besco-Int.com

Rob Malany – Owner

321-960-4001 • sales@Besco-Int.com

TLM-2 TOWER LIGHT MONITOR

Total Monitoring for Older Lighting Systems



A microprocessor based system designed to monitor the status of FAA type A incandescent tower lights.

- Individual alarms for photocell, flasher, beacon & marker.
- Status outputs for lights on/off and beacon on/off.
- LED indicators for each alarm and status output.
- Opto-isolated fail-safe outputs for each alarm.
- Easy setup – one button calibration.
- Installs at the circuit breaker panel.
- Available through broadcast distributors.

FM Services

www.towermonitor.com • 336-667-7091

RFENGINEERS, INC.

- Tower Grounding & Lightning Protection
- Coverage Modeling & Maps
- RF Exposure Studies
- FCC Applications

Call us to discuss your project needs.

352-367-1725

rfengineers.com/services

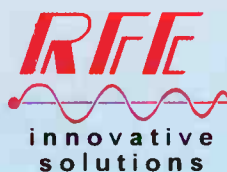

A Professional Engineering Company

Doug Vernier

Telecommunications Consultants

- FCC Applications for AM, FM, TV, DTV, LPTV, STL
- Upgrade and Due Diligence Analysis
- Frequency Searches
- Site Relocations
- Propagation Prediction with Custom Mapping
- Demographic Analysis
- Directional Antenna Design



We use V-Soft Software!

www.v-soft.com consulting@v-soft.com 800-743-3684

TRANSMITTING
CAPACITORS
MICA-VACUUM-CERAMIC

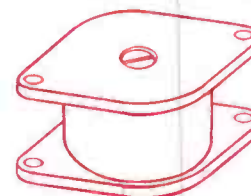

SURCOM ASSOCIATES, INC.
(760) 438-4420
LINK@SURCOM.COM

YOUR ULTIMATE SUPPLY & SERVICE SOLUTION



From our Facility to yours



Design & Integration

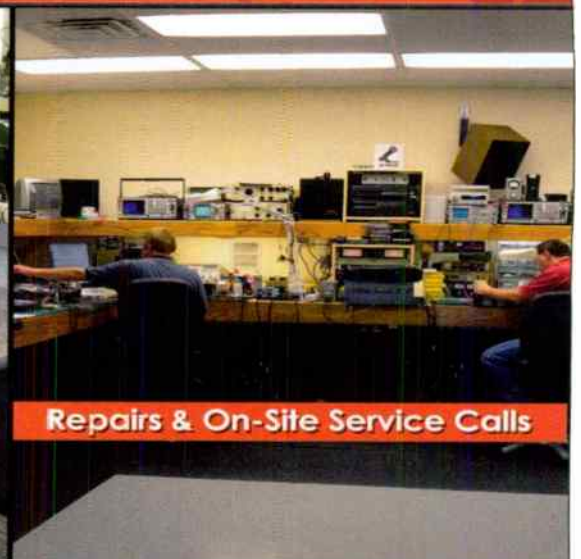

Repairs & On-Site Service Calls



LIGHTNER ELECTRONICS www.lightnerelectronics.com

Toll Free 1-866-239-3888 Shop online www.broadcastavsales.com

Simple. Easy.

Your life and your processing should be that way.

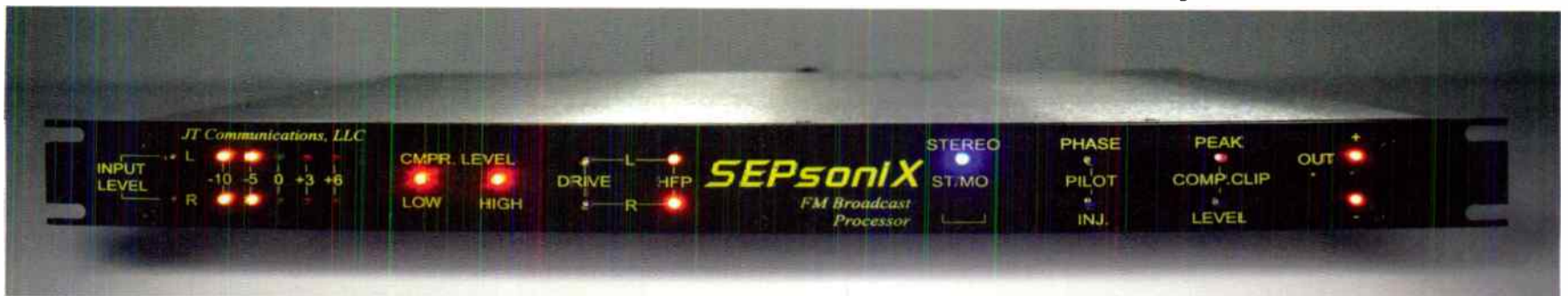

Complete FM broadcast processor with NO DIGITAL LATENCY.

- Simple, easy, and cost-effective audio processing solution.
- Rapid and simple installation, setup, and operation.
- Compressor out for audio streaming feed.
- Optional frequency-agile PLL FM signal generator for in-house modulation monitoring.

Even the price is easy: MSRP \$1094.95 | \$1249.95 with FM signal generator

Designed and built in the USA by:

SEPsonix
Simple. Easy Processing

JT Communications, LLC
Ocala, FL USA
352-236-0744
www.sepsonix.com





Ask almost anyone who has been on the air for close to a lifetime and they'll probably tell you that when the "Radio Bug" bites, it's a life sentence. My good friend Bobby Rich, mornings at "The Drive" in Tucson, is quoted on the station website: "Radio is my first love, and it will be my last." I enjoyed listening to *The Drive* while I was in Arizona in December of last year. You can hear it anywhere – it streams on-line at: thedrivetucson.com



Bobby Rich

The weeks of staying inside due to the worldwide pandemic offers time for reflection. Looking back at my personal radio history. I would not have enjoyed it without the people I've known. I was born in Hillsboro Oregon in 1952, the same year 1360 KRTV signed on – call for "Radio Tualatin Valley." Years later the station switched to KUIK.

In 1961, a nine year old kid could roam around town safely. I happened to walk past Schoen's Perfection Bakery on main street, while KUIK was doing a live remote. The announcer saw an opportunity to get a kid on the radio, so he stuck a microphone in my face and asked me what I thought of the pastries in the window. "They sure look good," was the response I remember. A short exchange followed and a moment later a lady appeared from out of the shop with a cream filled pastry and she said it was for me. I had just spent my money on the latest DC comic book so I said, "I'm Sorry but, I don't have any money." She insisted I should have it because I did such a good job on the radio. This simple broadcast encounter inspired me to learn more about radio.

By the time I was twelve I had made friends at various stations. Some gave me announcing tips and AP Wire news copy to read, to practice my youthful announcing skills. That summer I purchased my first **AM Broadcaster Kit**. I tuned in the large console stereo in the living room and asked my Mom to listen. She indulged me and is still my biggest fan.



The next summer I built a new station on AM with a 50 Watt carrier current signal. I contacted engineers around Portland asking for old equipment donations and struck gold when the KXL Chief Engineer gave me an old Audio Limiter. The signal really didn't go too far but it was on the air. By this time I had also made some new friends who also had the radio bug. A long-time friend, David Shult, lived only a block away. He would come down every Saturday and pull an

airshift on what we called KYDS. David later found success in Portland radio with his smooth FM delivery style. David is one of several friends gone too soon. I miss him a lot, but I know he is with God now.

Another radio pro who became my friend was Andy Broman, a "big voice" known as "Buddy Scott" on 91/KISN in Portland. He created the most incredible liners in the KISN production room for our little station. Many years later, Andy would hire me at 92/KGAL, Lebanon Oregon. Last I heard, Andy was in Truth or Consequences, New Mexico.



Nuvistor

My best friend throughout High School was Richard Johnson. It all started one day when, after school, I invited Rich to come over to see my radio station. He became interested in radio and from that time on, we were kinda on the radio road together. By this time I had two studios – sort-of. The make-shift newsroom was in the furnace room. Okay for sound unless the burner fired up while we were live. Each Saturday morning, we would broadcast on the made-up KYDS. Rich would drive down to KUIK first and get some of the overnight news copy. Since he had a car, he became the station's default news guy. Prophetic perhaps, because since then, Rich became a news pro in Portland, Seattle and nationally for ABC and Fox News Radio. He was, for a while, the Fox Radio White House Reporter. Rich and I remain friends today. He is now resides in Las Vegas.



Andy Broman



Richard Johnson

I was finally hired weekends at KUIK. The next summer, before my senior year of high school, I took a full time job – six to midnight at KFLY in Corvallis. After high school, I obtained a now outdated and largely useless FCC First Class Radio License. This class of license was required to be on the air at directional stations. I also learned that combo Engineers/Jocks were more in demand than just an air talent.

One of my favorite Portland stations was simulcast on 1410 kHz and 97.1 MHz with the coolest call signs KPAM and KPFM. The studios and transmitters were in the old KPTV Channel 27 Studio, overlooking the city offering a fabulous cityscape view. That's where I met Brant Miller, now in Chicago at WGN FM, as well as Craig Walker, who went on to become a Portland area morning legend at KGW and K103.



Dave Schult

I hope this article will stimulate happy memories of your radio experiences. If you know of kids interested in radio, help them if you can and urge them to listen to airchecks from the most talented and famous. You'll find some with video on *You Tube*. Have them search for Charlie Tuna, Wolfman Jack and The Real Don Steele among many others.

Ron Erickson may be reached at 541-460-0249 or at ronerickson@gmx.com.

TIME TO SYNCHRONIZE

ES-185E/NTP6 GPS Master Clock

Accurately generate time code with ESE's Master Clock via the 12-channel GPS receiver and output multiple types of Time Code, SMPTE-LTC/EBU, ESE, IRIG-B, ASCII (RS-232 & USB), and an extremely accurate 1PPS signal. Further reliability with dual battery back-up, and new control panel software. ESE's NTP6 feature provides an NTP server compatible with the latest version of Internet Protocol, IPv6. You can also easily interface with new or existing computers, automation and clock systems. Visit www.es-web.com for all your time synchronization needs.

ESE

www.es-web.com
+1-310-322-2136

Precision | Innovation | Proven

GRAHAM STUDIOS
Broadcast Furniture

815 222-3556
www.supportradio.com

866-481-6696 | www.graham-studios.com

FINAL STAGE



RADIO ROUNDUP

The Radio Guide Event Register

Email your dates and info to: radio@rconnect.com

Texas Association of Broadcasters (TAB)

CANCELLED July 29-30, 2020

JW Marriot Downtown – Austin, Texas

www.tab.org/convention-and-trade-show

Michigan Association of Broadcasters

August 3-4, 2020

MGM Grand, Detroit, Michigan

<https://michmab.com/programs-events/advocacy-conference-annual-meeting/>

NAB Radio Show

September 13-16, 2020

Omni Nashville – Nashville, Tennessee

www.radioshowweb.com

ABA Engineering Academy - Radio Engineering

September 17-21, 2020 – Hoover, Alabama

<http://al-ba.com/wp2/aba-engineering-academy/>

WBA Broadcasters Clinic

October 13-15, 2020

Madison Marriot West – Madison, Wisconsin

www.wi-broadcasters.org/events/broadcasters-clinic-2/

Midwest Broadcast & Technology Conference

November 17, 2020

Columbus Convention Center – Columbus, Ohio

mbmtc.oab.org

Radio Guide Advertiser Info – May-June 2020

Advertiser - Page

Altronic - 36
 Angry Audio - 35
 Arrakis - 21
 Bay Country - 44
 Besco - 44
 BEXT - 43
 Broadcast Devices - 3
 Broadcasters General Store - 11
 Broadcast Software Intl. - 23
 Broadcast Tools - 34, 47
 CircuitWerkes - 25
 Coaxial Dynamics - 30
 Davicom/Comlab - 38
 Deva - 4
 D&H Satellite - 39
 Econco Tubes - 42
 Enco - 41
 ESE - 46
 FM Services - 44
 GatesAir - 29
 Graham Studios - 46
 Henry Engineering - 2
 Inovonics - 1, 33
 Kintronic Labs - 28
 Lawo - 17
 Lightner Electronics - 45

Website

www.altronic.com
www.angryaudio.com
www.arrakis-systems.com
www.baycountry.com
www.besco-int.com
www.bext.com
www.broadcast-devices.com
www.bgs.cc
www.bsiusa.com
www.broadcasttools.com
www.circuitwerkes.com
www.coaxial.com
www.davicom.com
www.devabroadcast.com
www.dhsatellite.com
www.enco.com
www.enco.com
www.esa-web.com
www.towermonitor.com
www.gatesair.com
www.graham-studios.com
www.henryeng.com
www.inovon.com
www.kintronic.com
www.lawo.com
www.lightnerelectronics.com

Advertiser - Page

Logitek - 31
 Mega Industries/MCI - 26
 Nautel - 5
 Nicom - 43
 Owl Engineering - 47
 Paravel - 39
 Phasetek - 47
 PTEK - 24
 ProAudio.com - 48
 Propagation Systems (PSI) - 32
 RF Engineers - 27
 RF Specialties/Nautel - 42
 SCMS - 15
 Sepsonix - 45
 Shively - 41
 Smarts Broadcast Systems - 19
 Stackley Devices - 47
 Studio Items - 37
 Surcom - 44
 Telos Axia - 13
 Telos Omnia - 9
 Tieline - 7
 Titus Labs - 37
 Transcom - 43
 V-Soft Communications - 44
 Worldwide Antenna Systems - 43

Website

www.logitekaudio.com
www.mcibroadcast.com
www.nautel.com
www.nicomusa.com
www.owleng.com
www.paravelsystems.com
www.phasetekinc.com
www.ptekpower.com
www.proaudio.com
www.psbroadcast.com
www.rfengineers.com
www.rfspecialties.com
www.scmsinc.com
www.sepsonix.com
www.shively.com
www.smartsbroadcast.com
www.stackleydevices.com
www.studioitems.com
www.surcom.com
www.telosalliance.com
www.telosomnia.com
www.tieline.com
www.tituslabs.com
www.fmamtv.com
www.v-soft.com
www.worldwideantennasystems.com

Remote Reboot of AC Powered Devices

**Stackley
 Devices
 LLC**
 (609)
 647
 9677

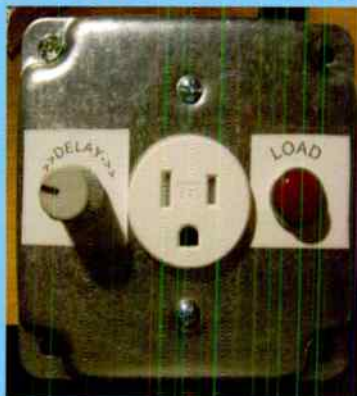

**RemOutlet
 Reboot
 Mini**
\$179
**Adjustable
 Power
 OFF Time**

www.RemOutlet.com



OWL ENGINEERING, INC.

Consulting Communications Engineers
 5844 Hamline Ave. N., Shoreview, MN 55126

651-784-7445

- AM/FM/NCE Applications
- Allocation and Upgrade Studies
- Pre-Purchase Inspections
- ANSI and NRSC Measurements
- AM Directional Array, Design, Tuning and Proof using Method of Moments
- Tower Detuning
- Intermodulation Studies
- Radiation Hazard Evaluation and Measurements

Fax (651) 784-7541 E-mail: info@owleng.com "Member AFCCE"

Switching Made Easy



SS 4.1 MLR/RJ Switcher/Router

The SS 4.1 MLR/RJ is a transparent four input, one output switcher/router with mechanical latching relays. The SS 4.1 MLR/RJ is perfect for all types of passive signal switching via front panel switches, contact closures and/or serial RS-232. The switching is accomplished with mechanical latching gold contact relays.



PHASETEK INC.

Custom Phasing Systems

Phasetek, Inc. is dedicated to provide the broadcast industry high quality AM Phasing and Branching systems, Antenna Tuning units, Multiplexers, and RF components.

Phone: 215-536-6648
sales@phasetekinc.com
www.phasetekinc.com

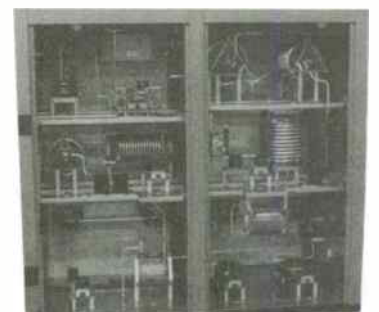

UNBEATABLE CLARITY & FLEXIBILITY.

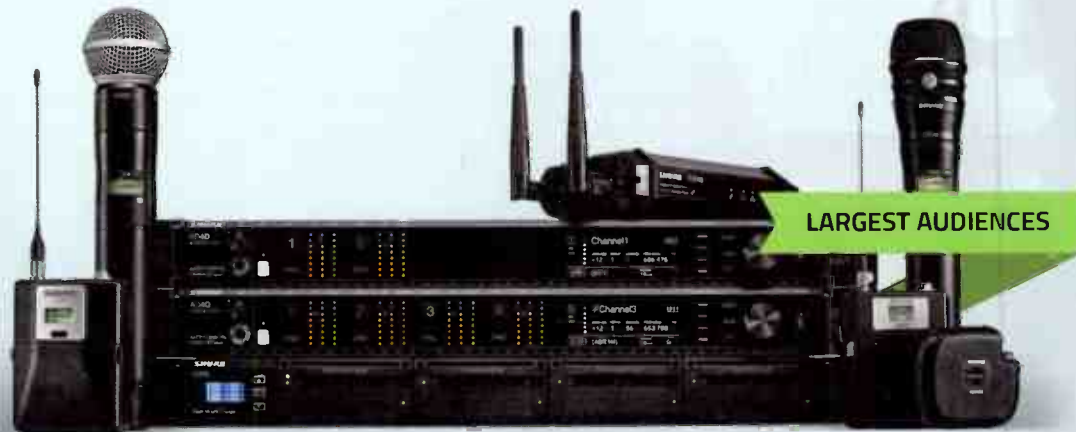

LARGEST AUDIENCES

Axient® Digital Wireless Systems

Engineered for performances commanding the highest degree of attention: complex setups, high channel counts, and constrained spectrum for major events and tours.



BROADCAST + PODCAST

SM7B Vocal Mic

Popular radio and TV mic featuring excellent shielding against electromagnetic hum.

Twin:Plex™ Subminiature Lavaliers

Stands up to the toughest conditions to make every word a clear statement of quality.

*New! TwinPlex™ TH53
Subminiature Headset*

SONG + SPEECH



Learn more at proaudio.com

or call us at (800) 433-2105 for more information.

PROAUDIO
•com

smart sound solutions