

# Radio Guide

Radio Technology for Engineers and Managers

May 2007

## Can Dissipaters Prevent Lightning Damage?

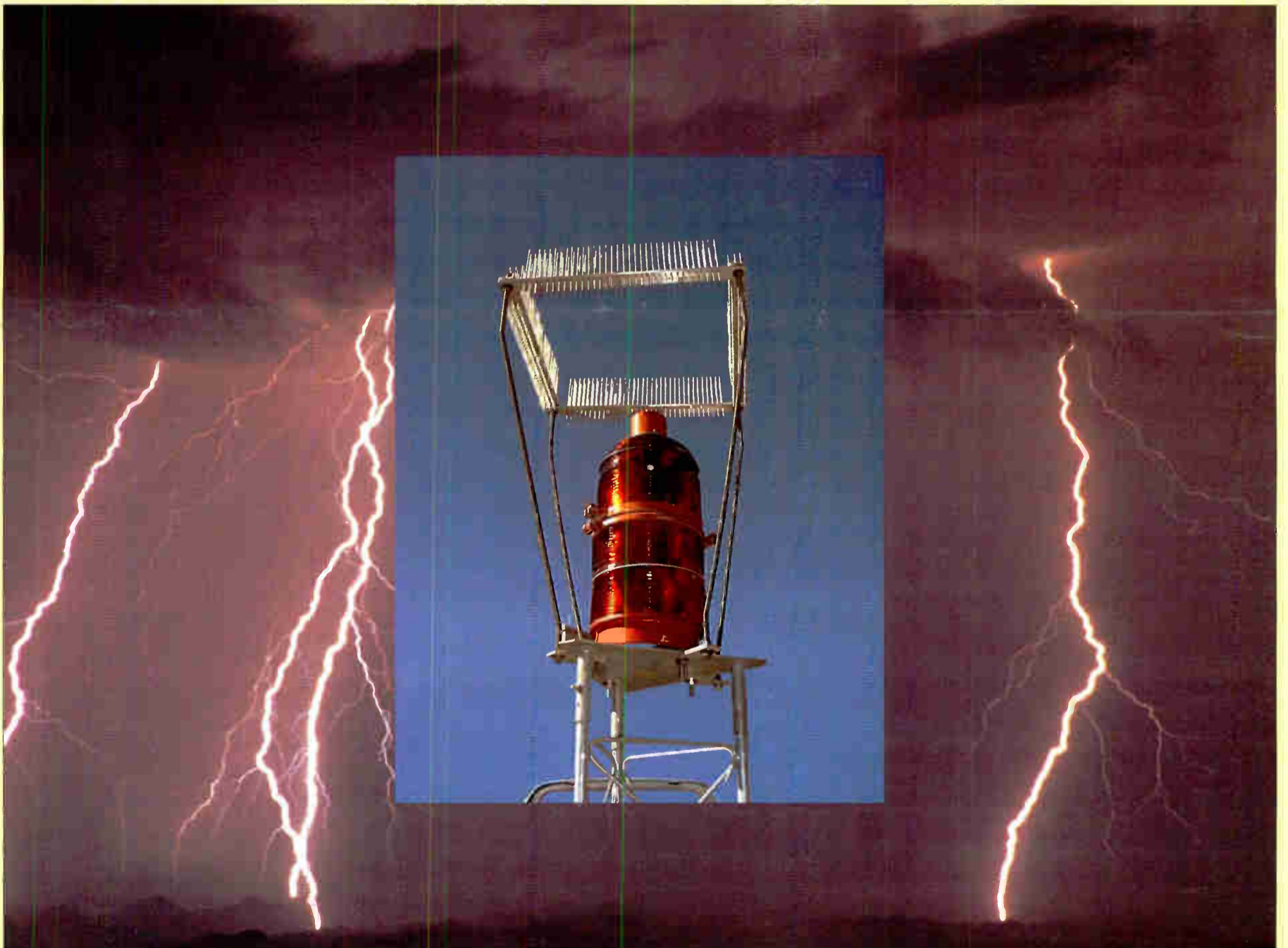

### Inside

Can Lightning Really be Prevented  
with Point Dissipation?

### Radio Guide

Page 4

As a thunderstorm approaches, the electric field between earth and cloud begins to increase. *This* is the time to begin to discharge this field. If the voltage can somehow be held to a value below that which is necessary to initiate a lightning strike, there will not be a strike.

A single lightning rod placed atop a tall structure will begin to discharge the field, but once its current capacity is exceeded, it may initiate an upward streamer that can cause a strike. If the goal is to *prevent* a strike and/or equipment damage at a location, the lightning rod may be the wrong approach.

**ACCESS**  
SUCCESS STORIES  
FROM THE FIELD.  
SEE PAGE 5

**COMREX**



# Don't Get Zapped!



**PowerClamp** surge suppressors clamp lightning-induced powerline transients to within a few volts of normal AC voltage!

**PowerClamp** will pay for itself by reducing expensive damage to transmitter site equipment caused by powerline spikes and surges.

Protect your transmitter and **Stay On The Air with PowerClamp!**



DISTRIBUTED BY  
**Broadcasters  
General Store**

[www.bgs.cc](http://www.bgs.cc)

**1-352-622-7700**



News • Talk • Sports • Music  
**BEST Satellite Automation in the Industry!**



- Simultaneously play & record (PCM, MP2/MP3)
- 24 liner decks for a live, local sound
- Watch windows for each commercial break
- Clock synchronization for perfect joins!
- Powerful features allow for complete control
- Pause & resume automation for live events
- Interfaces with all major traffic & billing software
- Buffered liners play correctly each time
- Control CDS<sup>32</sup> SAT remotely by phone or Internet
- Automate syndicated and local sports
- 24/7 product support available from the company made famous for fast & friendly support

"...our best decision to date was the installation of Pristine's CDS satellite automation system."  
William Ashworth, Owner  
WSHO, New Orleans, LA

Also available:

- CDS<sup>32</sup> music on hard drive
- Summit Traffic & Billing
- MusicPlus Scheduling
- Voice Tracking
- Digital Audio Logger



**Pristine Systems**

**25 years of  
Broadcast Automation**

[www.pristinesys.com](http://www.pristinesys.com) • 800.795.7234

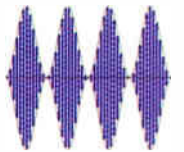

**Can Lightning Really be Prevented with Point Dissipation?** ..... 4

**RF Guide** ..... 8  
*AM – In Band, On Channel and Exactly on Frequency*

**Processing Guide** ..... 10  
*Part 4: The Present – Things are Changing*

**Studio Guide** ..... 14  
*Microphone Placement for Live and Studio Broadcasts*

**Audio Guide** ..... 18  
*Assessing Audio Handling – Analog vs Digital*

**Tech Tip** ..... 20  
*Building Pre-Wires for Major Equipment Installs*

**Heavy Metal** ..... 24  
*General Electric – The Early Years: Telegraphy to Telephony*

**Maintenance Guide** ..... 28  
*Risky Radio – Enabling the Gambler*

**Operations Guide** ..... 30  
*Cross Training from the IT Point of View*

**We Came, We Ate, We Talked** ..... 32  
*NAB, and the Lunch Gathering*

**The Worst I've Ever Seen** ..... 34  
*How Minimum Can an MPOE Be?*

**Radio War Stories** ..... 36  
*The Tale of the Haunted Transmitter Site*

**First Person** ..... 38  
*Helping Others to Reach Achievement*

**Pioneer Profiles** ..... 40  
*Harry & Walter Read: Oregon's Unconventional Radio Pioneers*

**Service Guide** ..... 44  
*Radio Equipment, Products, and Services*

**Radio Roundup** ..... 47  
*Radio Conventions and Events Datebook*

**Advertiser Info** ..... 47  
*Advertiser Website Information*

**Radio Engineering Services** ..... 47  
*Radio Contract and Consulting Services*

**Cover Photo**

*The Eagles Nest dissipation array, from Nott Ltd.*

## Radio Guide

Volume 15 – Issue 5

PO Box 20975, Sedona, AZ 86341  
Phone: 928-284-3700 Fax: 866-728-5764

**Ray Topp** (Publisher)  
Email: radio@rconnect.com

**Barry Mishkind** (Editor)  
Email: editor@radio-guide.com

Radio Guide, ISSN 1061-7027, is published monthly, 12 times a year, by Media Magazines Inc., PO Box 20975, Sedona, AZ 86341. Radio Guide is copyright 2007, Media Magazines Inc., and may not be copied, reproduced, or stored in any format, without the permission of the publisher.

A large part of radio technology is preparing for – and handling – the unexpected, whether it is a breaking news story, a local disaster, or ensuring the smooth operation of the transmitter plant, so the station does not drop off the air.

With summer looming, this is a good time to review the lightning mitigation systems at your facility. We continue our periodic look at different approaches. This month, on Page 4, we invite your consideration of Ron Nott's discussion of dissipation arrays.

Spring is also a good time to review the condition of the entire transmission facility. Our position is that every station should have a regular preventive maintenance program – and management should never try to "cheap out," especially on transmitter sites that are largely out of view.

There are far too many facilities out there that are in poor condition – with many of them just plain dangerous to the engineers tasked with maintaining them. Many are managed by what you would have to call Gamblers, as Jim Bender describes on Page 28.

It is also important to have the tools and training to handle the mission. As Drey Blevins shows on Page 30, this includes the IT folks, who often are asked to help or "cover" for the engineers.

One of the more satisfying things to happen this year was our first **AM Transmission Seminar**. Held in Orlando, FL in February, the program helped engineers better understand their systems, from the RF output through the antenna system.

In response to many requests, we are happy to announce we will repeat the program. Our second **Transmission Seminar** will be held in late September, in Charlotte, NC, just before the NAB Radio Show. A mixture of classroom instruction and opportunity for hands-on workshops is planned and more information is on Page 6.

We encourage you to make such education a part of your maintenance program. – Radio Guide –

# Broadcast Software

1-888-274-2721  
www.bsiusa.com

## Simian - Radio Automation

Fully automated or live assist play out software.

Suitable for radio stations, web casts, music-on-hold & retail outlets.



## Complete PC Systems

Ready to run, broadcast ready or retail play out systems.

Optional music, advert & promo scheduling software and remote control hardware.



## AudioScience Sound Cards

Multi-output, pro-quality sound-cards and tuners.

On-card processing and memory for glitch free playback & recording.



## SkimmerPlus Audio Logging

Advanced radio station or call-center logging with remote web playback.

Satisfies and exceeds the output logging requirements in many countries.



**Broadcast Software International**  
503 E. 11th Avenue  
Eugene, OR 97401 USA  
Direct: 541-338-8588  
Fax: 541-338-8656  
www.bsiusa.com sales@bsiusa.com



# Can Lightning Really be Prevented with Point Dissipation?

by Ron Nott

*The summer storm season is nearly upon us. Stations are checking their grounding and surge suppression systems, and wondering what else can be done. Can "point dissipation" provide an extra margin of safety from lightning? Ron Nott discusses the topic.*

After more than three decades of experience with this technology, what have we learned? Some users claim great success. Others disagree. Who is right?

## THE STORAGE AND DISCHARGE OF ELECTRICITY

More than two and a half centuries ago, the Leyden jar was invented. If you search its history, you will find that in most illustrations and photos, a round knob is affixed to the top terminal. Why the round knob?

This construction comes from the work of early experimenters who charged the Leyden jar with static electricity, which was high voltage and low current. The underlying principle is the same as when you shuffle across a carpet and touch a doorknob. The voltage can be as high as 35,000 Volts, but only a few microamperes of current are created – or you would be dead.

Experimenters of the eighteenth century learned that if a sharp, pointed wire were placed as the top terminal of a Leyden jar, the charge would rapidly dissipate into the air. But if a round knob were placed on the jar or the wire, the charge would be retained for much longer. Understanding the reason why this works will lead us to a better understanding of how to protect equipment from lightning.

### Sharp or Pointy Objects?

Early experimenters found that the larger the diameter of a sphere, the greater would be the voltage before corona began to occur. They found that a radius of one centimeter of the sphere would increase the corona threshold to somewhere between 35 and 55 kV. This was found to be a linear function so that a sphere of 10 cm radius (20 cm diameter) would begin corona discharge between 350 and 550 kV. When Tesla created artificial lightning more than a century ago, he simply built a sphere large enough to initiate corona at 5 million Volts.

Ben Franklin observed that a silent current flowed into the air above a sharp wire which led to his lightning rod. Seemed like a great idea, but why did it not work? It did work, but had limited capacity.

A single sharp point has a maximum current value that can flow from it. But when many points are placed in parallel with the *correct geometry*, the capacity is increased enormously.

## DEALING WITH LIGHTNING

As a thunderstorm approaches, the electric field between earth and cloud begins to increase. *This* is the time to begin to discharge this field. If the voltage can somehow be held to a value below that which is necessary to initiate a lightning strike, there will not be a strike.

A single lightning rod placed atop a tall structure will begin to discharge the field, but once its current capacity



Multiple points can dissipate larger charges.

is exceeded, it may initiate an upward streamer that can cause a strike. If the goal is to *prevent* a strike and/or equipment damage at a location, the lightning rod may be the wrong approach.

You can find information on the Internet stating that a dissipation system will not work, the writers often assuming that the field contains too much energy. However, a properly designed system does not wait for the field energy to reach this large value – it begins to dissipate the field *before* the buildup can reach the value necessary to initiate a strike.

## ENERGY POTENTIAL

We measure the energy contained in a lightning strike in Coulombs. Estimates from most lightning strikes range from 1 to about 50 Coulombs, but in the most extreme cases may reach 300 Coulombs. Typical is probably 5 to 10 Coulombs.

What is a Coulomb? It is a *quantity* of electrical charge consisting of a current flow of one Ampere past a point for one second. Since electric current consists of electron flow, the number of electrons in one Coulomb is approximately  $6.25 \times 10^{14}$  to the 14th power. This is a very big number, but it is a *finite number*.

As an example, suppose we have a 120 Watt light bulb which, when connected to a 120 Volt AC power source would have a flow of one Ampere through it. This means that in one second, one Coulomb of electrons would flow through it. In 30 seconds, 30 Coulombs would flow through it.

## DAMAGE POINT

If a lightning strike of 30 Coulombs occurs, why does it do so much damage? Simply because it occurs in such a short time period.

A typical strike happens in only 20 to 50 microseconds. If the same energy discharge could be spread out over even a few minutes, there would be no damage. This is how and why multiple point dissipation works, by discharging the same energy into the air over a longer time frame than lightning does.

You can find information on the Internet stating that the energy in a lightning strike can light a 100 Watt bulb for a long period of time, but this assumes millions of Volts at one Ampere, which is just not the case.

The reason why is that a Coulomb is a finite number of electrons and multiplying 10 million Volts times one Ampere does not result in 10 million Watts.

## DISCHARGE POINTS

An important point to remember is that as the electric field builds prior to a storm, it builds not just on the top of a tower, but from the ground up.

This means that while the top of a tall structure should be protected, the sides also need protection as side strikes may occur including those on guy wires. A Rule of Thumb is that dissipaters should project from the sides of the structure about every 200 feet to adequately discharge the structure.



The Eagle's Nest from Nott Ltd. Intended for tall towers, the points are bent, on site, to make shipping and installation easier.

## ANECDOTAL EVIDENCE

While some may discount the value of anecdotes, many are of great value at times. Here is one.

About 20 years ago, a dissipation system was installed on a tall TV transmission tower (more than 1,000 tall). After one thunderstorm season, the chief engineer called with a complaint. He said that the system had eliminated lightning damage to his site, but then asked if it possibly could have helped his competitor stations as well because their lightning damage had also been eliminated.

It turned out that several tall towers were located in an east-west row and his was the farthest west. The prevailing winds at that site during storms are from the west. I explained that the dissipater points generate plasma and, as a result, an ion cloud was carried downwind and apparently protected the towers to the east.

The engineer was not pleased to hear this (one must assume there were hard feelings between the stations) and asked what he could do. I told him the only solution that would protect him and remove protection from his neighbors would be for him to move his tower downwind from the others – and this, of course, was not acceptable. The competitors were happy, though.



Different adaptations of multiple point dissipaters.

## DEALING WITH AN ANTENNA GUY WIRES

You may have been near an AM transmitter site when lightning struck some distance away. If so, you heard crackling, like popcorn popping. This is because each segment of guy wire between insulators takes on a charge like a capacitor floating in air. A lightning strike nearby causes them to discharge across the insulators which causes the crackling sound.

Many years ago when guy wires were terminated with Crosby clips instead of modern preforms, an old tower erector told me that when he put together segmented guys for an AM station, he would use 10 or 12 excess guy wires at each insulator. Then before they were hoisted up, he would flare the excess lengths outward so that they could dissipate the charge into the air. It worked very well. No popcorn sounds were heard.

Down in the tropics of southern Mexico, another AM station had a terrible time with this problem. We fabricated some 42 small dissipaters that were attached to the guys adjacent to the insulators. This solved the problem completely.

However, please note that you cannot get American tower climbers to trolley down the guys to install dissipaters on them; OSHA would likely frown on such activity. Nevertheless, several more Mexican stations have used this same solution with success.

## SAFE RELEASE OF ENERGY

So after all this rambling, it can be seen that the science is there to greatly decrease damage from lightning. The reason that lightning does damage is not because it has massive energy, but that the energy is released in such a short period of time.

How energy is released is the key. We all use gasoline in our vehicles and prolong the release over a relatively long period. But a gallon of gasoline evaporated in a container that also has the proper quantity of air can result in a rapid, powerful, and damaging explosion.

Without doubt, there are those who will always believe that nothing can be done to prevent lightning damage. But those with open minds, willing to pursue the facts of how charge transfer by point dissipation works will realize that, with proper design and application, it can decrease damage from 95 to 99 percent.

Ron Nott operates Nott Ltd. in Farmington, NM, where he provides a wide array of tower systems and services. Contact Ron at ron@nottltd.com

Impossible Remote?  
Nah, You've Got ACCESS.



## Meet Some Real-World Super Heroes...

Mark Ericson and the WOKQ morning team, along with Steve Vanni from Technet, recently used ACCESS to deliver a three hour remote from the top of Mt. Washington. For mere mortals, this would have been an impossible task. The height, the weather, the distance – all conspired to prevent a successful remote. But because they carried ACCESS, they became real-world super heroes.

ACCESS delivers mono or stereo over DSL, Cable, Wi-Fi, 3G cellular, satellite, POTS (yep, ACCESS is a full featured POTS codec and works seamlessly with Matrix, Vector and Bluebox)—plus some services you may not have even heard of. Given the challenges of the public Internet, it's no small boast to say that ACCESS will perform in real time over most available IP connections.

Want to learn more? Contact Comrex to get a FREE booklet that explains ACCESS BRIC technology and how it differs from traditional IP codecs. Become a real-world super hero!



**ACCESS  
PORTABLE  
NOW  
SHIPPING!**  
[www.comrex.com](http://www.comrex.com)

Read more stories of real-world super heroes at [comrex.com](http://comrex.com):

- Springfield, MO: Miraculous ACCESS
- San Diego, CA: Somewhere... Beyond the Seal
- Boston, MA: Zakk Wylde Concert—Ozzie Osborne's Guitarist Plays for WAAF at a Listener's Workplace!
- Lynn, MA: Toys for Tots—Remote on the Move
- Boston, MA: Car Dealerships at Christmas. ACCESS Delivers.
- UK: ACCESS on VSAT—A Clever Solution From Our Friends in the UK
- Cancun: Sunrise Over IP
- Brackton, MA: Minuteman Communications Always Gets Their Man... um... I Mean, Their Remote
- Alpena/Tawas City, MI: Are You Tired of STL-Over-the-Public-Internet Stories Yet?
- Dallas: The Ticket
- Amarillo, TX: You Gotta Do What You Gotta Do
- Asia: Radio Free Asia - Live From the Himalayas
- Way Up In The Sky: Live From 37,000 Feet

Are YOU a real-world super hero? Log on to [comrex.com](http://comrex.com) and let us know how you've used ACCESS to save the day at an impossible remote!

Toll Free: 800-237-1776 • [www.comrex.com](http://www.comrex.com) • e-mail: [info@comrex.com](mailto:info@comrex.com)  
19 Pine Road, Devens, MA 01434 USA • Tel: 978-784-1776 • Fax: 978-784-1717

Put Comrex On The Line.  
**COMREX**

# Radio Guide 2007

## AM Transmission Seminar

*The System from Transmitter to Tower*

Three Days of Training Including  
Hands-On with Actual Hardware and Networks

Details at: [www.radio-guide.com/seminar](http://www.radio-guide.com/seminar)

### Seminar Dates:

Sunday - Tuesday  
September 23-25, 2007  
Charlotte, North Carolina

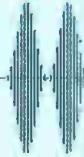

### Instructors:

Phil Alexander, CSRE, AMD  
Alan Alsobrook, CSRE, AMD

#### Learn What You Need to Know

- Transmission Lines
- Non-Directional Antennas
- ATUs and Matching Networks
- Directional Arrays and Phasors
- Hands-On Time With Networks
- Practical Information and Tips
- Question and Answer Session
- FCC Rules and Regs for DA's



#### Reservations Available Now

**\$495 Each**

[www.radio-guide.com/seminar](http://www.radio-guide.com/seminar)

Includes all materials, lunch for all three days, a digital multimeter, and a great experience.

#### Spend a Week with Radio

Our Transmission Seminar will be held prior to the NAB Fall Radio Show in Charlotte, North Carolina. Spend Sunday – Tuesday with Radio Guide then stay Wednesday – Friday for the NAB Radio Show.

the professional broadcaster's  
choice for **IP STLs**

WorldCast Eclipse



**At last! An IP audio codec that offers a reliable, DSP-based platform and automatic back-up for 24/7 reliability.**

APT's WorldCast Eclipse is the ultimate in flexibility and choice offering IP, X.21/V.35 and ISDN interfaces and a selection of popular coding algorithms including Enhanced apt-X, MPEG Layer 2/3, MPEG 4 AAC, G.711 and G.722

All the features you expect from a professional broadcast codec are supplied as standard: analog and AES/EBU I/Os, adjustable silence detection, alarm ports, contact closures, speed dials, embedded auxiliary data and many more...

Configuration and control of the WorldCast Eclipse is straight-forward and simple thanks to APT's powerful and intuitive Codec Management System (CMS). Offering extensive real-time management of multiple codec units, the CMS enables alarm monitoring, logging and performance monitoring as well as configurable user and audio profiles.

To see the full functionality of CMS, download a trial version from [www.aptx.com](http://www.aptx.com).



Also Available:



**WorldCast Horizon**  
Bidirectional stereo audio codec offering Enhanced apt-X over IP



**WorldCast Meridian**  
Multi-algorithm audio codec with both IP & X.21/V.35 interfaces

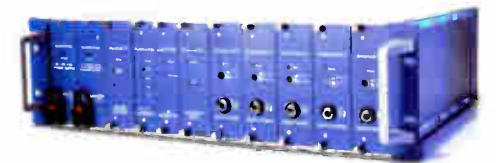

**WorldNet Oslo**  
Professional, Modular Audio Multiplexing Platform offering up to 14 stereo channels over T1/ E1 or IP links with Enhanced apt-X or linear audio. Built-in redundancy, automatic back-up and hot-swappable cards ensure round the clock reliability for multi-channel STLs.

APT Headquarters  
Tel: +44 (0)28 9037 1110  
Email: [info@aptx.com](mailto:info@aptx.com)

APT North America  
Toll Free: 800 955 APTX  
Boston Tel: 781 810 2260  
Florida Tel: 772 340 0850  
Email: [sales@aptx.com](mailto:sales@aptx.com)



[www.aptx.com](http://www.aptx.com)

# Wireless Broadband Internet Remotes



*"The first time out with the Tieline was a brilliantly simple experience for everyone involved. For lack of a better phrase, the codec just worked."*

- Christian Vang  
Chief Engineer  
Clear Channel St. Louis



*"The codecs sounded great. My management was very, very impressed with the demos"*

- Grady Jeffreys,  
Technical Manager,  
Mackay Communications



*"The remote was a spectacular success, in no small part thanks to the flawless sound which the Tieline G3 provided over the public Internet"*

- Mike Rabey  
Chief Engineer  
Entercom Indianapolis



**Get Free demo codecs delivered to your door Now!!**

**Tieline**   
www.tieline.com

**800-780-4750**

\*Compatible with Comrex Matrix, Blue, Vector POTS Codecs Comrex is a registered trademark of Comrex corporation

by Phil Alexander

## AM – In Band, On Channel and *Exactly* on Frequency

Stephen Smith thinks if every AM station spent about \$1,500-\$2,000, the useful range – especially the nighttime range – of AM stations could be extended – and extended by a large factor.

### AN UNUSUAL PRESENTATION

His entry on the NAB Engineering Conference agenda announced, “A Precision, Low-Cost GPS-Based Synchronization Scheme for Improved AM Reception,” to be presented by Stephen Smith from Oak Ridge National Laboratory at 4:30 p.m., Sunday afternoon.

Oak Ridge began as part of the Manhattan Project that built the first nuclear bombs during World War II, and has evolved into an advanced research community run by the U.S. Department of Energy. So, my first thought was what does Oak Ridge have to do with radio? And why?

Sunday, at 4:30 p.m. is not the best time for presenting a topic to the NAB Engineering Conference. Many of the potential audience are still in transit to Las Vegas on Sunday, and at that time of the afternoon, the thoughts of some, perhaps many, have probably turned to making their choice of buffets open for dinner that evening. In short, it is not the best time to expect a large, attentive audience. However, my curiosity won the battle and I found myself in the sparse NAB South Hall audience for the presentation.

### USING GPS TO IMPROVE AM

The answer to the, “What does Oak Ridge have to do with radio?” question is in Stephen Smith’s title. He is, more properly, Dr. Stephen F. Smith, Ph. D.; Director, Position, Navigation, and Timing Program; RF and Microwave Systems Group; Engineering Science and Technology Division; Oak Ridge National Laboratory (operated for the U.S. Government by Battelle).

In other words his interest not so much about radio itself, as it is about GPS and what GPS may be able to do for AM radio by synchronizing all AM signals to a single, extremely stable, frequency standard.

Smith’s idea is a simple one. If all AM stations operated on synchronized frequencies, the “deep fade” or co-channel phase cancellation interference that frequently limits nighttime listening and is a major tune-out factor after sunset, would vanish.

### What is a “Deep Fade?”

When two or more co-channel stations interfere in a zone of more or less equal strength with carrier frequencies nearly, but not exactly the same, deep fades will be heard in the receiver.

For example, if station “A” is 0.75 Hz higher in frequency than station “B,” at one and a half second intervals, when the signals are near 180 degrees out of phase, the combined signals will cancel, or nearly cancel, to the extent that only background noise or other weaker stations will be heard for a fraction of a second.

The situation is even worse when one of the signals is more or less listenable, as it might be if you were trying to pick up the final minutes of your favorite team battling it out with their arch rival. Perhaps the station carrying the game has a signal only 10 or 12 dB greater than the interfering signal, except, regular as clockwork, at 1-1/2 second intervals the signal nearly disappears and the automatic gain control in your radio goes to full gain followed by the signals returning to their previous state for a little over a second until it happens again, over and over and over.

The original reason for clear channels in the early days of radio was having stations that could give nighttime skywave service without the interference caused by deep fades at short intervals that would result from multiple stations transmitting on the same channel.

Smith readily agrees there would be underlying interference from co-channel stations, but not the one or two Hertz “deep fade” that can make listening to a weak AM so objectionable shortly after the nighttime power reduction or pattern change that often creates many weak signal areas.

### TRANSFORMING INTERFERENCE ZONES

Ideally, “deep fades” would be transformed into a phase interference cancellation zone beyond the useful listening limit of the stations, but the benefit would substantially increase within that limit.

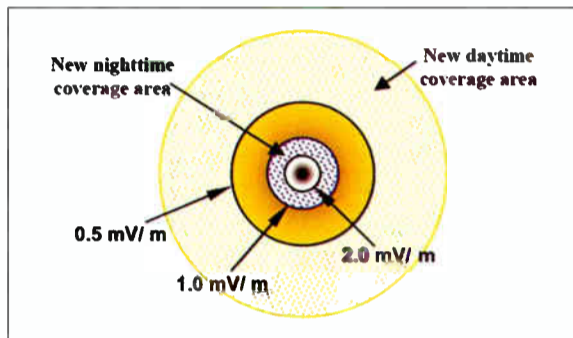

Effective synchronous day/night interference-limited coverage improvement.

Smith’s test recordings seem to prove the point, but he is the first to admit the need for more field testing, such as is planned for this summer.

This idea also seems to offer some possibilities for closely spaced Class C stations where deep fades can impair listening during daytime operation, but the useful coverage improvement versus loss to the phase cancellation zone needs more clarification. That should come with more testing.

### DEVELOPING A DIALOG

The big stumbling block for using frequency synchronization is that all stations on a frequency must be synchronized or the effect is lost. If any signal, even a weak one, is not synchronized with all others, periodic phase cancellations will result.

Thus, for successful deployment, either all stations on a frequency must agree to synchronize their frequencies, or the FCC must mandate synchronization. One major equipment manufacturer is ready to produce GPS locked frequency synthesizers that will reportedly sell for about \$1,500, but Dr. Smith says his limited contact with the FCC indicates they look at the idea of mandates unfavorably.

The main idea of his presentation was asking the broadcast engineering community to look at the possibilities – to make us aware of them – and to generate interest in frequency synchronization.

Smith is the first to admit that there are other interference problems he cannot solve such as power line interference, BPL and other terrestrial noise that plague the AM band. But it is clear he believes elimination of co-channel interference fading would be an inexpensive start to improving performance of stations on the band today and would also improve digital performance in the future.

### POTENTIAL BENEFITS

The benefits of frequency synchronization seem greatest at night on regional channels where some stations have tight patterns and low nighttime powers, or both.

Consider a station with severe minima (nulls) where “deep fading” interference is a fact of life in those low signal areas – and the number of listeners that tune out at the first signal loss. Also, consider listeners in rural areas where all signals are weak. In both these cases, frequency synchronization offers very interesting possibilities.

There is no FCC Rule prohibiting stations from synchronizing their frequencies on a single channel. Where only a few stations are on a particular frequency at night, they could agree to synchronize right now and each might benefit. All the FCC requires is meeting 73.1545(a) which requires AM stations maintain their assigned frequency +/- 20 Hz.

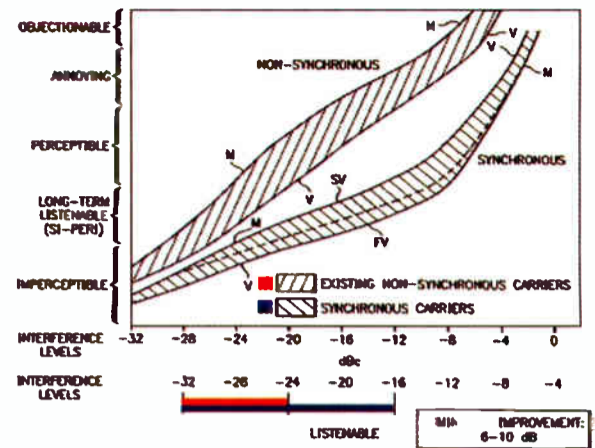

Audibility of synchronous vs. non-synchronous interference.

One thing experienced audio processor “tuners” will notice is that Dr. Smith’s concepts of “music” and “voice” readily translate into modulation density of the desired and undesired signals. Thus, in an unsynchronized world high modulation density makes deep fades more objectionable, while in a synchronized environment, high modulation density also gives the listener the equivalent of a higher desired/undesired signal ratio.

The dotted line in the synchronous section of the graph shows how modulation density affects listener perception as the D/U signal ratio approaches unity. The gain from modulation density is additional to the 6 to 10 dB minimum decrease in desired carrier that will permit satisfactory listening when deep fades are eliminated, assuming other interference is absent.

This increase, along with the other potential benefits of synchronization, makes Dr. Smith’s idea a very interesting one.

### ADDITIONAL BENEFITS

In fact, GPS synchronization might be only the beginning of better service.

For many years a few stations have intentionally operated near the limits of their frequency tolerance, perhaps 15 or 17 Hz above or below their assigned frequency to avoid the “deep fade” phenomena by increasing its rate into an inaudible range. With GPS synchronization, introduction of fixed offsets might reduce or eliminate some of the phase cancellation zones between two or three stations thus extending the useful nighttime range into areas where useful service does not now exist.

For example, suppose three stations create co-channel interference to each other and each is a primary contributor to increasing the nighttime interference free (NIF) coverage of the others. If these stations agreed to synchronize according to the idea developed in the Oak Ridge program, zones of phase interference would exist at some level of desired versus undesired signal.

However, consider the possibilities if they synchronized and also offset their frequencies with one station on frequency, another at 15 Hz above frequency and the third at 15 Hz below the nominal channel frequency. With GPS synchronization, this is not a difficult task – and the result is the “deep fade” cancellations would occur, but at an inaudible rate.

### LOOKING TOWARD DIGITAL

At some point, for the benefit of digital transmission, synchronization of all stations on channel, on frequency, probably would become necessary for preventing damage to the digital information. But that day may be some years away.

In the meantime, clever use of GPS synchronization might let us have our cake and eat it. It is a possibility that might bear further investigation. The outcome of the tests of on-channel frequency synchronization this summer is sure to be interesting. Stay tuned.

A regular contributor to Radio Guide, Phil Alexander is a contact engineer and consultant based in Indianapolis, IN. Contact Phil at [dymotherm@earthlink.net](mailto:dymotherm@earthlink.net)





# Meet The New Innkeepers (they're a very functional family)

We've refined our innkeeper 1(x) line, gussied it up, gave it some great new features, expanded its family AND lowered the cost!

Why take a successful line like the innkeeper 1 and change it? Because we knew we could make it better AND lower your cost!

For starters, we've combined the features of the innkeeper 1 and the innkeeper 1x into a single hybrid that's more than the sum of its parts. As with the original, the new innkeeper 1x is a full-featured phone line interface which uses a proprietary dual-convergence echo canceler algorithm. It's designed to achieve excellent separation without any setup, and without sending

a noise burst down the line. Plus, we've added an RS-232 connector for remote control applications and made them globally-compliant.

For remote control, we've now got two compatible products. The **Guest Module 1** gives you remote access to the on-hook/off-hook and dial features of the innkeeper 1x series digital hybrids, using an 8 pin RJ45 modular cable.

The **RIU-IP** interface contains a web server which allows you to send and receive control data

through your web browser. It can be connected to your computer NIC card for direct control, to a switch or hub for network control, or to an ethernet port with internet access for control from anywhere in the world.

Innkeeper 1x is more than a facelift. More than an upgraded feature set. It's a comprehensive, streamlined hybrid environment that gives you the tools you need to control it from anywhere. Visit us on the web or give us a call to learn more about innkeeper 1x.

## JK Audio

TOOLS FOR SUCCESSFUL RADIO

JK Audio, Inc. Sandwich, IL 60548 USA • Toll Free: 800-552-8346 • Tel: 815-786-2929 • Fax: 815-786-8502 • www.jkaudio.com • info@jkaudio.com

www.jkaudio.com

# AM Multiplexed Directional Antenna Systems For The Digital Revolution



**Directional Antenna Phasing Systems**

*The way they ought to be...*

**WFLF - AM 970  
50/46 KW DA-2**

**WQTM - AM 740  
50 KW DA-2**

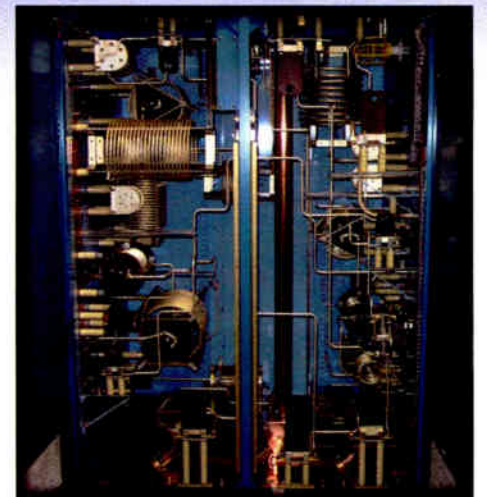

**Interior Craftsmanship  
Synonymous With Kintronic Labs**

**Built by Kintronic Labs for Clear Channel  
Communications, Tampa, Florida**



**Kintronic Labs, Inc.**

**Nobody Does It Better!**

423.878.3141 fax 423.878.4224 Email: ktl@kintronic.com www.kintronic.com

# Processing Guide

by Jim Somich

## Processing: Yesterday, Today, and Tomorrow

### Part 4: The Present – Things are Changing

Before his recent death, Jim Somich was very interested how audio processing has changed over the years – but even more so in considering what is to come in the future. In preparing these articles, Jim spoke with many folks involved in designing and building processors.

Last month, a “virtual roundtable” discussion featured Bob Orban’s and Frank Foti’s comments on how their products brought us to where we are today. As we continue the discussion this month Cornelius Gould joins the table.

#### LEARNING FROM OTHERS

**Jim Somich:** Cornelius Gould is a guy just starting out designing a DSP box, but I know he has been working in analog for years. Corny, who are your gurus? Who influences your processing ideas?

**Cornelius Gould:** Several people have influenced me over the years – definitely Steve Church and Frank Foti. Both of them are examples of how ordinary engineers with a dream can take them and grow them into a life-style. They also show the joys of having to continually raise the bar on what they do, aim to top that, and reset the bar again.

Others include the work of Glen Clark, Bob Orban (what current processing geek has not been influenced by him?) and Mike Dorrough.

The thing I admire about Glen Clark’s work is that he showed us another way to



Cornelius Gould

look at audio processing control system design. For me, his work on the Audio Prism showed me to never be afraid to look at audio processing from a different angle. Just because an idea is a radical departure from what was done before does not make it bad.

My other influences have come from my contact with various end users over the recent years. As you and many others are aware, I’ve been heavily focused on trying to teach the new generation of end users how to use audio processors. I’ve done a few seminars on the topic at a couple of state broadcast conferences. Out of this work came some ideas on different approaches to user interaction with an audio processor.

#### THE PATH FROM ANALOG TO DIGITAL

**Jim Somich:** What is your DSP experience? How do you operate? What development systems do you use?

**Cornelius Gould:** I’ve dabbled off and on for about 10 years with DSP development systems. I’ve been heavily researching DSP concepts and developing new ideas that can only be done with the power of DSP.

**Jim Somich:** Do you have a current DSP project? Can you talk about it?

**Cornelius Gould:** Currently, I’m working on new ideas that I couldn’t do in analog. Namely, having the audio processor be smart. Since we are basically dealing with computers, whether it be a

hardware-based DAP box, or in PC software. Why not take advantage and really build some “intelligence” into the audio processor?

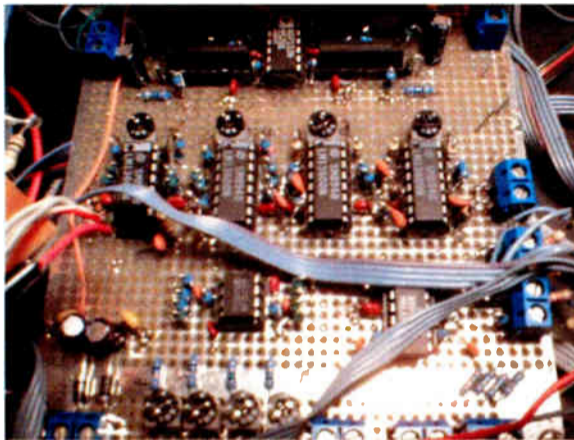

Corny’s early op-amp based audio processor. Dubbed the “Audio Chameleon,” it brought distinctive audio to several Cleveland FM stations.

Since a lot of what I’m working on hasn’t been tried in any existing processor yet, I naturally won’t elaborate more on this. You never know what I may do with these new techniques!



The “Internet Chameleon,” used VCA technology and some lessons learned while at Telos/Cutting Edge.

**Jim Somich:** What, in your opinion, is the current state of audio processing and what do you see in the future? Are you doing anything with processing for HD Radio?

**Cornelius Gould:** The bulk of what I’m experimenting with applies *directly* to HD Radio and any other “coded audio” based content delivery system. For almost ten years, I have been running various streaming stations on the Internet. In my natural effort to make them sound their best, I have been developing a steady stream of tools to deal with coding artifacts.

As luck would have it, the new wave of digital broadcasting could be described simply as “streaming audio over RF.” Almost overnight, it seems, there are suddenly lots of outlets I can throw my ideas at.

**Jim Somich:** Thank you, sir. I’ve got a feeling we will be hearing more from you in the future.

#### PROCESSING IS A REFLECTION OF THE TIMES

Challenges to broadcasting are everywhere, from iPods to satellite radio to Internet Radio – and to some new gadget or gizmo that is just over the horizon. The way things have been going over the past decade, it even might appear that free over-the-air terrestrial broadcasting has a target painted on its back.

Processing is not the most important thing in broadcasting; that honor probably goes to “compelling content.” Horribly processed stations have become successful due to great programming and sales. On the other hand, never have mediocre stations made it to the top just because they sounded great. But we are here to discuss the state of the processing art today, not programming, sales, or promotion. We leave the rest for others to analyze.

Nevertheless, everything is intertwined and co-dependent. You cannot discuss the general state of processing without considering the general state of broadcasting – and broadcasting has been in better shape. In my opinion, although we have the finest processing tools in history, we currently are doodling rather than painting Van Goghs!

#### A WINNING COMBINATION

The “magic” created by a #1 station is worth a quick analysis. I think back to the 70s and 80s and my time at WMMS, “The Buzzard” in Cleveland. It was the #1 station in Cleveland with boxcar numbers and #2 was not even close. Arguably, it was the best rock station in the country.

We certainly had compelling content. Program director John Gorman and founding jock Denny Sanders lived and breathed “The Buzzard,” and you could certainly sense their passion on the air. Promotion Director Dan Garfinkel had the magic touch when it came to getting the word out and promoting everything WMMS did. Walt Tiburski and a crack sales department were able to command spot rates previously unheard of in the Cleveland market.

The job of processing the station fell to me. In those days, the programming department had virtually no input as to the sound of the station and I was given free rein to try anything that I felt would give the station an edge. In a situation like this cost is no object, but this also can be a trap: with so many choices, it is easy to lose sight of the goal and experiment a little too much. Then you make wrong choices and the station never settles into a solid sound.

#### MAJOR CHOICES

Great Sound can make an average station a little better and an above-average station outstanding. But, like most big events in life, I had no idea at the time how important my choices were to the success of the station. I was just doing my job to the best of my abilities.

We did not talk about “sonic signatures” in those days, but that was something for which we strived. Raw loudness was important, of course, but also a signal that jumped off the dial, and with a consistency and a big sound that made an emotional connection with the listener. These were all components of the ‘MMS sound of the 70s and 80s. Yet, the tools I had to work with were crude by today’s standards.

At one point, I designed my own FM processor because I could not find anything else that gave me the sound that I was seeking. Many engineers have been in a situation where no commercial product would work as well as their own box; some of these creations even have led to successful commercial products.

#### PASSION

Permit me to side-track a bit for just a moment.

At WMMS, we mocked our competition on and off the air and they ate our exhaust fumes as we stayed in the #1 position book after book. John Gorman had pet names for all the competing PDs, and never lost an opportunity to rub their noses in our success. It was his mind game and it worked; WMMS became legendary.

People visited our studios just to see how it was done. Often they were disappointed; the equipment was nothing special. But the spirit of the Buzzard was not about fancy studios or luxurious offices – it came right out of the gut and hit the listener right in the brain, making an emotional connection that was difficult for many outsiders to understand or duplicate.

On every level and in every department WMMS was a group of hippies with a passion to win, who were doing what they loved, and did it very well indeed. WMMS made a lot of money for the station’s owner.

Why do I dwell on this? Maybe it is because I think this passion and spirit often is missing in

(Continued on Page 12)

# Get "In The (Talkback) Zone"!



Use up to 12 Guest Pods in any combination

The new **MultiPhones II** multi-user headphones system now has **Zoned Talkback!**

Use separate Guest Pod **Talkback Zones** for Host, A-Guests, and B-Guests. Talk to each group without bothering the others!

For complete details 626.355.3656 or visit [www.henryeng.com](http://www.henryeng.com)

- Easy upgrade for existing systems
- Simple "daisy chain" installation
- Uses cat5 cabling

Get MORE MultiPhones for LESS cash! The new lower price is just \$250\*. In stock at all Henry Engineering dealers.

**We Build Solutions**



\*Price is for MultiPhones II Master unit; Guest Pods sold separately.

# Processing Guide

Continued from Page 10

## Processing: Yesterday, Today, and Tomorrow

today's corporate, highly-consolidated, focus-grouped, cookie-cutter, voice-tracked, satellite-networked broadcasting industry.

### BACK TO PROCESSING

But what does all this have to do with audio processing today? Hey, we are engineers. We install and repair equipment and read technical magazines. Right? Is that a description of you?

Today, the sole engineer of a cluster of stations does not have the time to experiment with the fine nuances of audio processing. He does not have the time to just listen and think creatively about the sound. Yet, it is this experimentation that produces breakthroughs in broadcast sound.

Sadly, I think we engineers – some of us – are actually losing the ability to listen creatively. The digital processors of today are amazing machines that can perform exceptionally well using one of the supplied presets. There is a great temptation to punch up a pre-packaged preset and let it ride. After all, there are a thousand tasks on your to-do list.

### A LACK OF PASSION

Worse, with so many stations owned by so few corporations, there is less need to trounce the competition – which is often a sister station!

This lack of competitive spirit can even extend to processor manufacturers who, at one time, were at war with each other, publicly and privately, and the result was a better product. The attitude today seems much more laid back and comfortable. Good for the blood pressure, but maybe not so good for the state of the processing art.

Down and dirty competition is not polite, and it is not neat. Life in the trenches is never comfortable. What used to be war has become pleasantries and getting along. I believe something is lost when you let your guard down and think of your competition as anything but “the enemy.”

### PRESCRIPTION FOR SUCCESS

If radio is to make a big comeback – and I think it will – it will require improvements on every level: programming, promotion, sales, and engineering. And the station “sound” just cannot be ignored.

At this point we should have a much better picture of our present situation: why and how we got to where we are now.

- In the 40s and 50s, stations scrambled to control audio.
- In the 60s, everyone used the Audimax/Volumax system.
- In the 70s, DAPs dominated.
- In the 80s, it was Optimods.
- It is no different today. Anyone who can afford a ten kilobuck (plus) box

has an Omnia or an Orban digital processor. Many users are using a stock preset or something close to it.

Back in 1992, Bob Orban declared that processing was a mature craft. What he meant was that in 1992 processing was a mature analog craft, because we were on the verge of something totally new: the digital revolution in processing.

In Orban's view, the distance between processing in 1992 and 2007 is far smaller than the distance

between processing in 1960 and the processing in 1992. This was demonstrated by the number of stations that kept their analog systems (like the Optimod 8100) on the air until very recently because, as Orban relates: “they felt it was not until version 3.0 of the 8400 that DSP-based processing was clearly superior to the 8100 + XT2.”

And here is the key point: Orban continued: “While I don't happen to agree with that point of view, that's OK – processing comes down to preference, and not everyone's preference is the same as mine.”

Preference. How each person hears and perceives audio. This will lead us to the next part of our discussion.

*Jim Somich's career included positions as a major market Chief Engineer, Director of Engineering for a group owner, and as the designer of a number of products, including the FlexiMod FM Processor.*

# The best use the best.™

# 9000 stations 100 countries

## Welcome to the World's largest broadcast software company



Visit us at [www.rcsworks.com](http://www.rcsworks.com) or [www.prophetsys.com](http://www.prophetsys.com) Email us at [best@rcsworks.com](mailto:best@rcsworks.com)

© Copyright 2007, RCS, Inc. All Rights Reserved. RCS, RCS Sound Software, the featured product names and their logos are registered trademarks, or trademarks, of RCS, Inc.

New Broadcast equipment at exceptional prices.

Quality pre-owned equipment.

Customized automation systems.

Complete turnkey installation

Console pre-wiring packages.

Broadcast equipment repair.

Complete engineering services.

Studio design and project management.

Lightner Electronics Inc.  
Your Ultimate Solution.



Toll Free: 866-239-3888  
Fax: 814-239-8402  
www.LightnerElectronics.com

# the PETER DAHL CO. for custom transformers

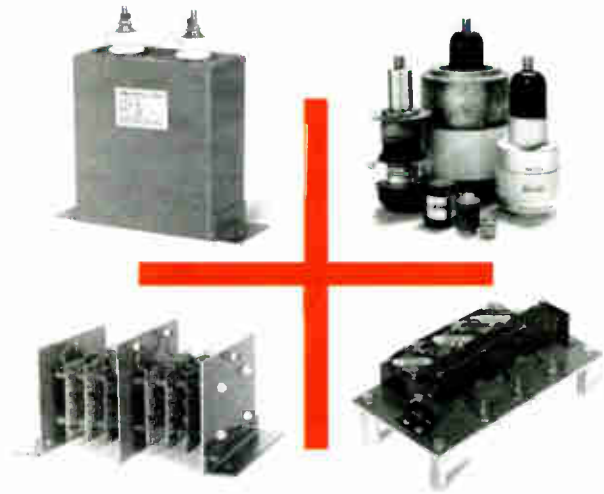

DC filter capacitors • variable capacitors  
custom rectifier assemblies • transient suppressors  
and then some...

**Peter Dahl Co.**

write or fax for an extensive catalog

915 751-2300 • fax: 915 751-0768 • 5869 Waycross • El Paso, TX 79924  
www.pwdahl.com • pwdco@pwdahl.com

**Wizard 4 Windows**  
now brings  
**Multi Station**  
**Monitoring**  
to your desktop  
with true multitasking

www.belar.com 610-687-5550  
Email sales@belar.com

**BELAR**  
"When accuracy counts, count on Belar."

See our interactive demo at [www.belar.com](http://www.belar.com)

The screenshot displays a Windows desktop environment with several open windows. On the left, there are three 'WizWin' monitoring windows for stations: '36.3 WHYY', '63.9 MODULATION', and '58.1 WOGL'. Below these is a 'WizWin' control window for '102.7 MODULATION'. On the right, there are three 'FMMA-1 TOTAL Bar Graph' windows for 'Rack1', 'Rack2', and 'Rack3', each showing a percentage bar and statistics: PEAK 107.4%, AVE 94.2%, and MIN 51.0%. At the bottom, there is a detailed control window for 'RFA-4' with fields for '610.1 WDEB', '107.4 MODULATION', '109 LEFT CHANNEL', and '105 RIGHT CHANNEL'. A 'RDS-1' window shows 'RDS INF 4.3%'. A 'FMMA-1 TOTAL vs Time' graph shows a fluctuating signal over 700 seconds. The taskbar at the bottom shows 'Start', 'wizwin', 'Adobe Photoshop Elements', 'Inbox - Outlook Express', and the system clock '3:53 PM'.

## Microphone Placement for Live and Studio Broadcasts

Live music, either in studio or from a concert venue, is an unusual offering for most stations today. However, there may come a time when you may be called upon to set up multiple microphones for a one-off or continuing program series. George Zahn continues his series on microphones with some helpful information on how to get the most from live and studio recordings.

At a music recording workshop at SUNY-Fredonia early in my career, I had a moment of epiphany.

The workshop was attended by engineers who were learning about everything from jazz to classical broadcasting. I was working for a jazz station at the time and was sitting at a table with another engineer who was stressed about getting equipment to broadcast a local symphony.

It was not until then that I realized we were using an arsenal of 16 different microphones and a multi-channel console to do our broadcasts, meticulously placing individual microphones on instruments and becoming an active part of the “mix,” while my classical colleague needed only two matched, unidirectional microphones plugged into the left and right inputs of a recorder to get started.

I had to be constantly concerned with trying to follow the 3-to-1 Rule. He had simply to find the appropriate distance from the orchestra to the microphones (critical distance), which varies depending on performers and venue, and he was ready to broadcast.

### AN ORCHESTRATED EFFORT

Simply placing a 90-degree coincident pair of microphones at an appropriate distance from the performers can allow the group to control their own dynamics and give you a balanced aural picture of their performance. In the case of a stereo broadcast, you can pan one microphone left and the other right – and voila! – you have a stereo spectrum of the orchestra. (It is very important to use matched brands and models of microphones for the most consistent product.)

Of course it is not quite that simple. Critical distance for music broadcast can be difficult to determine and it is best to experiment with the chorus or orchestra in the broadcast venue, preferably with people in the seats to give you the best indication of what challenges you may have.

If you are interested in music broadcasting, there are variations of coincident miking that include a Blumlein Pair (two bidirectional microphones) and Middle-Side miking (one cardioid and one bidirectional microphone). There may even be times when you have to use a combination of individual and coincident miking.

### X-Y COINCIDENT PAIR

Once you are armed with particularly effective tools for battling microphone phasing, the biggest hurdle is simply being aware of what phasing sounds like and how you can protect your listeners from it. As we discussed in the March 2007 issue of *Radio Guide* (Page 30), sometimes it is a “coincidence” that great audio comes from great microphone placement.

If you are one of those broadcasters who gets to broadcast or record large orchestras, church choirs, or a chorus, there are some very easy ways to get started. The X-Y Coincident Pair uses two matched – brand and model – cardioid microphones at approximately a 90-degree angle.

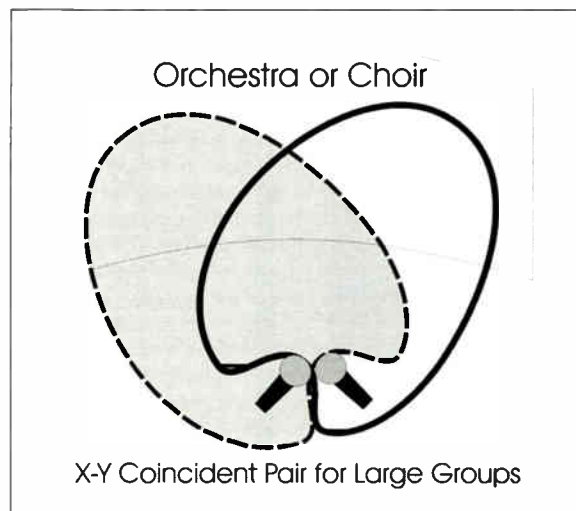

In the old days of reel-to-reel recording, many of the professional decks had standard microphone inputs. You could simply plug each microphone into either the left or the right input of the deck (depending on whether you want audience or stage perspective) and start recording.

Today, we can use any digital recorder with microphone inputs. You simply have to watch the levels and let the overall group dynamic microphones be handled by the performers on stage.

### MAKING THE PROPER MATCH

The most important part of this miking is to match the microphones. Some purists will demand microphones from the same manufacturer’s lot (usually sequential serial numbers if at all possible) to ensure that the two microphones will perform tonally in tandem.

When possible, that removes one more potential “problem” from producing the audio. However, most of us do not have that luxury, but we can survive with a pair of matched model condensers or even a really nice set of dynamics.

If you desire more “center” and less “sides,” you place the microphones at less than a 90-degree angle. For less center and a wider sound, you widen the pair beyond 90-degrees.

### MICROPHONE PLACEMENT

When doing this type of miking for a large group, you cannot just go out and blindly set up the microphones. There are some aesthetic considerations when it comes to audio and appearance.

For example, if you are setting up in an area that does not have a center aisle, it may be necessary to “fly” the microphones, suspending them from a cable attached to side walls or a balcony. This places the microphones above the audience and out of sight lines.

If you do have a center aisle, you may be able to set up a tall microphone stand. Make sure the micro-

phones are set up above the audience a bit so you do not catch absolutely every cough and snuffle from those folks sitting near to your X-Y pair.

### “CRITICAL DISTANCE”

Along with determining how high to place the microphones is the even more important concept of “critical distance.” This is the distance from the stage that the microphones should be placed.

This is an important concept because the critical distance will determine the amount of reflected side sound you will pick up from the microphones. If the microphones are too close to the stage, you will lose the ambience of the venue in which you are recording. If you are too far away, you will get too much side reverberation and hear less of the original performers.

To determine critical distance, it is best to go out and set up for a rehearsal and try moving the microphones (far easier if you are not flying them – even if you plan to fly them later, try a microphone stand in the empty seats first if possible). If you have no chance to check for critical distance, it is generally best to err toward being too close to the stage. You can always add artificial reverb later through a processor for live broadcast or in the studio if it is a recording, but there is no easy way to take out “too much reverb.”

The key to X-Y placement with microphones is to make sure the models of microphones match and that you use cardioid pickup patterns. Two omnis placed this way will not yield stereo. Two bidirectionals placed this way? Well, that leads us to the Blumlein Pair.

### THE BLUMLEIN PAIR

It sounds like something you would buy by-the-pound in the produce section of your grocer, but the Blumlein Pair has been a friend to classical music broadcasters and recorders for years. The concept is similar to the X-Y coincident pair, but instead of two cardioids at a 90-degree angle, we use two matched brand and model bidirectional microphones.

You might ask why you would want to do this. Well, when it is done correctly, the Blumlein Pair offers a fantastic opportunity to capture the ambience of the hall or venue in which you are recording. Imagine the ability for the microphone to pick up the stage performance, but also be “listening” backward to the rear of the recording location to get a fuller, more reverberant sound.

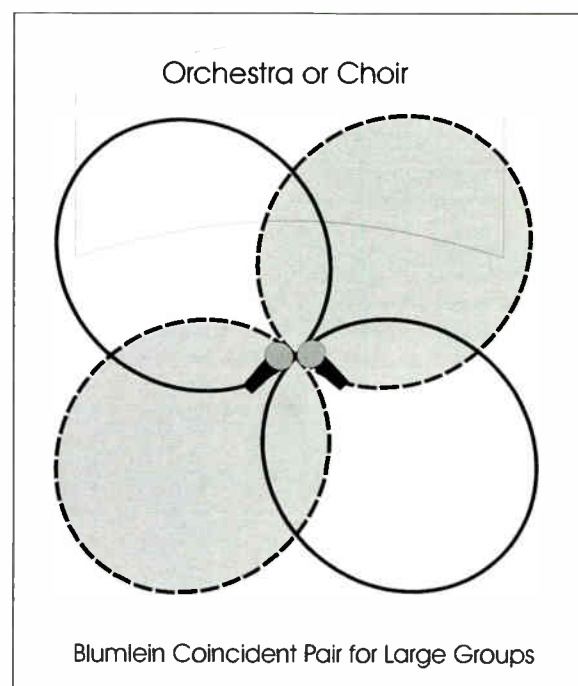

The Blumlein Pair is used far less for broadcast than the standard X-Y pair, simply because of the paucity of bidirectional microphones in the arsenals of most radio stations. On the other hand, if you hire a recording engineer to do your broadcast, you will at least have a better idea should the term come up.

(Continued on Page 16)

# The New Sicon-8 Voice Remote Control



## The CircuitWerkes Sicon-8 Voice Remote Control

- Use our pre-recorded voice responses or record your own!
- 8 channels of metering, status and control (expandable to 16) and up to 5 alarms per channel.
- No accessories necessary to control your site right out of the box.
- Auto-ranging, auto-calibrating meters make setup a snap.
- Function scheduler, auto-logging & alarm reporting included.

Introducing the Sicon-8, a revolutionary transmitter site controller with custom voice recording technology for perfectly natural sounding dial-up or radio link control. All of the I/O, including 8 channels of relays, are included on the main board so there is no need to buy anything else. All metering, status and control connections are on depluggable screw terminals. An expander chassis, the SX-8, adds eight channels of metering, status & control to an existing Sicon-8 for a maximum of 16 channels. Designed to be controlled from any dial-up telephone, an auto-answer cell phone or from its serial port, the Sicon-8 gives you the control options that you need. A free, Windows program, the Siconcontroller, gives you full access to all of the Sicon-8's programming and control functions. Basic logging functions are included. Live Internet interfacing is accomplished with an inexpensive accessory. Visit us online at [www.circuitwerkes.com](http://www.circuitwerkes.com) for complete info on the Sicon-8.

## Remote Broadcast Solutions



### MicTel Mic/Line to Telephone Interface

- Outputs & Inputs for telephone handset, cellular phone or balanced line level at up to +10dBm.
- Operates up to 36+ hours on two 9V alkaline batteries.
- High quality, user-switchable, internal limiter prevents clipping.
- External power input with silent, auto-switching battery backup.
- Individual gain controls for send, receive and headphones levels.



### Unattended Dial-Up Broadcasts with the DR-10

- The DR-10 is a Dial-Up remote control with balanced, telephone audio input & output that can control many automation systems or your audio console for unattended remote broadcasts.
- Our Silencer™ option removes control tones from the audio path.
- Use the DPDT relays to insert the phone audio directly into the program path when necessary, especially for emergencies.



### TelTap Pocket-Sized Manual Telephone Coupler

- Can be used as a phone tap or a passive manual telephone coupler.
- Send or receive telephone audio.
- Compact size & low cost makes the TelTap a great addition to your remote kit for main or backup capabilities.

Discover more online at [www.circuitwerkes.com](http://www.circuitwerkes.com)



CircuitWerkes, Inc. - 2805 NW 6th Street, Gainesville, Florida 32609, USA. 352-335-6555

## rfSoftware has the engineering tools you want and money saving features that you'll love!

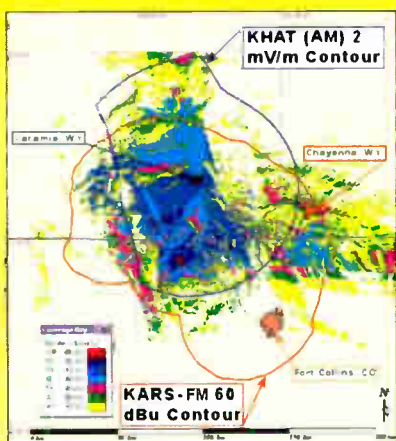

**rfInvestigator** is a tool for analyzing FCC spacing, FCC contours & much more! Population data, LULC data, terrain data, Longley-Rice models, Topo! maps & drive test data can all be displayed in **rfInvestigator**. It offers a host of advanced features, many of which are not found in similar programs or are offered as expensive additions, like a terrain profile tool and our antenna design tool that can automatically calculate your antenna pattern for you. Add our **DB-Builder** program and **never buy another FCC database!** Ever!

Although **rfInvestigator** offers sophisticated features, the user interface is intuitive & simple to use. **rfInvestigator's** power makes it useful to the experienced engineer while its easy-to-use menus make it friendly for station and group owners.

## Need AM Tools? Call Us!

**rfSoftware, Inc.**  
innovative engineering tools

Visit us at [www.rfsoftware.com](http://www.rfsoftware.com) or call us at 352-367-1700 for info on our AM & FM tools!

World Radio History

# Studio Guide

by George Zahn

Continued from Page 14

## PRE-RECORDING CHECK

When using Blumlein Pair microphones, critical distance is even, well, um, more critical. Having the Blumlein Pair too far from the stage would result in a reverberant nightmare that might well make your broadcast or recording irreparable. This set up is also a bit more susceptible to picking up extraneous audience noise. However, the fullness of sound that is achieved makes the Blumlein Pair a favorite for recording in an empty hall for later broadcast.

As with X-Y cardioid miking, always remember that the sound you get when you are checking in an empty hall, will change at least slightly once there are fannies in the seats.

Also, it is imperative to make sure that all microphone cables used in any coincident miking are wired correctly *in phase* with each other. Two cables wired out of phase will sound passable in stereo, but will almost totally cancel the audio to someone listening to the mono sum of your left and right channels on any mono radio.

## MORE EXOTIC OPTIONS

If you do not have access to matched microphones for a large group recording, you might consider Middle-Side miking. This one takes some engineering assistance, but it uses one cardioid microphone aimed at the center of the performing group, plus a coincident bi-directional microphone aimed "sideways" at the side walls of your venue.

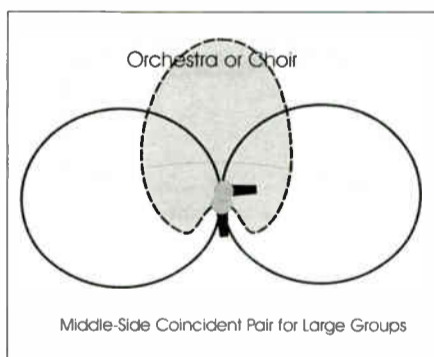

There are specialized boxes or wiring schematics I have seen to basically "split" the output of the bidirectional microphone and place each pole of the figure eight pattern to either the left or right. This is far harder to set up – and takes considerably more work.

As an alternative, if you have one cardioid microphone and one high-end stereo microphone, such as the Neumann USM 69, which has one rotating microphone capsule that lets you set the angle up to 180 degrees, you could substitute the specially wired bidirectional with the stereo microphone with the left and right capsules aimed 180 degrees apart.

## GIVE IT A GO

If you are an adventurous broadcaster who loves a challenge, why not

take a shot at one of these techniques for a trial recording before a broadcast?

In this day of satellite wallpaper radio, one of the things we have as local broadcasters is the ability to bring local orchestras, choirs, choral groups, and bands to our listeners. As you have seen here, it can be done with as few as two microphones and a recorder with two microphone inputs for left and right channels. Or you can tackle jazz or rock setups that are even more involved.

Perhaps we can cover some creative approaches to that form of local broadcasting in a future article. If you are a broadcaster considering doing live or recorded local music, let me know if an article on more elaborate music miking would be something you would like to read.

*George Zahn is the Station Director at WMKV-FM in Cincinnati, OH. He invites your comments at [GZahn@lifesphere.org](mailto:GZahn@lifesphere.org)*

## Radio Guide on CD

Version 2.7 of the Broadcaster's Desktop Reference Now Includes PDF Archives of Radio Guide

Get every issue of Radio Guide since January 2003. The BDR CD also includes several sets of Radio software utilities, as well as EAS printer paper sources, project schematics, historical data and pictures. A table of contents can be found at: [www.olderadio.com/bdr.htm](http://www.olderadio.com/bdr.htm)



Credit Card Payments Accepted On-Line at:

[www.radio-guide.com/products.html](http://www.radio-guide.com/products.html)



## Drive Time

COMET, the world leader for high voltage vacuum capacitors, leads the next wave of innovation with the Integrated Drive.

The ideal solution for today's transmitters, antenna tuning, phasing and coupling units; the Integrated Drive is a multi-functional product for the accurate alignment of motors, couplers, and capacitors eliminating the need to source and integrate components from multiple suppliers.

In addition to ensuring 100% accuracy, the Integrated Drive dramatically reduces R&D, procurement and assembly lead-times, and replaces tedious and error-prone manual assembly with a standardized, easy-to-install subsystem. Our single source solution is easily integrated into new and existing applications.

Contact us today for more information!

**The X-perts for security, inspection, electronics and communication**

COMET North America, Inc., 76 Progress Drive, Stamford, CT 06902, T +1 203 969 2161, F +1 203 969 2162, [usa@comet.ch](mailto:usa@comet.ch), [www.comet.ch](http://www.comet.ch)



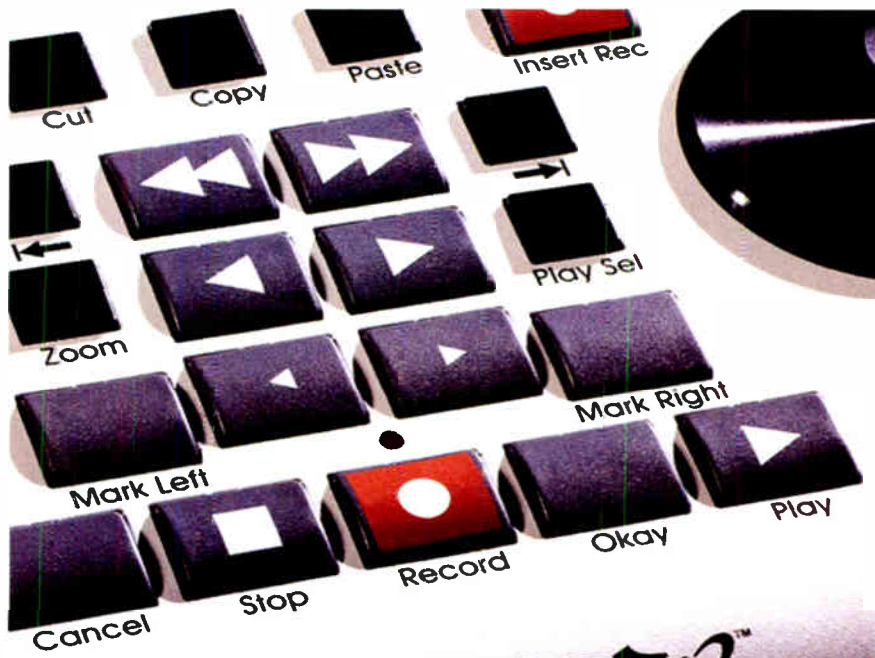

# VoxPro<sup>TM</sup> PC

## The Short/cut Replacement

Auto Network-MP3-AGC-Search-Fade-Advanced Effects-And Fast

AudionLabs.com 206 842 5202 x203  
Available at all broadcast distributors

©2006 Audion Labs, Inc. All rights reserved. Audion Labs and the registered trademarks of Audion Labs, Inc. are either registered trademarks or trademarks of their respective owners.



## Micro Communications, Inc.

### Full Line of FM Products

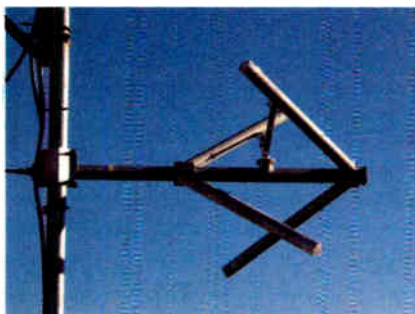

**FM Antennas**  
Horizontal Polarization  
Vertical Polarization  
Circular Polarization  
Top Mount  
Side Mount  
Leg Mount  
Custom Patterns

### Coaxial Components

Coax Switches  
Filters  
Power Combiners  
Channel Combiners  
Transmission Line Components



### Micro Communications, Inc.

PO Box 4365, Manchester, NH 03108  
Phone: 866-329-3394 Toll Free  
Fax: 603-624-4822  
E-Mail: jim.destefano@mcibroadcast.com  
www.mcibroadcast.com



# FT-1AP



Some call it

## "The Ultimate Translator Receiver"

**W**hy? Because it has so often brought 'iffy', as well as downright 'useless' translator sites to fully airable signal. Add to that, the FT-1AP's established record of reliability, and extraordinarily low maintenance and you have a receiver that will pay for itself many times over with service visits you won't have to make; not to mention a signal that will maintain your listener's attention. In other words, "it leaves you alone to do more important stuff."

The FT-1AP features our acclaimed, high resolution, analog, FM tuner, and state-of-art, digital control system which maintains tuning accuracy at all times, even after power failure. Included also is adjustable Composite Output and +10dB audio (XLR) outputs. To further enhance the FT-1AP's versatility, it offers optional, level-adjustable, Carrier Sense (to assist in meeting FCC regs); an RS232, Serial I/O port, and a gain-adjustable, stereo headphone outlet.

The FT-1AP (FM-only) and FTA-100P (AM/FM model) are available direct or through your favorite equipment dealer.



1-800-268-8637 (U.S. & Canada)

6509 Transit Road, Unit H-1  
Bowmansville NY 14026

Email "proinfo@fanfare.com"

Voice - 716-683-5451  
Fax - 716-683-5421

Website: "www.fanfare.com"

*"Designing receivers that broadcasters can rely on"*



## MT-MR Platinum STL System



### Why the MT-MR Platinum?

- For its excellent quality-price value.
- For its adjustable transmission power output from 0 to 20W for any selected operational frequency.
- For its double conversion receiver that makes it apt for digital codification (Up to 4 audio channels).
- For being digitally synthesized in 20 MHz operational band for frequencies from 150 MHz to 960 MHz.
- For the fact that both the transmitter and receiver can measure the modulation percentage and pilot signal level (19 KHz stereo without disconnecting the audio from the transmitter).
- For its remote control.
- For its analog telemetry.
- For being made for mono or stereo (MPX) signal.
- For its capability to work with AC power voltage from 90 to 250 V, 50/60 Hz, and also with external battery if needed.

OMB, the Future of Communication



OMB AMERICA  
phone. (305) 477-0973  
(305) 477-0974  
fax. (305) 477-0611

3100 NW 72nd. Ave. Unit 112  
MIAMI, Florida 33122 USA  
http://www.omb.com  
usa@omb.com

## Assessing Audio Handling Analog vs Digital

*In the quest for audio fidelity, or reproduction as close to the original as possible, is digital audio better just because it is digital? How can you explain to the non-technical person how to choose between analog and digital? Bill Weeks takes a shot at the target.*

When taken to the extreme, the idea of perfect audio fidelity is absurd.

### THE REAL SONIC GOAL

Consider an individual who is blindfolded, placed in a wheelchair, then moved back and forth between listening to a musical performance in Carnegie Hall and a recording of the same performance played on the best possible, high-end sound system in his living room.

Few individuals would have any difficulty at all in recognizing which experience is which. The reason is simple: no modern commercial presentation of music recordings can reproduce the exact original sound.

The much more realistic goal is to present a pleasing sound. This certainly includes reducing undesired artifacts of the electronic system as much as possible. It also includes adding desired artifacts.

### DESIRED OR UNDESIRED

Desired artifacts are really controlled versions of the undesired artifacts. Undesired artifacts include noise (such as hiss, pops, and hum), distortion, and uneven frequency response (a muffled or tinny sound).

Nevertheless, it is usually advantageous to at least even out the level of the audio. This is called compression – it is a *distortion* of the original audio, but appropriate amounts are very helpful in most practical listening environments.

Adjustments to the equalization (frequency response) of the audio are also often a help to pleasant listening.

### TRANSITION POINTS

The most delicate points in the trip that a sound makes from its original source through an electronic transmission medium to the listener's ear are at the transitions from one device to another, and in storage.

Therefore, the microphone, the connection between the microphone and the electronics, the transition from the electronics to the storage medium, the storage itself, the transition back to electronics, and the speaker, are all delicate points where audio fidelity can be harmed.

A simple example: back in the day, records were difficult to cut without distortions and had poor frequency response. There was much noise generated by the record surface as it was played back, it was difficult to keep the turntable at a constant speed without wow and various thumps, and the record deteriorated with each playing.

If one copied a record to a tape, the undesirable artifacts of the record were transferred to the tape, along with the undesirable artifacts of the tape medium. If one made that copy by holding a tape recorder microphone in front of a record player speaker, the shortcomings of both the speaker and microphone were added to the deterioration of the copy.

### DIGITAL CAN BE GOOD

Through the magic of modern technology, we can translate audio into a digital form. One advantage is that the digital information can be moved about and stored with much greater accuracy than could the audio.

In theory, the digital information can be stored then retrieved, essentially exactly as it was originally. It can also, in theory, be transported from one electronic device to another with the same accuracy. In most cases, the theory is correct –

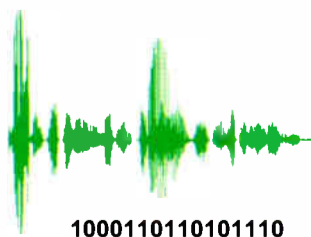

the digital system will usually work properly or not at all. This is in contrast to the more gradual degradation possible to analog audio streams.

A side benefit of having audio in a digital form is that it can also be manipulated with great accuracy. Changes in level, compression, frequency response, and so forth, are now literally mathematical manipulations of digitally represented numbers.

### THOSE TRANSITIONS AGAIN

Of course, many of the most troublesome points in the audio's trip are still at the transitions. There are still microphones, which still must connect to electronics. But now there is also a conversion from analog to digital, and later from digital back to analog (at least until we have digital implants).

Another issue is over conversions from one digital format to another – there is more than one format for digital audio itself, even more formats for storing and moving it around.

### STANDARDS

The Audio Engineering Society and the European Broadcasting Union have established a standard (AES/EBU or just AES), that covers what the digital information looks like and how the interconnections should be made. Their standard is broad enough to allow for a number of variations.

AES audio can be at various "sample rates," can be mono, stereo, surround, and so forth. It can be transported on a few different flavors of wire. However, it has to be converted among these variations; you cannot just plug one into another. AES is a modern, professional, set of standards.

Similar standards are used on some, mostly consumer grade, electronics. TOSLINK is a Toshiba brand name for a connection over optical fiber between electronic components. There is a Sony/Philips Digital Interface (S/PDIF) standard. These various standards are not interchangeable, but they can be converted from one to another.

### D/A AND A/D CONVERSION

At the conversion from analog to digital, the audio waveform is sampled very often. Each sample is a measured volume and frequency, stored as a digital number. At the conversion back to analog, those numbers are sequentially assembled back into an audio waveform.

The more often the audio is sampled, the more accurately the original audio is represented by the string of numbers, but the more numbers there have to be in the string. Common sample rates are 32, 44.1, and 48 kHz (so, for example, 32,000 samples per second). CDs, for example, are recorded at 44.1 kHz.

The digital number for each sample can be measured and saved with varying degrees of precision. More precision requires more digits in each digital number (greater bit depth). More digits means not only more precision, but a wider range between the biggest possible number and zero, so more dynamic range. More digits also means that the digital stream has to carry more information.

### CODEC ISSUES

If the audio waveform is presented to the analog to digital converter (Encoder) with too wide a frequency response or too wide a dynamic range for the particular converter design, horrible distortion can result. The transitions are still the weak point.

When the digital stream has more bits to carry, the digital hardware has to be more robust (and therefore more expensive). More digital bits means a larger storage space, faster converters, wires capable of handling faster transport. Various standards have been established for ways to reduce the amount of digital information. This compresses the audio, not in dynamic range, but in detail, and in storage space.

One body that established compression standards is the Moving Picture Experts Group (MPEG). One of their stan-

dards, highly popular in consumer applications, is MPEG Layer 3, commonly called MP3. This is a lossy compression standard – some information is lost purposely in the conversion process.

There are a number of other standards from other bodies, including for example AAC (Advanced Audio Coding). Different systems have different technical advantages, and different legal constraints.

### TRANSLATION ISSUES

There are issues at each translation of digital audio from one standard or compression scheme to another. The digital information can become compromised quickly as it is moved among sample rates, bit depths, and compression schemes.

In a modern radio plant virtually all music is stored in digital form on CDs and, increasingly, on a computer hard drive. The audio information may be transported out of the CD player or computer as either an analog or a digital stream. If analog, there has obviously already been a conversion within the machine from digital to analog.

The music then normally goes through a control console. There the level is adjusted and it is switched or mixed with other audio (such as that coming from an announcer's microphone). This console, depending on its design, may deal with the audio as an analog or a digital stream.

If it is an analog stream, there will be electronics in the console to turn the volume up or down, on or off. Each stage of amplification and each manipulation can, in theory, add noise and distortion to the audio. If it is a digital stream, moving a control on the console changes the mathematics that are applied to the digital audio stream. In theory, this is done with great precision and with no additional undesired distortion.

### DIGITAL AUDIO CONSOLES

In a modern digital console, the actual audio path is typically somewhat removed from the control surface. The actual path may never enter the control room, perhaps being handled in the engineering space of the station.

Digital transport of the audio within a radio station plant allows for significantly more flexibility in the design and operation of the system, including considerable simplification of wiring. A large number of individual audio streams, in digital form, may be carried on a single wire of the sort normally used in computer networks.

The digital stream is relatively immune to many sources of noise which can be introduced into analog wiring, such as hum from adjacent wiring or grounding issues, and such as noise from Radio Frequency energy induced from nearby transmitters.

However, this simplicity in wiring is bought at the price of increased complication of the associated electronics.

### STAYING DIGITAL TO THE TRANSMITTER

After the control console, radio station audio typically passes through various audio processors, then typically through a Studio Transmitter Link (STL) of some technology or other. Modern audio processors may be designed to work in either the digital or analog domain, although they are increasingly digital.

As analog studio-to-transmitter lines become very uncommon, they are typically replaced with something like a "T-1" (Transmission Level 1) line, which is a digital system. Radio-based STL systems, which can be designed either as analog or digital, again are increasingly digital.

FM exciters are available with either analog or digital inputs. The iBiquity HD Radio systems, either AM or FM, expect an AES input at 44.1 kHz sample rate.

### MAKING THE ANALOG vs DIGITAL CHOICE

The bottom line: the state of the engineering art is such that the resultant output from well designed and well maintained analog and digital plants will be indistinguishable from each other. Of course, the internal complexities will be very different, and the relative costs will vary. But the reasons for choosing one approach over the other will not be based on any audible difference in sound.

It is increasingly likely, however, that costs and other considerations, particularly flexibility in operation, will point toward digital plants for new construction.

*Bill Weeks is the man behind Hungry Wolf Electronics in Milton, NY, a broadcast contracting firm that specializes in project engineering. Email him at [Bill@Wolftron.com](mailto:Bill@Wolftron.com)*

# When You Want More Than Just An Antenna

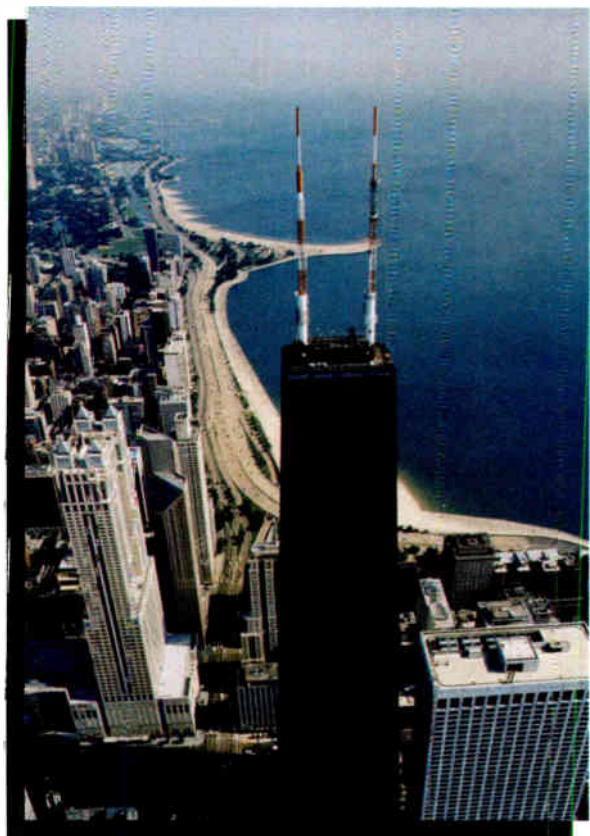

**Full line of  
HD Radio Accessories:  
Circulators, Mask Filters,  
Reject Tuners, and  
Rigid Components.**

## JAMPRO



Made in USA since 1954



**MASTER FM  
DUAL INPUT  
HD ANTENNA**



**JSHD DUAL INPUT  
HD SIDEMOUNT  
ANTENNA**



**RCHA 10dB  
HIGH LEVEL  
HD INJECTOR**

JAMPRO ANTENNAS/RF SYSTEMS, INC. • P.O. Box 292880 • Sacramento, CA 92829 USA • Phone (916) 383-1177 • Fax (916) 383-1182 • www.jampro.com Your Partner for HD Radio Solutions



# PHASETEK INC.

## Quality

PHASETEK'S manufacturing facility and components expertise are available to design and fabricate any type of inductor or special RF component.

Our engineering and production staff's years of experience and commitment to quality are available to fill any special requirements.

## Dependable

### RELIABLE & DEPENDABLE RF COMPONENTS & PARTS

Variable & Fixed Inductors  
Variable & Fixed Vacuum Capacitors  
Fixed Mica Capacitors  
RF Contactors  
Vacuum RF Contactors  
Test Jacks and Accessories  
Static Drain and Lighting Chokes  
Isolation Inductors  
Sampling Loops  
Dial Counters and Couplers  
Transmission Line Terminations  
Ribbon Clips and Tubing Clamps  
Horn Gaps  
Toroidal Current Transformers  
And More!

550 California Road, Unit 11  
Quakertown, PA 18951

Phone: 800-742-7383 215-536-6648  
Fax: 215-536-7180 Email: kgpti@epix.net  
Website: www.phasetekinc.com

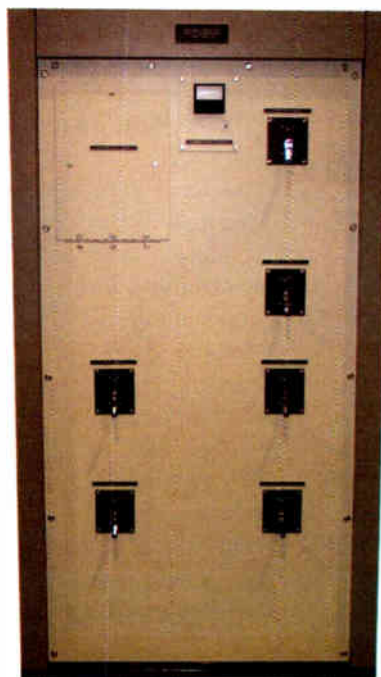
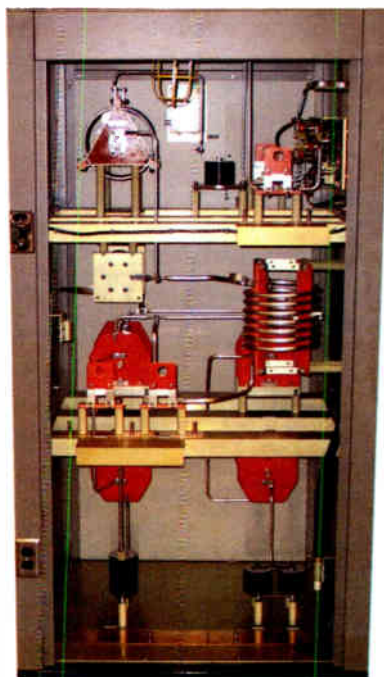

## Custom Phasing Systems

## Custom Manufactured

Antenna Phasing Systems  
Control Systems  
AM/MF Antenna Tuning Units  
Diplexers (NDA/DA and expanded band)  
Triplexers  
Transmitter Combiners  
Dummy Loads (with matching networks)  
Tower Detuning Units/Skirts  
Broadband Matching Networks  
Tunable Skirt Assemblies (TSA's)  
Isolation Transformers

## Experience

Phasetek's experienced staff of engineers and production personnel are dedicated to provide the broadcast industry the highest quality, custom designed phasing equipment.

## Value

### OTHER SERVICES AVAILABLE:

Phasing System Design  
Engineering & Technical Field Support  
AM & FM Installations.

by Bob Burnham

# Building Pre-Wires for Major Equipment Installs

*Wiring studios has changed somewhat in the Digital Age. While digital console engines can reduce the number of wires needed in many installations, there is still plenty to hook up. Bob Burnham takes a look at how building "pre-wires" can save time – and money – in the process.*

One thing is certain, from the time you start wiring a studio until the project is done, a lot of wire gets pulled through the ceiling, trenches, conduit, or soffits. It can very quickly become an overwhelming pile of undocumented wires that will afflict you for a long time to come.

There are several ways to make the job easier and neater. One is by building pre-wires for the system. There are two ways to go: pre-wiring from the manufacturer or, with a little preparation, build the pre-wiring yourself.

### CONNECTORS ARE THE KEY

Computer-style connectors are finding extensive use in the broadcast studio. Manufacturers find them a great way to connect to the console modules.

For a handsome price, most console manufacturers will gladly provide pre-assembled cabling that terminates with punch blocks or whatever you want, as well as the appropriate connector to their equipment.

Some types of connections force you to select this option based on the type of cabling you have selected for the job and practicality of building a connector such as a DB-25 (or 25 pin D sub) by hand.

As an example, it is impossible to build a digital pre-wire by hand using the standard Belden 1800B cable. The cable is simply too large to physically fit inside the connector, if more than a couple cable runs are needed.

### OVERCOMING AUDIO CARD HASSLES

Also, higher end computer audio cards sometimes supply a break-out cable, while others merely supply the 62-pin connector with solder style tabs inside. Good luck on that one!

Spend the extra money on the break-out cable, or forget the PCI-based sound card: Look into getting your audio in via one of the USB-based boxes such as from Henry Engineering (as featured in February 2007 *Radio Guide* on page 42).

### GOING THE DIY ROUTE

There is a great deal of money, however, to be saved by doing a lot of the assembly yourself, where

possible. There are basically four steps to building a pre-wire yourself.

**Step 1.** Determine if it is even practical and possible to do it by hand. If not, order the pre-wires – with the D-sub on one end – from the equipment manufacturer or your favorite vendor. (Expect to pay anywhere from \$200-300 *per connector*).

**Step 2.** Determine the length of each cable for a given run (always with a substantial additional service loop) and cut the cabling to length. If it is to be consolidated into a single studio, run a dummy cable, cut it to length then pull it out and use that as a means to determine the length of all other cabling taking the same path.

Your job may be simplified if you are using multi-conductor cable such as from Gepco (in which case, you will be working with the cable company's color code and numbering).

To a degree, however, costs may be minimized and cable dressing at the ends may be easier if you simply build your own cable bundles, using the infamous Belden 9451 for analog connections or 1800B for digital. If you go this route, you have to supply your own wire markers, which takes us to the next step.

**Step 3.** Mark and document the cabling. Prepare an Excel wiring chart identifying the wire number, equipment source pin-out in another column and destination equipment pin out (or punch block number) at the other end.

Physically number the end of each wire with the appropriate number and use clear heat shrink to bind that number to the cable. Wire number pads are readily available from manufacturers such as Brady or 3M as well as the heat shrink. 3/16 heat shrink works for both 9451 and 1800B. Contact your favorite electronics suppliers such as MCM or Mouser Electronics for these items.

**Step 4.** Prepare the entire bundle for routing. At one end, add the appropriate connectors to match the equipment. I usually also mark the connector with a Sharpie (for example: "Monitor Analog Outputs").

Plan for the opposite block end to be punched down during the actual studio install so the wire bundle can be easily routed. Wrap electrical tape around the very tip of the bundle (trimming any cables that are slightly too long). Using cable ties, bundle the cables together every 6-8 inches. Leave at least 12 inches at the punch block end un-bundled.

### USE A KRONE CONNECTOR BLOCK

A typical 66 block will carry 100 connections, while a Krone block will carry half that many, but is far superior for broadcast application.

Your old faithful punch tool will not work on these blocks. You will need a special tool for the Krone blocks, which is well worth the investment. Your favorite broadcast equipment vendor can supply these items.



**A Krone punch block with matching tool.**

### START AT THE CONSOLE

If the major equipment is a console, I will usually prepare all the connectors on the console end *and* physically connect them to the console *before* installing the console. It is easier to attach the connectors to a console on the bench rather than in studio. The exception is the power supply cable, which may not be practical to install until the actual studio installation.

I like to use a greenie or reddie (like the Xcelite R181 2 mm flat blade screwdriver) to tighten down screws on each side of a DB-25 connector. Put the loose ends of cabling on top of the console when physically carrying the console into the studio.

Take your time during this whole process and work carefully and methodically. Spend a few days on this process if you can spare it. Tape the ends of the wires together for routing through your furniture and ultimately, to be separated and punched down once they are routed.



**A console ready to go into its new studio.**

### SOME TIPS ON PREPARING THE DB-25

If you are going to put together the DB-25 (D-Sub) connectors, a little preparation will save a lot of aggravation. Again, it is easier to do this on the workbench, instead of in the studio itself, where you could find yourself upside-down and hanging from the desk.

Also, to get through this process as quickly as possible without driving yourself insane (unless your real identity is Clark Kent), remember the following:

- 1.) Your work area needs plenty of light.
- 2.) You should use a mounted magnifying glass and/or make sure your prescriptions for your glasses are current.

**Step 1.** Strip the shield/outer insulation about 1.5 to 2 inches.

**Step 2.** Strip the red and black leads to expose about an inch of wire. Without removing the insulation on the tip of the wire, use this as a tiny handle to twist the wire tightly.

**Step 3.** Using a pair of sharp diagonal cutters, cut the end off, leaving only about 1/16 inch of bare wire. Twist and trim the drain (ground) wire and cut to the same length as the insulated wires.

**Step 4.** Insert the tip of each wire into the gold-plated tips and using the ratchet-loaded crimpers, crimp the pin to the wire.

Be sure the crimp is seated correctly in the crimp or you will crush the assembly and it may not seat into the header properly or the wire may break off.



**Strip the wire, twist to bring wires together, then clip the insulation back 1/16 inch.**

(Continued on Page 22)



**A typical factory-built pre-wire using a Krone block.**



**Using Belden 1800B cable, the bulk adds up fast.**



**Using clear heat shrink makes identification of the wiring much easier.**



### Building Pre-Wires for Major Equipment installs

**Step 5.** Repeat the procedure above for all the analog wires. The reason for the twisting is to minimize the diameter of the strands and make insertion into the crimp-on pins easier, as well as eliminate any possible stray strands.



A pin properly crimped to the wire.

following the diagrams in the console manual, insert each pin into the DB-25 header, feeling a little snap as each pin locks into place.

**Step 7.** Complete the process by assembling the DB-25 hood (or shell), making sure all parts and screws are used.

#### SHORTENING THE PROCESS

Pre-wires should also be prepared for the rack end of the punch block, again being documented on your Excel wiring chart. (You actually can pre-punch this end of the block if you are certain the routing holes are large enough for your source/destination equipment in the rack).

When the time comes for the actual studio installation, the process becomes a 4-5 hour task, rather than an all-nighter. Most of your time is spend routing wires and in punch block activity, rather than crimping and soldering.

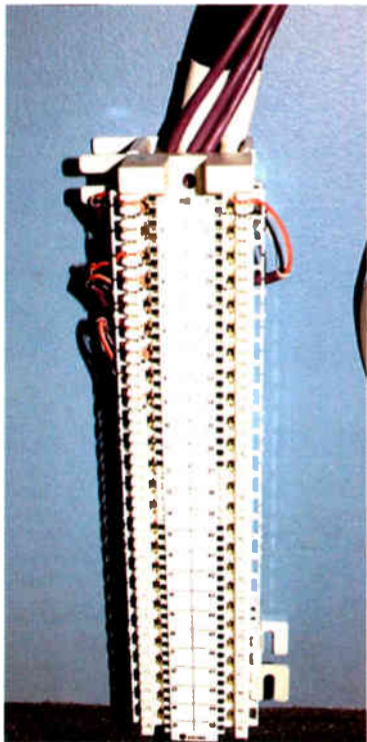

Mount the Krone block in the planned, convenient location and punch down the wires with the tool.

If your console is built around a racked engine such as the Logitech products, this same process can be used at the engine end.

#### WALK RIGHT IN, SIT RIGHT DOWN

When everything is done and you are ready to take the console (or other gear) into the studio, you can rapidly pull the cable and punch everything down. By building the pre-wires, the job will go much easier than any previous install you can remember.



The studio is ready to go after just a few quick connections.

Bob Burnham has installed 20 digital consoles using these methods (with more to go) at Specs Howard School of Broadcast Arts in Southfield, MI He can be reached at [bburnham@specshoward.edu](mailto:bburnham@specshoward.edu)

### Magazine Production Director

*Radio Guide Magazine* has an immediate opening for a publication production director.

We are looking for someone skilled in the production of technical magazines, publications, and display advertising copy.

We seek a person comfortable with programs such as Pagemaker, InDesign, Acrobat, Photoshop, and other graphics tools, especially with experience in the PC environment. We prefer a person with a few years of experience in magazine layout.

This is a full time position and will not require relocation. A basic knowledge of the radio broadcasting industry is highly desired.

Please email your resume to [radio@rconnect.com](mailto:radio@rconnect.com) Media Magazines Inc. is an Equal Opportunity Employer. — Ray Topp - publisher

# See why more broadcasters are choosing Nautel as their trusted source for digital transmission.

V Series: 1kW - 40kW Digital or Analog FM transmitters

**NEW!**

Transmitter control in the palm of your hand

Nautel's integrated digital solutions make your move to HD Radio easy and economical. Simplify your deployment with adaptive pre-correction, a Nautel industry-first. Use Nautel's award winning Reliable HD Transport Suite to ensure reliable data transfer. Minimize your operating costs with Nautel reliability, easy maintenance and outstanding hybrid mode efficiency. Save time, save money and make digital radio work with Nautel.

## Win a Cambridge Soundworks HD Radio Receiver!

Go to [www.nomoresecrets.com](http://www.nomoresecrets.com) to enter.

Phone: (902) 823.3900 Fax: (902) 823.3183 [info@nautel.com](mailto:info@nautel.com) [www.nautel.com](http://www.nautel.com)

HD Radio is a trademark of iBiquity Digital Corp. All rights reserved.

# Making Digital Radio Work.

# End-to-End Solutions From SCMS

## Moseley SL9003Q Studio Transmitter Link

Get your **STL** Solution from  
the Dealer That Knows Radio.



**The Starlink is SMOKING HOT!**

Whether you are faced with a studio move or IBOC conversion, make the right STL choice for today and tomorrow.

Moseley Starlink SL9003Q-2SLAN and new 4SLAN is the first STL to provide AES digital audio and Ethernet over the traditional 950 MHz STL band.

For T1 lines and license-free links, the Moseley Starlink SL9003T1 gives you bi-directional digital audio, Ethernet LAN extension, remote control, and telephone.

**Your best value for the future is the right STL choice today  
Moseley Starlink is available from the most reputable  
supplier in radio broadcast – SCMS**

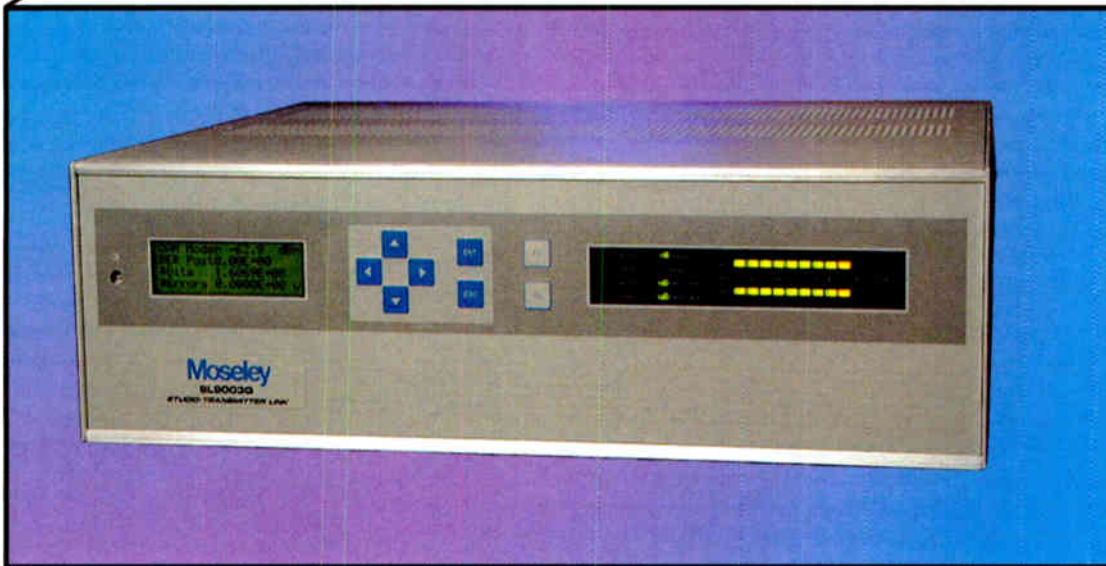

**Contact SCMS**  
at any of its offices  
to discuss your needs.  
**1-800-438-6040**  
**Bob, Ernie, Matt or Mike**  
**HQ in Pineville, NC**

Mid-South: 1-877-391-2650 Bob Mayben  
Central: 1-731-695-1714 Bernie O'Brien  
West Coast: 1-866-673-9267 Doug Tharp  
Mid-West: 1-513-899-3036 Mary Schnelle  
South-Atlantic: 1-770-632-1295 Art White  
North-East: 1-315-623-7655 Jim Peck  
South-West: 1-210-775-2725 John Lackness  
Pro Audio: 1-877-640-8205 Ric Goldstein  
Latin America: 1-760- 650-1427 Lily Massari



[www.SCMSinc.com](http://www.SCMSinc.com)

by Stanley Adams

## General Electric

### The Early Years: Telegraphy to Telephony



*Heavy Metal is a series devoted to the technology, engineers, and manufacturers that broke through and delivered the big transmitters that transformed and made broadcasting a national link in the 1920s and 1930s. In this installment, Stan Adams discusses some of the groundwork that made it possible to build the big rigs.*

The story of heavy metal really begins in the latter part of the 19th Century, because it was the devel-

opment of electrical service grids that paved the way towards broadcasting. And the metal got no heavier than the mighty steam and water turbines, generators, alternators, and those heavy transformers of the day – a world of wire and clamps.

#### GENERAL ELECTRIC LEADS THE WAY

In the forefront of all of this development we find the General Electric Company – a consortium of the Edison Electric and the Thomas-Houston Industries. It was during those early years that their people, along with so many others, created the beginning of electrical and electro-motive power.

As the 19th Century reached its climax, progress was in the air and the General Electric Company would consistently surpass itself with greater and larger, bigger and bolder products. Indeed, GE was in the forefront of technology no matter what the size, weight, kVA, or draw-bar horsepower was needed – it seemed that all classifications were but children's toys to the GE engineers.

Of course, we are not forgetting the work of many others, including the Westinghouse Corporation and especially the work of Nikola Tesla, from both of which GE shared patents. We will consider them in due course. But the focus of this article is on GE and the building of the communication systems of America.

This time our goal is to describe the time and show the progress of GE from the concept and development of the Steinmetz/Alexanderson alternator. The next installment will consider the work of Dr. Irving Langmuir, the vacuum tube, and the developmental stations for the RCA and KOA, KYO and WGY. And for the last section we will look at other stations that used products of the General Electric Company.

So grab a cup of your favorite beverage, take your time in reading and savor the history, as you consider how from electrical power experimentation came the extension to electrical power in the range of radio frequencies. We trust you will enjoy the trip.

#### STEINMETZ

To begin our journey at GE, we must give our attention to some of the greatest minds at the beginning of power transmission. At the top of the list of valuable contributors were Drs. Charles Steinmetz and Ernst Alexanderson. Truly symbiotic, each one's contribution led to the other's ability to add, build and complete. As one person put it, "We are standing on the shoulders of giants."

Dr. Charles Steinmetz was a small, malformed man, a Serbian by birth and new to America in the 1890's. However malformed the body of Steinmetz, there was housed one of the finest of minds; this would allow him to soar far above the earth so, as it were, to investigate and to mathematically describe the principles and properties that we now know govern the laws of alternating current.

Eddy currents, hysteresis and polyphase power were his specialties and his writings would allow the more earth-tied Drs. Alexanderson and Langmuir to find their footing. The world is indebted to this person. His trade in life was pure and applied science and the language, for him, was mathematics.



Dr. Charles Steinmetz

Dr. Steinmetz was the one that gave Reginald Fessenden his first try at using an alternator to broadcast (developed in the years 1901-1903). Work began as a result of a letter from Fessenden to the GEC. Steinmetz determined how to meet the specifications that Fessenden had insisted upon.

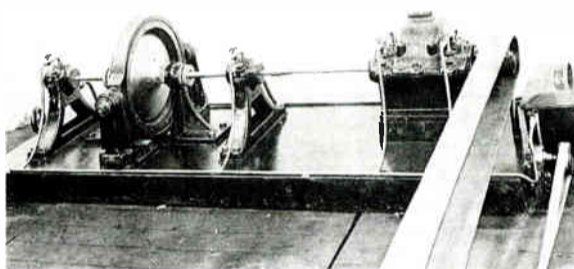

The Fessenden Alternator built by Steinmetz

It was not an easy job. The produced alternator would only work up to 10 kHz at 4000 RPM and then the armature would begin to disintegrate. Fessenden could not use the alternator as designed so he used the alternator to excite a spark gap, and by this method he was able to produce a 20 kHz signal – a signal that was noisy and the emission produced was still a damped wave.

In 1904 Fessenden submitted a second order to the General Electric Company, seeking a transmitter that would stand alone and have a power of at least 25 kW at the frequency of 150 kHz. For some reason, Steinmetz did not care to pursue the project any longer and assigned it to Ernst Alexanderson.

#### ALEXANDERSON BUILDS FESSENDEN'S ALTERNATOR

Born in Sweden, Dr. Ernst Alexanderson was 24 years of age, well educated with a doctorate from Germany, when he arrived in America and the General Electric Company in 1902. His early tasks were in working with the basics of the company – power products.

Alexanderson began work at GE as a draftsman and, even though processing a Doctorate, he rose up through the ranks as an engineer familiar with the use of wire, pliers, wrenches and plenty of grease. "Sweeping up the floor" at the end of the day was a well known practice of this engineer. And yet, at the same time, he was building upon the early work of Dr. Steinmetz, using the skills of his own: mathematics and practical shop experience.



Ernst Alexanderson

In time, Alexanderson was given a free hand in the design of a new alternator. Dr. Steinmetz said, "Enough, the alternator is yours to develop." He quickly realized the weakness of the original design was due to the limit placed upon the rotational speed of the armature. He finally chose a design that would be an inductive type of alternator, using a stationary armature and a stationary field with a toothed disc rotor between them.

Patent No. 905,621 was the result of this work. Alexanderson had produced a tapered rotating disc with angular strips of phosphor bronze wedged into the disc and machined to the tapered contour. His first successful test alternator worked at 100 kHz and produced 2 kW of power. This became the famous 1906 Fessenden alternator.

The Alexanderson system consisted of three parts: (1) the machining and design of the actual alternator had to be carefully constructed so that no lateral movements would occur and destroy the overall mechanics and reliability; (2) speed regulation which would keep the unit on frequency and the magnetic amplifier for modulating the currents of the alternator; and (3) the Alexanderson/Beverage antenna system" multiple-tuned "Alexanderson/Beverage antenna system" with its high-gain directivity.

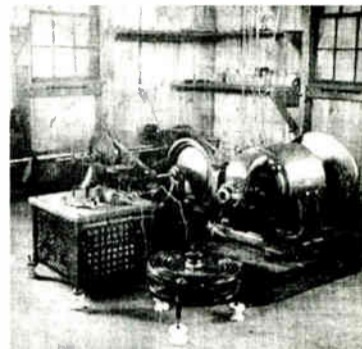

The Alexanderson Alternator at Fessenden's Brant Rock, MA site.

To make his final improvements Alexanderson found that the speed had to be regulated to within a few parts of one percent while feeding an antenna system that was tuned to the frequency or period of the alternator.

Modulation was by the use of a "magnetic amplifier" that would take the weak telephone currents and step them up in voltage and feed the antenna circuit of the alternator. A continuous oil flow was required on all bearings and a water cooling arrangement was made to cool all moving parts.

This was the Alexanderson system. The success of General Electric in fulfilling Fessenden's orders led to 19 other alternators that were later produced. Say what one will, Brant Rock was a product of the General Electric Company.

#### WHAT ALEXANDERSON DEvised

I want to call your attention to several photographs and diagrams that we have included to show his method of signal regulation and modulation.

The speed regulator circuit was a series circuit that was placed between a sample voltage loop on the output of the alternator and feed back into the poly-phase power supply that drove the alternator motor. This coil would feed back a constant current if the alternator was on frequency, any changes would be rectified by a GE Tungar or Kenotron (gas vapor rectifiers), and thus controlling a relay that would open or close, thus shorting across a liquid resistor.

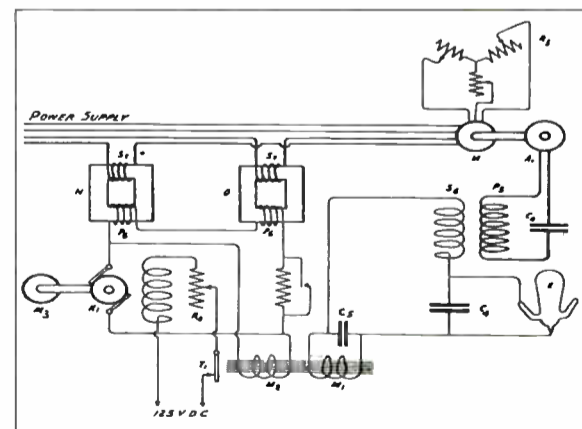

Alexanderson's regulator circuit, making the Fessenden transmissions possible.

This liquid resistor was composed of plates immersed in a carbonate of soda solution and was inserted into the control of the voltage going to the two phase voltage lines. If less or more speed was needed a pump would be turned on to change the amount of liquid and thus change the feedback current.

(Continued on Page 26)



# “My Number One Codec Rental is Zephyr Xstream”

-Steve Kirsch, President Silver Lake Audio



Rack 'em and stack 'em! The Silver Lake Audio Crew pictured from left to right: Steve Kirsch, Ken Stiver, Kirby Miovac and Jay Shoemaker

“When ISDN equipment rentals began in the early 1990s, we started with an equal number of different companies’ codecs. Today, Silver Lake has over 100 Zephyrs in stock, ten times more than any other brand.” says Steve Kirsch, owner of Silver Lake Audio.

The reasons should be obvious. Reliability, ease of use, compatibility, great support.

Telos: The Best Way To Hear From There.

And there. And there. And there.

*Telos*  
AUDIO | NETWORKS  
[www.telos-systems.com](http://www.telos-systems.com)

The Telos Logo and Zephyr Xstream are registered trademarks of TLS Corporation © 2007 TLS Corporation.  
Silver Lake Audio is a registered trademark of Silver Lake Audio™

World Radio History

## General Electric The Early Years

Continued From Page 24

### MODULATING THE CARRIER

The alternator was modulated for CW work and early telephony experimentation with the magnetic amplifier that you see in the following diagram.

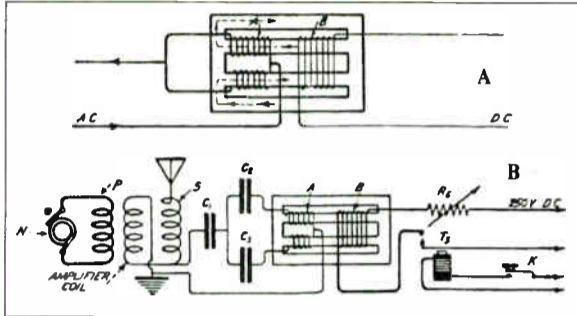

The magnetic amplifier used by GE.

The dual windings across an iron core allowed the keying of the very high RF current without the high voltage coming into contact with the operator circuit. The A coils are wound so as to produce a bucking voltage with no modulation. When the B coils produced an additional flux that would upset the balance of A, the feed back would control the voltage into the power supply of the alternator at either an audio or a pulsing on-off that was produced by a telegraph key.

When the magnetic amplifier was modulated by the carbon microphone, the six triodes for telephony would develop a variation of 0.2 amperes in the control current, which would in turn cause the antenna power to change from 5.8 to 42.7 kW – a change of almost 37 kW.

It was around this time that Charles Herrold developed his Arc Phone, based on Poulsen's work. Impressed upon a spark transmitter, six arc lights in series were used to develop a high frequency arc carrier. However, Alexanderson's method was much more stable electrically – and much safer to the operator, since Herrold's system exposed 500 VDC to the microphone (which also required water cooling to prevent burnout).

As the early telephony system from GE developed, the magnetic amplifier was driven by a bank of the Pliotrons, such as shown here driving the power amplifier control racks in New Brunswick, NJ.

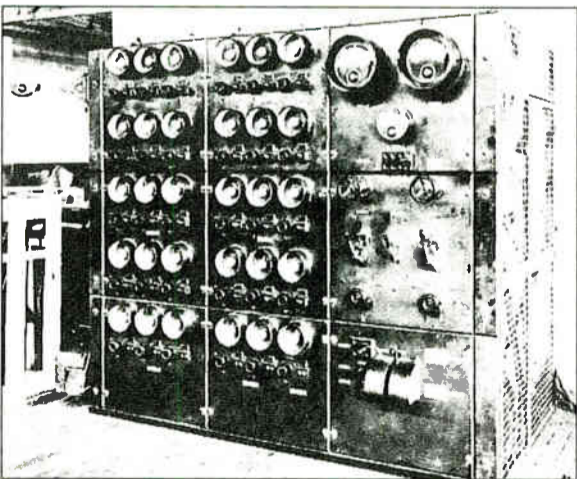

Pliotrons were among the early tubes used to drive the GE transmitters.

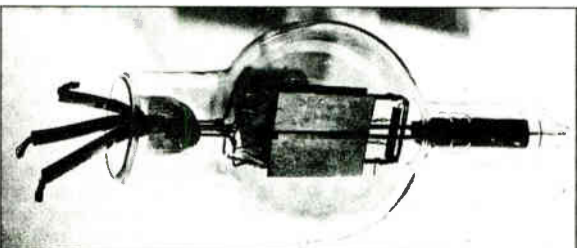

With the power amplification developed by the Pliotrons, Alexanderson was able to reach 50 and then 200 kW with his Alternator.

### CRANKING UP THE POWER

In the year 1916 Dr. Alexanderson was able to modify the magnetic amplifier with power tubes being developed at Schenectady, NY.

These tubes were the developmental beginnings of the UV206, a 1000 watt tube. GE was also known for some of the first developmental work on gaseous vapor rectifiers. These were called Kenotrons and the largest made during the age of early broadcasting were furnished for the WLW 500 kW power supply (UX-870).

1918 brought the Alexanderson system into use in worldwide communications. These historical experiments were carried on with a new 200 kW alternator delivered to the Marconi station (operation was on 25 kHz); with transmissions to the Presidential Yacht S.S. George Washington carrying President Wilson to the Peace Conferences of 1918/1919.

### FROM THE US TO EUROPE

The US transceiving stations of NFF, NAA (Arlington-Washington), and NCC in Maine were in constant touch with the President. Because of the powerful NFF, all of Europe, including the Germans where able to hear these communications in plain English text as it was telegraphed. Telephony was added to this generator and others that were built for a number of what would become RCA Communications which would follow the end of the World War I.

The "Great Compassionate President" was how all of Europe received Wilson. Naval Station NFF transmitted on a daily basis with the European allies, and with a transmission of Wilson's Fourteen Peace Points to the world on January 18, 1918. These "operational tests" represent the earliest "broadcasting" of the General Electric Company.

### CSI: ALEXANDERSON

A peculiar incident occurred to the Alexanderson family in June of 1923. Dr. Alexanderson had a six year old son by the name of Werner. On April 10th the small child was lured away from its home by the promise of some rabbits.

Finally on the evening of the third day the police received a call from a caretaker of some summer vacation cabins. Listening on a home made radio set to WGY he was able to "make" the kidnapper and the young boy as being in one of the cabins. A call to the sheriff and the Alexanderson family became whole again. Was this some divinely led activity furnished by the Gods of the Ether to thank the great Dr.? One will never know.

### RADIO CENTRAL

During the next five years Alexanderson worked at GE and RCA. Focusing on the new technology of broadcasting, he developed a number of new products and also put his Alexanderson System with a 200 kW alternator and a set of 12 multiple tuned directional antennas at RCA Communications, Inc. "Radio Central" on Long Island – one of the antennas was ten miles long.

Here he worked with a young associate by the name of Harold Beverage who was just a few years out of college. Perhaps you have heard of the Beverage Antenna. Dr. Alexanderson was the one who got it started.

I have been to the location of the receiving aerials of Radio Central which were at the very eastern section of the island. The assets at the time were owned by MCI Telecommunications (with whom I worked) and were acquired in the mid-1980's as part of the Western Union International acquisition and the RCA Globecom acquisition.

The stations were operational at the time for transoceanic as well as ship-to-shore traffic until turned down in about 1989 when satellite and undersea fiber cables

became available. Here is a schematic of the completed Alexanderson system, combined with the directional antenna that was installed at the New Brunswick, NJ Marconi station, and later at Radio Central on Long Island.

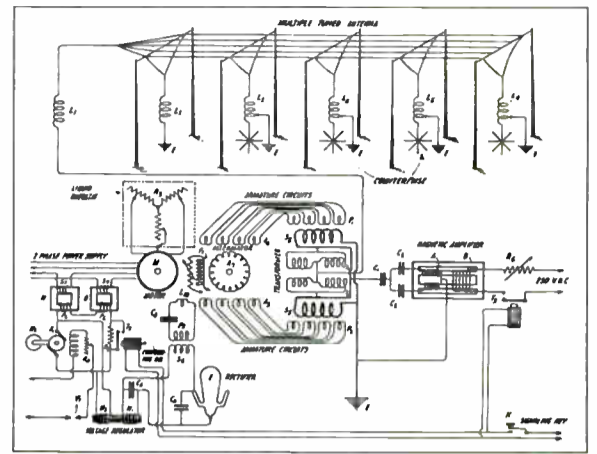

### HONORED FOR HIS ACHIEVEMENTS

Alexanderson's fertile mind touched virtually every aspect of electrical engineering. Over the years, he did pioneering work on transmission of pictures by radio, television and much more. He eventually was granted 344 patents, third only to Thomas Edison and Elihu Thompson, the founders of General Electric.

George Michael in an NBC interview of 1947 reported, "over the years, Alexanderson virtually invented everything GE did in the field of AM, FM, and TV."

Dr. Alexanderson received one honor after another: he was elected to the Royal Academy of Science in Sweden, he received the Medal of Honor from the IRE in 1919, Knighthood in Poland in 1924, The Edison Medal from the American IEEE in 1944, the Royal Danish Medal in 1946, etc. etc. Ernst Alexanderson passed away in 1975 at the age of 97.

### 90 YEARS OLD AND STILL TRANSMITTING

Several of the original Alexanderson Alternators can be found today in the museum set up in Grimeton, Sweden. In 1996, one was turned on during the 80th anniversary celebration. The station worked just it as it did in 1916 and transmitted signals back to the US.

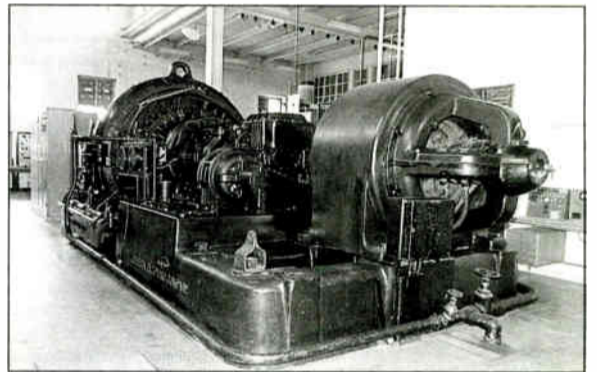

An Alexanderson Alternator is still operational as SAQ at Grimeton, Sweden.

There was an additional transmission on 24th December 2006 with the old Alexanderson Alternator in Grimeton. This was performed in order to celebrate the 100th anniversary of the first wireless telephony transmission in the world (by Reginald Fessenden). The reception seems to have been good all over Europe, but the signals appear to have been very weak in USA.

In our next installment, we will talk a bit more about RCA Central and then move into the development of total tube transmission. Dr. Irving Langmuir and Dr. W.R.G. Baker will be our hosts.

If you are interested in learning more about Steinmetz or Alexanderson, here are some places to look on the Internet:  
<http://www.oldradio.com/archives/jurassic/alexan.htm>  
[http://www.invent.org/hall\\_of\\_fame/139.html](http://www.invent.org/hall_of_fame/139.html)  
[http://www.invent.org/Hall\\_Of\\_Fame/2.html](http://www.invent.org/Hall_Of_Fame/2.html)  
<http://www.alexander.n.se>

The author wishes to thank the Schenectady, NY Hall of History for General Electric documentation, and the Antique Wireless Association of Holcomb, NY for their AWA Review and for the AWA Journal. These are both excellent sources of early broadcast and communications history.

Stanley Adams' family has been involved in broadcasting since the 1940s. He currently works at Sprint's Memphis RF Engineering department. Stan would love to hear from you at: [stanleyadams@yahoo.com](mailto:stanleyadams@yahoo.com)

# You're looking at a complete audio-over-IP routing system.

(Just add Cisco.™)

**Administer this** • The beauty of the Web is that you can get information anywhere. Same thing with Axia — you can set up and **administer an entire building full of Axia equipment** — audio nodes, consoles, virtual routers — whatever — from your own comfy office chair. All you need is a standard Web browser (PC or Mac, we like 'em both). Put an Internet gateway in your Axia network and you can even tweak stuff remotely — from home or anywhere there's a Net connection. Hey, isn't it time for a Mochachino?

## It's not rude to point

• Little kids tell mommy what they want by pointing — a pretty intuitive way of doing things. PathfinderPC software gives talent the same convenience. You can **build custom "button panels"** to execute complex operations with just one click. You can map these panels



to controller modules on Element consoles or to turret-mounted controls, place mini-applications on studio computer screens, even run them on touchscreen monitors.

**Jammin' on the mic** • Radio studios and microphones go together like Homer Simpson and donuts. Unfortunately, so do preamps, mic compressors, EQ boxes, de-essers — let's face it: most studios house more flying saucers than Area 51. Axia helps clean up the clutter by including mic preamps with our Microphone Nodes; not bargain-basement units either, but **studio grade preamps** with headroom enough to handle Chaka Kahn. Phantom power, too. And if you choose to use Axia Element consoles in your studios, you'll find world-class mic processing built right in: vocal dynamics (compression and de-essing) from the audio processing gurus at Omnia, plus three-band parametric EQ with SmartQ, available on every mic input. Rap on, Grandmaster.

**Push to play** • Axia Router Selector Nodes are **really advanced selector and monitor panels** that you can put anywhere you need access to audio streams. Like newsrooms, dubbing stations, or even the station's TOC, so you can monitor any of the thousands of audio streams on your network at a moment's notice. The LCD screen scrolls through a list of available streams; the eight Fast Access keys let you store and recall the streams you use most. There's even an input for convenient connection of an analog or AES device. Sweet.



**Quick Connect** • Axia I/O is presented on RJ-45 and adheres to the StudioHub+ standard. A couple of clicks and you're done

**Automation station** • Wouldn't it be cool to have a **self-monitoring air chain with silence-sense** that can fix problems — then e-mail a status report? To be able to switch your program feed from Studio 'A' to Studio 'B' with one button? Or build custom switching apps and scheduled scene changes based on Boolean logic and stacking events? PathfinderPC software does all these things and more. But unlike HAL 9000 — it doesn't talk back to you.

**Nothin' but Net** • Did you know you can plug a PC directly into an IP Audio network to exchange audio? Can't do that with a mainframe router. Well, you *could* add more input cards to the mainframe — buy high-end audio cards and run more wiring — but with Axia you just install the **IP-Audio Driver** on any Windows™ PC to send and receive pure digital audio right through the PC's Ethernet port — no sound card required or additional router inputs needed. The single-stream version is great for audio workstations; the multi-stream version lets you send and record **16 stereo channels simultaneously** — perfect for digital automation systems.

**Very logical, Captain** • Routing logic with audio used to be as hard as performing the Vulcan Mind Meld. But Axia makes it simple, converting machine logic to data and pairing it with audio streams. **So logic follows audio throughout the facility** on Axia's switched Ethernet backbone. Eight assignable GPI/GPO logic ports, each with five opto-isolated inputs/outputs are built into every Element power supply, so you can control on-air lights, monitor mutes, CD players, DAT decks, profanity delays, etc. Got more than eight audio devices? Add a GPIO node like this one wherever you've got gear.

**AES yes** • You like your audio to stay digital as much as possible, right? We get that: our AES/EBU Audio Nodes let you plug AES3 sources right into the network. Studio-grade sample-rate converters are inside; anything from **32 kHz to 96 kHz** will work. Oh, and there are 8 AES ins / 8 AES outs in each node. Digital distribution amp, anyone?

**Brains in the box** • The typical radio jock cares for studio equipment about the same as a five-year-old cares for a puppy: haphazardly, if at all. That's why we **took the CPU out** of our Element modular console and put it in here, with the power supply and GPIO ports.

That means a greatly reduced chance of being taken off the air by a Coke spilled into the board. Because we know that you have better things to do on a Sunday night than trying to dehumidify circuit boards with a hair dryer.

**Put that in your pipe** • How many discrete wires can a CAT-6 cable replace? Well, a T-3 data link has 44.7 Mbps of throughput. But Axia networks' Gigabit Ethernet links give 1000 Mbps of throughput between studios — more than 22 times the capacity of a T-3; enough for 250 stereo channels per link — the equivalent of a **500-pair bundle on one skinny piece of CAT-6**. Use media converters and optical fiber for even higher signal density. Think that might save a little coin in a multi-studio build-out?

**Level headed** • These green, bouncing dots built into every Axia Audio Node are confidence meters. One glance and you know whether an audio source is really active — or just playing possum.



**Heavyweight champion** • This Axia StudioEngine works with our Element Modular Consoles (the fastest growing console brand in the world by the way) to direct multiple simultaneous inputs and outputs, mix audio, apply EQ, process voice dynamics, and generate multiple mix minuses and monitor feeds on the fly. To make sure it delivers the reliability and ultra-low latency broadcast audio demands, we powered the StudioEngine with a fast, robust version of Linux — so fast that **total input to output latency is just a few hundred microseconds**. How can one little box do so much? There's a blazingly fast Intel processor inside — with enough CPU muscle to lift a small building. Strong *and* fast. Ali would approve.

**You got to have friends** • Deliver your system providers like ENCO Prophet, BSI, BE, iMediaTouch, DAVID Systems and more — all have products that **work directly** with Axia networks. So do hardware makers like AudioScience International, Datacasting 25 Seven, Telos and Omnia. Check out the whole list at [AxiaAudio.com/partners/](http://AxiaAudio.com/partners/)



[AxiaAudio.com](http://AxiaAudio.com)

# Maintenance Guide

by Jim Bender

## Risky Radio

### Enabling the Gambler

*Sometimes an engineer can become the enabler for a gambling addict at the station. Do you stand by while the GM bets the farm? Jim Bender shows how this can happen.*

Happy is the engineer whose employer seeks his opinion for the strategic plan, the business plan, the operating plan, the operating budget, and safeguarding his licenses – and then acts accordingly.

Unfortunately radio owners seldom consider the engineering department to be part of the team that brings success to the operation. Most often, radio engineering is viewed merely as a service, insurance, or an expense – perhaps like contracting for pool cleaning services.

If so, you probably have heard this sort of truism: "The transmitter is brand new. It doesn't need any preventive maintenance." Or this one: "We're all computers and satellites. The kid from *Radio Shack* can take care of them."

#### THE RISK TAKER

Free Tip Number One: Do not waste your time and energy trying to explain the value of good engineering to this sort of manager.

A GM who sees the technical department only as an expense is "The Gambler." When everything is working, The Gambler sees spending money on engineering as a carefully-calculated insurance payment – and not spending money on preventive maintenance essentially a carefully-calculated risk.

The Gambler will look at the age of the equipment, the overall health of the facility, the anticipated cost of something going down, the weather outlook, the phase of the moon, and the price of tea in China. Some seem to have even less basis for their gamble. They appear to be basing financial decisions on whether their wife or mistress yelled at them this morning.

The hallmark of The Gambler: Rather than invest in preventive maintenance, he will pinch every penny in the operating budget. Say you have a tube transmitter. Do you have a new spare or is it the weak one that came out of the transmitter last year? The Gambler will not let you order a new tube until the current tube will no longer make power or fails altogether.

#### THE GM WHO "SAVES" THE DAY

Another of The Gambler's tricks: There is no money set aside for capital improvements, but when catastrophe strikes, the checkbook suddenly is wide open.

Remember when you installed the new computer-based automation for the cluster? You told the GM the room with the computers needed its own air conditioner, but since it was getting toward winter, he blew you off.

Now, it is May and you could fry an egg on top of the server case. The Gambler tells you the *Farmer's Almanac* calls for a cool, mild summer and you should not worry. That you have to prop the back door open and rig up a half-dozen box fans to keep the room bearable is not relevant. In June, when the computers lock up and all the stations go down at once, he suddenly will direct you to get that air conditioner installed "right now."

The Gambler delayed that capital expense to the last possible moment, proving that he was prudent and you were an alarmist. Free Tip Number Two: Do not waste your time and energy saying, "I told you so." No one is listening.

#### COMPLIANCE IS FOR THE OTHER GUY

In recent years, the FCC resources are stretched pretty thin. From the time your current GM was just a

young AE to the day he took the big office, there has never been an FCC Inspector at your stations.

So when you bring up compliance issues, The Gambler scoffs. Without real consequences, the risk of FCC action is deemed negligible. You may show him the Checklist, but it is soon buried by mounds of more important papers and completely forgotten. Show him real examples of real fines assessed against similar violators in the here and now, and The Gambler counters by telling you he has signed up for the Alternative Broadcast Inspection Program, which will keep the FCC Inspector away for years.

The ABIP inspectors try hard, but because they have so many inspections to conduct in a limited span of time, they frequently rely upon representations made by the staff. More than one certificate has been issued on the basis of management's promise to "fix it right away." The Gambler wins another one.

#### THE MIRACLE WORKER

Maybe you recall the last time you miraculously repaired a dead transmitter by remembering a trick you learned over the years? You may think you are just doing your job. Actually, The Gambler thinks you have proven him right and justified his management style.

Free Tip Number Three: Do not try to explain that Gambler's Luck will eventually run out. The Gambler believes in Luck and will not hear anything else.

If you work for a Gambler, the first step toward recovery is to recognize the truth and admit you are powerless to change him. When you see the GM or owner as a gambling addict, you need to decide whether you are comfortable in helping him to manage risk, or you are tired of being a miracle worker. If you choose to stay, you will be less frustrated if you see the situation honestly.

*Jim Bender is an experienced contract engineer based in Three Forks, Montana. He can be reached at [jabender@imt.net](mailto:jabender@imt.net)*

## FlipJack FJ-500

# NEW!



### CELL PHONE INTERFACE MIXER

The FlipJack is the latest addition to the Conex line of cell phone interface products. The FlipJack is designed to interface most hand held phones that have a 2.5 mm hands-free adapter jack.

#### FEATURES:

- Two headphone jacks ... each with it's own volume control.
- Two Mic inputs and a separate Line Input
- Connection To A Standard Telephone Line.
- Separate headphone cue switch for more flexibility
- Operates on "AA" batteries (Included) or external power (Optional)
- Balanced Line Level Output
- Slots for shoulder straps.
- All IC's socketed for easy maintenance
- Tuner input for off-air monitoring
- LED level indicator

FOR MORE INFORMATION

**1-800-645-1061**

[www.conex-electro.com](http://www.conex-electro.com)

**CONEX ELECTRO SYSTEMS**

1602 Carolina St PO Box 1342 Bellingham WA 98227  
phone: 360.734.4323 fax: 360.676.4822

## The Broadcast Industry's **FIRST** 6-channel UNcompressed Digital STL

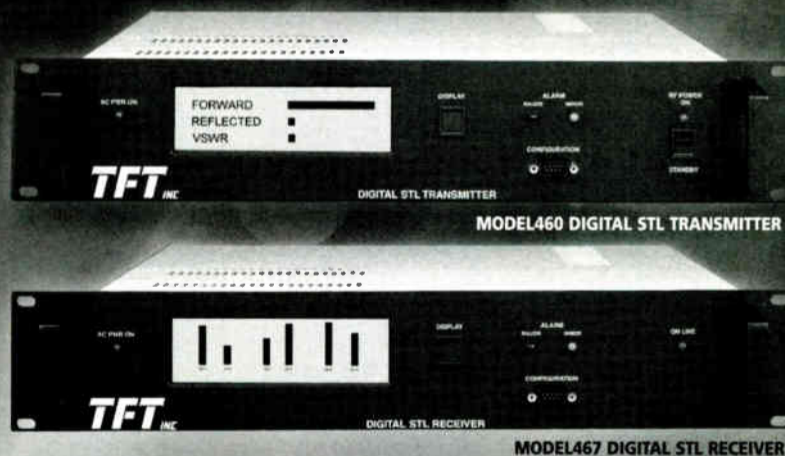

### Advanced Technology, Only From TFT

- 6 UNcompressed Program Channels, maximum
- PC Configurable from Front Panel for Frequency, I/O, Alarms, LCD
- Supports 48, 44.1, as well as 32 ks/s Sample Rates
- 256 QAM, 64 QAM, 16 QAM Modulation
- AES/EBU or Analog I/O - Built-In Sample Rate Converters
- Major/Minor Alarms on both Transmitter and Receiver
- 3.125 kHz Step Size

**TFT** INC

Phone: (+1)408-943-9323  
FAX: (+1)408-432-9218

[www.TFTInc.com](http://www.TFTInc.com) e-mail: [info@tftinc.com](mailto:info@tftinc.com)  
1953 Concourse Drive, San Jose, CA 95131



*C'mon babe, there's enough room  
in the rack for both of us.*

**OMNIA ONE: Small Box. Big Attitude.**

**Omnia**  
A Telos Company  
[OmniaAudio.com](http://OmniaAudio.com)

Omnia, ONE are registered trademarks of T.S. Corp. © 2007 All Rights Reserved

World Radio History

## Cross Training from the IT Point of View

I read the March 2007 *Radio Guide* article entitled "Is Cross Training an IT Person the Solution to the Engineer Shortage?" at the request of my Chief Engineer, George Newman. Normally I read every issue, but George thought this article could not wait. He was right.

As I began reading, I waited for the writer to offer some sort of answer to the engineer shortage or some tips for the eager IT person to help him/her gain some helpful knowledge. Neither came. In fact, I could feel myself becoming very protective of my IT/Engineering training. As a result, I emailed Ted Alexander, writer of the aforementioned piece. I had to let him know how I felt after reading his article.

### IT MEETS RADIO ENGINEERING

I came to Radio in 2005, after receiving a Computer Networking degree at a local Community College. I was given the title "IT Administrator/Assistant Chief Engineer." It was a dream come true.

Obviously, I knew more about computers and networking than radio engineering. I had a lot to learn and still do. So I followed George around, learning the daily workings of a radio station. At first, it seemed like we ran into problem after problem. But this was actually a good thing – I was learning a lot about engineering.

Then the tide seemed to turn. We were getting slammed with computer problems.

George explained to me how things were just a few years ago: simple networking with Novell, using

workgroups instead of domains, and having local computer shops build new machines for users as they were needed. Apparently, those were "the good old days." Now, having IT people on-staff is a necessity.

### CAN IT AND RF WORK TOGETHER?

These days I maintain a network domain with Active Directory, build or order new machines, maintain those systems and perform repairs when needed. In short, there is a definite need for an IT staff in a broadcast facility.

But can that IT staff be cross trained to work in radio engineering? Mr. Alexander does not seem to think so – and I disagree with that completely!

I am not saying that each and every IT person is suited to work in engineering, but most are smart enough to dig in and learn and follow directions when needed. I think it helps tremendously when the person hired for IT at a radio station is also somewhat familiar with electronics, circuitry and the like. On the other hand, there are those who truly do not have the temperament for broadcast technology – they should never be allowed to play with engineering equipment.

### FINDING THE RIGHT IT PERSON

When interviewing IT people, it is important a new hire show a vast working knowledge of computers, software and hardware, and networking. But a Chief Engineer should also make sure the candidate knows about simple electronics, working with multimeters, changing out parts within satellite receivers and boards, soldering and proper glue selection. Okay, maybe not proper glue selection, but you see my point.

During the interview, assess their mechanical aptitude as well as his/her ability to solve problems. Can they think through a problem at hand? And probably the most important question you could possibly ask yourself is "Can the candidate take and follow instructions?" This should be a "no brainer," but you would be surprised at how many mechanically adept persons cannot perform this simple task.

Sometimes interviewing can be truly a monumentally tedious task. But, that person sitting in the chair across from you, answering questions, may soon be your right-hand person. Take the time to ask questions and test abilities. Taking the time to make the correct hiring choice will make it all worth while later.

### BRINGING YOUR IT PERSON UP TO SPEED

Once you have made the choice and hired that "perfect fit," do not expect perfection right out of the gate. Take some time to explain the very basics of radio broadcasting. There is a distinct difference in the station being off the air, experiencing a loss of audio, or even a loss of the on-air feed. Make sure he/she knows the difference and troubleshooting the problem will be much easier. Help them understand the whole system.

Did you know all the terminology when you first started your career in broadcast engineering? My guess is no. After all, we use jargon that could confuse Nobel Prize winners. Make a list of broadcasting terms that you use on a daily basis and share it with the new hire.

Giving your IT person the tools needed to become the backup radio engineer is essential to their growth. Along with hiring the right person for the job, you also need to be instrumental in their education. I know most engineers are stretched thin and the thought of training someone to take your place – or even be your assistant – can be mentally draining at times. But, not taking the time to teach and mentor your new hire will only cause the engineer shortage to worsen.

So take the time needed during the hiring process to find the right person for the job. Then help mold them into the IT/engineering staff you would like them to become. Be there when the transformation takes place. I hear there is a really good feeling when watching your new hire perform engineering tasks on their own.

*Drey Blevins is the Market IT Director/Assistant Chief Engineer for the Curtis Media Group in Winston-Salem, NC. Contact her at dblevins@curtismedia.com*



**FM Broadcasters' First Choice**

**SHPX ROTOTILLER® FM Antenna**  
HD Radio Ready™

- Rugged brass construction
- Stainless steel brackets
- Reliable series fed elements
- Welded internally pressurized feed connection
- Multiplexed versions available

"HD Radio" is a trademark of iBiquity Digital Corporation

**ERI® ELECTRONICS RESEARCH, INC.**  
(812) 925-6000 | www.eriinc.com

**TRANSCOM CORPORATION**  
*Serving the Broadcast Industry Since 1978*

Visit Our Website – [www.fmamtv.com](http://www.fmamtv.com)  
Send your e-mail requests to: [transcom@fmamtv.com](mailto:transcom@fmamtv.com)

**Fine Used AM & FM Transmitters & New Equipment**

<b>AM</b>	5 kW	1996	Continental 315D <b>Solid State</b>
	5 kW	1974	Continental 315F
	5 kW	1982	Harris MW5A
	5 kW	1987	Harris MW5B
	10 kW	1985	Continental 316F
	50 kW	1985	Continental 317C2
<b>FM</b>	250 W	20067	Crown 250E
	1.0 kW	2007	Crown FM1000E
	1.5 kW	1983	BE FM 1.5A
	2 kW	1999	Crown FM 2000A
	2 kW	2007	Crown FM 2000E
	3.5 kW	1986	Harris HT 3.5
	5 kW	1987	Harris FM5K1
	7+ kW	2002	Harris Z16HD <b>IBOC</b>
	7+ kW	2005	Harris Z16 HDS <b>IBOC</b>
	10 kW	2001	Henry 10,000D-95
	20 kW	1985	Harris FM20K
	20 kW	1989	QEI FMQ20,000B
30 kW	1986	BE FM 30A	
30 kW	2006	Harris HT30CD	
50 kW	1982	Harris Combiner <i>(w/auto exciter-transmitter switcher)</i>	

**USED MISC. EQUIPMENT:**  
Altronic 20kW Air Cooled Load  
Bird RF ThruLine Watt Meter, 50S  
Denon 720R Cassette Player

**EXCITERS:**  
\*New\* 20W & 30W Synthesized Exciters  
Used 2004 Harris 2nd Generation  
*Please go to our website  
[www.fmamtv.com](http://www.fmamtv.com) for updated listings.*

*Equipment retuning and testing available. Please call for quote!*

**2655 Philmont Ave, Ste 200, Huntingdon Valley, PA 19006**  
**800-441-8454 215-938-7304 Fax: 215-938-7361**

# Bay Country Broadcast Equipment

*Buy • Sell • Trade*

**Your #1 Source for Quality  
Used Radio Broadcast Equipment**

View our latest list of equipment on-line at:

**www.baycountry.com**

Or call and we will fax it to you.

*All equipment sold with a 15 day return guarantee.*

### Turn Your Excess Gear Into Cash

Fax or email your list to us and we will respond with our offer promptly. We only buy good working equipment with traceable serial numbers.

*Fax Your List Today – 443-596-0212*



<http://www.baycountry.com>

*(Website Updated Daily)*

E-mail: [sales@baycountry.com](mailto:sales@baycountry.com)

877-722-1031 (Toll Free) 443-596-0212 (Fax)

7117 Olivia Rd, Baltimore, MD 21220

**BEXT**

## FROM THE TALL TO THE SMALL

**FM & TV  
Transmitters**  
Solid State or Tube  
Antennas & Combiners

**20 Years of Service**  
Asistencia en Español  
**24 Hour Support**  
**2 Years Warranty**

[www.bext.com](http://www.bext.com)  
Tel 619 239 8462  
Fax 619 239 8474  
[bext@bext.com](mailto:bext@bext.com)

**NEW  
EXCITERS/TRANSMITTERS**  
w/stereo generator & audio limiter,  
field programmable FSK ID keyer, all built-in!

## Experience Exceptional Quality, Reliability and Service! Experience Armstrong Transmitter!

Our single tube FM transmitters offer you exceptional quality and affordable prices.

Built for the "real world" environment these RF workhorses offer long term reliability and features not found in any other single tube transmitter available.

Like Fiber Optic PA arc detection, PA thermostatic protection Roll Out Power Supply, and Key Component temperature sensors

*Armstrong Transmitter brings you the best RF products, the best around the clock support and the best prices  
....because you deserve nothing less!*

web: [www.armstrongtx.com](http://www.armstrongtx.com) ph:315-673-1269  
email: [sales@armstrongtx.com](mailto:sales@armstrongtx.com) fx:315-673-9972

# AM Ground Systems Co.

## Ground System Construction, Evaluation & Repair

### 1-877-766-2999

[www.amgroundsystems.com](http://www.amgroundsystems.com)

- ◊ Has your station lost coverage over time?
- ◊ Is your AM ground system over 30 years old?
- ◊ Do you have a new CP or are moving transmitter sites?
- ◊ Has your ground system been damaged or vandalized?
- ◊ Is your base impedance or directional pattern unstable?
- ◊ Just wondering if you are getting all of the range your station is capable of?

If the answer to any of these questions is YES  
Call today for a free construction, repair or evaluation quote.

### Reliable On-time Installation Quality Workmanship Tower Tune-up Free Budgetary Estimates & Quotes

# We Came, We Ate, We Talked

## NAB, and the Lunch Gathering

The 2007 NAB Spring Show has come and gone and many folks are mulling over their piles of literature, notes and recordings from various meetings and sessions, and the experience of meeting, conferring, conversing, and otherwise hobnobbing with broadcasters from around the country and the world.

### THE LONG AND THE SHORT

The Show is both too long and too short. Although the NAB registered over 108,000 attendees, by Thursday, the North Hall was pretty empty and everyone was tired; there was talk of setting off a canon to see if it would hit anyone. (To be fair, traffic on Monday and Tuesday seemed improved, due to a changed mix of exhibitor locations.)

But the Show was also too short. More than ever, attendees need to choose in advance what things are most important to them and their companies. Many folks spent their show time talking with vendors to get information and buy equipment. Some noted that with the new exhibit floor plan, they rarely left the North Hall except for sessions and presentations that were important to them (and a major hike to the South Hall).

Indeed, at almost any time (especially on Monday and Tuesday) there were multiple events or receptions going on. Perhaps the best part of the Show, as always, was the chance to meet, greet, and network with vendors, engineers, and managers alike. Dancing on top of the bar was optional.

### A FINE LOOKING GROUP

True, there is some prejudice involved, but the Annual Lunch Gathering on Tuesday was a highlight for more than a few. Well over a hundred folks made it over to the Riviera

Hotel for the 15th edition of the Lunch, including many old friends – and a whole bunch of new ones!

During the hour or so before everyone had to drift back to the Show floor, there were a lot of conversations, folks being introduced to email correspondents, and some special surprises. Thanks to the support of our co-sponsors, we had a lot of goodies to hand out to the Lunch Bunch, including some very nice sweater vests from Orban and some handy gear bags and other goodies from Comrex. Shively and Prophet Systems (RCS) also contributed goodies, including a 15% discount coupon for the NAB Handbook, just released in its new edition.

In addition to the T-Shirts and caps from several companies, Neural Audio contributed a couple of nice tool kits, Broadcast Electronics sent some Flash Drives, RDL sent over some headphone amplifiers, and, as usual, Scott Fybush showed up with some of his calendars. But that was not all.

From CardScan we had “team” editions of their super business card scanning and database system. Dymo contributed a Labelwriter Turbo 400. From Microsoft, we



A portion of the crowd.



As usual, Barry came with a haul of door prizes.



The new Radiosophy HD100

had a copy of Office 2007 to hand out. And, the folks at discgear sent along some of their Selector 100 disc retrieval systems, a way to organize and quickly select a CD or DVD with a finger press.

We were not only pleased to have one of four prototypes of the Radiosophy HD100 radios to display at lunch and in the *Radio Guide* booth on the floor, but Radiosophy even gave us one to give away.

Radiosophy made the radios available at the show for \$99. But with the current rebate program running through July 3rd, the net cost is only \$59.95. More information may be found at <http://www.radiosophy.com/products/hd100.html>.

### EVERYONE IS A WINNER!

Plus, everyone at lunch went home with their choice of a calculator notepad or DVM, complete with a complete case, courtesy of *Radio Guide Magazine*.

But the big deal was the group itself that showed up. All in all, it was a great Lunch Gathering. About the only thing I can say about next year is that I have got to get a microphone and loudspeaker. Do any of you know where we could get something like that?



No one went away hungry or empty handed.

Clickable URLs for all the companies and products mentioned can be found at [www.radio-guide.com/URL.htm](http://www.radio-guide.com/URL.htm)

## AM Antenna Solutions

Reach Farther, Sound Better!

LBA is your trusted supplier for IBOC-ready AM antenna systems. For over 40 years we have been designing and manufacturing reliable *Directional Antenna Systems, ATU's, Multiplexers, Combiners, Cellular/PCS Colocation Isolators, and RF Components* for all power levels.

Choose an LBA system and join thousands of satisfied broadcasters in the US and worldwide!

LBA can also design, manage, install and finance your complete RF project. Please call us for a free technical consultation!

IBOC PHASE ROTATORS AVAILABLE!



Directional Antenna Systems

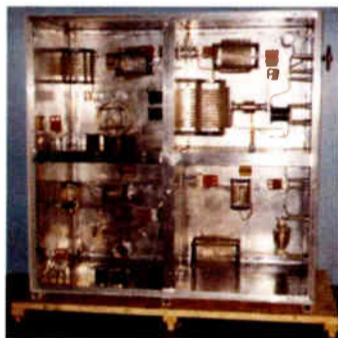

Diplexer/Triplexer Systems



High-Power Antenna Tuning Units

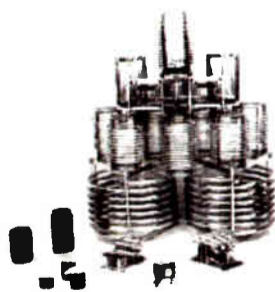

RF Components

Factory Dealer For:



**LBA Technology, Inc.**

3400 Tupper Drive, Greenville NC 27834  
252-757-0279 / Fax: 252-752-9155  
[www.LBAGroup.com](http://www.LBAGroup.com) / [jbrown@LBAGroup.com](mailto:jbrown@LBAGroup.com)



SINCE 1963



1.818.840.6749

www.sasaudio.com

# Yo Rick! You Rock!



Hey, when Rick talks, we listen.

Rick Dees has always liked the look and feel of the traditional 50s- and 60s-style rotary fader consoles. For his new studio complex, SAS custom designed and built the **Dees Digital Rubicon**, a true Rubicon digital console control surface in the traditional style.

In return we got more than a few kudos from industry big shots, plus a coveted 2007 Cool Stuff Award.

Interested? For more info, give us a ring.



**SIERRA  
AUTOMATED  
SYSTEMS**

20 years of listening. 20 years of innovation.



Congrats  
to you,  
Rick Dees,  
on your  
inauguration  
into the  
**Radio Hall  
of Fame.**

# The Worst I've Ever Seen

A Visual Display of the Good, the Bad, and the Plain Hard-to-Believe

## How Minimum Can an MPOE Be?

by Richard Rudman

As most readers know, U.S. telephone companies designate a Minimum Point of Entry (MPOE) as the demarcation point where their services terminate and internal wiring takes over. Recently I did a remote out of the country where MPOE took on a whole new meaning.

### A SMALL SURPRISE UPON ARRIVAL

The venue promised they could have a vanilla 2B+D BRI ISDN circuit for a syndicated show remote. They just did not say where they would deliver it or how minimum the point of entry for it would be.

As it turned out, it was fortunate that I had arrived a day early for testing. The backplane card cage was sitting on a drain sump next to an industrial washing machine in the basement of a clubhouse overlooking a scenic ocean bay.



A plastic chair was all that stood between the telco equipment and spark city.

Once testing was successful, we extended the ISDN pair upstairs to the first floor, mahogany paneled dining area where the atmosphere was better and the humidity was lower. All we could do was hope the washing machine would not find another way to get at the gear downstairs.

To make a long story short, the ISDN worked and the two-hour show went off without a hitch. And fortunately, no children, broadcast engineers or telephone technicians were harmed in the production of this remote.

*After four decades in large markets and small island resorts, Richard Rudman still has not seen it all and says he always enjoys the challenges of radio engineering. Contact Richard at rar01@earthlink.net*

### AND THEN IT GOT BETTER

I was watching while the technician began working on his cell phone to provision the switch two islands away. Suddenly, the tide figuratively came in right under the equipment shelf. Suds and dirty wash water oozed out from the washing machine and partially flooded the power supply that was sitting on the gravel.

Thinking as quickly as I could, I picked the power supply up by an insulated corner (Yes, I was standing on a wet cement floor!). Holding it as tightly as was possible, I held it clear until we could find a plastic deck chair to keep it and the equipment shelf above the high water mark.

## Wanted: Chief Engineer



**Morris Communications Company**, owner of Salina Media Group in Salina, KS has an opening for a Radio Chief Engineer.

The stations are in good shape, and we're looking for a radio veteran with at least 5-7 years experience as a Chief Engineer. Most of the IT and Hard Disk Automation work is handled in-house by the local IT expert or corporately, so this position will encompass the transmitter, studio and only a little IT, but you need to understand automation and computers anyway.

You'll be in charge of the technical operations for 4 FM and 2 AM stations in Salina and Abilene. We expect to see a resume with a great deal of experience in AM directional, AM and FM transmitters, compliance, leadership, maintenance, projects, and hard disk automation.

We have high standards for our products and we don't cut corners. We need you to be able to fix something permanently, quickly and economically. We'll give you all the resources you need to get the job done.

In return for your dedication and hard work, you'll be paid a great salary, outstanding benefits, and a 401(K) program the company will pay into.

Email your resume to [jay.white@morris.com](mailto:jay.white@morris.com)

Morris Communications Company, LLC is an Equal Opportunity Employer.

# RF Specialties® Group

Hi, thanks for reading our ad.  
Most sporting events are off and running.  
The RF Specialties Group has the remote equipment you'll need to do a bang up job covering the games.  
Microphones, Sports-Headsets, Mixers, POTS, ISDN, Marti RPU equipment and the list goes on.

**Give us a call!**

The call is free and you'll discover,  
**RF Specialties** is your ticket  
to a perfect Sports Season.

## RF is Good for You!

Visa and Mastercard are welcome.  
Offices Independently Owned and Operated.

[www.rfspec.com](http://www.rfspec.com)

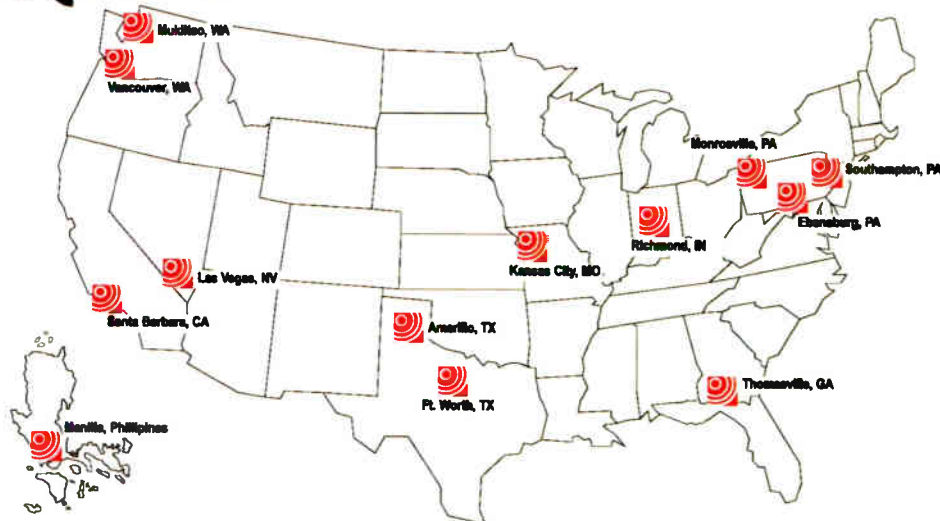

Sam Lane	Santa Barbara, CA	1-800-346-6434
Bill Newbrough	Las Vegas, NV	1-888-737-7321
Bob Trimble	Vancouver, WA	1-800-735-7051
Walt Lowery	Mukilteo, WA	1-425-210-9196
Don Jones	Amarillo, TX	1-800-537-1801
Wray Reed	Ft. Worth, TX	1-888-839-7373
Chris Kreger & John Sims	Kansas City, MO	1-800-467-7373
Rick Funk	Richmond, IN	1-888-966-1990
Ed Young	Monroeville, PA	1-866-412-7373
Dave Edmiston	Ebsensburg, PA	1-866-736-3736
Harry Larkin	Southampton, PA	1-888-260-9298
Alan Slaughter & Chris Hall	Thomasville, GA	1-800-476-8943
Ed Edmiston	RF Specialties of Asia (Manila, Philippines)	+63-2-412-4327

# Coverage, Reliability, and HD Radio™ Experience

When Vermont Public Radio installed HD Radio™  
at some of the worst weather sites in North America,  
they chose

## Shively Labs®

### ...again!

WVPR/Mt Ascutney; WNCH/Burke Mtn;  
WVPS/Mt Mansfield - Bringing the first  
HD Radio™ signals to the Green Mountain State!

Mt. Mansfield  
Vermont  
October 2006

P. O. Box 389, 138 Harrison Rd., Bridgton, Maine USA 04009  
(207) 647-3327 (888) SHIVELY FAX (207) 647-8273  
sales@shively.com www.shively.com

- An Employee-Owned Company -  
ISO-9001:2000 Certified

# RADIO SYSTEMS' CONSOLES DAS HYBRIDS CLOCKS



Year after year, broadcasters depend on Radio Systems' studio products.  
For performance, price and dependability **THERE IS NO BETTER VALUE.**

Millenium 6, 12, 18 & 24 Channel Analog and Digital Consoles • 4x4a & DA-16 Distribution Amplifiers  
DI-2000 & TI-101 Telephone Hybrids • CT-2002 Clock and Timing Systems w/GPS and Infrared Remote

**radio** SYSTEMS

**Radio Systems, Inc.**

601 Heron Drive, Logan Township, NJ 08085  
phone: 856 467-8000 Fax: 856 467-3044 www.radio@systems.com

## War Stories

### The Tale of the Haunted Transmitter Site

Have you ever thought your transmitter site was haunted? When a series of strange events happen at a site, you just might start wondering.

#### AN UNUSUAL SITE

This "tale of the strange" begins with the local folklore surrounding a 27-acre site that was once a sacred Native American burial ground. In the later 1900's, any further site development in the area encompassing the transmitter site was restricted by the local authorities. However, the transmitter site could stay.

My first visit to the site (originally built in 1950 with five 200-foot towers and an additional 485-foot tower a decade later) was in 1964, just after high school graduation. A newly-minted "First Phone," my first impression was "man is this place uncomfortable." Now, I am not afraid of the dark nor am I the least bit superstitious, but something felt wrong here.

Several years later (in 1967), I returned to keep an appointment with the station PD. Two days earlier, a local cloudburst had caused a flood through the combined studio-transmitter building; the carpets were smelly and some of the engineers were very busy cleaning out the cable runs in the floors. The place was dank, damp, and still felt wrong.

#### TAKING OVER THE SITE

As fortunes go, and sales occur, I eventually assumed the Chief Engineer's role at the location in 1978.

The station was "split" between day operation at the old site and night operation at a site about ten miles to the south. The old site still had a lot of debris and mud lingering in the cable runs. Even the nighttime half of the DA was still partially connected.

The first really weird thing we noticed was the resonance of the "singing tower" – the 485 footer. When the wind reached about 15 mph, the tower would "moan" a weird low-pitched growl that sounded like someone in pain.

Some folks pointed to a July 4th storm in 1969 that brought the original 485-foot tower down. The owners had wanted to restore the daytime pattern and a side mounted FM ASAP, so they called in a tower crew to hurriedly rebuild the tower. About three quarters of the way through the rebuild, something snapped and three members of the tower crew rode it into eternity. The gouges in the field remain to this day.

#### PHASOR FUN

The old-style design called for the phasor to be located in the center of the old DA, at the base of Tower Three, the middle tower of the original array. Adjustments were much easier to make in the wee hours, since we could sit with an unmodulated carrier for ease of adjustment.

The first time I went out to the phasor, carrying flashlight and tools, about 3 a.m., I got into the tiny concrete-block phasor house and encountered the usual spiders and cobwebs, dust, and assorted other dirt.

As I inspected the bundles of RG-17, one of them started to move! All alone – and with the building door open and my feet ready to bolt from the place should something unexpected happen – I gingerly prodded the cable with the end of a broom stick. The cable started to bend and soon I was looking into the face of a big black snake, the same diameter and color of the RG-17.

I finished the adjustments and secured the door. The trip back to the transmitter building was unevent-

ful but you can be sure I was "hyper-aware" of any nighttime noise in that field.

#### A HAZY "VISITOR"

I had noticed a cold spot behind one of the 5000-watt transmitters. At first, I attributed it to air flow. But when the transmitter and air-moving equipment were shut down, there still was a definite cold feeling in that area. Upon investigation, one of the retired engineers told me an engineer had been electrocuted at that very spot while working on an old transmitter.

One evening, my soon-to-be ex-wife asked who was talking in the room behind the transmitter. We went into that room and found no one there. But a year later, as I was showing the site to my fiancé, she also asked me who was talking in the back room. Again, it was late evening and everyone else had gone home.

Shortly after that, while doing an annual EPM on the AM transmitter I saw something quickly "dart past" a hallway just to my left. Thinking a squirrel or rabbit might have gotten in, I went looking and saw nothing. However, several minutes later, I clearly saw a misty kind of cloud that appeared to have a human form about it. Well, I am not a believer in ghosts, but this was a bit much. Yet, as I stood up and headed toward it, it just kind of "fizzled out."

#### AN ODD FEELING

From the very first time I was ever in that building, until it was finally razed, I was never comfortable there. I seemed to sense a presence every time I was there, especially if I was alone. I like towers, transmitters, and their buildings, and have never felt anything like a "presence" at any other transmitter site.

So, was it "haunted"? Were there "restless spirits" there? Or was it just a series of odd occurrences? What do you think?

*Ted Alexander enjoys sharing his experiences over the years. He would love to hear yours at AMFMTV@aol.com*

**LARCAN**  
We hear you. Loud and clear.

## LOOK TO LARCAN FOR TRULY MADE TO MEASURE FM SOLUTIONS

Designed with a difference to ensure the highest quality audio performance - LARCAN offers a superior range of solid-state FM solutions from 25w to 5kW. Customer driven and purpose designed for optimum performance - we bring you the ultimate in FM broadcast technology from 'start to service'.

We hear you. Loud and clear.



25w FM Translator  
FMT-25

U.S. Tel: 1-303-665-8000 • Fax: 1-303-673-9900 Canada Tel: 1-905-564-9222 • Fax: 1-905-564-9244

[www.larcan.com](http://www.larcan.com)

Email: [sales@larcan.com](mailto:sales@larcan.com)

#### Custom Fit Features:

- Superior Audio Performance
- Modular Design
- Wideband Operation
- Automatic Tuning (front-end)
- High Selectivity
- Fully Synthesized (Tx and Rx)
- Internal FCC Code Key Module
- Compact 1RU Design

**Missing Some of Your Radio Guides?  
Get Them All on the BDR**

Sometimes that magazine you lent out does not come back. Or, you left it at the studio, and need it at the transmitter. Version 2.7 of the Broadcaster's Desktop Reference (BDR) now includes every issue of **Radio Guide** from January 2003 to the present. Plus, there is an index for the PDFs, for easier location of older articles.

The BDR is an ongoing effort to provide useful tools, information, and history of interest to broadcasters.

The CD includes several sets of Radio Utilities, an AM and FM/TV database viewer (including DA patterns), as well as EAS printer paper sources, project schematics, historical data and pictures – even some humorous Top Ten lists.

Recent additions include the archives of the BROADCAST mailing list from www.radiolists.net, going back over seven years. Using your reader, lots of tech tips from the field and other helpful info are quickly searchable.

A Table of Contents for the BDR can be found at: [www.olderadio.com/bdr.htm](http://www.olderadio.com/bdr.htm)

The proceeds from this CD fund both future improvements of the BDR as well as helping the efforts of olderadio.com to document the industry's history.

There is no set price for the BDR. Many find \$15-\$20 appropriate to cover the costs of materials and shipping, plus a little extra for funding the improvements. If you pay more, it will be put to good use.

If you have wideband Internet, we can now make arrangements for you to get the BDR quicker, via the Internet.

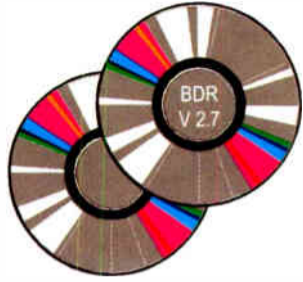

Credit Card Payments Accepted at:  
[www.radio-guide.com/products.html](http://www.radio-guide.com/products.html)

Or send your check or money order to:  
**Barry Mishkind, 2033 S. Augusta Place, Tucson, Arizona 85710**  
Please include your snailmail and email addresses.

**LEA INTERNATIONAL**

*Stay on the Air!*

**We Protect:**

- Digital & Analog Transmitters
- Studio Equipment & Facilities

Contact LEA Today for a Free Product Catalog!  
208.762.6121 • 800.881.8506  
[www.leaintl.com](http://www.leaintl.com) [lea@leaintl.com](mailto:lea@leaintl.com)

*Your Broadcast Surge Suppression Specialists*

smths



Manufacturers of the  
**Gila-Stat**  
Lightning Prevention System

**nott ltd**

Phone: 505-327-5646 • Fax: 505-325-1142  
[www.nottltd.com](http://www.nottltd.com) • [info@nottltd.com](mailto:info@nottltd.com)

3801 La Plata Hwy, Farmington, NM 87401

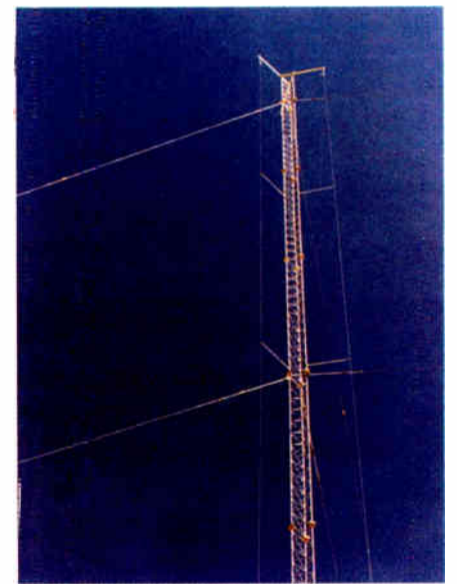

Design and Manufacture of  
**Folded Unipole Antennas**  
Structure Detuning Systems



**N E L L O**  
CORPORATION

Distributors of  
**Nello Towers**  
and Accessories

Over 40 Years  
Broadcasting  
Experience

## Helping Others to Reach Achievement

*When broadcast engineers get together, a common topic of conversation is "Where are the new guys going to come from?" As Dick Burden shows, when we encourage interest, we are making an investment in the future.*

I was asked recently to address a group of high school students on career day. In preparation, I looked back at my interests during that period of my life and reflected upon those individuals who influenced my path.

### MAKING CHOICES

I remember my dad asking me what my plans were following high school. My answer was "to retire." Not surprisingly, Dad took a rather dim view of my reply and turned the matter over to Miss Cameron, the Guidance Counselor at school.

She looked at my grades and found not much to go on there. She noted that I played football and basketball, but that baseball was my real love. She was painfully aware of my single-performance acting career, which made me a permanent member of the stage crew throughout my high school years. So, how do you build a career out of this?

Miss Cameron started by giving me an aptitude test, perhaps to see if there was any aptitude at all. She followed up by talking with my teachers. I bet there were some interesting conversations there! My Latin teacher likely did not to expect me to do well in languages. Mr. Bates, physics teacher and baseball coach, was not impressed with my performance, neither inside nor outside the classroom. His advice to future coaches was not to count on me in a pinch.

To be honest, Mr. Bates was annoyed because his physic experiments often seemed to depart from theory – Ohm's Law measurements did not match the equation. Of course, voltage dividers and shunts behind the meters will do that.

### THE MENTOR

Meanwhile, enter my friend Jack Mulley. Jack had opened a little radio shop at the foot of the hill near the school following his return from World War II in the Pacific. I would stop by to see him whenever I had a problem with a sound system for a school dance or a stage show.

Jack became my mentor. He taught me to understand what I was doing – and he made it interesting and

fun. He encouraged me to do some of the repair work and paid me in Pepsi Colas. This fostered my interest in radio and electronics.

Sadly, all good things come to an end; Jack and his family moved from the area. I promised Jack that I would be a mentor to others, and I have done that.

### BRINGING THE PARTS TOGETHER

Meanwhile, Miss Cameron was entering the home stretch. The aptitude test somehow had shown I possessed organizational skills. She then found a small college that would actually accept me in their economics program and wanted me to play baseball for them. Out of the ashes grew a rose; Miss Cameron had won the perseverance contest!

In spite of myself, here was an opportunity. Soon after my arrival on campus, I found that the students had a Carrier Current station and I became a member of the technical team. It was relatively safe: those were the days when the engineer was on one side of the glass and the talent was on the other. There was no danger of my getting on the air.

We had a great sports crew and, along with our remote technical crew, broadcast the football, basketball and baseball games. I also did a few remote big band broadcasts. Our mixers had only three or four mixing positions, so one microphone covered the basic orchestra, the second for the vocal, and a third on the piano was pretty much as good as it got.

### NEW MENTORS

As I completed my year of economics and baseball, the radio bug had bitten me pretty hard and I wanted a career change. I left Lafayette and entered RCA Institutes. It was at RCA that I gained a real fundamental background in broadcast technology.

My instructors had years of experience in the field prior to teaching a course. But what I really had there were mentors who understood the practice as well as the theory and had a way of presenting it so that it was properly captured in our minds. This strong background offered me the ability to design circuits, write tech manuals, work in a think tank, be part of a project management team, teach at the Signal School at Fort Monmouth, and do a tour of military duty with Armed Forces Radio.

Along the way I was blessed with the opportunity to work with well-respected engineers on interesting

projects as well as participate in broadcast technical standards. I really have enjoyed my career in radio.

### REACHING TODAY'S YOUTH

As I addressed this group of young people and reflected upon this scenario, I realized how blessed I was to have a Miss Cameron, a Jack Mulley, and a Mr. Bates, as well as many others who made significant contributions to the quality of my life. I needed to make them aware of the difference between a job and a career.

What did these kids have in comparison? The answer, in reality, was probably nowhere close what I had. The question is: how do we instill an interest in any profession without putting forth an effort to reach them? And then, once we develop interest, where is their mentor? Where do they get a formal training? How can we help prepare them for a satisfying career?

To start off, I told them to dream. I told them to identify the profession that would fulfill that dream and put forth an effort to learn more about it. I encouraged them to seek out advice from someone employed in that field. Ask for a tour of his or her workplace. Above all: make your own choice about your career – and promise yourself to do well.

I told them to love their chosen profession and always keep on learning. I told them to always give their best to their profession and to their employer in whatever they do.

### HOW TO MAKE RADIO MORE INVITING

When that young person steps forward, comes to you, and wants to learn more about what we do, the question is what will you do? I hope it is not simply saying "I don't have the time for that."

How does this profession hope to capture the mind of a young person today? How do we encourage his interest and give him an opportunity to fulfill his capability? Ham radio historically offered an introduction to radio and electronics and many broadcast engineers came via that route. With fewer new hams as a pool, how do we develop an interest in what we do?

It takes both employer and employee to create a good working atmosphere. Where the atmosphere is not conducive to productive employment, the logical choice is to further educate oneself and move on.

Attitude is important and many broadcast engineers feel already overworked and under-appreciated – and thus do not feel any obligation outside of working hours. This is an error in judgment and a potential stalemate in a career. Management that does not encourage an atmosphere for keeping up with technology is equally shortsighted. A change in both these attitudes needs to happen.

If we are going to bring new folks into radio engineering, we need to meet these challenges. What are your thoughts?

*Dick Burden received the SBE Lifetime Achievement Award for over 55 years of work in broadcast engineering, and he is still actively working. Contact Dick at [rwburden@pacbell.net](mailto:rwburden@pacbell.net)*

**NEXT GENERATION**  
**MAC & MiniMAC** Transmitter Remote Control

Relax,  
your sites are in good hands!

[www.davicom.com](http://www.davicom.com)

# NO MORE SECRETS.



Enter to  
win at

[nomoresecrets.com](http://nomoresecrets.com)



# Dreaming of the most innovative HD Radio solution in the universe? Rest easy with Nautel, where it really is rocket science.



Nautel engineers are at the cutting edge of transmitter design. In fact, the Nautel team is developing RF power solutions for deep space plasma propulsion. You'll find that same innovative spirit in every Nautel HD Radio solution. Innovation; just one more way that Nautel is making digital radio work. Learn more at [www.nautel.com/rocketscience](http://www.nautel.com/rocketscience).

## Win a Cambridge Soundworks HD Radio Receiver!

Go to [www.nomoresecrets.com](http://www.nomoresecrets.com) to enter.

Watch for more Nautel secrets and opportunities to win!  
Contest winner will be announced in June 2007.

Phone: (902) 823.3900 | Fax: (902) 823.3183 | [info@nautel.com](mailto:info@nautel.com) [www.nautel.com](http://www.nautel.com)



**HD Radio**  
Pure Digital. Clear Radio.

# Making Digital Radio Work.



# WE GIVE RADIO SUPER POWERS



**YES. REALLY.**

Continental Electronics' 816HD FM offers the highest power transmitter on the market for low-level combined digital HD and analog FM. The 816HD can deliver 28kW of power for the strongest, cleanest signal on the airwaves. And since the 816HD FM is built "Continental" tough, its performance and reliability will make you a superhero! For more information, call 800.733.5011 or visit our web site at [www.contelec.com](http://www.contelec.com)



## Digital and Analog Transmitter Audio Switching Solutions, Analog to IBOC!



The AES-302 Digital Audio Switcher/DA/D to A Converter



The CDS-300 Composite Audio Switcher/DA



The CDS-302 Automatic Composite Audio Switcher/DA

Introducing the next generation transmitter audio switchers from BDI. Now you can have complete confidence in your signal path with this series of switcher/DA systems. We have **composite** and **digital** solutions for your routing and distribution requirements. If your system is all digital, choose the AES-302 to automatically switch, distribute and monitor your transmitter audio feeds. Still running an analog STL or stereo generator? Use either the CDS-300 or 302 to switch and distribute your baseband audio signals. Select one of the optional modules for the CDS series and convert your analog signal path into an AES digital output suitable for digital excitors and IBOC implementations. Visit our web site and download complete information about these problem solver products.

**Broadcast Devices, Inc.**  
Tel. (914) 737-5032 Fax. (914) 736-6916  
Website: [www.Broadcast-Devices.com](http://www.Broadcast-Devices.com)



## Ultramod Classic Processor



UM-2000 Stereo Processor

The UM-2000 is a self-contained, split band stereo FM processor, with AGC and an **ultra transparent** digital stereo generator.

The audio processor section is an ultra-transparent AGC that preserves dynamic integrity while maintaining the modulation peak envelope at its maximum level.

Designed to give you a concert quality, at a price you will like.

- Selectable pre-emphasis
- Digitally synthesized stereo generation
- Dual composite outputs
- Ultra-transparent split band AGC
- 30 dB gain reduction capacity

**AFFORDABLE AUDIO PROCESSING**

**Just \$995.00**

Contact us for details and dealer demonstration.

**Broadcast Technology Company**

PO Box 2581, Garden City, KS 67846

620-640-3562 – [www.broadcasttech.com](http://www.broadcasttech.com)

by Ronald Kramer

## Harry and Walter Read Oregon's Unconventional Radio Pioneers

*The men (and women) who built and operated the first stations were definitely pioneering types. As the industry got started in Oregon, it was folks like the Read brothers that overcame obstacles. It truly was "the Wild West" in more ways than one!*

*The following excerpt is a chapter from Ronald Kramer's upcoming book "Pioneer Mikes, a History of Radio and Television in Oregon," to be published in 2008, in cooperation with the Oregon Association of Broadcasters.*

Brothers Harry and Walter Read are among the interesting and colorful of Oregon's pioneer broadcasters.

A kind of "Johnny Appleseed" of early Oregon radio, Harry Read had a hand in starting or operating a host of early stations including KFHB, KQP, both Hood River; KOIN, Portland; KXL, Portland; KSLM, Salem; KORE, Eugene and KOOS, Marshfield (now Coos Bay). Brother Walter, also heavily involved in radio, had worked for Harry's KXL, Portland, for a time and later managed/owned or started KOOS, Coos Bay; KWRO, Coquille and KVAN, Vancouver WA.

### A FAMILY AFFAIR

Born on August 29, 1892 in Seattle, Harry B. Read (the last name is variously spelled Read and Reed in Federal licensing documents, newspaper accounts, and other records) was the elder. The son of Louis B. Read and Elizabeth Read, Harry was one of four children including brother, Walter, and sisters Phoebe and Faith.

Harry apparently was first exposed to radio during a stint in the Merchant Marine following which he worked in Portland for the early radio manufacturer Hallock and Watson. In 1920 he moved to Hood River to set up his own radio shop. Walter apparently picked up his interest in radio from his brother.

Radio was clearly a family affair.

In Hood River, while operating the Hood River Radio Shop, Harry Read became the Chief Operator of KQP and eventually secured the station's license from the Hood River Radio Club. When the largely volunteer station failed in 1924, Harry arranged to move the station to Portland, returning the station to the air in 1925 and renaming it KOIN – which Walter assisted in building and operating.

Selling KOIN in 1926, Harry launched KXL in Portland that same year and KSLM, Salem, in 1934. Harry remained in Portland until 1936 when he sold KXL and moved to Salem.

### A UNIQUE APPROACH

Read appears to have always been heavily technically oriented, a visionary who was highly distrustful of big business. A colorful character, "Harry Read" stories abound and those in the know have long collected and traded anecdotes about him like treasured nuggets.

For example, Read was vehemently opposed to utility monopolies; perhaps the most widely known "Harry Read story" sprang from that antipathy.

Having launched KOIN in Portland, Read was loathe to order telephone lines from the phone company for live remote broadcasts. While leasing phone circuits for remotes had become fairly common in the late 1920s, Read resented the cost.

### UNDERGROUND COORDINATION

While it is unclear just when he began the practice, either from from KOIN's studio location in the Heathman Hotel or KXL's Multnomah Hotel studios (or both), Read discovered that he could flush a tennis ball – to which a wire was attached – down a Men's Room toilet. He could then flush a tennis ball down a toilet at the intended broadcast location and then, lifting a strategically identified sewer manhole cover, he would "fish" for the two wires with a fishing pole, connect them and complete the circuit.

Read apparently became quite a scholar about Portland's underground sewers and grew adept at "wiring" the station's studios to different remote broadcast locations using his "sewer system" of interconnection. While KXL and KOIN were both young stations, the sense of these stories is that Read's unique method of "floating" remote circuits stemmed from the challenge, a thrifty nature, and his dislike of the phone company more than from lack of funds to lease regular phone circuits.

Reportedly, Read used this system for some years until the phone company tipped off the City Public Works officials who put a stop to Read's self-installed remote broadcast circuits.

### LONG DISTANCE REMOTES

Increasingly, remote broadcasts also originated outside a station's home community, and another Harry Read story has him connecting his remote circuits, flushed through the sewers, to the old Portland railroad tracks along the Willamette River (one wire to each rail) and then "picking the circuit up" from the tracks in Salem, forty-four miles distant, in order to broadcast a Legislative meeting from Salem.

Read's "sewer system" of remote broadcast circuits became legendary in Portland radio circles and has occasionally been incorrectly attributed to several other early broadcasters. However, it seems fairly clear that credit for this unique system of remote broadcasting belongs to Harry Read and was fairly well-known at the time. A November 8, 1935 story in the Portland *Oregonian* reports that "Hairy Reed [sic] of KXL has not discovered any new sewers lately, although he goes on a sewer hunting expedition occasionally?"

During his radio career, Harry appears to have never quite given up his unique remote system. A 1938 *Oregonian* column glowingly praised KSLM's "remote system" which allowed connection to "40 or 50



Harry Read "running" a remote broadcast circuit.

Illustration from *Of Mikes and Men*, by Jane Woodfin (Evelyn Sibley Lampman), p. 71.

Courtesy: University of Oregon, Evelyn Sibley Lampman Collection

remote pickup points" – a scale of operating expense that could hardly have been expected of KSLM using leased phone company circuits.

### POWERING UP (AND DOWN)

Another story detailing Harry Read's unconventional thrift dates from the time KXL was quite young and was located in Portland's Multnomah Hotel. Reluctant to order the direct current power (needed to provide plate voltage for station's transmitter) from the power company, Read apparently tapped into the hotel elevator motor circuit (which ran on direct current).

The system appeared to work tolerably well during mid-day but in morning and afternoons, when the elevator was unusually busy with hotel guests checking in and out, power variations made the KXL transmitter unstable.

Engineers/operators were instructed to go to a large bank of tapered resistors which Read had installed, of the type commonly used in electric space heaters at the time, and insert/remove these resistors from the circuit in order to compensate for the fluctuating DC power levels occasioned by the Hotel's guest load.

### DOING IT HIS OWN WAY

A licensed pilot, Read was also a "tinkerer." He is said to have built functional microphones from cigar boxes, repaired tubes and transmitters in "down home" ways (rather than replacing them with new ones) and was known to cool his transmitter with tap water which exited through a bathtub.

Read was both smart and innovative, particularly in technical areas, and William B. Smullin, later owner of a variety of radio and TV stations and one of Oregon's pioneer television broadcasters, visited with Read to ask questions when he was first trying to learn broadcasting. According to Smullin, "(H)e was a 'wire guy,' he played with the wire and was always in hot water with the engineers and the FCC for not being on frequency."

Smullin added: "Judge Kendall (FCC lawyer for many Oregon broadcasters) got him to buy a brand new Western Electric transmitter, except Harry at night would take it apart." The story was that he often reassembled it differently than the manufacturer or designer had intended.

### BROADCASTING AT 27 MPH

While Read had sold KSLM by the time Blaine Hanks began working at the station in 1946, the studio and transmitter plant which Read had assembled was then still in use. Hanks tells of Read having rigged up the KSLM transmitter to secure DC power from a dynamotor connected to an old Ford car engine.

The car engine turned the dynamotor to create the electricity to run KLSM. According to Hanks, it was a smelly, smoky and somewhat "Rube Goldberg" affair. A contemporary newspaper account reports that Read had the car engine set to run at 27 mph – a speed Read had calculated the engine could maintain for years without breaking down – and consumed about \$50 worth of gasoline each month.

The engine, however, produced huge quantities of heat – enough to heat the studios to an uncomfortably warm degree. As a result the basement, where the Ford was located, was stiflingly hot. Read, ever disdainful of waste, reportedly explored selling the excess heat to neighbors for heating water and other household uses.

### FIGHTING THE POWER COMPANY

Read's quintessential assault against utility monopolies, however, finally surfaced as a result of his Salem residency. KSLM, in Salem, used considerable amounts of electricity and Read, who grew up in the Seattle area where power had been relatively inexpensive, chafed under the size of KSLM's power bill.

(Continued on Page 42)

# ProMix 12

Full-Featured 12 Input Audio Mixing Console



## Description

The Broadcast Tools® ProMix 12 is a feature-packed broadcast audio mixing console that is ideal for broadcast and audio production facilities needing an affordable compact solution. The ProMix 12 comes in a small package, but is loaded with useful features including a mix-minus output, an announce booth output with full duplex talkback, a monaural output, selectable metering, and remote starts on all line level stereo input channels. Whether you need a compact console for your on-air applications, or a mixer for post-production or fieldwork, the ProMix 12 is the right console at the right price. We're confident that the Broadcast Tools® ProMix 12 will provide many years of trouble-free operation.



[www.broadcasttools.com](http://www.broadcasttools.com)

**BROADCAST**  
tools  
support@broadcasttools.com

USA Proud



INNOVATIVE PROBLEM SOLVING TOOLS FOR BROADCAST

World Radio History

## Harry and Walter Read Oregon's Unconventional Radio Pioneers

Rebuffed when he approached the local power company for more favorable pricing, and resenting what he perceived as the company's arrogant attitude, Read threatened to "build his own" generating capacity. Doubtless it was perceived as an idle threat but that power company had not bargained for Read's tenacity and sense of invention.

In 1938, when the Bonneville Power Administration (BPA) began providing inexpensive power for municipal and non-profit cooperative power systems, with three other Salem residents Read incorporated a power co-op, the Salem Electric Company. Salem Electric hired Read as its manager and, after three years' struggle to secure access to BPA power, began operation in 1941. Fighting the well-established, well-funded and politically sophisticated incumbent power provider, both Salem Electric's lower prices and Harry Read's personal magnetism helped sell the system.



Harry Read in 1947

Read sold KSLM in 1944 in order to concentrate on Salem Electric's franchise battle with the City of Salem – a franchise which the City may have been reluctant to grant due to the influence of the incumbent commercial provider. Read was arrested on at least three separate occasions for installing power lines over City streets "without adequate authority."

Stubborn and outspoken, he litigated each arrest and, ultimately, won when the Oregon Supreme Court overturned his convictions.

### LEAVING A LEGACY

In his last months Read's health failed and he died in a Salem hospital on October 9, 1948. Harry's adopted son, Bill, worked for Salem Electric as a journeyman lineman and retired in 1993 after a 35-year career.

Following Harry's death, Walter and his wife Genevieve moved from Los Angeles – where Walter had been a broadcast equipment salesman representing Gates Radio among other manu-

facturers – to Coquille, OR where Walter had established KWRO in 1947.

Around 1953 Walter and Genevieve relocated to Salem, OR but Walter does not appear to have again been involved directly in radio station operation. From 1953-1957 he worked for Salem's Lou Johnson Company, and then for Willamette Radio Supply,

until leaving Salem around 1964. He returned to Salem and lived out his days in the Elderest Nursing Home where he lived from approximately 1975 until his death in July, 1985.

The Read brothers made an enormous contribution to the founding and flowing of radio in Oregon. The scope of their collective influence is striking.

Ever the visionary, today it is Harry who is the more remembered of the two brothers. Salem Electric continues to serve Salem-area residents with power, and the legend of its founder remains powerfully embedded in that company. Meanwhile, Harry Read's KSLM continues to broadcast to Salem listeners, although remote broadcasts are now handled in a somewhat more orthodox manner.

*Ronald Kramer is the Executive Director of Jefferson Public Radio in Ashland OR. You can email Ron at: rkramer@jeffnet.org*

## Able to leap tall buildings?



No distance or line-of-sight restriction makes **Starlink SL9003T1** the ideal choice for STL/TSL and intercity links.

**Starlink T1's** bidirectional high capacity significantly reduces communications costs compared to discrete audio, telephone and data circuits.

And **Starlink's** uncompressed digital audio will stand out above your competition.

## STL over any distance or terrain... ...Moseley Starlink T1



- HD Radio™ and Multicasting
- Transmitter remote control
- RBDS data
- Telephone extension
- IP-based equipment control
- Internet and e-mail connection

Call the digital STL experts today.

Dave Chancey 805.968.9621

Bill Gould 978.373.6303

[www.moseleysb.com](http://www.moseleysb.com)

# Moseley



**GORMAN-REDLICH**

257 W. Union Street, Athens, OH 45701  
Phone: 740-593-3150 – Fax: 740-592-3898

30 Years Experience with  
Alerting Equipment



Model CRW-S Weather Receiver

**Model CRW-S Weather Receiver**

For receiving alerts from the National Weather Service (NWS). Redesign of our Model CRW now with the "SAME" decoder feature.

**Easy to Use and Reliable EAS Equipment\***

- Pre-programmed for your location.
- Program interrupt relays built in.
- Six audio inputs.
- 2 minutes stored audio.
- All operations via keypad.



EAS1 Encoder-Decoder

**EAS1** Encoder-Decoder

**EAS1** Decoder

**EAS1-CG** Encoder Decoder with built-in character generator.

\*Optional DTMF interface available.



Model CMR Digital Antenna Monitor

**Model CMR Digital Antenna Monitor**

- Remote Controllable
- True ratio readings.
- Phase sign automatic, no extra operation.

Contact Jim Gorman at: 740-593-3150  
jimg@gorman-redlich.com – www.gorman-redlich.com

**TITUS TECHNOLOGICAL LABORATORIES**

**3-DRX**



Automatically switches between two AES digital audio signals or a stereo analog signal. Analyzes digital signal errors (CRC, bit framing, etc.) and checks for loss of audio on the digital signal. User programmable.

**800.806.8851 WWW.TITUSLABS.COM**

**DESIGN & FABRICATION & INSTALLATION**

Ram Broadcast Systems builds studios for most of North America's major networks, group stations, and news organizations. Ram offers comprehensive studio design, fabrication, systems integration, and custom furniture. Put Ram's 35 years of experience to work for you!

**RAM**  
RAM Broadcast Systems  
www.ramsyscom.com  
**800.779.7575**



**Rebuilt Power Tubes 1/2 the Cost of New!**

## ECONCO

Tel: 800-532-6626 Web: [www.econco.com](http://www.econco.com)  
 Intl: +1-530-662-7553 Fax: +1-530-666-7760



**Complete Station Automation and Live-Assist System** (800) 833 4459  
[sales@wireready.com](mailto:sales@wireready.com)

## ControlReady™

Since 1989, over 2000+ stations have chosen WireReady products. Our reliability, 800 support & service can't be beat.

- Software & 500GB rack-mount RAID packages from \$4,995
- Free 800 support & free upgrades
- Overlaps, background records, voice tracks
- Works with Broadcast Tools switchers
- Need pure uncompressed music? Only \$1/song
- For more info: [www.wireready.com/radio](http://www.wireready.com/radio)



Prices/Terms subject to change - Music sold by 3rd party

## TRANSMITTING CAPACITORS

MICA-VACUUM-CERAMIC



**SURCOM ASSOCIATES, INC.**  
 (760) 438-4420  
[LINK@SURCOM.COM](mailto:LINK@SURCOM.COM)









Around the County      Around the Country      Around the World

George Whitaker Owner      [www.mikeflags.com](http://www.mikeflags.com)      Practical Radio Communications  
 Arlington, TX

## Silver Plating Powder

Silver Plate On-The-Job with Cool-Amp!!

<p><b>Cool-Amp</b> Silver plating powder</p> <ul style="list-style-type: none"> <li>*Maintain your RF frequency</li> <li>*Keep your PCBs cool</li> <li>*Increase conductivity</li> <li>*Minimize power loss from corrosion &amp; oxidation</li> </ul>	<p><b>Conducto-Lube</b> Silver based lubricant</p> <ul style="list-style-type: none"> <li>*Reduce resistance</li> <li>*Prevent power interruptions</li> <li>*Prevent data errors</li> <li>*Prevent power failure</li> </ul>
---	---

  
 Ph: 503-624-6426      Fax: 503-624-6436  
[www.cool-amp.com](http://www.cool-amp.com)      60 years customer satisfaction!      email: [sales@cool-amp.com](mailto:sales@cool-amp.com)

## RF PARTS™

COMPANY  
From Milliwatts to Kilowatts™

Eimac • Amperex • Svetlana • M/A-Com  
 Motorola • Toshiba • Philips • Mitsubishi

Se Habla Español • We Export

### 800-737-2787

760-744-0700 Email: [rpf@rfparts.com](mailto:rpf@rfparts.com)  
[www.rfparts.com](http://www.rfparts.com)

## AM Ground Systems Co.

Ground System Construction,  
Evaluation & Repair

### 1-877-766-2999

[www.amgroundsystems.com](http://www.amgroundsystems.com)

## BAUER

TRANSMITTERS, INC.  
[www.bauertx.com](http://www.bauertx.com)

BAUER - ELCOM BAUER - SPARTA - CETEC  
 Re-Manufactured  
 Bauer Transmitters Available  
 AM/FM – 2.5 kW to 25 kW  
[www.bauertx.com](http://www.bauertx.com)    [paul@bauertx.com](mailto:paul@bauertx.com)  
 915-595-1048 Fax: 915-595-1840

**Now Available! New Sections!**

The updated 2004 version of Eimac's *Care & Feeding of Power Grid Tubes Handbook* is now available.

Contact Richardson Electronics today for your **FREE** copy.



**Richardson Electronics**  
Engineered Solutions

Toll Free: 800-882-3872  
 630-208-2200  
 Internet: [broadcast.rell.com](http://broadcast.rell.com)  
 E-mail: [broadcast@rell.com](mailto:broadcast@rell.com)

**DA HOOK**

Safety Grounding Hook



Solid Brass Hook & Hardware  
 Fiberglass Rod Handle  
 #10 Copper Cable & Alligator Clip

**DA GAP**

Lightning Dissipation Gap



Available with Horn or Ball Gaps  
 Patented (#5,661,262)  
 Hot Adjust Mechanism

**Wilk Science and Technology Inc.**  
 1112 North Grove Avenue, Oak Park, Illinois 60302  
 Telephone & Fax: (708) 524-8588

## D&C Electronics Co.

- New Tubes -

*We have the alternatives for all your needs,  
 at the lowest prices, direct from our stock!*

EIMAC, SVETLANA, PRO-TEK®, EEV, and many others.

### 352-688-2374 or 800-881-2374

 VISA & MASTERCARD Accepted

## Chris Scott & Associates

Visit our website  
[www.scott-inc.com](http://www.scott-inc.com)

Ph: (270)781-5301  
 Fax: (270)781-1232  
 Bowling Green, Kentucky



**NRSC Loop Antenna**



**AM-FM Notch Filters**

## CCA PARTS & SERVICE

V&J Electronics

Can supply all parts, schematics, and manuals for CCA, CSI, Sintronic, and Visual transmitters. Field service and complete rebuild transmitters available.

Call Van or Jerry Meier: 770-907-2694  
 Fax: 770-907-2694 – 24/7 Service  
 COD, Visa, Master, Discover, NET-15/30  
[www.ccaelectronics.net](http://www.ccaelectronics.net)

## Alert Monitors



[enbergelec.com](http://enbergelec.com)

# Service Guide Radio Equipment Products and Services

**ST Connectors for 66 Blocks...**  
 Bag of 10: \$ 6.95  
 Bag of 100: \$65.00  
*(Ridiculously Expensive!)*

Squeeze them on Jumper Wire. Great for temporary or permanent jumpers. You need 2 per pair!

We also have Punching Doublers, 66 Blocks, Single Pair Jumper Wire in Assorted Colors, 66 Block & Modular Attenuators, and many other Unique, Problem Solving Telecom Products.

**Fix RF Problems!**  
 Handset Modular: \$18.95  
 1 Pair Modular: \$14.95  
 2 Pair Modular: \$18.95  
 1 Pair Hard Wire: \$ 8.95

**99% Success Rate!**  
 RF Eliminator  
 RF Filter

Choose the frequency range for maximum rejection:  
 • 5 to 30mhz (AM) • 3 to 30mhz • 26 to 60mhz • 60 to 150mhz (FM)

Now Available... Combination AM & FM Filters!  
 See the RF Troubleshooting Flow Chart and four page RF Tech Bulletin at:  
[www.sandman.com](http://www.sandman.com)

Mike Sandman... Chicago's Telecom Expert  
 Call for FREE Catalog: 630-980-7710

**rf Investigator V 3.0**  
 FM...AM...or Both  
 You choose!  
 rfSoftware, Inc.  
 innovative engineering tools

Are you tired of switching from program to program to complete a project?  
 How about displaying your drive test output on top of your Longley-Rice prediction to SEE how your station is operating?

Save time, money, and hard drive space, with software that gives you all the tools in one program to work *smarter not harder.*

Call 352-367-1700 for Details!  
 Visit [www.rfsoftware.com](http://www.rfsoftware.com) Today

**MOORETRONIX**  
 BROADCAST & INDUSTRIAL ELECTRONICS

**Our 5<sup>th</sup> Year**

Our client list continues to grow. Thank you for your confidence and equipment purchases.

**We Re-Condition**

Pacific Recorders BMX I-II-III, AMX, ABX and RMX, Stereo-Mixer and Mixer News-Mixer products.

Solve Your System Wiring Problems Fast!



With **STEREOTRACER**  
 See our Web News-Update page, for details.  
 Tel: 800-300-0733 Fax: 231-924-7812  
[WWW.MOORETRONIX.COM](http://WWW.MOORETRONIX.COM)

**Microphone Flags**



800.450.6275  
[micflags.com](http://micflags.com)

All our Mic Flags feature our PRO-TECH paint (non-chip). All shapes and sizes, CUSTOM and BLANK mic flags. camera stickers-promotional products-label pins  
 your first choice for quality and service

**RF Professional Engineering Services**

- \*FCC Applications
- \*Coverage modeling
- \*RF exposure limit reports
- \*STL & microwave path analysis
- \*Co-location and interference studies
- \*Expert witness testimony by P.E.s

[www.rfengineers.com](http://www.rfengineers.com)  
**RFEngineers, Inc. 352-367-1725**

**FCC COMPLIANCE TOWER SIGNS**

AM & FM TOWER SIGNS  
 STANDARD & CUSTOM  
 TOWER REGISTRATION SIGNS  
 ANTENNA LEASING SIGNS  
 EXTENDED OUTDOOR LIFE

RED GUY WIRE MARKER BALLS  
 8 ft YELLOW GUY WIRE PROTECTORS

ANTENNA TAGS - NUMBERED

**FREE CATALOG**

**ANTENNA ID PRODUCTS**  
[antennaid@msn.com](mailto:antennaid@msn.com)  
 610-458-8418  
 VOX OR FAX  
[www.antennaid.com](http://www.antennaid.com)  
 GLENMOORE, PA  
 19343-9552

**BESCO INTERNACIONAL** World Leader in AM-FM Transmitters  
*"Now in Our 34th Year"*

**AM & FM Pre-Owned Units in Stock**

All Powers and Manufacturers  
 Instruction Books - Spares - Complete

Visit our Website: [www.besco-int.com](http://www.besco-int.com)  
 Or Call Rob Malany at: 321-960-4001

**IBS CORPORATION**

Let IBS plan your new Studio Build or Site Renovation

Contact:  
 Olen Booth or Houston McDavitt  
 24 Years in Business  
 with over 300 build outs.  
 662-324-6934 • [www.fixmystation.com](http://www.fixmystation.com)

**Professional Equipment Repair**

- Consoles at Lightner Electronics, Inc.
- Exciters
- STLS
- Automation Systems
- Audio Processors
- Transmitters
- Remote Equipment

Toll Free: 866-239-3888  
[www.LightnerElectronics.com](http://www.LightnerElectronics.com)



**McPherson Radio**  
 Specializing in pre-owned QEI transmitter products.

**QEI - 6 Month Warranty - QEI**

All equipment tuned and tested on your frequency. MRC has a repair facility to meet your broadcast needs, for repair of QEI exciters and low power transmitters. Other broadcast manufacturer products are welcomed too.

Bob Brown at 856-232-1625 Fax: 856-232-2075  
 Email: [mcpersonradio@comcast.net](mailto:mcpersonradio@comcast.net)

**Doug Vernier**  
 Telecommunications Consultants

- FCC Applications for AM, FM, TV, DTV, LPTV, STL
- Site Relocations
- Upgrade and Due Diligence Analysis
- Propagation Prediction with Custom Mapping
- Frequency Searches
- Demographic Analysis
- Directional Antenna Design

**VSoft COMMUNICATIONS**  
 We use V-Soft Software!  
[www.v-soft.com](http://www.v-soft.com) consulting@v-soft.com 800-743-3684

[www.digitalradioengineering.com](http://www.digitalradioengineering.com)  
 Phone: 845-355-4001

**digitalradio/engineering**

**Professional Broadcast Engineering Services**

Consulting • Project Management • Contract Engineering  
 FCC Alternative Inspections • Due Diligence Inspections  
 Engineering Staff Oversight • Engineering Staff Assistance  
 Facility Inventory • Broadcast Equipment Acquisition  
 New & Pre-owned Broadcast Equipment Sales

**OWN A LPAM STATION! LICENSE FREE!**

- 1-2 Miles Range Possible
- FCC Part 15 Type Accepted
- Best sound in the business!

Tel 919-362-9393 Fax 919-367-0607 Visa\M/C  
<http://www.am1000RANGEMASTER.com>  
[sales@am1000RANGEMASTER.com](mailto:sales@am1000RANGEMASTER.com)

RDS ENCODERS



RDS1

Get your name 'on-air'... The RDS1 is a low cost, simple to use static RDS encoder. No computer required.



RDS2

Dynamic RDS... The RDS2 is a dynamic RDS encoder at a great price. Serially controllable.



RDS3

Industry Standard RDS... The RDS3 is an industry standard UECP compliant fully dynamic RDS encoder with TCP/IP connectivity.

*BW have a range of static and dynamic Radio Data System encoders to suit every budget*

FM TRANSMITTERS



TX1 - TX5

Small scale broadcasting... These low power transmitters provide the ideal solution for university broadcasting, stadiums and cable modulators.



TX25 - TX50

Low Power FM (LPFM)... Low cost but fully featured FM stereo exciters which are great for stand-alone community broadcasting or driving high power amplifiers.

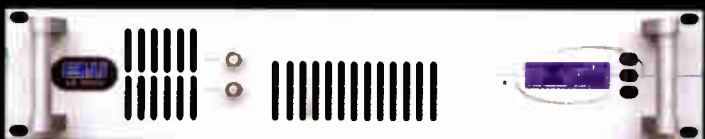

TX150 - TX 300 - TX600

More power... This range of 2RU transmitters outputs up to 600 Watts of RF power from an extremely power efficient and lightweight design.

*All transmitters in the range have integrated audio limiters, stereo generators, remote control and are FCC and CE certified*

AUDIO PROCESSORS



DSPXmini

For processing on a budget... The DSPXmini series are arguably the most cost effective broadcast processors on the planet.



DSPX

When you need to sound big... The DSPX is packed with all the features you would expect in a professional broadcast processor. With 1GHz of processing under the lid you'll sound great.



DSPXtra

When loudness is everything... The DSPXtra has 6 bands of processing, even more processing power and has a built in Ariane leveler to make your sound cleaner and louder.

*Small processors... Big Sound  
High performance, yet economical  
audio processors for FM, DAB  
and internet broadcasting*

**HD versions of the DSPX series are now available. Improve your HD / DAB and internet streams today!**



# FINAL STAGE



## RADIO ROUNDUP

The Radio Guide Event Register

Email your dates and info to: [radio@rconnect.com](mailto:radio@rconnect.com)

### Dayton Hamvention

May 18-20, 2007  
Trotwood, Ohio  
[www.hamvention.org](http://www.hamvention.org)

### Texas Assoc. of Bdcstrs. (TAB)/SBE Convention

August 8-10, 2007  
Austin, Texas  
[www.tab.org/convention.php](http://www.tab.org/convention.php)

### NAB 2007 Radio Show

September 26-28, 2007  
Charlotte, North Carolina  
[www.nabradioshow.com](http://www.nabradioshow.com)

### Madison Broadcasters Clinic

October 9-11, 2007  
Madison, Wisconsin  
[www.sbe24.org](http://www.sbe24.org)

### Pittsburgh SBE20 Regional Convention

October 10-11, 2007  
Monroeville, Pennsylvania  
[www.sbe20.org](http://www.sbe20.org)

### 35th Annual SBE22 Broadcast/Technology Expo

October 16-17, 2007  
Verona, New York  
[www.sbe22expo.org](http://www.sbe22expo.org)

### 5th Annual Ohio Broadcast Engineering Conf.

November 29, 2007  
Worthington, Ohio  
Contact: Patti Geary at [pgeary@oab.org](mailto:pgeary@oab.org)

## Radio Guide Advertiser Info – May 2007

Advertiser - Page	Website	Advertiser - Page	Website
AM Ground Systems - 31	<a href="http://www.amgroundsystems.com">www.amgroundsystems.com</a>	JK Audio - 9	<a href="http://www.jkaudio.com">www.jkaudio.com</a>
APT - 6	<a href="http://www.aptx.com">www.aptx.com</a>	Kintronic Labs - 9	<a href="http://www.kintronic.com">www.kintronic.com</a>
Armstrong Transmitters - 31	<a href="http://www.armstrongtx.com">www.armstrongtx.com</a>	Larcan - 36	<a href="http://www.larcan.com">www.larcan.com</a>
Audion - 17	<a href="http://www.audionlabs.com">www.audionlabs.com</a>	LBA Technology - 32	<a href="http://www.lbagroup.com">www.lbagroup.com</a>
Axia - 27	<a href="http://www.axiaaudio.com">www.axiaaudio.com</a>	LEA - 37	<a href="http://www.leaintl.com">www.leaintl.com</a>
Bay Country - 31	<a href="http://www.baycountry.com">www.baycountry.com</a>	Lightner Electronics - 13	<a href="http://www.lightnerelectronics.com">www.lightnerelectronics.com</a>
Belar - 13	<a href="http://www.belar.com">www.belar.com</a>	Micro Communications - 17	<a href="http://www.mcibroadcast.com">www.mcibroadcast.com</a>
BEXT - 31	<a href="http://www.bext.com">www.bext.com</a>	Moseley - 42	<a href="http://www.moseleysb.com">www.moseleysb.com</a>
Broadcast Devices - 39	<a href="http://www.broadcast-devices.com">www.broadcast-devices.com</a>	Nautel - 22	<a href="http://www.nautel.com">www.nautel.com</a>
Broadcast Software Intl. - 3	<a href="http://www.bsusa.com">www.bsusa.com</a>	Nott Ltd. - 37	<a href="http://www.nottltd.com">www.nottltd.com</a>
Broadcast Technology - 39	<a href="http://www.broadcasttech.com">www.broadcasttech.com</a>	OMB America - 17	<a href="http://www.omb.com">www.omb.com</a>
Broadcast Tools - 41	<a href="http://www.broadcasttools.com">www.broadcasttools.com</a>	Omnia - 29	<a href="http://www.omniaaudio.com">www.omniaaudio.com</a>
Broadcast Warehouse - 46	<a href="http://www.bwbroadcast.com">www.bwbroadcast.com</a>	Peter Dahl - 13	<a href="http://www.pwdahl.com">www.pwdahl.com</a>
CircuitWerkes - 15	<a href="http://www.circuitwerkes.com">www.circuitwerkes.com</a>	Phasetek - 19	<a href="http://www.phasetekinc.com">www.phasetekinc.com</a>
Comet - 16	<a href="http://www.comet.ch">www.comet.ch</a>	Pristine - 2	<a href="http://www.pristinesys.com">www.pristinesys.com</a>
Comrex - 1, 5	<a href="http://www.comrex.com">www.comrex.com</a>	RAM Broadcast Sys. - 43	<a href="http://www.ramsyscom.com">www.ramsyscom.com</a>
Conex Electro Systems - 28	<a href="http://www.conex-electro.com">www.conex-electro.com</a>	Radio Systems - 35	<a href="http://www.radiosystems.com">www.radiosystems.com</a>
Continental - 39	<a href="http://www.contelec.com">www.contelec.com</a>	RCS - 12	<a href="http://www.rcsworks.com">www.rcsworks.com</a>
D&H Antennas - 21	<a href="http://www.dhsatellite.com">www.dhsatellite.com</a>	RF Engineers -	<a href="http://www.rfengineers.com">www.rfengineers.com</a>
Davicom - 38	<a href="http://www.davicom.com">www.davicom.com</a>	RF Specialties - 34	<a href="http://www.rfspec.com">www.rfspec.com</a>
Econco Tubes - 21, 44	<a href="http://www.econco.com">www.econco.com</a>	SAS - 33	<a href="http://www.sasaudio.com">www.sasaudio.com</a>
ERI - 30	<a href="http://www.eriinc.com">www.eriinc.com</a>	SCMS Inc. - 23	<a href="http://www.scmsinc.com">www.scmsinc.com</a>
Fanfare - 17	<a href="http://www.fanfare.com">www.fanfare.com</a>	Shively Labs - 35	<a href="http://www.shively.com">www.shively.com</a>
Gorman Redlich - 43	<a href="http://www.gorman-redlich.com">www.gorman-redlich.com</a>	Telos - 25	<a href="http://www.telos-systems.com">www.telos-systems.com</a>
Harris - 48	<a href="http://www.broadcast.harris.com">www.broadcast.harris.com</a>	TFT - 28	<a href="http://www.tftinc.com">www.tftinc.com</a>
Henry Engineering - 2, 11	<a href="http://www.henryeng.com">www.henryeng.com</a>	Tieline - 7	<a href="http://www.tieline.com">www.tieline.com</a>
Inovonics - 21	<a href="http://www.inovon.com">www.inovon.com</a>	Titus Technology - 43	<a href="http://www.tituslabs.com">www.tituslabs.com</a>
Jampro - 19	<a href="http://www.jampro.com">www.jampro.com</a>	Transcom - 30	<a href="http://www.fmamtv.com">www.fmamtv.com</a>

## Radio Guide Engineering Services

### Consulting Professional Engineers

- Expert Witness Testimony
- FCC Applications
- Frequency Searches
- Co-location Studies
- Custom Map Preparation
- RF Exposure Reports & Maps
- Coverage Modeling & Maps
- STL & Microwave Path Analysis
- Interference Analysis Studies



### RFEngineers, Inc.

[alex@rfengineers.com](mailto:alex@rfengineers.com)

352-367-1725



The Leader in Broadcast Engineering Consulting Software!

- Use Probe 3™ to create stunning "real-world" coverage maps using Longley-Rice and other models.
- Run AM-Pro 2™ to perform AM skywave and groundwave allocation studies, interference analysis, & coverage mapping.
- Use FMCommander™ to study FM allocations using spacings and contour-to-contour protections.



- Run Terrain-3D™ to plot STL paths and Longley-Rice coverage over 3D terrain.

[www.v-soft.com](http://www.v-soft.com) • 800-743-3684 • [info@v-soft.com](mailto:info@v-soft.com)

## GOT ENDEC?

DM Engineering offers economical Remote Control and Interface solutions for interfacing the Sage-Endec EAS Encoder-Decoder with your Automation System and Personnel, and with solutions to fit most any budget. Automate your RWT's and stop worrying about missing them.



The Ultimate Remote Control and Automation Interface features one button remote control functions and a large LCD sign that acts just like the big LED signs along with a flashing strobe that changes color with the severity of the alert. Preview pending alert audio with the built in speaker or earphone jack and initiate RWT's and release or kill pending alerts. A local balanced EAS audio output is also provided. Features an Automation Interface for releasing RWT's and external relay contacts for pending and EOM automation functions. All of this with a small footprint to minimize desktop clutter.



The Ultimate Jr. has the same features as the Ultimate, less the audio functions and external relay contacts, with a smaller footprint and lower cost.



The SE1822 is the "bare bones" Remote Control and Automation Interface for initiating RWT's and releasing pending alerts.



The MS1822 Automation Interface Module is for initiating RWT's in multi station applications.

The LP1822 Automation Interface Module is for initiating both RWT's and RMT's.

For pricing and details on these and other innovative products, call or visit us on the web at:

[www.dmengineering.com](http://www.dmengineering.com)



2174 Chandler St. Camarillo, CA 93010 805-987-7881 800-249-0487

## Consulting Communications Engineers EMC Test Lab

- FCC Applications
- Frequency Searches and Coordination
- AM-FM-CATV-ITFS-LPTV
- EMC Test Lab - FCC and European (IEC)

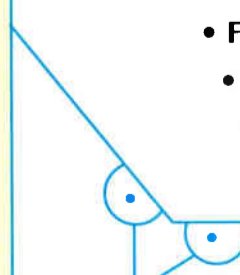

### OWL ENGINEERING, INC.

Email: [info@owleng.com](mailto:info@owleng.com) 651-784-7445 Fax: 651-784-7541

5844 Hamline Ave. N., Shoreview, MN 55126

Member AFCCE



## Harris is your end-to-end radio solution provider.

AM/FM Analog or HD Radio™ • Audio Consoles • Broadcast Studios  
High Power AM • Systems and Service • Intraplex Transport

HD Radio™ is a trademark of iBiquity Digital Corporation

Harris PR&E NetWave console with optional networking. Available in 8-16-24 channel frames, all with fully modular construction.



FlexStar HDx exciter—the gold-standard for FM and FM-HD exciters, featuring RTAC (Real Time Adaptive Correction for best mask compliance) and Engine, the latest iBiquity platform in HD Radio.



ZX1000, 1 kW tri-mode FM/FM-HD or digital only transmitter. FM transmitters available from 250 W to 70 kW, in analog or HD Radio.



Destiny 3DX-50, 50 kW medium wave direct digital drive high efficiency, high reliability AM transmitter. AM transmitters from 1 kW to 2 megawatts, all fully compatible with HD Radio.

## Imagine Harris transmitters... combined with legendary Orban audio processing.



### OPTIMOD 9400-AM Digital

No-compromise, independent, multiband processing for analog AM and digital radio—in one box!

For over 20 years, OPTIMOD-AM has dominated the sound of major-market AM radio. Orban's new 9400 offers even better analog AM processing, while its unified analog and digital design substantially reduces costs compared to a two-box configuration.



[www.orban.com](http://www.orban.com)

Contact Harris at 800-622-0022 or email [autoconfirm@harris.com](mailto:autoconfirm@harris.com)



*assuredcommunications*™

Government Systems • RF Comm • Broadcast • Microwave

[www.harris.com](http://www.harris.com)

PRSR STD  
U.S. POSTAGE  
PAID  
PERMIT NO. 410  
BEAVER DAM WI

### – Radio Guide Websites –

- Radio Guide: [www.radio-guide.com](http://www.radio-guide.com)
- White Papers: [www.radiopapers.net](http://www.radiopapers.net)
- Used Gear: [www.radio-classifieds.com](http://www.radio-classifieds.com)
- Radio History: [www.olderadio.com](http://www.olderadio.com)
- Tech Manuals: [www.radiogearguide.com](http://www.radiogearguide.com)