

Radio Guide

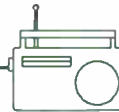

Radio's Technology Forum

October 1995

The Radio Guide **HELP-FAX**

Starting this month, you'll be receiving a new 4-page "insert" in your Radio Guide package. It will consist of the following:

Help-Fax Sheet — If you have any technical questions or need to find an unusual part, piece of equipment, schematic or manual, this is how we will help you locate it. Fill out the form, and fax it back to us. We'll publish your request in the next issue of Radio Guide at no charge.

Help-Fax Info Requests — Each month we'll list all of the requests for technical information, parts, equipment, etc., that we've received in the past month. If someone needs what you've got, give them a call, and help them out.

Radio Guide Subscription Form — Radio Guide is published twelve times a year, and if you're not getting it every month, then you need to subscribe. Fill out the subscription request form and mail or fax it back to us.

Broadcast.Net Information — This is where we'll keep you posted on Broadcasting's national information clearing house. The Broadcast.net is the place to find out about equipment, state broadcast associations, AM/FM FCC database, radio and TV Web sites, and much more. Each month we'll explore a subject or two, to help keep you current on broadcasting and the Internet.

Tech-Tips and Classifieds On-Line and Toll-Free, at 800-811-4045.

Our BBS is the place to submit your Radio Guide tech-tips and articles, and your Radio Shopper classified ads, for publication. We also have "back issues" of the Radio Shopper classifieds available for downloading.

Here's How to Reach Us . . .

INTERNET: Radio@broadcast.net
COMPUSERVE: 71203,2341
TOLL-FREE BBS: 800-811-4045
TELEPHONE: 507-280-9668
24-HOUR FAX: 507-280-9143

FEATURE OF THE MONTH

TASCAM PA-20 MK II Dual Power Amp
BIG POWER FOR A LITTLE PRICE

For maximum flexibility, the PA-20 MK II is equipped with both XLR balanced and RCA

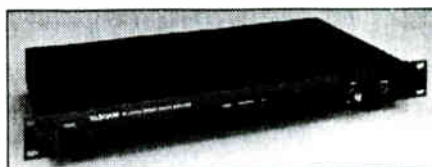

unbalanced input connectors. At 25 watts per channel, it excels in control room and production studio applications.

ABG Special Price **\$189⁰⁰**

Please call today!

MAIN SALES OFFICE
2342 S. Division Avenue
Grand Rapids, Michigan 49507
Phone: 800-999-9281
Fax: 616-452-1652

SOUTHEASTERN SALES OFFICE
200 Fareway Drive, Suite 2
Smithfield, North Carolina 27577
Phone: 800-369-7623
Fax: 919-934-8120

WESTERN SALES OFFICE
P.O. Box 1638
Palmdale, California 93550
Phone: 800-858-9008
Fax: 805-273-3321

For 35 years
AUDIO
broadcast group inc.

YOU MAY ALSO REACH US ANYTIME VIA ELECTRONIC MAIL

cServe: 75371,144

internet: support@abg.com

Inside This Issue

Keep Your RPU License	2
A Technical Trilogy	3
ISDN for Broadcasters (Part 2)	4
Satellite Radio Guide™	9
Music-On-Hold	11
Combining and Splitting RF Signals	12
Easy Polarity Measurement	14
Lifetime Subscription Form	16

Next Month: **More Great Guide Entries**
More Radio Satellite Guide
BROADCAST.NET Information

Radio Guide

October 1995

Volume 7, Number 10

The SBE Forum

By Ray Topp — Editor/Publisher



Radio Guide Publication

Raymond Topp (editor and publisher)

511 18th Street SE, Rochester, MN 55904

Phone: 507-280-9668

Fax: 507-280-9143

Our Contributing Technical Writers

Jim Somich - Radio Engineering Services

1208 Stoney Run Trail,
Broadview Heights, OH 44147
Phone: 216-546-0967

John Bredesen - KLCC, Eugene, OR

3120 Nob Court, Eugene, OR 97405
Phone: 503-485-6869

Gordon Carter - WFMT, Chicago, IL

34 North Madison Ave., LaGrange, IL 60525
Phone: 312-565-5032

Andy Butler - Broadcast Electronics Inc.

3712 Ridge Road, Annandale, VA 22003
Phone: 703-739-5474

Frank Berry Ph.D.

190 112th Ave. N, #708
St. Petersburg, FL 33716
Phone: 813-577-0041

Here's How to Reach Us:

BBS: Toll-free BBS at 800-811-4045

Internet: Radio@broadcast.net

CompuServe: 71203,2341

Fax: 507-280-9143

Phone: 507-280-9668

Keep Your RPU License

SBE Chapters are a great source of technical information, and all are welcome to send us any tech-tips and info suitable for publication. In exchange for their valuable contributions, those chapters that participate here will be supplied with Radio Guide technical copy to publish in their respective newsletters ... Editor

SBE Chapter 17 Minneapolis/St. Paul Minnesota

SBE Chapter 17 Frequency Coordinator, Scott Christensen, asks: "Have you operated your RPU system in the past 12 months, and can you prove it? If you can't prove it, you might be required to re-apply for 'your' frequencies."

FCC Rule 74.432(k) says: [text in brackets added for context clarity.]

“(k) In the case of permanent discontinuance of operation of a [RPU] station or system license under this subpart, the licensee shall forward the station or system license to the FCC in Washington, DC for cancellation. For purposes of this section, a station which is not operated for a period of one year is considered to have been permanently discontinued.”

On suggestion is that you come up with a "remote form" where information on your remote broadcasts is entered. These forms can be filled out by your Sales staff or Programming department, and passed to your Engineering or Production staff. In addition to the date and time of the broadcast, they should have blanks for the address, phone number, contact name, name(s) of the station personnel assigned, special equipment needed, and so on. As the staff in charge of the actual production of the remote finds out whether it will be done by RPU or Telco, this information should also be entered on the form, as well as the antenna location used.

This form could even have blanks for transmitter on and off times which could be filled in at the time of the remote. Then when the remote is done, put the form in the "Remotes" folder in your file cabinet. Now you have a record of whether or not your RPU will work from various locations, and where to put the antenna for best operation, so you won't have to survey a specific location if you are asked to go there again. And, you can prove that you used the RPU in the last year.

— From SBE Chapter 17, Frequency Coordinator Scott Christensen

Radio Guide (ISSN 1061-7027) is published monthly, 12 times a year, by Media Magazines Inc., 511 18th Street SE, Rochester, MN 55904.

All material contained in Radio Guide is copyright 1995 by Media Magazines Inc., and may not be reproduced or stored in any form without the written permission of the publisher.

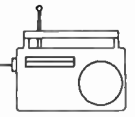

A Technical Trilogy

By John Stortz — WKES, St. Petersburg, Florida

Normally, we only allow one entry per person. But since this is our first annual contest, and since we didn't have time to establish any rules, John will be allowed three entries. Although this does increase his chances of winning a "prize," if he knew what the prizes actually were, he wouldn't have submitted so many. . . Editor

A Hot Barrel on the Rio Grande

This story takes place back when I was Chief Engineer for KDEF (AM) radio. The transmitter was out in a lonely field down by the banks of the Rio Grande river. I was replacing a small bias switching relay one night after midnight. I got the old unit out OK, then mounted the new unit. That's when the OK part ended.

Reaching up for the soldering iron, I grabbed not the handle, but the barrel of my 40 watt Ungar Imperial ... a soldering iron with a barrel so hot I used to use it to light my Lucky Strikes back when I used to smoke. In fact, if you turned the lights out, the barrel would glow dull red! Searing pain made me quickly drop the soldering iron. Now, looking at my hand, I had severe burns all across the palm of my right hand (I'm right handed), across the thumb, and across two fingers. The flesh was charred and parts of it were falling off.

So there I was ... all by myself, the transmitter apart, unspeakable pain, and the knowledge that if I left and went home, a 30 minute difficult drive with only one hand working, I'd have to return before 6 a.m. to finish the job so we could sign on.

There was only one thing to do. I ran my extremely painful hand under the cold water faucet to dull the pain, and slowly, painfully, continued to reinstall the bias relay. What should have taken no more than 15 minutes, took an excruciating hour to finish.

Finally, I packed up my tools and drove home. As the doctor said the next morning, yes, I would live ... but I sure look closely now at a "live" soldering iron before I grab to pick it up.

This is the first, of the finalists, in a series of entries in the annual Great Guide Contest.

180° = No Sleep

And then there's the night back in the '60's I installed a new control room audio console in KHFM. I checked everything ... or so I thought. The music sounded great ... the carts sounded great ... the levels were all padded perfectly to be "just right."

I left about 5:50 a.m. before the owner came in to sign on the station. By 6:20, I was nearly home ... wondering why he wasn't talking. And then it dawned on me. The control room microphone was wired out of phase. He did sound strange in stereo, but I'd chalked that one up to my fatigued state. Needless to say, when I switched my old car radio to mono, he was completely gone.

Exhausted, and more than frustrated, I drove back to the station, reversed the red and the black wire, apologized profusely, and drove home to hit the bed, for a long day's sleep. At least I did have a good feeling about the station's stereo separation!

Late Night Lightning

The current KHFM main transmitter is a Wilkinson FM-1000B. It's an interesting design, rebuilt by me after a former owner bypassed the air interlock, and set it on fire.

Several years later, I was installing a new 4CX10,000D. One of the Wilkinson's unique traits is that, rather than using conventional neutralization, the transmitter tunes the screen ring to ground to make the screen grid as effective a shield as it can be. After carefully tuning the screen ring for optimal isolation of the input and output circuits, I closed the transmitter doors, fired up the transmitter, and looked forward to heading down from the mountaintop location. It was about 4 a.m., and I was tired.

When I fired up the Wilkinson, all hell broke loose. Fire flashed around the edges of the final amplifier door. The lights in the building flashed. A loud "BOOM" jolted my senses into a remarkable state of awakeness. Upon opening the final amplifier door, I noted to my dismay that I'd left the plate cap and lead on the chassis. A seven thousand volt supply, capable of sourcing who knows how many amps, had welded the plate contactor shut, taken out three 60 amp fuses, and ended my night's work in a blaze of man-made lightning.

Thank goodness for our trusty Collins kilowatt standby transmitter. I put it on the air ... very carefully, knowing we would need it to run its full power for at least several days. I left the welded, ruined contactor behind me, closed the door, and left.

ISDN for Broadcasters — Part 2

Reprinted with permission from Comrex Corporation, 56 Nonset Path, Acton, MA 01720

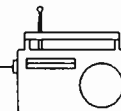

There are several correct answers to the question “What is ISDN?”. The acronym stands for “Integrated Services Digital Network,” but doesn’t really say much. A videoconferencer would say it is the “pipe” used to connect conference sites.

A computer user would say it is a faster substitute for an analog modem. And a LAN manager may say it is an emergency tool to back up the network. But to the audio folks, it is the way we move audio, replacing satellite channels and dedicated loops.

“Integrated Services” implies ISDN can perform more than one function. In fact it does three: Circuit Switched Voice, Packet Switched Data, and Circuit Switched Data. Circuit Switched Voice is the most familiar of all — you can place normal voice calls on an ISDN line. Not only to another ISDN user, but to the pizza shop and the movie theater as well. Your ISDN circuit becomes a simple, plain old telephone line.

Packet Switched Data is different than anything we have discussed. Most inter-computer data traffic is “bursty” i.e. the line is heavily active for short periods of time. An example is a user hitting the “enter” key and the characters being sent down the line at once. The rest of the time the line is idle, and much data capacity may be wasted. Packet Switched Data is a way to utilize only the digital bandwidth required to move your data around. It works much like the Post Office, with the user building “packets” of data, attaching an address, and sending them into the network. Packet switched data can be very economical for computer users since usage is billed on a “per packet” basis rather than “per minute.” Its bursty nature makes it unusable for moving sound or pictures, however. For this we must use the last option, Circuit Switched Data.

And that you already know about — we covered Circuit Switched Data (CSD) in Part 1 (Sep-95). It simply allows the user to connect to the 64 kb/s data stream used by the telephone network. Also, as mentioned before, many CSD calls in North America may be limited to 56 kb/s.

How ISDN is Packaged

ISDN is available in two forms: Primary Rate Interface (PRI) and Basic Rate Interface (BRI). We will concentrate our discussions on BRI because it is most readily available and useful for the audio application. PRI is a higher speed, more expensive service offering 24 individual telephone channels.

When you buy BRI ISDN, you get 2-for-1. BRI comes with two, independent high speed channels which may be

configured as any of the above services, and used independently or together. These two channels, called “B” channels, are multiplexed digitally onto a single pair of wires along with a lower speed control channel called the “D” channel. (See figure 1) The “D” channel is used primarily for dialing and control functions of the line, but some telephone companies actually allow packet data on it. All three channels on this single loop are full duplex. These data channels are always active between the terminal equipment and the central office. (The line status information is handed back and forth.) Data stops at the Central Office until a call is placed, and only then is it transferred to the phone network.

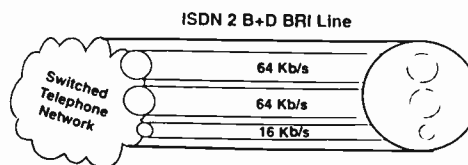

Figure 1

Terminal Adapters

Early in your ISDN adventure you will probably need to choose a Terminal Adapter (TA). The TA provides dialing and answering functions, de-multiplexes the channels of the ISDN, converts them to a computer oriented format, and provides diagnostic functions.

In some cases, the TA is included with the audio codec. In that case, you don’t need this section. The use of an external TA provides a level of flexibility while the built-in TA provides a more compact package.

Your choice of TA will depend on your application. They come in three basic configurations:

1) *Single data port.* This allows one single connection to the ISDN. Often, this may be one of the “B” channels, or even both (See section on inverse multiplexing). This type of TA can be the least expensive, but it may limit your flexibility.

2) *Dual data port.* This allows two, separate connections at a time. Generally, one “B” channel will be configured to feed one port, and one feeds the other. Some TAs of this type also allow you to add the data capability of the “B” channels and feed them through one data port. This allows for maximum flexibility, but usually at a cost.

3) *One voice port, one data port.* The voice port can come in the form of a telephone jack which provides connection for an external telephone, or the phone may be built right in. If only one channel is to be used, this allows for a convenient communications channel “on the side.”

(continued on page 5)

ISDN for Broadcasters

Continued from page 4

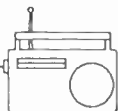

Some TAs are designed to function like modems, being dialed from a computer keyboard rather than from a front panel keypad. These can be difficult to use with audio codecs . . . better to opt for the versions with a dial pad included.

Setting up and configuring the TA can be the most challenging part of getting an ISDN system off the ground. Because ISDN is capable of so much, and comes in so many different versions, you will need to tell the TA exactly what it is connected to and exactly what you want it to do.

Some of the information you will need to know includes:

Switch Type - You will get this information from the phone company when you order a line. This refers to the switch that is located at the central office where your ISDN line will be attached. The most common switches in North America are AT&T and Northern Telecom. Many versions of these switches are in use. You will need to know the switch type and, depending on the terminal adapter you use, you may also need to know the software version of the switch to program your TA. The National ISDN-1 standard (and soon-to-be ISDN-2) removes the differences among switches in North America.

SPID - (Service Profile Identifier) The TA needs this number in order to access the "B" channels. Depending on the switch type and line configuration, there may be one or two SPID numbers. (In the case of AT&T's Point-to-Point Service, none at all.) The SPID usually resembles the ISDN phone number with some extra digits. Again, this comes from the phone company.

DTE Options - The term D(ata) T(erminal) E(quipment) refers to the equipment attached to the TA's data port, so this usually requires information about the audio codec attached to the TA. Things like interface type and data speed can be found in the manual for the codec. Most TAs are capable of rate adaptation from the 64 kb/s channel rate to lower speeds. The adaptation you may require is to 56 kb/s, if your phone company cannot guarantee clear-channel 64 kb/s due to robbed bit signaling, or if you are communicating to a Switched 56 line.

Let's stop here and talk a little more about the 56 vs. 64 kb/s issue, as it tends to be confusing. The important thing to remember is that for two audio codecs (or any other equipment) to communicate, the speed on the cable between TA and codec must be the same. The rest of the network will take care of itself. If you have 64 kb/s ISDN

(continued on page 6)

PUMP UP THE VOLUME!

**Now You Can be Dominant
and Sound Great at the Same Time**

We have written the book on FM composite processing. Move up to the crystal-clear sound of the FM Fleximod and control you market with a **dominant, dynamic** new sound.

Loudness without grunge!



The FM Fleximod is the only processor you will need to guarantee your dynamic presence on the dial. It will clean up your sound and increase your loudness by 3dB or more!

We guarantee it!

Only \$1,395⁰⁰
30 day no risk on-air trial

For further information contact:

Jim Somich at MicroCon Systems Ltd.
Phone 216-546-0967

**UNIVERSAL SCPC
XE-1000**

**SCPC BROADCAST
AUDIO RECEIVER**

New, affordable, frequency-agile receiver, direct channel entry by keyboard, selectable companding 1:1, 2:1, 3:1, wide/narrow bandwidth, de-emphasis selectable, 950-1450 MHz, line output 600 ohms, muting, transponder agile, LNB power supply, 50-channel memory, full baseband output, high-quality audio. Every needed feature at a sensible price (lowest in the industry). Write or call for full information on this quality receiver—the answer for your station. Networks call for prices. We cooperate with contract engineers.

Phone: (614) 866-4605 Fax: (614) 866-1201

UNIVERSAL ELECTRONICS, INC.
Communications Specialists
4555 Groves Road, Suite 12 Columbus, OH 43232-4135

ISDN for Broadcasters

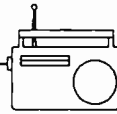

Continued from page 5

and are calling a SW56 line, your TA must be set to rate adapt the 64 kb/s "B" channel to 56 kb/s to feed the other codec. If two ISDN users are constrained to 56 kb/s due to their telephone network, they must each also set their TA to rate adapt to 56 kb/s.

Synchronous vs Asynchronous DTE Ports - The serial port on your personal computer is probably asynchronous (data is sent in "words" with start and stop bits attached, and without a system clock running between the devices.) Data devices which work at speeds like those on ISDN tend to be synchronous- they provide separate clock and data lines and operate without the "start" and "stop" overhead.

Your TA may be able to run its data ports asynchronously to interface with computers and other slower communications equipment, but this will not work with audio codecs. Always set your data port for synchronous operation.

Data Connector - The data connector on your TA may or may not match that of your audio codec. Also, simply because the connectors are the same does not guarantee that the pinning is the same. Fully investigate the actual protocol used by the TA and the codec to be sure that they match.

All late model Comrex codecs use the EIA530 protocol on DB-25 pin connectors and easily match to most codec and terminal adapters via a 25-pin straight through cable. Most manufacturers should supply this information readily and have adapter cables between the most popular protocols available, or at least cable diagrams.

The NT1 - During the initial design of the ISDN it was felt that some equipment would be needed at the user site which would be supplied by the phone company. This box (the NT1) provides the initial buffering and conversion of ISDN data as it enters your building. The concept of telephone equipment owned by the phone company being located on a customer's premises is, however, contrary to U.S. Telecommunication laws. There is not the case in the rest of the world.

In the U.S., an ISDN line is terminated simply on a jack, with no equipment attached. This type of interface is called a "U" interface. Both the NT1 and the TA must be provided by the user. Outside the U.S., the telephone company provides the NT1, called an S/T interface. Many terminal adapters in the U.S. now incorporate the NT1 internally. This frees the user from buying two individual boxes. These TAs are, however, unusable outside North America.

The Joy of Inverse Multiplexing

Inverse Multiplexing, or IMUXing for short, sounds technically complicated but is actually quite simple. It means combining two or more lower data rate channels into one, higher data rate channel and is an extremely important concept for Switched 56 and ISDN (See Figure 2). Remember, digital transmission channels on these services come in "chunks" of 56 or 64 kb/s. These "chunks" have very little to do with each other normally. They may be routed differently throughout the phone network and incur substantially different transmission path delay. Even the two "B" channels of a Basic Rate ISDN installation offer no guarantee that both calls will be routed via the same path. On a North American coast to coast linkup, for example, the first "B" channel connection may be routed via Texas, and the second via Michigan.

The reason for IMUXing is to achieve double the data throughput on a digital phone line. By using both "B" channels of an ISDN, we can create a single data link of 112 or 128 kb/s (depending on the network), or, if we stack multiple lines together, even higher rates like 224, 256, or 384 kb/s. This can allow the use of higher quality and multiple channel codecs on ISDN.

Figure 2

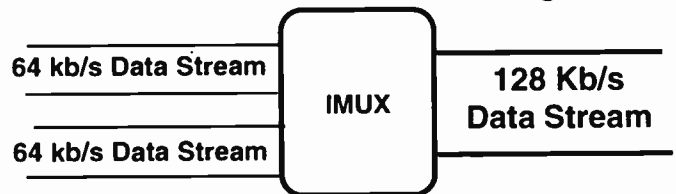

The IMUX algorithm must be able to measure the time delay between the two or more digital channels, and delay the fastest so that it arrives synchronously with the slowest. This procedure is called "aggregation" and is performed differently with different IMUX protocols. An IMUX will usually have some way to monitor the integrity of its aggregation throughout the digital linkup, and reset should a problem occur.

Several terminal adapters offer the capability to IMUX their two "B" channels to a single data port. Most often, these TAs use a protocol to do this called "BONDING" which is a standard agreed to between the companies manufacturing TAs.

Using a BONDING TA is quite easy for the user — only the first "B" channel call needs to be placed, and the next is placed automatically. The ISO/MPEG Layer II audio coding algorithm, among the most popular for wideband audio, has its own IMUX standard called J.52 which is being included in most late model codecs of this type.

(continued on page 7)

ISDN for Broadcasters

Continued from page 6

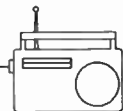

How to Order ISDN Service From Your Phone Company

Ordering ISDN service can be confusing and frustrating, but it is getting easier. Just to find a person in the telephone company who had heard of ISDN used to take several phone calls and hours on hold. Now most telephone companies have a special ISDN "hotline" number that removes these difficulties.

Once you reach the ISDN "order desk" you will be asked how you want the line configured. As we have pointed out, ISDN is a very versatile service and because of this, there are a bewildering number of choices. Basically, your line configuration depends on the functions supported by the terminal adapter you will be using. As an example, we provide a description of the ISDN line you would order when using an ADTRAN ISU128, one of the more popular terminal adapters in North America.

Request an ISDN Basic Rate Interface (BRI) line
A U-interface reference point
2B1Q line coding

Choose one of the following:

- 2B+D Service (Supports up to 128 kb/s)
- 1B+D Service (Supports up to 64 kb/s)

The following switches/protocols may be offered:

- AT&T 5ESS - with Custom protocol (5E6 or later software)
- Northern Telecom DMS-100 - with Pvc1 protocol (BCS-32 or later software)
- National ISDN-1 compatible (may be a Siemens switch, AT&T 5ESS NI1 switch, Northern Telecom Pvc2 or other)

Request that the ISDN line allocate one Dynamic Terminal Endpoint Identifier (TEI) per phone number.

With an AT&T 5ESS Custom Switch . . .

With an AT&T 5ESS switch, most telephone companies provide the option of Point-to-Point (one telephone number which operates both B-channels) or Point-to-Multipoint (two telephone numbers and two SPIDs or Service Profile Identifiers — one for each "B" channel). Point-to-Point service can complicate certain applications. For example if you have two codecs attached to one terminal adapter that need to be able to receive calls independently, you are probably better off with Point-to-Multipoint service. Point-to-Multipoint can be trickier to set up, so if you only plan to use one codec (either on one or both channels) then Point-to-Point may prove easier for you.

(continued on page 8)

HE HALL Electronics

706 Rose Hill Drive
Charlottesville, VA 22901

This Months Engineering Problem Solvers

ITC Cart Machine OEM & Update Components

Updates:

HE Cap. Board - Replaces old FP Power Supply Capacitors in ITC & other Cart Machines. Complete kit includes all hardware.

SP, WP, & RP Models  \$ 39
3D Model \$ 49

HE Replacement Audio Card Stereo \$ 229
Mono \$ 199

HE Replacement 3 Tone Detector Card \$ 159

O.E.M. Parts

Mag-Head (MEC) longlife tape heads Stereo \$ 99
for ITC & most other models Mono \$ 75

Top bearing for ITC 3D model  \$ 65
Standard Motor bearings \$ 20

ITC SP, WP, RP Capstan Motors - Brand New \$ 175
Dialite Start, Stop, Etc switch (Bezel & Lens not included) \$ 5

Call us for the Best New & Completely Rebuilt Equipment!
(804) 984-HALL (4255) Fax: (804) 984-FAXX (3299)

Commercial Radio Company

Duttonsville School Dr., Cavendish, VT 05142
Phone 802-226-7582 Fax 802-226-7738



Transmitter Parts
RCA - Gates
Collins/Continental



Mica Transmitting Capacitors: Sangamo, CD, Sprague, Aerovox, Acushnet types: CM-15, CM-20, CM-25, CM-30, HT, HK, AT, AK, F1, F2, F3, 30B, E, 1996, 291, 292, 293, 294 & G5.

Fixed and Variable Vacuum Capacitors: Jennings, Dolinko & Wilkins, Mounting brackets and flanges. Vacuum relays.

Oil Filled Filter Capacitors: Plastic Capacitor Corp., 600 to 40 kV, 1 mFd to 30 mFd with special mounting brackets. Non-PCB oil capacitor replacements are available for most transmitters.

Ceramic RF Capacitors: Centralab, Jennings, Sprague, High Energy, 5 kV to 40 kV.

Variable Transmitting Capacitors: E.F. Johnson Co., Cardwell Condenser Co., insulated shaft couplings as used in phasors, variable transmitting capacitors.

Weschler-Westinghouse: RF ammeters, 0-0.5 amps through 0-50 amps, internal and external thermocouples, expanded and linear or square-law scales. Sizes are 3 & 4 inch, round and square. Special meters are available.

RCA: Transmitter, phasor and antenna tuning unit parts.

ISDN for Broadcasters

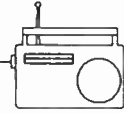

Continued from page 7

Request the following features:

Feature	Value
B1 Service	On Demand (DMD)
B2 Service	On Demand (DMD) if 2B+D
Data Line Class	Point-to-Point/Point-to-Multipoint
Maximum B Channels	2 if 2B+D, 1 if 1B+D
Number of CSV calls	1
Number of CSD calls	2 if 2B+D, 1 if 1B+D
Terminal Type	A
Circuit Switched Voice Bearer (CSV) Channel - Any Value	
Circuit Switched Data (CSD) Bearer Channel - Any Value	

Turn the following features OFF:

- Packet Mode Data
- Multiline Hunt Groups
- Multiple Call Appearances
- Electronic Key Telephone Sets (EKTS)
- Shared Dictionary Numbers
- Accept Special Type of Number
- Intercom Groups
- Network Resource Selector (Modem Pools)
- Message Waiting
- Hunting
- InterLata Competition

With an Northern Telecom DMS100 Pvc1 Switch . . .

When accessing a DMS100 switch you are required to have two phone numbers and two SPIDs. Therefore all service is Point-to-Multipoint.

Request an ISDN

Basic Rate Interface (BRI) with:

Line Type	Basic Rate, Functional
Electronic Key Telephone Sets (EKTS)	No
Call Appearance Handling (CACH)	No
Non-initializing Terminal	No
Packet Switched Data Service	No
TEI	Dynamic

Bearer Service: CSV and Data Permitted on any B Channel

Checklist for All Switch Types

After you have placed your order, make sure that the phone company provides you with the following information for programming your Terminal Adapter:

- ISDN Switch Type
- ISDN Switch Protocol Version
- ISDN phone number(s) or LDN
- Is the ISDN line Point-to-Point or Point-to-Multipoint?
- SPIDs with prefixes and suffixes (unless one is AT&T Point-to-Point).

Our thanks to Adtran for allowing us to use this information.

FCC Rules on Kahn POWER-side™

Motorola tried to deny broadcasters the right to increase coverage by using SSB — Kahn POWER-side™ equipment. But the FCC specifically ruled that the "Kahn POWER-side system ... may continue to be operated ..." as a mono improvement system. So you can now use POWER-side with Kahn independent sideband exciters to immediately increase coverage to listeners using any and all type of AM receivers.

Federal Communications Commission FCC 93-485:

21. Kahn "POWER-side" Operation. Several parties express concern over the continued acceptability under our rules of operating using the Kahn POWER-side AM single-sideband system. POWER-side operation, as distinct from Kahn stereo operation, involves an AM transmitter with two independent sidebands, containing identical program material, but with intentional level and frequency response differences. This system is implemented with a Kahn independent sideband stereo exciter and is claimed to have certain advantages for reception with monophonic receivers, particularly in adjacent-channel interference situations. CTI and Furr argue that adoption of the proposed standard would prohibit such an implementation. Motorola maintains that the Kahn POWER-side mode of operation is not stereophonic and questions its legality under the present rules.

22. Our AM rules do not include a definition of the term "stereophonic." However, generally accepted definitions of stereo service infer two or more channels of audio information designed to produce an audio "image" when demodulated by an appropriate receiver. On this basis, we find that stations employing the Kahn POWER-side system are not subject to the provisions of the stereophonic transmitting standard adopted herein and may continue to be operated, provided that the program material fed to both channels of the exciter is identical in content.

POWER-side™

PROBLEMS

Adjacent Channel Interference
Antenna Null Distortion
Co-Channel Interference
Power-Line Re-Radiation
Building Re-Radiation
Receiver Tuning
Low Fidelity Home Radios
Co-Channel Beat
Selective Fading

SOLUTION!

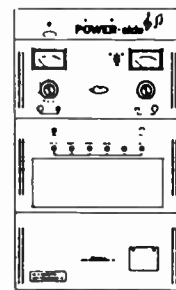

(212) 983-6765

POWER-side™

The solution to many of AM radio's most serious technical problems.

From the developers of the AM STEREO system that isn't afraid of the dark, and will let you drive right past FM Stereo.

Kahn Communications, Inc.

320 East 42nd Street, New York, New York 10017

Satellite Radio Guide™

Tom Harrington — President, Universal Electronics, Columbus, Ohio



The **Satellite Radio Guide™** provides over 825 up-to-date listings of Audio Subcarrier Services Above Video (5.0 MHz to 8.0 MHz), Audio Subcarrier Services Below Video (100 kHz to 5.0 MHz), and SCPC (Single Channel Per Carrier) Services.

The Satellite Radio Guide™ is published quarterly by Universal Electronics, Inc., 4555 Groves Road, Suite 12, Columbus, OH 43232-4135. Phone: (614) 866-4605 and FAX: (614) 866-1201. A one-year subscription (four issues) is \$25.00.

SCPC LISTINGS EXCERPTS

Hughes Galaxy 6 (G2/G6) C-Band 74°W

(Old G2 Satellite)

TR-03	SCPC
KIRO-AM, Seattle, Talk, News Radio, CBS News, Mariners, Seahawk Flagship, Sports Final	54.40
KQED, San Francisco, CA, Oldies Music, A's Flagship, Sports Byline USA	54.60
Sports, Jazz, Sport Shows, Occasional Audio	54.80
Talk Shows, Talk America, USA Radio News, 2nd Channel	55.10
Talk America Radio Network, Full Range Talk Radio, Call-In, Leading Talk Hosts, USA Radio News, Jack Anderson	55.40
Sports Radio, WTMJ, American Sports Network, Bullets, ESPN Radio, Brewers	55.90
Wisconsin Sports Network, WTMJ, Green Bay Packers (Alternate) CBS News, Classical Music	56.20
Sports, Talk, Occasional, MLB, American Positive Radio	56.60
Motor Racing Network, Morning Talk Shows	56.80
Tribune Network, Broncos, KTAR-AM, Phoenix Suns Radio, Nuggets, 2nd Channel	57.00
Illinois News Network, University of Illinois, Chicago Blackhawks, WTSO, Madison, Badger Hockey Network	57.20

Hughes Galaxy 6 (G2/G6) C-Band 74°W

(Old G2 Satellite)

TR-03	SCPC
WGR-AM, Buffalo Bills, Bisons, Sabres, Talk Radio, INN News	57.40
KOA-AM, Denver, CO, News, Talk, Broncos, Colorado Rockies MLB, Denver Nuggets Flagship, Rush Limbaugh 2:00-5:00 p.m. EST	58.00
KFPK, Sacramento, Talk	58.30
WGR-AM, Buffalo, NY, News, Talk Radio, Sabers Bills, Bisons Flagship	58.60
Baltimore Orioles, WBAL-AM	59.20
Occasional Audio, Sports, Celtics, Michael Reagan	59.40
Ray Communications, ESPN Radio, Sports	60.20
Sports, Tigers Network, WJR Detroit, Redwings	60.80
Florida Radio Network-Marlins, WQAM-AM Miami, ESPN Radio Rush Limbaugh	61.20
WGN-AM, Chicago, News, Talk, 2nd Channel	61.50
WGN-AM, Chicago, IL, News, Talk Radio, Cubs & Bears Flagship	61.70
Michigan State Sports, WJR-AM Detroit	62.00
Florida's Radio Network, Tampa Bay, EMSA Auto Racing, Bucs Radio, FSU Seminoles, WFAE, WQYK, WDBO, Rush Limbaugh, Bruce Williams	62.20
Florida's Radio Network, Miami Heat, Dolphins, Hurricanes Radio, Florida Talk, Laura L. Roberts, American Forum, Bill Morgan Show, Gators, CBS News	62.40
American Sports Network, Sports Talk Show, CBS Radio, WTMJ, Wisconsin Net (Secondary)	62.60
WTMJ-AM, Milwaukee News, Talk Radio, Brewers, Bucks Flagship, Bruce Williams, Green Bay Packers (Primary)	62.80
Sunstar Radio, Sports Byline, Sports Talk, Atlanta Braves	65.10

(continued on page 10)

Satellite Radio Guide™

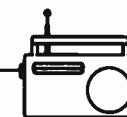

Continued from page 9

Hughes Galaxy 6 (G2/G6) C-Band 74°W <i>(Old G2 Satellite)</i>	Hughes Galaxy 6 (G2/G6) C-Band 74°W <i>(Old G2 Satellite)</i>
TR-03	TR-03
Sun Radio Network, Tom Valentine, USA Radio News, Sun Radio Network, Earl Jackson Talk 65.30	Sports Talk, Steelers 70.00 Data Link 70.30
WSB-AM, Atlanta, GA, News, Talk Radio, Bulldogs, Falcons, University of Georgia Sports, Sun Radio Network, Tom Valentine, USA Radio Network, News 65.50	Michael Reagan, Sports Scores, WINZ Network, Indy 500 Racing Network 70.80
White Sox, University of Maryland Sports, Sports Talk 66.00	Florida's Radio Networks, WINZ, Talk & Entertainment, CBS News, Capital Sports Auto Racing, A&M Rattlers, WJNO-AM, West Palm, Pete Rose Show, Paul Harvey ,Winston Cup 71.10
Florida's Radio Network, Main News Channel, Miami Heat, Dolphins, Talk, Hurricanes, WIOD, Miami 66.20	Occasional Audio 71.30
Florida Radio Network, Orlando Magic Radio 66.40	Sports, MLB, WLW-AM, Bengals 71.50
Tribune Radio Network/Chicago Bears Radio Network, WGN 66.60	Sports, MLB, WMAQ, Chicago 71.80
Illinois News Network, IDB Lease, Pack Wrap, Blackhawks 66.80	Sports, MLB, Talk Radio, Sports 72.00
Philadelphia Phillies Radio Network, Ray Communications Agri-News, American Sports, Sports Book, WOGL, USA Radio News 67.00	Sports, Miami Heat, NBA 72.20
WGN-AM, Chicago, IL, News, Talk Radio, Cubs & Bears Flagship Interstate Radio Network, American Stock Exchange, Truckers Radio, WSM-AM (12:00 a.m.), ABC News 67.30	KWKW-AM, Los Angeles, La Mexicana, Dodgers (Spanish) 72.50
Talk Shows, Sports, Braves 67.70	Occasional Audio, Sports 72.70
Hispanic Programming, XPRS-AM 68.00	University of Michigan Sports, WJR, Detroit Redwings, Hockey, Jets, Detroit Tigers 72.90
California Angels Radio Network-Spanish XPRS-AM, Tijuana, Variety & Entertainment 68.40	Sunstar Radio Network, Gators Sports, Michigan State Sports, Agri-Network 73.10
WIOD, Miami, KIRO (Secondary), Occasional Audio 68.60	Michigan News Network, Detroit Lions, Michigan State University Sports, Central Michigan University Sports, Detroit Pistons, Great Lakes Media Feeds 73.30
Mutual Radio, Talk Radio, Sports, Dolphins, IMSA Auto Racing, Florida Radio Network (IMSA also on G-4, TR-3, C-5 analog) University of Miami Hurricanes 68.80	WJR-AM, Detroit, News Talk Radio, Tigers, University Michigan Sports, Redwings 73.50
Sports, Sports Shows 69.10	Illinois Radio Network, DePaul Basketball, Chicago Bulls, College Football 73.70
Sports, L. A. Dodgers / English, USA Radio Network 69.40	Sports, ML Baseball, Royals, University of Kentucky 74.00
Sports, L. A. Dodgers / Spanish 69.60	WMAQ-AM, Chicago, IL, News, Talk Radio, White Sox, PIA Radio, Bulls 74.20
	American Forum, Talk Radio, Air Force Academy Sports 7 74.50
	Peoples Radio Network-Talk, 24 hours, UPI News Chuck Harder 74.90

(continued on page 11)

Satellite Radio Guide™

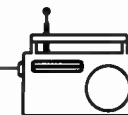

Continued from page 10

Hughes Galaxy 6 (G2/G6) C-Band 74°W

(Old G2 Satellite)

TR-03	SCPC
Occasional Audio, Sports, NHL, KRWB, Rouseau, MI	75.40
Rams Network, Secondary, Devils, Paul Harvey	75.60
KMPC-AM, Los Angeles, Show Tunes, Pop & Easy Listening, 710 Talk, Angels, Rams, L.A. Clippers, UCLA Sports, ESPN	75.80
Indiana Network / Indianapolis Colts Radio, Music, USA Radio Network, Music, Agri-America	76.00
Seattle Sonics Radio Network / KJR-AM, Sports, Talk Radio, ABC Radio	76.20
KFRC-AM, San Francisco, CA., Miami Dolphins (Spanish), Baseball	76.40
Oakland A's Radio Network, KFRC, San Francisco, CA, Sports	76.60
KDKA-AM, Pittsburg, PA, News, Talk Radio, Pirates Rush Limbaugh (12-3 EST)	76.80
KIRO Seattle, WLW, Various Programming, Bengals, Spanish Sports	77.00
Occasional Audio, Sports, Various Programming	77.20
Performance Racing Network, Auto Racing	77.40
L.A. Clippers Network / KLAC-AM Los Angeles, Country & Western, NHL, Lakers, Kings	82.00
Occasional Audio, Sports, Talk	82.40
California Angels, Sports, Various Programming	82.80
Occasional Audio, Sports	83.00
Spanish Programming	83.30
AgriNet / Ray Communications, USA Radio Network, Atlantic Sports, Jack Christy, Talk	84.60
Sports Final Network, Race Report, KFBK, Sacramento Kings	85.10
Calwest News Network, News Services, KEX-AM	85.70
Northwest News Network / University of Oregon Sports, Trailblazers	85.90

Music-On-Hold

From John Stortz, WKES, St. Petersburg, FL

1. Plugged into a local radio station: Interesting to hear weather and local news that's happening in some other city — but they usually pick up the phone just as something interesting comes on. This often implies a cheap phone system and a cheap company.

2. Rock music: That company's dominated by a bunch of party animals and they don't really care about my business.

3. Electronic operator: A small company trying to look big.

4. Fast music and electronic operator: "We're sorry you have to wait ... your call is important to us, and we're doing everything we can to get to you as quickly as possible." They've got one person covering three phones, all are ringing, and they're in hyper-stress.

5. Slow music and electronic operator: "Please stay on the line ... calls are answered in the order received." The person is taking a nap, and there's a cobweb growing on their phone, as it rings.

ERI - ELECTRONICS RESEARCH 812-925-6000

S.K.I.P. - Site Keeper Integrated Pager

Monitors, Reports and Controls antenna system and transmission site conditions including tower lights, VSWR, line pressure, antenna icing, tower or building security.



ARS-1003 - Automatic Transmitter Recycler

Engages the transmitter interlock when VSWR exceeds user set limits, breaks supply of RF to antenna system, re-sets transmitter, logs and reports sequence of events.

Combining and Splitting RF Signals

Jim Somich — Radio Engineering Services, Broadview Heights, Ohio [216-546-0967]

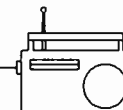

There are many situations where RF signals must be split or combined. RF splitters and combiners must operate with minimum degradation of the signal. This means that, when properly terminated, the splitter or combiner will exhibit a low standing wave ratio and minimum power loss.

For combining and splitting RF sources of the same frequency, 90-degree, 3dB hybrids are used almost exclusively. A 3dB hybrid coupler consists of two identical parallel transmission lines, coupled over a length equal, or approximately equal, to the quarter wavelength of the frequency to be acted upon, and mounted in a common outer conductor.

A 3dB hybrid coupler is inherently symmetrical. Both inner conductors have the same dimensions, and have the same capacitance per unit length, with respect to the outer conductor. 3dB hybrid couplers can be used both as power splitters and combiners. *Figure 1* shows the 3dB hybrid coupler as a power splitter, and *Figure 2* shows the coupler as a power combiner.

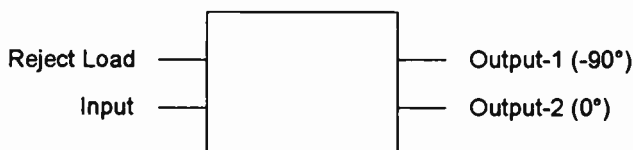

Figure 1: 3dB, 90-degree Hybrid as a Power Splitter



Figure 2: 3dB, 90-degree Hybrid as a Power Combiner

In the hybrid power splitter, the input RF signal is split equally between the two outputs. There will be a 90-degree phase lag in one of the outputs, with reference to the other. This is a characteristic of 3dB hybrid couplers. The input power will be split equally between the two outputs so each output will be precisely 3dB lower in power than the input. This assumes a perfect match to the hybrid coupler. Any mismatch will cause some of the input power to be fed to the reject load resistor and dissipated as heat.

In the hybrid power combiner, the electrical function is exactly the same as the power splitter, except reversed. In *Figure 2*, two RF signals at the same, or nearly the same, frequency are fed into the 3dB hybrid coupler. One of the signals must exhibit a 90-degree phase lag with respect to the other, for the coupler to work properly. This can be

accomplished by using a short piece of transmission line. Where precise combining is necessary, with minimal reject load power, an adjustable transmission line section is often used to fine-tune the hybrid combiner. This is especially important when combining high power transmitters, to avoid significant power loss in the reject load.

When the 3dB, 90-degree coupler is properly terminated, the isolation between the inputs ports is very high. For example, when combining two RF power amplifiers into a single antenna, it is important that the output of one amplifier does not feed into the output of the other. A trans-hybrid isolation of 30dB is not uncommon in a well designed system.

High power 3dB, 90-degree hybrids will be found in broadcast plants where it is necessary to combine the outputs of two or more RF power amplifiers to generate higher output power. For example, a 40kW transmitter may actually consist of two 20kW transmitters combined through a 3dB, 90-degree hybrid coupler. In these instances, it is important that the coupler reject load be able to handle at least one-half the power of one of the transmitters. If one transmitter is turned off or fails, the output power of the remaining transmitter will be split equally between the output load (antenna) and the reject load.

Low power 3dB, 90-degree couplers find common application in broadcasting where it is necessary to split a low power RF signal, such as the output of an FM exciter, to feed two power amplifiers. Once again, a reject load must be used to absorb any power caused by mismatches within the system.

Is it important to remember that the 3dB, 90-degree hybrid coupler is a purely mechanical device that performs an electronic function. This function is defined purely by the mechanical dimensions of the hybrid. Also note that power cannot be created by the hybrid coupler. You will never have more power at the output of a hybrid splitter or combiner than what you put it. As a matter of fact, unless the coupler is perfectly matched, you will almost always have slightly less power. The imbalance will be dissipated as heat by the reject load.

Even though hybrid couplers for low and high power use may differ considerably in size and appearance, their electrical function is exactly the same. The only difference is the power handling capability of the coupler and the reject load. In high power couplers, the reject load might be a large air or water-cooled resistor. In smaller splitters the reject load might be a simple 1 watt, 50 ohm resistor.

(continued on page 13)

RF Combiners/Splitters

Continued from page 12

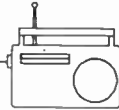

The theory is exactly the same in either instance. With this basic understanding of 3dB, 90-degree couplers, you will be able to understand 99% of their usage in transmitters and transmitter plants. Let's review the important characteristics of these couplers:

1) A 3dB hybrid coupler consists of two identical parallel transmission lines, coupled over a length equal, or approximately equal, to the quarter wavelength of the frequency to be acted upon, and mounted in a common outer conductor.

2) A 3dB hybrid coupler is inherently symmetrical. Both inner conductors have the same dimensions and have the same capacitance per unit with respect to the outer conductor.

3) 3dB hybrid couplers can be used as both power splitters and combiners. In a hybrid combiner, the frequencies combined must be the same or similar.

4) In the hybrid power splitter, the input RF signal is split equally between the two outputs. There will be a 90-degree phase lag in one of the outputs, with reference to the other.

5) In the hybrid power combiner, the action is exactly the opposite of the splitter. On of the inputs must lag the other by 90-degrees for the coupler to be balanced. A variable length line section is often used to balance the coupler.

6) Any mismatch or imbalance within the coupler causes power to be absorbed by the reject load and dissipated as heat. Therefore, it is important for the coupler to be properly balanced and matched, especially at high power levels.

7) A hybrid coupler will only be perfectly balanced when: a: The two signals to be combined are at the same frequencies, b: the power level of the two signals is identical, c: One of the inputs lags the other by precisely 90-degrees, and d: All ports are terminated in the same impedance.

In most well designed combining circuits, provision is made for adjusting the level and phase of the inputs to the combiner to satisfy these requirements.

8) A hybrid splitter will only be perfectly balanced when all ports are terminated in the same impedance, and one output will always lag the other by 90-degrees.

The next time you run into a 3dB, 90-degree hybrid coupler, you can feel a little more confident in understanding its function in the RF circuit. This is true whether you can hold the coupler in the palm of your hand, or it is a huge piece of plumbing mounted from the ceiling.

ULTRAMOD® .UM2000

FM STEREO MODULATION SYSTEM



- The UM2000 is a complete FM processing and stereo generating system featuring:
- Dual band, stereo AGC and peak processors of exceptional clarity.
- Digitally synthesized stereo generator with separation exceeding 60dB at 1kHz, and typically 55dB at 15kHz.
- Dual composite outputs for feeding main and auxiliary transmitters or STL's. Very affordable.

WHY PAY MORE ... AND GET LESS?

H NAT H INDES | inc

42 Elaine Street, RR1, Thompson, CT 06277
203-935-9066 203-935-9242

Econco

Rebuilt Power Tubes

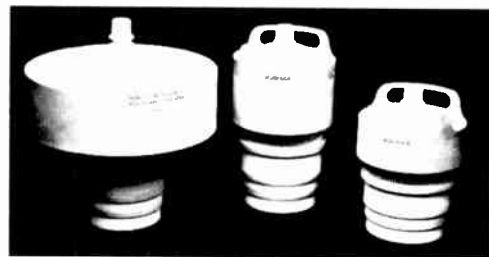

Approximately
One Half the Cost of New

Call for Our Price List

Econco

1318 Commerce Ave., Woodland, CA 95695
800-532-6626 Canada 800-848-8841

Easy Audio Polarity Measurement

Nick Kratz — Independent Broadcast Engineer, Albany, California [Nick_Kratz@bmgug.org]

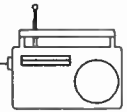

In the last article (August-95) we explored the desirability of maintaining absolute polarity (a.k.a. absolute phase) of audio signals from acoustic source to acoustic reproduction. And, the likelihood that such is not necessarily the case, especially where those pesky headphones are part of the process. While quite a bit of discussion ensued, regarding lack of standardization and optimum points in a system to correct polarity, there was little mention of testing and verification of actual polarity at a given point in a given system, nor relevant test equipment. Let's fill that void . . .

First Generation: The Cosky Phaser

You may be disappointed to learn (as I was) that the human mouth is an inconsistent generator of pressure waves. Enter the Cosky Phaser (Figure-1).

Simplicity itself: the electrolytic cap charges up to 9 volts. When the switch is thrown, the stored charge is

dumped into the speaker, whose cone pushes outward, producing a pressure wave. Foam damping between the rear of the cone and the frame, damps oscillations quite effectively, improving wave shape. The transducer under test is connected to a sufficiently sensitive non-inverting oscilloscope input according to marked polarity standards. Some of the dumped charge triggers the 'scope, via the BNC jack. Repeated throws of the switch (with sufficient charging interval) produce easily visible, repeatable pulses of known polarity.

Microphones compliant with EIA-221-A, will produce a *positive-going* wave-front, usually with an oscillatory decay, with an exact shape dependent upon the microphone and its positioning with respect to the Cosky Phaser speaker (Figure-2). "Tin-Can Standard" speakers and headphone (RS-331) elements will produce a *negative-going* wave-front under identical conditions, typically with more oscillatory activity (Figure-3).

(continued on page 15)

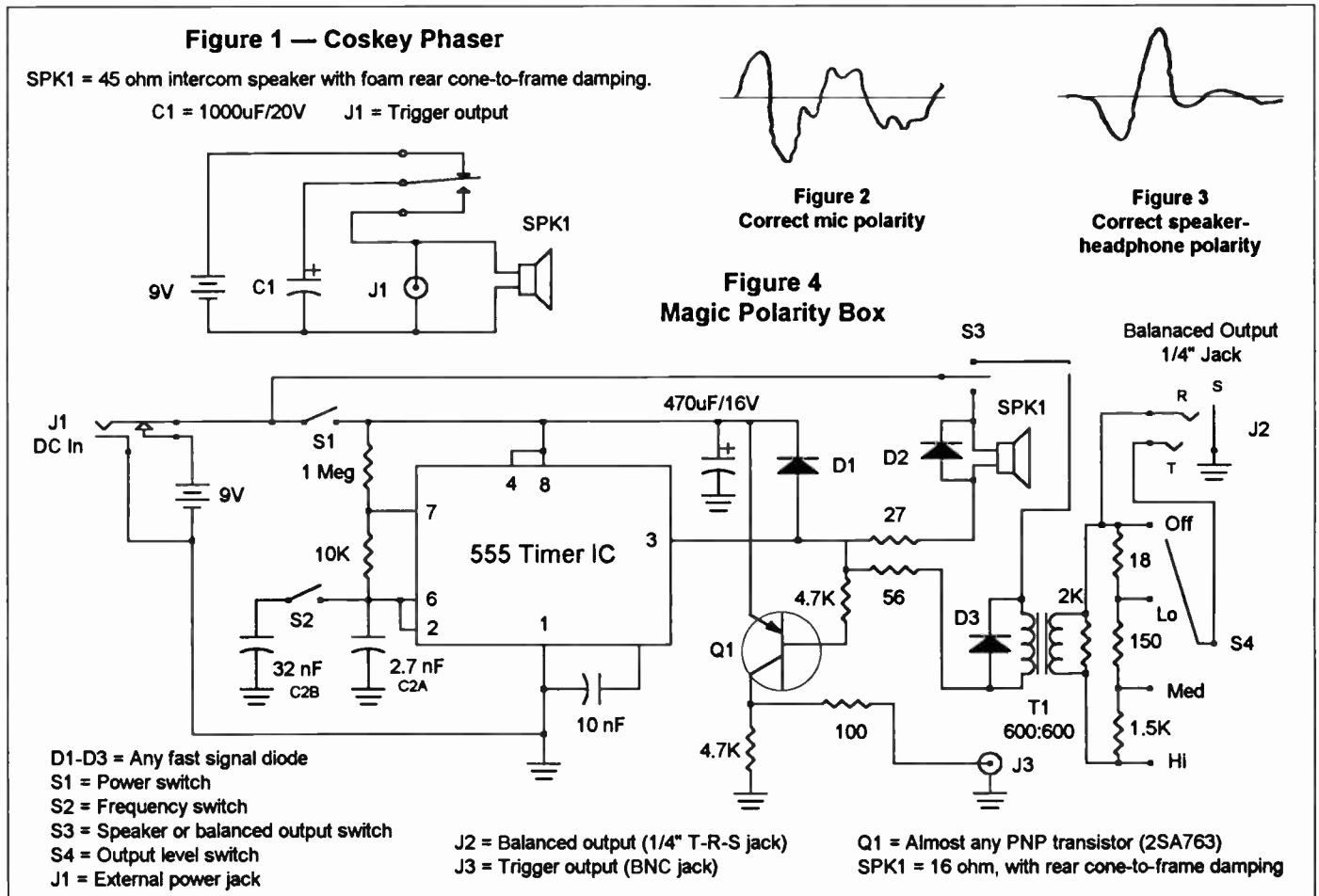

Polarity Measurement

Continued from page 14

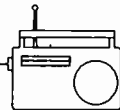

As long as one is careful to focus in on the initial direction (positive-going or negative-going) of the first cycle of the pulse, the results are consistent and repeatable across a wide cross-section of transducers. The Cosky Phaser is cheap, simple, and easy to make, but interfacing directly to electronics is inelegant, and one's hand does get awfully tired if there are a number of devices to measure.

Second Generation: The Magic Polarity Tester

It didn't take long to decide that the Age Of The IC dictated a more sophisticated approach. The working hypothesis: use a 1% duty-cycle waveform, and find the most appropriate frequency to, not only produce the fastest repetitions consistent with full mechanical oscillation decay, but also the most easily interpreted and visible 'scope waveform across the widest range of transducers and electronics possible. Extended experimentation yielded a circuit of only slightly greater complexity than the Cosky, but greatly improved functionality (*Figure 4*).

In addition to the built-in speaker of the original design, a transformer-isolated balanced output was added, level-selectable for compatibility with mic, low line (-10dBm to 0dBm), and high line (+8dBm) levels. A 1/4" T-R-S jack was chosen for both durability and "automatic" balanced/unbalanced switching via the use of T-S (unbalanced) or T-R-S (balanced) phone plugs on the cable.

Best of all, the entire affair is sufficiently non-critical as to provide the perfect opportunity to use all those 20% carbon resistors and ungraded capacitors you've been stockpiling all these years. The only components I bought specifically for this project were the enclosure and the battery clamp. A rotary switch was scrounged from a dead stereo recover for the combination power/level/speaker/output switch.

The PNP transistor inverts the negative-going output of the 555, to a positive-going trigger pulse. Although there is no reason one couldn't omit this stage, and merely trigger negative-going. However, I prefer to keep all outputs positive, both acoustic and electrical, for consistency. The series resistances were chosen for best results with the speaker and transformer at hand, so you may wish to vary these. The 470uF supply filter should help extend the usefulnesses of weak or Hi-Z batteries, though you can expect the trigger signal to "hang out" awhile after the unit is turned off.

Use a current-limited DC supply to verify the actual polarity of the speaker you plan to use. Make certain that

the cone pushes *out* with the application of DC, then mark the speaker terminal connected to the positive DC lead as "+" or "red" if it isn't already. Make sure that this terminal is the one going to the switched +9 volt rail, and all will be well. As tedious and obvious as this may seem, one doesn't want to make an oversight here. It is also worth spending a few minutes experimenting with the best mechanical damping arrangement to get clean, non-ringing pulses out of the speaker.

The 2K transformer load was chosen for best risetime with minimal overshoot. Putting the attenuator on the transformer side yielded much more consistent waveshape at the different amplitude steps.

The 32 nF, C2b frequency determining capacitance was originally the only C2. This odd value just happened to provide the best waveshapes for a wide variety of transducers with the 5 cm speaker used — around 40 Hz. There was *never* a problem interpreting results when a driver under test was connected directly to the Magic Polarity Box, but measuring the waveshapes from some tweeters and midranges in multi-way speaker systems through the stock crossovers, proved difficult.

Hence a frequency switch was added, along with C2a as shown. A capacitor of 2.7 nF yields about 414 Hz, the range of the highest frequencies which still had acceptable waveshape through the transformer. This has proven plenty high enough for any HF transducer/crossover to date, and might also prove useful for some extremely limited-bandwidth media. The parallel combination drops the low frequency to about 35 Hz, but no significant differences in waveshape were found.

I highly recommend enlisting any cheesy, spare microphone for ease of testing speakers. Verify its polarity in the usual way, and attach a BNC for direct 'scope attachment and guaranteed polarity every time. The little speaker in the Magic Polarity Box is more than enough for mics and headphone elements, and can be used with many speaker drivers, but isn't likely to put out enough to kick large woofers, especially back through a passive crossover. Feed the output of the Box into a power amp, verify electrical polarity with the 'scope as the signal enters the speaker, then use your reference cheesy mike to scope out each driver. Much faster!

Recorder/reproducers are straightforward electronic in/out affairs, but keep in mind the pulse will be delayed by whatever delay is inherent in the system. It may lag substantially after the trigger pulse, and you may not see it right away. Be sure to trigger off your input channel and not the Box when looking at reproduced pulses after recording has ceased.

Radio Guide

Radio's Technology Forum

Lifetime Subscription
For Only \$12⁰⁰

Not a Subscriber? Here's Your Chance!

Is this for real? Yes, you pay only \$12.00 for the first 12 monthly issues. After that, you'll continue to get **Radio Guide** every month, at no charge, for as long as you want it.

Radio Guide is the only technical, nuts and bolts publication, with straight-forward tech-tips, installation articles and repair and maintenance information. The **Radio Guide** concept is to develop a print forum for radio technology — a tool for technical education and information exchange. **Radio Guide** will provide you with exactly what you need to do your job. And it's now available at a one-time \$12.00 rate.

You can receive the technical information that you've always needed, but only if you subscribe right now. Fill out the form below, and either mail or fax it to us. We will accept your pre-paid subscription or we will bill you — just mark the appropriate item on the order form ... *Ray Topp (publisher)*

Radio Guide Only \$12⁰⁰

Radio's Technology Forum Lifetime Subscription

Radio's #1 technical publication is now even more affordable than ever. You pay only \$12.00 for your first 12 issues. After that, we'll continue to send Radio Guide free of charge, for as long as you like.



Fax Your Order to:
(507) 280-9143

— or —

Mail Your Order to:

Radio Guide
511 18th Street SE
Rochester, MN 55904



RGA-10-95

Radio Guide — Subscription Order Form

- Payment enclosed — \$12.00 lifetime subscription
- Please invoice me (fax your order to us for faster service)

Name: _____ Title: _____

Company: _____

Address: _____

City: _____ State: _____ Zip: _____

Phone: _____ Fax: _____

Radio Guide
511 18th Street SE
Rochester, MN 55904

Radio Guide
511 18th Street SE
Rochester, MN 55904

Address Correction Requested

Bulk Rate
U.S. Postage
PAID
Permit No. 445
Rochester, MN
55901