



# RADIO GUIDE

511 18th Street SE  
Rochester, MN 55904

Address Correction Requested

Fax Number (507) 280-9143

Bulk Rate  
U.S. Postage  
PAID  
Minneapolis, MN  
Permit 4632

*A Forum for Radio Broadcast Engineers*

Ray Topp - Editor/Publisher (507) 280-9668 February/March 1990 NAB Issue Volume 3 - Issue 2/3

## I'll NAB There

I've always envied those who live near an NAB convention site (better still, in the same town). No airlines, no room reservations and, best of all, you get to sleep in your own bed when you finish the day's collection of literature and tote bags. Those planes have got to use more fuel on the trip home from NAB. If only the manufacturers would give out bags with cushion-grip handles -- they'd have my business for life!

I haven't been to NAB for quite some time, and it will be fun to renew old acquaintances. More importantly, I'm looking forward to meeting some new ones face-to-face. When I started the Radio Guide a couple of years back, I wasn't prepared for the rapport I've established with many of you. It's meant a great deal to me.

It's worth repeating -- there are no hard and fast guidelines for Radio Guide. It's simply a forum for the expression of technical ideas and solutions. What you see, is what we receive. I exercise little, if any, editorial control over the content of Radio Guide. I feel that if someone has solved a problem, then they should tell it in their own words -- not mine!

Radio Guide is not a publication in which you must feel compelled to meet certain standards. We are all, in one way or another, problem solvers. It just happens that engineers do more than their share. If one of you has solved a technical problem, then why should anyone else, faced with the same problem, have to do it all over. Professionals, in all fields, exchange information.

Stop a minute, and give it some thought. What about that transmitter problem you spent all night on. You know darn well that someone, somewhere, has the same box -- and probably has been through it all before. How nice it would have been if they'd written it down and sent it in to be published. The only problem is, there wasn't a publication out there that would have accepted those nuts-and-bolts solutions. There is now . . . editor

## Radio Management

Rochester Radio Publications is gearing up for a new publication. This one's going to take a different approach than Radio Guide. In fact, it's going to reach a whole new readership -- Radio Management. That not only means GMs and GSMs, but engineering managers as well.

There are quite a number of publications in the broadcast industry that purport to deal with management. Unfortunately, most deal with the instruments of management rather than their use.

Since Radio is obviously a technical medium, this publication will have a technical flavor. Nevertheless, it will concentrate on people problems, as opposed to the strictly technical (as found in Radio Guide). Radio has a wider range of characters and attitudes than most other industries. Creativity and talent -- bottom line and deadlines. They must coexist, if Radio is to function in the future. The management of those relationships will be our prime focus.

We are soliciting column editors, writers, and others, who may wish to participate. Part of what this new publication is all about is establishing a common ground for all broadcast managers -- engineering, programming, sales, and general. That's why we need your talents. Give us a call, and we'll get started . . . editor

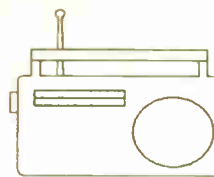

## Contents



Page 2	Correction & Help Wanted
Page 3	Revox PR-99 Tape Sensor Mod
Page 4	First Step To Automation
Page 6-7	Station Picture Book
Page 7	EBS Alert System
Page 8-9	A Cheap Mixer
Page 10	Racing Relay
	Smoking in the Studio
Page 11	Telco Interface Solution
	Continental 816 Driver Cap Failure
Page 12	Smoking Chokes
Page 13-15	Continental 816R Driver Modification
Page 16	IGM Instacart Noise
	Optimod 8100 Oscillation Fix
	Otari 5050B Popping Fix
Page 17	A Weighty Telco Problem
	CD Magic Marker
Page 18	SMC Data-Cells (revisited)
	Transmitter Contactor Problem
	Otari MX5050 Brake Tip
Page 20-26	Equipment Guide



**You receive an important extra with every quality TTC transmitter...**

We're there with Total Support if you need us. Our 24-hour Total Support Hot Line lets you call for technical, engineering, or maintenance support at any time. All our transmitters and translators are made with strict attention to quality control.

Get to know TTC and our full line of AM and FM Transmitters, made in the U.S.A.—FM from 10 Watts to 40,000 Watts, AM from 500 Watts to 50,000 Watts. For more information, call TTC: Television Technology Corporation (303) 665-8000 • FAX: (303) 673-9900

**The Quality is TTC**



## Corrections - Help Needed

### Contact Cleaning Alternative

By Joe Schloss - KICD  
Spencer, Iowa  
(712) 262-1240

On page 16 of the December issue of Radio guide, in the article Gold and Grungy -- a point of caution.

Some of the erasers have sulphur compounds in them, and will eat the plating away making the problem worse. A better way may be going to the store and getting some scotch-brite. It comes in different "roughnesses." If you combine this with some Cramolin R-2, you can't beat it. Don't rub real hard, or you will remove the plating, thereby throwing tolerances off.

### Help Wanted - Remote Control

From John Oelke - KSHE  
St. Louis, Missouri  
(314) 621-0095

Does anyone know how to modify a Harris Sentinal 16 remote control? I want to be able to access the remote control with my home computer and modem. Customer Service tells me it can't be done.

### Old Technical Books Needed

From Jeff Glass - WROK/WZOK  
3901 Brendenwood  
Rockford, IL 61107  
(815) 399-2233

I need the name and phone number of bookstores that deal with old, out of print, engineering books such as McGraw Hill, Pitman, John Wiley, etc. Can be a specialty store dealing with books on other subjects dealing with science/engineering. Help!

### Radio Guide

Volume 3, Issue 2/3  
February/March 1990  
Editor-Publisher: Ray Topp

#### Advertising Sales Representatives:

**West Coast:**  
Dale Tucker

4318 Kingswood Dr.  
Concord, CA 94518  
(415) 686-1538

**Midwest/East Coast:**

Ray Topp  
511 18th Street SE  
Rochester, MN 55904  
(507) 280-9668

Radio Guide is published monthly by Rochester Radio Publishing, 511 18th Street SE, Rochester, MN 55904. Phone (507) 280-9668, Fax (507) 280-9143. Copyright 1990 by Rochester Radio Publishing. All rights reserved.

Free subscriptions are available to all people involved in radio broadcasting and allied fields. Send name and address or any changes to Radio Guide at the above address.

Printed at Shakopee Valley Printing  
Shakopee, Minnesota  
A division of Guy Gannett Publishing

### Radio Guide

*It's Been There All Along*

*Joe Sands of Sands Broadcast Engineering sent a fax the other day. He told me he had heard (from where, I don't know) that the "RG" before a coax cable number, such as RG-8, comes from the words Radio Guide.*

*He hadn't been able to verify if it was true, but that it sounded resonable to him.*

*Yes Joe, it's true. It's one of those well kept secrets that, over time, just seems to leak out.*

*Speaking of leaking out, the RG (coax cables) keeps the RW (radio waves) under control, and keeps them from spilling out all over . . . editor*

#### The Radio Guide Fax Machine

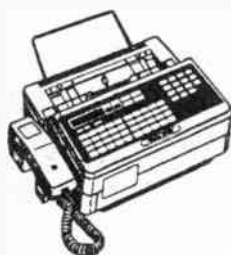

(507) 280-9143

### WORLD STANDARD IN SOLID STATE FM TRANSMITTERS

**Solid state quality and efficiency.** TTC's new FMS-Series FM Transmitters are available in 1kW, 2kW, 4kW and 8kW models. Broadband, efficient power amplifiers are transparent to the high-spec TTC Exciter.

**Redundant systems for high reliability.** Individual 1000 Watt plug-in amplifiers provide extremely easy service and maintenance. These transmitters remain on the air automatically—even in the unlikely event of a power amplifier failure. Exclusive "fail-on" control circuits keep the transmitter operating should a control circuit fail.

**World-acclaimed TTC Model X Exciter.** The Model X provides truly outstanding performance, with all distortions measuring .01% or less and FM composite signal-to-noise ratio an amazing 90dB down. Frequency response is .05dB from 20Hz to 100kHz for unparalleled loudness and clarity.

**Made in U.S.A.** For details on our full line of AM and FM transmitters and translators, call TTC: Television Technology Corporation, Phone: (303) 665-8000 FAX: (303) 673-9900

**The Quality is TTC**

- 100% solid state
- Very high efficiency
- Fully automated control
- Superlative specifications
- Integral lightning protection
- Redundant power amplifiers
- Broadband—no tuning required

## Digital Quality Transmission

### The Model FM 5B 5500 Watt FM Transmitter

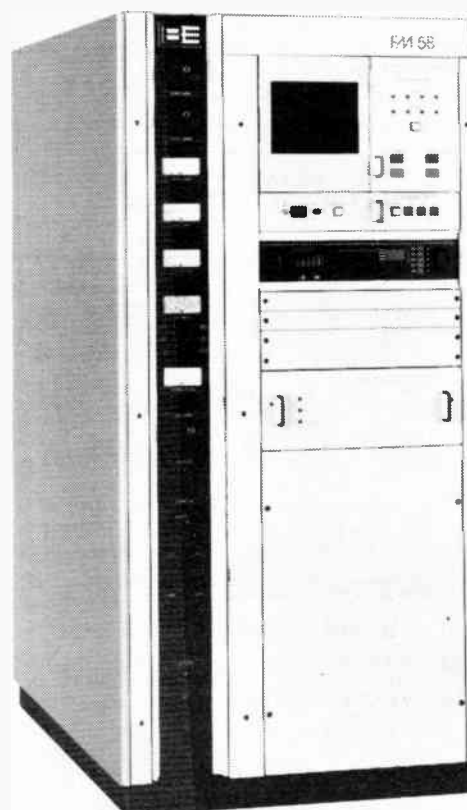

- **New** world standard FX 50 Exciter.
- **Guaranteed** 85 dB S/N.
- **Built-in** synchronous AM noise test facility.
- **Patented** folded half-wave coaxial cavity eliminates plate blocking capacitor and sliding contacts.
- **Self Contained** solid state broadband IPA in slide out drawer.
- **Emergency** 250 watt RF patching.
- **Automatic** power control with proportional VSWR foldback protection.
- **Single** or three phase version available.
- **Optional** microprocessor video display system (MVDS) with diagnostics.
- **Optional** PC Remote Control from MVDS.

With typical performance specifications of 0.02% IMD and 0.01% THD and guaranteed 85 dB FM S/N your listeners will hear the difference from a new FM 5B.

**BE** BROADCAST ELECTRONICS INC.

4100 N. 24th ST., P.O. BOX 3606, QUINCY, IL 62305, (217) 224-9600. TELEX: 250142. FAX: (217) 224-9607

# Revox PR-99 Recorder Tape Sensor Mod.

By Hal Schardin - WCCO  
Minneapolis, Minnesota

After WCCO installed four Revox PR99 reproduce decks, it soon was apparent there needed to be a time delay in the infrared tape sensor. Bad splices, and stretched tape would cause the machine to stop abruptly in the middle of the program.

I looked at the schematic provided in the owners manual, and decided that the simplest solution would be an RC component. The "R" part is a 47K, 1/4 watt resistor installed in the head nest. You can lift the gray wire off the phototransistor, and attach it to the nearest terminal on the dummy head next to the sensor. Now put the 47K resistor between the phototransistor and the gray wire.

Next remove the back of the Revox and install a 47 uF, 25 volt capacitor with the (+) lead on pin-7 and the minus lead on pin-12 of the Tape Drive Control PC board.

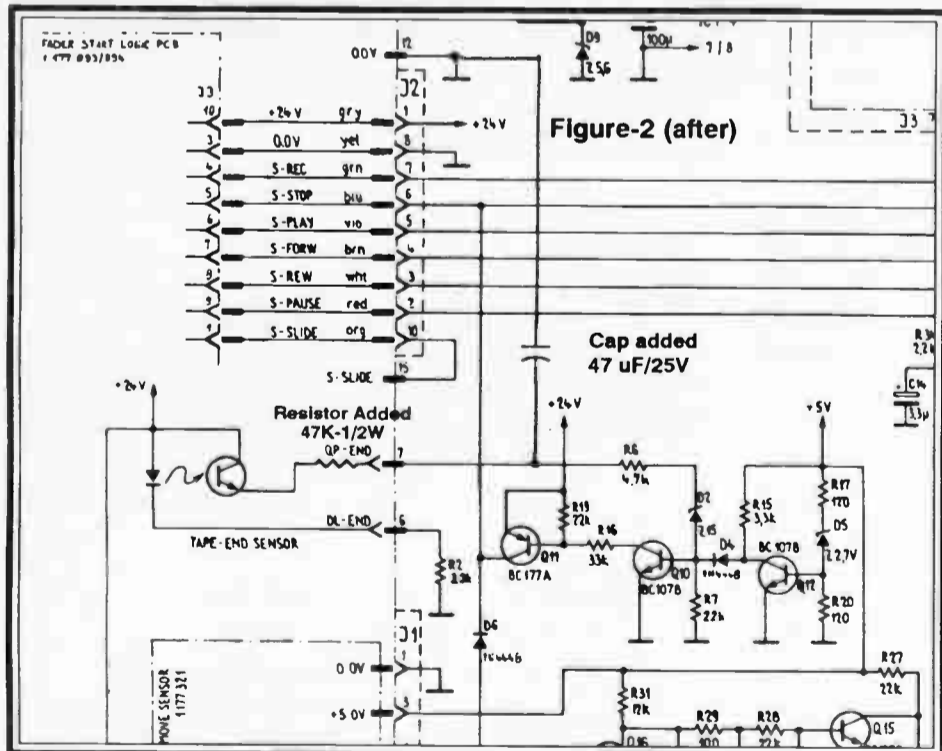
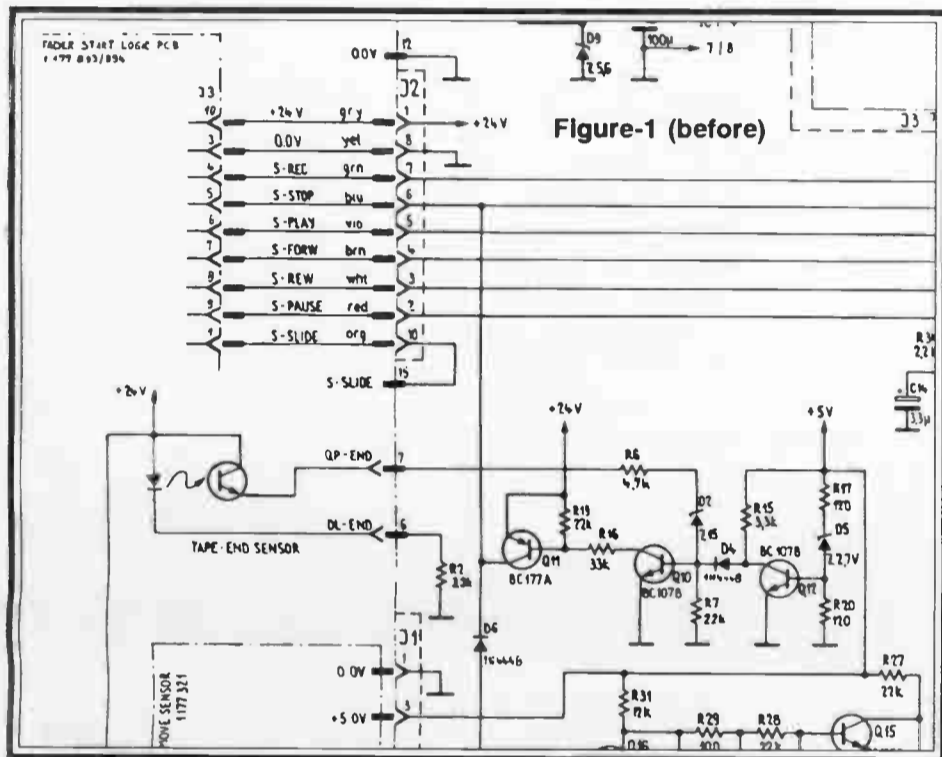

Before you seal the unit back up, you will have to adjust potentiometer R-51. The alignment procedure here is to see what voltage measured across the capacitor will cause the machine to stop, and then to set the voltage for 1/2 to 3/4 of a volt more. In our situation, we shoot for 6-1/4 volts give or take a 1/4 volt. (It's a tricky adjustment.)

You can now block the tape sensor with your finger, hit play, and take your finger away -- it should take 1 to 2 seconds for the machine to stop. At 7-1/2 IPS, that's 7-1/2 to 15 inches of stretch, or one heck of a bad splice!

# CARTING CD's?



**YOU NEED SYNCHROSTART!** Synchrostart will synchronize your CD player and cart recorder to make carting a one button operation. Eliminate those annoying "clipped intros" that often happen because your CD player starts quicker than the cart recorder. Whether your dubs are done by the PD or by the "nighttime college kid," they'll be tight and consistent. Synchrostart makes CD dubbing fast, accurate, and one-button easy!

**HENRY ENGINEERING**  
**(818) 355-3656**  
**We Build Solutions**

# CRL SPOTLIGHT

Converting to the  
NRSC Standard?

Want to Improve Coverage  
of Your Station?



CRL's AM2 audio processing system is a COST EFFECTIVE way to convert your station to the NRSC standard, and in many cases improve your coverage as well. The two unit system consists of a two-band AGC unit with our dynaflex® single ended noise reduction circuitry (AGC-400) followed by our tri-band peak modulation controller (PMC-450). Split studio and transmitter sites? Use the AGC unit at the studio and the limiter at the transmitter! An adjustable presence band boost lets you augment vocal clarity and punch. A patented overshoot corrected low-pass filter ensures maximum modulation control. Low frequency tilt correction circuits plus adjustable asymmetry levels assure compatibility with all transmitter types. Suggested retail price is only \$2995. Our TWO WEEK TRIAL PROGRAM will prove to you how sound of an investment the AM2 mono system is. Call or write us NOW for details.



**CRL Systems**  
2522 West Geneva Drive  
Tempe, Arizona 85282 U.S.A.  
(800) 535-7648 (602) 438-0888  
TELEX: 350464

# First Step to Automation

By Alan Roycroft - Hilo Hawaii

A resurgence of automation use has been accelerated by the introduction of new satellite equipment, switchers, and the proliferation of satellite programs. One of the most important factors that are overlooked, in such a new installation, is the source of local programming -- the cartridge and the cartridge player. Without the live operator's attention to carts that are too loud or too soft, carts that drag, and carts that run through, it is imperative that special attention be given to this important part of programming so that commercials, liners and IDs play faultlessly every time the computer calls them up.

Once the choice of the automatic players is made, ask the manufacturer (not the dealer) what type and make of cartridge they recommend. It is the manufacturer that usually receives the sad news of cart problems after the sale. At most stations, there is usually a habit of piling carts on top of warm or even hot cabinets. This, in time, warps the plastic cases and dries out the tape. You are warmly advised to abandon these, and invest in a completely new stock. Apart from the problem of cases, pressure pads and worn tape, different tapes are supplied in purchases over the years from the same source so there is usually up to 5 dB difference in recorded levels from one tape to the other. It's OK, if there is a DJ to correct the pot setting; but it is certainly a problem, particularly if you are an FMer with little limiting in the audio processing.

## Lazy Production

Before placing an order for new tapes, go through the tape length requirements carefully with the PD. In the finished cart, it is essential that there is no more than 15 seconds of cue-up time following a spot or commercial. With satellite programming, windows are provided for clusters of local plays, and if you have the usual number of cartridge players, they will be required to play perhaps three times in a break. It's just too bad if the next player is still cycling through to a stop when it is asked to play. Watch out for the lazy person in production who cannot find a 40 second cart for a 30 second spot, picks a 70 or even a 100 second cart, and records only one cut on it.

If replacing your old stock of cartridges is not possible, you are recommended to borrow (or steal) a cart winder, a stock of one type of tape and several boxes of tape pads, if that is what your old carts use. Set up a production line, first dismantling the cartridges, abandoning the old tape, cleaning off the nylon washer (if used) and the center pivot post. A small drop of quick glue to secure the nylon guide, and a drop of nail polish will hold the new pressure pad in place. The splice is the most important part of the job, in that the position of the cut determines the loop length and the tightness of the reel. The actual splice must be done with splicing tape that you have selected for its absolute reliability. Be prepared to abandon any rebuilt cart if it is warped and was not evident in your inspection.

## Aux Tones Important

Next are the cart recorders. The one factor that determines the need for new machines is the ability to record aux tones, but if you have to use the old machines, start off with replacing all, I repeat all, electrolytics. Check for noise and hum level and measure voltages, as some are basically regulated, with zeners that drift off over the years. If possible, replace all heads, even if response of play and record meet factory specs. It may be that, because of having too much high frequency boost in the equalizers to obtain the response, that distortion and an unnatural quality will result. Compare a cart with the original source by listening critically to synchronized playback with the original tape. Next measure the frequency of the stop and aux tones. They may have been OK for the old manual players, but new automatic cart players usually use a digital detector which cares little for level but is hot on frequency.

We will not examine the pitfalls of stereo cart production. In the practical area, stereo is to be avoided, particularly for commercial use, as the client will not be impressed with left and right voices and similar gimmicks -- all they want is a loud clean sound. The program and cue audio levels must be carefully adjusted after bias settings for program and cue are made for the new tape, to

ensure that both or all of your recorders lay down the same quality and levels. In setting azimuths and levels, a test cart direct from the factory is essential. Never copy one -- pay the \$80 (or whatever) and smile!

Observe the production people and diplomatically try to correct some of their bad habits they have acquired over the years. If diplomacy fails, simply hit them over the head with a soldering iron! You can help by showing an interest in their work and doing cleaning and demagnetization on a regular basis. If there are some old AGC amps available, preferably a CBS Audimax of any model, overhaul and test it out, and install it ahead of the cart recorders. If you have a peak limiter such as a Volumax installed, yank it out immediately. Observe the Audimax action, discreetly through the production room window, for the best control settings for everyone that uses the facility. It will be worth it for a controlled and consistent cart sound. The position of the aux tone controls the tightness of the breaks. If you are in a screaming rock format, experiment on your own for the best cue position; running too tight a break destroys the value of a spot, and you may have management and clients on your tail after several hundred carts are already out on the racks and in the players.

## Check Those Carts

PSAs are usually required as fillers at certain times to cover the window time. To avoid cluttering up the trays of the cart players, and so there is a change in copy, it is usual to employ long running carts, up to 10 minutes in length, to accommodate up to nine 60 second cuts. If you wind your own, you could try adding 7 to 10 seconds for each cut planned for the cart. You must inspect such finished long carts as production people may not remember to space out the cuts, leaving the excess cue-up time in one length, making it impossible for a player to end and re-cue in time for the next play. These long carts also require a lot more pull torque than other tape lengths. The usual cause of drag is silicone on the pinch-wheel and capstan. In over thirty years of cart problems, I have found that the best cleaner is Energine applied with a clean terry-cloth. Evidence of silicone on the capstan is proven by a squeal when the cleaner is applied.

A timer in production is a must; preferably one operated by the start light, on the cart and reel recorders, operating a relay. Say, two carts were recorded with the full copy supplied, were 7 to 10 seconds over the 30 or 60 second limit, and then played consecutively. Your network joiners will be late and sound like high school radio.

Once your automation is into operation, you will find all sorts of problems. Arrange for a three day dress rehearsal, and sit at the automation listening for all those cute errors that could mar the official new format change. Some take a little time to track down. For example, some aux tone lamp indicators on cart recorders operate from the detected play, so there is a short pause after pressing the aux record button before the aux indicator flashes. To the nervous Nellies, this is some evidence of a technical failure, so they will push the aux record button twice. In a multi-cut cart, they may forget to put the aux tone on one cut and go on to the next cut, hoping that no one will notice. You will notice, due to the fact that this cut silence-senses on each play, and your window gets out of sync.

## Splice Finders

There are good uses for splice finders but they do cause the cart to stop and start at the same spot for every use, stretching the tape or thinning the emulsion. On the other hand, if the splice is not used as a start point, you may lose clients irritated by the drop outs in an important part of a cut. You can't win, so just make very good splices.

You have probably heard all of the foregoing at some time or other, but now you have to abide by the rules or production will become a shipwrecked chorus -- everyone for themselves.

## Fix Something?

Send Your Technical Solutions  
To the Radio Guide Fax Machine  
(507) 280-9143

# Mighty Mean Machines Made for Modest Money! Just ask Maynard Meyer of Madison Minnesota...

**Q92**  
KLQP-FM

P.O. BOX 70  
MADISON, MINNESOTA 56256

January 5, 1990

Dear Sirs:

Just a note to let you know how much we like the Ramko xL62S stereo console we installed in our FM broadcast operation a few months ago. The audio quality is excellent and our announcers like the ease of operation. It's amazing that you can offer a console of that quality for the low price tag that was on it.

I had one occasion to call your service department for an answer to a question I had on a minor problem and I received some friendly and accurate advice. Incidentally, the minor problem resulted from a severe lightning strike at our studios, the Ramko board survived it nicely!

I would recommend the xL SERIES audio consoles to anyone with a small budget who is looking for "big" quality.

Very Truly Yours

*Maynard R. Meyer*  
Maynard R. Meyer  
General Mgr./Chief Engineer

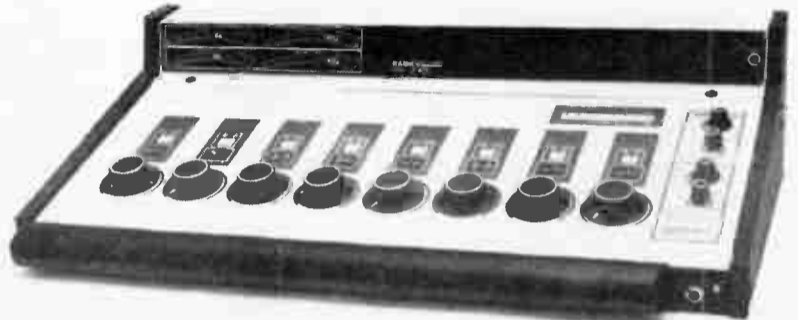
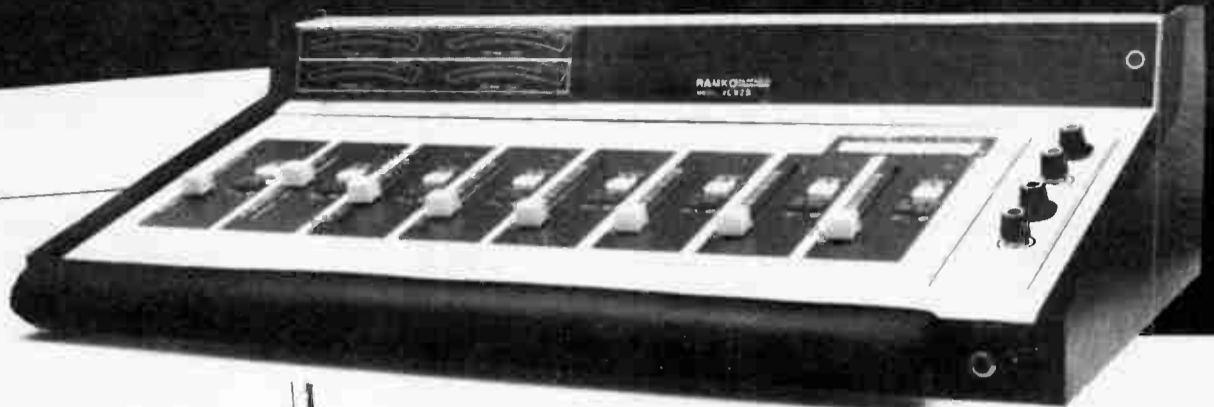

SEE THEM AT NAB BOOTH #4606

## THANK YOU KLQP-FM!

We could not have said it better. Ultimately there is no higher authority than you, the broadcaster, on how well we've done our job. How the equipment performs, stands up to every day use or abuse, looks & feels to the operator, plus delivering the features needed for the dollar spent. No less important is how we respond if a problem should ever occur.

## OUR DIRECTOR OF ENGINEERING DIDN'T HAVE JUST A HAND IN THE DESIGN, HE HAD HIS WHOLE ARM IN IT.

Before one PC board was laid out or pencil put to paper for any part of the metal structure, our Engineering Manager sat down and measured the most critical parts of the console's operation. The arm, the hand and fingers, & the operator's line of sight. The arm had to rest comfortably when at the controls; the input & output select switches had to be reachable while simultaneously controlling the faders; the selectors had to be illuminated and clearly discernable at any angle; and the meters had to be properly angled for normal seated operation and clearly show the levels, even across the room. What he finally designed in was a layout that is exceptionally easy to control without operator strain or unusual manipulations. Science calls this ergonomics; we call it just good common sense and a concern about you, the user.

## IT GETS EVEN BETTER AS YOU GO ALONG.

Dramatic new developments in IC technology have taken place that allowed us to design a console with fewer components, less manufacturing labor and higher performance than previously

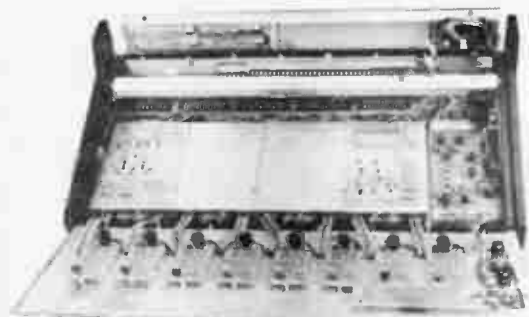

Interior view of the xL82S

possible. The end results are significant price reductions for the features provided and a quality of sound reproduction unsurpassed by units costing thousands of dollars more. Huge expanded scale -40dB to +3dB, multi-color VU meters - Four individual meters on dual channel units - Nine input selects on the last channel - Mono sum output - Plug-in modules for ease of service - Optional switch programmable remote start/stops Double shielding for total RF protection - Optional mix/minus buss with balanced out and much, much, more.

## YOU'RE INVESTING IN A CONSOLE...NOT PLAYING THE LOTTERY.

As you are reading this, the xL SERIES is proving itself in numerous installations across the country. "No RF problems of any kind".... "Our sound has noticeably improved since installing your boards".... "Our people really enjoy the ease of operation".... "Our console actually tested out better than your spec's".

## THE ULTIMATE INSURANCE POLICY.

All RAMKO products are shipped on a two week free trial basis. No ifs, ands, or buts! If at any time within two weeks of receipt, you are not entirely satisfied, ship it back. Upon receipt & verification of condition, an immediate refund or account credit (less shipping charges) will be issued. What more could anyone ask? Pricing that will save you hundreds of dollars.... Unsurpassed quality & performance...two weeks to make sure this is what you want to live with for years to come... and everything we manufacture is backed by a 2 year warranty.

## DON'T DELAY - CALL, FAX, OR WRITE TODAY!

Contact RAMKO RESEARCH direct, toll free, or your RAMKO dealer for further information or to place your order. You have nothing to lose except perhaps some preconceived notions about how much quality really costs.

TOLL FREE (800) 678-1357  
FAX (916) 635-0907

**RAMKO RESEARCH**

3501-4 SUNRISE BLVD./RANCHO CORDOVA, CA 95742 (916) 635-3600

## COMMON FEATURES:

- Mic/line select jumpers on each channel
- Mono/stereo feed selects on each channel
- Gain select patch panel on each input
- Programmable muting on each input
- Nine inputs on last mixer
- Two inputs on all mixers except the last
- 2 watt internal CUE amp & speaker
- 20 watt stereo external monitor amp.
- Padded arm rest
- VCA controlled audio mixing
- High voltage solid state audio switching
- On air lights relay (programmable follow mute)
- Illuminated, 5 million operation, input/output select switches
- Mono sum output, balanced
- Plug-in ICs throughout
- Optional remote equipment start/stop
- Optional 9 input, programmable mix/minus buss with balanced out
- Unique internal decals & labels for complete installation without referring to the manual

## PARTIAL SPECIFICATIONS

INPUTS: 2 per channel except last channel which has nine. Balanced bridging 1k ohms in mic mode & 150k ohms high level. Input A of each mixer programmable mic thru high level & strappable for mono or stereo feed. Input B is programmable for low thru high levels. OUTPUTS: Balanced low impedance, +24 dBm max into 600 ohms. Additional stereo sum balanced out. Main channel outputs factory set for +8dBm @ 0 VU. METERING: Expanded scale, multi color, solid state 2 each on single channel models & 4 each on dual channel models. MONITOR: Stereo, muted monitor outputs @ +4dBm. External 20 watt stereo amp. included. S/N: Mic level in @ -50dBm & +8dBm out; -68db. High level @ 0 dBm in; -75dB. DIST: Below noise floor. Typically 0.009%. RESP: 10Hz-20kHz, +0.00, -1.5dB. FINISH: Polyurethane Carbide black, Linear white & RAMKO grey.

## STEREO CONSOLES: Models & accessories

xL41S	4 mixer, single channel	\$1395
xL42S	4 mixer, dual channel	1650
xL61S	6 mixer, single channel	1975
xL62S	6 mixer, dual channel	2375
xL81S	8 mixer, single channel	2650
xL82S	8 mixer, dual channel	2950
xL12/1S	12 mixer, single channel	3850
xL12/2S	12 mixer, dual channel	4150
RSS2	2 mixer, 4 machine start/stop	225
RSS4	4 mixer, 8 machine start/stop	295
MMB 1/9	9 input mix/minus buss, bal. out	175
SLF	Super long life linear faders(per chnl)	75

# A Radio Picture Book (For Giving Operating Instructions)

By Ronald F. Balonis, CE - WILK  
Wilkes-Barre, Pennsylvania

Regardless of the kind of radio engineering you do, giving or writing and posting equipment operating instructions to others is part of the job -- like it or not. And, with the turnover at most radio stations these days, it's generally to "others" who have a blank, I-don't-really-comprehend, stare on their faces.

Ironically, as the "engineer," you end up not only as the technical specialist but in some cases as an operational one as well. Being more likely to be with a station longer, you end up getting "by default" the responsibility for making "others" know what they are supposed, should, or need to know.

While giving, writing, and posting "instructions" is a good way to maintain operational efficiency at any radio station, it can become just another engineering problem: making instructions so clear that the blank stares change to ones of informed enlightenment is very difficult to do -- for anyone.

But it's not impossible, if you approach it as an "engineering" problem, in a problem solving way. The instruction process, from the making, the writing or the giving -- to the reading and the doing, involves two different modes of thinking and two different levels of translation between them. Normally, you don't think about how you think while doing things -- there's no reason to. But, if you do, there are two distinct modes of thinking that we all unconsciously do: A linear or sequential one that orders things in time or space, such as writing or speaking. And, a nonlinear or holistic one that's generally disordered in time or space, such as reading or visual recognition and interpretation.

You use the nonlinear mode when creating the instructions -- seeing what needs to be done, and you use the linear mode when writing or verbally giving them. In our thinking processes, we internally translate from one mode to the other, subconsciously. For making instructions, the translation is from a nonlinear mode (visual and conceptual) to the linear mode (a written sequential list of instructions); it occurs in your mind, an engineer's. However, for the interpretation and use of them, the translation from a linear mode (reading or hearing of the instructions) to the nonlinear mode (visually conceptualizing them) occurs in the mind of an "other." The blank stares result from errors in translation, either to or from, because no one thinks in exactly the same ways, and everyone possesses their very own unique translation dictionaries. The meanings are not in the words, but in us. And, only with time and experience for both the engineer and the others, can the translation errors decline.

Without a doubt, the best way of giving instructions is verbally. It more closely mirrors the thinking pattern of the "others;" you can actually point while using pointing words, and you get direct feedback on whether the "other" understands, so you can repeat it in other words.

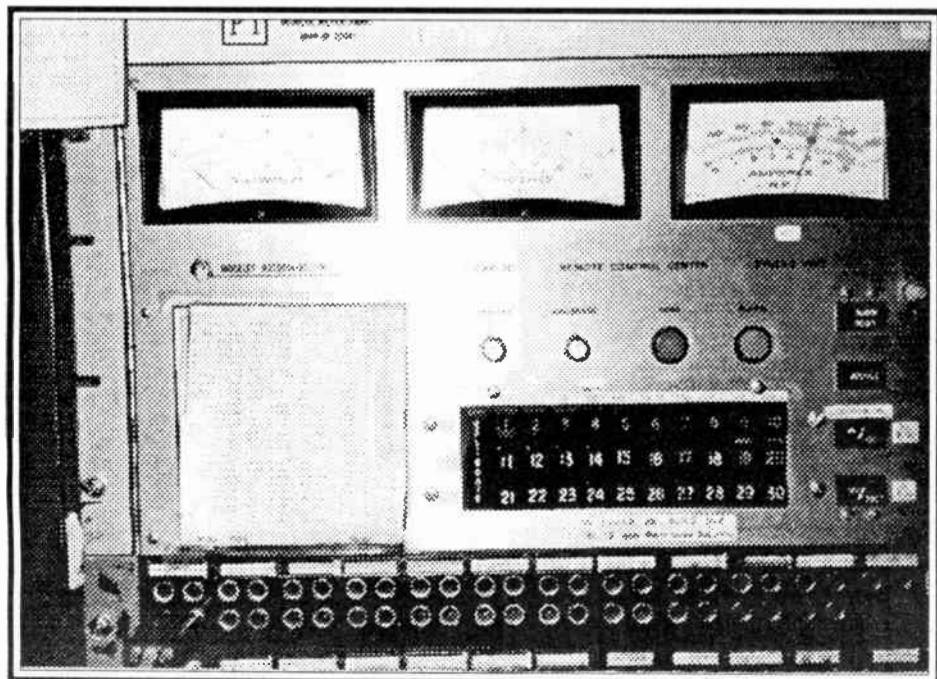

## NRSC Conversion Special



ONLY  
\$2650.00

Why just convert  
when you can upgrade...for less

- MIC-MAZE** — STL or Telco Preprocessor  
Eliminates headroom problems
- TRI-MAZE** — Complete NRSC processing  
Including tunable cutoff frequency
- ZH-1** — Main and Auxiliary transmitter  
peak control  
For precise modulation control on both your old  
and new transmitter

No other NRSC processing package offers so  
much performance and control for so little money.

**hnat hinders inc**

42 Elaine Street • R.R. 1 • Thompson, Connecticut 06277  
(203) 935-9066 • (203) 935-9242

## SERIES VI — A SOUND DECISION!

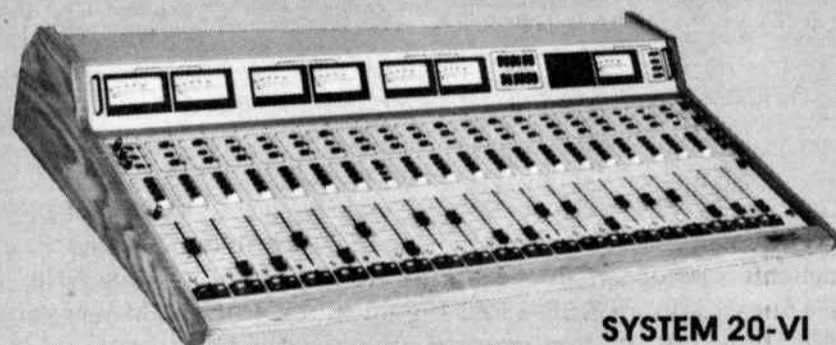

**SERIES VI Broadcast Audio consoles** are completely modular with a new low profile appearance and new features. Mainframe sizes of 8, 12, 16, 20, and 24 mixers are available. An LED clock/timer, peak level indicators, headphone EQ, monitor "dim", and 3 stereo, plus 1 mono mixing bus, are standard (except for the 8 mixer model). A 5-frequency EQ mixer and equalized Aux Send module are optional. All mixers have mic/line inputs. Double-sided ground plane motherboards are used for RFI rejection, and lowest possible noise and crosstalk. There are no VCA's or ribbon cable audio conductors.

These great sounding consoles are ideal for use with CD's, which require a wider audio bandwidth, to fully exploit their spectacular transient response. Call or write for our new brochure. **SERIES VI - A SOUND DECISION!**

**BROADCAST  
AUDIO CORPORATION**

11306 SUNCO DRIVE  
RANCHO CORDOVA, CA 95742  
(916) 635-1048

## A Station Picture Book . . . (continued)

But that only works for when you're there. For the other times, it's either the posted written instructions or, as the last resort, instructions given over a telephone. There is a way, however, to make telephone instructions nearly as effective as being "there."

One of the problems with posted instructions and those given by telephone is that there is no feedback to know whether the instructions are understood. Another one is that, in a flat verbal or visual context, words tend to lose some of their "in-person" contextual meanings resulting in "translation" errors.

It's as true today as when it was first said -- "a picture is worth a thousand words." Instructions over the telephone can be made almost as effective as "being there" by making a special kind of instruction book for yourself -- a picture book of close-up pictures of the equipment.

The new point-and-shoot 35mm auto-focus high-tech cameras make it easy to take close-up pictures of the equipment, its switches, knobs, and meters. The way to make instructions by telephone as effective as being there, is to let the instruction giver (you) be visually present. With an equipment picture book in front of you as you give instructions, you can give them using pointing words and directional references -- up or down, to the right or left. The dead silences on the phone still give you I-don't-comprehend feedback, but now the instructions/directions can be rephrased and repeated in different ways until the "other" understands. This picture illustrates one of many in my "station equipment picture book."

## EBS Alert System

By Steve Callahan - WFTI-FM  
St. Petersburg, Florida  
(813) 866-3544

WFTI-FM is part of Family Stations, Inc. and operates under the Automatic Transmission System provisions of FCC S73.1500. We get our 24 hour programming from our network headquarters and satellite uplink in Oakland, California. Our authorized control point is also the satellite uplink in Oakland. It's easy for the operator there to receive a national EBS test via KNBR in the San Francisco Bay Area, but next to impossible for them to monitor a local Tampa Bay EBS test or activation.

Additionally, our studios and offices are manned only a portion of each day, so local monitoring of the Tampa CPCS-1 is inconsistent. We came up with this simple system which could be utilized by other ATS stations. The auxiliary alarm contacts of our Gorman Redlich EBS decoder/encoder drive a four pole normally open relay, which uses one contact to start a small cassette recorder which records CPCS-1 audio. Another contact closes the "hold" contacts on an ESE-112E digital timer. (If the GM has you on a real tight budget, you can use the normally closed contact to interrupt the AC to an ordinary analog clock).

The third contact operates an alarm position on a Sensaphone (Phonetics, Inc. 101 State Road, Media, PA 19063, 215-565-8520), which calls the station operator pager first, his home second, and my home number third. The Sensaphone is programmed to leave "91.7" on his digital pager. All of the above occurs simultaneously when a local EBS test is sent by the CPCS-1: The cassette begins recording, the digital timer freezes and the station operator is beeped. He can tune in CPCS-1 on his car or home radio, or call the station to hear the EBS monitor speaker on the Sensaphone's internal microphone.

If it's more than a test, he can immediately call our Network Satellite uplink, and they'll take it from there. He now can get immediate notification of the EBS action wherever he is, and then get an exact time of the test and a tape of it. He simply logs the test, resets the decoder and resets the ESE timer, and it's ready for the next test. The system has been operational for two months and has worked perfectly. The Sensaphone has other alarm positions which we have adapted to an off-air alarm and an intrusion alarm for the studio. It's proven to be an inexpensive solution to the problem.

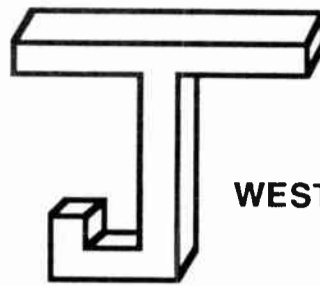

SQUARED  
TECHNICAL SERVICE

543 WEST 100 NORTH  
WEST BOUNTIFUL, UTAH 84010

801-298-8515

### EQUIPMENT REPAIR AND CALIBRATION SERVICE

WE SERVICE MOST AM/FM BROADCAST MONITORS,  
REMOTE CONTROL SYSTEMS, EXCITERS, STL's, TSL's,  
RPU's, ETC.

#### GIVE US A CALL

- CHECK OUR RATES-
- TURNAROUND TIME-
- STL LOANER PROGRAM-

GET IT  
RIGHT  
GET IT FROM ALLIED

Buy!  
Sell!  
Trade!

These ol' boys wheel & deal!



JIM

CHUCK

Allied has been serving the needs of broadcasters for used radio equipment since the late 1960's. Veteran broadcasters are the "heart" of the equipment exchange business at Allied. Call on Jim or Chuck — their expertise is unparalleled. CALL TODAY!

The number to call is 317-962-1471.

We accept TRADE-INS,  
SELL NEW & USED gear &  
selectively BUY used radio  
equipment. Let us help you  
economically!!

**ALLIED**  
EQUIPMENT EXCHANGE  
A HARRIS COMPANY

317-962-1471

635 SOUTH E ST. • P.O. BOX 1487 • RICHMOND, IN 47374

© 1990 HARRIS/ALLIED

# A Cheap Mixer

By Hal Schardin - WCCO Radio  
Minneapolis, Minnesota  
(612) 464-7587

A while back, a station manager came to me for technical assistance. He wanted to assemble two studios in neighboring communities. The idea was to represent these communities with a couple of short daily broadcasts. These broadcasts would consist of local interviews and community events. Since these were an experimental venture, costs had to be kept to a minimum.

I debated various mixers, phone attachments, frequency extenders, mike amplifiers, powered mikes, etc., and decided the Radio Shack 32-1200B stereo mixing console was the best piece of equipment. This unit can accommodate multiple inputs, and physically doesn't look half bad, either. A schematic is part of the owners manual (thanks!). See Figure-1 for original circuit.

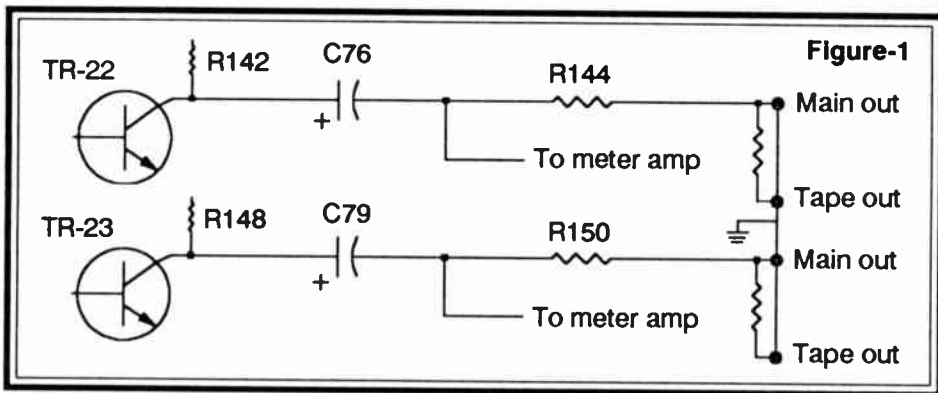

The "main outputs" are relatively high impedance, and unbalanced. To lower the impedance I chose a 5532 dual opamp. I set up the opamp as a voltage follower, as no gain was needed. This worked out well for driving a phone coupler.

The first step of the modification is to remove the bottom panel; this is the only panel you have to remove. Fortunately, the circuit board has the part numbers printed on it. You will need to remove the two 1K output resistors, R144 and R150. The technique I used was to remove the solder with a solder sucker; then I straightened the leads. I pushed the leads through the board, and then I shook the resistors from within the mixer. Now you can attach the input leads of the opamp to the collectors of TR22 and TR23.

The final circuit is shown in Figure 2. Since the TR22 and TR23 transistor's collectors run at 6.7 volts, I used them to "bias" the opamps by direct connection to the non-inverting opamp inputs. The output of the opamps is decoupled through a 10 uF capacitor. A series 600 ohm resistor protects the outputs from excessive load. The other end of the 600 ohm resistor then connects to the "main output" jacks.

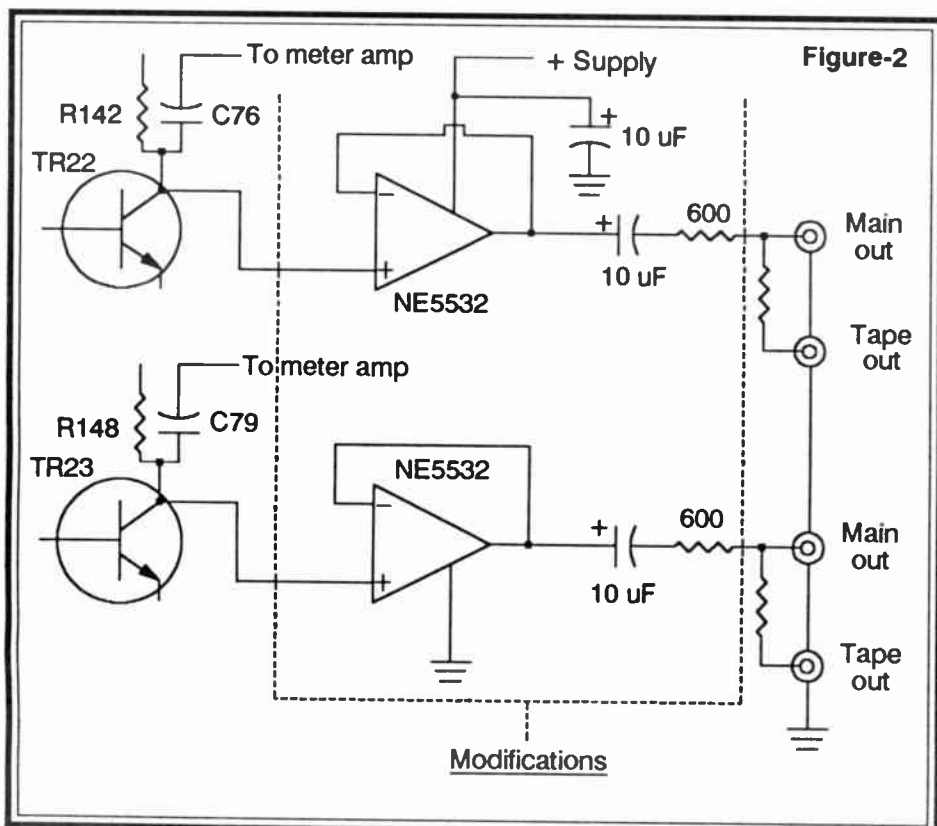

# ECONCO

Now in our 20th year  
providing quality rebuilt tubes.

These are a few of  
the tubes we rebuild:

3CX2500F3

3CX3000A7

3CX3000F7

4CX5000A

4CX15,000A

4CX3000A

WE BUY DUDS.

WE ALSO REBUILD REFLEX KLYSTRONS.



ECONCO  
1318 COMMERCE AVENUE  
WOODLAND, CA 95695  
TELEPHONE 916-666-7553

OUTSIDE CA 800-532-6626 EXT. 30  
FROM CANADA 800-848-8841  
TELEX 176756  
FAX 916-666-7760

## Audible Improvement!

### FM

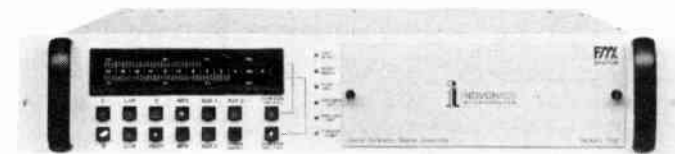

Our 706 FM Stereo Generator maintains 16kHz response and 75dB separation through *digital synthesis* of pilot and subcarrier. This assures full modulation with an *inherent* low residual above 54kHz, though an adjustable pre-pilot composite clipper is included.

The 706 also features internal combining and metering of up to 3 SCARD channels, and has two independent composite outputs. It is 100% - compatible with *your choice* of audio processing, and the FMX™ System is a plug-in option.

### AM



Inovonics' 222 is the simple, effective and affordable path to NRSC compliance. Its built-in peak control, adaptive preemphasis and no-overshoot 10kHz filter make you *sound better* too!

See these and other sonically-superior products at NAB Booth 5601/5603.

## Inovonics Inc.

1305 Fair Ave., Santa Cruz, CA 95060  
CALL: 1-800-733-0552 - FAX: (408) 458-0554





## A Cheap Mixer . . . (continued)

Supply voltage for the 5532 is decoupled with a 10 uF capacitor near the chip. The 26 volt supply is picked up near the power transformer, where it enters the main circuit board, from the emitter of TR28. I managed to fit a small circuit board with the 3 capacitors, and 2 resistors within the mixer.

The main output could now feed a QKT coupler -- or a small 600/600 transformer could drive the dedicated phone line, etc. Since this application required the driving (and holding) of a dial phone line, I used a 111C repeat coil I had lying around. The 111C appears to have enough iron in its core to hold a phone line and not get into core saturation. See Figure-3.

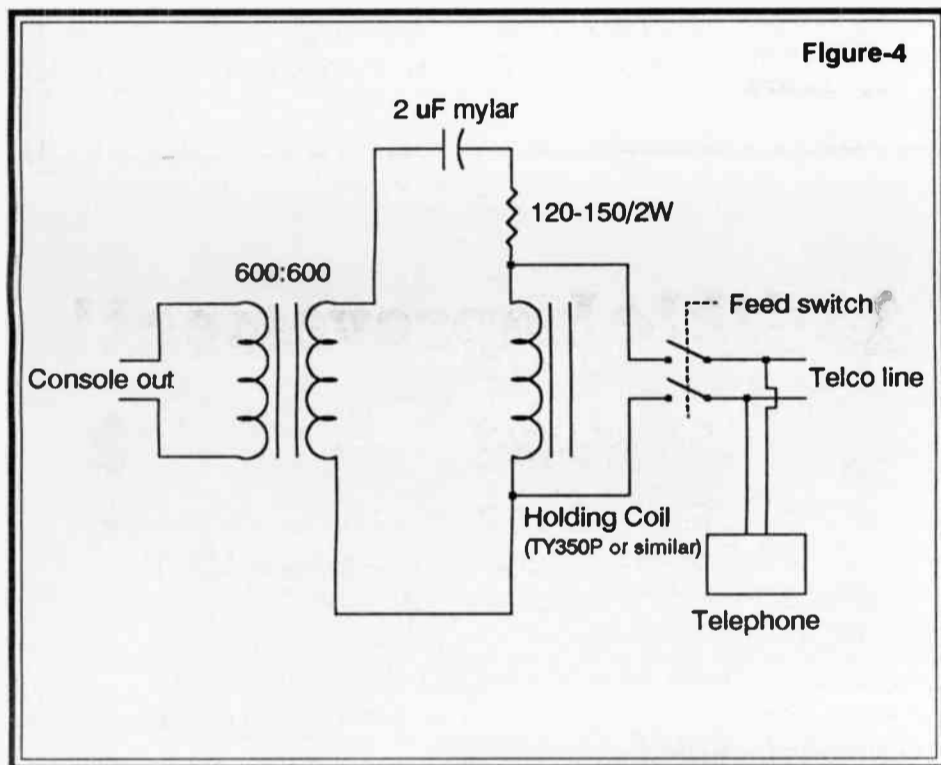
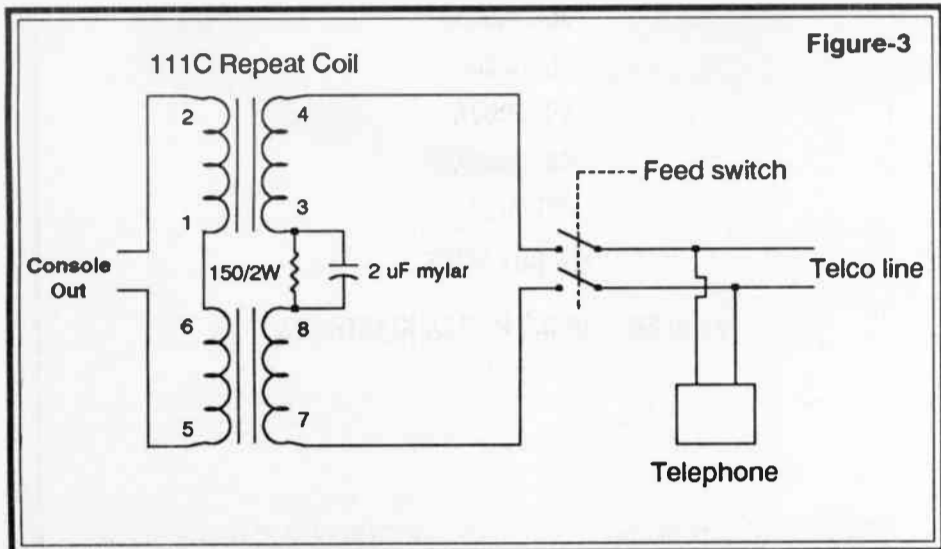

Another way to feed the phone line is to use a small transformer, a holding coil, and a capacitor to block the DC. See Fig-4.

With the setups shown, the dial phone establishes contact, the switch is thrown on, and the phone can then be hung up. A radio is used to get air cue.

## Free Classified Ads

Only three things matter:

1. Does it Cost?
2. Is There a Limit on Words?
3. Will I Sell My Equipment?

At Radio Guide - - The Ads Are Free  
There's No Limit on Words  
You Will Sell Your Equipment

# POWER-side™

## PROBLEMS

- Adjacent Channel Interference
- Antenna Null Distortion
- Co-Channel Interference
- Power-line Re-Radiation
- Building Re-Radiation
- Receiver Tuning
- Low Fidelity Home Radios
- Co-Channel Beat
- Selective Fading

## SOLUTION!

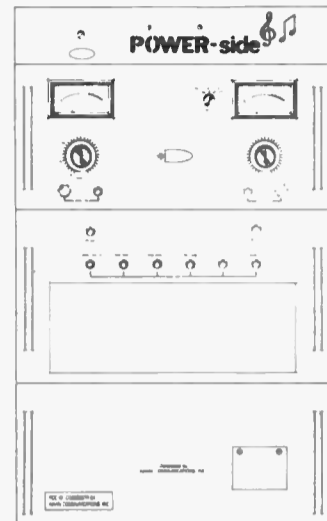

**POWER-side™**  
The solution to many of AM radio's most serious technical problems

From the developers of the AM STEREO system that isn't afraid of the dark and will let you drive right past FM Stereo

425 MERRICK AVENUE, WESTBURY, NY 11590 • (516) 222-2221

## Audio Interfacing Solutions

Whether you need consumer to pro interfacing, line amplifiers or distribution amplifiers, the Series-200 Utility Amplifier System is the solution. Up to 11 input or output modules can be arranged in one 3.5-inch rack chassis to provide the interface you need. We offer a wide variety of standard stock configurations at affordable prices. They include a 1 x 10 stereo DA, two 1 x four stereo DAs, five stereo line amps and 11 consumer-to-pro interfaces. Because each output has individual active balanced amplifiers you get separate gain controls for each. Levels can be easily matched to your exact requirements -- a feature only found on very costly distribution systems. Rear panel connections to the Series 200 are via simple screw clamp connectors for all balanced connections and standard phono jacks for unbalanced consumer interfacing. Contact your local distributor or Broadcast Devices today for more details.

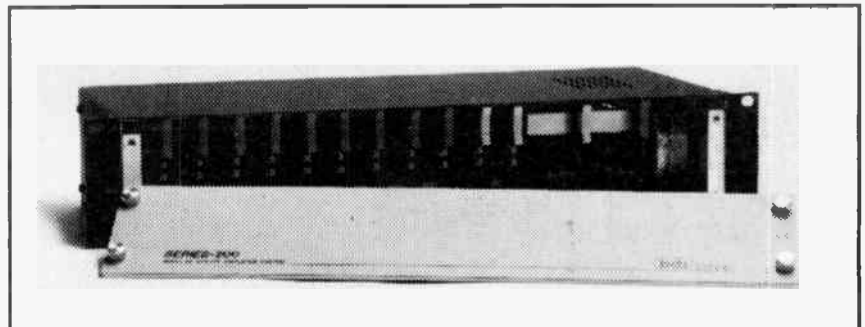

Complete systems start at under \$1400.  
Custom configurations are also available.

Affordable solutions for the broadcaster ...  
5 Crestview Avenue Peekskill, NY 10566 (914) 737-5032

**bdi** Broadcast Devices, Inc.

# A Racing Relay

By Ron Wood - KOWO

Waseca, Minnesota

(507) 835-5555

The KOWO-AM transmitter is a CCA AM-1000D. For what seemed a year or so (I didn't keep an accurate time count), it would intermittently shut the plate voltage off with what appeared to be some type of overload condition -- but no overload lights ever came on. After much thought, measurements, parts replacement, and calling to factory techs, the problem was still there.

It was finally discovered to be a "mechanical" race between the plate TD relay K2 and the main plate contactor K4. The TD would operate normally on its time cycle, but its metal straps that were the movable contacts had lost some spring tension.

Therefore, as soon as the plate contactor would slam shut, it vibrated the main transmitter component mounting plate just enough to mechanically shake the TD contact that was in series with the plate contactor pull-in coil. The TD contact bounce would open the plate contactor, the TD would again close, the plate contactor would slam in and vibrate the mounting plate, and the "race" was on. I can only imagine that the sound it made would put a gattling gun to shame.

Looking at the old and new TD relays side-by-side, made it clear that the contact holding power was different on the two parts. Maybe the coil pull-in had lost some holding power, but I didn't make any further tests on the old part, since the new TD solved the problem.

Although this may seem to be a straightforward problem, in my mind it's the subtlety that is so interesting. The TD appeared to be working correctly, but on a detailed check, it was found to be faulty.

## Smoking In The Studio

### An Argument To Ban It!

By Warren Schulz, CE - WYFR

An article appeared in the February 1988 issue of RECORDING ENGINEER/PRODUCER magazine, authored by Darrell Wilk, V-P of Marketing for ITT Schadow. ITT Schadow is the manufacturer of switches used by Pacific Recorders & Engineers audio console manufacture. In the article, titled, "APPLICATIONS GUIDE FOR SWITCH CONTACT SELECTION," the author discusses switch failures and cause for failures.

Within his introduction, the author cites a fact that airborne contaminants from cigarette smoke will affect switches. In particular, the sulfides from burning paper (cigarettes are wrapped in paper) form a film on the silver contact surface. These oxides react in the presences of moisture. The silver sulfide film creates an insulating film that insulates the contact from making an electrical circuit. The result is a noisy and intermittent switch contact. Because the surface is a film, its breakdown voltage can require at least the application of 5 volts. Unfortunately our audio systems operation in the 0.01 to 1 volt range.

Cleaning of the switches will flush away the contaminations. However, the cleaning process can also flush out the original lubrication and cause an early switch failure. We had one case at WFYR that, after a number of cleaning attempts, all switches on a BMX-14 console had to be replaced. This was an estimated direct and indirect cost of \$600!

We had recently measured a BMX Series-I console that has been in service for 10 years in a heavy smoking area. The switches were still serviceable. However, in performing intermodulation measurements, we came across conditions where distortion was 0.6% IMD in place of the uniform 0.02% IMD. Working the module switches would change the distortion level. Finally, using a contact cleaner (De-Oxide by GC) cleared the problem.

**We Need Your Help - - Write for Radio Guide**



Improved Tapecaster® X-100 cart loader with single lever control enables error-free loading to one-second tolerance. Long-life, heavy-duty synchronous motors and rugged all-steel chassis and top deck make X-100 the only loader you'll ever need. Among its features are:

- Adjustable tape tension
- Precision electronic timer with automatic reset
- Editall splicing block

For complete information call or write.

**TAPECASTER®**

a division of



**Auditronics, Inc.**

3750 Old Getwell Road • Memphis, TN 38118  
Phone: 901-362-1350 • FAX: 901-365-8629

## Silence is Golden and less work with telcom c4 for RADIO and TV.



### The NR system you just set and forget.

- A product of ANT Telecommunications, Inc.
- No overshooting.
- No pre or post echo.
- No wasting time with lining up — not even for tape exchanges.
- Applications: Cartridge machines, STL, RPU, Reel-to-reels, Cassettes.
- Up to 118dB dynamic range — the widest dynamic range available in any noise reduction system today.
- Over 15,000 channels in use worldwide.
- No breathing or pumping.

**telcom c4**  
Silence by Design.

Distributed by:

**RAM BROADCAST SYSTEMS INC.**

346 W. Colfax Street, Palatine, IL. 60067

New York (516) 832-8080

Chicago (708) 358-3330

Tennessee (615) 689-3030

# A Telco Interface Solution

By Keith Stokes - KLSU-FM  
Baton Rouge, Louisiana

For several years, the station had been using answering machines for the listener information line, but found that they just would not hold up to the volume of calls that were generated. I decided to come up with another idea. I had an old Spotmaster cart machine that was removed from service that I thought would be useful, both for its longevity and the ability for the staff to spice up the audio with music or sound effects in the production room. At the time, no one was making a universal cart machine controller, so I had to come up with one of my own.

All you need are two relays: one a 120 VAC, and the other a 24 VDC, and one capacitor. Here is the diagram of the circuit:

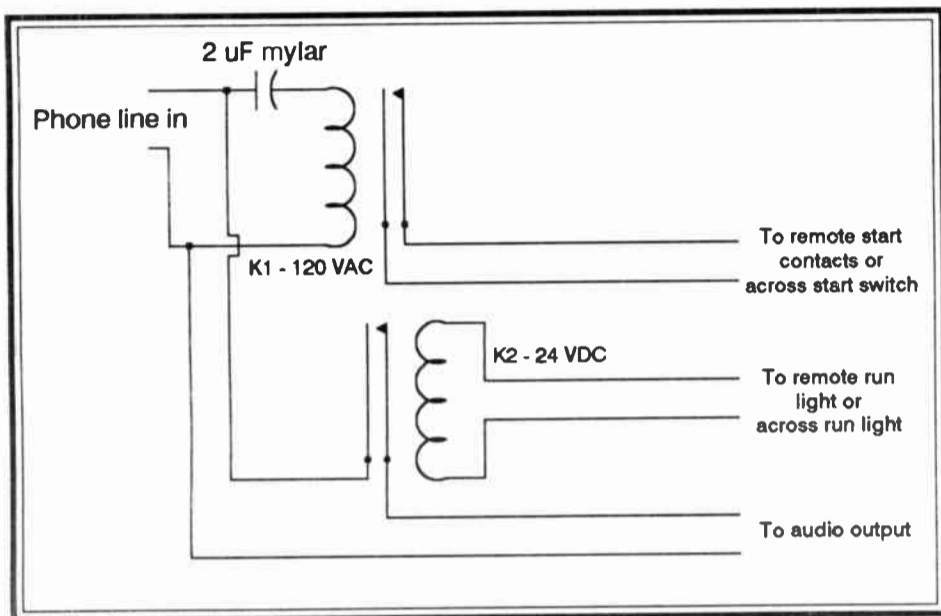

The capacitor blocks the DC from the phone line from energizing the start relay. The ringing voltage fires relay K1, whose normally-open contacts are across the start switch of the cart machine. K2 is connected across the start light of the cart machine. Its normally-open contacts interrupt the audio output of the machine. The output transformer holds the line while audio is fed to the caller and until the cart cues.

The only thing you have to ensure is that the cart machine does indeed have an output transformer. If not, you will have to add one so that you will not unbalance the phone line, in which case you will induce hum on the line.

## Continental 816R-1A Driver Cap Failure

By Jack Parker - WUBE-FM  
Cincinnati, Ohio  
(513) 621-6960

Over the past 3 years, I've experienced failure, on one occasion, of the driver plate tuning vacuum variable capacitor in my Continental 816R-1A. In addition, I know that my transmitter has had at least one other failure of this capacitor, as has one other Continental transmitter at my transmitter site. This failure is caused by the fact that the vacuum variable is operating near its maximum capacitance value, and is prone to arc over occasionally - ultimately leading to its complete failure! This arcing causes both the PA plate and screen overload tell-tales to come on since, from a DC standpoint, this capacitor is tied directly to the grid of the final amplifier tube. The momentary arc takes the grid to ground and permits excessive PA plate and screen current to flow!

Continental does have a fix for this problem, with a modification kit which places a doorknob capacitor in parallel with the vacuum variable, allowing the variable capacitor to be run at a much lower capacitance value to achieve resonance, and minimizing the opportunity for arc-over. The modification kit is priced at just under \$100, which is far better than paying \$400 to \$500 for a new vacuum variable! (Thanks to Jay Crawford, CE of WEBN-FM, Cincinnati, for his input on the 816R-1A problem. He'd been fighting with this for a long time).

# No Tool Case Should Be Without One



## The 1990 BSW Catalog

The BSW Catalog is your doorway to the tools of your trade. A reference book for the latest technology to maintain your presence in the market place. A dream book for future plans and growth.

Filled with 128 pages of audio and audio related equipment from the simple component to the most sophisticated system, the BSW Catalog will save you hours of research for the products you require.

BSW is the largest independent Broadcast Audio Dealer/Distributor in America with a buying power unexcelled in broadcasting. That, along with a consistent inventory in excess of one million dollars, permit the most competitive pricing and assurance of fast delivery.

Should your tool kit lack a BSW Catalog, call us toll free 1-800-426-8434 and we'll send a copy to you immediately.

# BSW®

BROADCAST SUPPLY WEST

America's Full-Time Broadcast Supplier

**1-800-426-8434**

ORDERS • INFORMATION • SPECIFICATIONS  
BSW • 7012 27th Street W • Tacoma, WA 98466 • FAX 206-565-8114

# Smoking Chokes

By Wayne M. Kube - KBTX-TV  
Bryan, Texas  
(409) 846-7777

I had a rather interesting occurrence, recently, at a station that I contract for. The transmitter is a Harris FM 2.5K. It has a solid state exciter, but a tube driver -- the final is also a tube, a 5CX1500B. The transmitter is normally trouble free. The phone rang at about 6 a.m. (the second most common time after 2 a.m.). The sign-on announcer had turned on the plates and started to log the first set of the day's meter readings. He noted that the output power was pegged, the plate current was much higher than normal, and the plate voltage was against the upper pin on the meter.

After attempting to decrease the output with the power level control, he still could not get it to go below 125%. He tried shutting down the plates and restarting, but the results were the same -- that prompted the call to me. I had him try it again and, while we were verifying the readings, he reported a burning wood smell. "Shut it down, I'll be right over," I told him.

Driving over, I tried to think of something that could cause this, but all I could imagine was that the power line voltage had somehow increased enough to cause the increase in high voltage. But, this would have to be some kind of increase. The normal plate voltage is around 4 kV, and the meter scale reads to 5 kV. This was past that point! Arriving, I checked the input 240 volt line. It read 247 volts, a little high, but certainly not enough to cause these problems. I verified the increased readings with the plate energized. Yep, everything too high, except screen voltage was lower than normal. That made sense, because the power is controlled by varying the screen, and that was down to its lower limit already.

Well, I thought of re-tapping the high voltage transformer. Setting the primary taps to the highest input points and the secondary taps to the lowest output points allowed the plate voltage to come up at normal. Plate current was also normal after the screen voltage was increased with the power control to bring the output up to 100%. It looked good, though it didn't make sense. But, after

watching it for a couple of minutes, I also noticed a smell like that of burning wood.

I shut it down quickly, and then tried to figure what was made of wood in a modern transmitter. I shut off the disconnect, opened the rear door, and shorted out all the high voltage points. Then looking closer, I could see a trickle of smoke still coming from one of the filter chokes after the high voltage rectifier. Seems that the laminations and the windings were held apart by some wooden wedges and there was enough heat being generated in the choke to let the smoke out of the wood. Strange.

The high voltage supply in this transmitter is a typical circuit with a four diode full wave bridge across the secondary, followed by a series choke, a shunt filter cap, another series choke, and another shunt cap. Thinking maybe the choke was bad, I removed and checked it, but it measured OK. Still, I swapped it with the second choke, but the results were the same. Both caps and all four rectifiers checked out OK as well. Measuring the secondary voltage with a high voltage probe showed that it was too high.

A call to Harris Field Service left them scratching their heads after they suggested everything that I had already tried. About all that we could come up with was that there was something wrong with the high voltage transformer. That seemed unlikely, but nothing else made much sense either. I ordered another transformer and another choke, since it could have been damaged from the generated heat. Next day, replacing the transformer cured the problem. The secondary voltage was back to normal with all taps in the proper position. The choke was also replaced, all was normal.

The theory is that something went bad in the primary of the HV transformer, possibly arcing between turns, effectively increasing the turns ratio. This arcing caused a lot of high frequency noise that the first choke had to deal with, causing it to overheat. Sounds weird, but that's what happened. It's the first time I've ever seen a transformer go bad and start to increase its output.

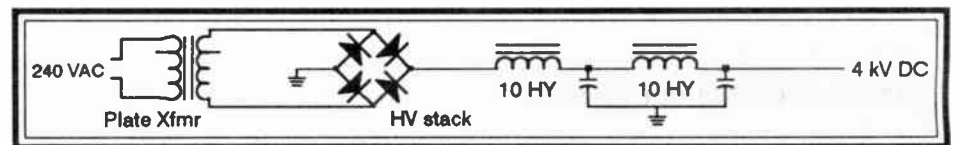

## CRL's NEW IPP-100 Create Personality Instantly ... Just Add Voice!

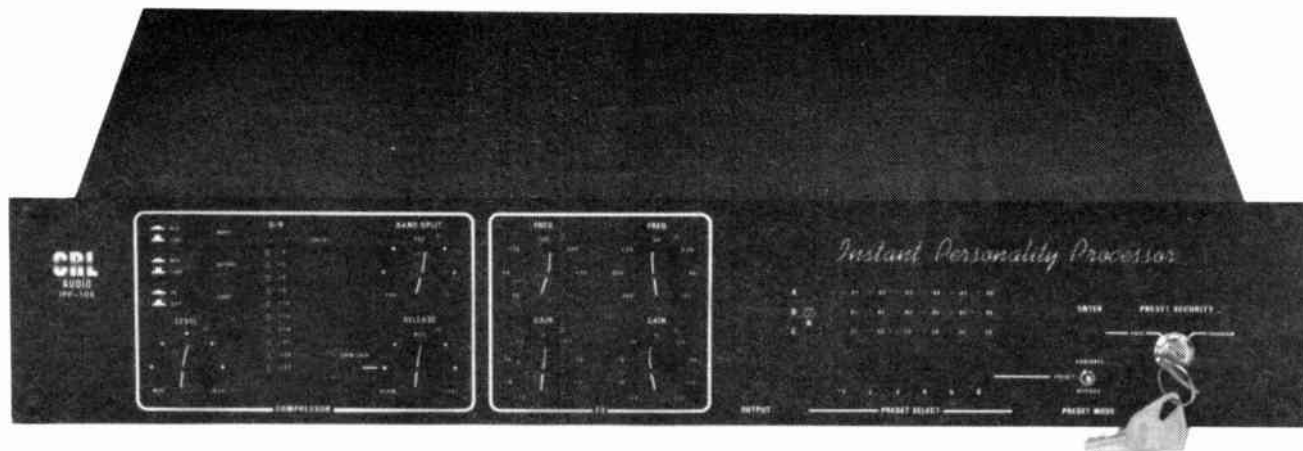

CRL's IPP-100 Instant Personality (mic) Processor is just what your station needs to enhance its personality. The IPP-100 is a fully integrated broadcast microphone processor with 18 pre-set memory positions. A powerful two band, parametric equalizer drives a two band compressor with adjustable band splitting. Mic or line level input and outputs, key lock security system, LED status system, and easy to use analog controls make the IPP-100 simple for anyone to use. Plus the IPP-100 features an external audio loop for special effects processors. An optional remote control unit, the IPP-100R makes control room use a snap! Best yet, get all this digitally controlled power for only \$1495.



IPP-100R  
\$395.00



**CRL Systems**

2522 West Geneva Drive • Tempe, Arizona 85282 U.S.A • (800) 535-7648 • (602) 438-0888 • FAX: (602) 438-8227

# Continental 816R-2A Driver Modification

By Robert King - WBUS  
Bourbonnais, Illinois

The first problem involved the driver stage of the Continental 816R-2A FM transmitter. In July 1988, I attempted to install a pair of Amperex 4CX-250BC tubes (drivers). The change was being made because of a drop in the screen current -- one sign the tubes were weakening. If the drive to the final stage (4CX-15,000A) is not close to saturation, the transmitter becomes unstable.

When the new tubes were installed, and the transmitter was turned on, the static current (by removing exciter drive for the two drivers (125 mA each) was adjusted according to the service manual. I suddenly heard what appeared to be a small pop in the driver cage. What was a balanced current reading between the two drivers, suddenly changed with the small pop sound. The left driver stayed at the proper current, but the right current dropped to 50 mA.

I changed position of the driver tubes, and the problem (low cathode current) moved with the tube. This led me to believe the problem was caused by a bad tube. The old drivers were installed, since they were the only "good" ones I had.

My technical reports showed that three attempts had been made to put in new drivers, each attempt had a somewhat different outcome, but it always seemed to appear that a driver tube was the problem. On one other occasion, the screen regulators were shorted again, making it appear the driver tubes were at fault.

In the meantime, the old drivers were put back in their respective tube sockets, and the transmitter was put back on the air. The transmitter worked fine; another attempt would be made, in the succeeding months, to change the drivers.

In August 1988, another set of drivers (Amperex 4CX-250BCs) were installed. Now, the cathode static current dropped in the left (front) socket about 75 mA.

Drivers from the old set and the new set were mixed, with the old driver in the left socket and the new driver in the right socket. The static current was set.

When drive (from the exciter) was applied to the set of drivers, the right side cathode current dropped to 100 mA (it normally operates at 180 mA). The old drivers were installed again until the problem could be found.

You are not going to believe the pattern of the problem, if not gotten already so far. The transmitter worked fine, except for a slight drop in drive to the final stage caused by an aging pair of drivers. When new drivers were installed, the transmitter was unstable, at best. Cathode currents were unstable in many attempts. There was a suspicion that screen regulators were shorted during this entire escapade of attempting to put in new drivers, which started in May of the same year (1988).

But finally, persistence paid off. I determined to, again, inspect the driver cage like I had never done before. Many previous inspections did not reveal the problem. I pulled on wires to see if something would come about. I found a loose filament transformer connection that should have been screwed tightly to the driver chassis. The connection was just barely touching the metal chassis.

My theory was that the new tubes were drawing more filament current than the old tubes, making the loose connection conduct poorly. When the old drivers were re-installed, that stage always worked. When the new drivers were in, the transmitter was unstable and the cathode current of some of the drivers was low.

Tightening the screw onto the chassis has corrected the problem permanently, and that has been a year ago.

My next problem is related to the gating cards of the same transmitter and similar transmitters, such as some of the Collins series. Previous articles in Radio Guide, have shown me that a careful inspection of the problem with these gating cards was in order. I realized that the problem appears to be so obvious, and I wondered why I (or no one else) had never caught it before.

(continued on page-14)



## Puts your signal in it's place!

If you need a quality antenna, you need:  
**JAMPRO ANTENNAS, INC.**  
The really experienced one for over 30 years.

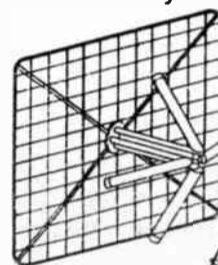

JAHD CP  
Arrowhead  
Screen Dipole

JSDP CP Spiral  
Broadband Antenna

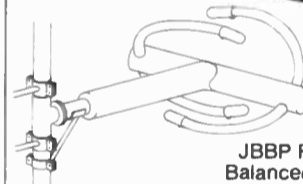
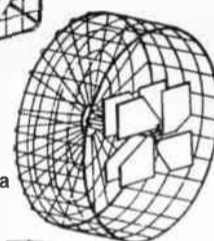

JBBP FM Antenna  
Balanced Excitation

**JAMPRO** is the world leader in custom-designed, directional, CP antennas.

- With over 1600 of our penetrators delivered, more stations have penetrated their market.
  - Our custom-made directional antennas are operating world wide.
  - Full-scale antenna measurements on **JAMPRO's** all-year, all-weather test range.
  - We custom-make tower structures to duplicate your's, for optimum results.
  - Ask about **JAMPRO's** low-power educational packages.
- Give us your requirements and see how fast we produce.

**JAMPRO Antennas, Inc.**

6939 Power Inn Road  
Sacramento, CA 95828  
(916) 383-1177 • Telex: 377321  
FAX (916) 383-1182

## Continental Driver Mod . . . (continued)

The problem with these cards is that the capacitors (C5, C6, C7, and C8) are nearby the high wattage resistors (R11) which radiates a high amount of heat. These capacitors are right in the pathway of the heat convection, which dries them out. Why not disturb that convection with a small fan. That is harder than it sounds. Things to consider:

1. The fan must move a high volume of air. In a restricted space, the fan can only be so thick because of the small clearance caused by the back service door.

2. Air should be moved from the back of the cage to the front (nearest the service door), so that dirt is not blown into the card's edge connectors. Due to the tight clearance, as described above, that will not be possible.

3. The fan should be of the right dimensions so that it can be mounted right on the end of the card cage, with just the construction of a plate which is the same size as the cover -- and still have a fan to move the highest CFMs (cubic feet per minute) of air.

4. The voltage rating of the fan should be a value that is easily accessible from within the transmitter, preferably that can be controlled with the filament buttons on the front of the unit.

Well, in July 1989, I came up with what I thought was an idea. I will not give the fan information in this first attempt because later tests showed it did not work.

A special kind of fan was installed and, three months later, capacitors installed on the boards and near the high-wattage resistors had show they still dried out. That showed that the fan was not moving enough air.

Another attempt was made with a different fan and, although it is way too early to tell, I believe I have come up with a better solution, but not perfect.

A Pamotor fan, Model 4600XP (120 VAC/115 CFM), was mounted on a metal plate, one inch larger than the one (metal cover) that was removed. The metal (6.5" x 6.0") is about 1/16 of inch thick, and a hole (4.5") was cut for the fan's air flow. The metal was made slightly larger because of the large hole for the fan. Making the metal the same size as the original cover would have made the plate too fragile with the large cutout in the center. The Pamotor fan has bearings rated for high-heat environment, so it is recommended that it (or a similar fan) be used.

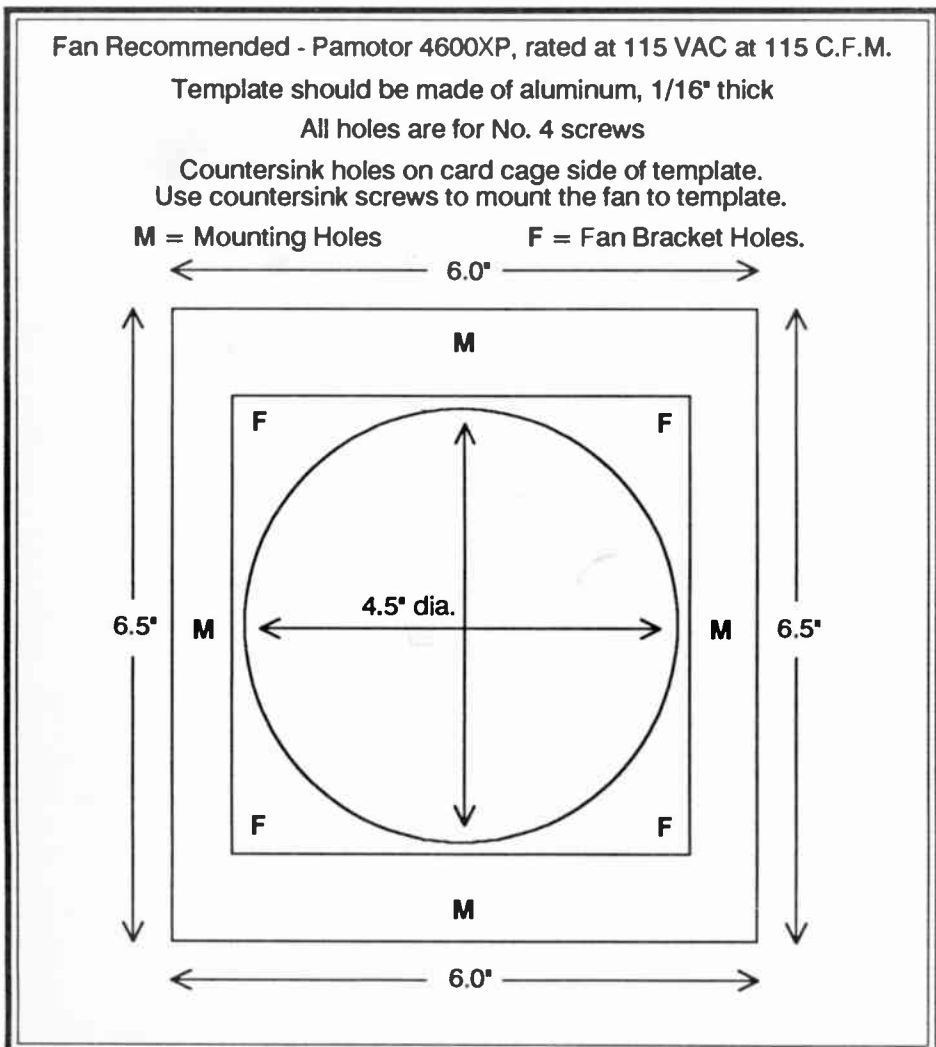

## Ron Radio Communications, Inc.

P.O. Box 201  
 Brightwaters, NY 11718

### AM NRSC Headquarters...

#### Inovonics 222 Add On Processor

■ Add to the end of your existing audio chain.

Ron Radio Priced at \$ 495

#### Energy Onix Add On Processor

■ With Mod Monitor Rolloff Filter

Ron Radio Priced at \$ 495

#### Hnat Hides Tri-Maze NRSC-AM Processor

■ Replaces your current processor. The BEST AM processor made today...

Ron Radio Priced \$ 1,595

### Call RON RADIO for all your equipment needs!!!

High Schools & College Stations are our Speciality.

Let us Bid on your next Project...

We represent all the Major Brands...Call us before you buy...

#### Call Ron Radio for:

License & CP Applications

Frequency Searches

AM Directional Tune-up, Adjustment & Repair

1-800-666-3525

1-516-665-6482Fax



**RUSSCO'S  
 GOT IT!**

Get our catalog!

#### TELEMOTE 321

This tiny phone-remote mixer never needs batteries or AC! Your phonenumber gets you on the air for great performance with 2 mic inputs, 1 tape input & pot controlled audio for 3 headsets.

Only \$599

#### STUDIO-MASTER S055

5 channels stereo, 4 built-in preamps, 5th channel accepts 5 inputs on push-buttons, cues any channel with Mod Pots, cue amp & speaker. Great specs, performance & dependability. Mono available too.

Only \$2195

#### MARK V TURNTABLE

This solid metal, variable speed adjusts easily 10% & starts Quick for precision play. LED speed readout, heavy aluminum platter with built-in 45, detachable tone arm plate & super performance!

Only \$720

TURNABLES, TONE ARMS,  
 PREAMPS, POWER, DIST., &  
 CD AMPS, MIXERS & MORE!



ELECTRONICS INCORPORATED

5690 E. SHIELDS AVE., FRESNO, CA 93727 • PHONE (209) 291-5591

## Continental Driver Mod . . . (continued)

The mounting of the new metal plate is identical to the old plate. The fan is mounted, perfectly centered, on the plate, and the same screws and mounting procedure are used for putting the plate onto the end of the card cage.

To make the most of the air flow, the air was made to blow into the cage, over the boards and high wattage resistors. This should reduce, if not eliminate, the drying out of the capacitors and the browning (burning) of the circuit boards.

With the fan in place and operating, the service door directly behind the fan was put into place. From a neighboring compartment, the clearance was checked between the door and the fan frame and there is about an inch of clearance. Air flow into the cage does not seem to have been greatly reduced by the service door, and air flow was felt all the way into the wiring area of the card cage. I had wanted to move air away from the board, but that was not practical, so the air was blown into the cage.

With this fan, it is recommended that the edge connector for these cards and checked periodically for dirt build up in those connectors.

Figure-1 is an exact drawing of the plate you should cut and drill to size. Figure-2 is a picture of the modification itself.

Now, the gating cards themselves. It is highly recommended -- and this cannot be stressed enough -- that the engineer have two sets (one set in the transmitter and one spare set: 3 boards to a set) of gating cards. Turning on and off the transmitter to find a bad gating card can do more damage than what you spend for a spare set of cards.

When I have a problem related to a gating card, all of them are changed. The spare set is installed and the old set is tested. Most likely, the problems are the capacitors reviewed earlier in this article.

I have found that keeping two sets of these cards has more than paid for the cost of the second set -- and I am talking about a complete spare set.

There is another problem seen in these Continental and Collins transmitters. Do not allow dirt to build up in the final stage area where the fingers of the tuning shelf or door meet a metal surface. This can cause arcing, and I have seen what can happen when these area are not kept clean.

The arcing, in one of my transmitters, got so bad that holes (about an inch in diameter) were burned into the tuning cavity area of the final stage. This makes tuning impossible, and a costly metal plate has to be installed. This arcing can also occur on the doors. **CHECK AND CLEAN THOSE AREAS AT REGULAR INTERVALS!**

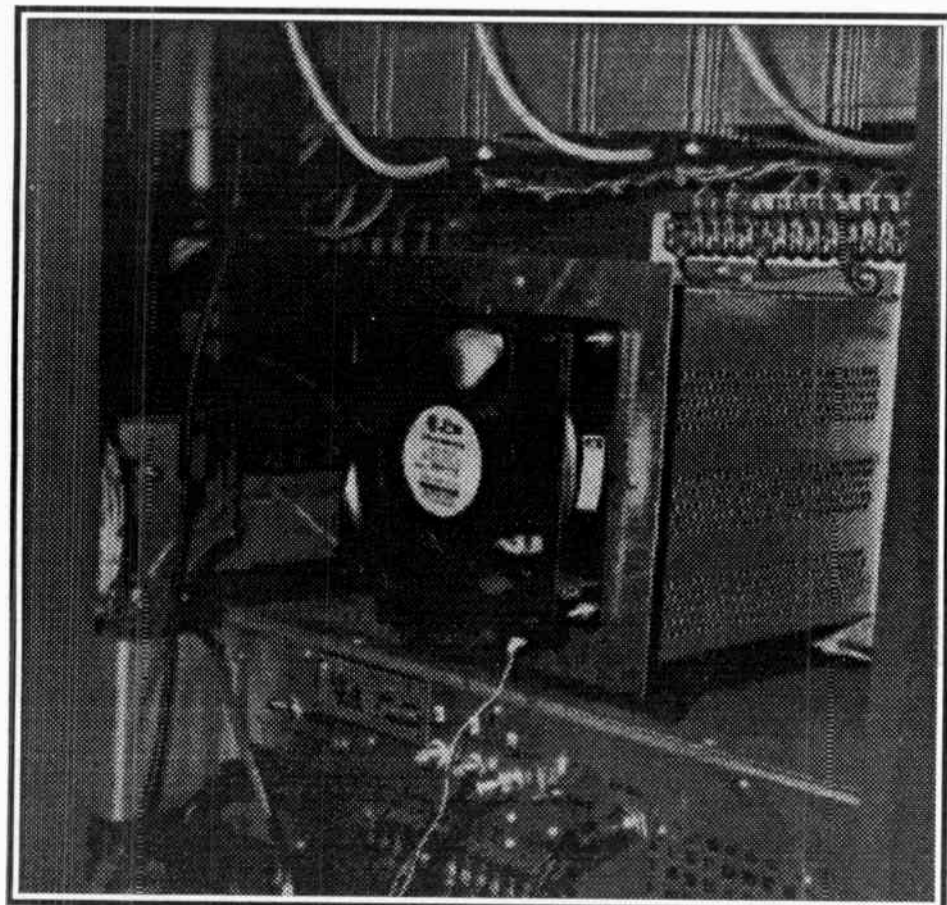

## Will 6kW Work?

(or B, B1, C1, etc.)

See It On Your PC!

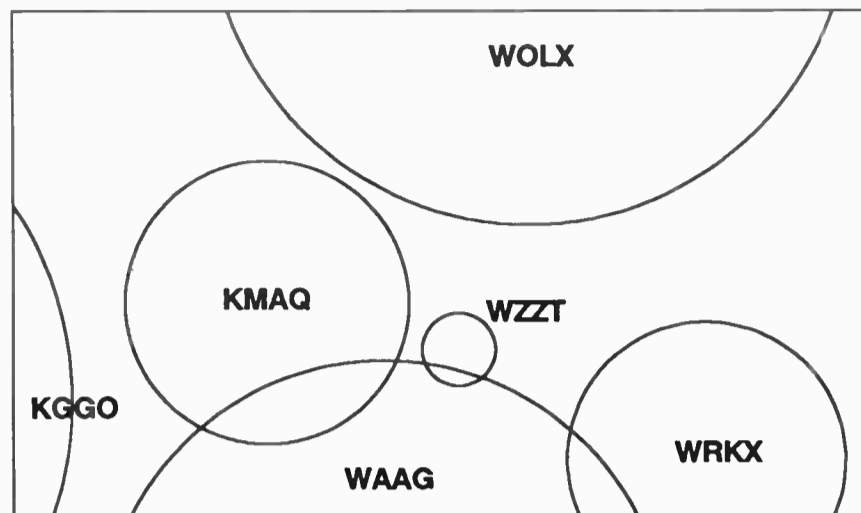

Enter latitude and longitude, and FMSTUDY will calculate distance, mileage, and FCC requirements, and graphically display stations.

Requirements: IBM AT, XT, PS/2 or compatible  
5-1/4" floppy drive  
Minimum CGA graphics card  
Will not work with Hercules Graphics  
EGA/VGA available. Specify when ordering

Regular  
\$29.95

Now **\$23.95**  
For limited time  
Add \$1.50 postage & handling

Mail to:  
BEAM Software  
3N460 Coulter Lane  
St. Charles, IL 60175

Allow 2-4 weeks for delivery

## If Your Only Excuse For Not Buying An ITC Cart Machine Has Been Money, You Just Ran Out Of Excuses.

Introducing the Series 1 cart machine from ITC. As the world's leading cart machine manufacturer, we understand how to make

a superior cart machine. And the new Series 1 cart machine is superior.

Equally as important, we realize each station has a different need and a different budget. That's why we designed the new Series 1 with all the



features you need at a realistic price.

Pound the buttons. Flip the switches, jam a cart in and yank it out a few



hundred thousand times. We've built the new Series 1 to take anything you can dish out, 24 hours a day, 365 days a year.

So before you

mortgage your program director or settle for something of less value than ITC, check out the new Series 1 today.

You won't need an excuse to buy one.

For more information and the names of the Series 1 dealers nearest you, call ITC toll free at 800-447-0414 or call collect at 309-828-1381 from Alaska and Illinois. Outside the USA, contact your local ITC distributor.



International Tapeconics Corporation... The World Leader in Cartridge Machines

SEE US AT NAB BOOTH #5422

## IGM Insta Cart Noise

By Tony Wortman - WJAG/KXEL  
Norfolk, Nebraska  
(402) 371-0780

Here at WJAG, we have a 1980's vintage IGM Insta Cart Model 12STK. Over the years, at intermittent times, this Insta Cart would develop a low level hiss on certain trays, when played on the air. IGM suggested that we had bad heads, and should send them in for replacement, which we did for several of the noisiest ones. When they came back, they were OK for a while then, from time to time, they would be noisy again. Usually cleaning them or using a different cart would help -- it seemed. Other trays also developed the same problem over time. However, cleaning or demagnetizing usually helped. This got to be very annoying and frustrating.

One day I decided to tear into this thing again. I took an ohm-meter, and checked the resistance from the head to ground. I found that all the noisy heads had a very high resistance. At first I thought it was the heads. However upon further investigation, I found that where the head assembly mounted into the body of the unit, the aluminum had oxidized with the other metal and caused the whole head assembly to have a high resistance connection. Moving the head assembly cleared up the problem.

My solution was to make a separate grounding strap that tied all of the assemblies to ground, and not depend on the original design. The machine sounds like a new one now.

## Optimod 8100 Oscillation Fix

By Keith Stokes - Interstate Communication  
Baton Rouge, Louisiana  
(504) 383-8695

Several years ago, the company I worked for, Patton Circuit Systems in Baton Rouge, Louisiana, was maintaining the local high school radio station. The station uses a CCA 2.5 kW transmitter, which originally had a narrowband grid tuning network. CCA had a recommended kit for modification to a more wideband network, which we installed. Over the next several days, we got complaints from listeners saying that we were appearing at three places on the dial. Sure enough, we found that this was true.

We discovered that the Optimod 8100 was producing a +/- 400 kHz signal on its output. We discovered it to be the output IC, the Analog Devices 518. We had a spare which we installed, and the oscillation promptly went away. The next day we called Orban, who immediately sent a replacement free of charge. We don't know how long the problem had existed, since before the modification to the grid circuit, the signal was not passed.

## Otari 5050B Popping Fix

By John Oelke - KSHE  
St. Louis, Missouri  
(314) 621-0095

Here is a fix for popping audio, if you do production on an Otari 5050B series, 8 or 4 track recorder. This noise is particularly annoying or noticeable when you have to punch in on a channel with no audio present. The cure is to replace the record relays.

Otari offers a replacement relay. The part number is RY2YC099. The original part number is RY2YC052. They are not too expensive (about \$4.00), but the job is not for beginners. The circuit board is double sided, and the spacing of the pins is that of an IC. If you know what you are into, the job is well worth the effort. You will need one relay for each channel. Otari's phone number is (415) 341-5900.

Page 16 February/March 1990

## FM Harmonic Low Pass Filters 500 - 50,000 Watts

Delivery: 30 Days (Faster For Your Emergencies)



7123  
500 Watts

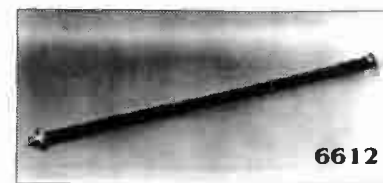

6612

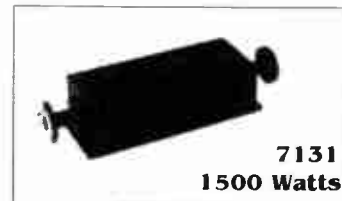

7131  
1500 Watts

Model #	Watts
6612	6,000
6516	15,000
7772	30,000
7455	50,000

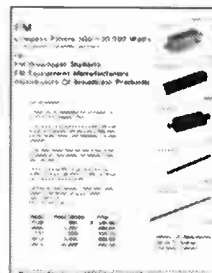

Bulletin #14

Full Details In Bulletin #14!

Also, request BTV/87 which describes TV/FM/MMDS Broadcast Filters & Combiners for service radio bands.

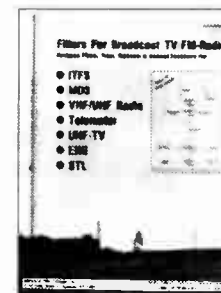

Catalog BTV/87

Need A Special Filter? Call Us Today!

"We make Filters In A Hurry For Customers In Trouble!"

Microwave Filter Company, Inc.  
6743 Kinne St. • E. Syracuse, NY 13057  
Toll Free(US/Can.): 1-800-448-1666 • Collect(NY/AK/HI): 315-437-3953  
FAX: 315-463-1467 • Telex: 249-613

## 125 REASONS TO CALL RADIO RESOURCES

...plus one we can't mention.\*

At Radio Resources, we're home to over 125 manufacturers of high quality equipment, supplies, accessories, and rental items. ■ For over 20 years, we've earned the business of thousands of broadcasters like yourself by providing exceptional service and competitive prices -- all delivered with a friendly touch.

\* And that other little reason... it's our ever-changing monthly special. Too outrageous to advertise -- you'll have to call each month for details. ■ So pick up the phone -- it's on our nickel!

WE'LL EARN YOUR BUSINESS

RADIO  
RESOURCES

1-800-54-RADIO  
in Maryland: (301) 859-1500  
24-Hour Fax: (301) 859-3042

7483 Candlewood Road  
Hanover, Maryland 21076



# A Weighty Telco Problem

By Rich Hann - Calhoun Communications  
Sioux Center, Iowa

A problem that I recently encountered involved a high level of 60 Hz hum on a station's 15 kHz equalized lines. The phone company measured the noise and was insistent that there was not a problem. As I observed the phone company people taking the measurements, I noticed that they were using a "C-message weighting" filter on the test set. I suggested that it was not appropriate to use that filter in this situation, and that the correct filter was the "15 kHz flat" filter. The problem with the "C-message filter" is the response is down more than 50 dB at 60 Hz, causing the measurements to practically ignore the 60 Hz hum.

I was unable to persuade the local phone company personnel that there was definitely a problem with both the line and their measurement procedure. Their reply was that it was necessary to use the "C-message" filter for all measurements.

After a number of calls, I managed to talk to someone sympathetic in one of the company's regional offices. He was able to educate the local people, and convinced them that corrective action was necessary. The section of the "Bell System Practices" that he referred them to, was Section 857-110-110, "Local Channel; Circuit: Control of Noise, Distortion, and Crosstalk."

# CD Magic Marker

By W. Grant Dozier - WVMG  
Cochran, Georgia  
(912)934-4548

Being a station in a small market, only a short time ago did we start using CDs on a regular basis. With several jocks inexperienced in the proper handling of the discs, we started experiencing scratches almost immediately. As we all know, a scratch on a disc can cause the player to "go crazy."

I have discovered that "covering" the scratch with an opaque "magic-marker," keeps the player's laser beam from scattering, thereby enabling the player to restore the missing data as it is programmed to do.

I would be interested in hearing from others who have the "scratched-disc" syndrome, and would like to know what solutions they have as an alternative to throwing the disc away.

## Blank Cassettes... Perfect for Demo Spots

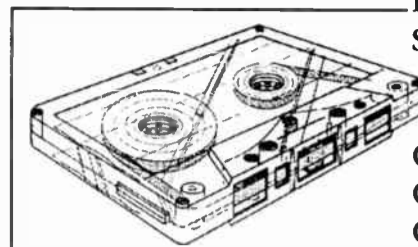

BASF Pure Chrome  
Shape Precision see-thru shell  
in quantities of:

	50	100
C-5's	\$.63 ea.	\$.55 ea.
C-10's	\$.69 ea.	\$.60 ea.
C-15's	\$.74 ea.	\$.65 ea.

Custom lengths are also available

BASF LHD Normal Bias  
Michelex German made shells  
in quantities of:

	50	100
C-5's	\$.49 ea.	\$.42 ea.
C-10's	\$.53 ea.	\$.46 ea.
C-15's	\$.58 ea.	\$.50 ea.



PHONE: (507) 288-7711

FAX: (507) 288-4531

Tom Jones Recording Studios  
220 South Broadway  
Rochester, Minnesota 55904

### Watch for the Radio Guide BBS

It's Radio  
It's Technical  
It's Toll-Free!

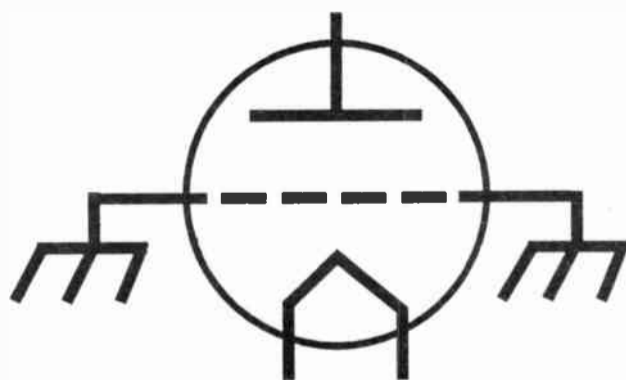

**CCA** ELECTRONICS, INC.

360 Bohannon Road/P.O. Box 426  
Fairburn, Georgia 30213  
Phone: (404) 964-3530 Fax: (404) 964-2222

## SMC Data-Cells (revisited)

By Donald L. Coleman - WBRK/WRCZ  
Pittsfield, Massachusetts  
(413) 442-1553

John Wittenmier is not alone in his problems with the non-available Sigma Data Cells, as used on older SMC automation gear. When I discovered that they were no longer available, I talked with SMC about a retrofit. Their reply was to spend a few thousand bucks for a new automation system.

I discovered that Magnecraft makes a fine solution. Their part # W301T1-12B1 is a 12 volt opto-isolator. I remove the metal cover on the Data Cell and removed the bulb and the photo-sensitive strips, saving just the header. Two of the Magnecraft units are then mounted on the header with their bulbs in series. The result is somewhat larger than the original, but I have found they will fit in any of the dozen or so locations in my equipment.

John must have smaller fingers than I do. I could not remove the original data cell bulb without damaging the photo strips.

I started making this conversion over a year ago and so far have not had one failure.

## Transmitter AC Power Contactor Problem

By Robert Denham - Cameron Communications

All transmitters have power relays or contactors for the various power supplies. On the Collins 21E/M they are mostly horizontally mounted and pose no problem, but on some older RCAs and Gates, as well as several models of the AM series Wilkinsons (we have a 10K-D), they are mounted vertically into wall-studded receiver nuts using three or four screws. If the relay is an open-point type (fully exposed) you probably are already making sure that the contacts are clean and the arm tension is OK.

Look carefully at the mounting screws. They are but a small insulator away from being a short circuit for the power supply they control. If all mounting screws do not have equal torque, then blower vibration can (and by Murphy's Law will) cause a screw to back out in time and expose the head to the power at the contacts, and shut you down. It's no big deal, until you find you ain't got a replacement. So next time into the juice box, take a set of screwdrivers.

Now here's the bad news. The design engineers think these babies are invincible and put them in the only place in the box that a circus contortionist can get to.

## Otari MX-5050 Brake Tip

By Jack Parker - WUBE-FM  
Cincinnati, Ohio  
(513) 621-6960

On the "Otari MX-5050 Tip" in the October issue, I've found that the brake drum in an MX-5050 has a matte finish which, with normal wear, will rub off on the brake band. This is evident by the dark deposits on the band. When a sufficient amount of this matte finish is rubbed off, it will result in binding, as noted by Greg Hahn of WKRA in Louisville.

The folks at Otari suggest that when brake bands require replacing, you should also replace the drums as well. The cost is very nominal (about \$20 for all four pieces), last time I did an MX-5050. Otari also suggests that you replace the little tensioning spring on the solenoid arm, also nominally priced at less than \$2 for two springs!

Look for us at the NAB  
Give us your ideas!

## LPTV Sideband Suppression Notch Filters & Video Aural Combiners

Reduce sideband radiated power & meet FCC transmitter standards.

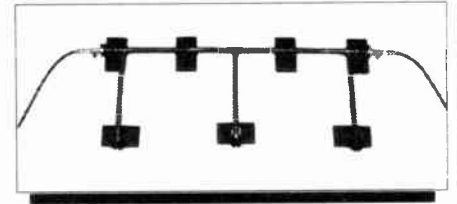

Full Details In Bulletin #15  
Ask For Our FREE Catalogs!

Request BTV/87 which describes TV/FM/MMDS Broadcast Filters and Combiners for service radio bands

Catalog BTV/87

Need A Special Filter? Call Us Today!

"We Make Filters In A Hurry For Customers In Trouble!"

Microwave Filter Co., Inc. • 6743 Kinne St. • E. Syracuse, NY 13057

Toll Free(US/Can.): 1-800-448-1666 • Collect(NY/AK/HI): 315-437-3953

FAX: 315-463-1467 • Telex: 249-613

## Don't Retire that Old Executive ... Retrofit!

With Broadcast Devices' field proven 10-minute retrofits you can make your old sturdy Harris Executive console perform like today's top of the line. These affordable retrofit electronics are modern plug-in replacements for the old technology mic preamps and line amps. They also will retrofit other Harris consoles including the Diplomat, President and Ambassador series. It makes good sense to retrofit -- you save thousands over the purchase of a new console and studio redesign, improve your sound and eliminate the maintenance headaches that cause embarrassing downtime. If you ever plan to sell your console, our retrofits can dramatically increase its resale value. Contact Broadcast Devices or your local broadcast distributor today for more details.

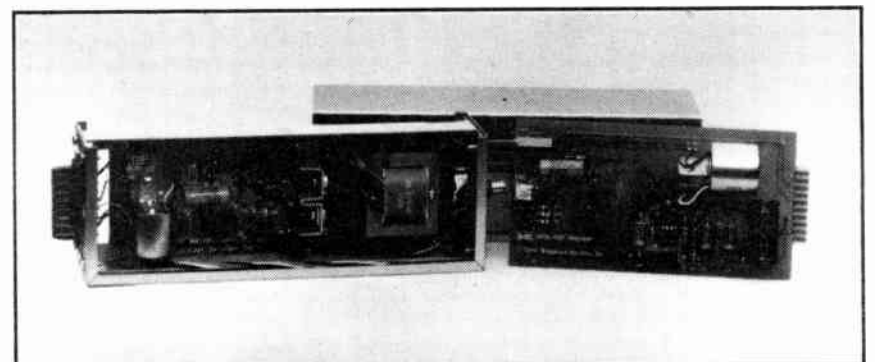

Suggested list prices: Line amp: \$360  
Mic Preamp: \$165

Coming soon: Retrofit modules for the Harris Stereo Statesman, Gateway II and Dualux II series consoles!

Affordable solutions for the broadcaster ...

5 Crestview Avenue Peekskill, NY 10566 (914) 737-5032

**bdi** Broadcast Devices, Inc.

# Win!

Come to our NAB Booth #8123  
for "Your Secret Combination"  
and a chance to WIN...

A Series 5000 set  
of Fine Studio Furniture  
from The Express Group.

Valued at over \$7000.

Or ...



(619) 298-2834



Equipment not included

**LIVE ASSISTANT.**  
The Ultimate Live-Assist  
Controller from Broadcast  
Automation Inc.

Valued at over \$2700.

**bai**

1 (800) 336-8004

Or ...

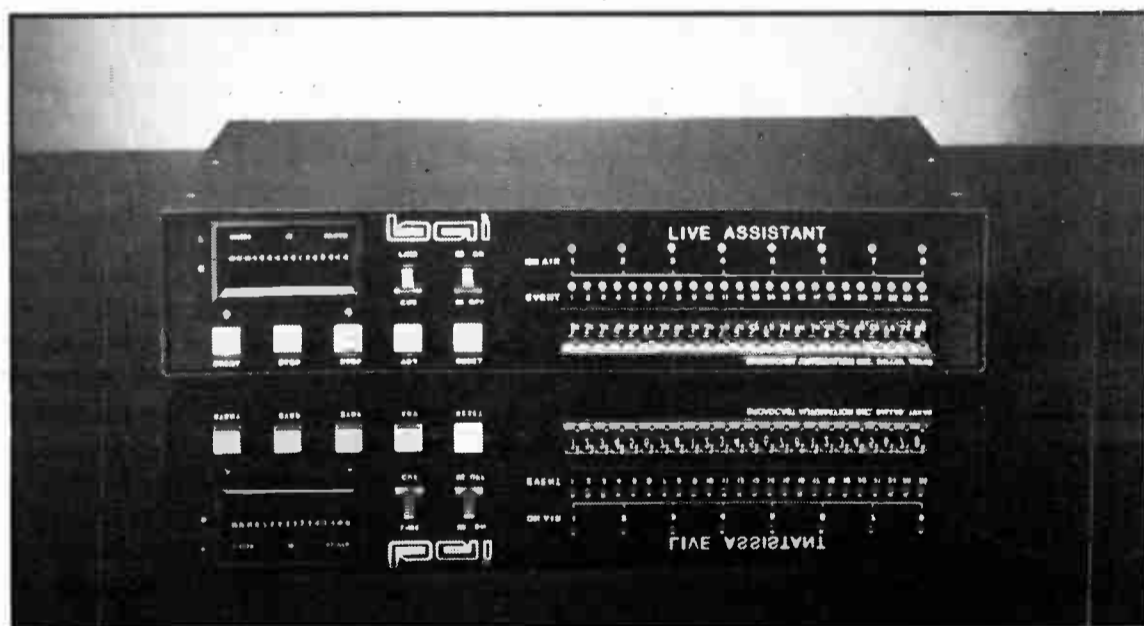

A chance to win one of four Sharp Pocket  
Auto Dialers which stores up to 400 phone numbers.  
Valued at \$100.

*Come to NAB Booth #8123 and ask for your  
Secret Combination — Open the Safe — and WIN*



# Equipment Guide

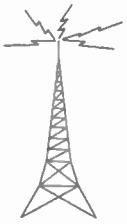

Equipment Guide - Box 7001 - Rochester, MN 55903 -or- Fax (507) 280-9143

## Here's Why We Do It

The **Equipment Guide** is published as the primary source for all of your used equipment needs - - buying or selling. Here's why **Equipment Guide** works:

**Equipment Guide** does not have ads that are ancient history.

**Equipment Guide** does not limit you to a fixed number of words to describe your gear.

**Equipment Guide** reaches the right people.

The **Equipment Guide** can only help you, if you help it. Use the Guide to place your classified ads.

Call us at (507) 280-9668, and let us know what you like (what you don't like), and give us your suggestions. They will be used!

You'll like the results you get in the **Equipment Guide**.

## Here's Where To Send It:

**Equipment Guide  
Box 7001  
Rochester, MN 55903  
Fax (507) 280-9143**

Name: \_\_\_\_\_

Station: \_\_\_\_\_

Address: \_\_\_\_\_

Address: \_\_\_\_\_

City: \_\_\_\_\_

State: \_\_\_\_\_

Zip: \_\_\_\_\_

Phone: \_\_\_\_\_

**Ad Copy Below:**  
(Use Extra Sheet of Paper if Needed)

---

---

---

---

---

---

---

---

---

---

---

---

---

---

---

---

---

---

---

---

---

---

---

---

## Fax It!

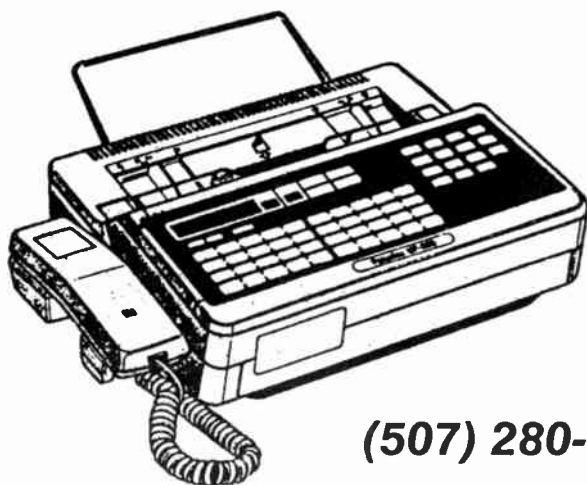

(507) 280-9143

## Here's What To Do:

**1** - Describe your used equipment, for sale or wanted, in as many words as you feel it takes to do the job.

**2** - Describe your help wanted or position wanted, again, in as many words as you feel you need.

**3** - Mail or Fax your list to Radio Guide -- we'll do the rest!

## Equipment Wanted

RF meters, used and tested

Sangamo mica transmitting capacitors, assorted sizes, large variety

**Dan's Discount Radio Parts**

Cavendish, VT  
802-226-7582

McMartin TBM-3500B baseband monitor with low-level input card. Tuned and tested to your FM frequency.

Electro-Impulse 25 kW dummy load. Air cooled, like new.

**Goodrich Enterprises**

11435 Maderson St.  
Omaha, NE 68164  
402-493-1886

Russco 505S Studio Master Console. 5 channels stereo, 4 built-in pre-amps, 5th channel accepts 5 inputs on push buttons. Cues any channel, modular pots, cue amp and speaker. Great specs, performance and dependability. Like new with custom wood cabinet, rack mountable. Only \$675.

**Rick Freeman**

WTRG  
3100 Smoketree Court  
Suite 709  
Raleigh, NC 27604  
919-876-1007

ERI #403 Iso-Coupler. Re-worked, in crate. You pay shipping and insurance. Works with 3kW FM and 5kW AM. \$500

Shafer GLS-7000 Automation System. Works with satellite programming. \$9995 as-is.

**Jerrone Hughey**

WIZK-FM/AM  
P.O. Box 548  
Bay Springs, MS 39422  
601-764-3209 (Home)  
601-729-8332  
601-764-3151

310' Andrew 7/8" LDF-50 coax cable with 1-5/8" end connectors.

2) Pioneer RT-707 reel decks with rack mounts.

**We Need Your Help  
Write for Radio Guide**

John Winquist  
WFPS  
P.O. Box 701  
Freeport, IL 61032  
815-235-7191

5) ITC 750 reel playback only reel decks with 25 Hz sensors. Working. \$250 each or \$1000 for all.

Teac A-3300SX-2T record/play reel deck. Looks great and works fine, with service manual. \$550

Collins 310Z-1 FM exciter on your frequency. Clean. \$1100

3-phase plate transformer and choke. From Gates FM-3H3. No shorts, clean. \$475 + shipping.

**Kirk Harnack**

Harnack Engineering  
1385 Lamar Ave.  
Suite 5  
Memphis, TN 38104  
800-366-7618

### SMC Automation System Includes:

RP-1000 brain  
DS-20 digital switcher  
PDC-3A clock/flagger  
TS-25 tone sensors  
Remote control  
Battery backup  
4) SMC 350RS Carousels  
4) Otari ARS-1000DC reel decks  
4) BE auto rewind units  
Cables, manuals, some spare parts  
Complete system offers long walk-away time. Complete system \$13,000.

Gentner VRC-1000. Fail safe, command relay, cable accessory, cables, manuals. Less than one year old. \$3400

Ramko ACL25IE cart rewinder. \$200  
Harris Stereo 5 production board, in use. \$500

**Eric Nichols**

KMCR-FM  
405 East Norman  
Montgomery City, MO 63361  
314-564-2275

320' used 1-5/8" Cablewave pressurized transmission line. There are some dinks and two holes in it, however, 200' is in fine condition. Cable is on a spool and in an easily accessible location. Also has two 1-5/8" connectors. \$800 + freight.

**David S. Rozek**

WSPK  
475 South Ave.  
Beacon, NY 12508  
914-831-8000 or 914-462-5800

# TRANSCOM CORP.

Fine used AM & FM Transmitters  
and also New Equipment

For the best deals on Celwave products  
Andrew cable,  
Shively & Comark antennas.

1980	CCA FM-28,500	28.5 kW FM
1980	Harris FM-20K	20 kW FM
1976	RCA BTF-20E1	20 kW FM
1978	Collins 828E1	5 kW AM
1984	McMartin 3.5K	3.5kW FM
1976	CCA AM-50,000D	50 kW AM
1974	RCA BTA-5L	5kW AM
1972	Harris BC10-H	10Kw AM

201 Old York Rd.  
York Plaza Suite 207  
Jenkintown, PA 19046  
215-884-0888

Telex No. 910-240-3856 (TRANSCOM CORP. UQ)  
Fax No.. 215-884-0738

Cetec 2-bay FM antenna. Power gain 1, frequency 95.9 mHz, true circular polarization.

2) Radomes designed to fit the above antenna. Antenna and radomes only 6 years old. Replaced due to power increase.

**Henry Beam**

WAEY-AM/FM  
P.O. Box 5588  
#1 Radio Lane  
Princeton, WV 24740  
304-425-2151

Pioneer RT-1011L reel deck. Will handle 10" reels, good condition. \$250 firm.

**Brian Pitts**

WZPQ  
P.O. Box 622  
407 9th Ave.  
Jasper, AL 35501  
205-384-3462 (Work)  
205-487-6400 (Home)

1978 Collins 831D-2 2 kW with 310Z-2 exciter and 67 kHz SCA generator. This is a cream puff. Now on 101.7 kHz. \$7500

1897 CSI 3 kW T-3-F. Clean as a pin and ready to go. Now on 100.5 mHz. \$10,500

All units in good condition and prices are firm.

**J. Boyd Ingram**

WBLE-FM  
P.O. Box 73  
Batesville, MS 38606  
601-563-4664 (Phone)  
601-563-9002 (Fax)

Phelps Dodge 2-bay CP antenna on 100.3 mHz. 10 years old, good shape. \$1000

Executone Equity telephone system. 2 KSU, 20+ phones, worked well when removed from service. Music on hold card, other features. \$1000 or offer.

**Alan P. McCarthy**

KVIC-FM  
600 E. Main Street Suite K  
Vacaville, CA 95688  
707-446-0200

RCA BTA-5F AM transmitter.

**Terry Vels**

KTFI  
P.O. Box 2820  
Highway 30 West  
Twin Falls, ID 83303  
208-733-3381

(continued on page-22)

CRL APP-300A Audio Preparation Processor  
CRL SEP-400 Spectral Energy Processor  
PMC-300A Peak Modulation Controller  
All three units in great working order, with manuals. \$1200

Dan Pregnar - WWDL  
1049 North Sekol Rd.  
Scranton, PA 18504  
717-344-1221

Eventide H-969 Harmonizer, like new. Best offer over \$1000 takes it.

Bill Glasser  
WHBC  
550 Market Ave. South  
Canton, OH 44702  
216-456-7166

**Transmitters For Sale:**  
1977 McMartin 25 kW FM  
1964 RCA 10 kW FM  
1977 Harris 2.5 kW FM  
1967 RCA 1 kW FM

Weather radar for sale.

Chuck Porter  
WCAZ  
P.O. Box 498  
84 South Madison  
Carthage, IL 62321  
217-357-2107

**AT&T Merlin 820 Telephone System:**

1) 820 control unit, fully carded with music on hold and paging.  
1) 34B deluxe attendant console with busy lamp field.

Purchased for expansion, but never installed. Still in box, programming manual included. \$1550

Stan Scharch  
WISC-TV  
2321 Whitlock Rd.  
Madison, WI 53719  
608-271-4321 Mon-Thur, 8 a.m. to 5 p.m. CST

Audi-Cord 132R network delay recorder.  
Gates Solid Statesman AM limiter (994-6543-001).  
2) Harris Solidstatesman FM limiters black face) (994-6631-006).  
Harris Solidstatesman FM limiter (grey face) (994-6631-006).  
Harris ME-1 modulation enhancer (AM mono) (994-7757-001).  
Gates "Cartridge Tape II" stereo cart recorder/playback machine (M6214F).  
Page-22 February/March 1990

2) Gates stereo playback cart machines (M6212C).

"Maze" R1 rack mounted reverb.

**Automation System:**

2) SMC 352 stereo Carousels  
2) SMC RCS-50 random controllers  
SMC AS-16 switcher  
SMC SSP-3060 programmer  
SMC LA-2465 stereo line amp  
SMC PDC-3 clock  
SMC PSA-230 power supply  
SMC 772 dual play stereo cart deck  
2) TS-25 tone sensors  
SMC RC-10 remote controller w/40' cable  
2) ITC 250 stereo reel decks  
Revox A77 reel deck  
Otari ARS-1000 reel deck  
3) SMC green equipment racks  
Prefer to sell as a system. Taken off the air around Oct/Nov 1989. Good for satellite interface. All equipment operational.

Bill Hopkins  
KAYZ/KELD  
2525 Northwest Ave.  
Eldorado Park, AR 71730  
501-863-6126

CRL AM4M audio processing system. 2 years old with NRSC built in. \$3500  
ITC 831-0002 mono playback card. \$20  
Straight Wire Audio UA-1. \$50  
Straight Wire Audio L+R/L-R matrix. \$40

Mark Persons  
218-829-1326 (Phone)  
218-829-2026 (Fax)

300' AM tower removed from service because of site change. 1/4" angle-iron construction. On the ground in 20-foot sections, ready for shipping. Guy wires, beacon and two sets of side lights, flasher and photo cell, base insulator, and two lighting chokes included. \$5000 or best offer.

Jampro JCP FM elements with heaters, tuned for 107.3 MHz, manufactured in 1968. Have three for sale, stored inside for past 3 years. Connecting cables without power divider. \$1500 for all or best offer.

Rick Shroyer or Todd Clark  
KMWX Radio  
P.O. Box 1460  
Yakima, WA 98907  
509-248-1460

2) Gates RDC-10 remote controls. \$50 each.  
Harris AM-80 remote panel. \$10

# 87 - AM & FM Transmitters

We Have

All Powers  
All Manufacturers  
All In Stock  
All Spares  
All Instruction Books  
All Complete

Besco Internacional  
5946 Club Oaks Drive  
Dallas, TX 75248

Contact Robert Malany

Phone (214) 630-3600  
Fax (214) 226-9416

**World Leader in AM & FM Transmitters**

Gates GTM-88F frequency monitor. \$25

2) Extel AF-11 printers. \$50 each.

ITC 850 mono reel recorder. \$100

ITC 850 stereo reel recorder (for parts). \$50

Teac A7030 reel recorder. \$50

Pioneer RT-701 reel recorder (needs heads). \$50

2) Collins 12-inch turntables. \$20 each.

Mark Persons  
218-829-1326 (Phone)  
216-829-2026 (Fax)

Wang 2200VP Computer. Complete as used with CBSI software. Includes CPU unit, CRT/keyboard, 2) 8-inch floppy drives, deck. CPU unit needs on new regulator transistor, otherwise like new. Make offer.

Teletype Model 40 300 line printer, in Local Data Quiet 300 cabinet. used with above, fast, battleship rugged, looks and works like new. Make offer.

3) Ampex AG-440 stereo decks. Very clean, working, good heads. Two channel with Ampex electronics. \$750 each or best offer.

Ampex AG-440 2-track stereo playback-only with Shafer electronics. \$600 or best offer.

About 25 brand new ribbons for Texas Instruments 850/855 printer. \$60 or best offer.

Howe Phase Chaser. Model just before current one, like new condition. \$500

Heath 10-104 15 MHz oscilloscope.

\$200

McMartin AM-25 noise meter, works well. \$50

Glen Barnett  
KWCY Radio  
Broadcast Centre  
Palm Springs, CA 92263  
619-328-1104

ITC Premium line single play cart deck (mono).

Sono-Mag stereo play cart deck.

Spotmaster mono play cart deck.

TFT remote control.

Jerrold field strength meter (up to 220 MHz).

Shure tone arm with cartridge (new).

GE 200 watt UHF amplifier (cont. duty).

2) Paso 200 speakers (on wheels) with Kenwood amp.

2) Technics turntables with dust covers.

Best offer buys all items listed. My wife says it has to go!

Martin Hensley  
1506 S. Parker Drive  
Evansville, IN 47714  
812-479-5741

Utility C1983 347' tower, standing. \$10,000

Barcus Berry processor, used 6 months. \$300

MCI RCR-9 remote control. \$1500  
 Orban 111 dual reverb. \$300  
 dBx 163 compressor limiter. \$200  
 3-Inch to 1-inch reducer for solid line, with gas hookups. Has EIA flanges and bullets. \$200  
 Gates Stereo "Yard" tube type console. 8 channels, removed from service this year. \$500  
 Gateway tube type console. Condition unknown, in storage. \$200  
 2) Background music play decks. \$150 each.  
 3) Revox 99-B stereo playback decks. \$700 each.  
 1000) Grey Fidelipac carts. 50 cents each for the lot, or 75 cents each split.  
 300) Scotchcarts with Country hits last 2 years. Various lengths, \$3.50 each or \$3.00 each for lot.  
 Best offer on any item!

Roger K. Bennett, CE  
 KJLO Radio  
 Box 4808  
 Monroe, LA 71211  
 318-388-2323

Collins Model 642E-2 stereo twin-tape cart machine parts. Lots of spare PC boards for player and recorder also, plus relays, switches, spare power supply module, etc., etc. Make and offer.

Hank Landsberg  
 Henry Engineering  
 503 Key Vista Drive  
 Sierra Madre, CA 91024  
 818-355-3656 (Phone)  
 818-355-0077 (Fax)

**Complete Automation System for Satellite:**

Sentry Brain  
 1) IGM Instacart  
 1) SMC 352 Carousel  
 6-foot equipment rack  
 IBM clone computer  
 Total asking price, including shipping is only \$12,500.  
 System used for only one year. Station upgraded to another automation system. This one is still in operation until 3/15/90.

Jerry Webb  
 KGLX-FM  
 219 W. Aztec  
 Gallup, NM 87301  
 505-863-9391

Moseley PCL-505/C STL system on 951.5 MHz. \$2500

WYRQ Radio  
 Little Falls, MN  
 Contact: Mark Persons  
 218-829-1326 (Phone)  
 218-829-2026 (Fax)

Epson LX-800 printer  
 Epson LQ-1000 printer  
 2) Wegner 1601 shelves  
 Wegner 2046-03 card  
 Wegner 1644-03 card  
 2) Wegner 1610 cards  
 Wegner 1606-01 card  
 Wegner 1605-12 card  
 Wegner 1605-3 card  
 Satecue 400  
 Ellason weather radar with remote controls  
 ITC 850 full track reel deck  
 ITC 850 2-track reel deck

Greg Kern  
 WDGY  
 611 Frontenac Place  
 St. Paul, MN 55104  
 612-642-5211

Schafer 903E Automation For Sale. 19 sources plus RAS and RAS manual control, cables, program console, and rack. Less memory, as-is for \$2000 or best offer.

Bill Glen  
 KOTY/KTCR  
 11 South Benton St.  
 Kennewick, WA 99336  
 509-586-4165

**IGM Automation System:**

5) Revox PR-99 playback decks  
 1) Audicord Network Delay cart machine  
 3) Audicord "A" mono cart playbacks  
 4) IGM Go-Kart 24 Carousels. Mono, but only needs stereo head.  
 IGM system A control unit with logging.  
 Will sell as a unit or any part. Unit was on air until December 1989. Would be "overkill" but could be used to insert local programming in a satellite format.

Chuck Gustafson  
 WKZO  
 590 West Maple St.  
 Kalamazoo, MI 49008  
 616-345-2101

M/A-Com VR3-X satellite receiver mainframe with onboard down-converter, IF Amp board, demod board, audio demod board on 5.01 MHz. Excellent condition, transponder agile. \$500

Robert Jones J316/J319 FM translator and dual RF amp. Input channel 296, output channel 288. \$2600

2) Gonset 3111 fixed frequency communicators with microphones, on 152.87 MHz AM. \$75

Gonset VHF power amplifier with two 804s. \$125

Heathkit HW-16 80/40/15 meter Ham CW transceiver with matching VFO and copy of manual. Needs some work. \$100

2) Bruel & Kjaer deviation bridges, type 1506, 100 kHz. One has cracked meter glass. \$50

Robin  
 KORE-AM  
 2080 Laura  
 Springfield, OR 97477  
 508-747-5673

Ramsa WR-130 portable studio mixer. Offer

Tapecaster 700P. AS-is. \$50

MCI 9-channel digital remote control. Offer.

MCI 450 kHz TSL. Offer.

ITC Premium R/P stereo. Mint condition. \$1700

Gates battery/AC remote amp. \$100

Revox remote control for A77. \$25

Heathkit microphone mixer. \$40

2) 8kW RF relays, 24VDC, new. \$100

Sparta cart machine, as-is. \$25

1-5/8" 10kW relay, EIA flange. \$200

SMC random access. \$250

2) Regency VHF radios, as-is. \$50 each.

4) Repeat coils. \$75 each.

Regency scanner. \$50

Shure M62V Level-Loc. New. \$75

Dictaphone logger system, 2 decks. \$600

McMartin TBM-3500 mod monitor, tube type. \$50

2) ERI 2-bay antennas. Installed 1985. Offer.

5-line key system speakerphone. \$100

6) Andrew 1-5/8 to "N" connectors. \$100 each.

Ampro 8-channel console, clean. Offer.

Regency UHF radio. As-is. \$50

5) VU meters. WE, Simpson, etc. \$25 each

20) Andrew 7/8" hanger kits. 1/2 price.

Microtrac 4-pot stereo board, new. \$500

CBS Volumax. Cover missing. \$75

Belar RFA-1 RF Amp. \$200

BE 8-channel mono board with aud/pgm. Offer.

McKay DA-9 Base. Offer

McKay DL-4 Head. Offer.

Revox PR-99 play-only. Offer.

5) Patch bays. \$25 each.

Bogen sound system w/2 Bell speakers. \$200

Martl MRA950 pre-amp. \$100

CRL AC400. New in 1988. Offer.

4) Sola constant voltage transformers. \$50 each.

ATI phono pre-amp. \$175

Sanyo cassette R/P with 19" rack ears. \$50

Jim Phillips  
 WZOM  
 408-1/2 Clinton  
 Defiance, OH 43512  
 419-782-8591

**Equipment Wanted**

Wanted: Orban 8000As and 8100s.  
 ITC Cart decks of all types.

Hall Electronics  
 John Hall  
 1712 Allied Street  
 Charlottesville, VA 22901  
 804-977-1100

Wanted: Dead or alive. Pultec EQs; Fairchild & Teletronix limiters; Neumann, Telefunken, AKG, RCA, and Scheps microphones. Tube Macintosh or Marantz amps and pre-amps. Sontec, ITI, and Lang EQs. Neve or API equipment. Boxes of old tubes. UREI, Orban, United audio, dBx, and other outboard gear. Ampex ATR-102 or 104. Parts for MCI JH-110/114 recorders. Altec 604s/crossovers/Tannoy speakers. JBL 2231; Altec 288-H driver; misc. equipment of all types.

Please call Dan Alexander  
 2944 San Pablo Ave.  
 Berkley, CA 94702  
 415-644-2363  
 Fax 415-644-1848

Wanted: 5-tower, 1kW phasor cabinet with tuning components. Any frequency OK, good condition, no junk please.

Tom McGinley  
 WPCG  
 6301 Ivy Lane  
 Suite 800  
 Greenbelt, MD 20770  
 301-441-3500



**Wanted: 10 kW power amp cabinet** from Collins 830F transmitter. Will buy entire transmitter if reasonable.

**J. Boyd Ingram**  
Broadcast Consultants  
P.O. Box 73  
Batesville, MS 38606  
601-563-4664 (Phone)  
601-563-9002 (Fax)

**Wanted: Surplus roller inductors** (amateur size), crystals, variable caps, other amateur radio type surplus gear.

**Robin**  
KORE-AM  
2080 Laura  
Springfield, OR 97477  
508-747-5673

**Wanted: 5kW Gates or Harris transmitters.**

**Chuck Porter**  
WCAZ  
P.O. Box 498  
84 South Madison  
Cathage, IL 62321  
217-357-2170

**Wanted: McMartin B-910 older FM exciter or any transmitter.**

**Goodrich Enterprises Inc.**  
11435 Manderson St.  
Omaha, NE 68164  
403-493-1886

**Wanted: Used to new Scotch I & II cartridges.** At least in repairable condition. Will have number of Audio-pac carts for sale.

**Clark Legg**  
KIUL/KWKR  
Box 878  
308 N. 7th St.  
Garden City, KS 67846  
316-276-3251 (Phone)  
316-276-3649 (Fax)

**Wanted: 30 kW recent vintage transmitter.** Prefer BE, Continental or Harris.  
**Wanted: 6-foot STL dishes.**

**KMSD Radio**  
Milbank, SD  
Contact: Mark Persons  
402 Buffalo Hills Lane  
Brainerd, MN 56401  
218-829-1326 (Fax) 218-829-2026

**Wanted: Gaetsway (tube) consoles** to purchase. Prefer in the South. Also looking for Sparta Century cart machines, mono preferred. Have stuff to trade.

**Bob Mayben**  
Power 93 WKQD  
137 McMurtrie Ln.  
Huntsville, AL 35806  
205-721-9393

**Wanted: RCA BK-10 Unlaxial microphone,** any condition. Will trade RCA 44 or 77 for same or cash paid.

**James U. Steele**  
WKBX-FM  
P.O. Box 2525  
20 N. Grove Blvd.  
Kingsland, GA 31548  
912-729-6106

**Wanted: Used but working satellite receiving equipment** for Satcom 1R.

**Brad Fuhr - WLTO-FM**  
P.O. Box 499  
Harbor Spring, MI 49740  
616-526-9604

**Wanted: UMC Beaucart decks.** Blue surface only.

**R. Divens**  
KYBS-FM  
302 W. Cauender  
Livingston, MT 59047  
406-222-6890

**Wanted: 7-1/2 kHz audio decoder card** for Scientific Atlanta 7325 digital processing unit (ABC Radio Network).

**Mike Ripley**  
KOZE-AM/FM  
P.O. Box 936  
Lewiston, ID 83501  
208-743-2502

**Wanted: To buy test equipment.**  
Potomac FIM-71 field strength meter  
Potomac SD-31  
Delta OIB-3  
Spectrum analyzer  
Also all operable test equipment.

**Bob Schneider**  
Broadcast Technical Services  
P.O. Box 64501  
Lubbock, TX 79464  
806-798-2601

# FM BROADCASTERS!!

## We can meet all your FM transmitter needs!!



### SOLID STATE - LOW POWER

Amplifiers and transmitters are available at the popular levels of 30W, 100W, 300W, 500W, and 1KW. All units are solid state, broadband, and designed for both local and remote operation.



### ONE AND TWO TUBE HIGH POWER

Medium transmitters with broadband solid state drivers and one zero bias grounded grid triode in their PA are available at 1.5KW, 3.5KW, 5.5KW, 7.5KW, and 12KW. Higher power transmitter utilizing two grounded grid triodes (one as a driver) are available at standard outputs of 15KW, 22KW, 25KW, 30KW, 40KW, and 50KW.



## Energy-Onix

752 Warren Street Hudson, New York 12534

(518) 828-1690 FAX (518) 828-8476

*A Wise Enterprise*

**Wanted: Christian station needs** Southern Gospel records to build library. Can give tax deduction for gifts. Will pay shipping and even small price for good albums.

**Jim Baggett - WWLK**  
P.O. Box 90  
Eddyville, KY 42038  
502-388-9726

**Wanted: 7.5 kHz audio card** for Scientific Atlanta digital receiver.

**Bob Reece - WHOU**  
North Road  
Houlton, ME 04730  
207-532-6587

**Wanted: AE, or similar, telephone dial** to fit in Moseley WRC-10 stepper remote control studio unit.

**Supplement chart for PACO T-60 tube tester** or test settings of same for type 807 tube. It has the socket.

**Correct type # rectifier tube** for Weston Model 777 type 7A ser #1317 tube tester. Has an octal socket with a 5Y3 but is too generous on emission test. Older Westons used a 4-pin type # 01-A.

**S. Marshall - WDME-AM/FM**  
P.O. Box 357  
Gulford Rd.  
Dover-Foxcroft, ME 04426  
207-564-2642

**Wanted: Tapecaster 700RP** with factory modification for delay. Can use any tape or electronic system that will give a delay for talk show use.

**Need any used console.**

**Genliss Foundation**  
201-704-0499  
201-359-5300

**Wanted: Professional disc recording equipment.** Presto, Rek-O-Kut, Scully, Fairchild. One good unit for cutting '45s.' Accessories, manuals, blank discs (such as thermo-stylus kits, chip chasers, lead screws, cutting heads, etc.). I also buy 50s records in quantity, old juke-boxes and coke machines.

**Kim Gutzke**  
7134 15th Ave. S.  
Minneapolis, MN 55423  
612-866-6183

**This is the place!**

**Your equipment will sell!**  
Your list seen by over  
10,000 engineers.

**It's Free . . .**  
**It Works!**



## Broadcast and Media Related Computer Bulletin Boards

### Second opinion BBS

24-hours  
300/1200/2400/9600 baud - 8/N/1  
SBE Chapter 28 news and files  
414-771-3032

### The Communications Exchange

24-hours  
300/1200/2400/9600 baud  
SBE Chapter 24 news and files  
608-274-7776

### Allied/RW Broadcast BBS

300/1200/2400/ baud - 8/N/1  
Basic programs and ASCII files  
317-935-0531

### AV-Sync

24-hours  
1200/2400/9600 baud - 8/N/1  
Broadcast, recording, engineering files  
404-320-6202

### Broadcasting Computer Database

24-hours  
300/1200/2400/9600  
19,200 Baud Hayes/HST  
Broadcast, Engineering, Ham radio,  
MediaNET, On line database  
713-937-9097

### Network Communication System Bdcst BBS

300/1200 baud  
Technical tips and schematic graphics  
601-373-0160

### Flamethrower Broadcast Resource Center

24-hours  
300/1200/2400/ baud - 8/N/1  
Broadcast engineering and Ham radio  
804-550-3338

### ICEWEB

24-hours  
300/1200 baud  
CATV and engineering files and msg. base  
608-274-8601

### Broadcasters BBS

24-hours  
1200/2400 baud  
Broadcast and media files and msg. base  
804-973-8235

### Western Washington Frequency Coordi- nation

24-hours  
300/1200/2400 baud  
WWFCC coordination pgm. and data files  
206-443-6170

### Broadcasters Link

24-hours  
Announcer/programming orientation  
919-739-6150

### SBE Chapter 22 (Central New York)

24-hours  
300/1200/2400 baud  
315-457-5070

### Ambersoft

24-hours  
300/1200/2400 baud  
Engineering and programming  
219-256-2255

### KTOL Radio Point

24-hours  
300/1200/2400 baud  
206-459-4689

### The Rock Board

24-hours  
300/1200 baud  
Music orientation  
201-857-8880

### Olympia Broadcasting Networks

24-hours  
1200/2400 baud - 8/N/1  
Fro Olympia affiliates  
314-361-6688

### DFW Frequency Coordination

24-hours  
300/1200/2400/9600 HST  
SBE Chapter 67 frequency coordination  
and general broadcast engineering  
214-647-0670

### Colorado Broadcasters

24-hours  
Denver SBE Chapter materials and  
Colorado frequency coordination  
303-341-0129

### Northern California FCC

24-hours  
300/1200/2400 baud  
San Francisco area frequency coordination  
FidoNet 1:125/777  
415-391-2657

### Broadcasters BBS

24-hours  
300/1200/2400 baud  
Wide ranging broadcast topics  
602-872-9148

### Trillion

24-hours  
300/1200/2400 baud  
Broadcast engineering topics  
616-530-0821

### Videopro

24-hours  
300/1200/2400 baud  
Production concerns  
703-455-1873

### Chapter 75 SBE

24-hours  
300/1200/2400 baud  
Little Rock Chapter  
501-753-6536

### Visions Infoline

General media  
201-769-1779

### Gannett HelpScreen

USA Today  
201-525-3982

### Rock and Roll Party

Broadcasters  
404-982-0960

### Broadcasters Forum

Broadcast info  
602-395-9978

### So. California Media Line

Broadcast  
619-454-1629

### Programmers Retreat

209-526-9987

### Colorado Springs Broadcast BBS

New BBS on line  
719-471-9600

### Black Hole BBS

9600 Baud (HST)  
419-228-7236  
Fidonet 1:234/16  
Amateur radio, Radio & TV engineering.

### CRL Customer Service BBS

602-438-0459

Call Radio Guide at

(507) 280-9668

Place Your Board Here

## Contract Engineers

Tom Becker  
Miami, Florida  
305-775-1351

Peter C.L. Boyce  
Midamerica Electronics Svc.  
New Albany, Indiana  
812-945-1209

James Boyd  
Boyd Broadcast Tech. Svc.  
Tualatin, Oregon  
503-692-6074

Mike Brown  
Portland, Oregon  
503-245-4889

Lee Freshwater  
Blue Ridge Consultants  
Flat Rock, North Carolina  
704-693-1642

Chuck Gennaro  
Wisconsin Rapids, Wisconsin  
715-423-6763

Kirk Harnack  
Memphis, Tennessee  
901-278-1306

Richard A. Hyatt  
Maine Engineering Assoc.  
Gardiner, Maine  
207-582-4192

John Morton  
Durango, Colorado  
303-247-8734

Don Musell  
Broadcast Engineering Svc.  
Mouth of Wilson, Virginia  
703-579-4461

Mark Pallock  
Marandee Broadcast Eng.  
Chatsworth, California  
818-882-9475

Ransom Y. Place III  
Westport, Massachusetts  
508-673-6831

John Ramsey  
West Hartford, Connecticut  
203-243-4703

Lee Soroca  
Soroca Electronics  
Syracuse, New York  
315-446-6106

Tom Toenjes  
Signal Specialists  
St. Marys, Kansas  
913-437-6549

Dave Wrenn  
Aiken, South Carolina  
803-649-1663

Brad Johnson  
Central California  
209-526-6277

Scott Dean  
Dean Engineering  
Fresno, California  
209-434-2358

Gary Smith  
Advanced Technical Svc.  
Abilene, Texas  
915-672-5149

James A. Chase  
Electro-Labs  
Angola, Indiana  
219-665-6427

Gary Reardon  
Ware, Massachusetts  
413-967-6156

James Droegge  
Electronic Engineering Svc.  
Beatrice, Nebraska  
402-228-0780

Michelle Hunt  
Denver, Colorado  
303-469-1293

Tim Pozar  
Broadcast Engineering Cons.  
San Francisco, California  
415-695-7727

Mark Bohach  
Columbus, Ohio  
614-385-7583

Bob Ladd  
Bellevue, Ohio  
419-483-2511

Dave Hebert  
Pasco, Washington  
509-545-9672

Dave Biondi  
The Radio Service Company  
Houston, Texas  
800-444-2301

Bud Stuart  
STURADCO  
Susanville, California  
916-257-7820

Ronald J. Dot'o Sr.  
Salem, Oregon  
503-378-7024

John L. Nix  
Tower & ground systems  
Salem, Oregon  
800-321-4056

Steve Agnew  
Broadcast Technical Svc.  
Lincoln, Nebraska  
402-475-8920

Marsh Johnson Sr.  
Broadcast Operational Sys.  
Albany, Oregon  
503-928-8318

Carl Sampieri  
Sampieri Engineering  
Huntsville, Alabama  
205-830-8300

Don Roden  
Roden Engineering  
Huntsville, Alabama  
205-533-3676

Don Haworth  
Haworth Engineering  
Fargo, North Dakota  
701-237-5346

Jim Taylor  
Jim Taylor Engineering Svc.  
Augusta, Georgia  
404-738-2911

Mike Tosch  
Interstellar Broadcast Eng.  
San Diego, California  
619-576-8239

Jeff Twilley  
Ocean City, Maryland  
301-289-4545

Howard M. Ginsberg  
Communications Eng. Inc.  
Essex Junction, Vermont  
802-878-8796

Donald Frank White  
Roanoke Rapids, No. Carolina  
919-535-2599

Adam Perry  
S&B Communications Inc.  
Buffalo, New York  
716-832-7090

Thomas C. Taylor  
Total Communications Tech.  
Old Fort, North Carolina  
704-668-7977

Roger Cucci  
Techworks  
Milford, Connecticut  
203-878-3196

Harold Snure  
Calvmet Business Comm.  
Merrillville, Indiana  
219-769-4044

(continued on page-26)

## Contract Engineers

Dwayne Burlison & Assoc.  
Houston, Texas  
713-890-6565

Rick Cruz  
Mount Vernon, Ohio  
614-397-6440

Mark Persons  
M.W. Persons & Associates  
Brainerd, Minnesota  
218-829-1326

Hal Ross  
Air Com Communications  
Greenville, Pennsylvania  
412-588-8999

Russell Hines  
Cincinnati, Ohio  
513-721-7625

Jim Zastrow  
Zastrow Technical Service  
Mosinee, Wisconsin  
715-693-4299

Steve Holderby  
Bemco Inc.  
Enid, Oklahoma  
405-242-7605

ACM Communications  
Napa, California  
707-257-6000

R. Michael King  
Circuit Doctors  
Frisco, Colorado  
303-668-3167

Joe Bellis  
RMF Associates  
Cape Girardeau, Missouri  
314-651-4272

Brian Walker  
Olympia, Washington  
206-438-2390

Jay Brentlinger  
Broadcast Engineering Inc.  
Phoenix, Arizona  
602-867-0181

Ken Bartz  
Bartz Engineering Services  
Fargo, North Dakota  
701-237-3006

Greg Blanchard  
Avila Engineering  
San Luis Obispo, California  
805-473-2396

J. Boyd Ingram  
J. Boyd Ingram & Associates  
Batesville, Mississippi  
601-563-4664

Troy D. Spencer  
Bassett, Virginia  
703-629-1161

Tom Oja  
ACM Communications  
Napa, California  
707-257-6000  
800-354-8600 (CA only)

Tom Lange  
TECS Electronics  
Kohler, Wisconsin  
414-458-1816

Lamar Ritchie  
Lamarco Inc.  
Hazard, Kentucky  
606-476-8438

Steve Weber Jr.  
Fresno, California  
209-276-1249

John Simmons  
Simmons Communications  
Columbus, Georgia  
404-596-0265

Jim Slawson  
Broadcast Engineering  
Swainsboro, Georgia  
912-237-2011

Bill Bowin  
Bowin Engineering Services  
Galion, Ohio  
419-468-1771

Chris Scott & Associates  
Bowling Green, Kentucky  
502-781-1232

Michael G. McCarthy  
McCarthy Radio Engineering  
Mount Prospect, Illinois  
708-640-8965

J.R. Galbreath  
Broadcast Technical Services  
Colorado City, Texas  
915-728-8076

Jim Stanford  
New Orleans, Louisiana  
504-822-1945

Al Martin  
Segue Services Inc.  
Merrifield, Minnesota  
218-765-3333

Jim Stitt & Associates  
Cincinnati, Ohio  
513-621-9292

Troy Langham  
Tulsa, Oklahoma  
918-587-0941

H. Scott Blake  
Wilson's Peak Eng.  
Mount Wilson, California  
805-273-7717

Bill Spitzer  
WLS Communications  
Rapid City, South Dakota  
605-343-6986

Chris R. Holt  
San Jose, California  
408-985-9459

Bob Biermann  
Tacocca, Georgia  
404-886-4727  
404-886-1912

T. Michael Ezell  
Audiotronics Tech Service  
Dothan, Alabama  
205-793-6519

Dick Warren  
Warren Engineering  
San Diego, California  
619-279-0759

Joe DeRosa &  
Frank Bolognino  
Brooklyn, New York  
718-764-9698

Frank Baker  
Towers & Ground Systems  
503-775-3366

Paul Easter  
D&E Broadcast Services  
Corpus Christi, Texas  
512-994-0659

Bill Sutton  
Bill's RF Engineering  
Bamberg, South Carolina  
803-245-4902

Mark Sadacca  
San Bernadino, California  
714-882-2575

Gary Brown  
Broadcast Allocations  
Nashville, Tennessee  
615-662-1526

David Sanford  
St. George, Utah  
801-628-3075

Sam Garfield  
Raleigh, North Carolina  
919-870-1289

Joseph Papp  
Charleston, South Carolina  
803-884-8513

James Parkinson  
Siloam Springs, Arkansas  
501-248-1108

Joe Furjanic  
Furjanic Communications  
Monongahela, Pennsylvania  
412-379-8311

Ronald J. Meyer  
Meyer Communications  
Winterhaven, Florida  
813-293-9646

Ken Ruhland  
Central Bdcst. Eng. Group  
West Edmeston, New York  
607-847-8244

Griffen E. Dameron  
Charleston, South Carolina  
803-767-1669

Frank Hertel  
Newman-Keys Freq. Meas.  
Evansville, Indiana  
812-963-3294

Dr. Smokey King  
Amarillo, Texas  
806-335-1954

Bob Schneider  
Broadcast Technical Services  
Lubbock, Texas  
806-798-2601

Walt Gradski  
Marionics Inc.  
Toms River, New Jersey  
201-240-3119

Phillip Robillard  
Robillard Communications  
Haynesville, Louisiana  
318-624-0105

Larry Fiebig  
Cincinnati, Ohio  
513-742-3600

Peter Stohrer  
Concord, New Hampshire  
603-225-5153

Jim Trapani  
JT Communications  
Ocala, Florida  
904-236-0744

Jim Stoneback  
Mid-Atlantic states - AM only  
703-671-1037

Mark W. Crom  
Broadcast Technical Svc.  
Pequot Lakes, Minnesota  
218-568-5369

Bill Major  
Rio Rancho, New Mexico  
505-891-0719

Jeff Baker  
Technical/Design Service  
Fairport, New York  
716-258-3380

Mike Loos  
Quad City Broadcast Svc.  
Blue Grass, Iowa  
319-381-2590

Tommy Gray  
Broadcast Service Co.  
Jonesboro, Louisiana  
318-259-8835

Peter Martin  
Technical Services  
Rupert, Vermont  
802-394-7858

Don Cook  
Devon Broadcasting  
Odessa, Texas  
915-362-8300

Phil Wells  
Giant Step Enterprises  
Facility wiring/reworking  
Southern California  
619-565-8103

Tom Rusk  
T&M Enterprises  
Little Rock, Arkansas  
501-375-1440

Gorman Broadcast Cons.  
Pinellas Park, Florida  
813-546-6996

Jack Parker  
Independence, Kentucky  
606-371-2231

Clifford L. Bryson  
Zelienople, Pennsylvania  
412-776-5204

Chuck Condron  
Condron Broadcast Eng.  
Salt Lake City, Utah  
801-580-3025

Dennis Silver, PE  
West Valley, Utah  
801-973-7759

Douglas White  
White & Associates  
Saginaw, Michigan  
517-793-9994

Tim McCartney  
Bemidji, Minnesota  
218-751-1680

Burt Rickenbacker  
Holly Hill, S. Carolina  
803-496-5291

Richard A. Franklin  
Mid-Atlantic Radio Svc.  
Blue Bell, Pennsylvania  
215-277-7122

David W. Schmidt  
Mid-Atlantic Radio Svc.  
Wilmington, Delaware  
302-323-0338

JJ Largen  
The Largen Companies  
Radford, Virginia  
703-639-4900

Kurt Elsavage  
K&E Engineering  
Aberdeen, Maryland  
301-272-4667

Robert J. Lankton  
Precision Audio & Engineering  
Sarasota, Florida  
813-377-1488

Eric Chromick  
Waynesville, Ohio  
513-885-7360

Dennis Wilson  
Grand Rapids, Michigan  
218-326-9308

Tom Elmore  
Vermont Radio Engineering  
Proctorsville, Vermont  
802-226-7380

Rob Ramseyer  
RJ Communications  
Albuquerque, New Mexico  
505-266-1237

Mike Patton  
Patton Circuit Systems  
Baton Rouge, Louisiana  
504-292-4189

John Almon  
5-9 Communications  
Franklin, Tennessee  
615-664-6427

Kirk Wallace  
Fairfield, Illinois  
618-842-7785

Glen Dingley  
Ottawa, Illinois  
815-433-2580

Roy Butler Jr.  
Texas A&I University  
Kingsville, Texas  
512-592-3578

Joel Clark Humeke  
J.C. Humke & Assoc.  
Aurora, Colorado  
303-367-1515

John Winquist  
Freeport Illinois  
815-235-7191

Doug Carter  
Darlington, South Carolina  
803-393-6091

**Contract Engineer?**  
**List Your Name Here**  
**Call (507) 280-9668**

## GOODRICH enterprises, Inc.

Parts and technical service for all  
**McMartin - Transmitters, Consoles, Exciters**  
*Modulation Monitors Calibrated*  
*Transmitter Tubes - New and Re-Built*

11435 Manderson St.  
Omaha, NE 68164  
Phone (402) 493-1886  
Fax (402) 331-0638  
Telex 940103 WU PUB TLX BSN



(802) 226-7582  
FAX: 802-226-7738

### COMMERCIAL RADIO COMPANY

Transmitter Parts for: RCA, Gates, Collins  
Non-PCB Filter and Mica Transmitting Capacitors

DUTTONSVILLE SCHOOL DRIVE  
CAVENDISH, VT. 05142  
DANIEL W. CHURCHILL

## Test Equipment

*Why Buy When You Can Rent?*

**POTOMAC - DELTA - BIRD**  
Other Equipment Available

*Call for Rates and Availability*

### Radio Resources

1-800-54-RADIO (1-800-547-2346)  
(301) 859-1500

## The Folded Unipole:

*The Ultimate Antenna  
for AM Broadcast!*

- Broad bandwidth
- Grounded antenna
- Eliminates isocouplers
- AM-FM site consolidation
- Effective as detuning skirt
- Custom kit; easy assembly



**nott ltd.**

atmospherics • electromagnetics

Box 761, Farmington NM 87499 • (505)327-5646

Oh-Oh!

Call  
**CORTANA**

For Affordable Lightning Protection  
**505-325-5336**

P.O. Box 2548, Farmington, N. M. 87499  
FAX 505-326-2337

## FCC's Engineering AM, FM and TV Data Bases

On floppy (or) 9-track tape

*Call today to request a free sample*

Communication Data Inc.

6105 E. Arlington Blvd.  
Falls Church, VA 22044  
703-534-0034

## SBE

### STANLEY BROADCAST ENGINEERING

James S. Stanley

P.O. Box 24601  
Tempe, AZ 85282

(602) 264-8752

## NORTHERN MAGNETICS

CERTIFIED TAPE HEAD SERVICES

Northern Magnetics is an industry leader in the  
supply and service of tape heads and tape head  
products.

P.O. Box 16409  
Minneapolis, MN 55416

Phone: (612) 333-3071  
Telex: 1561238 MPS UT  
FAA Repair Station # C14-57

## LIGHTNING PREVENTION SYSTEMS

LIGHTNING PROTECTION AND PREVENTION SYSTEMS

FOR COMMUNICATIONS TOWER SITES.

204B Cross Keys Road, Berlin, NJ 08009

FAX 609-767-7547 • (609) 767-7209

*Don't Wait Until It's Too Late!*

## HE HALL Electronics

**THE BEST DEALS ON QUALITY  
REBUILT & BRAND NEW  
BROADCAST EQUIPMENT**

We BUY & TRADE equipment too!  
Please phone or send for our latest flyer.

10:00AM-6:00PM EST

804-974-6466

FAX 804-974-6450

1305-F Seminole Trail

Charlottesville, VA 22901

## Kidd COMMUNICATIONS

CALL US FOR... Audi-Cord Cart Machines & Audiotape Carts  
• Bogner TV Antennas • Cablewave Transmission Line  
• CRL Audio Processing • Eventide Digital Effects • Gentner Patch Bays  
• Jampira FM & TV Antennas • JBL Speakers • M/A Comm Video STL's  
• Mark Antennas • Orban Optimod's • Scala Antennas  
• Soundolier Equipment Racks • Studer-Revovox Tape  
Recorders/Disc Players • Technics Turntables/Disc Players  
• TTC FM/TV Translators/Transmitters

CALL US TODAY! KIDD COMMUNICATIONS

916-961-KIDD(5433)

4096 Bridge Street • Suite 4  
Fair Oaks CA 95628

We have the knowledge  
and ability to provide  
you the best suited  
broadcast for your  
project... always at  
competitive prices!

## Tube Rebuilding Freeland Products

- We Buy Duds -

Since 1940  
Save About 50%



800-624-7626

504-893-1243

Fax 504-892-7323

Including for TV  
RCA Cermolox and UHF Klystrons

## Consulting Communications Engineers

- FCC Data Bases
- FCC Applications and Field Engineering
- Frequency Searches and Coordination
- AM-FM-CATV-ITFS-LPTV

### OWL ENGINEERING, INC.

1306 W. County Road. F,  
St. Paul, MN 55112  
(612)631-1338 "Member AFCCE"

# barrett associates

NAB Booth 4606

## TASCAM

- ★ DA 30  
digital audio tape recorder
- ★ 644 MIDISTUDIO  
8 channel (16 input) mixer  
& 4 Track Recorder
- 3030  
Stereo Reel to Reel
- 122MKII Cassette Deck  
and More

## Ramko Research

- ★ Optical Linear Fader
- XL Series Consoles

## Russco Electronics

- ★ "The Radio Spook"

## Dorrrough

- 610  
FM Processing
- Loudness Meters

— PLUS —

Henry Engineering  
Beyer Dynamic • Emerald MFG

- ★ Must See! NEW ITEMS  
1st NAB Appearance