

A SIMPLE, DUTCH-DESIGNED MONITOR WITH DANISH DRIVERS

TWO: 1998

US \$7.00

CANADA \$10.00

# Speaker Builder

THE LOUDSPEAKER JOURNAL

**BUILD THIS  
DOUBLE-CHAMBER REFLEX**

**PAUL SECHI**

**CONSTRUCT A  
SMALLER, MORE  
POWERFUL, ISOBARIK**

**PAUL KITTINGER**

**YEAGO PUTS  
THE AR-3a BACK  
TOGETHER**

**DRIVER TEST  
SEAS TWEETERS**

**VANCE DICKASON**

**MARCHAND'S XM9  
ACTIVE CROSSOVER**

**KEN KETLER**



\*\*\*\*\*  
PERIODICALS  
A0169740 91N 0798  
David Heiser  
410 E. MICHIGAN ST  
MUSKOGEE, MO 64850  
\*\*\*\*\*  
Reprint  
\*\*\*\*\*  
FOR ADC 54240  
594 PA



**MORE SECRETS: MAGNETS, MAGNETICS & BASKETS**





TC loudspeaker cable

# "8TC - The most accurate performer"

*Hi-Fi News & Record Review - Ben Duncan - February 1997 issue*

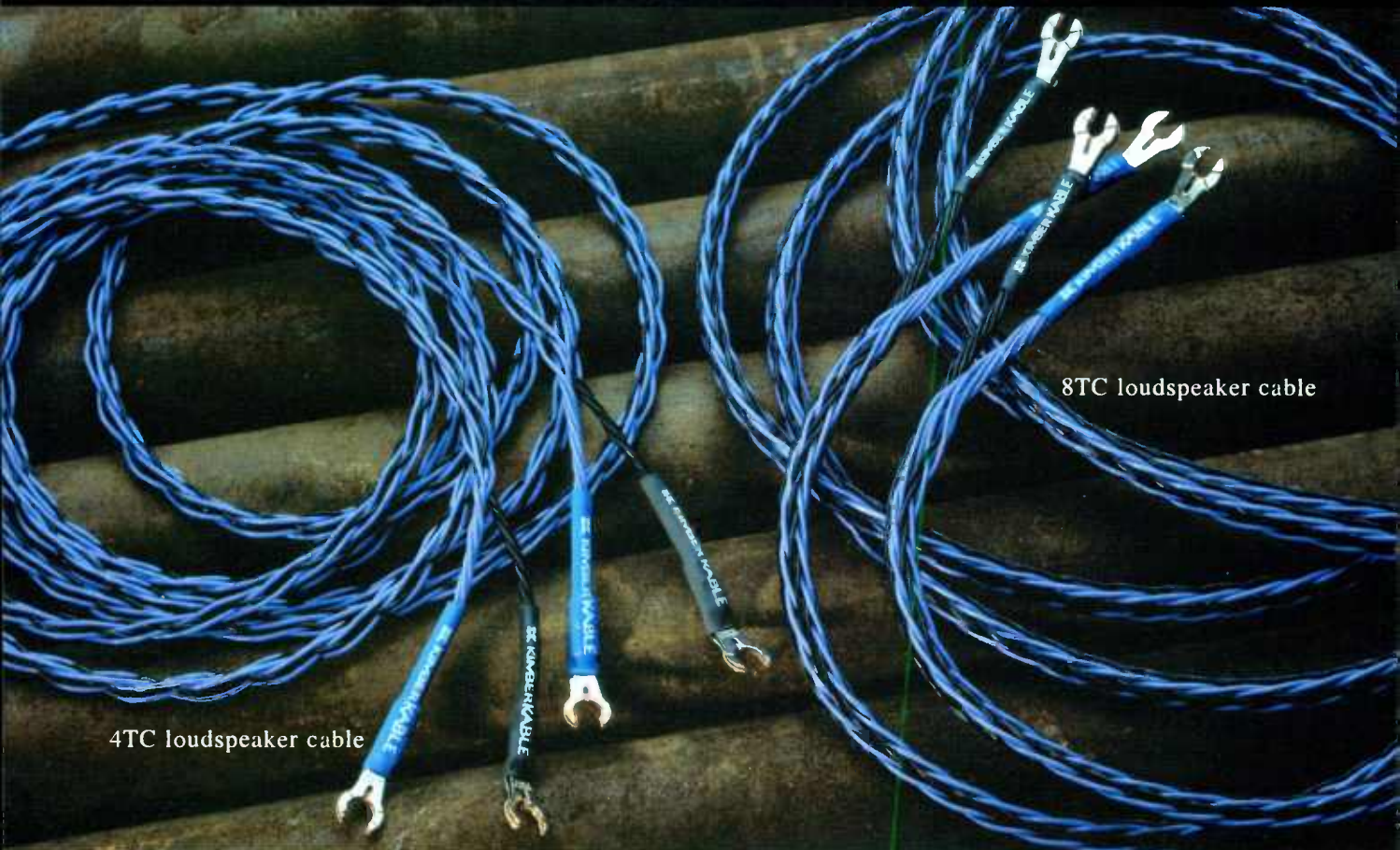

4TC loudspeaker cable

8TC loudspeaker cable

The TC series loudspeaker cables use individual conductors that are Hyper-pure copper, arranged in our VariStrand™ conductor geometry. The insulating dielectric is a high pressure, low temperature extruded, Teflon™.

4TC consists of eight individual TCSS conductors, four blue and four black. Aggregate wire gauge size is two #13 conductors. The focus, transparency, and transient speed of 4TC is stunning. 4TC continues to receive enthusiastic reviews and recommendations from consumers and critics worldwide.

8TC consists of sixteen individual TCSS conductors, eight blue and eight black, arranged in a large format braid. Aggregate wire gauge size is two #9 conductors. 8TC continues to receive rave reviews and recommendations, ranking as one of the best high end audio values of all time.

4TC and 8TC are without question, the best sounding "sensible" cables on the market.

 **KIMBER KABLE**

*Revealing the Nature of Music.*

2752 South 1900 West - Ogden Utah 84401 - 801-621-5530 - fax 801-627-6980 - [www.kimber.com](http://www.kimber.com)  
Reader Service #65



**New! LEAP**  
Version 4.5

**LEAP**

# Precision Development Tools for Precision Loudspeaker Designs

**LEAP System Response Prediction**

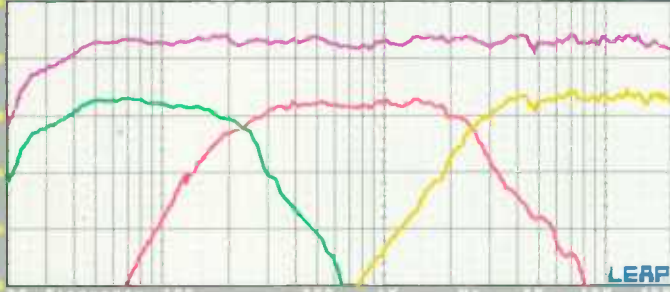

**Actual System Response Measurement**

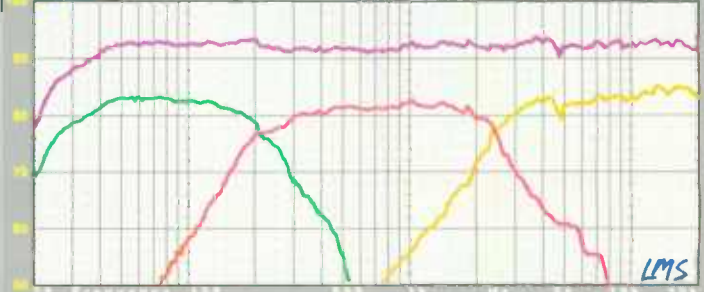

**The Art and Science...** of loudspeaker system development today has become more complex than ever before. Competition is tough, and to compete each design must perform to the best of its ability, and make the most out of every dollar's worth of transducer cost. The simple approach of choosing a combination of seemingly appropriate transducers coupled with network and filters, has given way to a painstaking process of meticulously blending selected transducers in combination with carefully devised and matched crossover designs.

■ Seminars/Workshops available, call for details

**LEAP** (Loudspeaker Enclosure Analysis Program) is a complete full range analysis package which provides virtually all of the tools necessary to develop precision loudspeaker systems, for today's demanding audio markets. Whether your applications are consumer audio, car stereo, professional audio, or custom esoteric markets, LEAP provides the power, flexibility, and accuracy to investigate every possible design permutation. The open architecture and broad spectrum of features provided will dramatically reduce your development time, while improving the quality of the final result... and demonstrates why LEAP has become the #1 choice of professional loudspeaker designers world-wide!

### Advanced Transducer/Enclosure Simulations

- ✓ Sealed/Vented, Bandpass, PR Simulations with multiple speaker/ port capability.
- ✓ Large signal analysis of TempVC, and Non-Linear BL/ Ports/ Compliance.
- ✓ Acoustic Parallel or Acoustic Series (Isobaric) Driver Mounting.
- ✓ Port Standing Wave resonance modeling.
- ✓ Frequency Dependent Réve and Levic modeling.
- ✓ Library storage of 36 transducer parameters, and over 24 enclosure parameters.
- ✓ Generic transducer modeling of electro-dynamic, ribbon, and piezo devices.

### Advanced System Analysis Features

- ✓ Use simulation or imported actual measured SPL/JZ data.
- ✓ 5-Way crossover system modeling, and more.
- ✓ Time offset between transducers.
- ✓ Active or Passive based crossovers.
- ✓ Hilbert-Bode transform for driving phases.
- ✓ 22 Passive components per crossover section.
- ✓ 16 Active filter blocks per crossover section.
- ✓ Passive Network Optimizer for single/system response.
- ✓ Active Filter Optimizer for single/system response.
- ✓ Frequency ranges from 1Hz to 100kHz.

### Printer/Output Formats

When you wish to produce a hardcopy output of your finished designs and graphical data, LEAP supports a large number of printer standards, and even supports numerous desktop publishing graphic formats in both black & white and color! Portrait/Landscape orientations in any custom size and aspect ratio are user controllable.

- ✓ IBM/Epson 8 Pin Dot Matrix
- ✓ Epson 24 Pin Dot Matrix
- ✓ HP LaserJet Series Printers
- ✓ HPGL Compatible Plotters
- ✓ PostScript EPS/TIF, B&W,Color
- ✓ AI-Adobe Illustrator B&W,Color
- ✓ NEC 24 Dot Matrix
- ✓ TOSHIBA 24 Dot Mat
- ✓ HP DeskJet 5#0C
- ✓ PostScript Printers
- ✓ DXF AutoCAD
- ✓ TIFF, BMP, PCX Plots



**Call for a free Demo Disk!**  
TEL: (503) 612-9565

### Development Utilities

- ✓ Quick Cabinet Box Designer
- ✓ Conjugate Network Designer
- ✓ Wire Table Calculator
- ✓ Multi Curve Averages
- ✓ Import Data from ASCII Files
- ✓ Crossover Network Designer
- ✓ Spkr Parameter Measurement
- ✓ Voltage/Current/Imp Calculator
- ✓ Motor Constants Calculator
- ✓ Export Data to ASCII Files

### Extensive Documentation

The two volume manual set comprises almost 1,000 pages of documentation which thoroughly covers the operation of the program and provides numerous examples of how to maximize your use and understanding of the program's many features. The Reference Manual describes all graphs, menus, commands, and their operation. This manual explains the unique and special non-linear speaker and port models, as well as proper use of the optimizers, importing data, and the many other utilities. The Application Manual provides many exciting examples showing how to use the powerful features of the system in a combined manner to perform both simple and complex design tasks. Both novice and experienced users alike will find this information invaluable for exploiting the full power of the system. Additional information is also provided on loudspeaker measurements, design tips, filter calculations, and complete crossover system development for both passive and active based systems.

- ✓ 502 Page Reference Manual
- ✓ 436 Page Application Manual



LinearX Systems Inc. 9500 SW Tualatin-Sherwood Road Tualatin, Or 97062 USA Tel: (503) 612-9565 Fax: (503) 612-9344 Web: www.linearx.com

**International Dealers:** Argentina Interforce SRL (54-11741-1389) **Australia** ME Technologies 61(0)65-50-2260 **Austria** Audiomax 49(0)71-31-162225 **Belgium** Beltram 32(0)2-736-50-00 **Canada** Germsch 416-556-2774 **Denmark** Finland A&T Ljudproduktion 46(0)8-623-08-70 **France** Beltram 32(0)2-736-50-00 **Germany** Audiomax 49(0)71-31-162225 **Indonesia** Ken's Audio 62(0)2-1639-5800 **Italy** Quire and 39-30-3591341 **Korea** Sammi Sound 82(0)2-483-0394 **Luxembourg** Beltram 32(0)2-736-50-00 **Malaysia** AUVI 65-283-2544 **New Zealand** ME Technologies 61-65-56-2254 **Norway** A&T Ljudproduktion 46(0)8-623-08-70 **Philippines** Dai-ichi Denso (63) 2631-69-80 **Poland** Inter Americom 48(22)43-23-34 **Singapore**: AUVI 65-283-2544 **Sweden**: A&T Ljudproduktion 46(0)8-623-08-70 **Switzerland** Audiomax 49(0)71-31-162225 **Taiwan** German Taiwan 86-2-786-3468 **Thailand**: AUVI 65-283-2544 **The Netherlands** Duran Audio 31-41-80-15583 **UK(England)** Munro Assoc 44(0)171-403-3000 **Reader Service #36**





## TERMINATOR TWO

Music Interface Technologies (MIT) announces the replacement of the "High-End Series" models (CV Terminator Twin MH-770 speaker cable and MI-350 interconnect) with MH-770 II and MI-350 CV Terminator Twin Series Two. Each includes MIT technologies, such as the Image Specific Technology (IST™), Output Terminator Network, Input Terminator Network, CVT Coupler, and Jitter-Free Analog (JFA). Music Interface Technologies, 13620 Lincoln Way, Ste. 320, Auburn, CA 95602, (916) 888-0394, FAX (916) 888-0783.

Reader Service #139



## PRODUCT-LINE EXPANSION

Miller & Kreisel Sound (M&K) introduces the MX-5000THX Mark II powered subwoofer, one of six new products in its line of speaker system components. Among these are the SW-85 and SW-95, frameless in-wall speakers which won CES Innovations '98 Awards. M&K's LCR-55 is designed for use as a left-, right-, center-, or surround-channel speaker in a 5.1 multichannel satellite speaker or stereo satellite-subwoofer setup. The MX-105 is a 100W powered subwoofer and the MX-125 Mark II offers a 150W amplifier and two 12" drivers. Like the 5000THX, both include push-pull dual-driver technology. M&K Sound Corp., 10391 Jefferson Blvd., Culver City, CA 90232, (310) 204-2854, FAX (310) 202-8782.

Reader Service #135

## ENHANCED AKABAK

Bang-Campbell Associates introduces AkAbak 2.1, an updated version of the popular loudspeaker-design software by Jörg Panzer. AkAbak's new beamwidth display is a useful feature for two- and three-way system designers. If set to -3dB, it can calculate the horizontal or vertical lobing pattern, showing the radiation angle as a function of frequency where beamwidth drops 3dB from the on-axis level. Upgrades in version 2.1 include: enhanced import function, polar coordinates in directivity outputs, switchable input parameters (RMS or peak), and enhanced diagram operations. Bang-Campbell Associates, 3 Water St., PO Box 47, Woods Hole, MA 02543, (508) 540-1309, FAX (508) 540-8347, E-mail rhcamp@ma.ultranet.com.

Reader Service #137

## PSB CELEBRATED

PSB Speakers received two CES Innovations '98 Awards for its Stratus Gold® full-range speaker system and Stratus subwoofer series. The Stratus Gold<sup>i</sup> is a bass-reflex tower speaker with 1" aluminum-dome tweeter, 6" midrange, 10" woofer, and 4Ω impedance. The Stratus subwoofer series includes the SubSonic 3<sup>i</sup> and SubSonic 4, both of which offer a 15" driver and 300W of steady-state power (700W peak). The SubSonic 4 also features digital signal processing and an infrared remote control. PSB, 1600 Providence Hwy., Walpole, MA 02081, (508) 660-8300, FAX (508) 660-8373, Website www.psbSpeakers.com.

Reader Service #136

## WHAT'S YOUR SIGN?

Gemini Sound released its XRS series of loudspeakers recommended for full-range applications or for use in conjunction with subs for extended bass response. Each in the series contains woofers with die-cast aluminum frames, tuned and ported cabinets made of ¾" Oriented Strand Board, and vented magnet structures. Gemini Sound Products Corp., 8 Germak Dr., Carteret, NJ 07008, (732) 802-6004, FAX (732) 969-9090, E-mail int-sls@geminiidj.com, Website www.geminiidj.com.

Reader Service #140

## LISTEN TO ROCK, LITERALLY

Rockustics, Inc., introduces four exciting new rock-mold speakers—the BP Subrock, Rockolyth, Coraltone, and Tunestone. The Coraltone offers the look of natural tube coral and omni-directional sound, the Rockolyth is a 4'-tall speaker (complete with petroglyphs) with two 8" 100W drivers and a dome tweeter, and the Tunestone features an 8" 70W driver and high bass performance. Lastly, at 250 lbs., the BP Subrock bandpass subwoofer delivers sound over a large area using two 300W 10" long-throw woofers. Rockustics, Inc., 15400 East Batavia Dr., Aurora, CO 80011, (303) 363-6161, FAX (303) 363-0011.

Reader Service #138



## TUBES-PARTS-BOOKS-SUPPLIES

(602) 820.5411 FAX (800) 706.6789

FIND EVERYTHING YOU NEED  
WITHOUT BEING TAKEN FOR A RIDE.

Where can I find a 6550 replacement audio tube?



Call or fax today for our new 60 page FREE catalog of vintage tubes, hard to find parts, books and supplies. We have everything you need to build new or repair classic audio equipment at prices you haven't seen in decades.



6221 SOUTH MAPLE AVENUE  
TEMPE, AZ U.S.A. 85283

Reader Service #88

# "We Give Your Speakers a Second Chance"



## Image Communications/Waldom Electronics Reconing Parts Supplier



- OLDEST SUPPLIER "50 YEARS IN 1996"
- LARGEST INVENTORY OF PARTS
- ALWAYS QUALITY FIRST RUN PARTS, NEVER SECONDS
- 24-48 HOUR TURNAROUND TIME ON ORDERS
- MANUFACTURER OF OVER 4700 CUSTOM VOICE COILS
- SPEAKER RECONING MANUAL AVAILABLE FOR \$49.95



IMAGE DISTRIBUTES TO OVER 850 AUTHORIZED REPAIR CENTERS WORLDWIDE. CALL TODAY FOR THE ONE NEAREST YOU!



Also distributor for:

**McCauley**

6000 Series Loudspeakers and Drivers

*Epitome*™

**Electro-Voice**®

**ALCATEL**  
COMPONENTS

*Epitome Pro*™

**EMINENCE**

Loudspeakers, Drivers, Diaphragms,  
and Recone Kits

**GIZMO'S**™

**GH** Industries

**FerroSound**  
The Solution Is Loud And Clear.™



**image**  
communications

A Katy Company / The Sound Source

5235 W. 65th Street • Unit D • Bedford Park, IL 60638  
(708) 563-4950 • Fax (708) 563-4956 • 1-800-552-1639



Reader Service #22



# Speaker Builder®

## The Staff

Editor and Publisher

**Edward T. Dell, Jr.**

Regular Contributors

**Joseph D'Appolito** **Robert Bullock**  
**Richard Campbell** **John Cockcroft**  
**David Davenport** **Vance Dickason**  
**Bruce Edgar** **Bill Fitzmaurice**  
**Gary Galo** **G.R. Koonce**  
**Richard Pierce** **Bill Waslo**

Vice President

**Karen Hebert**

**Dennis Brisson** Assistant Publisher  
**Swain Pratt** Associate Editor  
**Courtney E. Howard** Assistant Editor  
**Karen L. Hampsey** Editorial Assistant  
**Tina Hoppock** Graphics Director  
**Diane Luopa** Assistant Graphics Director  
**Joan Ahern** Production Assistant  
**Joannie Berriman** Production Assistant  
**Laurel Humphrey** Marketing Director  
**JoAnne Leclair** Customer Service Supervisor  
**Robyn Lasanen** Circulation Manager  
**Kelly Bennett** Customer Service  
**Peter B. Wostrel** National Advertising Director  
**Lisa DiRusso** Advertising Sales  
**Ann Avery** Advertising Coordinator

*The peculiar evil of silencing the expression of an opinion is, that it is robbing the human race; posterity as well as the existing generation; those who dissent from the opinion, still more than those who hold it.*

JOHN STUART MILL

*Speaker Builder* is published eight times a year in the interest of high-quality audio reproduction.

## LEGAL NOTICE

Each design published in *Speaker Builder* is the intellectual property of its author and is offered to readers for their personal use only. Any commercial use of such ideas or designs without prior written permission is an infringement of the copyright protection of the work of each contributing author.

## SUBSCRIPTION/CUSTOMER SERVICE INQUIRIES

A one year subscription costs \$32. Canada please add \$8. Overseas rate is \$50 per year.

To subscribe, renew or change address write to the Circulation Department (PO Box 494, Peterborough, NH 03458-0494) or telephone (603) 924-9464 or FAX (603) 924-9467 for MC/Visa/Discover charge card orders. **E-mail: [custserv@audioxpress.com](mailto:custserv@audioxpress.com).**

For gift subscriptions please include gift recipient's name and your own, with remittance. A gift card will be sent.

## EDITORIAL INQUIRIES

Send editorial correspondence and manuscripts to *Speaker Builder*, Editorial Dept., PO Box 494, Peterborough, NH 03458-0494. **E-mail: [editorial@audioxpress.com](mailto:editorial@audioxpress.com).** No responsibility is assumed for unsolicited manuscripts. Include a self-addressed envelope with return postage. The staff *will not* answer technical queries by telephone.

## ADVERTISING RATES & SCHEDULES

Contact Advertising Department, *Speaker Builder*, PO Box 494, Peterborough, NH 03458, 603-924-7292, FAX 603-924-9467. **E-mail: [advertising@audioxpress.com](mailto:advertising@audioxpress.com).**

Printed in the USA. Copyright © 1998 by Audio Amateur Corporation  
All rights reserved.

## About This Issue

Paul Sechi's quest to design the ultimate speaker unfolds in this issue. On this leg of his journey he achieves some of his goals with a two-chamber reflex design ("Double-Chamber Reflex Enclosure," p. 8). Extensive measurements and analysis reveal an impressive-sounding enclosure.

Paul Kittinger presents another design and construction project—this one an improvement on his Isobarik tower speaker design (from *SB* 5/97). In this sequel, the author presents a less complex design that produces more power ("An Isobarik Tower—The Sequel," p. 14).

We are pleased to reprint in this issue an article entitled "Reference Monitor" from *Loudspeaker Projects*. Originally published in *Hi-Fi Luidspreakers*—from the editors of *Elektuur* magazine—this construction piece features a top-class tweeter, the Revelator from Scan-Speak.

As evidence that we're getting down to the wire in this series, Tom Yeago leads us into the final assembly stages of the AR-3a project. This time we'll tackle the magnets, plates, and domes of the drivers ("Rebuilding the AR-3a, Part 5," p. 36).

In the review spotlight is a crossover kit from Marchand. Reviewer Ken Ketler puts this active crossover kit together and demonstrates how it provides a pleasing enhancement to your subwoofer/satellite setup ("Test Drive," p. 44).

Mike Klasco's series entitled *Trade Secrets* (p. 47) is a nice blend of history, industry perspective, and practical information about the use and manufacture of speaker components. His most recent topic is magnetic structures and baskets.

Also, speaker expert Vance Dickason tests two new drivers—metal-dome tweeters from SEAS ("Driver Report," p. 52).

## THIRD GENERATION CLASS-D POWER AMPLIFIERS

Reliable, high-efficiency  
switching amplifiers have  
come of age...

LGT is an OEM manufacturer of high performance audio amplifiers, either turnkey with a full feature set, or as pre-fabricated PCB assemblies. The high efficiency of Class-D is available in several configurations and output levels. Heatsinking requirements on all models are minimal. Contact Terry Taylor for full details and a developer kit.

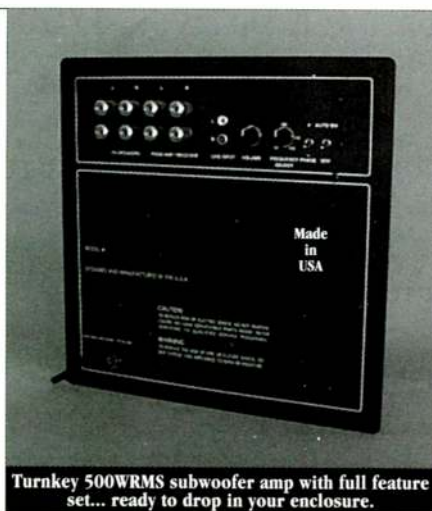

Turnkey 500W RMS subwoofer amp with full feature set... ready to drop in your enclosure.

**LGT** SWITCHING TECHNOLOGIES

©1996 LGT

910 Creekside Road • Building A • Chattanooga, TN 37406 • Email: [acoustical@aol.com](mailto:acoustical@aol.com)

Tel: 423-622-1505 Fax: 423-622-1485

Reader Service #79

*Speaker Builder* (US ISSN 0199-7920) is published every six weeks (eight times a year), at \$32 per year, \$58 for two years; Canada add \$8 per year; overseas rates \$50 one year, \$90 two years; by Audio Amateur Corporation, Edward T. Dell, Jr., President, at 305 Union Street, PO Box 494, Peterborough, NH 03458-0494. Periodicals postage paid at Peterborough, NH and an additional mailing office.

## POSTMASTER:

Send address change to:  
*Speaker Builder*, PO Box 494  
Peterborough, NH 03458-0494

# Speaker Builder

## THE LOUDSPEAKER JOURNAL

VOLUME 19 NUMBER 2

APRIL 1998



32

### 8 Double-Chamber Reflex Enclosure

BY PAUL SECHI

### 14 An Isobarik Tower—The Sequel

BY PAUL KITTINGER

### 32 The Reference Monitor

FROM HI-FI LOUDSPEAKERS, ELEKTUUR

### 36 Rebuilding the AR-3a, Part 5

BY TOM YEAGO

### 44 TEST DRIVE Marchand Electronics XM9 Crossover

REVIEWED BY KEN KETLER

### 52 DRIVER REPORT Tweeters from SEAS

BY VANCE DICKASON

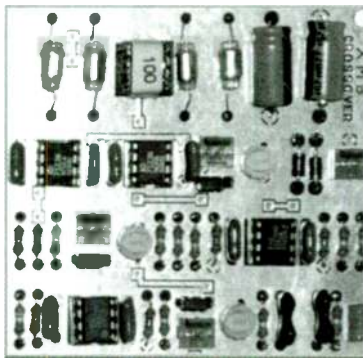

44

## DEPARTMENTS

4 GOOD NEWS

47 TRADE SECRETS

Magnetic Structures and Baskets

BY MIKE KLASCO

54 SB MAILBOX

56 CLASSIFIEDS

56 AD INDEX

## KEEP IN TOUCH

**EDITORIAL** — Send letters, questions, and comments to: Speaker Builder, Editorial Dept., PO Box 494, Peterborough, NH 03458 USA, FAX (603) 924-9467, E-mail: editorial@audioexpress.com.

Be sure to reference the issue, title, author, and page number of the article or letter in question; and if you request an answer from an author, please include a self-addressed envelope (and your FAX number and/or E-mail address, if applicable), with a loose stamp or postal coupon.

Due to the volume of correspondence, we cannot personally acknowledge or respond to each letter or query. All letters to the editor will be considered for publication unless you indicate otherwise. Speaker Builder reserves the right to edit your letters or technical queries for length and clarity.

Author guidelines are available by sending a self-addressed envelope with loose postage to the above address.

**CIRCULATION** — For subscriptions, renewals, back issues, or address changes, write to the Circulation Department (PO Box 494, Peterborough, NH 03458) or call (603) 924-9464 or FAX (603) 924-9467. E-mail: custserv@audioexpress.com

**ADVERTISING** — Address advertising inquiries and information requests to the Advertising Department, Audio Amateur Corporation, PO Box 494, Peterborough, NH 03458 0494, voice (603) 924-7292, FAX (603) 924-9467, E-mail: advertising@audioexpress.com

**OLD COLONY SOUND LAB** — For product information and ordering, contact Old Colony Sound Laboratory, PO Box 243, Peterborough, NH 03458-0243, voice (603) 924-6371 and (603) 924-6526, FAX (603) 924-9467, E-mail: custserv@audioexpress.com.

# DOUBLE-CHAMBER REFLEX ENCLOSURE

By Paul Sechi

Having completed my final year of an Electrical Engineering Degree in Australia and being unable to find employment, I decided to read my three years worth of *Speaker Builder* thoroughly. I was most surprised to find two articles on the double-chamber reflex enclosure, written by Mark J. Thompson (1/92 and 6/92).

The title "double-chamber reflex enclosure" stems from the acoustic radiation of the enclosure, that is, from the loudspeaker itself and the vent of the second (or bottom) chamber that radiates into free space. This enclosure was the one I had selected as the basis of my final year's project (Fig. 1)—hence my surprise.

## PROJECT SPECIFICATIONS

Initially the project guidelines were to analyze, build, and test an enclosure that was an extension of the standard sealed or vented box. These enclosures had already been researched thoroughly over the past two decades, and there was no point in reinventing the wheel. The definition I used in my project was "an extension to a standard loudspeaker enclosure design is the use of multiple chambers and/or multiple vents within the one main enclosure."

The initial objectives of the acoustical and electromechanical properties are:

- to obtain the lowest possible rolloff frequency without over-driving the loudspeaker itself;
- to achieve a flat frequency response from the design;
- to obtain the steepest possible rolloff rate at low frequency.

After lengthy consideration of these guidelines, I thought that if I could combine all three elements in one design, I would have achieved the loudspeaker designer's dream.

## ACOUSTICAL-RADIATION ANALYSIS

I derived the analysis of the enclosure's acoustical-radiation transfer function from first principles, excluding the vent and enclosure losses of each chamber. I divided the

transfer function into the denominator and numerator terms as polynomials of frequency.

The denominator polynomial was of sixth order, compared to a vented enclosure's fourth-order, indicating that the system's rolloff occurs faster. The numerator was a

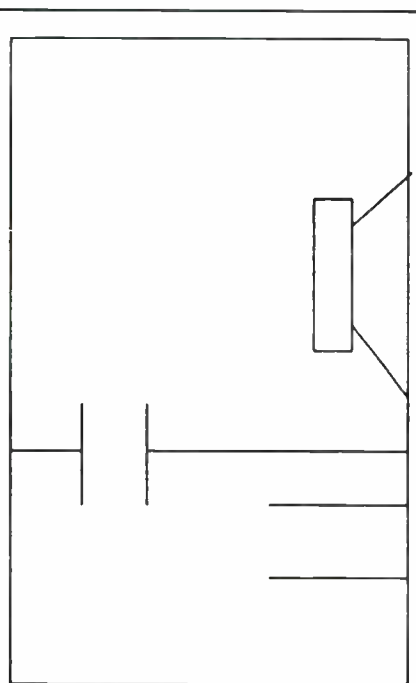

FIGURE 1: The double-chamber reflex enclosure.

third-order polynomial, compared to a vented system's zero order, and the numerator thus posed some design limitations.

The denominator polynomial indicated a rolloff rate of 36dB/decade, which is very steep and usually found only in bandpass subwoofer designs. The increased rolloff rate enhanced the possibility of lowering the rolloff frequency compared to a vented design. The rolloff rate and the dual chambers might also reduce the cone displacement at low frequencies.

All hopes of the denominator's frequency response having magical properties quickly

faded when the numerator's frequency response was plotted as a hyperbolic function. Such a response reduced the ability to obtain the flat frequency response of the overall system. Two ways to ensure a flat response were either to reduce the numerator's resonance to well below the denominator's rolloff frequency, or to increase it to a suitable frequency away from the bottom three or four octaves of operation.

The acoustical-radiation transfer function was of the form

$$E(s) = \frac{s^{-1} \times H + s^{-3} \times A}{1 + s^{-1} \times B + s^{-2} \times C + \dots + s^{-6} \times G}$$

where  $s = j\omega$ , in the complex frequency domain, and A, B, ..., G are coefficients of the terms of the polynomials representing the numerator and denominator.

## DENOMINATOR ANALYSIS

The denominator polynomial was originally aligned to Butterworth sixth-order filter coefficients. I analyzed each term to fulfill the Butterworth coefficients. The analysis showed that the first chamber—housing the speaker itself—had a volume dependent on the loudspeaker parameters and  $f_0$ , the box resonant frequency. The second chamber's volume depended on the loudspeaker parameters and both chambers' tuned frequencies.

I calculated the  $Q_{opt}$  of the Butterworth alignment (where  $f_s = f_0$ ) to be 0.259. Similarly, for a fourth-order Butterworth vented design, this figure is 0.382. The loudspeaker selected for the project was the very capable Peerless CC6.5 woofer, provided by Brad Serhan of Orpheus Loudspeakers in Sydney, Australia. The data-sheet Thiele/

## ABOUT THE AUTHOR

Paul Sechi was born and raised in Australia, where he worked for nearly three years on MW/satellite communications and high-reliability projects. Currently, he is working overseas in the MW communications field for a GSM provider. As much as possible, he listens to music and searches for the ultimate speaker design.



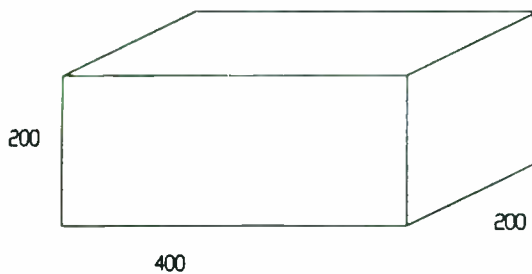

FIGURE 2: Top-chamber internal dimensions.

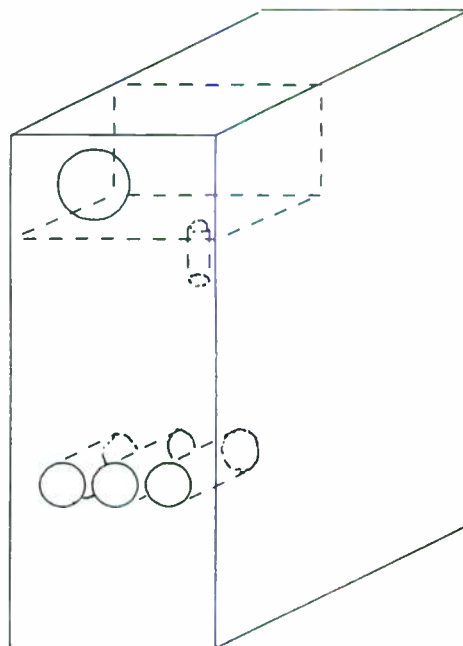

FIGURE 3: Bottom-chamber internal structure.

Small parameters for the unit were  $Q_t = 0.37$ ,  $f_s = 40\text{Hz}$ , and  $V_{as} = 24\text{ ltr}$ .

The Peerless unit had too high a total  $Q$  for the Butterworth filter alignment to achieve the original design goals. Reducing the loudspeaker total  $Q$  is much more difficult than increasing it, and with no other driver available to me at the time, I chose another sixth-order filter alignment.

The next alignment I analyzed was the 0.01dB ripple Chebychev, in which the ripple content of the filter in the passband was most acceptable in the loudspeaker-design criteria. I calculated the  $Q_{opt}$  for the design at 0.43, which allowed me to use the Peerless unit with an  $f_0$  less than  $f_s$ .

Articles by Augspurger<sup>1</sup> and Weems<sup>2</sup> suggest that there is a ratio of the two chambers' resonant frequencies and volumes. However, computer simulation of the frequency response of the enclosure ratios yielded discouraging results; likewise for the chamber-volume ratios.

#### FINDING THE KEY

I scrupulously examined the denominator term for errors and false assumptions that might explain the unimpressive simulation results. I discovered that a constant factor that had been used but not analyzed provided the key to the correct ratio of chamber frequencies: I was then able to calculate the chamber volumes as per the prior analysis.

The 0.01dB Chebychev alignment produced 19.1 and 373 ltr for the top and bottom chambers, respectively (the loudspeaker is mounted in the top one). The resonant frequencies for the top and bottom chambers were 36 and 23Hz, respec-

tively. Unfortunately, the enclosure was too large for one person to handle, and there was the problem of controlling the standing wave in a 400 ltr enclosure.

The next sixth-order Chebychev filter

coefficients I tried were those of the 0.05dB ripple, still within the acceptable criteria of the project design. I calculated the  $Q_{opt}$  for this design at 0.3667, allowing me to use the Peerless unit with an  $f_0$  very near  $f_s$ . The

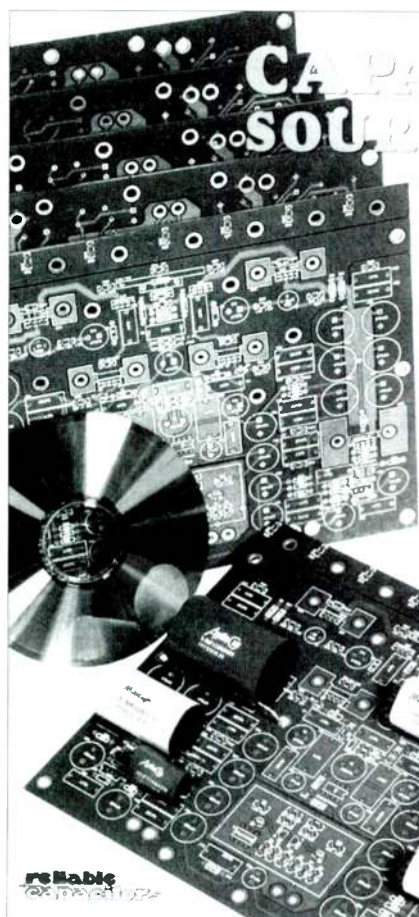

## CAPACITOR SOURCEBOOK

Full Range of Reliable's Film Capacitors for Audio & Video

- AudioCap™
- MultiCap™
- Exotica™

*Film & Foil  
Metalized Polypropylene*

*High Capacitance for Speakers  
High Voltage for Tubes & Power Supplies*

.001 - 100 microfarads  
100 - 2400 volts

For Catalog, Contact  
Finch & Marsh  
Audio Agents for Reliable

Tel: (530) 885-6809  
Fax: (530) 823-0156  
Please visit our website  
[www.capacitors.com](http://www.capacitors.com)

Reader Service #69

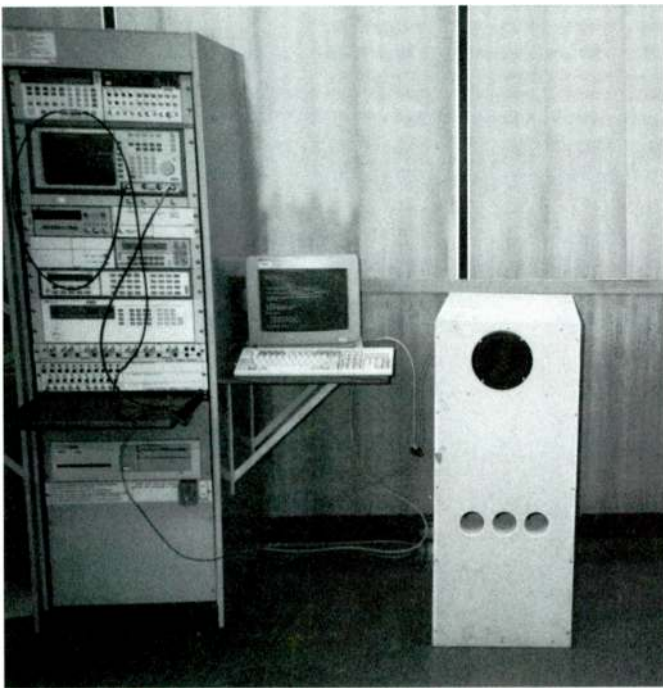

**PHOTO 1:** The enclosure next to the ATE rack.



**PHOTO 2:** The enclosure's internal structure.

completion of this analysis gave 14.6 and 226 ltr for the top and bottom chambers, respectively, with corresponding resonant frequencies of 41 and 28Hz.

### LOUDSPEAKER PARAMETERS

To verify the stated data-sheet Thiele/Small parameters, I tested the Peerless unit using a Hewlett-Packard Automated Test Equipment (ATE) rack. I used a computer to control the testing so as to increase the frequency and measure the electrical parameters from the voltmeter, logging both results to a file. The test produced the following results:  $Q_t = 0.376$ ,  $f_s = 46\text{Hz}$ , and  $V_{as} = 24.3\text{ ltr}$ .

The only result to fall outside a 10% tolerance band was the resonant frequency. A second test provided the reassuring specification of 40.2Hz as the resonant frequency. I obtained the above calculations of enclou-

sure volumes and chamber resonant frequencies from the data-sheet values and left them at that after seeing only minor differences in the measured results.

### LOUDSPEAKER ENCLOSURE DESIGN

Thiele<sup>3</sup> stressed the fact that the 0.8:1.0:1.25 enclosure ratio design was critical for the reduction of standing waves—most important in a design with a volume of nearly 250 ltr. The final enclosure design is shown in *Figs. 2 and 3*. The overall height of the enclosure was 1000mm, and its maximum depth 601mm, both measured internally.

Luckily, the top chamber would be able to break up some of the lower chamber's standing waves by intruding into the cavity space, but the standing-wave issue would still exist. I placed the loudspeaker off center

on the front of the cabinet. The vent connecting the chambers and reducing the coupling between them is likewise off-center. *Photo 1* displays the enclosure with its three vents in the lower chamber radiating air into free space. *Photo 2* shows the internal construction of the enclosure; note the white sealant I used on all the internal joints.

### FREQUENCY-RESPONSE SIMULATION

The frequency response of the denominator polynomial aligned to the Chebychev 0.05dB filter coefficients is shown in *Fig. 4*. The slight variation of  $Q_{opt}$  from the  $Q_t$  of the speaker reduced the  $f_o$ . The low ripple effect and the flat frequency response above about 30Hz seem quite perfect.

*Figure 5* details the numerator frequency response, with the hyperbolic shape cramped by the logarithmic scale. The dip in

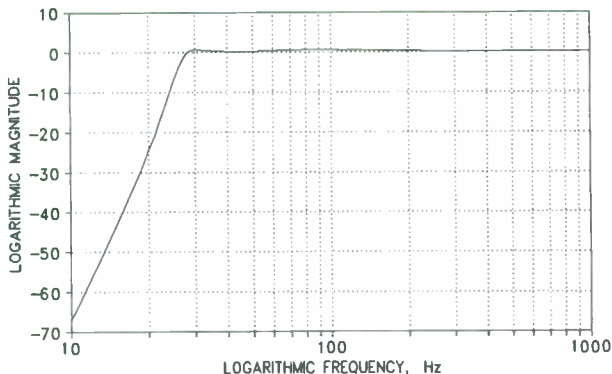

**FIGURE 4:** Denominator frequency response.

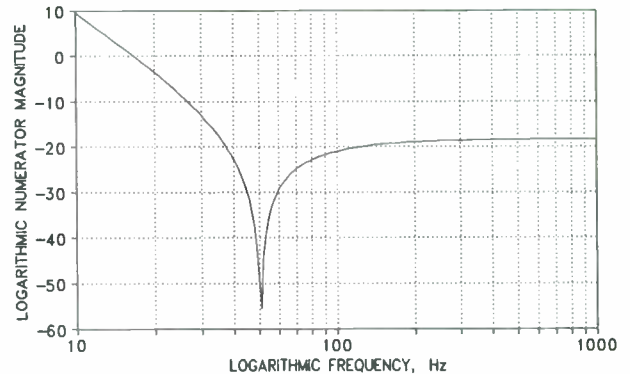

**FIGURE 5:** Numerator frequency response.



It can be your solution for **Perfect** **high frequency reproduction**

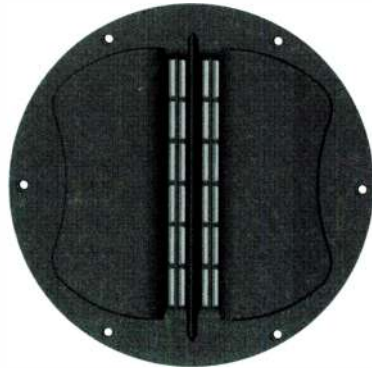

SPECIFICATIONS			
Characteristics	Symbol	Value	Units
Frequency Response		(± 1.5dB) 1.7-21kHz	
Nominal Impedance	Z	8	Ω
Nominal Power Handling	P <sub>nom</sub>	30	W
Sensitivity (1w/1m)	E	93.5	dB
Weight	M	0.6	kg

**MAGNET**

Neodymium / Ferrite combination

Why we call RT2 isodynamic? Contrary to a conventional dynamic driver, this transducer has a driving force distributed evenly over the whole area of vibrating element.

What is special in RT2?

The key element of RT2 is a membrane, which consists of a Kapton® film with a pattern of Aluminum conductors. The conductors take about 90% of the whole vibrating area. The membrane assembly is placed precisely between two rows of Neodymium and Barium Ferrite bar magnets. The plastic mounting flange with flared waveguide controls the frequency response and directivity of the tweeter.

This tweeter has large membrane area providing higher power handling and substantially extended low end cut-off frequency.

The clamped membrane area is connected to the massive front metal plate. This combined with a special heat conductive compound provide effective cooling of aluminium conductors, dramatically increasing dynamic range of RT2.

The vibrating element of RT2 is almost weightless in comparison to a dome tweeter. It provides an immediate and precise response to any transients in original signal.

RT2 has resistive impedance in audio frequency range. This unique feature makes RT2 an easy load for an amplifier and substantially facilitates a crossover design. Unlike other drivers, RT2 has essentially a linear phase response that provides time coherent reproduction resulting in accurate musical rhythm and imaging.

Unlike other conventional tweeters, RT2 has well controlled sound dispersion in vertical plane. This feature helps to avoid disturbing floor and ceiling reflections in a home environment thus enhancing clarity and imaging accuracy. Remarkably, you don't have to use three tweeters in home theater systems anymore in order to achieve desired vertical directivity!

Considering all properties of RT2, it becomes clear why many critical listeners among audiophiles prize very high planar transducers for their unsurpassed clarity, transparency and ability to deliver every tiniest musical detail.

Since RT2 has exceptional sonic resolution and ability to reveal the dynamics of instruments, it is recommended to match it with drivers having the similar properties in order to maximize overall integrity of a speaker system.

Recommended second order crossover cut-off frequency - from 1.8 kHz.

planar  
**isodynamic  
tweeter**

**RT2**

from  
**Hi-Vi RESEARCH®**

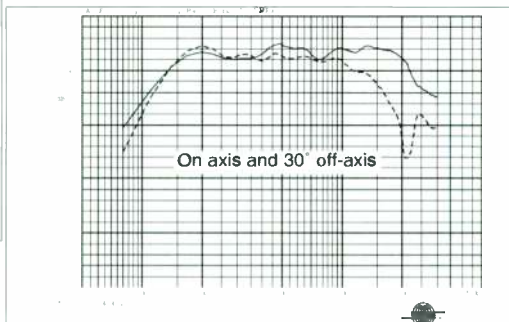
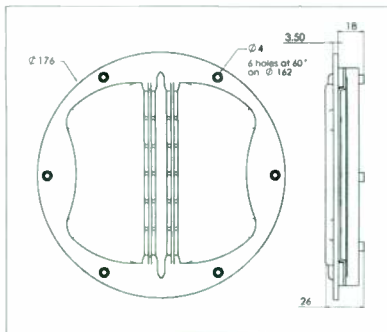

Kapton® is a registered trademark of DuPont

for more info please

**Call:** (905)-889-7876

**ACOUSTIC TECHNOLOGY  
INTERNATIONAL INC.**

15 WEST PEARCE STREET UNIT 2&3  
RICHMOND HILL, ON L4B 1H6 CANADA  
Tel: (905)-889-7876 Fax: (905)-889-9296

[www.dulcet.com](http://www.dulcet.com)

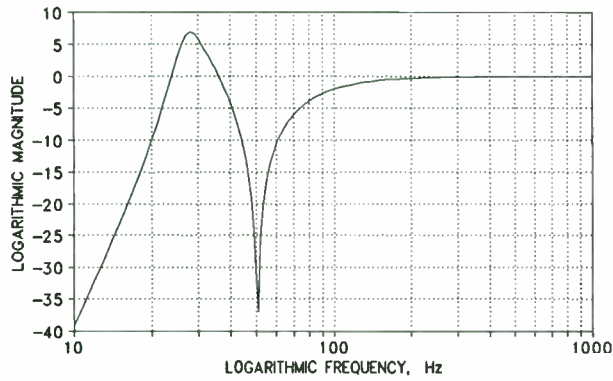

**FIGURE 6:** Transfer-function frequency response.

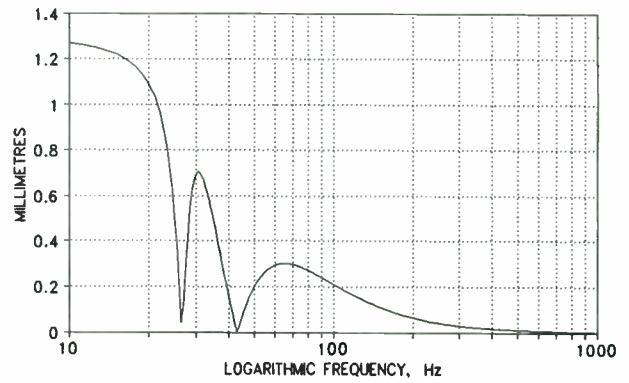

**FIGURE 7:** Loudspeaker cone displacement.

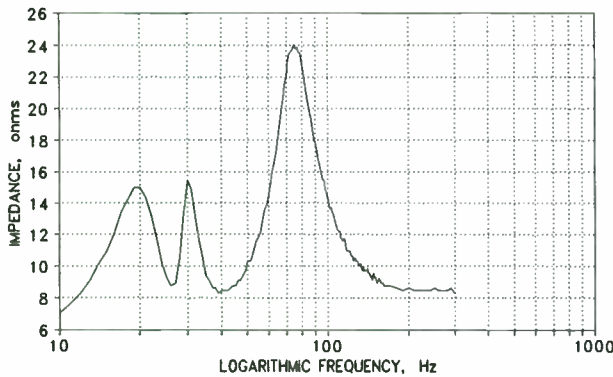

**FIGURE 8:** Measured electrical-impedance magnitude

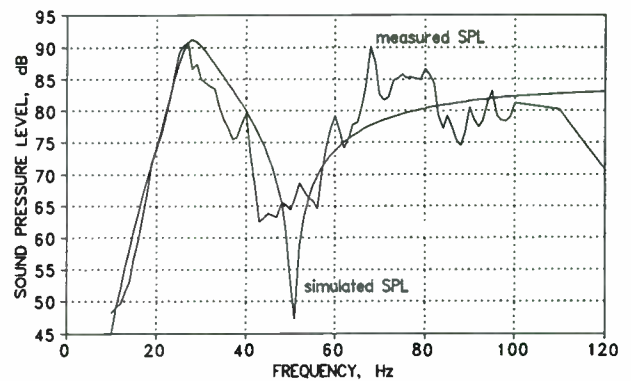

**FIGURE 9:** Measured and simulated frequency-response curves.

the numerator polynomial is a function of both chambers' resonant frequencies and their respective volumes, simulating a minimum at 50.4Hz.

The superposition of the numerator on the denominator produces *Fig. 6*, the transfer-function or overall system's frequency response. The system indicates a high roll-off rate, a low roll-off frequency, and a big dip and hump in the frequency response. The dip dominates from about 29Hz to 81Hz, where it is back at a -3dB point. The initial -3dB point occurs at about 20.5Hz; the hump peaks at +6.5dB at 28Hz and subsides to the second -3dB position at 41Hz.

The simulated results compare favorably to the measurements done by Weems, although the dip of the double reflex enclosure is not so evident in his test results. This could be due to enclosure losses, air mass in vents (especially at the 20-60Hz region), and system-coupling parameters.

### CONE DISPLACEMENT

The loudspeaker cone-displacement simulation was an important factor of the design. Obtaining 20Hz from a 6½" speaker is great, but it must be within the physical pos-

sibilities of the system. The cone-displacement measurements are shown in *Fig. 7*. To measure the cone movement, a sine wave was injected into the system, a lightweight plastic pointer attached to the cone, and a ruler placed under the pointer to verify the cone movement.

The input signal was a 7.87V sine wave from the ATE rack Reference Standard Audio Synthesizer (HP8904A). Cone motion measurements below 30Hz were accurate, but above this the displacement was too small, and the cone was moving too fast. The simulated results included the input signal used in the actual testing of the system.

### IMPEDANCE MEASUREMENTS

The impedance measurement of the system (*Fig. 8*) utilized the ATE rack, allowing me to do other tasks while the system data was recorded and logged. The impedance plot showed no irregularities with the design, two minimum points occurring when the two chambers were at their respective resonant frequencies. The three peaks of the impedance curve correlate with the enclosure's design of multiple chambers and ports.

### MEASURED ACOUSTICAL FREQUENCY RESPONSE

I measured the enclosure's acoustic radiation at a distance of 1m from the loudspeaker's front panel, on-axis vertically with the speaker and midway between the speaker and the second-chamber vents. The frequency response was measured with the enclosure in a bare state, that is, with no damping material inside either chamber, and limited to below 1kHz.

I performed the test manually using a Brüel and Kjaer 2209 SPL meter inside the Arts Theater on the university campus. I chose the theater because its large size and padded seating and walls would attenuate any reflections. (The ATE equipment room was too small and lacked absorptive qualities, so I did not use it for these tests.)

### SPECIAL THANKS

Special thanks to Jim Ball, who was my project supervisor throughout the year, and to Brad Serhan for the loudspeaker and his advice on the project.



The measured and simulated frequency-response curves are shown in Fig. 9, highlighting the correlation of results. The graph relates the two curves in the bass region only, where the simulated response was most interesting. As the test frequency was increased, it was evident that the lack of internal damping and bracing was affecting the measured results' smoothness, and some peaks and dips began to appear.

During the testing, the frequency generator and counter were set up on top of the enclosure itself. At 253Hz, the entire assembly began to vibrate, indicating that the internal standing waves of the enclosure peaked at this point.

Unfortunately, I did not have time to brace the enclosure and remeasure the system's frequency response. Moving the internal port between the two chambers (either all in the top or all in the bottom) did not affect the response of the system.

### CONCLUSION

Although I never played any music through the system, the sound produced by the enclosure was effortless, especially at low frequencies. During the impedance measurements through the ATE rack, this was quite evident as the test frequency increased to the 20Hz region and the internal walls of the ATE room began to vibrate. It would have been interesting to build the 400 ltr enclosure to verify the 24Hz resonance from the Peerless drive unit.

The effortless production of 28Hz from such a relatively small enclosure, using a loudspeaker whose resonant frequency was 46Hz, is quite amazing, especially considering the small cone displacement of the speaker throughout the bass-region frequencies. I am sure that if the enclosure were properly braced, built more solidly, and acoustically dampened, that the system's frequency response would be quite devastating.

Further development and design are currently under way, using similar design principles for suitable 4" and 5" drive units to provide excellent bass roll-off from a small-volume enclosure. Test results from the new designs should be available in the next few months for comparison with the enclosure this article describes.

### REFERENCES

1. Augspurger, G. L., "Double Chamber Speaker Enclosure," *Electronics World*, December 1961, p. 41.
2. Weems, David B., "A Small Double Chamber Reflex," *SB* 4/85, p. 14.
3. Thiele, A.N., "Loudspeakers in Vented Boxes," Sydney, Institution of Radio and Electronic Engineering Convention, 1961.



THE NAME TELLS IT ALL

---

## ELECTROSTATIC SPEAKER KITS

**CURVED**

**SEE-THRU**

**FULL-RANGE**

FROM:

**\$199.**

IT'S GOT FUNDS

**WOW!**

**TEN**

**NEW**

**KITS!**

TEN KITS TO SUIT EVERYONE! CHOOSE FROM THE SINGLE **IMPACT-8** (6" X 36") AT \$199. PAIR TO THE MONSTER DOUBLE **IMPACT-8S** (36" X 72") AT \$1,099. PER PAIR!



**SINGLE IMPACT-12**  
\$399. PAIR



**DOUBLE IMPACT-12**  
\$499. PAIR

SEND \$2.00 FOR COMPLETE IMPACT BROCHURE PACKAGE. MAKE CHECKS PAYABLE TO: DAVID LUCAS

**DAVID LUCAS**

924 Hulton St, Oakmont, PA 15139

WORLD'S LARGEST SUPPLIER OF ELECTROSTATIC SPEAKER KITS, COMPONENTS, MODS, REPAIR PARTS, EXOTIC CIRCUITS, TRADE SECRETS & TECHNICAL INFORMATION

# AN ISOBARIK TOWER—THE SEQUEL

By Paul L. Kittinger

In the 5/97 issue of *Speaker Builder*, I described an Isobarik tower speaker I designed and built. I was very pleased with the way it turned out, but having become an avid audio enthusiast in recent years, I couldn't leave well enough alone. So, I decided to build another, improving on the design. My objectives for this latest design were:

1. Size: Footprint of  $\sim 1\text{ft}^2$ ; height less than 48";
2. Construction: Less complicated design; easier to build;
3. Tweeter: Fabric dome;
4. Midrange: Increased acoustical power; improved imaging;
5. Bass: An  $f_3$  as close to 30Hz as possible;  $Q_{tc}$  of 0.7–0.8;
6. Enclosure type: Sealed;
7. Material cost: \$1100 or less.

## CHOICES AND COMPROMISES

As in my previous design, I opted to use two 8" woofers in an Isobarik configuration to minimize the cabinet's size and internal volume. I also decided to use two midrange drivers, for increased acoustical output, in a D'Appolito configuration around a dome tweeter for better imaging. To make construction as easy as possible, I'd locate the woofers at the bottom of the cabinet, firing down and then out of slots at the bottom of the cabinet's front and sides.

Primarily, that decision meant designing the system as a two-way with an integral subwoofer, so to speak—rather than as a typical three-way—with the crossover between woofer and midrange occurring at 100Hz or lower to eliminate localization of the woofers' output. Secondly, since the midrange would then need to respond down

to 100Hz or lower, its enclosure would also be sealed. Finally, I decided to use third-order Butterworth crossovers to minimize driver-response overlap and because odd-order crossovers tend to favor the D'Appolito configuration.

I expected the crossover from the midrange to the tweeter to be in the 2.4–3.2kHz range, determined by the center-to-center spacing between the midrange drivers and the tweeter. For the midrange drivers, I chose the Morel MW-166 6" units because they sounded so good in my previous design, have a fairly low resonant frequency (48Hz), and respond nicely up to 5kHz. As the dome tweeter, I picked the Morel MDT-40 for its specifications and especially its very small faceplate dimensions that allow short distances between midrange and tweeter centers.

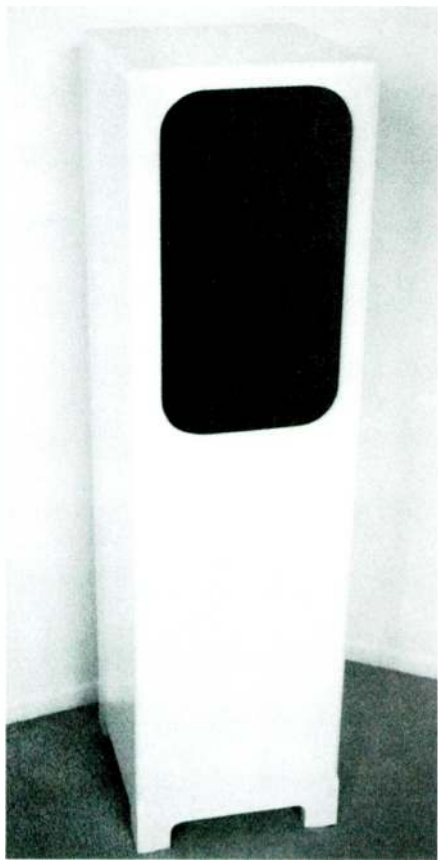

PHOTO 1: Front view, with grille.

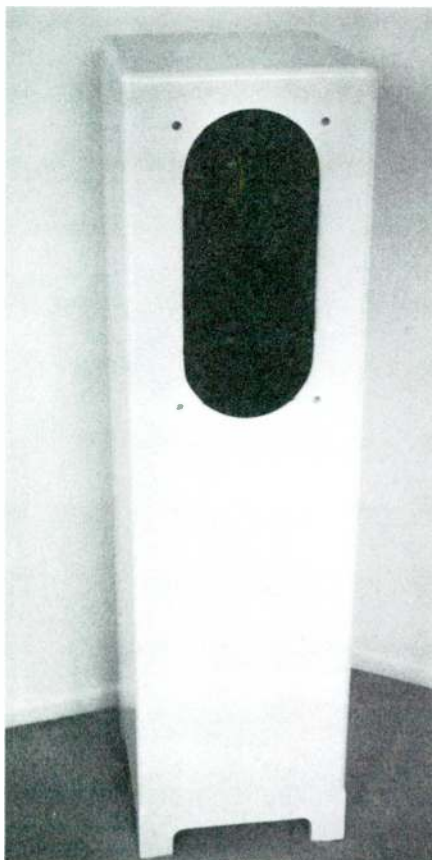

PHOTO 2: Front view, without grille.

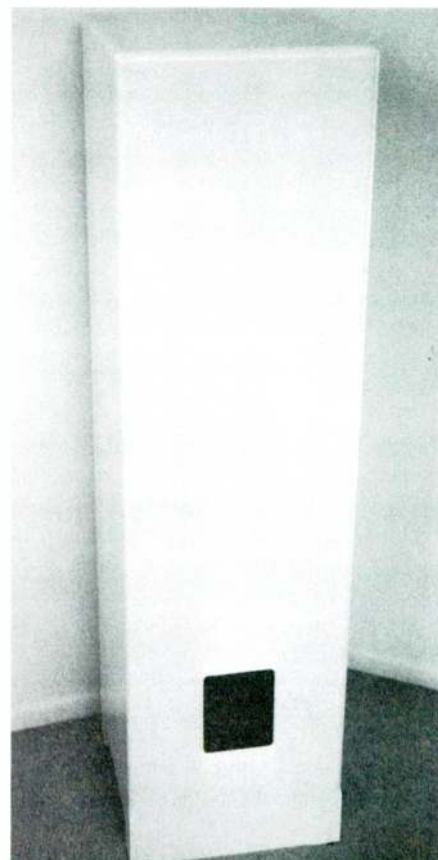
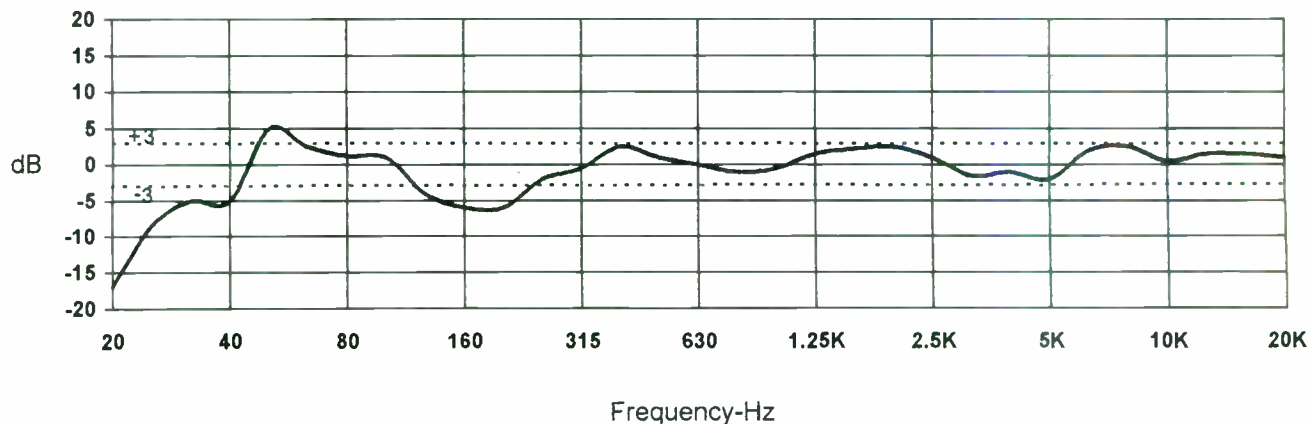

PHOTO 3: Rear view.





**FIGURE 1:** Frequency-response graph.

Lastly, after much research and calculation, I selected the Morel MW-266 for the woofers because, of all the drivers I considered, they had the best compromise between  $V_{as}$ ,  $F_s$ ,  $Q_{ts}$ , and  $X_{max}$  (there are always compromises). Also, the ratio of  $F_s$  to  $Q_{es}$  (40) made these woofers suitable for a sealed enclosure.

#### ENCLOSURE SIZES

In order to meet my size requirements, the sealed cavities for both midrange and woofers had to be somewhat undersized, but by using the proper type and amount of fill material (foam, fiberglass, polyester fiber, and so on), I expected to achieve my target  $Q_{tc}$  and  $f_3$ . Furthermore, even though the midrange drivers would not reproduce the very lowest frequencies, they would need to respond down to approximately 50Hz in their cavity in order to achieve a smooth transition at the woofers' crossover frequency.

I therefore chose a crossover of 100Hz, so the midrange drivers would have an  $f_3$  of approximately 50Hz if their high-pass crossover did not start rolling down at 100Hz. As it turned out, both woofer and midrange drivers in their cavities had calculated  $Q_{tc}$ s of approximately 0.9 prior to adding fill material.

Based on the test results published in Vance Dickason's excellent book, the *Loudspeaker Design Cookbook*, I decided to use a combination of convoluted foam lining the walls of the cavities and an appropriate amount of Acousta Stuf® filling the remaining volume. This combination of materials theoretically would result in the best compromise (there's that word, again) for lowering both  $Q_{tc}$  and  $f_3$ , with the calculated  $Q_{tc}$ s of both cavities expected to end up around 0.75, and the woofers'  $f_3$  at 34Hz.

Since it worked out so well with my previous speaker effort, I used the same basic design for the cabinet construction: butt

joints; nail and glue attachment; 3/4"-thick MDF (medium-density fiberboard) for all cabinet walls and braces; and strips of 1/2" wide MDF running top to bottom to form slots for horizontal braces and shelves, to create attachment "runners" for the front and rear panels, and to increase the cabinet's rigidity.

Unlike my previous design, mounting the woofers at the bottom in their Isobarik chamber made unnecessary an access door for installing the inner woofer (you install the woofers from the bottom, one behind the other). This made the cabinet less complicated and easier to assemble, and with ample bracing I expected it would have no bothersome resonances.

Builders almost always recommend using material for the front panel (baffle) that is thicker than the rest of the cabinet. If you're like me, however, you don't want to

end up wasting most of a 4' x 8' sheet of MDF. That's why I use the same thickness for all panels; but I make sure to use lots of bracing. Also, with this design, I do not mount the woofers on the same panel as the other drivers, so I assume there will be less vibration transferred to the other drivers at low frequencies. It's another compromise, and the designer's choice.

#### HOW DID IT WORK OUT?

A finished system is shown in *Photos 1, 2, and 3*. Its dimensions are 12" wide, 13" deep, and 44 1/2" tall, with the tweeter's center at 35" from the floor. *Figure 1* shows the overall frequency response of the system. I measured this with my sound-pressure-level (SPL) meter located 6' from the system at a height of 35", using tracks 16-18 of *Stereophile's Test CD 2* to generate frequencies at 1/3-octave

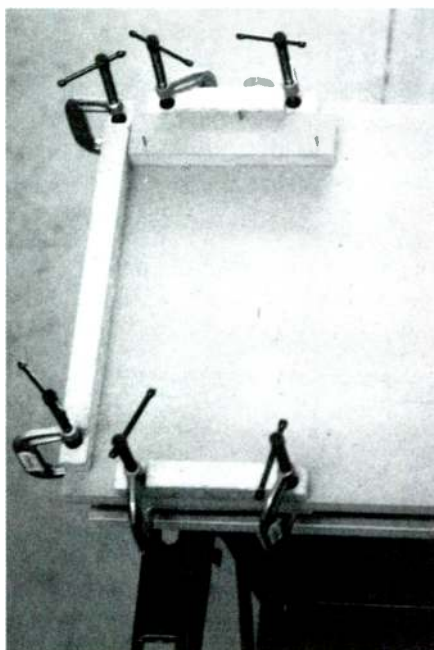

**PHOTO 4:** Side panel clamping detail #1.



**PHOTO 5:** Side panel clamping detail #2.

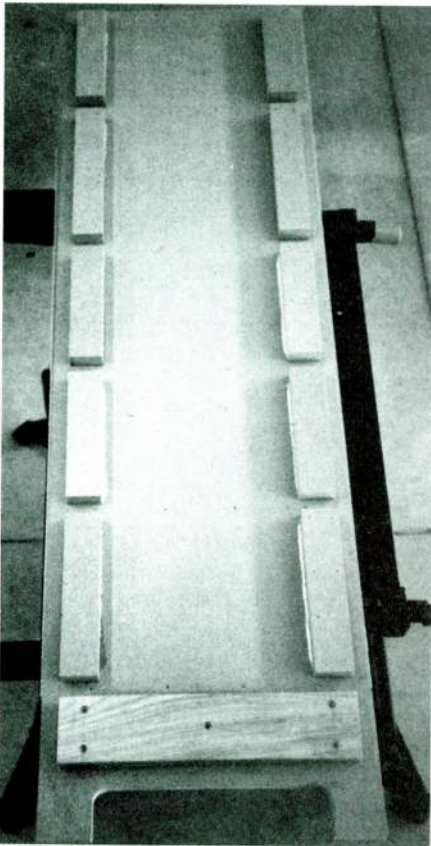

**PHOTO 6:** Completed side panel.

intervals. I used a reference SPL of 70dB.

From 250Hz on up, the measured response falls within about a 4–5dB window, which is pretty good performance in a normal room. Below 250Hz, the room characteristics dominate. I believe the large dip between 100–250Hz is typical of partial cancellations from “floor bounce,” and the peak at 50Hz followed by the sharp drop at 40Hz is caused by resonances in my room. If I could make these measurements in an anechoic chamber, I would expect a much smoother response.

I made two sets of measurements, one with and one without the grille attached. The differences were virtually negligible, so I’ve shown only the one with the grille on. Another measurement, which I haven’t shown, is that from the close-miked woofer. This peaked at 50Hz as expected, and indicated an  $f_3$  of 38Hz with  $Q_{tc}$  in the desired range. This  $f_3$  is higher than calculated, but I expect it to decrease a bit as the woofers loosen up with use. I’m estimating a sensitivity in the 86–89dB range based on the setting of my preamp’s volume control and previous sensitivity measurements of other speakers.

The music these speakers reproduce is quite good and pretty much as expected. With two midrange drivers sharing the load, I’m able to play music at higher levels than I normally use without obvious distor-

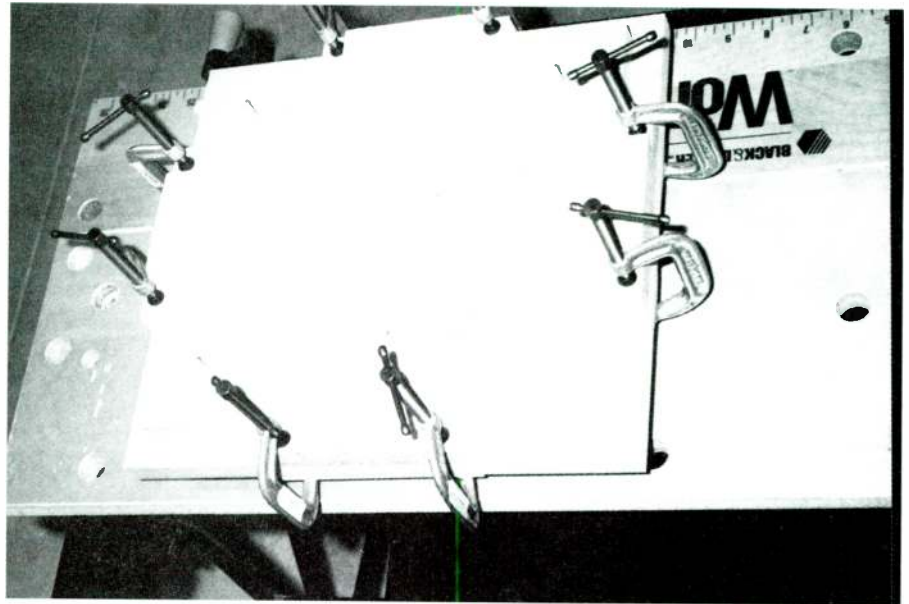

**PHOTO 7:** Top-assembly clamping detail.

tion, and the D’Appolito arrangement has resulted in extremely good imaging, allowing accurate depiction of various instruments’ stage positions.

One bit of advice is necessary, however. With the woofers located at the bottom of the cabinet, I found room resonances in the 50–80Hz range to be easily activated with the speakers located close to the wall behind them or to side walls or corners (my room has some really nasty resonances in the 50–65Hz area). I recommend placing the cabinets at least 1½ feet in front of a wall and several feet from side walls and corners. Speaking of resonances, even though I was unable to make any measurements, the cabinet seemed to be essentially free of any.

As far as costs are concerned, I spent just under \$1150 to build a pair of these speakers, including sales taxes and shipping costs for mail-order purchases. I certainly would not say these speakers are inexpensive, but anything commercial with comparable performance would cost significantly more—and you would not have the satisfaction of building it yourself. Could these speakers be improved? Certainly, but I’m satisfied with their overall performance, and any possible improvements would be incremental, not major, and probably limited to frequencies below 250Hz.

#### DESIGN DETAILS

I used ¾" MDF throughout, except for the crossover base boards and the grille boards, which I made from 3/8" particleboard. To ensure adequate strength, I reinforced the Isobarik chamber with strips of 1" × 3" birch (which actually measure ¾" × 2½"). The birch also forms mounting rails for the outer

(bottom) woofer panel, which I screwed into the birch strips. I bought the birch in 2' lengths (you’ll need four of these). Be aware that stock wood strips are not always square, so select your pieces carefully, making sure they aren’t curved or twisted.

I assembled each of the three crossovers on a separate board. Separate assemblies are supposed to have sonic benefits, but I did this for a more practical reason: the midrange and tweeter crossovers must fit through the midrange driver cutouts for installation, and one board would have been too large. I mounted the crossover assemblies on the side walls of their respective drivers’ cavities.

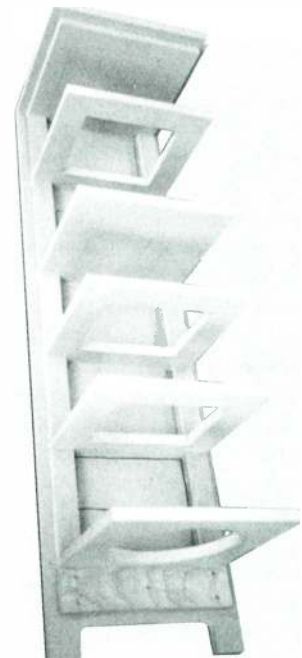

**PHOTO 8:** Side panel with the horizontal pieces and top in place.



# Peerless



MADISOUND SPEAKER COMPONENTS  
8608 UNIVERSITY GREEN  
P.O. BOX 44283  
MADISON, WI 53744-4283 U.S.A.  
TEL: 608-831-3433 FAX: 608-831-3771  
e-mail: madisound@itis.com  
Web Page: http://www.itis.com/madisound



## TWEETERS

Model	$\Omega$	Fs Hz	Qts	Vas Ltrs	Power	cB	Box Liters	F3 Hz	Price
801730: 62CT 13/40 PPb (conc tweeter)	8	1513			100	88.5			\$12.40
811582:80DT 26/55 SF	8	1075			90	89.0			15.55
811546:100DT 26/72 SF	8	1006			100	92.0			18.85
811528: 94 DT 26/72 SF (Square Flange)	8	980			100	9.15			18.00
812687: 105 DT 26/72 SF (811687)	8	963			130	91.6			25.75
811815: 100 DT 26 72 SF WA (Wide Angle)	8	917			100	93			20.20
810665:115DT 26/72 SF (Used in older Polk Systems)	8	1056			80	91.5			32.40
811647:100HT 26/72 SF (Horn Tweeter)	8	1040			100	99.0			22.40
We stock voice coils for all the Peerless tweeters, except the 810665. All voice coils are the same price:									7.65

## MIDRANGES

821214:134 DMR 51/100 SF	8	298	.65		200	89	chambered		\$44.20
821646:140 HDM 51/100 SF (Horn Mid)	8	454	1.07		200	93	chambered		45.75
821385:122 MF 26/72 SP (KO40MRF)	8	224	1.20		100	90	chambered		44.00
821615:122 M 26/72 PPB (TO105)	8	530	.72		180	91	chambered		44.00

## WOOFERS

832591:130 WR 26/72 PPB (5" Woofer)	4	51.5	.41	11.5	100	88.8	5.7S/10V	90/52	\$35.55
832592: " "	8	54.9	.43	11	100	86.9	7S/13V	89/49	35.55
833597:165 WF 33/100 PPB (6.5" Woofer)	4	45.2	.28	20.1	150	92.1	4S/5V	115/75	36.20
833429: " "	8	47.5	.34	20.7	150	88.7	6S/10V	95/65	36.20
833594:165 WR 33/100 PPB (6.5" Woofer)	4	40	.24	27.1	150	92.2	3.5S/6V	120/80	39.75
833599: " "	8	36.2	.28	32.2	150	88	6.5S/9.5V	90/60	39.75
831510:210 WF 26/72 PPB (8" Woofer)	8	37.9	.82	66.6	100	86.8	60+S	40	28.40
832556: " "	8	32.3	.37	82.4	150	89.7	34S/55V	61/38	37.75

## CC LINE WOOFERS

Model	Imp. $\Omega$	Fs Hz	Qts	Vas Ltrs	Power Watts	cB	Xmax mm P	Box Liter S/V	F3 Hz	Price Each
832733:146 MR 26/102 PPB/AL (5" Midrange)	8	59	.34	8.7	125	88.1	$\pm 3.5$	2.7S/4.5V	122/77	44.65
832757:180WR 33/102 PPB (7" Woofer)	4	35.2	.26	32.6	150	90.5	$\pm 5$	5S/7V	97/69	51.55
832732: " "	8	35.2	.29	32.9	150	87.9	$\pm 5.5$	7S/10V	86/58	51.55
831758:220 WR 33/102 PPX/AL (8" Woofer)	4	22.1	.36	109	150	88.8	$\pm 5$	39S/61V	43/28	56.20
831709: " "	8	25	.45	86.9	150	86.9	$\pm 5.5$	60S/115V	39/24	56.20
831858:220 SWR 39/115 PPX/AL DVC (8" W.)	8/8	22	.23	79.8	200	90.5	$\pm 7$	10S/15V	65/45	68.85
831759: 260 SWR 39/115 PPX/4L AL (10" Woofer)	4	22.4	.27	121.9	220	91.5	$\pm 7.5$	22S/32V	58/40	68.85
831727: " "	8	22.3	.34	136.2	220	87.8	$\pm 9$	40S/63V	45/30	68.85
831857: 315 SWR 39/115 PPX/4L AL (12" W.)	8	24	.44	210	220	89.3	$\pm 9.0$	100S/242V	39/23	91.10

## ➔NEW CSC LINE WOOFERS - Composite Sandwich Cone

850100: 116 WR 26 72 SD (4.5" Woofer)	8	80.7	.58	2.7	100	85.9	$\pm 1.5$	4S	99	\$31.00
850106: 145 WR 26 90 SD (5.5" Woofer)	8	50	.35	11.7	110	87.8	$\pm 3.5$	3.8S/6V	100/65	34.85
850118: 176 WR 33 102 SD (7" Woofer)	8	37.2	.43	28.5	150	87.0	$\pm 5.5$	14S/20V	60/45	45.55
850131: 217 WR 33 102 SD 4L (8" Woofer)	4	28	.37	77.4	150	91.4	$\pm 5.5$	28S/35V	53/39	50.00
850138: 257 WR 33 90 SDX 4L (10" Woofer)	8	26.7	.52	111.1	150	88.0	$\pm 4$	90S	36	62.65
850141: 257 WR 33 102 SDX 4L (10" Woofer)	4	25.7	.48	127.9	150	91.1	$\pm 5.5$	90S	38	66.40
850144: 257 WR 39 115 SDX (10" Woofer)	8	24.1	.45	137.6	200	88.0	$\pm 5$	80S	38	74.40
850145: 257 WR 39 115 SDX (10" Woofer)	4	23	.35	145.9	200	91.4	$\pm 5$	50S/80V	45/30	74.40

## ➔NEW CSC-X LINE WOOFERS - Composite Sandwich Cone and Short Circuit Ring

850108: 145 WR 26 90 SD AL (5.5" Woofer)	8	48	.34	12.5	110	87.3	$\pm 4.5$	4S/6.3V	96/62	\$39.55
850122: 176 WR 33 102 SD AL (7" Woofer)	8	38	.43	27.7	150	86.6	$\pm 5.5$	14S/20V	59/40	51.55
850136: 217 WR 33 102 SD 4L AL (8" Woofer)	8	28.2	.27	79.7	150	89.7	$\pm 4$	14S/21V	70/48	59.10
850146: 257 SWR 39 115 SDX 4L AL (10" Woofer)	8	22.6	.35	144.4	200	88.2	$\pm 9$	53S/88V	43/27	82.20

## ➔NEW CDC LINE AUTOSOUND WOOFER - Injection Molded Cone and Surround

830237: 100 WR 26 72 CD (4" Woofer)	4	81.2	.52	2.8	110	89.4	$\pm 0.5$	3S	112	\$24.85
-------------------------------------	---	------	-----	-----	-----	------	-----------	----	-----	---------

I used a terminal cup having two pairs of binding posts, with the woofer's crossover input wired to one pair, and the midrange and tweeter crossovers' inputs wired to the other. This allows the speaker system to be biwired, or driven with separate amplifiers, one for the woofer and the other for midrange and tweeter. You can use a single pair of binding posts instead if you do not desire biwiring or biamplification.

To make the electrical connections in the sealed cavities, I used a pair of 10–32 bolts through the inner woofer-mounting panel and another pair through the bottom panel of the midrange and tweeter cavity. I made the connections from the wires to the bolts with crimp-on ring lugs, secured with lock-washers and nuts. I placed a bit of silicone sealant in the holes for the pass-through bolts to prevent leaks.

I used 14-gauge stranded wire between the lower pair of input posts and the woofers' crossover, between that crossover's output and its pass-through bolts, and between the upper pair of input posts and the pass-through bolts for midrange and tweeter. All other interconnecting wire is stranded 16-gauge.

I soldered the connections to the input posts, but made all other connections with crimp-on solderless connectors. Using soldered connections is often preferred, but it's difficult to make changes later, and most driver warranties won't be honored, I believe, if their terminals have been soldered. I twisted together the leads in each pair. The woofers' coils are wired in parallel, positive to positive, and negative to negative, as are the coils of the midrange drivers.

## CROSSOVER DESIGN

Since this full-range system is really a two-way with an integral subwoofer, the crossovers are a bit nonstandard. Using published equations for a two-way, third-order Butterworth, I calculated values for inductors and capacitors of the 3kHz low-pass and high-pass sections for midrange and tweeter (I used 3kHz because the center-to-center spacing between each

midrange driver and the tweeter is equal to one wavelength at that frequency).

I used the same low-pass equation for the woofer crossover components as for the midrange. Then, to figure the value of the capacitor needed in series with the midrange crossover input, I first calculated the input impedance at 100Hz for the total midrange crossover with drivers connected. Not surprisingly, this came out to 4Ω,

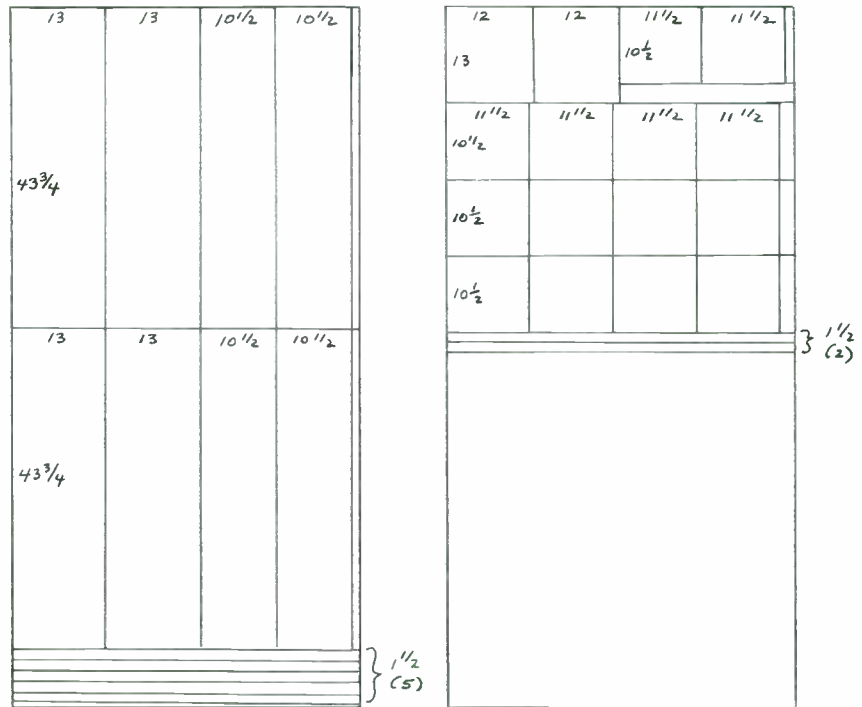

FIGURE 2: Cutting guide for MDF sheets.



PHOTO 9: Clamped side panels.

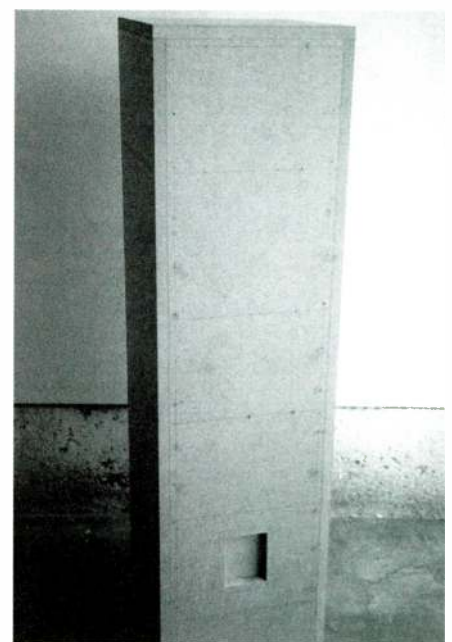

PHOTO 10: Rear panel installed on side panels.



# The Process of Design.

## DRIVERS:

- ▶ AIRBORNE
- ▶ ATC
- ▶ AUDAX
- ▶ DYNAUDIO
- ▶ ETON
- ▶ LPG
- ▶ MOREL
- ▶ PEERLESS
- ▶ SCAN-SPEAK
- ▶ SEAS
- ▶ VIFA
- ▶ VOLT

## COMPONENTS:

SOLEN HEPTA-LITZ AND STANDARD INDUCTORS AND CAPACITORS - THE CHOICE OF MANY HIGH-END SPEAKER MANUFACTURERS.

## HARDWARE:

POWER RESISTORS, L-PADS, CABLE, ABSORBING AND DAMPING MATERIALS, GOLD SPEAKER TERMINALS, GOLD BANANA PLUGS AND BINDING POSTS, GRILL FASTENERS, PORT TUBES AND TRIM RINGS, PAN HEAD SCREWS, SPIKES AND TEE NUTS WITH ALLEN HEAD BOLTS AND PLENTY MORE...

**CUSTOM  
COMPUTER AIDED  
CROSSOVER AND  
CABINET DESIGN**

## HOW TO BOOKS

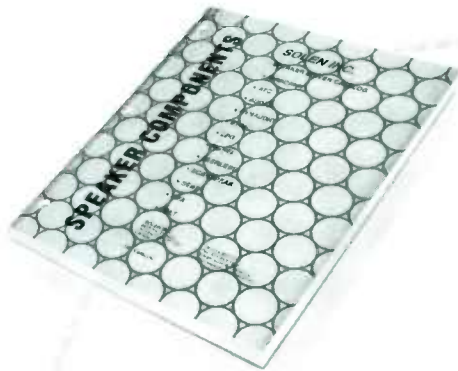

DYNAUDIO



When designing a loudspeaker, the initial driver considerations and final driver choice can make or break a project. To ensure your success - you want the most complete information and specifications at your finger tips - the 1998 Solen catalog

Order the 1998 Solen catalog - containing a wide selection of quality drivers - with complete manufacturer's spec sheets, as well as applications in detail on woofers, with predicted response in different sealed and vented enclosures. It is a valuable resource that will flush out the possibilities in your designs.

With your order we will also throw in our components catalog **FREE** - it's full of a wide selection of speaker hardware and crossover parts.



**Order the 1998 Solen Catalog for \$8.00, refundable on your first order over \$50.00.**

Fax 514-443-4949 or mail this coupon today, or call with your request, 514-656-2759.

Name: _____	<b>Payment Method</b>
Address: _____	<input type="checkbox"/> Payment Enclosed - Check or Money Order
State/Prov: _____	<input type="checkbox"/> VISA <input type="checkbox"/> Mastercard
Zip/Postal Code: _____	Card No: _____
Country: _____	Card Expiry Date: _____
Tel: _____	Email: _____
	Signature: _____



**SOLEIN INC.**  
4470 Avenue Thibault  
St-Hubert, QC  
Canada J3Y 7T9

Tel: 514.656.2759  
Fax: 514.443.4949  
Email: [solen@quebec.net](mailto:solen@quebec.net)  
WEB: <http://www.quebec.net/solen/>

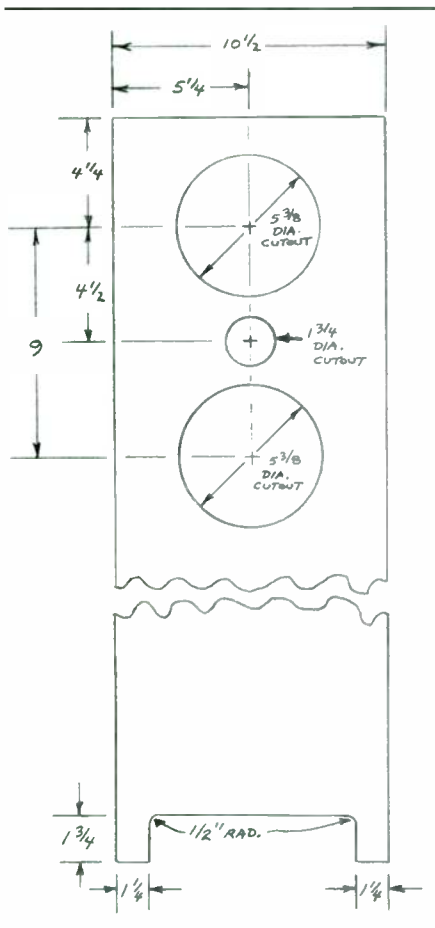

**FIGURE 3:** Front panel.

which I used for the value of the capacitive reactance to calculate that a capacitance of  $390\mu\text{F}$  would be required.

The primary purpose of this capacitor is to keep the very low frequencies out of the midrange drivers and avoid any distortion that would otherwise occur. The secondary purpose is to form a third-order rolloff by combining the natural second-order rolloff of the sealed midrange cavity with the first-order rolloff created by the capacitor.

Thus, the midrange response should be

3dB down at 100Hz, rolloff at 6dB/octave to approximately 50Hz, then rolloff at 18dB/octave below 50Hz. My initial tests of the midrange response, however, showed an  $f_3$  of about 60Hz, so I decreased the input capacitor's value experimentally until  $f_3$  was close to 100Hz.

For all three crossovers, I calculated sensitivity losses caused by coil resistances of any series inductors. I also calculated the natural frequency-dependent insertion losses of the crossovers with drivers connected at the corner frequencies, at one-half and one-quarter the corner frequencies for the

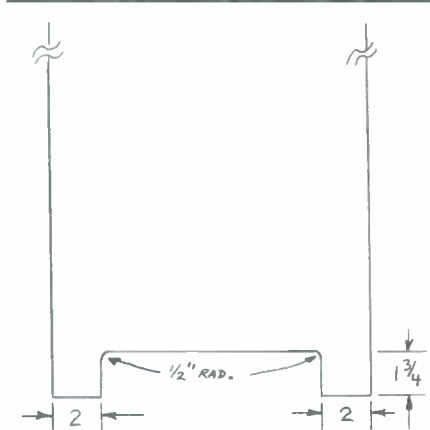

**FIGURE 4:** Side-panel bottom.

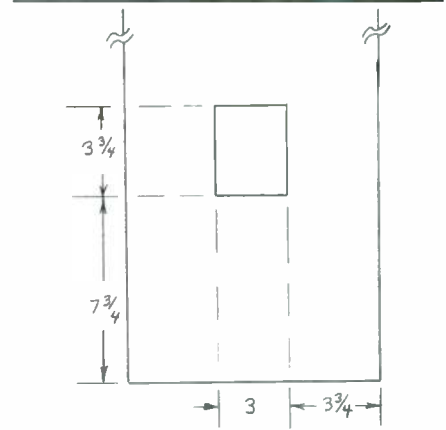

**FIGURE 5:** Rear-panel bottom.



**PHOTO 11:** Foam and wiring installed in cabinet.

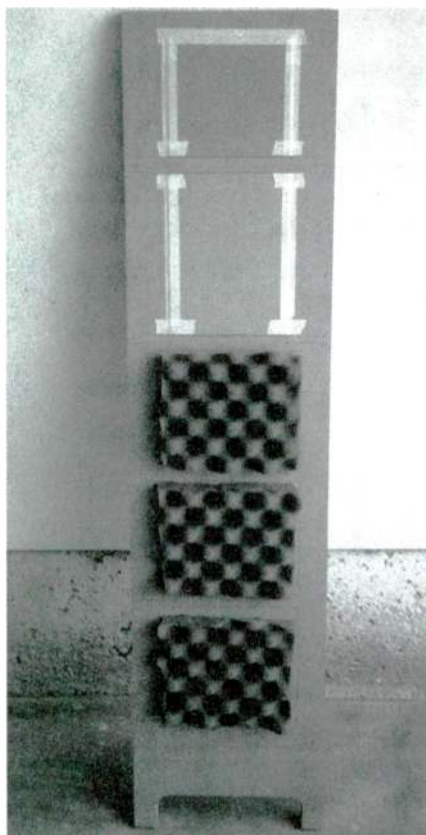

**PHOTO 12:** Foam installed inside front panel.



**PHOTO 13:** Cabinet with front panel installed.



# ZALYTRON

YOUR ONE STOP SHOPPING CENTER

FOCAL

VIETA

Cabasse

morel

SR

PHILIPS

Polydax  
speaker corporation

seas

ZALYTRON  
CUSTOM WOOFERS

l'atelier audio

ACCUTON

## Let's Revive the Aria Five!!

Zalytron is having a  
special Aria 5 Sale

**\$399**  
for parts.

**Cabinets and damping  
optional.**

The Aria 5 has been a classic Joe D'Appolito design for quite a while. It is one of the most popular small speakers we have ever carried. The current version is quite an improvement over the original. It features the new Focal TC90/TDX Tweeter and the Focal 5K0136 5" Woofer. Together they make a much better sounding speaker than the first generation. Zalytron has purchased giant quantities of both these models. This allows us to offer a special price and make it affordable to all customers that would like to experience this wonderful sound.



**ZALYTRON INDUSTRIES CORP.**

**469 JERICHO TURNPIKE, MINEOLA, N.Y. 11501**

**TEL. (516) 747-3515**

**FAX (516) 294-1943**

Our warehouse is open for pick-up 10 AM to 6 PM daily, Saturday 10 AM to 5 PM

UPS orders shipped same day \* Minimum order \$50.00

Call or Write for our latest catalog mailed FREE in the USA. Canada \$5 P&H, Worldwide \$10 P&H

low-pass sections, and at twice and four times the corner frequencies for the tweeter high-pass section. This should have resulted in fairly accurate calculations of relative sensitivities of the three driver sections when combined with their crossovers.

From these calculations, I determined that the midranges' overall sensitivity should be only a few tenths of a dB higher than that of the woofers', not requiring any attenuation of the midrange section to match it to the woofer section. The tweeter section, however, theoretically needed 1.2dB of attenuation. Final testing showed I

all sensitivities. If you use inductors with significantly different resistances, sensitivity mismatches between driver sections will likely result, and the system  $Q_{tc}$  will probably be different.

For some of the capacitor values, I paralleled multiple units to get combined labeled values as close as possible to those I calculated. Except for two of the Zobel networks, all nonpolarized electrolytics are paralleled with a polypropylene capacitor. I made no attempt to measure and select crossover components to achieve exact values.

Similarly, I used the manufacturer's

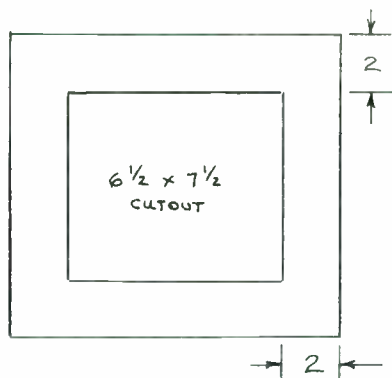

FIGURE 6: Shelf brace.

was wrong on both counts. The midrange actually needed 5dB of attenuation and the tweeter needed no attenuation. All three crossover sections have Zobel networks in parallel with the driver coils to counter the rising impedance of the drivers with rising frequency.

### CROSSOVER COMPONENT VALUES

All the component values used in the crossovers are standard "off the shelf" values that are closest to the values calculated from published equations. After first calculating inductor and capacitance values from the equations, I chose the closest standard values for the inductors, then recalculated the capacitance values while maintaining the initial "L x C" product and, therefore, the desired crossover frequency.

This affects the crossover response only slightly, and because inductors and capacitors are available in a wide range of values, this results in actual crossover frequencies within a few percent of those desired, not including the effects of component accuracies. Capacitor voltage ratings should be at least 100V, with accuracies of 5% for metallized polypropylene and 10% for nonpolarized electrolytics.

The inductors I used had advertised accuracies of 1%, and I took their DC resistances into account when I calculated over-

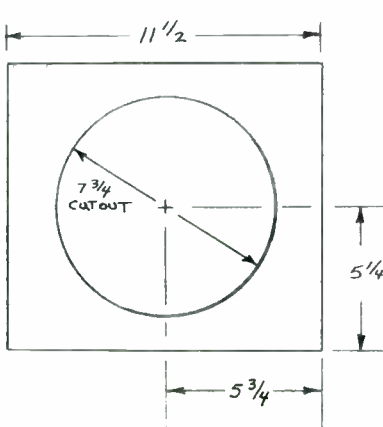

FIGURE 7: Woofer panels.

specified values for driver parameters, even though it is usually recommended to measure at least some of them because they do vary from those specified. I suspect that most hobbyists cannot make such measurements, but those of you who have both the equipment and expertise may want to make the measurements and selections.

### MATERIAL AND SUPPLIERS

Other than common hardware and materials such as nails, screws, glue, paint, wood, and so on, I purchased all the components from Madisound or Parts Express. In the parts list (Table 1), I've identified one of these suppliers (with catalog numbers where available) for those parts I believe are either important to be duplicated for purposes of performance or fit, or which you may not be able to find elsewhere.

The drivers are available from several suppliers, so base your purchases on the best price. I would advise against using cheap inductors or capacitors, since the small amount you may save, compared to the total cost and your labor, won't be worth the potential loss in performance. On the other hand, you can spend really big bucks on exotic wire and crossover components, but it's arguable whether they would make much difference in performance.

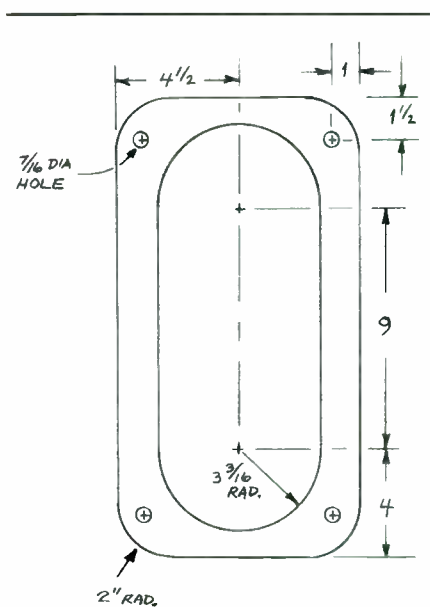

FIGURE 8: Grille board.

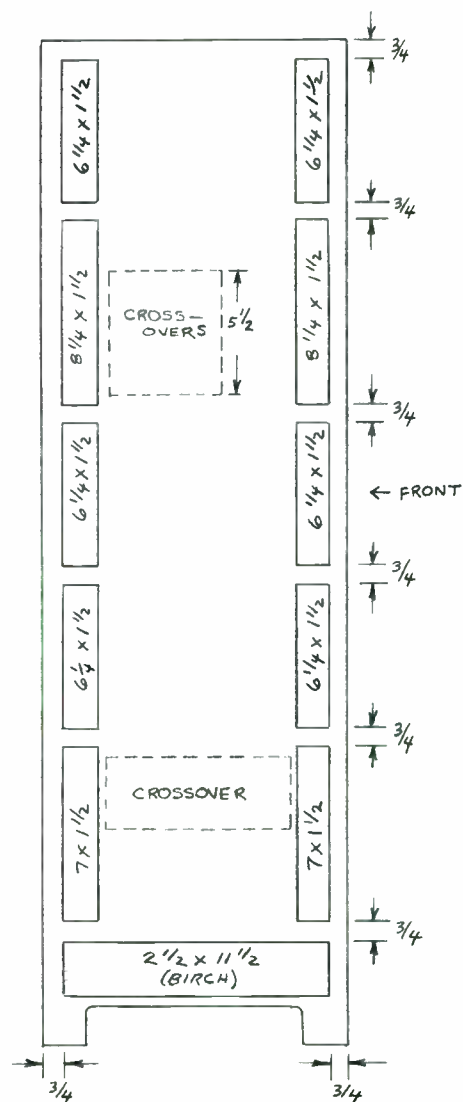

FIGURE 9: Side-panel assembly.



# SHOCKWAVE

## ELECTROSTATIC

## SUBWOOFER

Let's face it, some of you are hard-core bass addicts. You're not happy unless the walls are shaking and the neighbors are complaining!

I don't care how much you paid for your subwoofer, it will never come close to the electrostatic bass produced by SHOCKWAVE. It makes ALL subwoofers sound like boomy mush. No matter what type of system you own — conventional box speakers, horns, electrostatics (ESLs), planar magnetics, or dipoles of any type, SHOCKWAVE is the ultimate solution to attaining extremely deep and detailed bass.

Everyone recognizes electrostatic speakers for their unparalleled clarity and accuracy and SHOCKWAVE extends these attributes to the INFRASONIC (10. Hz).

This milestone product mates with, and vastly improves, ALL types of loudspeakers and you only need one unit, even if you desire two channel bass.

SHOCKWAVE uses the latest technology to produce articulate but EAR-SHATTERING bass. Phase cancellation (anti-noise) principles plus compound or parallel diaphragms, give SHOCKWAVE the equivalent electrostatic surface area of over 108 square feet!

Truly EXPLOSIVE acoustical power that exceeds 120. db at your listening position. And it only takes up 1.5 square feet of floor space in a "V" shape. The height is just 36 inches and it may be placed in ANY corner, behind one speaker, or at the center of your two speakers.

But the best part is that it connects into your system without the need of conventional active or passive crossovers (set your crossover point with a simple resistor from Radio Shack). AND YOU DON'T NEED A SECOND AMP TO DRIVE IT! Use your current amp for stereo or mono bass. Frequency response is 10. Hz to 500. Hz. Nominal impedance is 8 ohms and it requires only 30. watts to drive it (300. watts max.).

**Disclaimer:**  
We cannot be held responsible for any vibrational damage done to your home or contents.

SHOCKWAVE is fast and easy to build and most of the parts can be obtained from your local hardware store. Depending on your system, materials on-hand, exterior trim and grill cloth, SHOCKWAVE will cost between \$100. to \$500. to build. But most of you will end up spending about \$250. And please don't think that its low cost translates to low performance, since this design would sell for at least \$5,000.00 to \$8,000.00 at your local Hi-End audio shop!

This SECRET OF THE CENTURY will be revealed to you in a limited-edition manual and only 500 copies will be printed and personally signed by David Lucas. A true collectors item in every respect.

This extensive manual covers the theory of operation, step-by-step construction, wiring and circuit diagrams, a parts list, and sources of supply. Plus you also receive a precision hand-made model of SHOCKWAVE so that all construction details are as clear as the thunderous bass it produces.

Don't miss out on this limited time opportunity. YOU REALLY CANNOT AFFORD TO PASS IT UP!

**SEND \$99. TODAY TO RECEIVE THE RAREST OF AUDIO SECRETS AND ENJOY UNCOMPROMISED BASS THAT HAS NO EQUAL!**

We accept any form of check or money order in US dollars. No credit cards or CODs.



**FREE SHIPPING AND INSURANCE!**

**MAKE ALL CHECKS PAYABLE TO: DAVID LUCAS.**

**ALL ORDERS SHIP THE SAME DAY!**

**THERE ARE NO SHOCKWAVE BROCHURES. THIS AD IS IT!**

Note: You must be at least 18 years old to order. All sales final. Also, we assume you have a general or basic working knowledge of electrostatics, high voltage, and electronics. We assume no responsibility for the use or misuse of our products. If you have any further questions regarding SHOCKWAVE, please write or fax (412-828-0422).



**DAVID LUCAS**  
924 HULTON ST.  
OAKMONT, PA 15139



## CUTTING AND DRILLING

Start your construction by cutting all the pieces from the MDF and particleboard on a bench saw, making sure your cuts are square and accurate. It will require about 1½ sheets of the ¾-inch MDF to build two cabinets. *Figure 2* is a cutting guide for the MDF.

I laid out the cuts on two sheets so that you can cut all pieces of the same dimensions in sequence before changing to the next dimension, jockeying back and forth between the two sheets as necessary. This ensures that even if your cutting dimensions are *slightly* off, the various parts will fit together properly, but don't construe this to mean you can get by with sloppy measuring or cutting.

Then, with a jig saw, cut out all the circular holes, rectangular holes, and woofer exit slots in the side and front panels (see *Figs. 3–8* for details on these holes and slots). It would be best, at this time, to check the fit of all the drivers in their cutouts and make any necessary adjustments with sandpaper or a file.

To aid assembly, mark nail locations on side, front, and rear panels. These will be on the center lines of the internal horizontal shelves and braces, as well as the center lines of the vertical runners for attaching the front and rear panels.

Use nails approximately every two to three inches (closer spacing is okay, but don't get carried away—that's what the glue is for). I used 2", 6d finishing nails to attach sides, front, and back together. Holes for all these nails should be predrilled in these four panels, slightly smaller than the nail diameter.

At this time, you should drill holes through the grille boards and into the front panel for the grille fasteners. The fasteners I used are a plastic "mushroom" type that come in pairs—a male part (mushroom) and a female part (socket)—but I used only the male part. On the front panel, draw the outline of the grille boards centered around the midrange drivers, and set in the drivers. Place the grille boards around the drivers, ensuring that they clear the drivers and are square on the panel; then clamp the grille boards into place.

Mark the locations of the driver-mounting holes, then remove the drivers. With a 7/16"-diameter bit, drill four holes through the corners of the grille boards to a depth of ½" into the front panel (*Fig. 8*). If you do this accurately, either grille board should fit either cabinet.

## PREASSEMBLY

Begin assembly by attaching all the 1½"-wide MDF runners to the side panels. You must space these runners exactly ¾" from the front and back edges, from the top, and between them. To do this, use narrow strips of the ¾" MDF, approximately 6" and 13" long, as guides, clamped onto the side panel at the top, front and rear edges, and between the ends of the runners. You may be tempted to draw guide lines on the inner surfaces of the side panels, lay the runners along the lines, and then attach them. That would probably be quicker, but it isn't as accurate.

Attach the runners with glue, and hold them in place for drying with 1¼", 3d finishing nails. When nailing the runners, use a pair of nails on opposite sides about every 2" or 3", and make sure you nail the runners squarely against the clamped-on guides. Starting at the top of the side panel, attach the top two runners, remove the clamped guides, clamp the guides for the next pair of runners to be nailed, and so on, working your way down the side panel to the bottom (*Photos 4* and *5* show how to place the clamped guides).

As you move along, wipe off any excess glue from the runners where they will later join with other pieces (also, wipe off any glue that may get on the clamping guides). At the bottoms of the side panels, attach the 2½" × 11½" pieces of birch with countersunk 1¼" particleboard screws instead of the birch strip and one in the center, plus glue

(*Fig. 9* and *Photo 6* show the side-panel assembly).

TABLE 1

PARTS LIST (quantities shown are for two systems; dimensions are in inches)

Qty.	Dimensions	Description
<b>¾" MDF:</b>		
2	12 × 13	Top (outside)
14	10½ × 11½	Top (inside), shelves/braces, woofer panels
4	13 × 43¾	Side panel
4	10½ × 43¾	Front and rear panels
24	1½ × 6¼	Brace
8	1½ × 7	Brace
8	1½ × 8¼	Brace
<b>¾" particleboard:</b>		
2	3½ × 8	Woofer crossover base
4	5 × 5½	Midrange/tweeter-crossover base
2	9 × 17	Grille board
<b>1" × 3" birch:</b>		
4	2½ × 11½	Woofer chamber brace
4	2½ × 9	Woofer chamber brace
<b>Miscellaneous:</b>		
50'	1/8 × ½	Foam adhesive tape (Madisound)
1'	1/8 × 32	Adhesive-backed felt (Madisound)
2 sheets	24 × 36	Convuluted foam (Parts Express 260-316)
2		Terminal cup (Parts Express 260-304)
4 lb.		Acousta Stuf®
1 pkg.		Grille fasteners (Parts Express 260-367)
1 yd.		Grille cloth
As needed		Nails, screws, glue, paint, wire, crimp-on connectors, bolts, nuts, sealant

## Drivers:

4	Morel MW-266, 8Ω	Woofer
4	Morel MW-166, 8Ω	Midrange
2	Morel MDT-40, 8Ω	Tweeter

## Crossover Components

2	L1—10.0mH, 0.43Ω, ferrite bobbin (Madisound Sledgehammer)
2	L2—3.3mH, 0.21Ω, ferrite bobbin (Madisound Sledgehammer)
4	L3, L5—0.30mH, 0.16Ω, air core (Madisound Sidewinder)
2	L4—0.10mH, 0.10Ω, air core (Madisound Sidewinder)
4	C1A, C1B—250μF/100V, bipolar electrolytic
2	C1C—6.8μF/100V, metalized polypropylene
4	C2, C5—22μF/100V, bipolar electrolytic
2	C3A—140μF/100V, bipolar electrolytic
2	C3B—1.0μF/100V, metalized polypropylene
2	C4A—16μF/100V, metalized polypropylene
2	C4B—2.7μF/100V, metalized polypropylene
2	C6—4.7μF/100V, metalized polypropylene
2	C7A—12μF/100V, metalized polypropylene
2	C7B—2.2μF/100V, metalized polypropylene
2	C8—1.0μF, mylar
4	R1, R2—4.0Ω, 15W, wirewound
2	R3—2.0Ω, 15W, wirewound
2	R4—8.2Ω, 15W, wirewound
2	R5—6.5Ω, 15W, wirewound
6	Barrier strip

SERIOUS AUDIOPHILES

We understand the goal...  
and it can't be obtained in small rooms  
without room treatment... no way.



Our products  
add 2100 lbs.  
of MASS to  
your listening  
ROOM.

Put your pillows behind  
your head as you relax and  
listen to real room treatments  
create a reflection / node free  
environment for your ears!

BLUEPRINTS NOW AVAILABLE

Diaphragmatic Bass Traps  
Quadradic Theory Diffusers  
Linear results 23Hz ~ 8KHz  
Prints only \$29.95 ea.

SE-84 Zen Amps  
Single Ended Triode  
Stereo/Mono Amplifier  
NOW SHIPPING!

www.decware.com

(309) 671-2428

HIGH FIDELITY ENGINEERING CO. 103 SPRING STREET, PEORIA, IL 61603

Reader Service #64



# Swans M1 kit



The Swans M1 minimonitors open a new line of affordable high-end loudspeakers featuring several technological achievements and sound quality distinctions.

The speaker system is a two-way bass-reflex design. The front baffle is very narrow with rounded edges to reduce cabinet diffraction for better clarity and imaging. The internal panel and corner reinforcement substantially reduce unwanted cabinet vibrations. A flared port is mounted on the rear baffle for smooth transition from the port to cabinet boundaries. This provides linear bass performance and absence of port noise. The heavy-duty gold plated binding posts are mounted directly on the rear panel to enable easy cable connection.

The drivers used in the M1 represent a new high performance design from Hi-Vi Research. The 5-inch paper/Kevlar cone woofer has a rubber surround, cast aluminum frame and a magnetically shielded motor system. This driver utilizes a central phase plug to avoid air compression, improving frequency response and dispersion. The extremely rigid cone is hand coated with a special damping compound to further maximize its performance. The cone is then coupled to a selected grade rubber surround that provides break-up free operation and very low distortion even at high power levels. These key features greatly contribute to the M1's clear transparent sound and effortless dynamic performance.

The tweeter is a high-tech planar isodynamic design that employs Neodymium magnets and extremely light Kapton® film, with flat aluminum conductors.

The vibrating element of the tweeter is almost weightless in comparison to a conventional dome driver. This unit provides an immediate and precise response to any transients in original signal, and gives the M1 an exceptional ability to reveal the true dynamics of instruments with a complex high frequency spectrum.

The crossover is a second order Linkwitz-Riley type resulting in an in-phase connection of the drive units. The crossover frequency between the two drivers is 3.3 kHz and only high quality polypropylene capacitors are used. Each filter has its own dedicated board mounted on a special rubber interface to reduce vibrations and microphonic phenomenon. The filter boards are spaced inside the loudspeaker with the inductors positioned at right angles to minimize the interaction.

M1 provide very even acoustic power dispersion. The important horizontal early reflections that create spatial impression and add to the overall presentation have the same even spectral balance as the direct sound, these are crucial features of a good loudspeaker.

On the contrary, the M1's vertical dispersion is well controlled in the high frequency domain in a 15° arc symmetrically to the reference axis. While 15° create adequate room for adjusting a listening position, the floor and ceiling reflections are well down in amplitude. This feature greatly contributes to the clarity of sound and imaging of the M1. Swans M1 kit includes:

- 2x F5 paper/Kevlar bass-midrange drivers,
- 2x RT1C isodynamic tweeters with sealing gaskets,
- 2x dedicated tweeter crossovers,
- 2x dedicated bass-midrange crossovers.
- two flared ports and two swans logos,
- two pairs of heavy duty gold plated terminals.

The drawings of the cabinet shown here represent general dimensions required for optimum bass performance. Rounded corners are advisory as they improve imaging and clarity. Actual finish and appearance is a matter of personal taste.

Price: \$ 410.00 ( including everything )

Delivery in US within 4-6 days.

Warranty 3 years, 30 days money back guarantee.

High sonic resolution  
**Loudspeaker**  
with room friendly performance



The step beyond the limits



RT1C Tweeter

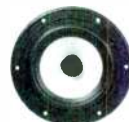

F5 Bass-midrange



Filter

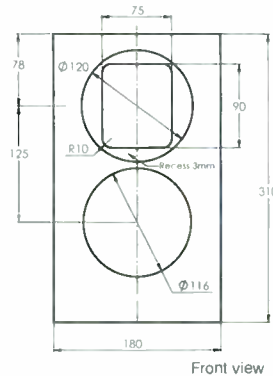

Front view

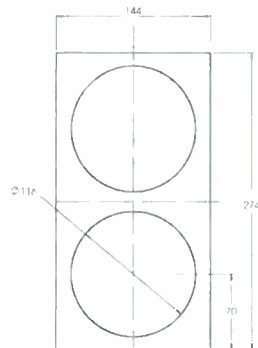

Internal panel

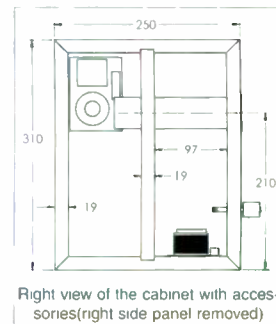
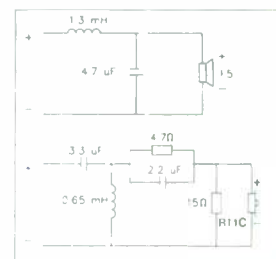

Right view of the cabinet with accessories(right side panel removed)

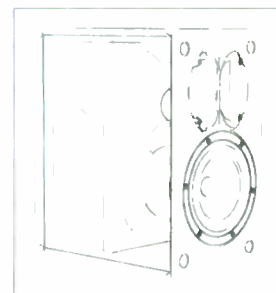

## SPECIFICATIONS

Frequency response	53Hz-40kHz, ±2dB (1m, half space)
Sensitivity, 1W/1m (100Hz-8kHz averaged)	85 dB
Nominal impedance	8 ohms (7.2 ohms minimum at 250 Hz)
Harmonic distortion	THD less than 1% At 90dB SPL, 100Hz-10kHz, 1m
Power handling	50W nominal, 90W music
Dimensions, HxWxD	310x180x250 mm
Net weight	7.8 kg (17 lb.) each
<b>Amplifier requirements:</b>	
30W recommended minimum.	

for more info please

**Call:** (905)-889-7876

**ACOUSTIC TECHNOLOGY INTERNATIONAL INC.**

15 WEST PEARCE STREET UNIT 2&3,  
RICHMOND HILL  
ONTARIO L4B 1H6 CANADA

Tel: (905)-889-7876 Fax: (905)-889-9296

[www.dulcet.com](http://www.dulcet.com)

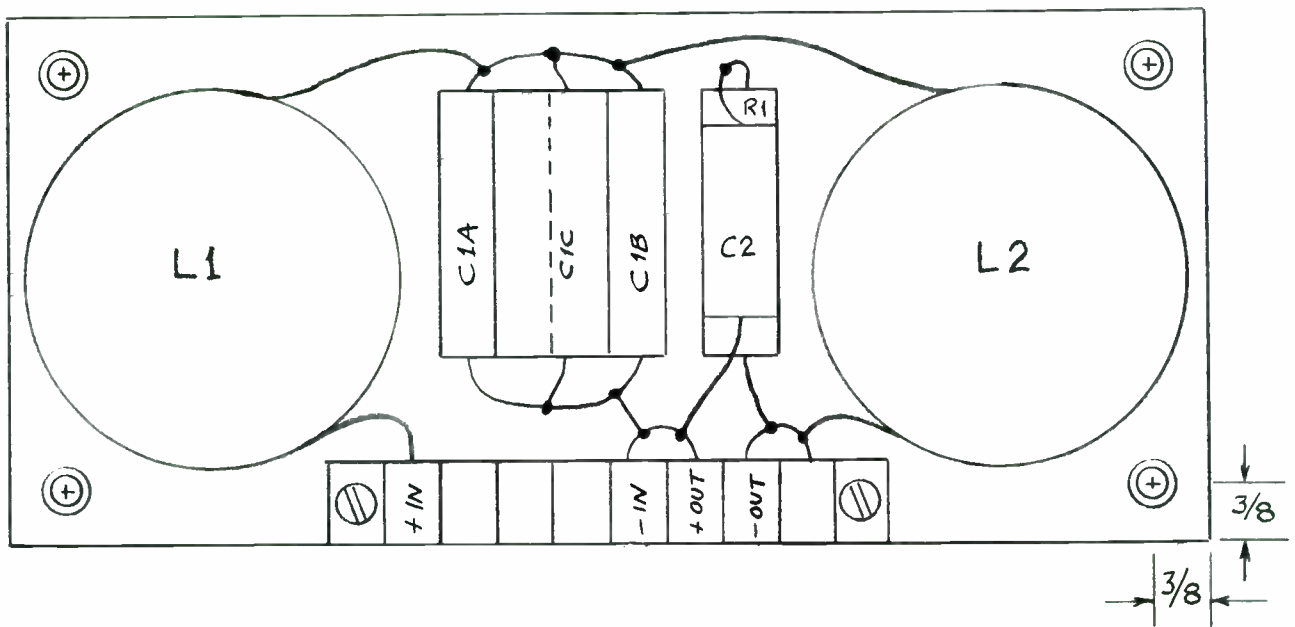

**FIGURE 10:** Woofer crossover-component layout.

Next, assemble the top of the cabinet by gluing and nailing together a  $10\frac{1}{2}'' \times 11\frac{1}{2}''$  piece of MDF to the  $12'' \times 13''$  piece. Use the clamping guides on all four edges of the larger piece to ensure the smaller one is located squarely in the exact center of the larger. *Photo 7* shows how to place the clamped guides. You'll need to use more nails than the five shown to firmly seat the two pieces together while the glue dries. You can use particleboard screws instead of nails, or, if you have the tools, these two pieces can simply be clamped together while the glue sets.

### DRILLING BOLT HOLES

Before actually assembling the cabinet with the side panels, locate and drill holes in the midrange cavity's bottom shelf and the inner woofer-mounting panel for the pairs of 10-32 pass-through bolts. You should space the holes for each pair an inch or more apart to allow clearance for the wires and lugs to be attached to them. Also, go ahead and drill bolt holes for mounting all of the drivers—four per driver for midranges and tweeter, and eight per woofer.

I highly recommend using T-nuts and bolts rather than wood screws to mount the drivers: 8-32 for woofers and midrange; 6-32 for the tweeter. Make sure to use a drill-bit diameter appropriate for the body of the T-nuts. Since the cabinet must be airtight, seal the inside seams of the  $1\frac{1}{2}''$  strips on the side panels with silicone sealant.

Finally, on the insides of the side panels, mark the locations of the crossovers'

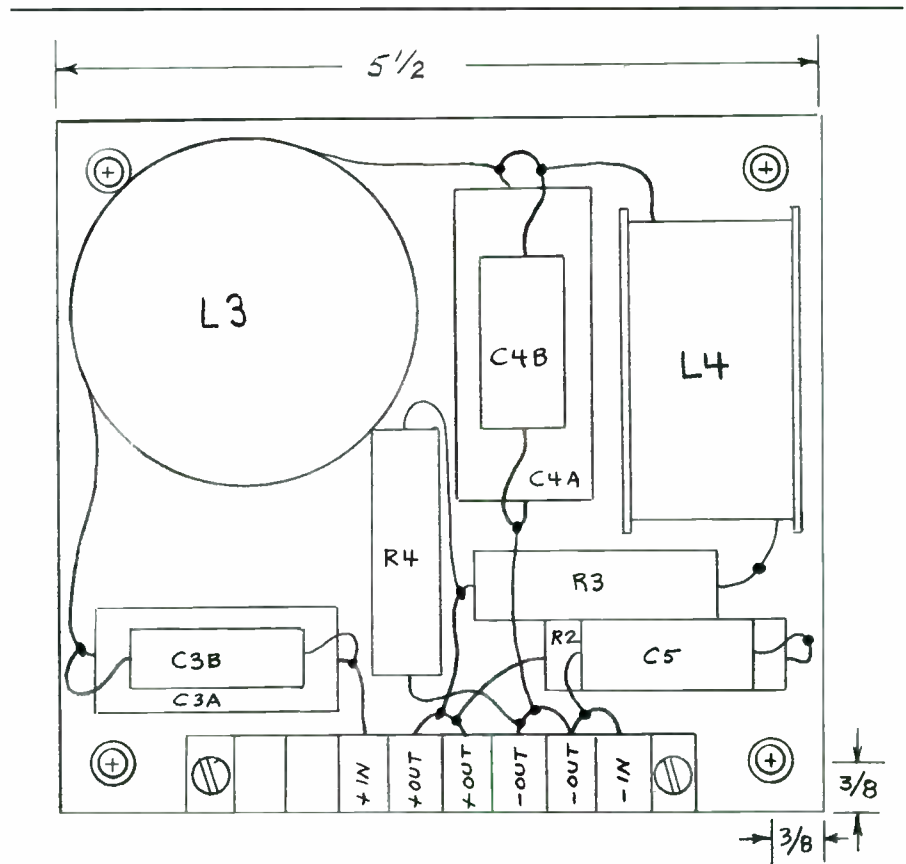

**FIGURE 11:** Midrange crossover-component layout.

mounting holes and drill pilot holes for the  $\frac{3}{4}''$  or  $1''$  particleboard screws you'll use to mount the crossover assemblies. The woofer crossover is mounted centrally on one side panel near the top of the cavity where you mount the inner woofer.

The midrange and tweeter crossovers are mounted on opposite side panels in the

bottom portion of the midrange cavity, about  $2\frac{3}{4}''$  from the back edge of the side panel. If you've already cut out the crossover boards from the  $\frac{3}{8}''$  particleboard, you should mark their outlines on the side panels to help guide you later when attaching the convoluted foam (see *Fig. 9* for crossover locations).



## Audio Amateur Loudspeaker Projects

compiled from *Audio Amateur Magazine*

A collection of the 25 best speaker articles published in *Audio Amateur* throughout the 1970's, this popular book is proof that great designs are never out-of-date, and can be as challenging and rewarding as when they first appeared in print. The electrostatic and transmission-line articles are particularly interesting and useful. Profusely illustrated. 1985, 135 pp., 8-1/2" x 11", softbound. ISBN 0-8338-0193-7. Shipping wt: 1 lb.

**BKAA1 \$20.00**

## The Electrostatic Loudspeaker Design Cookbook

by Roger R. Sanders, with Barry McClune

This volume is an encyclopedic exploration of the important issues, tradeoffs, and technical questions involved in building the radiating, electrostatically charged panel surfaces which make up the electrostatic loudspeaker. Construction advice for both flat and curved panels is offered, along with plans for the necessary interfaces and drive requirements, and power supply and crossover suggestions. Roger Sanders has been building electrostatics for nearly 25 years, and has consulted with and advised hundreds of fellow enthusiasts worldwide. 1995, 202pp., 8-1/2" x 11", softbound, ISBN 1-8825-8000-1. Shipping wt: 1 lb.

**BKAA20 \$34.95**

## Designing, Building and Testing Your Own Speaker System 4th Edition

by David B. Weems

With this fourth edition, you'll be able to build a durable, low-cost system as good or better than most expensive units. The book includes basic speaker theory, types and functions of speaker enclosures, closed-box and ported-box construction, crossover networks and filters, computer programs for test and design, speaker equipment selection, testing speakers, speaker placement and acoustics, plus four simple projects. Four appendixes include formulas, wire data, computer programs and mail order listings. A useful glossary of terms is also included. 1997, 256pp., 7-1/2" x 9-1/4", softbound, ISBN 0-07-069429-X. Shipping wt: 1 lb.

**BKT12 \$19.95**

## High Performance Loudspeakers

by Martin Colloms

This fully revised fifth edition gives the reader a unique analysis and review of high performance loudspeaker techniques, mapping the increasing pace of the industry, driven by new applications, materials and design techniques. Highly detailed technical coverage of every aspect of loudspeaker design, the new edition includes information on multimedia and home theater systems, taking into account their specific acoustic requirements. Other sections include practical advice for real world speaker design. All the latest information presented with Colloms' unique non-partisan interpretation of manufacturers' technologies and claims. 1997, 420pp., 9-5/8" x 7-1/2", softbound, ISBN 0471-97089-1. Shipping wt: 3 lbs.

**BKW1 \$54.95**

# FROM OLD COLONY SOUND LABORATORY



To order call  
**1-888-924-9465**

or  
fax to  
**603-924-9467**

**REQUEST YOUR  
COPY OF THE  
OLD COLONY SOUND  
LAB CATALOG TODAY!**

SHIPPING & HANDLING ADDITIONAL

## The Loudspeaker Design Cookbook

by Vance Dickason

19 years after the publication of the first edition, the latest version of the loudspeaker "bible" is more popular than ever. The new fifth edition adds special chapters on the current trends toward home theater and more advanced, serious car audio accompanied by updated chapters from previous editions. 1995, 165pp., 8-1/2" x 11", softbound, ISBN 1-8825-8010-9. Shipping wt: 2 lbs.

**BKAA2-V \$34.95**

## Electrostatic Loudspeaker Design and Construction

by Ronald Wagner

This classic, once produced by TAB Books, is now published by Audio Amateur Press. Both a "how-to" book and an informative text on electrostatic speakers, this publication provides a step-by-step sequence for building full-range electrostatic speakers, and acquaints the reader with their basic operating principles. Appendix with construction information, index and bibliography included. 1987, 1993, 243pp., 7" x 9-5/8", softbound, ISBN 0-9624-1916-8. Shipping wt: 1 lb.

**BKAA39 \$19.95**

## Bullock on Boxes

by Robert M. Bullock III, with Robert White

Since 1980, readers of *Speaker Builder* magazine have delighted in the scope and clarity of Mr. Bullock's explanations of vented-box loudspeaker systems. Now these articles have been collected into a single volume—*Bullock on Boxes*. This book is an easy-to-read guide to designing and building vented-box systems based on Tiele/Small models. In addition to the background theory and descriptions of the models, *Bullock on Boxes* covers a variety of related information drawn from numerous resources. Also included with the book is a reprint of the *Speaker Builder* 1/82 article by Dr. Bullock on the subject of sixth-order alignments. Index, glossary, bibliography, and over 100 illustrations. 1991, 72pp., 8-1/2" x 11", softbound, ISBN 0-9624-1915-X. Shipping wt: 1 lb.

**BKAA8 \$10.95**

## Loudspeaker Recipes: Book One

by Vance Dickason

Taking advantage of the latest techniques for computer-aided design, Dickason lays a firm groundwork, both theoretical and practical, for successfully building a variety of two-way loudspeaker systems. Design is demonstrated by four two-way systems. Valuable insight even if you don't use CAD. 1994, 112pp., 8-1/2" x 11", softbound, ISBN-8825-8004-4. Shipping wt: 1 lb.

**BKAA30 \$24.95**

## Ultimate Auto Sound: Your Guide to Heaven on Wheels

by Daniel Ferguson

Improved, upgraded version of *Killer Car Stereo* contains double the material, including updated information on system architecture, cabinet construction, crossovers, and installation, plus a new chapter on vans. 1995, 100pp., 8-1/2" x 11", softbound, ISBN 1-8825-8009-5. Shipping wt: 1 lb.

**BKAA37 \$29.95**

Old Colony Sound Laboratory, PO Box 876, Peterborough, NH 03458-0876

Phone: 603-924-6371 • Fax: 603-924-9467 • E-mail: [custserv@audioxpress.com](mailto:custserv@audioxpress.com)

TABLE 2

WIRING & ENDS TERMINATIONS LIST

(each connection is one or more pairs of twisted leads; Ends Terminations refer to "From"/"To")

From	To	Gauge	Ends Terminations
Upper input posts	Upper pass-thru bolts	14	Soldered/ring lugs
Upper pass-thru bolts	Midrange crossover input	16	Ring lugs/slip-ons
Upper pass-thru bolts	Tweeter crossover input	16	Ring lugs/slip-ons
Midrange crossover out	Midrange drivers	16 (2 pr)	Slip-ons/slip-ons
Tweeter crossover out	Tweeter	16	Slip-ons/slip-ons
Lower input posts	Woofer crossover input	14	Soldered/slip-ons
Woofer crossover out	Lower pass-thru bolts	14	Slip-ons/ring lugs
Lower pass-thru bolts	Woofers	16 (2 pr)	Ring lugs/slip-ons

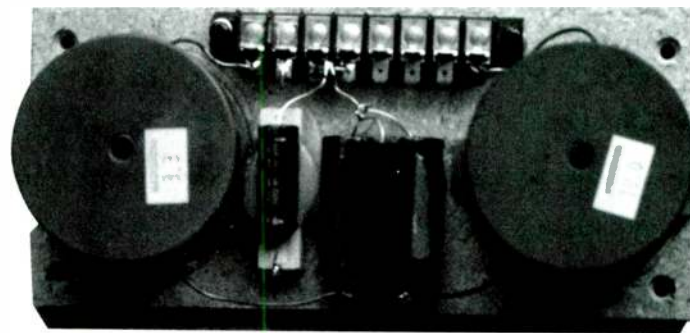

PHOTO 14: Woofer crossover assembly.

ASSEMBLING THE CABINET

After allowing the glue to dry on the side-panel assemblies for 24 hours, you're ready to assemble the cabinet. Lay one side panel with its outer side down on a sturdy work bench. Liberally apply glue all across the "slots" for the five horizontal pieces—midrange-cavity brace and bottom shelf, two woofer-cavity braces, and inner woofer-mounting panel. Set those five pieces in their slots and center them, front to back on the side panel.

Apply glue to the top inside edge of the side panel and set in the double-thick top, having a helper hold that in place (Photo 8 shows these six pieces sitting in a side panel). Now, apply glue to the upper edges of these six pieces and set the other side panel on them in the opposite slots. Use clamps to squeeze everything together.

I used bar clamps, a picture-frame strapping clamp, and quick-release clamps combined with wood brackets and blocks to make the cabinet go together squarely (see Photo 9). Before tightening the clamps, make sure everything is square and that top, shelves, and braces are exactly centered front to back.

From the upper side panel, hammer in about half the nails, some into each of the horizontal members. Then turn the assembly over and hammer in all the nails necessary for that side. Now turn it over once again and finish nailing the first side. Make sure everything is square before you start nailing.

Leave the assembly clamped for an hour or two, and allow the glue to dry for 24 hours. Proper preassembly of the 1½" runners on the side panels will result in a fit that's reasonably tight, yet that still has enough "give" to allow squaring everything together with the clamps.

REAR AND FRONT PANELS

Attach the rear panel to the cabinet by applying glue liberally along the vertical runners and across the horizontal pieces and nailing (Photo 10 shows the rear panel after attachment to the side panels). Allow the glue to dry for 24 hours.

Apply silicone sealant to the inside rear panel where it joins with the rest of the cabinet, to the top piece where it joins the cabinet sides, on the inside seams of the inner woofer-mounting panel, and on all the seams inside the midrange cavity. To the rear panel, using five screws and glue at the bottom, attach a 2½" x 9" birch strip against the bottom of the inner woofer panel and aligned with the birch pieces on the side panels.

Before attaching the front panel, you'll need to cut the convoluted foam into appropriately sized rectangles and glue them onto the inside of the cabinet. This works best if you apply spray-on adhesive to the backs of the foam pieces, then stick them on. Do the rear panel first, then underneath both the top and the midrange

shelf, finishing up with the sides.

The crossover outlines you previously made will guide you when gluing foam in those areas. Also, cut out and glue on foam pieces inside the front panel, but only in the three woofer cavities, not in the midrange cavity. You don't have to cover every last inch of the inside of the cabinet with foam, so you can get by with two of the 24" x 36" sheets.

Although you can do it later, it would be easier now to install the pair of pass-through bolts and the three pairs of wire leads that attach to them in the midrange cavity. Table 2 lists the required wiring. Attach the 14-gauge pair underneath the midrange cavity shelf, and two pairs of 16-gauge on the top of this shelf.

To avoid confusion later, it would be

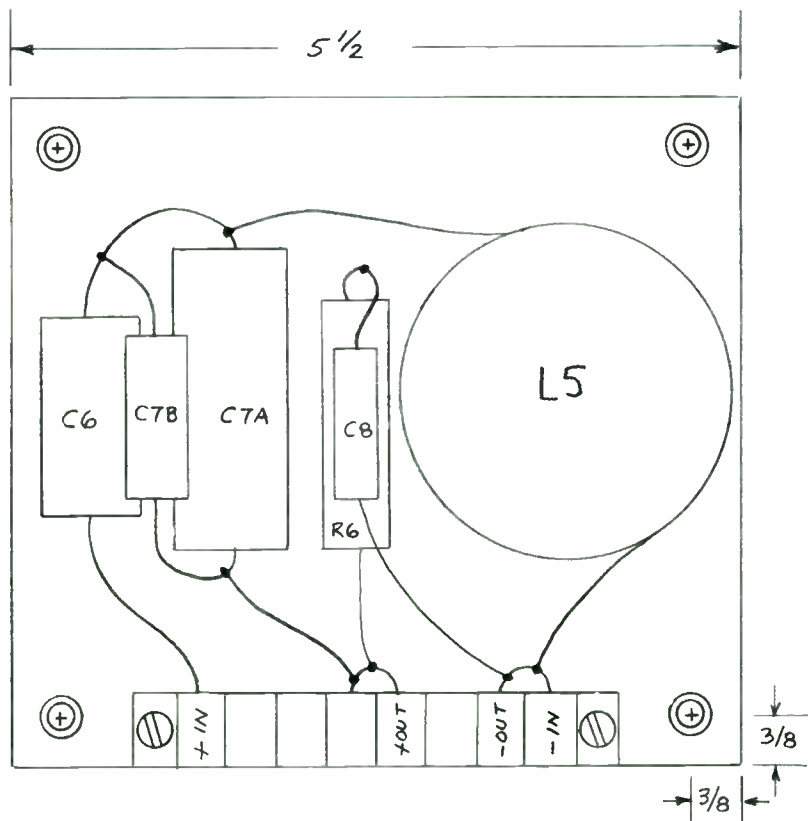

FIGURE 12: Tweeter crossover-component layout.



best to color-code the wiring, using black wires for all of the negative connections and a different color for the positive connections for the three driver sections. *Photo 11* shows foam and wiring installed in the cabinet, and *Photo 12* the foam attached to the back of the front panel.

#### DUST BARRIERS

Before attaching the front panel, tape cardboard on the inside of the driver cutouts to keep sanding dust and other debris out of the cabinet when you are sanding the outside for final finishing. Do the same on the outside of the inner woofer-mounting panel, over its driver cutout, and inside the terminal-cup cutout.

Now attach the front panel with glue and nails as you did the back panel, and allow it to dry for 24 hours (*Photo 13* shows the front panel attached to the cabinet). Later, you can apply silicone sealant around the inside seams of the front panel in the midrange cavity by reaching through the midrange driver cutouts. You won't, however, find it easy to apply silicone sealant in the woofer cavities, so use lots of glue when you attach the front panel.

Attach the remaining strip of 2½" x 9" birch to the inside of the front panel at the

bottom, just as you did with the rear panel. After the glue has dried, you'll need to apply silicone sealant to the inside seams of the Isobarik chamber. As you nail the cabinet's outside pieces together, you should countersink all nails before the glue has set.

If you notice warping of some of the long MDF pieces that you cut from the sheets, you may be able to use this bowing to your advantage. For example, when I laid out the side-panel assemblies and front and rear panels, I oriented the outsides of all four panels so they bowed up and away at the ends. As a result, when I clamped or nailed the ends of these panels, their middle sections pulled tightly together.

#### SANDING AND FINISHING

With the cabinet assembled and the glue thoroughly dried, fill all the nail-head holes and any seams with wood filler. After this has dried, sand the excess filler off smoothly to the MDF surface. With a ½"-radius router bit, round off the four vertical edges of the cabinet and the four edges of the top. As a small artistic touch, I stopped routing the four vertical edges about 3" from the bottom.

Sand the entire exterior surface of the cabinet, especially the rounded edges.

Vacuum off the sanding dust and wipe down with a tack cloth. Apply a coat of primer/sealer with a brush. Use a primer that is specially formulated for adhering to slick or shiny surfaces. Allow it to dry, and apply a second coat.

With the primer coats applied, it will be easy for you to notice any seams or holes that need additional wood filler. You'll also want to prime the bottom edges of the cabinet and the inside of the outer panels that will show through the bottom slots. Sand the cabinet with fine sandpaper after the second primer coat, and make sure you completely remove any sanding dust.

As I did on my previous speakers, I finished these cabinets by applying three coats of semigloss, white, 100% acrylic paint with a stippling roller to achieve a textured finish. You should allow 24 hours drying time between finish coats—longer if the humidity is high.

Since I did not recess the midranges and tweeters in the front panel, for diffraction control I rounded the inside edges of the cutouts in the grille boards with a ¼"-radius router bit. For appearances and to make the grille cloth easier to wrap around the edges without wrinkles, I also rounded the outside edges (see *Fig. 8* for routing details).

# MCM ELECTRONICS®

*The comprehensive source for all your electronics (and speaker) needs!*

- Over 200 Different Woofer Types
- Pre-assembled Crossovers and Crossover Components
- Enclosure Design Reference Books and Software

**FREE CATALOG!**



The ultimate subwoofer power amp module for speaker projects. Accepts either speaker level or RCA inputs for versatility, and large binding posts provide satellite outputs. Auto sense circuit automatically turns amp. Internal 12dB crossover is continuously variable from 60-160Hz. Mono amplifier provides 110W RMS @ 4ohm, 75W RMS @ 8ohm. Dimensions: 11" (W) x 7½" (H) x 2½" (D) •Cut out hole: 10" x 7"

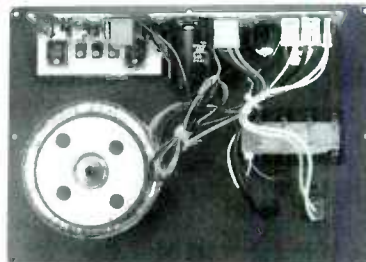

**Sub-Woofer Power Amp Module #50-4465**

Price effective from April 3, 1998 to May 29, 1998

Only **\$179<sup>00</sup>**



For over 20 years, MCM has been a leading supplier to audio enthusiasts, professional autosound installers and repair centers. Our broad selection, competitive prices and huge inventory make us the best source for speaker components. Discover the MCM Difference, Call today for your free catalog!



**MCM ELECTRONICS®**  
650 CONGRESS PARK DR.  
CENTERVILLE, OH 45459  
A PREMIER FARNELL Company

**1-800-543-4330**

www.mcmelectronics.com

**SOURCE CODE: SB45**

The grille boards need to be sanded, primed, and painted black. Before attaching the grille cloth, install the four fasteners in the back of each grille board by hammering them in. Since the bases of these fasteners are longer than the thickness of the grille board, you must cut off about 1/16" of each base.

I installed these fasteners in the backs of the grille boards instead of in the front panel so that if the systems performed better with the grilles off, there would be four fewer protrusions on the front panel to cause reflections. I wrapped and stretched the grille cloths around the grille boards, affixing them in place with contact cement on the backs of the boards.

### ASSEMBLING THE CROSSOVERS

I assembled the crossovers by attaching all the components to their particleboard bases with silicone sealant (*Photo 14* shows the completed woofer crossover as an example, and *Figs. 10-13* show all three crossover component layouts and schematics). Be sure to use enough of the sealant to securely hold the heavy inductors. I used eight-place barrier strips with two end terminals already commoned that accept slip-on solderless connectors for I/O connections. You may prefer other techniques, such as screw-type barrier strips or direct soldering. To

minimize mutual coupling, the inductors on the woofer crossover are spaced about 6" apart, and the inductors on the midrange crossover are oriented at 90° to one another.

### FINAL ASSEMBLY AND DRIVER MOUNTING

Using spray-on adhesive to attach it, I lined the inside walls of the Isobarik chamber with 3/8"-thick foam (you could also use 1/4"-thick felt or 1/2" foam). Drill 16 countersunk clearance holes, four per side, in the outer woofer panel to mount it to the birch frame of the Isobarik chamber. Use this drilled panel to locate and drill pilot holes in the birch frame for 1 1/2" #8 wood screws.

Remove the cardboard from the cutouts in the cabinet panels and install the crossovers. Be sure to vacuum out any dust that may have entered the cabinet around the seams of the cutouts' covers, and don't forget to apply silicone sealant inside the midrange cavity on the front-panel seams.

On the inner woofer panel, install the pass-through bolts for the woofer section and the three pairs of leads that are attached to them. Note that one pair of woofer leads on these bolts is attached to the inside of the inner woofer panel, and the other pair to the outside of this panel.

Connect the woofer-crossover output to the pass-through bolts, and connect one end

of the input post's leads to the woofer-crossover input. In the midrange cavity, connect one pair of the leads from the pass-through bolts to the midrange-crossover input, and the other pair to the tweeter-crossover input.

Then, for eventual connection to midranges and tweeter, connect two pairs of leads to the midrange-crossover outputs and one pair to the tweeter-crossover output. The midranges and tweeters are wired in phase with each other and out of phase with the woofers (see *Table 2* for wiring details).

### T-NUTS AND STUFFING

If you've not already done so, install all the T-nuts for mounting the drivers. I put a bit of silicone sealant inside the pointed flanges of the T-nuts for better sealing, but was careful *not* to get any in the T-nuts' internal threads. Because the midrange-cavity brace is in the way, I had to cut off about 1/3 of the flanges from the top two tweeter T-nuts.

Before mounting the drivers, lay down a strip of foam adhesive tape (1/8" thick, 1/2" wide) completely around the perimeter of each driver cutout. You will also need foam tape on the bottom edge of the birch frame to complete the sealing of the Isobarik chamber when the outer woofer panel is mounted, and around the cutout for the input terminal cup.

Place 16 oz of Acousta Stuf® in the midrange cavity, fluffed-up and more or less equally distributed. Place another 16 oz in the bottom of the cabinet, again equally distributed in the available cavities, but not letting it lie directly against the back of the inner woofer. You can use the internal wiring as a block between the fiber and the inner woofer.

As you install this fiber, fish out the various leads through the cutouts for drivers and the terminal cup. Solder the two pairs of 14-gauge leads to the lugs on the terminal cup, observing correct polarities, with the midrange/tweeter pair connected to the top pair of input posts, and the woofer pair connected to the bottom pair. Attach the terminal cup to the cabinet back with four 6-32 wood screws, making sure to tighten them enough to seal the cup against the foam tape.

As further assurance against leaks, I disassembled the binding posts from the terminal cup before attaching it, and put some silicone sealant on the posts' bases where they pass through the cup holes. Then I reassembled the binding posts.

### DRIVER INSTALLATION

In the woofer section, connect the inner pair of leads to the inner woofer's terminals,

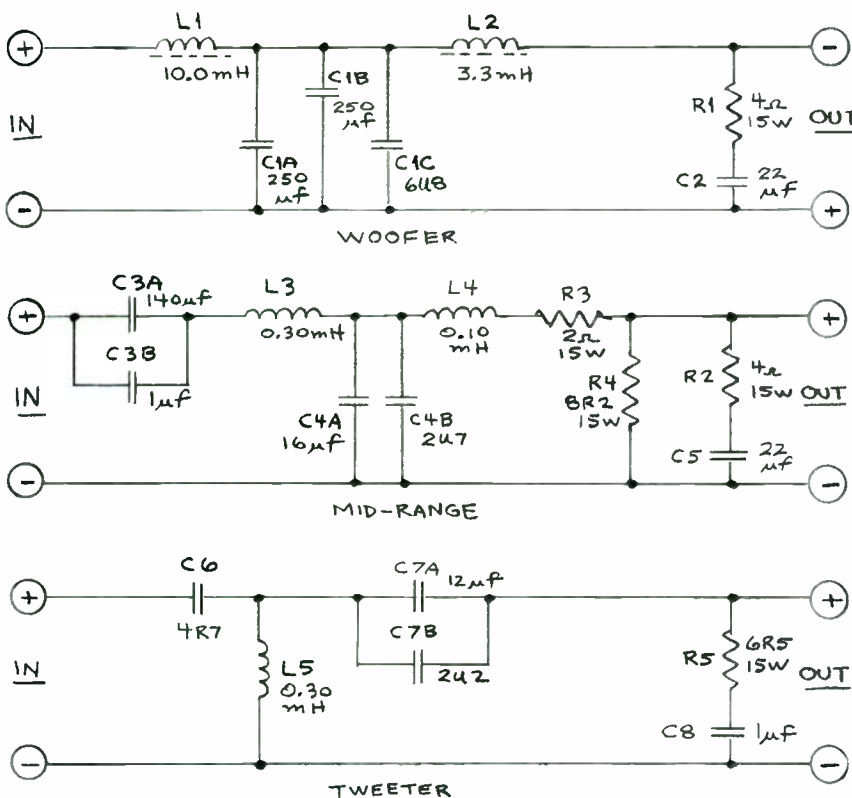

FIGURE 13: Crossover schematics.



then mount the inner woofer. Attach the outer woofer's mounting panel to the birch frame with the 16 wood screws. Now, connect the outer pair of leads to the outer woofer and mount it. Mount both woofers with their cones facing down.

Finish installing the drivers by connecting leads to midranges and tweeter and mounting the drivers with the bolts. You should have a leak-free cabinet, but be careful not to overtighten the driver-mounting bolts.

To allow the grille board to fit properly around the drivers, you may need to trim off excess foam tape that protrudes beyond the mounting flanges of the top half of the upper midrange driver and the bottom half of the lower midrange. For additional diffraction control, I covered the area around the tweeter and between the midrange drivers with two layers of adhesive-backed, 1/8"-thick felt just wide enough to be flush with the inside edges of the cutout in the grille board.

If you don't use the felt, you'll need to paint this area black so it won't be visible through the grille cloth. Similarly, the bolt heads for midranges and tweeter should be black or "painted" with a black felt marker. Snap the grille assembly on, and you're ready to enjoy listening to what you've built!

#### FINAL COMMENTS

As I've mentioned several times, there are always compromises that you must make in speaker-system design. And, you'll probably make some mistakes (I certainly did in calculating expected sensitivities). It's impossible to have every characteristic come out perfectly or exactly as you would like.

I made choices and was prepared to live with the results, doing whatever I could to achieve an overall balanced performance with no serious problems. If you undertake a similar project, you must make similar choices. 

#### SOURCES

##### Madisound

PO Box 44283, Madison, WI 53744-4283  
(608) 831-3433

##### Morel

414 Harvard St., Brookline, MA 02146  
(617) 277-6663, FAX (617) 277-2415  
E-mail [morelusa@gis.net](mailto:morelusa@gis.net)

##### Parts Express

725 Pleasant Valley Dr., Springboro, OH 45066-1158  
(800) 338-0531

# MENISCUS AUDIO

*For 15 years, your one stop source for premium speaker components and accessories featuring:*

- AUDAX
- DYNAUDIO
- ETON
- ECLIPSE
- LPG
- PEERLESS
- SCAN SPEAK
- VIFA
- Coils, Capacitors & Accessories
- Complete System Design
- Full Cabinet Shop
- Powered Subwoofers

## MEN•IS•CUS

MENISCUS AUDIO GROUP, INC.  
4669 S. Division Ave.  
Wyoming, MI 49548

616-534-9121  
fax 616-534-7676  
[meniscus@iserv.net](mailto:meniscus@iserv.net)  
[www.iserv.net/~meniscus](http://www.iserv.net/~meniscus)

Reader Service #12

# SCANSPEAK

## SPEAKER CITY, U.S.A.

Now has available the  
**SCANSPEAK 18W MTM**

These amazing D'Appolito style kits use two of the 18W/8545k Carbon woofers and your choice of tweeters ranging from the D2905/9300 to the top of the line D2905/9900 Revelator. Call for brochure and pricing.

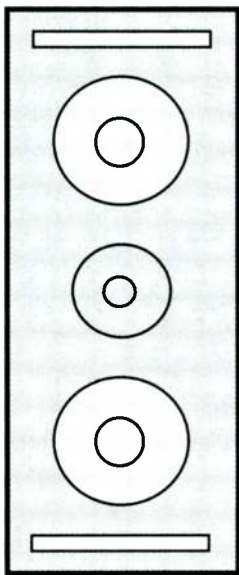

**ORDERS ONLY! 1-800-595-9924**

115 S. Victory Blvd., Burbank CA 91502  
(818) 846-9921 FAX (818) 846-1009  
[www.speakercity.com](http://www.speakercity.com)

Reader Service #27

# REFERENCE MONITOR

(Reprinted from HiFi Luidsprekers and translated by the editors of *Elektuur magazine, the Netherlands*)

**S**can-Speak is a small Danish loudspeaker firm that designs and produces top-class units. Many of its products are made partly by hand and assembled with great accuracy. Inevitably, such work carries a high price.

The Revelator (D2905/9900) is claimed to be the best tweeter in the world, which is, of course, difficult to prove or disprove. It is used in the Reference Monitor in combination with a first-class woofer: a Scan-Speak 18W8546/01.

## THE DRIVERS

The Revelator is the result of a lengthy development during which many technical improvements were incorporated. The magnet system is optimized mechanically as well as electrically. The shape of the chamber behind the dome and that of the conical aperture in the pole piece minimize resonances and reflections. The voice coil has been refined, too: the inductance of the winding has been reduced to only  $9\mu\text{H}$ .

At first glance, the dome looks like an ordinary soft dome, but somehow Scan-Speak has managed to achieve progressive damping that peaks in the suspension. At the same time, its mass has been reduced: the total moving mass, including the air, is only 0.35 grams, which, of course, benefits

the dynamic behavior. All these aspects result in a unit that has a resonance frequency of 500Hz, which enables it to take over from a woofer or mid-range driver at an early stage.

The mounting flange is large and heavy and shaped somewhat like a cup. This shape makes it imperative that the tweeter is flush-mounted. If this is not done, its frequency response will have a few dips (that disappear when it is flush-mounted).

There is another tweeter in the Scan-Speak range that is almost identical to the Revelator, but has a different mounting flange. It is type-coded D2905/9700, but is not called Revelator. Its specification is virtually the same as that of the Revelator, but it produces a small phase shift, which

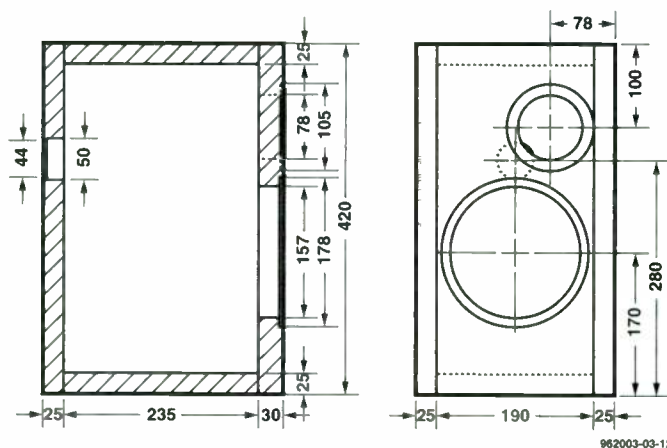
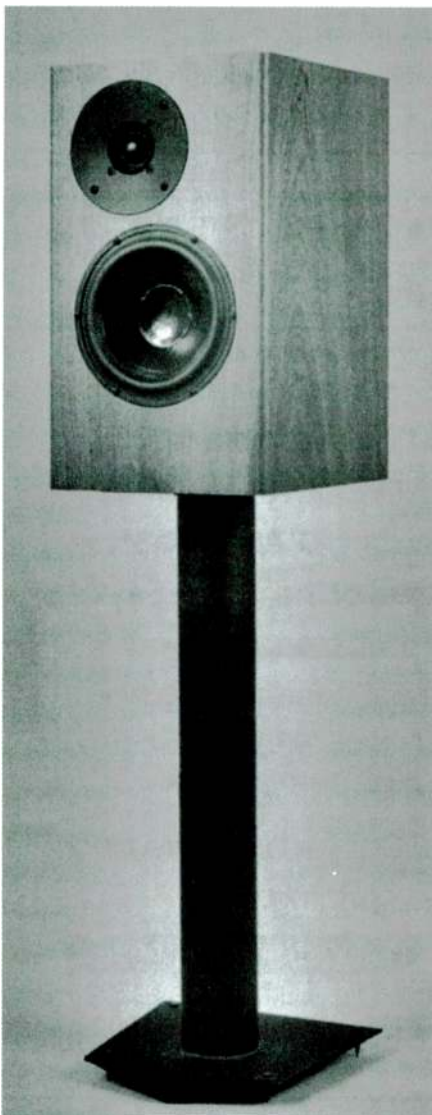

**FIGURE 1:** The construction plan of the Reference Monitor shows that it is easy to build, but mind the thickness of the MDF (or high-density chipboard).



the Revelator does not. The woofer used in combination with the Revelator is a Scan-Speak 18W8546/01, which is an 18cm unit with a black-coated Kevlar® cone.

## CONSTRUCTION

The Reference Monitor is a fairly small loudspeaker (*Fig. 1*) which is, however, very heavy. This is caused partly by the thick MDF and partly by the layer of bituminous felt with which the interior is clad.

Building the cabinet is straightforward, but to obtain good results, great accuracy is needed, which is particularly true of the recessing of the apertures for the drivers.

The bass reflex port is rather unusual. It consists of a 150mm (5.90") long PVC pipe of 50mm (2") diameter that is fitted into a recessed hole at the inside of the cabinet. The pipe is filled entirely with straws shortened to 150mm (5.90"). Do not use flexible straws, since these become too thick at the point where you have to shorten them. The straws form a multiple bass reflex port, which can be shorter than a single one and produces fewer interfering spurious sounds.

As mentioned earlier, the internal walls are clad first with bituminous felt and then with Dacron™ wadding.

## CROSSOVER NETWORK

The crossover of the Reference Monitor is a second-order filter whose circuit diagram is shown in *Fig. 2*. It does not contain networks for phase or impedance correction, since these were found unnecessary. All that is required additionally are two resistors to match the level of the tweeter to that of the woofer. Note, however, that the component values are given for use with the D2905/9700. If the Revelator is used, the values of C2 and L2 must be 3.9µF and 820µH, respectively.

Since the drivers used are expensive units, it stands to reason that good-quality components (polyester or polycarbonate capacitors and air-cored inductors) must be used in the crossover. Note in *Fig. 3* that the inductors are placed so that they affect one another as little as possible. (It is often seen that the magnetic field of one inductor overlaps with that of another, and this is, of course, not the intention.) Note also the large connectors to enable heavy-duty loudspeaker cable to be used.

## PHASE AND DISTORTION

The design of the Reference Monitor aims at minimum distortion and phase shift, since these contribute to a good frequency response. The curves showing the (measured) phase shift (Revelator as well as D2905/9700) and the distortion are shown

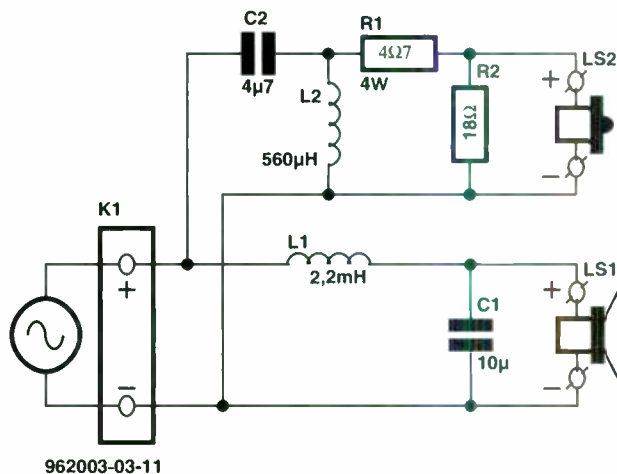

FIGURE 2: Circuit diagram of the crossover network.

in *Fig. 4*. The distortion is outstandingly low, even at low frequencies.

The sloping phase shift curves are caused by the acoustic center of the woofer being further back at high frequencies than at low frequencies (this means that in the case of a cone driver, the curve is never horizontal). If the cabinet is phase-linear, the sloping curve will have a constant fall-off. Phase errors cause humps and dips: a

deep dip or a high hump indicates a large phase jump. Since the curves in *Fig. 4* are reasonably straight, it can be assumed that the cabinet, even without a special front panel or special correction networks in the filter, is nearly phase-linear. Note the differences between the curves of the Revelator and the 9700, however.

Bear in mind also that the illustration must be seen as cylindrical, that is, +180°

## WE ARE BUILDING OUR REPUTATION WITH QUALITY MOBILE ELECTRONIC PRODUCTS

### WHAT CAN YOU EXPECT FROM AMERICAN BASS PRODUCTS

- Uncompromised clarity
- Reliability
- Affordability
- Years of enjoyment

### OTHER AMERICAN BASS PRODUCTS

- Four series of sub-woofers
- Band pass enclosures
- Eight models of amplifiers
- Interconnect cable
- Power/speaker cable
- Electronic crossovers

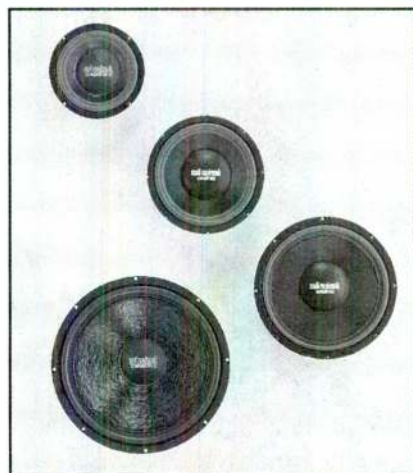

## AMERICAN BASS

"EXCELLENCE IN SOUND"

5242 Warrensville Center Road,  
Maple Heights, OH 44137 U.S. A.  
216-662-2522 • 800-798-9311 • FAX 216-475-9311



Reader Service #97

Our Samples Are Better Than

**FREE!**

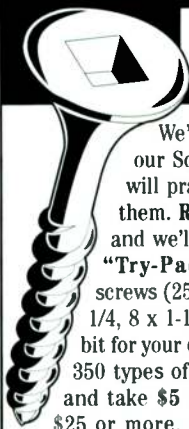

We're so sure you'll love our Square Drive Screws we will practically pay you to try them. Return this ad with \$5 and we'll send you our famous "Try-Pack" Sampler of 100 screws (25 each of #8 x 5/8, 8 x 1-1/4, 8 x 1-1/2 and 8 x 2), a driver bit for your drill, our catalog listing 350 types of Square Drive screws, and take \$5 off your first order of \$25 or more, or \$10 off your first order of \$50 or more! (Limited time offer. Available in USA only.)

"We tried a box of 1-3/4" #8 prelubricated flat heads with nibs from McFeely's, which quickly became our favorite fastener." Speaker-Enclosure Screws, Robert J. Spear and Alexander F. Thornhill, *Speaker Builder*, 2/94

© 1996 McFeely's All Rights Reserved

**McFEELY'S**  
**SQUARE DRIVE SCREWS**  
 PO Box 11169 • Dept SB6F  
 Lynchburg • VA • 24506-1169

Reader Service #83

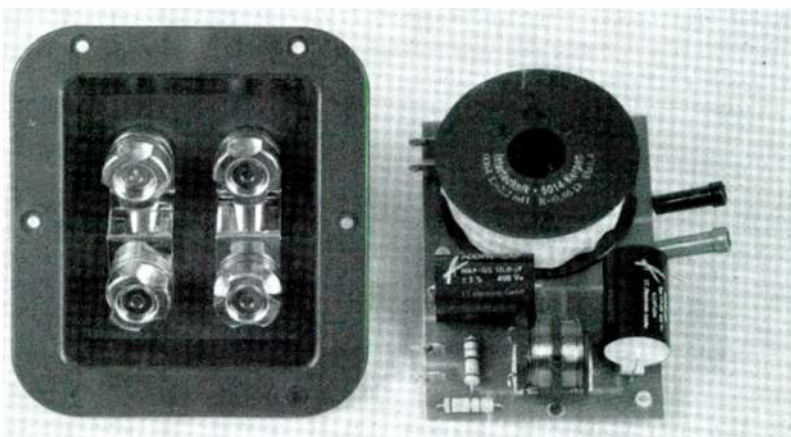

FIGURE 3: The completed crossover: note the location of the two inductors.

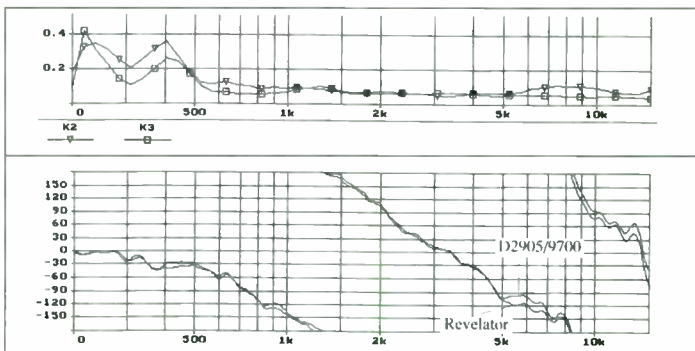
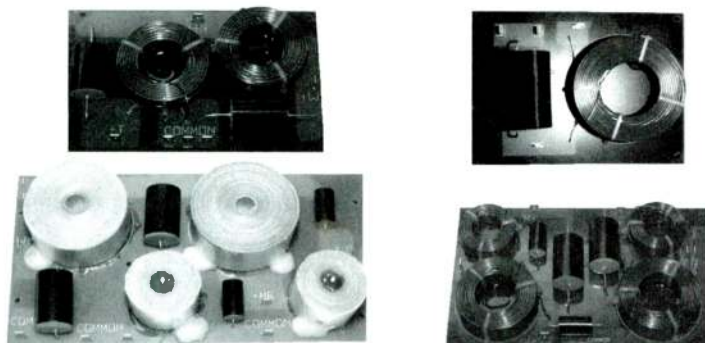

FIGURE 4: Distortion (top) and phase shift characteristics.

## CROSSTECH AUDIO INC.

### PREMIUM HIGH POWER 12dB PASSIVE CROSSOVER NETWORKS



We manufacture and supply the loudspeaker industry with the highest quality crossover networks. The components such as polypropylene fast capacitors, perfect lay air cored inductors, and printed circuit boards are used to manufacture our crossovers that handle from 300 to 1000 watts.

(No resistors to distort sound quality)

CUSTOM FREQUENCIES NOT A PROBLEM

30 Francine Lane Staten Island N.Y. 10314

Phone (718) 370-8399 Fax (718) 370-8297

www.crosstechaudio.com

Reader Service #85

is the same as  $-180^\circ$ . This means that the shifts at 1.5kHz and 8kHz are not phase jumps but are caused by the fact that the illustration only covers  $360^\circ$ .

#### PERFORMANCE

Evidently, the Reference Monitor is a loudspeaker full of promise, and during listening tests these promises are more than fulfilled. Once you are listening to a pair of these units, it is difficult to get away from them. After you have listened for only a few minutes, you start trying different CDs, popular, jazz, classical: how do they sound? In all cases, excellent. Concentrating on, say, the cellos or the oboes is fairly easy during a live performance, but certainly not always with recorded sound. Many loudspeakers lack the depth in the stereo imaging necessary to recognize individual instruments or sections of an orchestra. The Reference Monitor passes these tests handsomely; it is a loudspeaker that reproduces the original music with uncanny precision: it is as if you are present at the recording studio.

The overall reproduction remains taut and controlled down to very low frequencies thanks to the Kevlar (an aramid fiber, which is a very tough plastic) woofer. It must be said, however, that if the volume is turned up high (much higher than can be tolerated



in the average living room) the sound quality is not so good. This is because the cone is able to produce very large deflections during which the non-linearity of the magnetic field becomes evident. On the other hand, compression does not take place because the movement is damped by the cone suspension. So, the Reference Monitor is honest about this aspect, which is not noticed in many other brands because in these the non-linearity is hidden in the cone suspension.

## MEASUREMENTS

Distortion and phase shift have already been discussed, and now it is time to look at the frequency response, the waterfall plot, and the impedance characteristic, shown in Fig. 5. There is not much to be said about these: they are as good as attainable with modern technology. The only comment would be that it is clear that the crossover does not have an impedance correction network. This creates no difficulties at all, however, because almost all output amplifiers can cope with the impedance variations.

## CONCLUSION

In the Reference Monitor it is absolutely clear that the Scan-Speak promises in regard to the Revelator are more than fulfilled. Together with the excellent woofer, the tweeter forms a loudspeaker that belongs to the top units available.

## Parameters

### Design

Rolph Smulders (Audio Components)  
2-way vented

### Woofer

Scan-Speak Type 1828546/01

### Tweeter

Scan-Speak D2905/9900 or D2905/9700

### Bass reflex port

PVC pipe 150mm (5.90") long, 50mm (2") diameter filled with straws

### Crossover

12dB/octave

### Dimensions

420 x 240 x 290mm (16.53" x 9.45" x 11.42")

### Scan-Speak

Brogaards Vej 18, Videbaek DK-6920, Denmark  
(+45) 97-173-600

### Scan-Speak USA

2920 Wolff St., Racine, WI 53404  
414-635-3099, FAX 414-632-5393  
<http://www.vifa-usa.com>

### Distributors

Madisound Speaker Components  
608-831-3433

### Meniscus

616-534-9121

### Solen, Inc.

514-656-2759

### Speaker City USA

818-846-9921

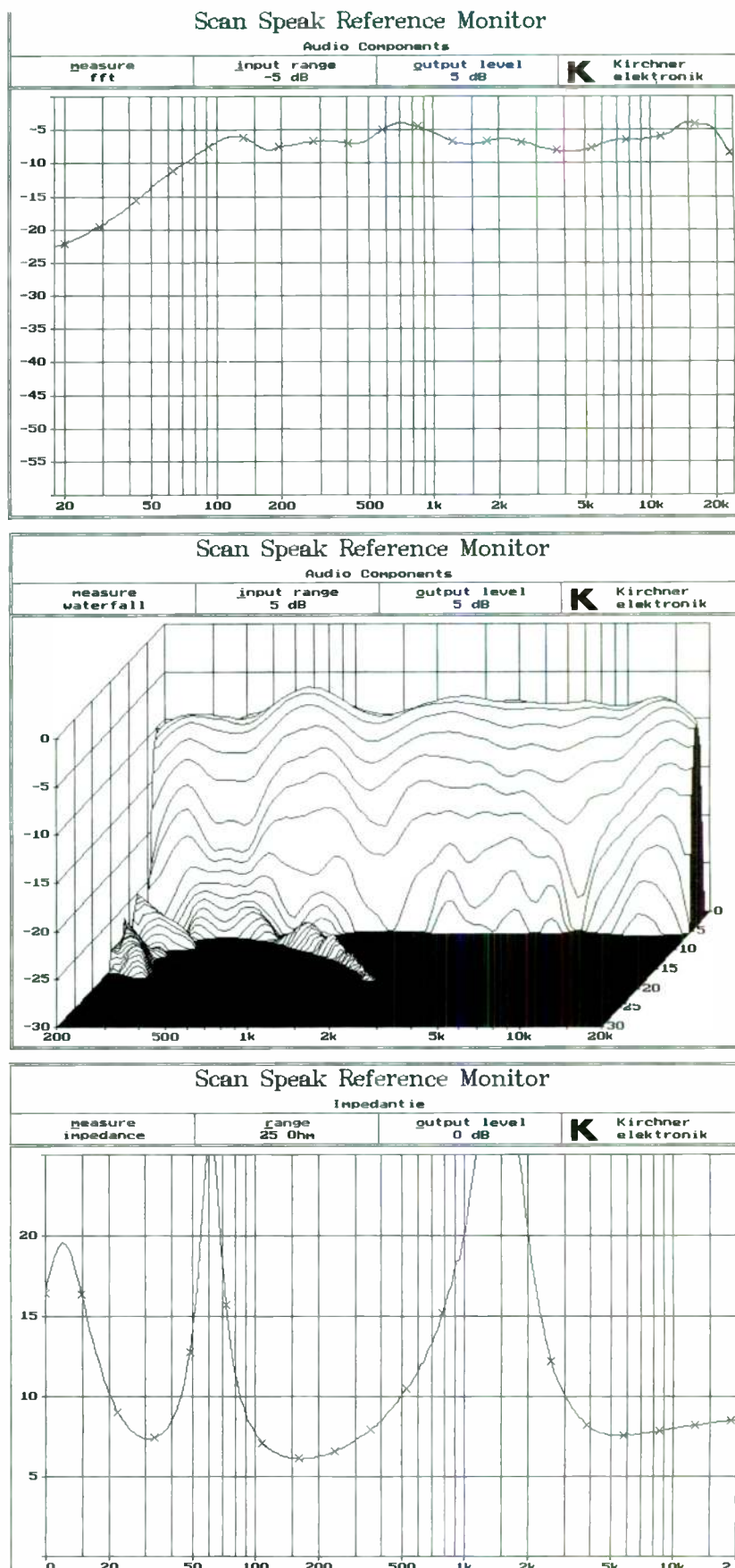

FIGURE 5: Frequency response curve, waterfall plot and impedance characteristic of the Reference Monitor.

# REBUILDING THE AR-3a, PART 5

By Tom Yeago

In this part, de- and reconstruction of the dome drivers continues.

## MIDRANGE IRON AND MAGNET

Now it's time to separate the magnet from the rest of the steel. In the first go-around, I just soaked the parts in a pot of acetone for a week or so, and then split the magnet from the steel by hammering a steak knife into the joint. This isn't entirely satisfactory, because if AR had done a good glue job, there's a fair chance you'd fracture the magnet. I was lucky.

Then I read Matt Honnert's letter ("Tools, Tips & Techniques," *SB* 6/90, p. 94) that advised heating the motor in an oven at 350° to soften the cyanoacrylate glues used (for obvious reasons) to hold the motor together. There is, so far as I can discover, no solvent that's really effective on these instant glues. Heat works, but it also saps the vigor of ceramic magnets, which I found out the hard way before reading about it in a magnet catalog.

So keep your magnets out of the oven, hope your drivers were built before AR discovered instant glues, and take your chances with mechanical separation. I am back to acetone (in a metal paint bucket), and I use a big vise to hold the steel, and a strap wrench around the magnet to twist it free. Mark the magnet as to which end is up, and scrape off the old epoxy.

The gap has a 1mm span, a 12.5cm circumference, and a stock height of 0.15". When I took my little iron probe to this structure, I measured it as stock, fitted dry—that is, I cleaned off all the glue and put the assembly back together as stock, keeping the gap by shimming with layers of tape—and a complete modified magnet structure (gap 0.2" tall instead of 0.15"), pole bored out, and with a backing magnet.

The stock assemblies varied from 350g for one structure with the magnet badly off-center, to 450g. For the dry fitted structure, I had approximately 550g on the balance before the probe pulled free, and my full modified structure held 530g. It may interest you to know that the stock dry structure held just over 710g with a backing magnet stuck to it.

I blame the underachieving performance

of the assembly—as AR put it together—on too much glue. I think I mentioned that glued-up assemblies were typically 0.01" taller than the same pieces put together dry.

For modifications, I drilled and chamfered a 3/8" hole in the central pole, and drilled three 1/4"-diameter holes, 1/4" from the pole piece, in the back plate. These holes enable all the air volumes under the dome to communicate. I checked the mating surface of the bottom plate for flatness, then sent the assembly off to be plated, which added a couple of mils of brass on top of the steel.

you need shims to hold the top plate away from the pole piece during glue-up. Four thicknesses of playing cards will probably do the trick, adding layers of masking tape as needed. Now fit your shims for thickness, since you can slide the top plate over the pole piece without a magnet causing trouble by pulling the two together.

Another immediate job is to wind a couple of turns of thick copper wire around the base of the center pole, solder them together, and viola—you have a Faraday ring in addition to the brass plating.

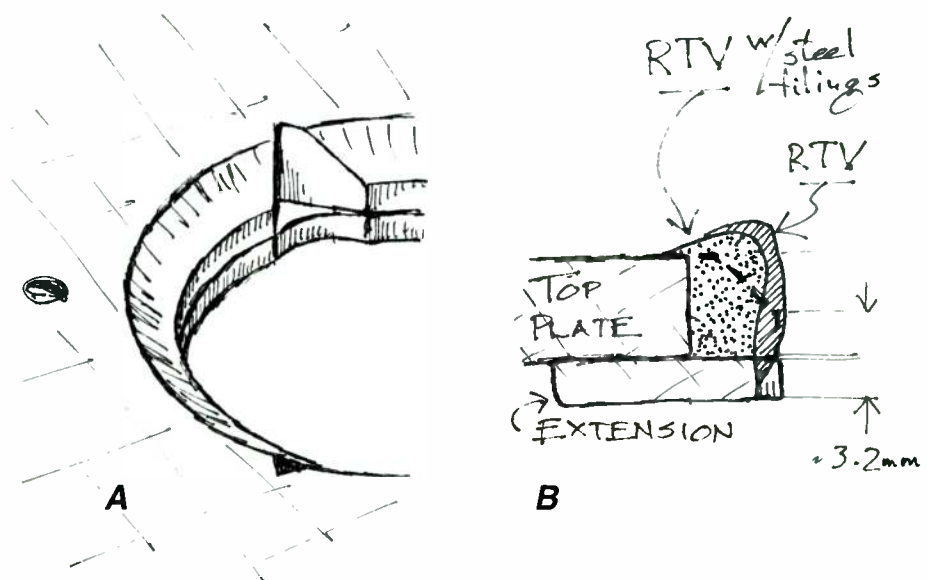

**FIGURE 12:** Treble top-plate details. **A** shows the gap-extension treatment at the notch. The 2-56 tapped hole is at the left. **B** shows a sectional view of the RTV silicone blob in the notch.

My plater couldn't be bothered to plate just the pole piece, so he plated the whole thing. I filed the brass off the mating surface, but that's probably academic. For those of you keeping track, my plating bill for this project came to \$30.

To couple the air under the surround with the air under the top plate, I drilled four 1/8" holes in the top plate, 1/4" away from the gap. Chamfer both ends of these holes.

## FINAL ASSEMBLY PREPARATIONS

You're now ready for assembly, but first

Time to glue! Spread a very thin layer of epoxy on both the bottom plate and magnet (everything's spotless, yes?) and mate them. Get the magnet nice and concentric, twisting it around on the bottom plate to seat it closely. Then get it truly concentric with spacers between the inside of the magnet and the side of the center pole. It's an odd dimension. Break a pencil into pieces and wind masking tape around them until they fit. Clamp. Wooden clamps are easier to work with, but C-clamps are fine, too. Just screw them down evenly, without applying too



much pressure. After ten minutes, retighten. Let it set for 24 hours.

At this point, add a little stuffing under the top plate, something that won't move up toward the gap. Circles of felt, fibrous carpet padding (if dust-free), or wads of polyester batting work well. Fill the cavity about half full without packing it tightly, and secure it with a little DAP smeared inside. This'll also hold the Faraday ring in place.

### GLUING THE TOP PLATE

Now glue the top plate. Arrange your shims so the hole in the top plate will find them evenly distributed when you drop it in position. Glue on both the magnet and top plate. Thread the four 8-32 screws that hold on the flange all the way in, so that they poke out the bottom. Now lower the top plate into position. The four screws will keep it from bottoming. Lower it onto the magnet by unscrewing the screws. Ease it into position, with all the shims in place. Once it's down, twist it around to spread out the glue, clamp it, and retighten your clamps after ten minutes. Let it set 24 hours. Then you can pull out the shims and mask over the gap.

For backing magnets, I chose more of those I used to back the woofer: 10cm outer diameter, 7cm inner diameter, and 2cm tall. A good fit. I was determined to have some fluff under the dome to help soak up the evil back wave, so I pulled a tuft of it through the hole in the bore, and shaped it with scissors and a soldering iron so it was not only well fitted to the dome profile, but, more importantly, was a good 1/4" or so away from the gap. I made sure it stayed in place by smearing a little DAP around the inside of the bore before I pulled it through, and I vacuumed any stray fibers out of the shaped tuft on the front.

Now unmask the gap, dribble in 0.35cm<sup>3</sup> of magnetic fluid, and lower the flange and dome assembly into position. Tighten the 8-32 screws evenly, pressing on the dome to make sure it isn't rubbing. Put a small dab of DAP on the screws to keep them tight.

### ADJUSTING BOX VOLUME

Consulting the midrange dome's  $V_{as}$  (about 160cm<sup>3</sup>), you'll see that the so-called box volume should be about 50cm<sup>3</sup>, given that it's stuffed, to double the final resonance to approximately 400Hz and qualify this as an air-suspension system. Fine. Make all the assorted connected volumes a total of 35cm<sup>3</sup>. You can easily enough adjust the volume inside the backing magnet to 12 to 15cm<sup>3</sup>.

To make this adjustment, I cut some rough chunks of 1/4" masonite to fill about half the exposed back of the bottom plate and support the 7cm-diameter plug I intended to glue on the back. The plug is 1/4" away

from the back plate, enclosing a volume of 38cm<sup>2</sup> × 0.63cm, or 24cm<sup>3</sup>, except that half of that volume is taken up by my odd-shaped chunks of masonite; hence it is 12cm<sup>3</sup>.

I threw in a little felt for good measure, without covering up any of the holes I'd drilled. I made my 7cm plug out of sheetrock, and glued it down with DAP. It's plenty sturdy, and if I need to get inside, I can just hack away at it and make another.

Now stuff what steel you can between the exposed magnet face and the top and bottom plates. The midranges are easier to do than the woofers in this respect. But mind the input connections. In fact, whack those silly little tabs off and tape over the rivets before you wind steel wire in the joints (not forgetting the DAP to hold things together). After you've done that, you can solder some 1' lengths of color-coded wire in the eyelets and make your connections to those.

The only steps left are cosmetic. In the matter of the expanded-metal grille and the stuffing between it and the dome, I opted to go for the stock look. I kept the little pupil-and-iris pieces and, instead of AR's disk of fiberglass, I trimmed down a disk of poly batting to about 1/4" thick, dyed it yellow by daubing it with Radio Shack's P.C.B. etchant, and stretched it to follow the grille's contours—and it stayed put when I glued the grille back in place (DAP, of course).

### THE COMPLETED DOME MIDRANGE

The data tells you the warmed-over midrange is about 2dB more efficient than the stock unit, but its higher impedance makes it a toss-up regarding sensitivity. Stock units vary significantly because of the variations in flux density (B), which puts those level set pots in a new light. My impedance curve tops out at about 9Ω at 400Hz. No surprise there. It's down to 6.2Ω at 1kHz and bottoms out at about 5.5Ω at 2kHz. It must be padded down, which will smooth things out as far as impedance is concerned, so I have no qualms about treating it as a simple resistive load and using a textbook crossover solution.

The aluminum former and ferrofluid should give plenty of power-handling. At the low end, you have  $X_{max} = \pm 1$ mm, which is plenty for a midrange dome. I see modern units (usually 2") advertised with less than half that, but this 30-year-old design can still beat 'em here, as modified. It kicks really well, considering it's such an old geezer.

For the record, motor-coil inductance is calculated at about 0.09mH, a figure I have no hesitation using, because the steel adjacent to the coil is much further toward saturation here than in the woofer. If all that steel was irrelevant to woofer coil L, I figure it's

less so for the midrange motor coil, despite the fact that the gap's span here is 1mm instead of 2mm. I might also mention that the ferrofluid plays a role in mechanically stabilizing the motor former, thus discouraging rocking.

Incidentally, one of my midrange motors decided to start rubbing the top plate a month or so after I buttoned it up—things sounded distinctively wrong. Of course, I hadn't taken quite as much care in assembly as I'm preaching to you here. A little doctoring of the countersinks fixed it.

### THE TREBLE UNIT

This unit was the most frustrating of the three. From my reading, I expected it to be down in output (re the woofer) by 5dB or so, or even—it depended on the source. After dissecting my treble units, I began to understand this spotty reputation. The top plate was typically dished; the voice coil, obviously wound by hand, wasn't done as neatly or compactly as it might have been. The suspension for the dome, three small blobs of foam squirted between the dome and notches in the top plate, was mystifying, unique, and a carryover from the AR-3 dome units.

I was determined to get the output up,

## GO AHEAD

Ask top engineers and music lovers worldwide what capacitors they choose for their ultimate designs.

H O V L A N D

## MUSICAP®

*"After auditioning a wide variety of caps, I find these film-and-foil capacitors to be the most musical performers—and by a large margin. The MusiCap specializes in textural liquidity (lack of grain) and delicacy of treble nuances."*

Dick Olsher, Reviewer and Designer, from November 1996 Samadhi Acoustics white paper

## COMPARE NOW

The most naturally revealing capacitor. Film and foil polypropylene construction—optimized for fine speakers and vacuum tube electronics. Precision made in USA. Values from .01 to 10μF.

To listen to MusiCaps for yourself, contact:

- Welborne Labs 303-470-6585
- Modisound Speaker Components 608-831-3433
- The Parts Connection 800-769-0747
- Michael Percy Audio Products 415-669-7181
- Handmade Electronics 610-432-5732
- American Audio Import, Netherlands 31-78-6510567
- Anchor Cross Co., Tokyo, Japan 81-3-3203-5606
- Bina Putra Datamas, Indonesia 62-21-8209126
- Octave Electronics, West Malaysia 603-793-793-9
- SJS Electroacoustics, England 44-1706-823025
- Tang Hill International Ltd., Taiwan 886-2-5813605
- Thai Audio Center, Thailand 66-2-226-0773
- OEMs contact Howland Company at: ph 209-966-4377 • fax 209-966-4632

Reader Service #73

maybe in the ballpark with the midranges so I could use the AR level-set pots (as part of a larger pad circuit). I had a laundry list of changes to accomplish, including a lower resonance, a  $6\Omega$  impedance to simplify the crossover, and increased power-handling.

Ferrofluid in the gap was a foregone conclusion, and I would rewind the voice coil to get more wire in the gap. I wished to enlarge the gap itself, like the midrange dome, if it didn't compromise flux density too much. There would be a backing magnet, a vented pole, a grille to protect the dome from inquisitive fingers, and a more substantial mounting flange.

After some noodling on paper, I wasn't satisfied until I hit on the notion of increasing  $S_d$  (piston area) by gluing a little diaphragm to the dome, held taut at its perimeter. It would seal the magnetic gap from dust, yet be small enough that it wouldn't (or shouldn't, since this is seat-of-the-pants engineering) resonate too aggressively in the mid-treble. I should add that I stole this idea from Roy Allison, who used this "inverted cone" arrangement in his drivers starting way back in the mid 1970s.

I planned to control the diaphragm extension by securing its perimeter with a glue that wasn't very hard, so the boundary at the perimeter wouldn't be distinct. I also intended to use a material that was decently self-damping, so it wouldn't support much resonant activity. I'd need to fabricate some flexible leads for the dome, too, and a way to attach them.

All of which I'll get to directly; first, I need to clear up some details on how to get this treble unit apart.

### TREBLE-UNIT DECONSTRUCTION

First, cut around the paper dome between the foam-rubber blobs with your X-acto knife. AR used a clear, flexible cement here to keep out dust. Then cut the foam clear from the top plate. Break up your blade into a shape that will reach down and cut the dome free. You've cut the leads to the dome, too, somewhere along the line. No matter; lift the dome free and notice how fragile the little Nomex<sup>®</sup> former is. Put it in a safe place, like a film container.

Now peel off the circle of vinyl stuck to the front and go to work with a hammer and chisel, whacking off all that black plastic. Get it all. No sense muddying up good acetone with plastic. Scrape off all the glue exposed around the joints, too. Then plop the assembly into the acetone.

There's little more you can do until you get the magnetic structure apart, so take some time to make the flange. For this, I used some 1/8" fiberglass composite I had on hand. I cut out the disk, drilled three

holes to mount the unit in the box, and six more for 6-32 screws on a 6cm-diameter circle. I drilled these with a 3/32" bit so I could use it later as a template for drilling the top plate. Then I drilled a 1 1/2" hole in the center for the dome, used a sanding disk to dish the front, and sanded the sharp edge off the hole on the magnet side.

To make the grilles, I laid a 4" x 8" piece of A1 window screen over two 1 1/2" holes drilled in some scrap, and beat on it with the rounded end of a handle and a golf ball until I had two nice dome contours in the screen. I smeared some epoxy on these, working it into the wires' interstices, while keeping the mesh open, and let it dry. The domes kept their shape nicely, thanks to the glue. Then I cut them out, leaving a 1/4" flange to hold them in place, and painted the screens and the fiberglass flange plate black. I was impressed with the dome grilles' strength. To dent them, you would need to press extremely hard.

Then I gouged two grooves in the back of the flange plate for the wire leads. These are 180° apart, running from the 1 1/2" cutout between the holes for the 6-32 hardware and stopping 1/2" from the edge. The grooves are about 1/8" wide and half as deep. They don't need to be pretty—just big enough to hold 24-gauge or similar insulated wire.

### MAGNETIC ASSEMBLY

Assuming you've been busy with other things and the treble magnetic assemblies have been sitting in acetone for 10 to 14 days, it's time to pull them out and separate the magnets from the steel.

Next, scrape off all the glue. Then bore a 1/4" hole down the center of the pole piece and three 3/16" holes through the bottom plate, spaced evenly around the base of the pole piece. These holes will come in handy when you need to shim the treble dome into position during the assembly phase. Dress the magnet-mating surface of the bottom plate flat with a big file, and send these pieces out to get a heavy plate job (again, copper is preferable, but brass is fine).

Now for the top plate. Using the front flange as a template, drill and then tap the top plate for the screws that will hold it and the front flange together. I used 6-32 hardware here. Then slightly chamfer the threaded holes on the magnet side to make sure no displaced steel keeps the top plate from settling flat against the magnet. For the same reason, check the top plate for flatness and file down the dished area until it's respectably flat. You don't need to take this all the way to the gap, since the magnet has a 3.3cm hole in it. Just true up the area that mates with the magnet.

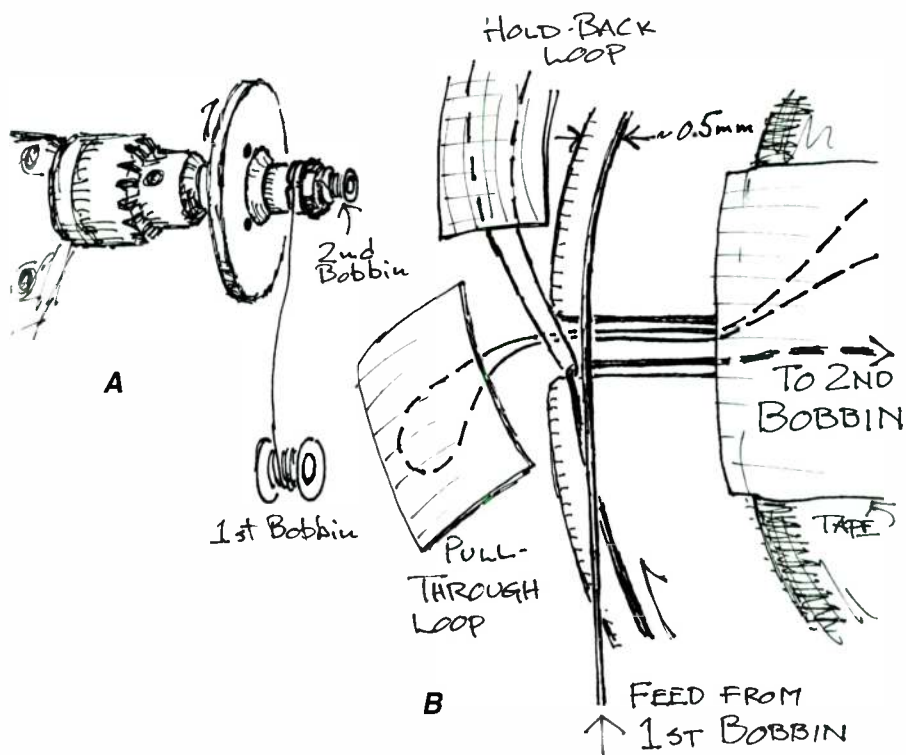

**FIGURE 13a:** Laying wire onto the treble motor former. **A** shows the general layout. Note the second bobbin taped to the top of the dome. **B** shows the first turn wound on. The hold-back loop gives a good bend, and the pull-through loop is needed at the finish of the second layer.



# THE OVID BELL PRESS, *Inc.*

MAGAZINE AND BOOK PRINTING

---

1201-1205 BLUFF STREET  
FULTON, MISSOURI 65251  
Telephone (573) 642-4117

April 23, 1998

Dear Subscriber,

You find enclosed a reprinted version of *Speaker Builder 2/98*. Please replace it with your original copy.

Due to the erroneous substitution of an incorrect font, many of the characters and other elements in the text were printed incorrectly. The Ovid Bell Press takes full responsibility for this problem and Audio Amateur Corporation, publisher, is not in any way accountable.

We apologize for this error and any inconvenience it has caused you.

Sincerely,



Paula LeSeure,  
Account Executive.

Enclosure

Supplement to *Speaker Builder 2/98*.





Now, using a 1/4" fender washer, increase the gap's height to about 3mm by screwing the washer to the top plate and drilling and filing it to bring it to the same diameter as the stock gap. (Just as you did with the 1.5" domes.) The only trick is what hardware to use. I used three 2-56 screws. Tap and die sets don't usually run this small. I got mine at a hobby store that carries supplies for RC model aircraft—\$5.50 for the tap and a 1/16" drill for the hole. Go very carefully when you're tapping for 2-56 threads. And make sure your washer is mounted concentrically; there's only 1mm or so of clearance between it and the magnet.

I had pieces from four tweeters to play with, and the chamfer AR puts on the front of the gap wasn't strictly consistent, but I managed to come up with two top plates having clean profiles and face heights of about 1/8". I had no clear idea of what to do about the notches in the top plate. Should I duplicate them in the washer extension? I compromised by filing an indent with a 1/4" round file at the notches. See Fig. 12. This left a little shelf at the bottom of the notches, but still followed the lead set by AR of pulling away from the pole piece at this part of the gap. See Fig. 12 again.

For the dome's suspension, I kept AR's

tripod arrangement, but used the same black RTV silicone I used to coat the woofer surround. I filled the notches in the top plate in two stages. In the first, I filled out to a level even with the fender washer's contours with a mix of RTV and steel filings. I reasoned that if I could convey a little more flux to the gap, why not?

I let that cure an hour or so, then filled to approximately the gap curvature with straight RTV. Keep in mind that these RTV blobs will primarily attach to the dome's structure above the motor coil and slightly up on the black pressed-paper dome itself. So you want to build your blobs up a little bit, about even with the face of the top plate. Again, I refer you to Fig. 12. It's good practice to get your little RTV blobs fairly similar in size and shape.

I had a terrible time getting the RTV to stick to this steel. I cleaned it and scraped it and did everything I know to give the RTV a good surface to adhere to. I was never really happy with the result, but decided in the end it didn't matter. More on that later.

#### DOMEWORX

I had extra parts to work with—a luxury. If you have a punched-in dome, you can either scout around for a cheap pair of 2axs or give dome restoration a shot. Here's what you

do. First, you need a fixture to hold the fragile assembly, and nothing works better than the pole piece of the magnet structure. It's back from the plater by now, isn't it? Wrap two tight turns of masking tape around the pole and see if the Nomex former slips firmly over the tape. If it's a little loose, take off the masking tape and try one turn of transparent tape, then two of masking. You must hold the dome firmly, but you should be able to twist it on the fixture without trouble.

Once it fits, take it off and mount a tuft of poly fluff to the top of the pole by pulling part of it through the 1/4" hole. Don't let it hang out over the side. Then carefully slide the dome down onto the fixture, making sure you don't catch any fluff between the Nomex and the side of the pole piece; all the fluff must be between the black-paper dome and the top of the pole piece. Once you have the dome assembly fully seated, lightly wind a turn of masking tape around it to hold it in place.

The fluff might partially push the dent out, but it won't be at all satisfactory. So, with a 1/8" drill bit or small rod start pushing the fluff through the 1/4" hole. It may be necessary to keep adding fluff and cramming it inside with the back of your drill bit. Go slowly, little tuft of fluff by little tuft.

The dome will eventually assume its cor-

#### COMPONENTS:

SOLEN HEPTA-LITZ AND STANDARD INDUCTORS AND CAPACITORS - THE CHOICE OF MANY HIGH-END SPEAKER MANUFACTURERS.

#### HARDWARE:

POWER RESISTORS, L-PADS, CABLE, ABSORBING AND DAMPING MATERIALS, GOLD SPEAKER TERMINALS, GOLD BANANA PLUGS AND BINDING POSTS, GRILL FASTENERS, PORT TUBES AND TRIM RINGS, PAN HEAD SCREWS, SPIKES AND TEE NUTS WITH ALLEN HEAD BOLTS AND PLENTY MORE...



## Solen crossover components - used by the most discriminating loudspeaker manufacturers.



#### SOLEN HEPTA-LITZ INDUCTORS

Air Cored Inductors, Litz-Wire Perfect Lay Hexagonal Winding  
Values from .10 mH to 30 mH  
Wire Size from 1.3 mm (16AWG) to 2.6 mm (10 AWG) 7 Strands

#### SOLEN STANDARD INDUCTORS

Air Cored Inductors, Solid Wire Perfect Lay Hexagonal Winding  
Values from .10 mH to 30mH  
Wire Size from 0.8 mm (20AWG) to 2.6 mm (10 AWG)



#### SOLEN FAST CAPACITORS

Fast Capacitors, Metalized Polypropylene  
Values from 0.10 µF to 330 µF  
Voltage Rating: 630, 400, 250 VDC



#### CROSSOVER AND SPEAKER PARTS

Metalized Polyester Capacitors, 1.0 µF to 47 µF, 160 VDC, Non Polar Electrolytic Capacitor, 22 µF to 330 µF, 100 VDC, Power Resistors 10 W, 1.0 Ω to 82 Ω, 8 Ω L-Pads plus all the hardware and supplies to complete any speaker project.

CALL TO ORDER THE 1998 SOLEN CROSSOVER COMPONENT CATALOG FOR \$8.00 PACKAGED WITH THE COMPREHENSIVE 1998 SOLEN SPEAKER DRIVER COMPONENTS CATALOG



### SOLEN INC.

4470 Avenue Thibault  
St-Hubert, QC  
Canada J3Y 7T9

Tel: 514.656.2759

Fax: 514.443.4949

Email: [solen@quebec.net](mailto:solen@quebec.net)

WEB: <http://www.quebec.net/solen/>

Reader Service #43

Speaker Builder 2/98 39

# THINK ABOUT THIS



SAVE THOUSANDS OF DOLLARS

*duplicating*

ANY high-end electrostatic loudspeaker (ESL) by using our parts & supplies!

*It's fast and easy*

to create the ESL of your dreams using our modern hi-tech construction methods.

Any size, shape, or design is possible with minimum effort and the curved see-throughs are a snap. We are the worlds largest supplier of ESL parts, components, mods, repair parts, exotic circuits, trade secrets, and obscure technical information.

Our high volume purchasing power allows us to stock over 70 hard-to-find parts & materials at the lowest possible prices.

Everything from the KIMMEL DIRECT-DRIVE AMP to a complete line of true ESL transformers EVEN AN AIRCORE MODEL I (and it's not a toroid)

Plus all sundry items such as Mylar® film, bias supplies (3 models), conductive tape, powder coated perforated metal, etc. WE HAVE IT ALL !!

**SEND \$19.95 TODAY**

*and receive our*

latest catalog/start-up manual plus a years worth of the **ELECTROSTATIC FORUM.**

**YOU SAVE \$15.05 plus you also receive a 10% DISCOUNT COUPON!**

**Make all checks payable to:**

**DAVID LUCAS**  
924 HULTON ST.  
OAKMONT, PA 15139

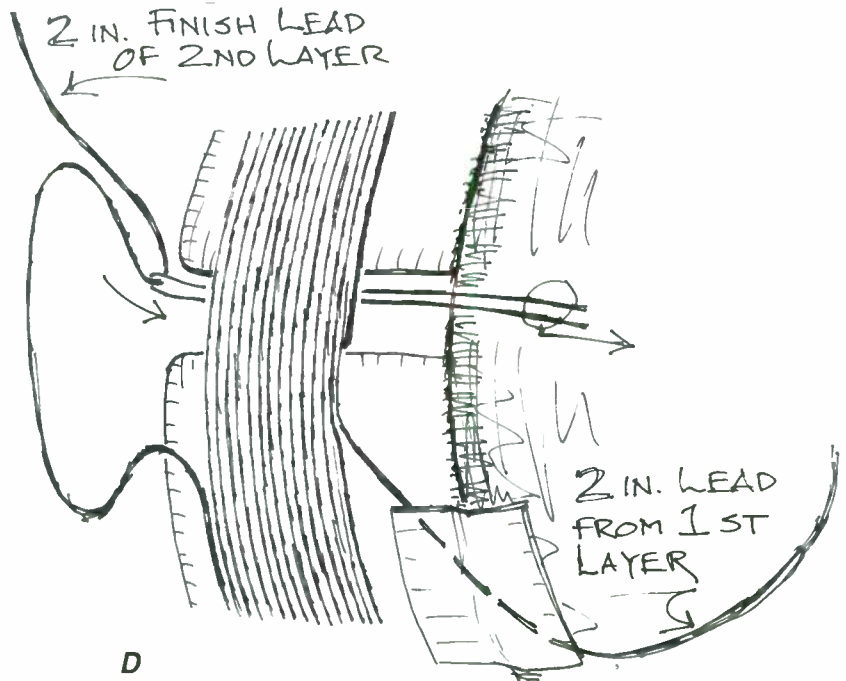
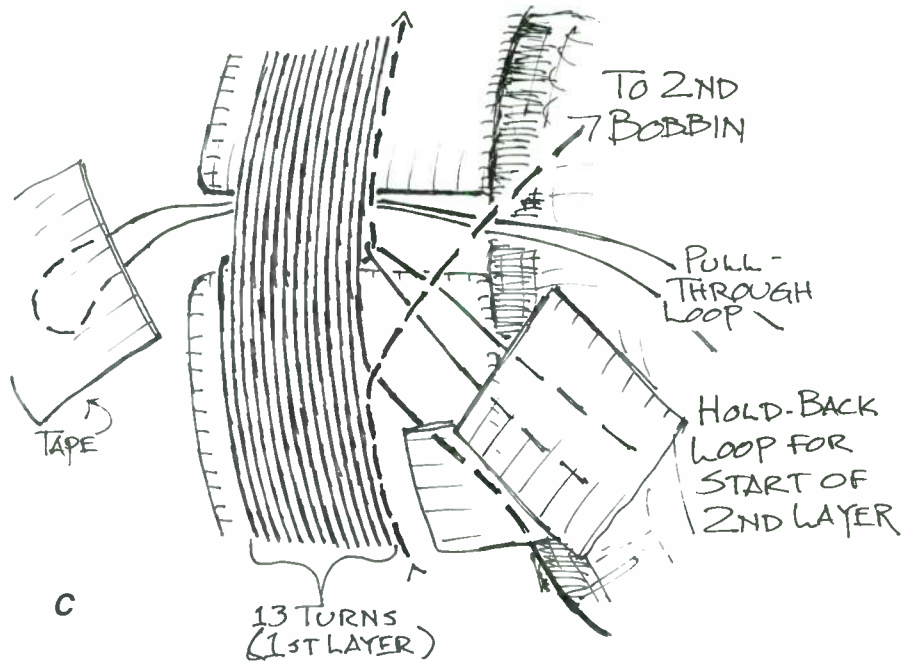

**FIGURE 13b:** C shows the first layer done, and one turn (dashed line) of the second layer down and glued to the former. In the next couple of millimeters, the wire climbs up onto the first layer, into the groove. D shows the finish, using the pull-through to bring the finish of the second layer under the coil and forward for dressing and flex-lead attachment.

rect shape. When it does, apply a coat of instant glue, especially at the creases in the paper, or on areas where it was severely bent, if not actually creased. After a couple of hours, it should be hard. Remove the masking tape and take the dome off the fixture by carefully twisting it. A short length of bicycle inner tube is useful here, giving you plenty of grip without applying

very much pressure. It would be a shame to crush the little paper dome.

### MORE DOMEWORK

Next, work with the coil. Insert a 1/4" bolt through the hole in the center pole, and screw a nut down tight against the bottom of the back plate so it won't twist. This lets you chuck it in the variable-speed drill.



Now mount the dome on the fixture, and once it's seated, place a turn of masking tape (slit to half its width) right at the bottom of the former, so no glue can get under the former there. Now slowly and carefully take off all of the stock motor coil. You just want the wire; don't peel off any Nomex with it. Once the wire's gone (18 turns, in case you weren't counting) smooth out the former's surface with a needle file or a diamond nail file. Usually there's a lot of glue left. Take off what you can and get the surface smooth and clean.

Now put on a two-layer coil, 27 or 28 turns, using 39-gauge wire. It's best to place 13 turns on the first layer, making up the difference with the second layer. Wind it according to Fig. 1 (Part 1), i.e., nested and with one run of wire, no joints. The only real trick is getting a good start for the first turns you wind; but I'm getting ahead of myself.

You'll need good magnification, strong light, and to keep your mind on what you're doing.

You must wind about four feet of wire onto a second bobbin. Oh, and snap a couple pieces of wire again, to get the feel of it; this stuff is almost delicate. Cut up a dozen or so pieces of masking tape, of various sizes, and have them handy. You'll need three or four short lengths of the 39-gauge wire, 2" or so, for small loops.

Figure 13, A-D, shows the procedure. Note the loops that hold the wire in place when you make sharp bends and pull the finish of the second layer through to the front. If you don't understand the process, experiment with some more twine or heavy thread and a pop can.

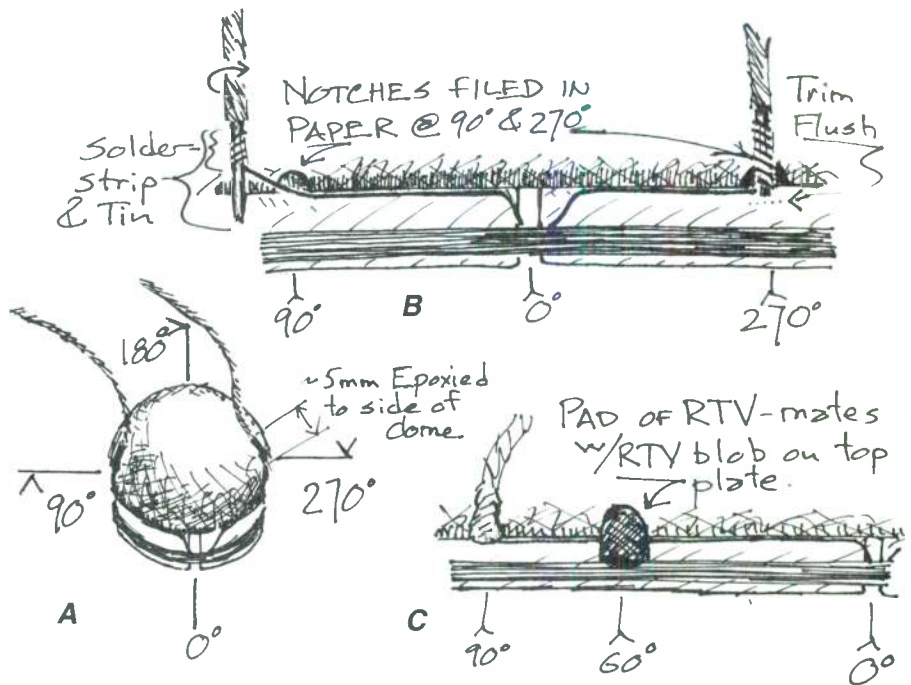

**FIGURE 14:** Dressing the motor-coil leads. **A** shows general layout. **B** shows the leads dressed and epoxied against the paper dome out of the field. Notches are filed into the paper, and the method of connecting the motor leads to the flexible leads is shown. **C** shows the thin patch of RTV on the dome and former that matches the RTV blobs on the top plate.

#### WINDING DETAILS

A few points need emphasis. When you mix up the epoxy for the first layer, make sure you don't spread any into the former gap. Wind the first layer, tie it off with masking tape, and take off the hold-back loop at the bottom of the coil. Examine your work closely. If the turns aren't close-

ly packed, you can push them together now with a needle. Be careful to keep everything even and straight. Install a hold-back loop as shown in **C** (Fig. 13) and lay down the first turn of the second layer, as shown. Tie off the lead from the second bobbin with a piece of masking tape, and use a small piece of rubber or tape to smooth out any

# BassBox™ Pro

# \$129.00

High-performance speaker box design software for Microsoft® WINDOWS®

Design low-frequency speaker boxes fast and accurately with BassBox Pro version 6. With powerful features like a "design wizard", interactive driver parameter verification, external filter modelling, a advanced database with information on thousands of drivers, nine graphs and custom printouts, BassBox excels at box design. With its attractive tab interface, Windows 95 support and context-sensitive balloon help, BassBox is fun to use.

Design boxes for indoor, outdoor and automotive environments.

Also Available:  
**X-over** passive crossover & filter software and the **HT Audio font** collection.

Box designs can be closed, vented or contain passive radiators. A variety of bandpass boxes can also be designed, including single-tuned, parallel double-tuned and series double-tuned. Multiple drivers can be used, including push-pull and isobaric mechanical configurations.

American Express, Discover, MasterCard and VISA credit cards are accepted.

**HARRISTECH** Harris Technologies, Inc.  
Post Office Box 622  
Edwardsburg, MI 49112-0622 U.S.A.

Tel: 616-641-5924 · Fax: 616-641-5738 · Email: [HarrisTech@compuserve.com](mailto:HarrisTech@compuserve.com)

©1997 by Harris Technologies, Inc. All rights reserved worldwide. BassBox is a trademark of Harris Technologies. Other trademarks are the property of their respective companies. Harris Technologies reserves the right to make changes without prior notice.

Reader Service #3

glue on top of the first layer; the grooves need to be distinct.

Now begin testing the epoxy remnant from the batch you mixed for the first layer. When it starts to harden, you know it's safe to start laying down the second layer, meaning that your second layer won't spread the turns of the first as you wind it on.

So mix the epoxy, spread it on, and, working very slowly and counting turns as you go, wind on the second layer. It's very easy to lose the groove, so go slowly and adjust the light and viewing angle so you can see the glossy epoxy. It's difficult to distinguish the first layer from the wire you're laying down. You have plenty of time. Use it.

When the groove runs out, take one more turn against the bottom of the first layer, cut 2" of lead, and use the pull-through loop to get you back to the front of the coil and give you a nice clean finish at the bottom of the second layer. Inspect your work, and if all is well, give the coil a thin finishing coat of epoxy and let it set for 24 hours.

The tables say you should be able to get 14 or 15 turns of 39-gauge enamel wire into a coil about 1.5mm tall. Mine came in at 1.6mm, giving me a nominal  $X_{max}$  of  $\pm 0.8\text{mm}$ —remember that I had a 3.2mm gap. Since I intended to increase the surface area ( $S_d$ ) and add ferrofluid, I was in very good shape—way ahead of the stock tweeter.

### HANDLING THE LEADS

For flexible leads, I used 1½" lengths of Litz wire, the nylon-wrapped stuff used in IF transformers in 60's and 70's vintage radios. First I melted off the nylon by pinning the wire against a board with a soldering iron; this gave me a nice sharp, melted edge. Then I was ready to scrape what enamel I could from the tiny wires. You don't have to get it all. Clamp where the nylon wrap begins with a heatsink (so you don't melt it), twist the wires together tightly, and tin the last ¼" or so. This will burn any lingering enamel off the wires.

Now look at Fig. 14. Use a small triangular file to make two notches in the edge of the black dome paper (at 90° and 270° in the figure). Now dress the two leads from the coil up to the black paper and around to the notches. Epoxy them fast. Scrape the enamel off these leads, starting about ⅛" past the notches.

Then start wrapping the motor-coil leads around the tinned Litz, as in B. After a few turns, heatsink the nylon wrap again and solder the joint. Then just keep twisting to take up the slack until the Litz flex lead fits into the notch. Glue the flex lead to the paper dome for the first 5mm or so, tape it down flat against the dome profile, and clip the excess of the Litz at the former (Fig. 14B). I put a very light coat of epoxy on the black paper—not enough for it to soak in, but just a glaze

over the surface to waterproof it and possibly help it structurally. Let it set for 24 hours.

### REMOVING THE DOME ASSEMBLY

Since the next step is to take the dome assembly off the fixture, you can use the time to get ready for that. Take off the masking tape below the former. Examine the coil and former minutely for any trace of epoxy attaching it to the fixture. Be thorough. Pay special attention to the former gap area. You must eradicate any trace of offending epoxy with a needle or a sharp blade.

That done and the epoxy thoroughly cured, cut a 5"-6" strip of masking tape 4-5mm wide and lightly wind it onto the former coil. Your aim is to reinforce the assembly without squeezing it onto the fixture more tightly, so, I repeat, wind lightly. Keep an edge up on the former-dome joint, and the tape will be thin enough so that the bottom edge will take care of itself.

Now get out your length of bike inner tube, slip it down over the dome assembly, squeeze, and twist. Apply pressure as evenly as you can to the coil former, and twist to and fro, using more force until the assembly begins to slide on the tape-covered fixture. Don't try to pull it off, or you will surely crush the dome. Just get it to twist. Once it's moving on the former, you can carefully twist it free, gently "unscrewing" it.

## VOICE COIL INTERNATIONAL SUBSCRIPTION FORM

# VOICE COIL

Join the thousands of engineers and technical personnel around the world reading *Voice Coil*, the international periodical for the loudspeaker industry. *Voice Coil* is published monthly and is available worldwide for \$98 per year.



**Yes! I'd like to subscribe!**

Method of Payment:  Check (in US \$ drawn on a US bank only)  Mastercard  
 VISA  American Express

Name \_\_\_\_\_

Title \_\_\_\_\_

Company \_\_\_\_\_

Mailing Address \_\_\_\_\_

City \_\_\_\_\_ State/Prov. \_\_\_\_\_

Postal Code \_\_\_\_\_ Country \_\_\_\_\_

Telephone \_\_\_\_\_ Fax \_\_\_\_\_

E-mail \_\_\_\_\_ Web address \_\_\_\_\_

Card No. \_\_\_\_\_ Exp. \_\_\_\_\_

Signature \_\_\_\_\_

- 1 Year-12 issues-\$98.00
- 2 Years-24 issues-\$175.00
- 3 Years-36 issues-\$245.00

## VOICE COIL

PO Box 876, Dept. B98, Peterborough, NH 03458-0876 USA  
Phone 603-924-9464 Fax 603-924-9467 E-mail [custserv@audioxpress.com](mailto:custserv@audioxpress.com)



Now place three little thin pads or patches of RTV silicone on the former and 2–3mm up onto the edge of the dome (Fig. 14C). (You will have gently removed the turns of masking tape you wound on it to help get the dome off the fixture.) These pads are at 60°, 180°, and 300°, and will mate with the RTV in the top-plate notches to form the tripod suspension. It's better to apply the RTV to the dome assembly now because you can get it nice and thin, and properly shaped. You'll work a little more RTV between these pads and the blobs when you assemble.

#### ADDING FOIL

I wished to have a layer of aluminum foil inside the motor former both to make the assembly slightly stronger and to aid in damping, so I cut a 6.3cm × 0.6cm rectangle of medium foil. Remove a turn of masking tape from the central pole/work fixture and replace it with a turn of thinner tape such as transparent cellophane.

Now mix up a little epoxy and spread a thin layer on the inside of the former and the periphery of the dome's inside, making sure you get a good coat on the tiny patch of motor coil you can see through the former gap. Spread an equally even coat on the dull side of the foil.

Now wait until the epoxy starts to set, becoming good and tacky, before you press the foil in place. Keep testing the unused epoxy, and when it starts to harden, form the foil into a circle and, holding it at the ends with a pair of tweezers, drop it inside the dome assembly. Work the foil into place from the middle of the strip toward the ends, bending the top edge to fit the inside of the dome profile as best you can. A pencil eraser works well.

Using your fingers if they're small enough, press the foil flat against the former. This is important. Let the crease against the dome part fall where it may. Once the former is covered with foil, there will be a little foil extending below the former. Bend this out at about a 90° angle to keep the foil from shifting. If any epoxy shows on the foil inside the assembly, clean it off.

Now slide the assembly carefully down onto the fixture. If there's no glue exposed, it should fit pretty smoothly. After about 20 minutes, twist the assembly carefully off and press the little crimps of foil flat against the inside of the dome with the eraser.

If things go badly awry here, just pull the foil out, scrape and smooth what epoxy you can from the inside and try again. Just be sensible and don't foolishly jeopardize the whole assembly. Trim off the excess foil at the bottom of the former. In the next, final, installment of this series, we complete the assembly and finally get the opportunity to kick back and take a listen to this unit.

## Precision Acoustic Measurements Require Precision Microphones



**PS9200KIT™ \$1650 USD**

**A complete IEC and ANSI traceable Type 1 Measurement Microphone System 2 Hz to 40 kHz, 15 dBA to 160 dB SPL**

**\*½ inch capsule \*4012 Preamp \*PS9200 2 Channel PS**

**\*AC adaptor \*WS1 windscreen \*SC1 die cut storage case.**

**Options: 511E Calibrator; 1 & ¼ inch mics; and Gain for DRA's MLSSA and other board level products.**

**ACO Pacific, Inc.**

2604 Read Ave. Belmont, CA 94002 USA

Tel: (650) 595-8588 FAX: (650) 591-2891

e-mail [acopac@acopacific.com](mailto:acopac@acopacific.com)

**ACOustics Begins With ACO™**

Reader Service #90

**WWW.HLABS.COM**  
(303) 841 5360  
FAX (303) 841 2927  
CALL FOR FREE CATALOG  
ASK ABOUT 10% DISCOUNT

400/800WATT  
90% EFFICIENT  
CLASS D AMPS

SMART CAPACITORS

SPEAKER BOX DESIGN SLIDERULES

100 WATT 3500HZ MID/TWEET COVER

1/3 OCTAVE EQ AND XOVER WITH NOISE GATE AND PINK NOISE GENERATOR

12 & 18-DB/OCTAVE ACTIVE XOVERS THAT REQUIRE NO POWER

MOBILE TRI-AMPED 3-WAY BOXES

EMOD

SUB WOOFER BOX KITS AVAILABLE ALSO

WE DO OUR OWN MANUFACTURING HERE IN THE U.S.A.

Reader Service #39

# Kit Review

## MARCHAND ELECTRONICS XM9 CROSSOVER

By Kenneth W. Ketler



*XM9 Crossover, Marchand Electronics Inc., PO Box 473, Webster, NY 14580, (716) 872-0980, E-mail info@marchandelec.com, Website <http://www.marchandelec.com>.*

When you go to a place like Big Joe's Pancake House, do you usually order a "Build-Your-Own Breakfast" or do you let Big Joe decide what you'll eat with his idea of a meal combo? It's a fact of life: some people can be extremely picky with their food. You and I both know there are people who are picky about audio gear, too. Are you one of them?

Marchand Electronics is an audio company that is definitely willing to let you build your own. It manufactures various high-performance power amplifiers and active crossovers that are available as unassembled kits or fully completed units. Moreover, it pledges to perform custom modifications or

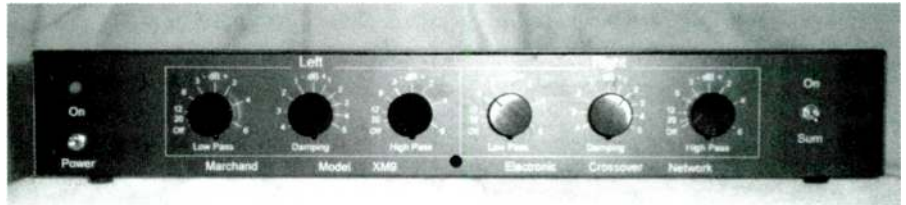

**PHOTO 1:** The completed XM9 crossover system.

even design completely new products to suit the needs of its customers! How could you not love these guys?

Marchand's kits are not simply exercises in square pegs and round holes. If you hunger for knowledge and experience, a lot of information is packed inside the user's manuals. However, if you desire the satisfaction of doing it yourself without getting too technical, you can skip directly to the building instructions and still wind up with a great piece of equipment.

I had the distinct pleasure of assembling the XM9 crossover system, which is available in two-way or three-way versions. The unit I received was a two-way, with a crossover frequency of 100Hz, intended for subwoofer use (Fig. 1). The XM9 utilizes fourth-order Linkwitz-Riley filters; however, the assembly manual explains how to modify the unit into a third-, second-, or first-order system. Wheat, white, rye, or punperrickel...your choice!

are 20, 30, 40, 50, 60, 70, 80, 90, 100, 125, 200, 250, 500, 1kHz, 2kHz, and 5kHz, but the company will create modules for any frequency you specify.

Although swapping DIPs on the circuit boards isn't the best way to perform AB tests, it's still a very quick way to completely change the character of your music system. Sure, it may not be a drive-through, but at least the lines aren't long.

Each stereo channel has three separate potentiometers. The left and rightmost controls vary the levels of the low-pass (LP) and high-pass (HP) outputs, respectively. Each has a range from OFF to +6dB of gain. The middle knob varies the damping of the LP and HP filters simultaneously, which helps achieve a perfect hand-off between satellites and subwoofer.

Since the sats and the sub are putting out equal levels at 100Hz (in this case), their acoustic interaction can cause a peak or a dip according to differing room locations and

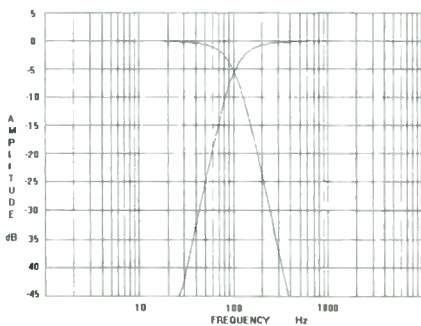

**FIGURE 1:** Two-way version of the XM9 with a crossover frequency of 100Hz.

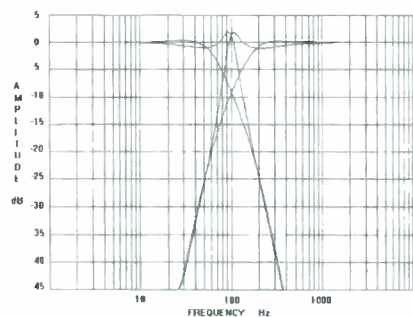

**FIGURE 2:** Graph of the damping control that allows you to vary response at the crossover point.

### THE MULTIFEATURE CREATURE

The XM9 has several traits that put it in the deluxe category in my book. For starters, it includes a relay that turns the unit on a few seconds after you power it up, eliminating transient thumps that could potentially ruin your speakers or your nervous system. It also has the handy ability to sum its low-pass outputs, which greatly simplifies any single versus dual voice-coil subwoofer choices you may have been forced to make in the past.

Marchand also makes changing crossover frequencies a snap. For each crosspoint, there is an 8-pin dual in-line package (DIP) housing four resistors that determine the frequency in question. These crossover modules are available for \$1.95 (unassembled) or \$3.95 (completed). The frequencies in stock

### MANUFACTURER'S SPECS

- Frequency response: DC to 100kHz
- Crossover frequency: 20Hz-5kHz
- Insertion gain: 6dB with level controls at maximum
- Filter slope: 24dB/octave
- Harmonic distortion @ 1kHz: less than 0.001%
- Signal-to-noise ratio: better than 110dB
- Input impedance: 25k $\Omega$
- Output impedance: 50 $\Omega$ , typical
- Output load capability: 2k $\Omega$ , minimum
- Maximum input voltage: 4V RMS
- Power supply: dual regulated  $\pm 15V$  @ 50mA, typical
- XM9 in cabinet: 110V AC, 0.3A



enclosure topologies. The damping control lets you vary the response within +5dB and -4dB at the crossoverpoint for a flat acoustic transition (Fig. 2).

### SPECIAL DELIVERY

I'll never forget the day when the stork brought the package to my front doorstep. I tore open the cardboard bassinet and plastic bubble-wrap blanket. Like a nervous father, I gently sifted through the zillions of tiny components. It was a bit intimidating at first, but it quickly occurred to me that *this* baby comes with complete instructions!

This kit does come with quite a few parts, but please don't be alarmed. They are all neatly separated and grouped according to their final destinations (power supply, circuit board, and cabinet). I suggest that even the most knowledgeable user should read all the assembly manuals (especially the Parts Substitution list) before unwrapping any parts.

I found that the unit I had received for review (XM9L-KK) was upgraded with high-performance op amps than the already reputable XM9-KK. Also, some capacitors had been changed since the assembly manuals were printed.

All manuals (crossover board, power sup-



PHOTO 2: XM9 kit fresh from the box.

### PHOTO 3:

Assembled power supply. Note LEDs (near 3-terminal block) that indicate proper  $\pm 15V$  operation. This is especially good for builders who have no test equipment.



## HIGH PERFORMANCE ELECTRONIC CROSSOVER NETWORKS THESE COMPONENTS AVAILABLE FULLY ASSEMBLED OR AS KITS

**XM9 Crossover Network** • 24 dB/octave slope • fourth-order constant-voltage design • Outputs in phase • Low noise • Controls on circuit board or panel • Settable crossover frequency from 20-5,000 Hz.



**XM16 Crossover Network** • 48 dB/octave slope • Eighth-order constant-voltage design • Outputs in phase • Low noise • Controls on circuit board or panel • Settable crossover frequency from 20-5,000 Hz.



**XM26 Tube Electronic Crossover** provides smooth tube audio, fourth-order design, 24 dB/octave slope, for both channels. Includes time-delayed power supply for long tube life and no transients during power-on/power-off. Plug-in frequency modules set crossover between 20 and 5,000 Hz. Quality components throughout. (Shown with cover removed.)

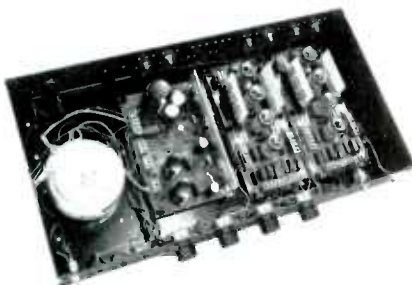

**PS24 Open Frame Power Amplifier** Power supply with toroidal power transformer, rectifier, and one or two PM21, PM22, or PM23 (MOSFET) Power Amplifier Modules—all in one compact, power package!



**PM21 and PM22 Power Amplifier Modules** provide 75 watts RMS into 8 ohms • Complementary Darlington output stage • Integrated-circuit driver circuit • Over-current and over-temperature protection • Class A or Class AB operation. (PM22 shown.)



WRITE NOW FOR FREE LITERATURE ABOUT THESE AND OTHER MARCHAND PRODUCTS

SEND YOUR NAME AND ADDRESS TO: MARCHAND ELECTRONICS, INC.  
P.O. Box 473 • WEBSTER, NY 14580 • PHONE (716) 872-0980 • FAX (716) 872-1960  
Web Page: <http://www.marchandelec.com> E-mail: [phil@marchandelec.com](mailto:phil@marchandelec.com)

**PHOTO 4:** Completed crossover PC boards (both sides shown). Note the DIP labeled 100; this determines the crossover frequency.

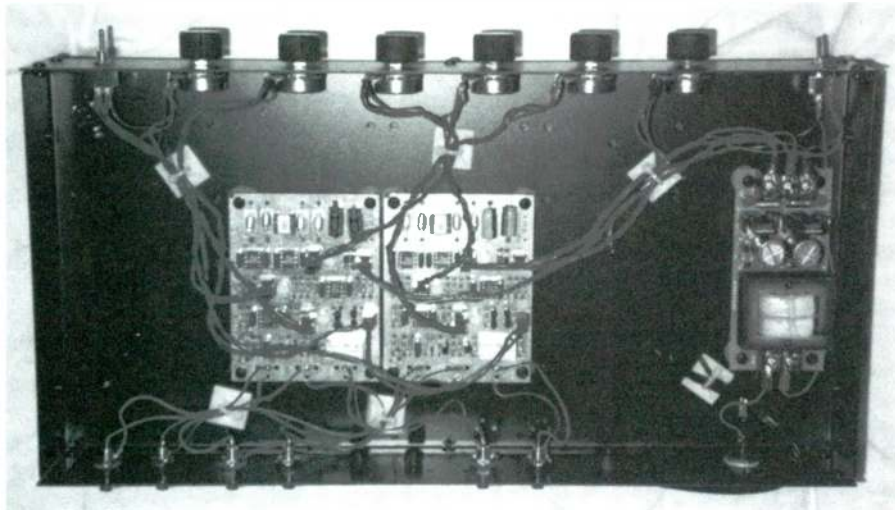
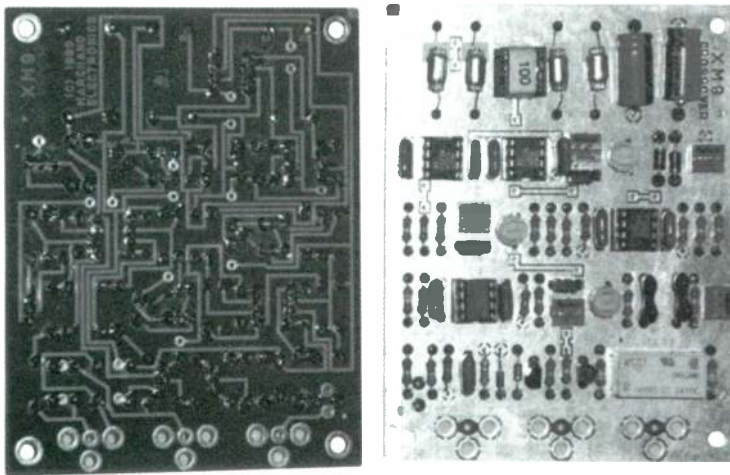

**PHOTO 5:** Innards of the completed system.

ply, and custom cabinet) were very clearly written, with plenty of diagrams and photographs. Each has a well-detailed theory of operation and step-by-step assembly process. Anyone who has ever handled a soldering iron, a screw driver, and a wrench will have no problem putting the XM9 together. I followed Marchand's steps word for word and the darn thing worked perfectly the first time I turned it on. Really!

### THE DOUBLE BLIND TASTE TEST

Once I had calibrated the HP, LP, and damping controls for unity gain, I measured the system clipping level (max level) to be 4.5V RMS at 1kHz. Its frequency response was flat from 5Hz to 40kHz (I did not look any higher than that). Left- and right-channel separation was a decent 73dB at 1kHz, while the signal-to-noise ratio was better than the lowest range of the Fluke 8060A multimeter that I used (better than 90dB).

The manufacturer's specifications claim a harmonic-distortion level of less than 0.001%. Using a Hewlett Packard 339A distortion analyzer, the best I could measure

was 0.0035% with a 1kHz, 2.7V RMS input. Although this may seem ominous, I don't really think so. The 339A measures total harmonic distortion plus noise, whereas Marchand's specs may not necessarily include the noise component. Also, the distortion level, like the signal-to-noise, was down into the lowest range possible for this analyzer—very difficult to read.

Although all of the lab equipment on earth might suggest that a piece of gear is going to perform a certain way, the most important measurement tools are, of course, your ears. Due to the complex characteristics of the program material, loudspeakers, and room acoustics involved, it's very difficult to describe the way a crossover sounds. However, I hope a brief note about my listening setup will shed a little light.

My listening room has a volume of 2300ft<sup>3</sup> with a fair balance of acoustic reflection and absorption. The satellites I used with the XM9 were a pair of PVC-pipe transmission lines (à la John Cockroft) that I built. I mounted them on 15" floor stands so that they were at the same height as my listening position on the couch. I found it

necessary to sacrifice the optimal acoustic placement of the satellites in favor of a less obtrusive location. I was able to space them 4.5' apart; however, the listening position was 8' away, so, needless to say, stereo imaging could have been better.

The sub was a transmission-line enclosure that utilized a Pioneer B20FU20-52D 8" woofer (available from Parts Express), with both voice coils connected in parallel. Its close-miked low-end response was down 5dB at 40Hz, so this was really more of a bass module than a subwoofer. It fit nicely on the floor, against the front wall, directly behind the left satellite. This placement seemed to give quite a smooth response for various locations in the room, with no particularly troublesome acoustic modes.

### IMPRESSIVE SOUND

As I played many of my favorite CDs (and even some I hate), I was very impressed with how well the satellites and the sub integrated with one another. There didn't appear to be any "holes" at the crossover point, and it wasn't aurally apparent where the sub was located. I varied the damping controls, but my system really sounded best when they were set to their 12 o'clock positions.

Just for fun, I moved the sub to the opposite side of the room. It sounded very detached from the satellites, but I still couldn't accurately locate its position. This was an interesting experiment; however, the sats and sub belonged closer together for pleasing results.

I must say that the XM9 is a wonderful piece of gear, whether you build it as a kit or purchase the finished model. In the throw-away type of society we live in, though, wouldn't it be nice to be able to modify your audio system as your needs change, rather than chuck it? If your crossover ever needed repair, imagine knowing where everything is and how to replace a faulty part yourself because you put it together in the first place.

If your system is already bi- or triamped, I would suggest looking at Marchand Electronics. Besides the XM9, Marchand makes a 24dB/octave tube crossover system and a 48dB/octave solid-state unit, plus a lot more. If you're the kind of person who never tried biamping, or if you swore you'd never buy triamping, you might be shocked at the difference in performance between active and passive crossover filters.

I give the Marchand XM9 an A+, five stars, and two thumbs up. You can visit Marchand's web site at [www.marchand-elec.com](http://www.marchand-elec.com) and decide for yourself.

I would like to thank my good friend Norman S. Stickney for his indispensable help with the graphics. ▶



# Trade Secrets

## MAGNETIC STRUCTURES AND BASKETS

By Mike Klasco

In this series, I take a close look at the speaker components themselves, providing an insider's perspective on how they work and how they can work better. In this second article, I look at magnetic systems and speaker baskets.

### MAGNETIC SYSTEM

Before World War II, speakers were electromagnetic, using field coils to produce the magnetic field and tapping the radio's power supply to compose an electromagnetic field. But as the first cheap permanent magnets (of aluminum-nickel-cobalt steel, and known as alnico) became available, it was curtains for the field-coil speaker. Throughout the 1950s alnico was king (Fig. 1).

During the late 1960s the supply of alnico became scarce and, eventually, the speaker industry switched over to ferrites (Fig. 2). While ferrites offered some benefits to alnico, including less vulnerability to demagnetization by heat and physical shock, they resulted in a much bulkier magnetic system. As speakers became heavier, they were also better able to dissipate the heat from the voice coil due to their larger mass and the increased surface area of the magnetic system.

Early ferrite magnets were dry pressed into their final form. A higher performance process, known as wet press, is now widely accepted. Although the tooling costs are greater for magnetic suppliers, wet-pressed magnets offer increased energy for magnets of the same size and weight. Some suppliers of ferrite magnets are General Magnetics, Sumitomo, TDK, Korea Ferrite, and Hitachi.

Many speaker companies resisted switching over to ferrites. When comparing speakers with identical construction, except for the magnetic system, those having alnico always sounded better. JBL introduced symmetrical

field geometry techniques that addressed some of the problems. These modifications included an undercut pole piece and an inductance-canceling aluminum ring on the pole piece—techniques often found in the better drivers today. But the speaker industry's use of ferrite was a choice of necessity, not performance. Since alnico used nickel and cobalt, and the countries from which these materials are sourced are politically unstable, the supply is problematic.

### NEODYMIUM INTRODUCED

Neodymium was first introduced to audio almost a decade ago by Electro-Voice in a professional compression horn driver (Fig. 3). Key patents for processing neodymium are held by GM Delco and Sumitomo. Quite a few firms make neodymium under license from one of the patent holders, offering many variations of this high-performance magnet material. Many of the early processing patents are expiring about now, but secondary patents, especially covering corrosion resistance and forming material into the final precise shape without damaging magnetic performance, still have a way to go.

Neodymium is a very potent magnetic

material (Fig. 4) and promises lighter, more efficient, and lower distortion speakers. Early neodymium was extremely expensive and too sensitive to temperature, but all aspects of this material have improved. Today, neodymium is very popular in autosound tweeters since it allows surface mounting to the interior. For audiophile and home-theater applications, the compact magnetic structure is inherently shielded and can be mounted much closer to the woofer—or even co-axially as in the KEF Uni-Q. JBL has introduced woofers for commercial sound applications having neodymium magnets based on a low-distortion push-pull magnetic structure geometry. Neodymium is the future for audiophile speaker design. Aura Systems, an aerospace and magnetics firm, has developed a magnetic geometry with good linearity for loudspeakers (Fig. 5).

### CIRCUIT STRUCTURE

But, I am getting ahead of myself—back to conventional magnets. The ferrite magnetic system consists of a steel magnetic flux return circuit. The conventional speaker's magnetic circuit consists of a donut- or washer-shaped top plate, a back plate, and a mag-

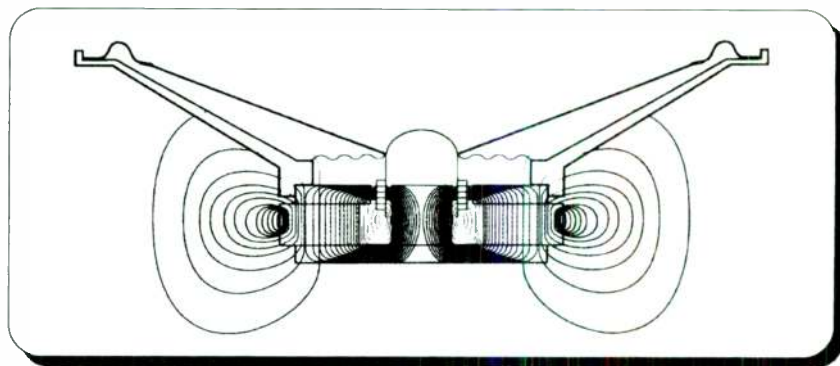

FIGURE 2: Conventional ferrite magnet structure including magnetic flux lines.

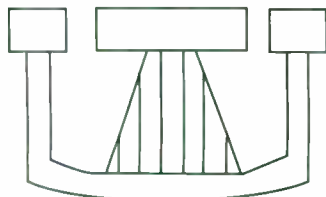

FIGURE 1: Cross-section of alnico magnet.

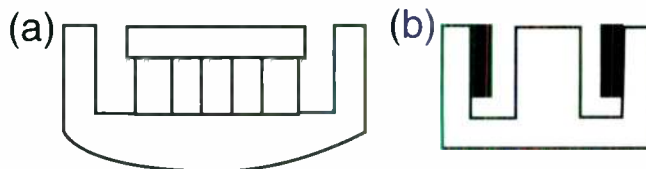
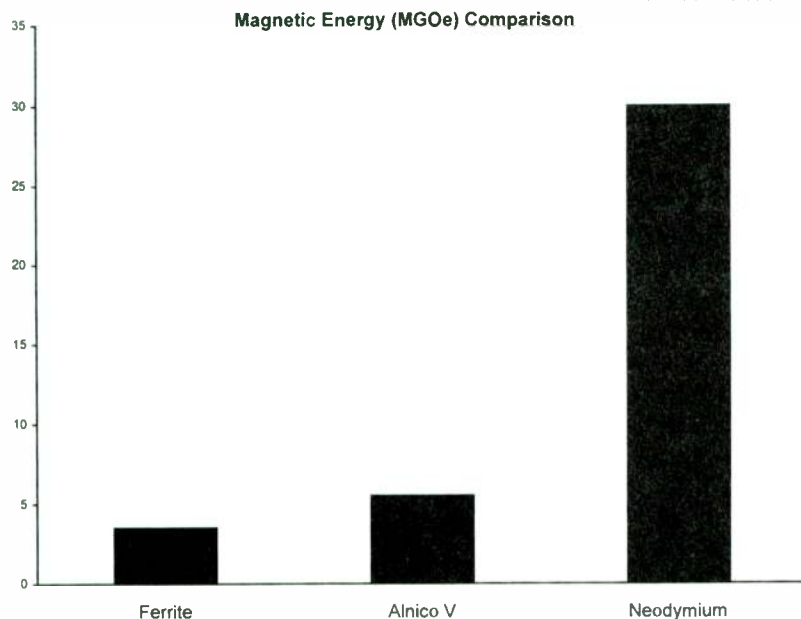

FIGURE 3: Axial (a) and radial (b) neodymium magnet cross-sections.



**FIGURE 4:** Magnetic energy comparison of ferrite, alnico, and neodymium magnets.

net ring sandwiched in between. The top plate and back plate are connected by a pole piece, although the pole piece is separated from the top plate by a tiny radial gap. The magnetic force jumps this gap, inside which is an intense magnetic field. This radial gap is the place to locate the voice coil.

Sometimes the back plate and pole piece are cold-forged as a single piece. A large-diameter soft steel (low carbon content) rod is cut into slices. Each slice is placed in a 1,000-ton (!) knuckle press about the size of a large room, but four floors high. The steel disc is then bashed and, by the sheer force of the

press, the metal flows and a cold-forged back plate/pole piece is formed.

Top-plate thickness, chamfering of the tips of the top plate, pole piece shape (such as under cutting the pole piece), will all have significant effects on excursion linearity, distortion, power handling, and sensitivity (Fig. 6). Ideally, the top plate would be much longer than the voice coil, which is known as underhung geometry (Fig. 7). With an underhung coil, the speaker's Thiele/Small parameters, especially the characteristics relating to force (Bl) remain stable with excursion. Bl is the product of the magnetic field and the number of turns of voice coil wire in that magnetic field. But almost all woofers use overhung coils (Fig. 8), where the coil is longer than the top plate, and typically, even with just a little excursion, the magnetic characteristics are constantly changing. This intrinsic instability results in all sorts of modulation effects that degrade the clarity and definition at medium to high sound levels.

Why don't speaker engineers use underhung coils? The reason is that a thick top plate (much deeper than the voice coil) is expensive, and would require too much magnet to drive the deep magnetic gap with adequate flux. The previously mentioned "Neo-Radial" magnetic circuit design lends itself to underhung voice coils.

From the publishers of Voice Coil

# Loudspeaker

## INDUSTRY SOURCEBOOK

## LOUDSPEAKER INDUSTRY SUPPLIERS!!

Target your market for a full year  
with an ad in the 1998 edition.

Brought to you by the publishers of *Voice Coil*, the **Loudspeaker Industry Sourcebook** is the most comprehensive collection of listings on loudspeaker materials ever assembled. It is designed to help engineers, designers, purchasing managers and key executives locate the resources that are essential to their loudspeaker manufacturing operations.

Fully updated each year for accuracy, this valuable information source is sought after by loudspeaker companies across the globe. Don't miss this once-a-year opportunity to place your own custom advertising message in front of the most targeted audience of industry buyers available. Space is sold first-come-first-serve, so call today.

For more information contact us at

**800-524-9464 (603) 924-7292, Fax (603) 924-9467**

**DEADLINES:** LISTINGS, 4/17/98; SPACE CLOSING, 4/24/98; MATERIAL DUE, 4/31/98



## VENTED POLE PIECE

Back to the back plate/pole piece! Often you will see a hole down the pole piece, known as the vented pole piece (Fig. 9). This is for cooling: the dust cap will pump air down the pole piece to reduce its temperature. Yet, the voice-coil temperature really must be dealt with first. (I will take a look at this next issue.) By the way, another benefit of vented pole pieces is the prevention of air cavity pressure build-up. As the cone assembly moves back and forth, air pressure will increase and decrease behind the dust cap. Without an escape path, the dust cap will either be pumped up or drawn inward.

Additionally, the high air velocity being forced through the voice-coil gap will cause whistling noises. The vented pole piece provides a pressure relief path for the air behind the dust cap, thereby reducing the speaker's modulation noise characteristics, sometimes called spectral contamination. (In future articles, I will discuss spectral contamination, how it is measured, and why a driver's signal-to-noise ratio is one of its most important specifications.) The speaker engineer must be careful, because if the vent in the pole piece is too small, then the vent will create turbulent noise, and if it is too large the effi-

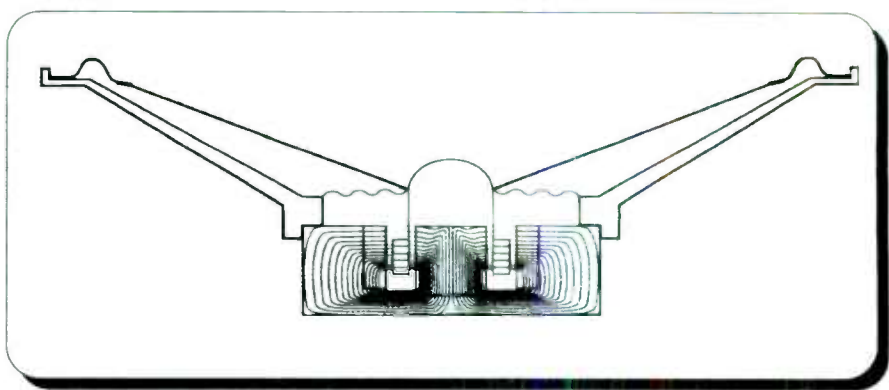

FIGURE 5: Aura's Neo-Radial technology magnet.

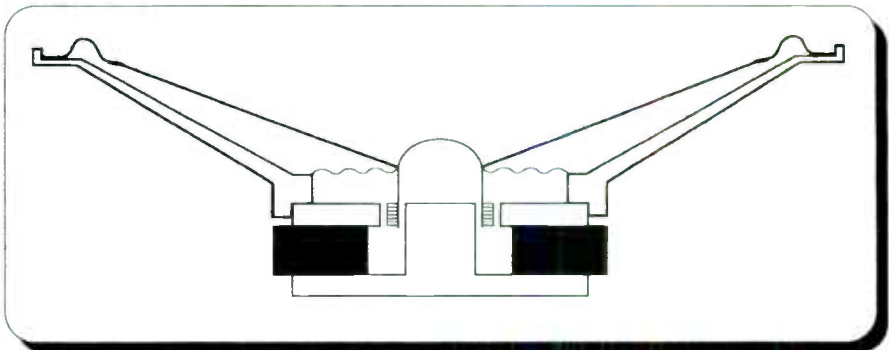

FIGURE 6: An equal-hung voice coil design.

# CROSSOVER NETWORKS

**ELYTONE** is a specialized factory in the field of electronic industry since founded in 1981. We manufacture and supply the loudspeaker industry with the highest quality crossover networks and related materials. We have combined the technical expertise and requirements of our customers with our own and have focused on:

- **SHORT LEAD TIME SERVICE**
- **ZERO DEFECTIVE PROGRAM**
- **COMPETITIVE PRICE**

## ELYTONE ELECTRONIC CO., LTD.

NO. 9, LANE 210 WEN CHANG STREET,  
TAIPEI 10664, TAIWAN  
TEL : 886-2-2709-2500  
FAX : 886-2-2755-5273  
E-mail: elytone4@ms1.hinet.net

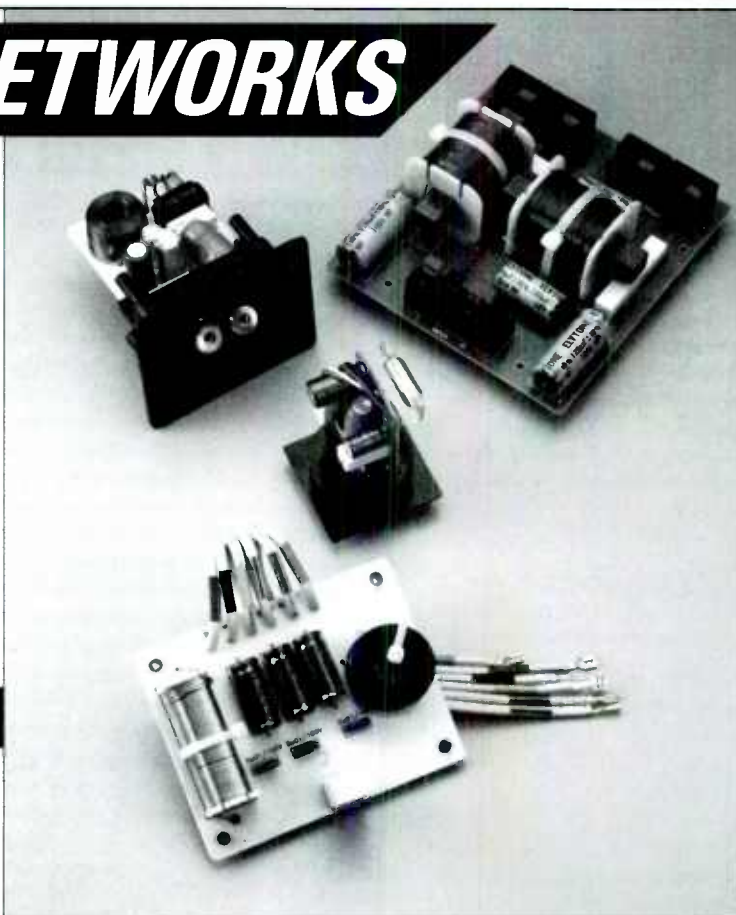

Reader Service #13

ciency of the magnetic circuit will be compromised.

The steel used for magnetic circuits must be soft, that is, have a low carbon content. Japan and Taiwan are big suppliers of low-carbon magnetic circuit steel. The lower the carbon content of the steel, the less loss of magnetic flux occurs. The motley gold finish you sometimes see is the cadmium-zinc plating, while the black finish is black zinc. Aside from looking better, the black offers better heat emissivity (the ability to dump heat) and is a bit more expensive. The gold finish has the best corrosion resistance, while the silver is the best compromise in between.

### THE BASKETS

The frame of the speaker is either stamped steel or cast aluminum. Stamped steel is common on all but the most expensive speakers. The appeal of steel frames for speaker manufacturers is that they are readily available. Tru-Die, US Speaker Basket, Sundstrom, Alden, Alpha, and others have tooling readily available to bang out all sorts of sizes and shapes with many options. The gauge of the steel (higher gauge numbers are thinner) is an important factor in the baskets' strength. Cheap 5" midrange speaker baskets might be only 20 gauge, while a typical 12" frame is 18

gauge, and a heavy 15" frame from Sundstrom is 16 gauge.

Aluminum baskets are associated with pro-

### SOURCES

**Ferrofluidics Corp.**  
40 Simon St.  
Nashua, NH 03061  
(603) 883-9800, FAX (603) 883-2308

**General Magnetics**  
5252 Investment Dr.  
Dallas, TX 75236  
(972) 296-4711, FAX (972) 298-4298

**Hitachi Metal America Ltd.**  
7800 Neff Rd.  
Edmore, MI 48829  
(517) 427-5151, FAX (517) 427-5772

**Sumitomo Special Metals**  
23326 Hawthorne Blvd.  
Ste. 360, Skypark 10  
Torrance, CA 90505  
(310) 378-7886, FAX (310) 378-0108

**Sundstrom Pressed Steel**  
8030 S. Chicago Ave.  
Chicago, IL 60617  
(773) 721-2237, FAX (773) 721-9534

**Tru-Die, Inc.**  
3700 N. Sandra  
Franklin Park, IL 60131  
(708) 455-0220, FAX (708) 451-9663

**US Speaker Basket Corp.**  
108 John St.  
North Aurora, IL 60542  
(708) 892-3777, FAX (708) 892-3810

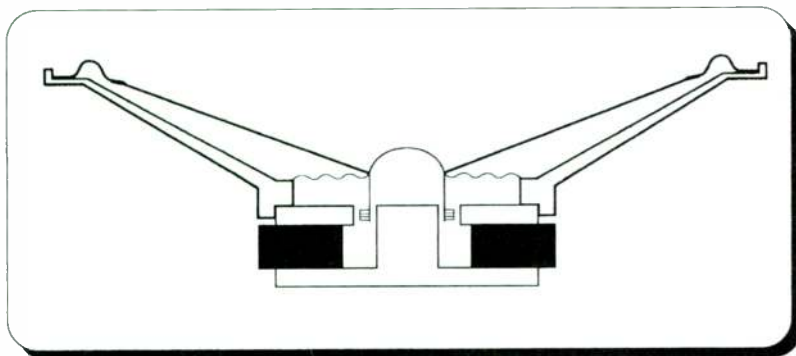

FIGURE 7: Underhung voice coil design.

★ BOOKS ★ SOFTWARE ★ TEST CD's ★ KITS ★ AND MORE

## The Old Colony Sound Laboratory Catalog!

*Your Source for Audio Information!*

Send in the form  
below to receive  
your **FREE OLD  
COLONY SOUND  
LABORATORY  
Catalog!**

**YES!** I'd like to receive my **FREE** copy of the  
**OLD COLONY SOUND LABORATORY Catalog.**

NAME \_\_\_\_\_

STREET & NO. \_\_\_\_\_

CITY \_\_\_\_\_

STATE \_\_\_\_\_

ZIP \_\_\_\_\_

COUNTRY \_\_\_\_\_

### OLD COLONY SOUND LABORATORY

PO Box 876 Dept. B98

Peterborough, NH 03458-0876 USA

PHONE: 603-924-6526 FAX: 603-924-9467

EMAIL: [custserv@audioexpress.com](mailto:custserv@audioexpress.com)

OLD COLONY SOUND LAB IS A DIVISION OF AUDIO AMATEUR CORPORATION.



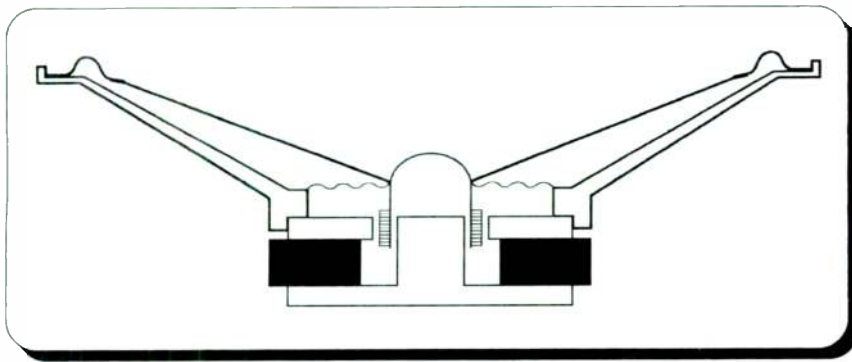

FIGURE 8: Overhung woofer design.

fessional speakers. Light, strong, and sexy, a cast aluminum basket can make a speaker look like a precision machine. Another appealing factor is that aluminum, unlike steel, is non-ferrous and does not drain the magnetic force from the magnetic system (maybe 0.5dB of the magnet's energy is lost with steel). Cast aluminum frames also tend to have less resonance than steel. These resonances have a way of finding a path to the sound quality. Very few sources sell raw cast aluminum frames. Most manufacturers that offer cast frame speakers have had to pay for the tooling.

Next time I will explore the heart of the speaker, the voice coil.

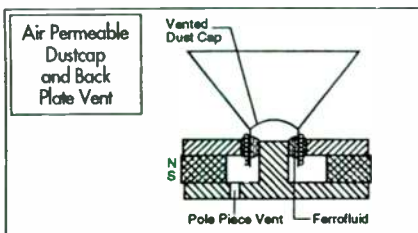
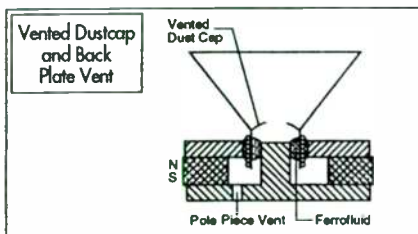
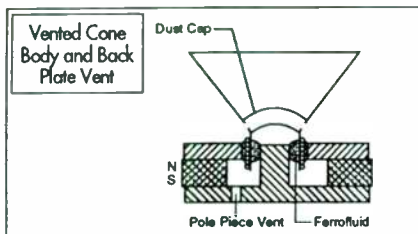
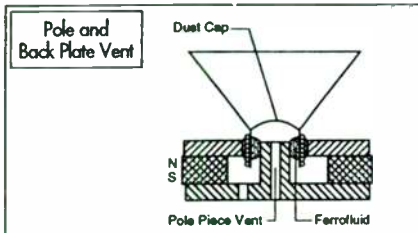
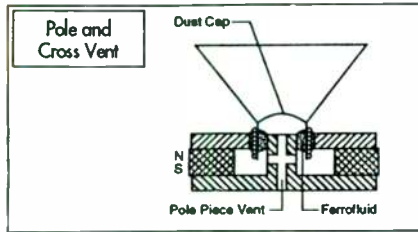

FIGURE 9: Venting schemes for woofers.

# HI-FI NEWS & RECORD REVIEW

## THE WORLD'S MOST RESPECTED HI-FI MAGAZINE

SUBSCRIBE TODAY AND GET THE NEXT 12 ISSUES FOR \$65.00 USA \$75.00 CANADA

Please send me the next 12 monthly issues of Hi-Fi News and record Review from the next available issue.

Mr/Mrs/Miss/Ms \_\_\_\_\_

Address \_\_\_\_\_

Apt# \_\_\_\_\_

City \_\_\_\_\_

State \_\_\_\_\_ Zip \_\_\_\_\_

### METHOD OF PAYMENT

- Check enclosed (US dollars and drawn on a US bank)
- Please charge my  Visa  Mastercard  American Express

Account No. \_\_\_\_\_ Exp. date \_\_\_\_\_

Signature \_\_\_\_\_ Date \_\_\_\_\_

- Please bill me

Return to Hi Fi News & Record Review, PO Box 384, Avenel, NJ 07001

**FOR FASTER SERVICE USE YOUR CREDIT CARD AND CALL TOLL FREE**

**800-688 6247**

AA41

# Driver Report

## TWEETERS FROM SEAS

By Vance Dickason

This month's report focuses on two new drivers: the SEAS 27TAF/G and 27TAF/G (Photo 1) metal-dome tweeters. SEAS has been making high-end aluminum domes for many years and has just released its latest incarnations, the 27TAF/G and 27TAF/G.

**Features:** Both tweeters use SEAS' high-definition aluminum/magnesium-alloy dome material with a wide soft-fabric surround made from Sonotec®, a proprietary material used by SEAS. Both domes are protected by a screen grille that also houses a small Mylar

phase-correction device built into the glass-fiber reinforced mounting flange. Both domes also use aluminum vented voice-coil formers and are damped with low-viscosity magnetic fluid. The 27TAF/G has a damped pole vent and the 27TAF/G has a complete vent and a reinforced cavity for lower crossover frequencies.

**Measurements:** Tweeter impedances were measured with LMS as shown in Figs. 1 and 2. The impedance of the cavity damped version (27TAF/G) shows a broad dampening

of the driver resonance. Both drivers were mounted on an 8" x 15" baffle recessed above a recessed 6½" driver. Response curves, depicted in Figs. 3 and 4, are very similar for both drivers, and differ mostly in the low-frequency rolloff of the drivers (the lower "Q" of the cavity version is obvious).

Both drivers exhibit a relatively smooth SPL profile and could likely be made to fit a less than ±2dB window above 2.5kHz with the proper network. The breakup mode for the metal dome material occurs at about 27kHz on both tweeters. On- and off-axis

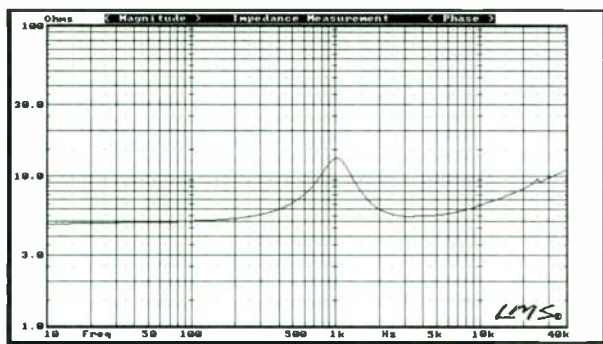

FIGURE 1: SEAS 27TAF/G tweeter impedance plot.



FIGURE 3: 27TAF/G tweeter on-axis frequency-response curve.

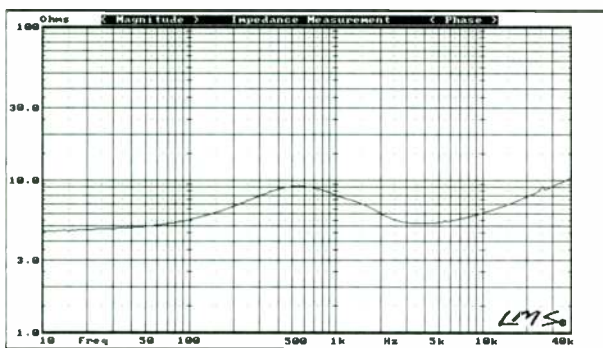
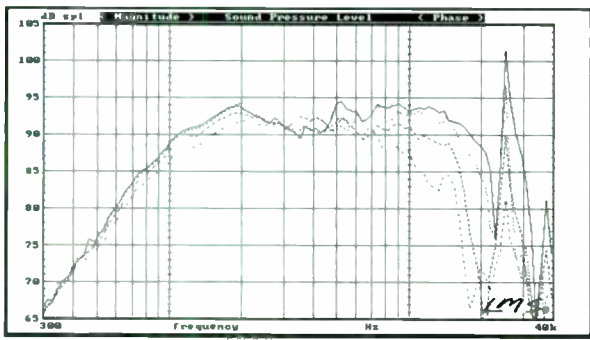

FIGURE 2: 27TAF/G tweeter impedance plot.

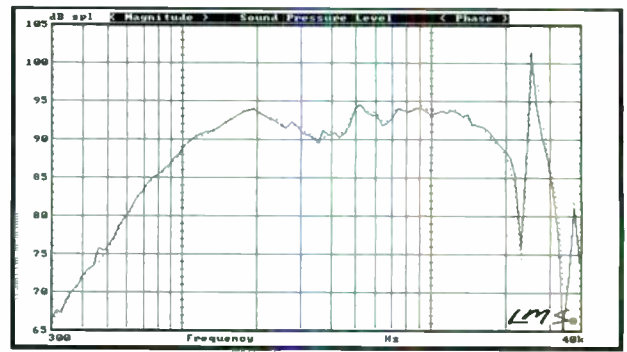

FIGURE 4: 27TAF/G tweeter on-axis frequency-response curve.

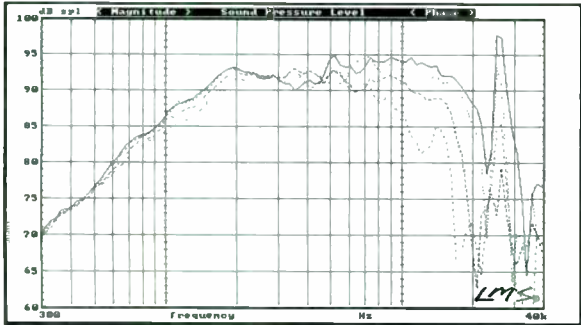



**FIGURE 5:** 27TAF/G tweeter on- and off-axis frequency response (solid = 0°, dot = 15°, dash = 30°, dot/dash = 45°).



**FIGURE 7:** 27TAF/G tweeter SPL comparison for two samples.



**FIGURE 6:** 27TAF/G tweeter on- and off-axis frequency response (solid = 0°, dot = 15°, dash = 30°, dot/dash = 45°).

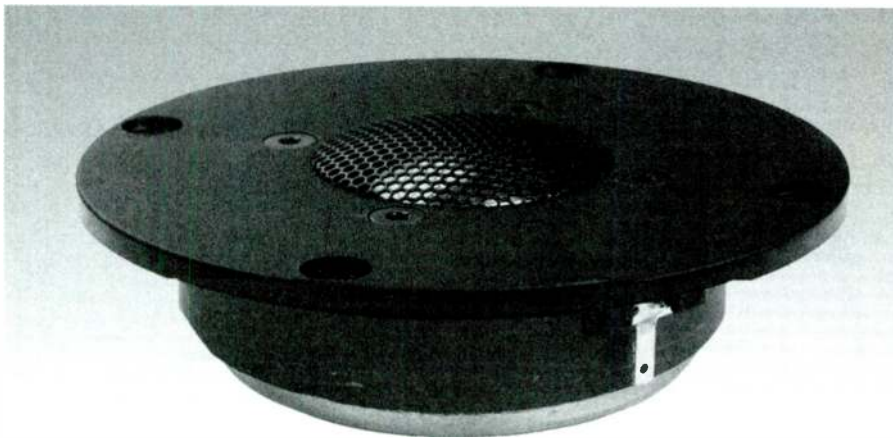

**FIGURE 8:** 27TAF/G tweeter SPL comparison for two samples.

performance is shown in Figs. 5 and 6, and is also nearly identical for both tweeters. Figures 7 and 8 show the two-sample SPL comparison, again showing the tight quality control exhibited by virtually all of the European driver manufacturers.

For more on these new metal domes, contact SEAS USA, 736 N. Western Ave., Ste. 33, Lake Forest, IL 60045, (847) 735-9255, FAX (847) 735-9256. The 27TAF/G and 27TAF/G are available to consumers from the following distributors: Madisound

Speaker Components, 8608 University Green, Madison, WI 53744-4283, (608) 831-3433, FAX (608) 831-3771, E-mail madisound@itis.com, Website www.itis.com/madisound; Zalytron Industries Corp., 469 Jericho Turnpike, Mineola, NY 11501, (516) 747-3515, FAX (516) 294-1943; and Solen Electronique, 4470 Avenue Thibault, St. Hubert, PQ J3Y 7T9, Canada, (514) 656-2759, FAX (514) 443-4949, E-mail solen@quebec.net, Website www.quebec.net/solen/.



**PHOTO 1:** SEAS' 27TAF/G metal-dome tweeter.

## MAHOGANY SOUND

The Transmission Line Specialist  
P.O. Box 9044  
Mobile, AL 36691-0044  
334-633-2054

### Acousta-Stuf

The Very Best Damping Material For Speaker Systems. It Produces Deeper Bass, Cleaner Mids, And Greater Dynamic Range. Acousta-Stuf Costs \$9.50 Per Pound UPS Paid.

### Q&ETLD

Quick & Easy Transmission Line Speaker Design Booklet & LOTUS 1-2-3 Software. Learn How To Design Optimizes 1/4 Wavelength TL Speakers. Q&ETLD Costs \$8.95 Plus \$2.05 P&H.

### Acousta-Tubes

Round Paper Tubes For Building Cylindrical Speaker Enclosures.

Please Note Our New Address & Area Code

Call Or Write For A Free Catalog

Reader Service #9

# SB Mailbox

**Exclusive  
Distributor of  
Acoustic Research  
Advent & Jensen  
NHT Parts**

# ARNHT

**We can bring your speakers  
and equipment back to life  
using the original components.**



800-225-9847 FAX: 508-478-9816  
17C Airport Drive  
Hopedale, MA 01746

Reader Service #55

## CROSSOVER CORRECTION

An error has appeared in *Loudspeaker Projects #1*, p. 64, Fig. 2. I have simulated the proposed crossover and it is inadequate. An 18dB series crossover should appear as noted in Fig 1.

Patrice Pelletier  
Quebec, Canada

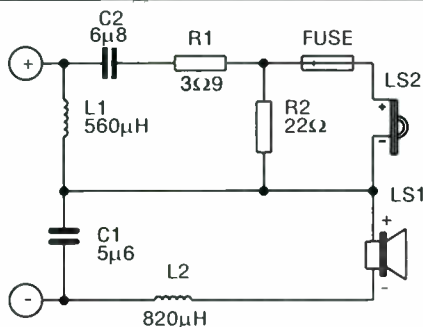

FIGURE 1: The corrected crossover.

## EARLY YEARS AT AR

Although writing letters to editors is not one of the items on my agenda, the article "Rebuilding the AR-3a, Part 2" (*SB 7/97*), screams for some comments. To start with,

the author, Tom Yeago, must have been consuming some of the hallucinogenic mushrooms of *Maria Sabina* (Cantata by Leonardo Balada, Louisville Records) in either his salads or omelets. Either that or he possesses very, very long legs (longer, perhaps, than Fred Astaire's) to be able to jump to some of the inaccurate conclusions which he has reached.

To begin with, the article should have been properly headed "Redesigning the AR-3a." Second, there are some comments in the article which require clarification or correction. Although it's really impossible to go through all the statements point by point, I will pick on some particularly salient ones.

1. The free-air resonance of the AR woofer was designed to be 14Hz and was meticulously kept at that frequency. It was also designed to have, and carefully kept at, a peak-to-peak excursion of 5/8-inch. Its resonance in the box was also designed to be, and kept at, 44Hz with a "Q" of 1.

2. It may surprise many people that Acoustic Research invented and applied for a patent covering the dome radiator (dome with poured latex suspension, 1959). When the dome was developed, there were really no suspensions which had been worked out previously, permitting utilization of a dome radiator in a magnetic structure. One must look at the AR-3 and the AR-3a domes as



**ETF** is a software application that runs on your computer using Windows 95/NT, any 16 bit sound card, and an omni-directional microphone.

- **ETF Room Acoustic Analysis** measuring - Early and Late Reflections
  - Room Resonance
  - Frequency Response
  - Loudspeaker Distortion
  - Reverberation Time Analysis
- **Device Designer** - Design of Helmholtz Resonators and QRDDiffusers
- **A primer and tutorial on Room Acoustics**
- **Using Time Delay Spectrometry techniques**
- **Used by Professional Studios Worldwide**

• **A calibrated microphone and pre-amplifier is also available for \$ 199.95 US**

The complete **ETF** System lists for **\$199.95US** Call: **1-800-301-1423**

Visit [www.etfacoustic.com](http://www.etfacoustic.com) e-mail: [sales@etfacoustic.com](mailto:sales@etfacoustic.com)

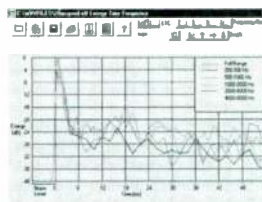
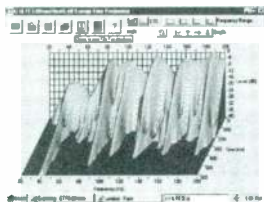

Reader Service #37



the beginning of a technology which evolved into the current, much-improved suspensions. Remember, the AR-3a dates back to the late '50s, making it some 40 years old. The foam suspension used in the AR-3 and AR-3a was the simplest and best available manner, at that time, to suspend the dome.

Contrary to Mr. Yeago's statement, there were no "Brits" lurking anywhere. In actuality, the people involved in the design of the AR-3a, including the domes, were all Americans. They were primarily of Jewish, Italian, and other extractions. There were many workers at AR, but no British nationals. That came 20 years after this period.

3. At the time of the AR-3a's design, it was much cheaper to buy a big magnet and essentially "throw away" some of its potential than to machine plates for perfect fit. The assembly of the midranges and highranges, nevertheless, was very carefully watched and the torque of the electric screwdrivers used during assembly was checked twice a day to make certain that the correct tension was applied to the top and bottom plates. If incorrect tension was placed on the top plate, the result would be a peak in the response of the highrange, primarily, and would cause a reject during test.

Furthermore, the tweeter was not down in output because of the magnetic structure or any other factor such as mass, voice coil, and so forth. It was actually designed to be down in output. There were many reasons for this design parameter, but the most important was that the AR-3a was designed to emulate the spectral energy distribution at an ideal seat in a concert hall such as Symphony Hall in Boston. Records of the day were neither recorded nor cut that way (spare me exceptions, please).

4. I quote one statement on page 19. "...those were hectic days; the company was opening factories right and left." The fact is that AR had only one factory and continued to have one factory for decades. The original was at 24 Thorndike Street in Cambridge, MA, and all the drivers were made in that building. In the very late '50s, AR expanded into a building directly across the street (actually, its entrance was on Otis Street), and this was primarily used for warehousing and shipping. Subsequently, the Test and Final Assembly departments were moved to Otis Street. In the early '60s, the Otis Street facility was expanded to accommodate the AR turntable manufacture and assembly, but it would be hard to say that this was opening another factory. The situation remained as in 1960 until Acoustic Research moved to 10 American Drive in

Norwood, MA, in the early '70s.

Oh yes, there was a Final Assembly facility set up in Holland, which subsequently moved to England (Houghton Regis), but the drivers were still manufactured in Cambridge. Only final assembly took place at this other facility. But this did not occur until the very late '60s and early '70s. Primarily the purpose was to try to reduce import duties of US-manufactured loudspeakers sold in Europe. It should be stated quite clearly that there were no other manufacturing facilities producing any of the AR products. This, of course, does not include the Western Electric "tweeter," which was used in the AR-1, nor the Carboneau tweeters/midranges, which were used in the AR-2 and AR-2a.

5. The "damned stuff" surround used on the AR woofer requires some explanation. The AR woofer was originally designed using Western Electric 728B as a source. This was a highly regarded driver used for monitoring in broadcast studios and for cinema work. The inventor of the acoustic suspension system, Edgar Villchur, used the cone on the 728B and had his wife Rosemary fabricate a surround using the edge ticking of an old mattress. This was used for the prototype of the acoustic suspension woofer, and was chosen because of its excellent cone performance and because it was readily available. The mattress material, of course, was treated to prevent leaks.

When the AR woofer was put into manufacture, the cone material had to be formulated for good damping characteristics, weight, and so forth. Most of the experimentation resulting in the final cone formulation seems to have been done by Henry Kloss<sup>1</sup>. The goal was to produce a cone with a Young's Modulus which would reduce cone breakup and be "lossy" enough to damp out the peaks and other breakup modes which were caused when the cone reached its upper limits (600Hz) and began to behave as several diaphragms rather than one. The surround was fabricated of a linen-like fabric which was saturated with phenolic and then pressed to shape in a mold. To make the annulus air-tight, the material was then painted with butyl rubber and darkened with carbon black.

The procedure was not as simple as it sounds. The impedance of the surround had to be correct so that when the acoustical energy traveled through the cone from the voice coil, particularly at and above cutoff, it would not be reflected back from the adhesive and surround, thereby causing standing waves which would ensure serious cone breakup. The butyl-rubber treatment of the surround was very helpful in the

to page 59



# DEFLEX<sup>®</sup>

## acoustic PANELS

**The simplest and most cost effective way to upgrade your existing system**



Once you have gained access to the inside of the cabinet, remove foam and/or wool damping from the inside of the speaker (if fitted)



You need at least 2 Deflex panels for a pair of small bookshelf speakers, 4 panels for a pair of Tannoy 6's, and at least 6 panels for larger cabinets

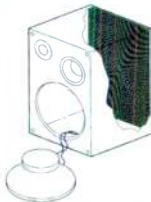

Place the flexible Deflex panel thru' the speaker cut-out and stick to the inside of the cabinet using the recommended adhesive

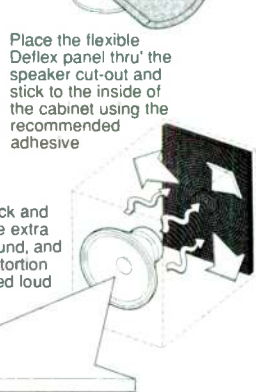

Now sit back and listen to the extra detail in sound, and far less distortion when played loud

**What the experts have to say...**

"...a marked improvement was obvious from the first few bars of REM's *Automatic for the people* album..."  
**HI-FI News & Record Review - March 1994**

"...Deflex panels seemed to give greater tightness and control, improved internal clarity, and pitch definition - all without deadening the sound in any way..."  
**Audiophile - January 1994**

"...the result was sharper imaging, wider dynamics and a more natural sound..."  
**CHOICE VERDICT**  
 Sound Quality       
 Value for money       
**HI-FI Choice - January 1994**

"...But one thing for sure - the Deflex panels are no gimmick. They work..."  
**Audio Video - November 1994**

**Some Of Our Other Products:**

- \*MIT MultiCaps... Better selection and the best prices anywhere!
- \*InfiniCap, Solen, SCR/AEON, Rel-Cap, etc., premium grade film capacitors.
- \*Kimber, Cardas, MIT, XLO, Acrotec, ultra high performance chassis wires.
- \*Non-inductive wirewound and power resistors from Mills, Caddock, others
- \*SOLO Copper Foil Air Core Inductors for no-compromise crossover designs.
- \*Cardas, Edison Price, Vampire, XLO, binding posts, banana plugs, etc.

*Send for FREE catalog today!*

**MICHAEL PERCY AUDIO**  
 P.O. Box 526  
 Inverness, CA 94937  
 (415) 669-7181 Fax (415) 669-7558

*Reader Service #21*

# Classifieds

## VENDORS

**ELECTROSTATIC** electronics, transformers, Mylar®, information. From author **ROGER SANDERS**, (404) 696-1998.

**WE RECONE** all home, auto, pro, and vintage speakers. **TRI-STATE LOUDSPEAKER**, www.nauticom.net/www/speakers, (412) 375-9203.

### La Palma Engineering Audio and Acoustic Consultants

5462 Bransford Dr.  
La Palma, CA 90623-1125  
(714) 523-5337 — PE #E13138  
E-mail: LPENG@PACBELL.NET

## FOR SALE

Satellite system: Acculine Radia 75s plus Accoustat 6s with radically modified DD servo amps and custom two-way active crossover, 400Hz, 18dB, \$5,500. Will separate. Eight Infinity EMIT tweeters, \$50 each; two AlphaCore CFAC inductors, 0.39mH, \$15. Four MIT multi-caps, 3µF PPMFX, \$15. All plus shipping. Joe, (609) 397-8315 (NJ EST).

One pair AR-3a, \$300; pair Empire 9000M 16" woofers, \$200; pair B&O 4702 speakers, rosewood, \$250; Richard Allen HP12B, \$60; thousand classical LPs, call for free printed list; Yamaha T-2 tuner, \$275; one B&W LM-1 panel-mount version, \$75; one B&W Matrix1 wired with VdHul cable, \$200. Jerry, (718) 339-0435, no machine.

### Audiophile Collector's Estate Sale

Some items are new (N). Others are like new (M).  
Most in original cartons and packing.

NAD517 five-disc CD player	N	\$350
Two Adcom GFA-565 power amplifiers (with fans)	N	\$1200 (pair)
Rotel 865BX CD player	M	\$320
Marantz 7T preamp		\$500
db Systems DBR 15B/2A in walnut cabinets	M	\$700
Adcom GFP-565 preamp	N	\$550
NEC T710BU tuner	M	\$160
Marantz 15 amplifier		\$500
Adcom GFP-555II preamp	M	\$350
NAD 1020 preamp		\$75
Adcom GFA-555II amplifier	M	\$550
Adcom GTP-50II preamp/tuner	M	\$350
Variance Hi-Fi (Germany) FM tuner/headphones	N	\$60
William, 603-642-4338 (Lv. message on machine if necessary), up till 10:30PM EST; P.O. Box 666, Danville, NH 03819.		

Use this convenient list to request the products and services that you need *fast*. Don't forget to mention *Speaker Builder!*

COMPANY	PRODUCT	FAX
Acoustic Technology Int'l	<i>Hi-End Drivers</i>	1-905-889-9296
Antique Electronic Supply	<i>Tubes, Transformers, Books, More!</i>	1-602-820-4643
Burnett Associates	<i>Sub &amp; Power Amps, Aluminum Cones</i>	1-603-924-3392
Gasoline Alley LLC	<i>Acoustasheet</i>	1-785-827-9337
GOERTZ	<i>Inductors</i>	1-203-384-0586
Harris Technologies Inc.	<i>BassBox and X*over</i>	1-616-641-5738
Hovland Company	<i>MusiCap Film &amp; Foil Capacitors</i>	1-209-966-4632
LinearX Systems Inc.	<i>LMS</i>	1-503-612-9344
Markertek Video Supply	<i>Unique &amp; Hard-To-Find Accessories</i>	1-914-246-1757
MCM Electronics	<i>Speakers, Woofers, Speaker Boxes</i>	1-937-434-6959
Meniscus	<i>New 1998 Catalog!</i>	1-616-534-7676
Morel Acoustics USA	<i>Loudspeaker Drivers, Car Speakers</i>	1-617-277-2415
Mouser Electronics	<i>Free Electronic Components Catalog</i>	1-817-483-0931
RCM Akustik	<i>Sub &amp; Power Amps, Aluminum Cones</i>	1-603-924-3392

## AD INDEX

RS#	ADVERTISER	PAGE	RS#	ADVERTISER	PAGE
55	AB Tech Services	54	21	Michael Percy Audio Products	55
90	ACO Pacific Inc.	43	15	Morel Acoustics USA	CV4
64	Acoustic Control	24	30	Mouser Electronics	58
	Acoustic Technology Int'l			Old Colony Sound Lab	
35	RT2	11	*	Loudspeaker Books	27
35	Swans	25	19	Parts Express Int'l, Inc	CV3
*	Allison Technology Corp.	58	17	RCM Akustik	61
97	American Bass	33	69	Reliable Capacitor	9
88	Antique Electronic Supply	4		Solen Inc.	
17	Burnett Associates	61	43	Crossover Components	39
85	Crosstech Audio, Inc.	34	24	Speakers and Components	19
	David Lucas Inc.		27	Speaker City, U.S.A.	31
*	Electrostatic Books	23		<i>Speaker Builder</i>	
*	Electrostatic Kits	13	*	Back Issues	57
*	Electrostatic Parts	40	*	Classified Form	58
*	Elektor Electronics	62	8	System ID Labs	59
13	Elytone Electronic Co. Ltd.	49	54	TRT	57
37	ETF	54	*	Voice Coil Subscriptions	42
81	Gasoline Alley L.L.C.	60	45	Zalytron Corp.	21
3	Harris Technologies, Inc.	41	<b>CLASSIFIEDS</b>		
39	Harrison Laboratories	43	7	D.H. Labs	57
*	Hi-Fi News/Record Review	51	*	La Palma Engineering	56
73	Hovland Company	37	*	Roger R. Sanders	56
22	Image Communications	5	*	Sonny Goldson	57
*	JL Audio	61	*	Tri-State Loudspeaker	56
65	Kimber Kable	CV2	*	Warren Gregoire & Assoc.	57
79	LGT Technologies	6	95	Welborne Labs	57
36	LinearX Systems Inc.	3	<b>GOOD NEWS/NEW PRODUCTS</b>		
	<i>Loudspeaker Industry Sourcebook</i>		137	Bang-Campbell Associates	4
*	Advertising Information	48	140	Gemini Sound Products Corp.	4
*	Madisound	17	135	M&K Sound Corp.	4
9	Mahogany Sound	53	139	Music Interface Technologies	4
28	Marchand Electronics, Inc.	45	136	PSB	4
10	Markertek Video Supply	60	138	Rockustics	4
83	McFeely's Square Drive Screws	34			
11	MCM Electronics	29			
12	Meniscus	31			



## WORLD'S SMALLEST ? TRANSMISSION LINE SYSTEM

3.5" x 4.0" x 1.25" Enclosure. *Single, One-Inch Driver* covers 120Hz-18kHz. Startling Transparency. Stable Imaging. Lively Dynamics. *Sounds better* than many larger systems. Enjoy it "stand-alone," or as wide bandwidth mid-range driver. Only \$199<sup>95</sup> each, plus S&H - LIMITED QUANTITY - VISA / MC / DISC / AMEX - PHONE ORDERS - 30-DAY MONEY BACK.

**CALL NOW - TOLL FREE**  
**1-800-634-0094** (510) 673-9393,  
FAX (510) 673-0538 Warren Gregoire & Associates  
229 El Pueblo Place, Clayton, CA 94517, USA  
<http://www.warregregoire.com/tls.htm>

LEAP 4.57, upgrade to 4.60 on the Internet. Complete package with manuals, \$800 or best offer. (805) 266-9945.

Bose 901 Series III speakers, all new drivers, \$300. Four Alpine 6062 6 1/2" midbass, 40Ω, ceramic-ferrite 4" voice coil, pristine, made in Denmark, \$110 per pair. Four Alpine 6022 tweeters, ceramic-ferrite ferrofluid, 80Ω, new in boxes, made in Denmark, \$75 per pair. Six AD5 320L tweeters, \$40 per pair; car amp AD5 PHi5, 300W amp 3 x 100 6 x 50, 5-6 channel bridgable, new in box, \$250; one used, \$200; six Alpine 6040 midrange, new in box, barium-ferrite, \$50 per pair. (301) 596-5637.

Adcom GFA555 with dual Ryan regulators, \$475 plus shipping; assembled/tested Ryan regulator, \$50; Newform ribbons, 5" ribbon/5" Peerless in ugly boxes, \$240 plus shipping. Noah Katz, (650) 964-9457, E-mail [katz@space.lockheed.com](mailto:katz@space.lockheed.com).

Pair 2395 JBL large horn/lens assemblies, \$600; two 375 drivers, different generation end-caps, \$500 each; pair Altec 515-G, \$450; single 515E, \$225; 515C, works, looks new, but voice coil rubs, \$125; pair 291-A horn drivers, \$350; Sonic Frontiers CD transport, Stereophile Class A, \$1,300. (914) 688-5024.

## SILVER SONIC™

High Performance Audio Cables

You *can* afford the best!

Silver Sonic T-14 Speaker Cable  
Silver Sonic BL-1 Series 2 Interconnect  
Silver Sonic D-110 AES/EBU Digital  
Silver Sonic D-75 Digital

D.H. Labs  
612 N. Orange Ave., Suite A-2  
Jupiter, FL 33458  
(561) 745-6406 (phone/fax)

DRA Labs MLSSA with SPO, LinearX LEAP with all options, both with the very latest software versions and all documentation. If you want the very best loudspeaker development tools available, this is it, \$2,950 for everything. Lang, (813) 328-7285.

## WANTED

Altec horn speakers, woofers, horns, crossovers, 515, 515B, 515C. Horns: 805, 1005, 1505A/B, 311-90, 329, 604, 605; 288B/C, 288-16 G/H. Larger corner speakers and console speakers, Laguna, Paragon; Western Electric horns, woofers, drivers, parts; Tannoy dual concentric, Goodman, E-V Patrician. Sonny, (405) 737-3312, FAX (405) 737-3355.

JBL 2344A bi-radial horns; JBL 1" Alnico drivers; JBL-2421A; JBL-2470. (301) 596-5637.

*Speaker Builder* encourages reader feedback in the form of letters, queries, and comments. Send correspondence to:

Speaker Builder, Editorial Dept.  
PO Box 494, Peterborough, NH 03458  
FAX (603) 924-9467, E-mail  
[Editorial@audioexpress.com](mailto:Editorial@audioexpress.com)

Be sure to reference the issue, title, author, and page number of the article or letter in question; and, if you request a response, please include a self-addressed envelope (or FAX number and E-mail address, as applicable) with a loose stamp or postal coupon. All letters will be considered for publication unless you indicate otherwise. *Speaker Builder* reserves the right to edit letters for length and clarity.

One pair Audio Concepts AC-12 drivers, two years old, barely used. High-quality poly cone and dust cap, rubber surround, excellent drivers.  $F_s$  20Hz, Imp 8Ω, RMS power 150W, Sens. 89.6dB/1W/1m, VC 50mm, MMg 1700g, SD meters 0.0545, DCR 6.1Ω, Inductance 1.6mH,  $X_{MAX}$  7.68,  $M_{MD}$  89g, BI 13.22,  $Q_{MS}$  5.458,  $Q_{ES}$  0.452,  $Q_{TS}$  0.418,  $V_{AS}$  242L, vented pole piece, \$130 or best offer (will split shipping). Mike, (618) 656-3341, E-mail [macgyver@plantnet.com](mailto:macgyver@plantnet.com).

Pair JBL 2445J 2" drivers, \$450; pair JBL 2441 2" drivers, \$500; NEI 2709B one-third octave analyzer, no microphone, \$180. Dave, (313) 427-6043, before 10 p.m. EST.

# BEST CAPS

for your system!

Audio pros rate InfiniCap® SETI™ and *Signature* caps better than Teflon® caps, better than oil-filled caps, better than premium film-foil caps! Yet SETI and *Signature* cost *less* than these other caps!

**Hear more of your music!** Ask today for info on these caps that everyone raves about, and the new Wonder Solder UltraClear that's taking the world by storm!

**Tomorrow's Research Today**  
408 Mason Rd, Vista CA 92084  
Voice mail/fax: 760-724-8999

Reader Service #54



## Welborne Labs

1998 Catalog Now Available

Vacuum tube preamplifiers and power amplifiers, passive line stages, phono stages, power conditioners and more.

Lowther Drivers and Cabinets

High efficiency drivers and enclosures for low powered single-ended amplifiers.

Parts and Supplies

Hovland MusiCaps, Rel MultiCaps, Jensen paper in oils, Kimber Kap, Solen, Wima and Elna Ceramfines; Caddock, Holco, Mills and Resista; KR Enterprise, Svetlana, Sovtek, Western Electric, Golden Dragon, Ram Labs; Cardas, Neutrik, DH Labs, Kimber Kable, Vampire; Alps, Noble and Stepped Attenuators. We also have enclosures, books, software and circuits. Call for our 200 page catalog \$12 (US/Canada), \$18 (International). Visa/Mastercard OK.

tel: 303.470.6585 fax: 303.791.5783  
e-mail: [wlabs@ix.netcom.com](mailto:wlabs@ix.netcom.com)  
website: <http://www.welbornelabs.com>

Reader Service #95

## Speaker Builder

BACK ISSUES  
ARE AVAILABLE  
FOR PURCHASE IN  
YEARLY SETS!



To receive a copy  
of our Complete  
Back Issue Listing  
Call 603-924-9464 or  
fax a request to 603-  
924-9467.

**Speaker Builder**

PO Box 494  
Peterborough, NH  
03458-0494

# Digital Storage Oscilloscopes

and Spectrum Analyzers from \$189.

ATC and Pico Technology Ltd. Modules allow your PC to work as a DSO, Spectrum Analyzer, DVM, Frequency Counter and data logger.

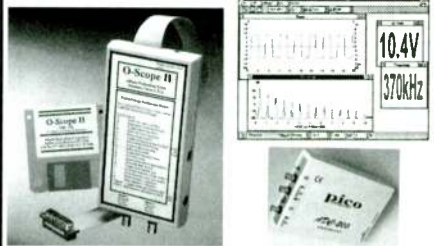
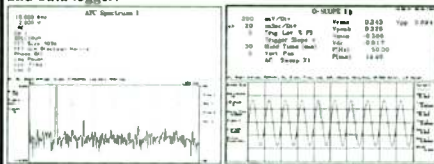

- Allison Products**
- O-Scope 1p - Single Trace, DC-50KHz \$189
  - O-Scope II - Dual Trace, DC-500KHz \$349
  - SPECTRUM - Enhanced spectrum SW \$ 39
- Pico Scopes and Loggers - Call for pricing**
- ADC-100 - Dual Trace, 100KSPS, 12-bit
  - ADC-200s - Dual Trace, 20 to 100 MSPS
  - Data-Loggers - 1 to 22 channels, DC-18KHz

**Allison Technology Corporation**  
8343 Carvel • Houston • TX • 77036

**Sales: 800-980-9806**

Tech: 713-777-0401 Fax: 713-777-4746

atc@accesscomm.net http://www.atcweb.com

# ELECTRONIC COMPONENTS

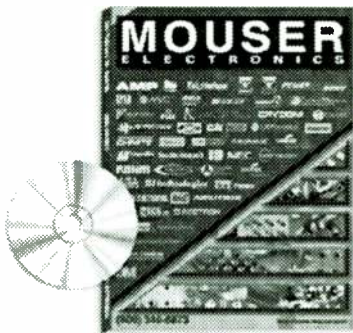

Visit our web site!  
[www.mouser.com](http://www.mouser.com)

FREE catalog is available on the internet, CD-ROM, or in paper!

- 70,000+ Products • 145 Suppliers
- Same Day Shipping • No Minimum Order

**800-992-9943**

817-483-6828 Fax: 817-483-0931  
[www.mouser.com](http://www.mouser.com) [catalog@mouser.com](mailto:catalog@mouser.com)

958 North Main St., Mansfield, TX 76063

Reader Service #30

# SPEAKER BUILDER

## CLASSIFIED INFORMATION

### Three Classified Advertising Categories are available in *Speaker Builder*

**VENDORS:** For any business or professional private party selling equipment, supplies or services for profit.

**FOR SALE:** For readers to sell personal equipment or supplies.

**WANTED:** Help readers find equipment or services.

#### HOW TO ORDER AN AD

**REGULAR CLASSIFIED** (ads without borders):

**\$1.50 per word. \$10.00 minimum.**

Deduct 5% for a 6X contract.

**CLASSIFIED DISPLAY** (all ads with borders):

**1" \$65.00, 2" \$115.00, 3" \$150.00**

Deduct 5% for an 8x contract

**PAYMENT MUST BE ENCLOSED** with your ad and mailed to *Speaker Builder* c/o, AAC Classified Dept., PO Box 576, 305 Union Street, Peterborough, NH 03458-0576. Ads can also be submitted by FAX (603) 924-9467 or by E-mail, [audiody@top.monad.net](mailto:audiody@top.monad.net). (faxed and E-mailed ads must include MC, Visa, Discover or AmEx payment).

**SUBMITTING COPY:** A word is any collection of letters or numbers with a space (a slash (/) is counted as a space) on either side. All hand written ads must be block printed on the form below. Please circle or underline all words to appear in bold. Illegible ads will be discarded. Submit copy by mail, fax, E-mail or on disc (QuarkXPress, Word-perfect, Microsoft Word 2.0 or 6.0, Word for DOS, Windows Write, or Word Star). If submitting by disc, include a list of fonts and graphics used and a printout of your ad.

**SUBSCRIBERS!** Subscribers are invited to run a word classified ad of up to a maximum of 50 words in the FOR SALE or WANTED sections for only a \$10.00 flat processing fee (per ad, per magazine). Ads that exceed 50 words will be charged the regular rate of \$1.00 for each additional word. All ads are run only once, and then discarded. Simply complete the Classified Order Form and include your subscriber number in the space provided.

#### CLASSIFIED ORDER FORM

Please check what type of ad you will be running.

- VENDORS     FOR SALE     WANTED

Advertisers are required to use this convenient form when hand printing your ad. Use block letters. No abbreviations.

1	2	3	4	5
6	7	8	9	10
11	12	13	14	15
16	17	18	19	20
21	22	23	24	25
26	27	28	29	30
31	32	33	34	35
36	37	38	39	40
41	42	43	44	45
46	47	48	49	50

Please charge to my:  DISCOVER     MASTERCARD     VISA     AMEX

CARD NUMBER

EXP. DATE

Check/Money Order Enclosed

Subscription Account Number: **A**

NAME

COMPANY

STREET & NO.

CITY

STATE

ZIP

PHONE

**AAC Classified Dept., PO Box 576, 305 Union Street, Peterborough, NH 03458-0576**  
FAX 603-924-9467

**ALL ADS SUBJECT TO RUN AT DISCRETION OF PUBLISHER / AD DIRECTOR**



mechanical performance of the surround. Some early woofers can be seen to have a termination at the junction of the surround and the cone, because, on test, specifications were not met for cone breakup after cutoff.

Unfortunately, the latex lost some of its properties through time and, after a few years, some of the surrounds began to "flap." Also, the manufacturing process of the surround could not be done precisely enough to ensure identical performance from each and every woofer. This latter was a characteristic which was demanded by Ed Villchur and held to very tight tolerances. Indeed, every woofer was thoroughly checked for all kinds of parameters to ensure that the performance of each woofer was as close to the ideal as possible.

Due, in part, to the factors described above, AR was always looking for a better and more uniform material for the annulus. This showed itself in the form of "foam." A lot of other materials were tried, of course. But it proved that this "damn stuff" was the best available to fulfill the requirements of the surround.

The closed-cell foam which was used for the annulus had to go through a forming process (actually pressed in a heated die) much as the original cloth, and there was no evidence, nor did tests reveal, that it would degrade with time. Please note that at this particular point, all loudspeakers used an

"accordion" outer suspension and no one used the half-roll surround technique. No other companies were interested in mechanically linear excursion in those days.

As an aside, the mat for the AR turntable was selected to damp not only resonances in the cast, machined turntable platen, but also to damp vinyl resonances (please remember in those days, the "raised edge" and label of vinyl discs made their appearance, leaving the center part of the record, with the modulated grooves, unsupported). The entire industry followed suit and used the foam half-roll surround, and many drivers still use it to this day, with consequent deterioration.

6. The original AR woofer used a voice-coil former made of a copper alloy similar to bronze. Circular perforations were punched on the top of the former, next to the apex of the cone, to relieve pressure behind the dust cap, while the woofer moved forward and backward, and to help cool the voice coil and its former. It was found, however, that the voice coil separated from the former under certain situations, due to heating of the voice coil and the former. The wire used to form the voice coil on the former was very similar to "transformer wire," which was supplied coated with an adhesive activated by heat.

Once the former, with a coat of a similar adhesive, had the voice coil wound on it (on a mandrel), the assembly was "cooked" in specialized ovens to activate and cure the adhesive and bond the voice coil turns to each other and to the former. Interestingly, KLH used DC running through the voice coil to generate heat and accomplish a simi-

lar result. In certain applications, particularly when people tried to get levels out of the loudspeaker beyond the capability of the power amplifier, the average power going into the woofer coil, primarily, exceeded the heat dissipation capabilities of the coil, resulting in serious voice-coil overheating. This softened the adhesive on the voice coil and the former, resulting in windings "letting go" and separation from the former.

Nomex® was picked because it was much more resistant to these over-temperature conditions. Using Nomex did not mean that the voice coil and former were made impervious to these circumstances (over-driving and overheating), but it made the assembly much more resistant to abuse. There were many other factors involved, but the length of the explanations preclude inclusion in this letter.

An aside concerning the impedance of the AR woofer and the AR-3a is necessary and interesting. The voice coil of the woofer ended up being 4W simply because in the original AR-1, the Western Electric "tweeter" selected for use (then made by Altec Lansing, the 755A) had a 4W impedance. The reason an 8" tweeter was selected for use was that, at that time, there were very few high-frequency devices available. The 755A was a highly respected, small monitor, full-range speaker used in both broadcast and cinema applications. Other loudspeakers, mainly made by G.E. and others, did not have the necessary uniformity from unit to unit which was demanded by people at AR.

Because the 755A had a nominal impedance of 4W, the woofer ended up being 4W.

# SYSid

The Complete Acoustic Test Instrument

- ▶ For speakers, acoustic spaces and electronics
- ▶ Dual channel FFT: 32K point resolution
- ▶ Frequency response and transient response
- ▶ Distortion: harmonic, intermodulation and linearity
- ▶ Wide dynamic range (130dB+ with time domain averaging)
- ▶ Plug-in 16-bit DSP board for IBM PC's
- ▶ Quantify subjective clarity (non-linear distortion) using spectral contamination

- ▶ Only \$3750
- ▶ New manual
- ▶ Upgrades to Ver. 6.3 \$250

▶ **SYSid Labs**

▶ **510-559-9075** ▶ 1563 Solano Ave., Suite 211 ▶ [SYSid\\_Labs@Compuserve.com](mailto:SYSid_Labs@Compuserve.com)  
 fax 510-526-8087 Berkeley, CA 94707

**SALE! PLUS FREE ADHESIVE!**

**MARKERFOAM™ ACOUSTIC FOAM GIANT 54" x 54"**



**Immediate Shipping**

2" Reg. \$29.95 Now \$19.99 • 3" Reg. \$39.95 Now \$29.99. **KILL NOISE QUICK!** High performance, full-size sheets of super high density Markerfoam. EZ mount. Blue or gray. Super-effective sound absorption for studios. Markerfoam offers best value, looks professional & is proven in studios worldwide. Request Foam Buyers Guide/Catalog, specs & free samples today.

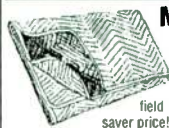

**MARKERTEK JUMBO SOUND ABSORB BLANKETS**

Heavy-duty 72"x80" padded blankets absorb sound wherever they're hung or draped. Fabulous for stage, studio and field use. Top professional quality at a super saver price! Weight: 6 lbs. Black. \$19.99

**MARKERTEK BLADE TILES™**

**HIGH PERFORMANCE - LOW, LOW COST!!!**

America's best acoustic tile value only from Markertek!

\$3.49 per tile, 16"x16"x2", charcoal or blue  
\$4.49 per tile, 16"x16"x3", charcoal or blue  
\$5.49 per tile, 16"x16"x4", charcoal.



**MARKERSTIK™ FOAM ADHESIVE**

FREE with any foam purchase in this ad! Limited offer. A \$4.00 per tube value.



**SONEX**

All the colors and sizes plus great prices!

**FREE** America's most unique catalog featuring 328 pages of over 6,000 exclusive and hard-to-find supplies for Pro Audio, Broadcast Video, Audio Visual & Multimedia production.

**MARKERTEK® VIDEO SUPPLY**

4 High St., Box 397, Saugerties, NY (USA) 12477

800-522-2025 • Fax: 914-246-1757

Web: www.markertek.com • E-Mail: markertek@markertek.com

Reader Service #10

# Acoustasheet® Damping Material

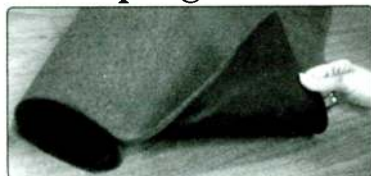

**TYPICAL TRANSMISSION LOSS**

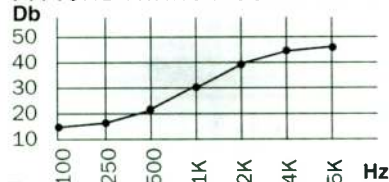

Improve the imaging and clarity of your speakers by reducing cabinet resonance and baffle diffraction. Transform the acoustics of your listening room. Make your car whisper quiet. Goodyear Acoustasheet will do all this for only \$2.98 per sq. ft. (12 min.) plus \$5 handling. It's a 4' wide, 1lb. per sq. ft. loaded vinyl with 1/4" acoustic foam lamination.

GASOLINE ALLEY, L.L.C.  
1700 East Iron, Salina, KS 67401  
1.800.326.8372



Reader Service #81

There have been a lot of explanations advanced for the AR speaker being 4W, but the actual reason is the one stated above. It had nothing to do with drawing more power from amplifiers, because at the time of the AR-1's design, amplifiers were almost all tube units with output transformers which had 4W taps. Transistor amplifiers did not make their appearance until five years after the design of the AR-1 woofer.

7. I am afraid that Mr. Yeago will find that ferrofluid, even the modern variety, will not remain in the woofer gap. Many, many experiments were run dating back some 25 years, and the result was that the woofer voice coil, moving over a distance of some 5/8-inch would "blow" the ferrofluid from the gap.

8. Concerning the extension of the bottom end of the design to 35Hz or lower, it can only be done at the expense of much higher low-frequency distortion, or a meaningful decrease in the sensitivity (sometimes incorrectly called "efficiency") of the woofer, and thereby the system. The spectral energy distribution of the AR-3a would be grossly affected and this would not be a "Rebuilding of the AR-3a," but a redesign of the loudspeaker, violating its original premises. My suggestion is that Mr. Yeago look into "Hofmann's Iron Law."

9. Interestingly, as far back as 1960, Acoustic Research had been experimenting with other cone materials. In one instance, we were checking the performance of an expanded polystyrene molded cone. The results were very unsatisfactory in that the peak-to-trough ratio in the response caused by cone breakup exceeded 14dB. In addition, the termination/matching of the surround became very, very critical and unsatisfactory. Mr. Yeago must be very careful when attempting to use aluminum-skinned polystyrene, particularly without extensive testing facilities, to assess the mechanical performance of the devices which he might be using.

The above is by no means intended to cover all statements or points concerning Mr. Yeago's articles. I have tried to cover the most meaningful ones (and not all) without writing a book. Some others will have to go unquestioned and unanswered.

The Quality Control procedures at AR during that time were incomparable and unique in the industry. Every step was checked and tested for important and critical specifications. No other loudspeaker manufacturer approached the thoroughness of this Quality Control. Even today most manufacturers fail to effect these control procedures with specialized test equipment at every step. In most cases, a final test of the finished product is undertaken at differ-

ing levels of thoroughness with a rather cavalier attitude toward variations in specific individual parameters. At AR, research was actually undertaken and followed through. AR did not simply stuff drivers made by someone else into a cabinet and call it the "Bopmagilvie Superior."

It is easy to look with disdain at the accomplishments which were effected 40 or more years ago, particularly when these techniques were used as the base for furtherings which progressed to what is now jokingly called "state-of-the-art." Incidentally, how is Mr. Yeago's 1960 automobile working nowadays? How about its door, engine, and hydraulic gaskets?

C. Victor Campos  
Framingham, MA

1. "Conversation with Henry Kloss," *Audio Amateur*, 3/71, pp. 3-7, 20.  
(Mr. Campos was a member of the early management team at the original AR facility in Cambridge, MA.—Eds.)

T.D. Yeago responds:

*A chastening, if not actually irate letter, from C. Victor Campos! What fun! I'll save his first paragraph for last, so let me start by agreeing absolutely that my humble little series ("Rebuilding the AR-3a," SB 6/97-3/98, barring catastrophe) would be better titled something other than "Rebuilding..." That's an editorial call. My working title was "AR-3a Remake" and sharp readers saw "Remaking..." surviving into the "About This Issue" and table of contents of 6/97, but no further. Any reader who got as far as the second page was warned I was embarking on a major modification, not a simple refurbish. To borrow across cultures from our automotive brethren: anybody can restore, real men chop and channel.*

*Now, let me say I'm very happy to have provoked Mr. C. Victor Campos into writing, because not only am I happy to be corrected, I am pleased that he took the time to give us some valuable background. "Salad Days at Acoustic Research" isn't a title that would jump onto the bestseller lists, but these anecdotes and war stories are camp for us audio geeks. Now, by the numbers:*

*1. I yield, and gladly. If I wanted to weasel out of this I could suppose my replacement (and modded) surround stiffened the composite suspension enough to bump  $f_s$  to 16Hz from the specified 14Hz. But no. I likewise accept correction when it comes to the stock system resonance of 44Hz (versus my calculated 43Hz) and system Q of 1.0 (versus my calculated 0.9).*



And regarding pk-pk woofer excursion, I think we can agree that the motor coil is 1.04" tall and the top plate 0.5" thick, although it's chamfered to 0.47" or so at the gap.

2. I thought the AR-3 showed up in '58, the AR-3a in '68, although I naturally enough don't know when the drivers were designed. And my crack about my suspicion of a Brit lurking, well, that was a joke. I believe it's generally accepted that, for whatever reason, the English have a history of and propensity for arriving at engineering solutions that are startling, eccentric, and even strange. Having said that, I would also add brilliant (sometimes) to the list. I think Peter Walker deserves a knighthood.

3. OK, so parts that fit poorly, by modern standards, were incorporated into the engineering. It seems to me that occasionally the pieces would fit, what then? And I'm not certain what Mr. Campos' point about the electric screwdrivers and their torque has to do with this, unless he's saying the clamping fixtures used to squeeze the magnetic structures during glue-up were tightened with screws, whose torque was closely controlled. Even so, the units I've played with showed considerable variation in flux density, remembering I'm not using the most sophisticated methods.

I'm glad to learn, at last, from an authoritative source that the treble unit was designed to be down on output (re: the woofer). Why did the AR ads of the time show the (spliced) response curves as predominately flat, eh?

4. I stand corrected. My remark about AR opening up factories was speculation arising from a remembered remark by Henry Kloss in some interview or other. He commented that one of the reasons he and his hand left to start KLH was that things were hectic, factories had to be started up, decisions had to be made, and because of AR's inert organization, nothing got done. I misremembered.

5. I thank Mr. Campos for telling us the tale of AR's woofer surrounds, culminating with the accursed foam. I hope he doesn't think I'm faulting AR for failing to see into the future and divining the dreaded foam rot (Y. Berra: Predictions are tough, especially about the future). But I am confident I speak for, well, hundreds when I say I hate it. Oh, and does anyone know if our present foam will suffer similarly?

6. Again, thanks to Mr. Campos for the skinny on the woofer's nominal 4W impedance.

7. Yeah, ferrofluid in a woofer. I haven't been inside to check, so Mr. Campos may be right. I wouldn't be surprised. In my reading I've come across only two instances of liq-

uid-cooled woofers—one in a '70s era system, the other in an aluminum-coned woofer in one of the catalogs. But I figured it was worth a shot, considering that I took steps to keep the ferrofluid in place (see Part 4, SB 1/98). I figure between the vent down the center pole, smooth surfaces (pole face and former surface), increased flux density, and filling the space only half full, I have a decent chance.

8. I never claimed to extend the bottom end to 35Hz. A speaker with a system resonance at 35Hz and system Q of 0.5 is very different from one with system resonance of 45Hz and system Q of 1.0. And yes, I'm familiar with mass/motor/efficiency-sensitivity tradeoffs; give me a little credit.

9. OK, about this cone; I was obviously aiming for a nice rigid (within the band) piston. Styrene foam with an aluminum skin glued to AR's woofer seemed like a good idea, since I was determined to add mass anyway. Just how good an idea we'll all find out when Mr. D'Appolito puts one of my units through the wringer, er, test regime. (When he wrote me telling of his decision to publish, Mr. Dell offered to have Mr. D'Appolito subject one of my units and a stock 3a to the usual tortures, which offer I eagerly accepted, as he's paying shipping.) It will be interesting to see how my seat-of-the-pants approach fares under duress, but I'm also curious to see how well the stock unit does.

I have tried to be careful not to characterize my efforts as authoritative or this loudspeaker as exceptional. I simply indulged myself to see what I could do with this unit. I hope readers have found my little project interesting. I half suspect Mr. Campos thinks I was mocking Acoustic Research and all who labored there. Not at all. I would never have given the time and effort to this little project (let alone write it up) if I didn't think these were worthy units to start with, which might be improved. One cannot make a silk purse from a sow's ear, or didn't I make all that clear in Part 1? At any rate, what exactly my labors have accomplished will be learned soon enough when Mr. D'Appolito goes to work.

In fact, the car I drive misses the '60s by only a few years, and although it needs regular attention, its doors (?), engine, and hydraulic systems function well enough. I have friends who have much older cars, and know of a few people with Model A Fords, Packards, and other similar cars, all in excellent order. I appreciate them in context, naturally. I don't confuse them for modern, or I should say contemporary, cars.

Lastly, I am curious to know: what's the provenance of the word "Bopmagilvie?" And, in fact I am confident that, while not

## LOUDSPEAKER PRODUCTION MANAGER

with speaker building  
experience and line  
management skills for  
leading speaker  
manufacturer in  
South Florida. JL AUDIO  
website://www.jlaudio.com/  
Fax resume with salary  
requirements to:  
HR Dept. 954-981-4889

### New Audio Dealer!

## BURNETT ASSOCIATES

Featuring  
RCM Akustik of Germany



- Famous DT! Series Subwoofer Amps
- NEW Alcone® Aluminum-Cone Drivers
- BK Electronics (UK) MOSFET Amps
- And MORE!
- For DIYers. OEMs, Installers, Dealers

## BURNETT ASSOCIATES

PO Box 26, Dept. SB28  
W. Peterborough NH 03468 USA  
603-924-2383 • Fax 603-924-3392  
FDTF77B@prodigy.com  
Call or write for free information!

Reader Service #17

"very, very long," my legs are longer than the late Mr. Astaire's. And if Mr. Campos will write or phone me and set me straight on my too-numerous-enumerate mistakes, I will cheerfully compile them for SB readers. And I say again: I'm glad I provoked Mr. Campos into writing. Let's have more tales from the formative years.

### STICKY SOLUTION

With regard to Tom Yeago's request for more information on high-temperature

adhesives ("Rebuilding the AR-3a, Part 3," SB 8/97), the following companies may be helpful.

Masterbond Adhesives  
154 Hobart St.  
Hackensack, NJ, 07601

Cotronics Corporation  
3379 Shore Pkwy  
Brooklyn, NY 11235-3693  
718-646-7996,  
FAX 718-646-3028

Cotronics manufactures 3000°F ceramics and 700°F epoxies, adhesives, sealants, and coatings.

Michael Machnica  
West Seneca, NY

### PEERLESS PARAMETERS

Vance Dickason's "Driver Report" covering the Peerless CSX 257H woofer (SB 1/97, p. 53) inadvertently included the incorrect table. The LEAP measurements of the CSX 257H compared to the factory specifications are as shown in Table 1.

TABLE 1

PEERLESS CSX 257H PARAMETER COMPARISON			
	SAMPLE A	SAMPLE B	FACTORY
F <sub>S</sub>	25.6Hz	25.7Hz	24.5Hz
R <sub>EVC</sub>	5.82	5.81	5.9
Q <sub>MS</sub>	4.05	5.50	4.32
Q <sub>ES</sub>	0.41	0.40	0.38
Q <sub>TS</sub>	0.37	0.37	0.35
V <sub>AS</sub>	125.3 ltr	122.8 ltr	139.5 ltr
Sens.	89.75dB	89.86dB	88.9dB
X <sub>MAX</sub>	4mm	4mm	4mm

### HELP WANTED

I have a pair of old Bose 601 series II speakers, and would like to rebuild them. Does anyone have any info or advice to make them better with updated crossovers and drivers?

Shawn Baker  
Classic Stereo  
3714 S. Reed Rd.  
Kokomo, IN 48092  
FAX 765-453-4534

*Readers with information about this topic are encouraged to respond directly to the letter writer at the address provided.—Eds.*

### LETTERS/INQUIRIES

Speaker Builder encourages reader feedback in the form of letters, queries, and comments. Send correspondence to:

Speaker Builder  
PO Box 494  
Peterborough, NH 03458-0494  
FAX (603) 924-9467  
E-Mail Editorial@audioxpress.com

## IS ELECTRONICS AND/OR COMPUTER TECHNOLOGY YOUR PROFESSION OR HOBBY?

If so, *Elektor Electronics* is just the magazine for you! Since 1977, it has been publishing construction projects at professional level as well as informative articles about the developing world of electronics and computers.

The world of electronics is in constant flux. What is new today may be obsolescent in a very short time. Of course, the basics do not change, but applications do. *Elektor Electronics* is quick to respond to the changing face of electronics and to adapt itself to the varying needs of its readers. It contains fairly easy as well as more complex construction projects on a wide variety of electronics subjects, from audio & hi-fi through computers and microprocessors to test and measuring instruments. Moreover, each issue contains a FREE 16-page supplement dealing with one subject only, such as Microcontrollers, Audio & Hi-fi, Test & Measurement, Computers, and others.

Make sure you are kept informed regularly about the changing world of electronics by taking out a subscription (price, airmailed, \$US67.00 per year) by writing or faxing to

**Elektor Electronics**  
**World Wide Subscription Service**  
**Unit 4, Gibbs Reed Farm**  
**Pashley Road, Ticehurst**  
**East Sussex, England TN5 7HE**  
**Telephone +44 580 200 657; fax +44 580 200 616;**  
**e-mail [wvs.subscription@virgin.net](mailto:wvs.subscription@virgin.net)**

Apart from the magazine, the company also produces software diskettes, programmed chips, printed-circuit boards, CD-ROMs, and publishes books on electronics and computers. All these are available from

**Old Colony Sound Lab**  
**PO Box 243, Peterborough NH03458**  
**Telephone (603) 924-6371; fax (603) 924-9467**  
**e-mail [audiotech@top.monad.net](mailto:audiotech@top.monad.net)**





# PARTS EXPRESS

ELECTRONICS & MORE

## The Woofer Tester™

Just ask any loudspeaker engineer, and they will say that the only way to design enclosures of the correct size and tuning is to measure the Thiele-Small parameters for the actual drivers to be used. The reason? Manufacturers published specs can be off by as much as 50%! But until now, measuring the parameters yourself required expensive test equipment and tedious calculations, or super expensive measurement systems (\$1,200 to \$20,000). The Woofer Tester changes all that. Finally, a cost effective, yet extremely accurate way to derive Thiele-Small parameters, in only minutes! The Woofer Tester is a combination hardware and software system that will run on any IBM compatible computer that has EGA or better graphics capability and an RS232 serial port. The Woofer Tester will generate the following parameters: Raw driver data: Fs, Qms, Qes, Qts, Vas, BL, RE, LE, SPL @ 1W/1m, Mmd, Cm, and Rm. Sealed box data: Fsb and system Q. Vented box data: Fsb, ha, alpha, and Q loss. The Woofer Tester system includes hardware, test leads, serial cable, AC wall adaptor, detailed instructions, and software.



**QUICKLY AND ACCURATELY MEASURES:**  
**Fs, Qms, Qes, Qts, Vas, BL, RE, LE, SPL @ 1W/wm, Mmd, CM, and Rm IN MINUTES**

#390-800 ..... **\$249.00** EACH

## Dayton Loudspeaker Co.®

### Why Our Cabinets Are Better

- ◆ **1-1/2" MDF Baffle Board:** Since the front baffle receives the highest amount of mechanical energy, reducing this energy by utilizing 1-1/2" thick medium density fiberboard material is critical to ensuring low levels of coloration.
- ◆ **1" MDF Shell:** Medium density fiberboard outperforms conventional particleboard in strength and vibration damping ability.

- ◆ **Bracing:** To further reduce panel resonance, all of our cabinets include a "shelf" brace that is dadoed and glued-in.
- ◆ **Superior Joinery:** Dado and slot joinery are used throughout to provide incredible strength.
- ◆ **Oak Laminate Veneer:** High quality, real oak laminate veneer covers the entire cabinet exterior, except for the front baffle. Enclosure can be stained and finished to your liking.



Part #	Description	Price
300-702	.22 cu. ft. bookshelf cabinet	\$44.30
300-712	.77 cu. ft. cabinet	69.30
300-722	1.52 cu. ft. cabinet	79.80
300-706	.53 cu. ft. bookshelf cabinet	49.50
300-716	1.02 cu. ft. cabinet	75.50
300-726	2.75 cu. ft. subwoofer cabinet	99.90

1-800-338-0531



725 Pleasant Valley Dr., Springboro, OH 45066-1158  
 Phone: 513/743-3000 ♦ FAX: 513/743-1677  
 E-Mail: sales@parts-express.com

## Dayton Loudspeaker Co.®

### 12" Professional Sound Reinforcement Driver

This 12" professional sound reinforcement driver was engineered to provide an ideal blend of performance parameters including high power handling, long excursion, good efficiency, and deep bass reproduction not commonly found in most pro sound drivers. Features a rugged aluminum die cast frame, natural sounding paper cone, treated cloth surround, flat spider suspension, spring loaded gold plated binding posts, heavy duty tinsel leads, and rubber magnet cover.



- ◆ Power handling: 300 watts RMS/425 watts max
- ◆ Voice coil diameter: 3"
- ◆ Voice coil inductance: 1.35 mH
- ◆ Nominal impedance: 8.0 ohms
- ◆ DC resistance: 5.8 ohms
- ◆ Frequency range: 25- 800 Hz
- ◆ Magnet weight: 105 ozs.
- ◆ Fs: 25 Hz
- ◆ SPL: 90 dB 1W/1m
- ◆ Vas: 3.81 cubic ft.
- ◆ Qms: 10.82
- ◆ Qes: .35
- ◆ Qts: .34
- ◆ Xmax: 7.90mm
- ◆ Net weight: 20 lbs.
- ◆ Dimensions: A: 12-3/8", B: 11", C: 4-7/8", D: 8-1/2", E: 1-3/4"

#295-065 ..... **\$94.90** (1-3) **\$86.95** (4-UP)

**FREE CATALOG CALL TOLL FREE 1-800-338-0531**

# Twenty Years and More...

The 1978 C.E.S. in Chicago was the very first time that Morel Acoustics USA, Inc. presented their product to the public. It became clear, early on, that the loudspeaker industry was in need of high quality speaker drivers. Shortly thereafter we introduced several drivers and established the MDT-28/30 as one of the most popular and highly demanded tweeters on the market.

Through the course of the years Morel brought many unique and innovative products to the speaker industry. The introduction of the 3" voice coil in a 5" basket, using hexagonal shaped aluminum wire, utilizing a double magnet system and ducted design woofers and mid-basses are a few examples of the company's breakthroughs. Also introduced were the Integra concept (single motor system for both the tweeter and woofer) and the Push-Pull 8" and 10" subwoofers (dual motor system, dual voice coils with a single cone).



**Integra**

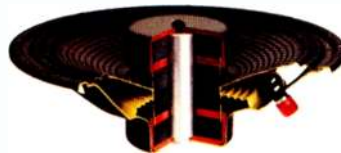

**Push-Pull**



**Double Magnet**

Morel Acoustics USA, Inc. has come a long way since 1978. Currently, the company has a diverse line of exciting products which includes over 40 models of tweeters, midranges, mid-basses, woofers and subwoofers. Being a leader in the field of speaker design, for our 20th year anniversary we are scheduled to launch several new products that are sure to attract attention.



Standard Voice Coil



Hexatech Voice Coil



Standard Voice Coil

Morel Voice Coil



Typical double magnet ducted woofer.



*For further information please contact:*

**D**ouble magnet tweeter



**morel acoustics usa, inc.**

414 Harvard Street  
Brookline, MA 02146 USA

Tel: ++ 617-277-6663

Fax: ++ 617-277-2415

E-mail: [morelusa@gis.net](mailto:morelusa@gis.net)