

# BUILD A DREAM 15" TL WOOFER

SEVEN: 1994

US\$7.00

# Speaker Builder

THE LOUDSPEAKER JOURNAL

## HOME THEATER ON THE CHEAP

SMITH

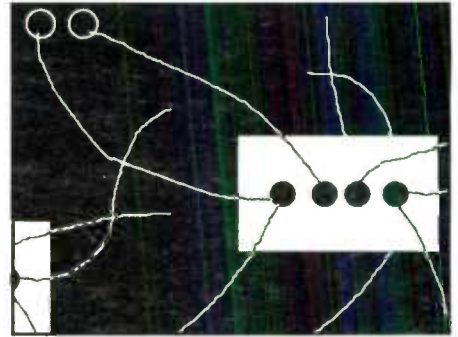

## INDUCTOR GEOGRAPHY IN CROSSOVERS

SANFILIPO

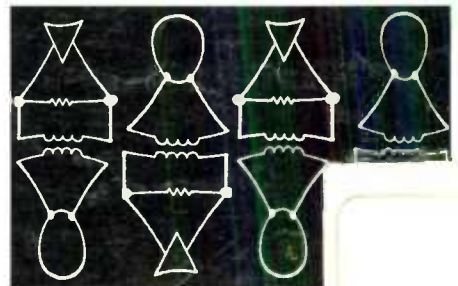

## DRESSING THE BOX FOR COMPANY

WAYLAND

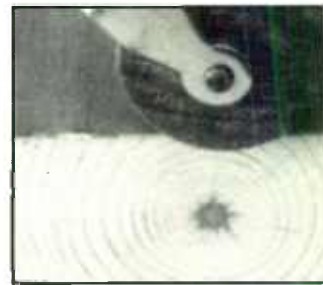

## IMP RESCUES A SOW'S EAR

WASLO

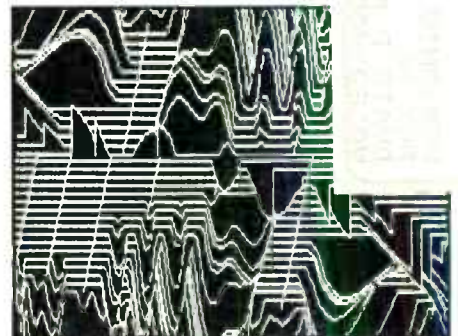

## BULLOCK ON CROSSOVER PUZZLES



0 174470 84699 4

# W

hether your acoustic analyzer requirements are in home theatre, cinema, church and stadium installations, car stereo, or industrial standards in factories and airports, the **pcRTA** has applications and solutions for you. Today's ever improving audio standards, and increasingly technical and creative acoustic applications, require precision realtime acoustic measurements and documentation more than ever before. Now you don't have to rely on vague LED readouts, inconsistent information, and limited test options, and you don't need to waste time copying and recopying information for the documents you require. Now there is a real solution that will solve problems and save you money!

True RMS Detection  
Peak Hold  
Long term averaging  
RT60, RT40, and RT20  
SPL measurements  
Power response averaging  
Impedance measurements  
IASCA Scoring

THX home theatre testing  
Curve storage and processing  
ASCII data import/export  
Bar or graph displays  
Macro control for Q/A testing  
Full data storage and printing facilities



## PCRTA: REAL TIME REALITY CHECK

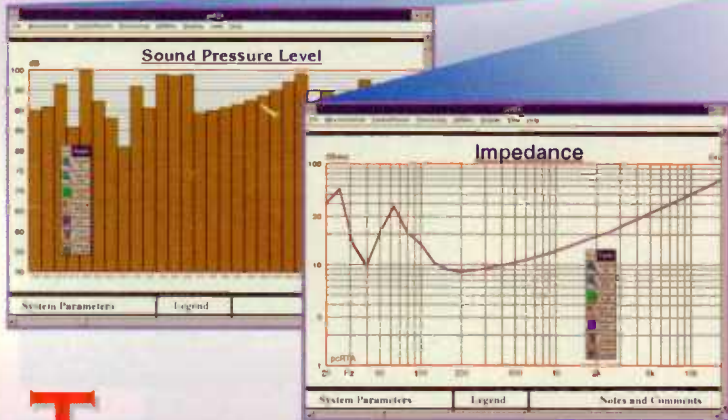

- ☑ REAL Computer Power
  - ☑ REAL Measurement Versatility
  - ☑ REAL Laboratory Precision
  - ☑ REAL Value for the Dollar
- REAL TIME ANALYZER!**  
*Saver!*

# T

he **LinearX pcRTA** gives you affordable laboratory precision and quality with all the power and functionality of a PC-based system. Designed with the same experience and expertise that brought the industry **LEAP** and **LMS**, the **pcRTA** is an easy-to-use, powerful, and reliable precision test and analysis tool for all real time audio acoustic measurements.

The **pcRTA** system consists of a full-length 8-bit PC slot card, a 4 microphone connector box, and the new **LinearX M51** High Performance Measurement Microphone. The M51 is a calibrated microphone with an astonishing 156 dB clipping level, extremely low noise and distortion levels, and temperature coefficient.

It features four mic multiplexing for spatial averaging, true RMS detection, 32 bands (31 ISO 1/3 octave bands plus a full width band) with ultra stable precision 4-pole 2nd order MLF filters, A, B, C, D and E ANSI weighting filters, built-in White and Pink Noise spectrums, and a custom 20-bit digital sequencer. The **pcRTA** also performs direct impedance curve measurements, as well as full SPL measurements with  $\pm 0.5$  dB accuracy and  $\pm 0.025$  dB resolution.

The MS-Windows based software is extremely well structured, easy to learn, and intuitive in operation. The **pcRTA** provides curve storage, curve inverting, ASCII data export/import, spatial averaging, Peak-hold, Long term averaging, RT60/40/20 plots, Macro controls for Q/C testing, and full printing facilities. It performs IASCA scoring, as well as THX home theatre testing, and can generate an array of reports with a few clicks of the mouse. Simultaneous viewing of multiple curves can be quickly produced in several different formats including bar, line, multi-color 1/3 octave, and single octave, all at a resolution only a computer can display. All data can be quickly stored for documentation or recall.



**LinearX Systems Inc.** 7556 SW Bridgeport Rd., Portland, OR 97224 USA Tel: 503-620-3044 Fax: 503-598-9258

**International Dealers:** Argentina: Interface SRL 54 1 741-1389/Australia: ME Technologies 61 (0)65-50-2200/Austria: Audiomax 49 (0)71-31-162224/Belgium: Belram 32 (0)2-736-50-00/Canada: Gerraudio 416-696-2779/Denmark: A&T Ljudproduktion 46 (0)9-732 11 77/France: Belram 32 (0)2-736-50-00/Germany: Audiomax 49 (0)71-31-162224/Indonesia: Ken's Audio 62 (0)21-385-4591/Italy: Outline snc 39 30-3581341/Luxembourg: Belram 32 (0)2-736-50-00/Malaysia: AUVI 65 283-2544/New Zealand: ME Technologies 61 (0)65-50-2200/Norway: A&T Ljudproduktion 46 (0)9-732 11 77/Switzerland: Audiomax 49 (0)71-31-162224/Taiwan: Gestion Taycan Intl 886 2-786.3468-9/Thailand: AUVI 65 283-2544/The Netherlands: Duran Audio 31 (0)41-80-15583/UK(England): Munro Assoc 44 (0)71-379-7600.

# Good News

## CELESTION SUBWOOFERS

The new CR Series™ loudspeakers, the CR151X and the CR181X, are sub-bass ported reflex enclosures. An internal passive crossover network allows them to be used in a sub/top cabinet combination without an additional amplifier and crossover network. For traditional bi-amplifier setups, the subwoofers can be connected so that the crossover is not activated. Celestion Industries, Inc., 89 Doug Brown Way, Holliston, MA 01746, (508) 429-6706, FAX (508) 429-2426.

*Reader Service #101*



## AUDIO CLASSICS

The Reference Catalog from Audio Classics, Ltd.<sup>SM</sup> features stereo components from manufacturers such as AudioQuest, B&K, Dahlquist, Denon, KEF, Philips, Rotel, Soloist, and Sound Lab, among others. The new and pre-owned components include amplifiers, cartridges, CD players, equalizers, headphones, interconnects, preamps, receivers, records, cables, speakers, tuners, turntables, books, and magazines. To receive the catalog, contact Audio Classics, Ltd., PO Box 176, Walton, NY 13856-0176, (607) 865-7200, FAX (607) 865-7222.

*Reader Service #109*

## RIBBON DRIVERS

Newform Research offers a full line of ribbon-based loudspeakers, including raw ribbon drivers (8", 15", and 30"), in-wall units, ribbon modules, and full-range systems. Ribbon technology offers the definition and air of large electrostatics in smaller, easier-to-drive packages. These wide-bandwidth ribbons cover the midrange and treble so the woofer operates within its natural range with minimal distortion. Newform Research, Inc., PO Box 475, Midland, ON L4R 4L3, Canada, (705) 835-9000, FAX (705) 835-0081.

*Reader Service #106*

## ROCK-IT SCIENCE

The Radio Rock-It RDS add-on internal board for home PCs enables your computer to receive FM-stereo signals as well as display radio text information on screen, including traffic announcements, news, and weather updates. The board picks up the signal from the Radio Broadcast Data System and converts it into text. The "smart radio" also offers SRS surround sound, five-band graphic equalizer, and onscreen digital paging system. For more information, contact Advanced Digital Systems, 13909 Bettencourt St., Cerritos, CA 90701, (800) 888-5244, FAX (310) 926-0518.

*Reader Service #107*



## SATELLITE SPEAKER

M&K Sound has introduced Ken Kreisel's 20th anniversary edition of its flagship S-1C Satellite Speaker System. The S-1C incorporates features such as push-pull dual drivers, user-controlled vertical directivity, open-back transmission line tweeters, bi-wiring capability, adjustable tonal balances, a tweeter/woofer driver offset for time alignment®, and a selectable, high-frequency radiation pattern control. Miller & Kreisel Sound Corp., 10391 Jefferson Blvd., Culver City, CA 90232, (310) 204-2854, FAX (310) 202-8782.

*Reader Service #110*

# Good News

## ■ ACCULINE PLANARS

Acculine's new model 2.8 dipole driver (28" long, 4-5/8" wide, and 1-3/16" thick) is a wide-range planar transducer. Its frequency response is  $\pm 3$ dB from 120Hz to 19kHz, with 2 $\Omega$  impedance, 87dB sensitivity, and power handling of 200W RMS. Lateral dispersion characteristics are enhanced by the 1.25" source width. For more information, contact Bohlander Graebener Corp., PO Box 8888, Incline Village, NV 89452, (702) 832-5402, FAX (702) 832-5407.

*Reader Service #103*

## ➤ COINCIDENTAL SPEAKERS

The SYN-519A, SYN-619A, and SYN-825A drivers from Madisound feature die-cast frames, PVC surrounds, Kapton formers, aluminum dome tweeters, and ferrofluid cooling. The tweeters are mounted at the base of the cone, in the middle of the woofers' voice coil, a design which places the woofer and tweeter in phase with each other. The in-wall WS008A speaker offers the same features in a one-piece polycarbonate chassis. Madisound Speaker Components, PO Box 44283, Madison, WI 53711, (608) 831-3433, FAX (608) 831-3771.

*Reader Service #102*



*Speaker Builder* (US ISSN 0199-7920) is published every six weeks (eight times a year), at \$32 per year, \$58 for two years; Canada add \$8 per year; overseas rates \$50 one year, \$90 two years; by Audio Amateur Publications, Inc., Edward T. Dell, Jr., President, at 305 Union Street, PO Box 494, Peterborough, NH 03458-0494. Second-class postage paid at Peterborough, NH and an additional mailing office.

### POSTMASTER:

Send address change to:  
*Speaker Builder*, PO Box 494  
Peterborough, NH 03458-0494

## ■ CLEAR-FINISH EPOXY

Syon's Tru-Set<sup>®</sup> General Purpose Adhesive is a two-part epoxy which sets to the touch in about 20 minutes; full cure is achieved in four hours. This adhesive has a flexural strength of 8,000 psi, and a mix ratio of 1:1. The cured product resists moisture, acid, and alkali. Syon Corp., 280 Eliot St., Ashland, MA 01721, (508) 881-8852, FAX (508) 881-4703.

*Reader Service #104*

# The Source for Pro Sound Speaker Builders

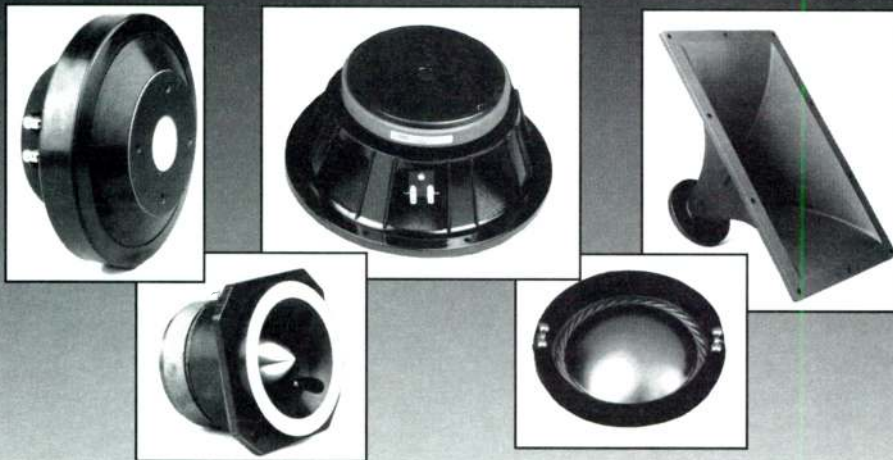

**Loudspeakers, Drivers, Horns, Tweeters, Crossovers, Hardware, Connectors... and much, much more!**

Image delivers virtually every component for the speaker builder.

See for yourself. Call or FAX for your FREE catalog today!

**image**  
COMMUNICATION

4301 W. 69th St. • Chicago, Illinois 60629 • (312) 585-1212 • FAX (312) 585-7847 • 1-800-552-1639

## EMINENCE

Loudspeakers, Drivers,  
Diaphragms and Recone Kits

## Electro Voice

Recone Kits

## McCauley

Loudspeakers & Drivers.

## Acoustician

Drivers, Horns, Tweeters,  
Diaphragms & Crossovers

## Waldom

Audio Products

Hardware, Connectors, Etc.

# Good News

## ■ SPEAKER SPECIALS

Zalytron's 1995 speaker catalog is packed with new products, including a car-audio line from Focal, high-end speakers and shielded drivers from SEAS, Polydax' 60 new drivers, and ERSE Electronics' line of coils. The 160-page catalog features systems and products for both the experienced hobbyist and the beginner on a budget. Zalytron Industries Corp., 4679 Jericho Turnpike, Mineola, NY 11501, (516) 747-3515, FAX (516) 294-1943.

Reader Service #111

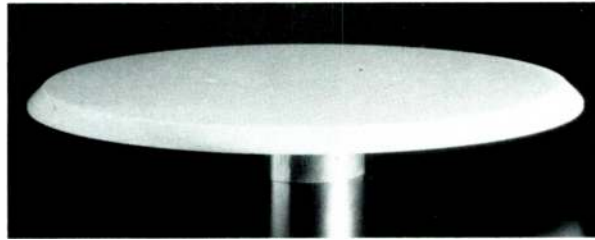

## U CLEAN ETREMA

The new ETREMA speaker has a flat, sealed plastic face, so no exchange of dust, pathogens, or other materials can occur between it and the environment. It can be mounted flush with a wall surface and covered to become invisible. The solid-state units require no maintenance, and can be used in virtually any environment. ETREMA Products, Inc., 2500 North Loop Dr., Ames, IA 50010, (515) 296-8030, (800) 327-7291.

Reader Service #105

## U MOUSER CATALOG

The latest catalog from Mouser Electronics contains over 45,000 items from more than 100 manufacturers in 276 pages. Selections include semiconductors, passive components, electromechanical devices, resistors, capacitors, switches, wire and cable, connectors, and more. The guide also provides specification drawings and up-to-date, guaranteed pricing information. Mouser Electronics, 2401 Hwy. 287 North, Mansfield, TX 76063, (817) 483-4422, (800) 992-9943.

Reader Service #108

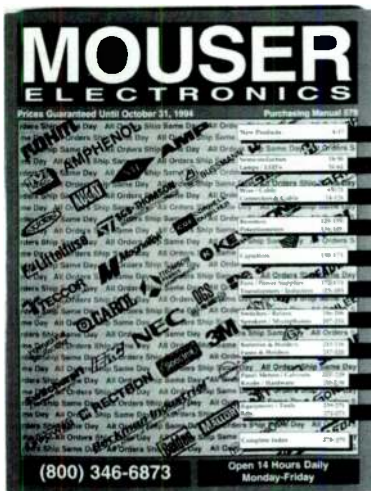

## ■ INSTALLER OLYMPICS

The first National Installer Olympics will be held in conjunction with the 1994 IASCA Finals on November 4-6 in Dallas, TX. The Installer Olympics is a fun-filled event designed to give installers from all over the country an opportunity to interact. A \$10 registration fee will be charged to enter, and the number of contestants will be limited to the first 300. For more details or a registration form, call (800) 354-6782. Installer Institute, 460 Walker St., Holly Hill, FL 32117, FAX (904) 255-3965.

## HOLOGRAPHIC INJECTED MOLDED GRAPHITE SUBWOOFERS MADE IN THE USA.



The combination of stiff, light-weight components of Graphite together with Polypropylene insure proper damping & musical accuracy.

Holographic cones are up to 60%

lighter and ten times stronger than conventional cones. Coupled with large vented magnetic structures, Kapton voice coils and insulated lead wires, the Holographic woofers produce tight & dynamic bass response.

Model: CW110-4	<b>\$139.00*</b>	Model: CW112-4	<b>\$159.00*</b>
Surround: Butyl Rubber		Surround: Rolled Foam	
Re: 3.27 Ohms	Le: 0.56 Mh	Re: 3.28 Ohms	Le: .93 Mh
Qm: 9.34	Qe: 0.33	Qm: 7.77	Qe: 0.57
Qt: 0.32	X-Max: 4.6 mm	Qt: 0.53	X-Max: 5.5 mm
BL: 7.21 T-M	VC Diam: 1.5"	BL: 9 T-M	VC Diam: 2.5"
Gap Height: .3100"	Fs: 19Hz	Gap Height: .3750"	Fs: 33Hz
Zmax: 96.2 Ohms	MMS: 42.6 g	Zmax: 48.3 Ohms	MMS: 67.02 g
CMS: 1.5574 MM/N	RMS: .5597 N*sec/m	CMS: 3433 MM/N	RMS: 1.798 N*sec/m
Vas: 9.19 cuft.	SD: 433.88 Sqcm	Vas: 4.37 cuft.	SD: 506.71 Sqcm
VD: 158.66 cc	Magnet: 56 oz	VD: 277.52 cc	Magnet: 70 oz
SPL: 90 dB	Winding: .625"	SPL: 91 dB	Winding: .750"

\*Prices include UPS freight & COD charges in the contiguous USA.

Call or write for our complete Catalog featuring over 50 drivers.

# CADENCE

Call Toll-Free 800/477-2328  
6519 Highway 9 North  
Howell, NJ 07731

Dealer inquiries welcome.

Reader Service #60

Speaker Builder / 7/94 5



# LEARN SPEAKER RECONING SPEAKER RECONING VIDEO

only **\$39.95**

- COMPLETE RECONING VIDEO
- HOW TO GET STARTED INFORMATION
- PARTS DESCRIPTION CATALOG
- PARTS ORDERING

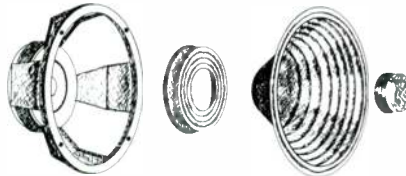

*This offer is designed to get you started right away. No hidden costs, No restrictions or other red tape to hinder you from getting started NOW! Act now if you want to recone your own speakers and expand your knowledge.*

#### ACCEPTABLE METHODS

CHECK  
MONEY ORDER  
C.O.D.  
VISA  
MASTER CARD

Make checks payable to:

**Workshop Video**  
1502 N. Harrison Street  
Ft. Wayne, Indiana 46808  
(219) 424-5463

WE MAKE IT EASY.

YOU MAKE IT  
SOUND GOOD.

Reader Service #66

# Speaker Builder

## The Staff

Editor and Publisher

Edward T. Dell, Jr.

Contributing Editors

Joseph D'Appolito Robert Bullock  
Richard Campbell John Cockroft  
David Davenport Vance Dickson  
Bruce Edgar Gary Galo  
G.R. Koonce

Director of Outside Projects & Personnel  
Karen Hebert

Dennis Brisson Managing Editor  
Mary Wagner Associate Editor

Glenn Galloway Graphics Director  
Production Assistants  
Brian Jenkins Diane Luopa

Laurel Humphrey Circulation Director  
Circulation Assistants  
Robyn Lasanen Lea Peterson

## Advertising Rates & Schedules

Martha L. Povey National Advertising Director  
Laura Brown Advertising Assistant  
(603) 924-9464 FAX (603) 924-9467

*The peculiar evil of silencing the expression of an opinion is, that it is robbing the human race; posterity as well as the existing generation; those who dissent from the opinion, still more than those who hold it.*

— JOHN STUART MILL

*Speaker Builder* is published eight times a year in the interest of high-quality audio reproduction.

No material in *Speaker Builder* may be used in any form without the written permission of the publisher.

## Subscription Inquiries

A one year subscription to *Speaker Builder* is \$32. Canada please add \$8. Overseas rate is \$50 per year.

To subscribe, renew or change address write to Circulation Department or call (603) 924-9464 or FAX (603) 924-9467 for MC/Visa/Discover charge card orders.

For gift subscriptions please include gift recipient's name and your own, with remittance. A gift card will be sent.

Send circulation and editorial correspondence to *Speaker Builder*, PO Box 494, Peterborough, NH 03458-0494. No responsibility is assumed for unsolicited manuscripts. All manuscripts must include a self-addressed envelope with return postage. The staff *will not* answer technical queries by telephone.

Printed in the USA. Copyright © 1994 by Audio Amateur Publications, Inc.  
All rights reserved.

Who says transmission line designs have to be complex, unmanageable, impractical beasts? In search of a smaller, shorter transmission line design, intrepid author **Darin Johns** ("A 15" Transmission Line Woofer," p. 10) traverses uncharted jungles to tame the TL tiger. He takes the mystery out of these misunderstood creatures and illustrates that the sound rewards can be great.

**Mark Sanfilippo** reminds us ("Inductor Coil Crosstalk," p. 14) that the placement of inductor coils on the crossover mounting base affects sound reproduction, and, if you're not careful, could create unwanted noise. He conducts an interesting crosstalk experiment to test this assertion, and demonstrates the optimum position for placing coils in your design to minimize crosstalk.

For those ready to start thinking about "surround sound," **Gregory Smith** outlines a construction piece—requiring a ridiculously low expenditure—for a pair of dipole rear speakers to incorporate into your system ("Quick Home Theater on a Budget," p. 18). Like the speakers themselves, this article gives depth, as well as width, to this new branch of sound reproduction.

**Gary Galo** chronicles the evolution of loudspeaker technology in part 2 of "Loudspeakers: A Short History" (p. 30). His focus on the development of vented speaker designs cites the events and individuals responsible for their acceptance.

The aphorism "necessity is the mother of invention" applies not only to loudspeaker history, but to individual speaker designers as well. Just ask **Bill Waslo**, who, faced with a particular speaker requirement, developed not one, but two, unique solutions ("Silk Purses: A Two-Way Salvage Design," p. 24). Purists might cringe at his somewhat undisciplined approach, but, in author Waslo's case, "chance favors the prepared mind."

This installment of **Bob Wayland's** "Wood World" introduces the magic of veneering, which can transform your most unattractive woodworking project into a work of art.

In response to reader comments and concerns, we introduce a new column entitled "Loudspeakers 101." As the name implies, its focus is educational and will emit some light on loudspeaker design, operation, terms, and principles. And who better to compose this series than **Dick Pierce**, who is involved in the industry—in an instructive way—as consultant, author, and lecturer.

Also in this issue, **Gary Galo** tests a new piece of audio gear from Crystal Lake Designs, and **Robert Bullock** tackles some tough reader questions in "Ask SB."

# Speaker Builder

THE LOUDSPEAKER JOURNAL

VOLUME 15 NUMBER 7

OCTOBER 1994

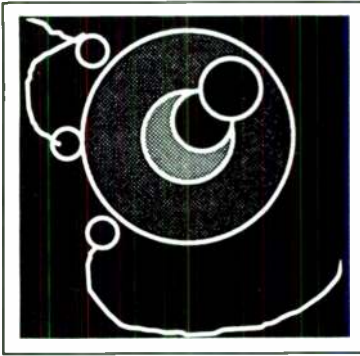

18

## 10 A 15" Transmission Line Woofer

BY DARIN K. JOHNS

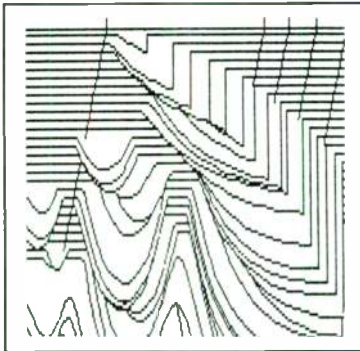

24

## 14 Inductor Coil Crosstalk

BY MARK SANFILIPO

## 18 Quick Home Theater on a Budget

BY GREGORY SMITH

## 24 Silk Purses: A Two-Way Salvage Design

BY BILL WASLO

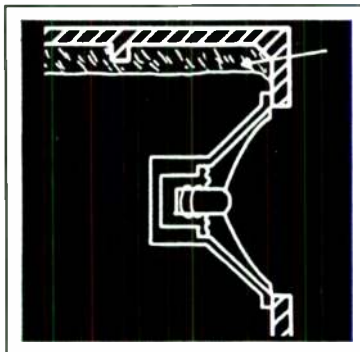

30

## 30 Loudspeakers: A Short History, Part 2

BY GARY GALO

## 46 PRODUCT REVIEW: Audio Phase Indicator

BY GARY GALO

### DEPARTMENTS

- |    |  |    |                                    |
|----|--|----|------------------------------------|
| 3  | GOOD NEWS                              | 56 | SB MAILBOX                         |
| 9  | EDITORIAL Share the Health             | 66 | CLASSIFIED                         |
| 42 | WAYLAND'S WOOD WORLD<br>BY BOB WAYLAND | 68 | AD INDEX                           |
| 48 | ASK SB<br>BY ROBERT BULLOCK            | 70 | LOUDSPEAKERS 101<br>BY DICK PIERCE |

# EXPERIENCE!

Nothing compares to being at a live musical performance...  
but Audax's experience can bring you close. We use cutting  
edge materials and processes—including ultra-light, rigid, maximally  
damped HD-A cones—to capture the subtlety and emotion of live music.  
Join the audiophiles who depend on Audax as their number one source for a complete  
line of loudspeaker products, many patented worldwide. And experience for yourself what  
these customers already know: Audax manufactures the highest quality loudspeaker components  
in the world, giving your system an unparalleled sonic advantage. **Let our expertise perform for you.**

For your 1994 catalogue or list of authorized distributors, contact Polydax Speaker Corporation, the U.S. subsidiary of Audax Industries, France.

**polydax**  
SPEAKER CORPORATION

**AUDAX**

POLYDAX SPEAKER CORPORATION 10 Upton Drive Wilmington, Massachusetts 01887 Tel: 508.658.0700 Fax: 508.658.0703



---

# Editorial

---

## Share the Health

**C**an you recall your joy the first time you made an object, or built a device which became a working tool? My earliest experience at making a gadget that actually worked happened when I was not quite ten years of age. I cannot remember a time when I was not interested in how things worked, but until that point, I had fashioned nothing which actually "did something."

Building that small code practice oscillator was a watershed in my life. The base was of wood, cut from an apple box end, planed and sanded and beveled. The tube socket was surface-mounted with screws, and the battery, code key, and headphone connections were all executed with fahnestock clips. (The wire was neither pure nor oxygen-free, alas.)

Ordinarily, you might suppose I learned about Morse code and the joys of amateur radio from my father. Unfortunately, although he worked most of his life for Western Electric and American Telephone and Telegraph, the inspiration for the project came from another quarter altogether. Our local church had a troop of Boy Scouts which I longed to join but was unable to because of family conventions. The scoutmaster, however, sought me out and suggested I try ham radio. He invited me to his house for a session on his shortwave rig, which provided me with the first technical excitement of my young life.

The parts for the project were readily available at a local repair shop. The sound in my headphones from the little glowing tube as I tapped out what every ham learns first, SOS (three short, three long, and three short), seemed a miracle. The greater miracle, of course, was the technology seed planted in a youngster's mind. Not long afterward, my scoutmaster friend Robert Honeycutt presented me with a large book of building plans for dozens of useful gadgets. I made a wooden mapping transit with a tripod for doing scaled drawings of all sorts of geography. I learned to build waterproof tents from recycled cotton sugar sacks and how to camp out overnight.

The book was important in opening my eyes to a new and exciting range of possibilities. Even more fundamental was the interest and encouragement my friend invested in me and the important discovery that I could make things, exciting things. Recently a friend and former employee sent me a letter from his desk at a new job. In it he mentioned, to my surprise, that his time on our staff had been the most important mentoring experience of his editing career. I have had the distinct pleasure, in these past months, of welcoming back to the staff three former employees who all mentioned the value of what they learned earlier.

In our not-too-long-ago history as a culture we had a very strong tradition of entrusting the learnings of one generation to another.

This happened between fathers and sons, between mothers and daughters, between masters and apprentices. Such links seem to me to have become rarer in our times. I believe we are poorer for it.

Most of us who share this wonderful enthusiasm for speaker designing and building invest a surprising amount of time gaining for ourselves experience and know-how about its complexities. Along the way some of us acquire an impressive array of information and some few share this through this periodical by words, pictures, and diagrams. This interactive enrichment is one of the very best parts of the whole process. But is it enough?

How many other speaker builders do you know? If you are part of a club, chances are you know a few, possibly a dozen or so. If not, speaker building colleagues may be very few indeed. In the larger picture, this current generation of Americans will not be remembered as avid electronics craftspeople. Is what we enjoy so much something we ought to be keeping exclusively for our own purposes: building speakers, dreaming about new systems, upgrading to the next level toward that elusive grail of perfect reproduction?

Hardly anything is more satisfying than sharing an avocation's pleasure with another. Speaker builders have a unique advantage in the matter of mentoring younger people. Sound has become almost as necessary an ingredient in the daily life of the young as food. The idea of building a loudspeaker of your own has a strong appeal to teenagers. If we believe it is important for people of this generation to rediscover the satisfactions and sense of fulfillment in working with their hands, then sharing our enthusiasm and know-how with another, possibly younger, person must be important.

Sharing a talent and experience could, as in the case of my early good fortune, be accomplished one-on-one with a relative, a neighbor, or a friend's youngster. It might take the form of a course offered through adult education programs for which you might volunteer. The traditional crafts are flourishing well enough. But too few see the new crafts' potential in shaping electrons and sound waves and video screens.

Such an investment in another human being pays more dividends of incalculable dimensions than any other of life's opportunities. Offering the means of awakening another person to his or her own undiscovered capabilities is a profoundly gratifying, and usually surprising, experience. Sharing with another is a small payback for what all of us have received from others. Nothing we learn happens in a vacuum or without a history. I commend mentoring to you. It will pay immediate and long-term dividends not only to your lucky friend, but to you as well.—E.T.D.

# A 15" TRANSMISSION LINE WOOFER

By Darin K. Johns

I don't often come across articles about a transmission line (TL) using a 15" woofer. Most common woofer sizes for TLs range from 4-12". I wanted to be different and try a 15" TL. My goal was a subwoofer transmission line that delivers a flat response from 25-200Hz. A one-quarter wavelength line for 25Hz would measure 11.3' long. Although my wonderful wife has accepted my speaker building hobby, such an enormous subwoofer in our living room was out of the question. I decided to use the research of others to base my design for a shorter transmission line.

## BACKGROUND

I was never really interested in transmission lines until I heard a pair while I was in college. These speakers were four-way systems based around KEF B-139 woofers loaded into wool-stuffed 11' lines. They had the smoothest, most accurate bass I had ever heard. A friend built these 200 lb giants in

his first TL attempt. Despite his success and my immediate interest, I placed the TL idea on the back burner.

As a theory-minded person who believes there is not enough established theory on TLs, I spent my time designing and building vented boxes. I'm also a tuba player in the band and a sub-bass freak, so my interests centered on subwoofers. Using calculator formulas at first and computer programs later, I designed and built successful "bass-reflex" subwoofers that performed amazingly close to theory.

After several years of building vented cabinets, I was ready for a change. I bought two 15" dual voice-coil woofers from Petras (38 SW8 DVC) with the intent of building a bandpass enclosure. Even though these woofers are designed for car use, they were reasonably priced with good-looking specs. After my first attempted bandpass enclosure failed, I turned the large box into a 10 ft<sup>3</sup> vented enclosure for a single 15" woofer. This left me with an extra woofer.

The idea of a transmission line resurfaced. A glance back at the many wonderful TL articles in *SB* by Gary Galo, Craig Cushing, John Cockroft, Thomas Cox, and others rekindled my interest. I saw others successfully using smaller than "optimal" lines. I searched these articles for any formulas that might help.

I was unsure and confused by so many different ideas on stuffing, line length, cross section, and their relationship to each other. About that time, Larry Sharp wrote a short, but insightful, TL article, "Optimizing Transmission Line Lengths" (*SB* 4/91, p. 30). Using formulas from this article, I started designing a transmission line for my 15" Petras.

## SYSTEM DESIGN

I have learned not to rely on manufacturers' specifications, so I performed my own tests to determine  $f_s$ ,  $Q_{TS}$ , and  $V_{AS}$ . I used an old Heath sine-wave generator and a digital multimeter to obtain the results and performed all measurements with the two voice coils wired in parallel. Measured specs turned out to be amazingly close to the manufacturer's (*Table 1*).

With a resonance frequency of 27Hz, my goal of 25Hz for a low range seemed right on target. According to the table in Larry's article, I could achieve -3dB at 25Hz with a 4' line using the standard stuffing density of 0.5 lb/ft<sup>3</sup>. This almost seemed unbelievable in comparison to my friend's 11' line; but according to Larry's equations and detailed explanations, it actually made sense.

The well-known equation for calculating a line length assumes an air speed of 1,130 ft/sec at sea level. This is fine for an un-

## ABOUT THE AUTHOR

Darin K. Johns is a band director at Franklin Middle School in Abilene, TX. Besides designing and building speaker projects, he enjoys hitting the trails on his dirt bike. He also works part-time as audio consultant for Spectra Sound Systems. He is married and has one child.

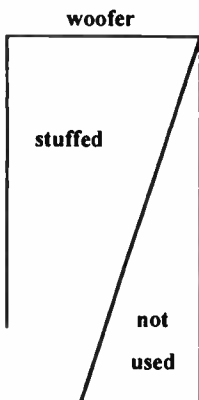

FIGURE 1: Speaker profile.

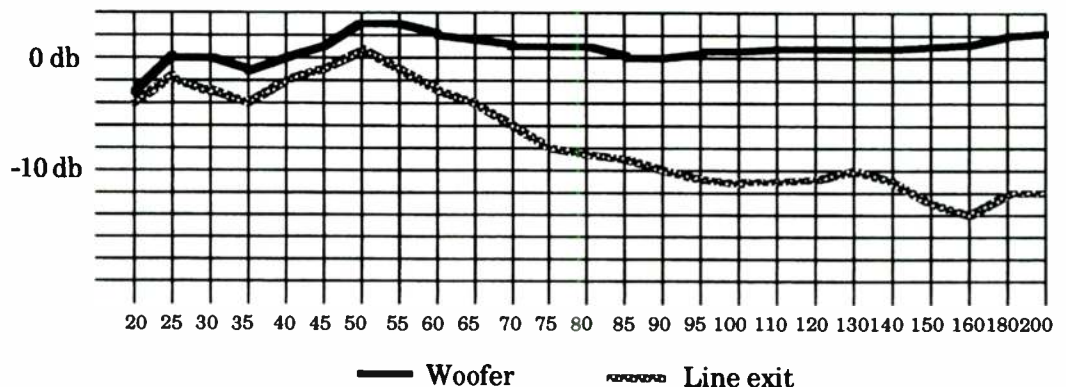

FIGURE 2: Frequency response graph using generator direct to speaker.

stuffed line, but when you stuff a line (or put anything in it), the speed of sound changes, as Robert Spear and Alex Thornhill ("Fibrous Tangle Effects On Acoustical TLs," *SB* 5/91, p. 11) have demonstrated. With a stuffing density of 0.5lb/ft<sup>3</sup>, the speed of sound is only 408 ft/sec, as derived from Bradbury's law (Equation 1) to determine the speed of sound through fiber.

$$\text{speed of sound through fiber} = \frac{1130 \text{ ft/sec}}{\sqrt{1 + (Pa/P)}} \quad (1)$$

Pa = density of stuffing  
P = density of air at 72° (0.0736 lb/ft<sup>3</sup>)

By plugging values into the transmission line formula:

$$1/4\lambda = 408 \text{ ft/sec} \div 25\text{Hz}(f_s) \div 4 = 4.08 \text{ ft}$$

I chose to taper the line to avoid major resonances and standing waves. My 15" woofer has an effective cone radiation area (S<sub>d</sub>) of 154 in<sup>2</sup>. I arbitrarily chose a cross-sectional area of 229 in<sup>2</sup>, which is almost 50% larger than S<sub>d</sub>.

## CONSTRUCTION

The external dimensions are 17" × 17" × 48.5", with the woofer mounted in the top, and the port at the bottom of the front panel. A board runs diagonally through the box forming the taper (Fig. 1). Table 2 lists the board cuts you must make. I made the entire enclosure with 3/4" industrial grade particle board.

I assembled the parts, except for the top and face, using wood glue and screws (#6 × 2"). I caulked all joints with clear silicone rubber, and then placed weather-stripping on the exposed edges where the face board and



PHOTO 1: Author's TL woofer (right) next to system's right main speaker.

top board would go. The weather-stripping provides a good seal, but lets you remove these boards at a later date, if necessary, without destroying the cabinet.

## STUFFING

I chose Acousta-Stuf® to fill the line. This is a good substitute for wool, but much easier to work with, and you don't have to worry about moths. The total line volume of 4.3 ft<sup>3</sup> required slightly over 2 lbs. Acousta-Stuf is normally self-supporting. However, because of the greater cross-sectional area of my line, it needed a little help. I stapled fish netting at the port opening and every 10–12" up the line, which solved the problem.

## WIRING AND EQUIPMENT

For the internal wiring I used 12-gauge, oxygen-free speaker cable. I connected separate wires to each voice coil lead so I could later wire them in parallel, series, or individually to separate channels. The wires, stapled to an inside wall so they would not disturb the evenly spaced stuffing, ran out the port directly to the amplifier to avoid any extra resistance which could degrade the amplifier damping factor.

My home audio system features a Kenwood 55W/channel receiver (for highs),

an Ashly 24dB/octave electronic crossover, and a Proton D540 integrated amplifier (for lows), which I use only as an amplifier via amp inputs on the back panel. This extremely clean model is conservatively rated at 40W/channel into 8Ω, stable down to 2Ω, and is bridgeable for high power. I highly recommend this great little unit, with its dynamic headroom of 6dB and a damping factor >90.

I wired the two 8Ω coils of the Petras woofer in parallel for a 4Ω load. Because I was only using one subwoofer, I combined the outputs of my crossover for a mono input into my bridged amp giving it a 2Ω load and over 200W RMS. To minimize damping loss I kept the amp within four feet of the TL.

## LISTENING TESTS

After stuffing the cabinet and screwing down the top and front, I began listening tests. For the first one, I bypassed the crossover to get an idea of the full-range sound. I decided to judge the sound quality myself before measuring instruments biased my opinion. I used a variety of music: hard rock, country, classical, movie soundtracks, orchestral, wind band, and so on. I wired the 10 ft<sup>3</sup> vented box with the identical woofer to the B speaker outputs on the amplifier for A/B comparisons.

After the first tests, I determined that the new TL was lacking in the sub-bass region, compared to the vented box (tuned to 29Hz). To fine-tune the TL, I added more stuffing just beneath the woofer. Stuffing density ended up approximately 0.6 lbs/ft<sup>3</sup>. I also stapled 8" long strips of 1" fiberglass insulation from Radio Shack to all four wooden surfaces behind the woofer.

It was ready for another listening test, and this time, the sound was much smoother. The bottom end seemed to open up, and its slight mid-bass boominess disappeared completely.

I reconnected the electronic crossover into the system. By varying the crossover frequency between 40–100Hz, I performed actual "subwoofer" listening tests. The TL was less efficient than the vented box, but it controlled cone motion much better. Although my ears were accustomed to the mid-bass hump of a vented box, TL's clear, natural-sounding bass was a pleasant change.

## MEASUREMENTS

I began by making an impedance curve on the woofer in the TL to compare with the

TABLE 1

### SPECIFICATIONS COMPARISON

	f <sub>s</sub>	Q <sub>TS</sub>	V <sub>AS</sub>
Rated	26	0.41	8.78
Measured	27	0.44	7.88

TABLE 2

### BOARD DIMENSIONS

(2)	17" × 17"	top/bottom
(2)	47" × 17"	sides
(1)	47" × 15.5"	back
(1)	42" × 15.5"	front
(1)	48" × 15.5"	divider

woofer curve in free air. One advantage of a TL is its ability to smooth out an impedance curve and ease the load on the amplifier. Usually two peaks are noticeable in transmission lines, but my line only contained one of only  $11.4\Omega$  at 50Hz (see Tables 3 and 4). Because I could not find a higher peak, I assumed this represented the high peak. The low peak may be below the range of my frequency generator.

I made a graph of the frequency response between 20 and 200Hz. Measurements were made with the TL lying horizontally on my couch. With pillows and couch cushions, I attempted to isolate the outputs of the woofer and port. I placed a Radio Shack SPL meter even with the top baffle at the

center of the woofer and level with the front baffle at the center of the port.

The first measurements, with the speaker wired directly to the frequency generator, confirmed what my ears were telling me (Fig. 2). It seemed too good to be true (20–200Hz,  $\pm 3\text{dB}$ ). For the next test, I connected the generator to the receiver. From there the signal went through the electronic crossover set at 50Hz and into the bass amp (Fig. 3). The system still looked good.

### PLACEMENT AND ADJUSTMENTS

It was now time to place the TL in the desired location in the living room, which is approximately 12' wide and 16' long with a 10' vaulted ceiling. The 6' wide, 6' tall enter-

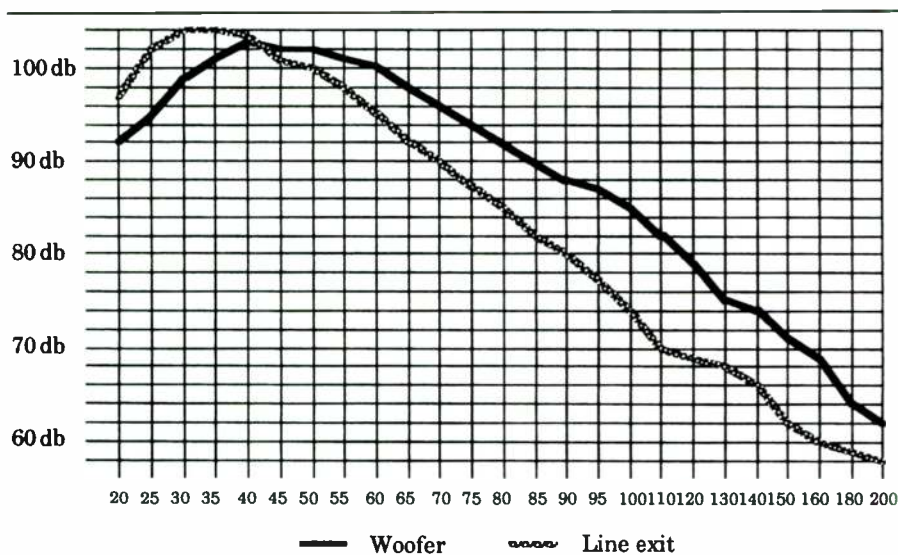

FIGURE 3: Frequency response graph, with signal going through crossover and amp.

TABLE 3

WOOFER IN FREE AIR	
$f_s$	Imp.(W)
20	11
25(27)	36 (65)
30	36
35	16
40	10
45	7.5
50	6
55	5
60	5
65	5
70	4.5
75	4.5
80	4.5
85	4.5
90	4.5
95	4.5
100	4
110	4.5
120	4.5
130	4.5
140	4.5
150	4.5
160	5
170	5
180	5
200	5

tainment center is against the 12' wall. The main speakers are flush with either side of the entertainment system, while the TL is against the back wall on the right, so the port exits into the space behind the right main speaker.

Choosing 50Hz as a crossover frequency was based around the main speakers, whose frequency response is rated at 42Hz–20kHz ( $\pm 3\text{dB}$ ). I experimented with various crossover settings. Using 100Hz made the whole system sound muddier. At 80Hz the system sounded good, but the bass became localized on the right side. Since my main speakers covered this range well, I decided to go lower. Using 40Hz cut out too much, but 50Hz blended well. I made final crossover level adjustments to fit my personal preferences.

### CONCLUSION

This short transmission line does not fall short in sound quality. I have spent much

TABLE 4

WOOFER IN STUFFED LINE	
$f_s$	Imp.(W)
20	6
25	6
30	6
35	7
40	8
45	10
50	11.4
55	10
60	8
65	6.5
70	6
75	5.5
80	5
85	5
90	5
95	5
100	5
110	4.5
120	4.5
130	5.8
140	4.8
150	5
160	5
170	5
180	5
200	5

time listening to this system and am now spoiled by the smooth, tight sound of my TL subwoofer. All types of music sound great. Movies are startling with effects you can feel. The sound from the subwoofer and the surround sound speakers really engulf you.

Why did I leave wasted space on one side of the cabinet? My original intention was to build two of these lines and two-way systems on the opposite side of the TL opening. With a volume of 2.2 ft<sup>3</sup> and a nonparallel surface, this is a good candidate for a sealed system with an 8" or 10" woofer, which I may consider for a future project.

### SOURCES

**Mahogany Sound**  
2610 Schillingers Rd. #48, Mobile, AL 36695  
(205) 633-2054

**Petras**  
131 Knight St., Arlington, TX 76015  
(817) 468-5780, FAX (817) 465-2756

### Your Privacy Preserved On Request

We're very selective about making our subscriber's names available to organizations whose products, services or purposes we consider will be of interest or value. However, if you prefer that we keep your name to ourselves, please send a postcard to our circulation department saying so.

# KITS



**THE SPEAKER WORKS, INC.**

1021 E. Camelback Rd.  
Phoenix, AZ 85014  
(602)230-0344 FAX (602)230-8533

# KITS

**LOOKING FOR A GREAT SET OF SPEAKERS? DON'T HAVE LOTS OF SPARE TIME?  
THE KIDS WANT TO PLAY NINTENDO ON YOUR COMPUTER?  
PERHAPS WE CAN HELP**

**TSW SPEAKER KITS ARE DESIGNED FOR THE SERIOUS LISTENER AND ALL HAVE PROVEN THEIR MERIT BY THEIR EXCELLENT SALES HISTORY! ALL ARE DESIGNED FOR PREMIER PERFORMANCE AND MAXIMUM RELIABILITY WITH TOP QUALITY DRIVERS AND COMPONENTS. WE, AT TSW, DO NOT FEEL THAT SOMETHING AS ENJOYABLE AS AN EXCELLENT SET OF LOUDSPEAKERS SHOULD BE A BURDEN ON YOUR TIME, ENERGY OR POCKETBOOK. WE OFFER THE FOLLOWING SOLUTIONS TO EAR POLLUTION:**

## **THE TSW D-1 KIT**

A petite two-way system using our TSW 5" woofer and a 13mm tweeter in a 10" high x 7" wide x 5" deep oak veneer enclosure. Designed originally as a dialogue channel system for AV systems, the **D-1** has been equally popular for AV rear channel application for bedrooms and offices and as a satellite system with our **D-10 SUBWOOFER**. Available in stained oak, black oak and white oak.

**COST:** A petite \$62.25 each.

## **THE TSW TUCSON**

A serious two-way system comprised of a SEAS 8" woofer and a SEAS 1" dome tweeter. The crossover is designed to give outstanding sonic performance from this medium sized book shelf system. The furniture quality oak veneered cabinets available in stained oak, black oak or white oak compliment most any decor. **THE TSW TUCSON** has long been our best selling loudspeaker system. Their 19" height x 12" width x 10" depth enclosure produces tight and unbelievably low bass.

**COST:** An unbelievably low \$259.50 per pair.

## **TSW D-10 SUBWOOFER**

Our own **TSW 10"** poly dual voice coil woofer with 125 Hertz second order roll off and first order satellite roll in. Subwoofer is 4 ohm and set up for 8 ohm satellites. We do not supply an enclosure but recommend 1.5 cu. ft. sealed. Works well in a down fire or front fire configuration.

**COST:** All parts except enclosure \$72.50.

## **THE TSW MINI MONITOR**

Maybe it's not a Rogers, but maybe it's pretty close! We feel the cost may be the most significant difference. The SEAS 6.5" woofer and the SEAS .75" dome tweeter are painstakingly melded together with a carefully designed crossover and installed in an oak veneered enclosure 13.5" high x 8" wide x 7" deep. **TSW MINI MONITORS** fare well as an independent system or may be used as satellites with our **D-10 or D-12 SUBWOOFER SYSTEMS**.

**COST:** A mini \$194.50 per pair.

## **THE TSW BUCKINGHAMS**

This three-way system equipped with our own **TSW 12"** woofer, a **PEERLESS 4"** poly midrange and a SEAS 1" aluminum tweeter was rated by the president of the Arizona Audiophile Association as being equal to any \$2000 system he has heard. Prejudice aside, we are inclined to agree. Magnificent cabinetry in stained oak, black oak or white oak veneers compliment **THE BUCKINGHAM'S** superb sound. **BIWIRE INPUTS AND MID AND TWEETER LEVEL CONTROLS** make this system a best buy. Cabinet 25" high x 14" wide x 12" deep.

**COST:** A paltry \$449.50 per pair.

## **TSW D-12 SUBWOOFER**

Our own **TSW 12"** poly dual voice coil woofer with 100 Hertz second order roll off and first order satellite roll in. Subwoofer is 4 ohm and set up for 8 ohm satellite roll in. We do not supply an enclosure but recommend 2.5 cu. ft. sealed. Works well down into the 20s in a down fire or front fire configuration.

**COST:** All parts except enclosure \$89.50.

**ANY QUESTIONS — CALL US  
ALL KITS F.O.B. PHOENIX VIA UPS  
We Accept VISA - Mastercard - Check — No C.O.D.  
195 PAGE CATALOG \$10.00**

# INDUCTOR COIL CROSSTALK

By Mark Sanfilipo

As a fledgling electronics buff, I accumulated the usual hodgepodge of spare parts, old TVs, and other electrical odds and ends that those bitten by the electronics bug seem to collect. Among my most prized possessions were two 25 lb spools of insulated, 12GA copper wire. Their weighty status, however, didn't spare them from featuring in many of my early experiments.

One day, I managed to connect one of the spools to an old kitchen radio and the other to an ancient driver of unknown origin. Much to my astonishment music popped out of the old driver. I also discovered that changing the orientation of the two spools caused the driver's output to vary amazingly. I spent hours listening in wonderment to this latest electrical contrivance of mine, unaware at the time that I was observing the phenomenon of mutual inductance coupling.

Although the experiment ended when the radio finally conked out in a magnificent plume of smoke, my observations were far more lasting. They would later gain new substance and serve me well in my loudspeaker design efforts. In this article I dis-

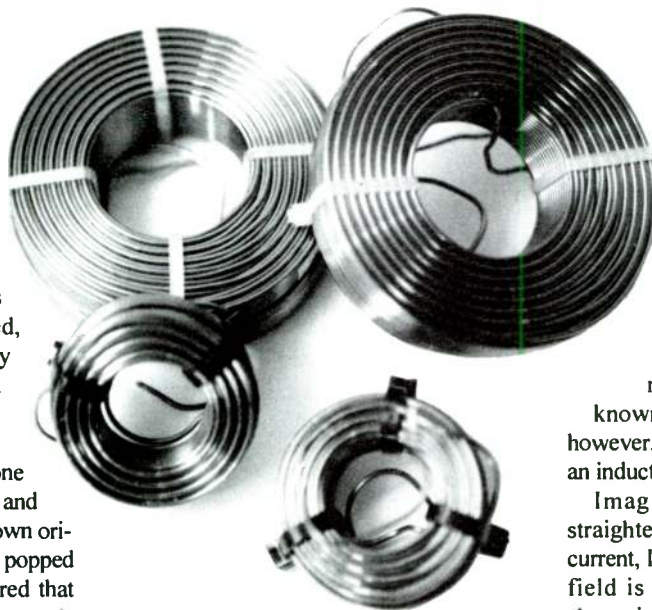

PHOTO 1: Wire spools. The author used the larger spools to connect the function generator and oscilloscope to provide signal.

cuss a more recent experiment investigating mutual inductance applied to inductor coils in passive crossover networks.

## MAGNETIC PERSONALITIES

Like most loudspeaker engineers, I am constantly on the lookout for cost-effective

methods of lowering the noise floor of the systems I design. Crossover networks, when improperly designed and/or laid out, are a proven, significant contributor to a system's noise picture. Inductor coils can generate unwanted noise in a handful of ways, primarily by mutual coupling or, as it is better known, "crosstalk." Before proceeding, however, a very brief look at the physics of an inductor is in order.

Imagine uncoiling an inductor and straightening out the wire. When a steady current,  $I$ , flows through the wire, a magnetic field is created. The Biot/Savart law is shown in *Fig. 1*:

$$B = (\mu_0 / 4\pi) * \int ((Idl \otimes r) / r^2)$$

Simplifying,  $B$  at a perpendicular distance  $R$  from the wire is found by:  $B = (\mu_0 * I) / 2\pi * R$ . If the formula looks a bit troublesome, no need to worry. The key point to remember is that a wire carrying a current will always set up a magnetic field.

Now imagine coiling this wire into a single large loop (coil  $I$ ). Place it next to another

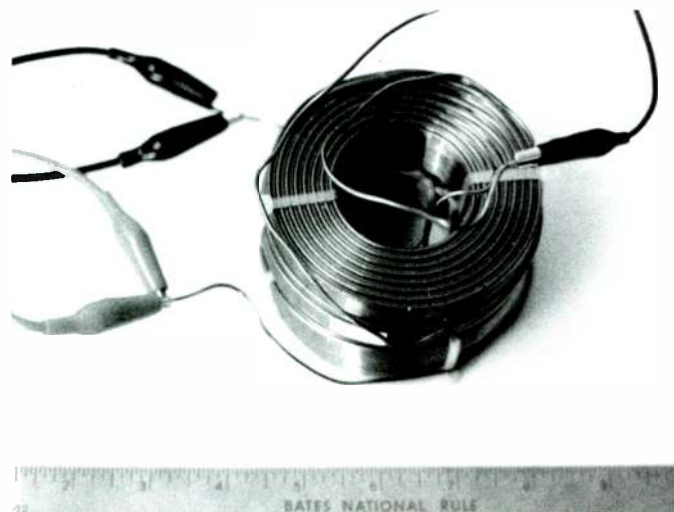
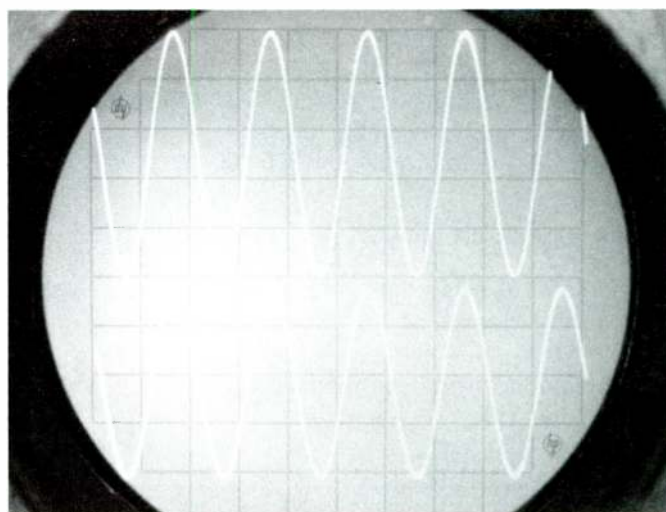

PHOTO 2 and 2A: For my mutual inductance experiment, I hooked one coil to a function generator to provide a sinusoidal signal and connected the other to an oscilloscope. The left-hand photos (2-7) depict the various wire coil arrangements, while the right-hand pho-



tos (2A-7A) show the corresponding oscilloscope readings. The top waveform represents the voltage fed to the coil, while the bottom is the crosstalk reading. Note the high crosstalk when you stack the coils on top of one another.

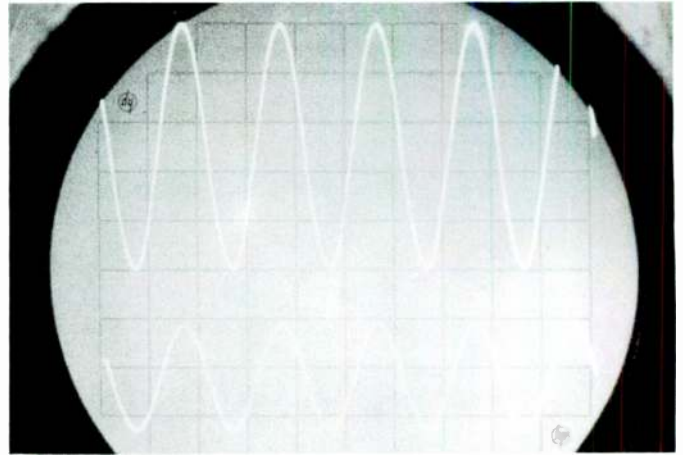
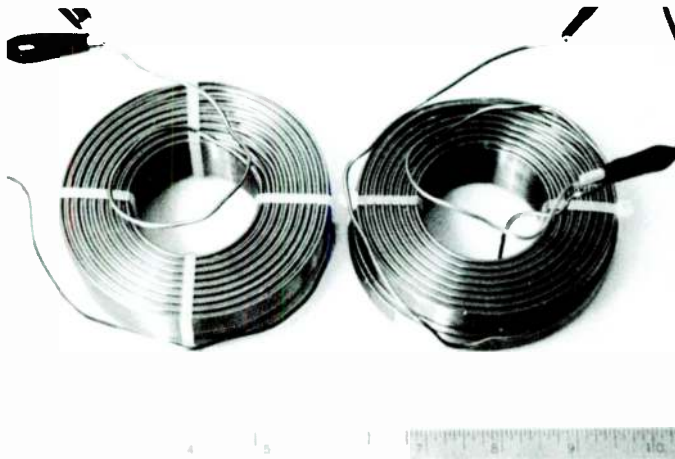

PHOTO 3 and 3A: The crosstalk reading is still poor when the coils are close together and in the same plane.

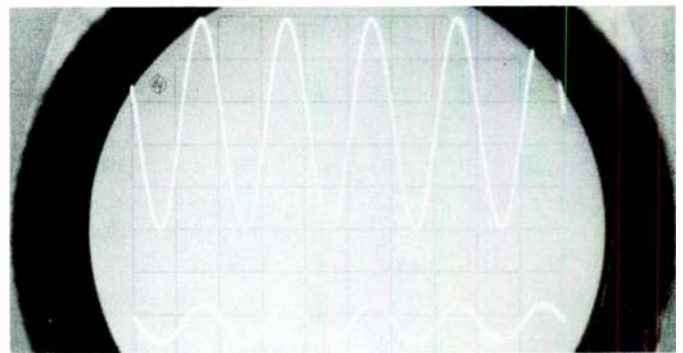
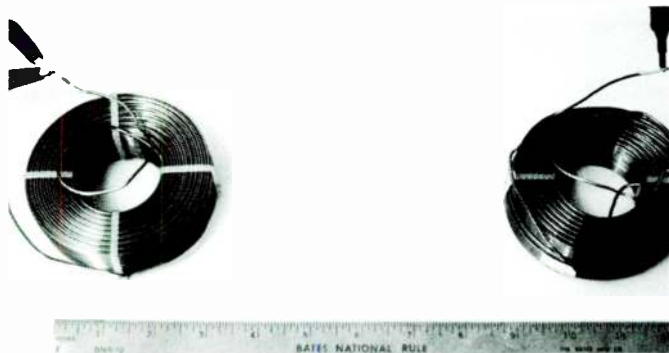

PHOTO 4 and 4A: Increase the distance between coils, and you decrease the crosstalk.

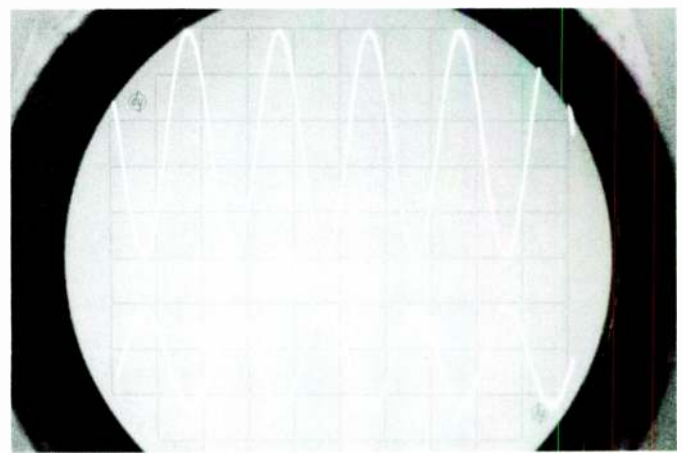
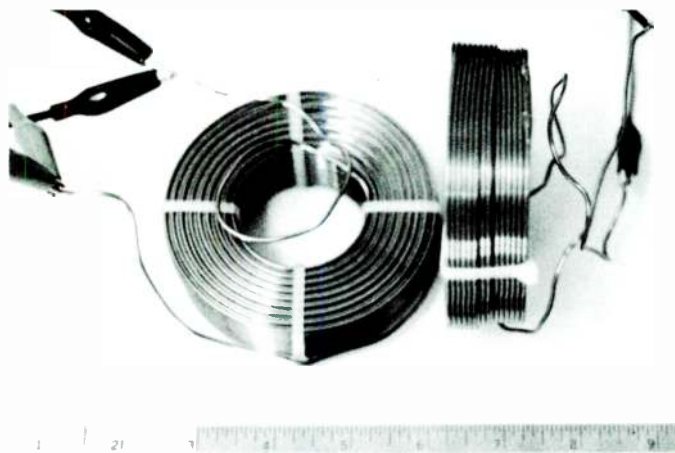

PHOTO 5 and 5A: Coils in close proximity placed perpendicular show no improvement.

er loop (coil 2) with a diameter equal to that of coil 1. Energize coil 1 with, for example, a sinusoidal signal to set up a magnetic field. Its flux,  $\Phi$ , will link coil 2 and will, in turn, set up an induced electromotive force (emf), measured in volts in coil 2. This induced emf equals the rate at which the magnetic flux of coil 1 changes with time.

By Faraday's law:

$$\text{emf} = -(d\Phi / dt)$$

Where there is voltage (in this case, the emf) and resistance, as found in any piece of wire,

there exists, of course, current.

A second way to express the emf that arises in coil 2 is:

$$\text{Coil 2 emf} = -M \cdot (di / dt)$$

Where  $i$  is the current flowing in coil 1,  $t$  is seconds, and  $M$  is the mutual inductance proportionality constant, expressed in henries (H) (*Fig. 2*). Where

$$M = (\mu_0 / 4\pi) \cdot \iint (dl_1 \odot dl_2) / r$$

Essentially then, the current, changing

with time in coil 1, sets up a magnetic field that links coil 2. In turn, an induced emf, given by Faraday's law, appears in coil 2.

#### TEST SETUP

The magnitude of coil 2's emf depends not only on the distance from coil 1, but also on the physical orientation of coil 2 to the direction of coil 1's magnetic flux. To verify the latter point I set up a simple experiment. For my test coils I chose two virtually identical 3mH air-core inductors (*Photo 1*). I connected coil 1 to a function generator, which provided a sinusoidal source, and attached

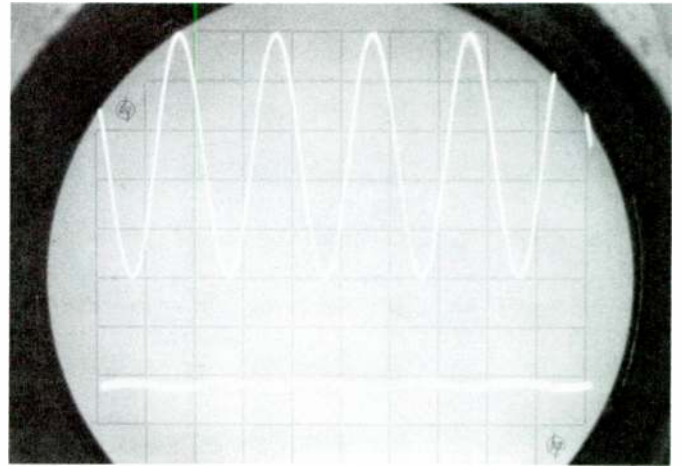
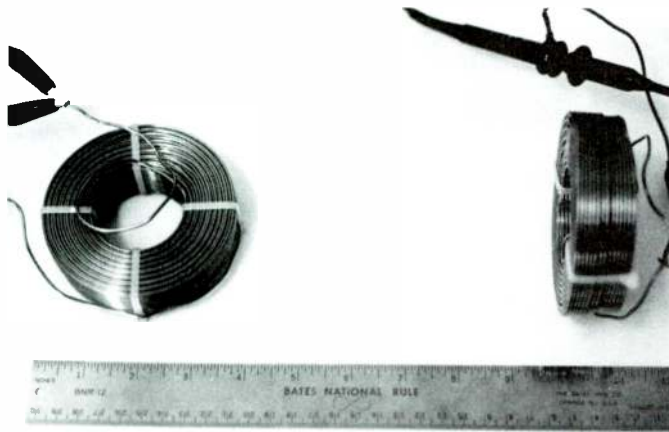

PHOTO 6 and 6A: Once again, distancing the coils minimizes crosstalk, and dramatically improves the crosstalk reading.

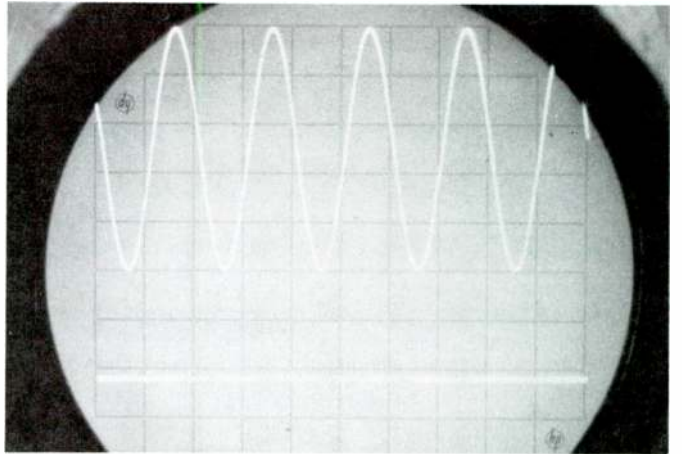
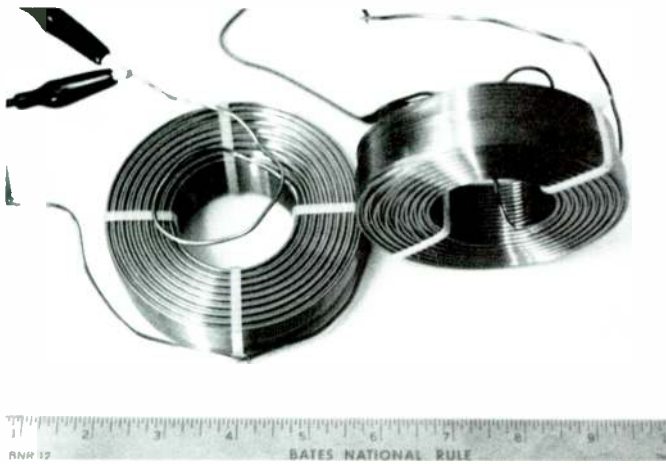

PHOTO 7 and 7A: Where tight quarters do not allow much space between the coils, consider this arrangement, which provides optimum results.

the second coil directly to my oscilloscope.

Photos 2-7 show the various coil orientations, while Photos 2A-7A show the respective results. In the oscilloscope photos the top waveform represents the voltage fed to

coil 1, while the bottom waveform corresponds to coil 2 measurements. The results clearly indicate that, although putting enough space between the coils will certainly minimize crosstalk, a far better solution exists, particularly where space is at a premium.

By placing the coils as shown in the last orientation photo in the series, you can reduce crosstalk to immeasurably low levels, even if they're as close as shown in the photo.

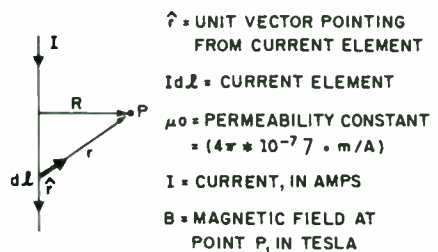

FIGURE 1: Graphic representation of the Biot/Savart law that mathematically expresses B @ point P.

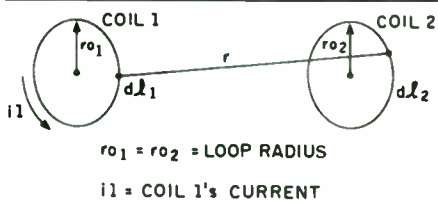

FIGURE 2: Illustrating emf generated at coil 2 according to Faraday's law.

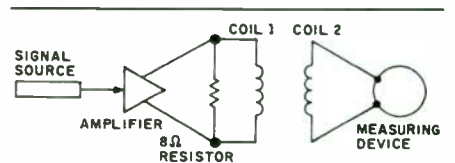

FIGURE 3: Author's test setup.

When you plan the location and orientation of your crossover network inside your cabinet, take into consideration that your driver's voice coil is also an inductor. Locate them improperly and your inductors and voice coils will become undesirably talkative neighbors. Properly orienting your inductor coils is well worth the time and effort, since you'll gain substantial improvements in your system.

REPRINTS

Available for articles, reviews, and advertisements.

Call today for details.

1-800-524-9464.

100 copy minimum



# SOLEN SPEAKER COMPONENTS

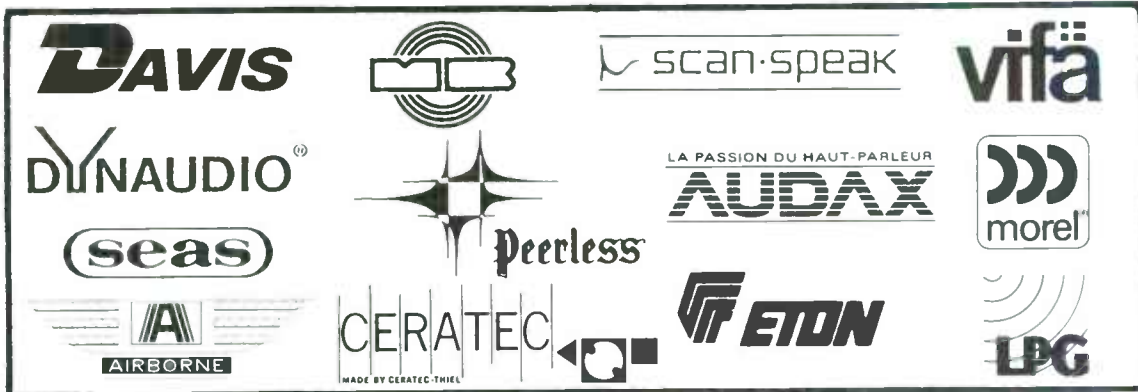

## CROSSOVER, SPEAKER COMPONENTS



### FAST CAPACITORS

Metallized Polypropylene (Non-Polarized)  
 Values from 1.0 mfd to 200 mfd.  
 Voltage Rating: 250 VDC / 150 VAC

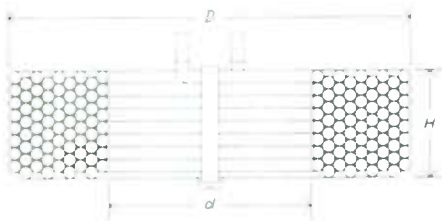

### SOLEN INDUCTORS

Perfect Lay Hexagonal Winding Air Cored  
 Values from .10 mH to 30 mH  
 Wire sizes from #20 AWG to #10 AWG



### HEPTA-LITZ INDUCTORS

Seven Strands Litz-Wire Constructions  
 Values from .10 mH to 30 mH  
 Wire sizes from #16 AWG to #12 AWG

### SOLEN CROSSOVERS

Custom Computer Design  
 Passive Crossover for Professional, Hi-Fi and  
 Car Hi-Fi, Power up to 1000 Watt

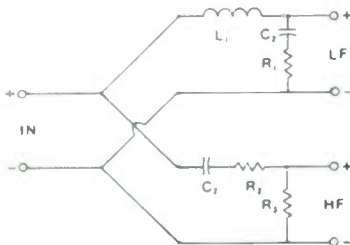

### CROSSOVER, SPEAKER PARTS

Gold Speaker Terminals, Gold Banana Plugs  
 Gold Binding Posts, Crossover Terminals  
 Power Resistors, Mylar Capacitors,  
 Bi-Polar Capacitors, Plastic Grille Fasteners,  
 Nylon Ties, Car Speaker Grilles, Speaker Books,  
 Speaker Kit Brochure, Miscellaneous Parts



**SOLEN INC.**  
 4470 Thibault Ave.  
 St-Hubert, QC J3Y 7T9  
 Canada  
 Tel.: (514) 656-2759  
 Fax: (514) 443-4949

**COMPUTER AIDED DESIGN FOR  
 ENCLOSURE AND CROSSOVER  
 AVAILABLE TO CUSTOMER**

Catalog \$6.00 refundable.

NEW 1994 CATALOG

NEW 1994 CATALOG

# QUICK HOME THEATER ON A BUDGET

By Gregory Smith

One of the '90s buzzwords is "home theater," which promises TV audio excitement previously experienced only during rare FM simulcasts. Now that good surround receivers are only slightly more expensive than their stereo-only brethren, the surround sound market is taking off. According to the standard line on selecting such speakers, you should match the sound of the rear to that of the front. This is fine when you buy a matched set of speakers from a manufacturer, but for the speaker builder it means producing another set of speakers.

I usually start with specifications and work toward a system to meet them, so, in this case, I investigated the requirements—and what is unnecessary—for a surround system. This article presents the results of that research: a set of dipole rear speakers I built for about \$25 each (see *Photo 1*). It's difficult to determine the important features of a speaker in a particular application unless you have heard one performing. These speakers let you listen and decide what you really need in a rear speaker before you spend a lot of money.

## SURROUNDED BY CHOICES

The simplest setup for surround is to feed the out-of-phase information from a recording to a set of rear speakers. "Ambience" sounds, such as hall reverberation or background noise in soundtracks, naturally occur out of phase in most recordings. Putting information out of phase is intentional on many pop recordings because such music isn't localized like in-phase material. Extracting this information is easy; *Fig. 1* shows one sample configuration.

**WARNING:** This circuit (*Fig. 1*) can cause problems with certain amplifier types, whose instruction manuals warn you about connecting their channels together. Check if

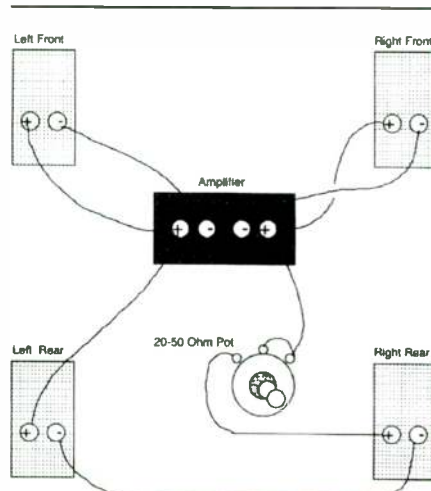

FIGURE 1: Matrix decoding.

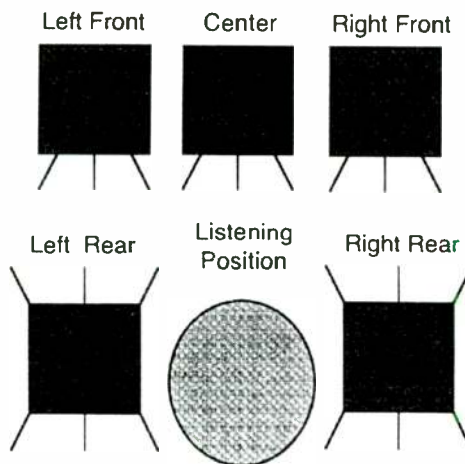

FIGURE 2: Pro-Logic speaker locations.

your amplifier can handle a common ground between its left and right output channels. My NAD amplifier is unusual because one set of outputs can handle this, but the other can't. Be sure to start with a low volume and turn it up slowly; usually an amplifier that can't handle this configuration will recognize this setup as a short circuit and shut down gracefully.

Systems with this simple decoding are referred to as matrix surround, pseudo-quad, or Hafler setups. For years Dynaco has made products based on this concept. Matrix still shows up on modern surround decoders as

an effective method of getting four-channel sound out of tracks that weren't recorded that way.

The first standard for recording four-channel sound was Dolby Surround, catapulted into fame by its use in the recording of *Star Wars*. In this format rear speaker sounds are encoded out of phase with the rest of the sound. Since this rear signal is mono, the same signal is applied to both rear speakers. On playback, a delay (typically 20ms) is added between the front and rear speakers to improve the sound.

The Dolby Pro-Logic standard followed, and has become most popular for home theater applications. It improves upon Dolby Surround by adding logic for a center speaker connection that enables viewers—no matter where they are seated—to hear sound coming from the area of the screen. Rather than a different way of encoding, Pro-Logic is an extension of the processing at the end of the listening chain. Since Pro-Logic is the *de facto* standard nowadays, I concentrated on building a set of speakers to its specifications rather than for another setup.

Frequency response below 100Hz is rolled off (12dB/octave) in the rear channel of a Dolby-encoded soundtrack. Everything above 7kHz is rolled off by the surround processor during playback. Full-range speakers, then, aren't required for rear use with Pro-Logic.

## THX-101

The new kid on the block, the one with all the expensive toys, is THX. This standard originated at Lucasfilm with the goal of producing home playback as close as possible to the sound the recording engineers intended. THX is not a new recording format, but a certification process.

A THX surround decoder's two main functions—beyond that of Pro-Logic—are: equalization to a standard curve for all speakers and pitch shifting, so different signals are applied to the rear speakers. It also performs auxiliary features such as setting volume level. Overall, the signals produced by a THX surround decoder are fundamentally the same as those produced by Pro-

## ABOUT THE AUTHOR

Gregory Smith recently completed a master's degree in computer science and occupies himself by listening to music and building speakers while searching for a full-time job. He knows he needs a real job eventually or else his designs will forever feature only cheap drivers.

Logic, but the sound is tweaked to be more accurate to the original source.

THX systems feature three identical front speakers (the only design point I disagree with, but who am I to argue with George Lucas and company?). But its rear speakers deserve special attention.

Rear THX speakers are laid out in a quasi-dipole format, that is, at least one driver firing both forward and backward, wired out of phase to each other. This system is configured so the sound field radiating from a driver is diffuse and hard to localize, which is what you desire from rear sound. The speakers are actually placed to the side of your listening position; Fig. 2 is a diagram of the setup.

This arrangement has caught on, and dipole speakers—some certified as good enough for THX, some not—have flooded the market. Since it seemed like a good idea, and I wasn't feeling particularly original, I decided to use this setup as my driver configuration and build a dipole speaker.

### GETTING CHEAP

A bandwidth of 100Hz–7kHz isn't difficult to achieve. Even some expensive THX speaker designs don't exceed this range, so why should I? This was also the perfect opportunity to use one full-range driver, and avoid messy crossover work. Why pay for highs and lows you don't need?

I searched for a single driver meeting this response requirement, and with good sensitivity, too. Also, since I didn't wish to spend too much for essentially a proof-of-concept set of speakers—and I needed four of them—the drivers must be inexpensive. Of course, initially I found no drivers meeting all these requirements.

### ENTER ZALYTRON

While I was leafing through the Zalytron catalog, I spied their 4" speaker. It claimed to

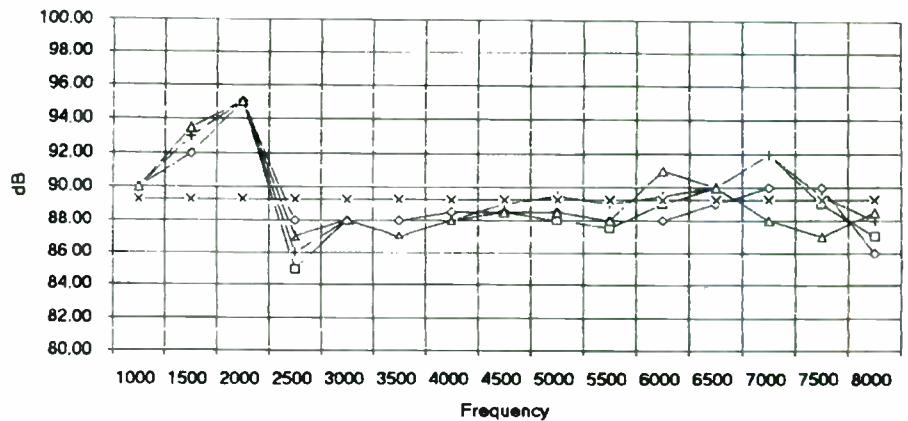

FIGURE 3: Zalytron 4" woofer frequency response.

approach 100Hz in a small closed box, highs were just above 7kHz, and response was smooth except for one peak which looked easy to notch out. It also promised 89dB sensitivity, which was good enough. But best of all, it was on sale at the time. As a bonus, it had a 4Ω impedance, so hooking up two per speaker as required would result in an efficient 8Ω load. I rushed to the phone and ordered four. This marked the first time I've ever had trouble meeting an order minimum on a speaker-related project.

### MEASURING T/S

I marked the drivers A through D so I could keep track of them individually. I hooked up

all four drivers in succession and measured their parameters (Table 1). All four had slightly higher—but not too far off— $f_s$  and Q values than the specifications. But my readings may not have been accurate, since the only frequency generator I could get was from the local high school. The equipment looked like it had been there since World War II, and had been through worse than that afterward.

I tested Vance Dickason's prediction that  $f_s/Q_{TS}$  is approximately the same across a run of drivers, and that proved to be true. Because  $V_{AS}$  is so small for this driver, I couldn't measure it accurately. I also tested Dickason's other production-quality prediction—that  $f_s^2 V_{AS}$  is constant despite differences in other constants—and calculated  $V_{AS}$  for each driver accordingly, assuming this value would be the same as stated in the ad. I checked all four carefully because I wished to pair the enclosures to match. I ended up putting A and C in one box and B and D together.

TABLE 1				
MEASURED T/S PARAMETERS				
Driver	$f_s$	$Q_{MS}$	$Q_{ES}$	$Q_{TS}$
A	78	1.710	0.384	0.314
B	87	1.818	0.444	0.357
C	87	1.837	0.469	0.374
D	80	1.843	0.398	0.327

### TEST BOX

I found a pile of 3/4" plywood left over from a big subwoofer project I had just finished. I cut the scraps into just the right size, and built two 11" × 8.25" × 6" test boxes, giving an internal volume of 0.153 ft<sup>3</sup>. That worked out to a  $Q_{TC}$  of 0.5 or so with a projected f<sub>3</sub> around 150Hz.

### LISTENING TEST

Pretending they were a set of full-range speakers, I hooked up the pair of enclosures to my (still stereo, not surround) amplifier. The sound from such small drivers was surprisingly full, and bass sounded much deeper than the f<sub>3</sub> suggests, probably because of the low 0.5 Q. The peak in response was clearly audible as a slight harshness, but the sound was smooth enough.

Since the peak was so noticeable, I used the Radio Shack meter to measure sound

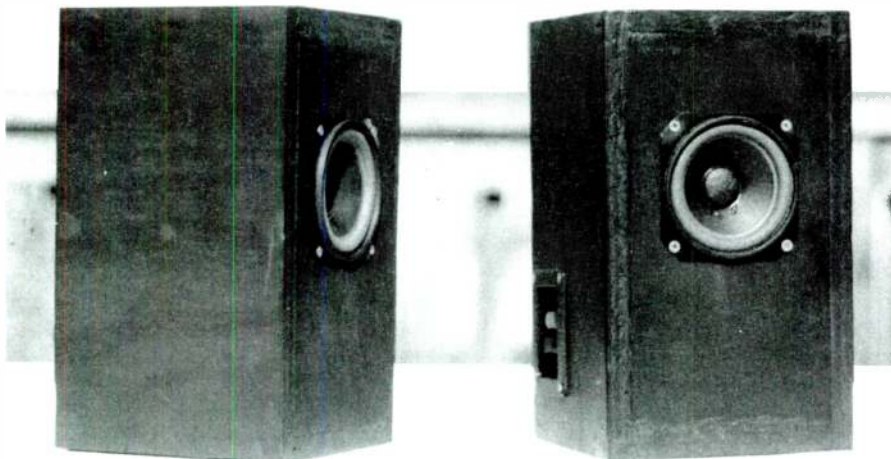

PHOTO 1: The author's 4" dipole rear speaker system.

pressure levels above 1kHz near-field. The results for all four drivers are shown in Fig. 3. Response was close to the sample in the catalog, and the tightness of the deviation between drivers established my faith in Zalytron quality control. I guessed a sharp, 2dB notch filter centered at 1.75kHz would probably smooth out the peak without dropping the level of adjacent valleys in response. But I never actually tried it.

**AXIS AS ALLY**

I'd been evaluating the direct sound of the driver. But that's unrealistic because of

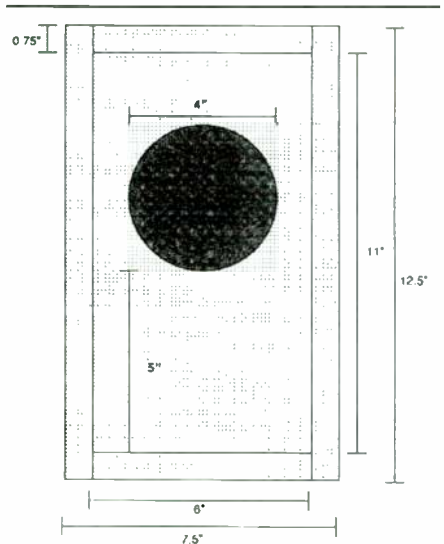

FIGURE 4: Front view.

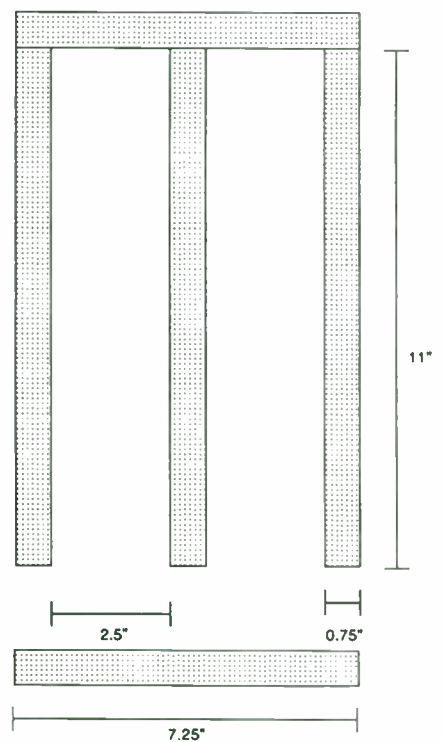

FIGURE 5: Side view (internal).

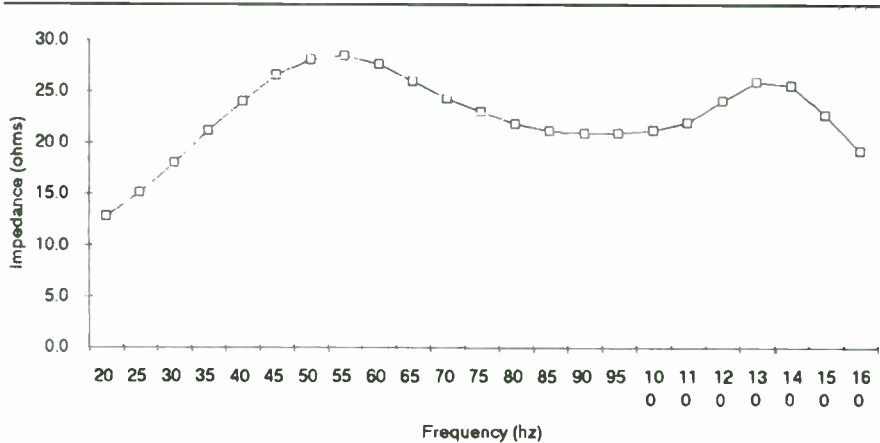

FIGURE 7: Final enclosure, with peaks at 56 and 132Hz.

speaker location; the sound you actually hear has bounced off some walls first. It's better to pay attention to the off-axis sound, since the drivers are 90° off axis to your ears.

When I moved off axis, the drivers exhibited no glaring response problems and sounded smooth all around. So I decided against attempting to flatten the response, since the drops from off-axis sound dwarfed the response peak. Besides, just leaving the response alone was a better fit with my "keep it cheap" approach to the design.

**FINAL ENCLOSURE**

The test box size was fine for listening, but still seemed too big. After analyzing several possibilities, I determined that the f3 points stayed about the same between a  $Q_{TS}$  of 0.5 and 0.7. An enclosure with two 11" x 6" x 2.5" sections gave a Q of 0.6 and was a convenient size to build. This gives  $f_c = 148\text{Hz}$  and  $f_3 = 174\text{Hz}$ , assuming the average for the driver parameters.

I built my final enclosures out of 3/4" plywood, but a project with small drivers and restricted bass such as this one would work fine with the 1/2" type. The layout for the wood pieces is shown in Figs. 4 and 5. Please note that the cutout tolerances are critical for the 4" driver; you should measure it twice and cut accordingly. I cut a rough guideline, slightly smaller than the driver, and carefully routed out to the full size.

**ASSEMBLY**

The simplest way to assemble the enclosure is to attach the top 7.5" x 7.25" piece to one of the 7.25" x 6" side panels. Carefully affix the three 6" x 11" pieces with the proper (2.5") spacing between them. Then, connect the bottom piece, being careful to keep the middle partition straight. Caulk the entire enclosure. Join the other side panel, and be sure to use lots of glue on this one because it will be difficult to seal later.

Reach through the driver hole to caulk this last panel. You'll find that space is tight, so if you have an assistant with small hands, he/she might be able to help. If not, be sure the glue itself makes most of the seal. Drill two holes through the middle partition to accommodate internal wiring.

After this dries, check out the two large 12.5" x 7.5" panels. Pick the better-looking one for your finished side, the one that will face the room. Wire the desired input

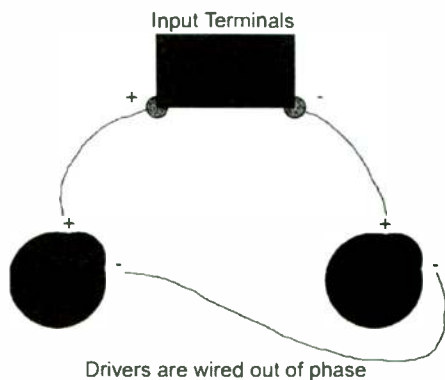

FIGURE 6: Wiring diagram.

through the other side. I used two terminals with five-way binding posts for no other reason than they were available. When you select your terminals, keep in mind that the available width is only 2.5". My terminals were 2" high and placement was pretty tight.

The internal wiring for the drivers is shown in Fig. 6. You need only be careful to wire the drivers out of phase. I'm not certain whether polarity makes any difference between the two pairs of dipoles; I chose to ignore this, but you may want to investigate it. Final chores included countersinking all holes, using wood filler, sand-

# ZALYTRON

YOUR ONE STOP SHOPPING CENTER

FOTAL

VIETA

Cabasse  
LA RÉFÉRENCE EN HAUTE FIDÉLITÉ



seas



ZALYTRON  
CUSTOM WOOFERS



PHILIPS



Polydax  
speaker corporation

l'atelier audio

ACCUTON

**THE ULTIMATE SYSTEMS CONTINUE!!**

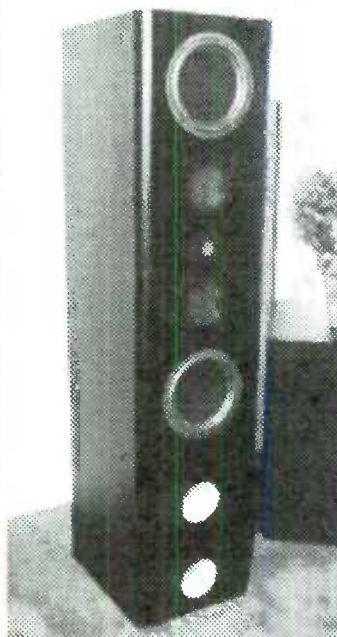

CABASSE  
SUPER A-3 PARTS  
**\$2115**  
CABINETS **\$999**

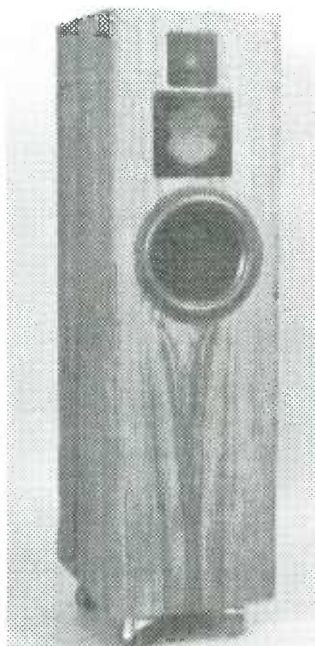

CABASSE  
A-3 PARTS  
**\$1230**  
CABINETS **\$799**

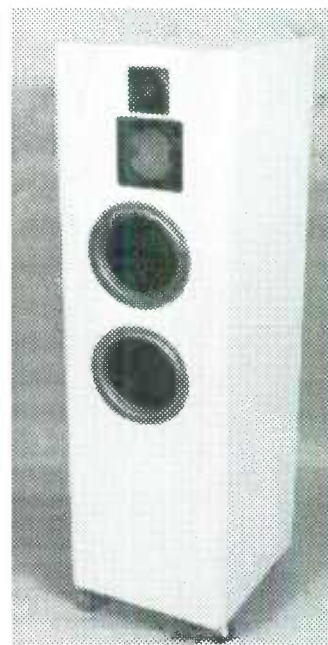

CABASSE  
A-3 PLUS PARTS  
**\$1650**  
CABINETS **\$999**

**ZALYTRON INDUSTRIES CORP.**

**469 JERICHO TURNPIKE, MINEOLA, N.Y. 11501**

**TEL. (516) 747-3515**

**FAX (516) 294-1943**

Our warehouse is open for pick-up 10AM to 6 PM daily, Monday thru Saturday  
UPS orders shipped same day • Minimum order \$50.00

**WRITE OR CALL FOR ALL YOUR SPEAKER NEEDS OR INQUIRIES**

ing, and painting. I painted mine black, not only to hide any mistakes, but to match my other speakers.

## FLASH MEASUREMENTS

I wished to compute the final  $f_s$  and Q for the box, but soon realized that the two drivers interacting no longer made it a simple closed box, since the parameters between them were slightly different. I ran an impedance curve for one completed speaker, shown in Fig. 7; the other was similar enough not to bother with a separate measurement. The SPL meter measured around

6dB down at 100Hz, as expected. That was the only SPL measuring I did simply because I wasn't sure exactly how to measure a dipole—it certainly isn't near-field, and my equipment wasn't sensitive enough to measure at other positions accurately.

## LISTENING

I tested the speakers using the laserdiscs for all three *Star Wars* movies. If you're skeptical of the home theater phenomenon, tune into the *Empire Strikes Back* scene in which the Falcon enters the asteroid belt. This will convince you it's worthwhile. Even with just

simple matrix decoding, almost zero cost, the whole soundtrack was enhanced significantly over simple stereo.

Front-to-back effects were impressive, even with minimal matrix decoding. The same material was spectacular with a Dolby Pro-Logic decoder; with surround, detail was even more pronounced. I must emphasize that even matrix decoding adds greatly to movie sound. If you've never used a surround system, I highly recommend this setup as an introduction, but be sure to heed the warning about common-ground-intolerant amplifiers before wiring.

## CONCLUSION

This design is especially useful for those who are inexperienced, like me (this is only the second set of speakers I've built), and should help to get you started building surround speakers. Now that I know this design works—and is a great value besides—I can investigate and justify spending more building the speakers. 

## ACKNOWLEDGEMENTS

I thank Chuck Masters, who volunteered his time and woodworking experience to help me transform my speaker building into an activity, rather than something I simply read about.

## REFERENCES

Berger, Ivan, "Quad Lives!," *Stereo Review* (July 1982): 52-53.

Dickason, Vance, *The Loudspeaker Design Cookbook*, 4th Ed., Audio Amateur Press, 1991 (available from Old Colony Sound Lab, PO Box 243, Peterborough, NH 03458, (603) 924-6526 or 6371, FAX (603) 924-9467).

Kumin, Daniel, "THX 1993," *CD Review* (May 1993): 28-34.

Mitchell, Peter, "Choosing Speakers for Surround Sound," *Stereo Review* (September 1992): 55-60.

## SOURCES

Zalytron Industries Corporation  
469 Jericho Tpk.  
Mineola, NY 11501  
(516) 747-3515, FAX (516) 294-1943



**CFAC™**  
Copper-Foil Air-Core Inductor™  
Extremely Designed For Precision Audio Transducer Speaker Driver Crossover Network.

*"The CFAC Inductor far exceeds anything I have used in the past." "Gone are the colorations I previously attributed to various drivers. It is now obvious that the colorations were in fact caused by interior inductor."*

**Arnie Nudell, President Genesis**

*"CFAC Inductor is a product that have advanced the state-of-the-art, providing me with a product that is the most sonically pure component available. They are, simply, the best..."*

**Robert Grost, President Unity Audio**

Minimized Skin Effect up to 100kHz

Reduce inductor coloration

Low DC resistance

Low AC resistance

Higher precision coil reactance

Uniform current density

Very high winding density

Computer optimized coil size

No saturation distortion

No hysteresis distortion

Made in USA

AVAILABLE AT:

MICHAEL PERCY (415) 669-7181, SONIC FRONTIERS (416) 847-3245, HANDMADE (215) 432-5732

For Catalog: Solo Electronics, 2462 Tripaldi Way, Hayward, CA 94545, USA. Tel:(510)887-8016 Fax:(510)887-1657

### CFAC INDUCTOR - CLOSE TO THE IDEAL INDUCTOR

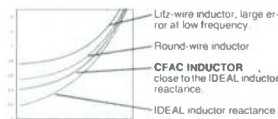

At low frequencies, inductor resistance error cause by the coil resistance will affect the accuracy of the crossover network and bass transit response.

CFAC INDUCTOR is more close to the ideal inductor reactance, which provide more accurate crossover frequency and improve bass transit response.

### CFAC INDUCTOR - ELIMINATE SKIN EFFECT

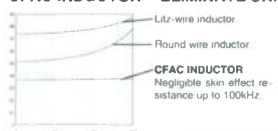

**Skin Effect Resistance**  
Skin Effect will cause the inductor resistive load increase, power loss, non-uniform current density in the conductor, signal amplitude decrease and phase delay. Sound quality will be degraded. The ultra-thin structure (0.003" thick) of the CFAC INDUCTOR is specially designed to minimized the Skin Effect.

## PREVIEW Glass Audio

### Issue 3, 1994

- A Purist Power Supply
- An Amplifier Soft-Starting Control
- Differential Series Feedback Pair
- More on Output Transformers

Reader Service #40

# Forgings TWEETER / SYNCHRONOUS SPEAKER

HUNDREDS OF OUTSTANDING TWEETERS  
ARE AVAILABLE FOR EVERY OF YOUR PROJECT



Newest Tweeter with  
one-piece diaphragm in Super  
Duralumin, Titanium ...  
material.



**DOM TWEETER :**  
**@USD 0.79**



**∅ 13mm Neirbon  
Super-Tweeter**



- ❑ Supreme know-how and continuous research
  - ❑ Hi-quality products at the most competitive pricing
  - ❑ Available for OEM design and free catalogues
- You'll be surprised to find we're the one you've been looking for !

**FORGINGS IND. CO., LTD. / P.O. BOX 1823, TAIPEI, TAIWAN, R.O.C.**  
**TEL: 886-2-585-3316/7 FAX : 886-2-594-2708 ATTN: MS. LU CHI YING**

# SILK PURSES: A TWO-WAY SALVAGE DESIGN

By Bill Waslo

This is not your usual speaker construction article. Whereas most speaker designs derive from a builder's vision and involve trade-offs and careful component selection, this one began as an attempt to develop a system with minimal expenditure of time or money. In addition, you're not likely to duplicate this project exactly, which I made from salvaged and closed-out components. But the process and techniques may offer a few ideas you can use in more

aggressive designs, as well as provide some brief examples of using IMP in speaker development.

## WHAT'S COOKING?

It all began when my wife Carol asked if I had any speakers which could mount in our kitchen soffits. Our main system is on the lower floor, so she thought it might be convenient to listen to music or radio news shows in the kitchen area. She didn't wish to

spend a lot of money or time on the idea and suggested I use some of the equipment cluttering up the basement workbench.

Fortunately, I had a pair of two-way cabinets which looked about soffit size. Their drivers had suffered the curse of many of their brethren of the late '70s: the foam surrounds had deteriorated from the 6.5" woofers and the ferrofluid had evidently drained out of the tweeters (or had they always been that peaky?). A few years previously I had given what was left of the drivers to my 10-year-old son to "experiment" with during his brief interest in magnets.

So, I needed some drivers. About that time, Madisound advertised a closeout sale in *SB*, including many items which were clearly surplus and not of the quality of their regularly stocked drivers. They listed 6.5" paper-cone woofers with cloth surrounds and parameters that seemed roughly usable in my boxes for \$7.50 each. They also offered 1" DTW9X8T125 BACAV titanium dome tweeters for \$10 each.

At those prices, I didn't expect much. But \$35 didn't seem like too much to risk, and I hoped that a 6.5" paper-cone woofer would go high enough to cross with a 1" tweeter which claimed to work down to 3kHz. So, I ordered the drivers and assembled the speakers.

## COMPLICATIONS

One problem was that I actually neglected to measure the available space in the soffits—and my boxes wouldn't quite fit. So I had to make custom boxes for the installation, after all.

The other complication concerned the drivers. Dealing with these was interesting enough, and the result pleasing enough that I ordered more of the bar-

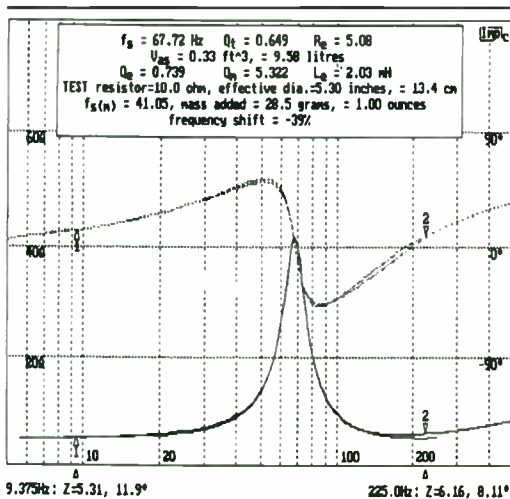

FIGURE 1: Impedance and parameters of unmodified woofer.

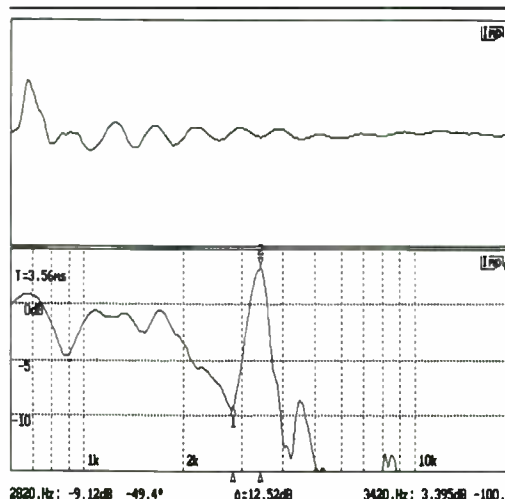

FIGURE 2: Impulse and frequency response of unmodified woofer.

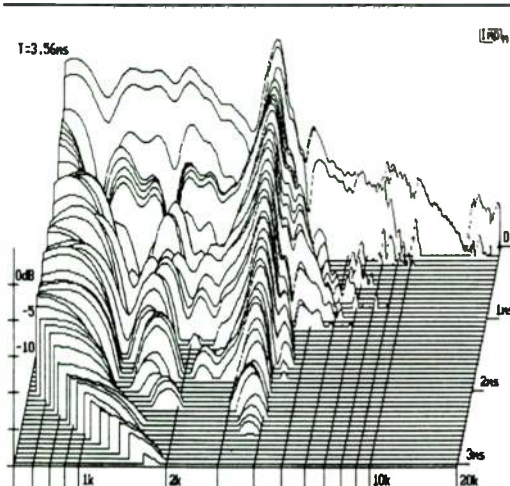

FIGURE 3: Waterfall plot of unmodified woofer in box.

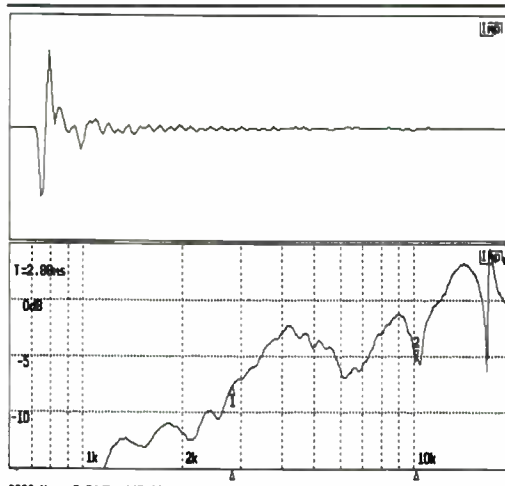

FIGURE 4: Tweeter responses in box (no grille); time above, frequency below.



gain drivers and repeated the process. I again recycled the old two-way boxes, but this time for speakers to use near-field style while I worked at the computer. And this time I made plots along the way for this article.

### SOW'S EARS IN THE PURSE FACTORY

Measured after an hour's break-in with high-level 20Hz sine waves in free air, the woofers' Thiele/Small parameters were not very far off from what the vendors claimed them to be (Fig. 1). Resonance was about 68Hz,  $V_{AS}$  was only 0.33ft<sup>3</sup>, and the  $Q_T$  was a high 0.65. I was hoping to reduce the Q by adding some mechanical loss, since modeling showed that I would otherwise barely reach an  $f_s$  of 59Hz (along with about 2dB of peaking at 90Hz) if I ported my 0.45ft<sup>3</sup> box.

The real shocker came when I measured the on-axis response of the woofers mounted in the box (Fig. 2). The curve was already dropping sharply by 2kHz, then bouncing back for a "monster" resonance at 3.42kHz (Fig. 3). "Drat!" I thought, "No wonder they only cost \$7.50 each. They can't do decent bass or midrange."

The tweeter's response in the box (Fig. 4) showed that it wasn't going to let me push it down to cover the 2kHz region, where its barely discernible suspension resonance occurred (Fig. 5).

### GOOEY SOLUTION

Clearly, this was a case of not having much to lose. From a box labeled "Glues, Coatings, Small Bottles, and Tubes of Maybe Lethal Substances," I pulled out general-purpose silicone rubber sealant, selected exclusively because it was the first thing I found. I applied a moderate coating of goo over the paper cone of the nonmidwoofer, then measured again. This showed some promise (Fig. 6), dropping the resonant peak almost 4dB and somewhat filling the notch just below the peak. Interestingly, the peak frequency was unchanged, but the notch increased in frequency—not what I expected from adding lossy mass to a resonant surface.

So maybe the silicone was affecting, but

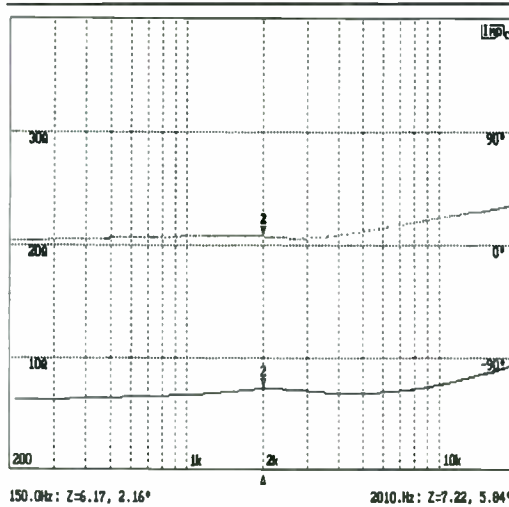

FIGURE 5: Tweeter impedance showing resonance.

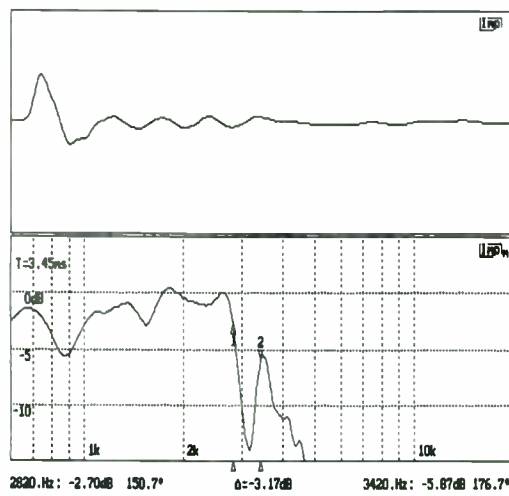

FIGURE 7: Woofer responses with sealed dust cap.

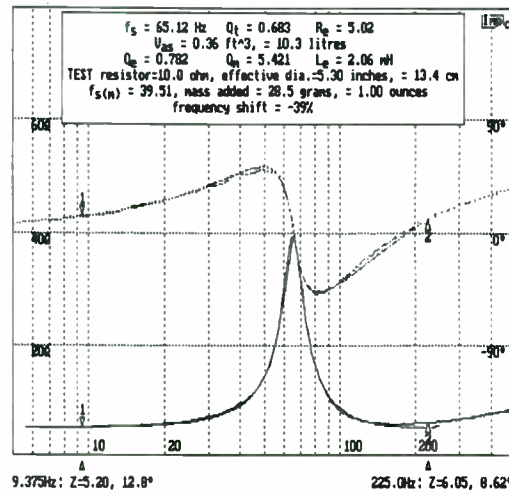

FIGURE 9: Woofer free-air impedance and parameters after silicone coatings.

hadn't actually been applied to, the offending source. I recalled an article ("More About Dust Caps," SB 6/92, p. 35) in which Ole Winberg and Knud Thorborg discovered that pole piece reflections radiating through

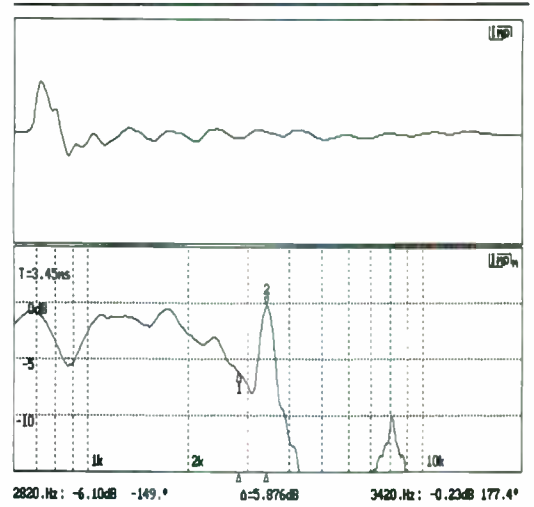

FIGURE 6: Woofer impulse and frequency response after silicone coating of cone.

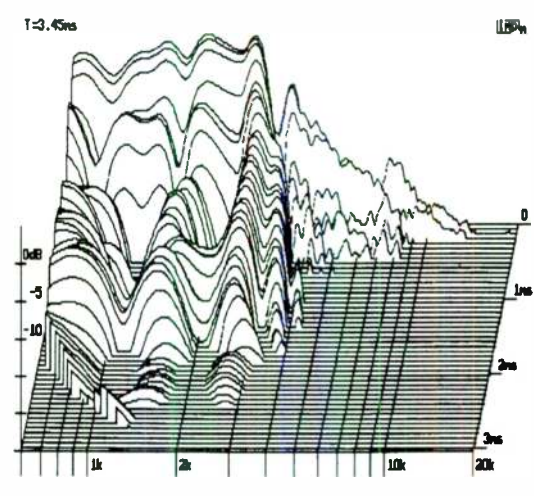

FIGURE 8: Waterfall of woofer after silicone coatings over cone and cap.

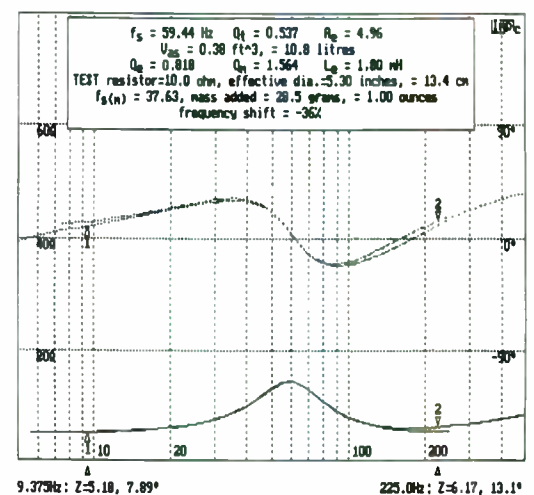

FIGURE 10: Impedance and parameters after adding loss resistance.

an acoustically transparent dust cap caused a similar "dip and peak." They alleviated the problem quite a bit by sealing the dust cap and then burning air release holes through the cone underneath the cap with a soldering

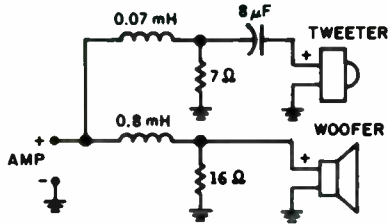

FIGURE 11: Crossover circuits.

iron to restore ventilation. My woofer's dust cap was of the ventilating open weave type also. Since the tube of silicone was open and a soldering iron was in reach, I decided, "Why not?"

I promptly smeared the cap and made four small holes just above the seam to the voice coil former in the inside of the paper cone. This time, the results were more dramatic (Figs. 7 and 8). The dip stayed at the same frequency and, in fact, became much deeper, but the frequency range just below it came up nicely and the peak dropped 5dB more. This was beginning to look like a usable midrange. Later measurements showed that the driver's response changed very little from the silicone curing.

Interestingly, the "ledge" visible in the waterfall of Fig. 3 between 1kHz and 3kHz and at around 0.3ms is essentially gone in Fig. 8. Could that have been the delayed pulse from the pole piece?

### LOSSES AND GAINS

Of course, the added mass of the silicone would change the driver's T/S parameters, so I measured them the next day, after the sealant cured (Fig. 9). As you might imagine, free-air resonant frequency went down a few hertz.  $Q_T$  increased as well, as did  $V_{AS}$ . This certainly

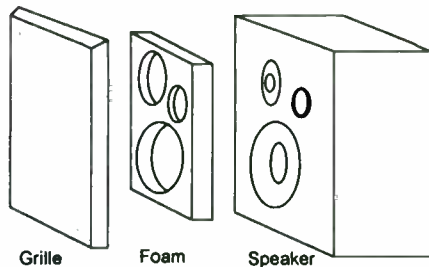

FIGURE 15: Foam for moderating diffraction inside grille frame.

ly didn't improve the outlook for producing bass in my box size, so I pulled out a sample of thin felt from the family art-supply box.

A return trip to "Glues, Coatings, Small Bottles, and Tubes of Maybe Lethal Substances" netted me a tube of "Shoe Goo," made for repairing the soles of running shoes. Other glues would probably work as well, but this stuff dries fast and sticks with a vengeance to nearly anything, and it was handy. I cut the felt into 1.5" x 3.5" rectangles and glued them over the openings in the woofer basket to add drag to the air movement. I cut a few slots into the rectangle covering the

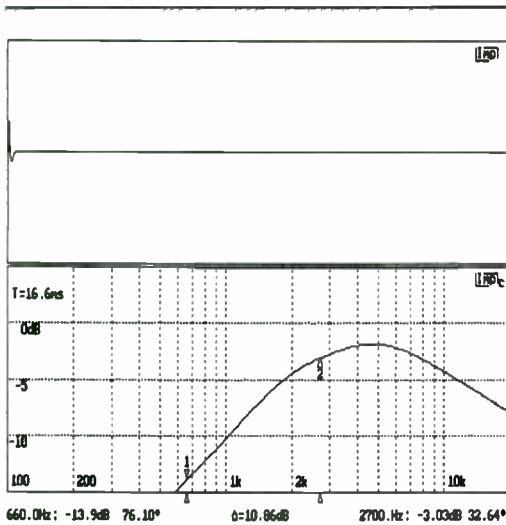

FIGURE 13: Tweeter crossover electrical responses.

opening in which the connection terminals resided to allow the terminal strip to protrude, and sealed around it with Shoe Goo. The entire operation took about five minutes.

I don't pretend to understand all the results (Fig. 10), but not only did  $Q_M$  and  $Q_T$  go down, so did  $f_S$ , while  $Q_E$  and  $V_{AS}$  increased. This kind of intentional loss will adversely affect a driver's efficiency and probably also its power handling, but modeling showed that bass output in a ported arrangement (box frequency = 51Hz) could now extend to around 52Hz if about 1.5dB of peaking could be tolerated.

In a kitchen soffit or near-field system, efficiency and power handling are minor considerations, so the trade-off was worth it. The alignment is, of course, nonclassical, but I chose it as the best compromise between extension and flatness in the given box size. The application of the felt only slightly affected the midrange response.

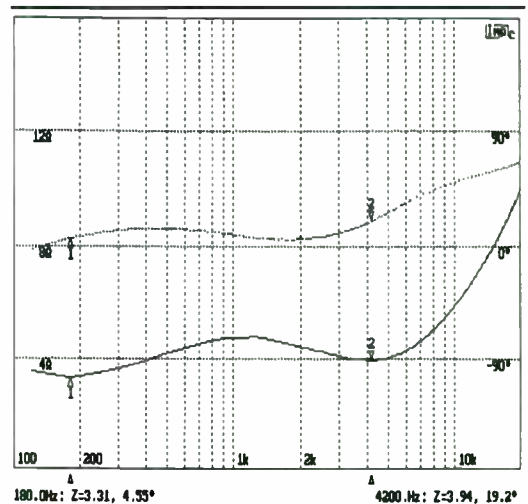

FIGURE 12: System impedance for upper frequencies.

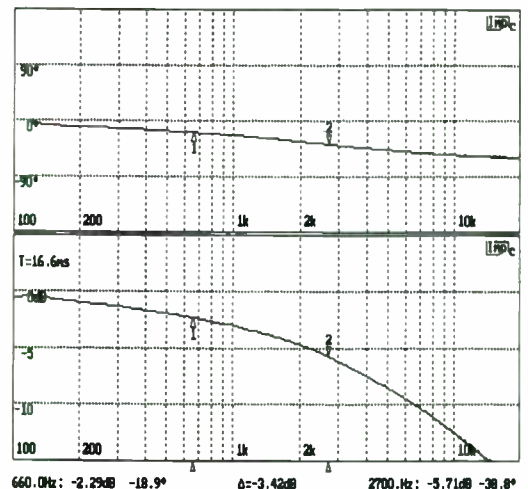

FIGURE 14: Woofer crossover electrical response magnitude and phase.

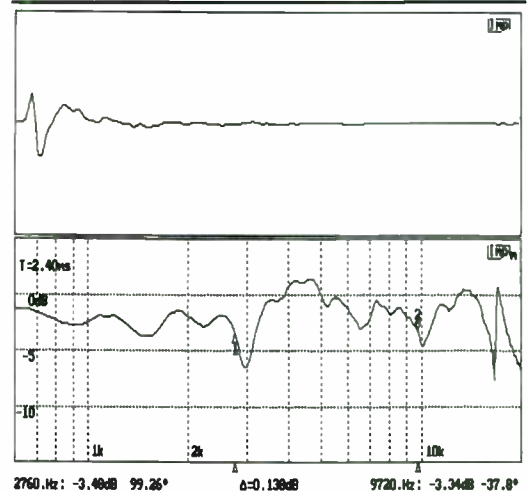

FIGURE 16: System impulse and frequency response with grille frame removed.

### HACKING A CROSSOVER

This section will probably get me into trouble with methodical speaker designers, assuming they haven't already skipped over this article after determining its rather hap-

**We'll tell you no lies...**



## **Sapphire III**

Awarded Component of Exceptional Merit By Martin G. DeWulf, publisher  
Bound for Sound

"In terms of midrange and highs, this is not only the best speaker known to me below a thousand dollars, it's one of the better speakers one can buy, period. If I were building a bookshelf 2-way, this is probably the way I would do it...for the most part. The Focal woofer is of Kevlar composition, and it plays its part by being ruthlessly revealing; what goes in is basically what comes out. The driver sounds sooo clean and fast as it, without blur or smearing, reveals detail and nuance with the precision of the Accuton vapor deposited ceramic driver. And, as this driver is a true 6 1/2" driver, it is able to move more air and be more forceful than the Accuton ever dreamt of being. Connected to the Focal driver is a Scanspeak softdome tweeter that integrates with the woofer oh-so-sweetly. Crossover is 6dB per octave (1st order), and as a result thereof this speaker properly captures the true ambience in a recording, and low level resolution, no matter how low it goes, is perfectly present. Very few speakers, regardless of cost, open up and seem so dynamically effortless in a system of equal capabilities."

### **Sapphire III \$929 pair**

(plus shipping and handling, and 5% sales tax in WI only.) Call for finish availabilities.

**ACI (Audio Concepts, Inc.)**

901 South Fourth Street, La Crosse, WI 54601 (608) 784-4579 Fax (608) 784-6367

Reader Service #6

hazard approach. I designed the crossover by trial and error, and selected only readily available components. I avoided modeling and trade-off analyses, and simply stuck together a handful of clip-leads, various inductors, power resistors, and film capacitors on the fly while watching the results on IMP using the cycling (quasi-real time) feature.

Of course, some basic knowledge of filter network operation is required to pull this off, and I wouldn't recommend the "hacking" approach for high-end system design. Nor would I recommend that you smear glop all over your expensive, carefully engineered drivers. This, remember, is a salvage operation.

I brought out the leads for both the tweeter and the mid-woofer separately to patch together the crossover on the table top alongside the speaker box. I arranged the box facing upwards and hung the microphone about 2' above it. (In this rather cramped work area, distances were less than optimum.)

I made and declared a 2,048 point 'Cal' for the high-frequency acoustic measurements, then selected [2] from the [\* auto\_Measure Setup Cal\_source] menu, so that the same cal would be used repeatedly. I then selected [\* auto\_Measure Setup cYcling oN] so the response measurement would be repeatedly made, up-dated, and displayed. I started it using [\* auto\_Measure Acous]. This allowed me to watch the response on the screen while I fiddled with the crossover.

If you try this, you must be careful to avoid accidentally connecting a capacitor, inductor, or a short directly across your amplifier's terminals (you may fry your amp). If you have any fears, use a series resistor between the amp and the crossover to avoid this possibility. You'll find details on this technique in "IMPcycling," *SB 5/94*, p. 40.

The crossovers (Fig. 11), such as they are, are electrically first-order and rather power-inefficient (notice the use of resistors to moderate the driver reactances and adjust the filter corners). As an unplanned side-benefit, the impedance (Fig. 12) is rather nonreactive below 10kHz, but that isn't particularly difficult to accomplish if speaker efficiency is sacrificed. In examining the tweeter and woofer electrical responses (Figs. 13 and 14), notice that the tweeter section has a

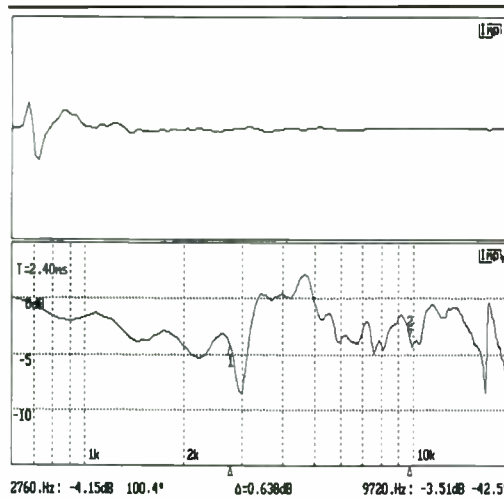

FIGURE 17: Impulse and frequency response with grille and grille frame installed.

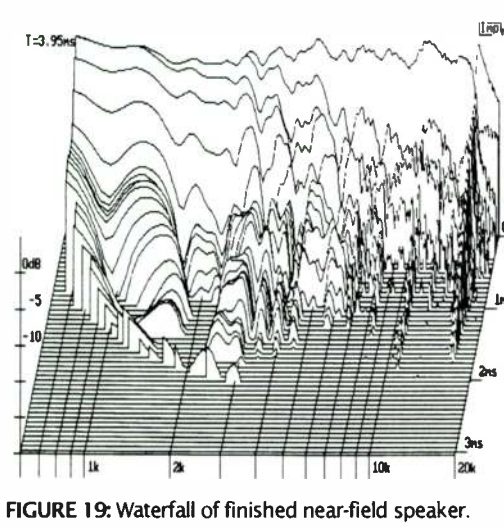

FIGURE 19: Waterfall of finished near-field speaker.

bandpass shape to flatten out the otherwise hot high end.

#### AVOIDING THE GOTCHAS

I took a couple of shortcuts when building the computer speakers as compared to the kitchen speakers. I avoided the tendency to ignore the system impedance while hacking the crossover. This error resulted in a kitchen speaker with a decent response, but an impedance which dipped below  $2\Omega$ . I had to redo the crossover. The lesson here is: don't wait until after the last fine tweak to check the system impedance.

When I developed the kitchen units, I optimized everything with the grilles off. But exposed woofers and tweeters are not usually appropriate kitchen decorations, and the unclothed speaker responses were irrelevant. With the wooden-framed grilles back on, the response was lousy. I eventually fixed this by (1) readjusting the crossover, and (2) installing a sheet of 1" foam rubber inside the grille frame (Fig. 15), with openings cut out to provide a clear path for the tweeter,

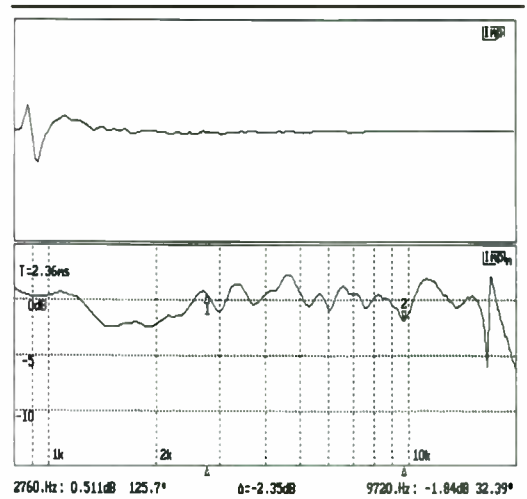

FIGURE 18: Impulse and frequency response with foam piece installed in grille frame.

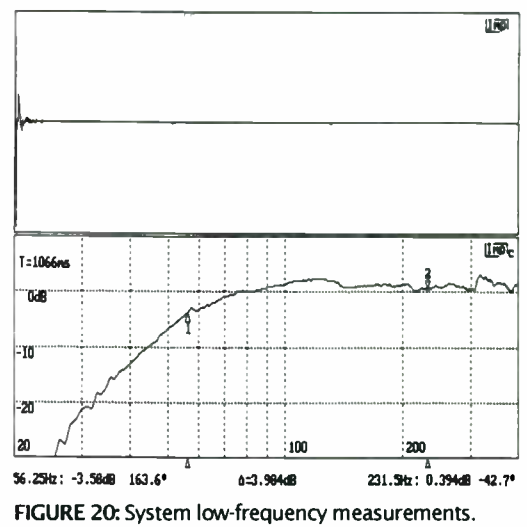

FIGURE 20: System low-frequency measurements.

woofer, and port output through the grille, but not to the grille frame.

The response using this arrangement was actually smoother than with no grilles. To illustrate the effects, I plotted the responses of the near-field speakers with the bare baffle (Fig. 16), with the grille only (Fig. 17), and with the grille and the foam (Fig. 18). The response of the finished near-field speaker (not bad for a salvage project) indicates that the foam sheet had a very beneficial effect (Fig. 19).

#### LOW END

Because the port exits from the front baffle, the bass response for this system was easy to measure (Fig. 20) by putting a few books on the floor, spacing them a little narrower than the baffle size, and then placing the microphone with its capsule between them. I then placed the speaker face down so the woofer and port fired between the books. The gap between the baffle and floor was about 3". The microphone senses the combined pres-

*Continued on page 65*



# SOUND PERFORMANCE.

## Brought to You by Speaker Materials of DuPont KAPTON®.

Everything — from Louis Armstrong to Led Zeppelin — sounds better coming out of loudspeakers designed with DuPont KAPTON. A truly sensational speaker material, KAPTON improves acoustics and stands up to high wattages and harsh environments better than any other.

You've probably heard about the success of KAPTON in voice coils...and now it's available for other speaker parts, too.



**VOICE COILS OF KAPTON**

Voice coils of KAPTON are non-conductive and non-magnetic, with a broader frequency response than aluminum in both high and low

Precision-formed parts of KAPTON exhibit a high stiffness-to-weight ratio — better than conventional speaker materials.

Voice coils of



**SPIDERS OF KAPTON**

And unlike aluminum and paper, KAPTON resists heat damage to glue joints. It stays cool and dry when the power, heat and humidity are turned up. So not only do your speakers generate better sound — even under environmental extremes — they last longer, too.

Available as flat film for voice coils or as precision-formed spiders, cones, surrounds and domes, KAPTON is extremely lightweight and stiff. And it won't dent,

ranges. No matter where it's found in the speaker, KAPTON enhances acoustical performance.



**DOMES OF KAPTON**

tear or crease, for added durability and easier speaker manufacturing.

### Sound Good?

Want to hear more about how KAPTON can improve the acoustics and durability of speakers you design? Just call 1-800-356-6714.

We'll put you in touch with our applications engineers. We'll also send you sample film and technical information on designing speakers using KAPTON parts. We're sure that once you evaluate DuPont KAPTON for yourself, you'll be impressed with its sound performance.



**CONES OF KAPTON**



# LOUDSPEAKERS: A SHORT HISTORY

By Gary A. Galo  
Contributing Editor

Part 1 (*SB* 6/94) highlighted some of the pioneers and key developments in the history of recorded sound, and examined the types of closed-box speakers. Part 2 continues with a short history of vented loudspeakers—from early bass reflex systems to the latest multi-way models.

The bass reflex loudspeaker uses a fully enclosed box, except for a small port or vent, usually on the front baffle board below the woofer (*Fig. 1*). Some of the back radiation from the woofer cone emerges from the port in phase with the front radiation, reinforcing the low bass frequencies.

In 1930 A.C. Thuras of Bell Laboratories performed the first experiments with ported loudspeaker enclosures. Thuras's model was based on the Helmholtz resonator. His 1932 patent describes the interaction of the driver and the port.<sup>1</sup> Voigt in England and Olson in the United States conducted similar work in the early 1930s, and in 1937 Jensen introduced the first modern bass reflex speaker system.<sup>2</sup>

## EARLY BOOM BOXES

Early versions had highly inaccurate low-frequency response by today's standards. The system output was normally excessive at resonance, resulting in what many have described as "boom box" response. Nevertheless, due to their relatively high sensitivity, they were extremely popular during the days of low-power amplifiers.

During the 1950s L.L. Beranek, B.N. Locanthi, R.H. Lyon, and J.F. Novak developed more precise mathematical models, but Australian A.N. Thiele first described the modern vented loudspeaker in 1961.<sup>1</sup> Thiele defined them in terms of their electrical equivalent circuits, and showed that it was possible to achieve a smooth low-frequency response equivalent to an ideal electrical high-pass filter. Thiele first presented his paper at the March 1961 I.R.E. Radio and

*An edited version of this article appeared in The Encyclopedia of Recorded Sound in the United States, published in 1993 by Garland Publishing, Guy Marco, editor. For this publication, I have made several revisions to my original manuscript.—GG.*

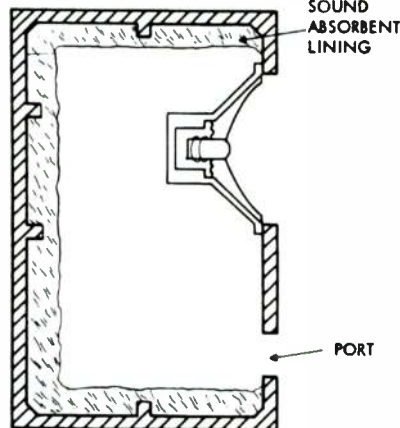

FIGURE 1: A bass reflex, or vented, speaker enclosure. (Figures 1, 3, 4, 5 courtesy of Dover Publications, *The Reproduction of Sound in High Fidelity and Stereo Phonographs*, by Edgar M. Villchur, 1965.)

Electronic Engineering Convention in Sydney. His work did not receive widespread attention until 1971, when the *JAES* reprinted his paper.<sup>3</sup>

Richard Small did much to enhance Thiele's findings, and the results of his work were published as a series of four articles in *JAES* in 1973.<sup>4</sup> Small showed that the vented speaker was a fourth-order, high-pass filter, which could be adjusted for a variety of mathematically predictable responses. He also demonstrated the effect of enclosure losses on the speaker performance, and presented the mathematics for matching an enclosure design to a specific driver, using the driver's electrical and mechanical specifications. These characteristics are now universally known as Thiele/Small parameters. The work of Thiele and Small revolutionized vented box design, and nearly all modern vented speakers are based on their research.

The work of another Australian, J. Ernest Benson, should not be overlooked. In 1968, 1971, and 1972 he published a series of papers in the *Amalgamated Wireless Australasia Technical Review* covering both vented and closed box designs. These papers have been collected and published in the US by Synergetic Audio Concepts.<sup>5</sup>

(See Robert Bullock's review in *SB* 5/94.) In the preface to the US edition, respected engineer and audio writer Don Keele notes that Benson's writings are "even more comprehensive and detailed" than the *JAES* articles by Thiele and Small. Benson notes that he obtained his results using a digital computer from theoretically derived equations, in contrast to the analog simulator used by Small. Benson was, incidentally, a reader for Richard Small's PhD dissertation.

It is important to differentiate between bass reflex and vented loudspeakers. Although superficially similar, *bass reflex* is normally confined to designs developed prior to the work of Thiele and Small; whereas, *vented* speaker describes the modern, mathematically predictable designs based on their research. The mathematics described in the Thiele and Small articles is quite complex, and often inaccessible to non-mathematicians. American Robert M. Bullock III has done much to synthesize Thiele's and Small's work, and has published his results in a series of *SB* and *JAES* articles.<sup>6,7,8</sup>

## DRONE CONES

A speaker category related to vented designs is the *passive radiator*, which actually contains two woofers—one with the usual voice coil and magnet structure, and the other without. The passive driver is acoustically coupled to the active speaker at low frequencies. As such, they contribute as much to the output at low frequencies as the vent does in a vented design. One advantage of passive radiator systems is the absence of wind noise and pipe resonances sometimes experienced in vented systems.<sup>1</sup>

Harry F. Olson received the first patent on these systems in 1935, and followed his original work with an article published in *JAES* in 1954.<sup>9</sup> Olson referred to the passive drivers as "drone cones." In 1974, the same journal published Richard Small's landmark article, which is still considered representative of current thought on the subject.<sup>10</sup>

Most of today's passive radiator systems use an active driver smaller than the passive unit. An 8" active speaker coupled

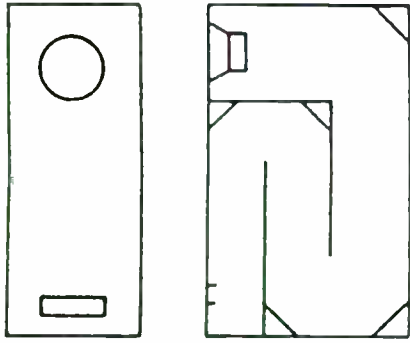

FIGURE 2: A transmission line enclosure. The illustration on the right is a side view showing the internal construction (from *The Loudspeaker Design Cookbook*, 4th ed., by Vance Dickason, Audio Amateur Press, 1991).

to a 10" passive driver is quite typical. Today, the best-known commercial proponent of passive radiator systems is Polk Audio, an American firm based in Baltimore, MD. Their systems typically use multiple 6½" active drivers with much larger passive units.

#### A CULT LEADER

The *transmission line* unit is a refined descendant of the Stromberg-Carlson acoustic *labyrinth*, which was invented by Benjamin Olney in 1936 (Fig. 2). The acoustic labyrinth is a long pipe into which the back radiation of the woofer is loaded. The pipe length is normally one quarter wavelength of the woofer's free-air resonant frequency, which produces a pressure node at resonance, controlling the cone motion of the woofer. Since the labyrinth is a completely open pipe, except for a fiberglass lining, a substantial amount of sound emerges from the end of the tube.

A.R. Bailey first described the modern transmission line speaker in 1965.<sup>11,12</sup> Although superficially resembling the acoustic labyrinth, the transmission line operates quite differently: It is completely filled with absorbent material, either long fiber wool or Dacron® polyester. The damping material acts as an acoustic low-pass filter, effectively increasing the length of the line as the frequency drops.

At the lowest operating frequencies the woofer is mass-loaded by the air in most of the line's length, resulting in excellent woofer control at low frequencies. The transmission line is a theoretically nonresonant enclosure, and the internal pressures in closed-box designs are nearly absent in a well-designed system.

In a classic transmission line, all of the back radiation from the driver is absorbed in the line, but some variations on this concept have made use of a portion of the back radia-

tion. A negative side effect is the relatively poor control of the woofer cone below the system cutoff frequency.

The transmission line is probably the least scientific of all present-day enclosures, and there are no hard-and-fast formulas for determining line length and stuffing density. Recent research by Robert Bullock and Peter Hillman has led to a more precise understanding of the transmission line, but designs are not as mathematically predictable as they are for closed and vented boxes.<sup>13,14</sup>

Since Bailey's 1965 article, only a handful of commercial designs have employed transmission lines; their relatively large size and complex internal construction make them somewhat expensive and impractical. But they have attained a kind of cult status among home builders. Irving M. Fried is the best-known commercial proponent of the transmission line, having marketed many such systems under the IMF and Fried Products brand names.

#### DAMPED DANISH MODELS

The *aperiodic* speaker is a closed box system containing a vent stuffed with damping material—usually foam or fiberglass—which provides a pressure release at low frequencies. Aperiodic literally means an absence of resonances at any specific frequency or multiples. Damping is "of such a high degree that the damped system, after disturbance, comes to rest without oscillation or hunting."<sup>15</sup>

In a standard acoustic suspension system the trapped air in the box is quite reactive, or springy, at very low frequencies. The reactive nature of the air will cause excessive cone excursion at system resonance. Adding an aperiodic vent to the system releases internal pressure at resonance, resulting in better control of the cone motion at very low frequencies.

The aperiodic speaker offers some of the performance advantages of the transmission line in terms of excellent woofer control and a reduction in internal pressure at frequencies near system resonance, but with enclosures which are much more manageable in size. It is important to note that no sound emerges from an aperiodic vent, so this design does not resemble a vented speaker.

The first patent on this type of enclosure was issued in 1936 to Marvel W. Scheldorf, an engineer for RCA.<sup>16</sup> Scheldorf never used the term *aperiodic* in his patent, instead describing his invention as an *acoustic resistance device*. Since Scheldorf's original patent appeared, information on aperiodic speakers has been sketchy, at best.

The greatest interest in this concept seems to be in the Scandinavian countries. In 1969 Dynaco introduced the model A-25, the first

in a series of critically acclaimed aperiodic units made for them in Denmark by SEAS. The Dynaco A-25 was considered, by many reviewers, to be the best bookshelf loudspeaker since Acoustic Research introduced the model AR-3A.<sup>17</sup>

Today, another Danish firm, Dynaudio, is a leading advocate of aperiodic loading. For many years they have manufactured a device called a Variovent, which contains tightly packed fiberglass stuffing held in place by a plastic grille and frame. A third Danish firm, Scan-Speak, manufactures a similar device. Audio Concepts, an American manufacturer based in LaCrosse, WI, also produces speakers with aperiodic loading, including the Sapphire series, introduced in 1990.<sup>18</sup>

#### STUCK IN A CORNER

Since the first acoustic phonographs appeared, horns have been used as amplifiers. A *horn* functions as an acoustical impedance matching device, coupling the relatively small surface area of the radiator to the large volume of air in the room (Fig. 3). Acoustic phonographs contained a small diaphragm attached to a stylus which vibrated according to the mechanical information in the disc or cylinder groove. By themselves, sound vibrations from the diaphragm would be very weak, so an acoustic phonograph must be coupled to a large horn to fill a large room with substantial volume. The size of the mouth opening determines the horn's low-frequency cutoff.

The horns' shapes prior to 1925 were determined largely by trial and error. No mathematical procedures had been developed for determining the size and rate of expansion between the throat and the mouth, and the horns usually had very uneven frequency response. In 1919 the American physicist Arthur G. Webster patented the first exponential horn.<sup>19</sup> The cross-sectional area of the horn increases exponentially, as the name implies, with distance from the throat, resulting in a far more uniform frequency response than its predecessor.

*Continued on page 34*

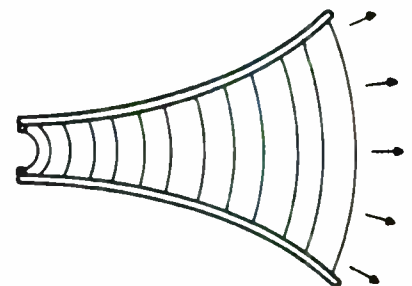

FIGURE 3: Horn loading for a dynamic speaker.



# AEON 250 VDC 5% FINE CAP

Metallized polypropylene capacitors for loudspeaker passive network.

Another brand of metallized polypropylene capacitors ? Well, not exactly ... At Orca we have been thinking for a while about how to make polypro caps more affordable for a larger number of speaker builders, people who use caps only for speaker passive X-over network. We thought that it would be tremendous if we could offer a line of polypro caps that would be so affordable that people would have no reason to use cheap mylar, as they would be able to get for not much more money a much much better cap. As you know, even extremely powerful solid state amps (we are talking KW here) can barely produce rail voltage higher than 60 V. So it is safe to assume that a 100 VDC cap would be a pretty robust cap to use in a passive loudspeaker network. So to be really safe, we decided to make all the AXON cap of our FINE CAP basic line 250 VDC. Now that's about where the compromises start and stop. On the other hand for example, you may or may not know that when a cap value is said to be 10.0  $\mu$ F with 5% precision, it means that the manufacturer of caps sets its winding machine to 9.7  $\mu$ F and then produces this series with 2% tolerance (not very difficult with numeric controlled winding machines). The result: the manufacturer saves more than 3% in material, the precision is respected, but chances are all your caps will measure on the low side ! Orca made the special arrangement that all the AXON caps were to be wound with 5% precision with the target value set at exactly the nominal value. That means now, as most of you do, and rightly so, expect, that you should find a much greater proportion of caps very close to exactly 10.0  $\mu$ F, if not 10.0  $\mu$ F exactly! As for the rest, we could display here all sorts of figures and graphs that would only makes sense to 1% of our customers, but what for ? We can simply tell you this is the first polypro cap at a price closing on mylar caps. It is made by the same company that makes all our high voltage and very high voltage SCR caps, as well as our film and foil caps. Some of the best loudspeaker manufacturers have already made that easy choice. Now see for yourself and ... let your ears make the call.

Value $\mu$ F	Diameter mm	Length mm	SRP US\$	Value $\mu$ F	Diameter mm	Length mm	SRP US\$
1.0	11	21	1.23	12.0	25	33	3.56
1.5	12	22	1.44	15.0	25	38	4.18
1.8	13	22	1.49	20.0	29	38	5.16
2.2	15	22	1.58	24.0	29	43	5.98
2.7	14	25	1.67	30.0	32	43	7.30
3.0	15	25	1.73	33.0	32	48	7.74
3.3	16	25	1.78	41.0	35	48	9.32
3.9	16	25	1.83	50.0	37	53	10.96
4.7	18	27	1.96	51.0	37	53	11.16
5.6	18	30	2.10	56.0	39	53	12.00
6.0	19	30	2.20	62.0	39	53	12.98
6.8	20	30	2.33	75.0	43	58	15.12
8.0	20	33	2.91	82.0	45	58	16.28
8.2	21	33	2.97	91.0	47	58	17.50
9.1	22	33	3.08	100.0	49	58	18.76
10.0	23	33	3.23	120.0	51	63	21.98
11.0	24	33	3.38	130.0	54	63	23.38

### STOCKING DISTRIBUTORS: BIG COVE RESEARCH

tel: (205) 722 9867 fax: (205) 430 3961

### SPEAKERS ETC...

tel: (602) 944 1878 fax: (602) 371 0605

### TECHNOLOGIE MDB

tel: (514) 526 8851 fax: (514) 443 5485

### ZALYTRON INDUSTRIES

tel: (516) 747 3515 fax: (516) 294 1943

### OEMs & EXPORT

Contact Kimon Bellas

or John Sangalli

tel: (818) 707 1629

fax: (818) 991 3072

### ORCA

1531 Lookout Drive

Agoura, CA 91301

USA

### COMING SOON:

FILM / FOIL 630 VDC CAPS for electronics and bypass from

0.1  $\mu$ F to 1.0  $\mu$ F.

POLYPRO ULTRA HIGH

VOLTAGE

1200 VDC 20  $\mu$ F

for power supply & tube electronics.



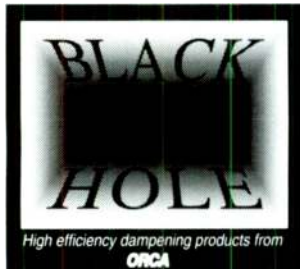

## A better speaker damping material...

If you've been building speakers for some time, you know how much guesswork goes with speaker damping and stuffing. The choices seem endless: fiberglass, wool, Dacron, flat foam, convoluted foam, felt, tar, plus various "magic" compounds that you're invited to brush or pour into your new cabinets. Everyone has their own recipe, and who knows if it's a recipe for disaster? Or what effects the vapors emitted by these chemicals might have on the glues that bond your woofer surround to its cone and chassis? In this era of costly, space-age drivers and computer-assisted design, we think such risks are totally unacceptable. So we went to work to find the ideal solution.

The problems are fairly well-known: a driver transforms electrical energy into mechanical energy. This mechanical energy is transformed into acoustical energy which is radiated to the outside of the cabinet - the useful front wave - and to the inside - the sometimes-useful back wave. Unfortunately, it is also transmitted through the frame of the driver to the cabinet itself, which acts as a very large "cone" of very small excursion. This means that the spurious resonances and vibrations of the cabinet have to be controlled in a predictable and reproducible way. That's how we came to BLACK HOLE 5 and the BLACK HOLE PAD.

First, THE PAD. It's a thin (1/16 inch) black flexible viscoelastic damping material (filled vinyl copolymer) with maximum performance between 50 and 100 degrees F (we hope that that covers the temperature range of your listening room) and excellent flame resistance - it meets UL94 V-O. Thanks to its outstanding damping characteristics, THE PAD will dramatically reduce the vibration energy stored in the walls to which it is applied.

Easy to cut and apply, THE PAD has a pressure-sensitive adhesive back: simply peel off the release paper and press hard onto a clean surface. You can use THE PAD on just about anything you suspect of vibrating: driver frames, thin panels like car doors, and, of course, the walls of your speaker cabinets. And it can be used to recess a driver without using a router: just laminate enough layers to match the thickness of the driver frame and apply to the front baffle. Finally, it is the ideal material for "constrained layer" wall construction, where two panels are laminated on each side of a damping material for optimum transmission loss. Because THE PAD has a fine grain leather finish, you can wrap an entire cabinet exterior and give it an attractive appearance at the same time!

For applications which require **maximum damping, isolation and absorption**, we've developed BLACK HOLE 5. One and 3/8" thick, BLACK HOLE 5 is a high-loss laminate that provides optimum acoustical damping performance. It consists of five layers:

Thin diamond-pattern embossing, densified with a polyurethane film surface. This unique surface layer dramatically improves the performance of the whole acoustical system, especially the lower mid-range and mid-bass frequencies where simple acoustical foam loses its effectiveness.

One-inch deep polyester urethane foam, structurally optimized for acoustical damping. Highly effective at "soaking" maximum sound energy with minimum thickness.

Barrier septum, 1/8 inch thick. Made of limp flexible vinyl copolymer loaded with non-lead inorganic fillers, it is a "dead wall" that isolates the vibrations in the walls of your cabinet from the vibrations created inside the enclosure.

Polyester urethane flexible open-cell foam, 1/4 inch thick. Thanks to special vibration-isolation characteristics, it decouples the vibrating structure (the wall) from the rest of the damping system, thus optimizing performance.

High-loss vibration damping material, same as The Pad. It is strongly bonded to the cabinet wall with pressure sensitive adhesive.

These layers are laminated using an adhesive-free mechanical and thermal process, thus optimizing performance and eliminating the risk of solvent fume damage. BLACK HOLE 5 can be used in any enclosure, as well as for acoustical panels to improve the characteristics of your listening room. **YOU PROVIDE THE MUSIC; BLACK HOLE FIVE WILL TAKE CARE OF THE NOISE!**

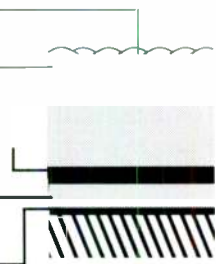

**orca**

1531 Lookout Drive  
Agoura, CA 91301 U.S.A

818-707-1629  
FAX 818-991-3072

## AEON Cables

**New from ORCA!**

AX-ON (Greek axon, axis): that part of a nerve cell through which impulses travel away from the cell body. AXON 8 speaker cable combines outstanding design features with component quality usually associated with the most expensive cable. With eight AXON 1 solid-core conductors and utilizing mylar/ polypropylene construction, AXON 8 offers outstanding performance for amp-speaker connections and perfectionist internal speaker wiring. Our superb AXON 1 AWG 20 solid core conductor is also available separately. Oxygen-free and 99.997% pure, it is ideal for most internal wiring applications.

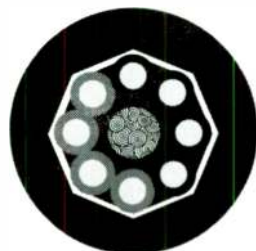

- Outer insulation:** UL approved TPE
- Cable geometry:** non interleaved spiral
- Individual conductor insulation:** 105 degree Celsius, UL approved PVC
- Cable equivalent gauge:** total - AWG 11, 2 conductors - AWG 17, 4 conductors - AWG 14
- Individual conductors:** solid core AWG 20 copper, long-grain and ultra-soft, free of all contaminants and oxygen.
- Cable core:** crushed polypropylene
- Inner envelope:** mylar film

Reader Service #32

Continued from page 31

Webster's work failed to affect the phonograph industry until 1925, when acoustical recording was abandoned in favor of the electrical process. The Orthophonic Victrola, mentioned in Part I, was the first to incorporate an exponential horn. It was also the first to use a folded horn design (Fig. 4). An exponential horn with low-frequency response adequate for the reproduction of electrical recordings required a large mouth opening, and consequently had to be quite long. The folded horn reduced the size to manageable proportions.

The first experiments with horns coupled to dynamic speakers were conducted by Rice and Kellogg in 1925. Because of the very high efficiency of horn-loaded speakers, they were most effective in large rooms requiring a high volume of sound. This made them especially suitable in early talk-



FIGURE 4: A folded-horn system.

ing motion picture theaters, since the vacuum tube amplifiers at that time had very limited power output capability. While horn systems were used extensively in theaters during the 1930s, their large dimensions made them impractical for home use.

That situation changed in 1940 when the American engineer Paul W. Klipsch invented the corner horn, which is a complex folded horn design using the walls of the room to form extensions to the mouth of the horn.<sup>19</sup> The Klipschorn loudspeaker in production today is still based on the original 1940 model, and uses a horn midrange and tweeter to fill out the remainder of the audible spectrum. Klipsch was not the first engineer to advocate corner speaker placement. In 1925 M. Weil filed the first patent application, which was issued in 1931.<sup>20</sup>

The audiophile community has shown little enthusiasm for horn designs over the past two decades, and a survey of reviews in *Stereophile* and *The Absolute Sound* magazines over the past 15 years shows a nearly complete lack of interest in horn systems in the high-end audio community. The 1993 *Audio* magazine equipment directory lists over 325 system manufacturers for home use, yet fewer than 20 use horn loading; six offer speakers with horn loading on the woofer.<sup>21</sup>

Only a few years ago Klipsch advocated horn loading over all other types. Now, Klipsch also offers models made entirely

with direct radiators. However, due to their exceptionally high efficiency, horn systems continue to be the preferred speakers for sound reinforcement and motion picture applications.

#### DIAPHRAGM DESIGN BREAKTHROUGH

The *electrostatic* loudspeaker, unlike the dynamic speaker, does not make use of electromagnetism for its operation (Fig. 5). An electrostatic model uses a thin plastic sheet, stretched over a rectangular frame, as the vibrating diaphragm. The plastic sheet is coated with an electrically conductive material, and is connected to a high voltage power supply which charges the diaphragm to a potential of between -2,000 to -3,000V DC. Suspended on either side of the plastic diaphragm is a pair of metal screens, called *stators*.

The audio output from the amplifier is connected, through a transformer, to the two stators. The charged diaphragm interacts electrostatically with the polarities of the signals on the screens. When the audio signal on the front stator is positive, the signal on the rear stator will be negative. The negatively charged diaphragm will be attracted toward the positively charged stator, and repelled by the negative stator.

When the audio signal reverses polarity, the opposite will occur, with the diaphragm moving back toward the rear, positive stator and away from the front, negative stator. The Fig. 5 electrostatic speaker is typical of modern designs in that it radiates an equal amount of sound from the front as well as the rear. The acoustical outputs from the two sides of the loudspeaker are reversed in polarity with respect to each other. This type of speaker is known as a *dipole*, and has no enclosure.<sup>22</sup>

With the absence of an enclosure, low bass information is normally weak due to cancellation. To overcome this problem, electrostatic panels for low-frequency reproduction are usually very large, floor-standing arrangements. Smaller electrostatic elements are usually used in conjunction with the large panels for midrange- and high-frequency coverage. The earliest electrostatic loudspeakers were small units used only for high-frequency reproduction, and normally in conjunction with a conventional dynamic woofer forming a two-way system.

The 1920s saw much experimentation with electrostatic speakers, particularly in England and Germany, but produced few commercial products. Among the first was the Kyle condenser loudspeaker, which Peerless used in a radio receiver introduced around 1930.<sup>23</sup> The Automatic Musical Instrument Company (AMI) used one of the first electrostatic speakers in a coin-operated

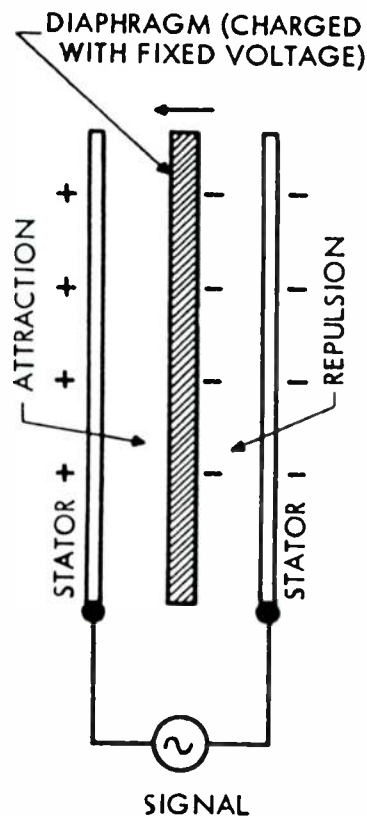

FIGURE 5: A side, cut-away view of an electrostatic speaker.

phonograph, also introduced in 1930.<sup>24</sup> These early units employed a single stator, in front of the diaphragm, and were enclosed at the rear; they were not dipoles.

Early commercial electrostatic models were not nearly as reliable as conventional dynamic speakers, due to, among other things, frequent electrical breakdown and low sensitivity. These speakers also generated ozone, which caused oxidation of the construction materials. Few of the materials available for the diaphragm were thin enough to allow the theoretical advantages to be realized.

At the 1954 Audio Engineering Society convention in New York City, Arthur Janszen described a breakthrough in electrostatic design which overcame most of these problems.<sup>25</sup> At the time Janszen operated Janszen Laboratory in Cambridge, MA, and conducted much of the research which formed the basis of his developments at the Acoustics Research Laboratory of Harvard University. Janszen's new design used the first truly low mass diaphragm, made possible by advances in polyester plastics. His design was noteworthy for its relatively high sensitivity, mechanical and electrical reliability, as well as an unusually wide frequency response of 1kHz-20kHz.

Janszen's speaker was intended for use as

Continued on page 38

# Accept no substitutes - insist on

Genuine Pyle  
**Pyle**  
Speakers and Components



- Over 200 speaker models
- Sizes range from 1" tweeters to 18" massive motor subwoofers
- Parameters and recommended enclosures available for all woofers

## PYLE

PYLE INDUSTRIES, INC. • 501 CENTER ST.  
HUNTINGTON, IN 46750 • (219) 356-1200

**H** A Harman International Company

*Made in U.S.A.*

Reader Service #49



## D2010/8513 3/4" Dome Tweeter

Similar to the D2008, but with several improvements, a foam impregnated front face plate and a lower resonance. Double chambered 3/4" damped textile dome tweeter with the same diaphragm and voice coil as the D2008.

The lower resonance of this driver will allow it to be crossed over lower than most other 3/4" dome tweeters, yet retain the low distortion and clarity characteristic of a 3/4" dome. We recommend a steeper x-over slope be used when the x-over point is below 3KHz.

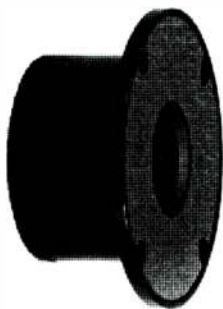

### TECHNICAL DATA:

Characteristic sensitivity	90dB 1W/1m	Lin. & max. excursion	±0.8 / ±1.2 mm
Free air resonance fs	800 Hz	Air gap flux density	1.6 T
DC resistance	5.7 ohm	Force factor BL Product	1.8 Tm
V.C. inductance	0.02 mH	Moving mass incl. air	0.20 g
Power 12dB@Hz	150W@4K	Net weight	0.41 kg
Effective cone area	3.8 cm <sup>2</sup>	Vas	-
V.C. diameter	19.4 mm	Qms	-
V.C. height	3.2 mm	Qes	-
Air gap height	1.6 mm	Qts	-

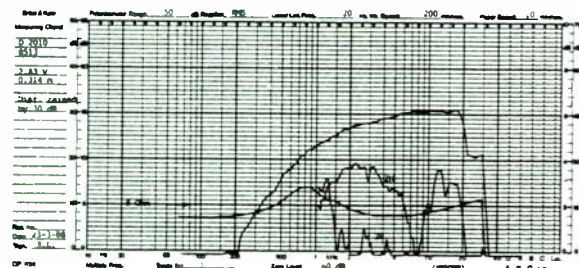

## D2905/9300 1" Dome Tweeter

The D2905/9300 is of the same construction as the well known D2905/9000 tweeter. This newer version achieves a lower resonance and increased clarity by using several coatings of damping material on the dome and a more refined chambering behind the dome. Both these damping factors and the use of a light magnetic fluid, reduce the resonances as much as possible, while reducing compression affects. This tweeters linear response and openness make it a good choice for any system.



### TECHNICAL DATA:

Characteristic sensitivity	90dB 1W/1m	Lin. & max. excursion	±0.5 / ±1.5 mm
Free air resonance fs	600 Hz	Air gap flux density	1.67T
DC resistance	4.9 ohm	Force factor BL Product	4.6 Tm
V.C. inductance	0.09 mH	Moving mass incl. air	0.40 g
Power 12dB@Hz	150W@2.5K	Net weight	0.70 kg
Effective cone area	8.5 cm <sup>2</sup>	Vas	-
V.C. diameter	28 mm	Qms	-
V.C. height	3.5 mm	Qes	-
Air gap height	2.5 mm	Qts	-

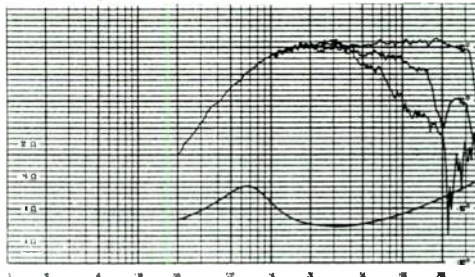

## 13M/8640 5" Midrange

This midrange has a very low resonance frequency for its size and can be used in an extremely wide band width. It features a magnesium cast frame, paper cone and rubber surround. The magnet system uses the Scan-speak Symmetric Drive short circuiting system for less distortion and a linear impedance.

This driver has a rich full-bodied sound, detailed and clean, with a natural tonal balance. It's intended uses are high quality 3-way systems that require low crossover frequencies.



### TECHNICAL DATA:

Characteristic sensitivity	88dB 1W/1m	Lin. & max. excursion	±1.5 / ±5 mm
Free air resonance fs	58 Hz	Air gap flux density	0.76 T
DC resistance	5.8 ohm	Force factor BL Product	4.6 Tm
V.C. inductance	0.1 mH	Moving mass incl. air	3.8 g
Power 12db@Hz	100W@300Hz	Net weight	1.1 kg
Effective cone area	48 cm <sup>2</sup>	Vas	6 liters
V.C. diameter	38.0 mm	Qms	2.56
V.C. height	9 mm	Qes	0.38
Air gap height	6 mm	Qts	0.33

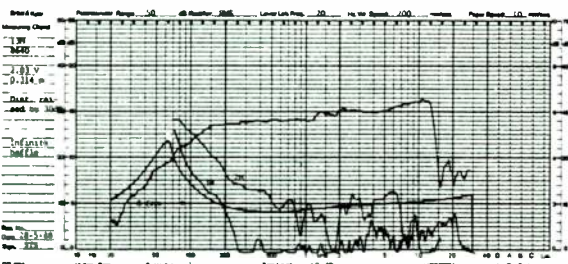

## 13M/4535R 5" Car Full-range

The 13M/4535R is a compact full-range autosound driver. Paper cone, rubber surround, magnesium diecast frame and protective metal grill. This driver uses Scan-speak's ventilated magnet system with symmetric lathed pole piece and Symetric Drive with copper cap, for lowest distortion and linear impedance. This driver offers good bass reproduction and clear treble to 14 KHz. The quality of this driver can be compared to real hi-fi units and is recommended in connection with high quality car stereo components.



### TECHNICAL DATA:

Characteristic sensitivity	90dB 1W/1m	Lin. & max. excursion	±2.5 / ±6mm
Free air resonance fs	56 Hz	Air gap flux density	0.76T
DC resistance	3.0 ohm	Force factor BL Product	4.15Tm
V.C. inductance	0.13 mH	Moving mass incl. air	4.5 g
Power 12db@Hz	35W Fullrange	Net weight	1.1 kg
Effective cone area	48 cm <sup>2</sup>	Vas	5 liters
V.C. diameter	38 mm	Qms	2.93
V.C. height	11 mm	Qes	0.28
Air gap height	6 mm	Qts	0.26

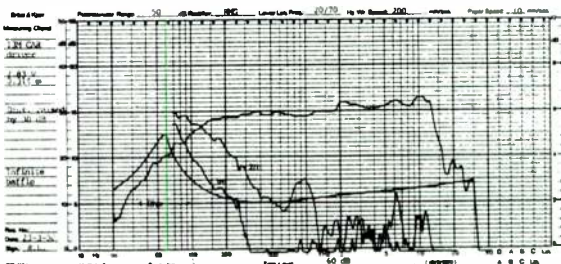



### 18W/8544 7" Kevlar Woofer

This 7" bass/mid driver uses a cast Kevlar cone material with a hand painted special coating. The frame is magnesium cast with a rubber/PVC surround. The magnet system uses the symmetric pole piece and Symmetric Drive copper cap. The long throw voice coil uses aluminum wire and an aluminum former.

This driver offers a precise and clear sound, even at high volume levels. Compression is minimized resulting in a lot of head room. Transient reproduction is reproduced flawlessly.



TECHNICAL DATA:			
Characteristic sensitivity	89dB 1W/1m	Lin. & max. excursion	±6.5 / ±10 mm
Free air resonance fs	29 Hz	Air gap flux density	1.16 T
DC resistance	5.5 ohm	Force factor BL Product	8.0 Tm
V.C. inductance	0.1 mH	Moving mass incl. air	17 g
Power	100W	Net weight	2.05 kg
Effective cone area	143 cm <sup>2</sup>	Vas	50 liters
V.C. diameter	42.5 mm	Qms	1.48
V.C. height	19 mm	Qes	0.27
Air gap height	6 mm	Qts	0.23

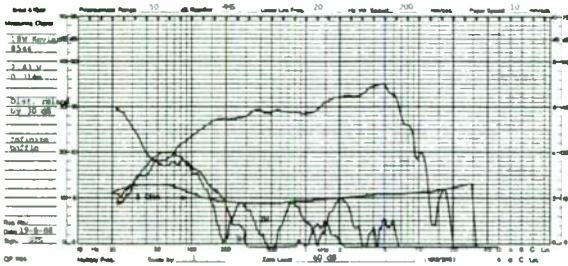

### 18W/8546 7" Kevlar Woofer

This new 7" Kevlar cone magnesium cast frame woofer features the new SD-1 magnet system, that eliminates modulation and dynamic distortion, as well as lowering clipping distortion caused when the driver exceeds it's linear excursion. The new magnet system coupled with a new non resonant low loss linear suspension, gives you a drive unit with a very "open" sound with excellent dynamic range and detailing combined with low coloration and very precise imaging. The best we have to offer.



TECHNICAL DATA:			
Characteristic sensitivity	89dB 1W/1m	Lin. & max. excursion	±6.5 / ±10 mm
Free air resonance fs	30 Hz	Air gap flux density	1.16T
DC resistance	5.5 ohm	Force factor BL Product	7.2 Tm
V.C. inductance	0.4 mH	Moving mass incl. air	17 g
Power	100W	Net weight	2.05 kg
Effective cone area	150 cm <sup>2</sup>	Vas	54 liters
V.C. diameter	42 mm	Qms	2.30
V.C. height	19 mm	Qes	0.34
Air gap height	6 mm	Qts	0.30

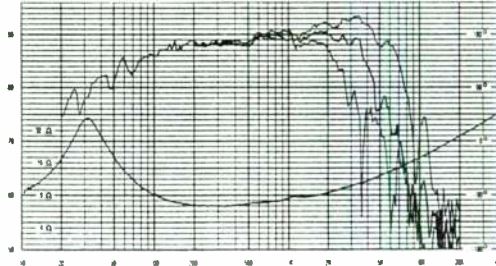

### 21W/8554 8" Kevlar Woofer

This 8" cast magnesium/Aluminum frame woofer features a hand coated cast Kevlar cone with a hand coated foam surround. The magnet system uses the patented SD copper cap and symmetrically shaped pole piece for lower distortion. The damped cone and surround offer a good balance between clarity and tonal balance.

This driver is fast and accurate even with the most demanding transients. A good choice for any high end system.



TECHNICAL DATA:			
Characteristic sensitivity	90dB 1W/1m	Lin. & max. excursion	±6.5 / ±10 mm
Free air resonance fs	25 Hz	Air gap flux density	1.16 T
DC resistance	5.5 ohm	Force factor BL Product	8.0 Tm
V.C. inductance	0.1 mH	Moving mass incl. air	20.5 g
Power	110W	Net weight	2.2 kg
Effective cone area	200 cm <sup>2</sup>	Vas	115 liters
V.C. diameter	42.5 mm	Qms	1.72
V.C. height	19 mm	Qes	0.28
Air gap height	6 mm	Qts	0.24

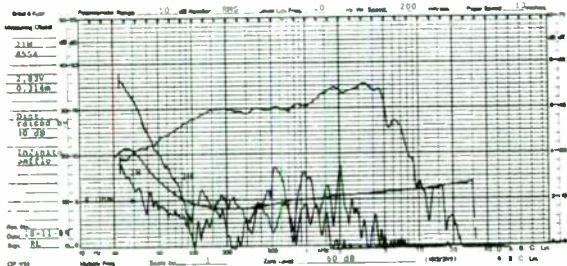

Unit	Description	A	B	C	D	Price
D2010/8513	3/4" textile dome tweeter	98	5	41	69	\$45.00
D2905/9300	1" textile dome tweeter	104.5	3	41	74	\$66.00
13M/8640	5" Paper cone midrange	130	6	48	100	\$58.00
13M/4535R	5" Car full-range w/grill	130	6	48	100	\$61.00
18W/8544	7" Kevlar cone woofer	177	4	70	157	\$95.00
18W/8546	7" Kevlar cone woofer - New	177	4	70	157	\$112.00
21W/8554	8" Kevlar cone woofer	222	5	77	192	\$105.00
Flow resistor	Aperiodic resistive vent	130	3	19	109	\$6.00



Flow resistive vent - aperiodic

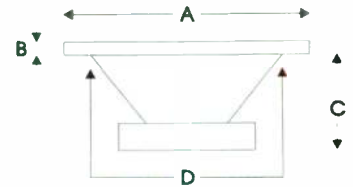

Ordering Information: All speaker orders will be shipped promptly, if possible by UPS. COD requires a 25% prepayment, and personal checks must clear before shipment. Add 10% for shipping charges. Residents of Alaska, Canada and Hawaii, and those who require Blue Label air service, please add 25%. There is no fee for packaging or handling, and we will refund or bill you to the exact shipping charge. We accept Mastercard or Visa on mail and phone orders.

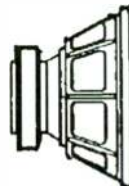

**Madisound Speaker Components**  
 (8608 University Green)  
 P.O. Box 44283  
 Madison, WI 53744-4283 U.S.A  
 Voice: 608-831-3433  
 Fax: 608-831-3771

Reader Service #8

Continued from page 34

the tweeter section of a two-way speaker system. A complete tweeter array consisted of four individual electrostatic modules placed side by side in a semicircular or staggered arrangement.<sup>23</sup> This design became the basis for the Janszen model 130. It was frequently used with the AR-1W and KLH-1 woofer systems mentioned in Part I. Since it was enclosed at the rear, Janszen's electrostatic loudspeaker wasn't a dipole.

#### CRITICS' CHOICE

The first modern, dipole electrostatic loudspeaker was the Quad, which was introduced in 1958 by its inventor Peter Walker (Quad is a trademark of the Acoustical Manufacturing Co., Ltd., a British firm, and has nothing to do with four-channel audio). The following year, KLH introduced the Model 9, which consisted of two tall dipole speakers, held at a fixed angle by a pair of brackets. A stereo installation, therefore, required the use of four panels.<sup>25</sup>

Because of the extremely low mass of the plastic diaphragm, electrostatic loudspeakers are capable of exceptional clarity and inner detail in the midrange and high frequencies. *Stereophile's* "Recommended Components" lists, and the "Reviewer's

Choice" listings in *The Absolute Sound* show that critical audiophiles often prefer electrostatic loudspeakers to designs using dynamic drivers.<sup>26,27</sup>

However, since electrostatic speakers often suffer from a lack of the low bass frequencies, many designs use a conventional dynamic woofer system, coupled to electrostatic elements for the midrange and high frequencies. Since electrostatic dipoles are completely free of enclosure-related resonance problems, successful integration with dynamic woofer systems is difficult and rare.

*Planar* loudspeakers are a category of speakers related to electrostatics. These are physically nearly identical to electrostatics, having a large, thin plastic diaphragm as the vibrating element. However, planars use conventional magnetic principles which makes them dynamic loudspeakers. Thin wires are embedded in the plastic diaphragm, forming the equivalent of a voice coil. Magnetic strips are placed in the front and back of the diaphragm, where the stators would be in an electrostatic loudspeaker. Magnetic interaction, rather than electrostatic, causes the diaphragm to move.

Magnepan, an American firm based in Minnesota, is the best-known manufacturer of planar loudspeakers. Their first such

speaker, designed by company founder Jim Winey, was the Magneplanar Tympani I, introduced in 1971 and featuring three tall panels operating as dipoles.<sup>28</sup>

#### DOMES TWEETERS

As early as 1925, Rice and Kellogg realized that the very large speakers suitable for low-frequency reproduction were far from optimum for reproducing the midrange and high frequencies. Their first multi-way system, developed that year, consisted of three horn-loaded drivers, each dedicated to a limited portion of the frequency spectrum.

There was little practical use for such a system until the sound motion picture industry was formed, since most early electric phonographs and radios used a single driver to cover the entire available range. In 1934 Shearer and Hilliard built the first modern two-way horn system for MGM's Culver City, CA, studios.<sup>2</sup> Before the late 1950s, multi-way systems for home use employed either small *direct radiator* cone drivers (which radiate directly into the room, without any horn loading to improve efficiency) for the midrange and treble, or cone drivers with horns attached.

In 1958 Edgar Villchur and Roy Allison introduced another significant development

# MCM AUDIO SELECT™



## High Performance Without the High Price

Introducing the latest in outstanding speaker value; MCM Audio Select. Manufactured exclusively to our specifications, these drivers offer outstanding performance at half the cost of most name brand competitors. Along with MCM Audio select, you will find the MCM catalog is packed with hundreds of woofers, midranges, tweeters, crossovers and all the accessories you'll need for any sound application. Call MCM Electronics today and discover true audio value, service and selection.

### FREE CATALOG



For a FREE Catalog, Call...  
**1-800-543-4330**  
Product Questions...  
**1-800-824-TECH (8324)**

New hours: M-F 7 a.m. - 9 p.m., Sat. 9 a.m. - 6 p.m. EST.



**MCM ELECTRONICS™**  
650 CONGRESS PARK DR.  
CENTERVILLE, OH 45459-4072  
A PREMIER Company **SB-18**

Serving you coast to coast! Distribution Facilities in Dayton, OH and Reno, NV!

Reader Service #11

*Announcing*  
**VANCE DICKASON'S**  
**LOUDSPEAKER RECIPES**  
**BOOK ONE**

An owner-built loudspeaker with truly dazzling performance is now within the reach of almost any reasonably intelligent constructor. Loudspeaker building, only a very few years ago, was a matter of a few hand tools and some plywood, plus some guesses as to the technical details. Our knowledge of what makes a special combination of drivers and crossover components the best possible has been growing explosively in the last decade.



Vance Dickason, bestselling author of *The Loudspeaker Design Cookbook* (over 33,000 English copies sold, with German and Portuguese versions also available) brings almost twenty years of experience, research and hands-on knowledge to this new book on designing and building four tested and proven two-way loudspeaker systems.



The best news, however, is that the directions, definitions and instructions for realizing these four demonstration systems, contain all the right questions and the clear paths to their answers which enable you to build excellent performing two-way systems with an almost endless combination of available woofers and tweeters.



Dickason shows you how to look for the right driver characteristics to be paired successfully

with the right crossover components and also how to fix any anomalies which may trouble your particular choices. Although the four two-way systems which are meticulously documented in this book, along with an outstanding general purpose subwoofer, may be built just as they are defined here, you are not limited to building these systems only.



*Loudspeaker Recipes*, Book 1, lays a firm groundwork, both theoretical and practical, for building as many varied and successful two-way loudspeaker systems as you wish. The book benefits from the latest techniques for computer aided design, but is also rich in proven construction practices for building practical systems. Mr. Dickason is not only a published author and Editor of *Voice Coil*, the monthly newsletter for the loudspeaker industry, a Contributing Editor for *Speaker Builder*, but also is a professional consultant and product reviewer as well.



*Loudspeaker Recipes*, Book 1 provides a powerful tool for any music lover who wishes to build a technically outstanding and satisfying loudspeaker system for home listening. Watch for new volumes in this series at your bookseller.

**ONLY \$24.95! ORDER NOW! ONLY \$24.95!**

**YES!** PLEASE SEND ME \_\_\_\_\_ #BKAA30 @ \$24.95

NAME \_\_\_\_\_ TODAY'S DATE \_\_\_\_\_

FOR S/H INCLUDE:  \$3 USA

STREET \_\_\_\_\_

\$5 OTHER SURFACE  \$10 OTHER AIR

CITY \_\_\_\_\_ ST \_\_\_\_\_ ZIP \_\_\_\_\_

TOTAL AMOUNT OF ORDER \$ \_\_\_\_\_

MASTERCARD / VISA / DISCOVER \_\_\_\_\_ EXP. DATE \_\_\_\_\_

**OLD COLONY SOUND LAB, PO BOX 243, PETERBOROUGH, NH 03458 USA**  
 24-Hour Tels.: (603) 924-6526 (603) 924-6371 24-Hour Fax: (603) 924-9467

to the loudspeaker industry—the first dome tweeter, which had several advantages over the cone drivers previously used. Because of its shape, the dome was more rigid than the cone, resulting in less distortion at high frequencies. In addition, its small size (typically one inch or less in today's systems) results in much wider dispersion at high frequencies, giving a uniform frequency response in various listening positions. By the mid-1960s, dome drivers had also become common for midrange reproduction.

Today's high-performance multi-way dynamic systems usually feature small dome

drivers as tweeters, and either dome or cone drivers for the midrange. Dome drivers are typically manufactured as sealed, self-contained units, and do not require an enclosure.

Cone midrange drivers, typically 4"–5" in diameter, are not sealed in the rear and will normally require a sub-enclosure which can be incorporated into the complete system. Sub-enclosures for midrange drivers can be either closed, aperiodic, or vented boxes, depending on the driver used and the designer's preference. Transmission line loading, though less popular, has also been used effectively with midrange speakers.

## MATCH GAME

Multi-way systems require a combination of filters which, together, form the crossover network. In a two-way system, a *low-pass* filter feeds the low frequencies to the woofer, and a *high-pass* filter sends the high frequencies to the tweeter. A three-way system contains both of these filters, plus a *bandpass* filter to feed the middle portion of the frequency spectrum to a dedicated midrange driver.

The earliest multi-way crossover networks were based on the theories of Bell Telephone engineers G.A. Campbell and O.J. Zobel.<sup>1</sup> Their crossovers were known as constant-K and M-derived designs, in which each filter section was designed individually, matching electrical impedance to the other sections. Their filters were supplanted in the 1950s by Butterworth types, which, using calculus-based network theory, were designed as a whole, allowing simpler and more precise matching of the filter sections.<sup>2</sup>

A crossover which uses filters rolling off at 6dB/octave outside of the bandpass yields minimum phase response across the entire spectrum, but this attenuation rate is not sufficient to ensure low distortion with many drivers. In 1971 Richard Small determined that a 12dB/octave rolloff was the minimum necessary to reduce driver distortion.<sup>1</sup>

Since the 12dB/octave crossover has both amplitude and phase problems, many engineers in agreement with Small's premise have sought higher rates of attenuation. Siegfried Linkwitz introduced the 24dB/octave all-pass crossovers in 1976. Known as Linkwitz-Riley crossovers, they have been widely accepted due to their symmetrical vertical radiation pattern.<sup>29</sup>

In 1956 C.P. Boegli analyzed the effects of improper time alignment.<sup>1</sup> Time Alignment® of the drivers in a multi-way system has become a major concern during the past two decades, but today's engineers cannot agree on the relative importance of flat amplitude response versus time alignment of drivers and minimum phase response across the audible spectrum. Similarly, no consensus about the best crossover rolloff characteristic exists. Every well-designed system is the result of balancing various trade-offs, and engineers have their own preferences for dealing with the required compromises.

The personal computer, which has revolutionized system design during the past decade, is now an essential tool for engineers and manufacturers. Much software has been written for both crossover and enclosure design, primarily for IBM-compatible computers. Sophisticated design is within reach of the non-mathematician,

# TCH

**YOUR** *Handles • Corners*  
**ONE** *Speaker Grills • Casters*  
**SOURCE** *Speaker Carpet*  
**FOR** *Jack Dishes • Feet • Clamps*  
**SPEAKER** *Grill Cloth*  
**CABINET** *Plugs & Jacks*  
**COMPONENTS**

• **OVER 500 ITEMS IN STOCK FOR IMMEDIATE DELIVERY**

• **\$50 MINIMUM ORDER**

VISA

Master Card

**Phone 800-387-5122**

**Fax (716) 892-4302**

# TCH

**1705 Broadway  
Buffalo NY 14212**

Reader Service #48



while those who are mathematically inclined can accomplish their work in a fraction of the time which would otherwise be required.

With an appropriate interface card and software, the computer can also function as a test and measurement system. The Maximum-Length Sequence System

Analyzer (MLSSA), developed and marketed by DRA Laboratories, has become a *de facto* standard for use in loudspeaker measurements. 

## REFERENCES

1. \*Dickason, Vance, *The Loudspeaker Design Cookbook*, 4th ed., Audio Amateur Press, 1991.
2. \*Tremaine, Howard M., *The Audio Cyclopedia*, 2nd ed., Howard W. Sams Co., Inc., 1977.
3. \*\*Thiele, A.N., "Loudspeakers in Vented Boxes," Parts I and II, *JAES*, May and June, 1971.
4. \*\*Small, Richard H., "Vented-Box Loudspeaker Systems," Parts I, II, III and IV, *JAES*, June 1973, July/Aug. 1973, Sept. 1973 and Oct. 1973.
5. \*Benson, J.E., *Theory and Design of Loudspeaker Enclosures*, Synergetic Audio Concepts, 1993.
6. \*\*\*Bullock, Robert M. III, "Thiele, Small and Vented Loudspeaker Design," *SB* (4/80): 7.
7. \*\*\*Bullock, Robert M. III, "How You Can Determine Design Parameters for Your Loudspeaker," *SB* (1/81): 12.
8. \*\*\*Bullock, Robert M. III, "Thiele, Small and Vented Loudspeaker Design, Part III: Fine Points of Speaker Design," *SB* (2/81): 18.
9. \*Olson, Harry F., John Preston and Everett G. May, "Recent Developments in Direct-Radiator High-Fidelity Loudspeakers," *JAES*, Oct. 1954.
10. Small, Richard H., "Passive Radiator Loudspeaker Systems," *JAES*, Oct./Nov. 1974.
11. Bailey, A.R., "A Non-Resonant Loudspeaker Enclosure," *Wireless World*, Oct. 1965.
12. Galo, Gary A., "Transmission Line Loudspeakers, Part I: Theory," *SB* (1/82): 7.
13. Bullock, Robert M. III and Peter E. Hillman, "A Transmission Line Woofer Model," AES Preprint #2384, presented at the 81st convention of the Audio Engineering Society, Nov. 1986.
14. Hillman, Peter E., "Symmetrical Speaker System with Dual Transmission Lines," *SB* (5/89): 10.
15. \*Turner, Rufus P. and Stan Gibilisco, *The Illustrated Dictionary of Electronics*, 4th ed., Tab Professional and Reference Books, 1988.
16. Scheldorf, Marvel W., "Acoustic Resistance Device," United States Patent Office, 1936.
17. Holt, J. Gordon, "Dynaco A-25 Speaker System," *Stereophile*, Summer 1968 (actually published in 1969, since *Stereophile's* publishing schedule was erratic at that time).
18. Galo, Gary A., "Audio Concepts Sapphire II," *SB* (6/90): 56.
19. Hirsch, Julian D., "Loudspeaker," *The Encyclopedia Americana*, 1989.
20. \*\*Klipsch, Paul W., "Corner Speaker Placement," *JAES*, July 1959.
21. "36th Annual Equipment Directory," *Audio*, Oct. 1993.
22. Holt, J. Gordon, "How Electrostatics Work," *Stereophile*, V. 4, No. 3, c. 1978 (Stereophile was not printing dates on their magazines at this time).
23. \*\*Janszen, Arthur A., "An Electrostatic Loudspeaker Development," *JAES*, April 1955.
24. Read, Oliver and Walter L. Welch, *From Tin Foil to Stereo*, 2nd ed., Howard W. Sams & Co., Inc., 1976.
25. Campos, C. Victor, Conversations with the author, Dec. 1990 and Jan. 1991.
26. "Recommended Components," *Stereophile*, Oct. 1993.
27. "Reviewers' Choices: The Best of 1989," *The Absolute Sound*, Mar./Apr. 1990.
28. Winey, Jim, Conversation with the author, Jan. 29, 1991.
29. \*\*Linkwitz, Siegfried H., "Active Crossover Networks for Noncoincident Drivers," *JAES*, Jan./Feb. 1976.

\*This or a similar edition is available from Old Colony Sound Lab, PO Box 243, Peterborough, NH 03458, (603) 924-6371 or 6526, FAX (603) 924-9467.

\*\*The AES has reprinted these articles in *Loudspeakers—An Anthology*, vol. 1, edited by Raymond E. Cooke, and available from Old Colony.

\*\*\*Audio Amateur Press has reprinted these articles in *Bullock on Boxes*, available from Old Colony.

## After You've Designed & Built The Perfect Loudspeaker, What Else Do You Need?

**Electronics:** The *Audio Ideas Guide* reviews over 100 new audio and video components in its 2 large issues (Winter and Summer/Fall) and extra Newsletters each year.

**Recordings:** Even more CDs and LPs are evaluated in the *Audio Ideas Guide*, with a special emphasis on audiophile recordings, including those we produce ourselves, using special purist microphone techniques and leading edge electronics. Our brand new *Test & Reference CD* not only provides setup tests for stereo and surround sound, but is also a sampler of current and future Audio Ideas Recordings.

We'd like to introduce you to our magazine, already recognized as the leading Canadian publication in the field. We'd also like you to enjoy our growing number of Audio Ideas Recordings. Here's your chance to get some great reading and listening at a special price! If you just want a sample issue, which could be any from the last year or two, send us \$2.00 to cover postage and handling. If you'd like our current issue, with its feature on Interconnects and the latest equipment reviews, send \$5.00.

But if you go for it, and subscribe for the next 8 issues and Newsletters at \$30.00, we'll throw in the *T&R CD* and our *Sounds Of Canada* cassette, plus the new issue seen above for just an additional \$10.00. What a deal, eh?

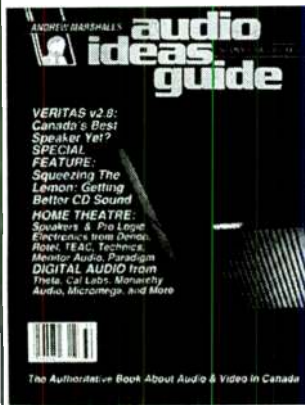
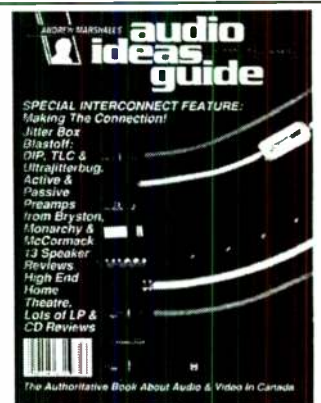

- Yes, Please send me a sample copy of the Audio Ideas Guide for 2 bucks
- Hey, now that the speakers are done, I need your current issue on Interconnects (\$5.00)
- Well, you convinced me, so enroll my subscription, and send out my goodies for \$40.00.

NAME: \_\_\_\_\_ ADDRESS: \_\_\_\_\_  
CITY/TOWN: \_\_\_\_\_ STATE/PROV: \_\_\_\_\_ ZIP \_\_\_\_\_

(Cheques or money orders only, please. U.S. orders should be in U.S. funds  
Send to AIG, 175 Sherwood Avenue, Toronto, Ont. Canada M4P 2A9)

# Wayland's Wood World

## SIMPLE VENEERING

By Bob Wayland

Long ago and far away, veneered wooden products required an extensive and expensive, well-equipped shop. The main piece of equipment was a veneer press that applied a uniform pressure over rather substantial areas. The press alone restricted this process to larger shops. Forms and a vast array of clamps were also needed, an expense only the most ardent woodworker could justify.

Of course, woodworkers are willing to go to such extremes to achieve the relative stability of the balanced construction (alternating layers of thin, cross-grained matched wood) found in the old veneered furniture and the savings afforded by using the expensive veneers only on the outer surfaces. In this column I will introduce you to a simpler approach.

### EQUIPMENT AND SUPPLIES

The tools you will need are minimal and inexpensive. The most unusual is the saw shown on the left of *Photo 1*. This reversible-blade device is available from Constantine's (VS275) for \$4.95 plus S&H. If you have a Japanese Dozuki or Ryoba saw, you can use it instead.

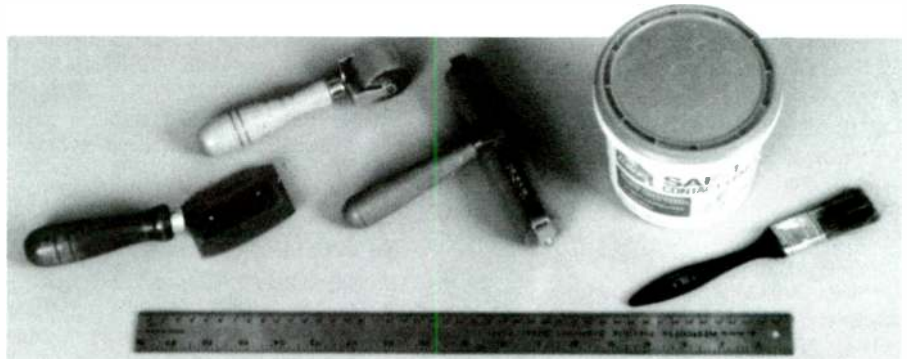

PHOTO 1: Common veneering tools, from left to right: veneer saw, small (1") wooden roller, large soft rubber roller, contact cement, brush, and a straightedge.

The smaller wooden roller is most useful for anchoring a piece in place; the larger rubber roller smoothly and firmly anchors the larger pieces. The brush can be any cheap throwaway. I prefer a 2-inch-wide one, but you can use any size that is handy. Although you can clean the brush, this soon becomes more trouble than it is worth, so buy a cheap one.

### MAKING CONTACT

Environmental concerns have affected the contact cements available to the woodworker/speaker builder. Solvent-borne cements normally contain 40–60% solids, and the remaining solvent is the liquid carrier. This solvent will usually vaporize quickly to leave the cement solids on the wooden surface. The concerns are fire safety, ozone depletion, and health.

The response of adhesive manufacturers has been to develop waterborne formulas such as Imperial's Flexweld 318, Bostik's 8155, H.B. Fuller Co.'s XR-1377, DAP's Weldwood 3030, and the most easily found, Borden's SAF-T (*Photo 1*). Waterborne contact cements are slightly more temperature sensitive than their solvent-borne counterparts. (Minimum-use temperature is 40°F for the latter versus 65°F for the former.) The open time before solidification starts, however, is about 25 minutes for waterborne versus 10–15 minutes for sol-

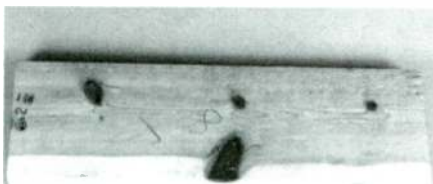

PHOTO 2: A piece of "bad" 2 x 8 pine before we dress it up with a veneer.



PHOTO 3: Sizing a piece of veneer by placing the surface to be veneered on top. Note that the veneer is cut a little larger than the surface to be veneered.

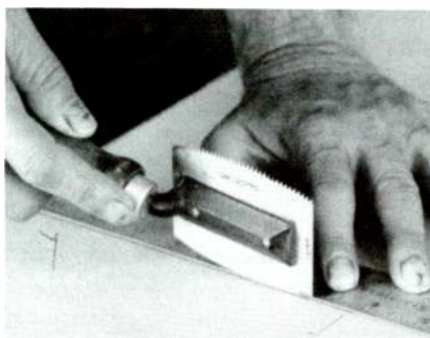

PHOTO 4: Cutting veneer to size using an X-acto knife (upper left), a veneer saw (left), or scissors (right).

vent-borne. Also, the waterborne formulas have a shelf life of only about six months as compared to a year for solvent-borne. Actually, if you carefully seal either one immediately after each use, it is possible to more than double this shelf life.

With almost any wood available as a veneer, the choice is extensive. If you are interested in the more figured cuts, there are burl veneers. The mirrored patterns of book-matched pieces can add a dimension that is difficult to produce in solid wood. The limits are more self-imposed than anything else. A few sources are Constantine, Bob Morgan, and Brookside Veneers, with others listed in the *Hardwood Plywood and Veneer Membership Directory* (\$5).

Most manufacturers offer extensive color catalogs, and a few will send you samples. In addition, sample sets of different veneers are available to help you choose just the right wood for your project. If you live in a large metropolitan area, a local well-stocked hardwood lumberyard will probably also carry them. Modern veneers are very thin and reinforced with a paper backing. (If you can, try to find the older-style products, which are about 1/28" thick.)

To illustrate the power of veneering, I will show you how to transform an ugly board, such as the one shown in *Photo 2*, into a top-



PHOTO 5: Veneer with cement applied and cement being applied to the wood.



PHOTO 6: Establishing one-point contact to ensure accurate alignment of the veneer.

rate surface for finishing. The first step is to prepare the substrate—the pine board. This piece must be smooth, flat, free from grease, wax, oil, or any other contamination. Prepare it as you would any surface for gluing: the key is to sand or scrape it just before you apply the contact cement. You can dress up an old speaker by putting veneers on it, but only if you are careful. Be sure that the old finish has been removed completely and that the surface is properly prepared.

#### PRESSING MATTERS

Once you have purchased the veneer, cut it to size. Simply place the substrate on top of the

veneer and mark off the boundaries, as shown in *Photo 3*. Good practice is to cut the veneer a little larger than the surface to be covered. You can cut the material to size in a number of ways: with an X-acto knife, a veneer saw, or scissors (*Photo 4*). If the piece is particularly warped, you may need to flatten it. To do so, spray it with water and place it between two absorbent layers of cloth or paper. Clamp this sandwich between two stiff boards and let it dry.

Stir the contact cement thoroughly until a uniform mixture results. Apply the glue with a smooth, quick motion to the veneer and the surface to which it will be glued (*Photo 5*).



PHOTO 7: Two-finger press.



PHOTO 8: Using a small hard roller to anchor the starting seam.



PHOTO 9: Smoothing the veneer after the waxed paper has been pulled out an inch or two.

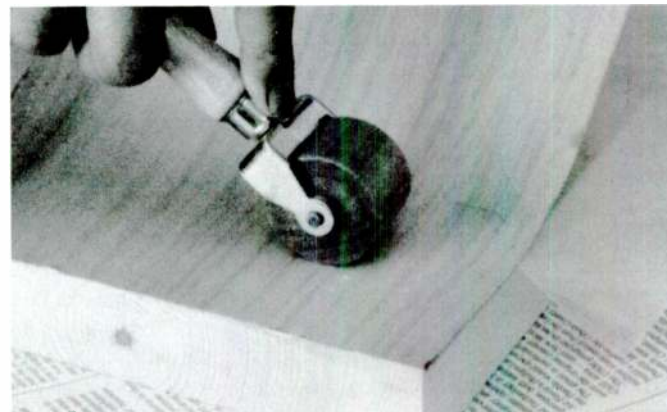

PHOTO 10: Rolling down the newly exposed area.



**PHOTO 11:** Cutting a slit with a sharp knife to repair a blister where the veneer did not stick to the wood.

right angles to that of the face veneer which will later cover it. This practice, called cross-banding, is done as a separate operation before the face veneering, usually with a plain, inexpensive veneer.

#### HELPFUL HINTS

One of woodworking's little secrets is to let the contact cement dry completely. In a shop with low humidity and high temperature, this normally takes about 30 minutes. As the humidity rises and the temperature decreases, however, drying time progressively lengthens. If you are in a time pinch, the drying time can be shortened by applying heat. A

reference point (*Photo 6*). Now check the alignment with the substrate. If you didn't press too hard on the reference point, you will be able to make minor adjustments to the position of the veneer. Once it is correctly aligned, use two fingers to form a seam where the two glued surfaces make contact (*Photo 7*). To anchor the veneer, use the small hard roller to firmly press this alignment seam together (*Photo 8*).

#### FINISHING TOUCHES

For the rest of the job, repeat the last two steps in finite increments. First, pull the waxed paper back an inch or two and smooth



**PHOTO 12:** Using a veneer saw to remove excess veneer when the veneer grain is parallel to the edge.

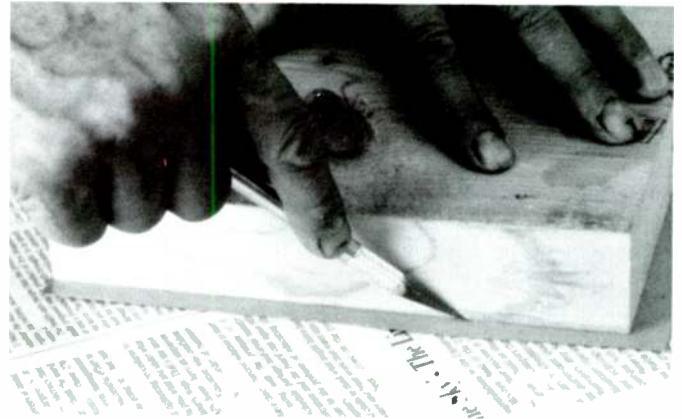

**PHOTO 13:** Using a sharp knife to remove excess veneer when the veneer grain is parallel to the edge.

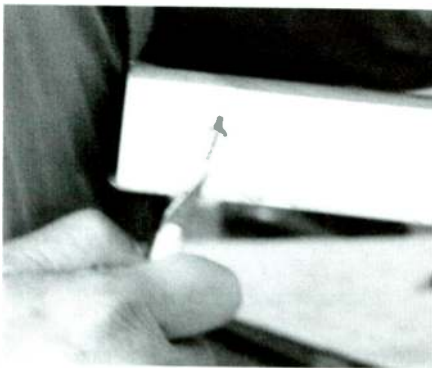

**PHOTO 14:** Cutting off the end-grain overlap veneer. An interesting experiment is to try this with a veneer saw, as shown in *Photo 12*.

Avoid excessive brushing and allow the contact cement to flow in a uniform coat. Use plenty of glue. Make certain it doesn't pile up in one area and leave others thin: flow the cement into a film with no holes. (This step is often done carelessly, to your regret.) Be careful and patient as you work, and don't hurry.

If the surface you are preparing is not uniform, if it has noticeable defects, or if it may check in time, you should first apply a layer of veneer which is laid so the grain runs at

hair dryer is effective, but a heat gun such as one you use for shrink tubing will also work. Be careful not to warp the veneer.

If you are working with porous woods, or you didn't achieve a uniform coat the first time, it is a good idea to apply a second coat of contact cement. The wood pores should be well filled, and the glue surface should have a smooth, glossy appearance. If your work has been interrupted and the glue has set up for more than about two hours, you should apply another coat.

Now comes the tricky part. Keep in mind that when the two glued surfaces make contact, an incredibly strong bond is formed. Any attempt to change it will usually result in tearing the veneer. So how do you position the two pieces in the proper orientation? Place a sheet of waxed paper large enough to cover the glued surfaces between the veneer and the substrate. (Of course, this is glued surface facing glued surface.) Now align the veneer so it completely covers the gluing surface. Remember that you have cut the veneer a bit oversized so it will extend a bit beyond the edges. Carefully pull the waxed paper back about a half inch, keeping the veneer aligned with the substrate.

With one finger, gently press down at the center of the exposed strip to establish a ref-

erence point (*Photo 9*). Second, firmly press together the newly exposed glue surfaces with the hard roller, as shown in *Photo 10*. Continue this process until you have removed all of the waxed paper and the veneer is completely adhered to the wood substrate. I usually take the large soft roller and go over the entire piece as a final check of proper gluing.

Some problem areas may not stick, which is usually a result of foreign material (such as sawdust). This causes bubbles or blisters. As

#### SOURCES

**Albert Constantine and Son, Inc.**  
2050 Eastchester Rd.  
Bronx, NY 10461  
(800) 223-8087

**Bob Morgan Woodworking Supplies, Inc.**  
1123 Bardstown Rd.  
Louisville, KY 40204  
(502) 456-2545

**Brookside Veneers, Ltd.**  
PO Box 4348  
Metuchen, NJ 08840  
(908) 494-3730

**Hardwood Plywood and Veneer Manufacturers Association**  
1825 Michael Faraday Dr.  
PO Box 2789  
Reston, VA 22090-2789



The man behind the hands in many of *Wood World's* photos is Ken Ronquillo, who also lends his woodworking insights and photography skills for these articles.

you roll over these areas with the soft roller, you will hear a crackling sound. When you find them, you need to reapply the glue. Make a slit with a sharp knife in the direction of the veneer's grain (*Photo 11*). Now inject some of the contact cement under the veneer,

into the void between the two nonsticking surfaces. Use a syringe full of thinned contact cement and squirt it into the void.

Finally, cut away the excess veneer. I hate ragged edges, so I have developed a fussy but simple procedure. For those edges that run in the direction of the veneer grain, there are two methods. The one I like best is to use the veneer saw, as shown in *Photo 12*. You can also use a sharp knife (*Photo 13*), although it is all too easy to cut into the sub-surface wood.

To remove the excess veneer on those edges where the grain is perpendicular to the edge, you should recall a lesson from a previous article: if the direction of the cutting force is such that it tends to pull away from the surface, you will probably have a ragged edge. One way to overcome this problem is to remove this edge with a sharp knife, cutting with a stroke toward the wood substrate, as shown by the arrow in *Photo 14*.

You now have the necessary knowledge to apply veneer to simple flat surfaces. Of course, if the surface is curved or there are more interesting shapes, or if you wish to match different grain patterns, then it is a little harder. I'll discuss these problems in a future column. ▶

## FREE! The Catalog For All Your Audio Woodworking Needs!



With over 4,000 of the finest woodworking tools in the world, Woodcraft can help you work more efficiently and skillfully than ever.

For Your Free Copy  
Of Our Catalog Call:

**1-800-542-9115**

# WOODCRAFT®

210 Wood County Industrial Park Dept. 94SB10S  
PO Box 1686, Parkersburg, WV 26102-1686

- Veneer Sheets
- Veneer Edging
- 100% Tung Oil
- Finishing Supplies
- Glueing Supplies
- Sanding Supplies
- Birch Plywood
- Hand Tools
- Power Tools
- More!

Reader Service # 62

# FOTAL

# ACCUTON

ORCA CONNECTORS

# SPEAKERS

QUALITY DRIVERS & MORE

etc.

Regulus  
CUSTOM SPEAKER CABLES & INTERCONNECTS

AUDIO  
**ERSE**  
ELECTRONICS  
INDUCTORS

**polyda**  
SPEAKER CORPORATION

## Speaker Kits Available

**We Offer State Of The Art Speaker Components and Kits  
(Specializing in Speaker & Crossover Design)**

### Request a FREE catalog

1828 W Peoria  
Phoenix, AZ 85029  
Phone (602) 944-1878 FAX (602) 371-0605

(Mntn Std Time)  
10:00 AM-7:00 PM Weekdays  
10:00 AM-5:00 PM Saturdays

Reader Service # 38

Speaker Builder / 7/94 45

# Product Review

## AUDIO PHASE INDICATOR

By Gary A. Galo  
Contributing Editor

**Audio Phase Indicator**, Crystal Lake Designs, PO Box 591, Crystal Lake, IL 60039-0591, (815) 455-0799, \$175.

If you frequently need to check the phase relationship between stereo loudspeaker pairs, Crystal Lake Designs offers a highly useful piece of test gear. The Audio Phase Indicator allows quick and easy phase or polarity comparisons between any two sound sources (*Photo 1*).

### AUDIO LINGUISTICS

Much confusion exists in the audio industry concerning the terms *phase* and *polarity*, although they represent a relatively simple concept. Even audio equipment manufacturers mistakenly use *phase* when they really mean *polarity*. These two terms would appear to be interchangeable, but they're not.

You can easily understand the difference

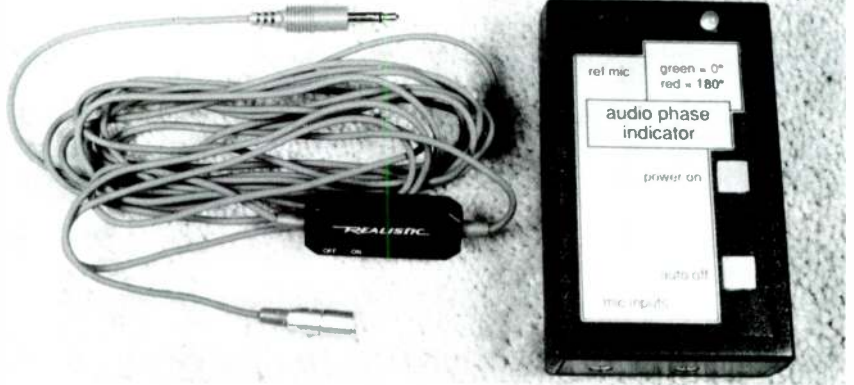

**PHOTO 1:** Crystal Lake Designs' Audio Phase Indicator, supplied with Radio Shack's #33-1063 Electret Condenser Microphone.

by looking at an asymmetrical waveform. *Figure 1* shows two waveforms which are *out-of-phase*. Relative to waveform "A," waveform "B" has been shifted in time by

180°, since it begins 0.5 cycles later than A. Both waveforms might be the low- and high-pass outputs of a two-way, second order (12dB/octave) crossover network, at the

## MENISCUS

Proudly supplies:

### CAPACITORS -

- Polypropylene
- Mylar
- NP Elec.

### INDUCTORS -

- Air Core
- Ferrite Bobbin
- 20 - 14ga. OFC

### RESISTORS -

- Wire wound
- Non - Inductive  
5 W - 25 W

### ACCESSORIES -

- Terminal cups
- Gold posts
- Speaker cabinets
- Wire & connectors
- Grille cloth & fasteners
- Black screws
- Port tubes & trim
- Spikes & cones
- Damping materials
- Design books
- Custom foam grilles

**MENISCUS** - 2575 28th St. SW #2 - Wyoming, MI 49509  
(616) 534-9121 FAX (616) 534-7676

## SPEAKERS -

### AUDIO CONCEPTS

CERATEC

DYNAUDIO

ECLIPSE

ENTRÉE

ETON

EMINENCE

FOCAL

MB

MADISOUND

MAGNAT

MOREL

POLYDAX

PEERLESS

SCAN SPEAK

SWAN

VERSA/TRONICS

VIFA

Reader Service #12

crossover frequency. All analog filters shift phase, with the amount depending on the filter's characteristics.

Figure 2 shows two identical waveforms of opposite polarity. In this case, waveforms A and B would be the outputs from your left and right loudspeakers if the leads to one channel were accidentally reversed. If speakers are connected this way, the condition is normally called out-of-phase. This is technically incorrect; they're really connected in *opposing polarity*.

## FEATURES

The Audio Phase Indicator should probably be called a polarity indicator, but Crystal Lake's choice of name isn't incorrect, since this device will indicate errors of either type. The Phase Indicator will compare either acoustic signals picked up by a pair of microphones or electrical signals fed to the two mini phone jacks. The reference microphone is an electret condenser type built into the Phase Indicator.

The secondary mike is a Radio Shack #33-1063 electret condenser, which can be plugged into either mini jack, and comes with nearly 10' of cable, allowing ample distance between it and the reference mike. Both mikes are omnidirectional. Electrical signals are connected to two mini phone jacks with the supplied RCA-to-mini phone interconnect cable. The cable incorporates attenuators to prevent overload of the mike inputs by line level signals. The Audio Phase Indicator is supplied with a padded carrying case.

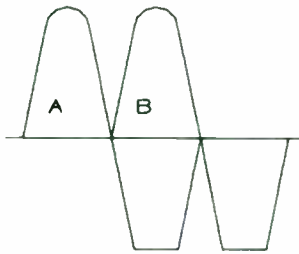

FIGURE 1: Two audio signals which are out-of-phase.

Amplification of the input signals is accomplished with a National Semiconductor LM324 low power quad op amp. The LM324 consumes only 0.7mA of current, ideal for a battery-operated device. The phase detector circuit is built around National's LM1496N balanced modulator/demodulator chip. Two AAA cells power the unit.

## HOW IT MEASURES UP

A single two-colored LED supplies the phase indication. When the two inputs are of the same polarity (or "in phase"), the LED lights green. If the inputs are of opposite

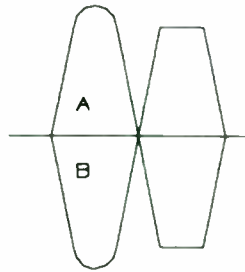

FIGURE 2: Two audio signals of opposite polarity.

polarity, the LED gives a red indication. Use is quite simple. For acoustic signals, simply place the two microphones in front of the two signals being compared. This will typically be in front of left and right loudspeakers while any program material is being played (you don't need test tones, music works just fine).

Program material works equally well with electrical connections. One common polarity error is mis-wiring phono cartridges. By connecting the Audio Phase Indicator to the tape outputs on your preamp, you can easily check the polarity of your source. You can test CD reissues of monaural source material for artificial stereo enhancement (it's still done more than it should be). In this case, a combination of red and green flickering will usually occur, since the two channels will have phase differences, but will rarely be 180° out. The Audio Phase Indicator can only measure relative polarity or phase differences between two signals; it can't measure absolute polarity of an audio source.

The Audio Phase Indicator works extremely well. Its factory-direct price of \$175 will probably keep it out of the reach of occasional users, or those doing a one-time setup. But I recommend this product for those with a frequent need to check phase or polarity of audio signals.

## MANUFACTURER'S RESPONSE

*Thank you for a thoughtful and informative review. While the Audio Phase Indicator does have other applications, you have focused on the ones that will be of most interest to your readers. We have made two changes in the product since the review unit was sent to you. First, the external microphone has been upgraded to a Radio Shack #33-3003, since the #33-1063 is no longer available. Second, I have decided to include a full schematic diagram with each unit. I did this after realizing how much I have learned over the years from reading schematics included with audio gear and measuring instruments. Registered owners can also get the schematic at no charge, on request.*

Mark Williamsen  
Crystal Lake Designs

# YES, IT REALLY EXISTS!

High-End Technology made in Germany



This driver delivers a genuine full-range 360° dipolar output, is currently available as OEM and/or with the ArtNOISE custom-built cabinet.

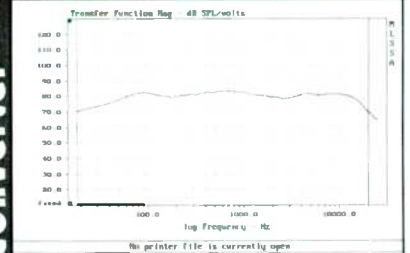

These measurements are taken without any form of filtering. Frequency Range: -6 dB at 70 Hz, from 150 Hz to 16 kHz ±2,5 dB, -3,5 dB at 16 kHz and above.

Resonance Frequency:	91 Hz
Coincidence Frequency:	220 Hz
Dipole Resonance Fre.:	6 kHz
Sensitivity:	87 dB/W/m
Output Characteristic:	360° toroidal
Impedance:	Z(1kHz)=4 Ω
Nominal Power Handling:	120 W
Frequency Range:	(see above)

Distributor enquiries welcome.  
Fax (0 11)-49-69-4 94 09 63

**GERMAN  
PHYSIKS**  
HIGH END TECHNOLOGY

Postbox 10 26  
D-63 506 Hainburg  
Germany

Reader Service #42

Speaker Builder / 7/94 47

# Ask SB

Robert M. Bullock III  
Contributing Editor

## PASSIVE MOD

My single-channel subwoofer amplifier incorporates a first-order low-pass at about 200Hz. I can change this frequency by changing the capacitor at C1 (Fig. 1). For instance, if I double its original value to 2 $\mu$ F, the frequency lowers to 100Hz.

However, I wish to increase the final rate of rolloff to either a second-order or third-order low-pass. Is adding an inductor, or inductor and capacitor to the intended subwoofer a viable method of doing this? Would there be any unfavorable interaction? From my understanding, when you cascade an active and passive filter the crossover point is down 6dB.

I would like to know how to achieve an overall, determined crossover frequency. Also, what about the type or shape of filter (Butterworth, Chebyshev, Bessel)? For simplicity let's say that the determined frequency

will be 100Hz and that subwoofer has a flat impedance of 8 $\Omega$ .

Alan Ersen  
Carmichael, CA 95608

Robert Bullock responds:

In response to your inquiry about modifying your subwoofer amplifier by adding a passive section at the input of your amp, I believe this can be done but I cannot tell you how. The design requires such information as load and source resistance that I don't know how to find. You also must take into account the loading effect of the high-pass filter (C2) and probably other factors that I don't see.

To increase the filter slope in your situation I would add a buffered active section between the preamp and amp. That way, you needn't worry about the possible interactions, just the cascading effect.

At this point you could use any second-

order section, which would cascade with the first-order section in the amp to give you a third-order filter. For example, if the second-order section had a corner at 200Hz and a Q of 1, then the combination would be a third-order Butterworth low-pass. Other filter shapes are possible, but determining the correct corner frequency and Q would be much harder. That is why Butterworth filters are so commonly used. Old Colony (PO Box 243, Peterborough, NH 03458, (603) 924-6371 or 6526, FAX (603) 924-9467) sells all the boards you need to design your own active filter.

If you are determined to pursue your passive modification, you could obtain some idea of how it would work by first adding the components before the amp. If it works OK that way then you could fix it permanently. Just remember that the inductor and capacitor values are different, depending on whether they are before or after the summing resistors (R1). I don't know the exact values you would need, but I hope this information is helpful.

## Roy Allison's Famed Tweeter Now Available Quantity Pricing Available---Save Big \$\$ on your Purchase

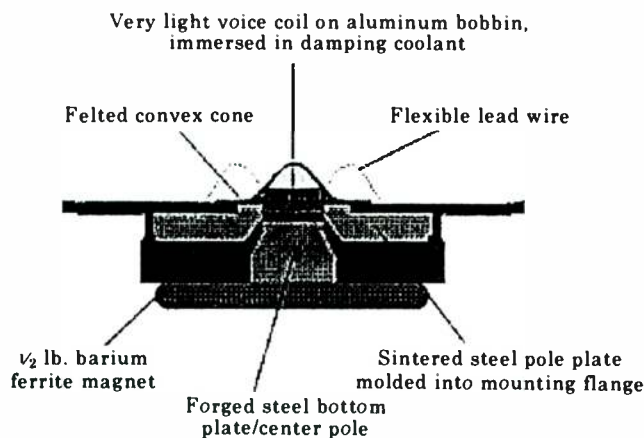

Roy Allison's Convex Dome Tweeter is world renowned for its almost perfect dispersion pattern. Edgar Villchur said of Roy Allison upon hearing this tweeter for the first time, "The student has surpassed the teacher." No other tweeter in the world creates such an even power response throughout the listening area. This is due to the pulsating hemisphere created by its unique design.

**New Low Price - \$41.00 each**

**For Specifications and Ordering**

**Call 1-800-227-0390**

# RDL ACOUSTICS

26 Pearl Street, #15  
Bellingham, MA 02019

Reader Service #39



$$L_v = \frac{1.463 \times 10^7 \times r^2}{V_B \times f_B^2} (1.463 \times r) \quad (1)$$

I would like to experiment with a rectangular port. Is the following formula correct?

$$f_H = \frac{54 \sqrt{HW/V}}{L + \frac{15HW}{H+W}} \quad (2)$$

And if so, is  $f_H$  the same as  $f_B$ ? How would you determine H, W, and L (height, width, and length)?

My second question concerns the use of R in crossover formulas. Is R the speaker resistance measured at a certain crossover frequency? Or would a more accurate result be obtained by using the speaker impedance Z calculated at crossover frequency? I have noticed the speaker impedance yields a higher value when using the law of cosines to determine the speaker impedance and resistance.

Finally, Weems' formulas for calculating ( $f_3 = 0.26Q^{-1.4}f_s$ ,  $f_B = 0.42Q^{-0.9}f_s$ ,  $V_B = 15Q^{2.8}V_{AS}$ ) differ from the formulas

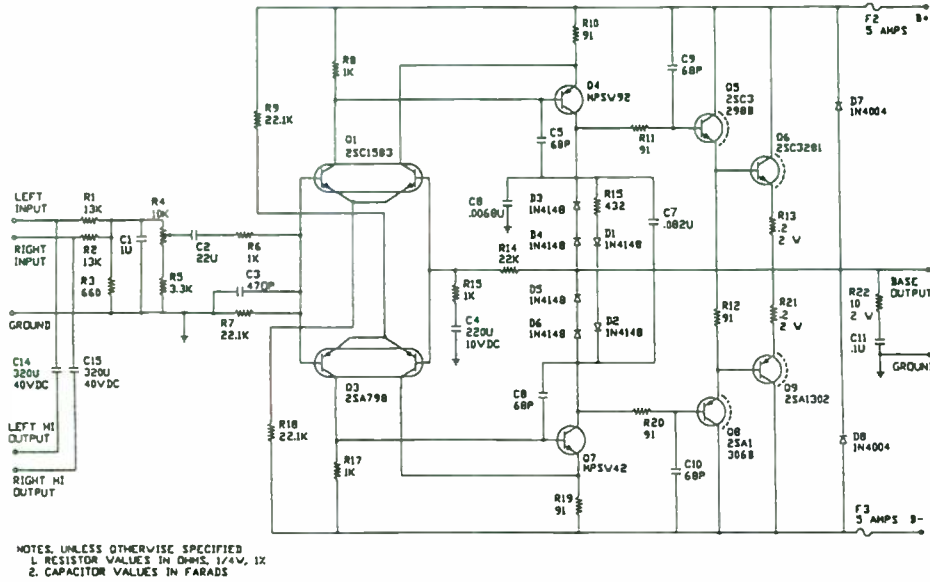

FIGURE 1: Reader Ersen's circuit candidate for modification.

## ENCLOSURE PORT SHAPES

As a novice speaker builder, I am in desperate need of some clarification which I've not been able to obtain from reading back issues

or from Mr. Dickason's (*Loudspeaker Design Cookbook*\*) and Mr. Weems' (*Designing, Building and Testing Your Own Speaker System—With Projects*\*) books. With regard to the (port length) calculations, the only formula that I've seen is for round port:

impedance and resistance.

Finally, Weems' formulas for calculating

( $f_3 = 0.26Q^{-1.4}f_s$ ,  $f_B = 0.42Q^{-0.9}f_s$ ,  $V_B = 15Q^{2.8}V_{AS}$ ) differ from the formulas

## WHY IS THIS GUY IS ALL SMILES?

(Hint: read the fine print at the bottom of this ad)

World Class Hardware  
at the best prices in  
Canada!

Loudspeaker Design  
Information Series -  
Providing hands-on  
learning for speaker  
builders



Kits galore!

Custom designs and  
consulting.

Our policy: Always  
suggest the lowest  
cost system which  
meets the customer's  
needs.

### Technologie MDB

Focal/Cabasse/Accuton/SEAS/Morel/SCR/Axon/Black Holc/l'Atelier Audio/Intertechnik/Top Box/Kits by Marc Bacon

Sales:  
5445 de Lorimier, Suite 108, Montreal, Quebec H2H 2C3  
Telephone: (514) 891-6265 9:00 A.M. to 5:00 P.M. EST

Administration and Engineering:  
4000 Terrasse Jean XXIII St. Hubert, Quebec J4T 3L6  
Fax: (514) 443-5485

**Answer:** He called our after-hours "hot line" and got an answer to his speaker building questions. You can get the same satisfaction at a time convenient to you by calling (514) 891-6265 from 6:30-8:00 EST weekday evenings and 9:00-12:00 A.M. Saturdays.

$$(V_B = V_{AS}/\alpha, f_B = H \times f_S, f_3 = (f_3/f_S) \times f_S)$$

used in design tables. Are Mr. Weems' formulas the same as discrete alignments? Or are they a general way of calculating?

Roman Lock  
Tustin, CA 92680

Robert Bullock responds:

All port length formulas that I know of are based on material in sections 5.5 and 5.6 of Acoustics\* by L. L. Beranek. The derivations

in Acoustics are for a circular tube, but Beranek implies that cross-sectional shape (round, square, rectangular, trapezoidal, and so forth) is immaterial as long as viscous losses and transverse resonances can be neglected. Thus, it would seem that any cross-sectional shape can be used as long as its area is not too large and it has no slit-like portions. For now, we will assume nothing about the shape of the port except that its cross-sectional area is  $S$ .

The resonant frequency of an enclosure-port combination is related to the compliance  $C$  of the enclosure air and the mass  $M$  of the port air by the formula

$$f_B^2 = \frac{1}{4\pi^2 CM} \quad (1)$$

For  $C$  and  $M$ , Beranek derives the formulas  $C = V/(\gamma P_0)$  and  $M = (\rho_0 L_E)/S$ , where  $V$  is the enclosure volume,  $L_E$  is the effective length of the port,  $\gamma = 1.4$ ,  $P_0$  is static air pressure, and  $\rho_0$  is air density. In practice the plug of air in a port that acts as a mass extends somewhat beyond the ends of the port at each end, so  $L_E = L + L_{C1} + L_{C2}$ , where  $L$  is the physical length of the port and  $L_{C1} + L_{C2}$  is the end correction, i.e.,  $L_{C1}$  and  $L_{C2}$  are the lengths of the extensions at each end. Plugging all this into Equation 1 and solving for  $L$  gives

$$L = \left( \frac{\gamma P_0}{\rho_0} \right) \left( \frac{S}{4\pi^2} \right) \left( \frac{1}{f_B^2 V} \right) - (L_{C1} + L_{C2})$$

To simplify it is known that  $c^2 = \gamma P_0 / \rho_0$  where  $c$  is the speed of sound in air. Also, Beranek shows that the end correction  $L_{C1} + L_{C2}$  always has the form  $A\sqrt{S}/\pi$ . This allows the general port length formula to be written as

$$L = k \left( \frac{S}{f_B^2 V} \right) - A \sqrt{\frac{S}{\pi}} \quad (2)$$

where

$$k = \left( \frac{c}{2\pi} \right)^2$$

A port end is either flanged (e.g., the end in the baffle) or unflanged (e.g., the end inside the enclosure). If both ends are flanged (e.g., a hole in the baffle) then  $A = 1.7$ . If one end is flanged and the other is not (the usual) then  $A = 1.463$ . If both ends are unflanged then  $A = 1.226$ .

For the usual circular port,  $S = \pi r^2$  and  $A = 1.463$ , so that Equation 2 becomes

$$L = (k\pi) \left( \frac{r^2}{f_B^2 V} \right) - 1.463r$$

For  $V$  and  $r$  in meters  $k\pi = 9441$ . In inches  $k\pi = 9441(39.37)^2 = 1.463 \times 10^7$ . This latter value gives your first formula.

To get formulas for an  $H$  by  $W$  rectangular port with one flanged and one unflanged end, let  $S = HW$  and  $A = 1.463$  in Equation 2. The result in inches is

$$L = 4.659 \times 10^6 \left( \frac{HW}{f_B^2 V} \right) - 0.825 \sqrt{HW}$$

This formula is not related to your second formula in any way I can see, even if the units were changed.

# HI-FI NEWS & RECORD REVIEW

## THE WORLD'S MOST RESPECTED HI-FI MAGAZINE

SUBSCRIBE TODAY AND GET THE NEXT 12 ISSUES FOR \$65.00 USA \$75.00 CANADA

Please send me the next 12 monthly issues of Hi-Fi News and Record Review from the next available issue.

Mr/Mrs/Miss/Ms \_\_\_\_\_

Address \_\_\_\_\_

Apt# \_\_\_\_\_

City \_\_\_\_\_

State \_\_\_\_\_ Zip \_\_\_\_\_

### METHOD OF PAYMENT

- Check enclosed (US dollars and drawn on a US bank)  
 Please charge my  Visa  Mastercard  American Express

Account No. \_\_\_\_\_ Exp. date \_\_\_\_\_

Signature \_\_\_\_\_ Date \_\_\_\_\_

Please bill me

Return to Hi Fi News & Record Review, PO Box 384, Avenel, NJ 07001

**FOR FASTER SERVICE USE YOUR CREDIT CARD AND CALL TOLL FREE**

**☎ 800-688 6247**

AA41

As a final observation, Equation 2 for a circular port in inches flanged on both ends is

$$L = 1.463 \times 10^7 \left( \frac{r^2}{f_B^2 V} \right) - 1.7r$$

This is sometimes solved for  $r$  in terms of  $L$  by the quadratic formula to obtain a formula for the radius of a hole drilled in a baffle of thickness  $t = L$  that would provide a resonant frequency  $f_B$  in a box of volume  $V$ . The resulting formula for  $r$  is

$$r = 5.81 \times 10^{-8} f_B^2 V + \sqrt{(5.81 \times 10^{-8} f_B^2 V)^2 + 6.84 \times 10^{-8} V t}$$

As to your second question, the best value to use for the resistance  $R$  in crossover design formulas is difficult to answer. The problem is that almost all such design formulas assume the load is resistive, but for practical crossovers this is almost never true. I try to make the load as close to resistive as possible, at least around crossover frequencies. Then the formulas have a better chance of giving good results.

I use a Zobel across the driver terminals for this purpose. It should be chosen to produce an impedance that is nearly constant, at least for

an octave or so on either side of the crossover frequency. Some experimentation with Zobel values may be necessary to do this. I use this nearly constant value for  $R$ . Theoretically this value should be  $R_E$  but sometimes another value may be a better choice, depending on the Zobel component values.

I am sure others have different procedures, which may be more or less sophisticated depending on their test equipment situation. This load problem can be eliminated only by using an active crossover. Then the filter-shaping circuit is isolated from the driver load. Of course, going active replaces one set of problems with another.

In response to your last question, the alignment formulas you list are approximations to a certain class of alignments, probably the QB3-C4 series. They are obtained by doing a least-squares fit to a table of exact data. The exact alignment data cannot usually be obtained from simple closed form formulas but must be found by one of various iteration techniques. To obtain closed form formulas for this data you then guess what type of functions would be appropriate.

In the case of your formulas, my guess is that the alignment variables  $h$  and  $\alpha$  are related to driver  $Q$  by a relation of the form  $y = aQ^b$ . The technique of least-squares fitting is a procedure for choosing  $a$  and  $b$  in each

## THE LEGENDARY



### STRATHEARN AUDIO Pure Ribbon Driver

Mid Range - High Frequency  
Perfectly made in Germany.

Specifications:

Frequency response: 450-20000 Hz  $\pm 3$  dB  
Crossover point 2 units = 350 Hz  
Crossover point 3 units = 250 Hz  
Power handling: 100 Watts RMS  
Sound pressure level:  
87 dB / 1 w / 1 m / 8 Ohm transformer  
90 dB / 1 w / 1 m / 4 Ohm transformer  
Dimensions: 135 x 595 x 30 mm  
Weight: 3.3 kg

Price: **\$399**

incl. transformer  
Payment per MasterCard  
or American Express Card.  
Distributor enquiries welcome.  
Brochure & technical data  
on request.



EXPORT DIVISION

Jüdefelderstraße 35 + 52  
D-48143 Münster

Phone: (011)-49-251-5 83 30  
Fax: (011)-49-251-4 39 56

Reader Service #53

## HIGH PERFORMANCE ELECTRONIC CROSSOVER NETWORKS THESE COMPONENTS AVAILABLE FULLY ASSEMBLED OR AS KITS



**XM9-CA2 and XM9-CA3 Custom Cabinet** (for automotive use) Accommodates 2 or 4 XM9 or XM16 Crossovers and PS15 (or PS10) power supply to make either 2-way or 3-way system. • Buy cabinet only, kit, or fully assembled with circuit boards.

**PS10 Power Supply** (for home use) converts 120 VAC to dual 15 VDC supply • Regulated • Can support 8 crossover networks.

**PS15 Power Supply** (for automotive use) converts 12 VDC to dual 15 VDC supply • Can support 4 crossover networks.

**XM9 Crossover Network** • 24 dB/octave slope • fourth-order constant-voltage design • Outputs in phase • Low noise • Controls on circuit board or panel • Settable crossover frequency from 20-5,000 Hz.

**XM16 Crossover Network** • 48 dB/octave slope • Eighth-order constant-voltage design • Outputs in phase • Low noise • Controls on circuit board or panel • Settable crossover frequency from 20-5,000 Hz.

**XM9-C and XM16-C Custom Cabinets** (for home use) Accommodates 2 or 4 XM9 or XM16 Crossovers and PS10 (or PS15) power supply to make either 2-way or 3-way system. • Buy cabinet only, kit, or fully assembled with circuit boards.

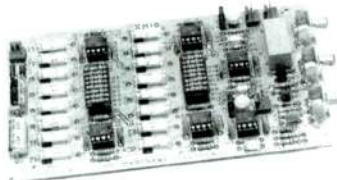

**WM8 "BASSIS" Bass Correction Equalizer** extends bass response by 1 to 2 octaves • Adjustable bass boost and damping • Rumble filter • 20 Hz subsonic filter.

**PM2 and PM22 Power Amplifier Modules** provide 75 watts RMS into 8 ohms • Complementary Darlington output stage • Integrated-circuit driver circuit • Over-current and over-temperature protection • Class A or Class AB operation.

WRITE NOW FOR FREE LITERATURE ABOUT THESE AND OTHER MARCHAND PRODUCTS

SEND YOUR NAME AND ADDRESS TO: MARCHAND ELECTRONICS, INC.

P.O. Box 473 • WEBSTER, NY 14580 • PHONE (716) 872-0980 • FAX (716) 872-1960

Reader Service #28

Speaker Builder / 7/94 51

case so that at table Q's the value of y is as close to the exact table value as possible. How closely such formulas are to exact alignments depends in part on how well you guess the function type to be used.

In Bullock on Boxes\* I give an alternative set of such formulas on p. 6. These are obtained from the tables of exact alignments appearing on the same page and the previous one. The error in these formulas ranges from a fraction of a percent to about 20%, depending on the value of Q.

These alignment formulas have nothing to do with the last formulas you list, which are just the definitions of the alignment variables  $\alpha$ ,  $h$ , and  $f_s$ .

\* (The four books mentioned in this correspondence are available from Old Colony Sound Lab, PO Box 243, Peterborough, NH 03458, (603) 924-6371, 6526. FAX (603) 924-9467.)

## CROSSOVER CONFUSION

I have read the *Loudspeaker Design Cookbook*, but I still have several unanswered questions concerning loudspeaker crossover design.

First, I understand the basics of why you reverse the polarity of the drivers for some

crossover slopes, but is it different for Butterworth filters compared to Linkwitz-Riley filters? I have built several crossovers and have used reverse polarity connections when specified in the LDC. When several driver suppliers analyzed the circuit with LEAP, the results did not call for reverse polarity hookup in the schematic. Why?

Second, what is meant by the term "quasi-second-order" filters and why and how are they implemented?

My final and most confusing questions involve loudspeakers with multiple drivers, i.e., large MTM-type designs with two additional woofers or loudspeakers with four or five drivers. These designs do not use an active crossover with more than one power amplifier to drive the loudspeaker. How do you design crossovers for multiple three-, four-, and five-driver systems? If these drivers are used in the preferred parallel crossover configuration (not series), won't this create a sub-ohm load to the power amplifier? How is this topology implemented in such excellent designs as, for example, the Thiele CS3.6 & CS5, Vandersteen 2Ce & 3, and the Dunlavy SC-IV & SC-VI?

These loudspeakers sound great with multiple drivers (4-8 $\Omega$  impedances each), yet they present easy loads for most amplifiers to drive (between 4-6 $\Omega$  minimum total system impedance). How do these talented designers incorporate so many drivers in a system without the harsh, <4 $\Omega$  minimum impedances? Are they using the preferred parallel connections to the drivers, or some combination of series/parallel that keeps the impedance minimum above 4 $\Omega$  over their frequency range?

Peter J. Groth  
Clinton Corners, NY 12514

*Robert Bullock responds:*

One reason driver suppliers may not recommend polarity reversal is that they may not give any recommendations at all regarding polarity. Another possibility is that the program they use for suggestions may not give advice on polarity or it may advise for or against reversal based on more complete information than just the crossover order. When polarity is best reversed in a system is not answered solely on the basis of crossover order. I have frequently recommended that a home builder try both polarities and use the one that sounds better, even if it goes against conventional polarity wisdom.

Consider a two-way system with a second-order crossover. The reason for reversing polarity is to adjust the phase of the two sections so they add together without a dip at the crossover frequency. Now, if the tweeter is set ahead of the woofer as is common, then there

# Increase your electronics know-how and skills

The speed and intensity with which electronics penetrates our daily lives at home, at work, or in our car, tends to make us forget that we **can use electronics creatively** by building designs with a practical application and having the satisfaction of a successfully finished project. *Elektor Electronics*, which is distributed all over the world, can help you achieve these goals. Throughout the year, the magazine features original construction projects, informative articles and news on the gamut of electronics, science & technology, book reviews and information on new products. The past 11 issues contained 80 major and 97 minor construction articles, 21 articles of an educative or instructional nature, and 10 articles dealing with Science & Technology.

If you wish to increase your electronics know-how and skills, take out an annual subscription to *Elektor Electronics* by writing or faxing to

**World Wide Subscription Service Ltd  
Unit 4, Gibbs Reed Farm  
Pashley Road, Ticehurst  
East Sussex TN5 7HE, England  
Telephone +44 580 200 657; Fax +44 580 616**

You will then have the convenience of having the magazine delivered to your home, and the peace of mind that you will not miss any issue. The current rate for an annual subscription (11 issues) is \$US 57.00 (post paid - airspeeded).

There are also a number of *Elektor Electronics* books geared to the electronics enthusiast - professional or amateur. These include data books and circuit books, which have proved highly popular. Two new books (published November 1993) are *305 Circuits* and *SMT Projects*. Books, printed-circuit boards, programmed EPROMs and diskettes are available from

**Old Colony Sound Lab  
PO Box 243, Peterborough NH 03458  
Telephone (603) 924-6371, 924-6526  
Fax (603) 924-9467**

is an additional phase increment already present in the high-pass branch of the system due to driver offset. If that phase component is close to  $180^\circ$ , then reversing the polarity will add another  $180^\circ$ .

The net effect will be no phase shift at all and the combined signal will have a severe dip at the crossover. The problem is that you cannot usually tell without sophisticated measurement how much of a phase increment the driver offset is causing. Also, there are other factors, such as listening position, that affect phase. So the simplest alternative is to listen to the system with both polarities and use the better-sounding one.

As to your second question, a quasi-second-order crossover is actually a first-order network that looks like second-order close to the crossover frequency. Small coined the term, I believe, in a paper that examined several nonstandard crossover topologies. This particular network was nonstandard, as I remember, because it was series-connected rather than parallel-connected. I have never seriously considered using it because I almost never use first-order networks. In circuit theory parlance the prefix "quasi" seems to mean "looks like."

The number of drivers in a system is only a load problem when there are several in the

same band. For example, if you have one woofer, one low midrange, one high midrange, a tweeter and a super tweeter, then the crossover takes care of maintaining a balanced load even though five drivers are in the system. You only have a problem if you do not use a crossover network.

On the other hand, if your system has two, four, or even eight drivers in the same band, then you must address a potential load problem. For two identical drivers in the same band the composite driver will have an impedance of either half or twice that of one of the drivers, depending on whether they are hooked in parallel or series. The  $4\Omega$  connection is usually chosen because most modern amplifiers will still be able to drive the load at its rated output. So you will expect to get a resulting doubled SPL.

Now consider using four drivers, say at  $8\Omega$  each. The parallel connection will present a  $2\Omega$  load to the amplifier. This load is unacceptable to some amplifiers; that is, the amplifier may not be able to deliver its rated power into this load. So, a designer may decide to use a parallel-series or a series-parallel connection to keep the composite driver at an  $8\Omega$  rating and be kinder to amplifiers. Greiner, who has studied the best connection in this case, recommends, as I

recall, parallel-series (two parallel branches each containing two drivers in series).

The Bose 901 is probably one of the most famous multiple driver systems in that it uses nine full-range drivers and yet maintains an acceptable load impedance. I do not know how it is arranged, but I am sure it required some work to figure out an optimal arrangement. It most likely includes some parallel-series juggling as well as the possible use of dummy loads (resistors).

## CORNER FREQUENCY

I would like to know how to mathematically derive corner frequencies for various orders of rolloff when the  $-3\text{dB}$  or  $-6\text{dB}$  down point is known. Conversely, how do you determine the  $-3\text{dB}$  or  $-6\text{dB}$  down point when the corner frequency is known?

Alan Ersen  
Carmichael, CA 95608

Robert Bullock responds:

The relationship between corner and cutoff frequency for filters is not simple; calculating

# Electrostatic Loudspeakers

"No other speakers on this planet unravels detail as well, while preserving music delicacy."

Dick Olsher, *Stereophile*, March 1994, vol. 17 No.3.

Amantis Audio ELP-48, 6"x48" electrostatic panels with interlocking frames. Designed to operate as a single transducer, or in arrays of 3, 5, or more. Adjust the array's curvature to suit your dispersion preferences.

The ELP-48 features:  
Vacuum coated diaphragms.  
Insulated perforated panels.  
Precise and constant diaphragm tension.

Amantis Audio components:  
High voltage power supplies, step-up audio transformers, equalizers and crossovers.

### Amantis Audio inc.

184 North Main St.  
Champlain, NY, 12919  
(514) 383-0475



Dealer and OEM inquiries welcomed!

**1981** A Testing Unit for Speaker Parameters • Variable-Volume Enclosure • Thiele/Small Theory, Pt 1-3 • Easy to Make Enclosure Using Concrete Blocks • The Tractrix Horn: Good Dispersion Bass From an Old Design • Diffuser Port for Small Boxes • Mini-Speaker Made From PVC Tubes • Closed vs. Vented Box Efficiency • Interview with P.G.A.H. Voigt • Dual 8" Symmetrical Air Friction Enclosure • Thiele/Small Calculator Computation • Thiele/Small Parameters for Passive Radiators •

**1982** Transmission Line Theory • Thiele/Small Sixth-Order Alignments • The Quad 63 • Table Saw Basics • AR-1 Mods • Active Crossovers and Phase • Three Transmission Line Speakers • A Beginner's First Speaker • How Passive Networks Interact with Drivers • Horn Loaded Heil • Phase Correcting Active Crossover • Wind Your Own Inductors • Series and Parallel Networks • High Performance Corner Speaker • Using Zobel's to Compensate for Driver Characteristics •

**1983** Building the Two-Way Dynaudio • A Crossover That Offsets Speaker Impedance • Using a Calculator for Box Design • Choosing a Calculator • A Simple Peak Power Indicator • A Small Horn Speaker • Audio Pulse Generator • How to Use Speaker Pads and Level Controls • An Easy-to-Build Voltmeter for Speaker Measuring • Nomograms for Easy Design Calculations • Interview with KEF's Raymond Cooke • Build a Simple Wattmeter • A New Type of Speaker Driver •

**1984** Build an Aligned Satellite/Woofer System • BOXRESPONSE: A Program to Calculate Thiele/Small Parameters • Casting with Resins • A Phase Meter • An Interview with Ted Jordan • Building the Jordan-5 System • Self-Powered Peak Power Indicator • Closed Box Design Trade-offs • How to Build Ribbon Tweeters • Build a Dual Measurement Impedance Meter • A High-Power Satellite Speaker System • Build and Use a White/Pink Generator • Sound Pressure Level Nomographs •

**1985** OUT OF PRINT, some single issues still available at \$5 each. •

**1986** The Edgar Midrange Horn • Sand-Filled Stands • Crossover Networks: Passive and Active • 5-Sided Boxes • A 2 x 4 Transmission Line • The Free-Volume Subwoofer • Notch Filters • By-Wiring the LS3/5A • A Push/Pull Constant Pressure System • Current and Power in Crossover Components • The Unbox (Egg) • Upgrade Speakerlab's S-6 Crossover • Measure Speakers with Step Response • A Gold Ribbon System • A Visit with Ken Kantor • A Tractrix Horn Design Program • Reviews: Audio Concepts "G"; Seven TL Midranges; Focal's Model 280; the Audio Source RTA-ONE •

**1987** A Compact TL Woofer • Frequency Response and Loudspeaker Modeling, Pt 1-3 • A Manual Coil Winder • The Model-One Speaker • Designing a Listening Room • A Sixth-Order Vented Woofer • Tapered Pipe Experiments • Visiting Boston Acoustics • A Vented Compound System • The Octaline • Spreadsheets for Speaker Design • In Memoriam: Richard Heyser, Pt 1-2 • Using Non-Optimum Vented Boxes • Building Speaker Stands • Evaluating Driver Impedance Compensation • Tuning Bass Reflex • Six Woofers Compared • Bullock on Passive Crossovers: Alternate Bandpass Types • Fast, Easy Filter Calculations • A Mobile Speaker • Polk 10 Mod •

**1988** Electronic Turns Counter • Two-Way Design • Minimus-7 Mod • Dome/Midrange/Tweeter Array • Plotting Complex Impedances • A Driver Design Primer • A Cabinet Primer • Tuning Up Old Systems • Low-Cost AR-3 Upgrade • Electronic Time Delay • Enclosure Shapes and Volumes • Minimum-Phase Crossovers • Spot Sound Absorbers • How to Add a Subwoofer • The Swan IV System • Sub-Bass Power Boosting • The OnLine: A Short TL • Active Filter Computer Design Program • Low-Cost Two-Way Ribbon • Amp-Speaker Interface Tester and Construction Plans • The QB<sub>3</sub> Vented Box is Best • A Pentagonal Box System • Keith Johnson Profile • Sheathed Conductor ESL • A Symmetrically Loaded System, Pt 1 • Ceramic Enclosure • Inductance Measuring Technique • Polk 10 Mods •

Please send me the following back issues of Speaker Builder

- |   |   |   |   |
|---|---|---|---|
| <input type="checkbox"/> <b>1993 \$25</b> | <input type="checkbox"/> <b>1992 \$25</b> | <input type="checkbox"/> <b>1991 \$25</b> | <input type="checkbox"/> <b>1990 \$25</b> |
| <input type="checkbox"/> <b>1989 \$21</b> | <input type="checkbox"/> <b>1988 \$23</b> | <input type="checkbox"/> <b>1987 \$20</b> | <input type="checkbox"/> <b>1986 \$20</b> |
| <input type="checkbox"/> <b>1984 \$18</b> | <input type="checkbox"/> <b>1983 \$18</b> | <input type="checkbox"/> <b>1982 \$18</b> | <input type="checkbox"/> <b>1981 \$18</b> |

### SHIPPING BACK ISSUES

UPS: Domestic ground service by value of order:  
 Less than \$60.00-\$4.50      \$131.00-220.00-\$ 8.50  
 \$61-\$130.00-\$6.50      \$221.00+-\$10.50

Canada: Add \$6.00 per year.

Foreign Air: Europe: add additional 40% of total order

Total Magazines \_\_\_\_\_

Other destinations: 50% of total order.

Postage \_\_\_\_\_

Foreign Surface: add additional 20% of total order.

TOTAL ENCLOSED \_\_\_\_\_

Rates subject to change without notice. All remittance in US \$ only drawn on US bank.

- Check or Money Order**     **Discover**     **MC**     **VISA**

**1989** (5 Issue Set: VERY LOW STOCK) The Audio Laboratory Speaker System • A Passively Assisted Woofer • Digital Filter Tutorial • The Listening Arc Alignment • Small IC Power Amp & Crossover • Easy Surround Sound • Building Speaker Spikes • An Isobarik in a Thunderbird • Sheetrock Cabinetry • A Picket Speaker • Servo-Controlling AR-1 • Silent, Safe Muting System • Equalizing the Klipsch Cornwall • A Test Switcher • Visiting the Klipsch Kingdom • Rehab for Kitchen Music • Spreadsheet Design • A Subwoofer/Satellite System • Impedance Measurement as a Tool • Practical Passive Radiators • A Symmetrical Dual Transmission Line, Pt 1-2 • The Microline • A Voice Coil Wheatstone Bridge • Tweeter Q Problems • A Dipole Subwoofer for the Quad • Adjusting Woofer Properties • Modifying Paradigm's 7se •

**1990** Acceleration Feedback System • Cylindrical Symmetric Guitar TLs • Compact Integrated Electrostatic TL, Pt 1-3 • Minimus-7 Super Mod • The Show (Bass Horn) • A Small Two-Way System • Helmholtz Spreadsheet • Heresy Upon a (Klipsch) Heresy • Beer Budget Window Rattler • Contact Basics • MDT Mini-Monitor Speaker System • Titanium + TPX + Polypropylene = Fidelity • Tom Holman, Skywalker, and THX, Pt 1-2 • Bud Box Enclosure • Klipschom Throat Riddle • Modular Three-Way Active Speaker • CD Speaker System • SPEAKER DESIGNER Software • Symmetrical Isobarik • Novice Crossovers • Triamplified Modular System • Magnetic Crosstalk in Passive Crossovers • Mitey Mike Loudspeaker Tester • Symmetrical Loading for Auto Subwoofers • Improved Vented Box with Low Q<sub>TS</sub> Drivers • BOXMODEL Woofer System Design Software • Four Eight By Twos • Dynaco A-25 Mod • Klipschom Throat Revisited •

**1991** Students Building Systems • Servo Subwoofers • An Apartment TL • L-R Crossover for the Swan IV • More or Less Power • New Guidelines for Vented Boxes • The Pipes • Macintosh's Wave and Sound Programs • Creating Professional Looking Grilles • Octaline Meets D'Appolito • Using Radar to Measure Drivers • Deep Bass for GMC • PSpice LF Response Calculating • Pipe and Ribbon Odyssey • The Delac S-10 • Infrared Remote Volume Control • Backloaded Wall Horn Speaker • Mod for the Minimus 7 • Simplifying Cabinet Assembly • Fibrous Effects on TLs • The DOALs • Loudspeaker Cable • Speaker to Ear Interface • Speaker Sensitivity to Errors in T/S Parameters • TL Speaker Evaluation • Cable and Sound • Kit Reports: Little V; Audio Concepts' Sub-1 •

**1992** Rumreich on Box Design & Woofer Selection • MLSSA • Double-Chambered Reflex by Weems • Active Crossover and Delay • Electrical Circuit Bandpass Enclosure • A Dreadnaught System (satellite swivels) • Designing Real-World Two-Way Crossovers • 20-foot Ribbon Dipole Speaker • Biamping the Sapphire II • Capping Passive Crossovers • A High Quality Speaker Cabinet • 1/3-Octave Noise Source • Disappearing Loudspeaker • The A&S Soundoff Winner, Pt 1-2 • Alignment Jamming • Marc Bacon's "Danielle," Pt 1-2 • Double-Chambered Isobarik Bass • Ferguson's Pickup Installation • Electronic Counter for Coil Winding • Oakley on Speaker Placement • Making Your Room Hi-Fi, Pt 1 • More on Dust Caps • Spreadsheet for Nonoptimum Vented Box Design • Acoustic Resistance Tuned Enclosure •

**1993** Waslo's IMP, Pt 1-3 • Quasi-Monotonic Vented Alignments • Making Your Room Hi-Fi, Pt 2-3 • A & S Soundoff Winner, Pt 3 • Flexible Dipole Woofer • The Spline • Stalking F<sub>3</sub> • A Bi-Structural Enclosure • A Sixth-Order T/S Subwoofer Design • Speaker Enclosure Screws • Electric Bass Tri-Horn • Prism V Satellite/JBL Subwoofer, Pt 1-2 • Fidduct: Program for Designing Duct Software • Compact Coincidental Point Source Speaker • IMP: Measuring T/S Parameters • KIT REPORT: Rockford's Beginner Software/Driver Paks • SOFTWARE REPORT: Low Frequency Designer 3.01 • Three Affordable Measurement Microphones • Two Ways to Realize a Dream • Matching Driver Efficiencies • Two-Woofer Box System • Designing a Dual Voice Coil Subwoofer • SOFTWARE REPORT: Blaubox 1.2 • Tale of Three Speaker Projects • A & S Sound-off 1992 • Monolith Horn • Orbiting Satellites • Real-World Three-Way Crossovers • The Simplex • Living with a Speaker Builder • The IMP Goes MLS •

NAME \_\_\_\_\_ ACCOUNT NO. \_\_\_\_\_

STREET & NO. \_\_\_\_\_

CITY \_\_\_\_\_ ST \_\_\_\_\_ ZIP \_\_\_\_\_

MC / VISA NO. \_\_\_\_\_ EXP. DATE \_\_\_\_\_

## Speaker Builder Magazine

Post Office Box 494, Dept. B94 Peterborough NH 03458-0494

(603) 924-9464 FAX (603) 924-9467

Answering machine for credit card orders only—before 9:00 a.m., after 4:00 p.m. and weekends

Please have all information plus MCVISA available.

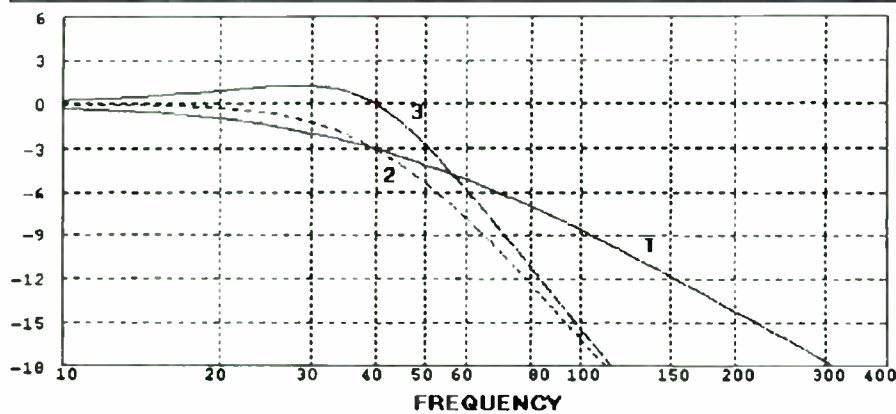

FIGURE 2: Response curves for first- and second-order filters.

one or both for a given filter always involves nontrivial algebraic manipulations and often requires more advanced mathematics. To put the matter briefly, the relationship depends on the order of the filter in a fundamental way. Discussing the problem for first- and second-order low-pass all-pole filters will give you some idea of what is involved.

For this discussion, let  $f$  be an arbitrary frequency,  $f_c$  the corner frequency of a filter, and  $x$  the ratio of the two:

$$x = \frac{f}{f_c}$$

In terms of this variable, the response function of a first-order filter is given by the formula

$$T_1(x) = 10 \log \left( \frac{1}{x^2 + 1} \right)$$

By this I mean the response curve of the filter is the graph of  $T_1$  as a function of the frequency  $f$ . This graph is shown as curve 1 for  $f_c = 40\text{Hz}$  (Fig. 2). As you see, the cutoff frequency is also 40Hz. This is always true for a first-order filter, i.e., its corner frequency  $f_c$  is always equal to its cutoff frequency  $f_3$ .

Now, let's look at a second-order filter. Its response function is given by the formula

$$T_2(x) = 10 \log \left( \frac{1}{x^4 + Ax^2 + 1} \right)$$

where  $A$  is a parameter determined by the components of the filter circuit. When  $A = 0$  the response curve is curve 2; when  $A = -1$  the response curve is curve 3 (Fig. 2). The cutoff in the former case is at 40Hz, but the cutoff frequency is not graphically clear in the latter case. In general the cutoff is found by solving for  $x$  in the equation

$$x^4 + Ax^2 + 1 = 2 \quad (1)$$

When  $A = 0$ ,  $x = 1$  clearly; but when  $A = -1$ , the quadratic formula is needed to find

$$x = \frac{\sqrt{5} + 1}{2} \approx 1.272$$

So, the cutoff frequency for the filter corresponding to curve 3 is about 50.9Hz. As you can see from this, a second-order filter can have a cutoff frequency quite different from its corner frequency. This is true for all filters of

Continued on page 65

## Mahogany Sound

2610 Schillingers Rd. #488  
Mobile, AL 36695  
(205) 633-2054

TRANSMISSION LINE SPECIALISTS

### Q&ETLD

**QUICK & EASY TRANSMISSION LINE SPEAKER DESIGN** is a new booklet that is a must for TL fans. It offers a step-by-step design procedure that really works. All you need is a calculator with a square root key, and imagination. There is also a computer diskette for use with Lotus 123, and a 6 1/2" 2-way TL project called *The Mini Monolith TL*.

Q&ETLD is \$8.95 postage paid.

### ACOUSTA-STUF

ACOUSTA-STUF is absolutely the best sound absorption fiber for transmission lines. You should order one pound per cubic foot of enclosure.

ACOUSTA-STUF costs \$8.95 per pound, UPS paid.

WRITE OR CALL  
FOR A FREE CATALOG

Reader Service #9

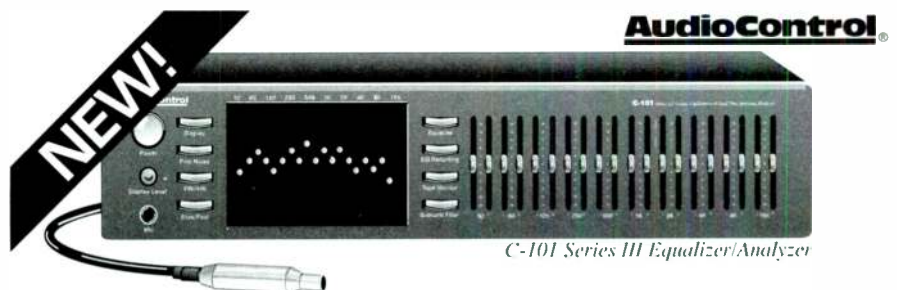

## Measure, Analyze & Equalize

- **10 band Real Time Spectrum Analyzer & Calibrated Microphone:** allows accurate analysis of listening room using built in digital pink noise generator
- **Integral trificated sliders:** provides highest levels of reliability for equalizer sliders
- **High-speed, low noise op-amps:** advanced components for improved sound quality
- **Digital audio switching:** provides shorter signal paths for better noise rejection
- **Sharp 18dB/octave subsonic filter:** removes power wasting, speaker damaging subsonic frequencies
- **Fully regulated power supplies:** maintains constant power levels for consistent performance and lower distortion
- **Made in USA with a 5 year parts & labor warranty**

**AudioControl**  
making good stereo sound better.®

Electronic Engineering & Mfg., Inc.  
22410 70th Avenue West • Mountlake Terrace, WA 98043 • 206-775-8461 • Fax 206-778-3166  
SHIPMENT TO FORMER SOVIET BLOC NATIONS NOW PERMITTED.

Reader Service #5

Speaker Builder / 7/94 55

# SB Mailbox

## CROSSOVER CORRECTION

Mr. Ron Welborne has pointed out an error in the Gaertner/Borbely article published in *SB* 1/94 ("Modular Active Crossovers," p. 20).

When calculating the crossover network (p. 22) of a third-order Butterworth (low-pass section), replace  $C_1 = m_1 C_0$ , so  $C_0 = 2,500\text{pF}$  with  $C_1 = m_1 C_0$ , so  $C_0 = 10,000\text{pF}$ .

Jean-Claude Gaertner  
91330 Yerres, France

## CHIP SOURCE

Ed Schilling recently contributed a power amp circuit (*SB* 3/94, p. 49) that uses a TDA1514

IC, which, he indicated, is difficult to obtain. I recently ordered some TDA1514s as listed in the current Catalog 14, p. 23, from Dalbani Corp., 4225 NW 72nd Ave., Miami, FL 33166, (800) 325-2264, \$20 minimum order. They cost \$9.50 each in quantities of 1-4, and \$8 for 5-9. I don't know whether these chips are made by Toshiba or have a second source, but that's always a question with ICs.

It would be helpful if Mr. Schilling could provide datasheets for the TDA1514.

Timothy Perper, PhD  
Philadelphia, PA 19147

*[Ed Schilling has the information you requested and has agreed to provide copies to those interested. Send your request with an SASE to SB c/o Editorial Dept.]*

## PIONEER COMMENTS

In reading *SB* 5/93 and 6/93, I noticed several articles describing systems with Pioneer 4.5" drivers, presumably the Pioneer model #A11EC80-02F ("A Two-Woofer Box System" by Paul T. Francis, *SB* 5/93, p. 22, and "Orbiting Satellites" by Bill Fitzmaurice, *SB* 6/93, p. 26). I have used many of these drivers in the last few years, both in home and automotive applications, and for the price, they are excellent. Currently, I am using two pairs in a D'Appolito MTM configuration in the satellites of my primary speaker system, as well as a pair for full-range drivers in my truck.

Due to a limited budget, I elected to recycle the drivers from my old car stereo system into my latest home system. The midbass drivers are modified Pioneer 4.5" A11EC80-

### FIRST PRE-PUBLICATION OFFER

### A Treasure Trove of Authoritative Power Amp and Pre-amp Designs

### AN APPROACH TO

## AUDIO FREQUENCY AMPLIFIER DESIGN

First published in 1957, this volume is the most comprehensive tubed power amp design guide available. Produced from the research laboratories of General Electric Company Limited, U.K., it covers designs from five watts to eleven hundred watts. The authors include W. I. Heath, D. M. Leakey, and G. R. Woodville. GEC and its subsidiary, M-O Valve Co., Ltd., produced some of the world's finest audio tubes, including the highly regarded KT66 and KT88. The book's nine chapters and four appendices cover Class AB and B power amps with their associated power supplies as well as two pre-amplifier designs. One of the appendices includes tube base diagrams, US and European equivalents for GEC types, as well as ratings. The book is a thorough and complete introduction to high quality amplifier design.

126pp, + 10p, 6" x 9", softbound BCAA31 **ONLY \$19.95!**

AVAILABLE SEPTEMBER 15, 1994

**YES!** PLEASE SEND ME \_\_\_\_\_ #BCAA31 @ \$19.95

FOR S/H I INCLUDE;  \$3 USA

\$5 OTHER SURFACE  \$10 OTHER AIR

TOTAL AMOUNT OF ORDER \$ \_\_\_\_\_

NAME	TODAY'S DATE
STREET	
CITY	STATE ZIP
MASTERCARD/VISA/DISCOVER#	EXP.

OLD COLONY SOUND LAB, PO BOX 243, DEPT. B94, PETERBOROUGH, NH 03458 USA

24-HOUR TELS.: (603) 924-6526 (603) 924-6371 24-HOUR FAX: (603) 924-9467



## Affordable, 1/3 Octave, Real Time Analyzer With Memories & SPL Display Under \$1000

02Fs. I sealed the cones and very porous surrounds with some Pliobond® adhesive thinned 50% with MEK. This adhesive dries to a non-tacky surface and remains flexible after drying. The modified A11EC80-02Fs are used from 70Hz-5kHz in a 0.65 ft³ ported enclosure tuned to 67Hz.

The low-pass crossover is a second-order Butterworth filter at 70Hz, chosen to protect the drivers at high SPL levels. At 5kHz, the Pioneer drivers are crossed over to the tweeters (Audax DW74s) with a third-order Butterworth crossover. The sound of these satellites is by far the best I have achieved to date. When combined with my subwoofers (four Madisound 8154s in ported enclosures), the results are amazing.

My audiophile friend was astonished that I could get such clarity from a transistor receiver and home-built speakers. He flipped when I told him that I spent less for all ten drivers in my system than he spent on his 3m pair of high-end speaker cables. With only my SPL meter, I hesitate to make any claims as to the actual system response, but the system is a pleasure to hear.

I have had excellent luck with the Pioneer A11EC80-02Fs in automotive applications as well. I used pairs from 125Hz-5kHz with an electronic crossover and a dedicated 40W/channel amplifier, and achieved excellent sound quality. SPL levels were not adequate for competition, but were more than enough to leave occupants with ringing ears after a moment's indiscretion at the volume control.

The A11EC80-02Fs fit stock 1992 Toyota 4x4 Pickup dash speaker locations without any modifications, offering a substantial improvement in sound quality over the stock speakers. This speaker is designated as an extended range model by Pioneer, and performs well full range. Low bass is lacking, as is crisp high-end definition, but the overall sound is good enough to keep me from installing anything better for the time being.

The Pioneer A11EC80-02F is an excellent low-cost driver for many applications. High efficiencies, relatively large magnets, and low prices make them an attractive option for midbass applications or minimonitors requiring multiple drivers. I have found that the best sound results from a pair used in a D'Appolito MTM type arrangement. (The articles mentioned above agree with this.) I would recommend sealing the surrounds, because those on my drivers were very poorly sealed by the factory.

Based upon my experience with these drivers, I wholeheartedly recommend them to fellow speaker builders. They are available from MCM Electronics (650 Congress Park Dr., Centerville, OH 45459, 800-543-4330, part #51-075), and Parts Express (340 E. First St., Dayton, OH 45402, 800-338-0531, part

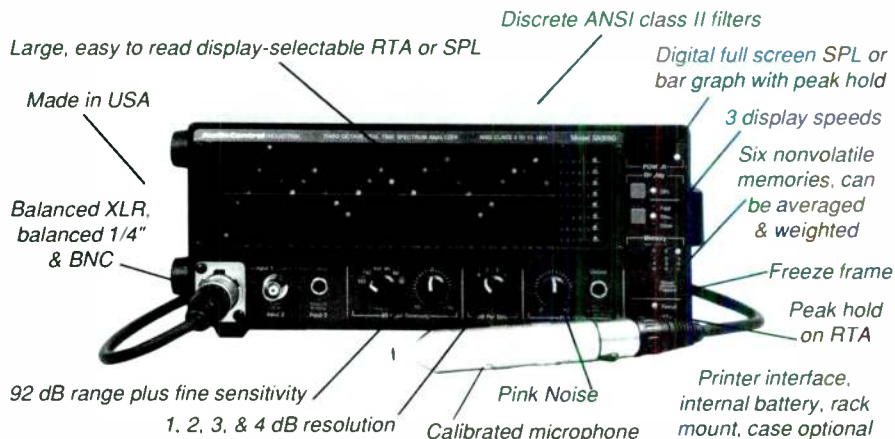

Printer interface, internal battery, rack mount, case optional

- SA-3050A with Mic \$ 995
- with Battery & Printer Interface \$1300
- Rack Mount \$ 55
- Soft Case \$ 59
- A/C Weighted Filter \$ 44

# AUDIO CLASSICS, LTD

34 Gardner Place • Walton, NY 13856 • Phone 607-865-7200 • Fax 607-865-7222

Reader Service #56

## A Quality Texture Look Without Laminating Costs and Labor! Designed For Use On Speaker Cabinets

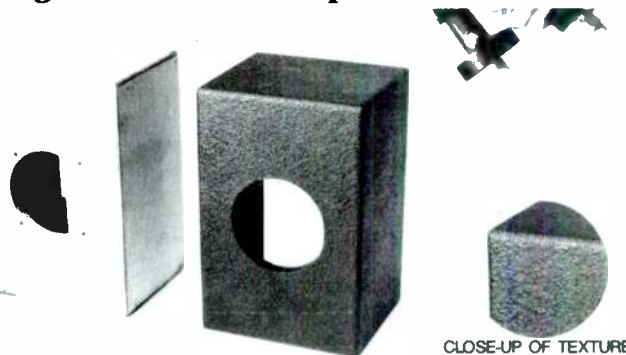

RESTORES OLD WORN OUT SURFACES

**TEXTURELAC** Spray finish produces a three-dimensional look that resembles a pebble, stucco or leather texture. It can be handled within 15 minutes of spraying and eliminates most sanding, spackling or extra paint operations. Dries to a hard mar-resistant and washable finish.

—Can reduce production spray room material and labor costs by 70 percent or more—

**TEXTURELAC** Is formulated for use on all wood, and composition woods, plastics and metal castings. It is available in most colors.

For a trial order or swatch panel of TEXTURELAC with descriptive literature call or write:



**Abilene Research and Development Corp.**

PO Box 294, Hewlett, NY 11557 • (516) 791-6943 • FAX (516) 791-6948

Reader Service #33

#290-010). I do not have current prices, but they should be approximately \$10 each. Experiment with them; they are durable, inexpensive, and sound great, too.

Mike Piechowski  
St. Louis, MO 63129

## DATA SEARCH

A friend recently returned a pair of two-way speakers based on Philips AD-8066 8" bass and 1" domes. The 10" passive radiators were shot, so I bought some cheapies. What used to sound good now sounds muddy and sloppy.

Can anyone provide T/S data for this woofer or suggest the appropriate duct diameter length to optimize a 1.6ft<sup>3</sup> box?

Paul E. Davis  
Atlanta, GA 30327

## ROOM FOR TWO?

I am designing a pair of dipole surround speakers for the rear channel of my home theater, but have been hindered by one aspect of enclosure parameters which perhaps you could clarify.

Typically, in a dual driver configuration the  $V_{AS}$  doubles. This applies to multiwoofer formats and push-pull configurations. Is this also true for dipole speakers, which appear to differ from dual woofer formats in that drivers are separated as far as possible from each other and are driven out-of-phase?

I suspect the  $V_{AS}$  doubles, but what are the advantages in making two small cabinets (i.e., separating both drivers)? Or do dipole speakers with drivers in the same cabinet and driven out-of-phase benefit in the same way as multiwoofer formats (i.e., decreased cone excursion, improved sensitivity, etc.)?

Brent Shulman  
London, Ontario N6H 1Z1

Gregory Smith replies:

$V_{AS}$  certainly does double in the out-of-phase dipole mounted in one enclosure, but don't mistake it for a push-pull driver despite the similar arrangement. A push-pull system

Published monthly and mailed first-class, *Voice Coil* is your best source of information on the ever-changing loudspeaker industry. Our regular six-page format provides you with the concise, up-to-the-minute information you need to know. Reviews of software, drivers, industry news and events, *Voice Coil* brings it all to you each month.

**YES!** I want to subscribe to Voice Coil,  
**THE** newsletter for the loudspeaker industry.

Please enter my subscription for:

- Two Years (24 issues) \$90       One Year (12 issues) \$50

Payment Method:

- Check or Money Order       VISA  
 Mastercard       Bill Me  
 Discover

CARD NO. \_\_\_\_\_ EXP \_\_\_\_\_  
NAME \_\_\_\_\_ TITLE \_\_\_\_\_  
COMPANY \_\_\_\_\_  
STREET & NO. \_\_\_\_\_  
CITY \_\_\_\_\_ STATE \_\_\_\_\_ ZIP \_\_\_\_\_

**Voice Coil**, PO Box 176 Dept B94,  
Peterborough, NH 03458-0176 USA

Phone: (603)924-9464 or FAX your order 24 hours a day to (603)924-9467

## THE SOUND OF PROFESSIONAL MONITORS AT A PRICE THAT SOUNDS EVEN BETTER

NOW YOU CAN MAKE AN EXCELLENT MONITORING SYSTEM FIT YOUR BUDGET.

For over a quarter of a century Wilmslow Audio have been "the firm for speakers" stocking the widest range of speaker drive units and speaker kits from most of the leading manufacturers and designers. Hi-fi products, Professional monitors, and Public Address equipment—all selected for sound design and reliability and in keeping with the Wilmslow Audio philosophy of value for money

### •SPL1

Near field monitor, reflex loaded design, utilising drive units manufactured by MOREL. Flatpack cabinets machined from 18mm M.D.F. **Cost £196**

"A really good monitor for under £200"

"I was immediately impressed by the sound which was surprisingly powerful and solid for such a small unit"  
Paul White, Recording Musician, May, 1990

### •VOLT HOME STUDIO MONITOR

It's not a case of "these are good for a kit," these are good—full stop. The combination of bass extension and total "honesty" will be appreciated. **Cost £420**

### •ATC K50/K100

A joint venture using the highly acclaimed ATC Loudspeaker Technology and Wilmslow Audio, has resulted in the ATC K50 and ATC K100 Loudspeaker kits.

Available in  
•ATC K50 (Passive) - £1,850 (Active) - £2,895  
•ATC K100 (Passive) - £1,950 (Active) - £2,995

Wellington Close, Parkgate Trading Estate, Knutsford,  
Cheshire WA16 8DX England



Telephone: 0565 650605 FAX: 0565 650080



All major credit cards accepted.

UK PRICES SHOWN. PLEASE CONTACT US STATING DESTINATION FOR ACCURATE QUOTATION.

FULL CATALOGUE AVAILABLE: £3.50

# Wilmslow Audio

Reader Service #50

exists only if the output from one driver fires into the enclosure. Examine your dipole system to discover that, given an input signal that moves one cone forward, the other cone moves backward due to its out-of-phase wiring. Since the cones are mounted in opposite directions, they actually move in the same direction, giving the impression that you can mount both drivers in one enclosure and not have them cancel out each other, and maybe even reinforce each other.

Keep in mind one big difference between a dipole and a standard multiple woofer system: normal multiple driver systems fire into the same hemispherical space; a dipole system fires into a full sphere (minus the dead area perpendicular to the width of the enclosure). Accordingly, you can't simply add the driver outputs to calculate system response. If the drivers aren't exactly the same (which in practice they never are), frequencies in which one driver produces a different output from the other will occur.

This is OK if both drivers fire into the same space, since the summed response will be the same. But in our surround system the interaction between the drivers becomes complicated. For example, one driver may cancel the other's output, or other such unwanted interference can occur. This will manifest itself as a different sound coming from one side of the

dipole than the other, which is unwelcome for surround speakers.

The usual benefits of multiple woofer formats don't apply here. While sensitivity over a single driver doubles, you need to distribute that output over twice as large an area. The decreased cone excursion disappears for the same reason. If you build speakers to standard surround specifications (with no significant output below 100Hz), cone excursion probably isn't a limitation anyway.

To summarize, there is no real advantage to using one enclosure as far as the drivers reinforcing each other, while there are certainly potential drawbacks. My last pair of dipole surround speakers used two separate compartments in the enclosure, which let each driver claim its own space without interaction. This design, which worked well, pre-

### PREVIEW Audio Amateur

Issue 3, 1994

- Build a Real-Time Analyzer
- Zen Revisited
- More About Resistors

# SPEAKERWORKS

## "SPECIALISTS IN THE ART OF SPEAKER REPAIR"

FACTORY AUTHORIZED SERVICE:  
Advent, B·I·C, Bozak, EPI, RTR,  
Cerwin-Vega, JBL Home & Pro

Speaker parts & adhesives,  
cones, spiders & dust caps

3 Way Crossovers Circuit  
Breaker Gold Plated Binding  
Posts \$19.95 each!

Replacement grilles for Altec,  
B·I·C, Cerwin-Vega, JBL & Marantz

Refoam kits available for 4", 5-1/4",  
6-1/2", 8", 10", 12", & 15" speakers  
- only \$29.95 (JBL slightly higher)

Special Closeout on rebuilt DYN  
Audio Drivers: MR 17.75, W30-100,  
W24-100, W17-75. BELOW COST!

**We Buy Dead Speakers: Altec, E-V & JBL**



# 1-800-526-8879



NO CATALOG AVAILABLE

CALL US FOR HARD TO FIND DISCONTINUED PARTS

4931 A-1 South Mingo / Tulsa, Oklahoma / 74146

## Resistance.



VISHAY & CADDOCK  
Metal foil and  
film resistors that  
are without equal.



## Capacitance.



SOLEN, MIT MULTICAP,  
HOVLAND & KIMBER KAPS  
Choose from our selection  
of the world's finest.



## Inductance.



SOLO-COPPER FOIL AIR CORE  
Lower resistance, reduced  
skin effect - an unbeatable  
sounding inductor.

## Performance.



KIMBER KABLE,  
AUDIOQUEST  
& CARDAS  
Precision crafted  
wire, interconnect  
and connectors.

To receive The Parts Connection 1994 Catalog  
and a \$10 discount coupon good on your first  
order over \$100, send \$5 along with your mailing  
address or call with credit card information.

## THE PARTS CONNECTION

A DIVISION OF SONIC FRONTIERS INC

2790 Brighton Road, Oakville, Ontario, Canada L6H 5T4

Toll Free Order Line 1-800-769-0747 (U.S. & Canada)

Telephone (905) 829-5858 Facsimile (905) 829-5388

MIT MultiCap • Wonder Cap • Kimber Kap • Solo • Solen  
Siemens • Hovland MuliCap • Wima • Holco • Rel-Cap  
Dralonc • Vishay • Caddock • Mills • Matsushita • TKD  
Noble • Cardas • Kimber Kable • Discovery • Audioquest  
MIT • ClearAudio • Alps • Bourns • Shalco Attenuators  
Elma • Electroschick • Nichicon • Gold Aero • RAM  
Mallory • Ruby Tubes • Linear Technology • Motorola  
Analog Devices/PMI • Edison Prico • International Rectifier  
MagneQuest • Sonic Frontiers • Pearl • Tube Sockets  
WBT • Neutrik • Curcio Audio Engineering • Kits

Reader Service #26

Speaker Builder / 7/94 59

# OHMITE



#### SPECIFICATIONS:

- 10 WATT NON-INDUCTIVE WIREWOUND.
- 1% TOLERANCE.
- TEMPERATURE COEFFICIENT:  $\pm 50$ ppm/ $^{\circ}$ C.
- OVERLOAD: 10 TIMES RATED WATTAGE FOR 5 SECONDS.
- MAXIMUM OPERATING VOLTAGE: 720 VAC.
- DIELECTRIC WITHSTANDING VOLTAGE: 1000 VAC.

#### SPECIAL FEATURES:

- SILICONE-CERAMIC CONFORMAL.
- CERAMIC CORE.
- ALL WELDED CONSTRUCTION.

#### AVAILABILITY:

0.249 $\Omega$ , 1.00 $\Omega$ , 1.21 $\Omega$ , 1.50 $\Omega$ , 1.82 $\Omega$ ,  
2.00 $\Omega$ , 2.21 $\Omega$ , 2.49 $\Omega$ , 2.74 $\Omega$ , 3.01 $\Omega$ ,  
3.32 $\Omega$ , 4.02 $\Omega$ , 4.53 $\Omega$ , 4.99 $\Omega$ , 6.19 $\Omega$ , 6.81 $\Omega$ ,  
8.08 $\Omega$ , 10.00 $\Omega$ , 15.00 $\Omega$ , 20.00 $\Omega$ , 49.9 $\Omega$ .

Don't compromise the sound of your \$50 tweeter with a 30¢ sand cast resistor. Experience the extraordinary clarity of North Creek's OHMITE precision power resistors, the most advanced power resistors made by the world leader in resistor technology. Please call or write for our complementary catalog.

## North Creek Music Systems

PO Box 1120, Old Forge, NY 13420  
Voice/Fax (315) 369-2500.

Reader Service #17

vented cancellation between the drivers (inside the cabinet, anyway). Based on experience, I recommend you use two small cabinets instead of one big one.

## A DREAM COME TRUE

If this is not quite archaeology, it's surely "BCD," before CD.

I have three kit-built DH-101s, dating from '78 and '83, in my systems, which continue to serve me well. No need for the posterous "high-end" (read: four-figure) prices here.

As at least initially supplied, the phono circuit uses a "modified RIAA...equalization similar to the IEC playback curve [producing] a low-frequency rolloff that in effect provides an infrasonic filter at all times in the phono mode [below 30cps]" (*Stereo Review*, June '78).

I'm a life-long organ nut who even 16 years ago dreamed of subwoofers. To correct this built-in bass limit, Hafler advised paralleling the existing "C5" 470 $\mu$ F with a second 470 $\mu$ F nonpolarized electrolytic in each phono channel. Hafler supplied the capacitors, which I fitted under the PC board where they cleared the bottom of the case. This might be of interest to other DH-101 owners—even though we're aware of the severe bass rolloff vinyl engineers use to keep the cutting stylus out of the aluminum base and the playback "needle" in the groove.

Woofers, especially high compliance ones in vented enclosures, can be given fits by infrasonic noise (rumble and warp) inherent in vinyl/LP playback. Hsu, which makes excellent subwoofers (I've had a pair of 82" columns with long-throw 12" speakers for about two years), suggests using a sharp cutoff below 20Hz when playing vinyl (but not CDs).

My early "Richter Scale" has just such a cutoff in addition to a rumble filter. I modified the RS for a 42Hz crossover. (More than ten years ago, I began planning for those subwoofers I would someday build, so now I use the Carver Cube at 201W per channel to drive the columns.) The CD player goes into a high-level input, and I rate my organ CDs according to floor heaving and plaster cracking.

Like Mr. Sehring ("Search for a Budget Subwoofer," *SB* 3/94, p. 20), I have four A-25 speakers, which I use as side and rear surround sources; a pair of small Adverts for "proscenium" speakers; and Definitive Technology's BP-10s for mains placed alongside the Hsu speakers. This eight-channel array is provided for by the Phase One delay unit that "saw its day" 15 or more years ago.

Continued on page 63

## ACCULINE PLANAR LINE SOURCE



Model 2.8  
Dipole Transducer  
 $\pm 3$ dB 120Hz to 19KHz  
2 ohms resistive  
87dB/1W/1M  
Power handling:  
200W RMS  
Size:  
28 $\frac{1}{4}$ "H x 4 $\frac{5}{8}$ "W x 1 $\frac{3}{16}$ "D

Breathtakingly transparent.  
Very wide dynamic range.

\$499/pr. Introductory price  
Dealer inquiries invited

(702) 832-5402 · FAX (702) 832-5407  
P.O. Box 8888 · Incline Village, NV 89452

A DIVISION OF  
**BOHLENDER GRÆBENER**  
CORPORATION

Reader Service #57

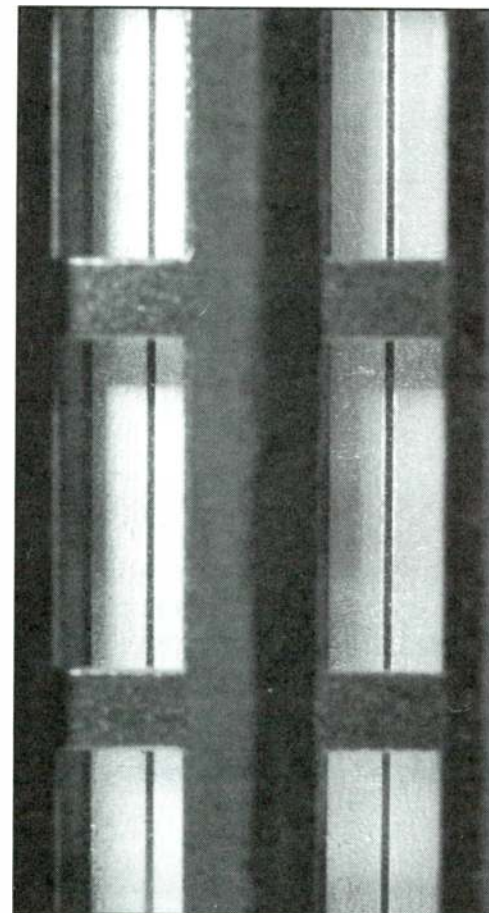

## **SPICE FOR CIRCUITS AND ELECTRONICS USING PSPICE**

*Muhammad H. Rashid*

This easy-to-read-and-follow text thoroughly and quickly introduces the reader to the SPICE simulator and its outstanding capabilities for analyzing electrical and electronic circuits. Examples of everything from passive circuits to those with active devices are provided herein. Rashid carefully describes simulation techniques and then covers the application of various SPICE commands. The circuit examples cited are those commonly used in basic circuits and electronics courses. Over 170 detailed figures. 1990, 240pp., 7 × 9¼, softbound.

**BKPH6**  
**\$33.95**

## **TROUBLESHOOTING & REPAIRING COMPACT DISC PLAYERS**

*Homer L. Davidson*

Now updated to cover the latest compact disc player makes and models, this second edition puts at your fingertips the practical service data you need to solve even the toughest problems in today's CD players quickly and easily. Whether you're an electronics student or a practicing technician, this book will prove an invaluable hands-on guide. Beginning with basic CD player principles and ending with schematic diagrams—straight from more than eleven different manufacturers—this heavily illustrated reference shows you exactly how to remove and replace defective laser heads; troubleshoot and replace low-voltage power supply circuits; service signal circuits with a scope; repair servo systems; locate and replace defective slide, load, and disc motors; build an infrared tester; troubleshoot and replace defective audio circuits; and much more!

**BKT20**  
**\$24.95**

## **BENCHWORK**

*Robert G. Dixon*

This textbook is designed to provide a basic understanding of the tools and procedures of applied benchwork related to the machine trades. Step-by-step instructions are augmented by photos, drawings, and charts, as well as safety precautions highlighted throughout the text. The book's five sections are Introduction to Practical Benchwork, including basics, materials, and fasteners; Measurement Systems, Tools, and Fitting, including units of measure, measuring tools and gages, and tolerances and fits; Layout Principles, including nonprecision, semiprecision, and precision tools; Hand Tools, including assembly tools, arbor and shop presses, chisels, files, drills, reamers, saws, taps, and dies; and Power Tools, including hand drills and grinders, saws, grinders, and special tools and procedures. 1981, 211pp., 7¼ × 10¼, softbound.

**BKDE5**  
**\$23.95**

## **THE ULTIMATE HI-FI TEST PACK 2-CD SET**

*CAD Music*

**NEW FROM SWEDEN!** These great new "gold" CDs represent the latest effort from CAD Music, one of Scandinavia's rising stars of audio precision. Produced by Clark A. Valleystream, René Corona, and Jimmy Z. 1994; two discs; CAD Music Ref. #003/1,2; 104:58. 15-page booklet in English and Swedish. Not to be confused with *The Ultimate Test CD* by Woodford Music (not carried by Old Colony). Some extremely dynamic signals—caution advised.

**CDCAD2**  
**\$54.95**

Contents: CD #1—[1] Grand gong, 0:19. [2] Guitar stack in cathedral, 1:31. [3] Soprano (recorder)/Korean song, 0:40. [4] Baroque flute, "Moon Over Ruined Castle" (Taki), 0:56. [5] Baroque flute, Japanese folksong (Sakura), 0:49. [6] Ancient Chinese folksong, 0:47. [7] Ancient Chinese folksong, 0:48. [8] Flute, "Du Går Icke Ensam" (Almqvist), 1:31. [9] Rock ballad, guitar mix, 6:13. [10]–[16] Classic guitar, stereo; mono; +6dB 125Hz, 250Hz, 500Hz, 1kHz, 3kHz; each approx. 0:49. [17]–[23] Classic vocal, stereo; +6dB 125Hz, 250Hz, 500Hz, 1kHz, 3kHz; reverse; each approx. 0:34. [24]–[27] Classic vocal 2, stereo (dummyhead); mono; L; R; each approx. 0:34. [28] Guitar stack in warehouse, 2:37. [29]–[32] Tom tom roll, stereo; mono; L; R; each approx. 0:07. [33] Tam tam tam test (tom toms), 2:12. [34]–[40] Dynamic tom toms, stereo; mono; 500Hz highpass; 500Hz lowpass; 1kHz highpass; 1kHz lowpass; reverse. [41] Autobahn, 3:40. [42] Autobahn, reverse edit, 2:17. [43] Golf swing, 0:34. [44] Stream, 1:04. [45] Airport (takeoff), 4:01. [46] Silence, 1:03. [47]–[56] 1/3-Octave band noise, left channel -20dB, right channel -16dB (On-Off); L 25Hz, 31.5Hz, 40Hz, R 31.5Hz; L 50, 63, 80, R 63; L 100, 125, 160, R 125; L 200, 250, 315, R 250; L 400, 500, 630, R 500; L 800, 1kHz, 1.25kHz, R 1kHz; L 1.6, 2, 2.5, R 2; L 3.15, 4, 5, R 4; L 6.3, 8, 10, R 8; L 12.5, 16, R 16. BONUS TRACKS from #CDCAD1, CAD Audio Reference Disc: [57] Splash in the

wilderness, 1:55. [58] Splash in the wilderness (reverse), 1:55. [59] Rain and rolling thunder, 1:56. [60] Dramatic movie magic, 3:40.

CD #2—[1] The ultimate demo ("Say aaah!"), 4:31. [2] Techno blaster, 2:10. [3] Fritz intro, 2:02. [4] Deep soft slow, 4:36. [5] Reggae groove, 1:35. [6] House groove, 1:33. [7] 3-D surround power, 1:00. [8] 3-D 360-degree spin beat, 1:10. [9] Bass blip I, 0:33. [10] Bass blip II, 0:31. [11] L vs. R, 1:35. [12] Phase out, 0:59. [13] Frequency sweep (1kHz, 5Hz-22kHz), 1:12. [14] Pink noise -20dB, L 0:30, R 0:30, both 1:00. [15] White noise 0dB, 2:06. [16]–[18] Master calibration, L 0:15, R 0:15, both 1:00, 1kHz, 10kHz, 100Hz. [19] Sine wave 1000Hz L-R check, 0:34. [20] Sine wave 1000Hz reference level, 0:35. [21]–[24] Frequency check, each approx. 0:15; 20Hz, 32, 40, 64; 120, 280, 420, 640; 800, 1.2kHz, 2.8, 5.0; 7.5, 12, 15, 20kHz. [25] 1000Hz toneburst (EIJ) 0dB, 0:33. [26] 1000Hz toneburst (EIAJ) 0dB, 0:37. [27] SMPTE code 25 fps, starts at 00:59:55:00, 8:16. [28] Pulsive signal (0dB 40ms 7 sec. +/-20% × 4), 0:32. [29] Impulse I (0dB 100ms +/-20% random × 256), 0:34. [30] Impulse II (0dB 4 sec. +/-20% random × 8), 0:28.

# **NEW THIS ISSUE**



## **PIANO TUNING**

*J. Cree Fischer*

This is the clearest and most complete book available for beginning tuners and amateur pianists. It explains all the basic processes practically and with model clarity, and even a nonmusician can use it without too much difficulty. You will learn how upright, grand, and square actions work, and how to take care of most small repairs such as repairing stuck keys, poorly adjusted bottoms and capstans, crowded back checks, felts and leather on the hammers, hammer stems; softening damper and hammer felts; installing new bridges; and eliminating "sympathetic rattles." This book teaches a professional method of tuning based on slightly flattened fifths—where only the octave and the upward fifth intervals are used—a method especially suitable for amateurs working without a teacher. If you want to experiment with tuning a piano, there is no better book to start with, and those who want to know how pianos work will find this unique volume both clear and useful. 1907, 1975, 201pp., 5¾ × 8, softbound.

**BKD12**  
**\$4.95**

## **BASSBOX 5.0 SOFTWARE FOR WINDOWS**

**SOF-BAS1B3G**

*Harris Technologies*

**\$99.00**

BassBox 5.0 is a great program that aids in the design of bass loudspeaker enclosures in two ways. First, it models how a speaker will sound in a variety of boxes. This small-signal analysis includes the amplitude (frequency response) and voice coil impedance response. Second, it models the maximum loudness of the loudspeaker/box combination. This large-signal analysis includes the displacement-limited maximum power response. Once these tools help you to decide what size and type of box to use, BassBox will then help you calculate the dimensions of its port, if the design is vented, and the box itself.

Other features include: multiple graph overlay capability for easy on-screen comparison; examination of one speaker in several different boxes or several different speakers in the same box; 1000-driver database which can be searched, edited, or added to; acceptance of both Thiele/Small (T/S) and electromechanical (E-M) parameters; allowance for damping specification; manual override of vented box tuning and QL; design capabilities for multiple-vented boxes, custom passive radiator boxes, and both "optimum" and custom closed boxes; multiple woofer designs including standard, push-pull, and compound (isobaric) acoustical parameters as well as parallel, series, and series-parallel electrical parameters; box dimension calculator accommodating many different volume shapes in a 20-volume database; English or metric units; and print capability by most printers supported under Windows 3.1 and later.

System requirements: Windows 3.1+; DOS 5.0+ recommended; IBM 386SX+ or compatible; 4Mb RAM; mouse; 4Mb hard disk space (cannot be run from floppy). Easy-to-use printed manual. Also available:

**SOF-BAS1B3G/X** BassBox 5.0 plus Xover 2.0 (see next page), **\$118.00** at a savings of \$10!

### **OLD COLONY SOUND LAB**

PO Box 243, Department B94  
Peterborough, NH 03458-0243 USA  
24-Hour Lines:  
Telephone: (603) 924-6371 or  
(603) 924-6526 FAX: (603) 924-9467

#### **OUR DISCOUNT POLICY**

Order Value	Discount
<\$50.00	0%
\$50.00-\$99.99	5%
\$100.00-\$199.99	10%
>\$200.00	15%

Mastercard, Visa, Discover, check or money order in US funds drawn on US bank.

#### **PLEASE BE SURE TO ADD SHIPPING CHARGES**

Shipping Charge According to Destination and Method Desired (\$)	United States		Canada		Other	
	Surface	Air	Surface	Air	Surface	Air
< \$50.00	3.00	7.50	5.00	7.50	10.00	20.00
\$50.00-99.99	4.00	15.00	7.50	15.00	20.00	30.00
\$100.00-199.99	5.00	20.00	15.00	20.00	30.00	40.00
> \$200.00	6.00	30.00	25.00	30.00	40.00	50.00

# NEW THIS ISSUE



## XOVER 2.0 SOF-XOV1B3G SOFTWARE FOR WINDOWS \$29.00 Harris Technologies

This package helps in the design of 2-way and 3-way passive dividing networks, as well as simple load-compensating circuits, and calculates the component values for many common first-, second-, third-, and fourth-order networks. Two-way designs include Bessel, Butterworth, Chebyshev, Gaussian, Legendre, Linear-Phase, and Linkwitz-Riley, while 3-ways include 3- and 3.4-octave spreads between crossover frequencies. Other features include design capability for load-compensating circuits such as L-pads, series notch filters, and loudspeaker impedance equalization networks; circuit diagrams with component lists that can be displayed and/or printed; and a new

filter for first-order 2-way networks, "Solen Split -6dB," in which the high-pass and low-pass halves of the network have Butterworth slopes and are set farther apart so that they cross at approximately -6dB (versus the usual -3dB).

System requirements: Windows 3.1+; DOS 5.0+ recommended; IBM 386SX+ or compatible; at least 2Mb RAM (4Mb recommended); mouse; 1.5Mb hard disk space. Easy-to-use printed manual.

## THE SEARCH FOR MUSICAL ECSTASY & THE ARCHAIC AURAL REVIVAL BKIM1 \$24.95 Harvey "Gizmo" Rosenberg

This is a bizarre book. Then again, it has a bizarre author. Founder of New York Audio Laboratories, gadfly, guru of all aural and musical, prolific *sans pareil*—these are just a few of the labels that could be pinned on Harvey Rosenberg, if you could catch up with him and keep him still in the first place. This new book is hard to describe—other than to say that it will surely be a classic—but let us say that it is one very sensitive, knowledgeable, fearless, experienced audiophile's wacky yet brilliant ramblings about his life, your life, and about a thousand other things—all infused and intertwined with an iconoclastic respect and reverence for beautiful sound and beautiful sound technology.

If you like tubes, you'll love this book. If you love music, you'll treasure it. If you treasure weird, one-of-a-kind things, you'll sleep with this under your pillow. But it is hard to describe. Parts include "My Search for the Audio Grail" and "Tweaking Ecstasy." Among the chapter titles are "Celebrating the Tribe of Audiostaxists" and "Speaking Down Untrodden Paths." One subtitle is "I Was A Teenage Mutant Audio Nerd." As Ken Kessler of *Hi-Fi News & Record Review* has written about Rosenberg's "crazed musings," "He sees music as an aphrodisiac, musical ecstasy a measure of one's development, a yardstick of maturity. Rosenberg overturns the standard values, telling us that sheer realism and total accuracy are not the final goals. The goal is musical ecstasy. Nearly all that has been written about hi-fi has been of the 'what' and 'how' variety. *The Search for Musical Ecstasy* tells us *why*."

So there you have it. This book is not for everybody, but it most certainly would be enjoyed by anybody who cares enough about quality audio to find himself reading these words. It's Julius Futterman Gets Yippie-ized. It's The Zenmeister Meets Tubezilla. Or something like that—we're still not sure. But this book should be yours—it imparts rare knowledge and makes for great fun. 1994, 350pp., 6 x 8½, spiralbound.

## ELECTROACOUSTICAL REFERENCE DATA BKNV8 John M. Eargle \$59.95

This valuable handbook offers a comprehensive collection of electroacoustical reference materials and design data—all presented in a clear and consistent graphic format that makes solving routine electroacoustical problems quick and easy. For each entry, graphical data is presented on the right-hand page, with corresponding text, examples, and references appearing on the left-hand page. Also included are sample problems with their solutions, and a convenient index that helps you to identify specific graphs and their relationships to the particular problem or project you are working on. Areas covered include: general acoustics; loudspeakers; microphones; signal transmission; psychoacoustics; musical instruments; and magnetic recording. 1994, 378pp., 8¼ x 11¼, hardbound.

## BEST OF DEMONSTRATION TEST CD, VOLUME 1 CDPV5 Disques Pierre Verany \$16.95

As the liner notes say, "These recordings were all made in natural surroundings, whether it be in the open air, in churches, or in concert halls. Our aim is to try to breathe a little human warmth into the icy indifference of electronics, and to let the sound and the music speak for themselves in all their naturalness and fullness. We shall be absolutely delighted, therefore, if the listener's initial curiosity gives way to pleasure and emotion."

Contents: [1] Nightingales, 2:51. [2] L'Epee music box, 1:56. [3] Arrival of the steam train, 1:04. [4] "Gilardeghi" barrel orchestration, 1:03. [5] Fireworks, 3:57. [6] Indian harp and organ, 2:30. [7] Big band Charleston, 3:10. [8] Tangos for two harpsichords, 4:53. [9] Percussion, 5:50. [10] Acoustical jazz, 5:19. [11] Symphonic orchestra, 4:29. [12] Russian Orthodox choirs, 3:05. [13] Steinway classical piano, 3:29. [14] Piano and chamber orchestra, 3:28. [15] Maurice Bourgue Wind Ensemble plays Mozart, 3:20. [16] Original Instrument Orchestra, 1:59. [17] Early music, 2:17. [18] Great lyrics, Pelléas and Mélisande (DeBussy), 6:01. [19] Symphonic orchestra, 2:54. [20] Great organs, 5:22. Eight-page French/English booklet.

## THE MAGIC OF INTERACTIVE ENTERTAINMENT BKS52 (WITH CD ROM) \$39.95 Mike Morrison

This blockbuster package, which includes a CD ROM as well as 3-D viewing glasses, takes a close look at hardware and software developments in numerous areas—from the text-based adventures of a decade ago to today's CD games with real-time video images. Thanks to the inside scoop from developers and employees of the hottest companies in the industry, the author and his technical editor (Johnny Wilson, Editor, *Computer Gaming World*) are able to explain the entire interactive field, what's hot now, and the future in interactive television, multimedia, edutainment, and games on all systems. Also fascinating is how they follow the creation of software titles from the initial concept through testing, marketing, and final release. In addition to the complete retail versions of VistaPro 1 (IBM PC) and Distant Suns (PC/Mac) from Virtual Reality Labs (a \$100+ value alone!), the CD ROM also contains more than 80 playable test flights of PC and Mac software, including Return to Zork; My First Atlas; Total Distortion; Aladdin and the Wonderful Lamp; Rock, Rap 'n' Roll; and Mech Warriors 2.

System requirements (in addition to CD ROM drive): Windows—386+, Windows 3.1+, 2Mb RAM, Windows-compatible mouse, VGA graphics minimum; 4Mb RAM, Windows-compatible sound card and speakers, SVGA (256-color) recommended. DOS—286+, 12MHz+, DOS 5.0+, 1Mb RAM, VGA minimum; 386+, 2Mb RAM, compatible sound card and speakers recommended. Mac—LC, II series, or better; 12-inch or larger color monitor; System 6+; 2Mb+ RAM minimum; System 7, 4Mb RAM recommended. 1994, 325pp., 11 x 8½, softbound, CD ROM included. Weighing in at more than three pounds, this is one of the best book bargains we have seen in years!

## VINTAGE HI-FI VIDEO: VDVHFP1 THE GOLDEN ERA, 1947-1965 \$29.95 Vintage Hi-Fi Productions

Divided into two segments, "Mono: 1947-57" and "Stereo: 1958-65," this nostalgic masterpiece is subtitled, "The Story of Classic American Tube Hi-Fi from Post-War to the Mid-Sixties." Included are more than 65 amps, preamps, tuners, and turntables (plus one speaker, the Stephens 106AX), created by such venerable names as Altec, Fisher, McIntosh, Scott, Dynaco, and Marantz. A worthwhile addition to any video collection! 1994, VHS, NTSC, color, 34:00.

## CANARE F-10 RCA PLUGS SCF10G Canare Cable Each \$3.95

As reviewed by Gary Galo on pages 42-43 in *Speaker Builder 4/94*, these popular new connectors are made by a performance-oriented company previously best known to audio professionals. To quote Galo: "The F-10 RCA plug is a rugged, gold-plated connector. The gold plating is extremely high quality, applied directly on brass. The best news is the insulator—pure Teflon TFE. The Canare F-10 connectors are the most economical Teflon-insulated RCA connector made, (comparing) favorably with high-end audio types costing several times as much..."

**OLD COLONY SOUND LAB**  
PO Box 243, Department B94  
Peterborough, NH 03458-0243 USA  
24-Hour Lines:  
Telephone: (603) 924-6371 or  
(603) 924-6526 FAX: (603) 924-9467

### OUR DISCOUNT POLICY

Order Value	Discount
<\$50.00	0%
\$50.00-\$99.99	5%
\$100.00-\$199.99	10%
>\$200.00	15%

Mastercard, Visa, Discover, check or money order in US funds drawn on US bank.

### PLEASE BE SURE TO ADD SHIPPING CHARGES

Shipping Charge According to Destination and Method Desired (\$)

Order Value	United States		Canada		Other	
	Surface	Air	Surface	Air	Surface	Air
<\$50.00	3.00	7.50	5.00	7.50	10.00	20.00
\$50.00-99.99	4.00	15.00	7.50	15.00	20.00	30.00
\$100.00-199.99	5.00	20.00	15.00	20.00	30.00	40.00
>\$200.00	6.00	30.00	25.00	30.00	40.00	50.00

Continued from page 60

It makes the room sound larger, but its delay is too short to let me roll reverb "down the nave" as I'd like. This requires four stereo Dynaco power amps which, with the Cube, add up to a potential 201 W per channel.

Although our rooms do not differ greatly in size or shape, Mr. Sehring's room arrangement is not practical for me because of the location of three doorways. In addition, the BP-10s are either dipolar or bipolar (I can never remember which) and must be placed several feet into the room to bounce the radiation from their rear speakers off the front wall. Pinpoint imaging is not great, but the sound is not in the main speakers but in back of them, spread uniformly across that front wall.

The author's description of phase changing with frequency is new to me. I've switched the leads to the main speakers without any real difference. The rather sharp rolloff by the electronic crossover above and below 42Hz makes phasing much less of a problem in my case. But using the audio generator and scope, or the sound level meter, to measure level at crossover is a new idea to me. Guess I'll have to put a fresh 9-volter into the Radio Shack equipment one of these days and give it a try. Keep up the interesting work, "think the good thought," and never lose hope.

E. D. Hoaglan  
Omaha, NE 68104

John F. Sehring responds:

Your modification to improve the subsonic performance of the Hafler DH-101 sounds like an excellent idea, which I shall try. Thank you for sharing it.

Your point about vented boxes for subwoofer use is well-taken. A speaker enclosure must provide a load on the driver in the form of an "air spring," which, among other things, helps protect the driver from bottoming out—reaching its maximum, safe excursion limits. With vented enclosures, at frequencies below the box resonant frequency minus one-half

octave, the driver becomes "unloaded" from the box, as if the driver were hanging in free air, effectively un-enclosed. The driver cone could then flap uncontrollably and become damaged. Correctly designed sealed box (sometimes called "air suspension") systems avoid this problem.

If your Definitive Technology BP-10s need



## BIG IMPROVEMENTS NOW COME IN SMALL PACKAGES.

### INTRODUCING FERROFLUID RETROFIT KITS.

Now OEMs who have already enhanced speaker performance with FerroSound can add ferrofluid packets to their retrofit kits.

These small, convenient packets enable service centers and retrofiters to apply ferrofluids correctly into replaceable diaphragms in the field. Results: fewer problems and more profits all along the line.

Each kit contains the right amount and type of ferrofluid for your speaker, a wicking cloth to extract used fluid, instructions, and a material safety data sheet. So add performance and profit to your speaker retrofits by calling FerroSound today at 603/883-9800 — or fax 603/883-2308.

**FerroSound**  
The Solution Is Loud And Clear™

Ferrofluids Corporation, 40 Simon Street, Nashua, NH 03061

© 1994. FerroSound and related graphics are registered trademarks of Ferrofluids Corporation.

Reader Service #51

**The Speaker Design Toolbox®**  
FRIENDLY LOUSPEAKER DESIGN SOFTWARE FOR THE MACINTOSH®

**NEW! v3.0 WITH BANDPASS ENCLOSEURE ANALYSIS \$299.00 Plus! WinSpeakerz™ FOR WINDOWS COMING SOON**

MacSpeakerz v3.0 provides everything you need to stay competitive in today's loudspeaker market...Easily, Accurately and Elegantly. MacSpeakerz enables you to expertly design these enclosures: • Closed • Vented • 3rd Order Closed • 4th Order Bandpass • 5th Order Bandpass • 6th Order Bandpass • Plus Isobarik variations on all of these! Includes: • Crossover Calculators • Box Calculators • Sound Pressure Level • Large, Expandable Driver Library (800 drivers) • Manual (with friendly tutorial) • Free Customer Support! **Call for a demo disk today!**

MacSpeakerz FROM True Image Audio® 349 WEST FELICITA AVENUE, SUITE 122, ESCONDIDO, CALIFORNIA 92025  
PHONE (800) 621-4411 8:00-5:00 PST, MON-FRI, FAX (619) 480-8961 24 HRS. A DAY, OUTSIDE THE U.S.A. PHONE/FAX (619) 480-8961

Reader Service #29

Speaker Builder / 7/94 63

**LOUDMAN™**

**Stereo power booster kit**

Plug this into the carphone jack on your portable stereo! Delivers 30 watts per channel into 8 ohm speakers with less than 0.3% distortion, 20Hz ~ 20KHz. 100% discrete transistor circuitry. Kit includes glass-epoxy printed circuit board, heatsink, all electronic parts, and complete assembly/operation manual. Requires +50 ~ 60VDC power supply (36VAC 1.5A min. transformer). \$37.95

Decade also offers a Versatile Electronic Crossover kit (\$39.95), 2-Digit Voltmeter kit (\$24.95), Speech Scrambler kit (\$34.95), and Motor Oil Tester kit (\$34.95).

MC/VISA accepted. We ship from stock.

**Decade Engineering**  
2302 5th St. NE, Salem, OR 97303-6832  
(503)363-5143 ~ FAX: (503)399-9747  
EMAIL: 73054.1755@compuserve.com

Reader Service #46

**SALE! PLUS FREE ADHESIVE!**

**MARKERFOAM™ ACOUSTIC FOAM GIANT 54" x 54"**

**Immediate Shipping**

2" Reg. \$29.95 Now \$19.99 - 3" Reg. \$39.95 Now \$29.99! KILL NOISE QUICK!

High performance, full-size sheets of super high density Markerfoam. EZ mount. Blue or gray. Super-effective sound absorption for studios. Markerfoam offers best value, looks professional & is proven in studios worldwide. Request Foam-Buyers Guide/Catalog, specs & free samples today. VISA, MC, AMEX, COD, PO's, QUANTITY DISCOUNTS.

**MARKERTEK JUMBO SOUND ABSORB BLANKETS**

Heavy-duty 72"x80" padded blankets absorb sound wherever they're hung or draped. Fabulous for stage, studio & field use. Top professional quality at a super saver price! Weight: 6 lbs. Black, \$19.99.

**MARKERTEK BLADE TILES™**

HIGH PERFORMANCE LOW, LOW COST!

\$3.49 per tile, 16x16x2". America's best acoustic tile value, only from Markertek! Charcoal. Also available 16x16x3" as shown, \$4.49 each.

**MARKERSTIK™** foam adhesive. FREE with any Foam purchase in this ad! Limited offer. A \$5.95 per tube value.

**SONEX**  
All the colors and sizes plus great prices!

**Get our FREE 149-page catalog of over 6,000 exclusive and hard-to-find supplies for audio & video.**

**800-522-2025** America's most unique catalog for audio & video!  
FAX: 914-246-1757

**MARKERTEK™ VIDEO SUPPLY**  
4 High St., Saugerties New York 12477 U.S.A.

Reader Service #10

to be located well away from surrounding walls, they may well be dipole loudspeakers. Yes, the terms bipolar and dipolar are easy to confuse. Basically, a bipolar system is capable of producing, at any time, either a positive or negative pressure in the air around it (at low frequencies anyway). Its driver cone pushes either outward or inward, creating a slight excess of pressure or vacuum, respectively.

Such a system's pattern (distribution of loudness as you walk around it) is essentially nondirectional at low frequencies. Plotted on paper, it looks roughly like a circle. If you install a second driver in the rear of the enclosure and wire it with the same polarity as the one in front, both cones will move outward and inward in unison, creating positive and negative pressure as before. So you'd still have a nondirectional pattern.

A dipolar system can also be made using our two drivers, which would need to be wired with opposite polarity. So while one cone moves outward, the other moves inward, and vice versa. If you stand directly to one side of such a system, at any one instant, the positive pressure from one driver will be mostly canceled by the negative pressure from the other driver. This gives a minimum (null) in loudness at each side at low frequencies.

Front and back, you'd discover two broad lobes of sound. If you walk around it and plot the loudness again, you'll get a figure-eight shape. Dipolar systems therefore reduce the amount of sound generated to the sides (and above and below). This can improve stereo imaging but makes reproducing a lot of loudness at low frequencies more difficult.

In surround sound applications, using dipole speakers turned 90° about their vertical axes aims the null in sound right at the listening area. This helps prevent localization of surround sound sources. As the foregoing shows, interdriver polarity is very important because you'll get very different results, and that includes woofers and subwoofers.

Even steep-slope subwoofer/woofer crossovers must work together correctly, because some frequency range overlap always occurs. Both woofer and subwoofer will therefore share in reproducing a certain band of frequencies. If they are not operated with correct relative polarity, they will tend to cancel one another at certain frequencies.

Also, low frequency transient reproduction will be impaired. A transient consists of many components of differing frequency. Due to the frequency-dividing action of the crossover, one part of the transient's spectrum may be reproduced only by the subwoofer and the other part only by the woofer. If the two parts are put back together incorrectly, with their original phase (and amplitude) relationships, the shape of the reproduced transient will be grossly changed, producing distortion.

Keeping track of phase is complex. Any

**RACKEM 'N' STACKEM™ SERIES**

**NEW!**

**Boxes**

MODEL	DESCRIPTION	PRICE \$
RSB 3	7.5 x 1.65 x 3	25.00
RSB 5	7.5 x 1.65 x 5	31.25
RSB 7	7.5 x 1.65 x 7	38.00
RSB 9	7.5 x 1.65 x 9	45.00
RSB 11	7.5 x 1.65 x 11	51.50
RSB 13	7.5 x 1.65 x 13	58.25

- Half rack size for small and dense constructing
- Full line of accessories
- Can be used on table or in rack
- Three colors available: clear standard, for black or gold add \$5.00 per box

(800) 634-3457  
Order Today!

**Table Top Racks**

MODEL	DESCRIPTION	PRICE \$
RSR 6	11.4 x 15.2 x 11	60.00
RSR 8	11.4 x 18.8 x 11	65.00
RSR 10	11.4 x 22.6 x 11	70.00
RSR 12	11.4 x 26.4 x 11	75.00
RSR 6-19	20.9 x 15.2 x 11	70.00
RSR 8-19	20.9 x 18.8 x 11	75.00
RSR 10-19	20.9 x 22.6 x 11	80.00
RSR 12-19	20.9 x 26.4 x 11	85.00

- Four models available in half and full rack widths
- Clear, black and gold anodized finishes
- Constructed of 1.0" square aluminum tubing

**SESCOM STOCKS AN ASSORTMENT OF OTHER ENCLOSURES AND MORE!**  
CALL OR WRITE FOR YOUR FREE EXPANDED 1994 CONSTRUCTOR'S CATALOG

**PREPAID ORDERS SHIP GROUND FREE (48 STATES) SESCOM, INC.**

2100 WARD DR. HENDERSON, NV. 89015 USA  
USA/CANADA (800) 634-3457 FAX (800) 551-2749  
OFFICE (702) 565-3400 FAX (702) 565-4828  
TECH LINE (702) 565-3993 M-Th 8 am to 4 pm (PST)

Reader Service #23

**"Roll Your Own Super Cables"**

A tutorial video that blows open the secrets of exotic 'HiEnd' cables, explains a radical new cable theory based on Maxwell's equations from 100 years ago, and shows you:

- \* How to make low cost interconnect cables that rival the best at any price (single or balanced)
- \* How to make the *Ultimate* interconnect — and still at a reasonable price (single or balanced)
- \* How to make paradigm breaking speaker cables that provide astonishing performance for price
- \* What wire to use, what connectors, what solder and where to buy it all
- \* Clearly shown step by step on camera, so with only basic electronics tools, you can do it too.

A response from one astonished client:  
"Should I really be bearing more definition and clarity from these \$25 homemade than I get from my \$1000 NBS interconnects?"

Special offer to **Speaker Builder** readers:  
VHS HiFi Video (specify NTSC or PAL)  
\$49.50 or £34.50 or DM79.50 inc. postage  
Ph, Fax or E-Mail Visa/MC (or just post cash)  
Fine Print: 14 days money back if not delighted.

**Vacuum State Electronics**  
Allen Wright/Allgauer  
Einsteinstr. 129  
81675 Munich, Germany  
Ph/Fax + +49 89 477415  
Compuserve: 100240,2562

Reader Service #61



crossover has inherent phase shifts (different for the subwoofer and woofer outputs) that vary with frequency and can lead to incorrect polarity when the phase shift reaches toward odd multiples of  $\pm 180^\circ$ . All speakers have their own phase versus frequency shifts too. Keeping track of the cumulative (crossover plus woofer plus subwoofer plus woofer/subwoofer-to-listener distance offsets plus room effects) phase shifts at each frequency is tricky. That's why setting up subwoofers to play correctly is not easy, but it's certainly worth the effort.

## Salvage Design

Continued from page 28

sure generated in this space and all relevant surfaces are then so close that low-frequency reflections are not an issue. The low end was within a few hertz of the predicted value.

And how do these \$35 drivers in old boxes sound? In my opinion (with the usual complete lack of bias typical of a speaker builder when judging his own work), they sound great. Vocals are rich and clear. The high end is airy and very convincing (I really like that tweeter!). And do they play loud?—uh, well, no, not very, but they do more than well enough.

In fact, the kitchen system probably receives more comment than the tri-amped, sloped-baffle, carefully-tuned-and-constructed main system. Now that I think of it, that system hasn't been on in quite a while. As I type this, I'm listening to Vivaldi's *Four Seasons* from near-field speakers sounding almost too good to be used for a computer system.

## Ask SB

Continued from page 55

order greater than 1. One reason Butterworth filters are so popular is that they satisfy the uncommon condition that their corner and cutoff are equal regardless of the order.

To determine corner and cutoff frequencies in general, you must first find the response function for the filter. Then you must solve an equation related to it and similar to Equation 1 above. For high-order filters solving this equation is usually not possible in exact terms and some numerical procedure must be used.

# PC AudioLab



...Finally, a complete low cost PC based measurement solution for all of your loudspeaker and audio measurements. Use your home/office computer and the CD quality 16 bit sound cards from Media Vision or Soundblaster to actually measure the performance of your loudspeakers, electronics and crossovers. VERSION 2.0 now available!

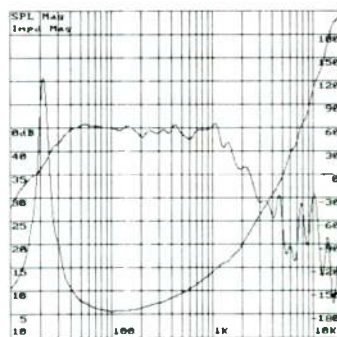

### SYSTEM REQUIREMENTS:

- 386/486 IBM AT compatible
- 4 Mb RAM memory
- Math Coprocessor
- VGA Graphics Display
- Media Vision or SoundBlaster 16 bit sound card

### PRODUCT HIGHLIGHTS

- OSCILLOSCOPE
- SPECTRUM ANALYZER
- NETWORK ANALYZER
- DISTORTION ANALYZER
- LOUDSPEAKER ANALYZER
- IMPULSE ANALYZER
- ROOM ACOUSTICS ANALYZER
- DETAILED MANUAL
- TEST CABLES
- GRAPHICAL USER INTERFACE
- PRINTER OUTPUT SUPPORT
- MOUSE SUPPORT
- EXPORT/IMPORT FILES
- \$300 CHECK/MONEY ORDER

## MICROACOUSTICS AUDIO SOFTWARE PRODUCTS

2553 CARPENTER ST. THOUSAND OAKS, CA. 91362 (805) 495-8945 PHONE/FAX

Reader Service #20

# BassBox™ 5.0

for Microsoft  
WINDOWS™

Driver Database  
with over 1,000 drivers.

Design speaker boxes fast and accurately with BassBox software. Accepts both Thiele-Small ( $F_s$ ,  $Q_{ts}$ ,  $V_{as}$ ,  $\eta_0$ ) and Electro-Mechanical ( $C_{es}$ ,  $G_{ms}$ ,  $C_{ms}$ ,  $M_{ms}$ ,  $R_{ms}$ ,  $B_L$ ) parameters with equal ease.

- ◆ Easy to use
- ◆ On-line help
- ◆ Large driver database
- ◆ Low price

### Design Types:

- Maximally Flat Vented
- Extended Bass Vented
- Custom Vented
- Band-Pass Vented
- Passive Radiator
- Optimum Closed
- Custom Closed
- Multiple Woofer designs (including isobaric)

### Built-In Test Procedures:

- Test and calculate loudspeaker parameters\*
- Test and calculate passive radiator parameters\*

\*Requires basic test equipment: sine wave generator, frequency counter, power amplifier, 1 kohm resistor, voltmeter, ohmmeter, test box.

### Design Options:

Small and large-signal analysis

Examine one loudspeaker in several different boxes or...

Examine several different loudspeakers in the same box

Convert between T-S and E-M parameters

Three graphs: Amplitude, Acoustic Power, Impedance

Can use multiple ports

Box dimension calculator with 18 different volume shapes

Can use loudspeaker measured acoustic response

Use English or metric units

Read BassBox 4.0 & 3.0 files

Save and recall designs

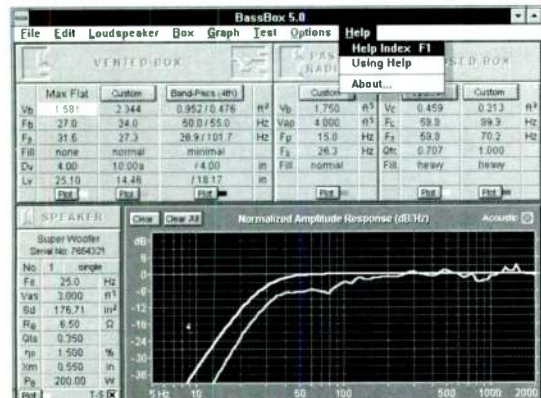

Copyright © 1994 by Harris Technologies. All rights reserved worldwide. BassBox is a trademark of Harris Technologies. Other trademarks are the property of their respective companies.



\$99.00



plus \$4.00 S&H  
(Canada +\$6.00)  
(Overseas +\$12.00)

Tel: 616-641-5924

Fax: 616-641-5738

Harris Technologies

P.O. Box 622  
Edwardsburg, MI  
49112-0622 U.S.A.

Also available:

X-over 2.0 passive cross-over program for Windows.

X-over calculates the component values for 1st, 2nd, 3rd and 4th-order 2-way and 3-way networks, load compensating networks and L-pads. Regular price: \$29. (\$19 if purchased with BassBox.)

### System Requirements:

MS-DOS 5.0, Microsoft Windows 3.1 & compatible computer (IBM® PC w/ 386SX or better), 1.44 MByte 3.5" disk drive and mouse 4 MBytes RAM recommended

Harris Technologies reserves the right to make changes without prior notice.

# Classified

## TRADE

**AUDIO PHASE INDICATOR:** Hand-held tool for engineers and enthusiasts. Bi-color LED shows "IN" or "OUT" relative phase for loudspeakers, microphones, etc. For more info, write or call **CRYSTAL LAKE DESIGNS**, PO Box 591, Crystal Lake, IL 60039, phone (815) 455-0799. 7/94

**CONTROL CABINET VIBRATIONS AT THE SOURCE:** Highly damped speaker gasket material. High-density, stays resilient, adhesive backed. **KELDAMP:** 1/16" x 1/2" x 100' roll, \$48. Hardened spikes, \$70/C. Threaded inserts, \$40/C. **MEADOWLARK AUDIO**, (619) 598-3763, FAX (619) 727-6473. 7/94

**WIDER, DEEPER, MORE HOLOGRAPHIC SOUNDSTAGE:** *Room Acoustics Handbook* \$14.95, Monarchy 22a DAC \$695, Level 1 Mod \$295, Digital Cable \$125, Loudspeakers from \$995. **MACH 1 ACOUSTICS**, RR #2, Box 334A, Wilton, NH 03086, Phone/FAX (603) 654-9826. 8/94



**The Ribbon Source**  
Our new technology Ribbons have the musicality and air of large electrostats but are mono-polar, high impedance drivers in easy to drive and place packages. They will simplify your designs and upgrade your audio or video systems sound.  
Ribbons are 8", 15" and 30" in full range systems, kits and Modules. Tubes love them! Ask for specs and international reviews.  
**Newform Research Inc.**  
1-705-835-9000 Fax: 705-835-0081  
Custom mfgs and overseas distributors sought.

**STATE-OF-THE-ART PASSIVE CROSSOVERS AND COMPONENTS.** Custom coil winding our specialty. Free Design Guide. **ALLPASS TECHNOLOGIES**, PO Box 453, Amityville, NY 11701, (516) 598-1320. 8/94

**ACT AUDIO GIVES GOOD SOUND!** Computer analysis of your listening room. Send SASE for details. **ACT AUDIO**, 619 Moon Clinton Rd., Corapolis, PA 15108. 8/94

**ELECTROSTATIC** parts, supplies, exotic circuits. Free catalog. **DAVID LUCAS, INC.**, 924 Hulton Rd., Oakmont, PA 15139, (412) 828-1967, FAX (412) 828-0422. 2/95

**MYLAR** 1/2 mil, genuine DuPont, 48" width, \$1/ft. ESL transformers. (503) 742-7640. 7/94

## FOR SALE

2kV/ $\mu$ s line-level buffer preamp in Sescor case, dual mono A/C and rechargeable battery power supplies, left & right voltage divider volume controls, bypass input (all soldered connections in signal path), fast recovery rectifiers, more, \$325; AVA SuperPAS 3 Omega, \$425; PAS 3 with power supply mods, \$70; broken CDB6830 for parts, \$60. Craig Nance, (404) 457-8748.

Pair Borbely's most recent design, Servo-50 high-current monoblock amps, \$800; Curcio DAC, \$500; Curcio active crossover kit, \$475; Curcio Daniel preamp, \$200; pair Cabasse dome mids, DOM12, \$150; interconnect, straight wire, Borbely; misc. wire & cable & all equipment. Dan, (602) 940-8074.

Bi-amplified speaker system with electronic crossover and amplifier. Custom designed for superior sound using KEF B110B, B200G and Dynaudio D28AF drivers; polycarbonate/polystyrene caps; air-core inductors; Hafler DH220 power amp; stereo RCA patch cords. Many other unique features. Unbelievable value. \$500/offer. Bill, (510) 548-5457.

Dynaudio D28/2 tweeters with frequency response curves, mint, \$90/pair (\$125); Audio Concepts DV12 12" woofers, hardly broken in, \$120/pair (\$180). Dan, (708) 831-3841.

Stratearn ribbon loudspeakers. Three drivers in each 6' curved oak baffle, 125Hz to 20kHz. Four extra drivers. All drivers are of the original design used in the Infinity Reference Standard. \$1,500 takes all. You transport. Andy Catanzaro, PO Box 26143, Wauwatosa, WI 53226, (414) 466-8266, eves.

Speakers & crossover networks of the Jensen Imperial group consisting of a P15LL 15" low-frequency driver, RP201 horn midrange, RP302 horn high-frequency, and A-61 & A-402 crossovers for 600Hz and 4kHz. Instruction sheets & Jensen construction manual #1060 included. \$100 plus shipping or best offer. J. L. Markwalter, (813) 764-8713.

Gemini cabinets, black oak with stuffing, OFC wiring harness and caps. \$160 shipped. Phil, (602) 579-1446.

Counterpoint SA20 power amp, excellent, \$1,000; Crown Macro Reference amp, "E" version, mint, \$2,300; pair Yamaha electronic crossovers, balanced, full featured, 2/3-way mono, \$395; Pioneer Spec I preamp, \$150; pair empty Altec 9849 monitor cabinets, \$100; pair Community horns for Altec 288 drivers, \$150. David, (914) 688-5024.

MLSSA System Analyzer, the industry standard for loudspeaker measurement. It is easy to use and is in perfect condition. Requires PC which is also available. \$3,250 when new, now \$2,350. Jeff, (206) 782-6569.

*Speaker Builder* magazines, January 1988 to present (less January 1989), \$75. Jim, (606) 441-9684.

Almost 200 classical LP records, list available on request; pair VIFA 6 1/2" C17WH, \$45; pair Dalesford 1" dome tweeters, \$50; pair EPOS ES-14 tweeters, coils blown, \$20; Yamaha 10 1/2" woofer, large Alnico magnet, needs reconing, cast frame, \$25. Jerry Feldstein, 2405 Southern Blvd., #4A, Bronx, NY 10458, (718) 364-3485, 7-10 p.m.

### Premium Parts & Accessories

The largest selection of audiophile capacitors, resistors, connectors, chassis wires in North America. MIT MultiCaps, Wonder Caps-solder-wire, SCR, Solen cap, Rel-Cap: Vishay, Holco, Caddock, Mills, Resista resistors: MIT, CARDAS, KIMBER, NIMTEC, & silver chassis wires, custom cables, SOLO foil inductors: all types of audio connectors: silver contact toggle, rotary switches & stepped attenuator kits. HEXFRED rectifiers, ANALOG DEVICES. HUBBELL hospital grade plugs & outlets. Tubes, feet, damping sheets & compounds, tools and many accessories. Extensive inventory - good prices and good service! Phone (415) 669-7181 or fax 669-7558 for a catalog. **Michael Percy, Box 526, Inverness, CA 94937**

## WANTED

Pair of Dynaudio 17W75, 4 $\Omega$ , XL or EXT. Nick, (501) 525-5863, evenings best.

QUAD ELS. California Institute of Technology Music Lab needs gifts of several pairs of original QUAD electrostats (not ESL-63). James Boyk, (818) 395-4590, FAX (310) 470-9140, E-mail: boyk@puck.caltech.edu.

ABX box, IM + THD analyzer. Bob, (602) 458-6072.

# CLUBS

**OUTPUT TRANSFORMERS: THE LAST FRONTIER?** Hobbyist seeks people interested in OPT design and building. I would like to network a critical mass of people together on this topic for strictly non-commercial interest. Possibly write a GA article/create a club newsletter? M.A. Martin, (416) 968-6101, monty@camtwh.eric.on.ca.

**WANTED: SPEAKER AND AUDIO AMATEURS IN THE BRADENTON/SARASOTA/ST. PETERSBURG/TAMPA, FL AREAS.** Would like to form a club and develop a lab for testing speakers/amps/preamps and passive and active crossovers or just to discuss speaker projects and ideas. Angel Rivera, Bradenton, FL 34206, (813) 792-3870.

**WANTED: SPEAKER/TUBE GEAR BUILDERS AND AUDIO AMATEURS IN SANTIAGO, CHILE.** Would like to form a club or just a friendly group of audio enthusiasts to discuss speakers/amps/preamps/crossovers and everything. Anyone interested, contact Christian Bargsted, Los Gomeros 1542, Vitacura, Santiago or call (562) 538-0638, office hours.

**WASATCH AUDIO**, located in Salt Lake City. Our club is interested in construction, modifications, design, and listening to music. We are looking for members and ideas for our new club. Edward Aho, (801) 364-4204.

**LONDON LIVE DIY HI-FI CIRCLE** meets quarterly in London, England. Our agenda is a broad one, including any aspect of audio design and construction. Subscription newsletter. We welcome all, from novice to expert, in free association. Contact Brian Stenning, UK, 081-748-7489.

**ARIZONA AUDIOPHILE SOCIETY** located in metropolitan Phoenix is a growing and active club in the pursuit and reproduction of recorded music. New members are welcome. Meetings are last Tuesday of each month. Receive monthly newsletter. Club discounts with local high-end audio dealers. Send inquiry to Arizona Audiophile Society, PO Box 13058, Scottsdale, AZ 85267, or call Bob Williams, (602) 944-5929.

**THE ATLANTA AUDIO SOCIETY, Inc.**—Open to persons that share a common interest in the art and science of audio and music. Activities include construction projects, equipment and recording evaluations, home theater, video, film, live music and recording sessions. Monthly meetings and seminars often include prominent speakers from the industry. Newsletters and bulletins regularly published. John Morrison, Pres., (404) 491-1553, or Chuck Bruce, (404) 876-5659, 4266 Roswell Rd. N.E., K-4, Atlanta, GA 30342-3738.

**AUDIO SOCIETY OF MINNESOTA.** Meeting the hobbyist needs of audiophiles in the Land of 10,000 Lakes for 16 years! Monthly meetings (Sept.-May), tours, audiophile concerts, special guests, technical assistance, etc. For information and a copy of our latest monthly Bulletin, write ASM, PO Box 32293, Fridley, MN 55432, or call our 24-hour "Audio Hotline," (612) 825-6806.

**THE HI-FI CLUB** in Cape Town, South Africa sends a monthly newsletter to its members and world-wide subscribers. Ask for an evaluation copy of our next newsletter, write to PO Box 18262, Wynberg 7824, South Africa or FAX (27) 21-7618862. We'll be pleased to hear from you.

**THE AUDIO SYNDROME**, Nassau and Suffolk county's oldest group of audiophiles is looking for new members. If you are interested, call Roy Harris, (516) 489-9576.

## Speaker Grilles

Professional quality, custom size grilles made to order.

## GRENIER CABINETS

(607) 594-3838

FAX (607) 594-4019

**THE BOSTON AUDIO SOCIETY**, the nation's oldest (founded 1972), seeks new members. Dues include the monthly meeting notice and our newsletter, the *BAS Speaker* (6/year). Recent issues cover Carver, a/d/s; the founder of Tech Hi-Fi, Photo CD. Plus visits from famous speaker designers, listening tests, measurement clinics, research investigations, and more. Back volumes available. Membership includes engineers, journalists, consultants, and music-loving audiophiles like yourself. For information write to PO Box 211, Boston, MA 02126-0002.

**WANTED: "CRADLE-TO-GRAVE" AUDIO ENTHUSIASTS.** Texas doesn't have an audio club; YET! If you're interested in audio reproduction on stage and in your home, let's get together. Rick, (915) 676-7360.

**ESL BUILDERS GROUP** is a new address for people who have built or want to build electrostatic loudspeakers and associated (tube) drivers, or are just interested. An answer is ensured, if you include some kind of compensation for postage and handling. Write to: Gunter Roehricht, Bühlerstr. 21, 71034 Böblingen, Germany.

**THE CATSKILL AND ADIRONDACK AUDIO SOCIETY** invites you to our informal meeting. Join our friendly group of audio enthusiasts as we discuss life, the universe and everything! Toobers, Tranzzeestors, vinyl canyons, or digital dots. No matter what your level of interest, experience, or preferences, you are welcome. Contact CAAS at (518) 756-9894 (leave message) or PO Box 144, Hannacroix, NY 12087.

**THE NEWLY FORMED CHICAGO AUDIO SOCIETY** invites all audiophiles to attend its opening meeting on Sunday, October 16, 1994. For details and meeting location, please call Brian at (708) 382-8433 or Pat at (708) 582-3913 evenings; E-mail to sysop@nybble.com or u24129@uicvm.uic.edu. Space is limited.

**THE COLORADO AUDIO SOCIETY (CAS)** is a group of audio enthusiasts dedicated to the pursuit of music and audiophile arts in the Rocky Mountain region. We offer a comprehensive annual journal, five newsletters, plus participation in meetings and lectures. For more information, send SASE to CAS, 1941 S. Grant St., Denver, CO 80210, (303) 733-1613.

**CONNECTICUT AUDIO SOCIETY** is an active and growing club with activities covering many facets of audio—including construction, subjective testing, and tours of local manufacturers. New members are always welcome. For a copy of our current newsletter and an invitation to our next meeting, write to: Richard Thompson, 129 Newgate Rd., E. Granby, CT 06026, (203) 653-7873.

**HI-FI COLLECTOR/HOBBYIST** seeks audio penpals to correspond via reel-to-reel tape. If you are into restorations, discarding old recorders, or parting out derelict gear, or have arcane technical secrets you'd like to discuss, or just want an excuse to obsess over Mylar, make it so. I'll return all tapes via parcel post. James Addison, 171 Hartford Rd., A-7, New Britain, CT 06053.

**THE LOS ANGELES AREA LOUDSPEAKERS DESIGNERS GROUP.** If you're just starting out or an experienced builder and would like to share ideas on speaker design and listen to each other's latest creations, give us a call. Geoffrey, (213) 965-0449 or Eduard, (310) 395-5196.

**MONTREAL SPEAKER BUILDER CLUB.** Meets when it can, BYOB, discussions range from speaker design and testing to equipment modification. All welcome. Contact Andrew McCrae, 4701 Jeanne Mance, Montreal, PQ, H2V 4J5 Canada, (514) 281-7954.

## Audio Engineer

Onkyo is seeking an audio system engineer to join our growing engineering organization. This candidate must have experience in car audio system design with knowledge of equalization and digital signal processing. Driver design is also required and the ability to interface well with customers will be highly regarded. Onkyo is a male/female equal opportunity employer. Interested candidates should forward their resumé to:

Robert Tetzlaff  
Onkyo America, Inc  
200 Williams Drive  
Ramsey, NJ 07446

**ONKYO AMERICA, INC.**

**THE PRAIRIE STATE AUDIO CONSTRUCTION SOCIETY (PSACS)** meets every other month. Meetings feature audio construction, design, and analyses, blind listening tests, equipment clinics, auto sound, lectures from manufacturers and reviewers. PSACS, PO Box 482, Cary, IL, 60013, or call Tom, (708) 248-3377 days, (708) 516-0170 eves.

Ernie Rawlings, 5411 Bocage St., Montreal, Canada H4J 1A2 (**FORMERLY SFORZANDO**) advises you that he is about to abandon the lending of organ music cassettes for you to test your loudspeaker building efforts. Instead video cassettes of non-entertainment subjects are offered on an exchange basis. Send him one of your best and request what you'd like in exchange.

# SPEAKERS — Go Factory Direct and \$AVE!



- 90-Day Home Trial
- Leading edge design for Home Theater and traditional systems
- Satisfaction guaranteed
- Upgrades and service plus complete speaker systems from \$200 to \$6,000 per pair.
- Call for free catalog & dealer listing

**800-783-1553**

Ohm Acoustics, 241 Taaffe Place  
Brooklyn, N.Y. 11205

**SOUTHEASTERN MICHIGAN WOOFER AND TWEETER MARCHING SOCIETY (SMWTMS).** Detroit area audio construction club. Meetings every two months featuring serious lectures, design analyses, digital audio, AB listening tests, equipment clinics, and audio fun. Club publication, *LC, The SMWTMS Network*, journals the club's activities and members' thoughts on audio. For information, send name and address: E-mail aa259@detroit.freenet.org; phone (810) 544-8453 (machine); SMWTMS, PO Box 721464, Berkley, MI 48072-0464.

**NEW JERSEY AUDIO SOCIETY** meets eight times a year. Emphasis is on extracting the best sound per dollar spent from your audio system. Dues include subscription to our newsletter, *The Source*, published four to six times yearly. Meetings focus on enjoying the hardware as well as the software. Contact Frank J. Alles, 209 Second St., Middlesex, NJ 08846, (908) 424-0463, or Valerie Kurlychek, (908) 206-0924.

## Electronic

by  
**ACE AUDIO CO.**

• est. 1973 •

RD3 Box 351  
Homer City, PA 15748  
write for free flyer

## Crossovers

**PACIFIC NORTHWEST AUDIO SOCIETY (PAS)** consists of 40 audio enthusiasts meeting monthly, second Wednesdays, 7:30 to 9:30 p.m., 4545 Island Crest Way, Mercer Island, WA. Write Box 435, Mercer Island, WA 98040 or call Ed Yang, (206) 232-6466, or Gill Loring, (206) 937-4705.

**WASHINGTON, D.C. AREA HORN ENTHUSIASTS GROUP** now forming. If you're interested in horn loudspeakers and live in the Washington, D.C. area, we want to talk to you. Please call Dirk Wright, (703) 471-8657, or John Hanley, (703) 425-7482. Our ears are tuned to the clear dynamics of horn loudspeakers.

**VINTAGE AUDIO LISTENERS AND VALVE ENTHUSIASTS (VALVE)** meets the first Sunday of every month to swap vintage audio gear, audition rare and collectible equipment, and evaluate modifications and scratchbuilt projects. Dues provide a monthly newsletter with current reviews of vintage components and modification information; vintage service data; and access to an active network of serious collectors. For information, call (206) 697-1936 or write to 1127 NW Brite Star Ln., Poulsbo, WA 98370.

**WEST VALLEY AUDIO SOCIETY** is a group interested in all aspects of high-performance audio. We are located in the west San Fernando Valley, CA, and look forward to hearing from interested audiophiles. Call Barry Kohan, (818) 225-1341.

**PIEDMONT AUDIO SOCIETY** in the Raleigh/Durham and Chapel Hill area is meeting monthly to listen to music, demonstrate owner-built and modified equipment, and exchange views and ideas on electronics and speaker construction. Tube and solid-state electronics are of interest and all levels of experience are welcome. Kevin Carter, 1004 Olive Chapel Rd., Apex, NC 27502, (919) 387-0911.



## AVAILABLE NOW!

TC SOUNDS makes no-compromise drivers with linear motor-structures (underhung), high-compliance linear mechanical systems, and stiff lightweight composite diaphragms. Individual T/S-parameters for 8", 10", 12", 15" (5.5" & 18" soon). Call (619) 622-1212, or FAX (619) 622-9293.

**TUBE AUDIO ENTHUSIASTS.** Northern California club meets every other month. For next meeting announcement send #10 SASE to Tim Eding, PO Box 611662, San Jose, CA 95161.

**MEMPHIS AREA AUDIO SOCIETY** being formed. Serious audiophiles contact J.J. McBride, 8182 Wind Valley Cove, Memphis, TN 38125, (901) 756-6831.

## Ad Index

ADVERTISER	PAGE	ADVERTISER	PAGE
Abilene Research & Development Corp.	57	Polydax Speaker Corp.	8
Amantis Audio	53	Pyle Industries	35
Audio Classics, Ltd.	57	RDL Acoustics	48
ACI	27	Sescom, Inc.	64
Audio Ideas Ink. Limited	41	Solen, Inc.	17
AudioControl		Solo Electronics	22
C-101 Series III Equalizer/Analyzer	55	Speaker Works	59
Real Time Analyzer	57	Speaker Workshop	6
Bohlender-Graebener Corp.	60	Speakers Etc.	45
Cadence Sound Systems	5	TCH Umbra	40
Decade Engineering	64	Technologie MDB	49
Dupont Kapton®	29	The Parts Connection	59
Elektor Electronics	52	The Speaker Works, Inc.	13
Ferrofluidics Corp.	63	True Image Audio	63
Forgings Industrial Co.	23	Vacuum State Electronics	64
German Physiks	47	Wilmslow Audio	58
Harris Technologies	65	Woodcraft Supply	45
Hi-Fi News & Record Review	50	Zalytron Industries Corp.	21
hifisound Saerbeck	51	<b>CLASSIFIEDS</b>	
Image Communications	4	Ace Audio Co.	68
Interactive Image Technologies	69	Grenier Cabinets	67
LinearX Systems, Inc.	CV2	Michael Percy	66
Madisound	36-37	Newform Research, Inc.	66
Mahogany Sound	55	Ohm Acoustics Corporation	68
Marchand Electronics, Inc.	51	Onkyo America	67
Markertek Video Supply	64	TC Sounds	68
MCM Electronics	38	<b>GOOD NEWS/NEW PRODUCTS</b>	
Meniscus	46	Advanced Digital Systems	3
MicroAcoustics	65	Audio Classics, Ltd.	3
Morel Acoustics	CV4	Bohlender-Graebener Corp.	4
North Creek Music Systems	60	Celestion Industries, Inc.	3
Old Colony Sound Lab		ETREMA Products, Inc.	5
Audio Frequency Amplifier Design	52	Installer Institute	5
Loudspeaker Recipes	39	Madisound	4
New Products	61-62	Miller & Kriesel Sound Corp.	3
Orca		Mouser Electronics	5
Axon Caps	32	Newform Research, Inc.	3
Black Hole/Axon Cables	33	Syon Corp.	4
Parts Express Int'l, Inc.	CV3	Zalytron Industries Corp.	5

“Design work is faster and cheaper with Electronics Workbench.”

Mark Weaver  
Production Engineer Technician  
Colorado Memory Systems/HP

Electronics Workbench is a highly productive bench where you design and verify circuits in a fraction of the time. Connections are always perfect. Wires route themselves. And the simulated components and test instruments work just like the real thing.

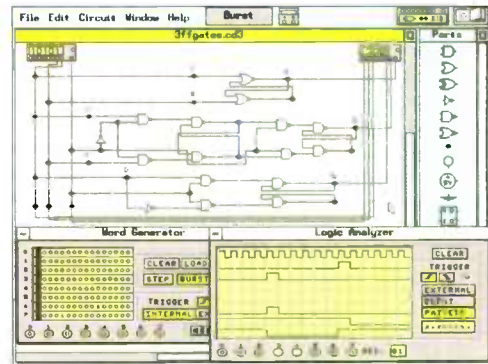

Digital Module: Analyzing a logic circuit.

It's faster than building with actual components because you change connections and component values instantly. And since the simulated components are free, you don't need to replace burnt-out parts or keep an extensive inventory. The result: You save precious time and money. Guaranteed!\*

The standard for simplicity and power for over six years, Electronics Workbench is the most popular tool of its kind. It has gained worldwide acclaim as the ideal complement to any test bench. **Fact: Over 90% of our customers recommend it to their friends and colleagues.**

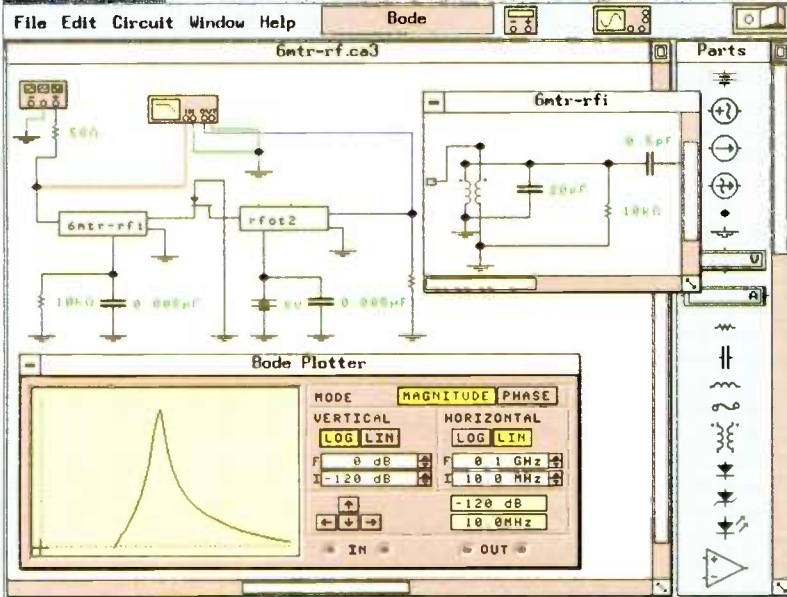
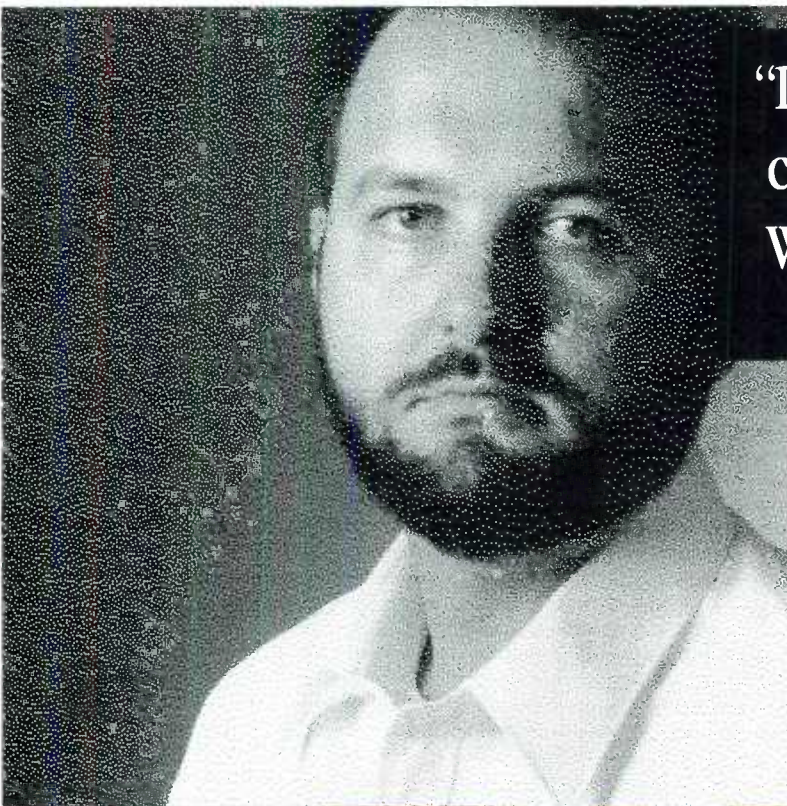

Analog Module: Tuning an RF front end.

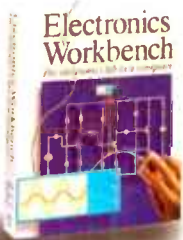

**Just \$299\***  
For DOS, Windows or Mac Version.



# Electronics Workbench®

The electronics lab in a computer™

**Call: 800 263-5552**

INTERACTIVE IMAGE TECHNOLOGIES LTD.  
908 Niagara Falls Blvd. #068, North Tonawanda, NY 14120-2060  
Telephone: (416) 361 0333 FAX: (416) 368 5799

\*30-day money-back guarantee.

Prices in U.S. dollars, shipping \$15. Offer valid in U.S. and Canada only.  
All trademarks are the property of their respective owners.



# Loudspeakers 101

## UNDERSTANDING THIELE/SMALL

By Dick Pierce

Whenever we talk about driver performance and specifications (especially woofers), we invariably refer to "Thiele/Small" parameters. Every speaker design and simulation program requires us to enter these parameters. More and more driver manufacturers include this data in their catalogs. So these parameters seem to be pretty important.

But how many of us understand, *really* understand, what these parameters mean? Most of us who know the names of the parameters know how to use them, but the physical reality behind them remains a mystery.

### A LITTLE HISTORY

Prior to the mid-1960s, designing woofers was pretty much a cut-and-try process. Engineers understood, at least empirically, the physical parameters of a woofer, that the cones had mass, the suspensions had stiffness, and mechanical and acoustical loads and losses occurred. But they were not able to develop a comprehensive theoretical understanding of how it all worked together.

In 1961, A. Neville Thiele in Australia presented a paper that outlined a fresh approach to low-frequency design. In "Loudspeakers in Vented Boxes," Thiele treated the loudspeaker *system* as a filter whose components included not only the driver, but the enclosure as well. He then applied well-understood principles of filter "alignment" to optimizing loudspeakers in a way very much like aligning a radio to optimize its response. Here was the first systematic method of low-frequency loudspeaker design to deal with (on both a theoretical and a practical basis) the interaction between the driver, the enclosure, and the system performance.

While Thiele's work helped us understand the relations between physical parameters and performance, designing a speaker based on these parameters was still cumbersome and often an arduous task.

Ten years later, an American teaching in Australia, Richard H. Small, presented the

first in a series of articles about low-frequency loudspeaker design and performance that used Thiele's work, and extended it. Small developed a system of units describing the important driver parameters so that they could more easily be used in designing a loudspeaker system. Small's analyses on direct radiator, closed box, vented box and passive radiator systems, along with Thiele's work, form a solid foundation upon which all modern loudspeaker design rests.

### DOMAINS OF CONFUSION

Much of the mystery about how loudspeakers and enclosures work together results from working in different physical "domains." For example, the driver can be described in terms of its mechanical parameters (mass, compliance or stiffness, frictional losses, magnetic field density), its electrical parameters (DC resistance), or its acoustical parameters (acoustical mass and compliance, radiation reactance, and so on).

While we can translate these quantities from one domain to the other, it's not an intuitive process, and it may not be obvious when to use what kinds of parameters.

Small not only fully described the interactions between drivers and enclosures in a way that could be used as both a theoretical and a practical tool, but he also developed a new set of parameters allowing us to talk about all acoustical elements in both in a single unified system. Let's explore each of the major Thiele/Small parameters.

### RESONANT FREQUENCY

Imagine a spring hanging from the ceiling. On the end we attach a weight, say, a brick. We pull the weight down a little bit, and we let it go. What happens? The weight bobs up and down as the string alternately contracts and expands. We notice the time it takes for each cycle is the same, and the "frequency" is quite regular and fixed. This system is "resonating." Add weight, and the system slows down. Use a stiffer spring, or two springs in parallel, and the system speeds up. The frequency at which the system oscillates is its natural, or resonant, frequency.

The mass of the woofer cone (plus a tiny bit more due to the air in front and behind the cone) and the cone's springiness, or "compliance" (plus, again, a little more due to the air it has to push), together form a very similar resonant system. The combination of the

cone mass and suspension compliance form a system with a resonant frequency we call  $f_s$ .

### SUSPENSION "VOLUME"

An important parameter is the compliance of the driver's suspension. Along with the cone mass, it determines the resonant frequency of the driver. It's also important because the final volume of the enclosure is strongly dependent upon the driver's compliance.

But instead of compliance (measured as the distance the suspension is deflected when a force is applied), the Thiele/Small parameter is called the "equivalent volume of compliance," abbreviated as  $V_{AS}$ , measured in cubic feet or (preferably) cubic meters or liters. What is the "equivalent volume of compliance"? It's very simple: An enclosed volume of air has compliance.

For example, if you push down on the handle of a bicycle pump with its outlet plugged, you compress the air and the air pushes back. It feels just like a spring. The harder you push, the farther you push, but the more the air (or the spring) pushes back. The equivalent volume of compliance,  $V_{AS}$ , has the same compliance as the driver's mechanical suspension.

Its significance is obvious when you consider that you're going to put the driver in a box enclosing a volume of air that contributes its own compliance to the system. We could translate the box volume and the driver mechanical compliance into equivalent acoustical compliances, but we would be working in strange compliance units of  $\text{cm}^4\text{sec}^2/\text{g}$ . But when we finish, and need to design our box, we still must return to our much simpler and ordinary units of volume (cubic feet or liters).  $V_{AS}$  lets us work in a simple, understandable unit: volume.

### NEXT TIME

We've covered just two of the important Thiele/Small parameters. Next time, we'll focus on probably the most puzzling and mysterious parameter, the "Qs." ➤

*(This series of articles first appeared in Polydax's newsletter, Audio Talk.)*

### ABOUT THE AUTHOR

Richard Pierce is director of his own independent consulting firm, doing work in design, measurement, and evaluation for a variety of driver and system manufacturers. He is also a principal member of the team in charge of the implementation of the Orban DSE-7000, a professional digital audio editing workstation for the radio spot production market. He has written articles about loudspeakers and lectured on loudspeakers and digital audio technology.

Send your questions, concerns, gripes, or problems for Richard Pierce to address through this column to: Speaker Builder, Editorial, Loudspeakers 101, PO Box 494, Peterborough, NH 03458.

# AUDAX KIT PLANS

Speaker Kit Plans Are Now Available From Parts Express!

"Kit Plans, Build Your Own Loudspeakers" is a 25 page booklet containing plans for 7 speaker kits. The Signature Series has 4 different kits utilizing Prestige and Reference Series components and was designed exclusively by Vance Dickason, author of "The Loudspeaker Design Cookbook". The enclosures, crossovers, and components were carefully selected by Mr. Dickason and computer optimized to ensure the highest level of performance. The Classic Series was designed in house by Polydax and includes 3 easy-to-build kits that offer great sound quality at an affordable price. All of the components and accessories you need to build any of these projects are available and in stock at Parts Express.

To receive the booklet "Kit Plans, Build Your Own Loudspeakers", and a copy of the 188 page Parts Express 1994 Catalog, just send \$1.00 to cover postage and handling (\$3.00 to Canada).

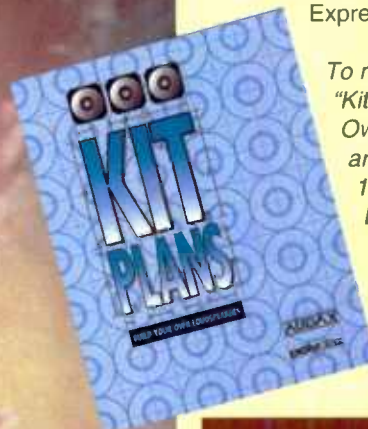

LA PASSION DU HAUT-PARLEUR

**AUDAX**

**polydax**  
SPEAKER CORPORATION

**Parts Express**  
International Inc

Please send check or money order to receive the kit plans. Be sure to include your name and complete address with zip code. Mail to:

PARTS EXPRESS INT'L.  
DEPARTMENT A  
340 E. FIRST STREET  
DAYTON, OH 45402-1257

LOCAL: 513/222-0173, FAX: 513/222-4644

World Radio History

© APRIL 1994



Made  
in  
England

# High-Tech Audiophile Loudspeakers

For Further Information Please Contact: **morel acoustics USA**

414 Harvard Street  
Brookline, MA 02146  
Tel: (617) 277-6663  
FAX: (617) 277-2415

World Radio History



Typical Double Magnet Woofer Cross Section.