

# *Speaker Builder*

THE LOUDSPEAKER JOURNAL

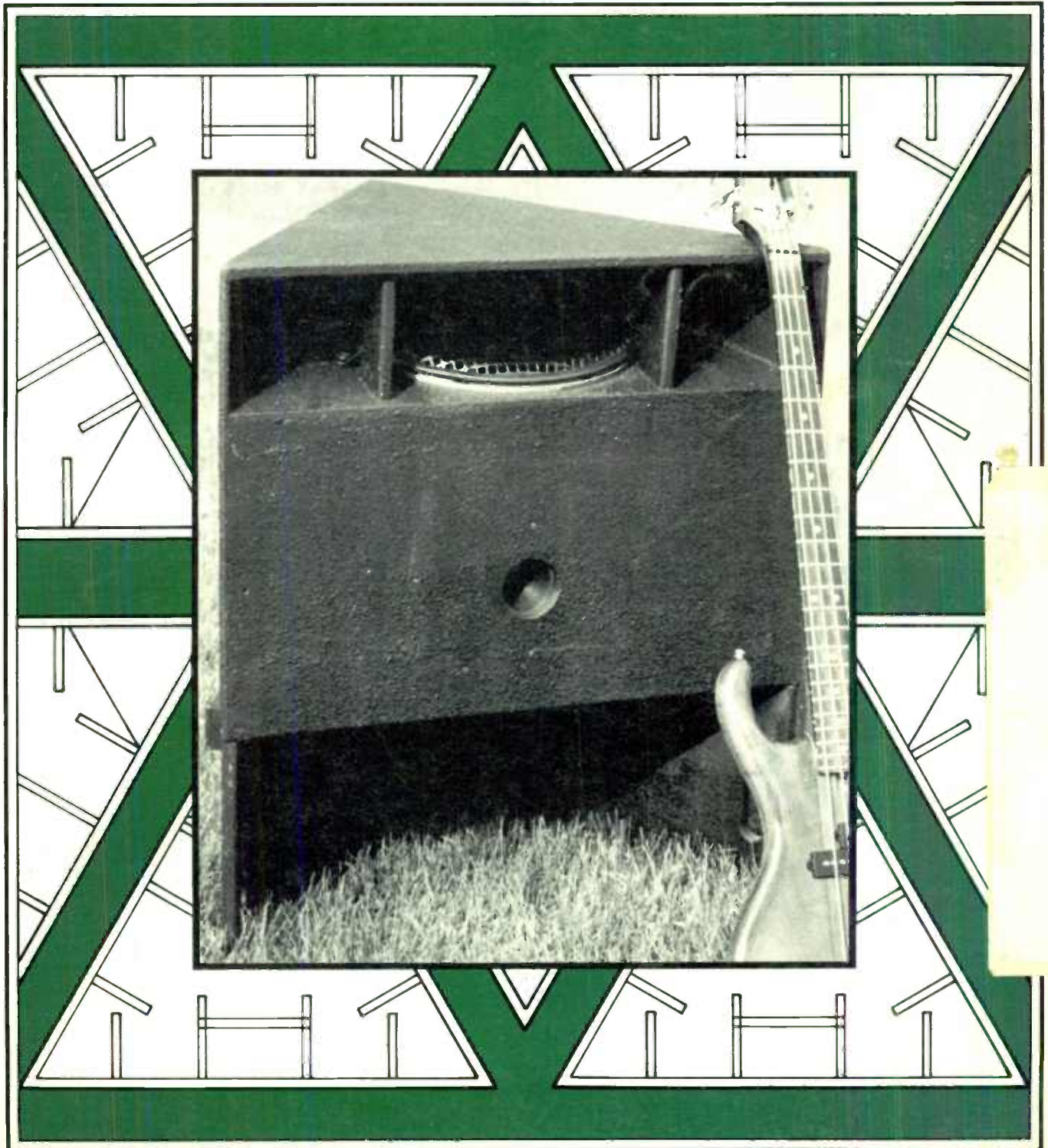

**What do** ...WILSON AUDIO, VTL, AUDIO RESEARCH, HALES, SONIC FRONTIERS, CARY, ARTEMIS, NESTOROVIC, PARADOX, MAS, WHATMOUGH, JACKSON BROWNE STUDIOS, ATHENA PRODUCTIONS, WATER LILY ACOUSTICS... **have in common?**

## The MultiCap

**Why?** FIRST – because it improves the sonic performance of their products. Audio manufacturers around the world are increasingly aware that when they need the best performance, MIT's unique, patented self-bypassed MultiCap delivers what other capacitor manufacturers claim but cannot offer: the highest level of *sonic* performance.

SECOND – MIT offers more: We can help you get the best results from our capacitors in your designs. MIT has over a half-million dollars in advanced test equipment. We know what it means when a capacitor

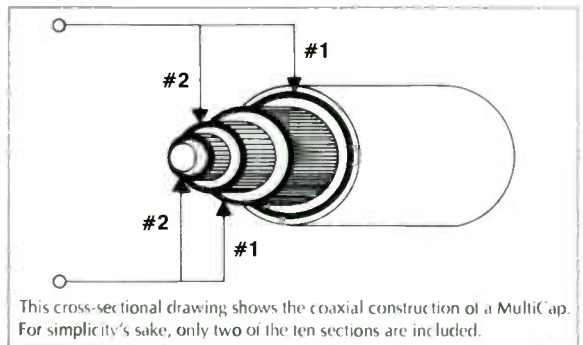

has "phase deviations," "high ESR," and "high series inductance." We know how important it is – to the final sound of your products – to reduce these and other parasitics.

Whether you use all MultiCaps in your all-out efforts or a few in only the most critical places for cost-effective products, you will find the MultiCap advances performance.

**So get the real story:** We don't want you to invest thousands of dollars in the best drivers and equipment only to have your sonics bottle-neck through a \$2 capacitor. MIT's conservative designs are trusted throughout the industry – our 200 volt dielectric is equivalent to another "audiophile-grade" capacitor's 600 volt rating!

Call us for our literature – which major capacitor companies outside of audio have used in in-house training for its informative and accurate presentations. And don't hesitate to call us for application advice.

### MIT MultiCap

*"The most advanced capacitor design in the world."*

For U.S. Inquiries: CVTL Inc.,  
Component Division of Music Interface Technologies  
3037 Grass Valley Hwy.  
Auburn, CA 95603  
(916) 823-1186 FAX (916) 823-0810

#### Papers Available

*Considerations for a High Performance Capacitor*  
*The MIT MultiCap: Phase Response vs. ESR*  
*MIT Introduces the New Metallized MultiCap*  
*The MIT MultiCap in Power Supplies & Filter Circuits*  
*The MIT Film & Foil MultiCap: Installation & Applications*  
*Questions & Answers About Capacitors*

For International Inquiries:  
MIT Components  
760 Pacific Road, Unit 19  
Oakville, ONT Canada L6L 6M5  
(416) 847-3277 FAX (416) 847-5471

# Good News



## ▲ PYLE

The RP1000A Toobz features a 10" dual voice coil subwoofer and built-in 80W amplifier. Other features include independent left and right RCA input connections, an adjustable 12dB crossover, and variable gain control. The

unit does not require a converter or removal of the head unit and has 25k $\Omega$  impedance. Pyle Industries, Inc., 501 Center St., Huntington, IN 46750, (219) 356-1200.

*Reader Service #52*

## ■ NORTH CREEK

The Tempo loudspeaker kit features the Scan-Speak D2905 tweeter and K18/8544 7" Kevlar woofer housed in an acoustic suspension enclosure, with a compliance ratio of greater than seven. The crossover frequency is 1.75kHz. Also newly released is a complete passive crossover replacement for the B&W 801 Matrix 2 loudspeaker. North Creek Music Systems, Route 8, PO Box 500, Speculator, NY 12164, (518) 548-3623.

*Reader Service #53*

## ■ WOMEN'S TECHNET

An industry-wide survey on the current status of women in audio is being conducted. Respondents are sought from companies ranging from recording studios to audio manufacturers (even if no women are currently employed) and individuals,

including women working in any facet of audio. EQ magazine is sponsoring the endeavor. Send a self-addressed, stamped envelope to: Women's Survey Request, c/o EQ Magazine, 939 Port Washington Blvd., Port Washington, NY 11050.

## ▶ SNELL ACOUSTICS

Type K/IIv magnetically-shielded video speaker system has flat frequency response which is optimized both on- and off-axis: 30-40° vertically and 60-75° horizontally. The loudspeakers are designed to work with amplifiers and receivers rated 10-100W/channel, and can be bi-wired and -amped. Suggested retail price is \$245/each. Snell Acoustics, 143 Essex St., Haverhill, MA 01832, (508) 373-6114, FAX (508) 373-6172.

*Reader Service #60*

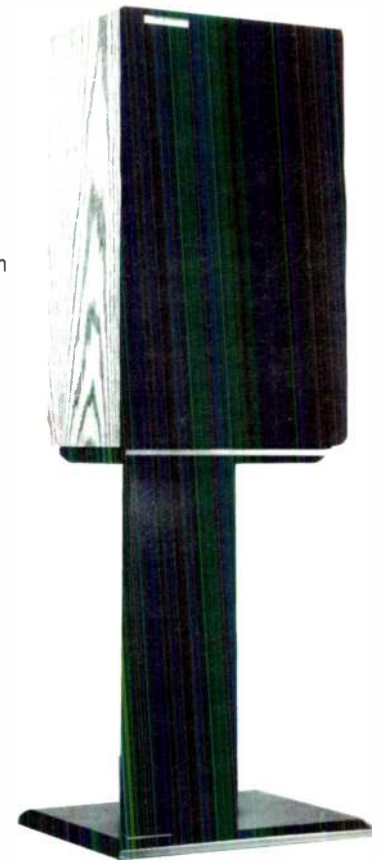

## ◀ ACOUSTIC DESIGN

Specializing in acoustic furniture, a typical package consists of a set of subwoofers (driven by a separate amp which powers both at 50W/channel), with speakers, components, and matching tables. The three-piece set also has a matching console that houses A/V equipment, a 41" projection TV, and the system's front and center channels. Contemporary Acoustic Design, 19 Knipfer Ave., Easthampton, MA 01027, (413) 527-8921.

*Reader Service #58*

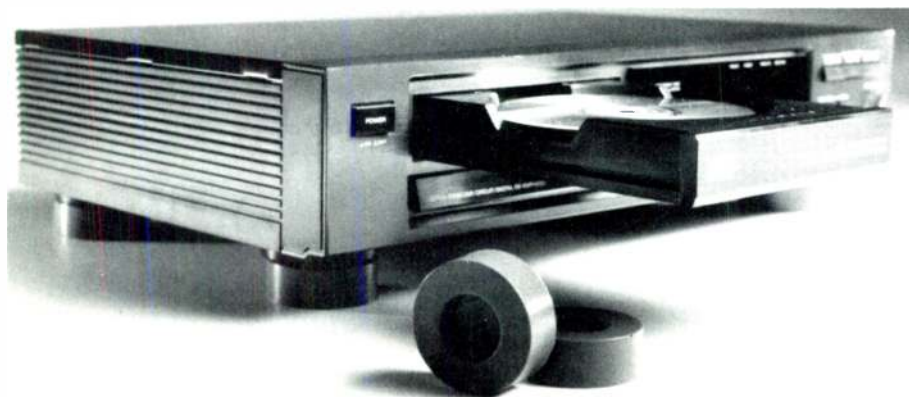

## ◀ SORBOTHANE

Anti-vibration mounts for audio equipment, made of Sorbothane®, dissipate external and/or internal vibrations. The devices can attenuate both low, impact and high, harmonic frequencies. They are available from most audio equipment retailers. Sorbothane, Inc., 2199 State Route 59, Kent, OH 44240, (216) 678-9444.

*Reader Service #51*

#### ▼ CRYSTAL LAKE

The Audio Phase Indicator is a hand-held device which allows quick verification of relative phase for virtually any audio source. A self-contained, battery-operated measuring instrument, it incorporates two matched microphone preamps with limiting, and a synchronous phase detector with bi-color LED readout. Crystal Lake Designs, PO Box 591, Crystal Lake, IL 60039-0591, (815) 455-0799.

*Reader Service #54*



## Good News

#### ■ DIMENSIONAL RESEARCH

The A2A loudspeaker is a minimum-diffraction design with a dipolar radiation pattern, push/pull dynamic driver elements, and a tuned labyrinth bass enclosure with nonparallel walls. Frequency response is 20Hz-20kHz; sensitivity is 91dB/1W/1M; nominal impedance is 4Ω. Dimensional Research Laboratories, 1086 N. Driftwood Ave., Rialto, CA 92376, (909) 875-3674, FAX (909) 873-5873.

*Reader Service #59*

#### ■ DYNACOMP

The PC Mathematics software library (IBM only) of mathematical procedures is fully menu-driven and includes a 206-page manual with operating instructions, a discussion of methodology, and detailed examples. The



#### ▲ TANNOY

The C Series home loudspeaker system has computer-optimized bass reflex design, liquid-cooled dome tweeters, gold-plated input terminals, low-loss crossover components, and high-density cabinet material. Available in black or oak vinyl veneer, the C Series is priced from \$229-699/pair. Tannoy, 30 Knoll Rd., Plymouth, MA 02360, (508) 746-3550, FAX (508) 746-8654.

*Reader Service #64*

8-disk program requires 256K RAM, MSDOS 2.0 or higher, and CGA/EGA/VGA or compatible graphics capability. Dynacomp, Inc., 178 Phillips Rd., Webster, NY 14580, (716) 265-4040.

*Reader Service #57*

# MENISCUS

Proudly supplies:

#### CAPACITORS -

- Polypropylene
- Mylar
- NP Elec.

#### INDUCTORS -

- Air Core
- Ferrite Bobbin
- 20 - 14ga. OFC

#### RESISTORS -

- Wire wound
- Non - Inductive
- 5 W - 25 W

#### ACCESSORIES -

- Terminal cups
- Gold posts
- Speaker cabinets
- Wire & connectors
- Grille cloth & fasteners
- Black screws
- Port tubes & trim
- Spikes & cones
- Damping materials
- Design books
- Custom foam grilles

**MENISCUS - 2575 28th St. SW #2 - Wyoming, MI 49509**  
(616) 534-9121 FAX (616) 534-7676

## SPEAKERS -

**AUDIO CONCEPTS  
CERATEC  
DYNAUDIO  
ECLIPSE  
ENTREÉ  
ETON  
EMINENCE  
FOCAL  
MB  
MADISOUND  
MAGNAT  
MOREL  
POLYDAX  
PEERLESS  
SCAN SPEAK  
SWAN  
VERSA/TRONICS  
VIFA**

*Reader Service #12*



# HEAR, HERE!



**O**ur 1993 product line just arrived and there's lots to celebrate. A comprehensive array of nearly 100 drivers. Innovative technologies. Leading edge materials. Engineered to provide flexibility in your design process and clear cut sonic quality advantages at every level of performance.

***You've heard about our quality for years. Now's the time to hear it for yourself.***



Subsidiary of Audax Industries, France.  
For your nearest authorized distributor  
please call 508.658.0700

## Copper-Foil Air-Core Inductor™

Extremely Designed For Precision Audio Transducer/Speaker Driver Crossover Network.



### PRODUCT HIGHLIGHT

Typ. 2.7mH, 1.4awg

#### FEATURE

- Low power loss (15-50% less)
- Lowest DC resistance
- Lowest AC resistance
- Lowest Q factor
- Higher precision coil reactance
- Uniform current density
- Minimized Skin Effect resistance up to 100kHz
- Very high winding density
- Polypropylene insulated material
- Computer optimized coil size
- No saturation distortion
- No hysteresis distortion
- Made in USA

#### PRICE EXAMPLE:

14awg	0.47mH	\$ 9.31
12awg	0.47mH	\$ 12.69
14awg	1.80mH	\$ 18.89
12awg	1.80mH	\$ 26.55

#### CFAC INDUCTOR™ - LOWEST Rdc

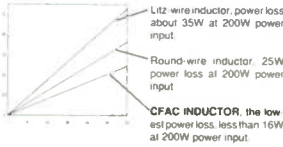

#### CFAC INDUCTOR™ - CLOSE TO THE IDEAL INDUCTOR

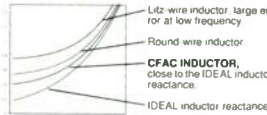

#### CFAC INDUCTOR™ - ELIMINATE SKIN EFFECT

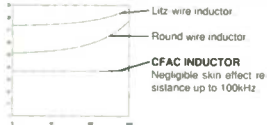

#### PLEASE CALL FOR FREE A CATALOG

TEL: (510)887-8016 FAX: (510) 887-1657

Solo Electronics, 2462 Tripaldi Way, Hayward, CA 94545, USA

Reader Service #35

## About This Issue

Bill Fitzmaurice, who plays electric bass, wanted a speaker which would suit his special needs—light weight, small size, and good output for live performance venues. So he designed the "Electric Bass Tri-Horn" (p. 10), a unit as unique as Bill's own fingerprints.

Just as outstanding for its adherence to a "no-compromise" philosophy is Randy Parker's "Prism V Satellite/JBL Subwoofer." Designed with a little help from some friends, Randy details its development in the first of a two-part article, beginning on page 16.

Speaker builders are increasingly aware of the importance of computer programs in realizing their designs. Homero Silva describes how he uses "Fitduct" to accurately tune vented systems (p. 28). Prof. Silva is the translator of the newest version of Vance Dickason's *Loudspeaker Design Cookbook* into Portuguese, *Caixas Acusticas e Alto-Falantes*.

Fred Thompson used another software program, LMP, in his design of the "CCPS." As he describes on page 30, the unique placement of the tweeters resolves some nagging issues.

For you "IMP" fans, Bill Waslo describes yet another of the program's many features: measuring T/S parameters. Bill puts the versatile software through its paces beginning on page 38.

Two reviews in this issue deal with current software: Term-Pro and related driver kits from Rockford Corp. are reviewed by Ray Alden (p. 54); Low Frequency Designer Software is discussed by G.R.

Koonce (p. 62). A no less important part of your equipment is the measurement microphone, and Gary Galo reviews three of the most affordable on p. 70.

# Speaker Builder

## The Staff

Edward T. Dell, Jr. Editor and Publisher  
Contributing Editors

Joseph D'Appolito Robert Bullock  
John Cockroft David Davenport  
Vance Dickason Bruce C. Edgar  
Gary Galo G.R. Koonce

Mary Wagner Managing Editor  
Rebecca De Fusco Assistant Editor

Christine Orellana Graphics Director  
Production  
Glenn Galloway Edward Roane

Laurel Humphrey Circulation Director  
Circulation Assistants  
Doris Hamberg Pat Kavenagh

## Advertising

Martha L. Povey  
National Advertising Director

Diane J. Smith  
Advertising Assistant  
(603) 924-9464 FAX (603) 924-9467

*The peculiar evil of silencing the expression of an opinion is, that it is robbing the human race; posterity as well as the existing generation; those who dissent from the opinion, still more than those who hold it."*

--JOHN STUART MILL.

Speaker Builder is published bi-monthly in the interest of the art and craft of speaker building.

### Subscription Inquiries

To subscribe, renew or change address write to Circulation Department. Call (603) 924-9464 or FAX (603) 924-9467 for MC/VISA charge card orders. For gift subscriptions please include gift recipient's name and your own, with remittance. A gift card will be sent.

Send circulation and editorial correspondence to PO Box 494, Peterborough, NH 03458-0494. No responsibility is assumed for unsolicited manuscripts. All MSs must include a self-addressed envelope with return postage. The staff **will not** answer technical queries by telephone.

Printed in the USA. No part of this publication may be reprinted or otherwise reproduced without the written permission of the publisher. Copyright © 1993 by Edward T. Dell, Jr. All rights reserved.

*Speaker Builder* (US ISSN 0199-7920) is published bi-monthly, at \$25 per year, \$45 for two years; Canada add \$6 per year; overseas rates \$40 one year, \$70 two years; by Edward T. Dell, Jr. at 305 Union Street, PO Box 494, Peterborough, NH 03458-0494. Second class postage paid at Peterborough, NH and an additional mailing office.

POSTMASTER: Send address change to:  
*Speaker Builder*, PO Box 494  
Peterborough, NH 03458-0494

# Speaker Builder

THE LOUDSPEAKER JOURNAL

VOLUME 14 NUMBER 4

JULY 1993

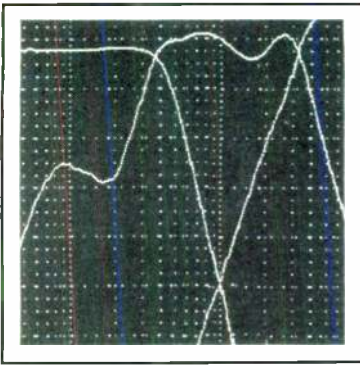

16

## 10 The Electric Bass Tri-Horn

BY BILL FITZMAURICE

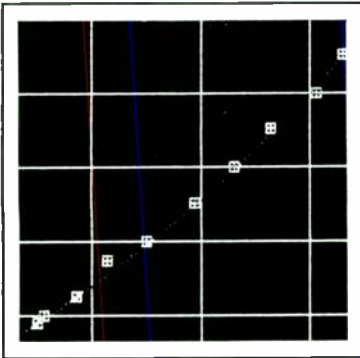

28

## 16 The Prism V Satellite/JBL Subwoofer, Part I

BY RANDY PARKER

## 28 Fitduct: A Program For Designing Duct Software

BY HOMERO SETTE SILVA

## 30 The CCPS: A Compact Coincidental Point Source Speaker

BY FRED THOMPSON

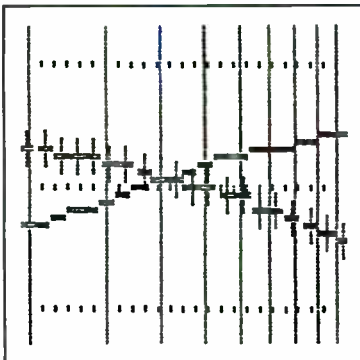

30

## 38 The IMP: Measuring T/S Parameters

BY BILL WASLO

## 54 KIT REPORT: Rockford's Beginner Software/Driver Paks

BY RAY ALDEN

## 62 SOFTWARE REPORT: Low Frequency Designer 3.01

BY G.R. KOONCE

## 70 PRODUCT REVIEW: Three Affordable Measurement Microphones

BY GARY GALO

### DEPARTMENTS

3 GOOD NEWS

9 EDITORIAL Symbiosis

76 SB MAILBOX

83 CLASSIFIED

86 AD INDEX

# MW114-S

## Neodymium Magnet DPC Cone 4" Woofer

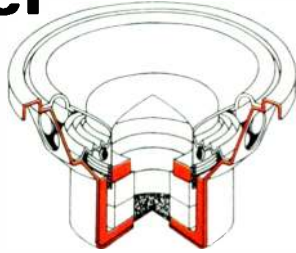

The 114-S is the first of Morel's new generation of woofers, featuring a powerful Neodymium magnet system which provides increased sensitivity, lower Q<sub>t</sub> and reduced distortion. For a 4" driver it is unique in having a large 54mm (2.125") diameter Hexatech aluminium voice coil.

Benefits of this large voice coil diameter include a very high power handling capacity and lack of sound level compression. In addition, it allows the use of a very shallow cone profile. Coupled with the use of Damped Polymer Composite cone material and a rubber surround, this provides excellent dispersion (off-axis response), resistance to cone break-up (even at high sound pressure levels) and lack of colouration.

Frequency and phase response are very flat, while the roll-off is very smooth. The MW 114-S may be used either as a bass-mid range in 2-way systems, or as a mid-range in multi-way systems.

The vented magnet system is encased within a steel chassis, which improves efficiency and shields the magnet, virtually eliminating stray magnetic fields. The MW 114-S is ideal not only for high quality hi-fi, but also TV, video and surround-sound applications.

### Specification

Overall Dimensions	Ø118mm (4.64") x 58mm (2.29")
Mounting Baffle Hole Diameter	Ø95mm (3.75")
Magnet System	Pot Type, Vented, Neodymium Magnet
Nominal Power Handling (Din)	150W
Transient Power - 10ms	800W
Voice Coil Diameter	54mm (2.125")
Voice Coil Type/Former	Hexatech Aluminium
Frequency Response	55-7000 Hz
FS - Resonant Frequency	65 Hz
Sensitivity 1W/1m	87 dB
Z - Nominal Impedance	8 ohms
RE - DC Resistance	5.6 ohms
LBM - Voice Coil Inductance @ 1kHz	0.47 mH
Magnetic Gap Width	1.25mm (0.050")
HE - Magnetic Gap Height	6mm (0.236")
Voice Coil Height	12mm (0.472")
X - Max. Linear Excursion	3mm
B - Flux Density	0.88T
BL Product (BXL)	6.75
Q <sub>ms</sub> - Mechanical Q Factor	2.32
Q <sub>es</sub> - Electrical Q Factor	0.36
Q/T - Total Q Factor	0.31
Vas - Equivalent Cas Air Load	3.18 litres (0.113 cu. ft.)
MMS - Moving Mass	7.00gm
CMS	807µm/n
SD - Effective Cone/Dome Area	53cm <sup>2</sup> (20.86 sq. in.)
Cone/Dome Material	DPC (Damped Polymer Composite)
Nett Weight	0.500 kg

Specifications given are as after at least 45 minutes of high power, low frequency running, or 24 hours normal power operation.

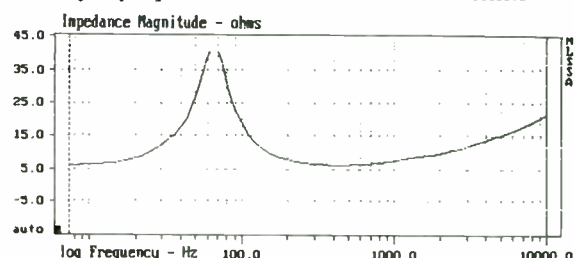
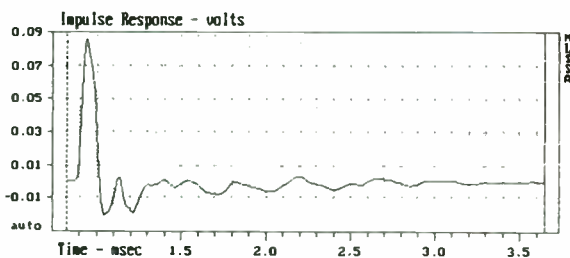
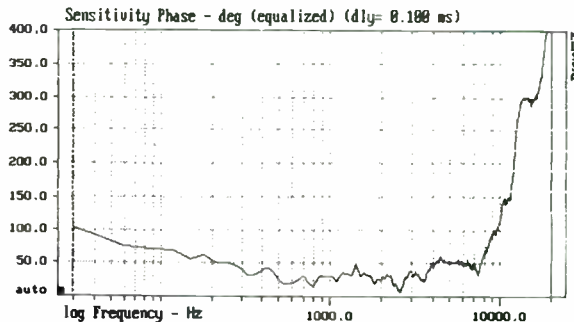
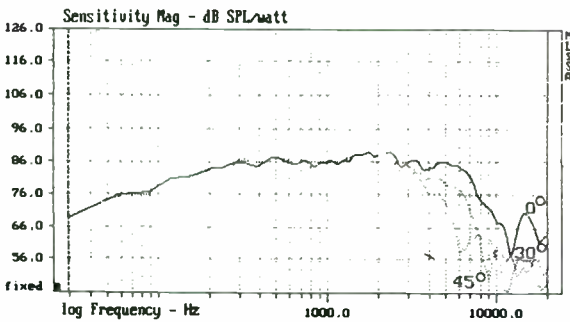

Morel operate a policy of continuous product design improvement, consequently specifications are subject to alteration without prior notice.

World Radio History

high fidelity  
range

morel (U.K.) Ltd.

11 Foxtail Road,  
Nacton Rd. (Ransomes  
Industrial Estate,  
Ipswich, IP3 9RT  
England  
Tel: (0473) 719212  
FAX: (0473) 716208

morel  
acoustics USA

414 Harvard Street  
Brookline, MA 02146  
Tel: (617) 277-6663  
FAX: (617) 277-2415





USE  
THESE  
CARDS



FOR  
Subscriptions,

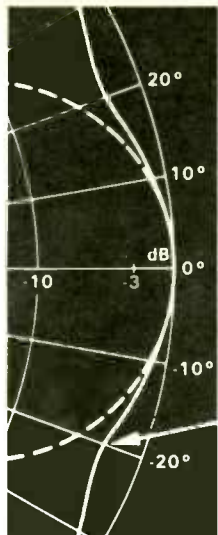

# Speaker Builder

THE LOUDSPEAKER JOURNAL

- New Subscription       Renewal (Please attach your label)  
 1 year (6 issues) \$25       2 years (12 issues) \$45

Canada add \$6 postage per year. Remit in US dollars only, drawn on a US bank. Overseas subscription and postage: 1 year/\$40; 2 years/\$70.

MC/VISA NUMBER \_\_\_\_\_ EXP. DATE \_\_\_\_\_

NAME \_\_\_\_\_

STREET & NO. \_\_\_\_\_

CITY \_\_\_\_\_ ST \_\_\_\_\_ ZIP \_\_\_\_\_

- Bill me (Please initial here) \_\_\_\_\_  Enclosed is my check  
 Charge my credit card  MC  VISA

(603) 924-9464, M-F, 9-4 EST; Answering machine 4 p.m.-8 a.m. EST daily; FAX (603)924-9467 24 hours  
 Please allow six weeks for delivery of first issue.

## FREE SHIPPING IN THE USA\*



WHEN YOU ORDER  
RONALD WAGNER'S

### ELECTROSTATIC LOUDSPEAKER DESIGN AND CONSTRUCTION (see ad this issue)

OLD COLONY  
FREE  
SHIPPING

Use this card  
alone for your  
Mastercard or  
VISA purchase,  
or include card  
in envelope  
with your check  
or money order.  
OFFER GOOD ONLY  
WITH THIS CARD.

YES! Please send me \_\_\_\_\_ #BKT6 @ \$19.95 = \$ \_\_\_\_\_

PLUS USA Shipping = 00.00

OR Canada/Other Surface\* shipping = \_\_\_\_\_

TOTAL ORDER = \$ \_\_\_\_\_

Check or money order enclosed    MC   VISA      US funds drawn on a US bank.

NAME \_\_\_\_\_ TODAY'S DATE \_\_\_\_\_

STREET & NO. \_\_\_\_\_

CITY \_\_\_\_\_ ST \_\_\_\_\_ ZIP \_\_\_\_\_

COUNTRY \_\_\_\_\_ DAYTIME TELEPHONE \_\_\_\_\_

MC / VISA CARD NO. \_\_\_\_\_ EXPIRATION DATE \_\_\_\_\_



\* \$2 Canada  
\$7 Other Surface

OR  
Information  
FOR YOUR  
FRIENDS



### What would your friends say about Speaker Builder?

Ask them and find out! Fill out the card below or call us with their name and address,  
we'll take it from there. They'll probably say, "Thank you" and we will too.

NAME \_\_\_\_\_

NAME \_\_\_\_\_

STREET & NO. \_\_\_\_\_

STREET & NO. \_\_\_\_\_

CITY \_\_\_\_\_ ST \_\_\_\_\_ ZIP \_\_\_\_\_

CITY \_\_\_\_\_ ST \_\_\_\_\_ ZIP \_\_\_\_\_

NAME \_\_\_\_\_

NAME \_\_\_\_\_

STREET & NO. \_\_\_\_\_

STREET & NO. \_\_\_\_\_

CITY \_\_\_\_\_ ST \_\_\_\_\_ ZIP \_\_\_\_\_

CITY \_\_\_\_\_ ST \_\_\_\_\_ ZIP \_\_\_\_\_

Speaker Builder  
World Radio History

PO Box 494, Peterborough, NH 03458-0494 (603) 924-9464

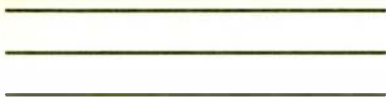

YOUR  
STAMP  
HELPS

**Speaker Builder**  
PO Box 494  
Peterborough NH 03458-0494



YOUR  
STAMP  
HELPS

**OLD COLONY SOUND LAB**  
PO Box 243, Dept. SBX  
Peterborough NH 03458-0243



YOUR  
STAMP  
HELPS

**Speaker Builder**  
PO Box 494  
Peterborough NH 03458-0494

# Editorial

## SYMBIOSIS

The Australian termite gets a terrible case of indigestion if his resident parasites die. Without these parasitic inhabitants of the termite's stomach, it cannot digest the only food it knows how to eat: wood. There are millions of examples of such interdependency. I'd like to talk about another.

When I founded *Audio Amateur* in 1970, I carried a prejudice about publishing which was popular in the fifties and sixties. We were all aware of how pervasive advertising in its proliferating forms had become and most thinking people reacted strongly, all the more so because we suspected we were being manipulated by subliminal messages buried in the TV and movie channels.

I thought of this as a purist ideal for the publication, avoiding any hint of commercial influence on what we wrote, edited and published. Somebody has said that the first thing a principle does is kill somebody. My high-principled view had the usual flaw of limited data. It took too long for me to discover that the relationship between a good vendor and a reader and a magazine was not a theory, but a primary interdependency which can enhance all three.

One of my first discoveries was that the only difference between a reader and a vendor is the entrepreneurial urge. Most of *Audio Amateur's* advertisers have, at some point, been hobbyists; then hobbyists with a dream, and finally, business people with hands-on savvy about what they sell.

I have come to see that an imaginative, innovative vendor with a genuine commitment to service can be a vital, necessary ingredient in the pursuit of excellent sound, beautiful craftsmanship and a pleasurable avocation. Such people are becoming scarcer, unfortunately, at least they are in the United States. Despite our reputation for innovation, inventiveness and design, we are falling behind other countries in how we do business, and we are losing our edge so far as understanding how goods are made, and our will to make them the best there is.

Dramatic evidence exists concerning my thesis about the interdependent nature of those who love an avocation, practice it, and supply the goods to enable it. This magazine's advertisers, from the smallest ad in our Classified section to the space ads throughout the book, are generally small enterprises whose specialty is the goods an audio amateur will need to build satisfying projects.

Unfortunately, some readers regard audio parts and hardware vendors in ways that are bad for everyone. First: some see the vendor as an adversary. Most of us must use mail-order (or phone-order) to find the parts we need. The process is long and requires a lot of patience—on the part of the vendor and of the customer.

I have the pleasure of knowing many of our advertisers and those I know are genuine enthusiasts about sound and equipment.

Realistically, every reader should keep in mind that such a vendor is serving a small market, and this being so, he or she is working as much for the pleasure of doing something he or she likes, as for the economic side of things. The profits are never very large. Such people are usually willing to work very hard to give the customer good service and high-quality, hard-to-find products.

But audio enthusiasts seem too often to forget that the vendor is in business and is not a free, giant source of design information from which he or she is at liberty to draw without any limit. Such abuse of vendors becomes venal when such an enthusiast uses up time and talent offered freely, and then goes to another vendor for the purchase. Service is not "free" in one sense. Information is not free, either. And using a vendor as a research arm, rather than doing your own homework, is manifestly unfair and damaging to the reader's ability to learn.

A thoughtless or unscrupulous amateur who misuses vendors harms this avocation. A thoughtless or unscrupulous vendor who fails to service his customers fairly and efficiently harms this avocation.

Having talked with and listened to readers over the more than two decades of this magazine's existence, I find that a few think their hobby should be free. I certainly know the pleasure of finding a bargain at a yard sale, a surplus store or whatever. But a totally "flea market" attitude about goods impoverishes this avocation.

We all enjoy the savings in doing the work of building and modifying equipment. But our handiwork is delivering performance for hundreds of dollars, where the less-fortunate audiophile with a taste for "high end" is spending thousands. It should not be hard to see that if the vendors who offer you excellent parts and services through these pages can flourish and grow as a result of your patronage, they can offer you better parts, more diverse goods and better service.

A thoughtful amateur will keep one further matter in mind. The task of finding, buying and cataloging parts for our market is much, much more difficult than you might imagine. We live in a giant country. Most electronics suppliers do not like to do business in small orders. Some restrict any order to a minimum of \$50. Electronics vendors prefer industrial-type purchase orders. Your friends advertising here work extremely hard and long to find what you need. Some of them face a manufacturer's restriction on minimum orders of as much as \$5,000 per line item. Most of them must find other

*Continued on page 82*

# THE ELECTRIC BASS TRI-HORN

BY BILL FITZMAURICE

The triangular cabinet in *Photo 1* is made of  $\frac{1}{2}$ " plywood, with no stuffing, horn-loaded front- and rearwaves, and a detachable stand—bet you've never seen anything like it. While this speaker is not for home use, many of its unique construction techniques can be utilized by all builders. For those of you who play electric bass, it will be a sight for sore eyes and relief from a sore back.

My requirements include light weight, small size, and high power output. I drive a subcompact and carry a lot of equipment, so I restricted the overall cabinet size to 5 ft.<sup>3</sup> and no more than 65 lbs. (so hauling it would be a one-person job). The triangular shape serves two purposes: it eliminates standing wave problems, and it allows the use of a bolt-on folding stand which doubles as a horn for the rearwave. The horn's 7dB boost in efficiency at 40Hz allows the cabinet volume to remain under 5 ft.<sup>3</sup>

I chose the EVM-15 B and the Pyle MH-516 for drivers. The EVM is rugged and efficient, but response falls off above 1.5kHz, so the 5" Pyle extends response beyond 10kHz. The Pyle's relative inefficiency (90dB versus 99dB for the EVM) presents no problem, since any musical instrument amp has at least 20dB of treble boost. When crossed over at 1kHz at only a 6dB slope, it is almost indestructible. (I also tested this cabinet with a JBL E-140 woofer for comparison, and it tests out within  $\pm 2$ dB across the spectrum.)

**DOUBLE CAULK.** Before describing the actual construction, a few tips are in order. I use butt joints throughout, with  $1\frac{1}{4}$ " drywall screws every 6" maximum. To save weight and speed construction, I don't use glue blocks. Instead I use a construction adhesive which is strong and easily applied with a caulking gun. Simply apply glue to the joint line, posi-

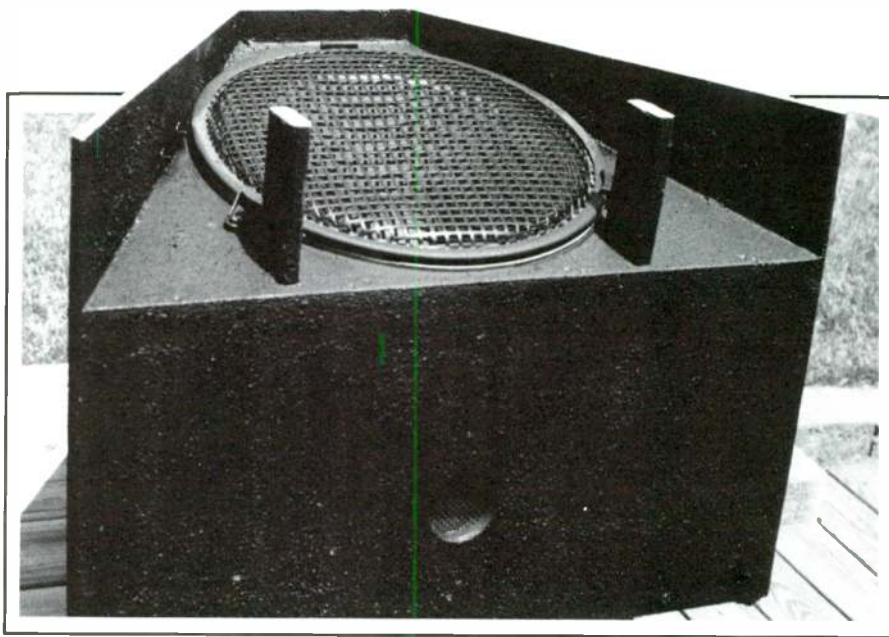

PHOTO 1: Completed cabinet, top removed.

tion and clamp the pieces, counterbore, and screw together. Then apply an extra bead of caulk along the joint line on the *inside* of the cabinet.

I always counterbore so the screw heads are  $\frac{1}{8}$ - $\frac{3}{16}$ " below the panel surface. This allows you to radius the cabinet edges without hitting the heads (*Fig. 1a*).

I cut the piece being joined about  $\frac{1}{8}$ " oversize, using the actual joint line on the inside of the cabinet as the reference. The resulting joint has an overhang which I later trim off with a router and flush-trimming bit. This speeds up construction, improves accuracy, and results in a perfectly flush joint. You could use a belt or disk sander, but a router is faster and more precise (*Fig. 1b*).

My cabinets are very lightweight but strong, because I build them with a thin skin over lots of panel-to-panel bracing. I even lighten my braces by drilling holes in them with a hole saw and radiusing all nonjointed edges, which also increases internal cabinet volume. This detail can

be omitted if you don't care about that last half-pound.

**PLYWOOD PANACEA.** I prefer Baltic birch plywood for its consistency, but a good void-free plywood will do. Particleboard is not a good choice, as it's too heavy and does not work or joint as well as plywood. I use  $\frac{3}{4}$ " plywood for the baffle, which needs the extra strength, and for the top and stand, which cannot be easily braced.

For the finish, I use regular latex house-paint mixed with a sand-finish additive. An ozite carpet finish is a good, albeit expensive, alternative.

## ABOUT THE AUTHOR

William Fitzmaurice (B.A., University of New Hampshire, 1971) has been a professional musician for over 25 years. He has used speaker cabinets of his own design and manufacture since 1968, and has sold cabinets as well. He is also a builder of custom-designed electric basses and guitars, and is the proprietor of Bill Fitzmaurice Luthiery.

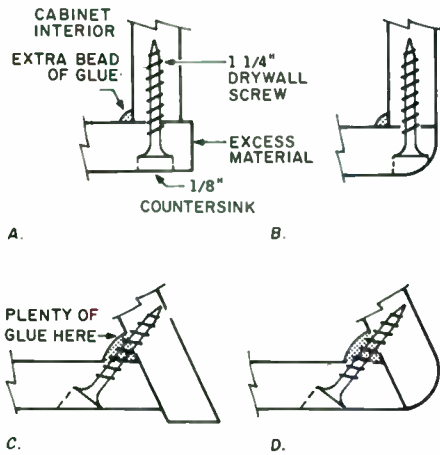

FIGURE 1: a. joint prior to trimming; b. after trimming and chamfering; c. triangular joint before trimming; d. triangular joint after trimming and chamfering.

I mount the carrying handles with T-nuts for strength. My own cabinet is equipped with a cheap but heavy chest handle, and because the cabinet is so stiff and strong, it does not vibrate. For good measure, I mount handles so they straddle a brace, where the cabinet is stiffest.

I recommend steel grilles for maximum driver protection, and they are available from a number of sources. You can find wire-mesh hardware cloth for the midrange grille at any hardware store.

**BRACE YOURSELF.** Now for the actual construction. First, lay out the cabinet bottom (Fig. 2). Draw a line  $\frac{5}{8}$ " from the edge of your plywood and use it as the base of an equilateral triangle 26" on each leg. Draw two more lines  $\frac{5}{8}$ " outside the other two legs. (When attached, the front and sides will align on the 26" lines on the inside of the cabinet, leaving about  $\frac{1}{8}$ " of selvage outside the joints.) Cut out the cabinet bottom. Cut the front so the bottom is square, the top is at a 12° angle, and the sides are at 30°. Measured on the shorter face, the cabinet front will be 26-inches wide (Fig. 3).

If you're using a midrange driver, you'll need a mid box. Cut the braces, top, bottom, and back, as in Fig. 4. The bottom is 2" up from the bottom of the braces; the top is 3" down from the mid-brace top. Your box interior will be 6" square. Attach the back with screws only—no glue. Remember, this back is removable.

Now cut a 3" hole, centered and 5½" up on the cabinet front. Tack the hardware cloth over the hole on the inside of the panel. Glue and screw the mid-box assembly to the panel, which will clamp the grille in place. You can now attach the completed cabinet front/mid-

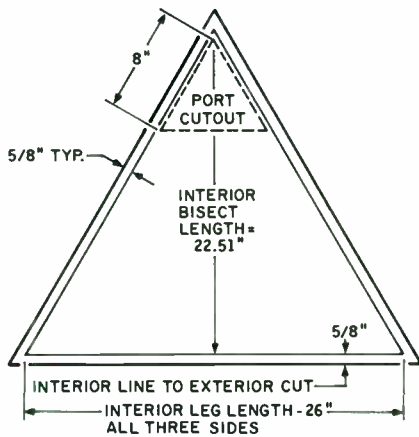

FIGURE 2: Cabinet bottom layout.

box assembly to the cabinet bottom. Line up the front panel's inside edge with the 26" baseline on the cabinet bottom, leaving a  $\frac{1}{8}$ " overhang outside the cabinet. Remember to run screws through the bottom into the mid braces.

Cut both sides 19-inches high, with the edges at a 30° angle. One side has an inside measurement of 26¾", and the other is 27½". Attach the sides to the bottom and front assemblies, as shown in Fig. 5. The bottom should extend out by about  $\frac{1}{8}$ " all around. Using the router with flush-trimming bit, remove any excess material from the joints. Addition-

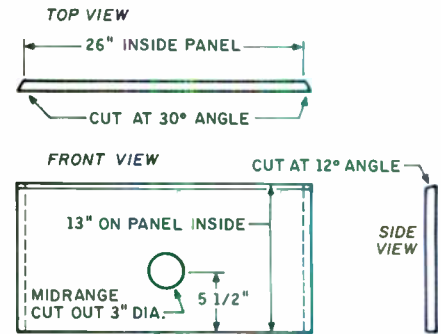

FIGURE 3: Front panel layout.

ally, I recommend rounding off the vertical joints with a ½-inch-radius molding bit, or sanding them.

With a saber saw, cut the bottom of the port. When you cut the side-to-bottom braces, lighten them by boring and chamfering. If you did not install a mid box, you will need to cut an additional Brace A. Install the braces in the approximate positions as shown in Fig. 4. Since identical measurements might lead to standing wave problems, randomize the positions somewhat (Photo 2).

**TOTALLY BAFFLED.** Cut out the baffle and its braces (Fig. 6). Temporarily fit the baffle in place with screws; it will overhang the cabinet front. Using the

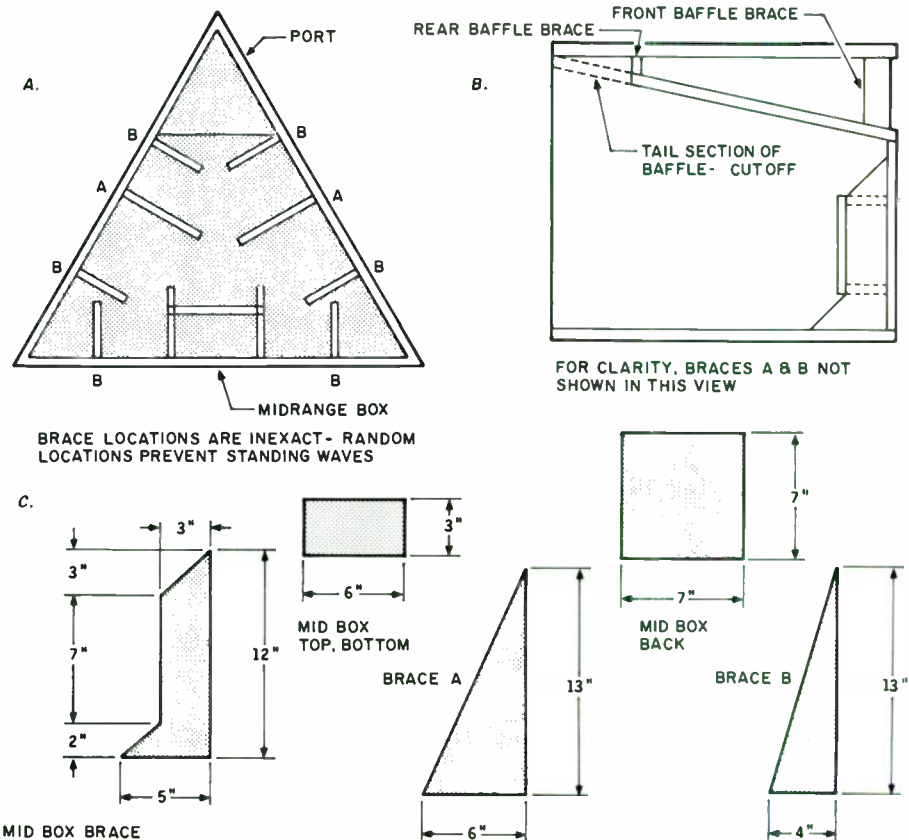

FIGURE 4: Bracing details: a. top view; b. side view; c. brace locations.

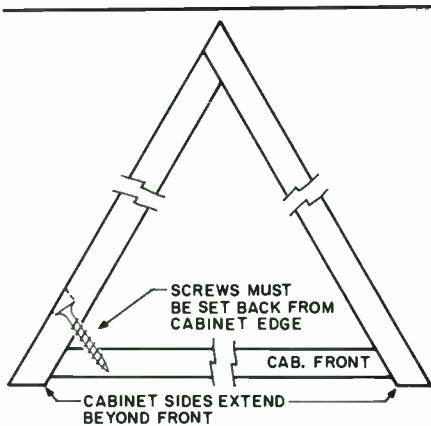

FIGURE 5: Midrange driver box construction.

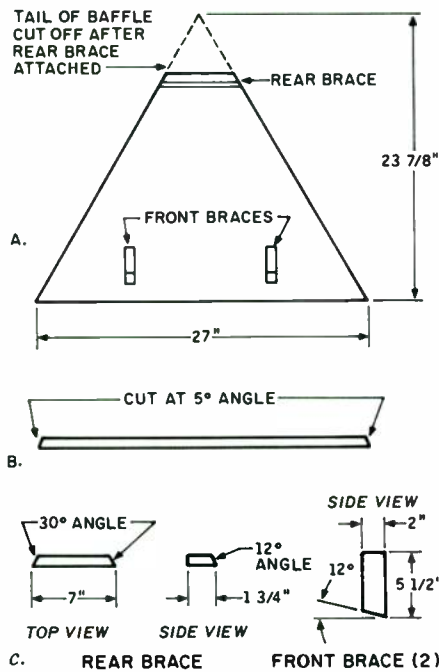

FIGURE 6: Baffle and brace positioning: a. top view; b. front view; c. rear and front brace.

driver as a template (by placing the inverted driver on top of the baffle), mark the mounting-bolt hole locations. You should have about  $\frac{1}{4}$ " clearance between the driver frame and the cabinet sides at the closest point. Remove the driver and draw lines connecting the bolt holes to determine the driver center point. With a compass, draw a  $14\frac{1}{8}$ " circle on the baffle for the cutout. Remove the baffle, cut the speaker hole, drill the bolt holes, and install the driver-mounting T-nuts to the rear of the baffle.

After marking the location of your handle-mounting holes on the cabinet, drill and install the T-nuts. Mark the location of the midrange mounting holes on the front panel and drill them, then install T-nuts from outside the panel. Cut or drill the appropriate hole(s) for your jack or binding posts.

Attach the baffle braces. Cut off the

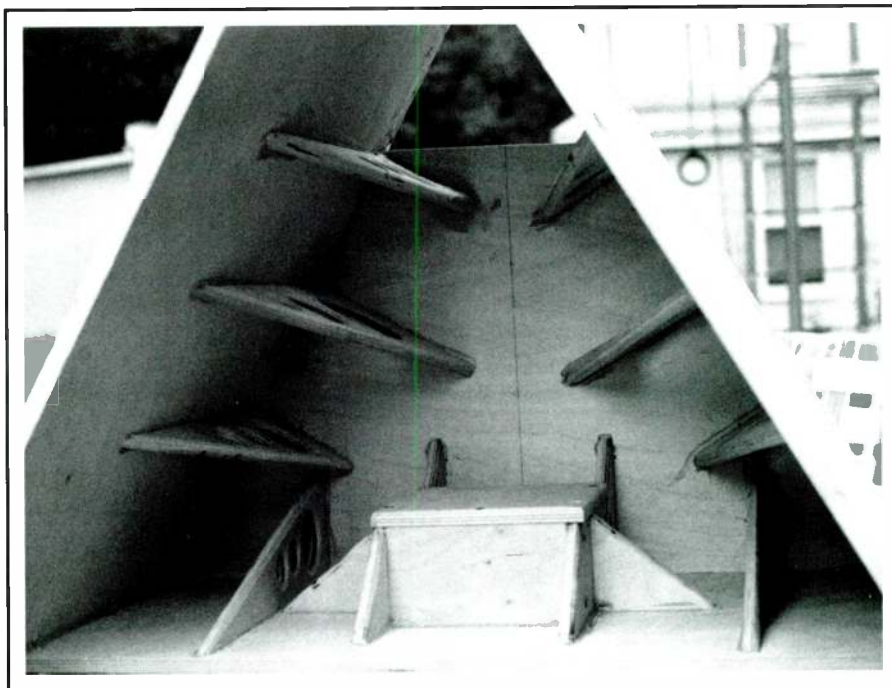

PHOTO 2: Interior view before baffle installation.

piece of baffle extending behind the rear brace, then permanently install the baffle with glue. The braces will extend above the cabinet sides. Using a board as a guide, rout the braces flush with the height of the cabinet sides (Photo 3) and the baffle flush with the front panel.

Cut the top to a size identical to the bottom, but with  $\frac{3}{4}$ " plywood. Attach it to the cabinet with screws, and rout the top flush with the sides.

Cut and attach the stand braces to the cabinet. Cut the stand halves and attach them to each other at their rear with the piano hinge, then fold them together. Mark the handle holes and cut both pieces simultaneously so they align, then chamfer the holes. Open the stand and hold it in place on the cabinet with C-clamps. Drill six  $\frac{7}{16}$ " holes (Fig. 7) simultaneously through the stands and their braces. Remove the stands and install  $\frac{3}{8}$ " T-nuts to the stand braces; reattach them using  $\frac{3}{8}$ "  $\times$   $1\frac{1}{2}$ " thumbscrews. Chamfer all remaining edges with a  $\frac{1}{4}$ -inch-radius trim bit or a sander. Remove the stand once again, and finish it and the cabinet as desired.

**ROCK READY.** When your finish is complete, install the jack/binding posts and handles. Working through the speaker hole, remove the back of the mid box. Drill a hole for the wire to pass through, then wire and install the mid driver. Stuff the mid box with fiberglass and attach the back with screws. Caulk the hole around the wire, and wire the

mid driver to the jack using the  $22\mu\text{F}$  cap in series.

After wiring the woofer to the jack, bolt it to the baffle. Caulk it with a bead around the frame edge. Do not caulk between the frame and the baffle or you may not be able to remove the woofer later (Fig. 8).

Continued on page 14

TABLE 1

TRI-HORN PARTS LIST

ITEM	DESCRIPTION
Baffle, baffle braces, top and stand	$\frac{3}{4}$ " plywood
Bolts (12), T-nuts	$\frac{3}{16}$ "
Capacitor	$22\mu\text{F}$ , 100V non-polar crossover (if using midrange)
Construction adhesive	"Liquid Nails" or equivalent
Drywall screws	$1\frac{1}{4}$ "
Finish material	paint, carpet, vinyl, as desired
Handles	
Hook-up wire	14- or 16-gauge
Jack or binding posts	as desired
Mesh hardware cloth	$\frac{1}{8}$ " or $\frac{1}{4}$ ", 8" $\times$ 8"
Midrange	Pyle MH-516 5" (optional)
Panels	$\frac{1}{2}$ " plywood
Piano hinge	12"
Steel grille	15"
Thumbscrews (6)	$\frac{3}{8}$ " $\times$ $1\frac{1}{2}$ "
T-nuts (6)	$\frac{3}{8}$ "
Woofer	EVM-15 B or JBL E-140 15"
Mounting hardware	

Total estimated cost, with suggested drivers: \$275-300



# A better speaker damping material...

If you've been building speakers for some time, you know how much guesswork goes with speaker damping and stuffing. The choices seem endless: fiberglass, wool, Dacron, flat foam, convoluted foam, felt, tar, plus various "magic" compounds that you're invited to brush or pour into your new cabinets. Everyone has their own recipe, and who knows if it's a recipe for disaster? Or what effects the vapors emitted by these chemicals might have on the glues that bond your woofer surround to its cone and chassis? In this era of costly, space-age drivers and computer-assisted design, we think such risks are

totally unacceptable. So we went to work to find the ideal solution.

The problems are fairly well-known: a driver transforms electrical energy into mechanical energy. This mechanical energy is transformed into acoustical energy which is radiated to the outside of the cabinet - the useful front wave - and to the inside - the sometimes-useful back wave. Unfortunately, it is also transmitted through the frame of the driver to the cabinet itself, which acts as a very large "cone" of very small excursion. This means that the spurious resonances and vibrations of the cabinet have to be controlled in a predictable and reproduceable way. That's how we came to BLACK HOLE 5 and the BLACK HOLE PAD.

First, THE PAD. It's a thin (1/16 inch) black flexible viscoelastic damping material (filled vinyl copolymer) with maximum performance between 50 and 100 degrees F (we hope that that covers the temperature range of your listening room) and excellent flame resistance - it meets UL94 V-O. Thanks to its outstanding damping characteristics, THE PAD will dramatically reduce the vibration energy stored in the walls to which it is applied.

Easy to cut and apply, THE PAD has a pressure-sensitive adhesive back: simply peel off the release paper and press hard onto a clean surface. You can use THE PAD on just about anything you suspect of vibrating: driver frames, thin panels like car doors, and, of course, the walls of your speaker cabinets. And it can be used to recess a driver without using a router: just laminate enough layers to match the thickness of the driver frame and apply to the front baffle. Finally, it is the ideal material for "constrained layer" wall construction, where two panels are laminated on each side of a damping material for optimum transmission loss. Because THE PAD has a fine grain leather finish, you can wrap an entire cabinet exterior and give it an attractive appearance at the same time!

For applications which require **maximum damping, isolation and absorption**, we've developed BLACK HOLE 5. One and 3/8" thick, BLACK HOLE 5 is a high-loss laminate that provides optimum acoustical damping performance. It consists of five layers:

Thin diamond-pattern embossing, densified with a polyurethane film surface. This unique surface layer dramatically improves the performance of the whole acoustical system, especially the lower mid-range and mid-bass frequencies where simple acoustical foam loses its effectiveness.

One-inch deep polyester urethane foam, structurally optimized for acoustical damping. Highly effective at "soaking" maximum sound energy with minimum thickness.

Barrier septum, 1/8 inch thick. Made of limp flexible vinyl copolymer loaded with non-lead inorganic fillers, it is a "dead wall" that isolates the vibrations in the walls of your cabinet from the vibrations created inside the enclosure.

Polyester urethane flexible open-cell foam, 1/4 inch thick. Thanks to special vibration-isolation characteristics, it decouples the vibrating structure (the wall) from the rest of the damping system, thus optimizing performance.

High-loss vibration damping material, same as The Pad. It is strongly bonded to the cabinet wall with pressure sensitive adhesive.

These layers are laminated using an adhesive-free mechanical and thermal process, thus optimizing performance and eliminating the risk of solvent fume damage. BLACK HOLE 5 can be used in any enclosure, as well as for acoustical panels to improve the characteristics of your listening room. **YOU PROVIDE THE MUSIC; BLACK HOLE FIVE WILL TAKE CARE OF THE NOISE!**

**orca**

1531 Lookout Drive  
Agoura, CA 91301 U.S.A

818-707-1629  
FAX 818-991-3072

## AEON Cables

New from ORCA!

AX-ON (Greek axon, axis): that part of a nerve cell through which impulses travel away from the cell body. AXON 8 speaker cable combines outstanding design features with component quality usually associated with the most expensive cable. With eight AXON 1 solid-core conductors and utilizing mylar/ polypropylene construction, AXON 8 offers outstanding performance for amp-speaker connections and perfectionist internal speaker wiring. Our superb AXON 1 AWG 20 solid core conductor is also available separately. Oxygen-free and 99.997% pure, it is ideal for most internal wiring applications.

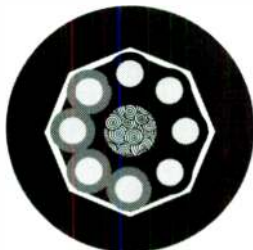

**Outer insulation:** UL approved TPE

**Cable geometry:** non interleaved spiral

**Individual conductor insulation:** 105 degree Celsius, UL approved PVC

**Cable equivalent gauge:** total - AWG 11, 2 conductors - AWG 17, 4 conductors - AWG 14

**Individual conductors:** solid core AWG 20 copper, long-grain and ultra-soft, free of all contaminants and oxygen.

**Cable core:** crushed polypropylene

**Inner envelope:** mylar film

Reader Service #32

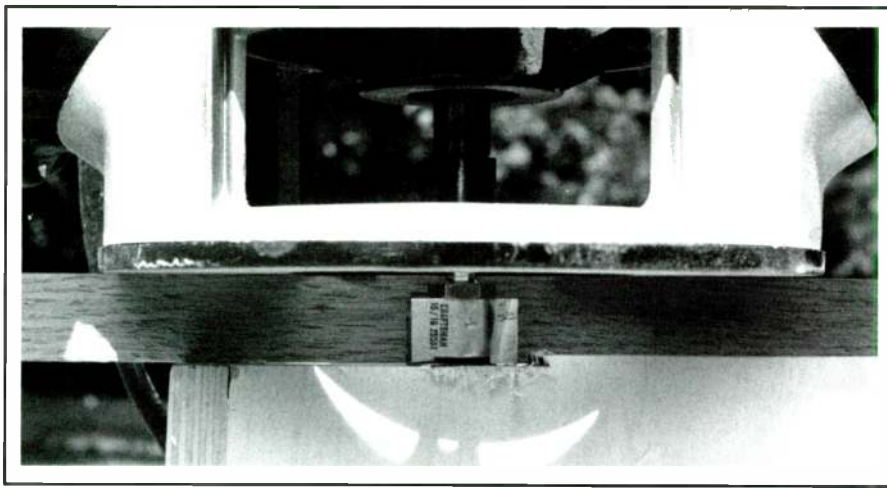

PHOTO 3: Routing parts to height using guide board.

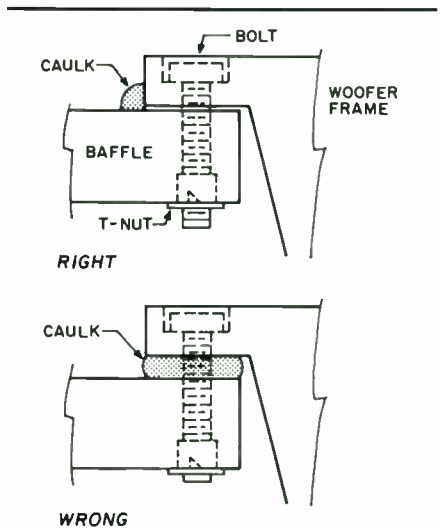

FIGURE 8: Woofer caulking.

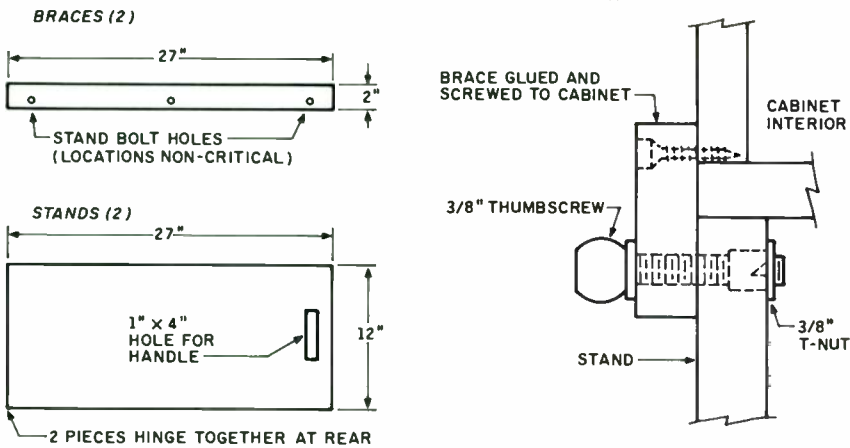

FIGURE 7: Stand construction.

Continued from page 12

Attach the steel grille. Screw the top to the sides and the baffle braces using thin foam gasket at all contact points, but do not use glue. Finally, attach the stand and you're ready to rock (Photo 4).

Is this an audiophile cabinet? Definitely not. Musical instrument speakers are intended to produce live music, and this unit sounds great for its intended usage.

The quasi-horn loading of the frontwave enhances the lower midrange around 300Hz, which gives it a very punchy sound, while the stand/horn boosts the bottom end from 3-7dB below 150Hz (Fig. 9). If you wish, you can gain more bottom end by increasing the cabinet height, and therefore volume, to whatever your mode of transport and strength

allow. (Remember to increase the brace sizes accordingly.)

I find the bottom end adequate even in outdoor venues, and I drive my rig with only 80W. Increasing the stand height, by the way, will actually cause a loss of power—it makes the horn throat too large for effective loading. I didn't bother stuffing the woofer compartment, since I found no discernible resonances from the cabinet. If you find it enhances performance, please let me know.

Aside from the satisfaction of playing through equipment I've designed and built myself, my greatest pleasure is when I set up my diminutive powerhouse on stage and hear: "What is that? Where did you get it?" Sometimes the Equipment Groupies (the resident "experts") assume that nothing so small or unconventional could sound so good. But it usually takes only five or six notes from my bass to convince them otherwise.

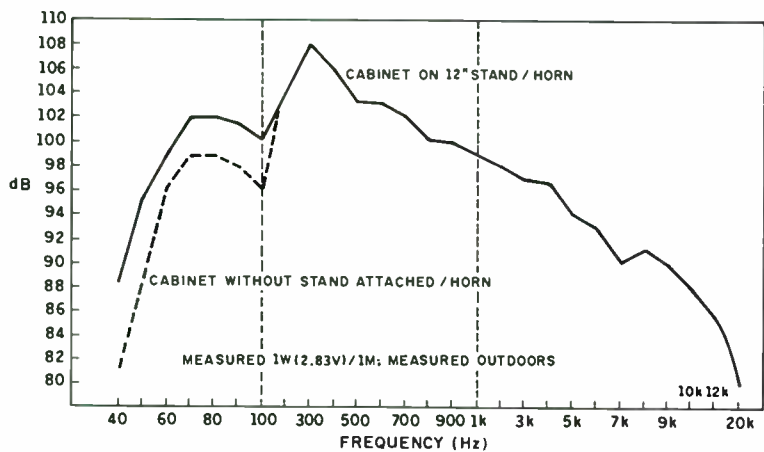

FIGURE 9: Frequency response of the Electric Bass Tri-horn (measured 1W [2.83V]/1m, outdoors).

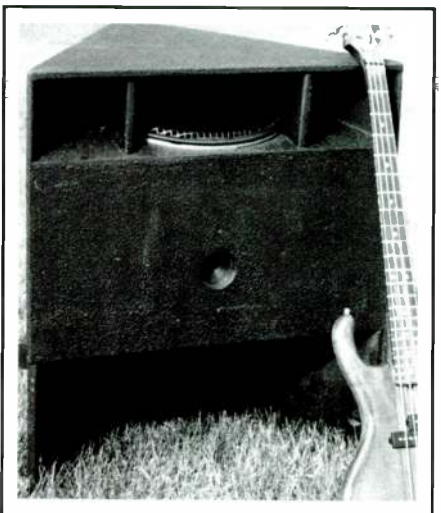

PHOTO 4: Completed cabinet, mounted on stand.



# ZALYTRON

**YOUR ONE STOP SHOPPING CENTER**

**FOCAL VIETA**

**Cabasse**  
LA RÉFÉRENCE EN HAUTE FIDÉLITÉ



**seas**



**ZALYTRON**  
CUSTOM WOOFERS

**PHILIPS**



**Polydax**  
speaker corporation

**l'atelier audio**  
F A N A S I E

**ACCUTON**

**In Our Efforts To Bring You the Best Equipment at the Best Price. . .**

**We Now Proudly Offer**

- ARIA 5  
With new focal Titanium Tweeter ..... **\$399**
- ARIA 5  
With Accuton Tweeter  
Due to an importer Authorized Sale  
we are reducing the price to ..... **\$599**
- ARIA 3..... **\$999**
- A-3 CABASSE ..... **\$1199**

**IMPORTER AUTHORIZED SALE  
ACCUTON REDUCED!!**

- C 211.....Each **\$125**
- C 222.....Each **\$150**
- C 277.....Each **\$185**

Now is the time to get the finest drivers on the planet at out of this world discounts.

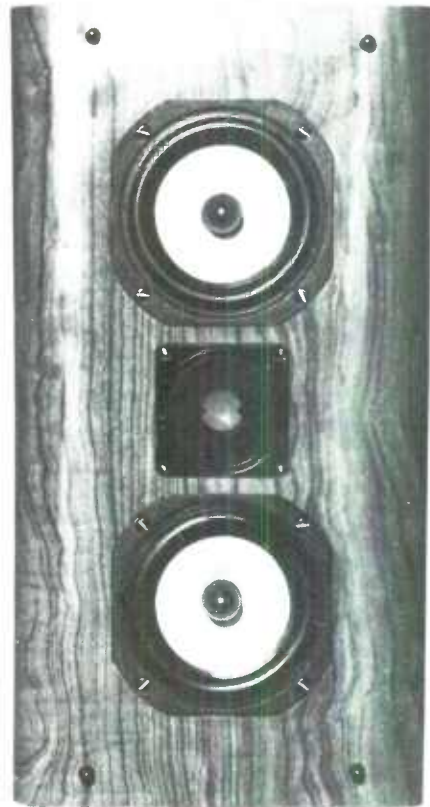

**ORDER YOUR BRAND NEW 1993 SPRING SPEAKER CATALOG**

**ZALYTRON INDUSTRIES CORP.**  
**469 JERICHO TURNPIKE, MINEOLA, N.Y. 11501**  
**TEL. (516) 747-3515      FAX (516) 294-1943**

Our warehouse is open for pick-up 10AM to 6 PM daily, Monday thru Saturday  
UPS orders shipped same day • Minimum order \$50.00  
**WRITE OR CALL FOR ALL YOUR SPEAKER NEEDS OR INQUIRIES**

# THE PRISM V SATELLITE/JBL SUBWOOFER

BY RANDY PARKER

**B**uilding the Prism V Satellite/JBL Subwoofer "no-compromise" system was well worth the effort (*Photo 1*). I attribute its outstanding performance to the higher quality of its drivers, the complexity of its enclosure, and the knowledge and care that went into its crossover design. In keeping with my "no-compromise" goal, I used the highest quality materials and construction techniques to achieve whatever acous-

tical benefits might be gained, no matter how small.

I was fortunate to have the technical support of DLC Design's David Clark in designing and optimizing the crossover. Dave's company produces the SPEAK Acoustic Simulation Software computer program which we used to create the initial crossover design. We also used his Techron TEF 10 Time-Delay Spectrometry (TDS) Analyzer to make all acoustical and electrical measurements.

**MOUNTING TENSION.** I derived the number of drivers and their mounting geometry from the work of Joe D'Appolito. The combination of elements that define a D'Appolito system ("Of Time and Phase," *SB 4/85*, p. 48) provide a broad and uniform, vertical and horizontal polar response. A five-driver, three-way (5,3) rendition adds two low-frequency drivers, one above and one below the midranges.

The (5,3) geometry produces a natural soundstage, is relatively forgiving of listener and speaker placement, mixes up

room modes well in the bass and lower midrange, and conforms to rules producing predictable results with documented performance parameters. Furthermore, the Allison effect of smoothing the bass and midrange response by staggering the driver's distances to room boundaries is enhanced with multiple drivers.<sup>1</sup>

The staggered heights of the vertically aligned driver pairs also helps minimize response dips caused by early reflections from the floor. When the Prism V is placed on top of the subwoofer, the top bass driver is an odd multiple of the bottom drivers' height, so cancellation and reinforcement effects from the floor have

## ABOUT THE AUTHOR

Randy Parker graduated from Albion College with a degree in economics, and is currently Plant Personnel Manager with the Kellogg Company. He has been interested in audio construction projects for the past 25 years; his primary audio interest is speaker system design and construction. He is a member of the Southeastern Michigan Woofer and Tweeter Marching Society, an audio construction club, with other interests including competitive swimming, biking, and performance boating.



PHOTO 1: Complete Prism V Satellite/JBL Subwoofer system

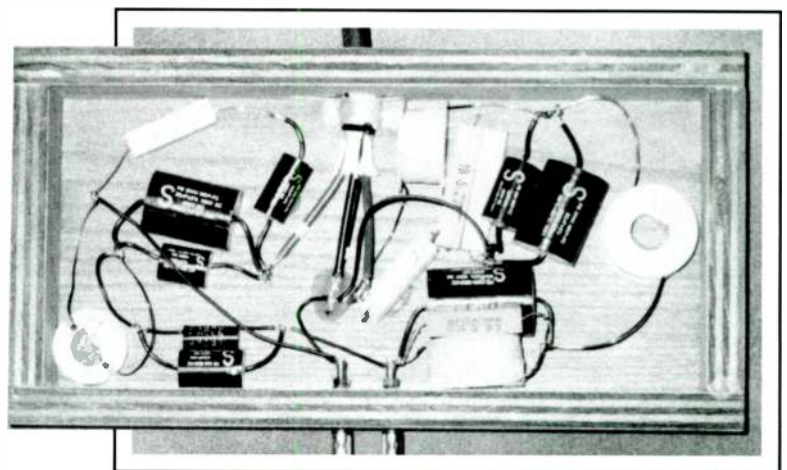

PHOTO 2: Passive crossover in external enclosure.

very few coincident frequencies. This is due to the averaging effect of the different reflected path lengths from the bass and midrange drivers to the listener.

The (5,3) geometry also seems to stabilize the apparent acoustic center despite frequency variation. With this configuration, the midrange and bass drivers are placed symmetrically above and below the tweeter so the sound source is centered at a single point above the floor at tweeter height. The result is accurate image placement and properly recreated soundstage size. Additional benefits to using paired drivers include increased power handling and sound-level output, reduced IM distortion, and increased available amplifier power when the drivers are connected in parallel.

**SHAPE SHIFTER.** Joe D'Appolito's Aria 3 design inspired me to use both the Accuton C2-11 tweeter and C2-77 midrange drivers. The Accuton midrange drivers have 89dB/W sensitivity, and their robust 2" voice coils will handle 180W of input power. A pair is capable of producing 117dB at 1m. My choice of bass drivers was also influenced by the Aria 3, which uses Focal's 8K415S Kevlar-composite coned 8" woofer. They also have 89dB/W sensitivity, and their 1½" voice coils will handle 150W of input power. A pair will produce 116dB at 1m.

I chose the 4Ω Accuton tweeter to help match the midranges' voltage sensitivity. Based on actual measurements, it has only 2-3dB less sensitivity than the pair of midranges. However, it's a very good match after the midranges' notch and crossover filters are placed in the circuit. The tweeter will handle 120W and produce 109dB at 1m.

An enclosure can sometimes do more to degrade a driver's performance than improve it, so I wanted to ensure that it contributed as little effect as possible, while allowing the drivers to perform to their full potential. I also envisioned an aesthetically pleasing shape. I received numerous recommendations, including: nonparallel sides to minimize internal standing waves and reduce the effect of the reflected waves from the enclosure's rear wall; small tweeter and midrange baffle dimensions to minimize the diffraction effects from the cabinet front edges; drivers located so they are not equidistant from any two baffle edges; flush mount all drivers; remove protrusions from the front baffle surface; avoid sharp edges and corners.

I chose an "oblique prism" for the enclosure shape, with two parallel pentagonal-shaped bases joined by five non-

BLOCK DRIVE UNIT = RJPAT01 Tweeter			
DRIVE UNIT PARAMETERS			
Resonance Frequency - Fs	840		Hz.
Electrical Q Factor - Qes	1.149		
Mechanical Q Factor - Qms	1.14		
Suspension Equiv. Vol. - Vas	.1400	FE-04	m.** 3
Radiating Area - Sd	.4000	FE-03	m.** 2
Voice Coil Resistance - Re	3.500		Ohms
Voice Coil Inductance - Le	.3000	E-01	m. Henry
Voice Coil Inductance (pseudo)	.000		Henry
Diaphragm Leakage	.100E+21		Mech. Ohms
SERIES 1			
First Section Inductor	.1000	FE-09	mil. Henry
Inductor Res.	.1000	FE+12	Ohms
Capacitor	9		uFarads
Parallel Res.	.1000	FE+12	Ohms
Second Section Inductor	.1000	FE-09	mil. Henry
Inductor Res.	.1000	FE-09	Ohms
Capacitor	.1000	FE-09	uFarads
Parallel Res.	.1000	FE-09	Ohms
PARALLEL 1			
First Section Inductor	.1600		mil. Henry
Inductor Res.	.3000		Ohms
Capacitor	.1000	FE-09	uFarads
Parallel Res.	.1000	FE+11	Ohms
Second Section Inductor	.1000	FE-09	mil. Henry
Inductor Res.	.1000	FE+11	Ohms
Capacitor	.000	FE-09	uFarads
Parallel Res.	.000	FE-09	Ohms
SERIES 2			
First Section Inductor	.1000	FE-09	mil. Henry
Inductor Res.	.1000	FE+12	Ohms
Capacitor	22		uFarads
Parallel Res.	.1000	FE+12	Ohms
Second Section Inductor	.1000	FE-09	mil. Henry
Inductor Res.	.1000	FE-09	Ohms
Capacitor	.1000	FE-09	uFarads
Parallel Res.	.1000	FE-09	Ohms
PARALLEL 2			
First Section Inductor	.1000	FE-09	mil. Henry
Inductor Res.	.1000	FE+12	Ohms
Capacitor	2		uFarads
Parallel Res.	.1000	FE+11	Ohms
Second Section Inductor	.1000	FE-09	mil. Henry
Inductor Res.	.1000	FE+13	Ohms
Capacitor	.1000	FE-09	uFarads
Parallel Res.	3.500		Ohms

FIGURE 1: C2-11 tweeter drive unit parameters and high-pass passive filter component values as entered into SPEAK.

equal-width sides. The bases are equiangular (all interior angles are 108°) but not equilateral (the side widths are not equal). The pentagonal shape achieves the objective of having nonparallel sides, and the cabinet's narrower panels have higher resonant frequencies so they are less likely to be excited by the bass drivers' low-frequency output. The three different panel sizes also cause resonances to occur at different frequencies.

I made further refinements by optimizing the shape of the front baffle. A triangular shape provides the desired

small dimension near the midrange and tweeter, and also achieves the objective of mounting drivers at unequal distances from cabinet edges so diffraction-induced irregularities are spread over a wide range of frequencies. The 5.75-11.75-inch-wide baffle increases the range at which diffraction loss begins to approximately 1,200-575Hz. In addition, the nonparallel sides produce smaller multiple ripples at a variety of frequencies.

For good dispersion, keep the baffle edge as close as practicable to the drive units. A triangular-shaped front baffle for

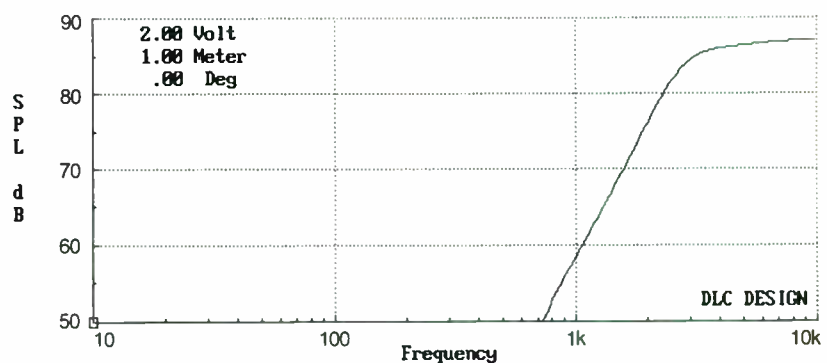

FIGURE 2: C2-11 tweeter sound-pressure response as predicted by SPEAK.

a (5,3) driver geometry assumes an hour-glass shape which, when combined with a pentagonal enclosure, satisfies several acoustical principles and produces a unique, sculptured cabinet.

**BASS BOX.** I determined the bass drivers' internal enclosure volume by optimizing their low-frequency response for integration with the subwoofers. You can use the bass drivers' low-frequency response to determine both the crossover frequency and the slope to the subwoofer. Dave Clark recommended using the bass drivers in a closed box with a  $Q_{TC}$  of 0.707. This would produce a maximally flat frequency response, improved transient response, a smooth 12dB/octave acoustical rolloff below  $f_c$ , and reduced driver excursion at the crossover frequency.

The closed-box system's resonance frequency ( $f_c$ ) would determine the cross-

over frequency to the subwoofer. The second-order acoustical rolloff below  $f_c$  would provide one-half of the high-pass filter to the bass drivers. An additional second-order electronic high-pass filter would obtain the desired fourth-order high-pass acoustical response. The subwoofer would then use a complementary, fourth-order electrical low-pass filter at that frequency. The resulting summed output produces a flat Linkwitz-Riley acoustical response and ensures a seamless transition between the bass drivers and the subwoofer.

The Focal 8K415S has a  $Q_{TS}$  of 0.24,  $f_s$  of 19.3Hz, and a  $V_{AS}$  of 6.29 ft.<sup>3</sup> Using tables from *The Loudspeaker Design Cookbook*, a closed-box system with a  $Q_{TC}$  of 0.707 would be obtained with a  $V_B$  of 0.82 ft.<sup>3</sup>, which would produce an  $f_c$  of 56.9Hz.<sup>2</sup> Theoretically, this would be the ideal crossover frequency. To achieve reduced bass-driver excursion and distor-

tion, and improved power handling, I went higher. Therefore, I chose 63Hz as the nearest standard 1/3-octave frequency.

Increasing  $f_c$  to 63Hz will increase the system  $Q_{TC}$ . Any speaker modeling system can be used to calculate these changes, however, the formulas are very simple. Using the ratio  $Q_{TC}/Q_{TS} = f_c/f_s$ , or  $Q_{TC} = Q_{TS}(f_c/f_s)$ , I calculated the  $Q_{TC}$  of a closed-box system with an  $f_c$  of 63Hz to be 0.78, which is still very close to optimum. To calculate the enclosure volume necessary to obtain an  $f_c$  of 63Hz, I used the following formulas:

$$f_c = f_s \sqrt{\frac{V_{AS}}{C_T}}$$

$$C_T \text{ (total compliance)} = \frac{1}{\frac{1}{V_{AS}} + \frac{1}{V_B}}$$

Solving for  $C_T$  (0.59) and  $V_B$  (0.65 ft.<sup>3</sup>), 1.3 ft.<sup>3</sup> is the total internal volume required for the pair of bass drivers.

### CROSSOVER CONTEMPLATIONS.

I based the Prism V crossover design upon optimizing the (5,3) geometry performance as well as the drivers' mounted response. The D'Appolito geometry works best when the interdriver spacing is less than one wavelength at the crossover frequency, with spacings no greater than two-thirds of a wavelength.<sup>3</sup> An 18dB/octave slope (electrical plus acoustical driver rolloff) will maintain the 90° phase difference necessary to achieve the desired polar axis tilt and response pattern. Increasing the interdriver spacing and/or crossover slope will narrow the vertical response lobe.

I determined the interdriver spacing from the driver's physical dimensions. Butting them closely together, without actually touching, the spacing between the midrange center and tweeter is 4 5/16", which is one wavelength at 3.1kHz and two-thirds wavelength at 2.1kHz. I chose a 3kHz crossover frequency, keeping the crossover frequency one to two octaves above the tweeter resonance frequency to avoid phase disturbance in the driver high-pass filter stopband.<sup>4</sup> The C2-11's resonance frequency is 840Hz; two octaves above resonance is 3,360Hz. Therefore, a 3kHz crossover frequency is near ideal. As with the bass drivers, the higher crossover frequency will improve the tweeter's power handling and distortion because of reduced cone excursion.

I also considered the upper crossover limit for the midrange drivers based on their horizontal polar response, which

*Continued on page 20*

BLOCK DRIVE UNIT = RJPAT02 RJP Accuton 3-way, Midrange			
DRIVE UNIT PARAMETERS			
Resonance Frequency - $f_s$	19.0		Hz.
Electrical Q Factor - $Q_{es}$	2.31		
Mechanical Q Factor - $Q_{ms}$	1.33		
Suspension Equiv. Vol. - $V_{as}$	6.29	E-02	m.** 3
Radiating Area - $S_d$	6.53	E-02	m.** 2
Voice Coil Resistance - $R_e$	6.50		Ohms
Voice Coil Inductance - $L_e$	1.00		m Henry
Voice Coil Inductance (pseudo)	1.00		m Henry
Diaphragm Leakage	1.00	E+21	Mech. Ohms
SERIES 1			
First Section Inductor	.518		mil. Henry
Inductor Res.	1.00		Ohms
Capacitor	1.00	E+10	uFarads
SERIES 2			
First Section Inductor	.500	E-01	mil. Henry
Inductor Res.	1.00		Ohms
Capacitor	1.00	E+09	uFarads
Parallel Res.	1.00	E+02	Ohms
PARALLEL 1			
First Section Inductor	1.00	E-09	mil. Henry
Inductor Res.	1.00	E+11	Ohms
Capacitor	10.0		uFarads
PARALLEL 2			
First Section Inductor	1.00	E-09	mil. Henry
Inductor Res.	1.00	E+11	Ohms
Capacitor	1.00	E+09	uFarads
Parallel Res.	1.00	E+11	Ohms
ACTIVE FILTER TRANSFER FUNCTION			
6 dB/Oct. low pass - freq.	3000		Hz.
12 dB/Oct. low pass - freq.	4000		Hz.
6 dB/Oct. high pass - freq.	3000		Hz.
12 dB/Oct. high pass - freq.	4000		Hz.
12 dB/Oct. high pass - freq.	7000		Hz.
	0.000		

FIGURE 3: C2-77 midrange drive unit parameters and low-pass passive filter component values as entered into SPEAK.

# TOP SECRET! Don't Read!\*

## AC Components Drivers

It's time for AC drivers to come out of the closet. No more well kept secrets. The fact is that AC drivers are highly regarded by the manufacturers, custom installers and hobbyists who use them. The AC12 for instance, is used in a major manufacturer's home theater subwoofer sold for \$750 each. The DV12, (dual voice coil) features an incredible 10.55mm linear one way excursion! This may be the lowest distortion 12" woofer available. Plug the numbers into your computers and you'll find AC drivers have been designed to work extremely well in sealed, transmission line, vented or bandpass enclosures. Choose AC drivers for your next high performance speaker project!

	AC5	AC5S (shielded)	AC7	AC8	AC10	AC12	DV12	AC15
Size:	5"	5"	6 1/2"	8"	10"	12"	12"	15"
Impedance:	8	8	8	8	8	8	8/8	8
Fs	57	67	43	32	24	20	17	18
RMS Power:	60	60	60	100	150	150	150	100
System Power:	150	150	150	175	200	200	200	150
Sensitivity:	88	88	89	90	89	89.6	89	92
Voice coil:	25	25	25	40	50	50	50	50
Magnet mass:	240	344	240	794	1134	1700	1700	1134
SD meters:	.008	.008	.0143	.022	.0345	.0545	.0545	.0855
Dcr:	5.5	5.6	5.6	4.7	6.45	6.1	3.11	4.6
Inductance:	.62	.7	.68	.98	1.7	1.6	2.0	2.3
Xmax:	2	2	3	4	7.68	7.68	10.54	5
Mmd:	7.24	6.5	11.9	26.4	57	89	73	119
BL:	4.97	5.07	5.61	6.3	12.15	13.22	7.8	15.866
Qms:	1.659	1.81	3.052	6.74	3.978	5.458	5.1	6.677
Qes:	.628	.652	.636	.441	.420	.452	.481	.288
Qts:	.455	.479	.526	.414	.38	.418	.44	.276
Vas:	9	7	28	56	111	242	380	561
Range:	57-9k	67-9k	43-7k	32-4k	24-2k	20-1k	17-500	18-1k
Your Cost:	\$29.90	\$39.90	\$29.90	\$55.00	\$65.00	\$79.00	\$89.00	\$65.00

AC drivers feature vented pole pieces and rubber surrounds, (except AC7 and AC15 which have foam surrounds, the AC15 does not have a vented pole piece). AC5S, AC8, AC10 and AC12 have polypropylene cones, AC5, AC7 and AC15 have doped paper cones, DV12 has long-fiber cone.

\*DON'T read about or purchase AC drivers if you believe that paying lots of money guarantees performance.

\*DO purchase AC drivers if you believe in sound performance and value.

### IAR Wonder Caps™, Still the Finest!

.01 mfd	\$2.00 each
.1	\$2.75
.22	\$4.00
.33	\$3.00
.47	\$3.75
.68	\$4.25
1	\$5.25
2	\$7.25
3	\$9.00
4	\$10.50
5	\$7.50
10	\$13.75

Values from .01 to 4 mfd are 425V or higher, 5 and 10 mfd are 310V. All are 5% tolerance or better.

We also stock selected products from: Chateauroux, Audioquest, Dynaudio, Focal, Lynk, Scan-Speak, Vifa, Sledgehammer electronic crossovers, Acoustical Magic™, AC Foam™, resistors, coils, AC Projects and much more!

Call, fax or write for complete catalog.

### AC Components

Box 212, La Crosse, WI 54601

Voice: (608) 784-4579

Fax: (608) 784-6367

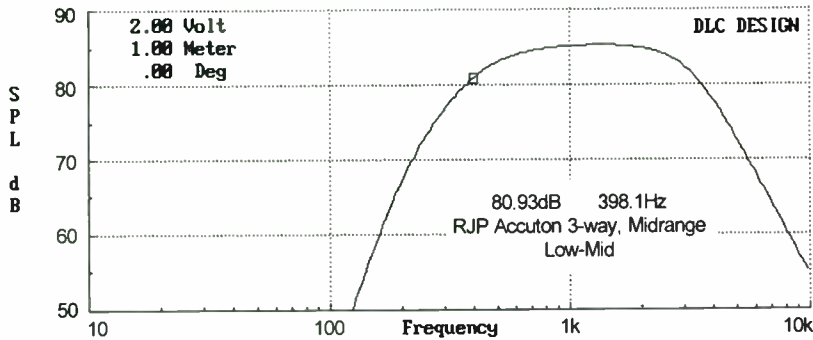

FIGURE 4: C2-77 midrange sound-pressure response as predicted by SPEAK.

Continued from page 18

can be approximated from the effective piston diameter. For a circular piston on a large baffle, the polar response is down 3dB relative to its on-axis response at  $\pm 30^\circ$ , when the piston diameter is equal to the radiated wavelength. The C2-77's effective piston diameter is 3.54", which corresponds to one wavelength at 3.8kHz, so a crossover frequency below this is preferred with 3kHz producing a broader radiation pattern.

Selecting the crossover frequency between the midrange and bass drivers also required I consider interdriver spacing, the midrange drivers' resonance frequency, and the bass drivers' effective piston diameter. The latter's interdriver spacing is 22¼", which corresponds to one wavelength at 600Hz and two-thirds wavelength at 400Hz. The C2-77's measured resonance frequency is 178Hz, therefore the crossover frequency should be above 356Hz.

The Focal 8K415s' effective piston diameter is 6.44", which corresponds to one wavelength at 2.1kHz, and indicates that a lower crossover frequency is preferred. I chose a tentative crossover frequency of 400Hz on the basis of ensuring a wide vertical polar response, and to have the midrange cover as wide a frequency range as possible. Using a pair of midrange drivers helped ensure satisfactory power handling.

**FILTER TIPS.** I next began designing the crossover filters, which would provide a drive voltage to produce the desired acoustic response. Dave Clark modeled the driver and filter response using SPEAK.

For the passive crossover between the midranges and tweeter, Dave entered the drivers' electrical, mechanical and acoustical parameters. SPEAK then generated the raw drivers' predicted acoustic responses and impedance curves. He also entered the (5,3) geometry and interdriver spacing, because of SPEAK's ability to specify the location of drivers relative to each other in space.

The drivers' relative acoustic centers are entered as aligned by time to better than 4µs when mounted flush on a flat baffle. When we entered hand-calculated textbook values for a passive 18dB/octave high-pass crossover at 3kHz, the resulting acoustic response was far from the desired slope. So Dave varied the crossover element values until he achieved the desired acoustic response (Figs. 1 and 2).

He followed the same process when designing the midranges' low-pass filter. Figure 3 shows the C2-77 unit parameters and the low-pass filter component values SPEAK determined, as well as the active high-pass filter crossover frequency and slopes. The desired high-pass response requires a 6dB/octave rolloff beginning at 300Hz, with an additional 12dB/octave rolloff at 400Hz. Figure 4 is the resultant SPEAK-generated graphic prediction of the midrange acoustic response.

The design process for the active high- and low-pass filters for the bass drivers was the same (Fig. 5). SPEAK determined that the low-pass frequency should be at 420Hz for the best integration with the midranges' high-pass response (Fig. 6).

**CONNECTIVE ISSUE.** The passive crossover (Fig. 7) is mounted externally in a separate, oak-veneered plywood enclosure (Photo 2). The external crossover's practical benefit is accessibility for fine-tuning crossover components. Its theoretical benefit is isolation from me-

Continued on page 22

BLOCK = RJPAT03			
DRIVE UNIT = 8K415S			
RJP 3-way, Low-Mid			
DRIVE UNIT PARAMETERS			
Resonance Frequency - Fs	162.3	Hz.	
Electrical Q Factor - Qes	2.23		
Mechanical Q Factor - Qms	5.178		
Suspension Equiv. Vol. - Vas	2.254E-01	m.** 3	
Radiating Area - Sd	7.80	m.** 2	
Voice Coil Resistance - Re	1.40	Ohms	
Voice Coil Inductance - Le	0.00	m. Henry	
Voice Coil Inductance (pseudo)	0.00	Henry	
Diaphragm Leakage	1.00E+21	Mech. Ohms	
ENCLOSURE PARAMETERS			
Rear Enclosure Volume	1.70E-01	m. ^ 3	
Internal Res.	2.00E+04	Mech. Ohms	
Leakage Res.	1.00E+11	Mech. Ohms	
Front Enclosure Volume	0.00	m. ^ 3	
Internal Res.	0.00	Mech. Ohms	
Leakage Res.	1.00E+11	Mech. Ohms	
ACTIVE FILTER TRANSFER FUNCTION			
6 dB/Oct. low pass - freq.	420.	Hz.	
12 dB/Oct. low pass - freq.	420.	Hz.	
12 dB/Oct. low pass - freq.	1.000	Hz.	
6 dB/Oct. high pass - freq.	0.000	Hz.	
12 dB/Oct. high pass - freq.	0.000	Hz.	
12 dB/Oct. high pass - freq.	630.0	Hz.	
12 dB/Oct. high pass - freq.	0.000	Hz.	
12 dB/Oct. high pass - Q	0.000		

FIGURE 5: 8K415S bass drive unit parameters, enclosure volume and active high- and low-pass filter parameters as entered into SPEAK.

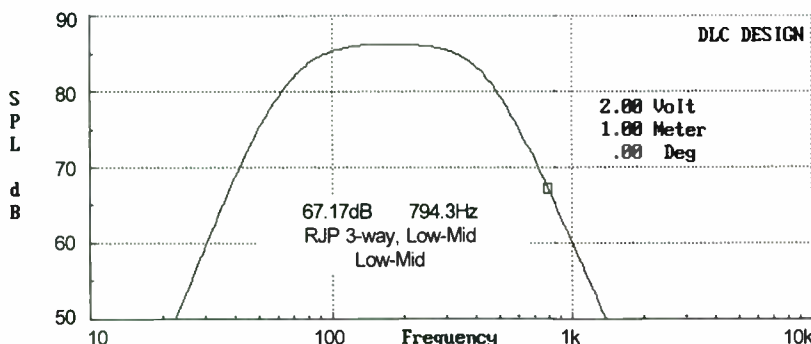
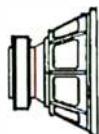

FIGURE 6: 8K415S bass response as predicted by SPEAK.

## SUMMER SALE SPECTACULAR

QTY	DESCRIPTION	PRICE
41	Philips AD11400 /T8 1" Textile dome tweeter: 3.25" SQ flange; Fs 1500; 90dB; 8Ω	\$7.00
506	.4 mH Iron Core inductor; 19 awg wire; 2" x 5/8"	10 / \$5.00
12	Focal 7N313 6.5" Cone Midrange with Phase Plug; 94dB; 8Ω; Neoflex cone; Fs 40; 150W; Good for use down to 200Hz in small sealed enclosure, frequency response to 6K; Below Cost!	\$58.00
322	Europa 23; Autosound wedge shaped surface mount tweeter; Mylar 6dB filter: Polymide 3/4" dome; 4Ω; 4.5 to 22K frequency response; Great Buy.	\$15.00/pr
201	Vifa M22WR-45; Cast frame 8" woofer, treated paper cone with rubber surround; 8Ω; 6.5mm X-max peak; Fs 27; Qts .3; Vas 75 ltrs; 89dB; 150W; 2" VC; F3 below 40Hz in 1ft <sup>3</sup> vented.	\$44.00
22,000	5 mfd Mylar Capacitors; Axial leads; 1.5" x 1/2"; 10% 50V with full leads by Elpac	10 / \$4.00
68	Peerless 1646 Horn Mid; 2" Textile dome; Round 14cm flange; Fs 450; 93dB; 1 to 5K, 8Ω	\$30.00
61	Scan-Speak 18W/8544-05; 6.5" Kevlar cone, foam surround woofer; Fs 40; Qts .36; Vas 26 ltrs; 88dB; F3 under 50Hz in .5 ft. <sup>3</sup> ported or 80Hz in .3 ft. <sup>3</sup> sealed; Compare price to std version	\$66.00
270	Audax DTWSP25BACAVFF 8Ω; 1" Polymer dome tweeter; 4" diameter round metal flange; Chambered back for lower resonance; 88dB; 2.5K - 20K frequency range.	\$10.00
53	Eton 4-203 4" Midbass with Kevlar Hexacone; 12cm round cast frame; Fs 59; Vas 6 ltrs; Qts .26; 92dB; 8Ω; A very high quality midrange at a good price.	\$79.00
126	Audax TW80A 8Ω; 10mm Polymer dome tweeter; 3.15" square flange; 1/4" depth for easy mounting; Fs 2900 Hz; 5.5K to 20K frequency response; 90dB; Good choice for car or home.	\$5.00
12,000	1.5 mfd Mylar Capacitors; Axial leads; 1" x 1/2"; 10%, 100V with full leads by Wesco	10 / \$2.00
12	Audax HD30P45TSMC 12" Woofer; Paper cone, foam surround; Fs 17, Vas 708 ltrs, Qts .23; 95dB; 8Ω; Good high output driver for home or car.	\$55.00
46	Focal 4V111 Midbass with Polyglass cone; 11cm cast frame; Fs 70; Vas 6 ltrs; Qts .32; 89dB; 8Ω; Exceptionally smooth response to 10K; F3 of 155Hz in 1.5 ltr sealed enclosure.	\$49.00
800	S-cups: Spring terminal on a 2 1/2" x 3" overall plastic cup with recessed terminals	10 / \$5.00
256	Peerless 1771 2" poly cone tweeter; 2 1/4" square; 4Ω; Fs 1450; 92dB; 3.5 to 20K; Poly cone version of industry standard; Exceptional value for automotive systems.	\$5.00
49	Dynaudio 17W75 EXT; 6.5" Polycone rubber surround woofer with extended upper frequency to 4500Hz; 3" VC; Fs 42; Vas 19 ltrs; Qts .74; 86dB; 12Ω; Great for D'Appolito.	\$50.00
17,800	10 mfd Mylar Capacitors; Radial leads; 1" x 1/2"; 10% 100V with full leads by Matsushita	10 / \$10
40	Accuton (Ceratec) C2-22 Ceramic 1" inverted dome tweeter; 90dB; Fs 495; 8Ω; Chambered back; Suitable for 2-Way or 3-Way systems; 2.5 to 22K frequency response.	\$125.00
49	Focal 8K516; 8" Kevlar woofer with cast frame; 7.5mm X-max; 8Ω, Fs 33.7; Vas 58.7 ltrs; Qts .3; 90.5dB; Exceptional as a woofer in a 3-Way system; F3 below 40Hz in 1.5 cf.	\$103.00
<b>KLIPSCH, KLIPSCH, KLIPSCH, at Very Special Prices!!!</b>		
564	Klipsch K5K 8" woofer; Paper cone cloth surround; Fs 40; Vas 46 ltrs; Qts .33; 91dB; 12Ω; 75Watts; Excellent High Output D'Appolito woofer.	\$20.00
227	Klipsch K6K 8" Woofer; Paper cone cloth surround; Fs 41; Vas 42 ltrs; Qts .325; 92dB; 6Ω; 75Watts; High efficiency, good for 2-Way Hi Fi or stage monitors.	\$20.00
709	Klipsch K82K Horn Tweeters; 4" x 10" Exponential; Fs 1500; 100dB; 16Ω; use a 12dB x-over at 3K; 3 to 17.5K; Exceptional value.	\$20.00
Madisound has some designs using the Klipsch products, if you are looking for high efficiency, high output systems at reasonable prices, give us a call. This is a rare opportunity.		
150	Vifa P17WH06 8Ω Woofer; Decorative stamped frame, poly cone rubber surround; Fs42; Qts .33; Vas 30 ltrs; 88dB; This is a good price for a driver of this quality.	\$20.00
280	Bennic Polypropylene 3.9 mfd capacitor 200V 5% axial leads	\$1.50
260	Bennic Polypropylene 7 mfd capacitor 200V 5% axial leads	\$2.40
350	Bennic Polypropylene 12 mfd capacitor 200V 5% axial leads	\$3.00

Order early while quantities are available. Sale ends October 31, 1993.



**Madisound Speaker Components**  
 (8608 University Green)  
 P.O. Box 44283  
 Madison, WI 53744-4283 U.S.A  
 Voice: 608-831-3433  
 Fax: 608-831-3771

Ordering Information: All speaker orders will be shipped promptly, if possible by UPS. COD requires a 25% prepayment, and personal checks must clear before shipment. Add 10% for shipping, residents of Alaska, Canada and Hawaii, and those who require Blue Label air service, please add 25%. There is no fee for packaging or handling, and we will refund to the exact shipping charge. We accept Mastercard or Visa on mail and phone orders.

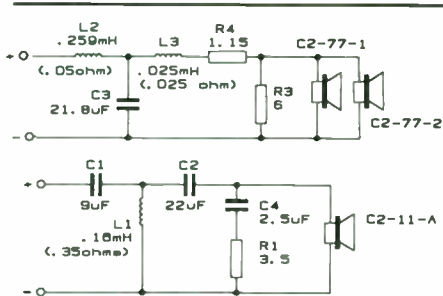

FIGURE 7: Passive crossover values as generated by SPEAK.

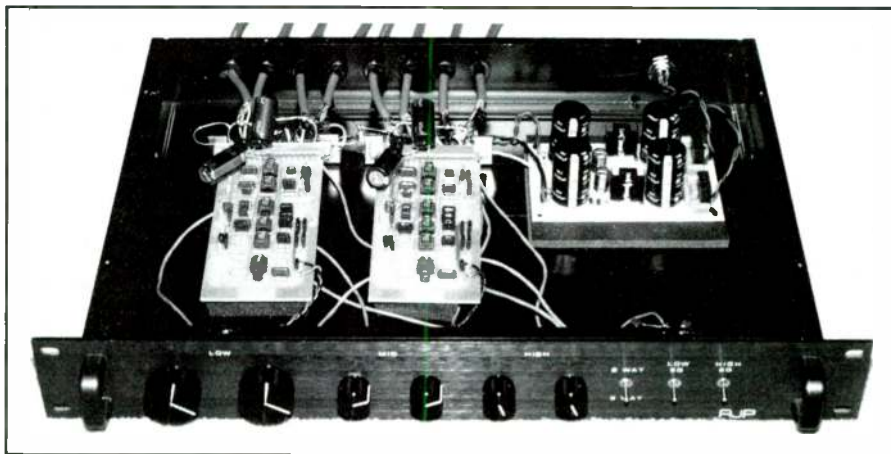

PHOTO 3: Active crossover in enclosure.

Continued from page 20

chanical vibrations inside the loudspeaker enclosure, occasionally cited as a possible source of distortion in passive components.

Construction and layout of the passive crossover network is also important. Place the inductors as far apart as possible (at least 3") on a crossover circuit board and mount them at 90° angles to each other in order to avoid magnetic coupling between different crossover sections.<sup>5</sup> I used 16-gauge air-core inductors in the midrange network, 18-gauge air-core inductors in the tweeter network, and hard-wired everything using silver-bearing solder and Audioquest "Type 12" OFHC speaker wire.

I connected the external passive crossover and the speaker enclosure with four-conductor Audioquest "Midnight" speaker cable: one pair connects to the midrange terminals; the other pair connects to the tweeter terminals. To eliminate improper connections, I used four-terminal Neutrik "SpeakOn" connectors. A male connector (model NL4FC) is installed on the end of the "umbilical cord"

from the crossover. The cord's other end is soldered directly to the crossover components. A female chassis-mount connector (model NL4MP) is mounted on the speaker enclosure.

The active crossover components include Analog Devices' OP275GP dual bipolar/JFET op amps and 1% metal film resistors. The custom filter circuit boards were provided by Alpha Electronics. They hand selected 5%-tolerance, Panasonic stacked-film capacitors using a Data Precision model 938 capacitance meter to guarantee phase and amplitude match between channels. Although SPEAK modeled the active crossover filter characteristics, Alpha created the circuit design. I built the Galo/Jung/Markell power supply (Gary Galo, "Pre-amp Power Supply," *TAA* 4/90, p. 47), which is offered in kit form from Old Colony.

I installed the active crossover and

power supply circuit boards in a rack-mountable enclosure (Photo 3). (The power transformer has its own external enclosure.) On the front panel, I mounted six plastic, conductive-film output-level potentiometers for adjusting the amplifier levels to the left- and right-channel subwoofers, bass drivers, and midrange-tweeters. The interconnects are Neglex (Mogami) 2534 wire, which I hard-wired to the crossover circuit boards. I paired and connected the four inner conductors

Continued on page 24

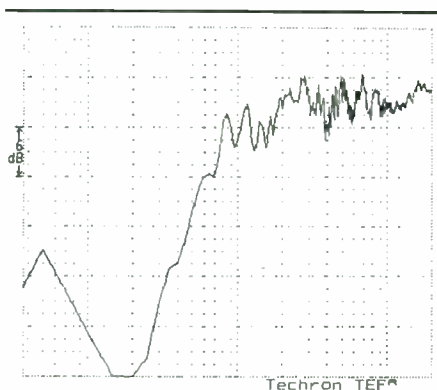

Vertical 6dB/div with base of display at 47 0dB  
0dB is located at 0.00002 Pa  
Horizontal Auto 0.00Hz to 19,998.10Hz  
Log frequency axis (2.7 decades)  
Resolution 3.3109E+00 meters & 1.0362E+02Hz  
Time of test 2.929us, 1.0046E+00 meters  
Sweep rate & bandwidth 10,734.80Hz/Sec & 1.0362E+02Hz  
Input configuration Balanced with 42dB of input gain & 6dB of IF gain

FIGURE 8: C2-11 tweeter frequency response in enclosure without crossover connected.

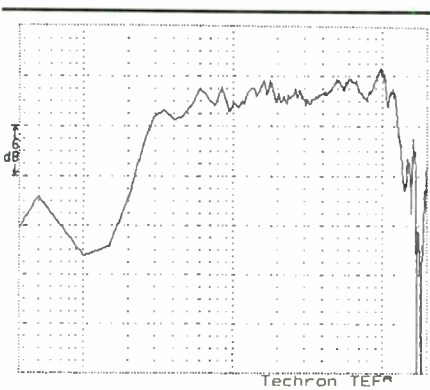

Vertical 6dB/div with base of display at 47 0dB  
0dB is located at 0.00002 Pa  
Horizontal Auto 0.00Hz to 19,998.10Hz  
Log frequency axis (2.7 decades)  
Resolution 3.3109E+00 meters & 1.0362E+02Hz  
Time of test 2.929us, 1.0046E+00 meters  
Sweep rate & bandwidth 10,734.80Hz/Sec & 1.0362E+02Hz  
Input configuration Balanced with 42dB of input gain & 6dB of IF gain

FIGURE 9: C2-77 midrange frequency response with 1.6kHz notch filter and 420Hz, 6dB/octave high-pass filter.

**A  
LETTER**

Asking  
For  
Help  
Without  
A  
Self  
Addressed  
Stamped  
Envelope  
Goes  
**HERE!!**

↓



# An A&S Classic Revisited

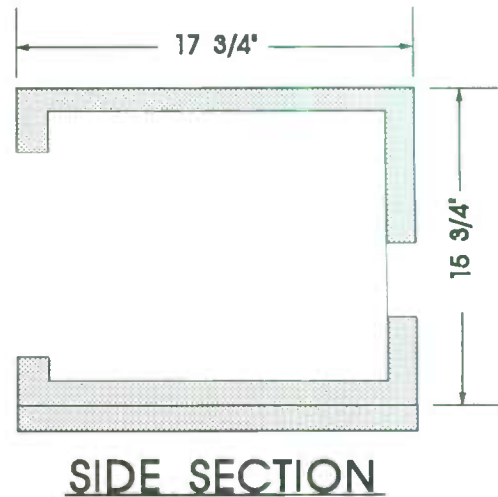
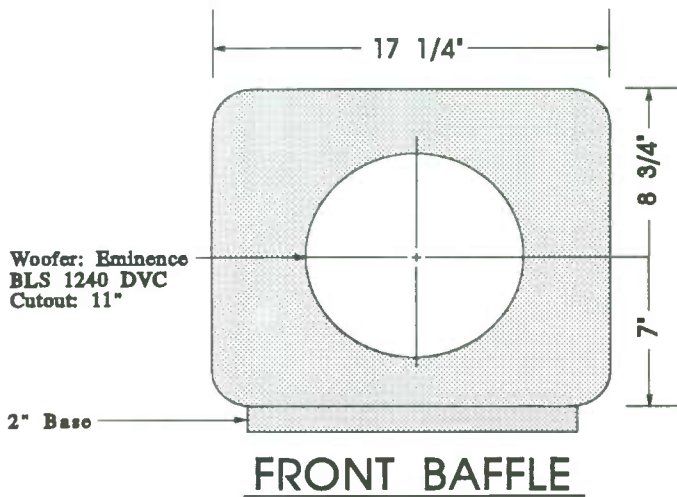

## TECHNICAL SPECIFICATIONS

Frequency response: 35 Hz - 90 Hz +/-3db  
Sensitivity: 93 db @ 2.83 volts  
Nominal Impedance: 4 ohms per voice coil  
Thermal power capability: 150 watts RMS  
Crossover frequency: 100 Hz

Terminal Cup: RP994L  
Cutout: 3 3/4" x 2 7/8"

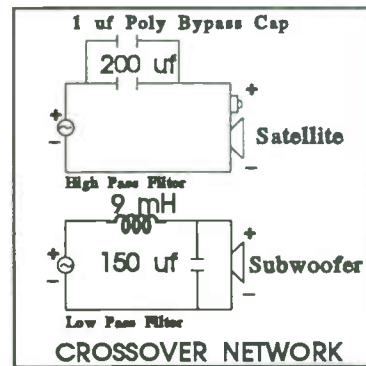
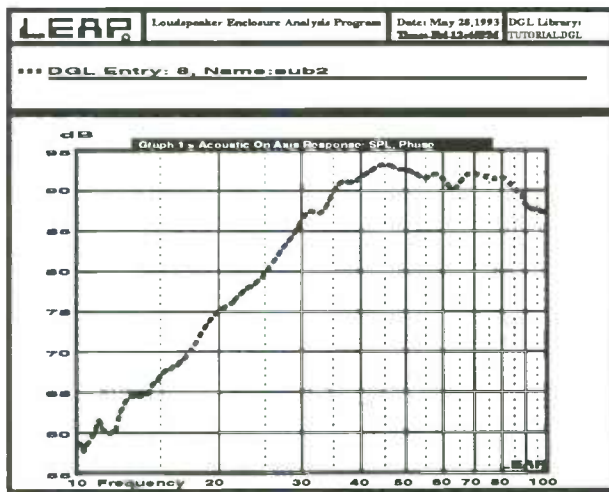
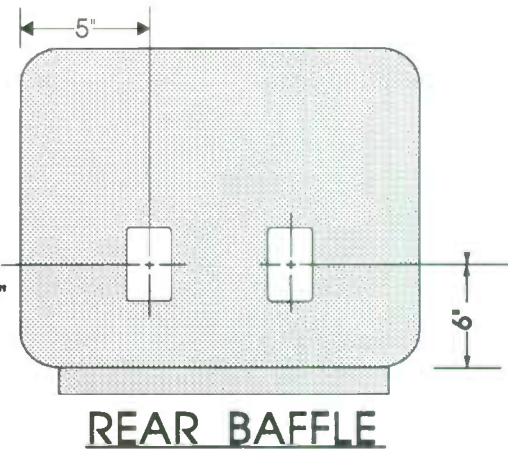

Price: Assembled: 260.00/each  
Kit: 220.00/each  
W/O cabinet: 110.00/each

## The Baby Boomer Subwoofer

# A&S speakers

3170 23rd Street; San Francisco, CA 94110

Telephone: (415) 641-4573 Fax: (415) 648-5306

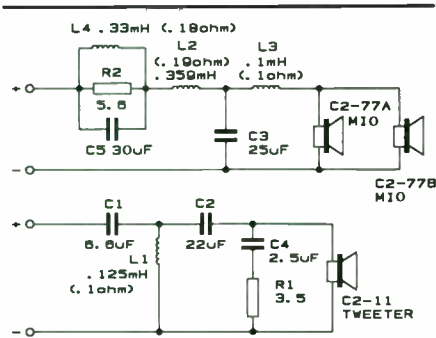

FIGURE 10: Finalized passive crossover values.

Continued from page 22 at both ends, but connected all shields only at the crossover ground, which resulted in a very low noise system.

**SECOND STAGE.** I was now ready to fine tune the crossover filters. Dave took Techron measurements with the microphone placed at a variety of on-and-off-axis positions, but the following measurements were all taken on the tweeter axis at a distance of one meter to ensure a consistent reference point.

Figure 8 is the tweeter response without the crossover connected. It appears ragged due to the cavity effects of the adjacent drivers. When I covered the midrange drivers with thin cardboard, the response variation was dramatically reduced. Unfortunately, these cavity effects are unavoidable when multiple drivers are mounted in close proximity on a common baffle.

Figure 9 shows the midrange frequency response very flat all the way to 10kHz, with a notch filter comprised of paralleling a 0.33mH inductor, a 30μF capacitor, and a 5.6Ω resistor, connected in series with the midranges. I placed the notch filter ahead of the low-pass filter, because

TABLE 1  
PRISM V PARTS LIST

- Drivers**
- 2 JBL 2245H 18" subwoofer drivers
  - 4 Focal 8K415S 8" bass drivers
  - 4 Accuton C2-77 8Ω midrange drivers
  - 2 Accuton C2-11 4Ω tweeters

**Passive Crossover: One Channel**

- Inductors**
- L1 0.125mH, R = 0.10Ω
  - L2 0.359mH, R = 0.19Ω
  - L3 0.10mH, R = 0.10Ω
  - L4 0.33mH, R = 0.18Ω

- Capacitors\***
- C1 6.6μF
  - C2 22.0μF
  - C3 25.0μF
  - C4 2.5μF
  - C5 30.0μF

- Resistors**
- R1 3.5Ω, 15W
  - R2 5.6Ω, 15W

\* All capacitors 5% metallized polypropylene

it works best when driven by the amplifier output's low impedance.

Figure 10 is the finalized passive-crossover schematic. Although the difference between the SPEAK-generated and the empirically-finalized values are minor, they support the conclusion that formulas and computer models should never be relied upon exclusively to produce crossover designs. Also, do not use passive crossover inductors having a DC resistance other than specified, as this will change the filter response.

Figure 11 shows the high-pass drive voltage (measured at the amplifier output terminals) to the midrange drivers. The bottom curve is the drive voltage necessary to achieve an acoustic 18dB/octave high-pass response at 420Hz,

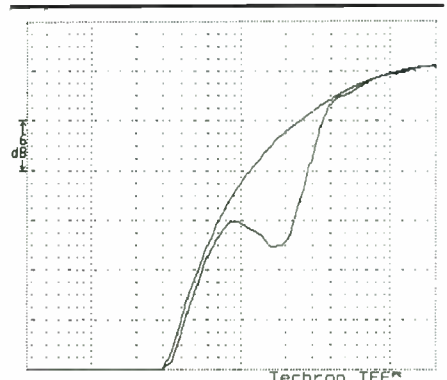

Vertical: 6dB/div with base of display at 83.0dB  
0dB is located at 0.00002 Pa  
Horizontal: Auto 0.00Hz to 2.000 24Hz  
Log frequency axis (2.7 decades)  
Resolution: 1.5325E+01 meters & 2.2382E+01Hz  
Time of test: 2.929us, 1.0046E+00 meters  
Sweep rate & bandwidth: 500.96Hz/Sec & 2.2382E+01Hz  
Input configuration: Noninverting with 12dB of input gain & 6dB of IF gain

FIGURE 11: Overlay of drive voltages produced by the 6dB/octave, 420Hz high-pass filter and the final filter response which includes a "Twin-T" notch filter.

which we obtained by combining a 6dB/octave, 420Hz high-pass filter with a notch filter. Dave derived the notch filter's shape with a 1/3-octave equalizer. The final circuit design involved experimentation and breadboarding by Alpha Electronics (Figs. 12 and 13).

Figure 14 is the final measurement of the complete Prism V system, with the Techron Analyzer set to roll off the response below 300Hz. Figure 15 is a composite of the drive voltages to the bass, midrange, and tweeter as provided by the passive and active filters (the bass high-pass filter at 63Hz is missing). Due to the bass drivers' rising response, it is necessary to roll them off at 24dB/octave electrically to achieve an 18dB/octave low-pass acoustic response. The Techron Analyzer is set to roll off the response below 20Hz.

Continued on page 26

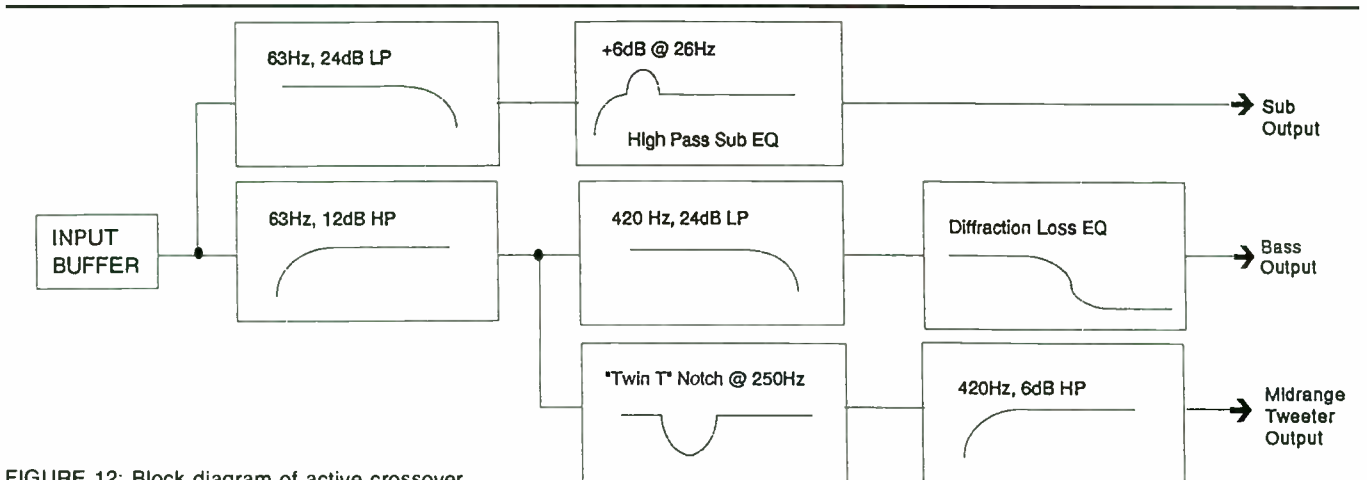
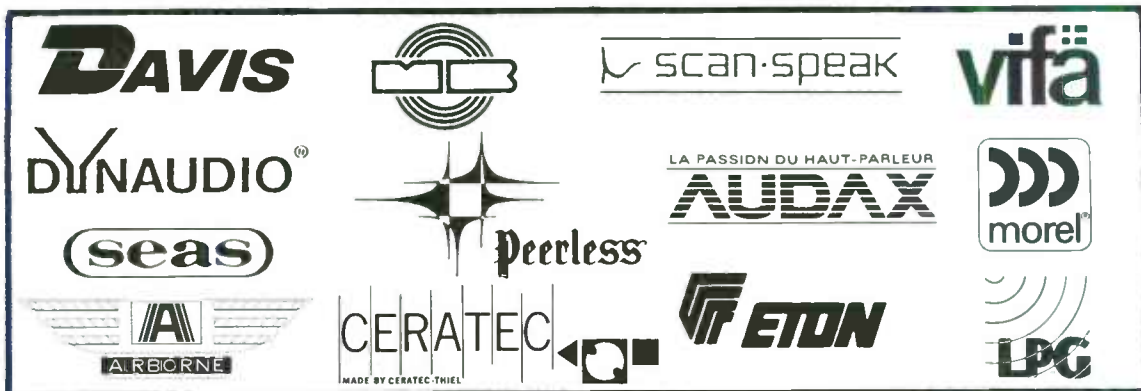
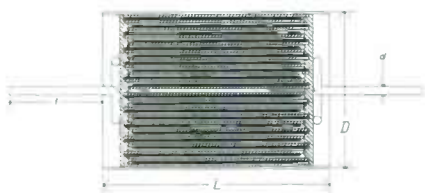

FIGURE 12: Block diagram of active crossover.

# SOLEN SPEAKER COMPONENTS



## CROSSOVER, SPEAKER COMPONENTS



### FAST CAPACITORS

Metallized Polypropylene (Non-Polarized)  
 Values from 1.0 mfd to 200 mfd.  
 Voltage Rating: 250 VDC / 150 VAC

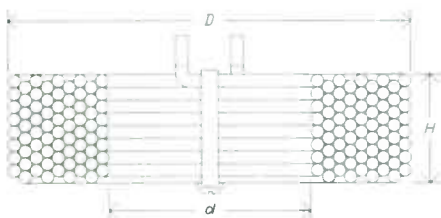

### SOLEN INDUCTORS

Perfect Lay Hexagonal Winding Air Cored  
 Values from .10 mH to 30 mH  
 Wire sizes from #20 AWG to #10 AWG



### HEPTA-LITZ INDUCTORS

Seven Strands Litz-Wire Constructions  
 Values from .10 mH to 30 mH  
 Wire sizes from #16 AWG to #12 AWG

### SOLEN CROSSOVERS

Custom Computer Design  
 Passive Crossover for Professional, Hi-Fi and  
 Car Hi-Fi, Power up to 1000 Watt

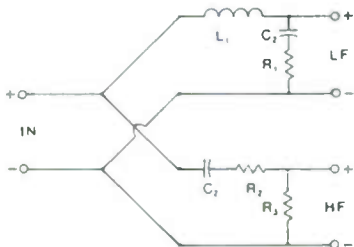

### CROSSOVER, SPEAKER PARTS

Gold Speaker Terminals, Gold Banana Plugs  
 Gold Binding Posts, Crossover Terminals  
 Power Resistors, Mylar Capacitors,  
 Bi-Polar Capacitors, Plastic Grille Fasteners,  
 Nylon Ties, Car Speaker Grilles, Speaker Books,  
 Speaker Kit Brochure, Miscellaneous Parts



**SOLEN INC.**  
 4470 Thibault Ave.  
 St-Hubert, QC J3Y 7T9  
 Canada  
 Tel.: (514) 656-2759  
 Fax: (514) 443-4949

**COMPUTER AIDED DESIGN FOR  
 ENCLOSURE AND CROSSOVER  
 AVAILABLE TO CUSTOMER**

Product specifications and prices  
 available upon request.

NEW 1993 CATALOG

NEW 1993 CATALOG

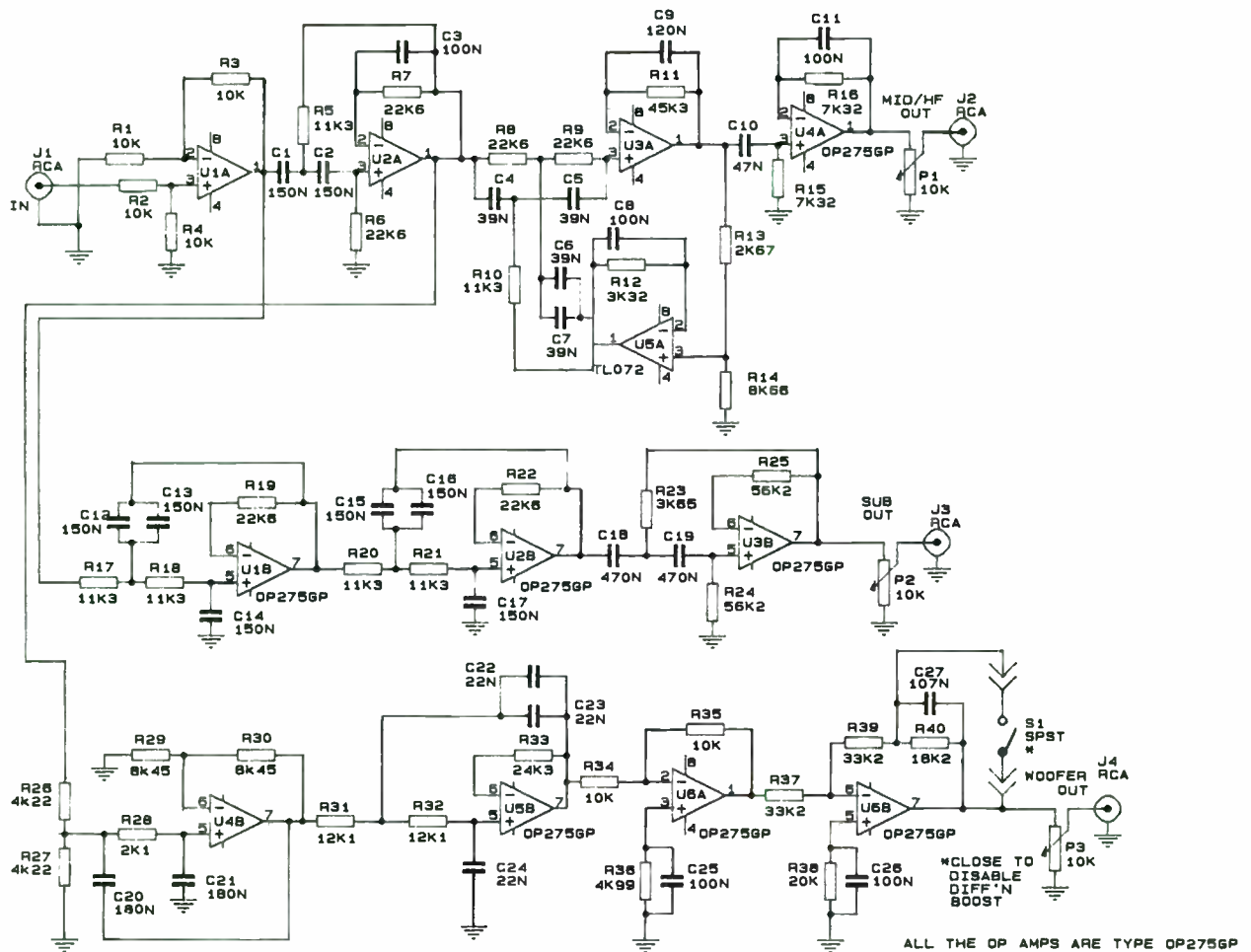

FIGURE 13: Active crossover schematic diagram.

Continued from page 24

The final design element was a switchable diffraction-loss-compensation circuit. The crossover design performance, as measured by the Techron Analyzer, had already compensated for diffraction loss. I included D'Appolito's basic circuit ("A High Power Satellite Speaker," *SB* 4/84, p. 7) primarily to provide room response equalization. Through a switching arrangement, a variety of capacitors provided different turnover frequencies, or completely bypassed the circuit.

Based on in-room measurements at the listening position with my Mitey Mike

and Warbler signal generator, I measured a shallow 2-3dB dip in the response, which was filled in with the circuit set for a 168Hz turnover frequency. The circuit's effect is very subtle, because it provides a maximum of 3.75dB of gain over a 3 $\frac{1}{3}$ -octave range. However, with the 1dB gain point at 168Hz, it is only up a couple of decibels by 63Hz and then the high-pass crossover filter rolls off the response at 12dB/octave.

**JBL SUBWOOFER.** The two 18" JBL drivers had previously been floor-mounted in an infinite-baffle enclosure and connected in mono ("A Triamplified Modular System," *SB* 5/90, p. 46). I decided to change to stereo subwoofers, which required building separate enclosures. An excellent article in *Audio* magazine describes a subwoofer using my 18" JBL 2245H's in 8 ft.<sup>3</sup> vented enclosures.<sup>6</sup> The completed system is a vented and equalized, quasi-fifth-order system which is acoustically equivalent to the JBL B460 low-frequency loudspeaker.

The *Audio* authors built both vented- and sealed-box subwoofers using the

same driver. When these systems were equalized for similar response, they judged the former's dynamic performance as significantly better. The vented/equalized subwoofers' dynamic "punch"

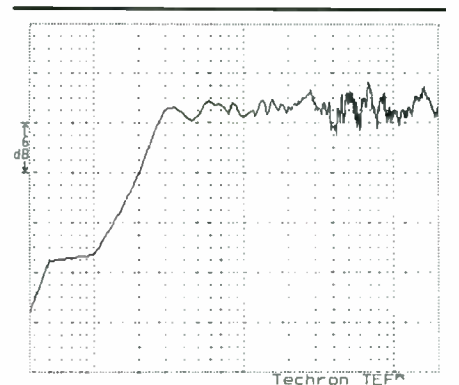

Vertical: 6dB/div with base of display at 47.0dB  
 Horizontal: 0dB is located at 0.00002 Pa  
 0.00Hz to 19,998 10Hz  
 Log frequency axis (2.7 decades)  
 Resolution: 3.3109E+00 meters & 1.0362E+02Hz  
 Time of test: 2.929us, 1.0046E+00 meters  
 Sweep rate & bandwidth: 10.734 80Hz/Sec & 1.0362E+02Hz  
 Input configuration: Balanced with 36dB of input gain & 6dB of IF gain

FIGURE 14: Final frequency response of Prism V satellite.

**PREVIEW**  
**Audio Amateur**  
**Issue 2, 1993**

- FET-80 Power Amp
- Line-Level Preamp, Part II
- Amplifier/Speaker Protection System

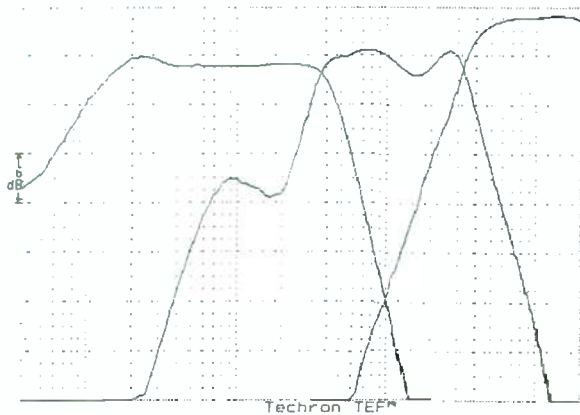

Vertical. 6dB/div with base of display at 71.0dB  
0db is located at 0.00002 Pa  
Horizontal Auto 0.00Hz to 2,000.24Hz  
Log frequency axis (2.7 decades)  
Resolution 1.5325E+01 meters & 2.2382E+01Hz

Time of test. 2.929µs, 1.0046E+00 meters  
Sweep rate & bandwidth: 500.96Hz/Sec & 2.2382E+01Hz  
Input configuration Noninverting with 18dB of input gain & 6dB of IF gain

FIGURE 15: Drive voltages to the bass, midrange and tweeter as produced by the passive and active crossovers.

is superior to my former in-floor-infinite-baffle system. The active equalizer circuit helps achieve extended low-frequency response in a smaller enclosure and provides driver protection from unwanted cone motion below 20Hz. While the new system takes up more floor space and doesn't have as much output below 20Hz, I believe that its benefits outweigh these disadvantages.

I revised the  $X_{MAX}$  and  $V_D$  driver parameters from the *Audio* article, which had published an  $X_{MAX}$  of  $\frac{1}{2}$ ". Although this was apparently based on using half of the driver's 1" P-P safe excursion limit, JBL specifies 0.375" as the linear  $X_{MAX}$ . Using this more conservative specification, the driver's volume displacement ( $V_D$ ) is 75 in.<sup>3</sup> or 1,230 cu. cm. A pair of these subwoofers provides outstanding

reproduction of deep, low-distortion bass at any level in my listening room.

In Part II, I will discuss cabinet construction.

#### REFERENCES

1. Allison, Roy F., "The Influence of Room Boundaries on Loudspeaker Power Output," *Loudspeakers, An Anthology, Vol. 1-25*. AES, New York, June 1974, p. 353.
2. Dickason, Vance, *The Loudspeaker Design Cookbook*, 4th ed., Audio Amateur Press, 1991.
3. D'Appolito, J.A., "A Geometric Approach to Eliminating Lobing Error in Multiway Loudspeakers," presented at the 74th Convention of the AES, October 8-12, 1983, New York. Preprint #2000.
4. Dickason, op. cit., p. 83.
5. Dickason, op. cit., p. 121.
6. Kramer, Lorr, and Greg Timbers, "New Lows in Home-Built Subwoofers," *Audio* (August 1985): 58.

#### SUPPLIERS

Agape Audio  
15518 Fox  
Redford, MI 48239

Alpha Electronics  
1415 Yorkshire  
Grosse Pointe Park, MI 48230

Custom Sound  
PO Box 463026  
Mount Clemens, MI 48046  
(313) 463-5039

DLC Design  
24166 Haggerty Rd.  
Farmington Hills, MI 48335  
(313) 477-5534  
FAX (313) 471-2611

Gold Sound  
PO Box 141  
Englewood, CO 80151  
(303) 789-5310

Old Colony Sound Lab  
PO Box 243  
Peterborough, NH 03458  
(603) 924-6371  
FAX (603) 924-9467

Orca  
1531 Lookout Dr.  
Agoura, CA 91301  
(818) 707-1629  
FAX (818) 991-3072

Precisionaire "Kwik Kut"  
Room Air Conditioner Filters  
2441 W. Commerce St.  
Dallas, TX 75212

The Wood Shed  
1807 Elmwood Ave.  
Buffalo, NY 14216  
(716) 876-4252

Zalytron Industries Corp.  
469 Jericho Tpk.  
Mineola, NY 11501  
(516) 747-3515  
FAX (516) 294-1943

# BassBox™ 4.0

for Microsoft®  
**WINDOWS™**

**BEST VALUE \$\$\$**  
**FREE X-over Program**  
**66 page Illustrated Manual**

Design loudspeaker boxes fast and accurately with BassBox software. Enter just three loudspeaker parameters ( $F_s$ ,  $Q_{ts}$ ,  $V_{as}$ ) and compare designs and response curves in seconds.

- ◆ Easy to use
- ◆ On-line help
- ◆ Cool graphics
- ◆ More options
- ◆ Low price

#### Design Types:

- Maximally Flat Vented
- Extended Bass Vented
- Custom Vented
- 4th & 6th-order Band-Pass
- Passive Radiator
- Optimum Closed
- Custom Closed
- Multiple Woofer designs (including isobaric)

#### Built-In Test Procedures:

- Test and calculate loudspeaker parameters\*
- Test and calculate passive radiator parameters\*

\*Requires basic test equipment: sine wave generator, frequency counter, power amplifier, 1 kohm resistor, voltmeter, ohmmeter, test box.

#### Design Options:

- Small and large-signal analysis
- Examine one loudspeaker in several different boxes or...
- Examine several different loudspeakers in the same box
- Manual override available for vented box tuning
- Multiple ports
- Box dimension calculator with 15 different volume shapes
- Enter loudspeaker amplitude (acoustic) response
- Control graph color, overlay, fill
- Use English or metric units
- Read BassBox 3.0 files
- Save and recall designs



**\$89.00**



plus \$4.00 S&H  
(Canada: +\$6.00)  
(Overseas: +\$12.00)

Tel: 616-641-5924  
Fax: 616-641-5738

Harris Technologies

P.O. Box 622  
Edwardsville, MI  
49112-0622 U.S.A.

For a limited time only:

**A Free passive crossover program for Microsoft Windows** ships with every BassBox 4.0 order. It calculates the component values for 1st, 2nd, 3rd and 4th-order 2-way and 3-way networks. And it includes an L-pad calculator and load compensating networks.

#### System Requirements:

MS-DOS 5.0, Microsoft Windows 3.1 & compatible computer (IBM® PC w/ 386SX or better), 1.44 MByte 3.5" disk drive and mouse. 4 MBytes RAM recommended.

Harris Technologies reserves the right to make changes without prior notice.

Copyright © 1993 by Harris Technologies. All rights reserved worldwide. BassBox is a trademark of Harris Technologies. Other trademarks are the property of their respective companies.

# FITDUCT: A PROGRAM FOR DESIGNING DUCT SOFTWARE

BY HOMERO SETTE SILVA

If you use the well known formula based on Equation 1 to calculate the proper arrangement for tuning a vent in your Bass-Reflex system, you will arrive at the correct position on the first try only if you are lucky.

$$L = \frac{K1 \times D^2}{Vb \times Fb^2} - K2 \times D \quad (1)$$

Where:

- L = Vent length (cm)
- D1 = Vent diameter (cm)
- Vb = Box volume (liters)
- Fb = Box resonance frequency (Hz)
- K1 = 23400 ; K2 = 0.74 (typically)

Authors such as D.B. Keele, Jr. and G.L. Augspurger ("New Guidelines For Vented-Box Construction," SB 2/91, p. 12) have addressed this problem previously.<sup>1</sup> While Keele proposed a method to increase the odds for success, it unfortunately did not solve my problem as his alternative deals mainly with smaller length variations. While I discovered and tried another similar equation based on large length variations, it worked a little better. I was far from satisfied.

Augspurger explained much of why tuning boxes with Equation 1 is difficult and proposed a correction factor. In fact, he was able to obtain a correction fac-

tor for the equation and achieved errors less than 5% for typical boxes.

When I started my work, the article hadn't as yet come to light. I had already begun to blame coefficient K1. It was supposedly a constant but, in fact, was temperature dependent according to Equations 2 and 3.

$$K1 = \frac{C^2}{1.6\pi} = \frac{331.6^2 \left(1 + \frac{T}{273.15}\right)}{1.6\pi} \quad (2)$$

$$C = 331.6 \sqrt{\left(1 + \frac{T}{273.15}\right)} \quad (3)$$

Where:

- T = Air temperature in Celsius degrees
- C = Speed of sound in air (μS)

By reading D. E. Hall's book, I learned of K2's dependence on end termination.<sup>2</sup> I found the theoretical K2 equal to 0.79 for a flanged short pipe and 0.82 for a flanged long tube. In practice, however, things are not this simple.

**GET WITH THE PROGRAM.** As we can see, K2 is anything but constant. It helps to understand what's happening if we think of the air moving in the vent as an inductor and the compliant air trapped inside the box as the capacitor of a tank circuit. The air mass entering or leaving the tube's ends will also be inductive with the exact value strongly dependent upon factors such as tube length, diameter, flange area and the like. The series equivalent inductor is the sum of three contributing parts: the tube itself and the two end corrections (not necessarily equal). Nevertheless, I intend K2 to represent both ends' correction. It

seems impractical to have an exact general analytical expression for it.

With these conditions in mind, I started looking for an empirical equation that could fit data from measurements. In the beginning, I tried a somewhat complex set of equations. With the help of the least-squares based-curve fitting program, I tried to satisfy data collected in a care-

TABLE 1

## FITDUCT-GENERATED PRINTOUT

- L = Duct length
- Fb = Measured box resonance frequency
- Fb-CAL = Calculated box resonance frequency
- Error % = Relative error between Fb and Fb-CAL

L	Fb	Fb-CAL	ERROR %
1.80	32.00	32.00	0.00
2.00	31.90	31.79	0.34
2.50	31.30	31.29	0.03
3.50	30.70	30.35	1.14
4.00	30.00	29.91	0.29
5.00	29.10	29.09	0.04
6.00	28.40	28.33	0.24
7.00	27.70	27.63	0.26
8.00	26.90	26.98	-0.29
9.00	26.40	26.37	0.12
10.00	25.80	25.80	0.00

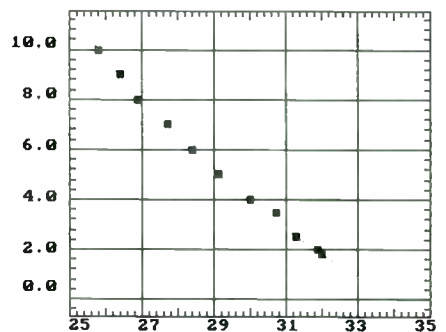

FIGURE 1: Graph after checking FIT. Vertical axis: duct length L (cm). Horizontal axis: box tuning frequency Fb (Hz).

## ABOUT THE AUTHOR

Homero Sette Silva was born in Rio de Janeiro, Brazil. He received a Bachelor of Science degree in Electrical Engineering, and has been an electronics instructor in high schools and universities. He is a prolific author, with numerous articles published in Brazilian technical magazines. Currently living in Roraima, he serves as a loudspeaker consultant and independent researcher. Besides electronics, Mr. Silva is devoted to the writings of Henry David Thoreau.

fully built test box with exactly 242 liters of volume (with the driver unit mounted outside the box) and 11 different tube lengths, beginning with panel thicknesses of 1.8 cm up to 10 cm. I had the tubes machine cut with tight tolerances for reliable results. I measured respective Fb values with a digital frequency meter and a digital zero phase detector.

Soon I could see experimental data fitting empirical curves so well I was tempted to simplify things: from an initial five parameter exponential equation, I moved to the much simpler one shown in *Equation 4*. I also simplified the complex curve fitting program.

$$F_b = \frac{1}{\sqrt{\frac{L}{T_1} + \frac{1}{T_2}}} \quad (4)$$

or

$$L = T_1 \left( \frac{1}{F_b^2} - \frac{1}{T_2} \right)$$

Since we have just the two unknown values T1 and T2, I could solve a two-equation system from two pairs (L; Fb): (1.8;32,0) and (10,0;25;8) and find T1 and T2. The other nine pairs were used to check the fitting. Notice the length of 1.8 is not a simple hole in the panel: I had a tube this length installed to keep the diameter consistent.

**TABLE I.** I used a software program called Fitduct to generate *Table I*, which displays several duct lengths and respective frequencies measured and calculated from the curve-fitting equation. As you can see, errors less than 1% could be achieved. The 3.5;30.7 pair suggests a measuring error during experience.

Another feature available in Fitduct is the ability to plot the box fitting curve and measured points, as in *Fig. 1*.

The proposed method is outlined as follows:

1. Find an approximate value for L in the usual way (using *Equation 1*, for instance).
2. Install a vent with an L1 length less

#### ACKNOWLEDGMENT

I would like to thank G.L. Augspurger for his kind assistance in checking method effectiveness, as well as his encouraging words.

#### REFERENCES

1. Keele, D.B., Jr., "A Tubular Tuning Method for Vented Enclosures," *JAES* Vol. 22, Number 2, March, 1974.
2. Hall, Donald E., *Basic Acoustics*, John Wiley & Sons, 1987.

than the expected value, reading corresponding Fb1.

3. Repeat Step 2 with a length L2 above expected value and read Fb2.

4. Give program the pairs (L1;Fb1) and (L2;Fb2).

5. Given the program desired Fb, it will return the correct length for the vent.

Of course, nothing is wrong with the trial and error method, the time-honored way to tune vented boxes. Many may argue it wastes time to measure the vent resonance three times but, as G.L. Augspurger told me, this method "...is really faster than the usual cutting and trim-

ming process. For the amateur experimenter, the main disadvantage is that he must somehow be able to measure vent resonance, which requires an accurate signal generator at the very least." ▶

FITDUCT software (IBM only, 1" × 5¼", DS/DD) is available from Old Colony Sound Lab, PO Box 243, Peterborough, NH 03458, (603) 924-6371, FAX (603) 924-9467. Order item #SOF-DCT1B5: \$25 plus \$3 shipping US, others inquire.

## TopBox for the Macintosh

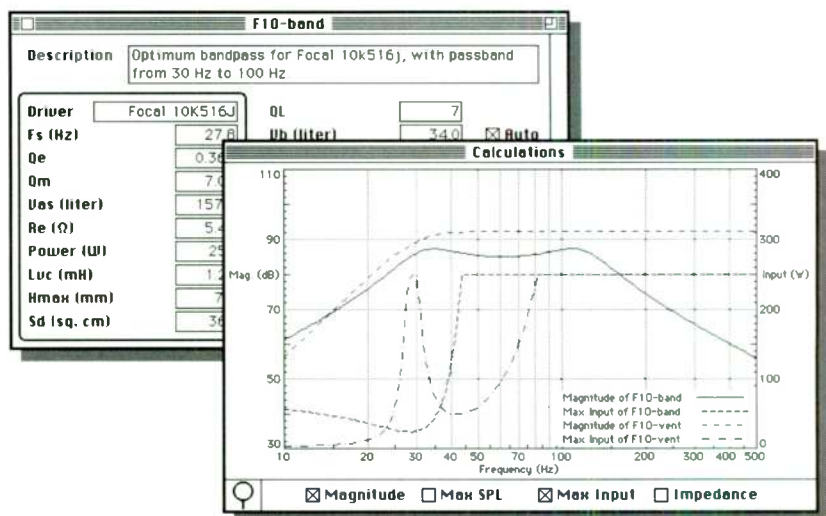

### Introducing TopBox software for Macintosh computers

by Joe D'Appolito, Ron Warren, and Ralph Gonzalez. **TopBox** accurately predicts the response of sealed, vented, and bandpass loudspeaker configurations, allowing the user to compare their impact on frequency response, maximum output SPL, power handling, and impedance. Its intuitive interface provides unsurpassed power, speed, and flexibility.

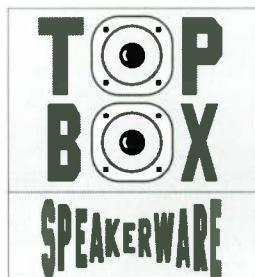

#### Design Types

- 2nd, 3rd, and 4th-order Closed Box
- 4th, 5th, and 6th-order Vented
- 4th and 6th-order Bandpass
- Round and rectangular vents, metric or English units

#### Output Features

- High-resolution black & white or color graphs, with up to six overlay curves
- Graphs and tables can be imported directly by word-processing or page-layout applications
- Tables can be imported by spreadsheet applications

**TopBox** is distributed with an extensible library of popular drivers and several sample designs. Data can be shared with the PC version. **TopBox** is compatible with all Macintosh computers with at least 512k RAM.

Price: \$99.95. Dealer inquiries invited. Also available: **TopBox** for PC-compatibles.

**ORCA**

1531 Lookout Drive • Agoura, CA 91301 • USA  
Tel: (818) 707-1629 • Fax: (818) 991-3072

Reader Service #3

# THE CCPS: A COMPACT COINCIDENTAL POINT SOURCE SPEAKER

BY FRED THOMPSON

I decided to build a pair of speakers based on SEAS' P17REX COAX/F coaxial drivers. These unique devices combine a 6½" polypropylene midwoofer with a 1" textile dome tweeter mounted on a single chassis (*Photo 1*). Unlike normal coaxials, the tweeter and its magnet structure are mounted inside the woofer's 1½" voice coil rather than supported in front by a frame. In fact, it is probably more accurate to call it a dual concentric rather than a coax.

Due to space limitations of the driver's design, SEAS' designers needed a special magnet which would be small in size, yet provide enough energy to drive the tweeter. Neodymium iron boron was developed for just this purpose: it offers ten times the strength of a normal ferrite magnet, so it can be one tenth the size. In addition, they used a rigid cast basket on the woofer to resist flexing and keep everything in proper alignment.

**BENEFICENT CONCENTRIC.** A number of engineering problems which normally plague systems with separated drivers are solved with the dual concentric configuration. Both zero delay planes (ZDP) are aligned at all listening positions, unlike sloped- or stepped-baffle designs which are aligned on only one specific axis. This forms a true coincidental point source and simplifies the crossover design, since it need not compensate for the time delay and interdriver phase differences caused by driver offset. As a point source, the entire fre-



PHOTO 1: The CCPS.

quency range is radiated from a single location.

The lobing errors which plague physically-separated drivers are also eliminated regardless of crossover type or system phase relationships. Vertical polar tilt causes the sound of most of these systems (and especially those with first-order crossovers) to change considerably with listener height, and necessitates sitting in a "sweet spot."

As a result of the woofer acting as a waveguide for the tweeter, both drivers have identical directivities around the crossover point so off-axis performance is very good. Conventional two-way systems usually have a big notch in their off-axis response due to the woofer's narrowing dispersion pattern, combined with the wider-dispersing tweeter.

Well-controlled vertical and horizontal forward directivity throughout the mid-range and treble, combined with on- and off-axis response similarity, precise time alignment, and absence of lobing errors,

translate into good imaging capabilities. Tonal balance will change little from one listening position to another.

Several minor side effects, however, are evident. The tweeter's response is somewhat rough and extends only to about 16kHz, mostly due to reflections from the midwoofer's cone. A peculiar 10dB dip occurs at 11kHz, although this is only apparent directly on-axis and is not a problem as you move 10° or more off-axis. A dip of this magnitude is far less audible than if it were a 10dB peak, since it is subtractive rather than additive and has a narrow bandwidth.

As a consequence of the tweeter's close proximity to the larger cone, significant doppler distortion can be generated when the woofer is making long excursions while reproducing low frequencies. I have noticed in some similar units nasally, honky colorations on vocal reproduction which I attribute to this problem.

**ZOBEL ZEALOT.** The coax driver's ZDP alignment, and its inherent lack of lobing problems, might tempt you to use a true minimum-phase, first-order network. This would probably be difficult to design, however, considering the narrow band of overlap between drivers. Although this network's phase response is nearly linear over most of the frequency range and is said to be transient perfect (it can accurately reproduce a square wave), it seriously compromises the tweeter's power-handling ability due to its gradual 6dB/octave slope. Distortion levels will also be higher. However, smooth amplitude response is far more desirable than phase accuracy and easier to achieve with higher-order filters.

I opted for a fourth-order Linkwitz-Riley at about 3.5kHz. Its sharp attenuation offers maximum tweeter protection and reduces the frequency range which

## ABOUT THE AUTHOR

*Fred Thompson and his wife Marci live in Peterborough, Ontario, Canada, where he is presently employed at Kawartha TV and Stereo. His other interests include building and modifying audio electronics, collecting classic tube equipment, and playing sports such as baseball and golf.*



could be modulated by the woofer. (With shallower slopes, the tweeter will still have considerable output for at least an octave or more below its crossover point.) When the filter is designed correctly, it will also produce flat on-axis response throughout the crossover region, with a seamless transition between drivers.

Textbook crossover designs are usually far off target, because they ignore important driver characteristics. You need accurate frequency-response plots which clearly show the rolloff shape and location, and whether peaks or dips appear near the intended crossover point. These must be factored into the design along with the impedance curve.

The best way to accomplish this is with a crossover-optimization program; I used Loudspeaker Modeling Program (LMP) by Ralph Gonzalez, and SEAS frequency-response graphs (Table 1). According to SEAS data, the woofer has smooth response out to about 4.5kHz, where it begins an approximate fourth-order roll off. The tweeter has the usual 12dB/octave rolloff below its 1.75kHz resonant frequency.

Since ferrofluid is present in the high-frequency driver's voice coil (to improve power handling and supply mechanical damping to its fundamental resonance), no series LCR circuit was needed, even though the crossover was only an octave above. After some trial and error with LMP, I found that a second-order electrical filter, when combined with the woofer's natural rolloff, provided the desired fourth-order acoustic low-pass response. I needed a full fourth-order electrical filter on the tweeter.

The LMP prediction (Fig. 1) shows that when the low- and high-pass crossover sections are summed, the result is a flat frequency response. These crossover component values assume a constant impedance for the drivers. Since this is definitely not the case, I used zobels to flatten the woofers' impedance and elim-

TABLE 1	
LMP PARAMETERS	
<b>Driver 1: Tweeter</b>	
Low freq. corner	1.75kHz
Low freq. dr	0.6
High freq. corner	20kHz
High freq. dr	0.65
High freq. rolloff	Second-order
Sensitivity	83.5dB
Polarity invert	No
Response step freq.	1.5kHz
Response step height	6dB
Depth displacement	0
Impedance	6Ω
<b>Driver 2: Coax Woofer</b>	
Low freq. corner	65Hz
Low freq. dr	0.7
High freq. corner	5.9kHz
High freq. dr	0.62
High freq. rolloff	Fourth-order
Sensitivity	83dB
Polarity invert	No
Response step freq.	1.5kHz
Response step height	6dB
Depth displacement	0
Impedance	6.5Ω with equalization
<b>Driver 3: Second Woofer</b>	
Same as Driver 2	

inate the effects of voice coil inductance, thus allowing the crossover to function properly. It would usually be unnecessary to use a zobel on the tweeter, because its impedance does not begin to rise until well above the crossover point (about 10kHz). I decided to try one anyway, and was surprised that the high frequencies sounded smoother.

Measurements confirmed that the zobels actually reduced the magnitude of a peak in the 6.3-8kHz range. After trying various resistors, I achieved the best high-frequency balance with the tweeter's output attenuated by about 6dB. You should use only high-grade crossover parts, as they will make a noticeable difference in sound quality. Also, verify that all resistor values are within at least ±5%.

I used Solen polypropylene capacitors throughout except for the zobels' 12μF electrolytics, which are bypassed with 2μF polypropylenes. I also used Solen air-core inductors wound with 18 AWG copper; the large 6mH is a low-loss, iron-core type for low DC resistance (a Sledgehammer unit from Madisound). To reduce the effects of magnetic interaction and crosstalk between inductors, separate the low- and high-pass sections as far from each other as possible inside the enclosure (the low-pass sections at the bottom, and the high-pass at the top). Doing so will improve clarity and detail.<sup>1</sup> You can give them biwiring capabilities by adding another set of input terminals, with one pair for the tweeter and the other for the woofers.

**DOUBLE INTENT.** Significant diffraction loss occurs in small speakers with narrow front baffles.<sup>2,3</sup> Frequencies with wavelengths equal to and shorter than the baffle's width (in this case, 1.5Hz for a baffle width of 9") are reflected in the forward axis with increased intensity, while frequencies with longer wavelengths become more omnidirectional as frequency decreases. Consequently, these lower frequencies receive less reinforcement from the speaker's front panel, with less intensity in the forward direction.

The total diffraction loss is about -6dB in the lower bass range compared to that above 1.5kHz (Fig. 2). As a result, small speakers tend to sound unbalanced, with a forward-sounding upper midrange and treble combined with somewhat thin bass and lower midrange. You can correct this in part by placing the speaker against a wall, although this might be detrimental to stereo imaging.

I added a second woofer, the SEAS P17REX, to compensate for this loss. As the name suggests, it is almost identical to the coax driver, but without the integral tweeter. It works in tandem with the main driver below 200Hz, then

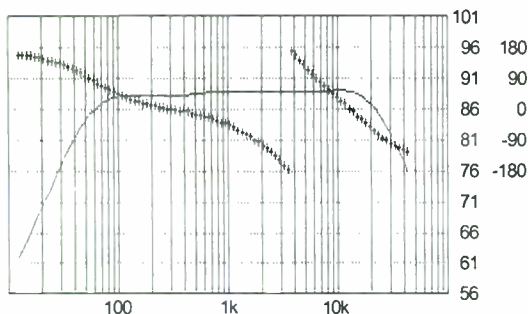

FIGURE 1: LMP-predicted anechoic response with fourth-order L-R at 3.5kHz with diffraction-loss compensation.

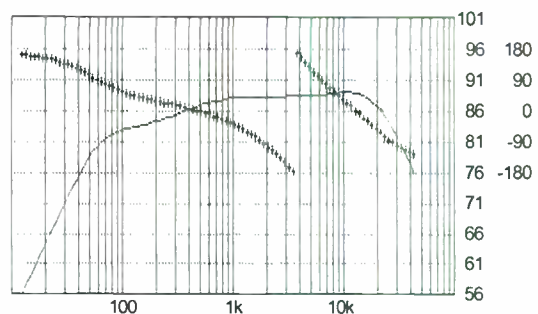

FIGURE 2: LMP-predicted anechoic response with fourth-order L-R at 3.5kHz with no diffraction-loss compensation.

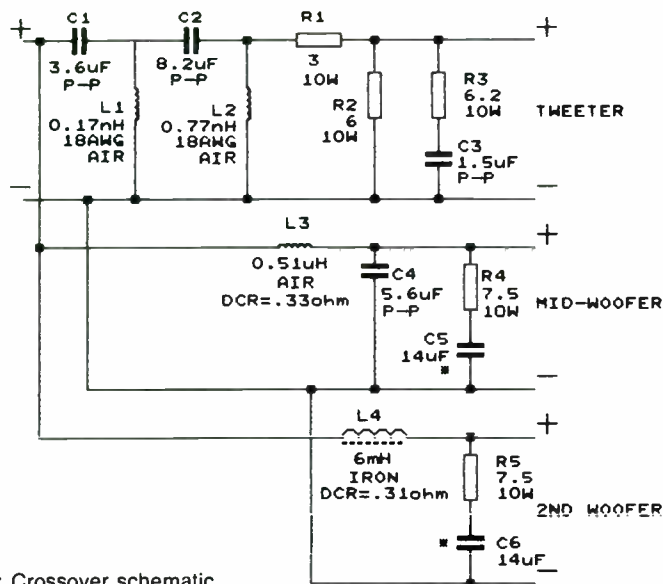

FIGURE 3: Crossover schematic.

slowly rolls off above that with a series inductor. If you compare the LMP predictions in Figs. 1 and 2, you will notice that the diffraction loss has been completely eliminated, except for about 1dB.

Adding the extra woofer also increases power-handling ability, with greater maximum SPL and dynamic range. Volume displacement is effectively doubled, and cone excursion is reduced to half that required of a single driver for the same input level. The coax driver's midwoofer section will not have to work as hard, so distortion in the critical midrange will be reduced. Using a bass-reflex enclosure will further lessen distortion and excursion requirements.

**BASS IS LOADED.** The woofers have a very large magnet and low  $Q_{TS}$ , and thus are well-suited for use in a QB3 vented box. The QB3 is reported to be audibly superior to other vented alignments, possibly because of its shallower rolloff (18dB/octave compared to 24dB). Theoretically, this should result in superior transient response, similar to that of a sealed box.<sup>4</sup>

With the aid of BOXMODEL and LOUDSPEAKER 5.11, I designed a compact unit which is similar to the QB3 and with acceptable bass. The predicted -3dB point is about 65Hz, which isn't too bad for a 16.5 liter (net) enclosure with 6 1/2" drivers. Room gain and proper placement should help extend the usable bass somewhat. Due to depth limitations, I used a 2-inch inside diameter and 5-inch long port. At higher listening levels, vent airspeed will be fairly high at around 10% of mach, and the port may exhibit some nonlinear behavior. At

normal volume levels, however, this should not be noticeable.

To reduce wind-noise audibility, I placed the vent directly behind the lower woofer. The rear-firing port, and the second woofer's extra bass and lower midrange output, dictate that the speaker not be placed too close (less than 2') to any room walls or corners. Otherwise, excessive output in the 200Hz region and below could result from boundary reinforcement. As with all bass-reflex systems, it would be a good idea to use a subsonic filter to prevent the woofers from making power-robbing and distortion-causing excursions below  $F_B$ . The DCR values of the 0.51mH and 6mH inductors must be the same as specified in the crossover diagram (Fig. 3). If not, the woofer's  $Q_{ES}$ , as well as the box/woofer tuning, could be adversely altered.

**BOXING DAY.** I built the enclosure entirely of 3/4" MDF, which has better damping properties than either particleboard or plywood (Fig. 4). Cabinet vibrations must be minimized to avoid severe colorations. Thin, poorly damped panels

TABLE 2

FREQUENCY RESPONSE LIST

(1/3-octave warble tones, 1 m, on tweeter axis)

(Hertz)	(dB)	(Hertz)	(dB)
250	+0.5	1.6k	0
315	-0.5	2k	-1
400	-3	2.5k	-1
500	-2	3.15k	-0.5
630	-2.5	4k	+1
800	-2	5k	+2.0
1k	0	6.3k	+1.5
1.25k	+1	8k	+1

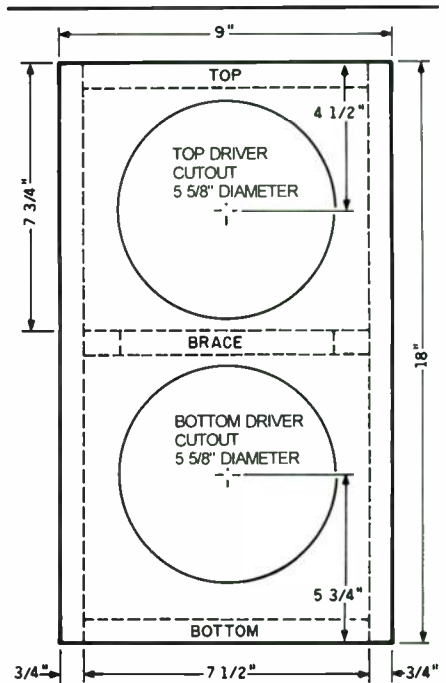

FIGURE 4: Front view of enclosure, with pieces needed for two enclosures. All material 3/4" MDF. Tops, bottoms and braces: 7 1/2" x 9" (six); sides, rear and double fronts: 18" x 9" (ten).

are capable of radiating almost as much acoustical energy as the drivers at some frequencies.<sup>5</sup> These panel resonances can mask fine details in the midrange, and cause the bass to sound muddy and lack articulation.

The front baffle is the most likely to suffer from resonance problems due to its direct contact with the drivers. I constructed it with two 3/4-inch-thick pieces of MDF laminated together with fiberglass resin (regular carpenter's glue will not work), which increases its stiffness and limits the amount of flexing induced by driver-frame movement. To give the front baffle some extra support where it was weakened by the large driver cutouts, I placed a circumferential brace a little above the center point and between the two drivers. The brace also stiffens the entire enclosure and prevents expansion (similar to a balloon) due to high internal pressures.

I used a fiberglass resin and mat combination to strengthen and increase the contact area between adjoining panels and on the braces. This helps dissipate vibrational energy from one panel to the next and reduces cabinet noise.<sup>6</sup> After you build the box, simply laminate the second section of the front baffle to the first. You can then cut the driver holes (Fig. 5), first marking the brace location on the outside panels. If you have a router, you may wish to flush mount the

Continued on page 34

World Famous  
**PYLE DRIVER® SPEAKERS...**

Your Source for  
Quality Woofers, Midrange,  
Tweeters and Crossovers



- Over 200 speaker models and sizes available
- Parameters available for every loudspeaker
- Recommended cabinet sizes available for all woofers

**Pyle is the source for all your loudspeaker needs!**



**PYLE**

Pyle Industries, Inc. • 501 Center St. • Huntington, IN 46750 • (219) 356-1200

Continued from page 32

drivers and round off the baffles' front edges. Glue the acoustic foam pieces which line the inside panels in place with silicone or similar adhesive. Install them either before the front baffle is attached or through the driver holes.

For the finishing touches, I applied real walnut veneer to five sides and painted the front flat black. During construction, it is especially important to ensure that no air leaks exist around the drivers, ports, or input terminals.

**HOLLOW VICTORY.** Just as cabinet resonances must be minimized, so do the internal reflections and standing waves within the enclosure. If these are not dealt with effectively, the overall sound can take on a boxy, hollow character, with the midrange being the most seriously affected.

The general rule for reflex enclosures is to line only the walls, leaving the central volume open so the port's efficiency is not significantly reduced by stuffing material.<sup>7</sup> In the interest of better sound quality, I violated this rule somewhat. After some experimentation, I decided on the following combination:  $\frac{5}{8}$ " acoustic

foam on the sides; 2" acoustic foam on the rear panel; 1" fiberglass on the tops and bottoms covering the crossovers.

Listening tests revealed that some nagging boxy colorations persisted. To eliminate them, I first took a 12" x 12" section of 1-inch-thick polyester batting (bonded Dacron) and wrapped it into a tight roll. I then placed it doughnut-shaped around the port tube's perimeter, taking care not to obstruct the opening. Next, I lightly stuffed the upper section above the brace and behind the top driver with polyester batting. (Do not completely fill this area, as some of the top driver's backwave must be allowed a free passage to the port.) Although this extra filling may reduce the port's output to some extent, the gains in midrange and midbass performance make it a worthwhile tradeoff.

**MEASURE OF SUCCESS.** Since I didn't have access to a PC-based analyzer, I did some frequency-response measurements using a *Stereophile* Test CD2 which contains  $\frac{1}{3}$ -octave warble tones, and a Radio Shack sound level meter. This inexpensive setup wasn't the most accurate because the SLM was not

calibrated, but it gave a general indication of response linearity. I took the measurements in my living room, with the SLM placed at a distance of one meter directly on-axis with the tweeter, and the speaker on a 23" stand well away from any reflective surfaces except the floor. Table 2 lists the responses at specific frequencies, which show remarkable agreement with the computer predictions between 1-4kHz (within a tight  $\pm 1$ dB tolerance) and substantiates good crossover performance.

To further check the crossover, I reversed the tweeter's polarity and took more tests. These clearly revealed a deep "suck-out" between 2.5-4kHz, indicating that when the drivers are connected with normal polarity, they are in phase (or at least close). The overall system response looks reasonably flat except for the slight valley between 400-800Hz. I did not include results above 8kHz, since SLM limitations above this point would render them unreliable. Accuracy of the one-meter measurements below 250Hz would be hindered by floor reflections, so I omitted them as well.

**SUGGESTIONS.** Room acoustics influence a system's sound considerably, and you should experiment with speaker positioning. Depending on the room's size and shape, and its reflective or absorptive qualities, even small changes in speaker location can make a big difference. You should mount them on solid stands 22-24-inches high, which will put the tweeters at about ear level for a seated listener. I designed this system more or less for free-field placement, with 2-3' from the rear wall as optimum. Positioned as such, the bass and midbass regions should sound properly balanced without any over-emphasis. According to the warble tones on my test CD, there will still be appreciable output down to 40Hz.

If you set up the speakers quite far from room boundaries, the lower bass may sound a bit too lean and over-

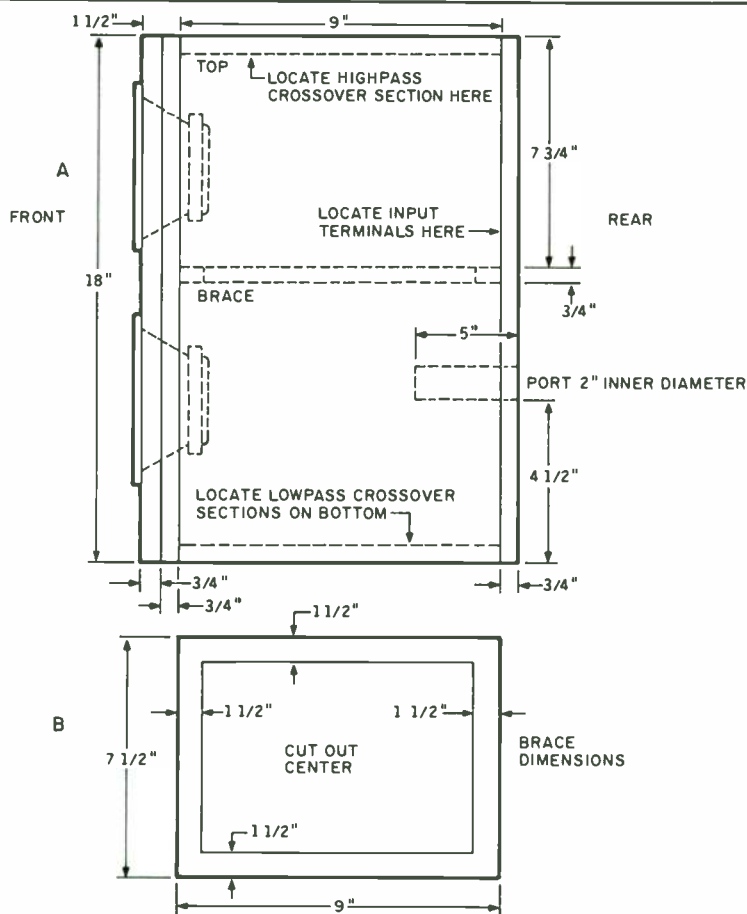

FIGURE 5: a: enclosure side view; b: brace dimensions.

**PREVIEW**  
**Glass Audio**

**Issue 2, 1993**

- 6DJ8
- Tube Line Driver
- Mu Stage
- Custom Tube Crossover, Part I

damped, due mainly to the relatively high bass-cutoff point. You can easily add some extra weight in the low end by shortening the vent, which raises the box-tuning frequency ( $F_B$ ). Try shortening it a quarter-inch at a time until you get the desired results. Avoid making it drastically shorter, or bass definition will be severely degraded.

You can make a smaller system for wall or bookshelf mounting by using only the coax driver and its crossover sections. This should work well in a 9-10 liter vented enclosure tuned to an  $F_B$  of about 52Hz. Of course, the power-handling and dynamic-range capabilities will be more limited, but all the coaxial advantages will remain. ▶

#### SOURCES

Solen Electronics  
4470 Thibault Ave.  
Quebec, Canada J3Y 7T9  
Phone (514) 656-2759  
FAX (514) 443-4949  
(drivers, polypropylene capacitors, air-core inductors)

Madisound Speaker Components  
Box 44283  
8608 University Green  
Madison, WI 53711  
Phone (608) 831-3433  
FAX (608) 831-3771  
(6mH iron-core inductors, port tubes, lmk resistors, input terminal cups)

Old Colony Sound Lab  
PO Box 243  
Peterborough, NH 03458-0243  
(603) 924-6371  
FAX (603) 924-9467

#### REFERENCES

1. Chin, M., "Magnetic Crosstalk in Passive Crossovers," *SB* 5/90, p. 64.
2. Gonzalez, R., "An Introduction to Frequency Response and LMP," *SB* 2/87, p. 42.
3. D'Appolito, J., and J.W. Bock, "The Swan IV Speaker System," *SB* 4/88, p. 9.
4. Koonce, G.R., "The QB3 Vented Box is Best," *SB* 5/88, p. 22.
5. Dickason, V., *The Loudspeaker Design Cookbook*, 4th ed., Audio Amateur Press, October, 1991, p. 79.
6. Colloms, M., *High Performance Loudspeakers*, 4th ed., Halsted Press, John Wiley & Sons, 1991, p. 293.
7. Augspurger, G.L., "New Guidelines for Vented Box Construction," *SB* 2/91, p. 12.

Nongraphics (\$17.50) and graphics (\$49.95) versions of LMP are available from Old Colony Sound Lab, PO Box 243, Peterborough NH 03458; tel. (603) 924-6371; FAX (603) 924-9467. Please include \$3 for shipping.

## AUDIO LIQUIDATORS- Presents

One of the finest all-Dynaudio speakers ever built. Take advantage of some one else's misery, turn it into your listening pleasure. These speakers retail for over \$8,000/pr., but because of a bankruptcy we are liquidating the entire inventory giving you incredible savings. We are offering them as either a full kit or a ready to plug-in version.

**Full kit includes:** precut and machined wood, matched drivers, assembled x-overs, grill cloth, felt, metal frame, and all hardware. \$2000.

**Plug-in version includes:** all of the above plus locally assembled boxes, top and bottom trimmed in hardwood, completely assembled, pretested and ready to hook up. \$2700.

**Specifications:** 30-20K  $\pm 3$  dB, 1000W @ 10mS,  $\eta = 90$ dB SPL, pulse coherency 10 $\mu$ S, THD .3% > 60Hz, shipping weight = 175 Lbs. each

**Drivers:** 2x300mm, 2x175mm, 1x21mm (optional 1x25mm)

Not affiliated with the original manufacturer.

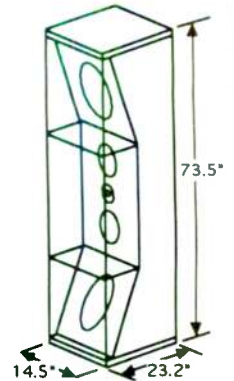

**AUDIO LIQUIDATORS**  
2916 Cortez Dr., Ft Worth TX, 76116  
(817) 244-3913

Specializing in audio related liquidations, foreclosures, bankruptcies, and closeouts.

Reader Service #19

## WE HAVE GONE FAR TO HAVE them HERE...

**90**  
of EUROPE'S  
FINEST KITS

**ETON** Peerless

scan-speak

morel

seas vifa DYNAUDIO

AUDAX DAVIS Acoustics



**S**  
phone  
fax

The most ingenious designs from European speaker kit builders, now available here. Order our special EUROPEAN KIT BROCHURE, featuring 90 fully detailed drawings and specifications for only \$6! Exclusively available from:

SOLEN Électronique Inc. 4470 Ave. Thibault  
phone (514) 656 - 2759 St-Hubert, QC J3Y 7T9  
fax (514) 443 - 4949 Canada

Reader Service #25

**LOUDSPEAKER DESIGN POWERSHEET****SOF-PSH2M3****Macintosh Software****\$69.95**

By popular demand, now available for Macintosh! This is the famous mega-program originally for IBM only as detailed on page 63 in our 1993 catalog and as appeared in SB 4-5/92; article reprints included. By Marc Bacon. Professional version. Macintosh; 3 x 3 1/2". PLEASE NOTE THAT SPREADSHEET SOFTWARE COMPATIBLE WITH LOTUS 1-2-3 IS REQUIRED AND NOT SUPPLIED WITH THIS PACKAGE.

**Karaoke Opera CDs and Cassettes**

At long last, a superior karaoke set for opera buffs! This high-quality package features the Czech Symphony Orchestra and Prague Philharmonic Choir performing sixteen all-time favorite arias and duets. One side of each CD or cassette features the complete pieces, while side 2 provides the orchestral-only versions for your sing-along sorties. 48-page libretti (lyrics) included. UK, 1992, 2:16:17.

Selections: "Votre Toast Je Peux Vous Le Rendre" (Toreador's Song from *Carmen*); "Seguidilla" (*Carmen*); "Habanera" (*Carmen*); "Au Fond du Temple Saint" (*The Pearlfishers*); "Mon Coeur S'Ouvre à Ta Voix" ("Softly Awakes My Heart" from *Samson & Delilah*); "Belle Nuit, O Nuit D'Amour" (*Tales of Hoffman*); "Un Bel Di Vedremo" ("One Fine Day" from *Madama Butterfly*); "Largo al Factotum" (*The Barber of Seville*); "Brindisi" (Drinking Song from *La Traviata*); "Che Gelida Manina" ("Your Tiny Hand is Frozen" from *La Bohème*); "La Donna e Mobile" ("Women Are Fickle" from *Rigoletto*); "O Mio Babbino Caro" ("My Beloved Daddy" from *Gianni Schicchi*); "Madamina" (Catalogue Aria from *Don Giovanni*); "Vestita Giubba" ("On With the Motley" from *I Pagliacci*); and "Nessun Dorma" ("None Shall Sleep" from *Turandot*). From IMP Classics. Purchasing options available:

**CDKAR** Karaoke Opera 2-CD Set with libretti **\$22.95**  
**CASKAR** Karaoke Opera 2-Cassette Set with libretti **12.95**

**Famous Denon Hi-Fi Check CD** **CDDEN**  
**\$19.95**

Audio Check, Side One: [1] Channel Check, L + R; [2] Phase Check; [3] Stereo Sound Check; [4] Left Frequency Band Level & Phase Check; [5] Right FBLPC; [6] Center FBLPC; [7] Operational Reference Level, 1kHz, -20dB; [8] ORL, 1kHz, -16dB; [9] ORL, 1kHz, -15dB; [10]-[24] Spot Frequency Signals, 997Hz-19997Hz; [25]-[26] Logarithmic Frequency Sweep, L + R; [27]-[28] Wow & Flutter Checks; [29]-[30] Channel Separations Checks; [31] Cassette Deck Azimuth Adjustment Signal; [32] Cassette Deck Bias/Equalizer Adjustment; [33]-[36] Music Samples for Recording Level Adjustment: Orchestra, Piano, Pop Vocal, Rock; [37] Silent Track (digital zero); [38] 1 LSB Square Wave Signal; [39]-[43] 1kHz Sine Wave Signals for D/A Converter Linearity Measurement; [44]-[48] Low Level Music Signals for Linearity Checking: Orchestra/Piano Music; [49] Compound Sine Wave Signal for Linearity Checking of D/A Converters.

General Sound Check, Side Two: [50] Mozart/Symphony No. 39 in E-Flat Major, KV543, 1st Mvmt.; [51] Bartók/Music for Strings, Percussion & Celesta, Sz. 106, 4th Mvmt.; [52] Bruch/Violin Concerto No. 1 in G Minor, Op. 26, 1st Mvmt.; [53] Händel/Concerto No. 1 in C Major, HWV319, 5th Mvmt.; [54] Debussy/Petite Pièce; [55] Liszt/Liebesträume S. 541, R211, Notturmo III, O Lieb; [56] Xenakis/Pléiades, 1st Mvmt.; [57] Händel/Musick for the Royal Fireworks; [58] Takemitsu/November Steps; [59] Bob Berg/In the Shadows; [60] Count Basie, Jon Hendricks/Jumpin' at the Woodside; [61] Neal Hefti/Whirly Bird. From Denon. Japan, 1992, 70:00. 30-page instruction booklet in English/German/French.

**Digital Sound Effects for Film & Video 2-CD Set** **CDEFX**  
**\$39.95**

The definitive sound effects package in terms of both quality and content, this 2-CD set features 188 tracks of sounds divided into four categories: in and around the house (20:20); animals/nature (50:50); traffic (vehicles) (31:21); and miscellaneous (42:37) Unbelievable diversity. From Sound Products Holland. The Netherlands, 1991, 145:08. 8-page track guide in Dutch/French/English/German.

**LIVE SOUND! Video****VDLISO****\$39.95**

*LIVE SOUND! How to Run Your PA System* provides a wealth of information—in plain English—from renowned sound engineer Scheirman, author of more than 75 published articles. Largely band-oriented yet nonetheless valuable to anyone with PA needs, this full-color video covers equipment selection; loudspeaker placement and setup; microphone selection and placement; the monitor system; mixer position; system assembly and cables; power amps; how to sound check; running the mixer; signal processing/effects; crossovers; equalizers; and more. By David Scheirman/Concert Sound Consultants. 1990, VHS, 75:00.

**VCR Maintenance and Repair Video****VDVT103****\$24.95**

Designed for the average VCR owner, this tape uses a comparison of three different VHS VCRs to illustrate design characteristics common to most units. By learning how to replace belts as well as clean and maintain the entire tape path, the viewer will eventually save wear and tear on both his tapes and his machine. From UCANDO. 1992, VHS, 32:00.

**Digital Series Part 6: CPUs and I/O Devices Video****VDVT306****\$34.95**

This newest installment in UCANDO's famous computer-animated instruction course makes the central processing unit and input/output devices easy to understand and fun to learn about. A must for the present or future serious computer technician. From UCANDO. 1992, VHS, 56:00.

**Complete 6-Video Digital Course****VDVTTDDDD/X6****\$179.95**

Parts 1-5 as shown on page 70 of our 1993 catalog, plus Part 6 as above, at a savings of \$29.75! Covers digital basics; gates; binary notation and math; octal, decimal, and hexadecimal notation; flip-flops; counters; complement numbers; multiplexers; registers; decoder drivers; displays; converters; memory devices; much more. Among the best tutorial media available in the world today. From UCANDO. 6 tapes; 5 hours, 34 minutes.

**High-Quality Printed Circuit Boards**

From *The Audio Amateur* projects as cited; epoxy glass; 2-oz. copper reflowed; silk-screened component layout on component side. By Old Colony Sound Lab. Please request article reprint if needed. Purchasing options available:

**PCBA-3A** John Allgaier TDA1541A DAC Enhancement **\$14.95**  
Mega-Mod, TAA 1/91, 1993 catalog page 4; one needed per CD player

**PCBA-3B** John Allgaier High Performance Piggyback #4 AD847 **12.95**  
Mod, TAA 4/89, 1993 catalog page 4; two needed per CD player

**PCBP-10A** Nelson Pass/Norman Thagard A75 Power Amplifier **14.95**  
front end (main) board (two channels), TAA 4/92-1/93

**PCBP-10B** Nelson Pass/Norman Thagard A75 Power Amplifier **8.95**  
power supply board, TAA 4/92-1/93

**OLD COLONY SOUND LAB**

PO Box 243, Department B93  
Peterborough, NH 03458-0243 USA  
24-Hour Lines:  
Telephone: (603) 924-6371 or  
(603) 924-6526 FAX: (603) 924-9467

**OUR DISCOUNT POLICY**

Order Value	Discount
<\$50.00	0%
\$50.00-\$99.99	5%
\$100.00-\$199.99	10%
>\$200.00	15%

Mastercard, VISA, check or money order in US funds drawn on US bank.

**PLEASE BE SURE TO ADD SHIPPING CHARGES****Shipping Charge According to Destination and Method Desired (\$)**

Order Value	United States		Canada		Other	
	Surface	Air	Surface	Air	Surface	Air
< \$50.00	3.00	7.50	5.00	7.50	10.00	20.00
\$50.00-99.99	4.00	15.00	7.50	15.00	20.00	30.00
\$100.00-199.99	5.00	20.00	15.00	20.00	30.00	40.00
> \$200.00	6.00	30.00	25.00	30.00	40.00	50.00

**NEW  
FOR  
'93**



**Music Speech Audio BKSP1  
\$34.95**

This book is the most recent revision of the authors' famous 1977 and 1983 editions of *Music Speech High-Fidelity*, in which they emphasized the application of physical principles in explaining and describing many diverse acoustical phenomena. Forty-seven chapters are divided into six areas of study: Physical and Acoustical Background; The Ear and Hearing; Listening Environments; The Human Voice and Speech; Musical Acoustics; and Electronic Reproduction of Music. Noted by Richard Campbell in *Speaker Builder* 2/93 as a "wonderful book" on descriptive acoustics. By William J. Strong and George R. Plitnik. 1992, 521pp., 8½ x 11, softbound.

**REAL-WORLD THREE-WAY CROSSOVERS Software SOF-GON1B5  
\$6.95**

As a follow-up to the designer's *SB* 2/92 article on two-way crossovers, this BASIC program finds the components for a second-order bandpass (midrange) crossover, given the user's choice of corner frequencies and their respective Q values. For a starting point, it suggests values for an ideal second-order APC, based on Robert Bullock's *SB* 2/85 article. By Ralph Gonzalez. IBM PC or compatible; 1 x 5¼" DS/DD. Documentation included.

**Recording Industry Sourcebook BKRI1  
\$64.95**

Fourth edition of the essential North American music business and production directory, featuring over 11,000 contacts divided into 75 categories. By Ascona Group, Inc. 1993, 562pp., 8½ x 11, spiralbound.

**OLD COLONY EASY ORDER FORM**

QTY.	ITEM NO.	PRICE EACH	TOTAL
_____	_____	_____	\$ _____
_____	_____	_____	\$ _____
_____	_____	_____	\$ _____
<input type="checkbox"/> FREE CATALOG			<b>SUBTOTAL</b> \$ _____
			Less Discount \$ _____
			<b>SUBTOTAL</b> \$ _____
			<b>PLUS SHIPPING</b> from chart \$ _____
			<b>TOTAL ORDER</b> \$ _____



PLEASE BE SURE TO ADD SHIPPING CHARGES. PLEASE REMIT IN US \$ ONLY, DRAWN ON US BANK. PAYMENT BY:  CHECK/MONEY ORDER  MASTERCARD  VISA

NAME _____	TODAY'S DATE _____
COMPANY _____	
STREET _____	
CITY _____	ST _____ ZIP _____
COUNTRY _____	DAYTIME TELEPHONE _____
MC OR VISA _____	EXP. _____

**OLD COLONY SOUND LAB**

PO Box 243, Department B93  
Peterborough, NH 03458-0243 USA  
24-Hour Telephone: (603) 924-6371 or (603) 924-6526  
24-Hour FAX: (603) 924-9467

**Outline Electronic Turntable Speaker Testing System**

Now available from Italy, the world's most state-of-the-art speaker turntable system! Any audio engineer knows that a speaker's polar plot has always been one of its most important parameters. Now these patterns are available easily and inexpensively with this unique setup consisting of electronic control unit (ET1), rotating turntable (ST1), and optional turntable stand hardware kit (ST2).

Although designed to work with high-performance analyzers such as DRA Labs' MLSSA and ATI's LMS, the Outline ET1/ST1 can also be used with any measurement system using a TTL signal to drive external equipment. The ST1 turntable drum itself is small and light, but it turns loudspeaker systems of any size and weight (up to 135 pounds), thanks to a very rugged bearing gear eleven inches in diameter. The turntable is usable with the optional stand hardware ST2, which consists of the 4-leg pedestal and height-adjustable stand, or with your own custom hardware bolttable to any of the five mounting holes in both the top and bottom of the turntable drum. The ST2 is very useful for taking measurements in the middle height of the room, with speaker components or small- to medium-size system enclosures.

The ET1 electronic control module is physically the equivalent of one standard EIA 19" rack equipment unit. It controls all the functions of the ST1, allowing automatic or manual operation and the choice of several parameters such as angular step increments. Connection between the ET1 and both the ST1 and your (IBM-compatible only) PC is made through twin DB9 9-pin connectors available on both the front and rear panel of the ET1. The Outline ET1/ST1 system comes complete with several macro programs to quick start both MLSSA and LMS, and is also readily adaptable to user-written macros as well.

Specifications: Power supply--110/220VAC 50/60Hz, fuse and voltage changeover jumper; 12/20VCC, XLR connector with fuse and protection against short circuit and polarity inversion. Max rotation speed--200 msec/degree. Precision--±/ 0.25 degree. Rotation control--optoswitch with flying spot scanning. I/O connections--9-pin (DB9) sockets. Input pulse--TTL (from 5 to 12VCC), imp. 680 Ohms. Output pulse--TTL with variable delay from 2 to 13 secs; pulse duration, 0.5 sec. Rotation offset--adjustable from 5 to 45 degrees by 5-degree steps; push-on automatic reset. Weight capacity--135 pounds (300 kg). Dimensions--ET1, one EIA 19-inch standard rack unit; ST1, 13.78 inches (35 cm) diam, 3.94 inches (10 cm) high. Complete instructions provided; fully assembled. Cables included.

PLEASE ALLOW 4-6 WEEKS FOR DELIVERY. Additional information available for \$1 plus 8½ x 11 SASE. Purchasing options available:

KET1/ST1	Outline ET1 Electronic Control Unit and ST1 Turntable (not sold separately)	\$1195.00
KST2	Outline Optional ST2 Turntable Stand Kit	\$195.00
KET1/ST1/ST2	Outline ET1, ST1, and ST2 as above, at a savings of \$45!	\$1345.00



Outline ET1/ST1/ST2 Electronic Control Unit, Turntable, and Turntable Stand. (Computer, monitor, table, and speaker not included.)

# THE IMP: MEASURING T/S PARAMETERS

BY BILL WASLO

In previous articles, I have described construction and operation of the IMP (Impulse response Measuring and Processing) system (SB 1/93, p. 10; 2/29, p. 30; 3/93, p. 36). This little board and its software complement, together with an amplifier from your stereo system and an IBM PC-compatible computer, allows quick and easy measurement of frequency and time domain impulse responses, and impedance characteristic curves of loudspeakers and circuits.

Those of you who have measured Thiele/Small woofer parameters manually know this involves painstaking impedance measurements, so the question naturally comes to mind: can IMP be used for this? If you have operated the IMP software version 1.11, you already know the answer. To facilitate the pro-

cess, I have added a new option to the `auto_Measure` menu: T/s, a Thiele/Small parameter extraction facility.

## IMPEDANCE CURVE ANATOMY.

Figure 1 shows a typical woofer free-air impedance curve. The solid curve is the magnitude (sometimes called the modulus) of impedance, and the dotted curve is the angle. A positive angle indicates that the impedance is inductive; a negative angle corresponds to a capacitive impedance; a pure resistance has an angle of zero. As you can see, a woofer impedance will usually be inductive at some frequencies, capacitive at others, and resistive at discrete frequency points in between. Changes in angle will occur quite rapidly near the woofer's resonant frequency ( $f_s$ ), at the big impedance magnitude bump.

2:SIZE 3:RATE 4:INPUT 5:MKR1 6:MKR2 7:WINDOW 8:GAIN DATA c IMP AUDIO ANALYZER  
4096 1.92kHz PROBE1 63 333 NONE EBN

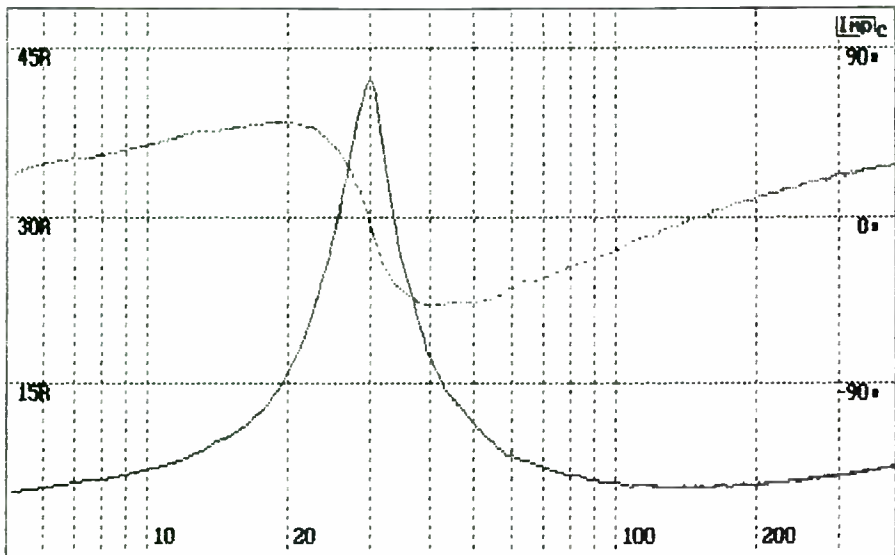

29.53Hz: Z=41.8, 0.40deg

156.0Hz: Z=5.80, 0.05deg

FIGURE 1: Woofer free-air impedance curve.

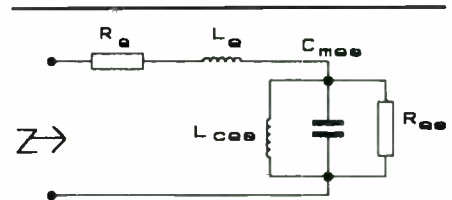

FIGURE 2: Woofer circuit model used by IMP.

A generally accepted equivalent electrical circuit of a loudspeaker in free air is shown in Fig. 2. Basically, this is Thiele's diagram with a series inductance included to represent the positive angle contributed by the voice coil. The circuit is only approximate; real-world drivers have impedances which behave very similarly to this network near the resonant frequency, but which may vary considerably at higher frequencies.

The resistor  $R_E$  represents the voice coil's DC resistance. Inductor  $L_E$  is the coil inductance at the resonant frequency. It generally will not be the same as the inductance at 1kHz, as typically specified on data sheets. Inductor  $L_{CES}$  models the compliance of the spider and surround as they are coupled to the voice coil by electromagnetic interaction. The moving masses, considered as a group and also electromagnetically coupled, are represented by the capacitor  $C_{MES}$ .  $R_{ES}$  encompasses system losses such as those in the suspension and the spider, shorted turns in the coil, and the acoustical radiation which generates sound output.

## FROM MEASURE TO MODEL.

The IMP's T/s facility determines most of the primary Thiele/Small parameters by manipulating the electrical component values (Fig. 2) until the model network's calculated impedance magnitude and angle closely agree with the woofer's measured complex impedance. The



results from two such measurement/curve-fit operations, plus some additional user-entered parameters, are then mathematically combined to derive the T/S parameters.

The primary low-frequency box design parameters are given in Table 1, with formulas for most of them in terms of Fig. 2's electrical components. Notably different is the formula for  $V_{AS}$ , the equivalent air volume compliance. While  $f_s$ ,  $Q_E$ ,  $Q_M$ ,  $Q_T$ , and  $R_E$  are all given in terms of electrical components from the model,  $V_{AS}$  determination requires knowledge of some other values.

$V_{AS}$ , as specified here, relates to the "delta mass" measurement method, similar to that described by Vance Dickason in *The Loudspeaker Design Cookbook*.<sup>1</sup> Factor "d" is the cone's effective diameter in inches, and will usually be about 80% of the nominal driver diameter. The value " $f_{s(M)}$ " is the resonant frequency measured with an additional mass coupled to the moving assembly. I have had good results using a measured one-ounce glob of clay, flattened and set on the cone or dust cap. The added weight enters the equation as "ma," measured in kilograms.

Of course, you needn't use the equations directly at all if you are using the delta-mass method. IMP will calculate and present the values you need to enter into your box-design software. If you prefer the "box method" of determining  $V_{AS}$ , you can still use values from IMP impedance measurements and perform the calculation with a calculator.

**INGREDIENTS.** To find a woofer's T/S parameters, you will need:

- The IMP module and software.
- An amplifier with a preamp or volume control capable of good low-frequency

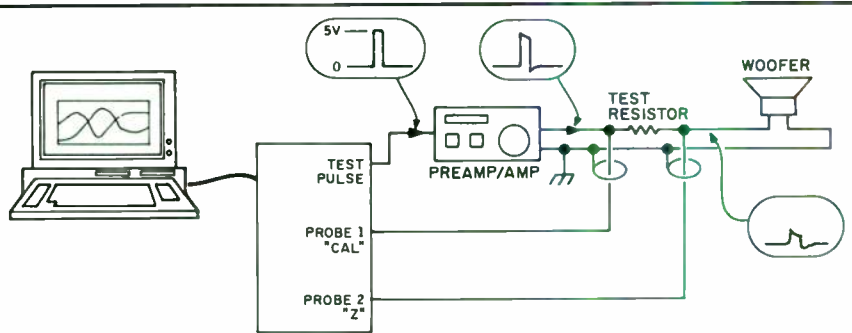

FIGURE 3: Equipment setup for measuring impedance.

response down to a few hertz or lower. A tube amplifier is probably not a good choice. One side of the amplifier output must be at ground (i.e., "bridged" amplifiers can not be used).

- A test resistor with value of about twice the nominal driver impedance. For instance, if you are measuring a nominal 8Ω woofer, you should use a 15 or 20Ω resistor. Half-watt or higher resistors are recommended.
- A calibrated glob of nonhardening modeling clay, obtainable at many toy stores. Plumber's putty also works, but it leaves a residue. (You must provide your own calibration.)
- A method of suspending the woofer, cone upward, in mostly open air. For example, you could lay it on some netting or screen to hold it off the floor. Or, if the woofer isn't a vented-magnet type, you could place it atop a small-diameter pedestal made from a section of PVC pipe. (Be creative.)
- A relatively quiet work area. Averaging helps, too, but you will be using rather low levels of stimulation for the drivers you are testing, so keep noise levels down. Accuracy is also improved by rolling off unneeded high-frequency energy from the test pulse. For woofer measurements, this is easily done by putting a 0.47μF film capacitor across the test pulse output jack during measurements.
- An ohmmeter or DVM capable of accurately measuring resistance down to a few ohms. While not absolutely essential, this is recommended both to check the test resistor value and to measure  $R_E$ . IMP is an AC-coupled system and cannot accurately measure resistance or impedance at or near zero frequency (DC). If you do not supply a DC value for  $R_E$ , it will use the measured impedance minimum, which is usually a bit higher and will introduce some error.

**WATCH YOUR STEP.** First, measure your test resistor and voice coil resistance

with the ohmmeter, if you are using one. Then, configure your equipment to measure impedance curves, as shown in Fig. 3. Here is the step-by-step procedure:

1. Turn on the computer and power up the IMP module. Once the software is up and running, press [F3] so RATE reads 1.92kHz. You want the slower sample rate for maximum low-frequency resolution. Press [F4] so INPUT reads PROBE1 (the "cal" probe, which is used to measure the test pulse signal at the amplifier output).
2. Press [\*] to get to the top-level menu. Select [Acquire, Repeat] with the key sequence A, R. The screen will then repeatedly draw the lower plot.
3. Turn on your amplifier and gradually bring up the volume until you can barely hear the test pulse "pop" from a few feet away. You will probably need to experiment with the first few woofers to arrive at an optimum level. If the level is too low, your accuracy will be limited by noise, while too high will cause the clay to "launch" off the cone surface and fall back when making the mass-loaded measurement.
4. Adjust the probe-level control on the IMP board until the plot in the screen's lower half shows a pulse peak at about 80% of full scale. An alternative method is to set the control to find the point above which the displayed pulse will remain constant when the level is turned up, then back the control off until the pulse is slightly below that point. The goal is to keep the IMP preamp and filter circuitry out of the clipping region while making a measurement.
5. Press [F2] until SIZE reads 2,048 points (4,096 points if you wish).

*Continued on page 51*

**Readers** wishing to purchase an assembled IMP unit, with software, may indicate their nonbinding interest by writing #76 on their Reader Service card.

TABLE 1

THIELE/SMALL PARAMETER EQUATIONS

$$f_s = \frac{1}{(2\pi \sqrt{L_{CES} C_{MES}})} \quad [\text{Hz}]$$

$$Q_E = R_E \sqrt{\frac{C_{MES}}{L_{CES}}}$$

$$Q_M = R_{ES} \sqrt{\frac{C_{MES}}{L_{CES}}}$$

$$Q_T = \frac{Q_M Q_E}{(Q_M + Q_E)}$$

$$V_{AS} = \frac{0.0327 d^4 \left[ \left( \frac{f_s}{f_{s(M)}} \right)^2 - 1 \right]}{f_s^2 M_A} \quad [\text{ft}^3]$$

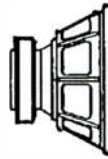

### Soft & Hard Dome Tweeters and Midranges

Model	Price	Ω	Description
TW010E1	\$6.00	8	Very small (60mm x 60mm) 10mm polymer dome tweeter. Suitable for 6K+ x-over frequency.
Wedge Mount	3.50		Wedge surface mount for the TW010E1. 60mm square, 32mm tall in the back, 8mm tall in front.
Hinged Wedge Mount	4.50		Same wedge shape as above, but with a hinge on the front for up and down tilting.
TW010F1	6.00	8	Very small (74mm round) 10mm polymer dome tweeter. Suitable for 6K+ x-over frequencies.
TW014B5	11.00	4	Small car audio tweeter (49.5mm round), no mounting holes. Could be glued to dash or woofer grill
Wedge and Trim ring	5.00		Wedge surface mount for TW014B5 tweeter. Same size as for TW010E1 but with trim ring adapter.
TW014F1	10.00	8	Rectangular (59mm x 109mm) 14mm polymer dome tweeter. Suitable for 5K x-over frequency.
TW025V2	25.00	4	Autosound 25mm textile dome tweeter with small mounting flange. Chambered for higher power.
TW025A0	21.00	8	Egg shaped 25mm textile dome tweeter. Extended frequency response and 91dB efficiency.
TW025A1	21.50	8	Same as above but with Ferrofluid cooled voice coil for higher power handling.
TW025L0	21.00	8	Same as TW025A0 but with 9cm x 12cm flange. Limited quantities.
TW025L1	21.50	8	Same as TW025A1 but with 9cm x 12cm flange. Limited quantities.
TW025M0	22.00	8	Egg shaped 25mm textile dome tweeter with 92dB efficiency. Glass fiber reinforced polymer flange.
TW025M1	22.50	8	Same as above but with Ferrofluid cooled voice coil for higher power handling.
AW025M1	28.00	8	Shielded magnet tweeter with egg shaped 25mm textile dome. Designed for audio/video systems.
AW025S1	39.50	8	Same as above but with Pure Titanium dome.
AW025S3	36.50	8	Same as above but with Aluminium Alloy dome.
DTI01	22.50	8	Pure Titanium dome with protective phasing ring. Flat response to 27Khz. Susp.& dome is one piece.
TW034X0	36.50	8	34mm textile dome tweeter with 93dB efficiency. Could use 2K x-over or higher for high power.
TW037Y0	38.00	8	37mm textile dome mid/tweeter. Could crossover as low as 1500 Hz.

### Prestige Series TPX and Aerogel Cone Drivers

HM100X0	48.50	8	4" TPX cone midrange with extremely flat response due to a high loss phasing plug.
HM130X0	55.50	8	5 1/4" TPX cone bass/midrange, looks good as a midrange, small satellite speaker or an MTM design
HM170X0	67.00	8	6 1/2" TPX cone bass/midrange for use in a 2-way system or stand alone MTM design.
HM210X0	80.50	8	8" TPX cone bass driver that looks good for use in a small 2-way system with good bass response.
HM130Z0	70.00	8	5 1/4" Aerogel cone bass/midrange, looks good for a small satellite or in a MTM design with F3 < 90Hz
HM170Z0	82.00	8	6 1/2" Aerogel cone bass/midrange with very smooth high end response for exceptional 2-way or sat.
HM210Z0	97.00	8	8" Aerogel cone woofer, looks great for a 2-way system with simple slopes, rolls off nicely at 3K.

### Reference Series Paper and Carbon Fiber Cone Drivers

HM100G0	36.50	8	4" Treated Paper cone bass/midrange for small 2-ways, MTM's or as a midrange. Autosound?
HM130G0	42.50	8	5 1/4" Treated Paper cone bass/midrange suitable as a midrange, a woofer in a 2-way or an MTM.
HM170G0	50.50	8	6 1/2" Treated Paper cone bass/midrange, looks good for efficient 2-way system or stand alone MTM
HM210G0	64.00	8	8" Treated Paper cone bass/midrange, extremely flat response, great for 2-way system.
HM100C0	54.00	8	4" Carbon Fiber cone bass/midrange, very flat midrange response. Good efficiency for autosound.
HM130C0	59.50	8	5 1/4" Carbon Fiber cone bass/midrange, exceptionally smooth response, good mid or woofer.
HM170C0	73.00	8	6 1/2" Carbon Fiber cone bass/midrange, looks great for small 2-way or MTM system. Very smooth.
HM210C0	88.00	8	8" Carbon Fiber cone bass /midrange, very nice woofer for 2-way or 3-way design.

### Classic Series Kevlar Cone and Professional Series Drivers

HT100K0	32.50	8	4" Kevlar cone bass/midrange, good bass response for small 2-way, MTM or autosound.
HT130K0	43.00	8	5 1/4" Kevlar cone bass/midrange, exceptional bass for small 2-way, MTM or autosound.
HT170K0	47.00	8	6 1/2" Kevlar cone bass/midrange, good value and exceptional bass for small 2-way or autosound.
HT210K0	53.50	8	8" Kevlar cone bass/midrange, looks good as a woofer in a 2-way or 3-way system, 90dB efficiency.
PR120I1	58.50	8	Professional 3/4" Titanium dome Bullet tweeter, 105dB. Recommended x-over: 8KHz @ 18dB slope
PR17M0	75.00	8	Professional 6 1/2" Paper cone midrange, 100dB efficiency. Frequency range from 500 to 8KHz.
PR17X0	80.00	8	Professional 6 1/2" TPX cone midrange with phase plug, 101dB. Usable from 500 to 8Khz.

# TW010E1

## 10 mm Polymer dome tweeter

Very compact dome tweeter for use in automotive systems or in small 2-ways systems.

- Formerless voice coil
- Balanced drive; dome and suspension are of one piece
- Ferrofluid cooled voice coil
- wedge-mount housing available for surface mounting
- Tiltable hinged wedge mount available for better on axis response when dash mounted

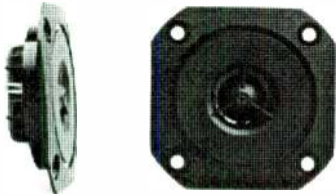

Technical Data	Symbol	Value	Unit
Nominal Impedance	Z	8	Ω
Resonance Frequency	Fs	2900	Hz
Power Handling (IEC)	P	25	W
Sensitivity (1W/1m)	E	90	dB
Voice coil Diameter	Ø	10	mm
Minimum Impedance	Zmin	6.4	Ω
DC Resistance	Re	5.5	Ω
Voice Coil Inductance	Lbm	32	µH
Voice Coil Length	h	2	mm
Former	-	none	-
Number of Layers	n	2	-
Magnet Weight	m	17*10 <sup>-3</sup>	kg
Flux Density	B	1.1	T
Force Factor	BL	1.3	NA <sup>-1</sup>
Height of Magnet Gap	He	1.5	mm
Linear Excursion peak	Xmax	0.25	mm
Suspension Compliance	Cms	-	mN <sup>-1</sup>
Mechanical Q Factor	Qms	-	-
Electrical Q Factor	Qes	-	-
Total Q Factor	Qts	-	-
Moving Mass	Mms	0.11*10 <sup>-3</sup>	kg
Effective Piston Area	S	3.14*10 <sup>-4</sup>	m <sup>2</sup>
Equivalent Air Volume	Vas	-	m <sup>3</sup>
Mass of Speaker	M	52*10 <sup>-3</sup>	kg

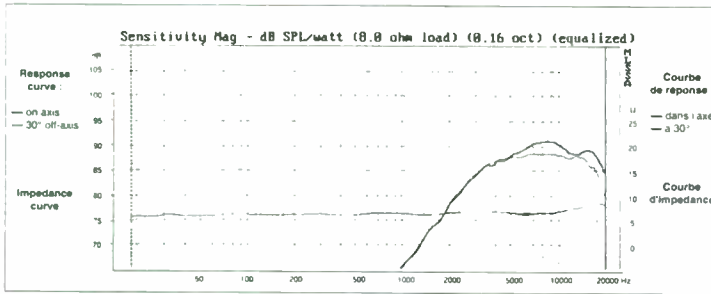

# TW010F1

## 10 mm Polymer dome tweeter

Very compact dome tweeter, suitable for use in small 2-way systems or as a supertweeter.

- Formerless voice coil
- Balanced drive; dome and suspension are of one piece
- Exceptional transient response
- Easily coupled with first order crossover above 6K
- ferrofluid cooled voice coil
- 74 mm diameter flange

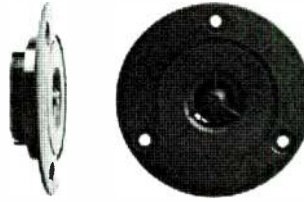

Technical Data	Symbol	Value	Unit
Nominal Impedance	Z	8	Ω
Resonance Frequency	Fs	2900	Hz
Power Handling (IEC)	P	25	W
Sensitivity (1W/1m)	E	90	dB
Voice coil Diameter	Ø	10	mm
Minimum Impedance	Zmin	6.4	Ω
DC Resistance	Re	5.5	Ω
Voice Coil Inductance	Lbm	32	µH
Voice Coil Length	h	2	mm
Former	-	-	-
Number of Layers	n	2	-
Magnet Weight	m	17*10 <sup>-3</sup>	kg
Flux Density	B	1.1	T
Force Factor	BL	1.3	NA <sup>-1</sup>
Height of Magnet Gap	He	1.5	mm
Linear Excursion peak	Xmax	0.25	mm
Suspension Compliance	Cms	-	mN <sup>-1</sup>
Mechanical Q Factor	Qms	-	-
Electrical Q Factor	Qes	-	-
Total Q Factor	Qts	-	-
Moving Mass	Mms	0.11*10 <sup>-3</sup>	kg
Effective Piston Area	S	3.14*10 <sup>-4</sup>	m <sup>2</sup>
Equivalent Air Volume	Vas	-	m <sup>3</sup>
Mass of Speaker	M	55*10 <sup>-3</sup>	kg

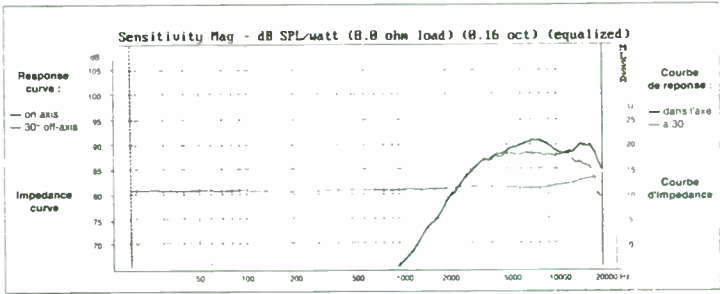

# TW014B5

## 4Ω 14mm Polymer dome tweeter

Compact dome tweeter designed for automotive use. High output and small size makes this tweeter very versatile in any automotive system.

- 95 db efficiency
- Ferrofluid cooled voice coil
- Direct drive; voice coil wound onto suspension
- 50 mm diameter flange
- Trim ring and wedge mount available for surface mounting

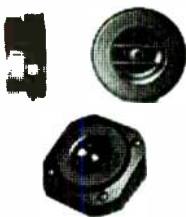

Technical Data	Symbol	Value	Unit
Nominal Impedance	Z	4	Ω
Resonance Frequency	Fs	2050	Hz
Power Handling (IEC)	P	45	W
Sensitivity (1W/1m)	E	95	dB
Voice coil Diameter	Ø	14	mm
Minimum Impedance	Zmin	5	Ω
DC Resistance	Re	2.8	Ω
Voice Coil Inductance	Lbm	19	µH
Voice Coil Length	h	2	mm
Former	-	Polymer	-
Number of Layers	n	2	-
Magnet Weight	m	53*10 <sup>-3</sup>	kg
Flux Density	B	1.51	T
Force Factor	BL	2	NA <sup>-1</sup>
Height of Magnet Gap	He	1.5	mm
Linear Excursion peak	Xmax	0.25	mm
Suspension Compliance	Cms	-	mN <sup>-1</sup>
Mechanical Q Factor	Qms	-	-
Electrical Q Factor	Qes	-	-
Total Q Factor	Qts	-	-
Moving Mass	Mms	0.19*10 <sup>-3</sup>	kg
Effective Piston Area	S	0.6*10 <sup>-4</sup>	m <sup>2</sup>
Equivalent Air Volume	Vas	-	m <sup>3</sup>
Mass of Speaker	M	112*10 <sup>-3</sup>	kg

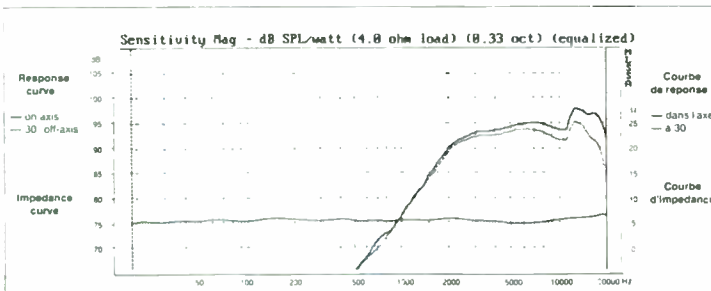

# TW014F1

## 14 mm Polymer dome tweeter

Compact, high efficiency tweeter for automotive and home use. Suitable for use as a supertweeter or in efficient 2-way designs.

- 91 db efficiency
- Ferrofluid cooled voice coil
- Direct drive; voice coil wound onto suspension
- 74 mm diameter flange
- High definition
- 6 db slope above 5K

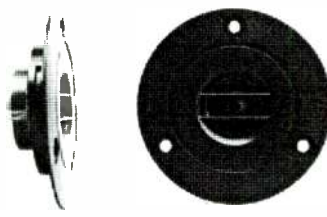

Technical Data	Symbol	Value	Unit
Nominal Impedance	Z	8	Ω
Resonance Frequency	Fs	2050	Hz
Power Handling (IEC)	P	45	W
Sensitivity (1W/1m)	E	91	dB
Voice coil Diameter	Ø	14	mm
Minimum Impedance	Zmin	7.2	Ω
DC Resistance	Re	5.7	Ω
Voice Coil Inductance	Lbm	43	µH
Voice Coil Length	h	2	mm
Former	-	Polymer	-
Number of Layers	n	2	-
Magnet Weight	m	17*10 <sup>-3</sup>	kg
Flux Density	B	1.25	T
Force Factor	BL	1.6	NA <sup>-1</sup>
Height of Magnet Gap	He	1.5	mm
Linear Excursion peak	Xmax	0.25	mm
Suspension Compliance	Cms	-	mN <sup>-1</sup>
Mechanical Q Factor	Qms	-	-
Electrical Q Factor	Qes	-	-
Total Q Factor	Qts	-	-
Moving Mass	Mms	0.19*10 <sup>-3</sup>	kg
Effective Piston Area	S	6.6*10 <sup>-4</sup>	m <sup>2</sup>
Equivalent Air Volume	Vas	-	m <sup>3</sup>
Mass of Speaker	M	64*10 <sup>-3</sup>	kg

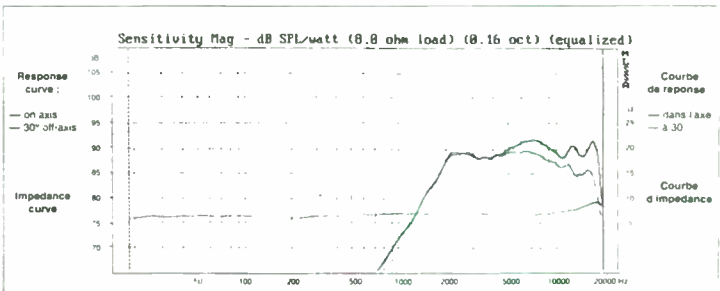

# TW014H1

## 14 mm Polymer dome tweeter

High efficiency dome tweeter in a compact size. This tweeter could be used effectively in a MTM design or stacked in an array.

- 95 db efficiency
- Ferrofluid cooled voice coil
- Direct drive; voice coil wound onto suspension
- 60 mm X 110 mm flange
- High definition
- 6 db slope above 5K



Technical Data	Symbol	Value	Unit
Nominal Impedance	Z	8	Ω
Resonance Frequency	Fs	2050	Hz
Power Handling (IEC)	P	45	W
Sensitivity (1W/1m)	E	95	dB
Voice coil Diameter	Ø	14	mm
Minimum Impedance	Zmin	7.2	Ω
DC Resistance	Re	5.7	Ω
Voice Coil Inductance	Lbm	37	µH
Voice Coil Length	h	2	mm
Former	-	Polymer	-
Number of Layers	n	2	-
Magnet Weight	m	53*10 <sup>-3</sup>	kg
Flux Density	B	1.51	T
Force Factor	BL	2	NA <sup>-1</sup>
Height of Magnet Gap	He	1.5	mm
Linear Excursion peak	Xmax	0.25	mm
Suspension Compliance	Cms	-	mN <sup>-1</sup>
Mechanical Q Factor	Qms	-	-
Electrical Q Factor	Qes	-	-
Total Q Factor	Qts	-	-
Moving Mass	Mms	0.19*10 <sup>-3</sup>	kg
Effective Piston Area	S	6.6*10 <sup>-4</sup>	m <sup>2</sup>
Equivalent Air Volume	Vas	-	m <sup>3</sup>
Mass of Speaker	M	117*10 <sup>-3</sup>	kg

# TW025A0

## 25 mm Textile dome tweeter

Egg shaped dome tweeter with frequency response beyond 20K. Clear, smooth and transparent sound reproduction.

- Egg shaped dome for maximum stiffness at the tip and for no phase break up at the tip.
- 1" impregnated textile dome
- 91 db efficiency
- 100 mm aluminium face plate
- Replaceable voice coil
- X-over down to 3K

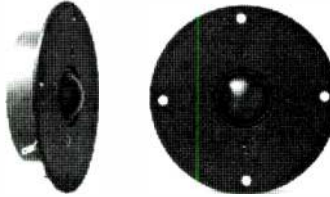

Technical Data	Symbol	Value	Unit
Nominal Impedance	Z	8	Ω
Resonance Frequency	Fs	900	Hz
Power Handling (IEC)	P	55	W
Sensitivity (1W/1m)	E	91	dB
Voice coil Diameter	Ø	25	mm
Minimum Impedance	Zmin	6.5	Ω
DC Resistance	Re	5.8	Ω
Voice Coil Inductance	Lbm	11	µH
Voice Coil Length	h	1.6	mm
Former	-	alum.	-
Number of Layers	n	2	-
Magnet Weight	m	240*10 <sup>-3</sup>	kg
Flux Density	B	1.5	T
Force Factor	BL	2.9	NA <sup>-1</sup>
Height of Magnet Gap	He	3	mm
Linear Excursion peak	Xmax	0.3	mm
Suspension Compliance	Cms	-	mN <sup>-1</sup>
Mechanical Q Factor	Qms	-	-
Electrical Q Factor	Qes	-	-
Total Q Factor	Qts	-	-
Moving Mass	Mms	0.29*10 <sup>-3</sup>	kg
Effective Piston Area	S	6.2*10 <sup>-4</sup>	m <sup>2</sup>
Equivalent Air Volume	Vas	-	m <sup>3</sup>
Mass of Speaker	M	460*10 <sup>-3</sup>	kg

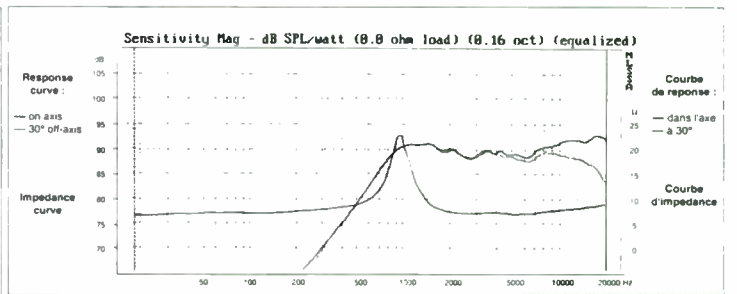
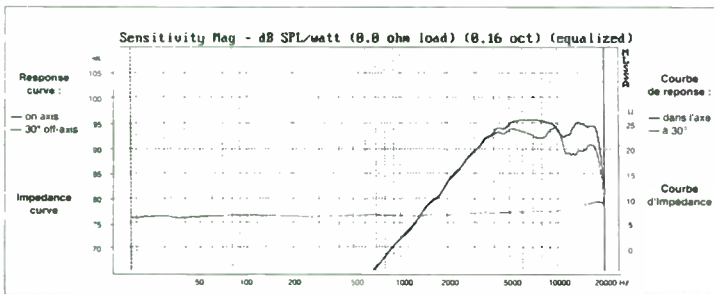

# TW025A1

## 25 mm Textile dome tweeter

Same as the TW025A0 but with ferrofluid for increased power handling.

- Egg shaped dome for maximum stiffness at the tip and for no phase break up at the tip.
- 1" impregnated textile dome
- 100 mm aluminum face plate
- Ferrofluid cooled voice coil
- 90.5 db efficiency
- Replaceable voice coil
- Extended frequency response

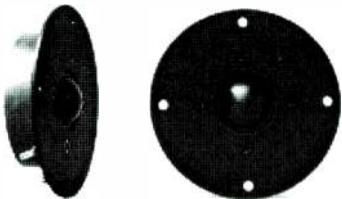

Technical Data	Symbol	Value	Unit
Nominal Impedance	Z	8	Ω
Resonance Frequency	Fs	1200	Hz
Power Handling (IEC)	P	70	W
Sensitivity (1W/1m)	E	90.5	dB
Voice coil Diameter	Ø	25	mm
Minimum Impedance	Zmin	7	Ω
DC Resistance	Re	5.8	Ω
Voice Coil Inductance	Lbm	13	µH
Voice Coil Length	h	1.6	mm
Former	-	alum.	-
Number of Layers	n	2	-
Magnet Weight	m	240*10 <sup>-3</sup>	kg
Flux Density	B	1.6	T
Force Factor	BL	3.1	NA <sup>-1</sup>
Height of Magnet Gap	He	3	mm
Linear Excursion peak	Xmax	0.3	mm
Suspension Compliance	Cms	-	mN <sup>-1</sup>
Mechanical Q Factor	Qms	-	-
Electrical Q Factor	Qes	-	-
Total Q Factor	Qts	-	-
Moving Mass	Mms	0.29*10 <sup>-3</sup>	kg
Effective Piston Area	S	6.2*10 <sup>-4</sup>	m <sup>2</sup>
Equivalent Air Volume	Vas	-	m <sup>3</sup>
Mass of Speaker	M	460*10 <sup>-3</sup>	kg

# TW025M0

## 25 mm Textile dome tweeter

Egg shaped dome tweeter, slightly horn loaded for higher efficiency and exceptional linearity

- Egg shaped dome for maximum stiffness at the tip and for no phase break up at the tip.
- 1" impregnated textile dome
- 100 mm reinforced glass fiber polymer face plate
- 92 db efficiency
- Replaceable voice coil

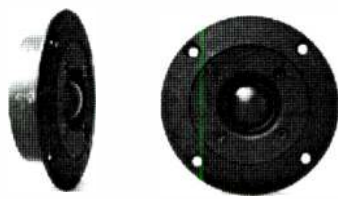

Technical Data	Symbol	Value	Unit
Nominal Impedance	Z	8	Ω
Resonance Frequency	Fs	900	Hz
Power Handling (IEC)	P	55	W
Sensitivity (1W/1m)	E	92	dB
Voice coil Diameter	Ø	25	mm
Minimum Impedance	Zmin	6.5	Ω
DC Resistance	Re	5.8	Ω
Voice Coil Inductance	Lbm	11	µH
Voice Coil Length	h	1.6	mm
Former	-	alum.	-
Number of Layers	n	2	-
Magnet Weight	m	240*10 <sup>-3</sup>	kg
Flux Density	B	1.5	T
Force Factor	BL	2.9	NA <sup>-1</sup>
Height of Magnet Gap	He	3	mm
Linear Excursion peak	Xmax	0.3	mm
Suspension Compliance	Cms	-	mN <sup>-1</sup>
Mechanical Q Factor	Qms	-	-
Electrical Q Factor	Qes	-	-
Total Q Factor	Qts	-	-
Moving Mass	Mms	0.29*10 <sup>-3</sup>	kg
Effective Piston Area	S	6.2*10 <sup>-4</sup>	m <sup>2</sup>
Equivalent Air Volume	Vas	-	m <sup>3</sup>
Mass of Speaker	M	460*10 <sup>-3</sup>	kg

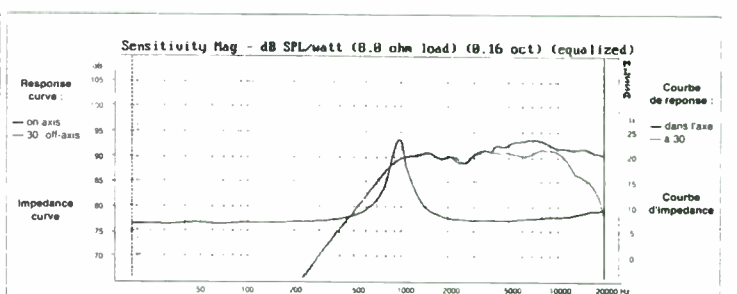
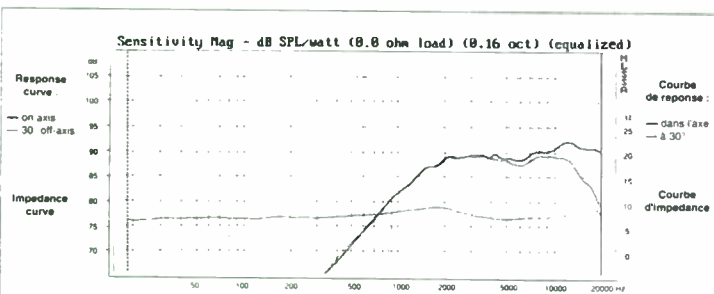

# TW025M1

## 25 mm Textile dome tweeter

Same as TW025M0 but with ferrofluid cooled voice coil for better power handling.

- Egg shaped dome for maximum stiffness at the tip and for no phase break up at the tip.
- 1" impregnated textile dome
- Ferrofluid cooled voice coil
- 100 mm reinforced glass fiber polymer face plate
- 92 db efficiency
- Replaceable voice coil

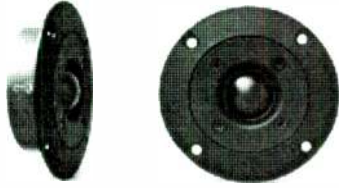

Technical Data	Symbol	Value	Unit
Nominal Impedance	Z	8	Ω
Resonance Frequency	Fs	1200	Hz
Power Handling (IEC)	P	70	W
Sensitivity (1W/1m)	E	92	dB
Voice coil Diameter	Ø	25	mm
Minimum Impedance	Zmin	7	Ω
DC Resistance	Re	5.8	Ω
Voice Coil Inductance	Lbm	13	μH
Voice Coil Length	h	1.6	mm
Former	-	alum.	-
Number of Layers	n	2	-
Magnet Weight	m	240*10 <sup>-3</sup>	kg
Flux Density	B	1.6	T
Force Factor	BL	3.1	NA <sup>-1</sup>
Height of Magnet Gap	He	3	mm
Linear Excursion peak	Xmax	0.3	mm
Suspension Compliance	Cms	-	mN <sup>-1</sup>
Mechanical Q Factor	Qms	-	-
Electrical Q Factor	Qcs	-	-
Total Q Factor	Qts	-	-
Moving Mass	Mms	0.29*10 <sup>-3</sup>	kg
Effective Piston Area	S	6.2*10 <sup>-4</sup>	m <sup>2</sup>
Equivalent Air Volume	Vas	-	m <sup>3</sup>
Mass of Speaker	M	460*10 <sup>-3</sup>	kg

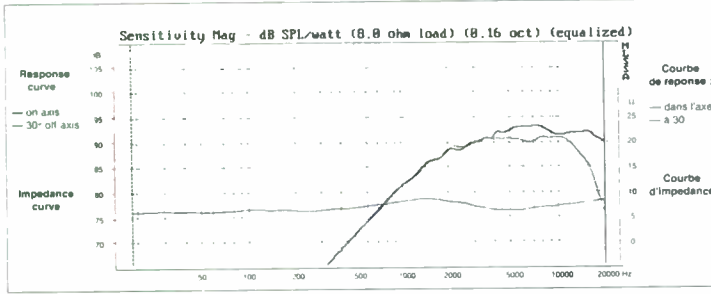

# TW025V2

## 4Ω 25 mm Textile dome tweeter

Chambered back autosound tweeter in compact size. This driver should be ideal for dash mounting.

- Egg shaped dome for maximum stiffness at the tip and for no phase break up at the tip.
- Injected polymer faceplate with protective dome cover
- Chambered back for low Fs
- Impregnated textile dome
- Replaceable voice coil



Technical Data	Symbol	Value	Unit
Nominal Impedance	Z	4	Ω
Resonance Frequency	Fs	600	Hz
Power Handling (IEC)	P	70	W
Sensitivity (1W/1m)	E	87	dB
Voice coil Diameter	Ø	25	mm
Minimum Impedance	Zmin	4.2	Ω
DC Resistance	Re	3.4	Ω
Voice Coil Inductance	Lbm	3.6	μH
Voice Coil Length	h	1.7	mm
Former	-	alum.	-
Number of Layers	n	2	-
Magnet Weight	m	104*10 <sup>-3</sup>	kg
Flux Density	B	1.2	T
Force Factor	BL	2	NA <sup>-1</sup>
Height of Magnet Gap	He	3	mm
Linear Excursion peak	Xmax	0.3	mm
Suspension Compliance	Cms	-	mN <sup>-1</sup>
Mechanical Q Factor	Qms	-	-
Electrical Q Factor	Qcs	-	-
Total Q Factor	Qts	-	-
Moving Mass	Mms	0.31*10 <sup>-3</sup>	kg
Effective Piston Area	S	6.2*10 <sup>-4</sup>	m <sup>2</sup>
Equivalent Air Volume	Vas	-	m <sup>3</sup>
Mass of Speaker	M	250*10 <sup>-3</sup>	kg

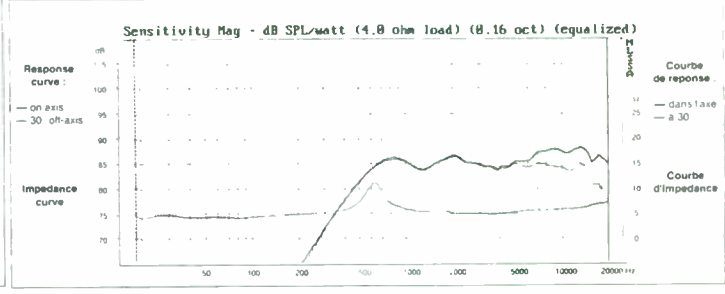

# AW025M1

## 25mm Shielded Textile dome tweeter

Shielded magnet tweeter for Audio/Video use. Chambered back and vented pole piece for lower resonant frequency.

- Shielded magnet
- Impregnated textile dome
- Ferrofluid cooled voice coil
- Vented pole piece with chambered back
- Glass fiber reinforced polymer faceplate
- Replaceable voice coil



Technical Data	Symbol	Value	Unit
Nominal Impedance	Z	8	Ω
Resonance Frequency	Fs	1000	Hz
Power Handling (IEC)	P	70	W
Sensitivity (1W/1m)	E	90	dB
Voice coil Diameter	Ø	25	mm
Minimum Impedance	Zmin	6.7	Ω
DC Resistance	Re	5.8	Ω
Voice Coil Inductance	Lbm	25	μH
Voice Coil Length	h	1.6	mm
Former	-	alum.	-
Number of Layers	n	2	-
Magnet Weight	m	150*10 <sup>-3</sup>	kg
Flux Density	B	1.3	T
Force Factor	BL	2.2	NA <sup>-1</sup>
Height of Magnet Gap	He	3	mm
Linear Excursion peak	Xmax	0.3	mm
Suspension Compliance	Cms	-	mN <sup>-1</sup>
Mechanical Q Factor	Qms	-	-
Electrical Q Factor	Qcs	-	-
Total Q Factor	Qts	-	-
Moving Mass	Mms	0.29*10 <sup>-3</sup>	kg
Effective Piston Area	S	6.2*10 <sup>-4</sup>	m <sup>2</sup>
Equivalent Air Volume	Vas	-	m <sup>3</sup>
Mass of Speaker	M	350*10 <sup>-3</sup>	kg

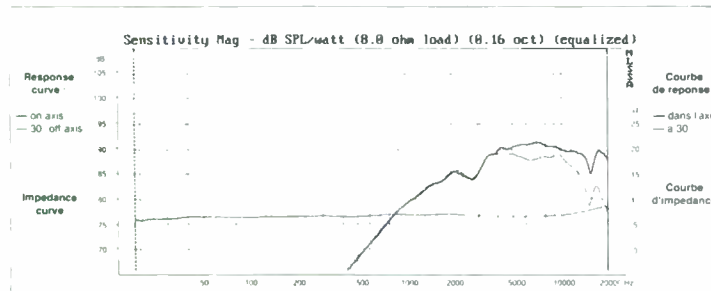

# AW025S1

## 25mm Shielded Titanium dome tweeter

Titanium dome shielded magnet tweeter for Audio/Video use. Chambered back with vented pole piece for lower x-over point.

- Shielded magnet
- Titanium dome
- Ferrofluid cooled voice coil
- Vented pole piece with chambered back
- Glass fiber reinforced polymer faceplate
- Replaceable voice coil

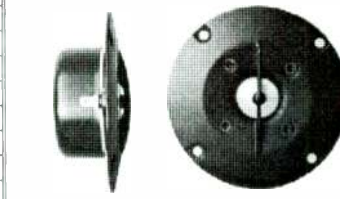

Technical Data	Symbol	Value	Unit
Nominal Impedance	Z	8	Ω
Resonance Frequency	Fs	1500	Hz
Power Handling (IEC)	P	80	W
Sensitivity (1W/1m)	E	92	dB
Voice coil Diameter	Ø	25	mm
Minimum Impedance	Zmin	7	Ω
DC Resistance	Re	5.8	Ω
Voice Coil Inductance	Lbm	25	μH
Voice Coil Length	h	1.6	mm
Former	-	alum.	-
Number of Layers	n	2	-
Magnet Weight	m	150*10 <sup>-3</sup>	kg
Flux Density	B	1.3	T
Force Factor	BL	2.2	NA <sup>-1</sup>
Height of Magnet Gap	He	3	mm
Linear Excursion peak	Xmax	0.3	mm
Suspension Compliance	Cms	-	mN <sup>-1</sup>
Mechanical Q Factor	Qms	-	-
Electrical Q Factor	Qcs	-	-
Total Q Factor	Qts	-	-
Moving Mass	Mms	0.31*10 <sup>-3</sup>	kg
Effective Piston Area	S	6.2*10 <sup>-4</sup>	m <sup>2</sup>
Equivalent Air Volume	Vas	-	m <sup>3</sup>
Mass of Speaker	M	370*10 <sup>-3</sup>	kg

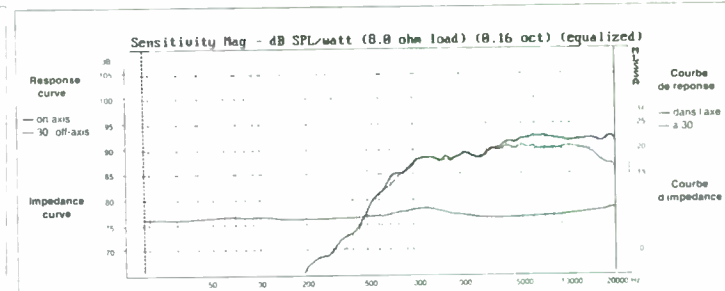

# AW025S3

25mm Shielded Aluminum alloy tweeter

Shielded magnet tweeter with aluminum alloy dome for Audio/Video use. Smooth and detailed response beyond 20 KHz.

- Shielded magnet
- Aluminum alloy dome, soft polymer suspension
- Chambered back with vented pole piece
- Ferrofluid cooled voice coil
- Polymer faceplate
- Replaceable voice coil

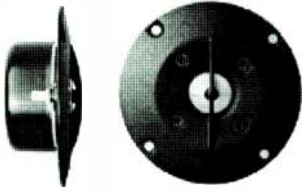

Technical Data	Symbol	Value	Unit
Nominal Impedance	Z	8	Ω
Resonance Frequency	Fs	1500	Hz
Power Handling (IEC)	P	80	W
Sensitivity (1W/1m)	E	92	dB
Voice coil Diameter	Ø	25	mm
Minimum Impedance	Zmin	7	Ω
DC Resistance	Re	5.8	Ω
Voice Coil Inductance	Lbm	25	µH
Voice Coil Length	h	1.6	mm
Former	-	alum.	-
Number of Layers	n	2	-
Magnet Weight	m	150*10 <sup>-3</sup>	kg
Flux Density	B	1.3	T
Force Factor	BL	2.2	NA <sup>-1</sup>
Height of Magnet Gap	He	3	mm
Linear Excursion peak	Xmax	0.3	mm
Suspension Compliance	Cms	-	mN <sup>-1</sup>
Mechanical Q Factor	Qms	-	-
Electrical Q Factor	Qes	-	-
Total Q Factor	Qts	-	-
Moving Mass	Mms	0.31*10 <sup>-3</sup>	kg
Effective Piston Area	S	6.2*10 <sup>-4</sup>	m <sup>2</sup>
Equivalent Air Volume	Vas	-	m <sup>3</sup>
Mass of Speaker	M	370*10 <sup>-3</sup>	kg

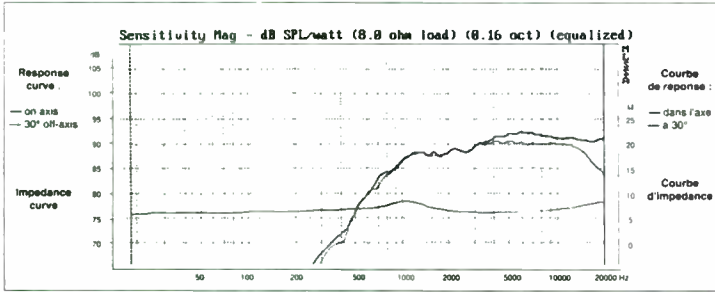

# TW034X0

34 mm Textile dome tweeter

1 1/4" textile dome tweeter suitable for a low crossover point or as a high output, high power tweeter at a higher crossover point.

- Impregnated textile dome
- Aluminum faceplate
- 93 db efficiency
- low resonant frequency
- 132mm diameter flange
- Replaceable voice coil

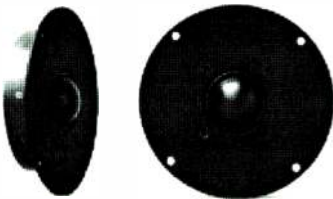

Technical Data	Symbol	Value	Unit
Nominal Impedance	Z	8	Ω
Resonance Frequency	Fs	800	Hz
Power Handling (IEC)	P	70	W
Sensitivity (1W/1m)	E	93	dB
Voice coil Diameter	Ø	34	mm
Minimum Impedance	Zmin	6.5	Ω
DC Resistance	Re	5.3	Ω
Voice Coil Inductance	Lbm	6	µH
Voice Coil Length	h	2.8	mm
Former	-	alum.	-
Number of Layers	n	1	-
Magnet Weight	m	550*10 <sup>-3</sup>	kg
Flux Density	B	1.5	T
Force Factor	BL	3.5	NA <sup>-1</sup>
Height of Magnet Gap	He	3	mm
Linear Excursion peak	Xmax	2.15	mm
Suspension Compliance	Cms	-	mN <sup>-1</sup>
Mechanical Q Factor	Qms	-	-
Electrical Q Factor	Qes	-	-
Total Q Factor	Qts	-	-
Moving Mass	Mms	0.50*10 <sup>-3</sup>	kg
Effective Piston Area	S	10.8*10 <sup>-4</sup>	m <sup>2</sup>
Equivalent Air Volume	Vas	-	m <sup>3</sup>
Mass of Speaker	M	1.18	kg

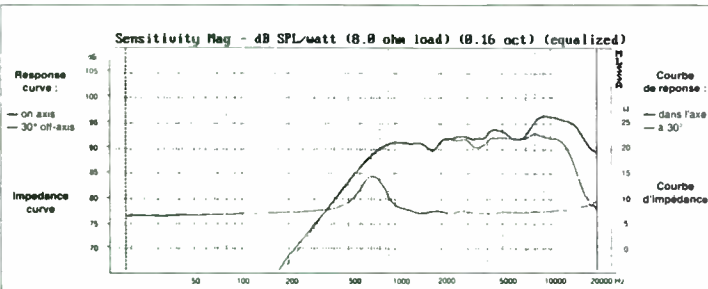

# DTI01

25mm Titanium dome tweeter

Extremely flat response to 29KHz at 94db efficiency. Does not show high frequency distortion of other metal domes.

- Dome and suspension made of a single piece of titanium, eliminating termination point reflections
- Kapton voice coil former
- Protective phase ring
- Detailed transient response
- Polymer faceplate

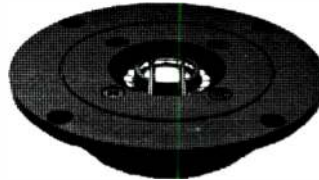

Technical Data	Symbol	Value	Unit
Nominal Impedance	Z	6	Ω
Resonance Frequency	Fs	1700	Hz
Power Handling (IEC)	P	50	W
Sensitivity (1W/1m)	E	94	dB
Voice coil Diameter	Ø	25	mm
Minimum Impedance	Zmin	5.5	Ω
DC Resistance	Re	4.1	Ω
Voice Coil Inductance	Lbm	-	µH
Voice Coil Length	h	2	mm
Former	-	Kapton	-
Number of Layers	n	-	-
Magnet Weight	m	-	kg
Flux Density	B	-	T
Force Factor	BL	-	NA <sup>-1</sup>
Height of Magnet Gap	He	2.5	mm
Linear Excursion peak	Xmax	-	mm
Suspension Compliance	Cms	-	mN <sup>-1</sup>
Mechanical Q Factor	Qms	-	-
Electrical Q Factor	Qes	-	-
Total Q Factor	Qts	-	-
Moving Mass	Mms	-	kg
Effective Piston Area	S	-	m <sup>2</sup>
Equivalent Air Volume	Vas	-	m <sup>3</sup>
Mass of Speaker	M	-	kg

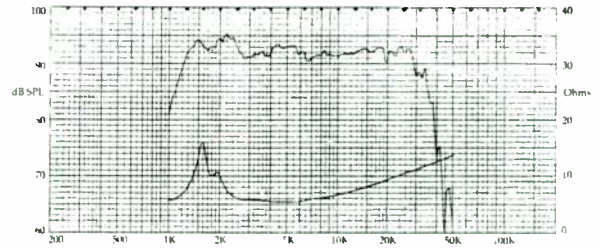

# TW037Y0

37 mm Textile dome Mid/Tweeter

1 1/4" textile dome mid/tweeter for use in systems where a super tweeter will be used for the extreme top end.

- Impregnated textile dome
- Aluminum faceplate
- Low Resonant frequency
- 89 db efficiency
- High power handling
- 132mm diameter faceplate
- Replaceable voice coil

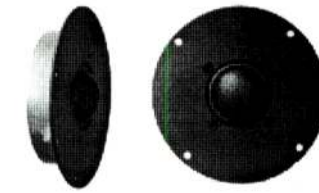

Technical Data	Symbol	Value	Unit
Nominal Impedance	Z	8	Ω
Resonance Frequency	Fs	650	Hz
Power Handling (IEC)	P	70	W
Sensitivity (1W/1m)	E	89	dB
Voice coil Diameter	Ø	37	mm
Minimum Impedance	Zmin	8.1	Ω
DC Resistance	Re	5.5	Ω
Voice Coil Inductance	Lbm	190	µH
Voice Coil Length	h	3.5	mm
Former	-	alum.	-
Number of Layers	n	2	-
Magnet Weight	m	550*10 <sup>-3</sup>	kg
Flux Density	B	1.4	T
Force Factor	BL	5.06	NA <sup>-1</sup>
Height of Magnet Gap	He	3	mm
Linear Excursion peak	Xmax	-	mm
Suspension Compliance	Cms	-	mN <sup>-1</sup>
Mechanical Q Factor	Qms	-	-
Electrical Q Factor	Qes	-	-
Total Q Factor	Qts	-	-
Moving Mass	Mms	-	kg
Effective Piston Area	S	0.14*10 <sup>-2</sup>	m <sup>2</sup>
Equivalent Air Volume	Vas	-	m <sup>3</sup>
Mass of Speaker	M	1.2	kg

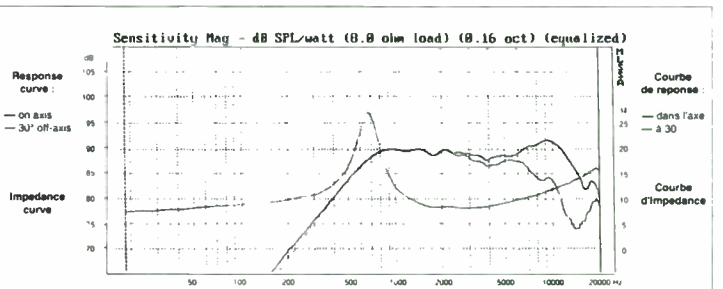

# HM100X0

## 4" TPX cone bass midrange

This 4" mid features the TPX stiff polymer cone with a rubber surround and edge wound voice coil. The phase plug ensures a smooth top end.

- TPX cone with rubber surround
- Phase plug
- Ventilated chassis under spider
- Diecast basket
- Gold plated terminals
- Edgewound flat copper voice coil on a Kapton former

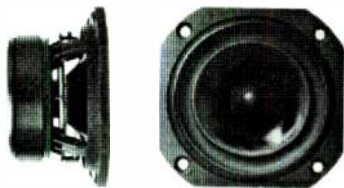

Technical Data	Symbol	Value	Unit
Nominal Impedance	Z	8	Ω
Resonance Frequency	Fs	59	Hz
Power Handling (IEC)	P	40	W
Sensitivity (1W/1m)	E	90	dB
Voice coil Diameter	Ø	25	mm
Minimum Impedance	Zmin	7.2	Ω
DC Resistance	Re	6.2	Ω
Voice Coil Inductance	Lbm	0.26	mH
Voice Coil Length	h	9.6	mm
Former	-	Kapton	-
Number of Layers	n	1	-
Magnet Weight	m	345*10 <sup>-3</sup>	kg
Flux Density	B	1.1	T
Force Factor	BL	5.82	NA <sup>-1</sup>
Height of Magnet Gap	He	5	mm
Linear Excursion peak	Xmax	2.3	mm
Suspension Compliance	Cms	2.25*10 <sup>-3</sup>	mN <sup>-1</sup>
Mechanical Q Factor	Qms	2	-
Electrical Q Factor	Qes	0.20	-
Total Q Factor	Qts	0.18	-
Moving Mass	Mms	3.23*10 <sup>-3</sup>	kg
Effective Piston Area	S	50.7*10 <sup>-2</sup>	m <sup>2</sup>
Equivalent Air Volume	Vas	8.13	ltr
Mass of Speaker	M	0.95	kg

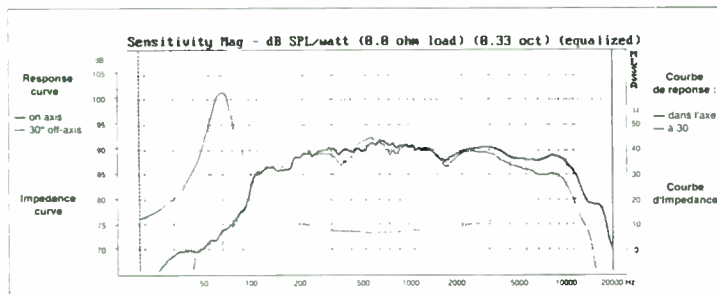

# HM130X0

## 5 1/4" TPX cone bass midrange

This driver is suitable for small 2-way systems, or as a midrange in a 3-way system. Tpx cone with rubber surround and phase plug for very smooth upper end.

- TPX cone with rubber surround
- Phase plug
- Ventilated chassis under spider
- Diecast basket
- Gold plated terminals
- Edgewound flat copper voice coil on a Kapton former



Technical Data	Symbol	Value	Unit
Nominal Impedance	Z	8	Ω
Resonance Frequency	Fs	55.2	Hz
Power Handling (IEC)	P	50	W
Sensitivity (1W/1m)	E	91	dB
Voice coil Diameter	Ø	30	mm
Minimum Impedance	Zmin	6.7	Ω
DC Resistance	Re	6.2	Ω
Voice Coil Inductance	Lbm	0.44	mH
Voice Coil Length	h	12	mm
Former	-	Kapton	-
Number of Layers	n	1	-
Magnet Weight	m	550*10 <sup>-3</sup>	kg
Flux Density	B	1.4	T
Force Factor	BL	7.69	NA <sup>-1</sup>
Height of Magnet Gap	He	6	mm
Linear Excursion peak	Xmax	2.5	mm
Suspension Compliance	Cms	1.09*10 <sup>-3</sup>	mN <sup>-1</sup>
Mechanical Q Factor	Qms	2.17	-
Electrical Q Factor	Qes	0.24	-
Total Q Factor	Qts	0.22	-
Moving Mass	Mms	7.6*10 <sup>-3</sup>	kg
Effective Piston Area	S	0.85*10 <sup>-2</sup>	m <sup>2</sup>
Equivalent Air Volume	Vas	11.3	ltr
Mass of Speaker	M	1.6	kg

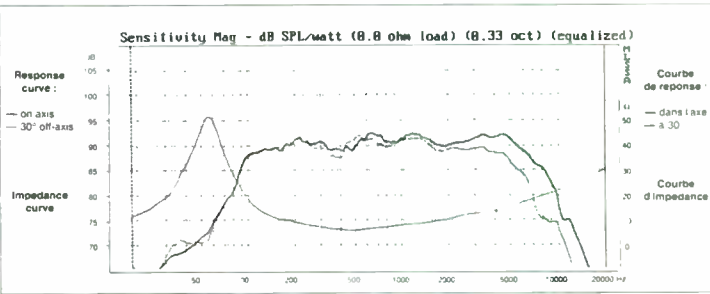

# HM170X0

## 6 1/2" TPX cone bass midrange

This driver was designed for compact 2-way high end bookshelf systems, but also looks good for a D'Appolito (MTM) arrangement.

- TPX cone with rubber surround
- Phase plug
- Ventilated chassis under spider
- Diecast basket
- Gold plated terminals
- Edgewound flat copper voice coil on a Kapton former

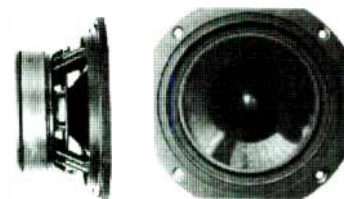

Technical Data	Symbol	Value	Unit
Nominal Impedance	Z	8	Ω
Resonance Frequency	Fs	32	Hz
Power Handling (IEC)	P	70	W
Sensitivity (1W/1m)	E	88	dB
Voice coil Diameter	Ø	40	mm
Minimum Impedance	Zmin	7.6	Ω
DC Resistance	Re	6.2	Ω
Voice Coil Inductance	Lbm	0.51	mH
Voice Coil Length	h	14.3	mm
Former	-	Kapton	-
Number of Layers	n	1	-
Magnet Weight	m	880*10 <sup>-3</sup>	kg
Flux Density	B	1.4	T
Force Factor	BL	9.32	NA <sup>-1</sup>
Height of Magnet Gap	He	6	mm
Linear Excursion peak	Xmax	4.15	mm
Suspension Compliance	Cms	1.77*10 <sup>-3</sup>	mN <sup>-1</sup>
Mechanical Q Factor	Qms	6.79	-
Electrical Q Factor	Qes	0.20	-
Total Q Factor	Qts	0.20	-
Moving Mass	Mms	14*10 <sup>-3</sup>	kg
Effective Piston Area	S	132*10 <sup>-3</sup>	m <sup>2</sup>
Equivalent Air Volume	Vas	43.4	ltr

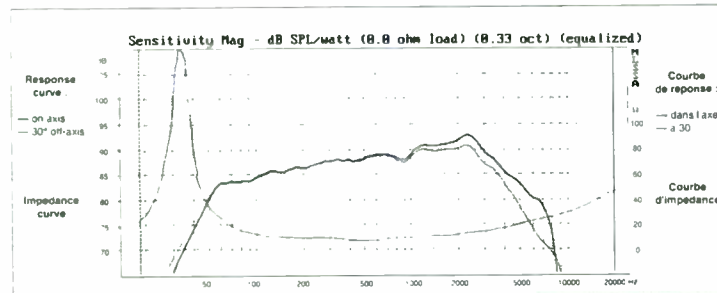

# HM210X0

## 8" TPX cone bass midrange

This driver is suitable for 2 or 3-way designs. Same exceptional features of the other TPX drivers

- TPX cone with rubber surround
- Phase plug
- Ventilated chassis under spider
- Diecast basket
- Gold plated terminals
- Edgewound flat copper voice coil on a Kapton former



Technical Data	Symbol	Value	Unit
Nominal Impedance	Z	8	Ω
Resonance Frequency	Fs	26.4	Hz
Power Handling (IEC)	P	70	W
Sensitivity (1W/1m)	E	90	dB
Voice coil Diameter	Ø	40	mm
Minimum Impedance	Zmin	7.4	Ω
DC Resistance	Re	6.2	Ω
Voice Coil Inductance	Lbm	0.45	mH
Voice Coil Length	h	14.3	mm
Former	-	Kapton	-
Number of Layers	n	1	-
Magnet Weight	m	880*10 <sup>-3</sup>	kg
Flux Density	B	1.4	T
Force Factor	BL	9.8	NA <sup>-1</sup>
Height of Magnet Gap	He	6	mm
Linear Excursion peak	Xmax	4.15	mm
Suspension Compliance	Cms	1.41*10 <sup>-3</sup>	mN <sup>-1</sup>
Mechanical Q Factor	Qms	13.3	-
Electrical Q Factor	Qes	0.27	-
Total Q Factor	Qts	0.27	-
Moving Mass	Mms	25.7*10 <sup>-3</sup>	kg
Effective Piston Area	S	232*10 <sup>-2</sup>	m <sup>2</sup>
Equivalent Air Volume	Vas	107	ltr

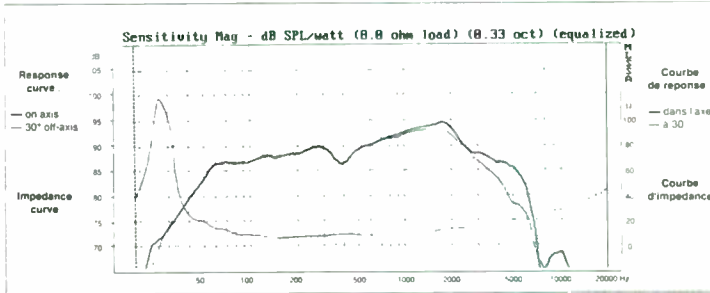

# HM130Z0

5 1/4" Aerogel cone midrange

High Density Aerogel cone with impregnated Carbon / Kevlar fibers for a very light and stiff cone. Precise and detailed, but retaining a neutral tonal balance.

- HD-Aerogel cone with rubber surround
- Diecast chassis
- Edgewound copper voice coil on a Kapton former
- Phase plug
- Gold plated terminals



Technical Data	Symbol	Value	Unit
Nominal Impedance	Z	8	Ω
Resonance Frequency	Fs	60	Hz
Power Handling (IEC)	P	50	W
Sensitivity (1W/1m)	E	93	dB
Voice coil Diameter	Ø	25	mm
Minimum Impedance	Zmin	6.7	Ω
DC Resistance	Re	6.2	Ω
Voice Coil Inductance	Lbm	0.15	mH
Voice Coil Length	h	11	mm
Former	-	Kapton	-
Number of Layers	n	1	-
Magnet Weight	m	345*10 <sup>-3</sup>	kg
Flux Density	B	1.1	T
Force Factor	BL	5.81	NA <sup>-1</sup>
Height of Magnet Gap	He	5	mm
Linear Excursion peak	Xmax	3	mm
Suspension Compliance	Cms	1.23*10 <sup>-3</sup>	mN <sup>-1</sup>
Mechanical Q Factor	Qms	2.17	-
Electrical Q Factor	Qes	0.36	-
Total Q Factor	Qts	0.31	-
Moving Mass	Mms	5.73*10 <sup>-3</sup>	kg
Effective Piston Area	S	85.7*10 <sup>-2</sup>	m <sup>2</sup>
Equivalent Air Volume	Vas	12.7	ltr

# HM170Z0

6 1/2" Aerogel cone bass midrange

This high definition driver should work well in any high end 2-way design as well as a D'Appolito (MTM) design.

- HD-Aerogel cone with rubber surround
- Diecast chassis
- Edgewound copper voice coil on a Kapton former
- Phase plug
- Venting under spider
- Gold plated terminals



Technical Data	Symbol	Value	Unit
Nominal Impedance	Z	8	Ω
Resonance Frequency	Fs	42	Hz
Power Handling (IEC)	P	60	W
Sensitivity (1W/1m)	E	92	dB
Voice coil Diameter	Ø	30	mm
Minimum Impedance	Zmin	7.4	Ω
DC Resistance	Re	6.2	Ω
Voice Coil Inductance	Lbm	0.42	mH
Voice Coil Length	h	12	mm
Former	-	Kapton	-
Number of Layers	n	1	-
Magnet Weight	m	345*10 <sup>-3</sup>	kg
Flux Density	B	1	T
Force Factor	BL	6.05	NA <sup>-1</sup>
Height of Magnet Gap	He	5	mm
Linear Excursion peak	Xmax	3.5	mm
Suspension Compliance	Cms	1.78*10 <sup>-3</sup>	mN <sup>-1</sup>
Mechanical Q Factor	Qms	7.88	-
Electrical Q Factor	Qes	0.36	-
Total Q Factor	Qts	0.35	-
Moving Mass	Mms	8.03*10 <sup>-3</sup>	kg
Effective Piston Area	S	139*10 <sup>-2</sup>	m <sup>2</sup>
Equivalent Air Volume	Vas	48.3	ltr

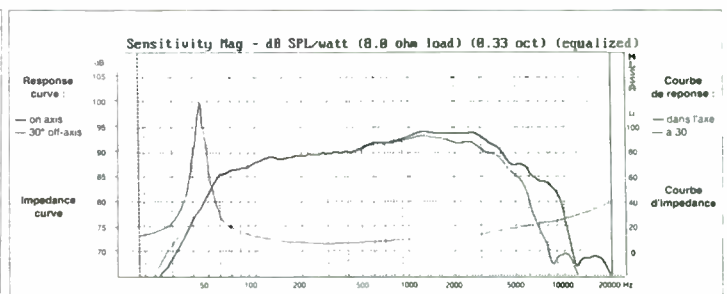
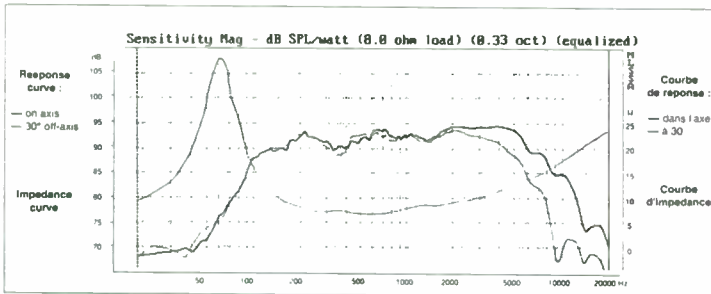

# HM210Z0

8" Aerogel cone bass midrange

Designed for no-compromise high end 2 or 3-way systems. Exceptionally smooth high end response.

- HD-Aerogel cone with rubber surround
- Diecast chassis
- Edgewound copper voice coil on a Kapton former
- Phase plug
- Venting under spider
- Gold plated terminals



Technical Data	Symbol	Value	Unit
Nominal Impedance	Z	8	Ω
Resonance Frequency	Fs	28	Hz
Power Handling (IEC)	P	70	W
Sensitivity (1W/1m)	E	91	dB
Voice coil Diameter	Ø	38	mm
Minimum Impedance	Zmin	7.9	Ω
DC Resistance	Re	6.2	Ω
Voice Coil Inductance	Lbm	0.30	mH
Voice Coil Length	h	14.5	mm
Former	-	Kapton	-
Number of Layers	n	1	-
Magnet Weight	m	550*10 <sup>-3</sup>	kg
Flux Density	B	1	T
Force Factor	BL	9.3	NA <sup>-1</sup>
Height of Magnet Gap	He	6	mm
Linear Excursion peak	Xmax	4.25	mm
Suspension Compliance	Cms	1.26*10 <sup>-3</sup>	mN <sup>-1</sup>
Mechanical Q Factor	Qms	9.7	-
Electrical Q Factor	Qes	0.30	-
Total Q Factor	Qts	0.30	-
Moving Mass	Mms	22.8*10 <sup>-3</sup>	kg
Effective Piston Area	S	2.32*10 <sup>-2</sup>	m <sup>2</sup>
Equivalent Air Volume	Vas	95.3	ltr
Mass of Speaker	M	2.2	kg

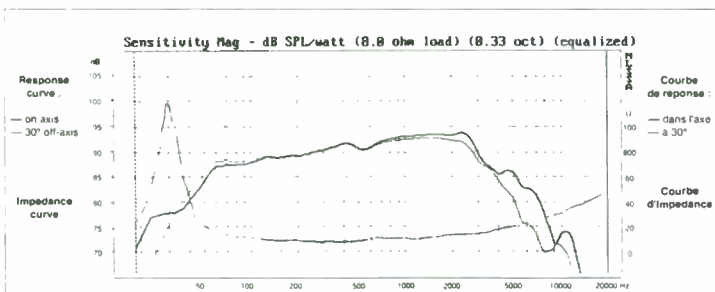

# HM100G0

4" Treated paper cone bass mid

Curvilinear shaped cone coated with a visco elastic compound for an exceptionally smooth response. Suitable as a small bass driver or as a midrange.

- Critically damped paper cone
- Diecast basket
- Rubber surround
- Edgewound copper voice coil on a Kapton former
- Vented spider and pole piece
- Gold plated terminals

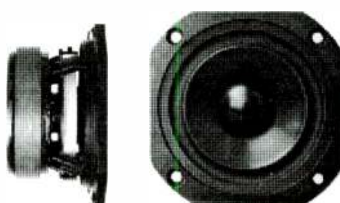

Technical Data	Symbol	Value	Unit
Nominal Impedance	Z	8	Ω
Resonance Frequency	Fs	56	Hz
Power Handling (IEC)	P	40	W
Sensitivity (1W/1m)	E	89	dB
Voice coil Diameter	Ø	25	mm
Minimum Impedance	Zmin	7.7	Ω
DC Resistance	Re	6.2	Ω
Voice Coil Inductance	Lbm	0.24	mH
Voice Coil Length	h	9.2	mm
Former	-	Kapton	-
Number of Layers	n	1	-
Magnet Weight	m	345*10 <sup>-3</sup>	kg
Flux Density	B	1.1	T
Force Factor	BL	5.78	NA <sup>-1</sup>
Height of Magnet Gap	He	5	mm
Linear Excursion peak	Xmax	2.1	mm
Suspension Compliance	Cms	1.8*10 <sup>-3</sup>	mN <sup>-1</sup>
Mechanical Q Factor	Qms	1.51	-
Electrical Q Factor	Qes	0.28	-
Total Q Factor	Qts	0.24	-
Moving Mass	Mms	4.46*10 <sup>-3</sup>	kg
Effective Piston Area	S	0.51*10 <sup>-2</sup>	m <sup>2</sup>
Equivalent Air Volume	Vas	6.7	ltr
Mass of Speaker	M	0.94	kg

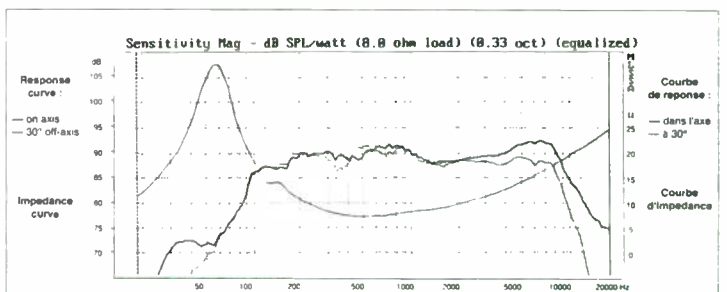



# HM130G0

5 1/4" Treated Paper cone bass mid

Designed for high end compact 2-way and satellite systems, but looks good as a midrange or in a D'Appolito arrangement.

- Critically damped paper cone
- Diecast basket
- Rubber surround
- Edgewound copper voice coil on a Kapton former
- Vented spider and pole piece
- Gold plated terminals
- 92 dB efficiency



Technical Data	Symbol	Value	Unit
Nominal Impedance	Z	8	Ω
Resonance Frequency	Fs	52	Hz
Power Handling (IEC)	P	50	W
Sensitivity (1W/1m)	E	92	dB
Voice coil Diameter	Ø	25	mm
Minimum Impedance	Zmin	9	Ω
DC Resistance	Re	6.2	Ω
Voice Coil Inductance	Lbm	0.55	mH
Voice Coil Length	h	9.6	mm
Former	-	Kapton	-
Number of Layers	n	1	-
Magnet Weight	m	345*10 <sup>-3</sup>	kg
Flux Density	B	1.1	T
Force Factor	BL	6.9	NA <sup>-1</sup>
Height of Magnet Gap	He	5	mm
Linear Excursion peak	Xmax	2.3	mm
Suspension Compliance	Cms	1.52*10 <sup>-3</sup>	mN <sup>-1</sup>
Mechanical Q Factor	Qms	3.12	-
Electrical Q Factor	Qes	0.27	-
Total Q Factor	Qts	0.25	-
Moving Mass	Mms	6.18*10 <sup>-3</sup>	kg
Effective Piston Area	S	0.85*10 <sup>-2</sup>	m <sup>2</sup>
Equivalent Air Volume	Vas	15.7	ltr

# HM170G0

6 1/2" Treated Paper cone bass mid

Good for small 2-way's or as satellite speakers, this driver has very smooth high end rolloff.

- Critically damped paper cone
- Diecast basket
- Rubber surround
- Edgewound copper voice coil on a Kapton former
- Vented spider and pole piece
- Gold plated terminals
- 91 dB efficiency



Technical Data	Symbol	Value	Unit
Nominal Impedance	Z	8	Ω
Resonance Frequency	Fs	42	Hz
Power Handling (IEC)	P	60	W
Sensitivity (1W/1m)	E	91	dB
Voice coil Diameter	Ø	30	mm
Minimum Impedance	Zmin	7.5	Ω
DC Resistance	Re	6.2	Ω
Voice Coil Inductance	Lbm	0.34	mH
Voice Coil Length	h	11	mm
Former	-	Kapton	-
Number of Layers	n	1	-
Magnet Weight	m	550*10 <sup>-3</sup>	kg
Flux Density	B	1.2	T
Force Factor	BL	6.5	NA <sup>-1</sup>
Height of Magnet Gap	He	6	mm
Linear Excursion peak	Xmax	2.5	mm
Suspension Compliance	Cms	1.41*10 <sup>-3</sup>	mN <sup>-1</sup>
Mechanical Q Factor	Qms	8.5	-
Electrical Q Factor	Qes	0.39	-
Total Q Factor	Qts	0.37	-
Moving Mass	Mms	9.9*10 <sup>-3</sup>	kg
Effective Piston Area	S	1.39*10 <sup>-2</sup>	m <sup>2</sup>
Equivalent Air Volume	Vas	38.3	ltr

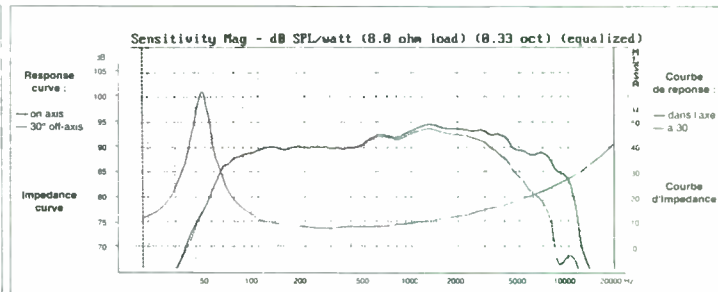
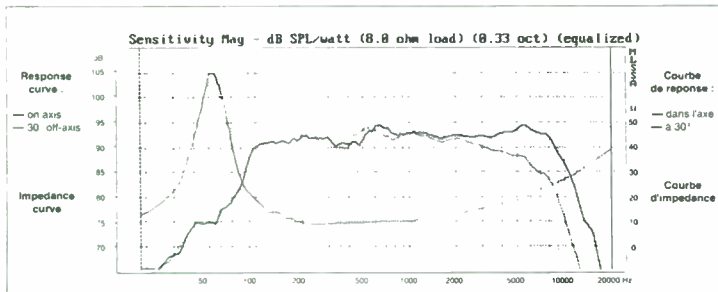

# HM210G0

8" Treated Paper cone bass mid

This woofer with it's smooth rolloff at 3K, makes it ideal for a high end 2-way or 3-way system.

- Critically damped paper cone
- Diecast basket
- Rubber surround
- Edgewound copper voice coil on a Kapton former
- Vented spider and pole piece
- Gold plated terminals
- 91 dB efficiency



Technical Data	Symbol	Value	Unit
Nominal Impedance	Z	8	Ω
Resonance Frequency	Fs	28	Hz
Power Handling (IEC)	P	70	W
Sensitivity (1W/1m)	E	91	dB
Voice coil Diameter	Ø	40	mm
Minimum Impedance	Zmin	7.5	Ω
DC Resistance	Re	6.2	Ω
Voice Coil Inductance	Lbm	0.63	mH
Voice Coil Length	h	14.3	mm
Former	-	Kapton	-
Number of Layers	n	1	-
Magnet Weight	m	550*10 <sup>-3</sup>	kg
Flux Density	B	1	T
Force Factor	BL	9.45	NA <sup>-1</sup>
Height of Magnet Gap	He	6	mm
Linear Excursion peak	Xmax	4.15	mm
Suspension Compliance	Cms	1.3*10 <sup>-3</sup>	mN <sup>-1</sup>
Mechanical Q Factor	Qms	2.7	-
Electrical Q Factor	Qes	0.3	-
Total Q Factor	Qts	0.27	-
Moving Mass	Mms	24.7*10 <sup>-3</sup>	kg
Effective Piston Area	S	2.32*10 <sup>-2</sup>	m <sup>2</sup>
Equivalent Air Volume	Vas	98.3	ltr
Mass of Speaker	M	2.1	kg

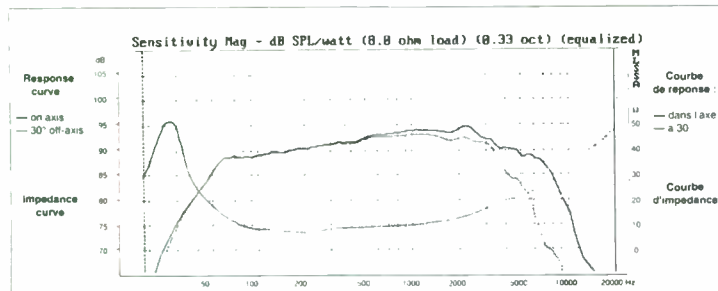

# HM100C0

4" Carbon Fiber cone bass mid

This mid/bass driver should perform well in small 2-way's or as a midrange in a 3-way or D'Appolito system.

- Woven carbon fiber cone
- Diecast basket
- Rubber surround
- Edgewound copper voice coil on a Kapton former
- Vented spider and pole piece
- Gold plated terminals

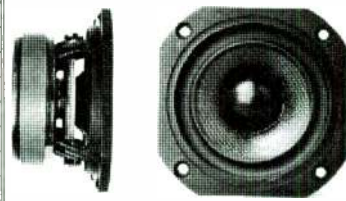

Technical Data	Symbol	Value	Unit
Nominal Impedance	Z	8	Ω
Resonance Frequency	Fs	65	Hz
Power Handling (IEC)	P	40	W
Sensitivity (1W/1m)	E	89	dB
Voice coil Diameter	Ø	25	mm
Minimum Impedance	Zmin	7.6	Ω
DC Resistance	Re	6.2	Ω
Voice Coil Inductance	Lbm	0.09	mH
Voice Coil Length	h	9.6	mm
Former	-	Kapton	-
Number of Layers	n	1	-
Magnet Weight	m	345*10 <sup>-3</sup>	kg
Flux Density	B	1.	T
Force Factor	BL	5.53	NA <sup>-1</sup>
Height of Magnet Gap	He	6	mm
Linear Excursion peak	Xmax	1.8	mm
Suspension Compliance	Cms	1.55*10 <sup>-3</sup>	mN <sup>-1</sup>
Mechanical Q Factor	Qms	1.69	-
Electrical Q Factor	Qes	0.30	-
Total Q Factor	Qts	0.26	-
Moving Mass	Mms	3.87*10 <sup>-3</sup>	kg
Effective Piston Area	S	0.51*10 <sup>-2</sup>	m <sup>2</sup>
Equivalent Air Volume	Vas	5.77	ltr
Mass of Speaker	M	0.93	kg

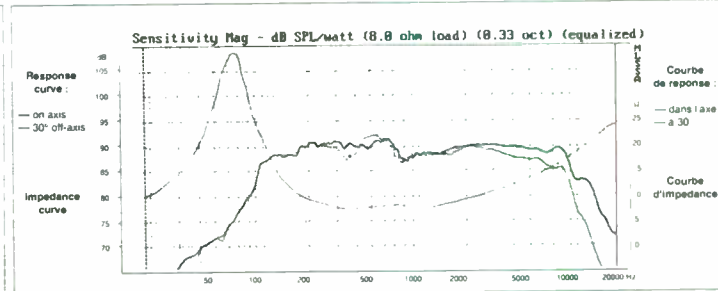

# HM130C0

## 5 1/4" Carbon Fiber cone bass mid

This driver features a very stiff and light cone material for fast and accurate response. Good for small 2-way's or as a midrange.

- Woven carbon fiber cone
- Diecast basket
- Rubber surround
- Edgewound copper voice coil on a Kapton former
- Vented spider and pole piece
- Gold plated terminals

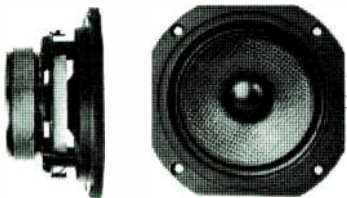

Technical Data	Symbol	Value	Unit
Nominal Impedance	Z	8	Ω
Resonance Frequency	Fs	50	Hz
Power Handling (IEC)	P	50	W
Sensitivity (1W/1m)	E	90	dB
Voice coil Diameter	Ø	25	mm
Minimum Impedance	Zmin	7.9	Ω
DC Resistance	Re	6.2	Ω
Voice Coil Inductance	Lbm	0.16	mH
Voice Coil Length	h	11	mm
Former	-	Kapton	-
Number of Layers	n	1	-
Magnet Weight	m	345*10 <sup>-3</sup>	kg
Flux Density	B	1.1	T
Force Factor	BL	6.28	NA <sup>-1</sup>
Height of Magnet Gap	He	5	mm
Linear Excursion peak	Xmax	3	mm
Suspension Compliance	Cms	1.45*10 <sup>-3</sup>	mN <sup>-1</sup>
Mechanical Q Factor	Qms	1.73	-
Electrical Q Factor	Qes	0.37	-
Total Q Factor	Qts	0.3	-
Moving Mass	Mms	6.97*10 <sup>-3</sup>	kg
Effective Piston Area	S	0.85*10 <sup>-2</sup>	m <sup>2</sup>
Equivalent Air Volume	Vas	14.9	ltr

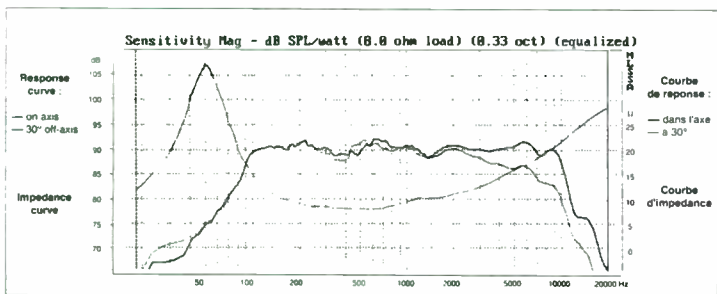

# HM170C0

## 6 1/2" Carbon Fiber cone bass mid

This driver looks good for a high end 2-way system or a MTM design. Fast and efficient.

- Woven carbon fiber cone
- Diecast basket
- Rubber surround
- Edgewound copper voice coil on a Kapton former
- Vented spider and pole piece
- Gold plated terminals



Technical Data	Symbol	Value	Unit
Nominal Impedance	Z	8	Ω
Resonance Frequency	Fs	43	Hz
Power Handling (IEC)	P	60	W
Sensitivity (1W/1m)	E	91	dB
Voice coil Diameter	Ø	30	mm
Minimum Impedance	Zmin	7.2	Ω
DC Resistance	Re	5.3	Ω
Voice Coil Inductance	Lbm	0.39	mH
Voice Coil Length	h	12	mm
Former	-	Kapton	-
Number of Layers	n	1	-
Magnet Weight	m	550*10 <sup>-3</sup>	kg
Flux Density	B	1	T
Force Factor	BL	7.5	NA <sup>-1</sup>
Height of Magnet Gap	He	6	mm
Linear Excursion peak	Xmax	3	mm
Suspension Compliance	Cms	1.2*10 <sup>-3</sup>	mN <sup>-1</sup>
Mechanical Q Factor	Qms	1.78	-
Electrical Q Factor	Qes	0.3	-
Total Q Factor	Qts	0.25	-
Moving Mass	Mms	11.6*10 <sup>-3</sup>	kg
Effective Piston Area	S	1.36*10 <sup>-2</sup>	m <sup>2</sup>
Equivalent Air Volume	Vas	31.3	ltr

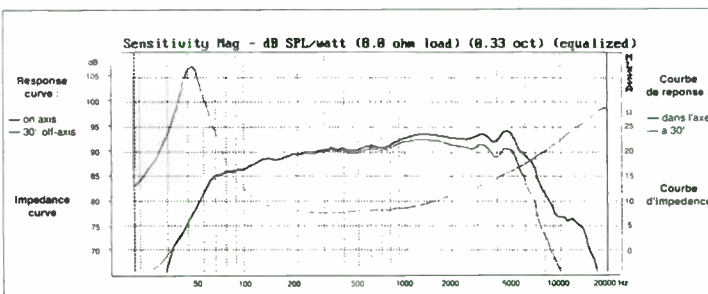

# HM210C0

## 8" Carbon Fiber cone bass mid

Very efficient bass driver for 2 or 3-way designs. Extremely flat high end response with smooth rolloff.

- Woven carbon fiber cone
- Diecast basket
- Rubber surround
- Edgewound copper voice coil on a Kapton former
- Vented spider and pole piece
- Gold plated terminals



Technical Data	Symbol	Value	Unit
Nominal Impedance	Z	8	Ω
Resonance Frequency	Fs	27.9	Hz
Power Handling (IEC)	P	70	W
Sensitivity (1W/1m)	E	91	dB
Voice coil Diameter	Ø	40	mm
Minimum Impedance	Zmin	7.8	Ω
DC Resistance	Re	6.2	Ω
Voice Coil Inductance	Lbm	0.65	mH
Voice Coil Length	h	14.3	mm
Former	-	Kapton	-
Number of Layers	n	1	-
Magnet Weight	m	550*10 <sup>-3</sup>	kg
Flux Density	B	1	T
Force Factor	BL	9.92	NA <sup>-1</sup>
Height of Magnet Gap	He	6	mm
Linear Excursion peak	Xmax	4.15	mm
Suspension Compliance	Cms	1.25*10 <sup>-3</sup>	mN <sup>-1</sup>
Mechanical Q Factor	Qms	4.37	-
Electrical Q Factor	Qes	0.29	-
Total Q Factor	Qts	0.27	-
Moving Mass	Mms	26*10 <sup>-3</sup>	kg
Effective Piston Area	S	2.32*10 <sup>-2</sup>	m <sup>2</sup>
Equivalent Air Volume	Vas	94.7	ltr
Mass of Speaker	M	2.1	kg

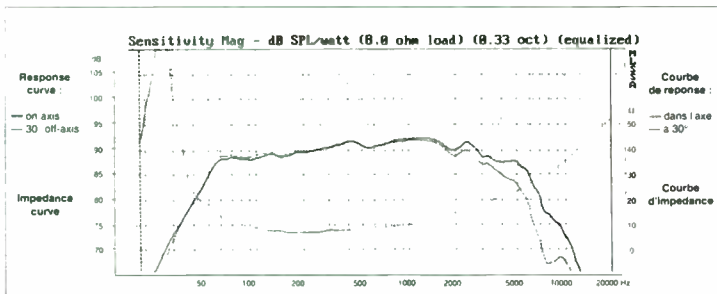

# HT100K0

## 4" Kevlar cone bass midrange

This 4" kevlar driver should be good in small 2-ways, as a mid in a 3-way or in autosound applications.

- Black woven kevlar cone
- Rubber surround
- Large magnet (240g)
- Low Resonance (62Hz)
- Decorative stamped frame



Technical Data	Symbol	Value	Unit
Nominal Impedance	Z	8	Ω
Resonance Frequency	Fs	62	Hz
Power Handling (IEC)	P	30	W
Sensitivity (1W/1m)	E	87	dB
Voice coil Diameter	Ø	25	mm
Minimum Impedance	Zmin	7	Ω
DC Resistance	Re	5.7	Ω
Voice Coil Inductance	Lbm	0.35	mH
Voice Coil Length	h	10	mm
Former	-	Alum.	-
Number of Layers	n	2	-
Magnet Weight	m	240*10 <sup>-3</sup>	kg
Flux Density	B	1	T
Force Factor	BL	4.16	NA <sup>-1</sup>
Height of Magnet Gap	He	4	mm
Linear Excursion peak	Xmax	3	mm
Suspension Compliance	Cms	1.5*10 <sup>-3</sup>	mN <sup>-1</sup>
Mechanical Q Factor	Qms	1.96	-
Electrical Q Factor	Qes	0.57	-
Total Q Factor	Qts	0.44	-
Moving Mass	Mms	4.4*10 <sup>-3</sup>	kg
Effective Piston Area	S	5.1*10 <sup>-3</sup>	m <sup>2</sup>
Equivalent Air Volume	Vas	5.3	ltr
Mass of Speaker	M	0.59	kg

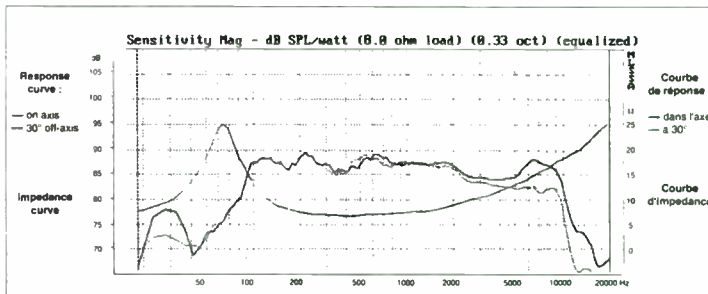

# HT130K0

5 1/4" Woven Kevlar cone bass mid

Efficient driver with rubber surround and kevlar cone. Suitable for small 2-way's or autosound. A good value.

- Black woven kevlar cone
- Rubber surround
- Large magnet (550g)
- Low resonance (45Hz)
- High temperature voice coil
- Decorative stamped frame

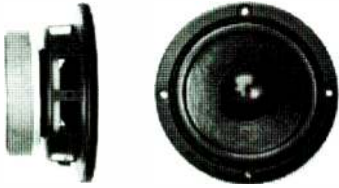

Technical Data	Symbol	Value	Unit
Nominal Impedance	Z	8	Ω
Resonance Frequency	Fs	45	Hz
Power Handling (IEC)	P	40	W
Sensitivity (1W/1m)	E	90	dB
Voice coil Diameter	Ø	25	mm
Minimum Impedance	Zmin	8	Ω
DC Resistance	Rc	6.6	Ω
Voice Coil Inductance	Lbm	0.3	mH
Voice Coil Length	h	11	mm
Former	-	Alum.	-
Number of Layers	n	2	-
Magnet Weight	m	550*10 <sup>-3</sup>	kg
Flux Density	B	1.3	T
Force Factor	BL	6.6	NA <sup>-1</sup>
Height of Magnet Gap	He	6	mm
Linear Excursion peak	Xmax	2.5	mm
Suspension Compliance	Cms	1.4*10 <sup>-3</sup>	mN <sup>-1</sup>
Mechanical Q Factor	Qms	1.2	-
Electrical Q Factor	Qes	0.33	-
Total Q Factor	Qts	0.24	-
Moving Mass	Mms	7*10 <sup>-3</sup>	kg
Effective Piston Area	S	8.5*10 <sup>-2</sup>	m <sup>2</sup>
Equivalent Air Volume	Vas	15	ltr

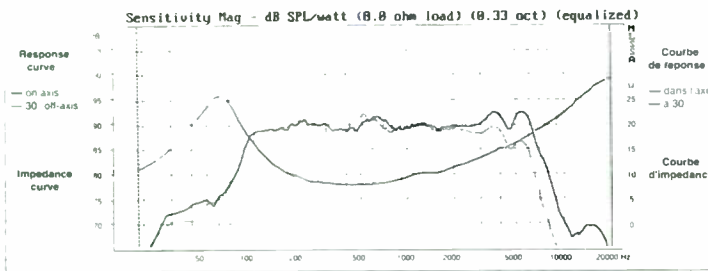

# HT170K0

6 1/2" Woven Kevlar cone bass mid

Good efficiency and light cone for a high end 2-way system or MTM design. Excellent transient response.

- Black woven kevlar cone
- Rubber surround
- Large magnet (550g)
- Low resonance (43Hz)
- High temperature voice coil
- Decorative stamped frame

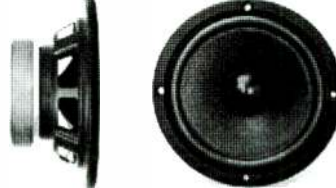

Technical Data	Symbol	Value	Unit
Nominal Impedance	Z	8	Ω
Resonance Frequency	Fs	43	Hz
Power Handling (IEC)	P	50	W
Sensitivity (1W/1m)	E	89	dB
Voice coil Diameter	Ø	25	mm
Minimum Impedance	Zmin	7.5	Ω
DC Resistance	Rc	6.5	Ω
Voice Coil Inductance	Lbm	0.12	mH
Voice Coil Length	h	11	mm
Former	-	Alum.	-
Number of Layers	n	2	-
Magnet Weight	m	550*10 <sup>-3</sup>	kg
Flux Density	B	1.3	T
Force Factor	BL	6.6	NA <sup>-1</sup>
Height of Magnet Gap	He	6	mm
Linear Excursion peak	Xmax	2.5	mm
Suspension Compliance	Cms	1.2*10 <sup>-3</sup>	mN <sup>-1</sup>
Mechanical Q Factor	Qms	2.26	-
Electrical Q Factor	Qes	0.48	-
Total Q Factor	Qts	0.39	-
Moving Mass	Mms	11*10 <sup>-3</sup>	kg
Effective Piston Area	S	1.4*10 <sup>-2</sup>	m <sup>2</sup>
Equivalent Air Volume	Vas	33	ltr

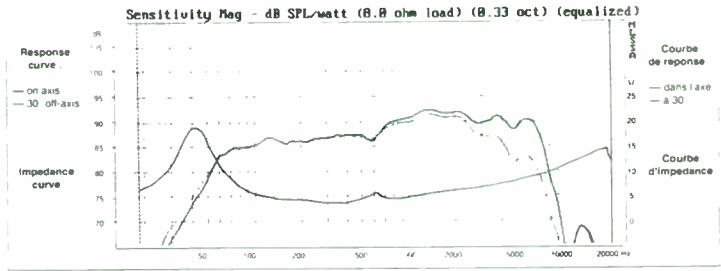

# HT210K0

8" Woven Kevlar cone bass mid

This inexpensive kevlar woofer looks good for either a 2-way or 3-way design. Smooth high end response and rolloff.

- Black woven kevlar cone
- Rubber surround
- Large magnet (550g)
- Low resonance (33Hz)
- High temperature voice coil
- Decorative stamped frame

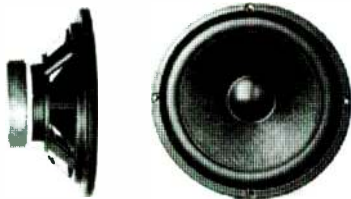

Technical Data	Symbol	Value	Unit
Nominal Impedance	Z	8	Ω
Resonance Frequency	Fs	33	Hz
Power Handling (IEC)	P	70	W
Sensitivity (1W/1m)	E	90	dB
Voice coil Diameter	Ø	37	mm
Minimum Impedance	Zmin	7.7	Ω
DC Resistance	Rc	6.2	Ω
Voice Coil Inductance	Lbm	0.59	mH
Voice Coil Length	h	15	mm
Former	-	Alum.	-
Number of Layers	n	2	-
Magnet Weight	m	550*10 <sup>-3</sup>	kg
Flux Density	B	1	T
Force Factor	BL	8.13	NA <sup>-1</sup>
Height of Magnet Gap	He	6	mm
Linear Excursion peak	Xmax	4.5	mm
Suspension Compliance	Cms	1.13*10 <sup>-3</sup>	mN <sup>-1</sup>
Mechanical Q Factor	Qms	1.73	-
Electrical Q Factor	Qes	0.41	-
Total Q Factor	Qts	0.33	-
Moving Mass	Mms	0.21*10 <sup>-3</sup>	kg
Effective Piston Area	S	2.24*10 <sup>-2</sup>	m <sup>2</sup>
Equivalent Air Volume	Vas	79	ltr
Mass of Speaker	M	1.72	kg

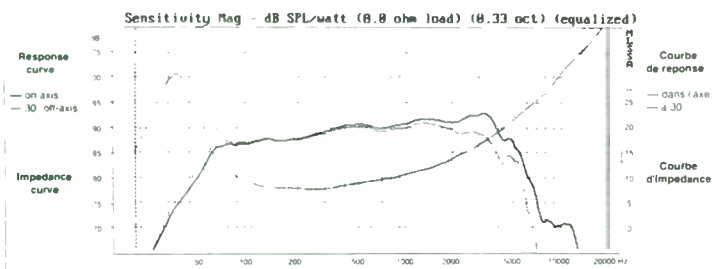

# PR12011

3/4" Titanium Bullet tweeter

This professional ring radiator horn tweeter features a Titanium diaphragm and solid aluminium phasing bullet for outstanding frequency response and no metal fatigue effects.

- 105 dB efficiency
- Pure Titanium diaphragm
- Zamak diecast horn
- Ferrofluid cooled voice coil
- Replaceable voice coil
- Smooth frequency response

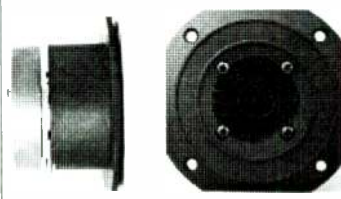

Technical Data	Symbol	Value	Unit
Nominal Impedance	Z	8	Ω
Resonance Frequency	Fs	8000	Hz
Power Handling (IEC)	P	120	W
Sensitivity (1W/1m)	E	105	dB
Voice coil Diameter	Ø	20	mm
Minimum Impedance	Zmin	7.5	Ω
DC Resistance	Rc	6.3	Ω
Voice Coil Inductance	Lbm	60	μH
Voice Coil Length	h	2	mm
Former	-	Alum.	-
Number of Layers	n	2	-
Magnet Weight	m	240*10 <sup>-3</sup>	kg
Flux Density	B	1.57	T
Force Factor	BL	-	NA <sup>-1</sup>
Height of Magnet Gap	He	3	mm
Linear Excursion peak	Xmax	-	mm
Suspension Compliance	Cms	-	mN <sup>-1</sup>
Mechanical Q Factor	Qms	-	-
Electrical Q Factor	Qes	-	-
Total Q Factor	Qts	-	-
Moving Mass	Mms	-	kg
Effective Piston Area	S	-	m <sup>2</sup>
Equivalent Air Volume	Vas	-	m <sup>3</sup>
Mass of Speaker	M	1.16	kg

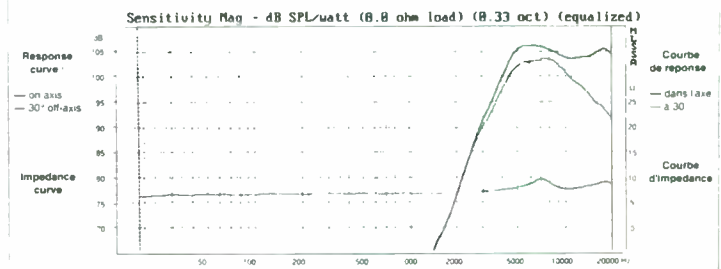

# PR170M0

6 1/2" Paper cone pro midrange

This driver has been designed for high quality professional sound reinforcement systems. High efficiency and high power handling.

- 100 dB efficiency
- 100 W power handling
- Diecast frame
- Treated flat foam surround
- Kapton voice coil former
- Flat aluminum edgewound voice coil (40mm)
- Gold plated terminals

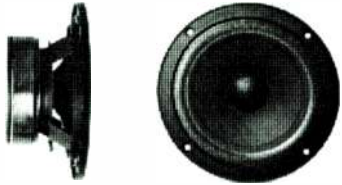

Technical Data	Symbol	Value	Unit
Nominal Impedance	Z	8	Ω
Resonance Frequency	Fs	124	Hz
Power Handling (IEC)	P	100	W
Sensitivity (1W/1m)	E	100	dB
Voice coil Diameter	Ø	40	mm
Minimum Impedance	Zmin	7.6	Ω
DC Resistance	Re	6.3	Ω
Voice Coil Inductance	Lbm	0.81	mH
Voice Coil Length	h	7	mm
Former	-	Kapton	-
Number of Layers	n	1	-
Magnet Weight	m	880*10 <sup>-3</sup>	kg
Flux Density	B	1.4	T
Force Factor	BL	8.36	NA <sup>-1</sup>
Height of Magnet Gap	He	6	mm
Linear Excursion peak	Xmax	0.5	mm
Suspension Compliance	Cms	2.43*10 <sup>-4</sup>	mN/l
Mechanical Q Factor	Qms	1.95	-
Electrical Q Factor	Qes	0.47	-
Total Q Factor	Qts	0.38	-
Moving Mass	Mms	6.74*10 <sup>-3</sup>	kg
Effective Piston Area	S	1.39*10 <sup>-2</sup>	m <sup>2</sup>
Equivalent Air Volume	Vas	6.6	ltr

# PR170X0

6 1/2" TPX cone pro midrange

Same high standards as the PR170M0, but with a TPX cone and a phase plug for exceptionally flat response to 5K.

- 101 dB efficiency
- 100 W power handling
- Diecast frame
- Solid aluminium phase plug
- Treated flat foam surround
- Kapton voice coil former
- Flat aluminum edgewound voice coil (40mm)

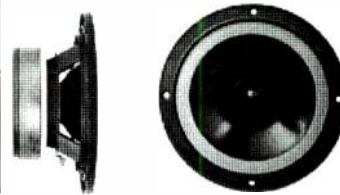

Technical Data	Symbol	Value	Unit
Nominal Impedance	Z	8	Ω
Resonance Frequency	Fs	119	Hz
Power Handling (IEC)	P	100	W
Sensitivity (1W/1m)	E	101	dB
Voice coil Diameter	Ø	40	mm
Minimum Impedance	Zmin	7.6	Ω
DC Resistance	Re	6.5	Ω
Voice Coil Inductance	Lbm	0.36	mH
Voice Coil Length	h	7	mm
Former	-	Kapton	-
Number of Layers	n	1	-
Magnet Weight	m	880*10 <sup>-3</sup>	kg
Flux Density	B	1.4	T
Force Factor	BL	8.5	NA <sup>-1</sup>
Height of Magnet Gap	He	6	mm
Linear Excursion peak	Xmax	0.5	mm
Suspension Compliance	Cms	2.8*10 <sup>-4</sup>	mN/l
Mechanical Q Factor	Qms	6.9	-
Electrical Q Factor	Qes	0.43	-
Total Q Factor	Qts	0.4	-
Moving Mass	Mms	6.4*10 <sup>-3</sup>	kg
Effective Piston Area	S	1.39*10 <sup>-2</sup>	m <sup>2</sup>
Equivalent Air Volume	Vas	7.57	ltr

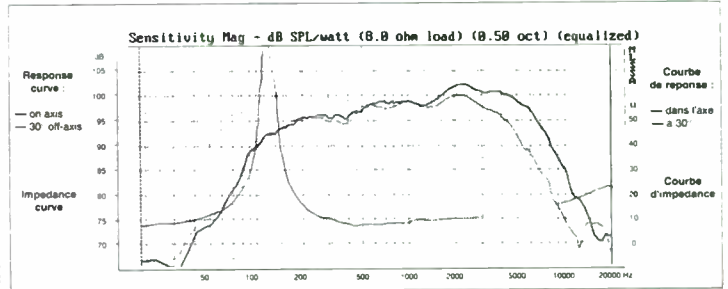
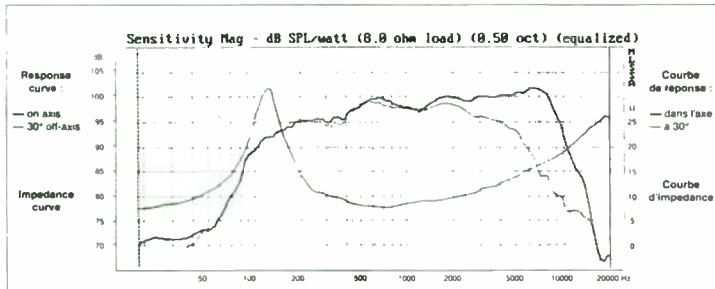

Unit	A mm	B mm	C mm	D mm	E mm
TW010E1	60x60	1	14.4	29x29	48
TW010F1	74	1.5	14.4	29x29	48
TW014B5	49.5	9.8	14.5	45	49.5
TW014F1	74	1.5	19.5	32	49.5
TW014H1	109x59.4	1.6	24.5	45	49.5
TW025A0	100	2	23.5	73.5	73.5
TW025A1	100	2	23.5	73.5	73.5
TW025M0	100	1.5	23.5	73.5	73.5
TW025M1	100	1.5	23.5	73.5	73.5
TW025V2	83.3x59	3	33.5	62	62
AW025M1	100	1.5	28	62.5	62.5
AW025S1	100	1.5	28	62.5	62.5
AW025S3	100	1.5	28	62.5	62.5

Vented Box Alignments (Mostly QB3) (Rg is resistance in line with the driver; inductor, wire.) (Call for other alignments)																Sealed Box						
V <sub>s</sub> liter	F <sub>b</sub> Hz	F <sub>3</sub> Hz	Vent Ø"	Vent L"	V <sub>s</sub> liter	F <sub>b</sub> Hz	F <sub>3</sub> Hz	Vent Ø"	Vent L"	V <sub>s</sub> liter	F <sub>b</sub> Hz	F <sub>3</sub> Hz	Vent Ø"	Vent L"	V <sub>s</sub> liter	F <sub>3</sub> Hz						
																Rg = 0						
																Rg = .2						
																Rg = .4						
																Rg = 0						
HM100X0	110x110	6	52	85.8	94					0.6		230										
HM130X0	136x136	6.8	70.5	102.5	115.4	1	102	125	1	4.2	1.3	98	120	1	4.1	1.4	93.5	115	1	4	1	180
HM170X0	166x166	7.2	77	124.6	145	5	65	85	1.5	5.3	5.5	62	79	1.5	5.25	5.5	62	77	1.5	5.25	3.6	116
HM210X0	210x210	7.3	89	124.6	186.5	25.8	39.7	48	2	4.4	28.5	38	47	2	4.3	31	37	44	2	4.1	18	70
HM130Z0	136x136	6.8	65	85.8	115.4	4.5	79	90	1.5	3.8	5	76	88	1.5	3.6	5.4	74	84	1.5	3.5	3	135
HM170Z0	166x166	7.2	69.5	85.8	145	24.5	49	54	2	2.6	27	48	51	2	2.4	29.5	46.5	49	2	2.3	15.5	86
HM210Z0	210x210	7.3	89	102.5	186.5	31	38	45	2	4	34	36.8	43	2	3.8	33.5	36.8	43	2	3.8	20	68
HM100G0	110x110	6	57	85.8	94																1	165
HM130G0	136x136	6.8	65	85.8	115.4	3	84.5	105	1.5	5	3.4	81	98	1.5	4.9	3.8	78	95	1.5	4.7	2.3	145
HM170G0	166x166	7.2	76	102.5	145	25	45.5	48	2	3	28	44.5	46	2	2.8	31	43	45	2	2.6	15	79
HM210G0	210x210	7.3	89	102.5	186.5	26	40.5	49	2	4.1	26	40.5	48	2	4	29	39	46	2	4	17	73
HM100C0	110x110	6	57	85.8	94																1	180
HM130C0	136x136	6.8	65	85.8	115.4	5.2	65.7	77	1.5	4.9	5.7	63.7	75	1.5	4.7	6.3	62	70	1.5	4.5	3.5	115
HM170C0	166x166	7.2	76	102.5	145	6.8	67	82	2	6.3	7.5	65	78	2	6	8.3	62	75	2	5.9	5	118
HM210C0	210x210	7.3	89	102.5	186.5	25	40.5	49	2	4.3	28	39	46	2	4.2	30	39	43	2	3.7	16	72
HT100K0	119	6	56	73.5	91																3.5	99
HT130K0	142	7	62	102.5	113	3.3	70	85	1	3	3.6	67.7	82	1	2.9	4	65	78	1	2.8	2.4	122
HT170K0	173	7	71	102.5	142	27	44.5	45	2	3	30	43.5	43	2	2.8	36.4	41.6	40	2	2.3	15.5	76
HT210K0	213	9.2	88	102	184	37	40	44	2	2.7	40	38.6	42	2	2.5	44	37.6	41	2	2.4	23	70
PR12011	95x95	6.3	56	73.5	73.5																	
PR170M0	190	8	70	124.6	145																	10-20
PR170X0	190	8	70	124.6	145																	10-20

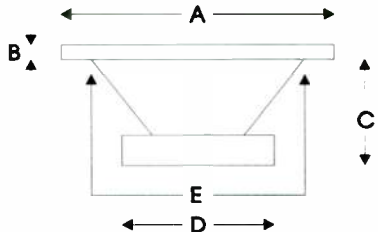

Continued from page 39

6. Press [Shift-F5]. You will be prompted for a lower frequency display limit. Type [5] for 5Hz, and press [Enter]. Use [Shift-F6] to set the upper display limit to about 400Hz. Unless you have a frequency response or impedance plot displayed, you will not see any immediate effect from these settings. For midrange- or tweeter-driver T/S measurements, you should set the sample rate and frequency display ranges to appropriately higher values.

7. Press [\*] to go to the top-level menu. Select the sequence [Display, Format, Scale, Ref\_resistor] (D, F, S, R). When prompted, type the test resistor's measured value and press [Enter]. Type only the numbers—not "ohms."

8. Make an impedance measurement. Press the sequence [\* , auto\_Measure, Impedance] and the program will take care of the rest. You may wish to adjust the display vertical scale so the magnitude of impedance curve spans only the screen's lower half. This will make it easier for you to see how well the curve-fit routine has performed. Use the sequence [\* , Display, Format, Scale, Ohms/div] and enter the scale value.

9. You can now do the first T/S parameter extraction. The sequence [\* , auto\_Measure, T/s] will give you a list of choices. Select [newDriver] to clear out old curve-fit data; this helps avoid confusion when measuring a batch of woofers. Don't use it between the normal and mass-loaded parameter extractions!

Assuming that the impedance curve just plotted represents the woofer without massloading, choose [Normal]. Enter the effective diameter in either "inches" or "cm." Go back to the Normal menu and, if you have made a woofer DC-resistance measurement, enter the value

2:SIZE 3:RATE 4:INPUT 5:MKR1 6:MKR2 7:WINDW 8:GAIN DATA c IMP AUDIO ANALYZER  
2048 1.92kHz PROBE1 24 122 NONE E8M

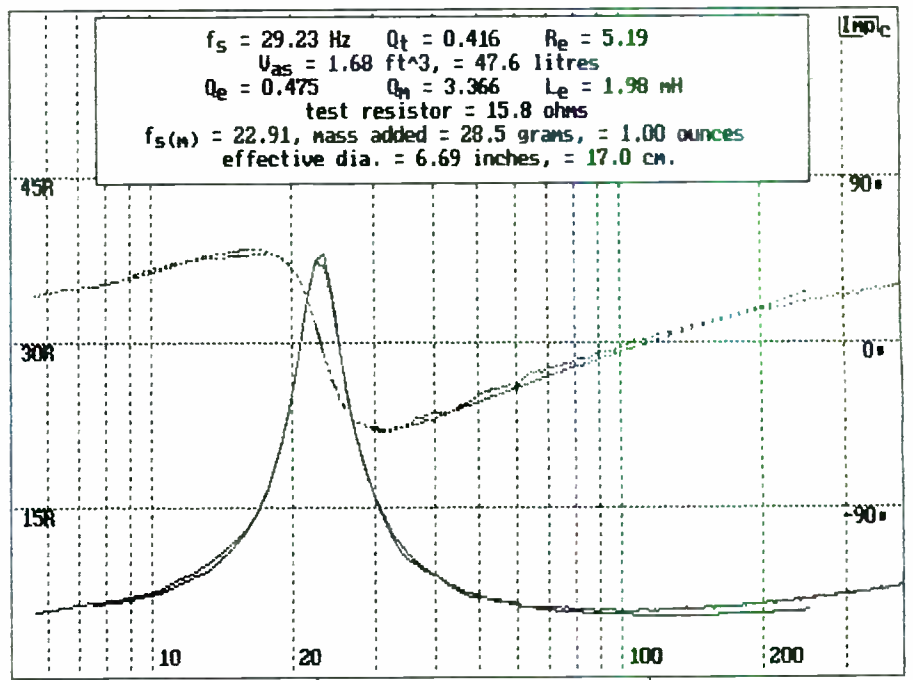

22.50Hz: Z=37.4, 8.58deg

114.3Hz: Z=5.64, 0.04deg

FIGURE 4: T/S parameter display.

using [[force\_R], rmiN], by pressing the R and N keys. This *must* be done just before selecting [Proceed] each time when performing a normal extraction if the measured DC resistance is to be accepted—so select [P] now.

10. The computer will crunch numbers for a while and then display parameters in a box at the top half of the screen. If the "normal" curve fit was performed first, the message "still need to run with mass loading" will also appear. A similar message referring to the "normal" run will be displayed if the mass-loaded run was performed first.

11. To perform the mass-loaded run, flatten out the clay glob like a pancake or form it into a ring to evenly distribute the weight, then place it on the woofer cone or dust cap. Repeat step eight to get the corresponding impedance curve. If the curve has multiple peaks or otherwise looks strange, an excessive test-pulse level may be launching the clay off the cone's surface. Try again with the amplifier volume control turned down. If the curve appears too noisy, you may need to turn up the volume control or increase the averaging for PROBE2 in the [Setup] menu. Don't forget to read-

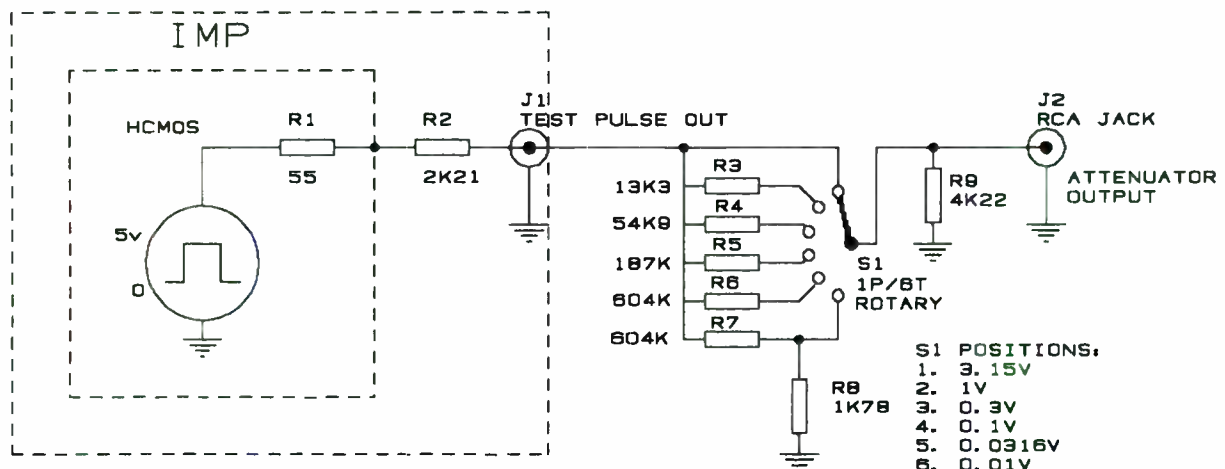

FIGURE 5: 10dB/step attenuator optimized for 50kΩ load (or for IMP probes). Output impedance less than 5kΩ.

just the probe level (step 4) if you change the volume control setting.

12. Perform the mass-loaded parameter extraction with the [Mass\_loaded] option under T/s in the auto\_Measure menu. Tell the program how much mass you are using to load the cone in either grams or ounces. To perform the curve fit, use [Proceed] under the Mass\_loaded option.

13. The T/S parameters will then be displayed in a screen box, as shown in Fig. 4. If the displayed value of  $f_{s(M)}$  is more than about 80% of  $f_s$ , you may wish to rerun the mass-loaded measurement using a larger clay glob. Until [new\_Driver] is selected, the impedance measurements and curve fits can be repeated and the parameter set will be recalculated using the most recent fit data. You'll find this helpful if a problem or error is suspected in one of the measurements.

Once the equipment is set up and the software configured, parameter measurements are very efficiently performed. I have found agreement between IMP and manually obtained results on several 8" woofers, with the IMP Q values tending to be a little higher.

**IMP UPDATES.** New data sheets from MAXIM have arrived for the MAX190 and MAX191. The 191 is a newer device which can operate with dual supplies and at somewhat higher sample rates. The good news is that it works in the IMP board without any modification. The bad news is that the lead time for delivery of either part from the manufacturer is currently about eight weeks due to high demand, so please be patient if kit or part shipments are delayed.

A few bugs have crept into the works in the IMP system. First, if you have been having acquisition problems with your IMP (erratic operation, very noisy time plots, or multiple impulses in each collection), you will want to perform a simple modification to clean up the printer port interface. In brief, it adds a total of three 0.001 $\mu$ F disk capacitors to bypass U11 Pin 9, U11 Pin 13, and U12 Pin 9 each to digital ground (U11 or U12 Pin 7). Details of this modification can be obtained from Liberty Instruments, Inc.

If you will be measuring T/S parameters of woofers with relatively high  $Q_E$ , you may experience problems with the T/S facility. In some cases, the curve fit will not converge due to a program bug in version 1.11. You can get a copy of the IMP software with a debugged T/S facility (ver. 1.12) by sending your original program disk, along with a stamped, self-addressed disk mailer, to Liberty Instruments. Also, please contact Liberty if you

would like to be put on their list for future IMP upgrades and information.

For those of you wishing to use IMP to measure the frequency characteristics of equalizers, tone controls, or other line-level circuitry, be advised that the output test pulse has a peak level of slightly under 5V, which is too high for proper operation of many line-level inputs. I suggest running the test pulse through several resistors configured as a voltage divider or a level control before applying it to active circuitry. For line-level equalizers, a 10k $\Omega$  series resistor followed by a 1k $\Omega$  shunt resistor should get you down to tolerable levels. For phono preamp/equalizers, much greater attenuation will typically be required.

I have solicited quotes from several fabricators for metal pre-punched, silk-screen-labeled cases for the IMP boards. Anyone who has not already made one can inquire about availability and pricing by writing to me at: Liberty Instruments, Inc., 6572 Gretel Court, Middletown, OH 45044.

#### REFERENCE

1. Dickason, Vance, *The Loudspeaker Design Cookbook*, 4th ed., Audio Amateur Press, 1991.

## ARE YOU MOVING?

Please send us your *new* address 4 weeks in advance. Thank you.

# TWICE THE BANG HALF THE BUCKS LAYO 1 PCB LAYOUT PACKAGE

- ✓ SCHEMATIC CAPTURE
- ✓ DRAFTING ✓ AUTOROUTING
- ✓ 16 LAYERS ✓ TEXT EDITOR
- ✓ 9 COMPONENT LIBRARIES
- ✓ MUCH MORE!

→ For IBM XT+,  
MS-DOS 3.xx

→ Complete 4000-  
coordinate package  
(Other versions available.)

→ Color info package, \$1

**\$99**  
POST-PAID

### OLD COLONY SOUND LAB

PO Box 243, Dept. SB3  
Peterborough, NH 03458 USA



24-Hour Lines:  
(603) 924-6371, (603) 924-6526  
FAX (603) 924-9467

## Related Products

The following products are available from *both* Liberty Instruments *and* Old Colony:

<b>SOF-IMP1B5GD</b> (5¼") or <b>SOF-IMP1B3GD</b> (3½")		\$ 5.00
	IMP software demo disk (usable as credit toward later purchase of full package)	
<b>SOF-IMP1B5G</b>	IMP software disk 1 × 5¼" DS/DD	49.95
<b>SOF-IMP1B3G</b>	IMP software disk 1 × 3½" DS/DD	49.95
<b>PCBW-4</b>	IMP double-sided PC board	39.95
<b>KW-4</b>	Unassembled IMP parts kit, incl. software (specify disk size) and PC board	249.00

The following products are available from Liberty Instruments *only*:

**TLC274CN** op amp, **MAX190** A/D converter, **6264** static RAM chip **Inquire for prices**

The following products are available from Old Colony *only*:

<b>KD-2</b>	Unassembled Mitey Mike test microphone	149.00
<b>KD-2AM</b>	Assembled Mitey Mike with calibrated cartridge and MLSSA data in hard copy form only	199.00
<b>KD-2AMM</b>	Assembled Mitey Mike with calibrated cartridge and MLSSA data on 3½" DS/DD diskette	209.00
<b>KMW-4</b>	Unassembled IMP parts kit (as above) plus unassembled Mitey Mike test microphone	389.00

### Shipping (USA):

For orders of less than \$50, please add \$3 for shipping/handling. \$50-99.99: \$4. \$100-199.99: \$5. Greater than \$200: \$6. Outside the USA, please inquire. MC/VISA accepted.

# Speaker Builder

BACK ISSUES

**1981** A Testing Unit for Speaker Parameters • Variable-Volume Enclosure • Thiele/Small Theory, Parts 1-3 • Easy to Make Enclosure Using Concrete Blocks • The Tractrix Horn: Good Dispersion Bass From an Old Design • Diffuser Port for Small Boxes • Mini-Speaker Made From PVC Tubes • Closed vs. Vented Box Efficiency • Interview with P.G.A.H. Voigt • Dual 8" Symmetrical Air Friction Enclosure • Thiele/Small Calculator Computations • Thiele/Small Parameters for Passive Radiators •

**1982** Transmission Line Theory • Thiele/Small Sixth-Order Alignments • The Quad 63 • Table Saw Basics • AR-1 Modifications • Active Crossovers and Phase • Three Transmission Line Speakers • A Beginner's First Speaker • How Passive Networks Interact with Drivers • Horn Loaded Heil • Phase Correcting Active Crossover • Wind Your Own Inductors • Series and Parallel Networks • High Performance Corner Speaker • Using Zobel's to Compensate for Driver Characteristics •

**1983** Building the Two-Way Dynaudio • A Crossover That Offsets Speaker Impedance • Using a Calculator for Box Design • Choosing a Calculator • A Simple Peak Power Indicator • A Small Horn Speaker • Audio Pulse Generator • How to Use Speaker Pads and Level Controls • An Easy-to-Build Voltmeter for Speaker Measuring • Nomograms for Easy Design Calculations • Interview with KEF's Raymond Cooke • Build a Simple Wattmeter • A New Type of Speaker Driver •

**1984** Build an Aligned Satellite/Woofer System • BOXRESPONSE: A Program to Calculate Thiele/Small Parameters • Casting with Resins • A Phase Meter • An Interview with Ted Jordan • Building the Jordan-5 System • Self-Powered Peak Power Indicator • Closed Box Design Trade-offs • How to Build Ribbon Tweeters • Build a Dual Measurement Impedance Meter • A High-Power Satellite Speaker System • Build and Use a White/Pink Generator • Sound Pressure Level Nomographs •

**1985** Compact Transmission Line Subwoofer • Bullock Crossovers, Passive and Active, Parts 1-3 • Drive Attenuator, Computer-Designed • Curved Vertical Array • Sontek Powered Subwoofer • An Isobarik System • Modifying Strathearn's Ribbon • Ambience Systems • Experimental Transmission Line • Small Double-Chamber Reflex • Loose Walled Speaker • Modifying the Daline •

**1986** The Edgar Midrange Horn • Sand-Filled Stands • Crossover Networks: Passive and Active • 5-Sided Boxes • A 2x4 Transmission Line • The Free-Volume Subwoofer • Notch Filters • By-Wiring the LS3/5A • A Push/Pull Constant Pressure System • Current and Power in Crossover Components • The Unbox (Egg) • Upgrade Speakerlab's S-6 Crossover • Measure Speakers with Step Response • A Gold Ribbon System • A Visit with Ken Kantor • A Tractrix Horn Design Program • Reviews: Audio Concepts "G"; Seven T.L. Midranges; Focal's Model 280; the Audio Source RTA-ONE •

**1987** A Compact TL Woofer • Frequency Response and Loudspeaker Modeling, Parts 1-3 • A Manual Coil Winder • The Model-One Speaker • Designing a Listening Room • A Six-Order Vented Woofer • Tapered Pipe Experiments • Visiting Boston Acoustics • A Vented Compound System • The Octaline • Spreadsheets for Speaker Design • In Memoriam: Richard Heyser, Parts 1, 2 • Using Non-Optimum Vented Boxes • Building Speaker Stands • Evaluating Driver Impedance Compensation • Tuning Bass-Reflex • Six Woofers Compared • Bullock on Passive Crossovers: Alternate Bandpass Types • Fast, Easy Filter Calculations • A Mobile Speaker • Modifying the Polk 10 •

**1988** Electronic Turns Counter • Two-Way Design • Minimus-7 Mod • Dome/Midrange/Tweeter Array • Plotting Complex Impedances • A Driver Design Primer • A Cabinet Primer • Tuning Up Old Systems • Low-Cost AR-3 Upgrade • Electronic Time Delay • Enclosure Shapes and Volumes • Minimum-Phase Crossovers • Spot Sound Absorbers • How to Add a Subwoofer • The Swan IV System • Sub-Bass Power Boosting • The Unline: A Short TL • Active Filter Computer Design Program • Low-Cost Two-Way Ribbon • Amp-Speaker Interface Tester and Construction Plans • The QB<sub>3</sub> Vented Box is Best • A Pentagonal Box System • Keith Johnson Profile • Sheathed Conductor ESL • A Symmetrically Loaded System, Part 1 • Ceramic Enclosure • Inductance Measuring Technique • Polk 10 Mods •

**1989** A Middle/Side Speaker • A Satellite/Woofer System • A T/S Driver Program • All About Cordless Drills • Symmetrically Loaded System, Part 2 • Adjusting Auditorium Acoustics • The Audio Laboratory Speaker System • A Passively Assisted Woofer • Digital Filter Tutorial • The Listening Arc Alignment • Small IC Power Amp & Crossover • Easy Surround Sound • Building Speaker Spikes • An Isobarik in a Thunderbird • Sheetrock Cabinetry • A Picket Speaker • Servo-Controlling AR-1 • Silent, Safe Muting System • Equalizing the Klipsch Cornwall • A Test Switcher • Visiting the Klipsch Kingdom • Rehab for Kitchen Music • Spreadsheet Design • A Subwoofer/Satellite System • Impedance Measurement as a Tool • Practical Passive Radiators • A Symmetrical Dual Transmission Line, Parts 1, 2 • The Microline • A Voice Coil Wheatstone Bridge • Tweeter Q Problems • A Dipole Subwoofer for the Quad • Adjusting Woofer Properties • Modifying Paradigm's 7se •

**1990** Acceleration Feedback System • Cylindrical Symmetric Guitar TLs • Compact Integrated Electrostatic TL, Parts 1-3 • Minimus-7 Super Mod • The Show (Bass Horn) • A Small Two-Way System • Helmholtz Spreadsheet • Heresy Upon a (Klipsch) Heresy • Beer Budget Window Rattler • Contact Basics • MDT Mini-Monitor Speaker System • Titanium + TPX + Polypropylene = Fidelity • Tom Holman, Skywalker, and THX, Parts 1, 2 • Bud Box Enclosure • Klipschorn Throat Riddle • Modular Three-Way Active Speaker • CD Speaker System • SPEAKER DESIGNER Software • Symmetrical Isobarik • Novice Crossovers • Triamplified Modular System • Magnetic Crosstalk in Passive Crossovers • Mitey Mike Loudspeaker Tester • Symmetrical Loading for Auto Subwoofers • Improved Vented Box with Low Q<sub>TS</sub> Drivers • BOXMODEL Woofer System Design Software • Four Eight By Twos • Dynaco A-25 Mod • Klipschorn Throat Revisited •

**1991** Students Building Systems • Servo Subwoofers • An Apartment TL • L-R Crossover for the Swan IV • More or Less Power • New Guidelines for Vented Boxes • The Pipes • Macintosh's Wave and Sound Programs • Creating Professional Looking Grilles • Octaline Meets D'Appolito • Using Radar to Measure Drivers • Deep Bass for GMC • PSpice LF Response Calculating • Pipe and Ribbon Odyssey • The Delac S-10 • Infrared Remote Volume Control • Backloaded Wall Horn Speaker • Mod for the Minimus 7 • Simplifying Cabinet Assembly • Fibrous Effects on TLs • The DOALs • Loudspeaker Cable • Speaker to Ear Interface • Speaker Sensitivity to Errors in T/S Parameters • TL Speaker Evaluation • Cable and Sound • KIT REPORTS: Little V; Audio Concepts' Sub-1 •

**1992** Rumreich on Box Design & Woofer Selection • MLSSA • Double-Chambered Reflex by Weems • Active Crossover and Delay • Electrical Circuit Bandpass Enclosure • A Dreadnaught System (satellite swivels) • Designing Real-World Two-Way Crossovers • 20-foot Ribbon Dipole Speaker • Biamping the Sapphire II • Capping Passive Crossovers • A High Quality Speaker Cabinet • 1/2-Octave Noise Source • Disappearing Loudspeaker • The A&S Soundoff Winner, Parts 1, 2 • Alignment Jamming • Marc Bacon's "Daneille," Parts 1, 2 • Double-Chambered Isobarik Bass • Ferguson's Pickup Installation • Electronic Counter for Coil Winding • Oakley on Speaker Placement • Making Your Room Hi-Fi, Part 1 • More on Dust Caps • Spreadsheet for Nonoptimum Vented Box Design • Acoustic Resistance Tuned Enclosure •

Please send me the following back issues of *Speaker Builder*:

- |   |   |   |
|---|---|---|
| <input type="checkbox"/> <b>1992 \$25</b> | <input type="checkbox"/> <b>1988 \$23</b> | <input type="checkbox"/> <b>1984 \$18</b> |
| <input type="checkbox"/> <b>1991 \$25</b> | <input type="checkbox"/> <b>1987 \$20</b> | <input type="checkbox"/> <b>1983 \$18</b> |
| <input type="checkbox"/> <b>1990 \$25</b> | <input type="checkbox"/> <b>1986 \$20</b> | <input type="checkbox"/> <b>1982 \$18</b> |
| <input type="checkbox"/> <b>1989 \$23</b> | <input type="checkbox"/> <b>1985 \$20</b> | <input type="checkbox"/> <b>1981 \$18</b> |

**SHIPPING: BACK ISSUES**

UPS: Domestic ground service by value of order:  
 Less than \$60.00—\$4.00 \$131.00—\$220.00—\$ 8.00  
 \$61.00—\$130.00—\$6.00 \$221.00+ —\$10.00

Canada: Add \$6 per year.  
 Foreign Air: Europe: 40% of total order.  
 Other destinations: 50% of total order.  
 Foreign Surface: 20% of total order.  
 Rates subject to change without notice.

All remittances must be in US \$ only drawn on US bank.

Total Magazines _____
Postage _____
<b>Total enclosed \$ _____</b>
<input type="checkbox"/> MC <input type="checkbox"/> VISA <input type="checkbox"/> CK/MO

**Speaker Builder Magazine**

PO Box 494, Dept. B93,

Peterborough, NH 03458-0494 (603) 924-9464 FAX: (603) 924-9467

Answering machine for credit card orders only—before 9:00 a.m., after 4:00 p.m. and weekends. Please have all information plus MC/VISA available.

NAME _____	ACCOUNT NO _____
STREET & NO. _____	
CITY _____	ST _____ ZIP _____
MC/VISA _____	EXP _____

# Kit Report

## Rockford's Beginner Software/Driver Paks

By Ray Alden

All the kits and software described are available from Rockford Corporation Educational Services, 613 S. Rockford Dr., Tempe, AZ 85281, or call toll-free (800) 366-2349 (for the kits, extension 3090; for the software, consult the operator). Term-1 and Term-Pro software are also distributed by Old Colony Sound Lab (see box).

Rockford Corp.'s recent release of the BMR10 satellite speaker kit and the BMR30 subwoofer kit, along with its powerful Term-Pro software, comes at a propitious time. These products fill the void left in the do-it-yourself kit market by Heathkits' 1992 decision to cease production. Heath's president, William Johnson, uses the term "eureka complex" to describe the excitement one experiences when electricity flows for the first time through a former box of parts. The Rockford kits and Term-Pro software allow less-experienced speaker builders to experience that thrill.

The kits and software are intended for industrial and vocational students as well as hobbyists. They can be purchased separately, so you can choose your own level of involvement. At the most sophisticated level, you could use the Term-Pro software to create an enclosure blueprint for the satellite speakers and the subwoofer. Instead of using the simple crossover provided, you also could design a higher level of filtering for each driver.

You could then build the speakers according to your plans which, if carefully engineered, should yield better performance than the layouts provided. Alternatively, you could use Rockford's speaker plans to build a perfectly functional system that you will enjoy for many years.

### Kit Contents

The BMR10 satellite kit contains two 10 mm Polydax DW6X11MC 8 $\Omega$  tweeters, each of which has a horn-loaded polymer dome partially covered with a phase plug. After calling Polydax, I managed to find out that these tweeters use ferrofluid and incorporate a direct-drive technology in which the voice coil is wound directly onto the cone assembly. A 35 mm, size-C magnet is used to produce an SPL of 93dB/1M/1W, an  $f_s$  of 2,050Hz, and a natural response



PHOTO 1: The BMR10 satellites and BMR30 subwoofer with Stuyvesant High School students Ulysses Dadacay, Gilbert Tang, and Richard Louis-Pierre.

curve that drops off below 2kHz at a rate of 18dB/octave. The impedance curve is very smooth, with only a slight increase of 2 $\Omega$  at resonance.

Also included are two 6.5" woofers made by Carbonneau for Rockford. They have a half-space SPL of 88.4dB/1M/1W and the following Thiele/Small parameters:  $f_s = 50\text{Hz}$ ,  $Q_{TS} = 0.59$ ,  $V_{AS} = 24.3$

liters. In addition, you receive two 3.3 $\mu\text{F}$ , 50V electrolytic capacitors, two terminals, five alternative sealed-enclosure layouts, the 72-page manual, internal speaker wire, and polyfiber fill material.

The BMR10 kit costs \$49.95 plus \$3 per kit shipping and handling. If you order three or more kits, you receive a 5% discount; if you order 11 or more kits, you

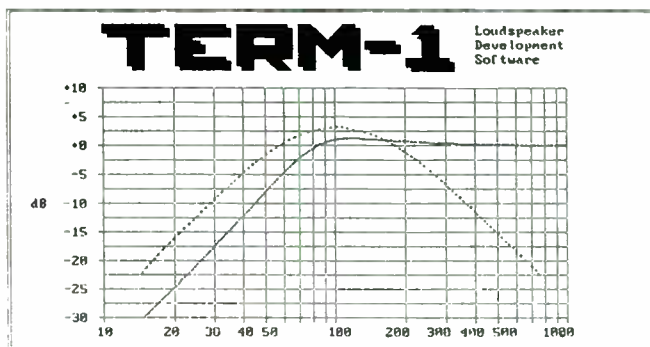

FIGURE 1: The Term-Pro software allows you to overlay the subwoofer's output on the satellites' response.



DRIVER DATA		DATABASE	LIBRARY STATISTICS
Name: ROCKFORD BOOMER DVC (PAR)		<PREV> GOTO TAG LOAD LIB	Name: EXPANDED Date: 05-11-92
Fs = 46.0	Pe = 75	MAKE LIB	Library capacity = 500
Qts = 0.43	Xmax = 0.19	NAME LIB	Current # drivers = 499
Vas = 2.2	Ref = 93.0	KILL LIB	Space remaining = 1
Z = 4.0	Diam = 10.00	SPEC TAG	Tagged drivers = 10
Nd = 1	Lt = ---	HARDCOPY	
S  P			
Name: --			
Fs: > 40.0 Hz	Ref: >= 91.8 db 1w/1m	Pe: >= 75 Wrms	
Qts: <= 0.45		Diam: = 10.00 in	
Vas: < 3.0 ft^3		Z: >= 4.0 Ohms	
Xmax: -- 0.00 in			

FIGURE 2: The SPEC TAG feature of the database allows you to specify up to eight parameters.

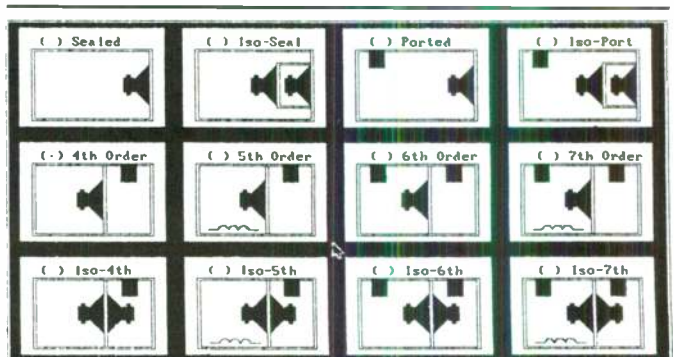

FIGURE 3: The 12 possible enclosures that Term-Pro can design.

get a 10% discount. Rockford offers an open-account privilege for public schools, requiring only a purchase order number, and provides coast-to-coast delivery within ten days.

The BMR30 subwoofer kit contains one 10" dual-voice-coil woofer (again made by Carbonneau for Rockford) which is rated at 4Ω when both voice coils are driven in parallel. Measured under the same conditions, the half-space SPL is 93dB/1M/1W, with the following parameters:  $f_s = 46\text{Hz}$ ,  $Q_{TS} = 0.432$ ,  $V_{AS} = 63.6$  liters. Also included are two 12mH inductors, two 200μF capacitors, four terminals, internal 18AWG speaker wire,

connecting screws, damping material, the 72-page manual, and five blueprints for sealed enclosures. The cost is \$49.95.

### Projecting the Performance

Looking at the layouts for the sealed enclosures and the crossover electronics provided for the satellites and the subwoofer, I thought it would be prudent to investigate the approximate results using these designs. In relation to the satellite components, I found that the 6.5" driver has a frequency response curve that, at 4kHz, begins to descend at the rate of 12dB/octave. The 3.3μF capacitor, placed

in series with the 8Ω tweeter, is normally intended to produce a 6dB/octave high-pass filter with an  $f_3$  that will materialize at 6kHz. I suspect, however, that when this is combined with the rapid descent in the response curve below 2kHz, the result is sharper filtering action.

Normally, using a first-order crossover for the tweeter would worry me. The  $f_3$  is not two octaves away, and some excitement of the resonant frequency seems inevitable. Further, first-order networks are highly susceptible to phase differences from both horizontal and vertical driver separations. In this case, though, because of the damped resonance peak of the

# MCM Electronics

## Your Ultimate Source for Quality Speaker Components



MCM is now a RCA/GE premier distributor



**MCM ELECTRONICS**  
650 CONGRESS PARK DR.  
CENTERVILLE, OH 45459-4072  
A PREMIER Company

- AMS, Pyle, Pioneer and Eminence- name brands you can trust
- From tweeters, woofers, midranges and enclosures to crossovers and grills
- MCM has all of the products you need and only a phone call away

**Discover the MCM Difference!**

For A FREE Catalog, Call **1-800-543-4330** FAX: 1-513-434-6959

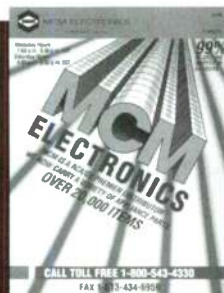

SB-10

Reader Service #11

tweeter and its rapid fall off, using just the 3.3 $\mu$ F capacitor may be tolerable. There is no reason not to design a more advanced filter, however, and to attenuate the tweeter, which is 4.6dB louder than the woofer.

To examine the bass capabilities of the satellites, I entered one of Rockford's suggested layouts (a sealed enclosure of 13.4 liters) into a computer model. According to this simulation, the speaker will have a 12dB/octave rolloff below  $f_3$ , which occurs at 70Hz, with a small rise in response above  $f_3$ .

Turning my attention to the subwoofer, I noted that the 12mH inductor and 200 $\mu$ F capacitor are indicative of a 12dB/octave low-pass filter with an upper cut-off of 100Hz. One of the Rockford subwoofer layouts recommends a 12" x 12" x 20" sealed enclosure, which translates

to a 37.6 liter box. When the projected bass response of the satellites and the subwoofer are overlaid on the same graph (Fig. 1), you cannot help but notice that the subwoofer does not significantly extend the satellites' bass, but merely increases the response in the region between 60Hz and 100Hz. This may be one of the reasons that Rockford has nicknamed the entire system "Boomer."

### Required Skills

The students in my speaker building class at a science and math high school can handle the mathematics required to model both sealed and ported enclosures and crossovers up to the fourth order. They are also able to design attenuation and impedance-compensating circuits. Although fewer vocational students may be familiar with exponential and logarithmic equa-

tions, there will be increasing demands for them to deal with some form of computer use in the workplace, and this might be a good introduction for them.

Using the Term-Pro software engineered by Wayne Harris and distributed by Rockford and Old Colony, students at any high-school level can design these kits to a high degree of sophistication without having to negotiate the underlying mathematics. Whether you are a neophyte or a seasoned speaker builder, this software offers you the ability to create a powerful assortment of designs for any set of drivers. Furthermore, it will implement these designs in a friendly, straightforward, menu-driven manner.

### Term-Pro Software

To use the Term-Pro software, you need an IBM PC, XT, or AT (or compatible)

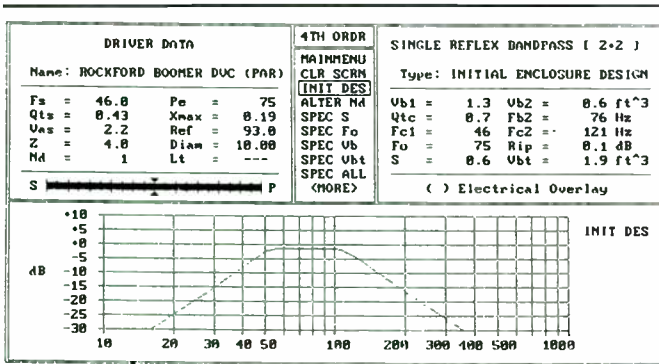

FIGURE 4: The initial design of a fourth-order bandpass subwoofer.

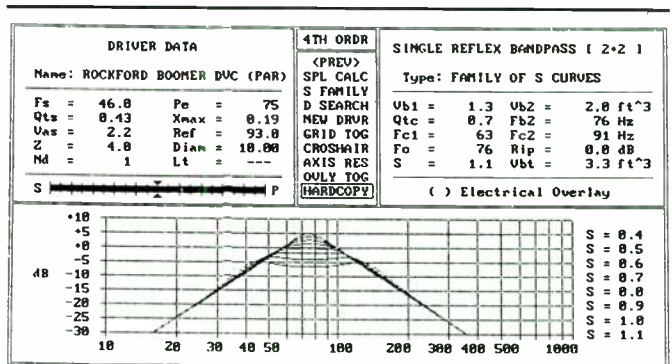

FIGURE 5: A family of S, or damping, curves generated by Term-Pro.

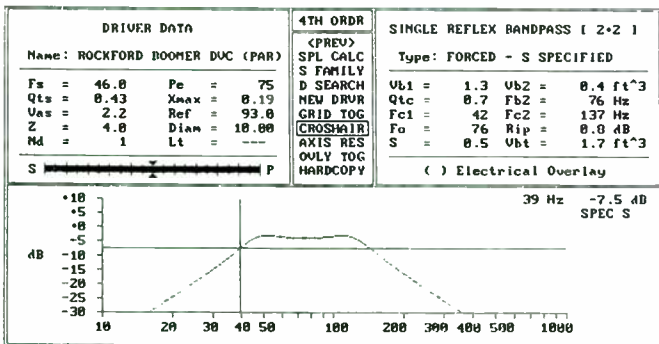

FIGURE 6: A curve with an S value of 0.5.

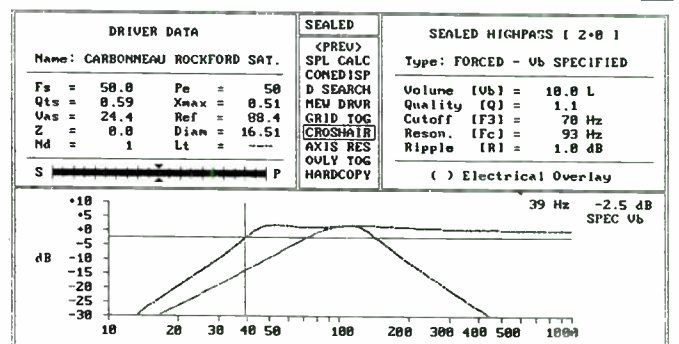

FIGURE 7: The CROSHAIR feature enables you to find a reference point so you can trace the subwoofer curve onto the satellite curve.

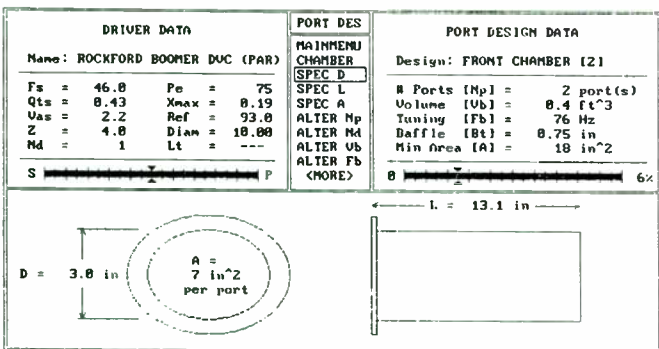

FIGURE 8: Designing two ports to be used in the bandpass subwoofer enclosure.

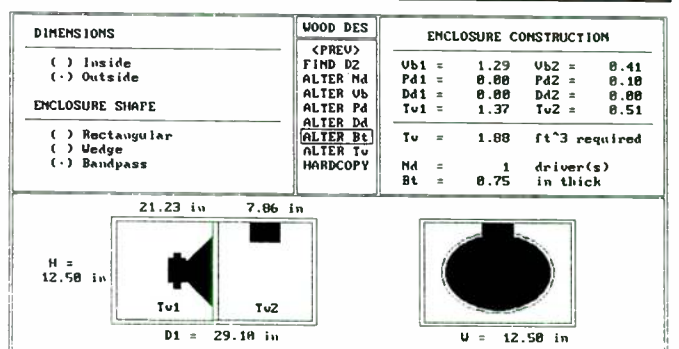

FIGURE 9: The Wood design section of the program can provide inside or outside dimensions and take into account everything that occupies volume.

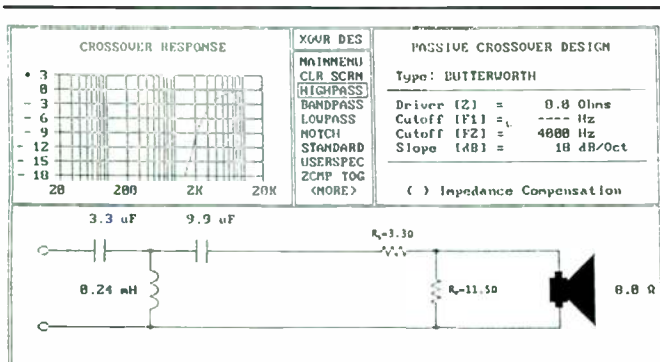

FIGURE 10: Calculation of the high-pass section of the Rockford satellite system. An attenuation circuit is sketched in.

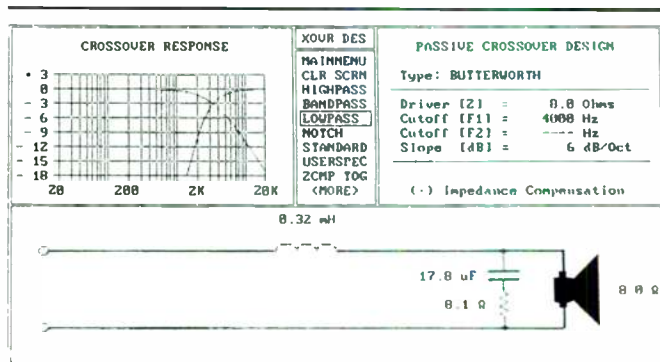

FIGURE 11: Calculation of the low-pass passive crossover section of the Rockford satellite system using impedance compensation.

with 640K of RAM and a CGA, EGA, or VGA graphics card. Upon entering Term-Pro, you are greeted with instructions on the use of the function keys. F1 offers help on every operation, so referring to the software guidebook is virtually unnecessary; F2 converts back and forth from English and metric units at any stage in the design process; F6 provides a hard copy of the screen; F7 provides full-screen graphics of any partial-screen graph; and so on.

Menu choices are presented in a logical order: DRIVER DATABASE, ENCLOSURE DESIGN, PORT DESIGN, WOOD DESIGN, CROSSOVER DESIGN, OVERLAY

DESIGN, OPTIONS, and QUIT. Entering DATABASE unveils a 500-driver library through which you can search (type in a company) or scroll (this also permits you to TAG an often-used driver and then use GOTO TAG to find it) to which you can add or delete drivers.

SPEC TAG is one of the menu items in DATABASE. When you select SPEC TAG (Fig. 2), you may enter up to eight specific restrictions on driver parameters. Then, by pressing T (for tag), you tag all the drivers that meet those specifications.

I asked for an impedance greater than or equal to 4, an SPL greater than or equal to 91dB/1W/1M, a  $V_{AS}$  less than 3 ft.<sup>3</sup>, a

free-air resonance greater than 40Hz, a power rating greater than or equal to 75W, a  $Q_{TS}$  less than or equal to 0.45, and a diameter equal to 10" (Fig. 2). You can do this by using the arrow keys and typing in your required values. Since I did not specify  $X_{MAX}$ , it is disregarded. In this example, ten drivers were tagged, one being the Rockford "Boomer" (in which values are given with the dual voice coil connected in parallel).

One nice feature of the software is the bar graph at the bottom of the driver data box, which tells you whether a particular driver is more inclined toward a ported (P) or a sealed (S) environment. Normally,

## HIGH PERFORMANCE ELECTRONIC CROSSOVER NETWORKS THESE COMPONENTS AVAILABLE FULLY ASSEMBLED OR AS KITS



XM9 Automotive System



XM9 Home System

**XM9-CA2 and XM9-CA3 Custom Cabinet** (for automotive use) Accommodates 2 or 4 XM9 or XM16 Crossovers and PS15 (or PS10) power supply to make either 2-way or 3-way system. • Buy cabinet only, kit, or fully assembled with circuit boards.

**PS10 Power Supply** (for home use) converts 120 VAC to dual 15 VDC supply • Regulated • Can support 8 crossover networks.

**PS15 Power Supply** (for automotive use) converts 12 VDC to dual 15 VDC supply • Can support 4 crossover networks.

**XM9 Crossover Network** • 24 dB/octave slope • fourth-order constant-voltage design • Outputs in phase • Low noise • Controls on circuit board or panel • Settable crossover frequency from 20-5,000 Hz.

**XM16 Crossover Network** • 48 dB/octave slope • Eighth-order constant-voltage design • Outputs in phase • Low noise • Controls on circuit board or panel • Settable crossover frequency from 20-5,000 Hz.

**XM9-C and XM16-C Custom Cabinets** (for home use) Accommodates 2 or 4 XM9 or XM16 Crossovers and PS10 (or PS15) power supply to make either 2-way or 3-way system. • Buy cabinet only, kit, or fully assembled with circuit boards.

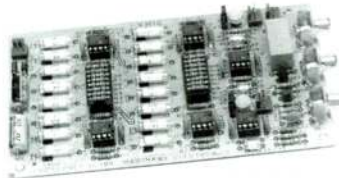

XM16 Circuit Board



WM8 "BASSIS"  
Bass Correction Equalizer

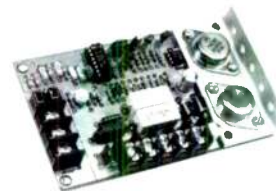

PM22 Power Amplifier

**WM8 "BASSIS" Bass Correction Equalizer** extends bass response by 1 to 2 octaves • Adjustable bass boost and damping • Rumble filter • 20 Hz subsonic filter.

**PM2 and PM22 Power Amplifier Modules** provide 75 watts RMS into 8 ohms • Complementary Darlington output stage • Integrated-circuit driver circuit • Over-current and over-temperature protection • Class A or Class AB operation.

WRITE NOW FOR FREE LITERATURE ABOUT THESE AND OTHER MARCHAND PRODUCTS

SEND YOUR NAME AND ADDRESS TO: MARCHAND ELECTRONICS, INC.

P.O. Box 473 • WEBSTER, NY 14580 • PHONE (716) 265-4930 • FAX (716) 265-1614



getting too long a tube, I used ALTER Np to tell the program I wanted to use two ports, each with a 3-inch diameter, to tune the 0.4 ft.<sup>3</sup> volume to 76Hz. The program beeped to warn me that the port wind velocities might be too high.

If you look at the Port Design Data box bar graph (Fig. 8), you will see arrows set at 5% of the speed of sound. This reference point alerts you to excessive wind noise. The dark portion of the bar graph indicates that these ports will be 6% of Mach one. Wayne Harris told me that this gusting effect is partially subjective and that 5% should not be considered incontestable. Based on this argument, I decided to use these values and move on to the next part of the program.

### Wood Design

I really like the program's wood design feature for several reasons. First, when you press F2, it immediately suggests dimensions for height, width, and depth in either inches or centimeters. In addition, you can toggle back and forth between inside and outside dimensions of the enclosure, which immediately alters all values in the box diagram (Fig. 9). The outside dimensions also are transformed instantly if you change the box thickness using ALTER Bt.

Virtually everything that occupies volume in both chambers is taken into ac-

count when the program specifies the total volume (Tv). The upper righthand corner in Fig. 9 shows the initial volume of each chamber (Vb1 and Vb2) and the amounts that are added for ports and drivers in each chamber. The program then uses these values to give the enclosure's final proportions.

### Crossover Design

Term-Pro can design a first-, second-, or third-order Butterworth crossover with or without impedance compensation, and it graphs the results. For the second-order network, Term-Pro calculates five different networks which achieve 12dB/octave, each with its own characteristic Q.

The networks are the ubiquitous and maximally flat Butterworth; the Bessel; the Bullock Equal Compromise (BEC) which, like the Bessel, provides an electrical topology that reportedly works better in rooms in which direct and reverberant sound coexist in somewhat equal proportions; the Chebychev; and the critically damped Linkwitz-Riley. This part of the software gives results based on sophisticated, albeit standard, formulas.

I chose HIGHPASS from the menu and entered a driver impedance of 8, a cutoff of 4kHz, and a slope of 18dB/octave. I did not use impedance compensation for this branch of the crossover. Figure 10 shows the results.

No menu selection is offered for an attenuation circuit, which seems to be the only feature missing in this part of the program. I included such a circuit based on formulas from Vance Dickason's *The Loudspeaker Design Cookbook*. Since the tweeter is about 4.6dB louder than the Carbonneau 6.5" driver, I suggest using the two resistors sketched in Fig. 10, where  $R_S = 3.3\Omega$  and  $R_P = 11.5\Omega$ . Even though an attenuation circuit is lacking, one useful feature of this program section is the ability to include a notch filter.

Selecting LOWPASS from the menu, I opted for impedance compensation and a 6dB/octave crossover. I have found that using such a crossover with a driver with a natural response (Fig. 11) that falls off at approximately 12dB/octave at the selected crossover frequency will result in an 18dB/octave rolloff.

Using SPEC TAG, you can change a specified part value (such as a 6.72mH inductor) to another value (perhaps a 7mH inductor) and watch all the part values, as well as the graph of the projected response, change. You can even use SPEC TAG to specify a crossover rate of 10dB/octave and watch the program synthesize values for such an unorthodox rate.

### Software Summary

I enjoy using the Term-Pro software for many reasons. The graphics are attractive

# LPG

one of the biggest manufacturers of high quality hi-fi loudspeakers in Germany, is now represented in the North American market.



LPG, whose know-how is based on a 65-year experience in designing and manufacturing loudspeakers, offers a totally new loudspeaker design range:

- ◆ woofer with polypropylene and coated paper cones (sizes 5", 6<sup>1</sup>/<sub>2</sub>", 8" and 12") in steel and diecast baskets for hi-fi and car audio applications
- ◆ midrange units (sizes 4" and 5")
- ◆ high quality coaxial-systems (with neodymium dome tweeters) for car audio applications with metal grilles and mounting rings
- ◆ 1" and 3/4" neodymium dome tweeters with enclosures for flush, surface and angle mounting
- ◆ Titanium and textile dome tweeters and midrange domes

**A & S Speakers**  
3170 23rd Street  
San Francisco, CA 94110  
415-641-4573  
FAX 415-648-5306

**Madisound Speaker Components**  
8608 University Green, Box 4283  
Madison, WI 53711  
608-831-3433  
FAX 608-831-3771

**Meniscus**  
2575 28th St., S.W. Unit 2  
Wyoming, MI 49509  
616-534-9121  
FAX 616-534-7676

**The Speaker Works**  
2539 E. Indian School  
Phoenix, AZ 85016  
602-956-6344

**Solen, Inc.**  
4470 Thibault Ave.  
St-Hubert, QC J3Y 7T9  
Canada  
514-656-2759  
FAX 514-443-4949

### Importer / representative

Norscan Trading Group, 9858 Vidor Drive, Los Angeles, CA 90035, 310-556-3611, FAX 310-556-0860

Reader Service #16

Speaker Builder / 4/93 59

**"IF YOU'RE NOT USING  
TERM-PRO™  
...GET SERIOUS!"**



**THE PROFESSIONAL'S CHOICE  
FOR SERIOUS  
ENCLOSURE DESIGN.**

**ENCLOSURE DESIGN**

*Enables you to design 20 different types of enclosures including: Sealed, Ported, Isobarik, Single Reflex Bandpass, Dual Reflex Bandpass and many more!*

**PASSIVE CROSSOVER DESIGN**

*Design Highpass, Bandpass, Lowpass, and Notch networks with just a few simple keystrokes!*

**PORT DESIGN**

*Design ports with a user-specified Diameter, Length, or Area. Our unique Port Velocity Bargraph will alert you to potentially noisy ports at a glance!*

**ENCLOSURE LAYOUT**

*Enclosure Layout for Rectangular, Wedge, and Bandpass enclosures - including dimensions and an animated 3-D scale representation of the design.*

**POWERFUL DATABASE FEATURES**

*The included driver library contains more than 600 of the most popular drivers available. You may add, edit, and delete drivers at any time!*

**AVAILABLE FROM**

**Old Colony Sound Lab**  
PO Box 243, Dept. B93  
Peterborough, NH 03458-0243 USA  
Tel. (603) 924-6371, (603) 924-6526  
FAX (603) 924-9467

Reader Service #36

and informative, and everything is arranged in a logical way. For example, the illustrations for the bandpass enclosure clearly show which chamber has the port and which is sealed.

Wayne Harris designed the program for ease of use and a minimum of data entry. For instance, I was puzzled when I saw the program calculate impedance compensation, but noticed that voice coil inductance was not one of the parameters requested. It seemed to me this parameter was needed to calculate that part of the circuit. Wayne informed me that this information is often omitted on specification sheets, therefore he came up with a way of calculating inductance based on other parameters.

I particularly like the wood design section. Knowing how long it takes to orchestrate a similar blueprint for an enclosure makes me appreciate the thought that went into this software. Several features I have not discussed here put the icing on the cake. For example, in the wood design section, the menu selection 3D MODEL uses your enclosure proportions to make a three-dimensional model which rotates on any axis you wish, and at any speed. If you were building an enclosure for someone who had trouble visualizing the proportions, showing him or her the spinning box could be useful.

Note that three software packages, tailored to various needs and budgets, are available. Term-1 designs passive crossovers and four of the twelve enclosures

pictured in Fig. 3: sealed, ported, Isobarik sealed, and Isobarik ported. Term-2 software designs the remaining eight enclosures. Term-Pro includes all of these capabilities with an even larger database and other features. It supports Epson dot matrix and HP Laserjet printers, or machines that simulate these formats.

**How Does it Sound?**

Elliot Zalayet of Zalytron Industries (469 Jericho Turnpike, Mineola, NY 11501, (516) 747-3515) built the cabinets for the satellites and subwoofer according to the plans generated by the Term-Pro software. Elliot used ¾" novaply and veneered the enclosures with charcoal gray, matrix-colored Formica. A small team of students built the crossovers and integrated the drivers into the enclosures. Photo 1 shows this team and the completed satellite/bandpass subwoofer system.

At first, we listened to the satellites without the subwoofer. We all thought they sounded quite good. One student asked why the bass was not as good as with another speaker we had built using the Focal drivers. Others replied that theory predicted that the Focal speakers would have a deeper bass, as they have a bigger enclosure and were ensured to have a low  $f_3$  by using an appropriately designed port.

Once the subwoofer was connected to the satellites, the students got the palpitations they wanted. I explained to them

**Term-Pro Update**

When I wrote this article, Rockford also offered a small amplifier kit, the BMR20. Having mentioned the demise of the Heathkit line, it is ironic that this last remaining vestige of the amplifier kit tradition has vanished. Maybe, if enough interest were shown, it could be restored.

Other Rockford offerings are flourishing. The Term-Pro software is becoming even more bountiful, as Wayne Harris includes supplemental enclosures that this powerful software can engineer (Fig. A). In addition, Wayne is now completing Term-3, which can be added to Term-Pro and will be available in July or August.

This would provide CAD capabilities enabling the user to generate several views of a speaker enclosure, with each proportion given in English or metric units. A library of predesignated enclosures will enable the user to design shapes, such as octagonal or pyramidal, and save the result for future use.

Wayne is going to culminate this with the ability to blueprint, from these enclosures, a detailed cut sheet from standard 4' x 8' stock, and consequently provide a bill for materials in cost per linear foot. He can send this latest version or, for registered owners of the software, he maintains a BBS board to enable them to quickly download the latest files.

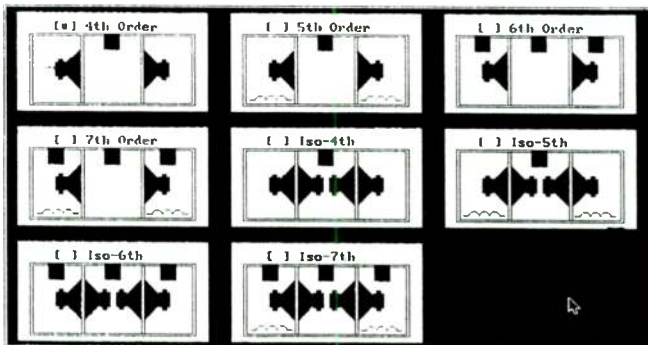

FIGURE A: The additional enclosures which Term-Pro can design.

that a good subwoofer asserts itself only when called upon by the music. We played other types of music lacking deep bass content, and the subwoofer remained subdued and unobtrusive.

#### Educational Value

These kits present a great educational opportunity for high school students and those who have little or no experience building speakers. Two separate courses could result from these kits: one in designing and completing the speakers (the Term-Pro software could be employed here), and another to build the speaker enclosures, or even cabinets to house all the associated equipment.

I recommend that Rockford consider an upgrade of the 72-page manual if these kits ever take off in high schools. Speaker theory is sorely lacking in the manual. Seven pages are devoted to a rather lightweight theory, consisting of text and diagrams (such as an exploded view of a driver and drawings of sound waves pictured as rarefactions and compressions emanating from a driver). No filter or enclosure theory is provided. Here an instructor should consult books such as David Weems's *How to Build and Test Complete Speaker Systems* (Tab Books), Abraham Cohen's *Hi-Fi Loudspeakers and Enclosures* (Hayden Books), and Vance Dickason's *The Loudspeaker Design Cookbook* (Old Colony Sound Lab).

Quizzes on safe sound, the satellites, and the subwoofer are included in the manual. However, some of the quizzes, particularly those on the satellites, trivialize the material. We should not set our expectations of students at too low a level. The wonderful thing about these kits is that they can capture students' interest and imagination. They provide a perfect opportunity for students to understand the inner architecture of electronic units and perhaps will instill a desire to continue learning about this special field.

My students and I thought that the long hours of design and assembly work had rewarded us with a well-integrated, satisfying system. The students had learned many new concepts and showed genuine enthusiasm for the process. I strongly recommend that schools consider using these kits and the Term-Pro software to provide an excellent learning opportunity that integrates theoretical design work with practical hands-on experience. ▶

#### If you should have a TECHNICAL QUERY...

about an article appearing in this magazine, write it clearly, leaving space for a reply and referencing the magazine, the article and the page about which you are inquiring. Enclose a self-addressed stamped envelope and send these to *Speaker Builder*, PO Box 494, Peterborough, NH 03458.

## A Quality Texture Look Without Laminating Costs and Labor! Designed For Use On Speaker Cabinets

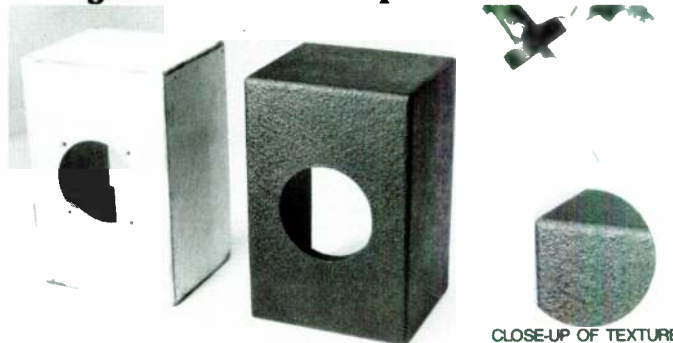

RESTORES OLD WORN OUT SURFACES

**TEXTURELAC** Spray finish produces a three-dimensional look that resembles a pebble, stucco or leather texture. It can be handled within 15 minutes of spraying and eliminates most sanding, spackling or extra paint operations. Dries to a hard mar-resistant and washable finish.

—Can reduce production spray room material and labor costs by 70 percent or more—

**TEXTURELAC** Is formulated for use on all wood, and composition woods, plastics and metal castings. It is available in most colors.

For a trial order or swatch panel of **TEXTURELAC** with descriptive literature call or write:



**Abilene Research and Development Corp.**

PO Box 294, Hewlett, NY 11557 • (516) 791-6943 • FAX (516) 791-6948

Reader Service #33

# SPEAKERWORKS

## YOUR CURE FOR SPEAKER HEADACHES!

- **FACTORY AUTHORIZED SERVICE:** Advent, B-I-C, Cerwin Vega, EPI, Genesis, JBL, & RTR
- **Polypropylene Cones For Reconers** 8", 10", 12" & 15"
- **Parts & Adhesives**
- **We Buy Blown Speakers**
- **Call Us For Hard To Find Parts**
- **WE RECONE, RESURROUND AND MANUFACTURE**
- **WE BUY, SELL AND TRADE MARANTZ, McINTOSH, Tube Equipment**
- **25 Years Audio Experience**
- **Custom Grilles for B-I-C, JBL, Marantz, Altec, & Cerwin Vega From \$29.95 Each**



**1-800-526-8879**



4931 A-1 South Mingo • Tulsa, Oklahoma • 74146

# Software Report

## Low Frequency Designer 3.01

Reviewed by G.R. Koonce  
Contributing Editor

**Low Frequency Designer 3.01**, Speak-Easy, 46 Cook St., Newton, MA 02158, (617) 969-1460, FAX (617) 969-5833.

Low Frequency Designer is a professional-level software package for analyzing and optimizing the low-frequency performance of loudspeakers. It runs on IBM PC and compatible computers, and will work on closed-box (CB) and vented-box (VB) designs as well as bandpass (BP) box designs with one or multiple ports.

Some information for tuning a VB design via a passive radiator rather than a port duct is provided, but analyzing and optimizing passive-radiator systems is not directly supported. The software will support work with identical and Isobarik-configured dual drivers. Printing capability is included, mouse operation and reading and writing of data files are supported, and full on-line help is provided. The program requires computer graphics capability and supports color monitors.

Michael Chamness, president of Speak-Easy, wrote the program and has spent more than nine years in the professional development of loudspeaker systems in the New England area.

The software package includes two 5¼", 360K disks and one page of information. Disk one contains the Low Frequency Designer program (LFD), the second includes demos for both LFD and a companion program, Filter Designer 1.0, which is not covered in this review. Suggested price is \$195 including shipping.

### Computer Requirements

The program runs on machines with 640K of memory. CGA, EGA, VGA, Hercules, or AT&T graphics are required, with support for Epson or Hewlett-Packard printers. A future revision will greatly expand this number. The program runs under DOS, but no DOS version requirement is stated; it will support a math coprocessor.

The computer I used for this review was a 50MHz 486DX IBM clone with coprocessor, SVGA display capabilities, and a Panasonic KX-P2123 printer which emulates the Epson LQ-850. The program displays responded to an EGA screen dump, indicating that 350 × 480 pixel color graphics were being used.

### On-line Help

A manual is not included with the program. The manufacturer assumes you will know how to install and run it without any instructions. I believe this is an unsafe assumption, and a one-page instruction sheet should be included.

The program does provide great on-line help screens. In addition, I suggest you print out and study the following three documents on the program disk before attempting operation:

LFEXAMP.DOC—examples using the program

LFDES.DOC—discusses monitor, printer, and help options

LFHELP.DOC—the information included in the on-line help screens

Despite the .DOC extension, these are ASCII text files and can be printed from DOS with the command Type FileSpec > Prn [Enter], where FileSpec is the drive/path/filename for any of the files. You should also study the document file on the demo disk before running either demo.

### Program Setup

You can run the program and demos from floppy disks, but please take the reasonable precaution of making copies of

the originals and run from these. Do not write-protect the disk you are using if you plan to save data files to it or change the program configuration file. You must be logged onto the path containing the program files for proper operation.

If you plan to run from a hard disk, which is recommended for speed, you must copy the floppy disks to it. Note that the demo and program disks both contain a configuration file of the same name, DEFAULT.CFG, so if you plan to put both floppy disks on your hard disk, use independent directories. Information about starting the program with different display or printer options and modifying the configuration file is in the LFDES.DOC file on the program disk. The DEMO.DOC file on the demo disk provides the same information relating to the demo program. The printer options can be set from inside the program, so it is not necessary to modify the configuration file for printer setup.

### Program Description

Capabilities are described in the LFHELP .DOC file. The program works through a series of windows available from a horizontal menu bar at the top of the screen. In the following descriptions, the names appearing in upper case are the main windows selected via the menu bar.

Fs =	42.5	Hz	V1 =	0.97	cu ft	V2 =	1.00	cu ft
Qt =	0.34		F1 =	48.4	Hz	F2 =	39.6	Hz
Qes =			Q1 =	7.0		Q2 =	7.0	
Qms =	2.96		d1 =	2.00	in	d2 =	2.00	in
Vas =	1.75	cu ft	l1 =		in	l2 =		in
Re =	8.40	ohms	Mp1 =		g	Mp2 =		g
Diam =	6.30	in						
Mms =		g	input resistor			Ri =		ohms
Cms =		cm/M	woofer configuration			Single Woofer		
Rms =			units:			British		
BL =		T-m						
SPL =		dB/W/m				Clear Params		
						ESC to close		

FIGURE 1: EDIT PARAMS window after initial data entry.



EDIT PARAMS allows you to enter driver and box data relating to chamber volume and tuning. It also returns information computed by the program. You have the option of using British (volume in ft.<sup>3</sup>) or metric (volume in liters) units. Additionally, you may select single or dual drivers, or dual Isobarik drivers. You also may add external resistance to the driver circuit by setting a value for the resistance (Ri) parameter. The program supports data for a single driver, but will work simultaneously with two box volumes: left #1 chamber and right #2 chamber. Either may be used for CB and VB work, while both are used for BP work. Not all the information you provide is used with all systems, so it's important to understand everything shown in the EDIT PARAMS window.

The PLOT window allows you to select a plot and define up to five systems with which to work. The systems can be VB, CB, or BP. You define them via the Cabinet Editor window, which can be called for each of the systems while you're in the PLOT window. This window appears with the name you have assigned to the system and allows you to define, in a picture of it, the chambers and ports used. It allows you to select which system(s) to plot, whether to plot some of the special options (to be defined later), and whether to plot response or displacement.

The response plots are low-power frequency response in absolute decibels SPL (sound pressure level) at 1m for 1W input based on the computed driver reference efficiency. If added Ri has been included, the plots will reflect the changed efficiency. The displacement plots are the cone displacement for 1V input for the entered piston diameter versus frequency. The reference for displacement is 1mm/V, which equals 90dB. This allows the re-

sponse and displacement curves to have nearly the same decibel level and thus appear on the same graph. The plots also include the effects of using dual or Isobarik dual drivers.

The program always works internally in 1/8-octave intervals over the frequency range 2Hz-2kHz. The PLOT window allows you to select the plot frequency range within the total interval and to set the maximum and minimum decibels. You can also display a single marker frequency. Each new plot can clear the previously plotted curves or be added on top of the existing ones.

CURVE FIT let's you select parameters

that the program can vary to try to fit the system response to a Desired response curve. All parameters not selected are fixed. You can specify limits and set the frequency range over which the curve fit function will operate.

FAMILY allows you to define curve families to show the effects of varying a single system parameter. The number of curves in the family, the maximum and minimum parameter values, and which parameter to vary may all be selected. In addition, you can select the speed with which the curves are drawn so you can determine the parameter value representing each curve as it is drawn on the

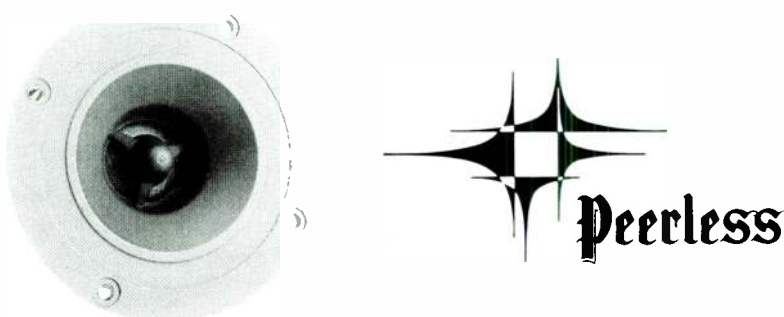

## HORN DOME TWEETERS

The Peerless 811647 and 811655 are horn dome tweeters in 8 ohm and 4 ohm respectively.

Peerless' horn dome tweeters are especially recommendable for use in power systems, where they ensure full exploitation of the systems capacity.

Special features of 811647 and 811655:

- ★ **Combines the high sensitivity of horn speakers with the smooth response of dome tweeters.**
- ★ **Replaceable self-centering dome assembly.**

Due to the horn of these dome tweeters it is possible to combine the high sensitivity of a horn speaker with the smooth response of a dome tweeter.

Peerless' horn dome tweeters are especially suitable for boxes, where a high output is required.

For a catalog of our entire line of speakers including the horn dome tweeter please respond to the Reader Service # below or contact us directly.

**PEERLESS OF AMERICA, INC.**  
 800 W. Central Road, Mt. Prospect, IL 60056  
**Phone: 708-394-9678 FAX: 708-394-5952**

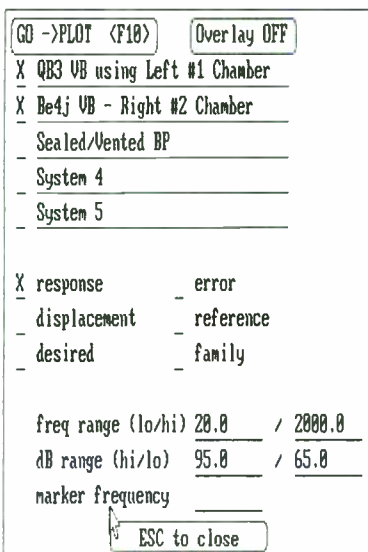

FIGURE 2: PLOT window after defining two VB systems.

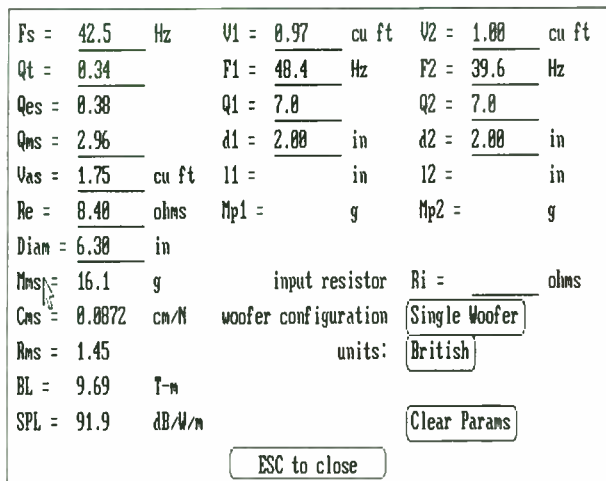

FIGURE 3: EDIT PARAMS window after plotting response curves.

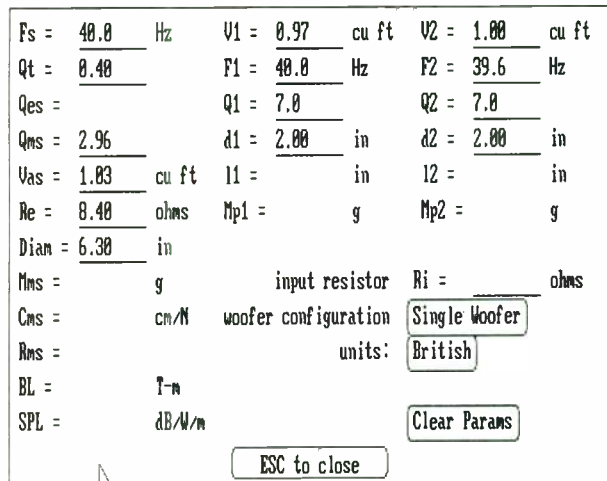

FIGURE 4: EDIT PARAMS window after synthesis of B<sub>4</sub> VB system.

screen. Actual plotting is handled under the PLOT window.

SYNTHESIS allows you to specify a system response you would like to realize. The system can be a CB or VB high-pass response. The CB response is specified by giving a value for  $Q_{TC}$ , the total system Q. The VB response is specified as a fourth-order Butterworth (B<sub>4</sub>), or by giving the desired transfer-function poles.

RESPONSE is used to enter, edit, copy, or list responses. The program stores seven response and seven displacement curves: the five defined system curves, one Desired curve set, and one Reference curve set. Five Error responses are also stored, which are the differences between the Desired response and the five defined system responses. You can manually enter a Desired response curve by entering data for 1/3-octave intervals or by specifying the desired  $f_3$  and efficiency (two  $f_3$  values are entered for BP systems).

This window allows you to copy various response curves from one location in the program to another (for example, one of your systems to Reference), and to display a tabulated listing of the response data. This listing covers the full frequency range and shows the responses for the selected system, Desired and Reference systems, and the Error response between the defined system and Desired response, all in decibels SPL. The listing also shows the displacement for the selected system in millimeters at 1V input.

DISK writes or loads files that contain driver or system information. These files contain all the information in the EDIT PARAMS window and the system configurations defined in the PLOT window. The DISK window allows you to change file path and displays a directory of the specified path. It also allows you to store response files to be used with the companion Filter Designer program. Finally, you can use the window to prepare DEFAULT.CFG configuration files.

QUIT opens the usual message box asking if you really want to quit.

SCREEN DUMP does not appear in the menu, but is called by pressing F5 when a plot is displayed or a menu window opened. It allows configuration of the printer setup and printing of the plot or information in the open window. You can enter a title via this window when a plot is to be printed. If you leave the mouse cursor within the window area you are printing, it will appear in the printout.

F1 enables HELP. The content depends on the context in which it is called. Different information is presented for the case of a menu item selected but the window not open versus the window opened.

### Program Operation

I'm sure I did not exercise all the capabilities of this powerful program. I concentrated on those items that an amateur speaker builder would use. It performed all operations very quickly, but keep in mind that it was reviewed on a fast computer. In most cases, operation is intuitive. The HELP windows are always available if you get stuck.

I started in the EDIT PARAMS window by entering the measured data for an 8" driver. I also entered box volumes and tunings for optimum (QB<sub>3</sub>) VB and jammed Bessel (Be<sub>4j</sub>) VB alignments in the two-chamber data areas provided. A printout of the EDIT PARAMS window at this point is shown in Fig. 1. The QB<sub>3</sub> values are in the left #1 chamber and the Be<sub>4j</sub> values in the right #2 chamber. I used the PLOT window to define VB systems using the two chambers (Fig. 2).

I then plotted the response curves (Fig. 3), which are the expected shapes and show a passband level of 91.9dB. This matches the driver's computed reference efficiency and indicates that the program is using the common reference (100% efficiency yields an SPL of 112dB).

When I returned to the EDIT PARAMS

window, I found that the program had computed and added extra data, as shown in Fig. 4. Note, however, that the duct lengths (l1 and l2) and equivalent passive radiator moving masses (Mp1 and Mp2) are not shown. If you plot just the QB<sub>3</sub> system using the left #1 chamber, you will get l1 and Mp1. However, if you plot just the Be<sub>4j</sub> system using right #2 chamber, you will not get l2 and Mp2. This problem is discussed later.

For VB systems, the EDIT PARAMS window provides default box Q values of seven, Q1 for the left #1 chamber and Q2 for the right #2 chamber. You can change these to any nonzero value and the plotted responses will vary with that value.

When I added an Ri of 3Ω to the driver circuit, the pass band response dropped to 90.6dB. This reflects the effect of Ri on the computed driver Q<sub>ES</sub> and does not account for impedance variations in the actual driver that may be affecting the response at these frequencies. The program asks you to input total Q (Q<sub>TS</sub>) and mechanical Q (Q<sub>MS</sub>), and then computes electrical Q (Q<sub>ES</sub>), including any Ri if defined.

When I moved to the CURVE FIT window, I had the program modify the chamber volume and tuning of the Be<sub>4j</sub> response to yield the QB<sub>3</sub> response. I set it up so that only the box volume and tuning could change, and the program produced the correct results. On one occasion, I tried curve fitting without limiting the parameters to be varied, and the program got hung up with a box volume of zero. I recommend putting limits on the parameters when using the curve-fitting capability. This feature could be very useful in getting a pair of drivers to yield nearly identical responses, however, the program will work on only one set of driver data at a time.

I was able to synthesize desired second-order (CB) and fourth-order (VB) B<sub>4</sub> responses. I did not try entering the poles to fit other fourth-order responses, as this

is not the way amateur speaker builders normally work. You must be careful when doing a system synthesis, as the program changes the driver data to that needed to build the system. When you return to the EDIT PARAMS window, you will find new driver and chamber data. Figure 5 shows the EDIT PARAMS window after synthesizing a B<sub>4</sub> system response with f<sub>3</sub> equal to 40Hz and box volume set to 0.97 ft.<sup>3</sup> Take notice of the changes in the driver data.

I experimented with the FAMILY window, which you can use to investigate your system's sensitivity to parameter variations. Figure 6 shows the results when I varied the box volume for the initial QB<sub>3</sub> design from 0.5 to 1.5 ft.<sup>3</sup> (optimum volume is 0.974 ft.<sup>3</sup>).

The DISK window allowed me to store and retrieve my data and setup. The data file restored the information in the EDIT PARAMS window and the five systems defined in the PLOT window. Other data was not restored when I restarted the program and loaded the data file. I did not try to modify the configuration file, but I did play with the directory display. Under the RESPONSE window, I viewed the tabulated response listing and moved responses around using copy commands.

The program allows a variety of BP configurations. You can vent either chamber to the outside or vent between chambers in the Cabinet Editor window. With both chamber volume and tuning settings the same, I obtained the results in Table 1. It shows where the various ports are located, as well as the results when I tried to plot the system, and what I found for duct length when I returned to the EDIT PARAMS window.

I lack sufficient experience with the BP configuration to state whether either of the two curve types obtained is the correct response, but there appear to be some problems. When I vented only the left chamber, no duct length was reported in the EDIT PARAMS window. When both chambers were vented, I received no curve or error message. I tried to run the program with both chambers vented externally and the program plotted, but when I returned to the Cabinet Editor window, the left vent had been removed. I could not consistently produce this result, however, and when it did not happen, both vent lengths were reported.

I experimented with how the program tests data entered into the EDIT PARAMS window. Most data is only verified to be above zero, not checked for reasonableness. When a negative or zero value is entered, a message box appears to tell you the value cannot be accepted. Figure 7 shows the EDIT PARAMS window after I entered unreasonable data (such as f<sub>5</sub> = 12,000,000Hz), tried to plot a curve, and then returned to the EDIT PARAMS window. The program ran fine, did not produce a plot in the 20Hz-2kHz range, and

provided additional unreasonable data in the window. At no time was I able to enter data that caused the program to fail.

### Problems

Sometimes the program failed to do what the HELP windows led me to believe it would or operation was confusing or misleading. In my opinion, revisions should be made to correct these problems.

**Computer information:** No instructions are included on installing the program, copying the supplied disks, and so on. I believe an instruction sheet should be supplied.

**Messy exit:** Always on exit from the

demo program, and sometimes on exit from the Low Frequency Designer program, I was left with a monitor screen containing vertical columns of dots which prevented my reading anything. If you get in this situation, CLS will not help, but the DOS command MODE 80 will fix things. The problem was inconsistent when exiting from the designer program, but it did occur at least once when I selected EXIT from the menu when the EDIT PARAMS, RESPONSE, or CURVE FIT window was open.

**Limited printing capability and curve identification:** A new version of this program will have added printer sup-

## STONECRAFT SPEAKER SYSTEMS, INC.

### The ultimate SPEAKER SYSTEM in genuine Marble or Granite!

MDF board is now obsolete. No wood or wood by-product compares to the sound quality and beauty of genuine marble or granite cabinets.

\* \* \*

The natural sound you hear from your drivers installed in these beautiful marble cabinets is breathtaking, pure, wholesome, live music.

\* \* \*

All cabinets are custom made to your design or size. Our artists, designers and engineers will assist you in your order.

\* \* \*

We also design and build custom marble, granite, slate and onyx speaker stands. Any size or shape, square, rectangle or pedestal.

\* \* \*

The entire speaker cabinet or stand is made from ¾" cut and polished stone. All corners and edges are cut at a 45° angle. We have no production line, every speaker cabinet is hand-made by craftsmen who take great pride and personal satisfaction in every stone cabinet we make.

### STONECRAFT

*Where beauty and performance are in perfect harmony.*

## STONECRAFT SPEAKER SYSTEMS, INC.

1116 Oliver Street  
Houston, TX 77007  
1-800-856-7445

*Visa and Mastercard welcome*

Reader Service #8

Speaker Builder / 4/93 65

port. I believe it should also have improved print-out capabilities. The present plot printout is rather small on my printer (about 5" x 5"), and I could not change that. I tried to print the screen with an EGA screen dump, but the background is colored, so I got a nearly all-black print-out. These plots should be full-size with automatic advance to the next page.

The various curves also are not identifiable on the printout. On the screen, different curves are in different colors, but that is not enough. With five curves of the same color for your five systems, you are still at a loss to identify them. You must resort to printing individual response curves, thus losing the ability to compare them easily. Some form of dot-dashing or labeling should be used to identify the curves. The file documentation indicates that dashed lines are used for some plots on monochrome monitors, but I did not try this.

The program prints all data screens in a graphics format, making it slow and cumbersome (Figs. 1, 4, and 5). This data is available inside the program and could be printed out in a text format on nearly any printer.

Documenting what type of system you are working with on a printout is nearly impossible. You have only the plot title and system names to print all the desired information. The actual configuration is established in the Cabinet Editor window. I tried printing one window, but because of the colored background, it was nearly all black. This window should be printable, or some text description of the defined system should be made available for print out. There is not enough room in the system name for all the information you need.

I could not print the tabulated response/displacement listing. If you have printer compatibility problems and can't print the plots, you will need a printout of this

listing. The data is included in the program and should be available in a text mode printout.

When you have printed two plots or windows on continuous-feed paper, the third will print right across the tear line. I'm not sure whether this happens with the Hewlett-Packard printer. There should be some way to eject the current page and call up a new one.

As you can see, the program's printing capability is marginal and should be greatly expanded. I'd also recommend adding the current date to all printouts.

**Family display:** You can slow down the family generation on the screen so you can identify the value of the variable for the curve being plotted. As you can see in Fig. 6, however, there is no way to identify the variable value for a specific curve on a printout, or even which curve is which.

**Port duct length calculation:** The program supposedly computes the duct length if you add duct diameter in the EDIT PARAMS window. On VB systems, this worked correctly for the left #1 chamber but not for the right #2. I made all five systems VBs, using the right #2 chamber, and all systems plotted correctly. But on return to the EDIT PARAMS window, no variety of system selection produced the computed duct length and associated passive-radiator moving mass. I could obtain a duct length for the right #2 chamber only if the defined system was a BP, but then I had problems obtaining a duct length for the left #1 chamber. This should be fixed.

**BP problems:** The inconsistent results I obtained when I tried a BP system with both chambers vented, and the fact that no curve or error note appeared most of the time, should be resolved. The program should either support dual vented-chamber BP systems or show some form of error message.

**Incorrect error tabulated results:**

Working in the RESPONSE window, I examined the tabulated listing with no Desired curve defined. As you would expect, the Error values matched the Response values for the selected system. I then copied the actual Response curve to the Desired curve and reexamined the tabulated listing. The Desired curve had been correctly updated, but the Error data was unchanged. When you are working with a real Desired curve, the mistake may not be so obvious. If the Desired curve is updated in the tabulated data, the Error data also should be updated or cleared. Bringing up tabulated data that has incorrect information listed is dangerous. The Error data is corrected only if you plot something and then return.

**Curve fitting with no Desired response:** The CURVE FIT window provides error messages if you have indicated invalid parameters to be varied, but when I tried to do a curve fit without first installing a Desired curve, I received no error message. The program tried to fit a 0dB response. I believe an error message makes more sense.

**Driver cone displacement computation:** When I went from single to standard dual drivers, the passband driver displacement increased by 3dB. Going from single to dual Isobarik drivers produced a 3dB decrease in computed displacement. Something is wrong here; driver cone displacement is proportional to input voltage. The documentation clearly states that the plot is referenced to millimeters per volt plus 90dB, and the tabulated displacement is in millimeters for an input of 1V.

When you connect two drivers in parallel, the passband cone displacement for each is the same as for a single driver, since they both see the full input voltage (independent of enclosure type). When you put the two drivers in series, the dis-

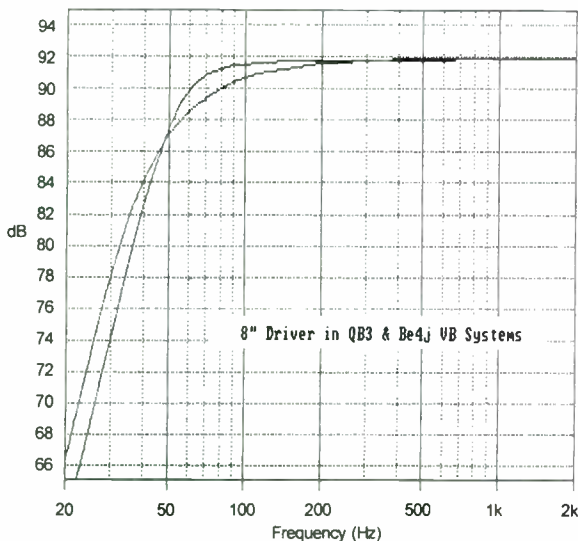

FIGURE 5: Response plots for two VB systems.

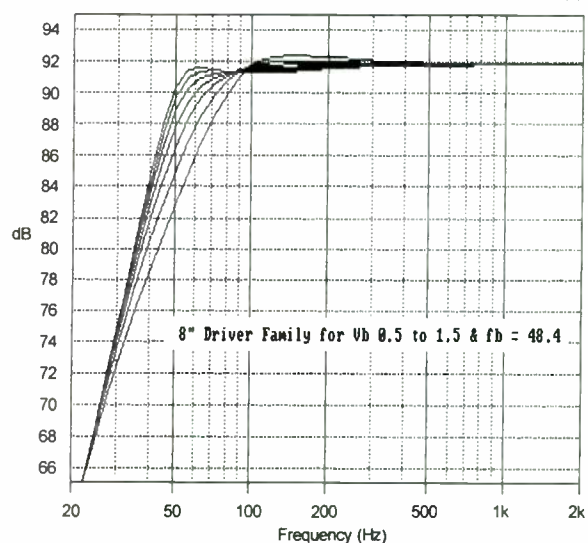

FIGURE 6: Response plots for VB family with varying box volume.

placement of each is cut in half (down 6dB), as each driver sees half the voltage. The program appears to be displaying displacement referenced to some power level rather than to a voltage level. In fact, the program must reference to a power level unless it asks whether the drivers are connected in series or parallel.

When I added  $R_i$  in the driver circuit equal to the voice coil resistance ( $R_e$ ), the passband cone displacement dropped by 6dB. This is the correct value, as the voltage across the driver would be halved under these conditions.

### Nit-Picking

These are areas where the program does as the HELP windows indicate, but where I would prefer to see things done differently.

**EDIT PARAMS window update:** The program-supplied data in the EDIT PARAMS window is not updated until you plot something and then return. I would prefer to have this information updated without exiting the window.

**EDIT PARAMS window display accuracy:** The EDIT PARAMS window shows only one or two decimal places on data. I would prefer to see one more decimal place, especially on the Qs. If you are working with small boxes, where two decimal places for volume in cubic feet is insufficient, switching to metric will help.

**Plot decibel scaling:** The program requires you to manually set the maximum and minimum decibel values for the plots. When you go to BP or Error plotting, this is a nuisance. I would like limits computed automatically, if all the data is off-scale. Otherwise, use the manually entered limits. This would let you locate the curve you wish, while allowing you to expand them manually by setting other limits.

Note that changes you make in the curve's decibel limits will not be recognized if you have "Overlay ON" in the PLOT window to add new curves. This can be confusing, as the new plot's decibel limit data has been accepted in the PLOT window. If you have a problem with changes in decibel scale, verify that "Overlay OFF" is being displayed in the PLOT window (Fig. 2).

**Response listing paging:** Each time you call the tabulated listing, it comes up at 2Hz. Usually, this is well below where you are working and forces you to do a lot of paging. I would prefer it if the tabulated data came up on the same page as last used.

**Mouse limitations:** I have used a mouse for years, so I appreciate the considerable mouse capability built into this program. The mouse becomes disabled under one condition, however: when you have just typed in numeric or certain types of text data. You must enter the data by pressing the Enter key or an arrow key. Mouse action is then suspended until the new data is entered or cleared. I would prefer a mouse click on a new data field, then enter the data and select the new field. When I selected file names from the directory listing, double mouse clicks caused the program to select and load the file. Thus, using the mouse to enter data is inconsistent.

**Editing names and titles:** When you return to a window containing an entered name or title (system names in PLOT, file names in DISK, or graph title in Screen Dump window), you cannot edit the text. If you wish to correct a mistake or modify the text slightly, you must retype the entire line. I would prefer it if, when you move off the first character with an arrow key, the line does not clear when you

start to type, but edits via insert or over-type set by the Insert key.

**Stopping in curve fit:** I tried to fit the VB response using the values specified for the right #2 chamber to the VB response specified by the values in the left #1 chamber. The program accomplished this, producing the same values for box volume and tuning as in the left #1 chamber. However, even though the program was displaying the RMS error as zero, it continued until I manually stopped the process. I believe the program should stop automatically if the RMS error drops below a very low value.

### Pro/Amateur Differences

This professional-level analyzing and optimizing program does not do some things that the amateur speaker builder might expect. For example, you cannot instruct it to design a QB<sub>3</sub> VB for your specified driver, nor is it intended to do so. The speaker builder has measured or catalog data for a driver and wishes to design the best system possible with that driver. The professional designer has a set of system requirements for which he or she wishes to design the box and establish the driver requirements. This difference is reflected in the software, and might cause the home speaker builder some problems.

**Designing VB systems:** Using the driver data you specify in the EDIT PARAMS window, the program will not design nonoptimum VB systems, or optimum VB systems in the popular QB<sub>3</sub>, C<sub>4</sub>, and BB<sub>4</sub> alignments. If you establish the box volume and tuning, it will accept these values and allow you to analyze and optimize the design, and perform all the previously described functions.

**Data for a single driver:** The program works with a single set of driver data; it

# OHMITE

PRECISION POWER RESISTORS

# Ultra-CAP™

THE NEW REFERENCE CAPACITOR

# MUSIC COILS

TWELVE GAUGE HEX-LAY INDUCTORS

# SCAN-SPEAK

DRIVERS OF WORLD RENOWN

**Design Without Compromise™** with high performance drivers and crossover components from **North Creek Music Systems**. Please call or write for our complementary catalog: Route 8, PO Box 500, Speculator, NY 12154, (518) 548-3623. The high end is here.

Fs = 12000000 Hz	V1 = 12300.00 cu ft	V2 = _____ cu ft
Qt = 22.00	F1 = 0.3 Hz	F2 = _____ Hz
Qes = 50751100	Q1 = 7.0	Q2 = 7.0
Qms = 22.00	d1 = 1200.00 in	d2 = _____ in
Vas = 0.00 cu ft	l1 = 2420069. in	l2 = _____ in
Re = 0.00 ohms	Mp1 = 61.5 g	Mp2 = _____ g
Diam = 7.00 in	input resistor	Ri = _____ ohms
Mms = 0.0 g	woofer configuration	Single Woofer
Cms = 0.0000 cm/M	units:	British
Rms = 0.00		Clear Params
BL = 0.00 T-m		
SPL = 141.8 dB/W/m	ESC to close	

FIGURE 7: EDIT PARAMS window with unreasonable data entered.

does not work simultaneously on a pair of drivers. Since you can retain the curves on a plot and store responses, it is possible to plot one driver and then change data and work with a second driver. Exercise great care when working this way.

**Entering  $Q_{MS}$ :** The program requires you to enter  $Q_{MS}$  and  $Q_{TS}$ . When working with catalog data, you may not know  $Q_{MS}$ . You can approximate it by entering a value equal to five or ten times  $Q_{TS}$ . Remember, any parameters that depend on  $Q_{ES}$ , which the program calculates from  $Q_{TS}$  and  $Q_{MS}$ , will be inaccurate. Absolute SPL used in the plots is computed from  $Q_{ES}$  and is thus affected (Table 2).

**Identifying the -3dB point:** I find it much more difficult to identify the -3dB down frequency in the system response when the curves are plotted in absolute decibel rather than relative to the pass-band response.

**Plotted absolute SPL:** When working with two drivers, you must be careful reading the plotted SPL curves as they are efficiency (1W/1m), not sensitivity (2.83V/1M). The sensitivity is acoustic output relative to input voltage, which is important when matching the drivers in a system. When you use dual woofers, the plotted SPL increases by 3dB relative to a single woofer, which is correct. The sensitivity for the system would increase by 6dB if the woofers were in parallel, and by 0dB if they were in series. When you use dual Isobarik woofers, the program shows the plotted SPL dropping by 3dB relative to a single woofer. Should you build the Isobarik, the sensitivity would be unchanged for parallel woofers and would drop 6dB for series woofers.

**Understanding EDIT PARAMS window data:** You must understand the data entered in the EDIT PARAMS window. First, not all the data is always used. For example, a CB system using the left #1 chamber would ignore any tuning information entered. Keep this in mind when documenting what you are doing. Also, the data in the EDIT PARAMS window

may change when you make changes in other windows or when various functions are performed. You should review this window after performing any function to be sure it still contains what you expect. If you are using manually entered data, my recommendation is to go to the DISK window and save the data and setup so you can restore it quickly if necessary.

**Displacement curves:** Programs such as BOXRESPONSE plot the driver cone displacement differently. This program plots the displacement for 1V input versus frequency based on the specified piston diameter. The more common approach is to specify the driver's maximum linear displacement and then plot the maximum output SPL or input power versus frequency that can be obtained without exceeding the driver's electrical power or maximum displacement limits. The difference is one of working with a known driver as opposed to developing a given system with the driver parameters to be established.

### Summary

Low Frequency Designer 3.01 is a powerful, professional-level program for analyzing and optimizing systems. It works very well and offers many useful features. Although it comes with no printed documentation, it provides complete online help concerning operation and definitions. Its main failing is in not allowing you to easily print your system configura-

TABLE 1

### RESULTS WITH VARIOUS BP CONFIGURATIONS

PORTS USED IN CHAMBERS			RETURNED DUCT LENGTH		PLOT RESULTS
LEFT	RIGHT	BETWEEN	LEFT	RIGHT	
No	No	No	—	—	Error message, no plot
No	No	Yes	—	—	Error message, no plot
No	Yes	No	No	Yes	Response plot type A
Yes	No	No	No	No	Response plot type A
Yes	Yes	No	Yes	Yes	No error message, no plot
Yes	No	Yes	Yes	Yes	Response plot type B
No	Yes	Yes	Yes	Yes	Response plot type B

tion, tabulated responses, and plots with curve identification.

The program does not provide some features the amateur builder expects, and thus requires you to do outside initial optimum and nonoptimum VB designs. If you have other ways to do the initial box design, Low Frequency Designer 3.01 is a good investment.

Michael Chamness, president of SpeakEasy, responds:

Thanks for taking the time to review our *Low Frequency Designer* program. We appreciate the opportunity to comment.

There is a small error in your program description. *Low Frequency Designer* includes only one disk, not two. The second disk you received is our free demo disk, which we encourage potential buyers to look at before buying the program so they can evaluate it. It might also be worth mentioning that SpeakEasy offers a 30-day full refund to guarantee our customer's satisfaction.

Under "Computer Requirements" heading, your EGA graphics resolution should read 640 x 350, not 350 x 480. The next version of the program will support VGA (640 x 480) and probably Super VGA as well (800 x 600).

The one-page instruction sheet you suggest is a good idea is, in fact, included as part of the cover letter sent with each program. You should have received this with the review copy. It includes most of the information you have duplicated in your "On Line Help" section.

Yes, we do assume our customers know the basics of their computer system (i.e., how to copy files and print text files). We provide generous free technical support for anyone who needs some extra help. While we are not always available to answer calls, we return them promptly and save our customer the phone bill. You might have taken advantage of this service for your review to clear up any problems.

The file DEFAULT.CFG has nothing to do with printer setup and should never be edited directly by the user. It contains information about the loudspeaker system configurations the user has defined in his *Low Frequency Designer* session.

TABLE 2

### ABSOLUTE SPL

CASE	8" DRIVER, $Q_{MS}$ ESTIMATED		CURVE SPL
	ENTERED	COMPUTED	
Actual	2.956	0.38	91.9dB
5 x $Q_{TS}$	1.675	0.42	91.5dB
10 x $Q_{TS}$	3.350	0.37	92.0dB

The DISK window is used to save (overwrite) the DEFAULT.CFG file so the user's custom configurations will be loaded next time the program is run.

I replicated your setup of left- and right-chamber VB systems and found that you have indeed uncovered a minor bug where the port length doesn't appear as it should in the EDIT PARAMS window. Thanks for pointing this out. It will be corrected ASAP in a new version.

Concerning your comments on problems with double-vented BP system modeling, a little thought will reveal that venting both sides of a driver equally (i.e., volumes and tunings) gives no acoustic output at low frequencies, the same as a driver in free air. *Low Frequency Designer* does an accurate job of modeling all the popular BP systems, and we have built our reputation on it. The calculated response curve for your nonfunctional system was simply out of the plot's range (the program limit of approximately  $-2\text{kdB}$ ) as you could have seen by expanding the plot range or looking at the response listing. I wish you had called our technical support to clear this up.

In your "PROBLEMS" section, I have the following comments:

1. Your statement, "No instructions at all are included on how to install the program, copy the supplied disks..." is untrue. As already mentioned, we include a cover letter introducing the program to the customer which provides information on installation and use. The document files on disk provide further information, as you admitted a few pages earlier.

2. Your "messy exit" problem is one we have not seen before in a release version of the program. I believe it may be a problem with your computer system or setup. It would help us to know if another program that runs in EGA or VGA graphics mode on your system does the same thing. We are working to find and, if necessary, correct any problem in this area.

3. The new version of *Low Frequency Designer*, in addition to having support for over 300 printers,

will have scalable output size, portrait or landscape selection, and several other printing enhancements I think you will like.

4. I agree it would be nice to be able to print the "Family" information as you suggest. We may add this capability in a future version. Thanks for the suggestion.

5. The missing port length bug will be corrected immediately. Thanks again.

6. Please try designing a usable, double-vented BP system, and you will see it works fine.

7. You are correct, the tabulated "Error" data does not update properly. Thanks, and this oversight will be corrected immediately.

8. The program makes no assumptions about what a desired response curve should be. If the user does not enter a curve, the program correctly tries to match the default 0dB curve. This is the way we think it should be.

9. The probable bug in the driver cone displacement computation is being investigated. Thanks for the comment.

In your "NIT PICKS" section, we appreciate a number of suggestions we might like to add to a future version of the program. We encourage our users to do the same nit-picking so we can meet their needs more closely.

I was a little disappointed with some of this review. You seem to breeze by the features that make *Low Frequency Designer* unique and useful, such as the FAMILY, CURVE FIT, and SYNTHESIS functions. I think readers who are familiar with the more common methods for designing standard alignments might appreciate a little explanation of how these different tools can be used. I think you underestimate the abilities of some of *Speaker Builder's* readers. Many of them are capable and happy users of *Low Frequency Designer*.

You are correct in stating that *Low Frequency Designer* is a professional-level program and one that does things differently, but I can't agree that the program doesn't do what an "amateur speaker builder has come to expect." *Low Frequency De-*

*signer* does an efficient and accurate job of modeling the low-frequency loudspeaker systems. Compared with other programs we have evaluated, it is more rigorous and user-friendly. This is the opinion of those who use our software—both professionals and amateur speaker builders.

Thanks again for the time and effort you put into the review, and for the many good suggestions. We greatly appreciate the feedback.

Contributing Editor G.R. Koonce responds:

I concede there is a bias in my review of this software; I tried to review it from the standpoint of someone with fixed driver parameters who wishes to design an enclosure for his driver. This viewpoint did not emphasize some of the excellent system synthesis-oriented features of the software as noted by Mr. Chamness.

The one-page printed instruction sheet was missing from the package I received; having now seen it, I feel it lacking in detail. I misunderstood the on-disk documentation with regard to what is stored in the DEFAULT.CFG file and thank Mr. Chamness for clarifying this area.

Once pointed out, the problem I experienced with the double-vented BP design becomes clear. Clearly, my lack of experience with this enclosure type shows through. *Low Frequency Designer* is to be commended for surviving this "null" test. Other software I have tried halted execution with a runtime error. I tried a double-vented BP with unequal chamber volumes and tunings, and the program does work properly with this configuration. I assume the problem with failing to report all duct lengths in the various BP configurations will be resolved along with the fix for the VB systems. 

## Put *SpeakEasy* Designers to Work for You.

creative audio software tools

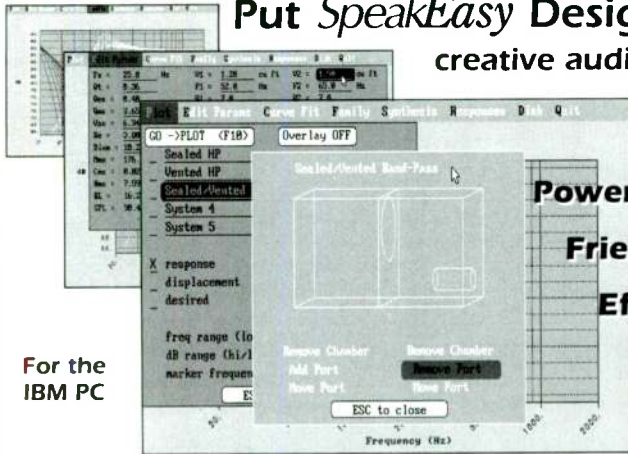

**Powerful**  
**Friendly**  
**Efficient**  
**Versatile**

For the IBM PC

**LOW FREQUENCY DESIGNER 3.0**  
State of the art loudspeaker modeling.

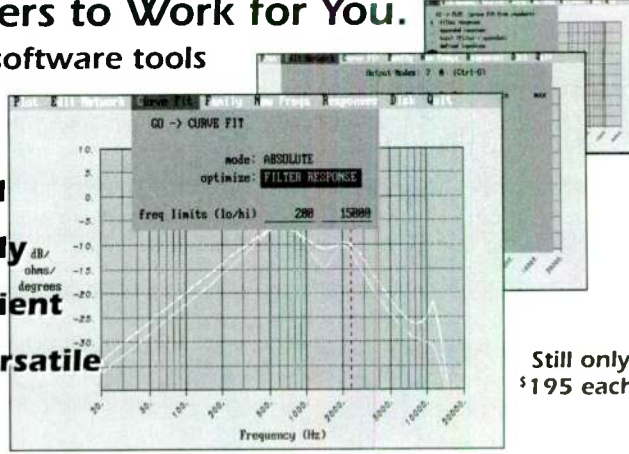

Still only \$195 each.

**FILTER DESIGNER 1.5**  
Flexible passive and active filter design.

CALL TODAY FOR A FREE DEMO DISK TEL: 617-969-1460 FAX: 617-969-5833  
*SpeakEasy* 46 Cook St., Newton MA 01258 USA

Reader Service #27

# Product Review

## Three Affordable Measurement Microphones

By Gary A. Galo  
Contributing Editor

**Josephson Engineering C-550 and C-550A Measurement Microphones.** Josephson Engineering, 3729 Corkerhill Way, San Jose, CA 95121, (408) 238-6062. Frequency Response: 20Hz-20kHz  $\pm$  2dB. Maximum SPL: 130dB. Output: 3-pin balanced XLR. Power: DIN Phantom, 14-52V DC. Output level: 10mV/Pa. Price: \$350. Calibration curve included. Review Samples: SN 121 (C-550) and 769 (C-550A). (C-550L: 50mV/Pa, \$350; C-550H: same as C-550A, \$400. All mikes match within  $\pm$ 0.25dB for use in arrays and other precision work.)

**Neutrik 3382 Measuring Microphone.** Neutrik USA, Inc., 195 Lehigh Ave., Lakewood, NJ 08701, (908) 901-9488. Frequency Response: 20Hz-10kHz  $\pm$  1dB; 10-20kHz  $\pm$  2dB. Maximum SPL: 130dB (133dB w/30V DC supply). Price: \$210. Review sample: SN 1431.

**D'Appolito Mitey Mike Kit.** Old Colony Sound Lab, PO Box 243, Peterborough, NH 03458, (603) 924-6371. Frequency Response: 20Hz-10kHz  $\pm$  1dB; 10-20kHz  $\pm$  2dB. Maximum SPL: 120dBa. Power: 9V battery. Complete Kit Price: \$149. Calibration by Joe D'Appolito: \$20. Do-it-yourself project: No SN.

Until very recently, accurate microphones for room and loudspeaker measurements

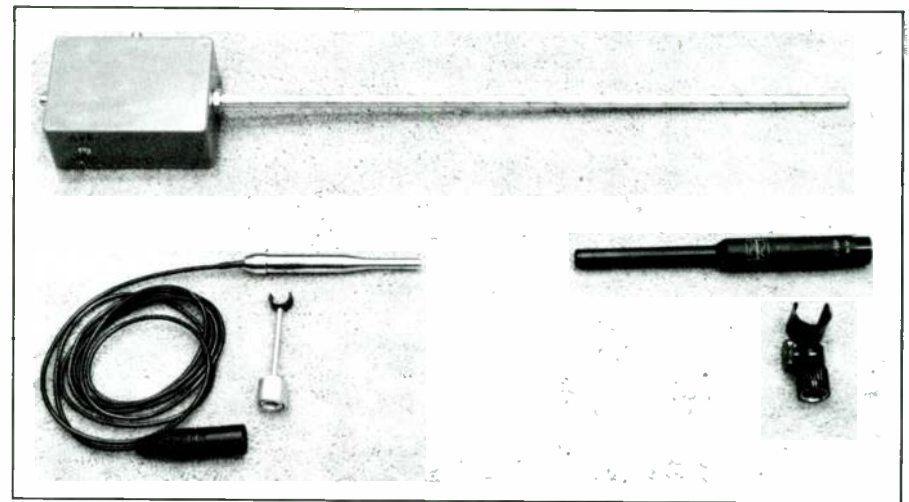

PHOTO 1: Three inexpensive measurement microphones: D'Appolito's Mitey Mike (top), the Neutrik 3382 (lower left), and the Josephson C-550.

from the leading manufacturers have been priced in the four-figure range, putting them out of the reach of most speaker builders. We've sorely needed a microphone somewhere in quality and price between Radio Shack's \$29.95 sound-level meter and these expensive industry standards. I herewith offer an evaluation of three affordable microphones which I've used for previous *SB* loudspeaker kit reports (Photo 1).

### Josephson C-550

At the 1989 AES convention, Josephson Engineering exhibited a mike that appeared to be the speaker builder's dream: the C-550, especially made for loudspeaker and room measurements. It features an electret condenser capsule in a sleek, machined-brass housing with a matte-black chrome plating, requires standard-DIN phantom powering, and operates over a wide supply-voltage range

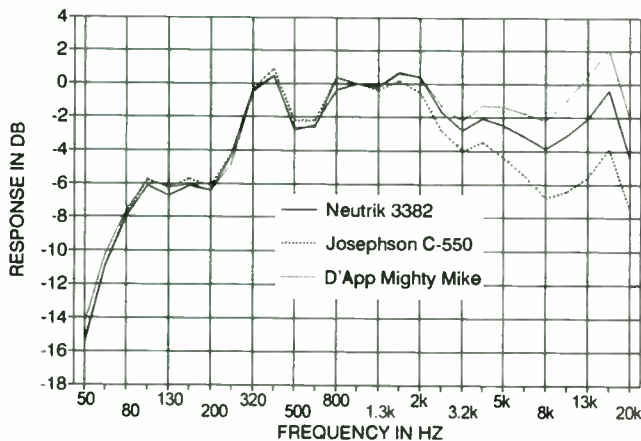

FIGURE 1: 1/3-octave, 1W/1M response of Audio Concepts Little V loudspeaker using the Neutrik, Josephson C-550, and D'Appolito microphones.

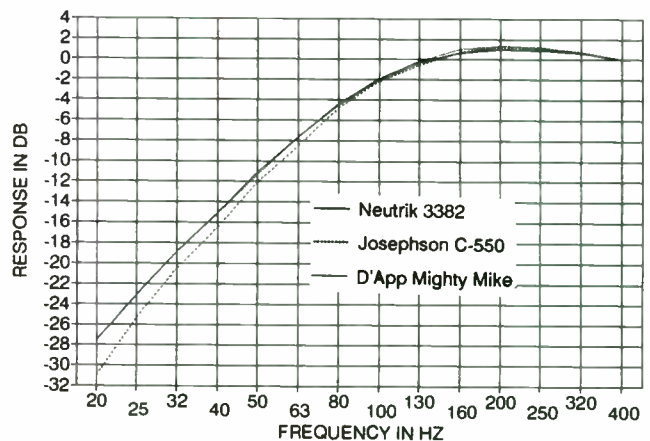

FIGURE 2: Near-field response curves using the three mikes. The Neutrik and D'Appolito mikes are identical, but the Josephson shows some additional low-frequency rolloff.



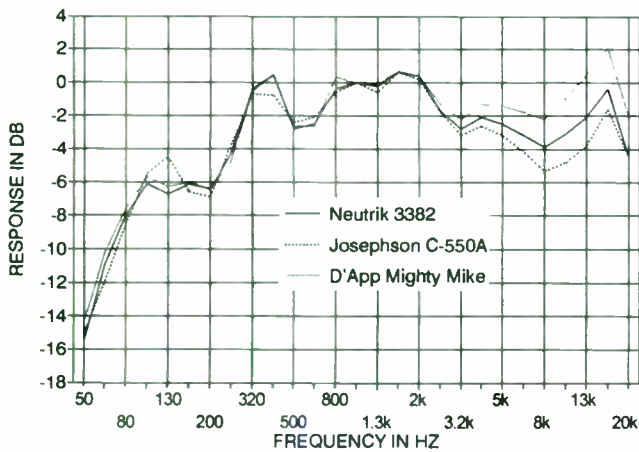

FIGURE 3: 1/3-octave, 1W/1M response of the Little V loudspeaker with the new Josephson C-550A, the Neutrik, and D'Appolito mikes.

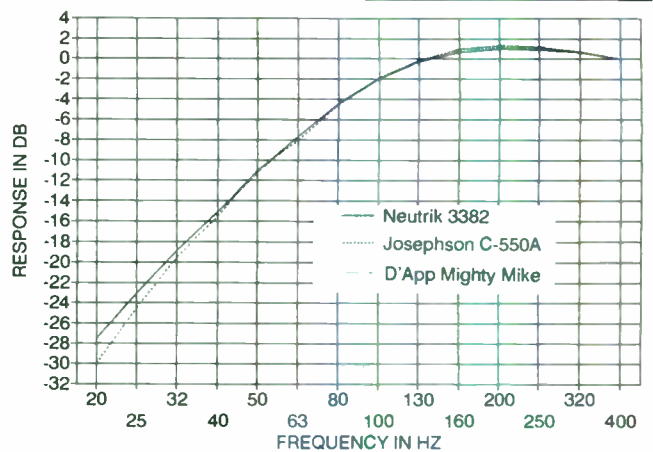

FIGURE 4: Near-field, low-frequency response curve of the new Josephson C-550A, Neutrik, and D'Appolito mikes.

from 14–52V DC. The business end of the C-550 is only 12.8 mm in diameter to reduce diffraction. The mike housing expands to the standard 21 mm diameter at the rear, so conventional mounting adapters can be used; a plastic swivel adapter is included. An industry-standard 3-pin XLR connector is mounted in the rear of the housing. Each C-550 is supplied in a padded case, with an individual-response calibration curve.

I needed an accurate loudspeaker and room-evaluation measurement microphone for my production studio at the

Crane School of Music, so I had the school purchase the C-550. The school's budgetary limitations made the \$350 price seem ideal. I used this microphone while preparing my reviews of Audio Concept's Sapphire II and Little V loudspeakers (*SB* 6/90, p. 56; 5/91, p. 46).

When I heard rumors of calibration problems in early samples of the C-550, I contacted David Josephson. He said some samples did roll off prematurely above 16kHz, and offered to recalibrate my mike for free if I would simply ship it back to him, which I did. In a short

time, the mike was returned to me, complete with a chart indicating flat response to 20kHz  $\pm$  1dB.

#### Neutrik 3382

At the 1991 New York AES, I visited the Neutrik booth and arranged to receive a review sample of their model 3382 Measuring Microphone. The Neutrik 3382 is actually an accessory for their Audio-graph 3300 audio and acoustic-measurement system, and can be purchased separately for \$210. Like the Josephson, the 3382 uses an electret condenser capsule.

## Roy Allison's Famed Tweeter Now Available

**RDL**  
ACOUSTICS

RDL drive units are made by hand in our Massachusetts factory which overlooks the headwaters of the Charles River. We don't claim that the location gives them any special virtue; *that* comes from decades of experience in design and manufacture of what many consider to be among the finest systems available. Our pulsating-dome tweeter, for example, has wider and more uniform dispersion than any other. Our woofers have lots of overhang, linear suspensions, and smooth response. We are now offering these drive units separately.

**For Specifications and Ordering Information:  
Call 1 800 227 0390**

RDL Acoustics  
26 Pearl Street, # 15  
Bellingham, MA 02019

The mike housing is made of chrome stainless steel, and is extremely slender in profile. The capsule end is 7.5 mm in diameter, increasing to 14 mm at the rear. A 6' cable, terminating in a standard, 3-pin XLR plug, is connected directly to the microphone. Altogether, the Neutrik is a beautifully machined product.

The 3382 requires DIN phantom powering, and will operate with supply voltages from 10–30V DC. The mike is supplied with a nonswivel stand adapter, foam windscreen, and padded plastic case. Each unit comes with an individual calibration curve; the one supplied with my review sample showed the mike well within published specs, flat to 20kHz  $\pm$  1dB. The nonswivel stand adapter can be a bit of a nuisance, since even the smallest movement of the mike requires moving and repositioning the entire stand.

### Mitey Mike

Joe D'Appolito's Mitey Mike project was described in *SB 6/90* (p. 10), and Old Colony offers it as a kit with a reprint of the article included. Old Colony sells the Mitey Mike for \$149, and Joe D'Appolito will calibrate it for you for a mere \$20. I highly recommend having the calibration done, as it's the only way to know exactly what your mike is doing.

Like the Josephson and Neutrik mikes, the Mitey Mike also uses an electret condenser capsule, although it differs considerably in other respects. To minimize diffraction, the capsule is housed at the end of an 18" brass wand which is fastened to a small plastic project box containing the power supply and preamp. Phantom powering isn't required: a standard 9V battery supplies the necessary power. The output is unbalanced, and my sample has an RCA output jack.

The Mitey Mike's output voltage is quite high compared to most other microphones. A sound-pressure level of 120dB produces a 0dBm output, and even at 70dB the output is a hot -50dBm. Normally, you don't need an outboard mike preamp. The Mitey Mike was designed to directly feed the input of any AC voltmeter with a calibrated decibel scale.

Joe tells me that the plastic box supplied with the Old Colony kit is large enough to cause some diffraction. This won't affect warble-tone-frequency-response measurements, but it will affect MLSSA cumulative-spectral-decay measurements. He recommends using a square piece of Sonex, which reduces the reflections by around 10dB. Simply poke a hole in the center of the Sonex, push the wand through the hole, and move the Sonex all the way back.

### Test Results

To compare the mikes, I ran  $\frac{1}{3}$ -octave warble-tone curves on an Audio Concepts Little V loudspeaker. *Figure 1* shows the 1W/1M results from 50Hz to 20kHz. The

three mikes differ above 1.3kHz: the Mitey Mike is roughly 2dB higher than the Neutrik above 8kHz; the Neutrik is between 3 and 4dB higher than the Josephson in the same frequency range. Since both the Mitey Mike and the Neutrik have tolerances of  $\pm$  2dB above 10kHz, one mike could be roughly 1dB low and the other 1dB high, and still be within spec. On the other hand, the C-550 seemed to be out of bounds. It originally had the tightest factory spec ( $\pm$  1dB to 20kHz), but in their latest product literature Josephson had relaxed the tolerance to  $\pm$  2dB. I still questioned its high-frequency ac-

curacy, since it was so far below the other two mikes.

Below 1.3kHz, the Mitey Mike and the Neutrik are so close that the differences are no cause for concern. I also ran near-field measurements from 400Hz down to 20Hz (*Fig. 2*). As these curves indicate, the Mitey Mike and the Neutrik are identical. The Josephson rolls off faster below 50Hz, and at 20Hz it is over 3dB lower than the other two.

### New Josephson

I considered the review complete at this point, and a proof copy was sent to all

## Graphs with Quattro Pro

If you use a personal computer, a spreadsheet program can be a powerful tool for turning your loudspeaker measurements into publication-quality graphs. I've used Borland's *Quattro* for about two years, and had recently upgraded to *Quattro Pro 3.0* at the time I prepared this report. *Quattro Pro 4.0* is currently available, and there's also a special version for Microsoft Windows. *Quattro Pro* has become one of the most respected spreadsheet programs available, perhaps rivaled only by Microsoft's EXCEL (also available for Windows). I've found *Quattro Pro* ideal for making loudspeaker measurement graphs.

My printer is a Hewlett-Packard DeskJet 500, an inkjet printer which produces graphs and documents that closely approach laser-printer quality. All of the graphs in the article were printed on my DeskJet 500 in the high-resolution 300  $\times$  300 mode.

Preparing a spreadsheet to produce a frequency-response graph is really quite easy. Horizontally, the *Quattro Pro* screen is divided into columns; vertically, it is divided into rows. At each intersection of a column and a row, there's a space called a cell for entering numerical data or comments.

*Table A* shows a spreadsheet I created to plot the frequency response of the Audio Concepts Little V loudspeaker. At the top, I describe the spreadsheet and briefly note how the measurements were made. Just below the descriptive comments, I label each column. The first column contains the  $\frac{1}{3}$ -octave frequencies produced by my Old Colony Warble Tone Generator from 16Hz to 20kHz. As I mentioned in the article, Joe D'Appolito supplies a calibration printout which shows your mike's response relative to his calibrated Neutrik 3382. I use this data to obtain a "corrected" response graph.

The second column contains the corrections necessary for my Mitey Mike above 1kHz. If Joe's calibration data shows your mike to be +1.4dB at 6.3kHz, the necessary correction at this frequency is -1.4dB, so you enter that figure in the cell corresponding to 6.3kHz. The data Joe supplies makes interpolation quite easy. The third column contains the measurements made with

D'Appolito's Mitey Mike above 1kHz; the fourth column contains the corrected response data above 1kHz.

A spreadsheet program is designed to perform calculations, so it's ideal for using calibration data to provide a "corrected" measurement. *Quattro Pro* uses the command "@SUM" to add data in two columns. To derive the corrected response, you must add the correction data to the measured data. To correct the 1kHz response, move to the 1kHz cell in the fourth column (row 29 in my sample). Instead of

TABLE A

### AUDIO CONCEPTS LITTLE V LOUDSPEAKER

#### Sample #2

$\frac{1}{3}$ -octave warble-tone response—1W/1M

FREQ. in Hz	MITEY MIKE Correction	LITTLE V Measured	LITTLE V Corrected
16	—	—	—
20	—	—	—
25	—	—	—
32	—	—	—
40	—	—	—
50	—	—	-14.3
63	—	—	-10.2
80	—	—	-7.6
100	—	—	-5.7
130	—	—	-6.3
160	—	—	-6
200	—	—	-6.4
250	—	—	-4.8
320	—	—	-0.5
400	—	—	0.4
500	—	—	-2.6
630	—	—	-2.6
800	—	—	0.3
1k	0.2	0	0.2
1.3k	-0.05	-0.1	-0.15
1.6k	-0.16	0.7	0.54
2k	0.01	0.4	0.41
2.5k	-0.4	-1.3	-1.7
3.2k	-0.6	-2.2	-2.8
4k	-0.7	-1.3	-2
5k	-0.9	-1.4	-2.3
6.3k	-1.4	-1.8	-3.2
8k	-1.65	-2.2	-3.85
10k	-1.7	-1	-2.7
13k	-1.3	0.5	-0.8
16k	-0.8	2.1	1.3
20k	0.2	-2.1	-1.9

three manufacturers. David Josephson was understandably concerned with the rather poor showing of his C-550: first, he wanted to send me a more recent production sample; then, he questioned my measurement methodology; finally, he questioned the ethics of *Speaker Builder* in publishing a very favorable review of the Mitey Mike. (The magazine's subsidiary, Old Colony Sound Lab, sells the microphone kit.) Mr. Josephson and I had some lengthy correspondence regarding these issues, and I believe we have now resolved them to our mutual satisfaction.

Let me state for the record that *none* of

the authors or contributing editors who write for *Speaker Builder*, *Audio Amateur*, or *Glass Audio* are employed by Audio Amateur Publications, Inc. We all have our own day jobs and write for these magazines (and, in some cases, others) "after hours." I have no vested interest in these magazines or in Old Colony Sound Lab. If I had reached negative conclusions about the Mitey Mike, this review would have reported them.

I should also stress that this review is not intended for professional loudspeaker and/or microphone manufacturers. I am reporting these findings for typical *SB*

readers, who normally do not have access to anechoic chambers and perform loudspeaker measurements in their listening rooms. Only a modest percentage of you will have access to measurement systems as sophisticated as MLSSA and will probably use warble tones or pink noise as a source. Consequently, I have evaluated these mikes under conditions similar to those encountered by the majority of readers, rather than members of the Audio Engineering Society.

As David Josephson correctly stated, if the measurement environment isn't anechoic, differences in microphone geometry will cause measured differences in their high-frequency response. Therefore, he doesn't find absolute comparisons between mikes valid if they are measured in an actual listening room. He pointed out that mikes with larger physical dimensions will be more prone to high-frequency measurement errors in a reflective environment than smaller mikes. (The Josephson microphone has the largest physical dimensions of the three.)

He promptly sent me a current sample of the C-550A, which I measured under the same conditions as the C-550. The results shown in Fig. 3 include the same Neutrik and D'Appolito curves as in Fig. 1. The C-550A is considerably improved in its high-frequency performance. At 20kHz, it is identical to the Neutrik and is no more than 2dB lower between 1kHz and 16kHz. The C-550A's near-field response below 400Hz, and that of the other two mikes, is shown in Fig. 4. Its low-frequency performance is also closer to the other mikes.

I plotted the average of these mikes above 1kHz (Fig. 5). The Neutrik is virtually identical to the average of the three curves. The D'Appolito calibration data actually correlates quite nicely with my measured differences between the Mitey Mike and the Neutrik. Since none of these microphones claim accuracy greater than  $\pm 2$ dB to 20kHz, none of them appear to deviate beyond reasonable bounds and all can be considered within specified limits.

Joe's calibration data could be extremely helpful in preparing more accurate frequency-response graphs. He supplies an expanded graph in large 0.5dB increments, and a printout for each frequency with the corresponding error relative to his own calibrated Neutrik 3382. I explain in the sidebar how a spreadsheet program can use this data to make the necessary corrections.

Figure 6 is my graph of the Neutrik mike and the corrected Mitey Mike, with virtually identical curves up to 8kHz. The differences above 8kHz are inconsequential and could be the result of a  $\pm 1$ dB calibration difference. In fact, I place more faith in the corrected Mitey Mike curve, since the corrections are referenced to Joe's own Neutrik which he calibrated himself to an ACO 7012.

entering a number in this cell, enter the following command: @SUM (B29..C29). This will automatically put the sum of columns two and three in column four. Then move to 1.3kHz (fourth column, row 30) and enter: @SUM (B30..C30).

Repeat this for each frequency above 1kHz using *Quattro Pro's* Copy command. You'll notice that the third column is blank below 1kHz. Frequencies below this are so close that they don't require any corrections. I entered the measured data directly into column four below this frequency.

I find it useful to create templates for the various types of measurements I normally make. My " $\frac{1}{2}$ -Octave/1 Meter" template already has the frequencies entered in the first column, the correction data in the second column, and the various "@SUM" commands in the fourth column. Another is for near-field response measurements, and contains only the  $\frac{1}{2}$ -octave frequencies below 400Hz. A third is for impedance curves, with all of the  $\frac{1}{2}$ -octave frequencies but without the microphone correction data.

I often plot the left and right loudspeakers on the same graph. In this case, I have "measured" and "corrected" columns for each loudspeaker. The second loudspeaker's "corrected" column contains its own set of "@SUM" commands. You can even select different line styles for the two loudspeakers. Even though my  $\frac{1}{2}$ -octave template goes down to 16Hz, I don't always

use the lowest frequencies. For the Little V, my 1W/1M measurements stopped at 50Hz.

Figure A is the graph produced by the Table A spreadsheet. Once you've built your spreadsheet, you need to enter the "Graph" menu and instruct *Quattro Pro* on how to make the graph. First, tell the program that you wish to create a line graph. Then, select the "Series" option and define the X-axis series. You must also define the series values for each line you wish to plot. If you're plotting the left and right loudspeakers, you'll have first and second series values to define.

*Quattro Pro* has several text options, including X and Y axis titles and fonts. Under the "Customize Series" option you can specify line styles and colors. *Quattro Pro* offers eight different line styles—including four heavy lines. On my DeskJet 500, however, there's no difference between normal and heavy lines when they're printed in the high-resolution mode. The "X-Axis" and "Y-Axis" options allow you to customize how the "X" and "Y" values will appear, the increments between displayed values, and the like.

Overall, *Quattro Pro* offers graphics capabilities which I've found extremely useful as a loudspeaker reviewer. With a high-resolution printer, I can produce accurate, publication-quality graphs which rival those made by professionals.

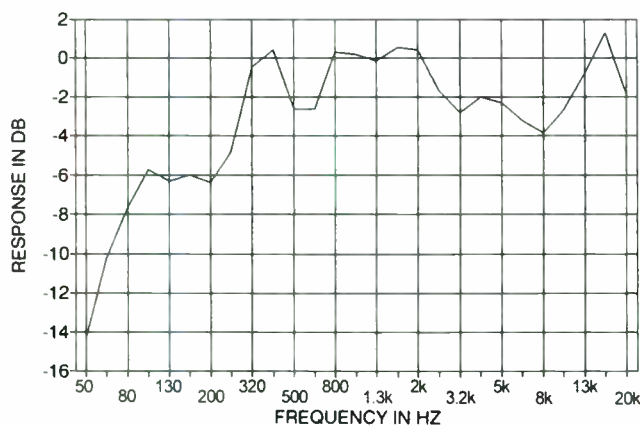

FIGURE A: Spreadsheet-generated graph.

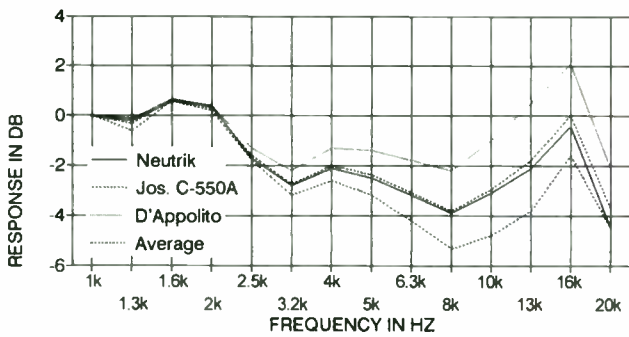

FIGURE 5: Expanded graph showing the Little V response with the three mikes above 1kHz, and the average of the three. The Neutrik 3382 is extremely close to the average.

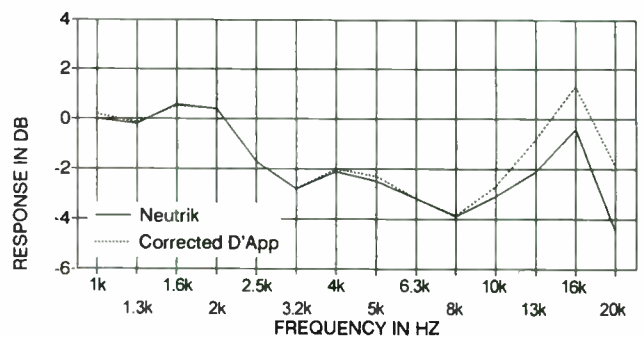

FIGURE 6: The Neutrik 3382 compared to D'Appolito's Mitey Mike with corrections. Since the mikes have a tolerance of  $\pm 2$ dB at 20kHz, they can be considered within specified limits.

### Conclusions

Although I wasn't too enthusiastic about the original Josephson C-550, the C-550A is considerably improved in its high-frequency performance. If cost isn't a concern, both the Neutrik 3382 and the Josephson C-550A can be safely recommended. In the fall of 1991, Josephson introduced the model C-550L with a built-in preamp. It has a line-level output which allows direct connection to an AC voltmeter or other analysis system. The original C-550L was supplied with a 12V power supply, but the current production versions use standard-DIN phantom powering. With the exception of increased output level, the C-550L is identical to the C-550A.

Josephson Engineering also manufactures a complete line of affordable condenser microphones for recording applications. Some of their products are unique, especially their Jecklin Disk for the Optimum Stereo Signal (OSS) recording method developed by Jürg Jecklin. I don't know of any mike manufacturer who sells a Jecklin disk. Both amateur and professional recording engineers will find quite a few interesting products in the Josephson catalog.

A calibrated Mitey Mike may be the best choice of all. Joe D'Appolito has done speaker builders a great service by designing and offering such a fine microphone at such a ridiculously low price. With the optional calibration (imperative in my opinion), you'll have an extremely reliable

measurement tool. Since the Mitey Mike is powered by a 9V battery, no extra costs are required to get you up and running. Both the Josephson and the Neutrik mikes require a DIN-compatible phantom power supply. The least expensive namebrand phantom supply I've found is the AKG N62E (\$110).

If you purchase the Josephson or Neutrik microphones, you'll also need a mike preamp which will add even more expense to the total package. You could use a tape deck's, but most home recorders have unbalanced inputs. To use these mikes with a home tape deck, you'll need to buy a balanced-to-unbalanced transformer. If you do this, you should measure the transformer/mike preamp combination's frequency response. You'll find

## Dear Canadian Subscriber,

Maybe it's because we are in a small town, but our bank just cannot seem to make a decision regarding Canadian remittances. We are being charged exorbitant fees for processing all but the most clearly defined checks. The details of acceptable checks are below, please help us out by making every effort to follow these guidelines to aid in our quick processing of your orders.

*Thank you.*

- ☛ All checks must be drawn in US dollars and must list a corresponding bank in the United States. This service is available at your bank.

<b>THE TORONTO-DOMINION BANK</b>		1-324/260
ON DEMAND PAY TO THE ORDER OF	AUDIO AMATEUR	NOVEMBER 06, 1992
*****37.95		
TOR-DOM BANK ★ 37USD95 ★		DOLLARS UNITED STATES CURRENCY
NOT TO EXCEED U.S. \$1000.00 CHARGE ACCOUNT OF INTERNATIONAL CENTRE TORONTO		<i>Richard [Signature]</i> PRESIDENT
TO THE TORONTO-DOMINION BANK NEW YORK BRANCH 42 WALL STREET NEW YORK, N.Y.		<b>NOT NEGOTIABLE</b>

- ☛ If you use a Canadian Postal Money Order, have it written in US\$.
- ☛ If you have access to a Mastercard or Visa, this is the fastest and easiest method of payment.

many cases, especially with inexpensive home equipment, where the response is at least 1dB down at 20kHz. Some low-frequency rolloff is also common. The frequency response of the preamp and transformer must be taken into account when you make loudspeaker measurements. AKG makes the N62ET phantom supply (\$180), which has built-in transformers.

Many inexpensive mike preamps have limited headroom. Peaks in the loudspeaker response can easily drive them into clipping, at which point all measurements are worthless. Monitoring the tape recorder's VU meters won't help: the tape deck's mike preamp can be clipping and yet the record electronics may still have plenty of headroom. You really must monitor the tape deck output on an oscilloscope to be certain the preamp isn't clipping. Don't ever rely on tape recorder meters for measurements, as most of them give inaccurate frequency-response readings. You should connect an AC voltmeter to the tape deck's line outputs.

All things considered, you can appreciate what a great bargain the D'Appolito Mitey Mike really is. You won't find a better loudspeaker-measurement mike anywhere close to the price. Of the three affordable mikes considered here, I've decided that Joe D'Appolito's calibrated Mitey Mike is the best choice.

David Josephson of Josephson Engineering responds:

*It's difficult to make a mike that is completely flat, and none of the samples claim to be. Joe D'Appolito has provided corrections to be applied to the Mitey Mike, and Gary has applied them in the "corrected" curves. That's entirely appropriate. However, corrections are also supplied with the C-550A and Gary has not mentioned them, nor has he applied them to the data. Much of the variation in the curves above 10kHz is a result of this, and if Mitey Mike corrected data is shown, the other types providing correction information should be given the same treatment. Much of the cost of the mike is in preparing an accurate calibration curve—for the article to ignore this in one product and to show it prominently in the discussion of another is indefensible.*

*It would really help for the magazine to provide more information so that builders can understand a little more about the measurements they are making. It is too easy to assume that data generated by a measurement is correct without considering the various error sources that are present. Our ears do a good job sorting out between the direct and reflected sounds; omnidirectional measurement microphones cannot, and any measurement will include the effects of reflected sounds.*

*In some cases (low-frequency response changes versus speaker distance from a wall, for instance), this information is very important; in others, it only introduces error. Any*

*simple averaging technique (spatial averaging, warble tones, and the like) will reduce the effect of reflections but not eliminate them. Synchronous techniques like MLSSA, TDS and IMP can reduce these effects to a few tenths of a decibel. More importantly, even simple synchronous methods like IMP give the user a clue about how inaccurate the measurement is.*

Contributing Editor Gary Galo responds:

The D'Appolito mike is the only one which comes with a numeric calibration printout in addition to a frequency-response graph, which is why his calibration data is so easy to use for corrections. Data from a graph is more difficult to interpret, and less accurate, than from a numeric printout. Therefore, D'Appolito's calibration data is the only data I believe is suitable for use in making corrections. I may not have made it clear that "calibration data" refers to the numeric printout. I apologize for this confusion. I'm not faulting Josephson or Neutrik for failing to provide numeric data—hardly any mike manufacturers do. But, since D'Appolito does, I believe it is sensible to make the best use of it.

In a September 28, 1992 letter from David Josephson, he states that the C-550A and the C-550L are "identical but for increased output level for use without a preamp." That's all the information he provided, so that's all I wrote. ➤

## CLEARANCE CORNER TELEPHONE ORDERS ONLY!

### Slightly Damaged Books

301,302,303, 304 Circuits **\$4.95 ea.**

K-1 Recording Index **\$1.**

OCSL Grab Bag **\$1.**

CRL PA1008 3-Sec 3P11T Shtg. Rotary Switch **\$5.**

CRL PA49 1P10T Prog. Shtg. Phenolic Section **50¢**

- ALL SALES FINAL
- MC/VISA WELCOME
- SUPPLIES LIMITED

## OLD COLONY SOUND LAB



(603) 924-6371  
(603) 924-6526

# GLASS AUDIO

**Vacuum Tubes are Back... and sound better than ever**

*Glass Audio* features the best vacuum tube designs for audio reproduction—past and contemporary. The new designs take advantage of improved components and control techniques that make the end results far superior to anything possible during the early days of audio's rebirth after World War II.

That's why tubes are having such a renaissance of interest as a perfectionist approach to good sound. And that's why tubes are reappearing in original equipment, in high end consumer and professional audio systems.

Published quarterly, *Glass Audio* will inform you about new innovations in the field and about parts sources. We'll also include modification projects, reviews of technical basics and regular columns such as Tube Troubles, Tube Tips and much more.

Subscribe today!



### GLASS AUDIO

- Two years (8 issues) **\$35**  
 One year, (4 issues) **\$20**

Canada add \$4 per year postage.  
Remit in US \$ drawn on a US bank.

NAME \_\_\_\_\_  
STREET & NO \_\_\_\_\_  
CITY \_\_\_\_\_  
STATE \_\_\_\_\_ ZIP \_\_\_\_\_  
MC OR VISA NUMBER \_\_\_\_\_ EXPIRE \_\_\_\_\_

### AUDIO AMATEUR PUBLICATIONS, INC.

PO Box 176, Dept. B93  
Peterborough, NH 03458-0176  
(603) 924-9464 FAX: (603) 924-9467

Answering machine for credit card orders only:  
before 9:00 a.m., after 4:00 p.m. and weekends.  
Have all information plus MC/VISA available.

# SB Mailbox

## HARD BARGAIN DRIVER

It's happened for the Nth time. My anticipation turned first to apprehension, then to disgust, when my new "Prestige" woofer buzzed and the replacement sped out with  $f_3$  10Hz too high. My initial burst of enthusiasm ten years ago has been dissipated by a steady stream of drivers that seldom meet their wildly optimistic specs. I would undoubtedly have bought and built more than a few dozen drivers if each purchase hadn't required the willing suspension of disbelief.

Quality control is a customer-driven phenomenon. You can bet that Snell and Vandersteen aren't accepting the consistently degraded products we individual consumers are sold. The only way we can force the distributors and manufacturers to supply a predictable product is to return deficient drivers at a rate that will make honest advertising and quality assurance their only economical choice.

W.S. Mitchell  
Jamaica Plain, MA 02130

## HORNS APLENTY

I have been asked to look into building a speaker system for my daughter's gymnastics club, so I've been reviewing Bruce Edgar's horn articles. The gymnasium, located in a warehouse-type building, is approximately 100' x 50' x 30', so a horn system would seem to be indicated.

Real high fidelity is less of a priority than low cost and high efficiency/SPLs, and a monosystem is a possibility. The system would be used for PA, and for providing background music for the gymnasts' routines. Space is not a problem; if I get the system off the floor, it could be huge. A straight horn would be OK.

Your "Show Horn" article (SB 2/90, p. 10) would be a good starting point, but the EV driver is fairly rich for our budget. The 70Hz horn ("A 70Hz Mini Horn," SB 2/83, p. 7) was what I first thought of, but

the Pyle driver W6C200F is not available (at least I haven't located it yet). I also have the impression that you now consider it misdesigned, since it uses the Tractrix expansion.

I did find two possible substitutes: the Pioneer C16EU20-52D, a 6.5" poly woofer with  $f_s = 52$ ,  $Q_{TS} = 0.23$ ,  $Q_{ES} = 0.25$ ,  $V_{AS} = 0.81'$ , 93dB, 20 oz. magnet; and the Pioneer C16LU20-51F, a paper cone 6.5" woofer with resin coating, 93dB,  $V_{AS} = 0.53'$ ,  $Q_{TS} = 0.22$ , and  $Q_{ES} = 0.23$ ,  $f_s = 57$ , 20 oz. magnet. Neither has the huge magnetic structure you indicate, but otherwise look close; both are in the Parts Express catalog.

I haven't found anything else comparable to the EV you used in the show horn. My original idea was to build the 70Hz horn and mate it to a Motorola piezo driver/horn combination. Over the years, I have yet to read an article in favor of piezo drivers, so I'm suspicious of them. They may be fine, however, for both the application and the budget. I could perhaps avoid having to do much in the way of a crossover, as well, and thought this

combination would make an effective and inexpensive system.

I would like to find out what you think of these ideas, and whether you have any experience with these units or would suggest others. Also, what are your thoughts on horn design, since you seem to have moved away from the Tractrix expansion?

Stephan E. Katz  
Topeka, KS 66614

Contributing Editor Bruce Edgar replies:

I agree that the 70Hz horn would make a good basis for a PA system. Recently, I took back my original 70Hz horns in trade for an upgrade to a friend's system. I was pleasantly surprised by how good they sounded, after ten years.

In terms of drivers, the C16EU20-52D has a 416Hz mass roll-off and a 8.4 in.<sup>2</sup> optimum throat size; the C16EU20-51F has a 495Hz mass roll-off and a 5.6 in.<sup>2</sup> optimum throat size. Both models will work, but the 52D will better match the 70Hz horn throat. The replacement driver for the original Pyle 6.5" driver (368Hz mass roll-off and 7.6 in.<sup>2</sup> optimum throat size) is the Pyle W6520-4 (MCM #55-650). The choice of a woofer is really between it and the Pioneer 52D. The Pyle woofer is the 4Ω version, and the impedance will go up to 8Ω when loaded by a horn. I suspect the Pioneer's impedance is 8Ω, which will be higher when the horn is loaded.

For a wider bandwidth, I recommend you make the 70Hz horn corner reflectors larger, so the driver's higher mass roll-off can be used. Otherwise, the corners will always roll off the response at 300Hz. The outside walls can be stiffened with 1" x 1" pine strips around the mouth openings, and you can use 3/4-inch-thick particleboard instead of the specified 1/2" thickness for the outside walls.

The Motorola piezo driver has a rated sensitivity of 93dB, which will not match the 70Hz bass horn's sensitivity of 105dB. Besides, there will be a big hole in the response where the bass horn rolls off and the 800Hz Motorola tweeter/midrange horn turns on. I recommend that you make a midrange horn from my article, "The Edgar Midrange Horn" (SB 1/86, p. 7). The Pyle MH516 5" stage monitor (MCM #55-320) will load a 300Hz tractrix horn shortened at the throat to 9" length. With a 1/2" air gap at the throat, the Pyle 5" driver will give a flat 500Hz-5kHz response with 100dB sensitivity. A Pyle H2610 horn tweeter (MCM #53-195) will fill in the top end.

The whole system can be integrated with a 6dB

## Glad you asked that! Good Idea!

You really have some great ideas, so why not share them with your fellow readers? We love to receive typed letters (or even better, a word processor file or output) including clearly written comments and questions. Not everyone's penmanship is easily discernible—please don't make us guess.

If you are responding to a previously published letter or article, please identify it by author; it helps us research and get the answers or comments you seek. In addition, please include your full name and address on your letter in case we need to contact you (and your envelope goes south).

Direct your comments, questions, and concerns to *Speaker Builder*, PO Box 494, Peterborough, NH 03458-0494.

One more thing... a SASE always puts your letter on the top of the pile.

crossover at 500Hz and 5kHz, and the bass horn's higher sensitivity can be trimmed down with an L-pad. The resultant system will sound better than the typical PA system, and will certainly be appreciated by your daughter's gymnastics club.

## INFINITY ISSUE

I am compelled to add to the discussions found in two exchanges: the first in *SB* 6/92 (p. 46) between Dick Crawford and Gary Galo, and the second in *SB* 5/92 (p. 66) between Tom Sharpe and Gary Galo. Both exchanges left open some issues of importance to audiophiles in general, and to speaker builders in particular.

In the first exchange, Gary Galo attempted to give a well-researched answer to Dick Crawford's letter, but left readers with the impression that the subject matter was arcane and not well understood. Actually, nothing could be further from the truth. Direct answers, based on well-established theory, exist to all the issues and questions raised.

All conventional audio amplifiers, whether tube or transistor design, attempt to present a low-impedance voltage source to the speaker. The most direct way to model such an amplifier's output is with a resistor in series with an ideal voltage source, as shown in *Fig. 1*.

The resistor  $R_O$  represents the amplifier's output impedance, which for almost all modern transistor amplifiers is typically less than  $0.2\Omega$  or so. The output impedance is not purely resistive, as I have shown. Nevertheless, it is accurate enough for our present discussion.

For some unfortunate reason, it has become customary to express amplifier output impedance as damping factor, which is simply  $8/R_O$ . From the model, it is clear that any impedance in the speaker cables is in series with the amplifier's output impedance and, therefore, the two impedances simply add.

To understand how the amplifier and cable impedances interact with the loudspeaker's own voice coil resistance, we need an electrical model of the loudspeaker. Fortunately, such models have existed for years and have been thoroughly analyzed by such people as Beranek and Small (*Fig. 2*).<sup>1</sup>

Where:

$E_O$  = amplifier output voltage

$R_O$  = amplifier output impedance and speaker cable resistance

$R_E$  = voice coil resistance

$C_{MES}$  = electrical capacitance due to driver mass

$$\frac{M_{AS} \times S_D^2}{Bl^2}$$

$L_{CES}$  = electrical inductance due to driver compliance

$$\frac{C_{AS} \times Bl^2}{S_D^2}$$

$R_{ES}$  = electrical resistance due to driver suspension losses

$$\frac{Bl^2}{S_D^2 \times R_{AS}}$$

We clearly see that the amplifier output impedance, cable and voice coil resistances effectively add. The next question we should ask is what effect this added resistance has on the speaker.

Luckily, a direct answer is once again available. As we all know, speakers have a  $Q$ , commonly called  $Q_{TS}$ .  $Q_{TS}$  is calculated from the speaker's electrical  $Q$  ( $Q_{ES}$ ) and its mechanical  $Q$  ( $Q_{MS}$ ) by the formula:

$$Q_{TS} = \frac{Q_{ES} \times Q_{MS}}{Q_{ES} + Q_{MS}}$$

In the same article, Small indicates that the source resistance ( $R_O$ ) added to the

voice coil resistance ( $R_E$ ) modifies the  $Q_{ES}$  (and therefore the  $Q_{TS}$ ) of the speaker by the formula:

$$Q_E = Q_{ES} \frac{R_O + R_E}{R_E}$$

The following example will illustrate the effect of a  $1\Omega$  source impedance on a typical speaker with  $Q_{MS} = 3$ ,  $Q_{ES} = 0.3$ ,  $Q_{TS} = 0.27$ , and  $R_E = 5.8\Omega$ . Small's formula shows that the combined voice coil and source resistance will produce a new electrical  $Q$  for the speaker of 0.35. This new  $Q_E$  will then combine with  $Q_{MS}$  to produce a new  $Q_{TS}$  of 0.31. Such a change would produce a small, but probably audible, modification of a speaker's low-frequency response.

The effective change in voice coil resistance also causes a reduction in the speaker's efficiency. Once again, from Small's article, we learn that reference efficiency is inversely proportional to  $R_E$ . Therefore, in the example above, the speaker's efficiency would be 5.8/6.8 times its former value, a drop of about 1.4dB.

In his response to Dick Crawford, Gary Galo asserts that "it is possible for a loudspeaker in an enclosure to have an impedance lower than the voice coil's DC resistance." I hope I have not misinterpreted Mr. Galo's words, but this assertion is simply incorrect.

Unless an additional energy source is added to the cone, the best a resonant enclosure with infinite  $Q$  can do is to increase the acoustic load on the loudspeaker's cone to the point that the cone is effectively clamped. At this point, the speaker's impedance is simply that of its voice coil. I realize this explanation may be unsatisfactory, but space constraints prevent me from elaborating.

Finally, I would like to comment on the Sharpe/Galo exchanges. Actually, I wish to take issue with neither Galo nor Sharpe, but with the editor. Sharpe states

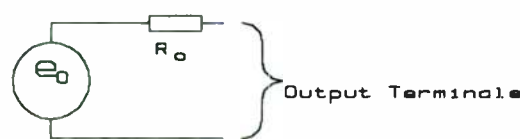

FIGURE 1: Resistor in series with a voltage source.

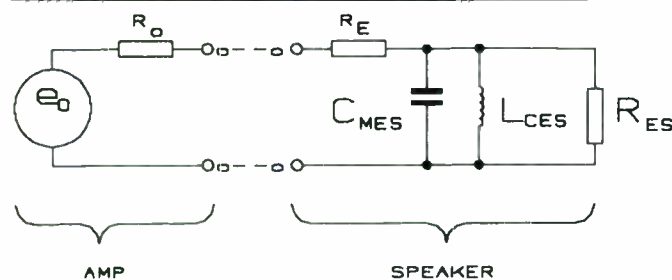

FIGURE 2: Loudspeaker electrical equivalent circuit.

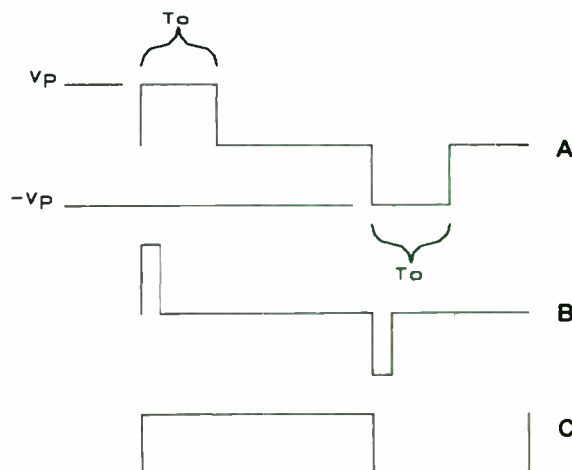
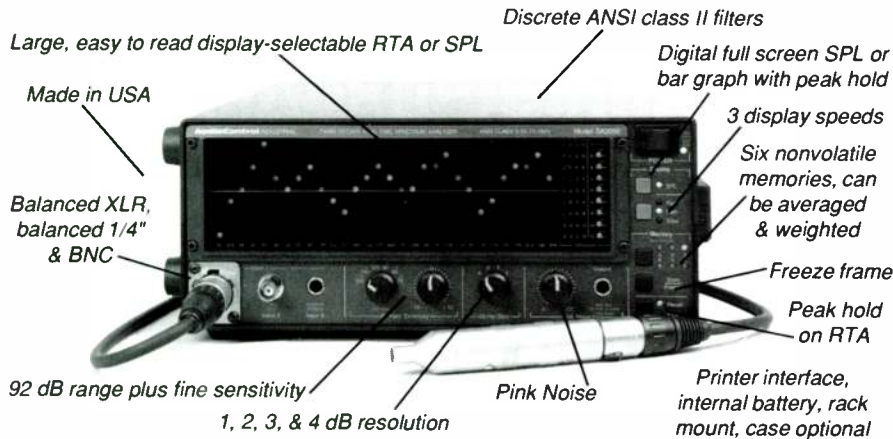

FIGURE 3: Wave forms.

# Affordable, 1/3 Octave, Real Time Analyzer With Memories & SPL Display Under \$1000



- SA3050A with Mic \$ 995
- With Battery & Printer Interface \$1300
- Rack Mount \$ 55
- Soft Case \$ 59
- A/C Weighted Filter \$ 44



**Call TOLL FREE: 1-800-732-7665**

Reader Service #4

in his letter that "although the RMS value of a sine wave is 0.707 of its peak, this is not true of most other waveforms, of which there are an infinite number." The editor erroneously comments that this statement is "an unprovable assumption on Mr. Sharpe's part." Actually, Mr. Sharpe is quite correct, and his statement is very easily proven.

Although one could offer a rigorous mathematical proof of this assertion, I prefer to prove it through the following example; it is easy to understand and rather elegant in its simplicity. The three odd-looking waveforms shown in Fig. 3 are identical except that the parameter  $T_O$  has been varied from near zero (b) to its maximum value of half the waveform's period (c). If we call the waveform's period  $T$ , then the RMS value of this waveform expressed as a percentage of its peak value  $V_P$  is:

$$V_{RMS} = V_P \frac{2 T_O}{T}$$

As  $T_O$  varies from zero to half of  $T$ , an infinite number of waveforms will be created. Only one of them, when  $2T_O = 0.707T$ , will have an RMS value that is 0.707 times its peak.

Roy Mallory  
Bedford, MA 01730

The editor responds:

My dictionary gives "immeasurable" as the first word to describe "infinite." Thus, infinite is a concept, but it is not now, nor has it ever been provable, not mathematically nor theologically, two areas of belief where it is popular. Inside the mathematical world it is a useful concept, but just because it is a useful idea for handling certain problems does not mean it is more than a human assumption. Richard Feynman, accepting the Nobel Peace Prize for physics in 1965 (along with Julian Schwinger and Shin'Ichiro Tomonaga) remarked that his work had been to eliminate infinities in calculations. "We have designed a method for sweeping them under the rug," he said.—E.T.D.

### REFERENCES

Small, Richard H., "Direct-Radiator Loudspeaker System Analysis," *JAES*, Vol. 20, No. 5 (June 1972), p. 383.

## DAHLIA DISCORD

I would like to comment on Gary Galo's review of Dick Olsher's Black Dahlia Mk II Loudspeaker kit (*SB* 2/93, p. 58).

1. The MB quart MCD-25R tweeter mesh grille pops off with a little prying.
2. This tweeter needs break-in time to sound its best.
3. Try RLC Resonance Network and some ferrofluid in the gap for better damping.

# YOU DON'T NEED A BOUNTY HUNTER

*to track down  
the latest  
Speaker Builder*

**They can be found at:**

**Audio Lab**  
5269-2 Buford Hwy.  
Doraville, GA

**D.H. Crump, Co.**  
6340 W. Mississippi Ave.  
Lakewood, CO

**Parts Express**  
340 E. 1st St.  
Dayton, OH

**Record Revolution**  
24262 Lyons Ave.  
Newhall, CA

**Zalytron Industries**  
469 Jericho Turnpike  
Mineola, NY

**Atlantic News**  
5560 Morris St.  
Halifax, NS  
CANADA

**Egyetti Ltd.**  
1st Fl, Chung Shan Bld. 13  
Chung Shan North Rd.  
Taipei  
TAIWAN

*If you prefer home delivery,  
use the handy subscription  
form enclosed.*





4. My intuition is that Dick's "stock" four-pole crossovers are too complicated for best sound. Try reoptimizing with XOPT. I bet you can realize the same rolloffs with fewer elements. Probably two poles on the low pass and three poles on the high pass. Keep up the good work.

Jean Mateson  
South Fallsburg, NY 12779

Contributing Editor Gary Galo responds:

It certainly isn't obvious that the tweeter grille is removable. I doubt that even Dick Olsher realized this, since he made no mention of it in his reply. In fact, he agreed that the screen makes the Tuffix fixative difficult to apply. If I had attempted to remove the grille and had damaged the tweeter, I would have looked quite silly, since A&S makes no mention of the tweeter mod in the instructions. This was a review of the kit as supplied by A&S Speakers, and was built following their instructions to the letter.

Regarding break-in, I ran the speakers on pink noise for 48 hours prior to listening. I clearly stated this in my reply to Olsher.

This wasn't a modification article; it was a review of a supposedly finished design. If further design work is needed, it's the designer's problem, not the reviewer's.

## STATUS SYMBOLS

I thought *SB* readers might like to have the latest in "official" SI prefixes:

10 <sup>24</sup>	yotta	Y
10 <sup>21</sup>	zetta	Z
10 <sup>18</sup>	exa	E
10 <sup>15</sup>	peta	P
10 <sup>12</sup>	tera	T
10 <sup>9</sup>	giga	G
10 <sup>6</sup>	mega	M
10 <sup>3</sup>	kilo	k
10 <sup>-3</sup>	milli	m
10 <sup>-6</sup>	micro	μ
10 <sup>-9</sup>	nano	n
10 <sup>-12</sup>	pico	p
10 <sup>-15</sup>	femto	f
10 <sup>-18</sup>	atto	a
10 <sup>-21</sup>	zepto	z
10 <sup>-24</sup>	yocto	y

Several "intermediate" units exist, some in common use, not among scientists in general, but more among real estate agents and auto mechanics:

10 <sup>2</sup>	hecto	h
10 <sup>1</sup>	deka	da
10 <sup>-1</sup>	deci	d
10 <sup>-2</sup>	centi	c

Believe it or not, there is an official, negotiated standard (specifically, ANSI Y10.19-1969 and its international equivalents) that codifies such rude behavior. By the stroke of the almighty pen, it renders generations of radio equipment non-working and possibly nonexistent.

# When it comes to speaker stuffing choose a natural Wool

- unequaled natural sound absorption qualities
- loose batting form makes density control easy
- currently specified in a top-of-the-line speaker

Now you can use nature's most versatile fiber

Send \$5.00 for 4 oz. sample or \$30.00 for 5 pounds  
(all U.S. shipping charges paid)

to: **R.H. Lindsay Company**

Dept. S P.O. Box 218  
Boston, MA 02124

Tel: (617) 288-1155 Fax: (617) 288-1050



Reader Service #22



## WE GET BOARD.

**DynaBoard** is the new enclosure material from Dynamic Control. We take a sheet of Dynamat® damping material and with high pressure, sandwich it between two sheets of 3/8" MDF. The resulting

composite panel has excellent acoustical properties. This self-damped enclosure material offers a **breakthrough in speaker performance technology.**

Dynamic Control  
125-B Constitution Drive  
Fairfield, Ohio 45014.  
1-800-225-8133

**DynaBoard**  
ENCLOSURE COMPOSITE™

Reader Service #5

Speaker Builder / 4/93 79

## FOR THE CONSTRUCTOR

Ideal for desktop devices that require easily accessible controls, meters, switches, etc.

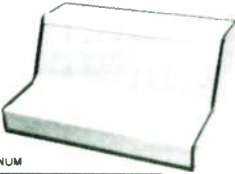

PANELS ARE .063" ALUMINUM

DUAL SLOPE METAL CABINETS		
MODEL	DESCRIPTION W x D x H x H1 x S1 x S2 x D1 (inches)	PRICE \$
DS-1	4 x 6 x 4 x 1.2 x 1.9 x 2.4 x 1.6	59.00
DS-2	6 x 6 x 4 x 1.2 x 1.9 x 2.4 x 1.6	63.25
DS-3	8 x 6 x 4 x 1.2 x 1.9 x 2.4 x 1.6	67.50
DS-4	10 x 6 x 4 x 1.2 x 1.9 x 2.4 x 1.6	71.50
DS-5	12 x 6 x 4 x 1.2 x 1.9 x 2.4 x 1.6	76.00
DS-6	18 x 6 x 4 x 1.2 x 1.9 x 2.4 x 1.6	81.00
DS-7	4 x 8 x 6 x 2 x 3.1 x 3.5 x 1.9	69.00
DS-8	6 x 8 x 6 x 2 x 3.1 x 3.5 x 1.9	73.00
DS-9	8 x 8 x 6 x 2 x 3.1 x 3.5 x 1.9	78.00
DS-10	10 x 8 x 6 x 2 x 3.1 x 3.5 x 1.9	82.75
DS-11	12 x 8 x 6 x 2 x 3.1 x 3.5 x 1.9	87.75
DS-12	18 x 8 x 6 x 2 x 3.1 x 3.5 x 1.9	100.75



PANELS ARE .063" ALUMINUM

- EASY TO FABRICATE
- SHIPPED FLAT
- ALL ITEMS STOCKED FOR QUICK DELIVERY
- DESIGNED FOR SMALL LOT PRODUCTION

RACK CHASSIS		
MODEL	DESCRIPTION W x D x H (inches)	PRICE \$
1RU5	19 x 5 x 1.75	30.85
1RU7	19 x 7 x 1.75	33.10
1RU10	19 x 10 x 1.75	35.25
2RU5	19 x 5 x 3.5	33.10
2RU7	19 x 7 x 3.5	35.25
2RU10	19 x 10 x 3.5	37.50
3RU5	19 x 5 x 5.25	41.90
3RU7	19 x 7 x 5.25	44.10
3RU10	19 x 10 x 5.25	46.30

SESCOM ALSO STOCKS HEAVY DUTY RACK CHASSIS, METAL CABINETS, EXTRUDED BOXES AND MORE! CALL OR WRITE FOR YOUR FREE 24 PAGE CATALOG



USA AND CANADA ORDERS (800) 634-3457  
SESCOM, INC., 2100 WARD DRIVE  
HENDERSON, NEVADA 89015 USA  
TECHNICAL HELP (702) 565-3400  
FAX (702) 565-4828

Reader Service #23

No more is it possible to have, for example, a 20 milli-micro farad (20m $\mu$ F) capacitor. They must all be replaced with an officially recognized 20nF capacitor. Compound prefixes are out. Alternatively, you could use 20 thousand-million one-farad capacitors in series, though only in the United Kingdom. Here in the US, you would have a hard time filling such an order. Instead, you would be forced to use 20 billion one-farad capacitors, but it would probably work equally well.

Further codified is the decision to use upper- or lower-case letters for the units themselves. Upper-case letters will be used when the unit's name has been derived from the proper name of a famous scientist or philosopher. For example, we use "F" for Farad (after Michael Faraday), "W" for Watt (after James Watt), "G" for Gauss (after Karl Friederich Gauss) and "N" for Newton (after Nabisco, the inventor of the Fig Newton).

Lower-case letters are used when the unit's name was derived from the improper name of a less-than-famous scientist, philosopher or banker. For example, "m" for meter (after Jean-Francois Richard Perfluer August de la Metre, a person of less-than-average stature who was obsessed with size, leading to the term "le metre-shtick"), or "g" from gram (after the Reverend John Graham, inventor of that other Nabisco cracker), and "b" for barn (as in "can't hit the broad side of").

This is all part of the metrification of the world. Metrification is good, because now we don't have to remember any strange conversion factors to move from one unit to another. For example, we used to have to deal with 12 inches to the foot. Now it's much easier to remember that there are simply 4.1868 joules per calorie. It's even easier to remember fundamental constants: before, in the English system,  $\pi$  was equal to 3.141592653589-7932384626434. Now, in the metric system, it's 3.14159265358979323846264338.

This is official—you can go to the bank on it.

Dick Pierce  
Pepperell, MA 01463

## SIMPLINE ANGLING

I was delighted by John Cockroft's article "The Simpline" (SB 2/93, p. 14). It's good to see a cheap and simple speaker project where one can build a pair just for the fun of experimenting. These speakers, however, have one fatal but easily remediable flaw: their appearance. They look so weird angled up against a wall that few people would be willing to put them in a den or living room, thus relegating them to the workshop.

I suggest lengthening the enclosure by about 4" to install a simple port/deflector,

## MAHOGANY SOUND

### ACOUSTA-STUF

THE VERY BEST DAMPING MATERIAL AVAILABLE FOR SPEAKER SYSTEMS. COST IS \$ 8.00 PER POUND. CANADIAN RESIDENTS ADD \$ 1.00 PER LB. FOR SHIPPING. WE ACCEPT CHECKS, MONEY ORDERS, AND C.O.D.'S BY PHONE.

" THE HATCHBACK "

8" 2 WAY VENTED AUTOSOUND SYSTEM



\$ 450.00 COMPLETE KIT  
SPEAKER KITS

WE NOW HAVE SIX SPEAKER SYSTEM KITS, INCLUDING TWO AUTOSOUND SYSTEMS. ALL KITS ARE COMPLETE WITH CABINETS, CROSSOVERS, AND ACOUSTA-STUF DAMPING MATERIAL. CALL OR WRITE FOR A FREE CATALOG.

## MAHOGANY SOUND

2610 SCHILLINGERS RD. \* 488  
MOBILE, ALABAMA 36695  
(205)-633-2054 AFTER 5 PM CST

Reader Service #9

# 42,398

## ELECTRONIC COMPONENTS

Whether you order 1 part or all 42,398...MOUSER stocks and...ships same day!!

CALL...  
(800) 992-9943

for your  
FREE  
CATALOG

2401 Hwy 287 N.  
Mansfield, TX 76063

# MOUSER ELECTRONICS

Sales & Stocking Locations Nationwide

Reader Service #30

**SALE!** PLUS FREE ADHESIVE!

MARKERFOAM™ ACOUSTIC FOAM  
GIANT 54" x 54"



Immediate Shipping

2" Reg. \$29.95 Now \$19.99 • 3" Reg. \$39.95 Now \$29.99! KILL NOISE QUICK!  
EZ mount. Blue or grey. Super-effective sound absorption for studios. High performance, full-size sheets of super high density Markerfoam. Markerfoam offers best value, looks professional & is proven in studios worldwide. Request Foam-Buyers Guide/Catalog, specs & free samples today. VISA, MC, AMEX, COD, PO'S, QUANTITY DISCOUNTS.



MARKERTEK JUMBO SOUND ABSORB BLANKETS

Heavy-duty 72" x 80" padded blankets absorb sound wherever they're hung or draped. Fabulous for stage, studio & field use. Top professional quality at a super saver price! Weight: 6 lbs. Black, \$19.99.

MARKERTEK BLADE TILES™

HIGH PERFORMANCE  
LOW, LOW COST!  
\$3.49 per tile, 16x16x2". America's best acoustic tile value, only from Markertek! Charcoal. Also available 16x16x3" as shown, \$4.49 each.

MARKERSTIK™ foam adhesive. FREE with any Foam purchase in this ad! Limited offer. A \$5.95 per tube value.

SONEX  
All the colors and sizes plus great prices!

Get our FREE 149-page catalog of over 6,000 exclusive and hard-to-find supplies for audio & video.

800-522-2025 America's most unique catalog for audio & video!  
FAX: 914-246-1757

MARKERTEK™  
4 High St., Saugerties  
New York 12477 U.S.A. VIDEO SUPPLY

Reader Service #10

and angling the speaker (Fig. 1). Now it can stand up straight near a wall. Besides improving the appearance, this would allow closer coupling of the port to the wall/floor intersection (as preferred by Allison and Cockroft) and the ability to rotate the enclosure so the speaker can face either the wall or the listener. I believe the increase in cabinet complexity would be well worthwhile.

Another point worth considering is the speaker's efficiency, which Mr. Cockroft suggests is low. A simple calculation is sobering. Radio Shack supplies no information with the specified driver, but let's say it has a reference efficiency of 88dB and a cone mass of 5g. Adding 5g of lead and about 1-1.5g of white glue to the cone will lower the efficiency to about 74dB. If we assume that the speaker has a voice coil resistance of  $6.5\Omega$ , the equalizing filter will lower the efficiency another 8dB to about 66dB for frequencies below the filter's knee.

Why not put the filter between the preamp and the amp where it would absorb no sensible power? For example, the speaker and the  $10\Omega$  resistor could be replaced by  $1k\Omega$  resistors, and the capacitor by a  $0.02\mu F$  unit. These values would give the same approximate response.

A possible caveat to using the filter as I suggest is its effect on bass response. Mr. Cockroft suggests that the filter is used only for high-frequency pre-emphasis, but it will also profoundly raise the driver's Q. Perhaps this increase does not cause a noticeable change in bass response. I would be interested in Mr. Cockroft's input.

Tom Sharpe  
Lexington, MA 02173

Contributing Editor John Cockroft responds:

I am pleased you are interested in my Simpline article, and you present some well-taken points. In the six years since I designed the original Simpline, I have made them in various configurations, although not in the exact one shown in your sketch. I've made them standing vertically with a single port facing forward at the base, and also the same with two side ports (of half the area each). I also made a free-standing one with the speaker facing forward and two side ports. Then there was a folded one. They all worked well, although I cared for the free-standing one less than the rest.

My decision to present the Simpline in its original configuration was determined by what I wanted the article to accomplish. I was hoping to reach readers who are interested in obtaining excellent sound, but who are perhaps lacking the courage or skill to tackle a typical SB construction article. I had planned at a later date to present ways of upgrading the system. I felt that by that time they might be ready to move on.

Yes, the Simpline's efficiency is low (although my neighbors will attest that I can play them too loudly). Many people, especially those who are interested in reading and comparing speaker specifica-

## First, let's talk sound design



USAP utilizes and distributes



Term™ sound  
design software.

## then let's talk about our sound line.



USAP features over 25 models of horns, tweeters and woofers.

**Call USAP today:  
(713) 894-2227**

USA Products, Inc., 11552 Cypress North Houston  
Cypress, TX 77429 FAX: 713-894-2119

## VIRGIN CABINETS



### **FINE ENCLOSURES FOR HOME SPEAKER BUILDERS**

**Moulded Appearance • No Visible Joints • No Order Too Small**

Other models available - in black or with base coat to paint colour desired.  
Blank faces - you select holes, installed components are for illustration purposes only.

Call or write for product information/price list:

Virgin Cabinets, R.R. #1, Desbarats, Ontario, Canada P0R 1E0 Tel. (705) 736-2826

Reader Service #38

Speaker Builder / 4/93 81

# CANADIAN SPEAKER BUILDERS

Free Speaker  
and Accessories  
Catalog. Call or  
Write Today.

**polydax** EMINENCE

**FOTAL** (M) MOTOROLA

**PHILIPS** (P) **PIONEER**

... PLUS MANY OTHERS

**Q COMPONENTS**  
DIRECT MAIL ORDER

638 COLBY DR., WATERLOO,  
ONT. N2V 1A2

PHONE: (519) 884 - 1140

CANADA ONLY PLEASE.

Reader Service #2

## RIGG AUDIO Distributors

### Intertechnik Crossover Components

- Air Core Inductors
- Ferrite Bobbin Core
- Corobar Core
- Transformer Bar Core
- Polypropylene Caps
- Polyester Caps
- NP Electrolytics
- 5 to 20 watt resistors

### Accessories

- Gold Posts
- Port Tubes
- Grill Fasteners
- Speaker Protectors

### Service

- Computer Design
- LMS Lab

Call or write for our free catalog:  
Rigg Audio Distributors  
P.O. Box 787 Station A  
Kelowna, B.C. V1Y 7P4  
(604) 862-9399

Reader Service #7

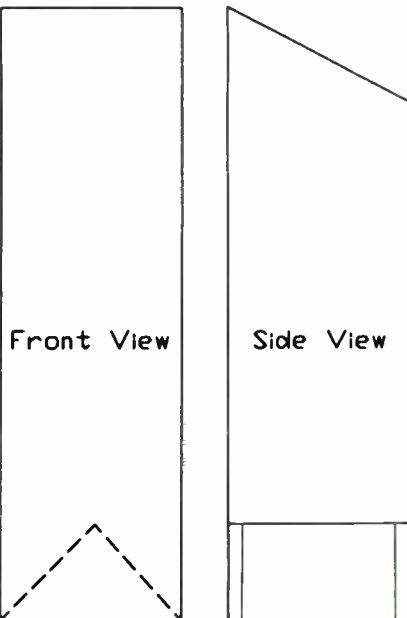

FIGURE 1: Suggested Simpline improvement.

tions, are worried about efficiency. You only need to worry about this when you have a theater or hall to fill and your amplifier power is scarce.

I believe most people would rather have good bass response and would be willing to pay for a 60W amplifier in order to achieve it. The direct tradeoff of bass is efficiency. My designs are inefficient because I believe the bass range to be a natural part of music. Incidentally, many exotic high-end (i.e., expensive) systems are very low in both efficiency and impedance. The amplifiers required to drive them are more on the order of welding machines. The Simplines require nothing like that.

I originally used a line-level filter. Whenever I begin a new design, I almost invariably do so at line level when working out crossovers and filters, as this is easier and more predictable. Later comes the task of working things out at the higher levels.

The main reason I went to the high-level version in the Simpline was for one of the very reasons you touched upon: to raise the speaker's  $Q_T$ . I failed to mention this in the article. Another important consideration was that line-level filters vary depending upon the load impedance of the amplifiers they feed. Not having any control over this in a given situation, I decided to go the way I did.

Thanks again for your interest and your efforts.

## Symbiosis

continued from page 9

vendors or small audio manufacturers to make group orders, just to acquire what you need in the way of transformers, potentiometers, and exotic capacitors and resistors.

Consult and work with your vendors. Let them know about your needs and your projects. Give them feedback on what works and what doesn't. Realize that we are all in an interactive, growing, evol-

ing process in this avocation. This journal relays as much information as we can manage in the pages we can afford. But the number of those pages must be tied to advertising support. Thus, if you wish for more pages in *Audio Amateur*, relate well to the vendors whose wares are offered to you in these pages. Explore what they have to offer, collect catalogs, put your name on their mailing lists.

Some of you will doubtless accuse me of shilling for our advertisers. On the contrary, I am shilling for the endangered hobby all of us love and enjoy. It cannot flourish on air, or good intentions, or unfulfilled projects. And if you think the audio hobby is expensive, try owning a boat. Technological work such as ours is still regarded with suspicion, fear and uncertainty by the generality of people in the United States. And the large kit companies have all but disappeared.

This magazine has been, and is, a labor of love. Without good manuscripts, good advertising, and an active, enthusiastic subscriber group, it cannot remain healthy. I am glad to say that subscriptions are near an all-time high. Nonetheless, the level of interactive life in the audio amateur world determines its usefulness, vitality and progress. We welcome your input, as always. Diversity of opinion has always been welcome here.—E.T.D.

## T-SHIRT CLEARANCE

TELEPHONE ORDERS  
ONLY!

Reg. NOW \$6.95 EA.  
\$13.

AVAILABLE SIZES:

Green "Old Colony Sound Lab":  
S, M, L, XL

Black "Speaker Builders Do It  
With Raw Drivers": S, M

Red "Audio Amateur": S, L, XL

Blue "Speaker Builder": S

- ALL SALES FINAL
- MC/VISA WELCOME
- SUPPLIES LIMITED

## OLD COLONY SOUND LAB



(603) 924-6371  
(603) 924-6526

# Classified

## TRADE

**BANDOR** 50 mm aluminum cone-drive units, made in England and built with exceptional quality. Response 100-22kHz  $\pm$  1.5dB, 35W rms,  $f_s$  = 75Hz with unbelievable low distortion and electrostatic like transparency. Four models in stock. Call for reviews and more information. **EN INNOVATION** (916) 421-8935. T4/93

**COMPLETE SPEAKER SYSTEMS AND KITS** from 5" two-way to 12" three-way, sub-woofers, high-definition systems. Oak, black piano, and texture lac finishes. **FACTORY DIRECT PRICING. SPEAKER-WORLD TECHNOLOGY** (510) 490-5842, FAX (510) 490-1961. T1/94

**HAFLER HEADQUARTERS IN PENNSYLVANIA!** Featuring the highly-rated TransNova Power Amplifiers (*Stereophile* Class B), new FET preamplifiers; professional power amps with balanced inputs. Free shipping. Call or write. **AUDIO ARTS**, RD 2, Wernersville, PA 19565, (215) 693-6740. T3/94

**ROOM ACOUSTICS HANDBOOK** *Get the Most Out of Your Room*, \$14.95. Vibration isolation feet, improves imaging and bass, for equipment and speakers. **MACH 1 ACOUSTICS**, RR2 Box 334A, Wilton, NH 03086, (603) 654-9826. T1/94

**AUDIO CONCEPTS** Sapphire-Subl system, oak, mint, with stands, boxes, manuals, \$1,350. Jay (518) 766-2174. T4/93

**EXCITING NEW COMPANY! SPEAKER SCULPTURE.** Transmission lines. Remarkable designs, look like sculptures, not speakers. Extraordinary sound. Satisfaction guaranteed. For a brochure call: (914) 576-2896. Write: 2 Division St., New Rochelle, NY 10801. Buy direct/save! American trade. T4/93

**ULTIMATE STEREO MICROPHONES**  
Micro-sized head-worn DSM stereo microphones are perfect for 3-dimensional live sound recording!

**DAT POCKET BATTERY™!**  
Sealed Lead/Acid design. Dependable! Compact! Reg. \$229. **NOW ONLY \$199.!**



**Sonic Studios**  
438 Soup Creek, Reedsport, OR 97467  
CALL: 503-599-2217

**ALL SPEAKERS RE-CONED.** New 12" woofers \$36, wire grills, headphones, warranty repairs, more! Nice prices, free catalog. **TRI-STATE LOUDSPEAKER** (412) 375-9203. T5/93

**This publication is available in microform from University Microfilms International.**

Call toll-free 800-521-3044. Or mail inquiry to: University Microfilms International, 300 North Zeeb Road, Ann Arbor, MI 48106.

## FOR SALE

Audio Concepts Saturn Subwoofer, \$200; Marchand 24dB Crossover, \$100; JBL (L-100), \$150/pr., (no grill foam); original large Advent tweeters, \$20/ea., woofers, \$50/ea.; RTR Electrostats, include crossover and power supply, \$40/pr.; Dynaudio D-28AF \$75/pr.; Eton 4-203, \$120/pr., you pay shipping. Bill (513) 321-3175.

VPI HW 19 MK III turntable with lead filled acrylic platter, Dynavector 507 arm, Sumiko BIP2 and Ortofon Super OM-20 cartridge. "It Rocks!" \$1,000. Greg Boggs, 428 Hickory Lane, Waterford, MI 48327, (313) 681-2546.

Dynaco Tube equipment. Stereo 70 (stock) \$145. PAT preamp (stock, very clean) \$85. Two FM-3 tuners (stock) \$35/ea. Buyer pays shipping costs. Contact Jerry McNutt, 519A Cook St., Philly, MS 39350, (601) 656-9277.

## SPEAKER BUILDER CLASSIFIED ORDER FORM

PLEASE PRINT IN CLEAR BLOCK LETTERS OR TYPE. SPELL OUT EACH WORD. NO ABBREVIATIONS.

1	2	3	4	5	6	7	8	9	10
11	12	13	14	15	16	17	18	19	20
21	22	23	24	25	26	27	28	29	30
31	32	33	34	35	36	37	38	39	40
41	42	43	44	45	46	47	48	49	50

For Sale

Wanted

Trade, indicate number of insertions \_\_\_\_\_

**For Sale** ads are to *sell* personal equipment or supplies. **Wanted** ads are to *find* supplies, equipment or services. Both are "not for profit" ads and will only run once unless they are resubmitted. **Trade** ads are for any business or private party selling something for a profit.

**Ad copy:** A word is any collection of letters or numbers with a space on either side. **Illegible ads will be discarded.**

**Price:** All ads are \$1.00 per word. Deduct 5% on a 6X contract for **Trade** ads. Ten dollar minimum per insertion. **Payment must accompany ad. No billing.**

Subscribers receive *free* **For sale** and **Wanted** ads up to 50 words; .20 each additional word. Only one ad per category, per issue.

Please include your name, address and telephone number.

Please charge to my MasterCard/Visa:

CARD NUMBER \_\_\_\_\_ EXP. DATE \_\_\_\_\_

Check/Money Order Enclosed

Subscription Account Number: A

NAME \_\_\_\_\_

COMPANY \_\_\_\_\_

STREET & NO \_\_\_\_\_

CITY \_\_\_\_\_ ST \_\_\_\_\_ ZIP \_\_\_\_\_

PHONE \_\_\_\_\_

Cal Audio Delta CD transport \$600, remote, box and manual. Bought 7-24-92. Low hours, mint condition. Essence Gem high resolution monitors in exotic Zebra wood, \$800, current list price is \$1,600. 40-19kHz  $\pm 2$ , bought 11-25-92. Perfect condition and low hours. Amazing bass. Call Mr. Willes (800) 227-6121, weekdays 9-5, central time.

Eight ea. ElectroVoice EVM15B II 15" (new) \$150; Altec 416A 15" \$165; 15" woofers from '30s/'40s "Voice-of-the-Theater" make offer. New Sony DTC-M100 SemiPro DAT recorders \$750; new Hafler x L600s; Adcom GTP500 preamp/tuner \$335; two SoundCraftsman 200W power amps; Sony CDP707-ESD CD player \$750; Kenwood 5300 tuner \$85; Thores w/Rabco one lot Disgo stage lighting equipment. Tektronix oscilloscopes 531A and 453; much other test equipment, parts, PC compatible computer equipment and parts. Will fax/send list on request. John (602) 553-8207, or leave voice-mail message.

Dynaudio 20W75 new, \$130/pr.; D52AF good shape Cardas lead wires \$75/pr.; one Scanspeak 18W Kevlar driver used for testing \$50; one JBL 2226H 15" pro bass driver, new \$150; one JBL 2204H horn tweeter new \$130. Marc Bremmer (410) 338-4458, days.

## ACTIVE ELECTRONIC CROSSOVERS

### MODEL 120 CABINET & NEW 120-R "RACK AND PANEL" DESIGNS

Plug-in Butterworth (maximally flat) filters 6 db., 12 db., or 18 db. per octave slopes, any specified frequency. Model 120 instrument style case or 120-R "Rack and Panel" case with all terminations and regulated power supply.

Made in monaural or stereo bi-amp, tri-amp, or quad-amp with optional level controls, subsonic filters supplies with or without bass boost, and summers for "single woofer" systems. Also available, 500 Series filters, plug-in filters, regulated power supplies.

**New catalog and price sheet. Free!**

**DeCoursey Eng. Lab.**

11828 Jefferson Bl, Culver City, CA 90230  
PHONE (310) 397-9668

Electronic crossover, Audio concepts (TDM) 2-way/24dB \$175; Gauss 1502 Bullet Tweeters, 111dB @ 1W/m \$70/ea.; Audio Quest Sorbothane feet, new in package \$18/set.; Toroid power transformers, 110 primary/48V CT secondary, 300W \$20/ea.; HP41C card reader \$40. Dan (801) 224-8080(w) or (801) 225-8577(h), 1768 N. 980, W. Orem, UT 84057.

Pair of vintage speakers KEF model K-2 celeste MK II's made in England with serial numbers sold by Radio People Ltd., Kowloon, Hong Kong. Size 6 1/2 x 18 x 11. These units are rare and unusual. Ideal buy for collectors. They work fine and sound good. \$225. Dave (305) 931-7131.

New VMPS (Brian Cheney) BC820 8" poly woofers, \$50/pr.; new Polydax HD12.9025A 1" dome tweeters, \$20/pr. Ken (414) 442-3695.

One pair Morel MDT33, \$150, or BO. One pair Eaton Honeycombe 8" woofer, \$150, or BO. One pair Audaux 4" Prestige Midranges, \$70, or BO. Phase Meter, BO or trade Mac 2100 amp. Jean Mateson (914) 434-1291, leave message.

Jensen Concerto-15 (Ultraflex) 3-way kit (SB 6/89 p. 61, 5/90 p. 72). Amateurish blond walnut finish, tweeter unrepairable. Any offers of a new home considered. I can also point you toward a similar cabinet near Schenectady, probably for sale. Alan Douglas, Box 225, Pocasset, MA 02559.

Tandberg TD-20A SE reel-to-reel tape recorder. 20 to 30k  $\pm 2$ dB, 80dB S/N without noise reduction. Outstanding condition, \$450. (408) 438-8084, leave message.

Philips Ribbons AD 21600, \$30/pr.; Seas H-456, 1" soft dome, \$22/pr.; Peerless 6 1/2" mid/woofer 831732m \$30/pr.; 6" double magnet, \$34/pr.; SR-10 tweeter, \$25/pr.; eight pairs available, all drivers brand new/unused. Ed (310) 402-9649.

Peerless CC line 10" woofers (seven of them), asking \$50/ea.? Eight beautiful 63 liter boxes, make offer. Ben (703) 951-8468.

ARC LS-1, \$1,000; Classic 30, \$1,500; Boulder 250 AE, \$2,600/pr.; Rane AC-22 crossover, balanced I/O, protective cover, \$250; AT OC-7 cartridge, \$75. Steve (203) 397-3888.

Turntable Ariston RD-40, SMEIII tonearm extras, \$200/pr.; SpeakerLab DAS-2 bookshelf speakers, \$125; Zenith CV650 audio/video receiver, \$60; Zenith linear turntable, \$50.; Dell 386/20 system board with coprocessor 2M RAM, \$150. Scott (708) 582-3643.

Preamp—P.S. Audio 4.6 with 250W supply. Mint, \$375. Amp—Audio Research D115 MK II. Factory checked, retubed, \$1,800. Scanspeak D2905 tweeters, \$50/pr. All prices, or BO. John (203) 872-9210.

Accuton C<sup>11</sup> tweeters, \$160/pr. Jerry (601) 264-6971.

Altec 604K coaxial speakers with factory crossovers, \$650/pr.; Seeburg "bar-room disco" speakers, 2 x 15" with Altec 8" horn in each, 1" thick walls, \$450/pr.; Pioneer 10 band stereo equalizer, \$100; Pioneer dynamic range expander, \$60; Kenwood preamp, top quality, \$175; Marantz DC-170 amp, \$200. David (914) 688-5024.

McIntosh MR-66 tube tuner, mint, \$450; Altec 292-8A 1.4" horn midrange drivers, \$275/pr.; JBL 10" woofers, \$75/ea.; JBL 2.5kHz crossovers, \$75/pr.; Pioneer stereo equalizer, \$75; Pioneer range expander, \$50; Thorens TD135 turntable, \$60; Altec 500Hz crossovers, \$125/pr.; laser discs. David (914) 688-5024.

Pair Focal 7N-313 \$100; one EV-T35 Alnico \$15, New Beyer M-101N omni mike list \$190-\$100, three 1/2 HP 1,800 rpm hysteresis synchronous motors, 1/4 D. shaft W1, 4 $\mu$ f starting caps \$100/lot. Tektronix type 130 L.C. meter manual, no probes \$65, shipping extra. Jim (708) 425-6719.

Focal T120K \$35; 5N313 \$35; 5K011 \$50; 8K415S \$40; 8K515T \$50. All are new or cosmetic blemish. umps 15" \$25; JBL L19 two-way with 8" 116H cast woofers. All prices plus shipping. Dan, (206) 874-8411.

## WANTED

Would any current or aspiring SB readers in the Portland/Oregon area be interested in starting an informal club with an emphasis on reasonable cost but high quality home audio, information and parts exchange, listening and so forth? Call Rod Hickerson (503) 774-2649.

Quad ESL bass and treble panels. J. Smith, 518 Palo Alto Drive, Vancouver, WA 98661, (206) 694-4144.



## NEW!

TC SOUNDS manufactures drivers unsurpassed in quality and performance. Our cones are flat carbon-fiber/expanded polymer composite structures. Individual T/S-parameters, 4", 6", 8", 12", 15". Call (619) 622-1212.

Information, article references, reprints, published tests and trials, improvements, modifications, power amplifier recommendations for Dahlquist DQ10A (matched pair) speakers. S. Alekman, One Macintosh Court, East Brunswick, NJ 08816, (908) 238-7493; Internet address: salekman@heartland.bradley.edu.

Repair and calibration of warbler by technician familiar with the Old Colony Kit. Dion Sanders, 108 E. Oadfield Rd., Pensacola, FL 32503, (904) 479-9088.



(616) 534-9121

**MENISCUS**

HIGH FIDELITY SPEAKER COMPONENTS

**DYNAUDIO MOREL FOCAL ECLIPSE**

2575 28th St., S.W., Unit 2, Wyoming, MI 49509

Old tube Hi-Fi equipment; Altec W.E. Thordarson, Fisher, etc. Not a dealer, just love tubes. Will pick-up. Paul Gil, 180 Union Ave., Belleville, NJ 07109, (201) 751-5959.

One used magnet charger, reasonably priced. John (816) 637-4800.

Two Morel MDT-33. Two Focal T1-20K. Two ACT 50mm module tweeters. Write: Gerard Stuchlik, 70 Rue Vaillant, 69100 Villeurbanne, France.

Four 8V416J Focal drivers; one 10V516 woofer; two AC10R drivers; Pioneer PD-65 CD player or JVC XL-21050TN CD player. Jim (708) 425-6719.



## PRODUCT MANAGER Studio Monitor Specialist

JBL Professional has immediate opportunities in the area of product management. JBL Product Managers function in a diverse, fast-paced environment, taking new products from concept, through development to market launch, managing all aspects of the process while working in cross-functional development teams.

The successful candidate will have a college degree in engineering or related discipline and 3-5 years experience in loudspeaker and/or acoustic design. Additionally, particular emphasis will be placed upon project and schedule management, communication skills, and familiarity with the studio and home recording markets. Computer literacy is also required.

JBL Professional is an equal opportunity employer, offers a competitive salary, a comprehensive benefits package, and the challenge of working for an industry leader. If you would like to join our team, please submit your resume, including salary history to:

Ted R. Telesky  
Director of Product Development  
JBL Professional  
8500 Balboa Blvd., P.O. Box 2200  
Northridge, CA 91329

## CLUBS

**THOSE INTERESTED IN AUDIO** and speaker building in the Knoxville-East Tennessee area please contact Bob Wright, 7344 Toxaway Dr., Knoxville, TN 37909-2452, (615) 691-1668 after 6 p.m.

**AUDIOPHILES IN THE DAYTON/SPRINGFIELD, OHIO AREA:** We are forming an audio club. Please contact me if you're interested in construction, modifications, testing, recording or just plain listening to music. Ken Beers, 1756 Hill Rd., Yellow Springs, OH 45387, (513) 767-1457.

**ARIZONA AUDIOPHILE SOCIETY** Located in Metropolitan Phoenix is a growing and active club in the pursuit and reproduction of recorded music. New members are welcome. Meetings are last Tuesday of each month. Receive monthly newsletter and bi-annual journal. Club discounts with local high-end audio dealers. Send inquiry to Arizona Audiophile Society, PO Box 13058, Scottsdale, AZ 85267, or call Bob Williams, (602) 944-5929.

## BORBELY AUDIO

Whether you are using easy-to-drive 8Ω speakers or difficult 1 or 2Ω ribbons, the high quality power amp KITS from BORBELY AUDIO can drive them all. All amps are using cascode FET input stages for good linearity and multiple pairs of output MOSFETs for high current capability.

BORBELY AUDIO also offers high quality cables for speaker wiring, speaker and cable connectors and many more.

Please send two International Reply Coupons (available at your post office) for our price list. We accept VISA and MC/EUROCARD.

### BORBELY AUDIO

Melchior Fanger Strasse 34A  
82205 Neu-Gilching, Germany

Tel. Int+49/8105/5291 FAX Int+49/8105/24605 (24 hours)

**THE CATSKILL AND ADIRONDACK AUDIO SOCIETY** invites you to our informal meeting. Join our friendly group of audio enthusiasts as we discuss life, the universe and everything! Tubers, Transistors, vinyl canyons or digital dots. No matter what your level of interest, experience, or preferences, you are welcome. Contact CAAS at (518) 756-9894 (leave message), or write CAAS, PO Box 144, Hannacroix, NY 12087. See you soon!

**CONNECTICUT AUDIO SOCIETY** is an active and growing club with activities covering many facets of audio—including construction, subjective testing, and tours of local manufacturers. New members are always welcome. For a copy of our current newsletter and an invitation to our next meeting, write to: Richard Thompson, 129 Newgate Rd., E. Granby, CT 06026, (203) 653-7873.

**ELECTROSTATIC LOUDSPEAKER USERS GROUP** is now a world-wide network for those interested in sharing valuable theory, design, construction, and parts source information. If you are interested in building, or have built, your own SOTA ESL we invite you to join our loose-knit organization. For information, send a SASE to: Barry Waldron, 1847 Country Club Dr., Placerville, CA 95667.

For Advertising Information

Call **Martha Povey**  
(603) 924-9464

or write

**Audio Amateur  
Publications, Inc.**

PO Box 576, Ad Dept.  
Peterborough, NH 03458-0576



**LONDON LIVE D.I.Y. HI-FI CIRCLE** meets quarterly in London, England. Our overall agenda is a broad one, having anything to do with any aspect of audio design and construction. We welcome everyone, from novice to expert. For information contact Brian Stenning, 081-748-7489.

**MEMPHIS AREA AUDIO SOCIETY** being formed. Serious audiophiles contact J.J. McBride, 8182 Wind Valley Cove, Memphis, TN 38125, (901) 756-6831.

**NEW JERSEY AUDIO SOCIETY** meets monthly. Emphasis is on construction and modification of electronics and speakers. Dues includes monthly newsletter with high-end news, construction articles, analysis of commercial circuits, etc. Meetings are devoted to listening to records and CDs, comparing and A-Bing equipment. New members welcome. Contact Frank J. Alles, (908) 424-0463, 209 Second St., Middlesex, NJ 08846; or contact Bob Young, (908) 381-6269, or Bob Clark, (908) 647-0194.

**PACIFICNORTHWEST AUDIO SOCIETY (PAS)** consists of 60 audio enthusiasts meeting monthly, second Wednesdays, 7:30-9:30 p.m. at 4545 Island Crest Way, Mercer Island, WA. Be our guest, write Box 435, Mercer Island, WA 98040 or call Bob McDonald, (206) 232-8130 or Nick Daniggelis, (206) 323-6196.

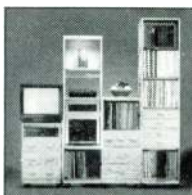

The best disc, tape,  
component storage system  
in America

Stackable, portable oak units  
hold all recording formats  
and audio/video components

Free mailorder brochure  
(please mention Speaker Builder)

Per Madsen Design (415) 928-4509  
P.O. Box 330101, San Francisco, CA 94133

**PIEDMONT AUDIO SOCIETY** Audio club in the Raleigh, Durham, and Chapel Hill area is meeting monthly to listen to music, demonstrate owner-built and modified equipment, and exchange views and ideas on electronics and speaker construction. Tube and solid state electronics are of interest and all levels of experience are welcome. Kevin Carter, 1004 Olive Chapel Rd., Apex, NC 27502, (919) 387-0911.

**THE INLAND EMPIRE AUDIO SOCIETY** (soon to become) **THE SOUTHERN CALIFORNIA AUDIO SOCIETY—SCAS** is now inviting audiophiles from all areas of Southern California and abroad to join our serious pursuit for that elusive sonic truth through our meetings and the **IEAS'** official speaker, *The Reference Newsletter*. For information write or call, Frank Manrique, President, 1219 Fulbright Ave., Redlands, CA 92373. (714) 793-9209.

**THE BOSTON AUDIO SOCIETY** the nation's oldest (founded 1972), seeks new members. Dues includes the monthly meeting notice and our newsletter, the *BAS Speaker* (6 times/year). Recent issues cover Carver, a/d/s; the founder of Tech Hi-Fi; Photo CD; plus visits from famous speaker designers; listening tests; measurement clinics; research investigations; and more. Back volumes available. Membership includes engineers, journalists, consultants, and music-loving audiophiles like yourself. For information write to PO Box 211, Boston, MA 02126-0002, USA.

**THE COLORADO AUDIO SOCIETY** is a group of audio enthusiasts dedicated to the pursuit of music and audiophile arts in the Rocky Mountain region. We offer a comprehensive annual journal, five bi-monthly newsletters, plus participation in meetings and lectures. For more information, send SASE to: CAS, 11685 W 22nd St., Lakewood, CO 80215, (303) 231-9978.

**MONTREAL AREA SPEAKER BUILDER** looking for others interested in speaker design and construction from small to large systems. Feeling like I'm the only one. Prove me wrong! Andrew McCree, 4701 Jeanne Mance, Montreal, Quebec H3V 4J5, Canada, (514) 281-7954.

**DO YOU LIVE NEAR LAWRENCE KANSAS?** I am a student at the University of Kansas looking for other speaker builders within driving distance. I would like to exchange ideas and listen to other homebrew systems. Michael Marmor, 1520 Lynch Court #2, Lawrence, KS 66044, (913) 843-8993.

# VOICE COIL

THE NEWSLETTER FOR THE LOUDSPEAKER INDUSTRY

## The Newsletter for the Loudspeaker Industry

*Voice Coil*, the monthly 4 page newsletter for loudspeaker people, is now four years old. Most experts agree editor Vance Dickason is a world class authority on the technology and exploring the significant news and advances which are vital to the loudspeaker industry.

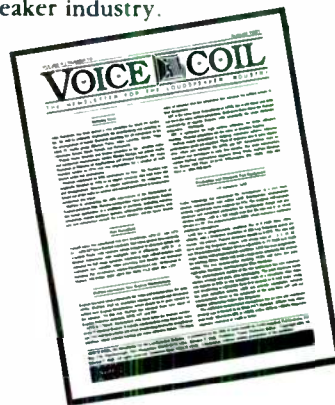

Reliable, practical information about the major changes in the loudspeaker industry is the primary priority. *Voice Coil* is a collection of information from and about loudspeaker and peripherals manufacturers. It represents the most up-to-date information and developments in the industry—FAST. Each issue features new products, new patents, product reports, reviews of all the new computer aided design and test software, meeting highlights and much more.

It will be the very rare issue where you won't find something you didn't know.

**Yes, start my subscription to VOICE COIL**

**Two years @ \$90 (24 issues)**

**One year @ \$50 (12 issues)**

Remit in US \$ drawn on a US bank.

NAME \_\_\_\_\_

COMPANY \_\_\_\_\_

STREET & NO \_\_\_\_\_

CITY \_\_\_\_\_

STATE \_\_\_\_\_ ZIP \_\_\_\_\_

MC OR VISA \_\_\_\_\_ EXP \_\_\_\_\_

### VOICE COIL

PO Box 176, Dept. B93  
Peterborough, NH 03458-0176  
(603) 924-9464 FAX: (603) 924-9467

Answering machine for credit card orders only:  
before 9:00 a.m., after 4:00 p.m. and weekends.  
Have all information plus MC/VISA available.

**IF YOU ARE** an "Organ Music Lover" and like to test your audio system, **SFORZANDO** has room for a few more members. We have about three thousand "Live," on-the-spot, cassette tapes that are not available in the stores. We are happy to lend them to you via the mail. Just ask EA Rawlings, 5411 Bocage St., Montreal, Canada, H4J 1A2.

**SOUTHEASTERN MICHIGAN WOOFER AND TWEETER MARCHING SOCIETY (SMWTMS).** Detroit area audio construction club. Meetings every two months featuring serious lectures, design analyses, digital audio, A-B listening tests, equipment clinics, recording studio visits, and audio fun. The club journal is *LC, The SMWTMS Network*. Corresponding member's subscription available. Call (313) 544-8453 or write David Carlstrom, SMWTMS, PO Box 721464, Berkley, MI 48072-0464.

## Electronic

by  
**ACE AUDIO CO.**  
• est. 1973 •  
RD3 Box 351  
Homer City, PA 15748  
write for free flyer

## Crossovers

**THE PRAIRIE STATE AUDIO CONSTRUCTION SOCIETY (PSACS)** meets every other month. Meetings feature audio construction, design, and analyses, blind listening tests, equipment clinics, auto-sound, lectures from manufacturers and reviewers. PSACS, PO Box 482, Cary, IL 60013, call Tom, (708) 248-3377 days, (708) 516-0170 eves.

**HI-FI COLLECTOR/HOBBYIST** seeks "living letters"/audio pen pals from other states to correspond via reel-to-reel tape. Non-commercial strictly; make up short monologues on subjects from vintage technology, with regional FM excerpts for background or equipment samples, from personal tales of yard sales scavaging success, repair/restoration tactics and strategies, favorite service centers, general ways to handle the burgeoning obsession with arcane hi-fi gear. All correspondence on 3", 5", 7" reels (1/4" tape) will be cheerfully answered and tapes returned via parcel post. James Addison, 171 Hartford Rd., Apt. #7, New Britain, CT 06053.

**Premium Parts & Accessories**

The largest selection of audiophile capacitors, resistors, connectors, chassis wires in North America. MIT MultiCaps, Wonder Caps-solder-wire, SCR, Solen cap, Rel-Cap: Vishay, Holco, Caddock, Mills, Resista resistors: MIT, CARDAS, KIMBER, & silver chassis wires, custom cables & terminations: all types of audio connectors and adaptors: silver contact toggle, rotary switches & stepped attenuator kits. PMI BUF-03's (kit too!). Hubbell hospital grade plugs & outlets. Tubes, feet, damping sheets & compounds, tools and many accessories. Extensive inventory - no delays, good prices and good service!  
Phone (415) 669-7181 or fax 669-7558 for a catalog.  
**Michael Percy, Box 526, Inverness, CA 94937**

**ESL BUILDERS GROUP** is a new address for people who have built or want to build **ELECTROSTATIC LOUDSPEAKERS** and **ASSOCIATED (TUBE) DRIVERS**, or are just interested. We will concentrate on ESL-related building projects but also look at the theoretical aspects of acoustics and electronics. Interested? An answer is ensured, if you include some kind of compensation for postage and handling. Write to: Gunter Roehricht, Buhler STR.21, 7030 Boblingen, Germany.

**STATE OF THE ART  
CROSSOVER NETWORKS**

CALL / WRITE FOR FREE DESIGN GUIDE  
**ALLPASS TECHNOLOGIES Inc.**  
P.O. BOX 453 AMITYVILLE, N.Y. 11701  
PHONE : (516) 598-1320

**THE WESTERN NEW YORK Audio Society** is an active, long established club located in the Buffalo area. We issue a newsletter and hold meetings the first Tuesday of every month. Our meetings attract many prominent manufacturers of audio related equipment. We are involved in all facets of audio—from building/modifying to exposure to the newest high-end gear, and the chance to hear more types of music. For information regarding our society, please write to WNY Audio Society, PO Box 312, N. Tonawanda, NY 14120.

**AUDIO SOCIETY OF MINNESOTA** Now in its 15th consecutive year! Serving the many and varied interests of audiophiles in the upper midwest. Monthly meetings, tours, audiophile concerts, special guests. For information and a sample of our latest newsletter, write ASM, PO Box 32293, Fridley, MN 55432 or call our 24 hour "Audio Hotline," (612) 825-6806.

**THE ATLANTA AUDIO SOCIETY** is dedicated to furnishing pleasure and education for people with a common interest in fine music and audio equipment. Monthly meetings often feature guest speakers from the audio manufacturing and recording industry. Members receive a monthly newsletter. Call: Chuck Bruce, (404) 876-5659, or Eddie Carter, (404) 847-9296, or write: A.A.S., 4266 Roswell Rd. N.E., K-4, Atlanta, GA 30342-3738.

**WASHINGTON AREA AUDIO SOCIETY** Meetings are held every two weeks, on Fridays from 19:00 hours to 21:30 hours at the Charles Barrett Elementary School in the city of Alexandria, VA. Prospective members are welcome but must register in advance in order to be admitted to the meetings. No exceptions please. If interested please call Horace Vignale, (703) 578-4929.

**THE LOS ANGELES AREA LOUDSPEAKERS DESIGNERS GROUP** If you're just starting out or an experienced builder and would like to share ideas on speaker design and listen to each others latest creations, give us a call. Geoffrey (213) 965-9173, Edward (310) 395-5196.

**THE HI-FI CLUB** of Cape Town in South Africa sends a monthly-newsletter to its members and world-wide subscribers. To receive an evaluation copy of our current newsletter, write to: PO Box 18262, Wynberg 7824, South Africa. We'll be very pleased to hear from you.

**TUBE AUDIO ENTHUSIASTS.** Northern California club meets every other month. For next meeting announcement send a self-addressed, stamped #10 envelope to Tim Eding, PO Box 611662, San Jose, CA 95161.

<h2 style="margin: 0;">Ad Index</h2>			
ADVERTISER	PAGE	ADVERTISER	PAGE
A & S Speakers	23	RDL Acoustics	71
Abilene Research and Development	61	RH Lindsay Company	79
AC Components	19	Rigg Audio Distributors	82
Audio Liquidators	35	Sescom, Inc.	80
AudioControl	78	<b>SOLEN</b>	
Dynamic Control	79	Crossovers	25
Harris Technologies	27	Kits	35
Hi-Fi News & Record Review	58	Solo Electronics	6
<b>MADISOUND</b>		SpeakEasy	69
Audax	40-50	Speaker Works	61
Summer Sale	21	StoneCraft Speaker Systems, Inc.	65
Mahogany Sound	80	USA Products	81
Marchand Electronics, Inc.	57	Virgin Cabinets	81
Markertek Video Supply	80	Zalytron Industries Corp.	15
McBride Loudspeakers	82	<b>CLASSIFIED SECTION</b>	
MCM Electronics	55	Ace Audio Co.	86
Meniscus	4	All Pass Technologies	86
MIT Components	CV II	Borbely Audio	85
<b>MOREL ACOUSTICS</b>		DeCoursey Engineering Lab	84
High Tech	CV IV	JBL Professional	84
MW 114S	8	Meniscus	84
Mouser Electronics	80	Michael Percy	86
Norscan Trading Group	59	Per Madsen Design	85
North Creek Music Systems	67	Sonic Studios	83
<b>OLD COLONY SOUND LAB</b>		TC Sounds	84
Clearance Corner	75	<b>GOOD NEWS/NEW PRODUCTS</b>	
LAY01	52	Contemporary Acoustic Design	3
New Products	36-37	Crystal Lake Designs	4
T-Shirts	82	Dimensional Research Laboratories	4
Term Pro	60	Dynacomp, Inc.	4
<b>ORCA</b>		North Creek Music Systems	3
Black Hole/Aeon Cables	13	Pyle Industries	3
TopBox	29	Snell Acoustics	3
Parts Express	CV III	Sorbothane, Inc.	3
Peerless of America, Inc.	63	Tannoy	4
Polydax Speaker Corp.	5	Women's Survey Request	3
Pyle Industries	33		



# Just Listen!



**A. 5-1/4" Fiberglass Cone Bass/Midrange**

This high quality bass/mid uses fiberglass cone technology and a rubber surround for superior damping. Suitable for use in a 2 way or can be used as a premium midrange. Provides very smooth response.

◆8 ohms ◆Fs: 49 Hz ◆SPL: 90 dB ◆VAs: .56 cu. ft. ◆Qts: .27 ◆Manufacturer model number: HT130F0.  
#SF-296-050 ..... \$45<sup>60</sup><sub>(1-3)</sub> ..... \$41<sup>80</sup><sub>(4-UP)</sub>

**B. 10" Paper Cone Woofer**

Paper cone, foam surround unit couples high efficiency and excellent power handling. Long excursion and low 28 Hz resonance provide a deep extended bass response.

◆8 ohms ◆Fs: 28 Hz ◆SPL: 92 dB ◆VAs: 7.41 cu. ft. ◆Qts: .38 ◆Manufacturer model number: HT240M0.  
#SF-296-100 ..... \$52<sup>90</sup><sub>(1-3)</sub> ..... \$49<sup>60</sup><sub>(4-UP)</sub>

**C. 5-1/4" TPX Cone Midrange**

Premium quality driver designed for high end systems. Features a cone material made of a lightweight and rigid, advanced polymer named TPX. Copper coil is edgewound and mounted on a fiberglass reinforced Kapton former. Vented Zamak diecast chassis and phasing plug assure a very smooth top end, dramatic transient response, and very neutral sound quality. Gold plated terminals.

◆8 ohms ◆Fs: 55 Hz ◆SPL: 91 dB ◆VAs: .4 cu. ft. ◆Qts: .22 ◆Manufacturer model number: HM130X0.  
#SF-286-020 ..... \$65<sup>90</sup><sub>(1-3)</sub> ..... \$61<sup>50</sup><sub>(4-UP)</sub>

**D. 1" Titanium Composite Dome Tweeter**

Composed of pure titanium deposited on a polymer diaphragm, this composite offers the exceptional detail of metal domes while retaining the smoothness of soft domes. The result is outstanding clarity, low distortion, and very high efficiency.

◆8 ohms ◆Fs: 1500 Hz ◆SPL: 93 dB ◆Manufacturer model number: TW025M3.  
#SF-276-070 ..... \$34<sup>60</sup><sub>(1-9)</sub> ..... \$32<sup>90</sup><sub>(10-UP)</sub>

... to this fine new line of loudspeakers from Polydax Speaker Corporation. We at Parts Express are proud to offer you these innovative products that are engineered using extensive computer analysis through systems such as MLSSA (Maximum Length Sequence System Analyzer) and FFT (Fast Fourier Transform). The result of this technology, combined with careful subjective acoustical evaluation, is some of the finest loudspeakers produced in the world today. For more information on our complete line of Polydax products or to order your copy of our free catalog, call our sales staff toll free.



**E. 1" Soft Dome Tweeter**

1" textile diaphragm features a catenary profile for maximum stiffness with no out of phase break up at the tip. The result is smooth and transparent sound reproduction and exceptional linearity.

◆Impedance: 8 ohms ◆Fs: 1200 Hz ◆SPL: 92 dB ◆Manufacturer model number: TW025M1.  
#SF-270-046 ..... \$21<sup>95</sup><sub>(1-9)</sub> ..... \$19<sup>50</sup><sub>(10-UP)</sub>

**F. 8" Fiberglass Cone Bass/Midrange**

A premium quality driver. The woven fiberglass cone, high loss rubber surround, and 29 Hz resonance combine to offer excellent sonic definition and deep, tight bass. Perfect for high-end monitors.

◆8 ohms ◆Fs: 29 Hz ◆SPL: 89 dB ◆VAs: 2.98 cu. ft. ◆Qts: .39 ◆Manufacturer model number: HT210F0.  
#SF-296-095 ..... \$55<sup>60</sup><sub>(1-10)</sub> ..... \$51<sup>90</sup><sub>(11-UP)</sub>



340 E. First Street, Dayton, Ohio 45402  
PHONE: 513-222-0173 ◆ FAX: 513-222-4644

**CALL TOLL FREE  
1-800-338-0531**



# High-Tech Audiophile Loudspeakers

For Further Information Please Contact: **morel acoustics USA**

414 Harvard Street  
Brookline, MA 02146  
Tel: (617) 277-6663  
FAX: (617) 277-2415

World Radio History

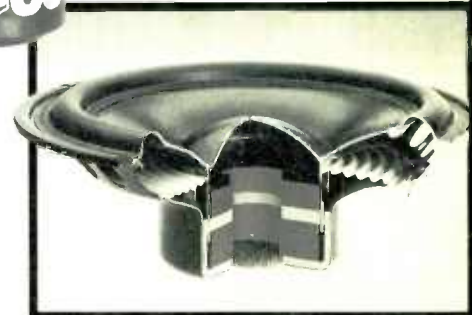

Typical Double Magnet Woofer Cross Section.