

# *Speaker Builder*

THE LOUDSPEAKER JOURNAL

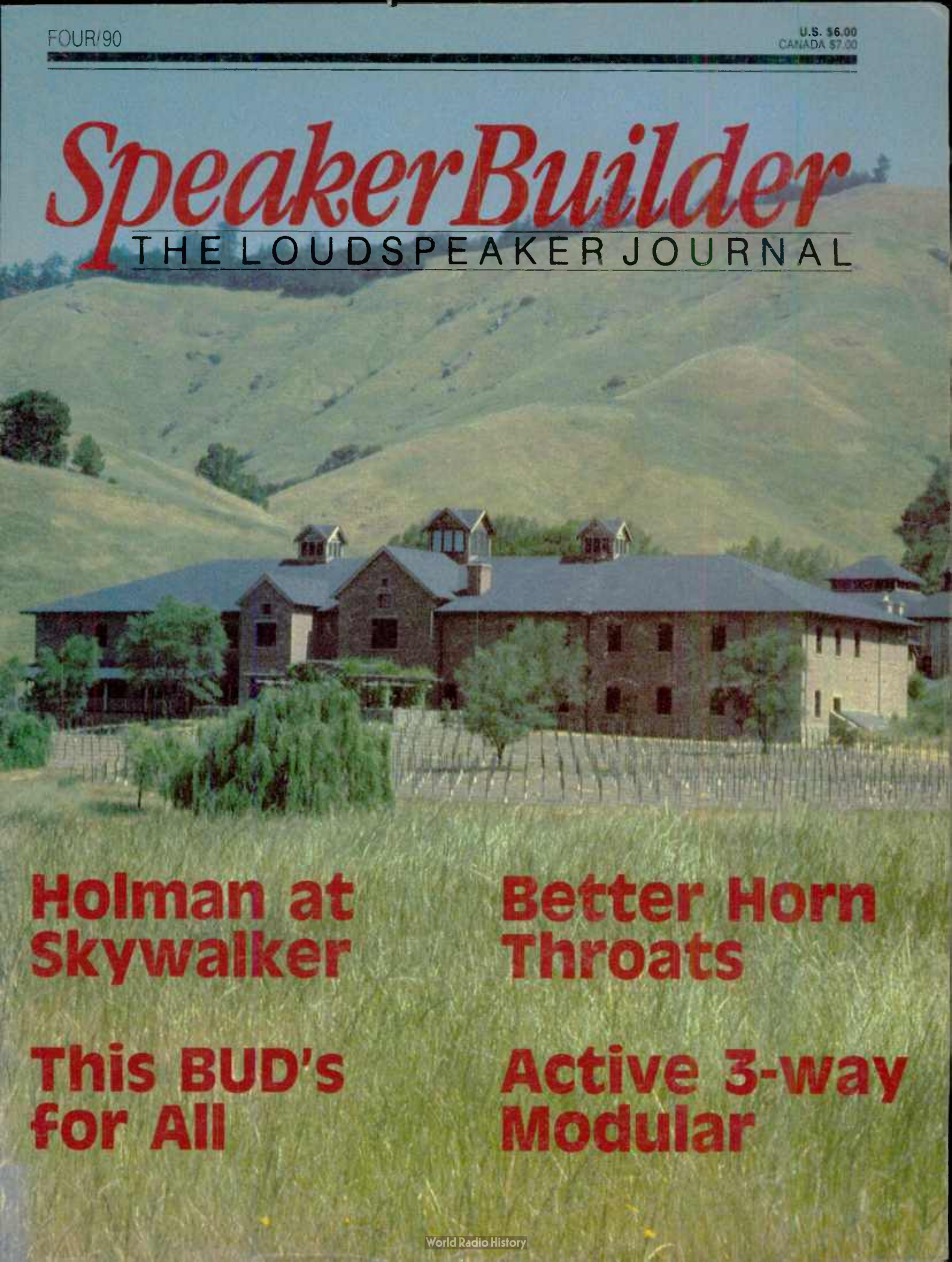

**Holman at  
Skywalker**

**Better Horn  
Throats**

**This BUD's  
for All**

**Active 3-way  
Modular**

*Fished  
with us!*

ETON AMERICA, Box 9274, Grand Rapids, MI 49509-0274

- 3 Layer Kevlar—  
Honeycomb Diaphragm  
HEXACONE
- 70% Greater Stiffness
- Cast Aluminum Chassis
- Rubber/PVC Surround
- Edgewound Ribbon Wire
- All Parts Weighed and  
Matched
- DTB Diffraction Foam
- ETON Caps—  
1% Polypropylene
- New Metal Dome  
MID-RANGE



4-203 / 25 HEX

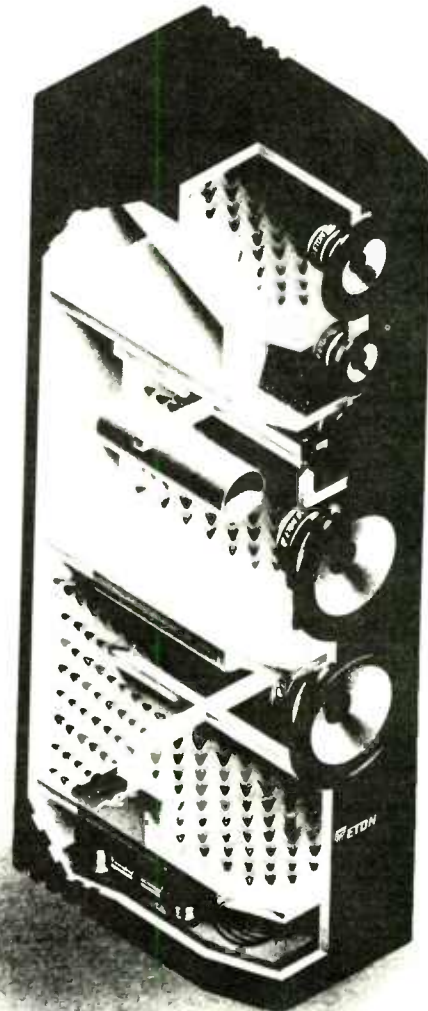

KIT VELOCE 550 DTB

*If you have any questions, please do not hesitate to contact us.*

A&S SPEAKERS  
3170 23rd St.  
San Francisco, CA 94110  
(415) 641-4573  
FAX: (415) 648-5306

AUDIO CONCEPTS  
901 S. 4th St.  
LaCrosse, WI 54601  
(608) 784-4570  
(800) 346-9183

MADISOUND  
8608 University Green  
Box 4283  
Madison, WI 53711  
(608) 831-3433  
FAX: (608) 831-3771

MENISCUS  
2442 28th St., S.W.  
Suite D  
Wyoming, MI 49509  
(616) 534-9121  
FAX: (616) 534-7676

SOLEN ELECTRONIQUE INC.  
4470 Ave. Thibault  
St.-Hubert, QC  
Canada J3Y 7T9  
(514) 656-2759  
FAX: (514) 443-4949

**ETON**

# SB Mailbox

## CORRECTION

I have been getting calls from readers with two complaints associated with the "Compact/Integrated ESL/TL article (SB 3/90). First, an essential drawing, the overall schematic diagram, was omitted (Fig. 1).

Second, somehow an incorrect capacitor value appeared in Fig. 6 on page 45. The capacitor in the feedback loop of the equalizer should be 7200pF rather than 8500pF.

Roger Sanders  
Halfway, OR 97834

## HARTLEY HASSLE

Thank you for publishing my extended comments on the Hartley 224 HS driver (SB 2/90). I really don't want to get into an argument with Mr. Schmetterer, and were it not for the tone of his reply, I would have been happy to let the matter lie. As it is, I ask your indulgence for a

few more comments, after which I hope the matter will be closed.

First, the measurement techniques I employed are widely used and I believe that I have given sufficient information about the conditions of measurement so that others can repeat them to verify their accuracy, or lack thereof. The Heath analyzer I used is specified as  $\pm 2\text{dB}$  over the range, but the calibration curve supplied with the microphone is actually flat in the bass. Since Mr. Schmetterer stated that the anomalies he cited disappear under voltage, it should be noted that all the measurements in my article and comments were made under voltage drive except for the impedance curve which was measured in the standard way, using an approximate constant current source ( $1\text{k}\Omega$  resistor). Also, since he objected to my near-field measurement technique, I have remeasured the near-field frequency response with the microphone outside the heatsink, about 3 inches off-center, with results identical to my published curve (SB 6/88).

Second, although my measuring equipment is modest I make no great claims of absolute accuracy, if all the measurements

were flawed, as Mr. Schmetterer contends, I would expect the results to be contradictory and inconsistent. In fact my measured impedance curve predicted my measured frequency response curve and, together with my compliance measurement, predicted *The Audio Critic's* measured frequency response, with excellent accuracy. Furthermore, if you take my compliance value and Hartley's specified cone mass (214gm), you can calculate a speaker resonance frequency of 32Hz, which is within spitting distance of my measured 28.4Hz. In addition, the person who sold me the used Hartley driver had  $f_s$  and  $Q_{TS}$  measured (by what methods I do not know) with results essentially identical to mine.

Thus, three persons measuring two drivers have obtained remarkably consistent results using different equipment and methodology. In fact, I consider this consistency one of the strongest arguments for the data being correct. If Mr. Schmetterer contends that the data is incorrect, then he must also explain how it is that each piece of data is erroneous by just the right amount and direction so as to be consistent with every other incorrect

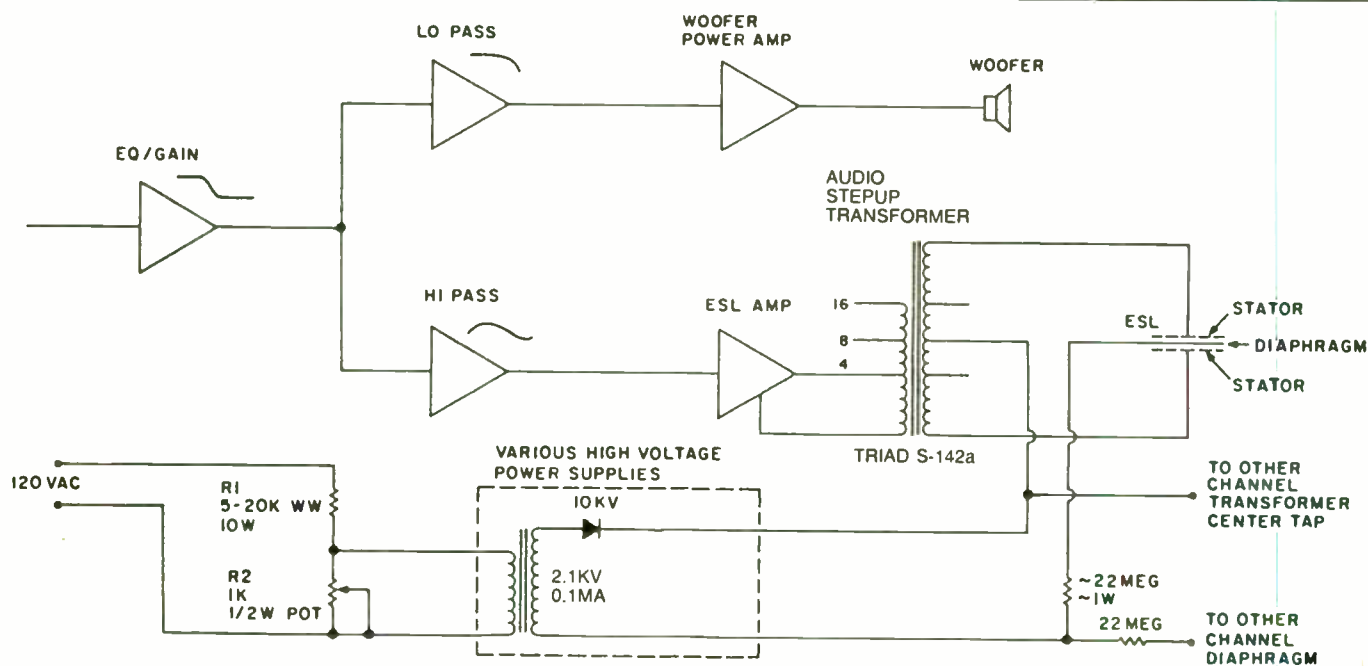
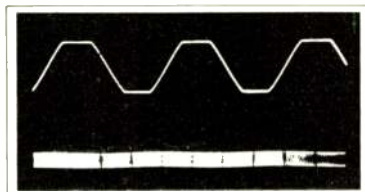
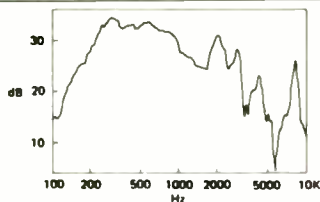
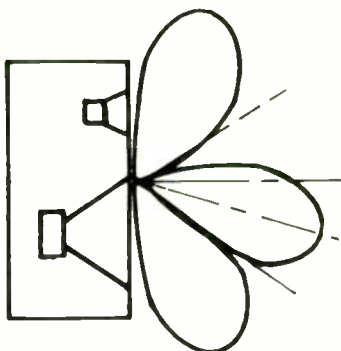

FIGURE 1: Schematic for "Compact/Integrated ESL/TL."



## Technical Audio Insight

### Technical Paper Series from Audio Control

Send the coupon below (or a photocopy) today for the complete series of Audio Control technical papers by author and sound engineer Rick Chinn. Normally \$1.50 each (\$1.00 plus \$.50 shipping), receive all 7 for only \$5.00.

- No. 101 The Effect of Car Acoustics on Automobile Sound Systems
- No. 102 Crossover Networks from A to Linkwitz-Riley
- No. 103 Level Matching
- No. 104 Crossover and Biamplication
- No. 105 How Recordings are Made
- No. 106 Constant Q and Equalizers
- No. 107 Real Time Spectrum Analyzers as a Sound Tool

Send all 7 technical papers. My hard earned \$5 is enclosed

Send Richter Scale information

Name \_\_\_\_\_

Address \_\_\_\_\_

City \_\_\_\_\_ State \_\_\_\_\_ Zip \_\_\_\_\_

**AudioControl**

22313 70th Ave West • Mountlake Terrace, WA 98043  
(206)775-8461 • FAX (206)778-3166

Fast Reply #HE123

## Introducing the MultiCap™ High Performance Capacitor

Few people know capacitors as well as Richard Marsh. He has now patented a new design uniquely suited to the demands of high definition audio and produced it with the help of Music Interface Technologies.

The MIT MultiCap eliminates the need for additional bypass capacitors, and, as the following graphs show, has considerably less oscillation than conventional designs.

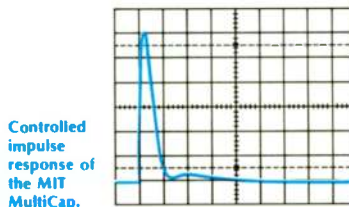
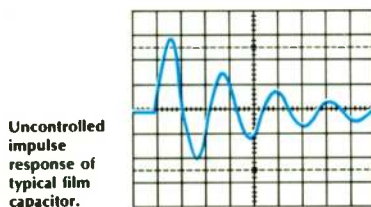

The result is more focused sound throughout the critical midrange and fewer compression effects at frequency extremes.

**Music Interface Technologies** 

For more information, including a detailed white paper, please contact:

**TRANSPARENT AUDIO MARKETING**  
Rt. 202, Box 117, Hollis, Maine 04042 (207) 596-7151

Fast Reply #HE607

piece of data. It seems to me that this consistency is far more likely to be due to concurrence with T/S theory than by multiple bad measurements which miraculously agree with each other.

Third, Mr. Schmetterer's notion of a "normal second-order peak" in my impedance curve appears to be unique to him, as I have never seen this "normal" phenomenon mentioned in loudspeaker literature.

Fourth, Mr. Schmetterer continues to misstate the facts about the *Audio Critic* review. His assertion that *The Audio Critic's* 4' x 2' x 3' box is "much smaller" than the 48" x 36" x 24" box Hartley specifies for the same driver is obviously absurd.

Fifth, Mr. Schmetterer still refuses to suggest a suitable size fuse. The 224 HS driver is specified as 125W RMS power handling capacity, so with a 5Ω impedance, that gives 5A for the current—but should that be the trip current (5A fuse), or the hold current (6A fuse)? Or should you use the RMS peak power spec of 400W, which gives almost 9A of current? I don't know, and Mr. Schmetterer isn't telling. If this is an example of sharing expertise, perhaps you can see why I was dissatisfied.

Sixth, I did contact Hartley to request more technical data and to benefit from their "expertise and ... 60 years' worth of accumulated knowledge," but little useful data was forthcoming. Specifically, here is a complete list of the technical specs Hartley sent me: nominal impedance; minimum, maximum and maximum peak power; voice coil length and diameter; voice coil wire size, length, number of turns and DC resistance; magnet weight, flux density and BL product; cone diameter, mass and excursion limits, and frequency limits with no dB limits or conditions of measurement.

Note that this information is not sufficient to calculate the resonance frequency or driver Q. I suggest that amateur builders compare the amount of useful data in this list compared with a Madisound ad for a driver one-tenth the price, and draw your own conclusions. It was in fact the lack of useful data contained herein that led me to make my measurements.

I had hoped that my comments would have prodded Mr. Schmetterer to provide more accurate data in the form of response and impedance curves than I could provide with my limited resources, and that he would take the opportunity to discuss why he totally rejects T/S theory in view of the consistent measurements that I and others have made of various T/S parameters for the Hartley driver. Obviously, that hope was not fulfilled.

Seventh, Mr. Schmetterer states that I obviously don't understand the technology of Hartley's magnetic suspension. As

Continued on page 77

# TRANSDUCER TECHNOLOGY

Representing these lines

## ACCUTON

*High-technology loudspeakers*

Simply the best high and mid frequency drivers available... period!



Exclusive use of concave rigid dome Kevlar Honeycomb woofers in 6" to 22" Diameters.

## VIETA

A unique 13" woofer made by Accutres in Spain. PVA impregnated pure cotton cone. Inner and outer winding of the voice coil offers maximized magnetic coupling and air flow cooling.



SA 8520 and SA 8525 Compact Drivers. Finally a Driver that combines high efficiency, sonic accuracy and high power handling with pristine high-end sound.

## AUDJUM by

## FOTAL™

High quality components combining light moving parts with massive and efficient motor assemblies. Clean musical subtleties at high sound pressure levels.

## T E K T O N S U B - B A S S

Tekton sub-bass drivers are our own proprietary line featuring machined steel motor assemblies, cast aluminum baskets and immense magnet structure. True extension below audibility.

A Division of Watters Sound Wave Co.  
4320 Spring Valley Road Dallas, Texas 75244 214-991-6994 Fax 214-991-5016

Fast Reply NHE401

# ALUMINUM RACK AND CHASSIS BOXES FOR CONSTRUCTORS

ABOVE BOXES MADE OF .063 ALUMINUM: TOPS, BOTTOMS AND SIDES BLACK ANODIZED, FRONT AND REARS .063 ALUMINUM CLEAR ANODIZED.

RACK BOXES		CHASSIS BOXES	
<b>MODEL</b>	<b>1-9</b>	<b>MODEL</b>	<b>SIZE (inches)</b>
1RU5	28.00	MC-1A	4x3x2 15.00
1RU7	30.00	MC-2A	6x3x2 17.00
1RU10	32.00	MC-3A	8x3x2 19.00
2RU5	30.00	MC-4A	4x5x3 17.00
2RU7	32.00	MC-5A	6x5x3 19.00
2RU10	34.00	MC-6A	8x5x3 21.00
3RU5	38.00	MC-7A	4x7x4 19.00
3RU7	40.00	MC-8A	6x7x4 21.00
3RU10	42.00	MC-9A	8x7x4 23.00
WITH RACK EARS			WITH FEET

10-99 — 10%      100-UP — 20%  
 COMPLETE CATALOG AVAILABLE      SHIPPED UNASSEMBLED



## SESCOM, INC.

2100 WARD DR.  
 HENDERSON, NV 89015 USA

UPS SURFACE FREE  
 UPS BLUE \$10.00  
 UPS RED \$20.00  
 VISA/MC ACCEPTED

702-565-3400 — 800-634-3457 — FAX: 702-565-4828

Fast Reply #HE499

# Speaker Builder

Edward T. Dell, Jr. *Editor/Publisher*  
 Karen Hebert *General Manager*

*Contributing Editors*  
 Joseph D'Appolito Robert Bullock  
 John Cockcroft David Davenport  
 Vance Dickason Bruce C. Edgar  
 Gary Galo G. R. Koonce

*Managing Editor*  
 Paul Quinn  
*Graphics Director*  
 Christine Holt  
*Graphics Assistant*  
 Kendall Hawes  
*Graphics Assistant*  
 James Butler  
*Circulation Director*  
 Katharine Gadwah  
*Circulation Assistant*  
 Doris Hamberg  
*Drawings*  
 Techart Associates

### Advertising Rates & Schedules

Rally Dennis  
 PO Box 494  
 Peterborough, NH 03458  
 Advertising Phone: (603) 924-6710

### Editorial and Circulation Offices

Post Office Box 494  
 Peterborough, New Hampshire 03458  
 (603) 924-9464  
 FAX: (603) 924-9467

**Speaker Builder** is published bi-monthly by Edward T. Dell, Jr., PO Box 494, Peterborough, NH 03458. Copyright © 1990 by Edward T. Dell, Jr. All rights reserved. No part of this publication may be reprinted or otherwise reproduced without the written permission of the publisher.

All subscriptions are for the whole year. Each subscription begins with the first issue of the year and ends with the last issue of the year. A sample issue costs \$4 in the US, \$5 in Canada.

Subscription rates in the United States and possessions: one year (six issues) \$20, two years (twelve issues) \$35. All sets of back issues are available beginning with 1980. Canada add \$4 per year for postage. Overseas rates available on request. Subscribers residing outside the US and Canada are served by air.

To subscribe, renew or change address in all areas write to Circulation Department or call (603) 924-9464 for MC/Visa charge card orders. For gift subscriptions please include gift recipient's name and your own, with remittance. A gift card will be sent.

### A Note To Contributors

We welcome contributions for possible publication in the form of manuscripts, photographs or drawings, and will be glad to consider them for publication. Please enclose a stamped, addressed return envelope with each submission. While we cannot accept responsibility for loss or damage, all material will be handled with care while in our possession. Receipt of material is acknowledged by postcard. Payment is on publication.

**Speaker Builder** (US ISSN 0199-7920) is published bi-monthly at \$20 per year; \$35 for two years, by Edward T. Dell, Jr. at 305 Union St., Peterborough, NH 03458 USA. Second class postage paid at Peterborough, NH and additional mailing office.

POSTMASTER: Send address changes to **SPEAKER BUILDER**, PO Box 494, Peterborough, NH 03458.

## About This Issue

These days, Hollywood's leading soundtrack man is Lucasfilm's Tom Holman. We were fortunate enough to obtain an interview with Tom who took time out from his busy schedule to talk shop with author **Reid Woodbury, Jr.** Part I of this fascinating interview begins on page 10.

The first step is always the hardest in most speaker construction projects. **Dave Davenport's** solution (page 26) was to buy a ready-made Bud Box for a fast start. The resulting speakers are now fixtures in a friend's car, but yours can go in the living room, if you like.

From a theory viewpoint, the Klipschorn's throat opening should not function well. But those who own and love it, believe it does. In "Solving the Klipschorn Throat Riddle" (page 28), **Bruce Edgar** discovers some new answers.

Years of experimentation led **Fernando Ricart** to develop an extraordinary three-way active modular loudspeaker utilizing the Linkwitz equalized fourth-order filter circuits. His well-illustrated article starts on page 36.

**Philip Erhorn** has built an affordable speaker system able to handle CDs. So if you'd like to listen to premier-quality Bach or rock at "lease-breaking" levels, make sure to read Phil's article, starting on page 44.

And finally, with **Stuart Bonney's Speaker Designer** program (page 47) you'll be well on your way to designing an original system with your IBM PC.

# Speaker Builder

THE LOUDSPEAKER JOURNAL

VOLUME 11 NUMBER 4

AUGUST 1990

## FEATURES

### 10 TOM HOLMAN, SKYWALKER AND THX Part I

BY REID WOODBURY, JR.

### 26 THE BUD BOX

BY DAVID DAVENPORT

### 28 THE KLIPSCHORN THROAT RIDDLE

BY BRUCE EDGAR

### 36 A MODULAR THREE-WAY ACTIVE LOUDSPEAKER

BY FERNANDO RICART

### 44 A SPEAKER SYSTEM FOR CDs THE SIMPLE APPROACH

BY PHILIP ERHORN

### 47 "SPEAKER DESIGNER" A COMPUTERIZED DESIGN AND MODELING TOOL

BY STUART BONNEY

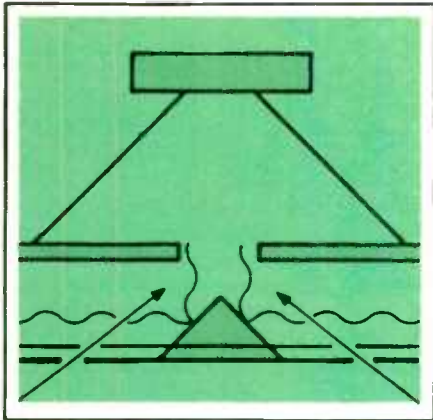

28

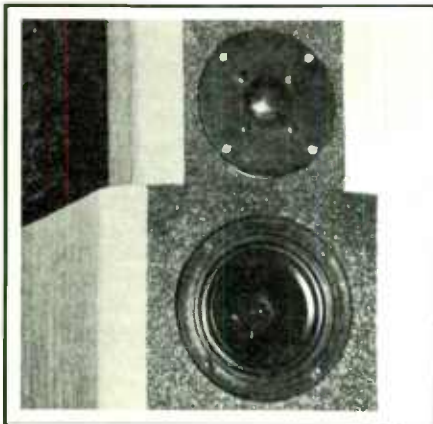

36

## DEPARTMENTS

3 MAILBOX

8 GUEST EDITORIAL Mike Chin

60 TOOLS, TIPS & TECHNIQUES

65 KIT REPORT The Pitts Loudspeaker  
BY FERNANDO GARCIA VIESCA

68 ASK *SPEAKER BUILDER*

76 VINTAGE DESIGNS

Altec-Lansing's 606-Type Cabinet

95 CLASSIFIED

98 AD INDEX

99 GOOD NEWS

102 POX HUMANA

## SYSTEM PRIORITIES

by Mike Chin

Since *SB* appeared a decade ago, it has matured into what must be one of the most sophisticated DIY journals in any field, with tremendous value as a source material of speaker technology and as a forum for practitioners in the field. Many of the projects published are fabulous, both in conception as well as execution, and there can be little doubt that some of these represent something very close to the best information available at any price, anywhere.

Nevertheless, there is a recurrent serious shortcoming in the perspective and approach of some article writers and, judging from letters, from readers as well. This can be summed up as an overemphasis of the importance of loudspeakers in the performance of the reproduction system and, to exaggerate a little, a belief in improving the speaker as a universal cure for all audio ills.

Given the nature of *SB*, this attitude is hardly surprising. As a long-time speaker-building enthusiast, I can certainly attest to the enormous differences that improvements in speakers and their setup can make. I'm not about to deny that.

However, the speaker is only one link in the component chain, and its performance is profoundly influenced by the signal fed to it. The "upstream" components in a system determine to a large degree the quality of that signal, and herein lies my point: many *SB* activists seem to utilize signal source components (turntables, CD players, etc) and other components of a quality that is likely to be poorer than that of the speaker systems they are attempting to design and build. This is a task akin to making distortion measurements with test equipment which has higher residual distortion levels than the items being tested. In such cases, it would be more productive to examine and improve weak points in the upstream components rather than tackling another speaker project.

Better source components (and amplifiers and cables and stands) provide a more accurate signal with which to evaluate and design loudspeakers. Conversely, there is virtually no way that errors introduced by source components can be adequately corrected by "downstream" components. I know from personal experience that as the quality and resolution of the whole audio system prior to the speakers improve, so does our ability to produce a better speaker using this system as an evaluation tool. Our listening ability improves and becomes refined in direct correlation with the resolution of the system.

We should all recognize that the speaker systems are part of the larger system we use to listen to them. And we should ensure that when we communicate with others, we describe the other components in that system, along with any problems known about each component. A speaker carefully tailored to sound wonderful always has a context: that of the system(s) in which it was designed—including the room(s)—and the hearing process of those who listened and designed. It cannot possibly sound quite the same with other systems.

For example, the typical "speaker" problem of a "harsh top end" is often caused by inadequate CD players, am-

plifiers and turntable systems. If a speaker system is designed to have a smooth top end with such components, then its resolution and high frequency response will naturally suffer when connected to better equipment. For example, the search for that perfect tweeter might stop with a new tonearm that has fewer resonances which excite those in tweeters.

In my experience, the most important component is the recording itself, and then the source components' ability to extract and project an acceptable facsimile of the original performance into downstream components. We've all had the experience, I'm sure, of deriving great pleasure from a little transistor radio playing a wonderful tune, or of marvelling at how a great recording can transform the sound of mediocre systems, or of being disturbed at the impressive sound of an elaborate audio system that excelled in all sorts of standard "hi-fi" ways, and yet failed to make the listening a pleasure. I suspect the latter experience is much more common than you might think, and I believe it arises mainly (assuming we can't do much about the quality of the original performances or the way they were captured) from the inadequacy of signal source components and their setup, and from component-matching.

Some of the British audio publications have been quite progressive with their system-matching methodologies, trusting experienced human hearing and perception much more than instrumentation (something I agree with wholeheartedly—if it is heard but cannot be measured, it does almost invariably exist!), and taking the real-world attitude that simply substituting a better component without regard to the other components in an audio system can have either positive or negative results. One common observation of many of their reviewers is that using a highly accurate and refined loudspeaker with poorer upstream components almost always provides a performance less convincing, pleasant or musical than using more limited speakers with better upstream components. I have heard this particular observation easily verified many times to many listeners, seasoned and neophyte.

I'd like to suggest a forum much like "Tools, Tips & Techniques" but focusing more on getting better performance from components other than loudspeakers (without becoming another *Audio Amateur*) and from the audio system as a whole, or perhaps an ongoing series of articles about this subject. I would also encourage writers to describe in greater detail the other components used with their speaker systems, and about how the whole system is set up.

It is impossible to have an absolute and universal system reference with which relative loudspeaker performance can be gauged. We should at least make some effort to disclose all the factors that determine the final performance of our speakers for readers who obviously cannot listen for themselves. Ultimately, such efforts should improve our ability to judge clearly the fruits of our own labor. 



**Distributors: USA**

A & S Speakers  
3170 23rd St.  
San Francisco, CA 94110  
(415) 641-4573  
FAX: (415) 648-5306

Advanced Audio Products  
1916 Pike Place, #1243  
Seattle, WA 98101  
(206) 527-3393

Audio Concepts  
901 South 4th St.  
LaCrosse, WI 54601  
(608) 784-4570

Big Cove Research  
105 Catherine Dr.  
Owens Cross Roads, AL 35763  
(205) 881-8677  
FAX: (205) 882-6765

Madisound Speaker Components  
8608 University Green  
Box 4283  
Madison, WI 53711  
(608) 831-3433  
FAX: (608) 831-3771

Meniscus  
2442 28th St., S.W., Suite D  
Wyoming, MI 49509  
(616) 534-9121

Speaker City U.S.A.  
10615 Vanowen St.  
Burbank, CA 91505  
(818) 508-1908

Speakers Etc...  
1828 W. Peoria Ave.  
Phoenix, AZ 85029  
(602) 944-1878

Zalytron Industries  
469 Jericho Turnpike  
Mineola, NY 11501  
(516) 747-3515  
FAX: (516) 294-1943

**Distributors: CANADA**

We are pleased to introduce our new distributor in Canada:

Younge Speaker Shop  
508 Younge St.  
Toronto, Ontario  
Canada M4Y 1X9  
(416) 966-3377

**FOCAL** America, Inc.  
1531 Lookout Drive  
Agoura, CA 91301

# SUBS

**ARIA 10** by Joe D'Appolito  
BAND PASS—6th order passive  
 $F_B = 25\text{Hz}$  89.5dB  
H x W x D = 28½ x 15¾ x 18"

<b>SUB 8 BR</b>	<b>SUB 8 S</b>
Bass reflex	Sealed
$F_B = 31\text{Hz}$ 90dB	$F_B = 42\text{Hz}$ 88dB
H x W x D = 25 x 12 x 14½"	



Long Throw  
8K415S



Long Throw  
8V416

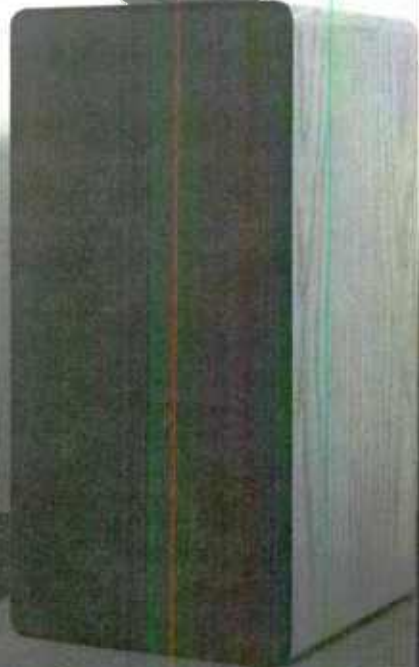

**CABINETS:**  
Call FOCAL AMERICA  
(818) 707-1629

## Part I

# TOM HOLMAN, SKYWALKER AND THX

BY REID WOODBURY, JR.

When we go to the movies, we go for the big theatrical experience of sight and sound. I mean, what are we paying \$7 (or more) per ticket for? We want sound at least as good as what we get at home from our own finely tuned systems. After all, *Speaker Builder* readers know what good sound should be, or at least have a very strong opinion about it. And nowhere will you find better big-screen sound than in a theater equipped with the THX Sound System.

So when I got an invitation to interview Tom Holman, I figured now's my chance to find out what's behind the THX Sound System I met Tom (Photo 1) at his office on the campus of USC/LA. Friendly and soft-spoken, he has a teenager's enthusiasm for technical details and the self-confidence of someone who truly knows what he's talking about. We spent a few minutes discussing how he got started in audio.

**PERSONAL.** In high school, Tom got involved with school plays. He worked mainly with lighting until his junior year at the University of Illinois when he shifted to sound, first in theater and television, and then in technical film.

### ABOUT THE AUTHOR

Reid Woodbury Jr. is a free-lance audio engineer in the Los Angeles area, working with production and post-production sound for television, film, and audio/visual productions. He has also done sound designs for various live theaters in the US. He graduated from the University of Missouri at Kansas City Conservatory of Music and also studied electrical engineering for two years. While at UMKC he worked as a sound technician for the Missouri Repertory Theater and was on staff with the Conservatory Recording Department. Currently he's running his own classical recording service and is a substitute teacher for the Glendale (CA) school district.

During this time he also did summer production jobs for the college. Graduating in 1968 with a B.S. in communications, he went to work full time for the university; mixing, editing, and doing whatever else was needed. During the ensuing five years Tom says he really learned about sound because he had access to the facilities of a great college library.

"I think it's better than MIT's or Stanford's," says Tom. I've looked at audio at all three of them. And, because they (UI) would buy everything I wanted, I was able at that time to read pretty much

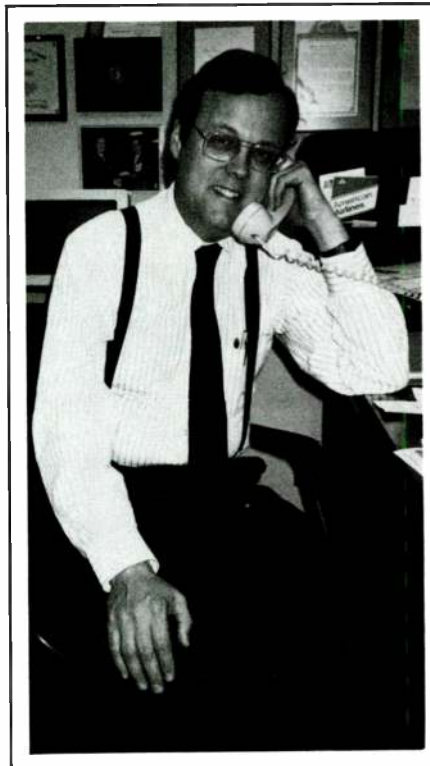

PHOTO 1: Tom Holman, corporate technical director for Lucasfilm, Ltd., and assistant professor at USC's School of Cinema-Television.

everything that had been published about audio. Today, that's impossible because there's ten times as much stuff out there. But back then you had to read two shelves full of Audio Engineering Society material, and over a five-year period I pretty much did that."

Tom spent most of his time working in cinema, eventually concluding that the likelihood of improving film sound quality seemed to be pretty slim. So in 1973, at the age of 26, he went to work for Advent where he felt he could do higher quality work. While there, he worked as an engineer with Andy Petite, the firm's chief speaker designer, as well as with Henry Kloss, the company's founding engineer.

In 1977, Tom left to start his own company, Apt, because, "Advent wasn't in great shape. Although it was a very successful loudspeaker company, their television line ate up all of the loudspeaker profits. I worked mainly in receiver and radio, and on the loudspeakers, a little on the television. I started Apt to make the preamp and power-amp, which I did for three years."

When a chance to work for Lucasfilm came along in 1980, it was just too good an opportunity to pass up. Film sound was improving. Recently, Dolby Labs had greatly enhanced the quality of theater audio by adding noise reduction, stereo format and standardization.

"And it was also a field where things were a little backward. It was pretty easy to make a contribution, because I just used the principles I learned in high fidelity and applied them to film sound," says Tom.

USC. I readily accepted Tom's offer of a tour of the USC film department. A courtyard between buildings was full of sculptures arrayed around a quiet foun-

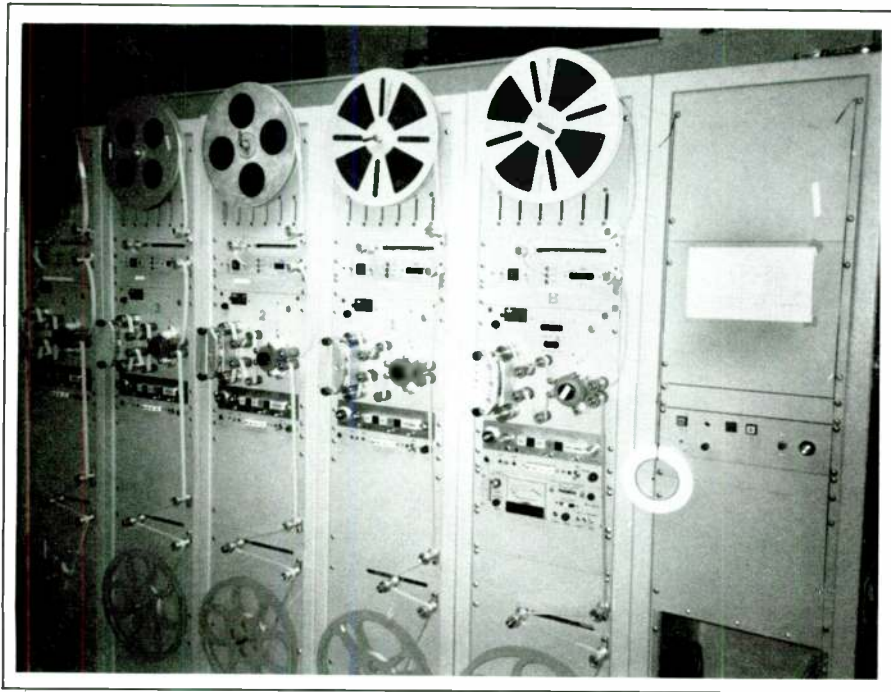

PHOTO 2: Dubbers, USC film lab.

tain. Students were walking all about. Two brass players practiced outside against a backdrop of bird songs and distant traffic. Tom pointed out that one of his assignments for students in his beginning film sound class is to sit in this courtyard and write down everything they hear.

USC has a very complete sound facility with Foley stage, mixing stage, and a large scoring stage with 24-track recorder. The screening room also serves as a lecture hall. Student productions are kept small enough not to need dialogue replacement.

When we went through the machine room (Photo 2) of the two film-mixing stages he stopped to assist a student who had accidentally let the dubber reel run past the end. A few minutes later, the dubber was reloaded and work resumed. It was almost time for Tom to go back to work, so we made arrangements to continue the interview later at Skywalker Ranch, home of Lucasfilm, Ltd.

The drive through the wine country just north of San Francisco was mesmerizing. Thick patches of trees dotted the valleys between grass-covered hills, with narrow, well-maintained roads winding their way through it all. This is highly-recommended territory for anyone who likes wine and country drives.

**SKYWALKER.** Named after Luke Skywalker from the *Star Wars* series, Skywalker Ranch occupies a sizable chunk of this marvelous landscape. Tom assured me that every building here is brand new,

just constructed with different styles, as if over a long span of time.

Having traded in his professor's coat and tie, Tom was casually attired when I pulled up the long driveway. Noting my camera, he said management doesn't like pictures to be taken because they are afraid of a photo being misused by one of the scandal sheets. But he added that he would let me know when it was safe to take a few shots.

The centerpiece of the ranch is a lake gravity-fed by seven wells in the hills, creating a reservoir for fire fighting. That's important because the ranch is far from town, and those beautiful grassy hills get very dry and brown in summer. The ranch has its own fire department which is also part of the security department. These personnel are also trained paramedics.

**TECH BUILDING.** One of the more obvious structures is the Tech Building, devoted entirely to post production. This first segment of the winery-shaped structure contains two edit/mix suites, back-to-back and mirror-imaged. Each has 11 editing rooms, a pre-mix room, a final mix room and machine and control rooms. Thus editors and mixers are brought close together. The rest of the building houses support people.

"The sound studios are set at the points of a star in order to separate them from one another, conceptually," said Tom. "And the center of the star is a set of technical rooms with heavier floor

loads, more cooling and more power. The idea is that technology today—or in the future—is likely to be concentrated in a form where you need to take care of some high tech equipment with heavy power, heating and cooling requirements. And then your sound editors are going to be separated from the equipment, not like the Movieola, where they're physically working on stuff. So that's why there's a central, heavy-duty area."

**MILES OF DUBBERS.** "The editing suites are set up conventionally for two editors" continued Tom. "These are the simplest rooms with just benches and mag readers, squawk-box-type deals. But there are hidden troughs under the floor ... in order to run any amount of high tech fiber optic or what have you. Each room has its own thermostat and air volume control because you're likely to have different technologies in different rooms.

"In the final mix machine room all the dubbers are centralized in the central core, but the recorders for a room are located here," Tom continued. "There can be a lot of debate on which place you want to have them. It wound up that you want a machine-room operator here and you want your masters here. The central core basically is miles and miles of dubbers—about 600; you switch them to whatever room you need. There are about 600 channels of Dolby SR (Spectral Recording) in the building. I think we're the largest single customer for Dolby.

"Patching for 24 tracks at a time, plus cross patching. You could patch up, basically, your normals with that scheme. It's Magnotek equipment, thoroughly aligned with this 'tweak cart' that we built with a Bradford audio noise meter that goes down to 0.1dB calibrations. And we use those tenths," says Tom. Alignment is done for every reel. With 35mm film, a reel is about ten minutes long.

"And it has a spectrum analyzer, tones or pink noise. You can choose to azimuth from any pair of channels you like." The tweak cart is also connected in 24-tracks at a time to do everything, including Dolby levels.

"(In the rack there) is SSL automation. This is dubber and recorder patching, dubber to inputs of consoles. But the monitor system is not a console function. The actual sends and returns from recorders and all the things in the path to the loudspeaker are in this rack we built. We called it the CP-250, a kind

of tongue-in-cheek reference to the Dolby CP-200. This actually does the task of the studio DS-4: encoding and decoding the matrix, plus all the noise reduction needed for that, plus sends and returns to recorders. They're doing an L-t-R-t [left-total, right-total] here.

"All the patch configurations are on floppies, so if you want to be in the Academy mono mode you press the 'A' button on the console and load this disk. It puts all the processes available into the correct order. Here are cards from the Dolby CP-200 (Photo 4.) to which we've added a carrier card which does differential input and output amplifiers here—input amps, 100dB common mode rejection input amps and output amps."

The rack also contains a number of things for simulation, like optical clash, dirt noise, grain noise. "And this (unit also) simulates the frequency range and octave-to-octave balance of the range of different sound systems: A4's, THX full range, or A4 equalized, or A4 unequalized—pretty much any condition you might encounter in a theater ... There's a background-noise adder, a clipper, a clipper per octave band, and so forth," he said.

The signal goes from there to the room EQ, the THX crossovers, and the power amps. They can also mix for IMAX-equipped theaters by switching in the top center speaker. The THX and IMAX systems are the same except for the added channel in IMAX.

While we are in one of the mixing theaters, Tom presses a button on the console and the sound of air conditioning rumble can be heard. "Average theater background noise level," he explains, "so you know what you're working against. Footage counter and level meters appear out of black under the screen, by virtue of scrim cloth—the old theatrical trick, scrim."

Lucasfilm worked with Solid State Logic on the SSL 5000 series mixing console to turn it into a film sound console. "These modules, in particular the panning modules, are the most complicated ones," adds Tom.

"We have another little input console over here called the mix-in-context mixer. It takes existing pre-mixes and puts them onto main busses, so you can put up whatever you like. If you're mixing Foley, you can run the dialogue tracks and use the whole console for Foley. You can still add in the dialogue tracks, so you can mix in the context of the already existing pre-mixes."

The mixing stages are nothing special, just good mixing stages. Tom demon-

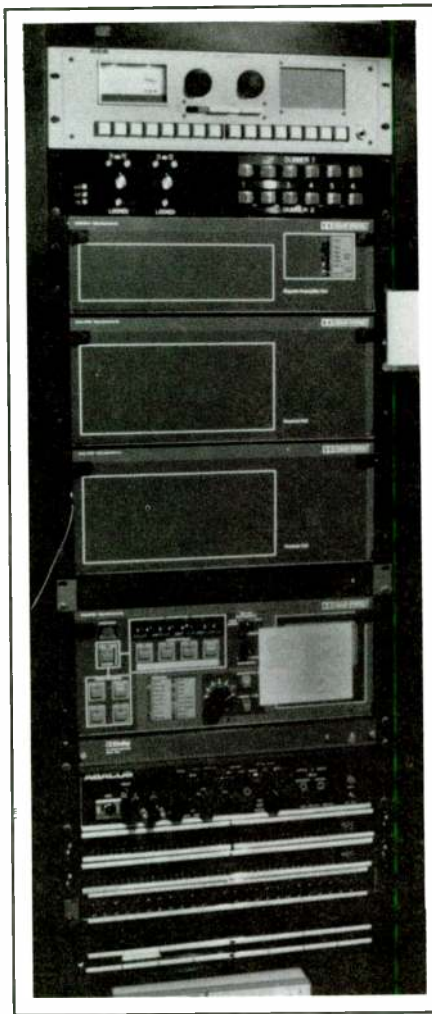

PHOTO 3: Dolby decoders.

strated how dead they are by clapping his hands. The surround speakers are hidden behind scrim panels, 14 in all. The rooms are also set up for the power requirements of digital audio. They have massive air handlers that take in water, chilled and circulated from an underground plant below the parking lot out back.

Of the two one-man spaces, one is being used mainly for storage; the other is set up for the sound designer, Ben Burt. To get the projection to the proper length they use a periscope arrangement. The screen has adjustable masking for the different film formats and the extra IMAX speaker.

**LAWYERS, ACCOUNTANTS, AND ENGINEERS.** "The second floor also has editing rooms and smaller work rooms, and also a room that looks down, balcony-like, into the stage so that you could use it as a control room to record in the stage. If all the other stages are booked and you just need one effect, just go up there and run a mike line down."

Tom continued to point out things as

we walked through the halls. "There are eight overflow editing rooms here for each floor, which are apparently being used as offices. George's (Lucas) philosophy about that is if you don't build a lot of offices you won't have a lot of overhead, because you won't have any place to put the people. So don't build a lot of offices. He once said to me in a meeting, 'Engineers: I know what they do; lawyers and accountants: I don't know what they do.'"

A lot of odd angles in the Tech Building help break up the work spaces, with no feeling of a sterile business office. One section is made to look as if an exterior space were roofed over with a skylight to connect two buildings. Office windows look out onto this space, providing lots of natural light. Very European, and very comfortable, according to Tom.

**TRANSFERS AND LIBRARY.** The transfer room has just about every kind of tape machine. The centerpiece is a multi-format Magnotek mag film recorder which has head stacks for all track configurations and film guides for 16mm and 35mm. Sound effects can be processed by an array of signal processing devices, including an old Burwen single-ended noise reduction unit. The room also has its own tweak cart.

All of Lucasfilm's sound effects are stored on 15ips ¼" tape, using Dolby A or SR-type noise reduction. This is an unpublished library, but is something clients get when they do their films here. An even more restricted library, not on the shelf, contains the signature sounds for *Star Wars* and *Indiana Jones*.

Transfer room monitoring is accomplished with standard LCRS (left, center, right, surround) speakers and encoder so you can really tell what's happening on four-channel. "One of the problems I find common in Hollywood," says Tom, "is that unless you're in a dubbing stage, you can't make any judgements about sound quality, because the transfer rooms are usually badly equipped with old Altec monitors, or something. And operators sit in the transfer room, and they try to figure out what to do about the rumble or something. They can't really do a good job because they're not hearing it properly.

"Our point is that every step of the process is made as standardized as it can possibly be. And at the points where you make judgements, then, you have to have the right monitoring. So we probably do the correct kind of monitoring early on in the chain, like in pre-mix,

that other people do when they're trying to make judgements on a Movieola. That's OK if you know your effects library and how it's going to wind up in the end. But it's really hard to make judgements, say, on production sound recordings. That's why transfers are made as routine as possible, so that you're set up in a prescribed way and you do it every day. So six months later you can make exactly the same transfer, and you can cut in a word and it drops in. Levels have to be very accurate, equalization has to be very accurate in order to do that."

**ADR AND FOLEY.** The rooms I most wanted to see were the ADR (Automated Dialogue Replacement) and Foley stages (all the non-vocal sounds an actor makes, named after an early sound editor named Jack Foley).

The Foley stage has a background noise level of NC 5. They had to extrapolate that value because the official tables only go down to NC 15. The room was so quiet I could hear my ears ringing and blood flowing. When I mentioned this, Tom assured me that the air conditioning was on. Very quiet. It has to be quiet enough to get quiet clothing

sounds without bringing up any room noise.

We stomped on the different "special noise" surfaces such as wood floor, concrete, metal grate, and there's also a shallow depression for creating water noises. The room also has an outside door for bringing in cars, and is made as dead as possible with four inches of fuzz everywhere. The Foley stage is slightly more live than the screening room (see below) because of the extra surfaces.

The ADR stage is similar to the Foley stage. It's just big enough for a 6 x 14 foot screen. It's furnished with a stool, script stand, headphones and microphone. And it has another nice touch: a window to the outside world. The control room has a very basic one-channel mixer and monitor for the replacement line and the original production sound.

**BIG SPACES.** The scoring stage was booked, so we only got to see it from an observation deck. This is one of the two largest spaces at the facility, more than large enough for a full orchestra. The stage walls and ceiling are made from massive semi-cylindrical cast-concrete forms. This gives the room a very long reverb time with very diffuse reverberation over a wide frequency range, even

at low frequencies. It also provides a high degree of isolation from outside noise. There are pockets in the ceiling and walls for movable panels that allow wide adjustment of the reverb time, from 0.7 seconds to 3.5 seconds.

I asked Tom about the trouble of getting contractors to correctly follow the plans of an acoustic designer. "Well," said Tom, "Ted Schultz designed this. He's got lots of experience. He's just retired, in fact. He worked at BB&N (Bolt, Beranek & Newman) forever, and then went off on his own about ten years ago. He did Baltimore, Toronto, Davies Symphony Hall, some in Australia, some in Europe, all over the place."

The other large space is the screening room. "So, this is what we think a screening room ought to be," Tom noted. "It's fairly shallow for its width. In other words, it's almost square. It starts with the picture as the beginning point for determining what the ratio of dimensions should be. There's about equal masking all around. That tells you what the height ought to be, and depth for a certain room volume and listening angle. It's not really a theater space, it really is a cinema space."

The room is very dead with a slight echo off of the screen. It has five main-channel speakers in the new format and hidden split surrounds.

The projector was made in the 1950s and came from a theater in San Francisco. Tom pointed out the flutter idlers for 70mm are very well damped, and very difficult to turn. The film is moving quite fast, 112 fpm or 22.5 ips.

"This is an old projector," observed Tom. "And it's still the best available dual-gauge projector. Well, it's been repainted, but basically projection is not a new issue. It was well faced in the past. Now we do have, for example, much better heads than they had in the past: six-track Teccon—an awfully good head compared to what they had in the 50s. The booth also has all the standard sound equipment."

As we completed our brief tour of the ranch's audio installation, I was more than a little impressed. It's quite a place, and it was truly gratifying to see a facility where no expense was spared to do things right. But now it was time to sit down with Tom and get the story on the THX sound system. Here's what he had to say.

**TH:** Well, we've built a sound system called THX and it's in about 350 theaters now. [See *Audio*, September, 1989, p. 65 for THX theater list.] It's very strong in

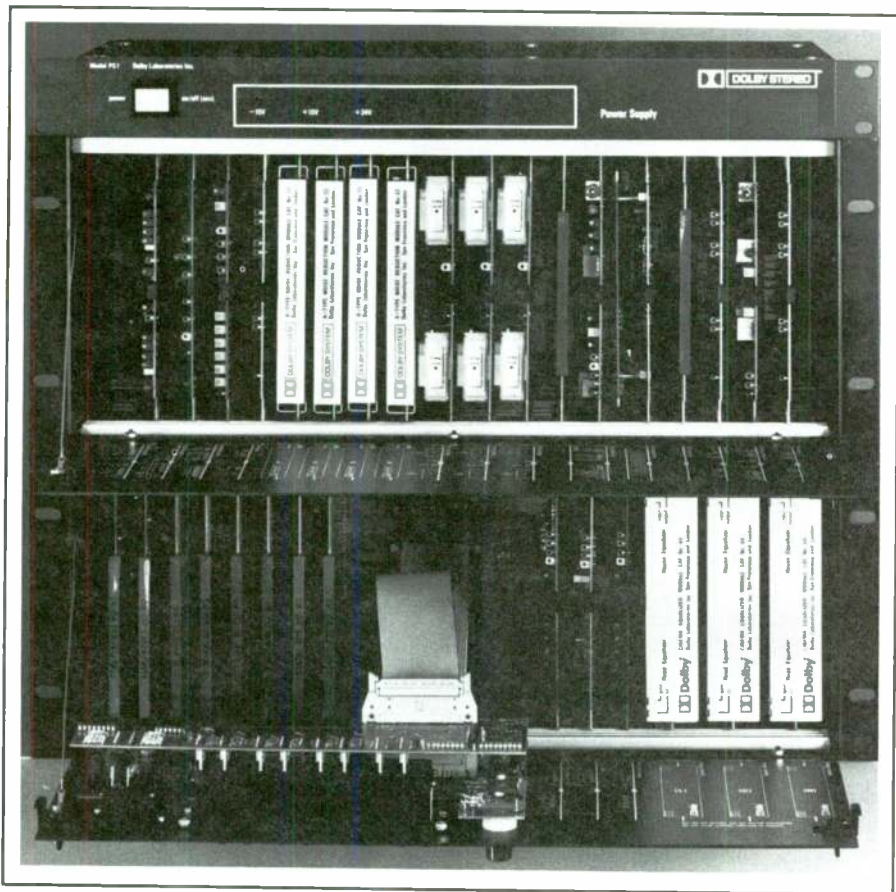

PHOTO 4: Dolby CP-200.

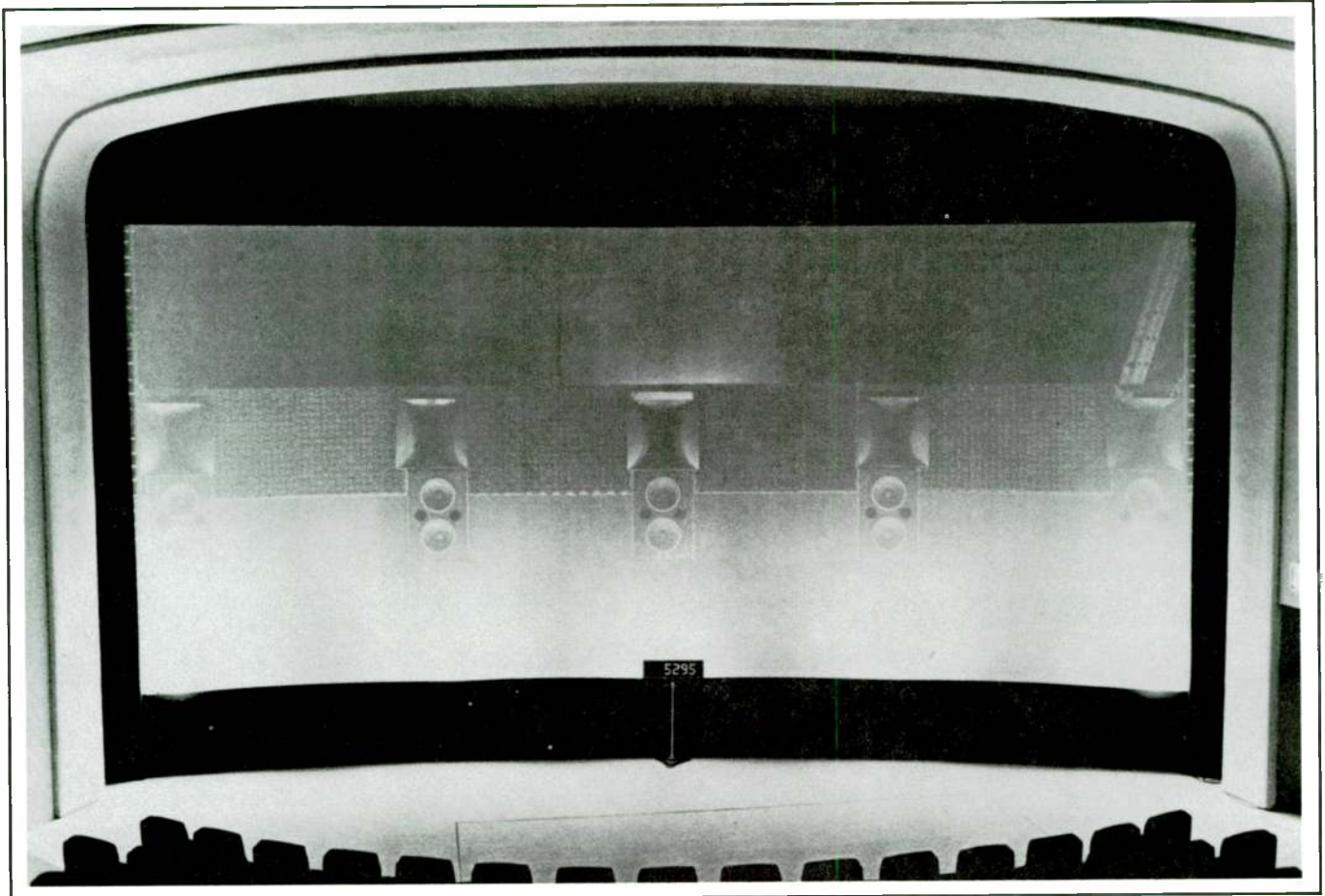

PHOTO 5a: First THX installation showing former placement of speakers behind screen.

some markets and weak in others. It's in Paris, London, Germany, Canada, Australia, Hong Kong, Singapore, Korea, all over the place. But it really started in 1980 simply as an experiment to make a better sound system for a dubbing stage.

*Is it a refinement for existing theaters, or is it a completely new system?*

**TH:** It's actually both. If you look at the whole chain—from the microphone to the listener—you could say that certain parts of that chain were of much higher quality than other parts. If you simply tune up a Nagra (a portable reel-to-reel) and use it, it exceeds the dynamic range of the sources it's capturing. If you tune up dubbers, and you do things like adding better azimuth stability to them, we found that mag film was a fairly good medium.

It has to be what I call "super tuned." By that I mean tuning the level to within 0.1dB, tuning the equalization at 10k to within a tenth.

*Phase adjustments?*

**TH:** We make phase adjustments for azimuth every day. So those mag film generations which were, at the time,

audible changes from generation to generation, get to be much smaller changes when you do that.

In 1980 I felt the film sound consoles were rather backward in sound quality. In order to get the features you needed, you had to sacrifice performance, because you needed these customized features. So we chose a music industry console in order to start with a basic good-quality sound, high isolation and (low) crosstalk, low distortion and all those things. We modified it substantially to turn it into a quad panning, LCRS, console. That was a Neve 8108, our first.

Later, fortunately, we were able to work with SSL when they started building modular consoles. It then became clear that all they needed were a few different module designs and you could do a real film console that's as good as any today. And that's what's in use at the ranch tech building now.

When it came to the theater sound system we said, "Well, let's start from scratch," because standardization had arisen, really, as two standards. In the 1930s when the exhibitors owned the distribution, they owned the theaters. They built a sample theater in Hollywood and they equipped it with 1.5-mil

slits, xyz screen, xyz loudspeaker, and a certain electrical filter. They tuned-up the whole thing and made their negatives for that system, and mixed on that system in those theaters. Then they went out and duplicated that theater hundreds of times across the country.

*This was when the "Academy Curve" started?*

**TH:** Partly. But the "Academy Curve" was never really standardized, studio to studio. For example, MGM always put more high frequency boost in the negative and had more rolloff in projection than other people. So they weren't really interchangeable, but they didn't need to be.

Right after World War II, two things happened. First, the justice department stepped in and said studios couldn't own the theaters anymore. Second, this explosion of new technology that had been developed during the war brought about the Altec Lansing A4 "Voice of the Theatre" about 1947. So the standard became the A4 with a certain equalization ahead of it.

Now the standard was no different from room to room. There were recom-

*Continued on page 16*

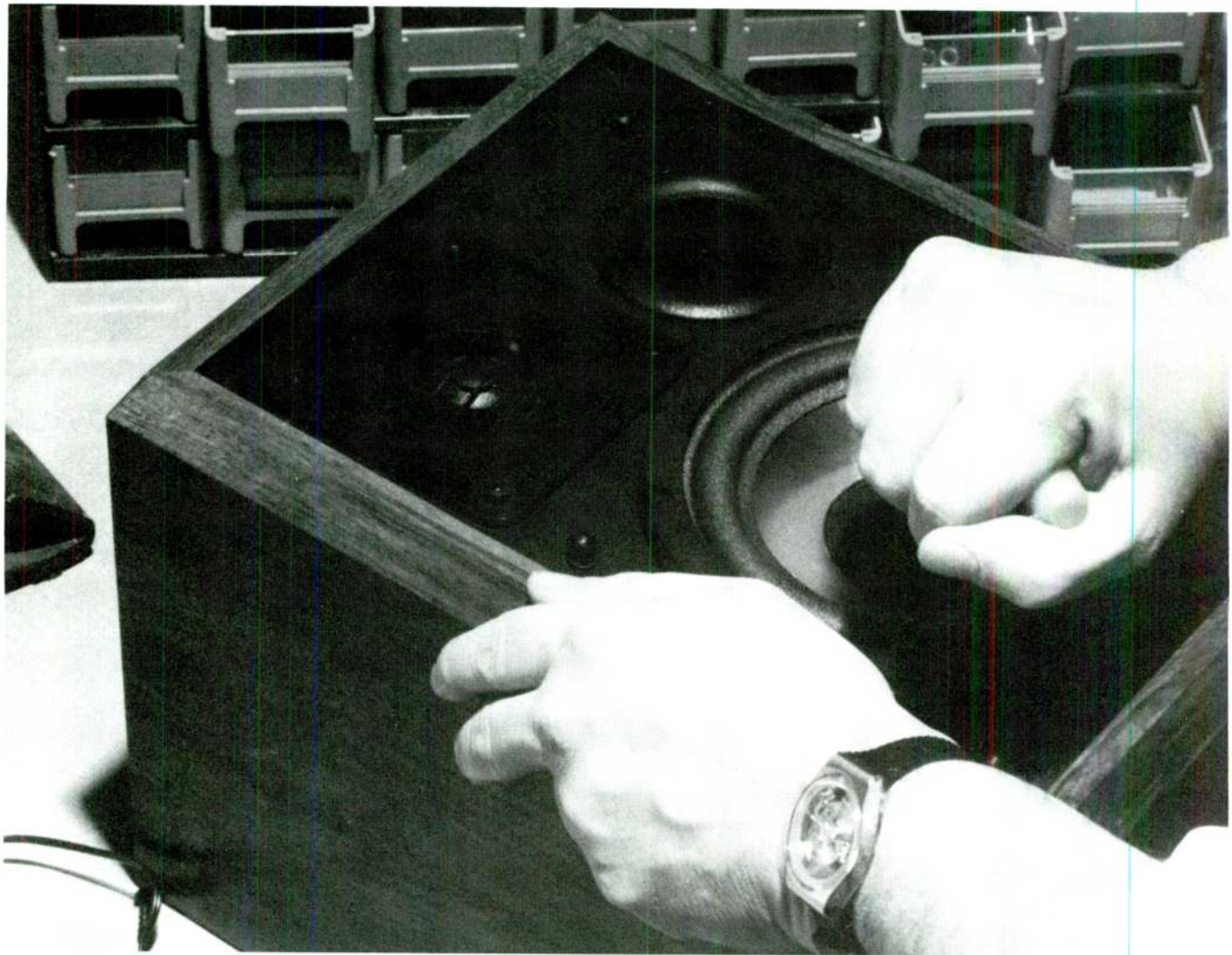

# Innovative components for creative hands.

Whether you're the weekend hobbyist or the serious installer, you know where the sound comes from. Speaker builders all over the world are choosing MTX drivers and components because they mean better sound for your money. Consistent specs. Superior reliability. From our famous bass drivers, mid-ranges and tweeters to our indestructible grille kits and state of the art crossovers, you can rely on MTX, the most installed speakers in the world.



MTX • Makers of the world's best loudspeakers and sound components • Winslow, IL  
The Mitek Group • One Mitek Plaza • Winslow, IL 61089 • 815/367-3000

Fast Reply #HE186

Continued from page 14

mendations, like reverb time. (Tom opens a book.) "A reasonable summary of currently accepted optimum reverberation times is given for 500Hz ... it is based on audience judgements of acoustic quality of existing rooms and auditoriums." This is no statement of what ought to exist. It's a result of motion picture theaters growing out of vaudeville houses where some reverberation was necessary to support the loudness of live speech. Therefore, they went directly from vaudeville to motion picture theaters with no stops in between. A lot of those are still around; the Castro Theatre in San Francisco, for example.

*There's one in the small town I used to live in.*

TH: It probably has a lot of bric-a-brac.

*It has an Egyptian-theme interior, bas-relief sphinxes and a tented ceiling.*

TH: Great! But probably fairly live. They weren't very dead spaces.

*It was a theater for a while, but it's now a concert hall.*

TH: So no one had ever set out to say what ought to be. "If given a blank slate,

here is what you would make." The A4 was standardized and applied to many auditoriums and dominated the market. Even to this day it accounts for about 80% of the installed base of theater loudspeakers. It has a number of problems which its own designers tried to remedy in the 1960s. They didn't get anywhere because it was so entrenched they couldn't change things.

When we came at it in 1980, we said, "Well look, the performance of this thing is rather poor in a number of known ways. And many people have contributed directly to making improvements in large-scale sound systems over the years. Let's draw on all these experiences and combine the best of them into one comprehensive system."

The first battle we had in designing the system was room acoustics. We started with Beranek. Our first room measured 70,000-cubic feet, and Beranek says it should have between 0.8 and 0.9 seconds reverb time. Fairly short, but I thought it should be even deader than that for several reasons. Both *Acustica* (the main European acoustical journal) and *JASA* (Journal of the Acoustical Society of America) have published a lot about the influence of reverberation time

on speech intelligibility and background noise, and how they combine to harm dialogue intelligibility. Here, we are our own worst enemies, because most of the examples are cases of public address systems in noisy reverberant rooms.

Now motion picture theaters are usually quieter and deader than such rooms. But again, we are our own worst competition because we also have sound effects and music, all going on at the same time, competing for dialogue intelligibility. So I wanted to go for the most transparent channel possible. The other factor, seldom operative in Beranek's day, is the widespread use of stereo, where localization of the screen speakers is so important for giving the kind of wonderful directionality that's possible on the screen.

It was easy to determine that we wanted a lower than normal-reverb-time room, so I went down to a 0.5 second from his 0.8 second ... for that size. And I also agreed with the recommendation that the reverb time be flat with frequency. That's an old idea. It says that music sounds warmer in a room where the reverberation time goes up at low frequencies. If we want that in a sound

Continued on page 18

LOUD  
carbonneau  
SPEAKERS

## Manufacturing OEM loudspeakers in the USA since 1946

Carbonneau is now offering a product line of loudspeakers to the hobbist and small speaker manufacturer that has all the traditional top quality engineering traits that go into any of our custom designed drivers.

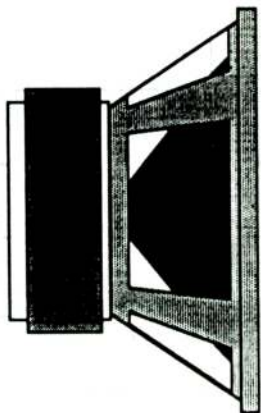

A total of 16 different woofers are available in quantities of 1 to 250 pieces along with quantity price breaks.

- CARBON-GRAPHITE CONE FORMULATIONS
- RUBBER SURROUND SUSPENSIONS
- FLAT SPIDER SUSPENSIONS
- VENTED POLE PIECE ASSEMBLIES
- KAPTONTM VOICE COIL FORMERS

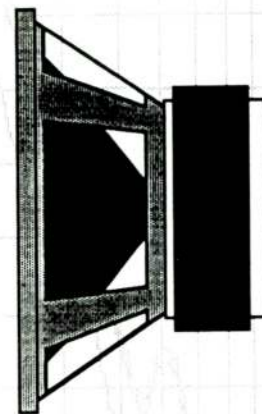

CALL OR WRITE TODAY FOR MORE INFORMATION

custom engineered and manufactured loudspeakers

carbonneau 609 myrtle n.w. grand rapids michigan 49504 usa ph 616.456.9528 fax 616.456.5648



World Famous  
**PYLE DRIVER® SPEAKERS...**

Your Source for  
Quality Woofers, Midrange,  
Tweeters and Crossovers



- Over 200 speaker models and sizes available
- Parameters available for every loudspeaker
- Recommended cabinet sizes available for all woofers

**Pyle is the source for all your loudspeaker needs!**

  
**PYLE**

Pyle Industries, Inc. • 501 Center St. • Huntington, IN 46750 • (219) 356-1200

Fast Reply #WE128

Continued from page 16

track, it's easy: we put it in a sound track. Yet we maintain the kind of articulation, you might say, of low frequencies. The most obvious example of low-frequency reverb time problems is in *2010* where there was the cut between loud spaceship rumble and the vacuum of space. So it's supposed to go instantaneously from rumble to silence in abrupt cuts. The auditorium where I saw it had about a 5-second reverb time at 31Hz. It just sort of *smears* over the edits.

So we wanted it flat, and we wanted a low reverb time. Then, of course, you want it quiet. We made our first stage super quiet because we needed to use it for dual purposes, for a Foley stage as well. So it's down around NC10, NC12. Which is really outrageously quiet and led to some problems later on, which I'll get to.

Then look at the screen speaker. You say, "What is it the A4 does right, what is it that it does wrong?" There are some axioms. One of mine is that sound must be emitted from the same space as the screen. We have to shoot (the sound) through the screen. When you shoot *over* the screen you can see people's heads drift up as they adjust their pinnae (external ears) to the angle of the sound field, and they notice this sound coming from above them.

*I always thought the way we perceived direction up and down was by turning our heads toward the sound. You're saying we perceive vertical positioning by the shape of the ear?*

**TH:** Right. So, it's an axiom that we're going to put left, center, and right loudspeakers on the screen. That was just a given because the sound effects are made so they seem to be on the screen. A lot of people have thought you could have put left and right outside the screen image and shoot through black transparent masking and get wider stereo. Well, actually that could be kind of nice in the music and the ambience tracks. But when there's a synchronous sound effect of Indiana Jones entering camera-left, moving to the center, when the footsteps come from (elsewhere) suddenly things don't make sense anymore. There's no sense for what we call "the effect-effect." It's off-picture.

*I once rented Silverado and set up a pair of small speakers a couple feet on each side of the TV. During a scene with a card game, a noise came from the right speaker and the card players turned and looked at the speaker.*

**TH:** Right! There they are, in your living room! And the problem with the typical TV case is the image simply isn't big enough. And of course if the TV image is made big enough, it doesn't look good enough. That's another problem.

We went back to some Kodak information from the early 1950s as to grain sharpness, focus, and basically how big a picture can appear. You know, in a home stereo we use a 60°-wide field most typically. Well, that's too wide for films. We say that a 50°-wide Cinemascope picture with the sound speakers at 45°—plus or minus 22.5°, left and right—is the kind of optimum seat.

That's how we designed all the dubbing stages. And in the technical building, every room you enter, despite its size, you're always at a place where that same angle is intended.

In the case of a theater where we have completely adjustable masking, we make the other format pictures—2.2 to 1, 1.85 to 1, 70mm, 1.85 to 1, 35mm—and change the masking so you get the biggest picture you can fit. You can come as close as possible to that. But the rooms are all laid out for the 2.35 to 1 Cinemascope image. By the way, it's really nice to start a room design from a picture because it means you can leave, for example, an equal amount of masking—like two feet—of masking all the way around, and that forms the dimensions of the room. *Voilà!* You've got the width and height of the room right there, and depth is governed by the optimum listening angle.

*What's the difference between 1.85 to 1, 70mm and 1.85 to 1, 35mm?*

**TH:** Everything shot today—since *Lawrence of Arabia*—originates on 35mm film in one of two formats (*Fig. 1*). In the Cinemascope format, the picture is squeezed onto the film and expanded on projection, and the aspect ratio is 2.35 to 1. When that kind of Cinemascope negative is blown up to 70, it's de-anamorphized, spread out, and the outsides are cropped down to 2.2 to 1. So it's not exact. That was in order to provide sound track area inside the perforations. There were also existing standards. That accounts for maybe less than a quarter, maybe 20% of the negatives shot in Cinemascope.

The screening room at the ranch has five main channel loudspeakers (*Photos 5a and 5b*). The old way to do it, the original 70-mil way, was equal spacing, a left, left-center, center, right-center, right (*Photos 5a and 5b*.) That all dropped out of use by the early 1970s, and when *Star Wars* came along they said, well, let's use these intermediate channels for just bass, and invented the "baby boom" format. And, of course, that's much less important as to where it is. So what we have is left, then left-extra is rather close to it, then center, then right-extra and right close together. And those—right-extra and right—lie just inside the 2.2, 70-mil format and 1.85, 35 format. So what you do is interchange the outside pairs when you're going from 2.2, 70-mil or 2.35 Cinemascope to the 1.85, 35-mil.

So it's a whole speaker at the left- and

*Continued on page 20*

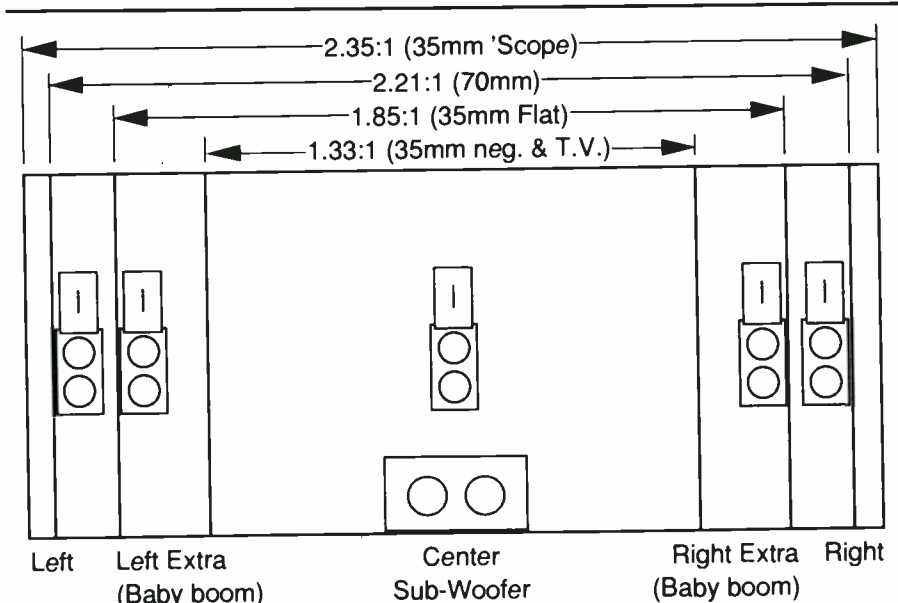

FIGURE 1: Comparison of different aspect ratios and THX speaker placement.



# CAPACITORS

Société des Condensateurs Record



Design integrity for sonic transparency.

Designed by Kimon Bellas and exclusively represented by **FOCAL AMERICA, INC.**, this new line of caps offers a unique sum of exceptional features:

- 400VAC/630VDC omnidirectionally metallized polypropylene film by BOLLORE (high voltage caps do exhibit faster rise time, and can be used in solid state and tube electronics).
- 5% precision value.
- Ultra compact winding on solid core, with heat-shrunk PVC envelope and polyurethane encapsulation.
- 14 AWG Teflon damped silver coated pure copper lead wire with Y-shape silver solder.

To create such a cap was only half of the challenge. We also wanted to bring it to you at a price as attractive as its exceptional performance.

IT IS NOW IN STOCK at selected distributors

**BIG COVE RESEARCH**, AL: (205) 881-8677

**SPEAKERS ETC.**, AZ: (602) 944-1878

**TRANSDUCERS TECHNOLOGY**, TX: (214) 991-6994

**ZALYTRON INDUSTRIES**, NY: (516) 747-3515

OEMs: Please contact directly FOCAL AMERICA.

*Aria 5*

# FOCAL

*Aria 7*

Kimon Bellas of Focal America and Joseph D'Appolito have collaborated to produce two remarkable new loudspeaker systems, the Aria 5 and the Aria 7. These loudspeakers offer state-of-the-art sound at an incredible price!

**Aria 5 - \$695/pair !**

Two Focal 5" polykevlar bass/midranges and a Focal tweeter in a 19" x 9" x 10" (HxWxD) black lacquered cabinet, with grill. Includes Focal-made crossover and solid brass binding posts. Completely assembled systems at \$695/pair. Subwoofer not needed, really!

**Aria 7 - \$995/pair !**

Two Focal 7" polykevlar bass/midranges and a Focal tweeter in a 45" x 9" x 10" (HxWxD) black lacquered cabinet, with grill. Includes our own crossover (air core inductors, serial polycaps, poly-bypassed parallel caps) and solid brass binding posts. Completely assembled systems at \$995/pair.

## Advanced Audio Products

Located in Seattle, we are now stocking distributors of Focal products. We have specialized our inventory to support the Aria loudspeakers as well as the Autosound market. All Aria components are available separately. Please call or write for free product information.

Advanced Audio Products • 1916 Pike Place • Suite 1243  
Seattle • Washington • 98101-1013 • (206) 527-3393

Fast Reply #NE588

Continued from page 18

right-extra, but you just use the bass for the baby boom.

I read somewhere that Panavision now has a 70mm camera quiet enough for use on a set.

TH: There are cameras, and they're used in process photography in all kinds of ways, but they're not usually used for principal photography. There hasn't been any show shot in it. Maybe some day.

The other 80% are shot with a cropped negative. That is, the actual negative area on the film is approximately 1.33 to one. They just leave off the top and the bottom, and there's a line in the viewfinder to show where the 1.85 frame is. So the cameraman composes for the 1.85 frame. In any case, there's nothing special done about that. The projector in the theater can be framed up and down, and you'll see the ceiling and the boom and some of the lights, possibly. Some directors print a simple black matte in the top and bottom, so if the theater mis-frames it, it will be very obvious. That's a big debate. And when you blow up 1.85 negatives, like *E.T.*, to 70-mil, you can only blow them up to 1.85. So they don't fill the 2.2-to-one frame. And because you're blowing them up further, the image quality is not as good as the 1.85 to one.

With Cinemascope, there's more glass, there are more lenses, and there's a little more difficulty. If you pull focus from foreground to background, things seem to change aspect ratios because there's stuff in there. So there are some drawbacks to the Cinemascope, but it gives so much more negative area that it is in fact the better process.

**DIRECTIVITY.** So that got us reverb time, reverb time flatness, background noise, spatialization. Then we come to the next factor: what should the Q of the loudspeaker be, what should its directivity be? The simple-minded theory is that you want to basically direct the sound at the audience. You don't want to put excesses of sound energy on the ceiling, on the back wall, because it's likely to return to them later and cause echoes or add to reverberation. So basically, you use a Q of a loudspeaker so that the audience lies in the 6dB contours of the speaker.

Now that's one theory. Another theory goes directly to the problem of amateur loudspeaker design, and that is the "two-way problem." And the "two-way problem" is that if you put a crossover at say, 1,500Hz, in a two-way loudspeaker, 10"

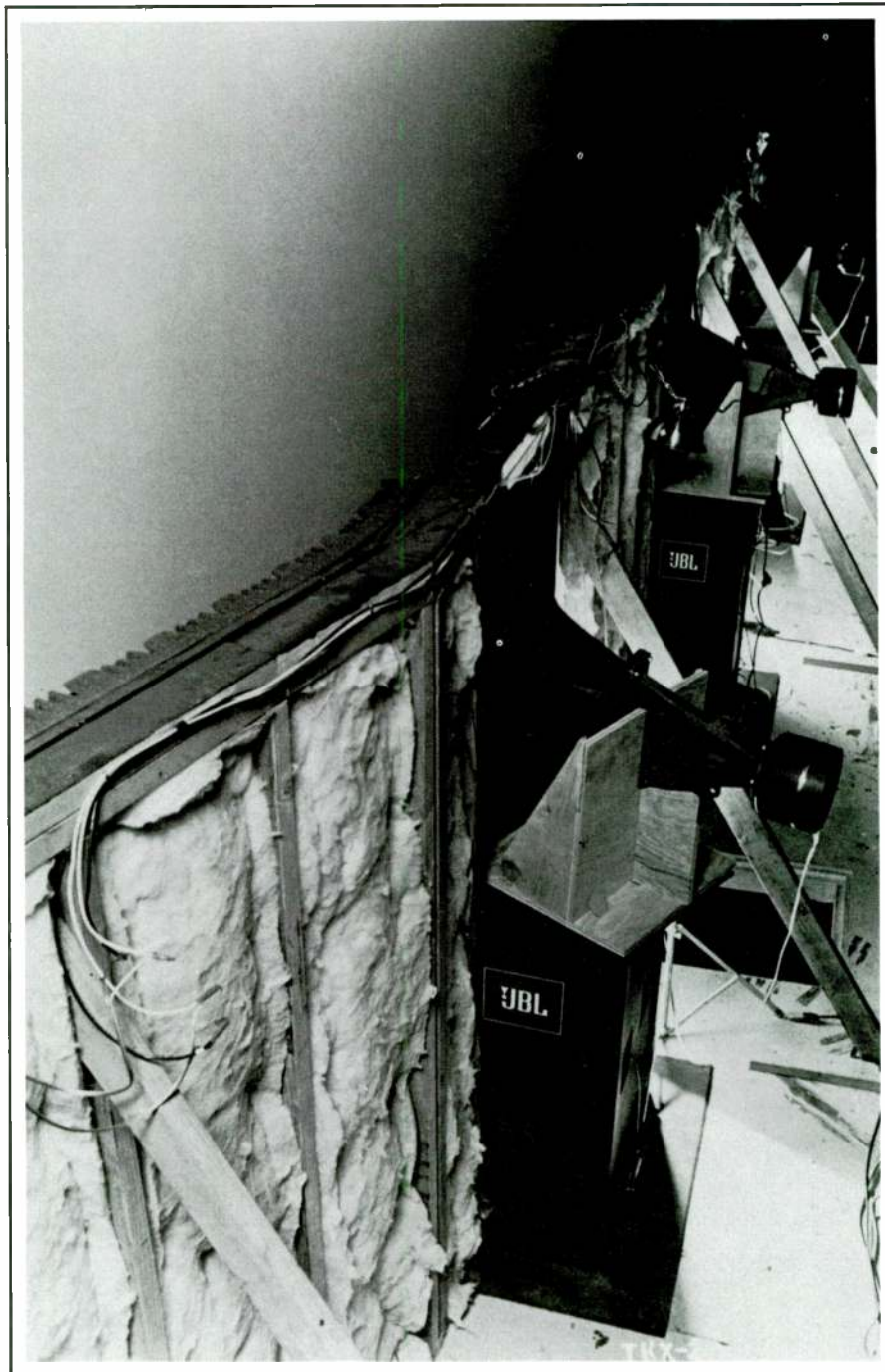

PHOTO 5b: Behind-the-screen view of first THX installation.

and a 1" dome, you can design that loudspeaker to be flat on axis. The trouble is that in the far field, when you start considering the power response for the long term, what you will get is a rolloff.

*Including all reflections?*

TH: Including all reflections, you will get a rolloff at the top end of the woofer due to its directivity collapse. It will cross over to the tweeter, going wide. So you design it for flat on axis, and you can make it flat on axis, but it's got this rolloff and then opening up that causes a hump in its curve. And it is quite audible. It does have a little coloration.

*Aha, I've heard that in my own design!*

TH: It's not an unpleasant coloration, but it's nevertheless there. So that says to me you have to match the directivity at crossover. It's almost impossible to build a system that's going to work over ten octaves and still have constant radiation with frequency. But one of the mistakes of a lot of amateur—and especially very-high-end—designs is that they go for different radiation patterns in different frequency ranges. They have some theory that it should be forward-facing treble and omnidirectional bass or what have you. And there's some *dramatic*

*Continued on page 22*

# One Last Fling

with

# Madisound

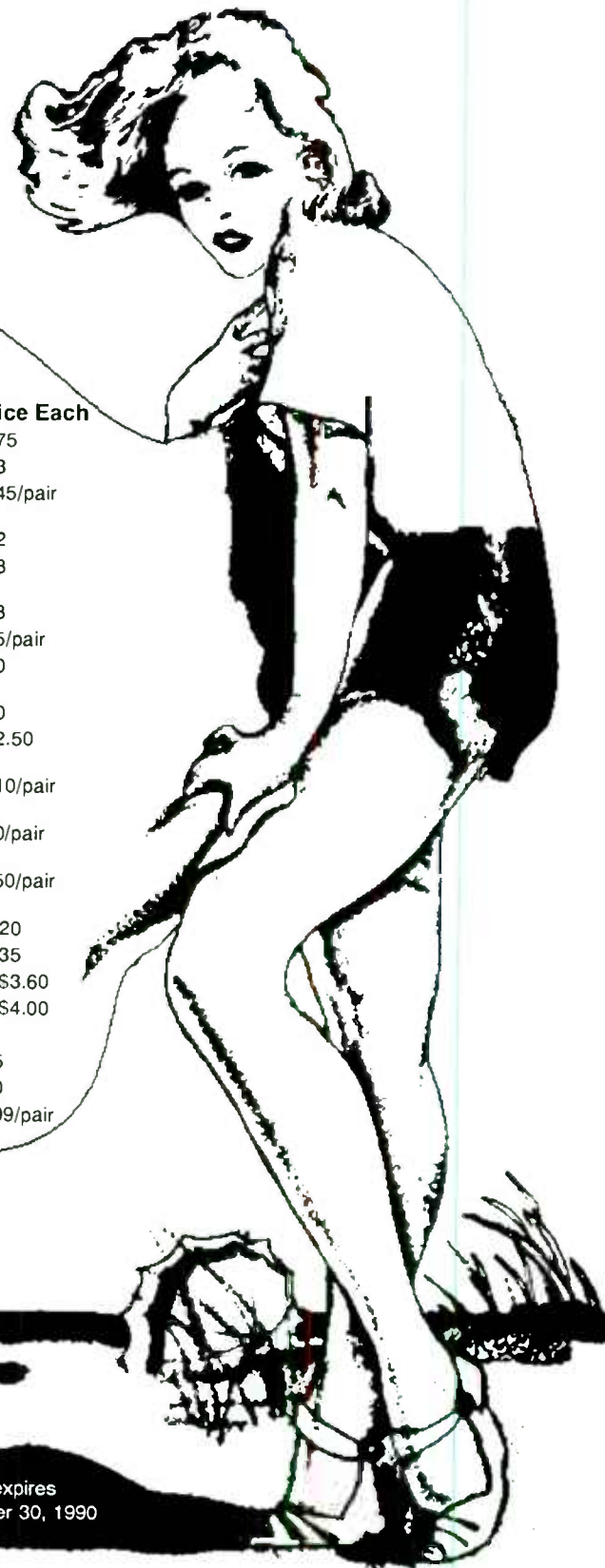

## Beach Blanket Bargains

Qty	Description	Price Each
80	Dynaudio 30W100 4Ω, Fs 19, Qts .41, Vas 340 Liter	\$175
86	Dynaudio 24W75 8Ω Fs 33, Qts .84, Vas 88 Liters	\$53
7 pair	Morel MCW224 double magnet woofer, rubber surround, grill	\$145/pair
280	Vifa H25TG31 horn tweeter, Fs 750, 94 db 1w/1m	\$12
100	Vifa M25WO46 10" paper cone, rubber surround cast frame, 80 watts, 90db	\$18
41	Audax HIF17HVX 4Ω paper cone, PVC surround	\$18
800	Audax DTW100Ti25FFF 1" DomeTitanium Tweeter with grill	\$25/pair
90	Electro-Voice Turbosound 10" for mid horn load 250hz->, 92db, qts .95, 100watts	\$70
200	Peerless 1721 8" woofer, Fs 36, Qts .41, Vas 51 liters	\$30
80	Siare 290SPCM 10" Sealed box woofer, Fs 36, Qts .49 Vas 141 Liters	\$12.50
4	Siare 26FC 10" carbon cone, foam surround, cast frame, fs 33hz, 8Ω, 91db, Qts .32 Vas 118, 100wt	\$110/pair
4	Siare 10" treated paper cone, foam surround, cast frame, Fs 28hz, 8Ω, 90db, Qts.39, Vas 170, 100 watt	\$70/pair
4	Siare 3iTE 12" paper cone, accordian surround fs 32, 8Ω, 94 db, Qts .28, Vas 415, 120 watt	\$150/pair
3,600	Aerovox 12ufd mylar 130v	\$1.20
4,600	ChateauRoux 4.5ufd polypropylene, solid axial lead	\$1.35
42,500	Plessey 2.2ufd mylar 63v 5% 7.5mmx26mm	10/\$3.60
37,000	Elpac 5.0ufd mylar 50v 10% 5mmx10mm oval	10/\$4.00
150	2.5mh SideWinder coils .5Ω DCR	\$5
84	Morel MDT32 110mm flange, Fs 700, 91 db 1w/1m	\$35
102	Focal T120KF, Fs 700, 100watt, 93db1w/1m	\$50
12 pair	Phoenix 3Way Speaker Kits with Oak Cabinets	\$499/pair

Ordering Information: All speaker orders will be shipped promptly, if possible by UPS. COD requires a 25% prepayment, and personal checks must clear before shipment. Adding 10% for shipping charges facilitates shipping procedure (Residents of Alaska, Canada and Hawaii, and those who require Blue Label air service, please add 25%). There is no fee for packaging or handling, and we will refund to the exact shipping charge. We accept Mastercharge or Visa on mail and phone orders.



**Madisound Speaker Components**  
 8608 University Green  
 Box 4283 Madison WI 53711  
 Phone: 608-831-3433  
 Fax: 608-831-3771

Offer expires  
 October 30, 1990

Fast Reply #NE670

Continued from page 20

directivity change somewhere. I think it should be as constant and controlled as we can make it. So that's another requirement of the system. You must have drivers that go over enough bandwidth with enough uniformity, enough directivity, enough power handling. You can add equalization, that's kind of a minor issue. But they've got to cover the bandwidth. They've got to be smooth. They've got to cover a uniform directivity. Those are the big things by which you choose what technology to use.

**THIELE/SMALL.** Now, if you look at some of the ingredient parts, what were these developments we used? Well, one was the Thiele/Small parameters that all speaker builders today are using and pretty much understand.

*That's how I'm learning speaker design.*

**TH:** Did you use the LEAP (Loudspeaker Enclosure Analysis Program) program?

*The program I'm using came from a Speaker Builder article. (Thanks, Reid. The check's in the mail—Ed.)*

**TH:** Of course the influence they had was not only in understanding how loudspeakers and boxes worked together, but then really going back and redesigning the loudspeakers for particular box configurations. And what we found was that you need a certain cone area to reach a certain sound pressure level. And that is rather equal to what the A4 is, which is two 15" drivers.

Now you think about which ways you can orient those. Well, if you stack them vertically and you match the directivity at crossover, by which I mean you use a horn that's wider than it is high in radiation pattern, you can do something very nifty, which is, you can beg the difference on this power response versus axial response. You can make the axial response right and, because the radiation patterns are equal at crossover, they will have smooth constant power. This is a long debate I had with Peter Snell and others back in the 1970s about which is more important: the axial sound field or the power response? The system we're working on kind of begs the difference. You just make them both the same, and you don't have the issue.

There are some reasons to do coaxial designs, but no coaxial design has really done everything properly, I think.

The high frequencies need to be handled by horns for the directivity control, and they need to be rather large ones.

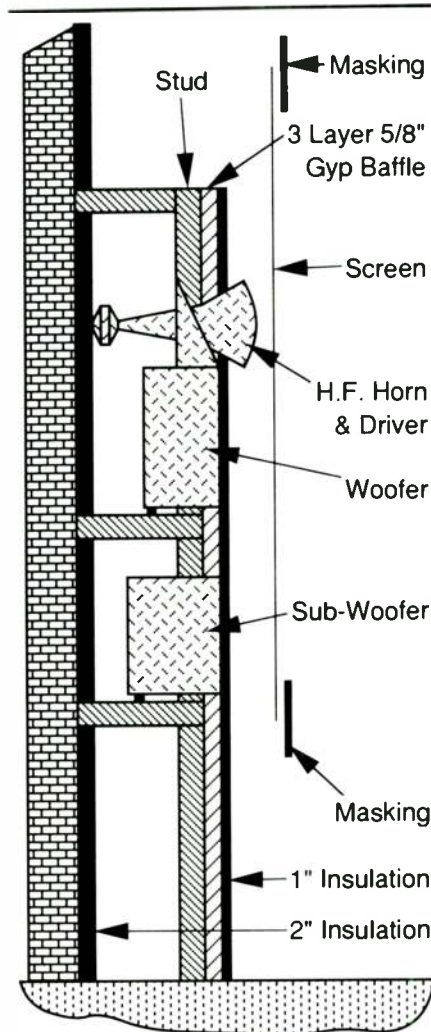

FIGURE 2: Side view of the THX baffle.

They must have mouths about a yard square. Anything smaller, like foot-high types, have a terrible problem since they can't maintain uniformity down to the crossover frequency. You choose the crossover frequency based on where the directivity patterns match and where the drivers can handle the power. That gives you one of the constraints of how big the horn must be to keep the pattern controlled down to that frequency. So all the horns used in THX are rather big.

*Is it just a two-way system?*

**TH:** It is two-way. I looked at three-way and decided not to, but I'll come to that.

The type of horn used is a new style—as of the last ten years—called "constant directivity" because they really are much more uniform than the older horns. The straight axial horns, used by Klipsch for example, can be more or less constant in one plane, horizontally, but they will collapse vertically across frequencies. So they have a strong change with frequency in the vertical plane

whereas they can stay reasonably constant in the horizontal plane.

That's the problem with the old fashioned, pre-1940 horns, the multi-celled ones invented for the A4. The problem with the multi-cell is that although it's the first attempt to get more uniform coverage, it has terrible lows. So if you put up pink noise and walk around the room, you get a "wish-woosh-wish-woosh"—very obvious holes. I was able to measure that in a dubbing stage and confirmed that what you hear is there. It's quite clear there are holes in the pattern.

*What is the name of the curve used in the throat of the constant directivity horn?*

**TH:** Various manufacturers use different techniques. JBL calls theirs "bi-radial." I don't know what EV calls theirs. But they're based on several things. They join two horns together, in effect. One controls the vertical directivity, and that feeds into a slot-type radiator, which then forms what's called a diffraction horn to set the horizontal pattern. There's a kind of joint there. And I don't know any way to design those mathematically. You just duke around with 'em till they work.

You are splicing a couple of things together. So that's definitely an ingredient. Someone tried to apply it to film sound before, but it had been done so poorly, and in such bad demonstrations, that nobody believed it. They blew out peoples' ears in the demos. They tried it at the Academy. It was not good. Then there's the compression driver on the back of the horn. The Altec 288 is a venerable device—with a phenolic diaphragm which was susceptible to breaking, and was chopped off at about 8kHz (at 24dB per octave). Some research—I think it was done by Howard Durbin at JBL—showed that the reason it chopped off so abruptly at 8k was the fact that the surround was going out of phase with the main dome. The surround has a significant area which also feeds right into the slot. So it was notching by virtue of that feature. So JBL got a patent on a diamond—kind of pyramidal—surround that does, in fact, not go out of phase at high frequencies, and doesn't suffer the abrupt chop that the others do. Then the diaphragm material became important about 1980. The ability to whip titanium into domes was new at that time.

This was, in classical terms, like a Western Electric driver designed in the 1930s, only it's designed out of much more exotic materials. And today we've

even taken another step in that direction. It's now a titanium dome embossed with all kinds of funny little patterns to stiffen it up. And now the neodymium magnet makes it much lighter. Things are getting more exotic and more expensive. (But) I don't know whether it's actually better quality.

*It still looks like the same ol' speaker.*

**TH:** It's different. It's a very cleaned up version of the Western Electric, I don't know the model number. I'll bet it's in here (*Grabs book!*) ... 1938!

This has a lot of great things in it. There are whole paragraphs in here you can lift out and put in today's manuals, and they're still not done. Like projectionists riding the volume control. You know, complete no-no ... the movie's already been mixed. (*Leafs further through book*) There it is. Lansing 285, high-frequency unit, 1938, showing a two-mil Dural, durable aluminum, 2 mils thick, radial slot openings, a voice coil. Of course they had a field coil ... they didn't have permanent magnets! Oh my God! Look what they were concerned with. Directivity. "A certain amount of directivity is required since the best illusion is obtained if the ratio of direct to reflected sound is as high as possible." (*Snaps book closed.*) 1938! Still true today. Oh my gosh, I keep finding things like that, gems of wisdom in this book.

*They keep proving you right.*

**TH:** That's right, the ancients have stolen my wisdom! No, the fact is what we're doing here is very much rooted in the history of how things ought to be. It's simply been greatly cleaned up.

*You're proving the theory of things they came up with over 50 years ago.*

**TH:** Yeah. Frequency range extended, amplitude capacity extended. But it really falls in the same tradition. These guys would understand it perfectly. So now you've got a low-frequency system, a high-frequency compression driver and a horn, and you look at it and you think, maybe a three-way would be a good idea, simply for power handling if nothing else. But the titanium, although falling off, does fall off smoothly into the top octave. There's a problem of where you're going to line things up. You have a speaker and you put a microphone out in front of it, and if you measure its acoustic phase you can find where its acoustic center is. That turns out to be a different place—electrically, measured acoustically—than it is for vertical pat-

tern or for horizontal pattern. All three of those are different points. So where are you going to line up the tweeter...on which of those three? You want it to speak at the same instant. You want it to have the same source—all the rays going out from the same point. It gets to be tricky.

*Adding a third driver creates too many variables?*

**TH:** Well, it's not impossible, but it's difficult for a another reason. These horns that have to have about a yard-square mouth are about 40-45" long. Now if you set them where you want to, that

is, on top of the woofer cabinet, the woofer speaks well before the horn tweeter. And even if we align things with equalization of the time difference, 1.9mS, or so, you'll have noticeable radiation pattern changes, *and* it won't pass the 1938 test.

One of the 1938 tests was tap dancing, with Eleanor Powell. On (reproducing) tap dancing they heard, "ta-thunk, ta-thunk, ta-thunk," instead of one hit. So they slid the horn in and out and found they could have less than 2mS of delay between the two. Paul Klipsch repeated this in the 1960s and claimed he couldn't find it. But he's wrong. He's just wrong.



The McCauley Model 6520 is a two inch compression driver used in systems demanding maximum power and articulation. The Model 6520 features a field servicable titanium diaphragm, a conservative 150 watt RMS power rating, and a frequency response from 500 Hz to 16,000 Hz. These advanced features make it especially useful in upgrading existing speaker systems. When matched to the McCauley Model 472 CD horn, a perfect 90×40 degree coverage pattern with a bandwidth from 1,200 Hz to 13,500 Hz +/- 3dB is obtained. The 6520 is used in the McCauley professional series main speaker arrays and stage monitor systems. Its superior voice reproduction makes it unparalleled in performance in custom projects such as studio reference monitors, club and discoteque systems, commercial/professional sound installations, and concert hall system stacks.

Call or write for a full line McCauley Loudspeaker Component Brochure and the authorized dealer nearest you.

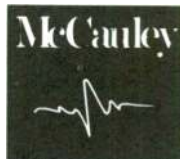

McCauley Sound, Inc.

13608 94th Avenue East • Puyallup, Washington 98373  
(206) 848-0363 FAX (206) 841-3050

*Fast Reply #NE278*

I mean, his experiment wasn't any good, apparently. He was moving loudspeakers all over space. The frequency response must have been changing all over the place—transfer function changing. About 2mS in the midrange is quite audible as a "ta-thunk."

So you say, "The first thing we're gonna do is delay the woofers." Now the first job of the crossover is to delay the woofers by 1.9mS. And we do that with a delay line of all-pass filters. Now if we do that with a delay line of all-pass filters, and we have a tweeter somewhere up top that is going to speak sooner than the midrange, we're going to have to delay the tweeter as well. It turns out you can delay bass a lot more easily than you can delay high treble.

I did look at the thing being a three-way system and decided against it, basically because of moving a delay line. I've got a delay line in there now that goes up to 500Hz and takes up to three op-amp sections to do it. If that delay line had to be extended to 5kHz it would be much more complicated and I'd have 15 sections, be less reliable, and all that stuff. Otherwise, you would have to go with a digital converter and an actual time delay or something to get it. So that's another reason not to use a three-way. So we chose not to because, yes the response is falling off, but—and this is an important point for amateurs—every real commercial loudspeaker has the crossover network designed for the specific drivers, in two ways. One, with the driver as its terminal impedance, instead of with a resistor. The most common fault of amateur designs is that they don't take into account the impedance of the driver. They just calculate something out of a book for an 8Ω resistive load. And that's way too simplified. That's the first problem, I would say, of amateur designs.

*In my own design I used a stock crossover. That is likely the cause of a lot of the strange coloring. Knowing this, I'm going to tear back into it.*

TH: You have to start by measuring the terminal voltages with crossover in place and taking a lot of acoustic measurements. So that's the second part. This is the way THX was designed. You start by measuring the drivers. You find out their acoustic transfer function. Then you determine what target transfer function you want for the whole system. Then the crossover makes up the difference between the two.

So, for example, we wanted a Linkwitz-Riley fourth order alignment for all its known good properties. It's because

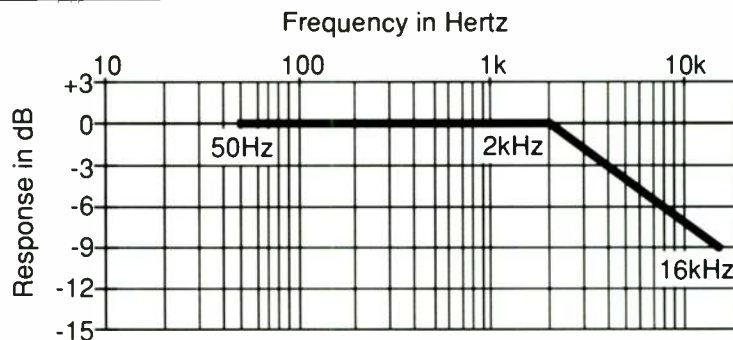

FIGURE 3: Graph of ISO 2969, curve X.

of the way in which we rank the relative importance of the various things that the crossover does that we say the fourth order Linkwitz-Riley is best for our purposes. First-order crossovers are hopeless because they have bad radiation pattern tilts, a very strong positive-going lobe and very bad notches. Which means that as you move up and down with respect to that loudspeaker—as you move up and down the auditorium—you get quite different transfer functions in the crossover region. That's not good. Linkwitz-Riley, with its one principal lobe on axis and two very minor lobes off, is the best in lobing behavior if you can't have a coincident driver.

*There was an extensive article in Speaker Builder (1/85) on crossovers and lobe patterns. I'll have to read it again.*

TH: (Laughs) Good! You measure the woofers and you say you want this kind of a response to be Linkwitz-Riley. *Acoustical* Linkwitz-Riley, not electrical.<sup>2,3</sup> But overall, acoustical. Then you determine what poles and zeros you need in the electrical domain to add up with the drivers to make the final response. Siegfried Linkwitz doesn't say that anything that's called Linkwitz-Riley is Linkwitz-Riley. Because *electrically* they (may be) Linkwitz-Riley, but unless you know what the acoustic transfer function is, you don't know.

And you do the same thing with the compression driver. The one for the woofer turns out to be pretty simple. It's a couple-pole high pass (-1dB at 40Hz) to prevent overload at very low frequencies. It has quite a flat passband and then it's a four-pole rolloff, as you would expect, because the woofers go quite a bit past the 500Hz crossover frequency. On the other hand, the compression driver is kind of close to the 500Hz limit. It's rolling off itself. So that, more or less, forms one pole of response so that the highpass is three-pole electrically, and becomes four-pole when you add in the acoustic

transfer function. So, you get two four-pole-squared Butterworth response that is Linkwitz-Riley, and it works out for all the good reasons. Then you come up to a kind of plateau where we find that the horn is about 10.5dB more sensitive than the woofers, so you can set it down by that amount. Then we have a whole bunch of things going at high frequencies. For one, the compression driver is rolling off because of air trapped between the diaphragm and the phasing plug, having to squeeze the air in and out. Another reason is the moving mass. Yet another reason is that the inductance just doesn't allow the current to be usable at very high frequencies. So there are a bunch of reasons why it rolls off.

Number two, we hang a motion picture screen in front of it. And a motion picture screen with its perforations is a one-pole low-pass, RC and just 6dB per octave, located between about 5kHz and about 8.5kHz, depending on the screen, its thickness and perforations and such. So there's one factor to account for.

All of these things contribute to some kind of high-frequency rolloff which we compensate for electrically. And there's a fourth consideration, which is that there's an international standard on what we ought to measure in the far field. There's no standard on what a home ought to be, except people would probably go for flat when they measure things. But in a motion picture theater it's well known that if you make things perfectly flat—on pink noise, say—then all program material appears to be too bright. So it all has this standard curve, ISO 2969, Curve X, which is a Dolby-promulgated standard (Fig. 3). It is flat to 2kHz, and it's down 1dB per third octave beyond there. It's a standardized house curve. It's -6 at 8k. And it tips up and down some with room volume. There's a room volume correction in it, based on an average room.

We took an empirical approach. We designed a crossover so the speaker would be flat. And then we hung a screen



in front of it which we knew would roll off the highs. Then we corrected the network to get it down to the standard. So we can be, on the average, on the ISO standard.

*So, the audio on a sound track is flat?*

**TH:** No it isn't. It's been listened to and monitored over an X curve. So it has some degree of built-in boost. It won't be as much as 6 or 7dB at 10k. That's too much. If you play back a CD in a motion picture house, or in a dubbing theater, you have to brighten up the highs to work against the X curve rolloff. But it's like a standardized de-emphasis like RIAA or NAB. It's the same kind of idea except that it's electroacoustic. And if everybody is using it, then it's all translatable.

*It's done acoustically, with the crossover, instead of, e.g., the playback EQ electronics of a tape machine.*

**TH:** Right, exactly.

We get the ingredients by looking around manufacturers' catalogs and picking what we think are the best available. The ones that have been made to the Linkwitz-Riley network. The ones that will give us actual chamber curves, and such. And we send them up to the

University of Waterloo in Canada and start taking measurements. We put the speaker on the edge of the stage, as it would be in a movie theater, and we raise and lower the pit to see the effect of the first reflection off the floor, and all kinds of things.

We discover we can't get anything like the rated frequency response with the woofer system. There are many phone calls back and forth, and we look at the manufacturer's data and we sort out how it was made. We discover that Linkwitz-Riley all depends on a 2 pi environment. It's not for 4 pi. It's for half space. And so we look at the woofer on its back on the stage floor and hang a microphone up in the air. And sure enough, we get the Roy Allison famous classical dip caused by the reflection off the boundary behind it.

*How deep was the speaker?*

**TH:** About two feet. It's down maybe an octave from a home speaker, but it's still there.

So we tip it up on the edge of the stage and we put boards all around it, build a wall all around it and discover, sure enough, the bass comes up—quite a lot, as you'd expect. And subsequently, when

you install it in a dubbing stage here in Hollywood, when you interrupt this wall diaphragm and put two A4 bins on either side and two bass bins on either side of the woofer section, you lose 15dB at 100Hz.

*You lose...?*

**TH:** Yup. 15dB worth of loading. You'd think it'd be only six or something. But it was a huge notch at a hundred. So the walls are a very important ingredient of the system, because it makes the bass smoother, it eliminates any Allison interactions with the environment because you've flush-mounted everything. You have only beneficial reflections from the local environment (Fig. 2). Then it performs like it's supposed to, as its design standards and Thiele/Small tell you it's supposed to be. ▶

*(Continued in our next issue.)*

#### REFERENCES

1. Academy of Motion Picture Arts and Sciences, Motion Picture Sound Engineering, New York: D. van Nostrand, 1938.
2. Linkwitz, Siegfried H., "A Three-Enclosure Loudspeaker System: Part III," *SB 4/80*, pp. 14-19, 22-24, 30.
3. Linkwitz, Siegfried H., "Active Crossover Networks for Non-Coincident Drivers," *JAES*, Vol. 24, January 1976, p. 2.

## Neutrik ProFi™... phono connectors that break "no" ground

"Grounding" noise is completely eliminated due to a retractable ground contact that makes first and breaks last.

Another  
Neutrik  
innovation

Neutrik USA, Inc. • 195-S3 Lehigh Ave. • Lakewood, NJ 08701-4527  
TEL: 201-901-9488 • FAX: 201-901-9608

**NEUTRIK**  
USA, INC.  
CONNECTORS  
AUDIO TEST SYSTEMS  
INFOMATIC SYSTEMS

Fast Reply #NE598



# THE BUD BOX ENCLOSURE

BY DAVID W. DAVENPORT

"Why don't you use a Bud Box?" The smile on my face said that, I was, of course joking. My friend Steve Leonard had asked me to recommend a small enclosure for use in a car stereo system. The smile faded as an idea from the past surfaced—an idea I had years ago but never developed. I was not pleased with the resonances in the enclosure that I built for the Falcon LS3/5A clone (*SB* 4/81). It was a fine loudspeaker, but I believed that I could improve on the enclosure.

After careful consideration, I decided the best approach would be to build a box with natural high-frequency resonances that could be easily damped. High-frequency resonances imply stiff, low mass walls. What could be better than sheet metal? The next step logically follows—sheet metal boxes are commercially available in a wide variety of sizes as electronic chassis. A Bud Box could provide the skeleton of an enclosure, but it needed some meat on its bones to dampen resonances. Characteristics of damping material are opposite from the stiff, low mass metal box. The ideal damping material exhibits relatively high density as well as high compliance.

Vinyl floor covering came to mind as perfectly fitting the bill. Layers of vinyl flooring covering the metal box would add mass, and its resilience would easily dampen any resonances. Well, so was the theory. For one reason or another I never built the enclosures for the LS3/5As. I still thought it was a pretty good concept, so I convinced Steve to use it in his car stereo.

Steve liked the sound of my home stereo system, so we decided to do something similar for his car. It's no secret that I favor a system incorporating satellites with a subwoofer. This type of design works well in a car stereo system,

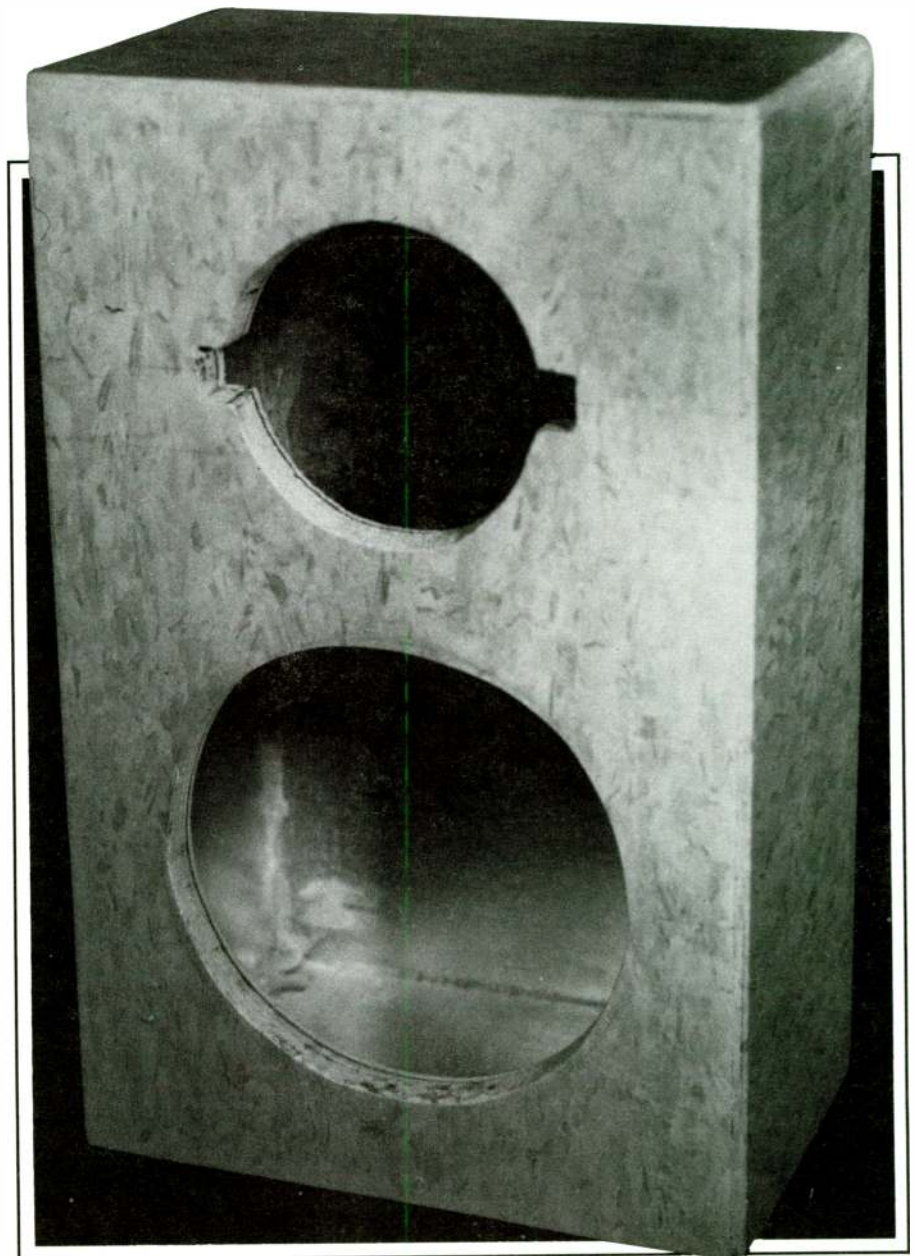

PHOTO 1: Completed enclosure ready for hardware, fur coat and grilles.

so that is what we used. My current speaker system is a pair of Focal Eggs used as satellites with a separate subwoofer—bi-amped of course, with an electronic crossover. The Eggs are a little large for a car, so I opted to use

Focal's smaller versions of the drivers used in the Eggs.

The 5-inch 5N412DBE bass-midrange is a little gem. Like its big brother, the 7N412DBE, it has a dual voice-coil and Neoflex cone. The T90K tweeter, like the

larger T120K, has an inverted Kevlar dome. Focal has used the combination of the 5N412DBE and T90K in their 033 kit. Rather than re-invent the wheel, I used the crossover suggested for the 033. For the system design we dipped into *Killer Car Stereo on a Budget* by Dan Ferguson (available from Old Colony). I consider this book, as well as the Crutchfield catalog, indispensable to anyone wanting to install their own system. Steve selected a dash unit from Crutchfield, and a bi-amped system configuration from KCS.

### CONSTRUCTING THE BUD BOX.

Because the satellite will not be called on to reproduce frequencies below 100Hz, its enclosure doesn't have to be very large. I chose the 10" x 6" x 3.5" Bud CU-3010A Minibox for the shell. I really don't know whether it makes any difference what kind of vinyl flooring is used for damping (a purist may prefer to use polypropylene). Our criterion was the cheapest that we could find. It was one eighth-inch thick, relatively stiff tile. As with the first time for anything, we learned as we went.

Steve had had a bad experience cutting sheet metal with a saber saw—the cut was ragged and deformed. Concerned that we couldn't make smooth cutouts for the drivers in the bare aluminum box, we decided to wait until after the vinyl was in place before cutting the holes. We also thought it wise to provide additional reinforcement where the cutouts would be, so we installed an extra layer of vinyl on the inside surface of the front of the enclosure. Since the drivers are mounted from the outside, the enclosure will never need to be opened. Therefore, the two parts of the box were glued together after first installing the piece of vinyl on the inside of the front wall.

To ensure a good bonding between the vinyl and aluminum, Pliobond contact cement was used for the first layer of vinyl. Subsequent layers were held in place with normal vinyl tile adhesive. The layers were staggered, so that each joint was covered by the next layer (Fig. 1). We weren't sure how many layers of vinyl would be required to obtain the desired result, so we played it by ear. Tapping the bare box produced the expected "ping." Applying a single layer of vinyl gave a noticeable effect—tapping now produced a "thwack;" after a second layer, a "thunk"; and after a third layer, a dull "thud." We added one more layer for good luck. It worked!

I had that feeling that you get when something works out the way that you

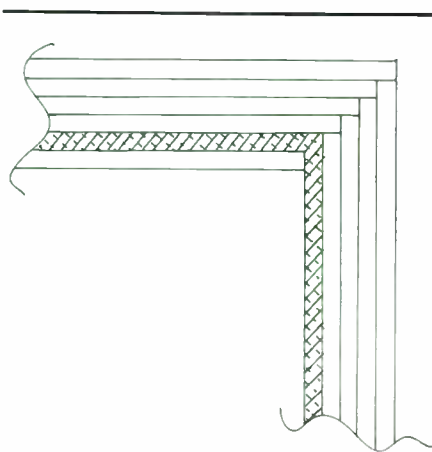

FIGURE 1: Cutaway (top view) of Bud Box enclosure. Corner joints used "butt and pass" method of overlapping to stiffen layers of vinyl.

planned the first time—without those frustrating dead ends, or Murphy's law intervening. It's not surprising that the mass of vinyl absorbed the resonances of the aluminum—the weight of the enclosure is an impressive eight pounds. Waiting until the vinyl was applied before cutting the holes also worked out well. The saw cut through the wall like it was made of cheese—with no chatter or grabbing normally associated with bare metal.

A completed speaker weighs over 10 pounds. It wouldn't do to have such a missile launched in an emergency, so we decided to bolt it in place. Four three-inch-long #10 machine screws were permanently installed in the enclosure. A hole was drilled in each corner of the base, the screw inserted from the inside and held in place with epoxy.

There is no reason why a car speaker should be inferior to a speaker used in a home stereo system. Therefore, the crossover was constructed using the finest quality components. Polypropylene capacitors and air-core inductors were used throughout, and larger-valued capacitors were bypassed with smaller units. The capacitors and resistors were installed on a small perf board which was mounted in the center of the enclosure. The inductors were glued directly to the interior of the enclosure. Rather than using a normal speaker connector, a six-foot wire was soldered directly to the crossover. The wire exited the enclosure through a small hole sealed with Mortite. The drivers were glued in place and then secured with wood screws.

The surface of the vinyl is smooth and hard, making it possible to cover the vinyl with real wood veneer. A veneered Bud Box would have the appearance of

a normal wood or particle board enclosure. Such a treatment would be appropriate for a home speaker; however, cosmetics of a car speaker is quite different from that of a home speaker. Steve liked the gray indoor-outdoor carpeting that a local car stereo installer uses on his custom enclosures, so he had the installer carpet the Bud Boxes. Conventional grilles were fabricated and held in place with Fastex fasteners.

**CONCLUSIONS.** I didn't set out to build a car speaker—I wanted one that could hold its own in the home. I believe the quality of the components used attests to that. The finished speakers sounded so good in Steve's car that I just had to try them in my home system. I was not disappointed—they exceeded all of my expectations. Although I could present an in-depth analysis of the sound of these units, the purpose of this article is to introduce the unique enclosure construction. Therefore, I would like to discuss characteristics that would be common to any design using the concept.

First, I must emphasize that the vibration damping capability of the enclosure is an unqualified success. Playing full-range music containing plenty of dynamics, such as rock or up-beat jazz, on conventional speakers normally produces panel vibrations that can be easily felt when you place your hand on the enclosure. The Bud Box is completely inert when playing music at normal levels. When music is played at very high levels, only the loudest impulses produced barely detectable vibrations.

Although the Bud Box is no more difficult to build than a conventional wooden enclosure, several interesting options are possible. First is the ease of recessing a driver. Cut a piece of vinyl slightly larger than the front of the enclosure, trace the periphery of the driver on it, and cut out the hole. After the driver is mounted in the enclosure, glue the vinyl in place around the driver, and trim the piece of vinyl flush with the edge of the enclosure. Drivers with thick frames may require two or more pieces of vinyl to make the driver flush with the front surface of the enclosure.

Although I haven't tried it, I'm sure this technique could even be used to provide a little damping for an existing conventional enclosure. Another possibility of the Bud Box technique is in building enclosures with time-aligned drivers. Merely place additional layers of vinyl under the driver that is to be set forward in the alignment.

*Continued on page 91*

# SOLVING THE KLIPSCHORN THROAT RIDDLE

BY BRUCE C. EDGAR

Over the past few years, a number of *Speaker Builder* readers (*SB* Letters 4/86, 1/89) have been asking questions about the throat design rationale of the Klipschorn and its clone, the Speakerlab SK. The design, as shown in Fig. 1, uses a throat opening size of 3" x 13" that interfaces to two horn ducts, each with 3" x 13" cross sections. When Dave Wharren (*SB* 4/86) pointed out the differences between the throat plate area (39 in<sup>2</sup>) and the actual throat area (78 in<sup>2</sup>), my first reaction was one of puzzlement. I could not fathom the reason why a horn designer would make the throat opening equal to half the actual horn throat.

## ABOUT THE AUTHOR

Dr. Bruce Edgar is a Space Scientist/Project Engineer for a Los Angeles-based aerospace company and a contributing editor for *SB*. His interests include horn loudspeaker design, woodworking, and the history of loudspeakers.

Later I asked Paul Klipsch about how the constricted throat worked, and in jest he pleaded the Fifth Amendment. But the situation remained; neither Paul, his engineers, nor any other acoustical expert I talked with could volunteer a defensible explanation of how the Klipschorn throat worked. Dick Moore (*Letters* 5/89) described the evolution of the constricted throat which corrected a response dip of the Klipsch bass horn above 200Hz. It was a good empirical solution to a problem that had bothered the Klipschorn for many years.

**MODELING OF THE PROBLEM.** In a long acoustical waveguide, a constricting plate can be modeled as an acoustical inductance as shown by Kergomard and Garcia.<sup>1</sup> An inductor in this case acts as a low pass filter which conflicts with the results claimed by Moore (*Letters* 5/89). This seeming contradiction puzzled me for some time until I read Small's<sup>2</sup> A.E.S.

paper on horn design. Using simple mechanical-acoustical circuit models, Small showed that the upper frequency limit could be increased by using smaller throat areas. He also demonstrated that the efficiency-bandwidth product for horns is essentially constant and that a reduction of throat area (resulting in increased bandwidth) would proportionally reduce the efficiency. Small's work convinced me to try a horn circuit model approach in investigating the Klipschorn throat.

For those unfamiliar with mathematical modeling techniques, the game plan is to use only the important parts of the problem to simplify the model. The process can be likened to a cartoon where only a simple line drawing of the gross features of a subject is needed to convey the message. First, let's look at a horn model that uses a normal throat configuration. For our model, I decided to

*Continued on page 31*

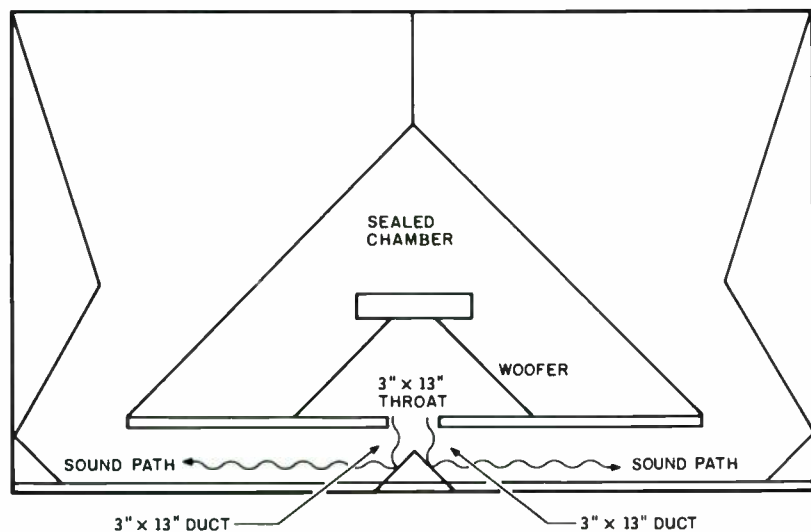

FIGURE 1: Klipschorn throat configuration.

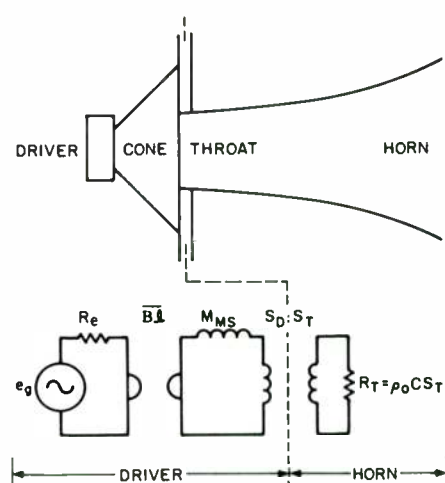

FIGURE 2: A typical horn loudspeaker setup with a simplified electromechanical circuit model.

# The Tweeter Is Coming...

**A&S**  
**speakers**

3170 - 23RD STREET  
SAN FRANCISCO, CA 94110  
PHONE: (415) 641-4573  
FAX: (415) 648-5306

# KITS

from OLD COLONY

Post Office Box 243 • Peterborough, NH 03458-0243

**ORDERING INFORMATION:** Postpaid in US; in Canada, please add 10% of total order; overseas, add 20%. Shipment is via UPS—please provide street address. If you cannot receive UPS delivery, please include an additional \$2 for insurance service via parcel post. We cannot accept responsibility for safety or delivery of uninsured parcel post. UPS next and second day air are available to some areas upon request. **REMIT IN US \$ ONLY** by MC/VISA, check or money order. Absolutely no CODs.

PRICES SUBJECT TO CHANGE WITHOUT NOTICE

(603) 924-6371 / 924-6526 FAX: (603) 924-9467

Answering machine for credit card orders only: (603) 924-6371 before 9:00 a.m., after 4:00 p.m. and weekends. Have all information plus MC/VISA available.

PLEASE SEE OUR SELF-MAILING ORDER FORM ELSEWHERE IN THIS ISSUE

## SPEAKER SAVER, FILTER

**KH-2: SPEAKER SAVER AND OUTPUT FAULT DETECTOR.** [3:77] This basic two-channel kit includes board and all board-mounted components for control circuitry and power supply. It features turn-on and -off protection and fast optocoupler circuitry that prevents transients from damaging your system. The output fault detector has additional board-mounted components for speaker protection in case of amplifier failure. **\$65**

**KF-6: 30Hz RUMBLE FILTER.** [4:75] This kit implements a 1975 design for a low frequency garbage filter. The filter knee is set to 30Hz. Roll-off below that knee is the 18dB/octave characteristic of its three pole design. Gain for the filter is unity (0dB) but can be simply adjusted for up to 12dB of gain. The reprint of the article explores the use of the filter with other components in crossovers [see kits SBK-C1A, C1B]. It shows how to obtain slopes of 6, 12 or 18dB in high and low pass filters. The kit contains all parts for building a two channel HPF including a board (3" x 3"), quad op amp IC, precision resistors and capacitors. Requires a bipolar supply of  $\pm 15V$ —the KE-5 is suitable. **\$30**

## AIDS & TEST EQUIPMENT

**KK-3: THE WARBLER OSCILLATOR.** [1:79] This unit will produce a swept signal covering any 1/2-octave between 16Hz and 20kHz. The total harmonic distortion at the output is less than 1.5%. The output voltage is adjustable from 0 to 1V. When used with a microphone it is as effective as a pink noise source in evaluating speaker system performance. It also reveals the listening environment's effect on sound through reflection and absorption. The sweep rate is set at about 5Hz. The kit includes 3 1/4" x 3 3/8" circuit board, transformer, all parts and article reprint. **\$70**

**KH-7: GLOECKLER PRECISION 101dB ATTENUATOR.** [4:77] All switches, 1% metal film and 5% carbon film resistors to build prototype. Chassis, input/output jacks are not included. **\$65**

**KC-5: GLOECKLER 23-POSITION LEVEL CONTROL.** [2:72] All metal film resistors, shorting rotary switch and two boards for a two-channel, 2dB per step attenuator. Choose 10k or 250k $\Omega$ . **\$48**

**KL-6: MASTEL TIMERLESS TONE BURST GENERATOR.** [2:80] All parts with circuit board. No power supply. **\$24**

**KP-2: TWO TONE INTERMODULATION TEST FILTER.** [1:82] This filter is designed to isolate the two high frequency tones at an amplifier's input from low frequency intermodulation products present at the output. The high pass filter corners at 2kHz and rolls off at 24dB/octave. A 5kHz signal at the low pass input will be down at the output by 80dB. An article reprint detailing design and use is included with the kit. All parts are supplied, including quad op amp IC, circuit board and precision resistors and capacitors. **\$26**

**SBK-D2: WITTENBREDER AUDIO PULSE GENERATOR.** [SB 2:83] All parts, board, pots, power cord, switches and power supply included. **\$80**

**SBK-E4: MULLER PINK NOISE GENERATOR.** [SB 4:84] All parts, board, 1% MF resistors, capacitors, ICs, toggle switches included. No battery or enclosure. **\$35**

## CROSSOVERS

**KC-4A: ELECTRONIC CROSSOVER, KIT A.** [2:72] Single channel, two-way. All parts including C-4 board and LF351 ICs. Choose frequency of 60, 120, 240, 480, 960, 1920, 5k or 10k. KE-5 or KF-3 supplies are suitable. **\$14**

**KC-4B: ELECTRONIC CROSSOVER, KIT B.** [2:72] Single channel, three-way. All parts including C-4 board & LF351 ICs. Choose two frequencies of 60, 120, 240, 480, 960, 1920, 5k or 10k. **\$18**

**KK-6L: WALDRON TUBE CROSSOVER LOW PASS.** Single channel, 18dB/octave, Butterworth [3:79], includes three-gang pot. Choose 1: 19-210; 43-465; 88-960; 190-2100; 430-4650; 880-9600; 1900-21,000 hertz. **\$60**

**KK-6H: WALDRON TUBE CROSSOVER HIGH PASS:** Single channel, 18dB/octave, Butterworth [3:79], includes three-gang pot. Please specify 1 of the frequencies in KK-6L. No other can be supplied. **\$62**

**KK-7: WALDRON TUBE CROSSOVER POWER SUPPLY.** [3:79] Includes board, transformer, fuse, semiconductors, line cord, capacitors to power four tube crossover boards (8 tubes), 1 stereo bi-amped circuit. **\$110**

**SBK-A1: LINKWITZ CROSSOVER/FILTER.** [SB 4:80] Three-way crossover/filter/delay. 24dB/octave at 100Hz and 1.5kHz and 12dB/octave below 30Hz, with delayed woofer turn-on. Use the Sulzer supply KL-4A with KL-4B or KL-4C. Per channel **\$75** Two channels **\$140** SBK board only **\$25.50**

**SBK-C1A: ELECTRONIC TWO-WAY CROSSOVER.** [SB 3:82] 30Hz filter with WJ-3 board & 4136 IC adapted as one channel crossover. Can be 6, 12 or 18dB/octave. Choose frequency of 60, 120, 250, 500, 1k, 2k, 5k or 10k. The KL-4A/KL-4B or KW-3 are suitable supplies. **\$32**

**SBK-C1B: THREE-WAY, SINGLE CHANNEL CROSSOVER.** [SB 3:82] Contains 2 each SBK-C1A. Choose high & low frequency. **\$60**

## SYSTEM ACCESSORIES

**CDDA:** Reusable soft vinyl Disc Ade CD damper from Apature. **\$18.95**

**HDTT:** Mod Squad Tiptoes decouple system components from surface beneath, providing greater sound resolution. Special alloy cones, 1/2" high, 1 1/2" in diam., are placed point down under speakers, CD players, turntables, to optimize stabilization. 3 per component recommended. **\$6 ea. 3/\$17**

**KW-3: BORBELY IMPROVED POWER SUPPLY.** [1:87] This single channel, low impedance supply was designed for the exacting requirements of Erno Borbely's moving-coil preamp [2:86, 1:87]. The design utilizes polypropylene caps and 1% metal film resistors. LM317/337s are used in the preregulator and Signetics NE5534 in the op amp regulator. The kit includes a low profile 24V toroidal transformer, 4 1/4" x 5 1/2" circuit board and all board-mounted components. Chassis and heatsink are not included. **\$135** Two or more, **\$128**

**KE-5: OLD COLONY POWER SUPPLY.** Unregulated,  $\pm 18V$  @ 55mA. **\$20**

**KF-3: GATELY REGULATED SUPPLY.**  $\pm 18V$  or  $\pm 15V$  @ 100mA. **\$52**

**KL-4A: SULZER POWER SUPPLY REGULATOR.** **\$40**

**KL-4B: SULZER DC RAW SUPPLY.**  $\pm 20V$  @ 300mA. **\$60**

**KL-4C: SULZER DC SUPPLY w/ toroidal transformer.** **\$85**

**KH-8: MORREY SUPER BUFFER.** [4:77] All parts, 1% metal film resistors, NE531 ICs, and PC board for two-channel output buffer. **\$22**

**SBK-E2: NEWCOMB NEW PEAK POWER INDICATOR.** [SB 2:84] All parts & board, new multicolor bar graph display; red, green & yellow LEDs for one channel. No power supply needed. **\$14** Two for **\$22**

**KL-2: WHITE DYNAMIC RANGE & CLIPPING INDICATOR.** [1:80] One channel, including board, with 12 indicators for preamp or crossover output indicators. Requires  $\pm 15V$  power supply @ 63 mils. Single channel **\$58** Two channels **\$110** Four channels **\$198**

**KW-1: MAGNAVOX CD PLAYER MODIFICATION.** Improves frequency response. Includes two Signetics NE5535s, two Panasonic HF series 330 $\mu$ F capacitors and four 3.92k, 1% metal film resistors. **\$12**

**KW-2: MAGNAVOX CD PLAYER MODIFICATION.** As above, but with two AD-712 op amps in addition to the NE5535s. **\$16**

**KX-1A: DISC STABILIZER.** Set of 3 Sorbothane feet, 3 Tiptoes and Mod Squad's Disc Damper with 15 centering rings. **\$70**

**KY-1: BEERS' BUDGET CD MOD.** [1:89] Kit provides POOGE-4 improvements without additional wiring or circuit boards. Complete parts for assembling amplifier modules and replacing DAC components. Article reprint included. Soldering skills required: not recommended for beginners. **\$95**

**What's included?** Kits include all the parts needed to make a functioning circuit, such as circuit boards, semiconductors, resistors and capacitors. Power supplies are not included in most cases. Unlike kits by Heath, Dyna and others, the enclosure, faceplate, knobs, hookup wire, line cord, patch cords and similar parts are not included. Step-by-step instructions usually are not included, but the articles in TAA and SB are helpful guides. Article reprints are included with the kits. Our aim is to get you started with the basic parts—some of which are often difficult to find—and let you have the satisfaction and pride of finishing your unit in your own way.

VOICE COIL GYRATOR MODEL

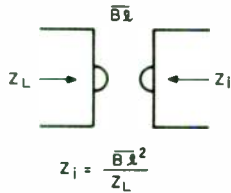

ACOUSTICAL TRANSFORMER MODEL

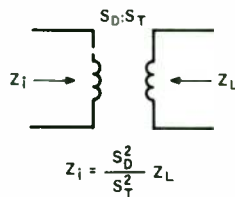

FIGURE 3: Impedance transformation by a gyrator and a transformer.

Continued from page 28

use Beranek's<sup>3</sup> mechanical mobility horn model modified by Leach's model of the voice coil gyrator.<sup>4</sup> Figure 2 shows a mid-band version which ignores throat reactance, back volume, voice-coil inductance, and front cavity effects and emphasizes the mass rolloff effects of the interaction between the throat and voice-coil resistances and the mass of the cone/voice coil.

The circuit elements remaining after simplification are the voice coil resistance ( $R_E$ ), the loudspeaker  $B_l$  factor ( $B$  = magnetic flux density in the gap and  $l$  = effective length of the wire in the voice coil), the mass of the cone as represented by the mechanical inductance  $M_{MS}$ , the areas of the diaphragm  $S_D$  and throat  $S_T$ , and the mechanical throat resistance  $R_T$ . The constants  $\rho$  and  $c$  are the density of air and the speed of sound in air, respectively.

The circuit of Fig. 2 uses Leach's gyrator model for representing the way that the voice coil inverts impedances. (See Ref. 4 for a good discussion of the gyrator concept.) For the purposes of our discussion, the voice coil inverts impedances as shown in Fig. 3. (Note: The use of a gyrator model simplifies Beranek's model. If you look up Ref. 3, you will note odd differences between it and Fig. 2 because Beranek's model already includes the inversion of the impedances.) The transformation of the mechanical motion of the cone into acoustical energy at the throat is represented as a transformer with a turns ratio of  $S_D:S_T$ . The conversion of impedances through this transformer and a gyrator are given by Fig. 3.

By using the impedance transformations of Fig. 3, we can literally push the throat transformer through the circuit to the right and the voice coil gyrator through the circuit to the left in Fig. 2. The results are given in Fig. 4. As you can see, the voice coil resistance and the signal generator are changed by the  $B_l$  factor, and the throat resistance is only modified by the throat transformer.

The mass rolloff frequency occurs at

the frequency where the mass reactance is equal to the total circuit resistance. Below the mass rolloff frequency the horn is controlled by the circuit resistance. Maximum power is transferred to the throat when the transformed voice-coil resistance is equal to the throat resistance. From Fig. 4, we have:

$$\frac{B_l^2}{R_E} = \frac{S_D^2}{S_T^2} \rho_o C S_T$$

for maximum power transfer. Solving for which now becomes the optimum throat area  $S_{TO}$ , corresponding to max power transfer, gives:

$$S_{TO} = \frac{R_E}{B_l^2} \rho_o C S_D \quad (1)$$

a result first found by Keele.<sup>5</sup>

From Fig. 4, to find the mass rolloff frequency ( $F_{HM}$ ), we equate the total circuit resistance to the mass reactance to give:

$$\frac{B_l^2}{R_E} + \frac{S_D^2}{S_T^2} \rho_o C S_T = 2\pi F_{HM} M_{MS}$$

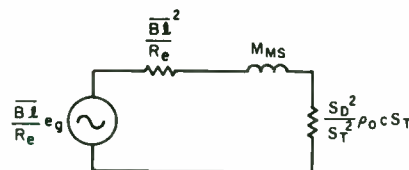

FIGURE 4. The model of a horn with the transformer and gyrator pushed through the circuit.

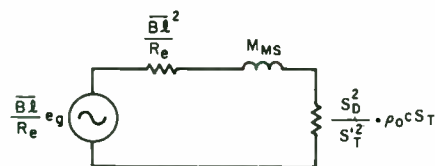
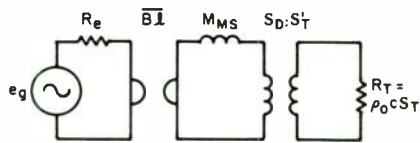

FIGURE 5: The circuit model of a horn with a constricted throat plate before and after the removal of the gyrator and transformer.

Solving for  $F_{HM}$  yields:

$$F_{HM} = \frac{1}{2\pi M_{MS}} \left[ \frac{B_l^2}{R_E} + \frac{S_D^2}{S_T^2} \rho_o C S_T \right] \quad (2)$$

Noting that the definitions for  $F_S$  and  $Q_{ES}$  are given by:

$$F_S = \frac{1}{2\pi \sqrt{M_{MS} C_{MS}}} \quad (3)$$

$$Q_{ES} = \frac{R_E}{B_l^2} \sqrt{\frac{M_{MS}}{C_{MS}}} \quad (4)$$

where  $F_S$  is the driver resonant frequency,  $Q_{ES}$  is the Thiele/Small electrical  $Q$ , and  $C_{MS}$  is the mechanical compliance of the suspension, we can group the parameters in equation (2) to include  $F_S$  (equation 3) and  $Q_{ES}$  (equation 4). Thus, we can transform equation 2 by multiplying with the unity quantity  $\sqrt{C_{MS}}/\sqrt{C_{MS}}$  and factoring  $M_{MS}$  into  $\sqrt{M_{MS}} \cdot \sqrt{M_{MS}}$  to give:

$$F_{HM} = \frac{1}{2\pi \sqrt{M_{MS} C_{MS}}} \cdot \sqrt{\frac{C_{MS}}{M_{MS}}} \cdot \frac{B_l^2}{R_E} \left[ 1 + \frac{R_E \rho_o C S_D^2}{B_l^2 S_T} \right]$$

Substituting  $F_S$  and  $Q_{ES}$  in the above equation gives:

$$F_{HM} = \frac{F_S}{Q_{ES}} \left[ 1 + \frac{S_{TO}}{S_T} \right] \quad (5)$$

If  $S_T$  equals  $S_{TO}$ , then equation 5 reduces to Keele's<sup>4</sup> result of:

$$F_{HM} = \frac{2 F_S}{Q_{ES}} \quad (6)$$

that I quote in the "Show Horn" article (SB 2/90). In a similar manner, one can substitute equations 3 and 4 into equation 1 to find a simplified T/S version of the optimum throat area given by:

$$S_{TO} = 2\pi F_S \cdot Q_{ES} \cdot V_{AS}/C$$

But now let us apply equation 5 to the old Klipschorn without the constrictor

Continued on page 34

TABLE 1  
KLIPSCH K-33E T/S PARAMETERS

$F_S = 31.5\text{Hz}$
$Q_{ES} = 0.43$
$R_E = 3.5\Omega$
$V_{AS} = 9.25\text{ Ft}^3$

Speaker Builder's Publisher announces:

# THE WORLD'S FINEST RECREATIONAL ELECTRONICS JOURNAL

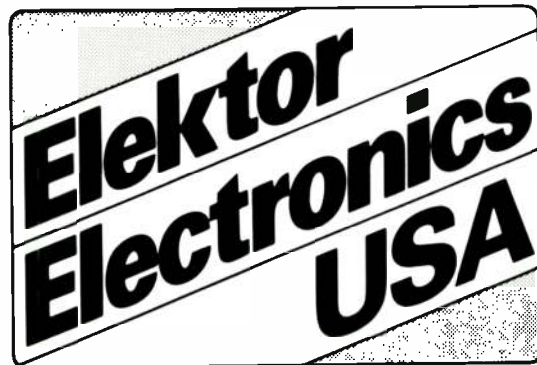

## THE POWER

*Elektor Electronics USA* is a 76-page monthly with an average of 14 articles per issue, covering virtually every technology. Over 80% are construction features which include circuit diagrams, schematics, parts lists, and sources. The magazine's service department will supply circuit cards, software, firmware, and front panels for most projects.

Tutorial articles by outstanding authorities explain the latest technological developments.

*Elektor Electronics USA* construction projects are written, with few exceptions, by staff engineers who design and test them with the aid of staff technicians and support people. All project prototypes are built and thoroughly tested before publication and also reviewed by the Dutch government's equivalent of the US Underwriters Laboratories.

*Elektor Electronics USA* originates in Beek, The Netherlands. The multilingual staff not only produces the magazine's content, but also translates the articles into Swedish, English, French, German, Spanish and Portuguese. The magazine is published in separate editions for Sweden, Germany, England, The Netherlands, France, Spain, Portugal, Greece, India and Pakistan—and now The United States and Canada. The North American edition will feature new product and conference news as well as reader correspondence and free classified ads.

## YOUR CHARTER SUB

Become a Charter Subscriber to *ELEKTOR ELECTRONICS USA* at almost **50% OFF THE REGULAR SUBSCRIPTION PRICE** just \$15 for twelve monthly issues. (Save \$13 off the regular \$28 annual rate.)

We're so sure you'll be delighted, we guarantee it: ALL your money back if you are not completely satisfied, for any reason. No ifs, no buts, period.

O.K. Ed, sign me up as a charter subscriber to *Elektor Electronics USA*\* I understand my first issue will be mailed September 21, 1990.

\_\_\_ One year (12 issues) @ \$15    CK MO MC VISA

\_\_\_ Two years (24 issues) @ \$26

Please add \$8 per year for Canadian postage.

\*Available to subscribers in USA and Canada, only.

## THE FUN

### SAMPLES FROM SIX RECENT ISSUES:

A Facsimile Interface for the IBM-PC, Automatic Power-down for PCs, A Mini EPROM Viewer, A MIDI Master Keyboard, Remotely Controlled Stroboscope, Rear Window Wiper Coupler, A Four-sensor sunshine recorder, Power Zener Diode, An Electronic Load, PLL sine wave generator, A Horn Loudspeaker, Intro-scan for CD Players, A PC Servicing Card, Centronics A/D-D-A converter, Acoustic Temperature monitor, Experimental all-waveband ferrite rod antenna, Image segmentation, Budget sweep/function generator, Transistor characteristic plots, An RS-232 Splitter/Multiplier, Digitally controlled preamplifier, All Solid State Preamplifier (2 parts), A Visual Hard Disk monitor, Coded locking security circuit, The digital model train: (13 parts), A wiring allocation tester, A video line selector, A Q meter, A Video mixer, Bridge Rectifiers for high output AC-DC and Multiplier use, Automatic Power line isolator switch, A 3-pen, 20" plotter with parallel port, An AC Millivoltmeter, An FM tuner board for your PC.

NAME \_\_\_\_\_

ADDRESS \_\_\_\_\_

CITY \_\_\_\_\_

STATE \_\_\_\_\_

ZIP \_\_\_\_\_

MC/VISA \_\_\_\_\_

EXP. \_\_\_\_\_

### AUDIO AMATEUR PUBLICATIONS

PO Box 876, Dept. B90

Peterborough, NH 03458-0876

(603) 924-9464

FAX: (603) 924-9467

Answering machine for credit card orders only:  
before 9:00 a.m., after 4:00 p.m. and weekends.  
Have all information plus MC/VISA available.



# Elektor Electronics USA

- Video line selector
- Q meter
- Automatic mains switch
- RS232 splitter
- Bridge rectifiers revisited
- Coded locking circuit



TVN **TV Norge**  
 Mandag 15. Januar

- 18.45 DENT TV-TIRM
- 19.00 "HEMMETS LIFESTYLE"
- 19.30 MUSIKK MUSIKK MUSIKK
- 20.00 CASINO
- 21.15 POLITIET PÅ HILL STREET
- 22.10 ENGELSK FOTBALL
- 22.55 BEYOND 2000 (r)

MUSIKK: OCEANS APART

# TDF

ARD/BADN 1 PLUS

ITC STOCKHOLM

Svejdalen	8	Åkersberg 60
Pöskelåsa	8	Åkersberg 6
Transtrand	8	8
Gröndalen	8	Åkersberg 60
Pöskelåsa	8	8

NORDIC CHANNEL



9 770268 451012

Continued from page 31

plate. Using the K-33E Klipschorn 15" driver's T/S parameters (Table 1), we find that  $S_{TO} = 100 \text{ in}^2$ . Using an unconstricted throat of  $78 \text{ in}^2$ , the mass rolloff frequency is  $166 \text{ Hz}$ . If we use the larger optimum throat size of  $100 \text{ in}^2$ ,  $F_{HM}$  is  $146 \text{ Hz}$ . Clearly, there is a small improvement in the mass rolloff frequency made by going to a smaller throat size, but it's not a great one. If we had a bass horn with a throat size of  $39 \text{ in}^2$ , the mass rolloff frequency improves to  $261 \text{ Hz}$ , but at the cost of added throat length.

### MODELING THE KLIPSCHORN THROAT.

We can account for the constricted throat plate in the present day Klipschorn by a simple change in the model of Fig. 2. We change the term  $S_T$  in the throat-diaphragm transformer to  $S'_T$ , the area of the constricted throat plate. The  $R_T$  term in the throat resistance remains the same because the horn throat does not change, only the throat plate. Going through the same circuit transformations as Fig. 3 by pushing through the transformer and voice coil gyrator, we arrive at the circuit of Fig. 5 for the case of the Klipschorn.

Equating the mass reactance to the total circuit resistance in Fig. 5 to find the mass rolloff frequency gives:

$$\frac{B_l^2}{R_E} + \frac{S_D^2}{S_T'^2} \rho_o C S_T = 2\pi F_{HM} M_{MS} \quad (7)$$

Substituting equations 1, 3, and 4 into equation 7 and solving for  $F_{HM}$ , we obtain the mass rolloff frequency for the constricted throat case:

$$F_{HM}' = \frac{F_S}{Q_{ES}} \left[ 1 + \frac{S_T S_{TO}}{S_T'^2} \right] \quad (8)$$

Plugging in the Klipschorn parameters ( $S_T' = 39 \text{ in}^2$ ,  $S_T = 78 \text{ in}^2$ , and  $S_{TO} = 100 \text{ in}^2$ ), we find that the mass rolloff frequency has increased to  $447 \text{ Hz}$ , a significant improvement. So we now know that adding a constrictor throat plate can produce a radical improvement for a driver/horn system where the driver does not have a low  $Q$  and high  $F_S$  that is normally associated with horn drivers.

**PHYSICAL INTERPRETATION.** One does not have to wade through all the math and circuit models to understand how the constricted throat works. Basically, when you reduce the throat area, the turns ratio of the throat-diaphragm transformer is increased which in turn boosts up the throat resistance as shown in Fig. 6. We know that the mass reac-

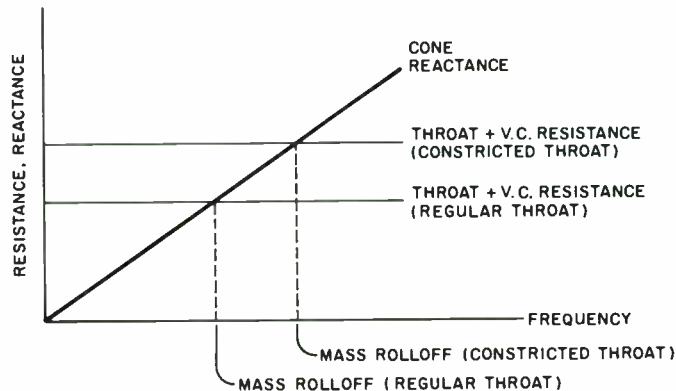

FIGURE 6: A schematic representation of the voice coil and throat resistances (horizontal lines) and the mass reactance of the cone (linearly rising with frequency) showing how the constricted throat gives a wider bandwidth.

tance is directly proportional to frequency which is represented as a rising line in Fig. 6. Thus, with the constricted throat you have to go to a higher frequency before the mass of the cone will swamp the boosted throat resistance, as compared to the case without the constricted throat plate. And thus you obtain a wider horn bandwidth.

**DISCUSSION.** The advantage of the constricted throat is, in the case of the Klipschorn, that it saves in driver costs. The K-33E uses a smaller magnet which is half the weight of magnets used for musical instrument drivers that I have recommended for bass horns. And you pay dearly for those large magnets.

But as usually happens in physics, a gain in one parameter implies a loss in another parameter. In the constricted throat case, you lose efficiency as shown

by Small.<sup>2</sup> But I claim that loss is an acceptable one. My midrange horn sensitivities usually range between 100–105dB, and my bass horn sensitivities run higher on the order of 105–110dB, which I usually have to pad down. So the loss in bass efficiency actually helps in system matching.

Another concern in using a constricted throat is the almost certain increase in throat overload distortion. With a smaller throat area, the sound intensity will be larger which in turn leads to higher second harmonic distortion as shown by Beranek.<sup>3</sup> But the throat overload distortion is probably swamped by nonlinearities in the driver suspension that may not like working into a small throat area. So if you want the cleanest horn system possible, use an expensive musical instrument driver in a conventional horn. But if your wallet is lacking, then the use

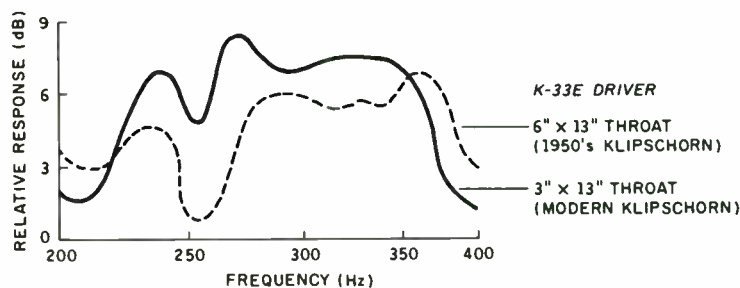

FIGURE 7: A comparison of the relative responses of a new and old Klipschorn models using the same driver.

TABLE 2

T/S PARAMETERS FOR 15" DRIVERS						
Driver	$F_S$ (Hz)	$Q_{ES}$	$V_{AS}$ (ft <sup>3</sup> .)	$S_{TO}$ (in <sup>2</sup> .)	$F_S/Q_{ES}$ (Hz)	$F_{HM}$ (Hz)
Goldstar 1574	19	0.35	11.0	58.5	54	216
JBL 2235	20	0.28	16.0	71.7	71	334
EV Force 15	40	0.51	10.0	163.2	78	734
Sledgehammer 15	43	0.30	7.9	81.5	143	743
Madisound	20	0.47	12.6	94.0	42	249
JBL 2225H	40	0.31	6.0	59.5	129	522

of a bass reflex class driver with a throat constrictor is a good compromise.

#### EXPERIMENTAL VERIFICATION.

As I was finishing up the article, I wanted a simple way of verifying the model predictions. So I proposed to Jim Hunter of Klipsch the following experiment. Take an early Klipschorn with a large throat from the Klipsch museum and a present production model with a constricted throat, and measure their respective frequency responses in a chamber using the same K-33E driver. Jim promptly performed the experiment, and the results are plotted in Fig. 7. As you can see, the constricted throat does improve the response above 250Hz on the order of several dB. The result also shows the effects of internal reflections which can modify the good points of a constricted throat.

**DRIVER CHOICE.** After obtaining the formula of equation 8 that predicts the mass rolloff frequency, I decided to do a survey of 15" drivers to see which drivers might work with a constricted throat on a bass horn. I assumed the same throat configuration as the Klipschorn ( $S_T = 78 \text{ in}^2$  and  $S'_T = 39 \text{ in}^2$ ). Table 2 lists seven current drivers from manufacturers and distributors well known to SB readers.

Three of the drivers (Goldsound, JBL 2235, and Madisound) have rolloff frequencies between 200 and 300Hz which does not make them good candidates for this application. The  $F_S/Q_{ES}$  ratio for the drivers (42-71Hz) indicates that they are really suited for closed box applications. And their suspensions probably would not like a small horn throat. But the EV, Sledgehammer, and JBL 2225 do have high mass rolloff frequencies (above 500Hz) and thus would be good candidates for the constricted throat horn. All of these drivers have  $F_S/Q_{ES}$  specs above 75Hz. So an ad hoc criterion for choosing a driver is to make sure that the ratio  $F_S/Q_{ES}$  is above 75Hz. The EV and Sledgehammer drivers have mass rolloffs above 700Hz. In a realistic folded horn, the folds would not allow this bandwidth to be achieved. If one chose to have a lower mass rolloff, then the resultant horn would have a larger throat and a shorter horn length.

**CONCLUSIONS.** The constricted throat bass horn design as found in the present Klipschorn is a result of inspired experimentation many years ago by Paul Klipsch. But the theoretical understanding for the use of a constricted throat

was lacking until now. With the simple models presented in this article, one can now adapt the constricted throat idea to his own application, recognizing that it is not a panacea for all of a driver's shortcomings. But if properly utilized in a bass horn, the design technique can allow a wider choice of drivers to be considered. By adjusting the relative throat sizes, the designer can tailor the bandpass characteristics of his horn. 

#### REFERENCES

1. Kergomard, J. and A. Garcia, "Simple Discontinuities in Acoustic Waveguides at Low Frequencies," *J. Sound and Vib.*, Vol. 114, pp. 465-479, 1987.

2. Small, R. H., "Suitability of Low Frequency Drivers for Horn Loaded Loudspeaker Systems," AES reprint #1251, May 1979.

3. Beranek, L., *Acoustics*, McGraw-Hill, New York, 1954.

4. Leach, W. M., "On the Specification of Moving Coil Drivers for Low Frequency Horn Loaded Loudspeakers," *JAES*, pp. 950-959, Dec. 1979.

5. Keele, D. B., "Low Frequency Horn Design Using Thiele/Small Driver Parameters," AES reprint #1250, May 1977.

#### ACKNOWLEDGEMENTS

I thank Jim Hunter of Klipsch and Associates for performing the response measurements on the Klipschorns, and Jeff Nelson for checking the calculations.

### The Greatest Summer Speaker Sale Ever!

We're overstocked and need to make room *now*! Brand new speakers are offered at low prices you'll never see again! Quantities are limited and this sale is over as soon as stocking levels are reduced. Call, write or fax *today* to order! Here are just a few of the incredible specials:

#### Kits:

-The G2R 10" 3-way speaker. A true classic well reviewed in High Fidelity. Full kits with cabinets in walnut or oak regular \$499 pair, limited quantity at *only* \$399 pair plus \$45 shipping.

-Sapphire 2-way high-resolution monitor, "state-of-the-art in imaging," says Peter Aczel of The Audio Critic. Full kits with oak cabinets regular \$999 pair, 30 pair left at *only* \$799 pair! Add \$50 for UPS shipping.

-Saturns, least expensive subwoofers on Stereophile recommended list. Add a pair to the Sapphires for *only* \$699, (regular \$899), plus \$70 shipping.

-M2R 12" 3-way speaker. Similar to the famous G2R but more bass. *Only* 40 pair of oak at \$499 pair plus \$50 shipping. Save \$100!

-Pulse subwoofer pairs in oak with crossovers, regular \$548 now \$449 per pair plus \$55 UPS shipping. Match many smaller speakers.

Also clearing out a lot of demos and speakers with slightly damaged cabinets. Call for availability and pricing!

\*\*\*Our 30 Day money-back guarantee on all the above, at these low prices we refund half the shipping.

#### Drivers:

-AC8 4 ohm, popular polypropylene cone vented voice coil 30Hz Fs 8" for sealed or vented box. Car sound installers and home builders love them, regular \$45 each, \$29 each or ten for \$250.

-AC12 4 ohms as above, 19Hz Fs reg. \$65 each, \$49 or ten for \$450

-Focal T90K kevlar tweeters, \$29 each

-Focal 5K013L kevlar bass-mids with curves \$59 each

-Focal 8K415S kevlar woofers with curves \$59 each

-Focal 8N411DBE neoflex woofers \$39 each

-Vifa D25A Aluminum dome tweeters \$17 each

-Vifa D26T Textile dome tweeters \$12 each

\*\*\*All the above plus shipping, quantities limited\*\*\*

### AUDIO CONCEPTS, INC.

901 S. 4th St. La Crosse, WI 54601

Orders: 1-800-346-9183, 608-784-4570, FAX 608-784-6367

# A MODULAR THREE-WAY ACTIVE LOUDSPEAKER

BY FERNANDO RICART

For about nine years I have been experimenting with active systems. They have usually been full three-way designs incorporating the equalized fourth-order filter circuits introduced by Siegfried Linkwitz in his landmark articles first published in the May, June, and December 1978 issues of *Wireless World*.

After years of trying to modify and rebuild enclosures (and never finishing any of them) I decided to build a modular system with replaceable sections. Each section is optimized for its function and can be discarded if a new driver dictates a different design. The units are covered with matching oak veneer and finished with Danish oil.

**GENERAL DESIGN.** Unlike the subwoofer and satellite system described in the Linkwitz articles, mine is a rather conventional three-way design. I determined crossover frequencies by using subjective judgment tempered by driver limitations. Through trial and error I came to the conclusion that most tweeters on the market simply do not sound very good below 3kHz. This determination established the minimum high-frequency (HF) crossover. In order to establish an acoustic fourth-order response characteristic from the driver and filter combination without relying on roll-off equalization, the mid-

## ABOUT THE AUTHOR

Born in Santo Domingo, in the Dominican Republic, 38-year-old Fernando Ricart has a bachelor's degree in electrical engineering from Villanova University (1974). With a professional background in control systems for industrial and nuclear plants, he is currently with Public Service Electric and Gas and lives with his wife and three children in New Jersey. He built his first speaker from Isophon and Philips components at age 15 in the Dominican Republic.



PHOTO 1: Front view.

range driver must exhibit relatively flat response for at least an octave above the crossover point.

Equalization of the high end of a driver is difficult to accomplish, but with recent advances in diaphragm materials, the goal of pushing diaphragm breakup resonances beyond the working range is becoming attainable. Utilizing the driver's mechanical rolloff would negate this advantage. The requirement for flat driver response beyond 6-7kHz rules out two-way designs as well as the use of larger midranges.

The low-frequency (LF) crossover is affected by several factors. Most ten- and twelve-inch woofers begin to exhibit roughness above 500Hz, the midrange enclosure begins to suffer significant diffraction losses below about 400Hz, the HF and LF crossovers must be kept sufficiently apart to minimize interactions,

and suppression of LF enclosure panel resonances at high frequencies is a tall order. My current system operates with 450Hz and 3.2kHz crossover points.

**ENCLOSURE DESIGN.** The mid- and high-frequency enclosures feature rounded edges to help reduce cabinet reflections. Another feature which helps to reduce reflections as well as provide flexibility and good looks is a front baffle covered with  $\frac{3}{8}$ -inch acoustic foam. This foam, marketed by Audio Concepts, Inc., of LaCrosse, WI, also serves to flush-mount the drivers. To avoid cutting into the baffle with a router, I surface-mounted the drivers and then surrounded them with the foam. The installation of a new driver requires no more than a replacement foam sheet with a new cutout. In combination with the finished oak veneer, the results are very satisfying.

The HF enclosure is shown in *Fig. 1*. I sized it to handle tweeters with flange widths or diameters of up to 4.75 inches. This is sufficient for almost any tweeter on the market, with the exception of the Polydax\* HD13D34 series.

The midrange enclosure is shown in *Fig. 2*. I designed it to accommodate up to 5.25-inch drivers, although it is possible to squeeze in some 6.5-inch units. The enclosure actually consists of an outer shell made of  $\frac{1}{2}$ -inch particle board with an inner shell that can be made of either a 6-inch-diameter cardboard construction tube or one of the subenclosures marketed by some speaker manufacturers.

The volume between the outer and inner shells is then filled with fine-grain play sand. A subenclosure marketed by SEAS for their 13cm midrange has an internal volume of 1.65 liters, while one made from the 6-inch tube can be made

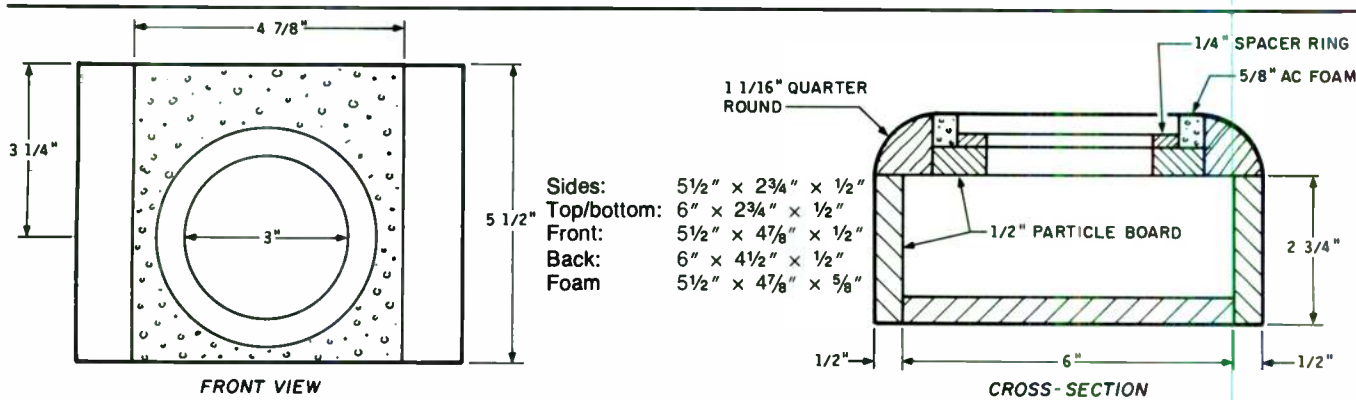

FIGURE 1: High-frequency enclosure.

to yield up to 3 liters in this outer enclosure. After selecting the midrange driver, I calculated an increase of the midrange system resonance from 150Hz to 170Hz if the smaller 1.65-liter subenclosure was used instead of the cardboard tube. Since this difference was not that significant in light of the 450Hz crossover and the circuit's ability to compensate for the fundamental resonance, I selected the pre-made SEAS subenclosure for its convenience. However, anyone intending to use larger drivers or lower crossover frequencies may be well advised to opt for the larger volume of the construction tube.

**BRUTE FORCE.** Low frequency enclosure loading is always a controversial subject. Having built a number of trans-

mission lines for 8-inch woofers which exhibited superb mid-bass but which lacked the impact of live music, I concluded that sophisticated enclosure design could not adequately replace brute force. The impact of genuinely reproduced low frequencies is as much an integral part of high fidelity realism as low midrange coloration and extended highs. Regardless of what some in the English audio press would lead you to believe, a small woofer with tight bass that can "play tunes" does not resemble live music.

Since a transmission line enclosure of adequate length for a 12-inch woofer is prohibitively large for my listening room, I had to consider more conventional sealed or vented systems. Past experimentation with vented boxes in my

listening rooms never yielded satisfactory results. The vents always seemed to incite room standing waves and contributed to midrange coloration. I have therefore arrived at my compromise by using a 64-liter (59-liter net) sealed system, equalized to extend LF response below resonance. The low frequency enclosure is shown in Fig. 3. Its height was determined by the need to support the mid- and HF enclosures at ear level. The internal dimension ratios were chosen to minimize standing waves. An excellent treatment of this subject can be found in Lubos R. Palounek's "Enclosure Shapes and Volumes" in the 3/88 issue of *Speaker Builder*.

Rather than select heavier 1" particle board, I attempted to raise the panel resonances above the LF range by using

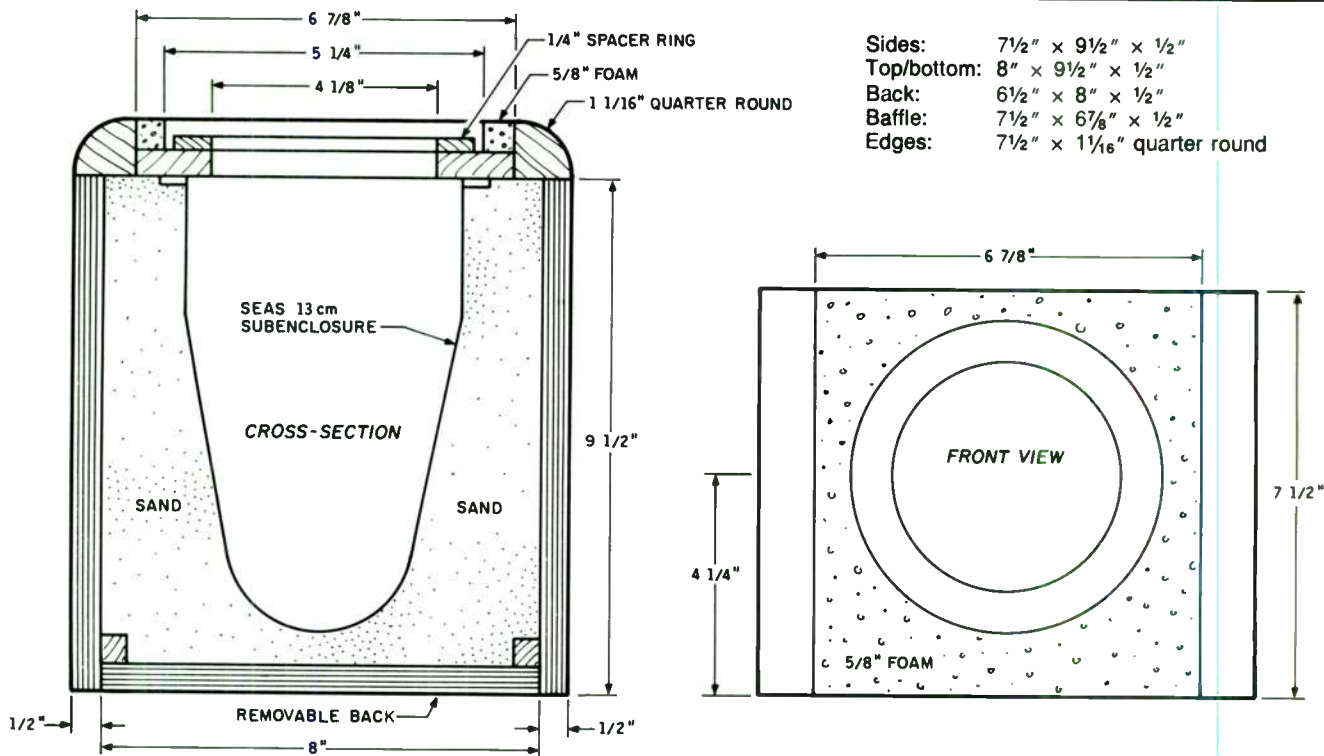

FIGURE 2: Midrange enclosure.

Sides: 22" x 24 5/8" x 3/4"  
 Top/bottom: 15 3/4" x 12 1/2" x 3/4"  
 Front/back: 21 3/8" x 15 3/4" x 3/4"  
 Top foam: 15 3/4" x 14" x 5/8"  
 Front foam: 22" x 15 3/4" x 5/8"

Internal braces: 1" x 1"

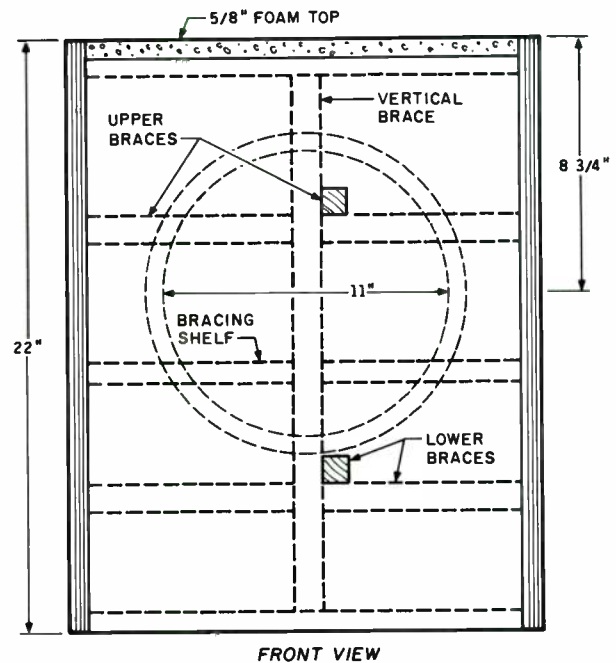
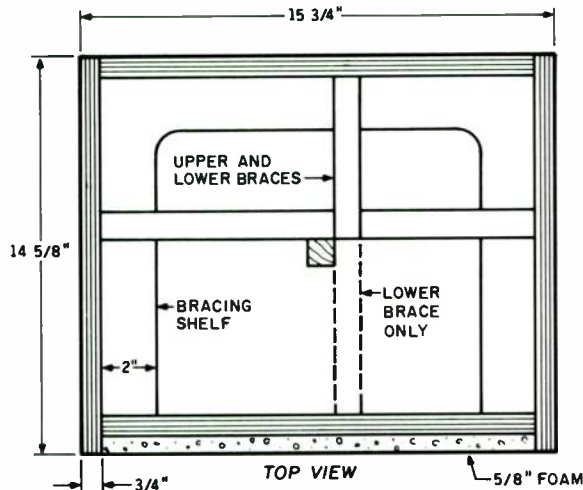

FIGURE 3: Low-frequency enclosure.

heavily-braced, lighter, 3/4" panels. I have not measured the individual panel resonances but the enclosure performs well in the standard "knuckle on the side" test. I lined the walls with aggregate foam and lightly filled each enclosure's cavity with about 1.25 pounds of wool. This is just enough material to prevent standing waves but not enough to appreciably change the resonance or Q. I am not a fan of tightly-stuffed enclosures, as I perceive their sound to be thick and heavy.

**DRIVER SELECTION.** My selection of a tweeter was somewhat evolutionary. The original active system used the classic Polydax HD100D25 soft dome. Replacing it with a SEAS H107 polyamide dome resulted in a dramatic improvement in liquidity and transparency. When a ferrofluid version, the H211, became available, I quickly installed it. The results, however, were disappointing. I found that the transparency had been replaced by a veiled and rather two-dimensional sound. When I tried to measure the resonance and  $Q_T$  of the drivers to design the compensation stage, the measured parameters varied from day to day and with different input signal levels. I finally designed a filter using compromise parameters from the various tests, but the results were sonically inferior to the H107. Eventually I gave up and returned the H107 to service. In the 1/86 issue of *Speaker Builder* ("SB Mailbox"), Mr. Linkwitz discussed similar findings regarding the variability of

ferrofluid driver parameters and even described a procedure to remove ferrofluid from Dynaudio D28 tweeters. While ferrofluid offers many advantages in some designs, I have since been reluctant to utilize ferrofluid drivers with this design. Another driver which I used with good success was the polyamide Polydax HD11.10D25SP.

Recent developments in diaphragms have created a new generation of tweeters in which the upper resonant frequencies have been raised beyond the audio range. I have been experimenting with an aluminum dome, the SEAS H400, and a Kevlar inverted dome, the Focal T90K. The H400 has become a popular original equipment component in some high-quality commercial systems—it is easy to see why. It has a crystal clear quality which is particularly evident in percussive "ringing" sounds such as those produced by bells and cymbals. This is undoubtedly a result of its >25kHz resonance.

The T90K appears to have a lower HF limit than the H400. However, it is able to sonically "disappear" in a manner unattainable by the H400. With classical music, it can convey the timbre, ambiance, and overall stage presentation of an orchestra with uncanny realism. The metal dome is a very promising concept, but it seems to be very sensitive to the means employed to protect it and control its resonance. The H400 is recessed into its front plate and covered by a grille with a phase plate. This creates an uneven radiating pattern which I believe is

responsible for preventing this unit from equalling the natural sound stage of the T90K. I elected to use the Focal unit, but I have included crossover equalization values for both units here so you may use the SEAS unit if you wish.

I chose the T90K over the more expensive T120K because of the T90K's more linear response in the 2-4kHz range and because its 72mm magnet diameter creates a mounting hole that is more compatible with the SEAS H400 as well as other alternate metal domes. Such units would be the MB MCD-25M, Polydax DTW100T125F, and new units from Vifa, Eton, Scan-Speak, and LPG.

Midrange driver selection has been the most difficult part of this evolving project. For reasons explained earlier, the midrange's response must extend beyond 6kHz. Until recently, only light paper cone drivers or some dome midranges could exceed this criterion. However, the cone drivers' responses were usually rough and the domes' LF crossover requirements were usually above 700Hz, making their match with large woofers somewhat difficult.

Some Bextrene models just met the HF response requirements. My first system used Bextrene KEF B110 units, but I had very little time to assess these drivers because an amplifier failure literally cooked the voice coil in one of them. Due to economic considerations, I replaced them with the Polydax HD13B25H4C12. These Bextrene drivers had a sweet sound and very detailed lower mid. Their upper end

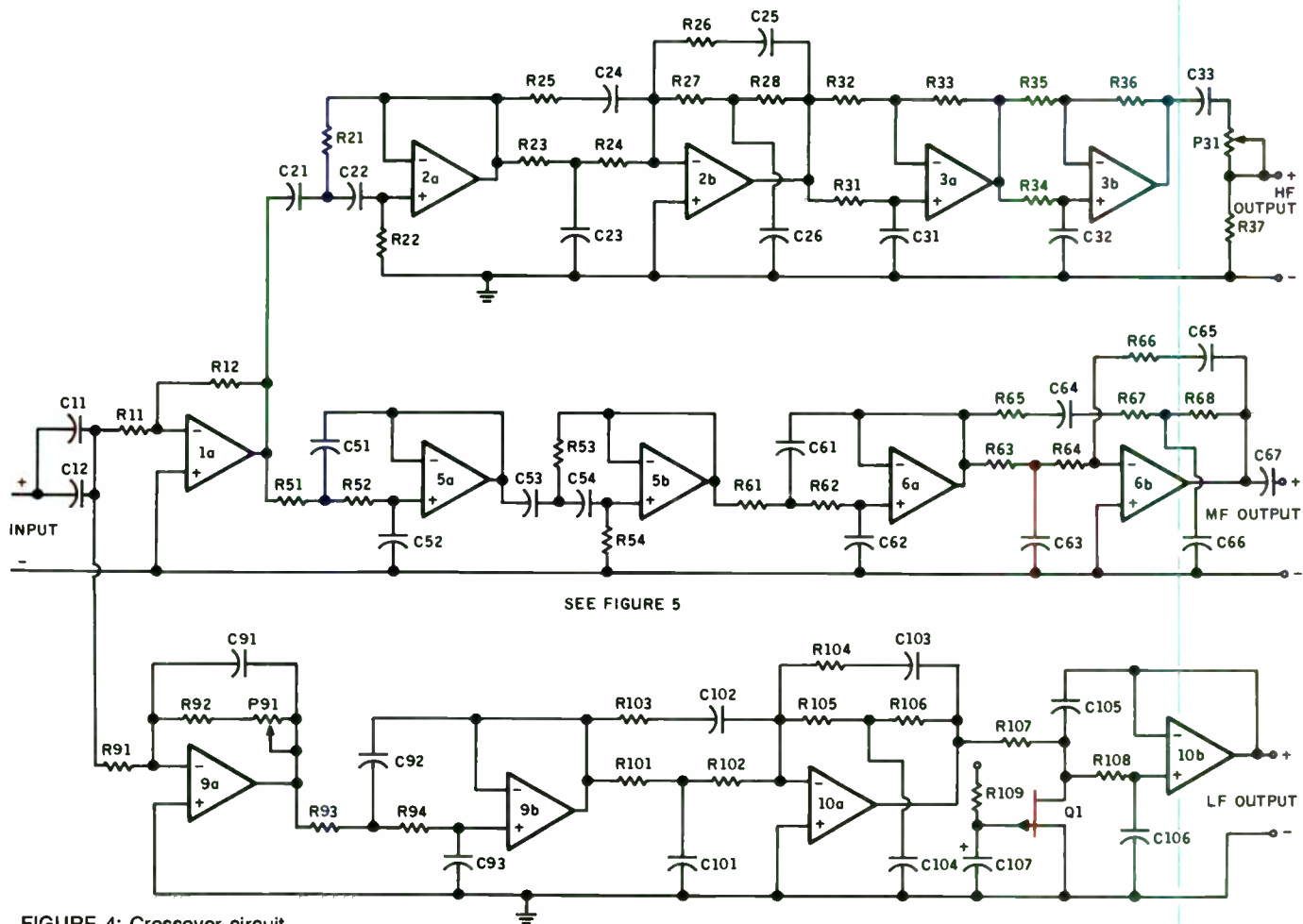

FIGURE 4: Crossover circuit.

however, was reticent and somewhat colored, a drawback particularly evident in piano reproduction.

Other drivers followed. The Peerless TO125F sounded lively and balanced but somewhat harsh. Next I tried the SEAS 13F-GMBX and the H204 3" plastic dome. Both sounded bland, creating an impression of compressed dynamics which may have been due to a response shelving below 800Hz measured on both units. This was a particular shame with the H204, since it had a smooth extended upper range that seemed to integrate perfectly with the tweeter. If crossed over above 900Hz, the H204 could be a superb unit.

The fiberglass Siare 12VR had an extended upper range, but a large undamped peak at about 7kHz roughed the response above 2kHz, so the subjective results were mixed. I kept returning to the admittedly colored but more pleasing compromise of the Polydax HD13B25H4C12.

**SUPERIOR PIANO.** As with tweeters, the last few years have seen some significant developments in midrange drivers.

1. All resistors are 1/4W, 1% metal film unless otherwise noted.
  2. All capacitors are 2% polypropylene unless otherwise noted.
  3. Resistor values in kΩ. Capacitor values in μF.
  4. IC1, 2, 3, 5, 6, 9, and 10 are TL072, AD-712, or MC34082.
- \*If R28 || R31 || R32 || R26 || <2kHz, then IC2 should be NE5532 (see text).

#### PARTS LIST

R11, 12	33.2k	C23	0.0018μF for H400
R21, 51, 52, 61, 62	10.5k	C24, 25	0.01μF for T90K
R22	21k		0.0015μF for H400
R23, 24	140k for SEAS H400 41.2k for Focal T90K	C26	0.0022μF for T90K 0.039μF for H400
R25, 26	34k for H400 26.7k for T90K	C33, 67	0.15μF for T90K 0.33μF
R27, 28	6.49k for H400 2.74k for T90K	C51, 61, 92, 105	0.0068μF
R31, 34, 37	6.49k	C63	0.033μF
R32, 33, 35, 36	21k	C64, 65	0.0039μF
R53, 93, 94, 107, 108	75k	C66	0.22μF
R54, 91	150k	C91	100pF 50V DC, 5% polypropylene
R63, 64	80.6k	C101-104	See Fig. 5
R65, 66	105k	C107	22μF 50V DC, electrolytic
R67, 68	12.1k	P31	5k linear pot.
R92	100k	P91	100k linear pot.
R101-106	See Fig. 5	IC1-3	NE5532
R109	1.5M, 1/4W, 5% car- bon film	IC5, 6, 9, 10	TL072, AD-712, or MC34082
C11	4.7μF 100V DC, 10% polyester film	Q1	2N4360
C12	0.47μF		
C21, 22, 31, 32, 52-54, 62, 93, 106	0.0033μF		

Polydax has introduced a family of drivers with TPX diaphragms. The TX1125JSN is a 4.5" unit with very smooth response in the working range and extended response beyond 9kHz. I am currently using this driver in my system, since it offers the first real overall midrange improvement. Voices are reproduced with proper size and perspective, and piano reproduction is far superior to that with any of the drivers previously used. If you prefer a forward sound you may not be satisfied with this driver. It has a neutral perspective, somewhat akin to that from a BBC LS3/5A. It is available in 9mm and 6mm voice-coil versions, suffixed 2CN9 and 2CN6 respectively. I used the 2CN9 version so I could experiment with lower crossover frequencies. With the 450Hz crossover, the 2CN6 should work just as well. A note of caution: you should always measure a driver's parameters rather than rely on the manufacturer's data. Polydax specifies this driver's resonance at 130Hz and its  $Q_T$  at 0.52. The actual resonances on my two samples were 145 and 152Hz and  $Q_{ES}$  were 0.93 and 0.99.  $Q_T$ s were 0.76 and 0.79, respectively. The higher resonances are understandable, especially since my test current was 1mA instead of the 30mA used by Polydax. However, the measured  $Q_{ES}$  were significantly higher than expected, even considering the higher resonances. This implies substantially lower BL specifications than advertised. Since both drivers had resonances/ $Q_{ES}$  ratios consistent with each other, I must conclude that the manufacturer's specification are in error. In addition, calculating  $Q_{ES}$  from published values for  $f_s$ ,  $R_{SCC}$ ,  $M_{MD}$  and  $B_L$  yields entirely different results from the published  $Q_{ES}$  value or from my measured values. Polydax needs to better sort out the specifications for this model.

The TX1125JSN comes with a plastic decorative trim ring which is shown installed in the photographs. I have come to prefer the sound of the midrange without this ring, as it seems to introduce some roughness in the upper range.

A promising alternative seems to be the Focal 5KO13-L. The Kevlar sandwich diaphragm in this unit provides extended response beyond 10kHz and the manufacturer-supplied curves exhibit a better controlled upper end than most other Kevlar drivers. This unit appears preferable to the more expensive but less extended 5K413 in this application. I have not tried this unit, so I can not comment on its sound quality.

**ADVICE IGNORED.** The equalized

closed box loading makes woofer selection much less critical than it would be with a vented or unequalized closed box. Almost any high-quality 12" woofer will work as long as there is enough coil overhang to withstand equalization and the midrange response is adequate. Since I had a pair of Peerless TA305F units for a few years, I installed them in my system. I understand that they are no longer made, so if you are starting without drivers you must consider other options.

At this point I have no choice but to ignore my own advice and believe manufacturers' spec sheets. I surveyed published specifications for various 12" woofers on the market and found that the Audio Concepts AC12 and the Eclipse W1238R appear to be excellent replacements for my TA305Fs. They may be even *better* suited for this system. Peerless has introduced a European-made replacement for the TA305F, the 3155SWR39, that also might be a good performer in

this application. (I have yet to see it for sale.)

Another possibility is the Dynaudio 30W54. Although it is very expensive and on paper its specifications (system resonance and coil overhang) are not comparable to the other units, its Mercedes-Benz construction makes it worthy of consideration. There may be other excellent units which will provide good performance in this system, but since I didn't have full specifications for them, including a response curve, I am hesitant to offer more recommendations. The expected resonances and  $Q_T$ s of these woofers in the 59-liter enclosure are listed in Fig. 5. The figures for the TA305F are measured values, but the others are calculated from manufacturer specifications. I can vouch neither for their accuracy nor for the consistency of the production samples.

**CROSSOVER DESIGN.** The fourth-

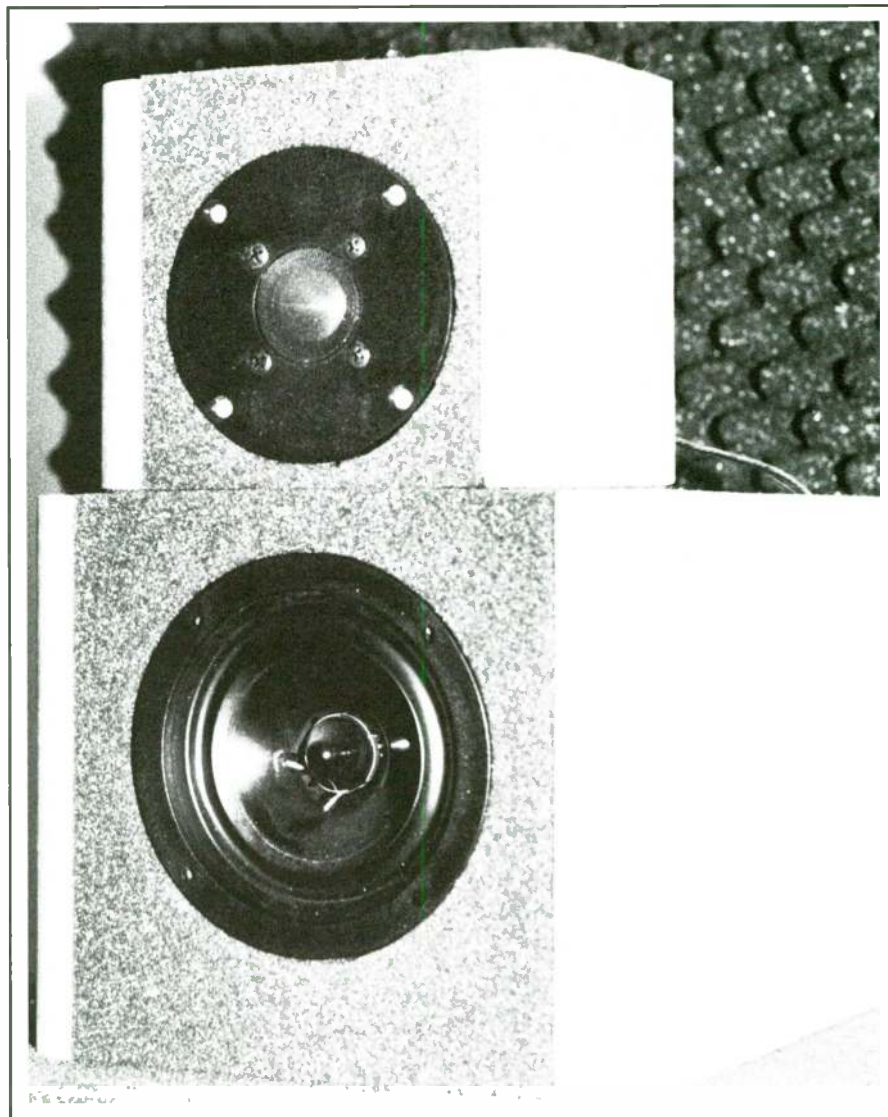

PHOTO 2: Close-up.



59 LITER ENCLOSURE EQUALIZATION

	$f_s$ (Hz)	$V_{AS}$ (lit.)	$Q_{TS}$	Coil Ovng. (mm)	$f_c$ (Hz)	$f_{3dB}$ $Q_{TS}$		Boost (dB)	C101 ( $\mu$ F)	C102 C103 ( $\mu$ F)	C104 ( $\mu$ F)	R101 R102 (k $\Omega$ )	R103 R104 (k $\Omega$ )	R105 R106 (k $\Omega$ )
Peerless TA305F*	25Hz	180	0.34	$\pm 6$	47	0.63	32	7	0.22	0.01	0.1	71.5	392	158
Peerless 315SWR39	18Hz	372	0.28	$\pm 5$	45	0.69	31	7	0.33	0.022	0.15	41.2	150	90.9
Audio Concepts AC12	18Hz	240	0.43	$\pm 8$	38	0.88	28	5	0.1	0.022	0.056	90.9	41.2	162
Eclipse W1238R	19Hz	280	0.33	$\pm 5.5$	42	0.72	32	5	0.1	0.01	0.056	118	280	210
Dynaudio 30W54	2Hz	257	0.36	$\pm 3.5$	47	0.77	32	7	0.33	0.039	0.15	29.4	52.3	64.9

\*Measured values. Other drivers' parameters supplied by manufacturer or calculated from manufacturer-supplied data.

order Linkwitz-Riley network has gained wide acceptance in both active and passive form for use in state-of-the-art loudspeakers, so I employed it in this project. Discussion of the relative merits of various crossover configurations is beyond the scope of this article, but if you desire additional insight you might refer to *The Loudspeaker Design Cookbook* by Vance Dickason (Old Colony Sound Lab, Peterborough, NH, 1987), which has an excellent discussion on the subject and is a good starting point.

The crossover circuit is shown in Fig. 4. Although I built my prototypes on homemade printed circuit boards, this design can be built on the Linkwitz crossover board sold by Old Colony Sound Lab (part number SB-A1). The stage designations used in this description and in Fig. 4 correspond to the IC location number on this board. The *a* or *b* designates the op amp in the dual chip.

The high-frequency channel consists of buffer stage 1a, high-pass stage 2a, equalized high-pass stage 2b, and two 37 $\mu$ S delay stages 3a and 3b. The board provides another delay stage at 4a. Since the 25mm offset of the TX1125JSN midrange is shallower than the 40mm offset of the original KEF units for which the boards were designed, this additional stage is not necessary (thus eliminating IC4). With the ability to move the tweeter enclosures and align them with the mid enclosures, stages 3a and 3b could also be eliminated. I have kept them in order to avoid sharp cabinet edges that would be exposed by staggering the enclosures. A volume control at the output can match the tweeter level to the midrange.

**MID AND LOW.** The midrange channel shares buffer stage 1a with the tweeter channel. Following that is low-pass stage 5a, high-pass stage 5b, low-pass stage 6a, and equalized low-pass stage 6b. The board provides for phase compensation stages 7a and 7ba, but these stages are not used since the midrange enclosures easily can be staggered and, at the longer wavelengths, cabinet

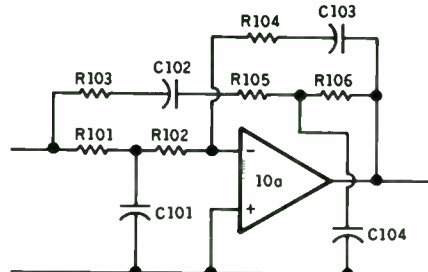

FIGURE 5: Woofer parameters and equalization circuit.

edge reflections are not as big a problem. Diffraction compensation stage 8a is also not necessary, since the crossover point is above frequencies where diffraction losses take effect.

The low-frequency channel consists of buffer stage 9a with variable gain, low-pass stage 9b, bass-equalization stage 10a, and low-pass stage 10b. Q1 provides a turn-on delay to prevent turn-on pops.

The level control provided for the tweeter can only reduce tweeter level relative to the midrange. This should not be a serious problem since it is very unlikely that a tweeter with less sensitivity than a midrange will be used. The woofer's level control can provide both gain and cut. *These controls should never be used as tone controls.* They should be used to match driver outputs around the crossover frequencies and then forgotten. Using them as tone controls will cause frequency response discontinuities that will be clearly audible.

The Old Colony boards are designed for 8-pin dual internally-compensated IC op amps. If you can find op amps with the DC characteristics of the FET devices, the slew rate of the MC34082, and the noise, bandwidth, and drive capability of the NE5532, buy them. For this application, low-noise FET devices such as the TLO72 or the AD-712 provide a good compromise.

With some tweeters, the compensation stage can face relatively low impedance loads due to low values of R28. Therefore, for maximum flexibility, I recommend the use of an NE5532 for IC2. If you desire, the NE5532 can be used in all the tweeter and buffer stages to take

advantage of its exceptional bandwidth. However, you should not use it in the woofer channel because of its high input bias current requirements and the high resistance values utilized. *Audio IC Op-Amp Applications* by Walt Jung (Howard W. Sams & Co., Indianapolis, 1987) is an excellent reference source for further IC application information. The crossover requires a  $\pm 15$  or  $\pm 18$ V DC regulated power supply. The absence of IC7 and 8 can be used to advantage by mounting IC voltage regulators and capacitors at their locations. In this manner, all you need do is "borrow" unregulated DC from a power amplifier. A board with three NE5532s and four TLO72s or AD-712s will require a maximum DC supply current of 75mA, while one with all TLO72s or AD-712s will need only 48mA.

**BASS EQUALIZATION.** You can use bass equalization in this design to compensate for a poor bass alignment or to extend the bass on an already good alignment. Just what constitutes a good alignment in a sealed system is a matter of debate. Advocates can be found for any Q value between 0.5 and 1.1. While high Q values may be desirable on small systems with high cutoffs, larger systems with lower cutoffs work well with Q values near the maximally flat 0.71. Everyone agrees that the lower the cutoff, the better. Eventually, though, with bass equalization you run out of amplifier power or cone travel as boost is increased.

The equalization circuit is located in stage 10a. If you don't want equalization, don't bypass this stage but instead set it up as an inverting unity-gain amplifier. Otherwise, the woofer output will be 180° out of phase. I configured the circuit so that the signal in each of the three channels passes through two inverting stages. This way, you can wire all drivers to their amplifiers with normal polarity.

Figure 5 shows the equalization stage component values for the TA305F and the four alternates listed. I selected a target resonance between 28 and 32Hz

with a  $Q_{TS}$  of about 0.71. My alignment does not require excessive boost with the recommended woofers. This is particularly true with the AC12, which requires the least and could be considered the optimum driver for this system. The design formulas can be found in the previously referenced Linkwitz articles.

Logic would indicate that the AC12 would be somewhat less efficient than the others, but its sensitivity is rated at 89.5dB—equal to the TA305F. So much for manufacturers' specifications.

Caution should be exercised when playing LPs since the arm and cartridge resonance can cause excessive cone

travel. If this is a possibility, the use of a low-frequency filter may be advisable.

**AMPLIFIERS.** The feasibility of active loudspeaker projects is always contingent upon the availability of inexpensive amplification. Unlike some years ago when cheap Dynaco ST-70s were fixtures in college dormitories, today, separate components have become the sole province of the high price market. My system uses 8-year-old Southwest Technical Products kit amplifiers. The woofers use 60W versions while the midranges and tweeters use 30W ones. I find them sufficient for my moderately

high listening levels (as you might), but, like most other good inexpensive things, they are no longer available.

In the 4/88 issue of *Speaker Builder*, Art Newcomb described a new high-power operational amplifier, the National Semiconductor LM12. This device sells for about \$30 and could make high-quality active systems commercially more viable. The Newcomb circuit for the basic amplifier utilizes the LM12 in a 27dB gain configuration. Due to their 750kHz gain bandwidth product, stage gain should be limited to 10 or 12dB to ensure enough feedback for low HF distortion. This would require an additional gain stage with an inexpensive low-power device to make up the difference. Such a circuit is shown in an article by L. K. Ross and A. Watts in the 3/89 issue of *Radio Electronics*.

**FINAL NOTES.** This system is the result of a series of compromises influenced by many factors including the listening room. While the drivers used may not be the absolute best, whatever that is, they possess specific qualities which complement the overall design and they therefore work better than many more expensive units.

In the future, I do not see imminent changes to my low-frequency system. If I ever move to a location with a tamer listening room, I may attempt a sixth-order vented alignment, something that is within the capabilities of the TA305F in this enclosure. I have no immediate plans to replace the TX1125JSN midrange. If I were starting the system today, I might be tempted to try the Focal 5KO13L. Until metal domes evolve to the point where they do not require phase plates and other mechanical protective means, I will stay with the Focal inverted domes. There are other promising designs on the horizon such as ceramic diaphragms, so who knows what will follow. Have fun with this project!

**ADDENDUM.** Since the original submission of this article there have been several driver developments worth mentioning. Many excellent 12" units have recently appeared, including the Swan 305. This driver is intended to be a replacement for the Peerless/Precision TA305F. Also of interest are the CG-308DR from Carboneau and the Focal 12V617.

In the midrange front, a very smooth wideband paper cone unit is available from Scan-Speak, the 13M/8640. Polydax has

## BULLOCK & WHITE SOFTWARE

### BOXRESPONSE

Model-based performance data for either closed-box or vented-box loudspeakers with or without a first- or second-order electrical high pass filter as an active equalizer [SB 1/84]. The program disk also contains seven additional programs as follows:

**Air Core:** This program was written as a quick way of evaluating the resistance effects of different gauge wire on a given value inductor. The basis for the program is an article in *Speaker Builder* (1/83, pp. 13-14) by Max Knittel. The program asks for the inductor value in millihenries (mH) and the gauge wire to be used. (NOTE: only gauges 16-38.)

**Series Notch:** Developed to study the effects of notch filters in the schematics of some manufacturers. Enter the components of the network in whole numbers (i.e., 10 for 10μF and 1.5 for 1.5mH) and indicate whether you want one or two octaves on either side of resonance. Output is frequency, phase angle and dB loss.

**Stabilizer 1:** Calculates the resistor-capacitor values needed to compensate for a known voice coil inductance and driver DC resistance.

**Optimum Box:** A quick program based on Thiele/Small to predict the proper vented box size, tuning and -3dB down point. It is based only on small signal parameters, therefore, it is only an estimate of the response at low power (i.e., limited excursion).

**Response Function:** Calculates the small signal response curve of a given box/driver combination after inputting the free-air resonance of the driver ( $f_s$ ), the overall "Q" of the driver ( $Q_{TS}$ ), the equivalent volume of air equal to the suspension ( $V_{AS}$ ), the box tuning frequency ( $f_B$ ), and the box volume ( $V_B$ ). Output is the frequency and relative output at that frequency.

**L-Pad Program** by Glenn Phillips: Appeared in *Speaker Builder* (2/83, pp. 20-22). It is useful for padding down a tweeter or midrange while still retaining the same load as the driver itself.

**Vent Computation** by Glenn Phillips: Calculates the needed vent length for 1, 2 or 4 ports of the same diameter. Input box volume in cubic feet and required tuning frequency ( $f_B$ ), output is vent length and vent area for each case.

**Medium:** 5¼ SS/DD Disk. Price, \$25 (unless otherwise specified) postpaid USA; in Canada, add \$4; overseas, add \$6.

Specify:

#### BOXRESPONSE

Apple ..... BOX-1A5  
Commodore 64 (Disk) ..... BOX-1C5  
IBM ..... BOX-1B5

IBM Plus Graphics

BOXRESPONSE ..... BOX-2B5G \$50

### PASSIVE CROSSOVER

This disk is a result of Mr. Bullock's extensive research concerning first-, second-, third-, and fourth-order passive crossovers in *Speaker Builder* 1, 2 & 3/85; \$25

Specify:

#### PASSIVE CROSSOVER CAD

Apple ..... PAS-1A5  
Commodore 64 (Disk) ..... PAS-1C5  
IBM ..... PAS-1B5

IBM Plus Graphics

CROSSOVER CAD ..... PAS-2B5G \$50

**NOTE: SOFTWARE IS NOT RETURNABLE FOR REFUND OR CREDIT.** Please print in clear block capitals quantity needed and prices. Total amounts and REMIT IN US \$ ONLY by MC/VISA, check or money order. Postpaid in US. In Canada, please add 10% of total. Overseas, please include 20% of total.

According to the Connecticut Dept. of Revenue Service, Regulation #27, Section 12-426-27, in order to sell software to residents of Connecticut, we must register with the department as well as collect taxes for the state from the purchaser. We regret to inform our customers that we will not sell software to anyone from Connecticut, as it will prove to be costly and burdensome.

NAME \_\_\_\_\_ MAGIC NO. \_\_\_\_\_

STREET & NO. \_\_\_\_\_

CITY \_\_\_\_\_ STATE \_\_\_\_\_ ZIP \_\_\_\_\_

MC/VISA \_\_\_\_\_ EXP. \_\_\_\_\_

MC  VISA  CK/MO

### OLD COLONY SOUND LAB

PO Box 243, Dept. B90, Peterborough, NH 03458 (603) 924-6371 / 924-6526 FAX: (603) 924-9467

Answering machine for credit card orders only: (603) 924-6371 before 9:00 a.m., after 4:00 p.m. and weekends. Have all information plus MC/VISA available.

#### BOXRESPONSE

BOX-1A5 Apple ..... \$25 each  
BOX-1C5 Commodore ..... \$25 each  
BOX-1B5 IBM ..... \$25 each  
BOX-2B5G IBM Graphics ..... \$50 each

#### PASSIVE CROSSOVER CAD

PAS-1A5 Apple ..... \$25 each  
PAS-1C5 Commodore ..... \$25 each  
PAS-1B5 IBM ..... \$25 each  
PAS-2B5G IBM Graphics ..... \$50 each

Total \_\_\_\_\_

Postage if applicable \_\_\_\_\_

TOTAL ORDER \_\_\_\_\_

also announced a new TPX midrange in their "Prestige" series, the MDA 100. This unit seems to trade some of the wideband response of the RX1125JSN for a smoother rolloff. Polydax is also no longer stocking the 6 and 9mm coil versions of the TX1125JSN, settling instead for a 7mm version. This version could probably be used as a direct replacement for the 9mm version without major changes. When I get a chance to test one I will write in with any required changes.

I have had a chance to test a sample of the MDA 100. This appears to be an excellent unit but its efficiency would dictate additional gain in the high frequency channel or the use of a higher efficiency tweeter such as the Focal T120K. Also, redesigning the crossover to compensate for the lower HF rolloff may be necessary.

Finally, the ceramic drivers have arrived in the form of a tweeter, the Accuton C<sup>2</sup>11 and a midrange, the C<sup>2</sup>77. These units are extremely expensive but appear, at least on paper, to be the ultimate drivers for this type of design. Until my second mortgage is approved, I will remain with the Polydax RX1125JSN and Focal T90K combination.

—F.R.

\*Polydax is the legal name of Audax in the USA.

#### SOURCES

A&S Speakers  
3170 23rd Street  
San Francisco, CA 94110  
Polydax, SEAS, Focal, MB, and Dynaudio drivers, SEAS 13cm subenclosures, long hair wool, terminals, and other accessories

Audio Concepts, Inc.  
901 S. 4th Street  
LaCrosse, WI 54601  
Audio Concepts, Dynaudio, SEAS, Focal drivers, ¾" acoustic foam, 2" egg crate foam, long hair wool, casters, terminals, and other accessories

Digi-Key Corp.  
701 Brooks Avenue South  
PO box 677  
Thief River Falls, MI 56701  
Panasonic 2% polypropylene capacitors, 1% metal film resistors, Signetics NE5532 operational amplifiers, National Semiconductor LM12 power amplifiers

Jameco Electronics  
1355 Shoreway Road  
Belmont, CA 94002  
TLO72 and NE5532 operational amplifiers

Madisound  
8608 University Green  
Madison, WI 53711  
Polydax, Focal, Peerless, MB, and Dynaudio drivers

Meniscus  
3275 Gladiola SW  
Wyoming, MI 49509  
Eclipse, Audio Concepts, Dynaudio, SEAS, MB, Focal, and Polydax drivers

Old Colony Sound Lab  
PO Box 243  
Peterborough, NH 03458  
AD-712 operational amplifiers, SB-A1 Linkwitz crossover board, 1% metal film resistors (limited values), Audio IC Op-Amp Applications (Jung), The Loudspeaker Design Cookbook (Dickason).

Zalytron Industries Corp.  
469 Jericho Turnpike  
Mineola, NY 11501  
Polydax, Focal, Dynaudio, and SEAS drivers

#### LETTER WRITERS AHOY . . .

We need your cooperation in the matter of your welcome letters to authors and other readers. Please enclose a stamped and addressed envelope if you expect a reply. If the author/reader lives outside the USA, please include two International Postal Reply coupons (available at your post office) instead of stamps on your envelope.

In questioning authors, please leave room in your letter for replies which should relate to the article, be framed clearly, and written legibly. Please do not ask for design advice or for equipment evaluations.



**Peerless**  
HI-FI speaker

**Reliable in supply and quality**

#### CC-LINE

Peerless' new CC-line is for absolute connoisseurs. Music lovers who know how to appreciate the slight difference.

The CC-line, which consists of tweeters, midrange and woofers 6 ½", 8" and 12", is an exclusive improvement to Peerless' standard line and the absolute top products Peerless has ever manufactured.

Peerless has introduced a specially developed magnet system with built-in short-circuiting ring, which eliminates AC magnetization of the pole piece and linearizes the impedance, thus reducing distortion substantially.



The CC-line is a genuinely peerless product. A guaranteed hi-tuned clarity of sound from Peerless.

For a catalog including the CC-line and standard line, please respond to reply number below.

#### PEERLESS OF AMERICA, INC.

800 W. Central Road  
Mt. Prospect, IL 60056  
708-394-9678

Fast Reply #HE666

# A SPEAKER SYSTEM FOR CDs

## THE SIMPLE APPROACH

BY PHILIP C. ERHORN

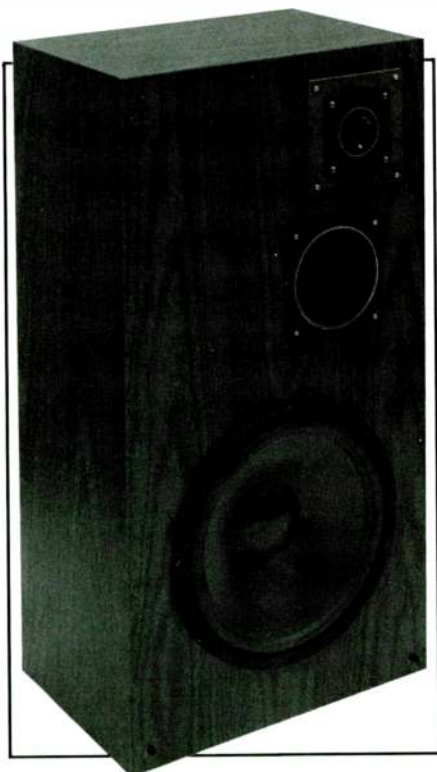

PHOTO 1: Enclosure with grille removed.

While the compact disc has been available for over ten years, I can't believe how many of my friends have yet to enjoy its delights. They have

### ABOUT THE AUTHOR

Philip Erhorn is a consultant and technical writer, now retired. He was the chief technician (Signal Corps) for the recording and interpreting equipment at the Nuremberg war crimes trials. As a technical writer, he has served on the editorial board of the AES Journal, and has lectured before that Society as well as the Society of Motion Picture and Television Engineers. He has written many magazine articles, as well as instruction manuals and technical data sheets for industry. He has designed numerous industrial sound systems including paging and music systems for schools, municipal auditoriums and multi-floor office buildings. Mr. Erhorn plays the piano, and listens extensively to all kinds of music.

no concept of listening to music at concert hall volume in the home, and in many cases treat it only as a background palliative for life's daily rigors. I don't find it easy to convince them that this new recorded medium has no record scratch or tape hiss; that distortion is a thing of the past, and that most importantly, the usable dynamic range is at least four times what they are accustomed to hearing.

Of course their audio systems will have to be updated, particularly in the important matter of a speaker system to handle this wide dynamic range without blowing. This precludes the use of their little bookshelf system. At some point I usually invite them over to experience the thrill of hearing good music for the first time at floor-shaking levels.

I spent most of my life, before I retired, as an audio engineer. Much of my adult life was spent designing and manufacturing large multi-track mixing consoles and other studio gear, as well as mixing thousands of radio and TV shows while at CBS, New York. I have owned various large commercial speaker systems, interspersed with some of my own designs.

Most recently, I have spent countless hours working up closed-box systems, one after the other, towards the ultimate goal of something which will do full justice to CDs at reasonable cost as well as keeping the members of our local classical music listening group happy, if not ecstatic, with the results.

What I have come up with is the rather uncomplicated CD speaker system shown in the photos. It should interest, and more than satisfy, most audiophiles. It will handle the rigors of rock as well as classical music at lease-breaking levels. You'll not need a sound pressure level meter to verify this statement.

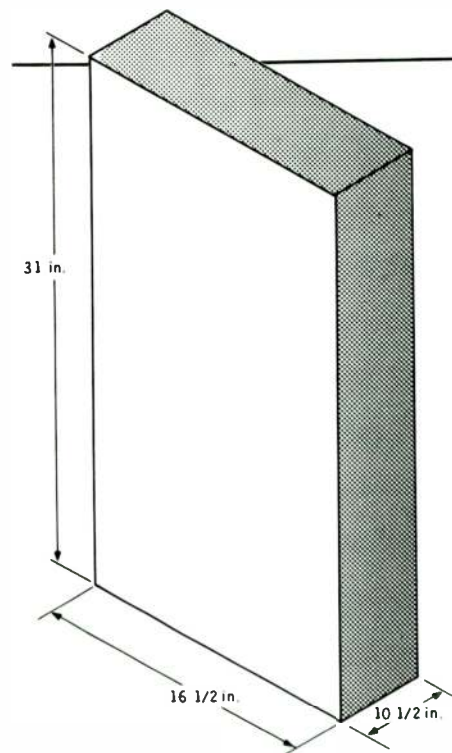

FIGURE 1: Overall dimensions of enclosure. "English Oak" Formica was applied over particle board.

**SYSTEM DESIGN.** My approach was an empirical one. I wanted a straightforward, one-box-for-all-components design, using readily available drivers, to be fed from a good amplifier or receiver of at least 65W/channel capability. No extra expense for bi-amping, electronic crossovers or equalizers. A 12" three-way system was deemed adequate. To keep the project simple, my ears served in lieu of instrumentation.

Based on prior experience, I started by selecting each 8Ω driver to have closely matched SPL ratings, as well as adequate power handling capability. A box for the drivers, of reasonable, if not ideal, volume was made for me by a nearby

source, and finished in easy-to-clean English Oak Formica. It is made of 3/4" particle board with outside dimensions 31"H x 16 1/2"W x 10 1/2"D (Fig. 1). Internally it is about 2.3 cubic feet, or better than 60 liters, and can be readily made in a home workshop equipped with a table saw, saber saw, router and hole saw, these last ideally requiring a drill press. Stuff the box with one and a half bags of Polyfil, or equivalent 4" rock wool insulation. Don't overstuff.

I had two sets of boxes on hand for my listening tests, enabling one to compare two systems instantaneously.

**SYSTEM DRIVERS.** The 12" polypropylene woofer made by Carbonneau Industries, an OEM supplier, has an SPL rating of 92dB. Along with a 40 oz. magnet structure it handles a nominal 100W. With the combination of other drivers, the system is not tubby or warm in the mid-bass range, even at high levels.

Because it is crossed at 1kHz, a lot of midrange music, as well as bass, comes from this woofer. Bear in mind that 1kHz is about two octaves above middle C on the piano. Any good woofer can cope with this.

The midrange driver is the heart of a system, and must be picked to contribute no coloration or other non-musical sounds of its own. From among at least a dozen units, I picked the Philips AD 02170/SQ8. As a result, I not only matched the woofer closely, but the midrange is very clean and articulated as compared with others, and simply makes the system quite outstanding on all kinds of music, at either quiet or stirring levels. This driver is unlike others too, in that it utilizes a circular, flat plate interface, rather than a conventional cone. You will be fascinated by its appearance as well as its performance. A heavy magnet structure and closed back complete the package.

The tweeter I chose is from the same cosmetic "family design" of the midrange driver: an 8Ω, ferrofluid one-inch soft dome by Philips, type AD11600, T8FP. Above 5kHz its clarity and smoothness complement the midrange driver perfectly.

A conventional passive 12dB/octave crossover network (Fig. 2) was my choice; a type not using ferrite core inductors and electrolytic capacitors. Crossover points are 1kHz and 5kHz to properly accommodate the selected drivers. This network will handle 150W.

I used #14 gauge stranded zip cord for inter-component wiring. Each wire's end

## TRUST "YOUR" EARS

YOU know the sound of live music! Are you hearing ALL there is on your favorite record or disc?

**ACOUSTICAL MAGIC**, Flexible Borosilicate Ceramic coating will bring you a step closer to MUSICAL REALISM.

- Better dynamic contrasts.
- Increased sense of speaker speed.
- Finer resolution of low level detail.

HOW? Application of recommended three coats on the inside of cabinets will significantly reduce resonant distortions.

**ACOUSTICAL MAGIC** is also highly effective on turntables, tone-arms and cartridges.

Effective July 1, 1990

**\$18.00 per quart      \$60.00 per gallon**  
plus shipping

Available in 5 gallon containers at large discount.



### ACOUSTICAL MAGIC COMPANY

INSULATION EXPERTS

1201 JAYNES DRIVE      GRANTS PASS, OREGON 97527

(800) 654-4761

OFFICE HOURS: 9-9 PACIFIC TIME

Fast Reply #HE27

## Advanced Sound

Speakers for the Demanding Listener

Handcrafted speaker kits, assembled speaker systems, mono and stereo subwoofers – assembled or Kit – with or without powered amplifiers and cabinets from .3 cubic feet to 6.0 cubic feet. Systems for the beginner to the advanced audiophile, from bookshelf to our large 4-unit, 800 lb., 4-way system.

No automation for us. Each Kit, speaker system and cabinet is handcrafted to allow for the precise tolerances and finest quality only possible through the pride and craftsmanship that goes into each piece.

We also repair and recone speakers of any make, something an assembly line can't do at all. Our inventory of original manufacturer's parts (we can special order really esoteric parts) enables us to make our customer's speakers good as new. We'll even repair the scratches on the cabinet or replace the grill your cat sharpened it's claws on, if you wish. So, if you already have speakers you're really happy with, there's no need to replace them when a drunken guest decides to prove how many decibels a real macho man's eardrums can endure.

Send for our 1990, 14" x 20" catalog of handcrafted Kits, cabinets and complete speaker systems, \$5.00. Advanced Sound, Dept. SB, 711 E. Magnolia Ave., Knoxville, TN 37917-7636. (615) 637-6694 (Foreign & Canadian shipments please add \$1.00 for 1st class postage. US Currency Only)

Fast Reply #HE1061

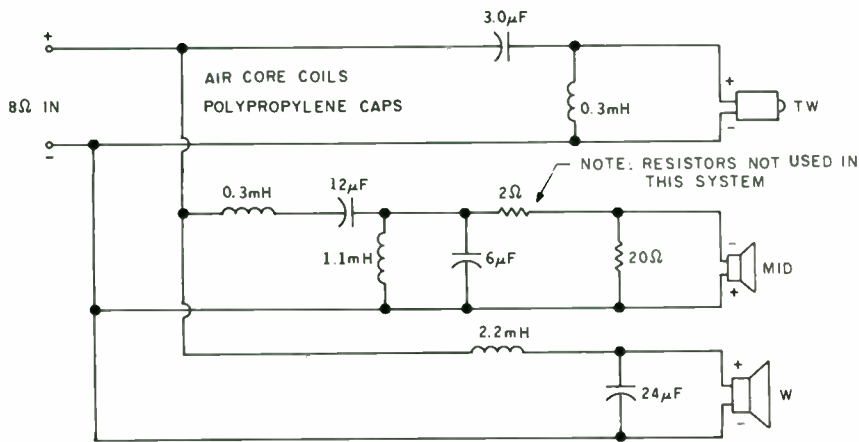

FIGURE 2: Crossover network for CD speaker systems. Standard 12dB/octave design keeps it simple.

is crimped and soldered to push-on terminals. This allowed me to interchange my drivers easily and quickly, while developing each system. As is usual, I reversed the leads to the midrange drivers for proper system phasing. All the drivers are situated in the approved vertical alignment in the boxes. As noted in *Photo 1*, I used a tempered Masonite adapter plate to mount the tweeters. This covers the larger hole required by wide magnet types, used in other tests. A variety of hole saws were useful here.

**DESIGNING YOUR SYSTEM.** Before going on to final details, let me offer some comments concerning the pleasures and pitfalls you may find in selecting your own drivers for a proposed system.

Let's start with the woofer, often mistakenly thought of as the most important component. Everyone likes bass in adequate proportion, but an over-efficient woofer can overpower the rest of the system, washing out detail, and producing a very warm, boomy sound, quite inappropriate for serious listeners. SPL ratings for typical air suspension woofers range from a low of about 88dB to a high of 99dB. Because many good midrange drivers are in the 90-93dB range, they can easily be overcome by a woofer of 95-96dB SPL, such as the Polydax MHD 12P 25FSM SQ2CA5 or the Philips 2252/W8. The heavy bass may be impressive to rock music fans—terrible on classical music. Woofers from the Orient are well made and finished, but in general they are too efficient except when coupled with their own family of drivers.

Fortunately, while we have many good midrange drivers to choose from, only a limited selection are musically outstanding. You will know these immediately even without an instantaneous

A/B comparison. You'll hear details in your favorite CDs that were simply not noticed previously. Stereo separation will be improved as well.

One-inch soft dome tweeters will certainly produce a very adequate and smooth high end and are much more palatable than their hard-domed cousins. The latter may sound more spectacular on certain types of music, but do not wear well for listening to a wide variety of music. Ferrofluid treatment is frequently used to improve power handling capability. Note that larger domes will work well down into the midrange, and are typically used in two-way systems.

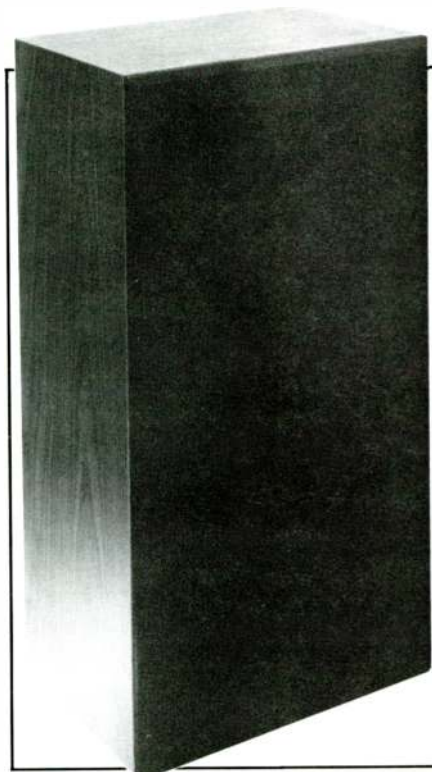

PHOTO 2: Completed system, grille in place. Simple design yields sophisticated CD sound.

Those large, impressive looking "bullet tweeters" are designed for high power rock and sound reinforcement systems. Their SPL ratings of over 100dB are not for serious music listening.

**EMPIRICAL MODE.** If you find it stimulating to develop a speaker system by trial and error, as I do, you'll find quite a few suppliers who advertise regularly in *SB*, and who offer a good selection of drivers at reasonable prices. You can make your own selection by keeping in mind some of the guidelines mentioned here. Then you'll learn what units sound good together. Purists may be horrified by this approach, since the only instrumentation needed are your own ears and familiar CDs. But you are the one to be satisfied, and you will surely learn something practical along the way, without the rather stiff outlay for engineering instruments. Such gear is important to designers and commercial manufacturers, but generally beyond the means of most experimenters.

You will want to enjoy your speaker system on a long term basis, so first impressions based on limited listening can be misleading. Certainly, initial enthusiasm is exciting, so after you have come up with a system that really pleases you, keep it in use for a period of weeks or even months, and you may well change your mind, and go on to try another selection of drivers. As I noted previously, for those who like a warm overall sound, a slightly more efficient woofer, or a slightly less efficient midrange driver will provide this, but at the expense of midrange detail. Choosing a high efficiency tweeter will not compensate this loss.

**RESULTS.** The CD Speaker System stereo separation is better than many commercial systems. You will certainly enjoy orchestral bass drums, organ pedal stops and bass guitars on the big polypropylene woofers. I believe the Philips midranges are like nothing you have heard before. Their musical clarity is exceptional. The dome tweeters are quite capable of putting that extra sizzle on rhythm instruments when it is appropriate. The taller, not so deep wood grain cabinets can be finished to blend well with any decor, while looking rather impressive. Keep them on the floor, not on a stand, or you will lose deep bass.

**DOUBLE UP.** Since I had two complete systems working alternately so as to improve my ability to make judgments, it

*Continued on page 92*

# "SPEAKER DESIGNER"

## A COMPUTERIZED DESIGN AND MODELING TOOL

BY STUART E. BONNEY

**B**etter sounding loudspeakers are among the benefits resulting from the advent of low-cost computers and computer-aided design software. Loudspeaker system design and modeling is nearly an ideal computer application, since it involves many variables and large numbers of calculations. By removing the computational drudgery of design, computers encourage more thorough analysis than might otherwise be undertaken.

Realizing this potential, however, implies a means to apply "what if" design strategies, ease and convenience in doing so, and the ability to see results quickly. These attributes simplify and thereby stimulate exploration of design possibilities, which is the essence of modeling.

**SOFTWARE CONSIDERATIONS.** As always, software is the key. Currently, available programs range from simple and inexpensive interpretative BASIC programs to elaborate, compiled programs written in advanced languages and often featuring complex graphics. But the low-end programs, while often attractively priced, tend to lack the polish and user-friendliness needed for extended modeling sessions. On the other hand, high-end programs usually reflect their higher development and marketing costs. They often cost more than can be justified by loudspeaker designers who are not exercising their craft for profit.

Another point to consider when selecting software is that program size and the number of features usually have a direct

### ABOUT THE AUTHOR

*Stuart Bonney is president of Exicom, Inc., a communications consulting firm. In addition to loudspeakers and classical jazz music, his interests include computers and amateur radio. He has been licensed for 38 years, which parallels his interest in loudspeakers.*

bearing on speed and ease of use. If a well designed smaller program is capable of doing the desired job, it will usually load and execute faster, be easier to use, and require fewer keystrokes than a larger, more complex program.

"Speaker Designer" was conceived as a system design aid and modeling tool that would retain low-end program simplicity and economy but improve on ease of use and incorporate techniques found in the more sophisticated programs. Designed for low frequency analysis of both closed and vented systems, it is an outgrowth of a program written by the author several years ago in Pascal for closed systems only. Like the popular BASIC program, "BoxResponse," its algorithms are based on Thiele/Small parameters and are faithful to the equations published by Small.<sup>1</sup>

With a program that facilitates modeling, our loudspeaker system design efforts can take either of two directions. First, we can start with a woofer of given specifications—a frequent situation for hobbyists and designers not intending volume production. We then find an enclosure type, size, and tuning that produces optimum performance. Or we can

begin with a general set of desired system performance characteristics, such as enclosure type, size, or response curve, and attempt to define a practical and available driver that produces desired results or something acceptably close.

In either case, converging quickly on a suitable design requires that we be able to modify individual driver or system input parameters easily and rapidly. To this end, "Speaker Designer" is menu-driven. Once initial inputs are made, the program displays all input parameters on a single menu and it provides for easy modification of one or more of these parameters, rapid computation of outputs, and single-key return to this menu for successive changes and iterations.

**INPUTS AND MENUS.** The opening menu of "Speaker Designer" allows single-key selection of a closed design, a vented design, or exit to DOS. Selection of an enclosure type brings up a screen allowing you to choose the units in which you wish to work, English (cubic feet and inches) or metric (liters, centimeters, and millimeters). This is followed by a series of screens for input of driver and system parameters. Each input screen contains

TABLE 1

REVISE/ACCEPT INPUTS			
[A] Driver name:	Focal 8N401 8"		
[B] Resonant freq ( $F_S$ ):	33.0	[G] Rated $X_{MAX}$ (in.):	0.16
[C] Electrical Q ( $Q_{ES}$ ):	0.50	[H] Piston dia. (in.):	6.6
[D] Mechanical Q ( $Q_{MS}$ ):	3.66	[I] Power rating (W):	60
[E] $V_{AS}$ rating (Cu. Ft.):	3.0	[J] Box volume (Cu. Ft.):	1.20
[F] Voice coil res. (Re):	6.5	[K] Change box type:	C
For Vented Boxes Only			
[L] Tuning ratio (H):	0.000	[M] Leakage loss ( $Q_L$ ):	0

Press key shown for your choice.  
Press X when Done.

TABLE 2

## CLOSED SYSTEM DESIGN FOR FOCAL 8N401 8"

Freq. (Hz)	Resp. (dB)	Max. Inp. Pwr. (W)	Rel. SPL Out (dB)	Freq. (Hz)	Resp. (dB)	Max. Inp. Pwr. (W)	Rel. SPL Out (dB)
10	-31.56	16.6	70.6	80	-0.18	49.5	106.7
15	-24.46	16.4	77.6	90	0.11	60.0	107.8
20	-19.39	16.1	82.6	100	0.24	60.0	107.9
25	-15.44	15.8	86.5	120	0.31	60.0	108.0
30	-12.23	15.7	89.6	140	0.29	60.0	108.0
35	-9.57	15.7	92.3	160	0.25	60.0	108.0
40	-7.35	16.1	94.6	180	0.21	60.0	107.9
45	-5.51	16.9	96.7	200	0.18	60.0	107.9
50	-4.02	18.3	98.5	220	0.15	60.0	107.9
55	-2.85	20.4	100.2	240	0.13	60.0	107.8
60	-1.95	23.5	101.7	260	0.12	60.0	107.8
65	-1.28	27.7	103.1	280	0.10	60.0	107.8
70	-0.78	33.3	104.4	300	0.09	60.0	107.8

**DRIVER DATA**  $F_S$ : 33Hz  $R_E$ : 6.5  $Q_{ES}$ : 0.50  $Q_{MS}$ : 3.66  $Q_{TS}$ : 0.44  $X_{MAX}$ : 0.16 in. Cone Dia.: 6.6 in.  $V_{AS}$ : 3.0 Cu. Ft. Pwr. Rtg.: 60W

**SYSTEM DATA** Enc. Vol: 1.20 Cu. Ft.  $Q_{TC}$ : 0.82 SPL(1W/1M): 90.2dB Pk. Ampl.: 0.31dB at 121Hz  $F_{XMAX}$ : 32Hz  $F_3$ : 54Hz  $F_C$ : 62Hz

notes as required for the associated input parameter, such as units required or a conversion factor if needed. When you select a vented box, you are also prompted for enclosure tuning and system leakage loss inputs. If you make a numeric format error while entering inputs, such as attempting to enter 3,66 instead of 3.66, a "beep" sounds and the program waits for you to correct the error.

Once you complete the initial inputs, the program displays a summary Revise/Accept Inputs menu. As illustrated in Table 1, this menu shows all driver and system inputs for review and possible change prior to computing the outputs. Pressing the appropriate key clears the current value for that parameter and allows you to input a new value. If you accidentally press the wrong menu key for a numeric input (i.e., all but selections A and K on the menu), simply press Return to restore the original value. As with initial inputs, numeric format errors are trapped and you can then correct them. When you are satisfied with the inputs, pressing X initiates computation of output values.

**OUTPUTS AND DISPLAYS.** Computed outputs are displayed on-screen and can also be printed; Table 2 shows a typical printout. System frequency response, displacement-limited or maximum RMS input power, and relative SPL output values are computed and displayed for each of 26 discrete frequencies from 10 to 300Hz.

Below these outputs are summaries of the driver input data and computed

system outputs, providing a record for later reference. (Note: To conserve screen space, and since driver inputs are only one keystroke away on the Revise/Accept Inputs menu, driver input data is not shown on this screen.)

For closed systems the computed system data includes total system  $Q$  ( $Q_{TC}$ ), system sensitivity or SPL for 1W input at a distance of one meter, frequency and amplitude of the response peak (applicable only when  $Q_{TC}$  is more than 0.707), the frequency of maximum diaphragm displacement ( $F_{XMAX}$ ), the frequency at which relative frequency response is down 3dB ( $F_3$ ), and system resonant frequency ( $F_C$ ). The sensitivity figure includes a factor for enclosure filling typical of sealed enclosures.

For vented systems the displayed system input data (also included in the printout, Table 3) consists of box volume ( $V_B$ ), box tuning ratio (H), and system leakage loss ( $Q_L$ ). Computed system output consists of sensitivity (SPL 1W/1M), vent dimensions for a tubular vent or one of equivalent cross sectional area, and enclosure tuning data ( $F_L$ ,  $F_M = F_B$ , and  $F_H$ ). The latter are the frequencies of lower ( $F_L$ ) and upper ( $F_H$ ) input impedance peaks as well as that of the null between peaks and box resonance ( $F_M = F_B$ ). All three frequencies are corrected for shifts caused by leakage loss ( $Q_L$ ). The  $F_L$  and  $F_H$  outputs are especially useful in final tuning of a practical enclosure and in verifying that results are consistent with design goals.

A menu not illustrated here is displayed on-screen below the output data. This menu includes selections for printing the outputs, computing vent data, returning

TABLE 3

## VENTED SYSTEM DESIGN FOR EXPERIMENTAL 8"

Freq. (Hz)	Resp. (dB)	Max. Inp. Pwr. (W)	Rel. SPL Out (dB)	Freq. (Hz)	Resp. (dB)	Max. Inp. Pwr. (W)	Rel. SPL Out (dB)
10	-43.81	1.4	48.8	80	-0.54	60.0	108.6
15	-30.68	2.1	63.9	90	-0.33	60.0	108.8
20	-22.07	4.0	75.3	100	-0.21	60.0	108.9
25	-16.06	10.4	85.4	120	-0.09	60.0	109.0
30	-11.72	40.9	95.8	140	-0.04	60.0	109.1
35	-8.51	60.0	100.6	160	-0.02	60.0	109.1
40	-6.15	60.0	103.0	180	-0.01	60.0	109.1
45	-4.43	60.0	104.7	200	-0.00	60.0	109.1
50	-3.19	46.4	104.8	220	-0.00	60.0	109.1
55	-2.31	39.7	105.0	240	-0.00	60.0	109.1
60	-1.69	38.9	105.6	260	0.00	60.0	109.1
65	-1.25	41.3	106.3	280	0.00	60.0	109.1
70	-0.93	46.0	107.0	300	0.00	60.0	109.1

**DRIVER DATA**  $F_S$ : 33Hz  $R_E$ : 6.5  $Q_{ES}$ : 0.36  $Q_{MS}$ : 3.66  $Q_{TS}$ : 0.33  $X_{MAX}$ : 0.16 in. Cone Dia.: 6.6 in.  $V_{AS}$ : 3.0 Cu. Ft. Pwr. Rtg.: 60W

**SYSTEM DATA**  $V_B$ : 1.20 Cu. Ft. H: 1.100  $Q_L$ : 7 SPL(1W/1M): 91.2dB Vent ID: 2.5 Lgth: 6.6 in.  $F_L$ : 17.2  $F_M = F_B$ : 36.3  $F_H$ : 69.5Hz

to the Revise/Accept Inputs menu for revisions, or returning to the Main menu.

**VENT CALCULATIONS.** Vent data obviously is required only for vented enclosures; thus, it is accessible and requires inputs only if the selected box type is V (vented). When V is selected on the output menu, an input screen appears and prompts you to enter the inside diameter of the vent. The program then computes and displays the correct vent length for this system and the corresponding maximum vent wind speed. You are then given the opportunity to accept these results or enter a new vent diameter, which repeats the process.

Normally you'll do vent calculations last, after you have completed the iterations necessary to refine the basic system design. To prevent retention of potentially erroneous vent data, current vent data (if any) is cleared each time you return to the Revise/Accept Inputs menu and recompute outputs.

**MODELING.** For a simplified illustration of how "Speaker Designer" can be used for system modeling, let's return to Table 1. As shown, the entered input data is for a representative good quality driver in a closed box. Inputs shown are as-measured values but are quite close to Focal's spec-sheet values. Having selected a particular driver, we are left with box size as the only parameter materially affecting system performance.

Assume for this example that we want minimal peaking but a box of fairly com-

*Continued on page 57*



**polydax**  
SPEAKER CORPORATION

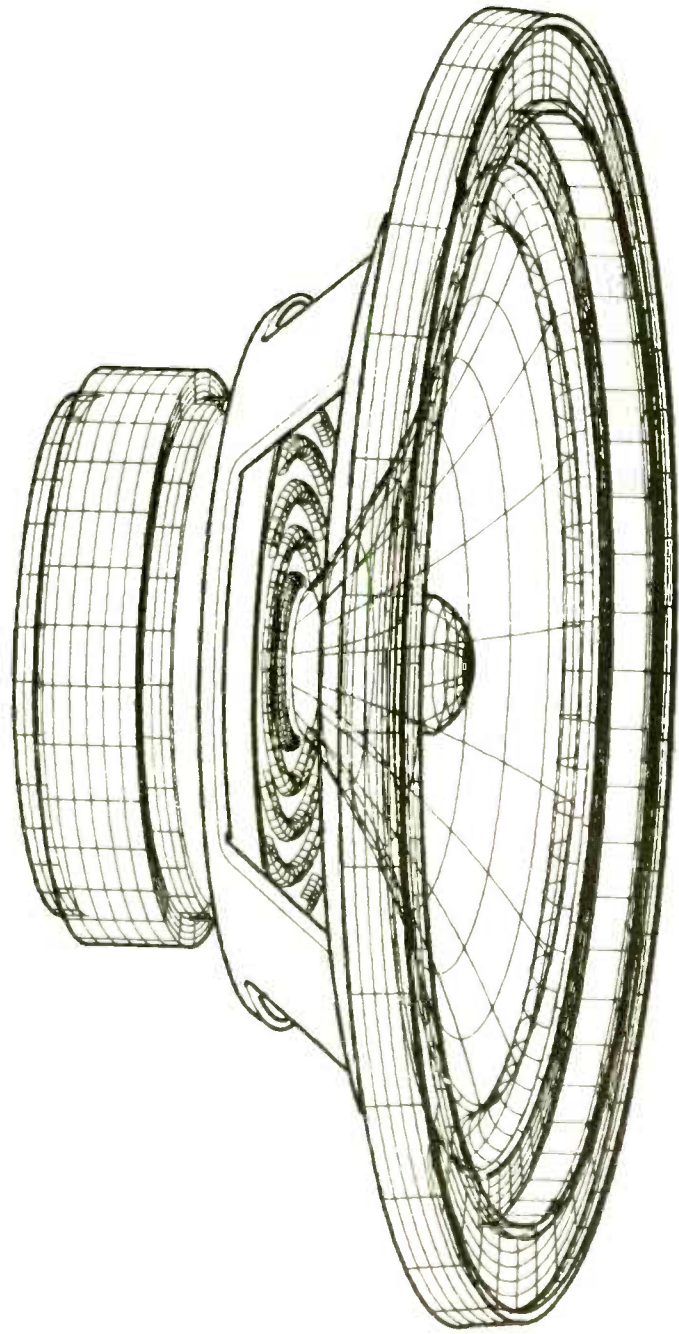

# TPX SYSTEM II

# TPX System II Performance Specifications

## Horizontal Dispersion

Note the excellent dispersion characteristic which has been measured at 0, 30 and 45 degrees off axis.

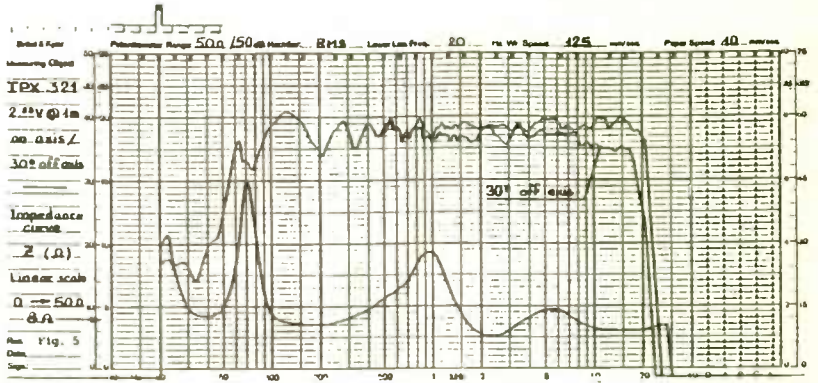

## Vertical Directivity

The directivity has been measured at 0, 5 and 10 degrees off axis.

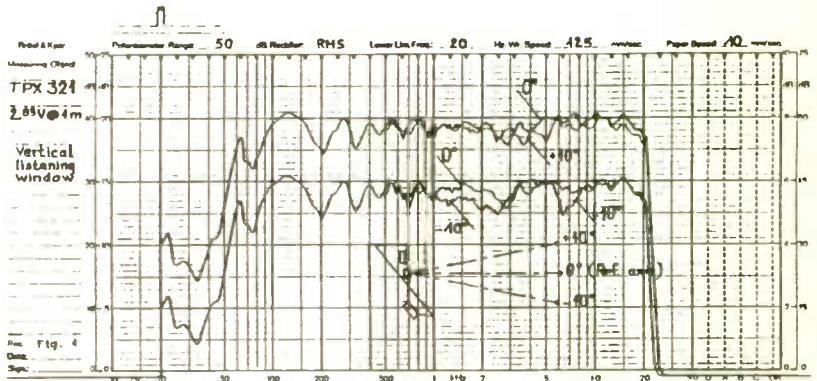

## Transient and Phase Response

The excellent transient and phase characteristic account for the extraordinary sound stage and natural sonic quality.

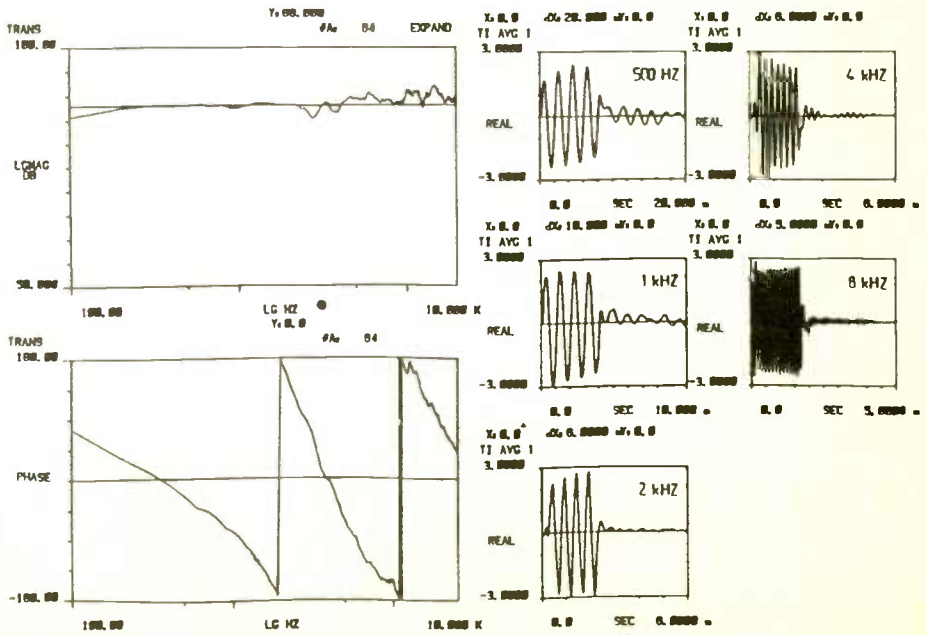

Crossover Network for TPX System II

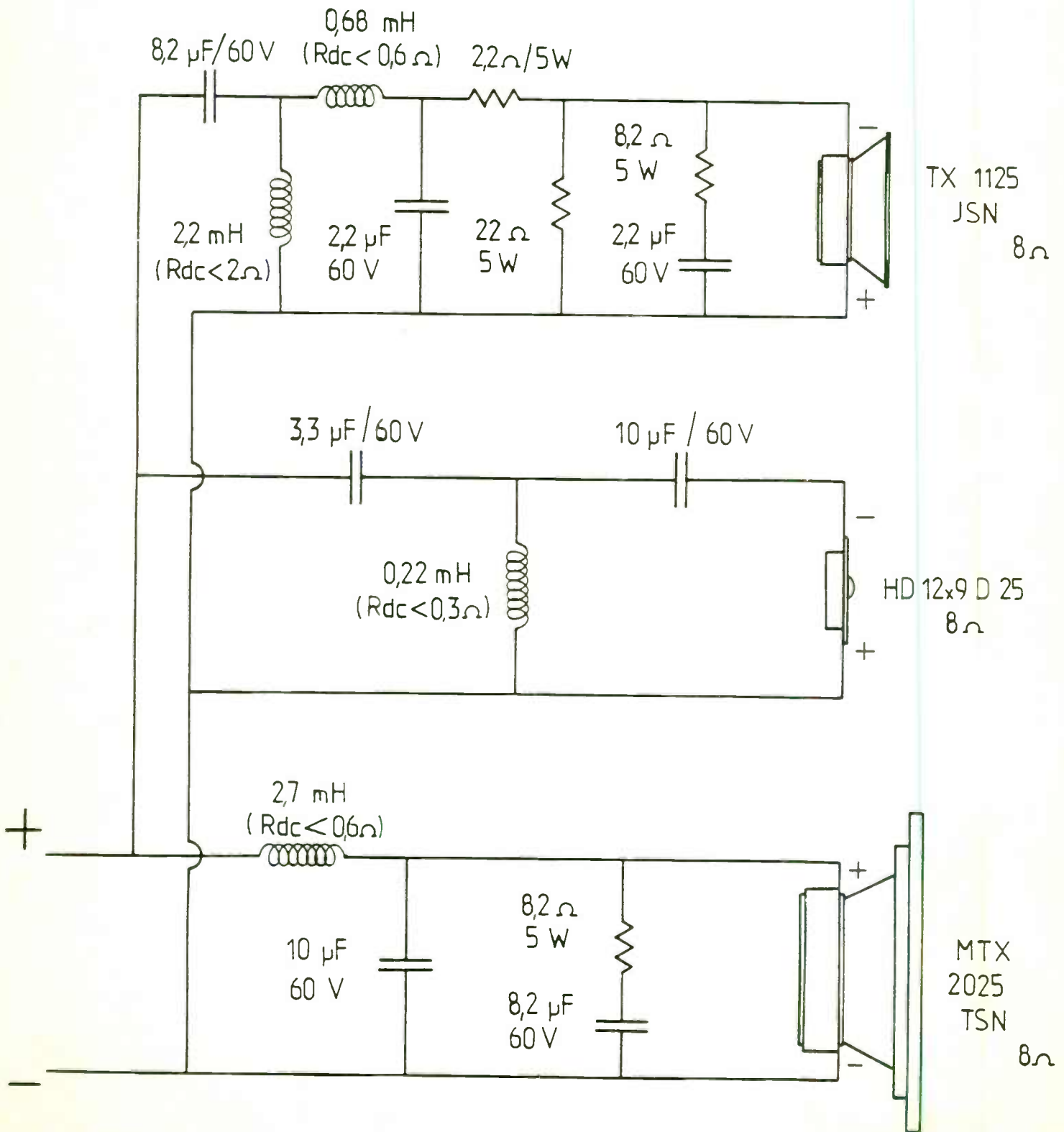

# Box Design Construction Details for TPX System II

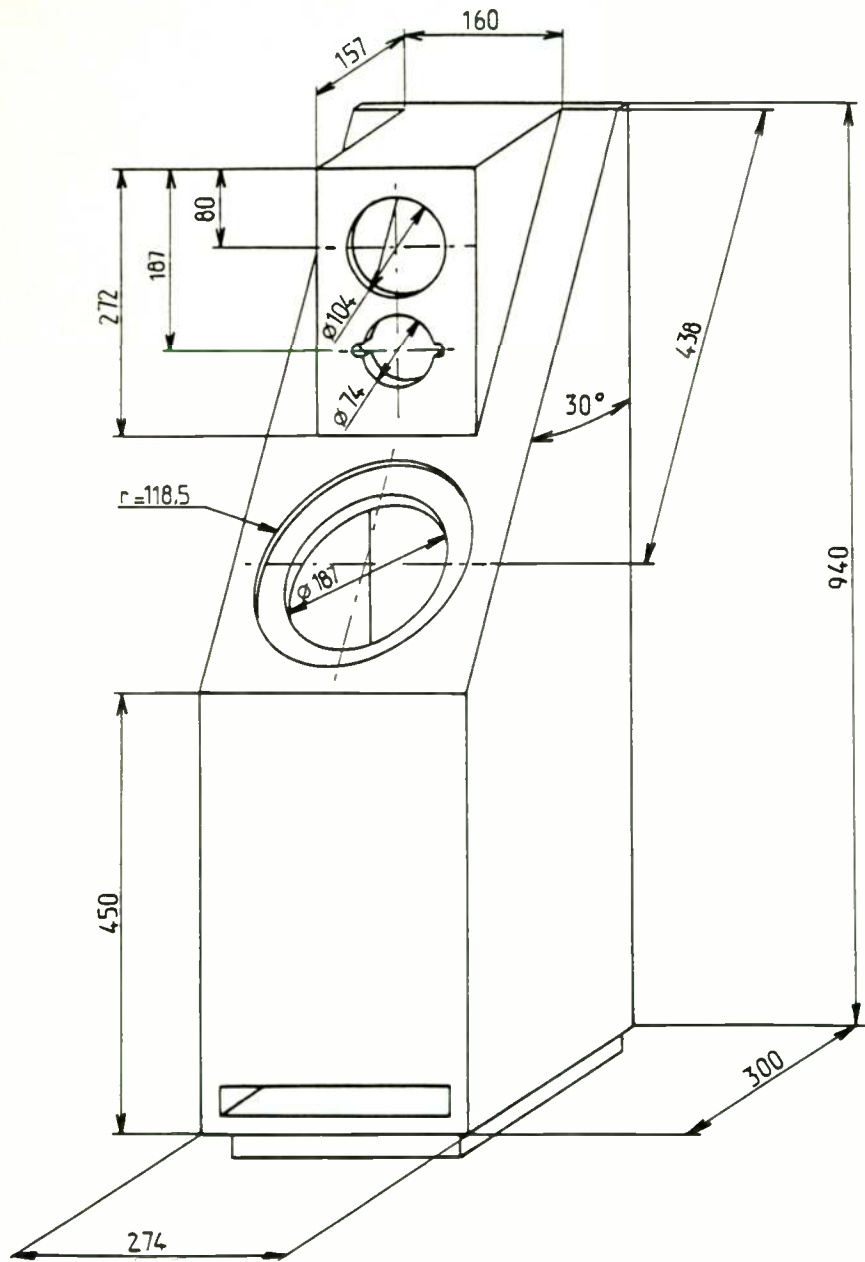

ALL METRIC COTATION ( mm )

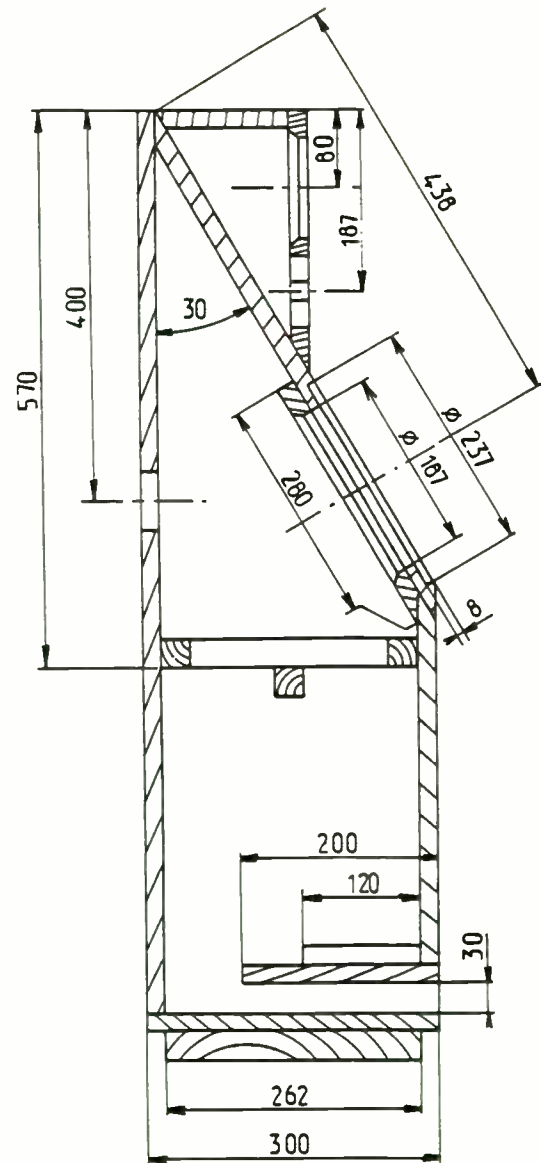
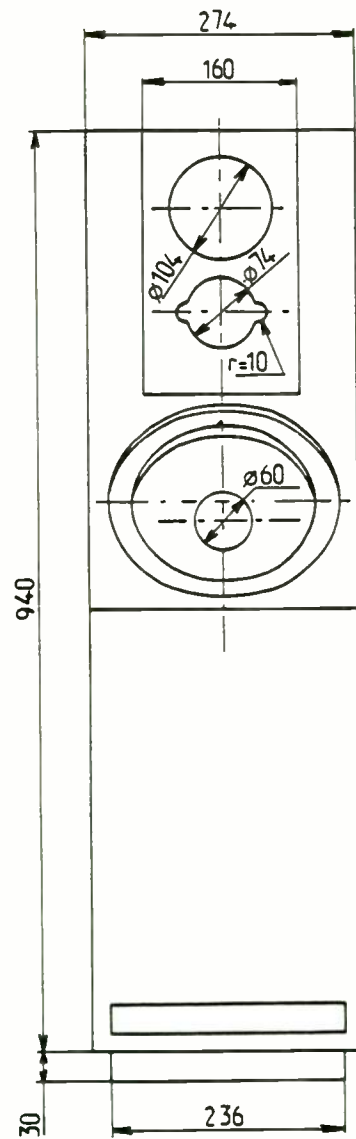

ALL METRIC COTATION ( mm )  
MATERIAL : 19 mm THICK CHIPBOARD



## AUTHORIZED DISTRIBUTORS

### West Coast

Circle Sound  
2772 West Olympic Blvd.  
Los Angeles, CA 90006  
(213) 388-0624

Speaker City  
10615 Vanowen Street  
Burbank, CA 91505  
(818) 508-1908

Just Speakers  
3170 23rd Street  
San Francisco, CA 94110  
(415) 641-9228

Speakers, Etc.  
1828 West Peoria  
Phoenix, AZ 85029  
(602) 944-1878

### East Coast

Select Distributors  
6036 S.W. 23rd Street  
Miramar, FL 33023  
(305) 985-2698

AudioLab of GA., Inc.  
5269-2 Buford Hwy.  
Atlanta, GA 30340  
(404) 455-0571

Zalytron Industries  
469 Jericho Turnpike  
Mineola, NY 11501  
(516) 747-3515

### Central

Madisound Speakers  
8608 University Green  
Middleton, WI 53562  
(608) 831-3433

Martin Sound  
28 Alpha Park  
Cleveland, OH 44143  
(216) 442-2286

Parts Express  
340 East First Street  
Dayton, OH 45402  
(513) 222-0173

### Canada

Solen Incorporated  
4470 Thibault Avenue  
St. Hubert, QC J3Y 7T9  
(514) 656-2759



Subsidiary of AUDAX INDUSTRIES

Audax Industries  
2 Route de Tours  
72500 Chateau du Loir  
FRANCE  
Tel: (4) 344-0235  
FAX: (4) 344-1202  
Telex: 723803

Affiliated Agents Worldwide

Distributed by:



catalog 321-P

World Radio History

Continued from page 48

pact size, which is a trade-off. Having made initial driver inputs, we then run quickly through various box sizes (selection J on the Revise/Accept Inputs menu) and compute the outputs. In relatively short order we arrive at a volume of 1.2 cubic feet, producing the results shown in Table 2.

Our output indicates reasonably good performance from an 8" woofer of moderate cost. The response is acceptably flat in the upper bass region, and cutoff frequency is about 54Hz. Note, however, that from 30-60Hz the input power capacity (displacement-limited) is a bit skimpy and SPL numbers are modest. This system should prove satisfying at moderate volume levels, but not if room-rattling bass is what you want.

Curious to see what a vented enclosure might produce, we return to the Revise/Accept Inputs menu. Pressing K automatically switches the box type to vented, and we then make entries at selections L and M for tuning ratio and estimated leakage loss factor. The initial tuning ratio can be a guesstimate or can be selected from an alignment table<sup>2</sup>.

A couple of runs (not shown) with dif-

ferent tuning ratios quickly shows that better low-end frequency response can be had, but a much larger box is required for acceptably flat upper bass. This is not an ideal driver for a vented enclosure. (Nor does Focal recommend it as such.) We need something with a larger magnet and resulting lower  $Q_{ES}$  if we are to achieve improved results in the same size box as the original.

**TRY ANOTHER.** Wishing to retain the original box size of 1.2 cubic feet as well as the controlled bass sound quality of a low- $Q_{TC}$  closed system, we are now ready for some experimental modeling. Returning to the original driver inputs from Table 1, we go to work with lower values of  $Q_{ES}$ . Since the  $Q_{B3}$  family of alignments has gentle roll-off characteristics similar to a closed box and thus should approach our desired bass goal, we try box tuning ratios (H) in the range of 1.0 to 1.2.

A few more runs produces the results shown in Table 3. As you can see by comparing these results with Table 2, the response is more nearly flat in the upper bass region, and low-end cutoff (F3) is slightly extended. Power handling capa-

city and SPL in the range from 30-60Hz are substantially improved. At least on paper, the only area where the vented design suffers in comparison with the closed system from which it was derived is in power capabilities at very low frequencies, typical of all vented systems.

Are our experimentally derived driver specifications practical? A quick check of literature from various driver manufacturers indicates that drivers with similar specifications are available. Once a driver is selected, it is then simple to plug in exact values and tweak up the final design.

This entire process can be done in only a few minutes at the computer. On an IBM PC (standard 4.77MHz clock), the several hundred calculations for each output run take just four seconds. On an AT or faster clone, they take two seconds or less. You will probably spend more time thinking about inputs or revisions than it actually takes to enter them and compute the outputs.

#### COMPUTER REQUIREMENTS.

"Speaker Designer" runs on any IBM PC, XT, AT, PS/2, or true compatible machine running MS/PC-DOS version 2.0 or later.

Continued on page 92

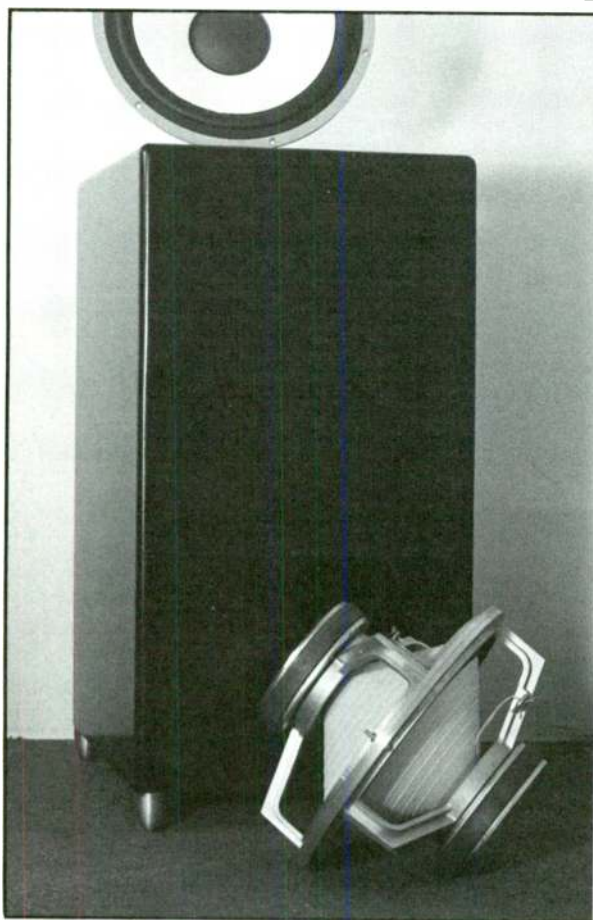

# VIETA

## BASS REFLEX, FLOOR FIRING TRUE PUSH-PULL SUBWOOFER.

H x W x D = 28½ x 15¾ x 18.

F<sub>3</sub> = 26Hz. Power handling: over 400W.

**Truly amazing power, control and freedom of distortion at very low frequencies. This subwoofer, passive or active, will transform your listening room into a cathedral of gothic dimensions.**

**Plans (X-over and cabinet), components and cabinets are available from:**

**SPEAKER CITY**, 10615 Vanowen St., Burbank, CA 91505 (818) 508-1908

**SPEAKERS ETC.**, 1828 W. Peoria Ave., Phoenix, AZ 85029 (602) 944-1878

**WATTERS SOUND WAVE**, 4320 Spring Valley, Dallas, TX 75244 (214) 991-6994

**ZALYTRON INDUSTRIES**, 469 Jericho Tpk., Mineola, NY 11501 (516) 747-3515

# BOXES & BINDERS

• FOR YOUR TECHNICAL LIBRARY •

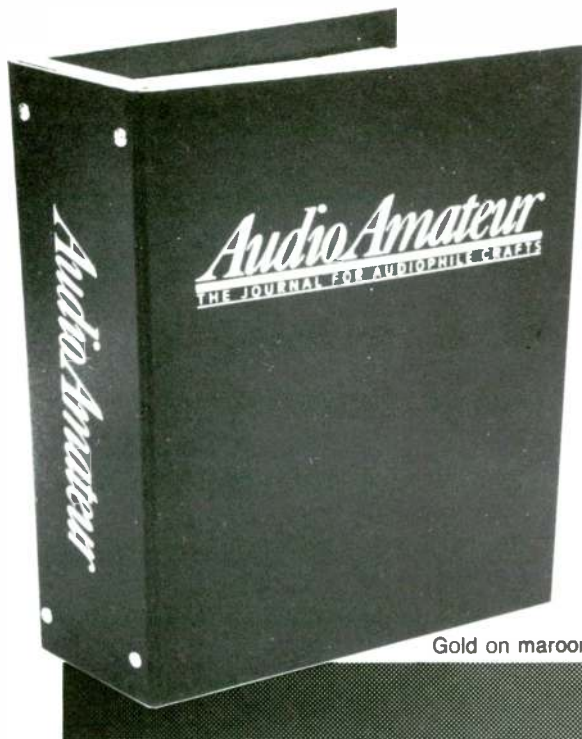

Gold on maroon

## THE BINDER

A "loose wire" heavy book binder cloth construction case holds twelve issues of your magazines in a readily accessible format. The logo is hot stamped on cover and spine.

EACH \$12

Three or more, \$10 each

### Shipping:

Postpaid in US.  
Canada and Caribbean, please add \$4 for one, \$2 for each additional binder.  
Overseas, please add \$4 per binder.

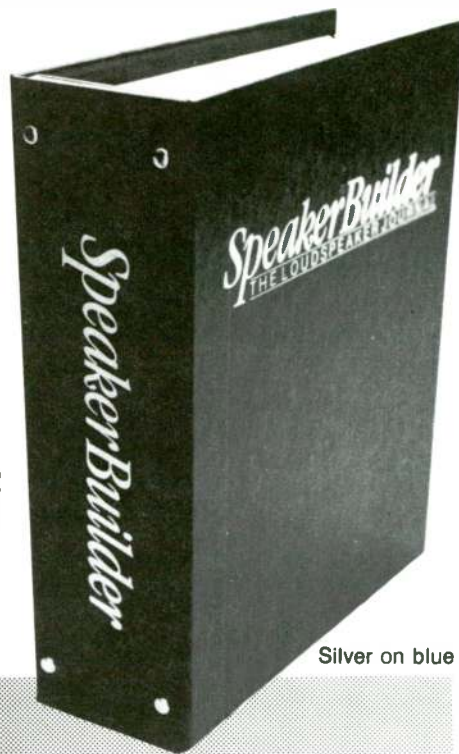

Silver on blue

## THE BOX

Library quality boxes. 4 1/4 x 9 1/4 x 12" high, brown woodgrain, folding corrugated boxes with handle/label holder to identify contents. Holds 12 issues of *Audio Amateur* or *Speaker Builder* or other valuable magazines in your technical library. Each order supplied with pre-printed labels for each magazine.

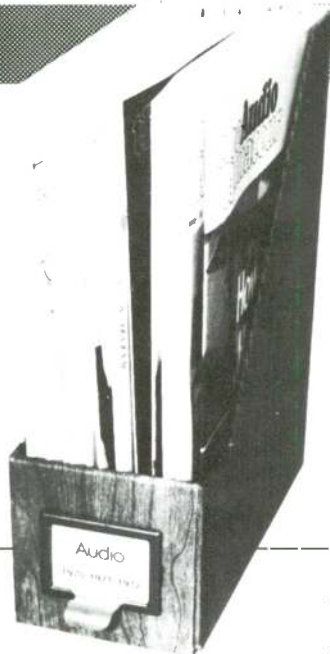

\$8 pair  
\$12, four

### Shipping:

Postpaid in US.  
Canada and Caribbean, please add \$3 for each set of two, \$1 for each additional set of two.  
Overseas, please add \$3 per set of two boxes.

QTY.		PRICE
___	Audio Amateur binders @ \$12	___
___	Audio Amateur binders @ \$10 (3+)	___
___	Speaker Builder binders @ \$12	___
___	Speaker Builder binders @ \$10 (3+)	___
___	Boxes @ \$8 (2)	___
___	Boxes @ \$12 (4)	___

POSTAGE \_\_\_\_\_  
TOTAL \_\_\_\_\_

MC     VISA     CK/MO

\_\_\_\_\_  
AUDIO AMATEUR MAGIC NO.  
\_\_\_\_\_  
SPEAKER BUILDER MAGIC NO.

NAME \_\_\_\_\_  
STREET \_\_\_\_\_  
CITY \_\_\_\_\_ STATE \_\_\_\_\_ ZIP \_\_\_\_\_  
MC/VISA \_\_\_\_\_ EXP. \_\_\_\_\_

**AUDIO AMATEUR PUBLICATIONS, INC.**

PO BOX 576, DEPT. B90  
PETERBOROUGH, NH 03458-0576

(603) 924-9464

FAX: (603) 924-9467

Answering machine for credit card orders only: (603) 924-9464 before 9:00 a.m., after 4:00 p.m. and weekends.  
Have all information plus MC/VISA available.



# ZALYTRON

## YOUR ONE STOP SHOPPING CENTER



Polydax



### THE ZALYTRON CUSTOM WOOFERS



THE ZALYTRON WOOFERS WERE ORIGINALLY INTENDED TO BE A SUBSTITUTE FOR THE PRECISION LOUDSPEAKER WOOFERS. GUESS WHAT? AFTER 3,000 PIECES SOLD, THE CUSTOMERS SAY OUR WOOFERS ARE EVEN BETTER.

ZALYTRON 12" 8 OHM WOOFER supercedes (TA-305F)	\$45.00
ZALYTRON 10" 8 OHM WOOFER supercedes (TD-255F)	\$35.00
ZALYTRON 6" 8 OHM WOOFER supercedes (TP-165F)	\$22.00
ZALYTRON 12" DUAL VOICE COIL SUB WOOFER	\$49.00
ZALYTRON 8" 8 OHM WOOFER supercedes (TX-205F)	\$25.00
ZALYTRON 5" 8 OHM WOOFER	<b>SPECIAL OFFER</b> \$12.00
ZALYTRON CAR COAXIALS 6 1/2" / 5 1/4" HEAVY DUTY	\$27.00

### SEAS FACTORY SURPLUS SPECIAL

P21RE 8" Woofer	\$25.00	1" Dome Ferro Fluid	\$12.00
3/4" Dome Tweeter	\$7.00	P21REXDD 8" Woofer 4 Ohm	\$28.00
3" Dome Midrange	\$22.00	P25REY 10" 40 oz. magnet	\$38.00
25F-EWX Doped 10" Woofer	\$26.00	P21REY/DD 8" 40 oz. magnet	\$35.00
21FWBXDD 8" Woofer (Now available in coated paper version)			\$28.00

**LIMITED EDITION**

**POLYDAX HD13B25RSC2N12**

AVAILABLE IN SINGLE OR DUAL COIL

Q<sub>TS</sub> 0.29 V<sub>AS</sub> 23 F<sub>S</sub> 35! **\$19.00**

*EXCELLENT FOR MTM SYSTEMS*

**POLYDAX SPECIALS**

MHD24B45T 10" BEXTRANE	\$35.00
HIF165F 6 1/2" WOOFER	\$8.00
HIF13HSM 5"	\$15.00
HIF17JSM 6 1/2" WOOFER	\$14.00
HD9x8HR 4 ohm	\$8.00
1" Ferro Fluid 8 ohm	\$10.00
3/4" Dome Tweeter	\$4.00
HD9x8BA 8 ohms	\$6.00
S1ARE 6.5" Woofer	\$10.00

**PANASONIC RIBBON TWEETERS**

EAS-10TH200D	\$25.00
EAS-10TH400A	\$39.00

SCR POLYPROPYLENE CAPACITORS IN STOCK. VIETA & ARIA SYSTEMS IN STOCK

OUR WAREHOUSE IS OPEN FOR PICK-UP 10AM TO 6PM DAILY, MONDAY THRU SATURDAY  
UPS ORDERS SHIPPED SAME DAY • MINIMUM ORDER \$50.00

**ZALYTRON INDUSTRIES CORP.**

469 JERICHO TURNPIKE, MINEOLA, NY 11501

TEL. (516) 747-3515

FAX (516) 294-1943

FOR ALL YOUR NEEDS - WRITE OR CALL AND ASK FOR ELLIOT!

# Tools, Tips & Techniques

## STURDY STANDS

Building a large speaker cabinet is difficult without proper support. That's why I constructed a pair of "sturdy stands" (Photo 1). They prevent moisture gain by holding the box 5½" off the floor yet maintain a reasonable working height for most operations.

My stands are two feet long, but you can easily cut them to any desired length. To ensure good lateral stability, join the feet to each cross member with a ¾" by 1½" dado (Fig. 1). Then glue soft carpet material along the top to avoid scratching your projects.

Bill Schwefel  
Jackson, WI 53037

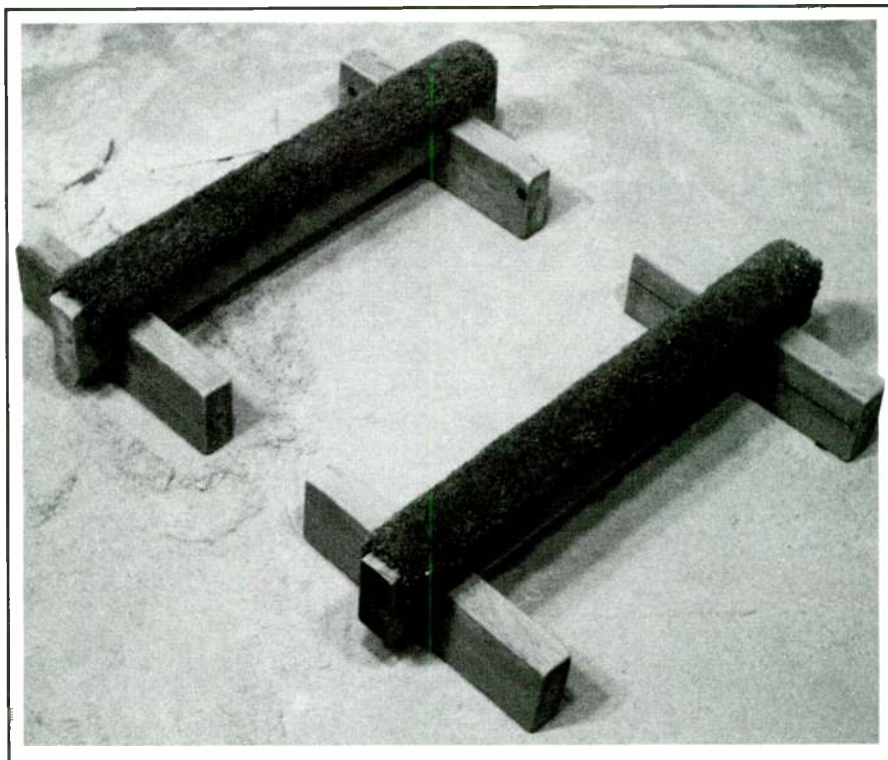

PHOTO 1: Completed stands; ready, willing and stable.

## TRACTRIX TRICKS

Recently, I came across some useful information concerning graphics programming which I applied to a program found in SB 4/86. The program is by Brian D. Smith and will calculate the various dimensions for a tractrix horn. The program is very straightforward and easy to implement but tends to run rather slowly when confronted with a prospective horn that has a very low cutoff frequency. Of course, compared to doing calculations by hand it is an immense improvement.

My changes optimize the numerical calculations to allow faster processing of information. In BASIC, multiplication is much faster than division, and multiplying a number by itself is more efficient than using exponentiation to square it.

Only a few changes have been made to the original program to allow easier conversion to your specific application and programs you have developed around it. They are as follows:

```

130 THROAT = SQR(AREA1 * 0.31831)
REM 0.31831 = 1/PI
150 B = SQR(PI * (A * A))
290 (A * A) * PI
310 ((A * A) * PI) / 8
440 YONE = SQR((R * R) * PI * .5)
470 YTWO = SQR((R * R) * PI) * .5
    
```

Continued on page 62

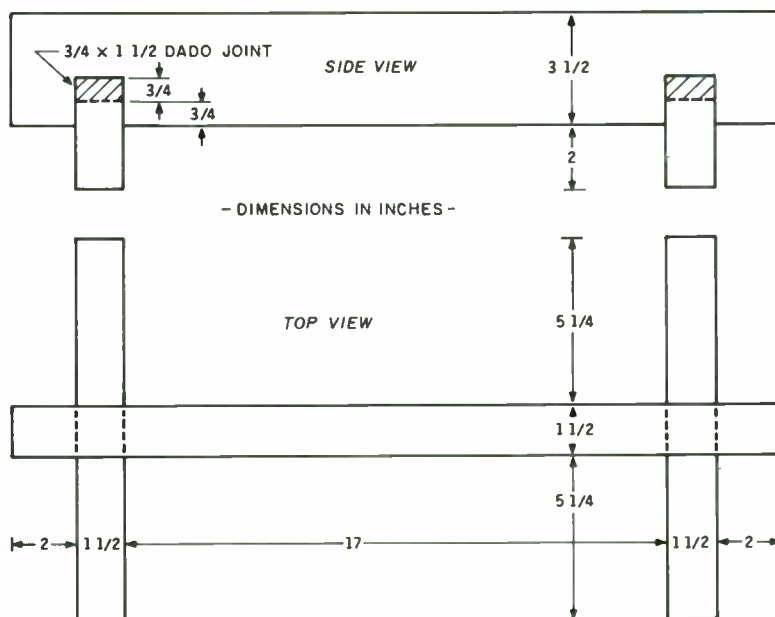

FIGURE 1: Dado joint firmly attaches feet to cross members.

# PERFECT LAY WINDING Air Core Inductors

MADISOUND is now stocking **PERFECT LAY WINDING** audio inductors from Solen Engineering. These are audio grade inductors using 14 gauge wire with the following specifications:

- Perfect Lay Hexagonal Winding. Winding Space Factor: 86.7%
- Oxygen Content: Less than 200 parts per million on surface.
- Insulation: 130 degree centigrade Single coating Nylon-Polyurethane.
- Computer Optimized Coil Dimension.
- Encapsulation: Varnish dip coating with 4 nylon ties.
- No Saturation distortion: Test voltage 1500 VAC
- No Hysteresis distortion: Test voltage 1500 VAX
- Inductance tolerance: within 1% of value listed.
- Conductivity: Better than 101.5% of National Electrical and Manufacturing Association (NEMA) standard sample.
- Wire Diameter: .064 inches; 1.63 mm. High Purity Annealed Copper.



Induct L-MH	Resistance DC Ω	Size Ht	Price Diam. Each	.91mh	.20Ω	.75	3.0	\$8.90	2.75mh	.39Ω	.88	3.5	\$16.85
.22	.08	.56	2.25 \$4.10	1.0	.21	.75	3.0	9.35	3.0	.42	.88	3.5	17.60
.33	.10	.63	2.5 5.05	1.1	.23	.75	3.0	9.90	3.3	.45	1.0	4.0	18.50
.47	.13	.63	2.5 6.25	1.2	.26	.75	3.0	10.80	3.7	.49	1.0	4.0	19.25
.56	.15	.63	2.5 7.05	1.3	.27	.75	3.0	11.55	4.0	.50	1.0	4.0	20.15
.62	.16	.63	2.5 7.50	1.5	.28	.75	3.0	12.10	4.5	.56	1.0	4.0	21.55
.68	.17	.75	3.0 7.80	1.8	.30	.88	3.5	13.65	5.0	.59	1.0	4.0	24.20
.75	.18	.75	3.0 8.15	2.0	.31	.88	3.5	14.30	5.5	.63	1.0	4.0	25.75
.82	.19	.75	3.0 8.60	2.25	.33	.88	3.5	15.20					
				2.5	.36	.88	3.5	16.05					

Values between sizes listed are also available. Add 10% to cost of value larger than your requirement. Madisound stocks **audio standard** inductors as well as the popular **SIDEWINDER** and **SLEDGEHAMMER** inductors.

## CHATEAUROUX POLYPROPYLENE CAPACITORS

We are pleased to announce that we now have in stock **CHATEAUROUX** METALLIZED POLYPROPYLENE CAPACITORS of exceptional quality and excellent price. This type of dielectric has been characterized by Walter Jung and Richard Marsh as "outstanding" when compared with all other dielectrics in the areas of:

### DISIPATION FACTOR PERCENTAGE—DIELECTRIC ABSORPTION PERCENTAGE—STABILITY

- Low dissipation factor
- Low dielectric absorption factor
- High insulation resistance
- High frequency and temperature stability
- Good self healing characteristics of polypropylene dielectric
- High Current Capacity
- Excellent Overvoltage and Pulse handling capability
- Low self inductance
- Low equivalent series resistance
- Excellent stability
- Leads: Tinned pure copper multistrand insulated sleeves, radial, 4 inches.
- Superior high frequency characteristics
- High Ionization level
- Dissipation factor @ 20o C: Less than .01 %.
- Dielectric absorption factor at 20o C: Less than .01%.
- Insulation resistance @ 20o C: More than 100 K megohms/mfd
- Temperature range: -25o C to +85o C.

Dimensions in mm:	12 μfd: 26 D, 47 L	50 μfd: 42 D, 65 L	120 μfd: 54 D, 83 L
2 μfd: 18 D, 28 L	15 μfd: 28 D, 47 L	70 μfd: 45 D, 71 L	150 μfd: 60 D, 83 L
4 μfd: 18 D, 33 L	25 μfd: 32 D, 53 L	80 μfd: 50 D, 71 L	180 μfd: 58 D, 108 L
8 μfd: 22 D, 47 L	35 μfd: 35 D, 65 L	100 μfd: 54 D, 71 L	200 μfd: 60 D, 108 L

Audiophile Prices	5.0	2.80	25.0	7.55	100.0	25.50
1.0 μfd \$2.00	5.6	3.05	30.0*	9.00	120.0	31.25
1.5 2.10	6.0	3.10	35.0	10.50	150.0	37.00
2.0 2.15	7.0	3.25	40.0	11.30	200.0	47.00
2.5 2.20	8.0	3.70	45.0	12.50	Pairs matched to within 1% of each other; add 10% 10 or more pieces of same value; deduct 10%.	
3.0 2.30	10.0	4.20	50.0	14.00	*radial leads	
3.3 2.40	12.0*	4.60	60.0	15.70		
4.0 2.60	15.0	5.30	70.0	17.60		
4.7 2.75	20.0	6.80	80.0	20.50		

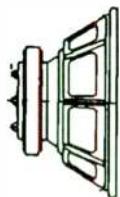

**Madisound Speaker Components**  
**8608 University Green**  
**Box 4283 Madison WI 53711**  
**Phone: 608-831-3433**  
**Fax: 608-831-3771**

Ordering Information: All speaker orders will be shipped promptly, if possible by UPS. COD requires a 25% prepayment, and personal checks must clear before shipment. Add 10% for shipping charges (Residents of Alaska, Canada and Hawaii, and those who require Blue Label airtservice, please add 25%). There is no fee for packaging or handling, and we will refund to the exact shipping charge. We accept Mastercharge or Visa on mail and phone orders.

# Music to your eyes.

## Speaker cabinets for the custom builder.

Grenier Cabinets offers a full line of speaker cabinets and stands that allow you to custom design your own speaker system.

You can choose from 25 models in several different styles of oak and walnut veneer. The cabinets come fully assembled and unfinished, allowing you to create just the right finish to match your room. Lacquer and matte-laminated finishes are available in all colors of Formica®, Wilson Art® and Pionite®.

Choice of brown or black grille cloth. Stands can also be made to complement the cabinets. Round holes cut for drivers at nominal charge. Terminal plates and ports available.

Call or write for our new, color brochure and price list.

Formica® is a registered trademark of the Formica Corporation. Wilson Art® is a registered trademark of Ralph Wilson Plastics. Pionite® is a registered trademark of Pioneer Plastics Inc.



Grenier Cabinets, 5901 Jennings Road,  
Horseheads, NY 14845, (607) 594-3838

Fast Reply #NE166

# The way our competition duplicates our breakthroughs, you'd think they make copiers.

YOU CAN BUY AN INNOVATIVE GOLD SOUND SPEAKER NOW, OR WAIT THREE YEARS FOR AN IMITATION.

- 1981, 4-WAY 18", 600W JBL Studio monitor; Copied with same cabinet, crossovers & components.
- 1985, GS began ROLLING THUNDER car cabinets with polypropylene woofers; later copied.
- 1985, " 4, 5.25 & 6.5" coaxial speakers; " ".
- 1986, " Dual Voice Coil 8, 10, 12 & 15"; " ".
- 1986, " 2 ohm 6x9", 8", 10", 12", 15"; " ".
- 1986, " 8" coax; chosen by National Bureau of Standards; competitors, 100' away, ducked when we played a CD of a 747 landing; " ".
- 1987, 24db Linkwitz-Riley electronic crossover; chosen for CES innovation award; " ".
- 1988, Cast frame dual voice coil 12" & 15"; " ".



2080 W. HAMILTON, ENGLEWOOD, CO 80151 303 789-5310

Fast Reply #NE149

Continued from page 60

$$490 \text{ PRODUCT} = \text{SQR}((A * A) - (R * R))$$

$$530 \text{ DIST} = \text{SQR}(((XONE - XTWO) * (XONE - XTWO)) + ((YONE - YTWO) * (YONE - YTWO)))$$

$$590 \text{ AREA} = (R * R) * \text{PI}$$

(PI references = 3.14159)

You may wonder why some of the division calculations have not been changed to multiplication. Integer operations process data much faster than single- or double-precision decimal numbers, so I felt it was unnecessary to change them at this time. The REM line is just a reminder of what this number corresponds to.

TABLE 1

### PERFORMANCE COMPARISON

F <sub>c</sub>	100Hz	20Hz	5Hz
Original	1' 20"	7' 35"	31' 17"
Optimized	0' 20"	1' 54"	7' 54"

The difference made by just these few changes is astounding and certainly seems to make a case for optimizing code to increase performance. The other possible changes would be to convert single- and double-precision values to integers (possibly using an assembly language subroutine) for processing, and then convert them back for output to the printer or screen.

I have included some performance times of horn calculations with and without the stated changes (Table 1). I hope this will be of use to people using Brian Smith's program to further increase productivity. Of course, now you may not have time to finish that sandwich...

Gregg S. Irwin  
5837 Comstock #5  
Whittier, CA 90601

If you already have a copy of Brian Smith's program you may wish to simply add the above modifications. Copies of the modification, as well as the original program, are available from Mr. Irwin whom you may contact at the above address.

#### Thin Bin

Mother Hubbard's cupboard was no doubt in worse condition than our file folders for SB's "TT&T" and "Craftsman's Corner" features, but we're about to get the "impending famine" warning light on our computer. Your handy tips, shortcuts and unique insights are all welcome, and SB pays \$7.50 minimum for them. (It's a great way to pay for your subscription.) Photos of your handiwork and an account of how and why you built your beautiful gear are also welcome. Payment for illustrated tips is \$15 and up, depending on length of copy and quality and number of photos.

# Cabasse



21 NDC

12 M15

DOM 2

**NOW  
IN STOCK**

A complete line of beautifully crafted drive units from 3/4" carbone dome tweeter to 22" honeycomb concave dome subwoofer. Curvilinear honeycomb structures, foam/skin cones, carbon loaded domes, Cabasse engineers know about today's technology, and they know how to put it to work to better serve music.

## STOCKING MASTER DISTRIBUTORS:

Transducer Technology • 4320 Spring Valley, DALLAS, TX 75244 • (214) 991-6994 • FAX: (214) 991-5016  
Zalytron Industries • 469 Jericho Turnpike, MINEOLA, NY 11501 • (516) 747-3515 • FAX: (516) 294-1943

*Exclusively imported by KIMON BELLAS*

# VIETA

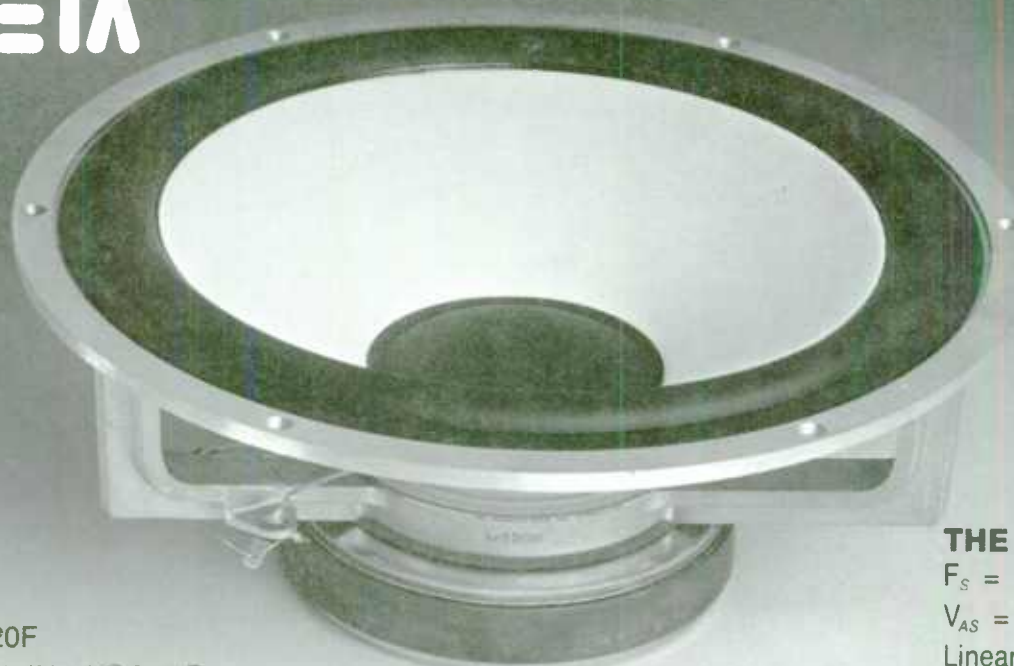

L120F  
13 1/4 IN. WOOFER  
\$125.00

**NOW IN STOCK**

## THE FACTS

Unique PVA/Long cotton fibers super damped cone.  
Unique 2 in VC with outer and inner winding! Superb die cast aluminum open frame: 11 1/2 lbs. total weight.

## THE PERFORMANCES

$F_s = 22.3\text{Hz}$  /  $Q_T = .379$   
 $V_{AS} = 206.21$  liters  
Linear one way  $X_{MAX} = 7.5\text{mm}$   
Effective piston: 550 cm<sup>2</sup>  
200W RMS power

# BOOKS *from Old Colony Sound Lab*

## BUILDER'S GUIDES, general

BKAA-4	KILLER CAR STEREO ON A BUDGET . . . . .	\$19.95
MH-2	HOW TO MAKE PRINTED CIRCUIT BOARDS . . .	\$8.90
S-25	ELECTRONIC PROTOTYPE CONSTRUCTION . .	\$17.95
S-27	DESIGN OF OP AMP CIRCUITS . . . . .	\$12.95
S-32	HOW TO READ SCHEMATICS . . . . .	\$14.95
T-8	ENHANCED SOUND—22 Electronics Projects for the Audiophile . . . . .	\$11.95
T-10	ACOUSTIC TECHNIQUES FOR HOME AND STUDIO . . . . .	\$16.95

## SOUND ENGINEERING, REFERENCE WORKS

B-1	LOUDSPEAKER AND HEADPHONE HANDBOOK . . . . .	\$97.95
MH-1	HANDBOOK FOR ELECTRONICS ENGINEERING TECHNICIANS (2nd Ed.) . . .	\$49.95
MH-4	AUDIO ENGINEERING HANDBOOK . . . . .	\$86.95
NE-1	NEW EARS: A Guide to Education and the Recording Sciences . . . . .	\$11.95
PH-1	HANDBOOK OF SIMPLIFIED SOLID-STATE CIRCUIT DESIGN . . . . .	\$39.95
RR-1	1990 ARRL HANDBOOK FOR THE RADIO AMATEUR . . . . .	\$23.00
S-19	SOUND SYSTEM ENGINEERING . . . . .	\$49.95
S-28	HANDBOOK FOR SOUND ENGINEERS: The New Audio Cyclopedia . . . . .	\$69.95
X-1	PERCEPTION OF REPRODUCED SOUND . . . .	\$22.95

## GUIDEBOOKS AND DATABOOKS

N-6	GENERAL PURPOSE LIN DEVICES (LIN DBK 1)	\$16.95
N-7	DATA ACQUIS LIN DEVICES . . . (LIN DBK 2)	\$10.95
N-8	SPECIAL PURPOSE LIN DEVICES . (LIN DBK 3)	\$10.95
N-678	LINEAR DATA BOOKS (3-volume set) . . . . .	\$35.00
N-9	LINEAR APPLICATIONS HANDBOOK . . . . .	\$16.95
P-1A	THE PENGUIN GUIDE TO COMPACT DISCS, CASSETTES AND LPs . . . . .	\$19.95

### SPECIAL!

BKL/K: BKAA-2 (\$19.95) plus BKAA-4 (\$19.95) for \$30 (\$2 S/H)

NOTE: BOOKS ARE NOT RETURNABLE FOR EXCHANGE OR CREDIT. Prices are subject to change without notice. Please print in clear block capitals quantity needed, book number and price. Total the amounts and REMIT IN US \$ ONLY by MC/VISA, check or money order. Charge card orders under \$10, please include an additional \$2.

POSTAGE & HANDLING: In US, please add \$1.75 for first book and 50¢ each additional book. In Canada, please add \$4.50. Overseas, please include 20% of total order for shipping.

DEALER INQUIRES INVITED

Qty.	Book No.	Price
_____	_____	_____
_____	_____	_____
_____	_____	_____
_____	_____	_____
_____	_____	_____
_____	_____	_____
_____	_____	_____
_____	_____	_____
_____	_____	_____
_____	_____	_____
		Postage \$ _____
<input type="checkbox"/> MC	<input type="checkbox"/> VISA	<input type="checkbox"/> CK/MO
		TOTAL \$ _____

## BUILDER'S GUIDES, specific (cookbooks)

S-9	REGULATED POWER SUPPLIES . . . . .	\$21.95
S-10	IC OP AMP COOKBOOK . . . . .	\$21.95
S-13	AUDIO IC OP AMP APPLICATIONS . . . . .	\$19.95
S-14	ACTIVE FILTER COOKBOOK . . . . .	\$15.95
S-17	IC TIMER COOKBOOK . . . . .	\$17.95
S-18	TTL COOKBOOK . . . . .	\$14.95
S-26	CMOS COOKBOOK . . . . .	\$18.95

## TUTORIAL

BKAA-3/1	AUDIO ANTHOLOGY (Vol. 1) . . . . .	\$16.95
BKAA-3/2	AUDIO ANTHOLOGY (Vol. 2) . . . . .	\$16.95
BKAA-3/3	AUDIO ANTHOLOGY (Vol. 3) . . . . .	\$16.95
BKAA-3/S	AUDIO ANTHOLOGY (Vols. 1-3) . . . . .	\$42.00
BKAA-5	LOUDSPEAKERS: The Why & How of Good Reproduction . . . . .	\$6.95
BKAA-6	THE WILLIAMSON AMPLIFIER . . . . .	\$4.95
D-3	MUSIC, PHYSICS AND ENGINEERING . . . .	\$7.95
G-1	LIVING WITH HI-FI . . . . .	\$6.95
P-8	INTRODUCING MUSIC . . . . .	\$5.95
S-4	UNDERSTANDING IC OPERATIONAL AMPLIFIERS . . . . .	\$12.95
S-29	PRINCIPLES OF DIGITAL AUDIO . . . . .	\$24.95
T-7	BASIC ELECTRONICS COURSE . . . . .	\$17.95
T-11	UNDERSTANDING ELECTRONICS (3rd Ed.) . .	\$11.95

## LOUDSPEAKERS (see also sound engineering)

BKAA-1	AUDIO AMATEUR LOUDSPEAKER PROJECTS .	\$20.00
BKAA-2	THE LOUDSPEAKER DESIGN COOKBOOK . . .	\$19.95
S-11	HOW TO BUILD SPEAKER ENCLOSURES . . .	\$5.95
T-12	DESIGNING, BUILDING AND TESTING YOUR OWN SPEAKER SYSTEM—WITH PROJECTS .	\$14.95
W-1	HIGH PERFORMANCE LOUDSPEAKERS . . . .	\$35.95

## DICTIONARIES

BKAA-7/S	THE AUDIO GLOSSARY (Softbound) . . . . .	\$9.95
BKAA-7/H	THE AUDIO GLOSSARY (Hardbound) . . . .	\$17.95
BKAA-7/L	THE AUDIO GLOSSARY (Limited Edition) . .	\$30.00
S-22	MODERN DICTIONARY OF ELECTRONICS . . .	\$39.95
T-9	THE ILLUSTRATED DICTIONARY OF ELECTRONICS . . . . .	\$24.95
P-2	DICTIONARY OF ELECTRONICS . . . . .	\$8.95
P-3	A NEW DICTIONARY OF MUSIC . . . . .	\$8.95



NAME \_\_\_\_\_ MAGIC NO. \_\_\_\_\_

STREET & NO. \_\_\_\_\_

CITY \_\_\_\_\_ STATE \_\_\_\_\_ ZIP \_\_\_\_\_

MC/VISA \_\_\_\_\_ EXP. \_\_\_\_\_

### OLD COLONY SOUND LAB

PO Box 243, Dept. B90, Peterborough, New Hampshire 03458-0243 USA  
(603) 924-6371 / 924-6526 / FAX: (603) 924-9467

Answering machine for credit card orders only: (603) 924-6371  
before 9:00 a.m., after 4:00 p.m. and weekends.  
Have information plus MC/VISA available.

# Kit Report

## The Pitts Loudspeaker Kit

By Fernando Garcia Viesca

If everybody had a listening room the size of Versailles' hall of mirrors, full-size Klipschorns or ESLs would be mandatory. But thanks to high real state prices, we must be content with more modest households or apartments.

In this realm is where the so-called "bookshelf" speaker is found. It is also a favorite in college dorms where the only furniture is a bed, a desk and a stereo. The speakers lie on the bookshelves and the books—well—on the floor.

Small wonder that bookshelf speakers abound. But it is difficult to find a good bookshelf speaker; rare, if that loudspeaker is also affordable.

Actually, the term bookshelf speaker does not do justice to this useful device. It causes the reader to think from a prejudiced point of view. This hides the fact that these units can be put to good use, like ambience speakers, good-sounding extensions located in places other than your main listening environment; or, with a suitable subwoofer, the satellite of a full range system.

This last statement leads us to the fact that a good bookshelf speaker should not be designed to achieve the lowest possible bass. This may be added later. However, a good bookshelf speaker should have a tight mid-bass, presence in the midrange and clarity and smoothness in the high-end.

The Pitts loudspeaker kit is such a device. For only \$128, you can have two woofers and two tweeters. If you are not proficient in woodworking and choose not to build a simple enclosure, you can buy a couple plus all hardware and cabinet for less than \$200.

The original design, superbly described in Ken Kantor's article, "Speakers by Design" (*Audio*, 11/88 & 12/88), is an elegant example of how computer-aided design can be effectively employed with Thiele/Small parameters to create a nice-sounding loudspeaker.

Since efficiency, response and enclosure size are interrelated and one change in a parameter affects one of the others, the article describes how to effectively employ the computer to achieve the following design criteria:

- Two-way, sealed-box type
- 10-liter enclosure
- 60Hz cutoff (-3dB)

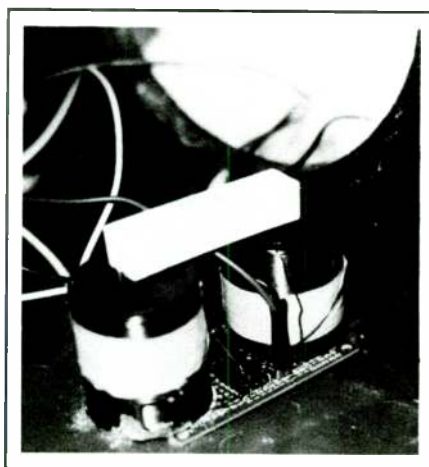

PHOTO 1: Kantor's suggested crossover.

The computer iterates through the different engineering compromises until an acceptable design is reached. The results can then be fine-tuned with measurements and listening tests. Before CAD, a time-consuming method of trial-and-error building and testing was employed (called the "exhaustive method" because the design engineer was left exhausted).

The loudspeakers chosen for this design are the Japanese-made Tonegen 16K65 woofer and 94C70 dome tweeter. I personally like the choice of the 6½" woofer as a good compromise between size and performance. True, 8" units give better performance, but the resultant box size cannot be precisely called "bookshelf." On the other hand, 4" woofers compromise the low end efficiency too much.

A 1" dome tweeter operating at a crossover frequency of 3,000Hz, is able to reproduce the mid-highs and highs with

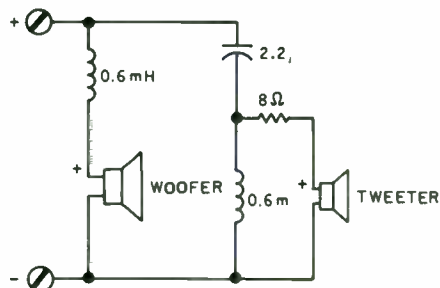

FIGURE 1: Crossover schematic.

astonishing clarity. Its efficiency is so high that it has to be padded down to equalize its output to that of the woofer.

### Building the crossover

Mr. Kantor used a simple 6dB/octave crossover for the woofer. It has a rapid and predictable natural cutoff frequency and, for protection, a faster 12dB/octave crossover for the tweeter.

A schematic of the crossover is shown in Fig. 1. It is very simple, but a few guidelines should be applied. The article suggests that non-polar electrolytics be used for the crossover's capacitors. Where poly caps are employed to offset the lowered impedance and increased tweeter level, he also suggests that an additional 3Ω resistor be employed in series with R1.

If you plan on winding your own coils, you'll find instructions in back issues of *Speaker Builder*.

A good rule of thumb is that the DC resistance of the coil should be from 1/8 to 1/10 the speaker's impedance. If this is not the case, you'll have to employ a larger gauge and wind again. And again. (Who said coil winding is not fun?) Mine worked out with 20-gauge wire and 205 turns, on my third trial.

Keep coils separated by at least two inches to avoid coupling, and use suitable 10W non-inductive resistors.

### Building the enclosure

I love building speaker projects, but I consider woodworking a necessary evil. Fortunately, there are several sources of cabinets. You can purchase everything from unfinished panels up to an enclosure that is basically complete with finished textures and grilles (*Photos 2 and 3*). For the connecting posts, be sure they are of the sealed type; remember that an airtight box is fundamental in a sealed type enclosure such as this one. This means that all joints should be caulked, and that the speaker-enclosure interface should have some form of gasket.

### The finished unit

The beauty of a well-designed, closed-box system is that your system will almost certainly work perfectly as soon as you finish it. This contrasts sharply with bass-reflex boxes where some small fiddling with the vent is almost always necessary.

## Specializing in Speaker & Crossover Design



SCR metallized  
polypropylene  
capacitors



VIETA woofers from Spain



ACCUTON  
ceramic concave  
Dome Drivers



FMS cables • Audioquest • Isoda Hybrid cables • Solen Coils • WBT  
Edison Price Music Post  
are just a few of the many lines we stock



The Best Products  
Knowledgeable Service  
At The Right Price!

1828 W. Peoria  
Phoenix, AZ 85029  
(602) 944-1878

Call or write for Free Catalog

Fast Reply NHE412

PHOTO 2: Enclosure without grille.

To properly evaluate their performance, the units were tested with both a 15W/channel and 60W/channel amplifiers. I was surprised with the tweeter response. The problem with most "wide range" tweeters is getting them to respond well on the high end while avoiding shrillness in the medium to medium-high range. The distortion in this critical range rapidly leads to listener fatigue. But this moderately priced tweeter performed flawlessly. I was impressed.

This doesn't mean to minimize the woofer's sound. Since in a two-way system  
*Continued on page 93*

# Speaker Design on the Mac!

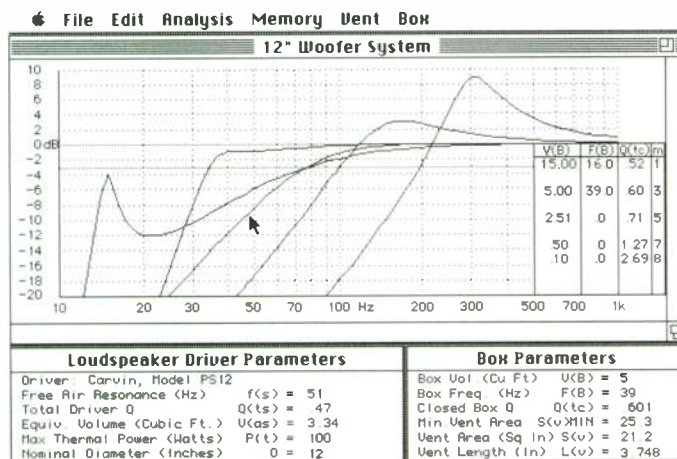

MacSpeakerz™  
The Speaker Design Toolbox™

- Plots Response of any Driver / Box Combination
- Closed (Air Suspension) or Vented Enclosures
- Large Driver Library Included (easily expandable)
- Build an Optimum Enclosure on the First Try!
- Runs on any Macintosh™ Computer

from True Image™  
349 W. Felicita Ave., Suite 122,  
Escondido, CA 92025

To Order Software and Speaker Design Reference  
Send \$145.00 plus \$3.00 shipping  
for Charge Card Orders call: 619-480-8961  
(California Residents add 7% sales tax)



Fast Reply NHE544

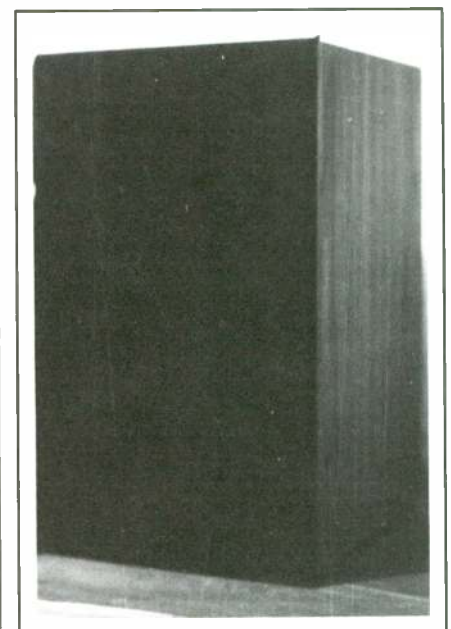

PHOTO 3: Completed unit, grille in place.



# CIRCUIT BOARDS

★ Of special interest to  
Speaker Builder readers

Old Colony's circuit boards are made of top quality epoxy glass, two ounce copper and reflowed solder-coated material for ease of constructing projects which have appeared in *Audio Amateur*, *Glass Audio* and *Speaker Builder* magazines. Many also have the component layout printed right on the board!

The builder needs the original article (indicated by the date in brackets) to construct the project. Articles are not supplied but are available through *Audio Amateur Publications*.

## AUDIO AMATEUR

- A-1:** WILLIAMSON TWIN 20 POWER AMPLIFIER. (RW-8) 3x5" [1:70] Each **\$8.35**
- A-2:** WILLIAMSON TWIN 20. Power supply board. (RW-9:2) 2½x3" [1:70] Each **\$6.85**
- B-2:** WILLIAMSON-WATLING 4+4 MIXER. Staked terminals. (RW:AW) 3½x5" [2:71] Each **\$10.00**
- B-5:** WILLIAMSON TWIN 20 PREAMP. Stereo. (RW-11) 3½x8" [2:71] Each **\$16.00**
- B-7:** V.U. METER. (DG-7-A) 1¾x3" [3:71] Each **\$8.00**
- ★ **C-4:** ELECTRONIC CROSSOVER. Board takes 8 pin DIPs, ten eyelets for variable components. (DG-13R) 2x3" [2:72] Each **\$10.00**
- C-5:** GLOECKLER VOLUME CONTROL. 23 position wafers. (FG-1) 3x3" [2:72] Each **\$5.50**
- D-1:** HERMEYER ELECAST AMP II. 4½x4¾" [3:73] Each **\$12.00**
- E-2:** REGULATED LAB POWER SUPPLY. ±15V. (Ref. 1) 4¾x3½" [4:74] Each **\$8.00**
- F-3:** GATELY ±18V POWER SUPPLY. Regulated. (EG-2) 2½x4" [2:75] Each **\$8.00**
- ★ **F-6:** 30Hz FILTER/CROSSOVER. High pass or universal filter or crossover. (WJ-3) 3x3" [4:75] Each **\$10.00**
- G-1:** GATELY PEAK DETECTING OVERLOAD INDICATOR. Two channel. (EG-3) 1½x2½" [2:3:76] Each **\$6.40**
- ★ **H-2:** SPEAKER SAVER. (WJ-4) 3¼x5¼" [3:77] Each **\$13.25**
- H-4:** GATELY MICROMIXER. Input. 15 pin plug-in gold edge. (MIC-10S) 8¼x3" [3:77] Ea. **\$17.00** Five or more, Each **\$15.00**
- H-5:** GATELY MICROMIXER. Output. 15 pin plug-in gold edge. Two channel. (MIC11-005) 12¼x3" Each **\$26.20**
- H-7:** GLOECKLER 101dB ATTENUATOR. (FG-3) 2x2" [4:77] Each **\$8.00** Five for **\$35.00**
- H-8:** MORREY SUPER BUFFER. Two channel. (WM-3) 1½x2½" [4:77] Each **\$8.00**
- J-4:** DIDDEN AUDIO ACTIVATED POWER SWITCH. (J-4) 3x4¼" [3:78] Each **\$7.55**
- J-5:** PASS A-40 POWER AMP. One channel. 3x3" [4:78] Each **\$6.00**
- ★ **J-6:** SCHROEDER CAPACITANCE CHECKER. (CT-10) [4:78] 3¼x6" Each **\$9.95**
- ★ **K-3:** CRAWFORD WARBLER. 3¼x3¾" [1:79] Each **\$11.20**

- ★ **K-6:** WALDRON TUBE CROSSOVER. (Two needed per 2-way channel.) 2x4½" [3:79] Each **\$12.00** Four **\$40.00**
- ★ **K-7:** WALDRON TUBE CROSSOVER POWER SUPPLY. 5x5½" [3:79] Each **\$12.95**
- K-11:** WILLIAMSON 40/40 POWER AMP. One channel. 3x5" [4:79] Each **\$7.00**
- L-1A:** BOAK POWER AMP REGULATED SUPPLY. Plus or minus supply for power. 2¾x4½" [1:80] Each **\$8.00**
- ★ **L-2:** WHITE LED OVERLOAD & PEAK METER. One channel. 3x6" [1:80] Each **\$18.70**
- L-4:** SULZER OP-AMP PREAMP POWER SUPPLY. ±15V supply for preamps. 4¾x4" [2:80] Each **\$12.00**
- ★ **L-6:** MASTEL TONE BURST GENERATOR. 3½x6½" [2:80] Each **\$15.75**
- ★ **L-9:** MASTEL PHASE METER. 6½x2¾" [4:80] **\$11.25**
- M-1:** MULLER-CARLSTROM. Sweep Generator-Oscillator. (Two required.) (CM-2) 2½x5" [2:81] Each **\$8.50** Pair **\$14.00**
- M-2:** MULLER-CARLSTROM. Log Sweep Board. (CM-4) 2x2½" [2:81] Each **\$5.00**
- M-3:** MULLER-CARLSTROM. Sweep Power Supply. (CM-5) 2½x3½" [2:81] Each **\$6.50**
- M-4:** MULLER-CARLSTROM. Logger Board. (CM-3) 3½x4" [3:81] Each **\$9.25**
- M-5:** MULLER-CARLSTROM. Logger Power Supply. (DG-12B) 2½x2¾" [3:81] Each **\$5.00**
- M-6:** CARLSTROM IM FILTER. Intermodulation Filter. 2½x3¾" [1:82] Each **\$6.50**
- P-3:** BORBELY 60W POWER AMP. (EB-60) 3½x6½" [2:82] Each **\$11.75**
- P-5:** SWEEP MARKER ADDER. 3½x2¾" [2:82] Each **\$6.20**
- P-6:** ADVENT MIKE PREAMP UPDATED. (K5) 3½x2½" [3:82] Each **\$18.75**
- R-2:** BORISH DIGITAL DELAY. 5¾x9" [1,2:83] Each **\$79.80**
- R-4:** DIDDEN MAIN PWR AMP. 4½x6¾" [4:83] Each **\$30.00**
- S-1:** BORBELY SERVO 100 AMP. 4½x6½" [1:84] Each **\$16.00**
- S-3:** BORBELY DC 100 AMP. 6½x4½" [2:84] Each **\$16.00**
- S-5:** KRUEGER MOD FOR MORREY IG-18. 2½x2½" [3:84] Each **\$7.80**
- S-6:** CURCIO VACUUM TUBE PRE-PREAMP AMP/REGULATOR. 4¾x2¾" [5:84] Each **\$12.35**

- S-6A:** CURCIO VACUUM TUBE PRE-PREAMP MASTER POWER SUPPLY. 4¾x3¾" [5:84] Each **\$10.35**
- S-8:** DIDDEN FAN CONTROL. 6¼x1½" [4:84] Each **\$11.25**
- T-1:** CURCIO VACUUM TUBE PREAMP/AMP REGULATOR. 10½x6½" [2:85] Each **\$36.00**
- T-1A:** CURCIO VACUUM TUBE PREAMP MASTER POWER SUPPLY. 3½x2½" [2:85] Each **\$8.00**
- T-2A:** BORBELY R1AA-1. 3¾x3¾" Each **\$10.50**
- T-2B:** BORBELY R1AA-2. 3¾x5¾" Each **\$15.00**
- T-2C:** BORBELY TAPE BUFFER. 1¾x3¾" Each **\$5.45**
- T-2D:** BORBELY LINE BUFFER. 3¾x5¾" Each **\$9.50**
- T-2S:** BORBELY PREAMP BOARD SET. Eight boards. [4:85, 1:86] Set **\$90.00**
- T-2F:** BORBELY PREAMP POWER SUPPLY. (Two required.) 3¾x4¾" Each **\$12.00**
- V-2:** LANG CLASS A MOSFET AMP. 5½x6½" [2:86] Each **\$21.40**
- V-3A:** CURCIO AUTO MUTE. 1½x2" Each **\$8.00**
- W-3:** BORBELY IMPROVED POWER SUPPLY. 4¼x5½" [1:87] Each **\$16.00**
- X-3:** CHATER 40W MOSFET AMP. Two sided, one channel. 4x6¾" [2, 3:88] Each **\$26.00**
- X-3A:** CHATER AMP POWER SUPPLY. 3½x6" [2, 3:88] Each **\$14.00**
- X-4A:** VIKAN CAR AMPLIFIER. 4x5" [4:88, 1:89] Each **\$23.20**
- X-4B:** VIKAN PWR SUPPLY. 4½x5½" [4:88, 1:89] Each **\$17.00**
- Y-2:** RYAN ADCOM GFA-555 POWER SUPPLY REGULATOR. (One per channel required.) 3x6¼" [4:89] Each **\$28.50**

## SPEAKER BUILDER

- ★ **SB-A1:** LINKWITZ CROSSOVER. 5½x8½" [4:80] Each **\$25.50**
- ★ **SB-D2:** WITTENBREDER PULSE GENERATOR. 3½x5" [2:83] Each **\$11.85**
- ★ **SB-E2:** NEWCOMB PEAK PWR INDICATOR. 1x2" [2:84] Each **\$3.90**
- ★ **SB-E4:** MULLER PINK NOISE GENERATOR. 4½x2¾" [4:84] Each **\$9.40**

## GLASS AUDIO

- GB-1A:** CURCIO ST-70 POWER SUPPLY. 5x9" [1:89] Each **\$27.00**
- GB-1B:** CURCIO ST-70 DRIVER BOARD. 3¼x7" [1:89] Each **\$17.00**

## CIRCUIT BOARD ORDER FORM

Please print in clear block capitals quantity needed, board number and price. Total the amounts and REMIT IN US \$ ONLY by MC/VISA, check or money order. Postpaid in US; in Canada, please add 10%; overseas, add 20%.



NAME	MAGIC NO.	QTY	PRICE
_____	_____	_____ board(s) # _____	\$ _____
STREET & NO.	_____	_____ board(s) # _____	\$ _____
CITY	STATE	ZIP	_____ board(s) # _____
MC/VISA	EXP.	_____ board(s) # _____	\$ _____

FOR CHARGE CARD ORDERS UNDER \$10, PLEASE ADD \$2.

MC  VISA  CK/MO

Shipping \$ \_\_\_\_\_

CALL OR WRITE FOR YOUR FREE OLD COLONY CATALOG!

(603) 924-6371 / 924-6526 / FAX: (603) 924-9467

TOTAL \$ \_\_\_\_\_

Answering machine for credit card orders only: (603) 924-6371 before 9:00 a.m., after 4:00 p.m. and weekends. Have all information plus MC/VISA available.

---

# Ask Speaker Builder

---

## TOUR de MAGNETIC FORCE

---

By Richard Pierce

My apologies to the faithful readers of "Ask Speaker Builder" for my absence last issue. As some of you may know, I am directing the software effort at AKG Acoustics Digital Products Division and building a professional all-digital audio editing workstation. These projects, the pressure of the NAB convention in early April and an upcoming release prevented me from keeping up with a variety of projects. I promise never to let it happen again. Thus, ever onward...

I'll begin this edition with an anecdote, one I'm sure many of you may have encountered yourselves. Being heavily involved in both loudspeaker development and software engineering not only keeps me extremely busy, but just a little paranoid. I've developed a rigidly enforced practice of keeping all loudspeakers on one side of my lab, and all magnetic media (floppy disks, digital tapes, all the computers) safely in the opposite corner. I've not had an accidental erasure yet. At least not one that's my fault.

Up until recently, my standard spreadsheet program was Lotus 1-2-3. I was willing to tolerate some of its quirks because of its wide industry acceptance. However, I was not a little disturbed by what I considered to be extremely restrictive and excessively childish copy protection.

Well, one day my hard disk crashed, and I was unable (because of this copy protection) to reload the Lotus software. I proceeded to engage in a very heated discussion with the tech support department at Lotus, explaining to them in no uncertain terms my opinion that imposing such a protection scheme on a professional software developer was patently stupid, exhibited poor, if not nonexistent forethought, crippled my development effort. Lotus agreed to send me an early release of their non-protected version, via Federal Express, no charge, forthwith.

### Fed X'd

At the same time, I was providing design consultation to a well-known European driver manufacturer, and they were constantly sending me evaluation samples

which I would measure and report on to the U.S. importer. Of course, the inevitable happened. Down the driveway came the Federal Express driver, cheerfully carrying two cartons, each containing a 10" woofer. Sandwiched securely between them, safe from all the elements, safe from the rain, the sleet, the snow and the rapidly approaching dark of night, was a single, flat envelope containing the disk from Lotus. And of course, it was wiped absolutely, irretrievably clean of any readable information.

Now, all speakers come Federal Express, all software via UPS!

Speaking of magnets, I received a letter from Keith Kinsley. He writes regarding the article by Brian D. Smith ("Adjusting Woofers for High Performance," *Speaker Builder*, 6/89) describing how a reverse-polarized magnet is used to lower the  $Q_{TS}$  of a driver. He has several questions:

"...Brian Smith alters the woofer's  $Q_{TS}$  by adding a second magnet, 'so the force is repulsive.' He also adds a metal can to complete the magnetic circuit.

"My first guess would have been to add the magnet so the force is attractive! (Well, it would be easier to glue on!) I obviously do not understand what is happening in the 'magnetic circuit.' Could you please explain this to me? Should the magnet be about the same size as the one on the driver?"

First, let's try to understand what's happening in the magnetic circuit of a "typical" loudspeaker. In such a circuit, there are several components. The two most important ones are the magnet and the voice coil gap.

### The Right Stuff

The magnet is typically a material which is magnetically "soft," one which can be easily magnetized. Interestingly, most materials which are magnetically soft turn out to be mechanically quite hard. Today loudspeaker magnets are mostly a ceramic made of strontium or barium ferrite, "hot pressed" at extremely high temperatures, then fired in a kiln to cure them. The result is a somewhat brittle substance so hard it will quickly dull any

cutting or grinding tools. Alnico, another magnetic material, is an alloy of iron, aluminum, nickel and copper which is as hard as many tool steels. The ferrite material is the one we'll consider here, but much of what we will be discussing is also true for other magnetic materials as well.

The typical magnet in a loudspeaker is shaped like a very thick-walled tube. A "16 oz." magnet, as an example, will be about four inches in outside diameter, with a two-inch diameter hole in the center and about ¾" long. Most of the magnetic energy is stored in this material, with the magnetic field oriented parallel to its axis. This material is manufactured in such a way that the preferred direction of magnetization is optimized by aligning the crystal structure parallel to the axis as well. (You might see references to "anisotropic" structure, which means, roughly, "not the same in every direction.")

The second major component of the circuit is the voice coil gap, the region of the magnetic circuit where the voice coil resides. When a current is passed through the voice coil, it produces a magnetic field of its own, proportional to the current. The attractive or repulsive force between the voice coil's field and the magnet's is what generates the mechanical force that accelerates the voice coil and, therefore, the cone itself.

To maximize the efficiency of the system, i.e., maximize the amount of force for a given input current, we want to try to immerse the voice coil in the strongest magnetic field possible. In magnetic terms, we want the highest *field density* we can get. Unfortunately, the field density in our magnet is the highest *inside* the magnet, surely a rather inconvenient place to try to put a voice coil.

### Force Fields

Imagine, if you will, the magnetic force radiating outwards from one face of our magnet and returning to the other face via nice neat circular paths. If you think of a Slinky, pulled around so that one end meets the other, like a doughnut, you'll have a rough idea of what the field looks

*Continued on page 74*

# THE CURE FOR WIMPY SOUND

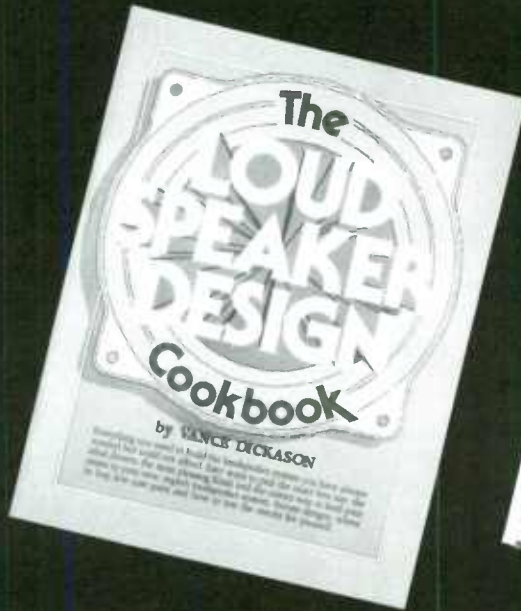

**The world's best loudspeaker book should be on your shelf if you are serious about speaker systems**

Here in one place are all the definitions for closed or vented boxes, woofers, passive radiators, transmission lines, how to do cabinets and choose drivers. What to do about crossovers. How to build and test your project. "...The best single reference available." Robert M. Bullock, III, Professor of Applied Math., Miami University, Oxford, Ohio; Contributing Editor, Speaker Builder.

8½ x 11 format, 82pp., softbound \$19.95



**A quick, easy, tested method for upgrading your car's sound**

Here's an excellent, concrete, hands-on, treatment of the cost effective design and installation of a high quality auto sound system. Ferguson concentrates on the loudspeaker end of the system, the weak link in auto sound. Has an excellent discussion of equipment, design, installation and modification options.

125pp. spiral bound. \$19.95

**SPECIAL OFFER**  
Buy BOTH books and pay only \$30. Plus \$2 shipping

Order Today! Only **\$19.95** each, Order Both for **\$30**.

Send LDC \_\_\_ @ **\$19.95** Send KCS \_\_\_ **\$19.95** Both **\$30.00**

Add \$1.75 postage and handling per book or \$2.00 for both.

I enclose: \_\_\_ Check/Money Order \_\_\_ for \$ \_\_\_\_\_

MC/Visa: \_\_\_\_\_ Exp. \_\_\_\_\_

Name \_\_\_\_\_

Address \_\_\_\_\_

City \_\_\_\_\_ State \_\_\_\_\_ Zip \_\_\_\_\_

**OLD COLONY SOUND LAB** PO Box 243, Dept. B90

Peterborough, NH 03458-0243

(603) 924-6371 FAX: (603) 924-9467

# Loudspeaker and Headphone Handbook

Edited by John Borwick

## LOUDSPEAKER AND HEADPHONE HANDBOOK by John Borwick, ed.

This 573-page hardbound classic, featuring contributions from Baxandall, Colloms, Gander, Woodgate, and many others, has long been an invaluable reference for dedicated speaker builders. If the question is about loudspeaker or headphone design, operation, or performance, in theory or practice, the answer is in this book. Greatly detailed, yet easy to understand.

REG. \$110 **BKB-1** NOW \$97.95

## HANDBOOK FOR SOUND ENGINEERS: The New Audio Cyclopaedia by Glen Ballou, ed.

The thirty-one sections of this mammoth (1,250 pp.) hardbound reference cover just about every imaginable aspect of audio engineering: room acoustics, loudspeakers, amplifiers, image projection, soundfield measurements, and much, *much* more. The complete audio reference library in one volume.

REG. \$79.95 **BKS-28** NOW \$69.95

### HANDBOOK SPECIAL!

SAVE \$30!

**BKB-1 plus BKS-28**  
BOTH FOR \$159.95

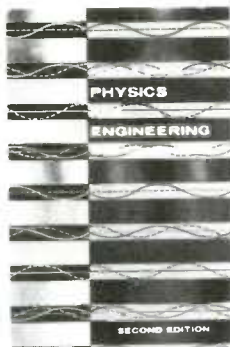

## MUSIC, PHYSICS, AND ENGINEERING [2nd Ed.] by Harry F. Olson

A classic by one of the giants of the audio field, *MPE* explores the physical characteristics of sound and its relationship to musical instruments. Recording and playback systems, acoustics, mikes—even electronic music—are all analyzed in this fun-to-read investigation of music and sound. Softbound, 460pp.

REG. \$8.95 **BKD-3** NOW \$7.95

## LIVING WITH HI-FI [3rd Ed.] by John Borwick

*LWHF* provides the best explanation we've yet seen of how to recognize good sound and realize it in home installation. In reviewing the roles of all audio system components, this 120-page softbound volume proves exceptionally helpful about correct installation procedures. Also a great primer for new or potential audiophiles.

REG. \$7.95 **BKG-1** NOW \$6.95

## SOFTWARE: STEPPEDED VOLUME CONTROLS by Joseph O'Connell

These ready-to-run Mac programs come on a 3½-inch SS/DD disk initialized as a 400K disk for compatibility with all machines. **Program A:** Precisely matches the resistor values to the measured or estimated source and load impedances, yielding great accuracy. The program will ask you how many dB each step should be attenuated and has provisions for a standard audio taper or any other taper you devise. **Program B:** Calculates the taper that will result with your actual resistor values. It can also show the effects of different source and load impedances on the taper. Both programs (contained on the same disk) include author support via mail.

REG. \$25

**SVC-1M3 (Mac 3½" SS/DD)** NOW \$23

## SOFTWARE: "SOUPED-UP" LOUDSPEAKER MODELING PROGRAM by Ralph Gonzalez

This popular program produces a full-range frequency response prediction for multi-way loudspeakers, including the effects of the crossover, driver rollofts, interdriver time delay, and "diffraction loss." Featuring professional-quality graphics and a friendly user interface, "Souped-Up" LMP is available for both the IBM-PC (CGA, EGA, VGA, or Hercules graphics) and the Macintosh. The Mac version also provides square wave analysis with audible output. Author support included.

REG. \$49.50

**LMP-3B5G (IBM 5¼" DS/DD)** NOW \$44.50

REG. \$49.50

**LMP-3M3G (Mac 3½" SS/DD)** NOW \$44.50

# SUMMER SAVINGS SPECIAL! (SALE ENDS AUGUST 31)

# OLD COLONY SOUND LAB



## DESIGNING, BUILDING AND TESTING YOUR OWN SPEAKER SYSTEM—WITH PROJECTS

by David B. Weems

This 7¾" by 9¼" hands-on manual packs an incredible amount of useful info into its 208 pages, including easy-to-understand directions for ten speaker projects. Chapters include How a Speaker Works, Kinds of Speaker Enclosures, Speaker-Box Construction, Crossover Networks, Testing Your Speakers, and Useful Formulas. Softbound.

REG. \$16.95 **BKT-12** NOW \$14.95

## ACOUSTIC TECHNIQUES FOR HOME AND STUDIO

by F. Allen Everest

Change your listening room's characteristics to improve your system's sound: that's what this best seller teaches you how to do. A great combination of theory, practice, and construction ideas, this 344-page softbound cookbook is fully illustrated and written in easy-to-follow language.

REG. \$18.95 **BKT-10** NOW \$16.95

### SPECIAL!

SAVE \$6!

**BKT-12 plus BKT-10**  
BOTH FOR \$29.90



## HOW TO BUILD SPEAKER ENCLOSURES

by Alexts Badmaleff and Don Davis

Easy-to-follow drawings and instructions in this builder's bible cover infinite baffle, bass reflex, and horn types, as well as combinations and much more. The "whys" and "hows" of speaker enclosures are all here in this handy 144-page softbound guide.

REG. \$6.95 **BKS-11** NOW \$5.95

## HIGH PERFORMANCE LOUDSPEAKERS [3rd Ed.]

by Martin Colloms

Along with highly original proposals for low frequency alignments, listening tests [see BKX-1], and much more, *HPL* provides one of the most thorough analyses of the field ever written. An indispensable tool for today's—or tomorrow's—serious speaker builder. Hardbound, 313pp.

REG. \$38.95 **BKW-1** NOW \$35.95

### SPEAKER SPECIAL!

SAVE \$6!

**BKS-11 plus BKW-1**  
BOTH FOR \$39.90



## PERCEPTION OF REPRODUCED SOUND

by Søren Bech and O. Juhl Pedersen, eds.

*PRS* is a hard-to-find, 165-page, hardbound collection of the proceedings of a symposium held in Denmark in 1987. As far as we know, it's the most extensive compendium that exists on the role of subjectivity in sound evaluation. Like many academic presentations this is dry reading, to be sure, but it's absolutely fascinating. Just how good does your system sound?

REG. \$35

**BKX-1** NOW \$22.95

## PRINCIPLES OF DIGITAL AUDIO [2nd Ed.]

by Kenneth C. Pohlmann

Audiophiles and engineers alike speak very highly of the simplicity yet depth with which digital audio technology is explained in this 350-page handbook. State-of-the-art all the way, *PDA* spells out in detail the fundamentals, the recording and reproduction techniques, and much more. A great reference or teaching (learning!) text.

REG. \$29.95

**BKS-29** NOW \$24.95

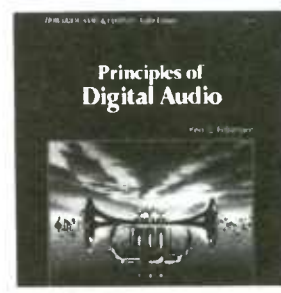

**OLD COLONY SOUND LAB  
PO BOX 243  
PETERBOROUGH, NH 03458**

# SELF-MAILING ORDER FORM

**TELEPHONE CHARGE ORDERS  
(603) 924-6371, 924-6526  
Answering machine before 9 a.m.,  
after 4:00 p.m. and weekends  
FAX: (603) 924-9467, 24 hours**

## CUSTOMER ADDRESS

NAME \_\_\_\_\_  
STREET & NO. \_\_\_\_\_  
CITY \_\_\_\_\_ STATE \_\_\_\_\_ ZIP \_\_\_\_\_  
MAGIC NUMBER \_\_\_\_\_

## SHIPPING ADDRESS IF DIFFERENT

NAME \_\_\_\_\_  
COMPANY \_\_\_\_\_  
STREET & NO. \_\_\_\_\_  
CITY \_\_\_\_\_ STATE \_\_\_\_\_ ZIP \_\_\_\_\_

## PAYMENT METHOD

CHECK  MONEY ORDER  MASTERCARD  VISA   
CARD NUMBER \_\_\_\_\_ EXPIRES \_\_\_\_\_ / \_\_\_\_\_  
AUTHORIZED SIGNATURE \_\_\_\_\_ DAYTIME PHONE \_\_\_\_\_

**OUR DISCOUNT POLICY:** Old Colony Sound Lab is happy to offer a discount on selected items. In general, **discountable** items include accessories, connectors, cable, tubes, and most parts. **Nondiscountable** items include kits, boards, pots, books, CDs, and software. IF YOU HAVE A QUESTION ABOUT DISCOUNT ELIGIBILITY, PLEASE CALL US. If your order for discountable merchandise is between \$25 and \$75, you may subtract a 10% discount; if it is over \$75, you may subtract 15%. Please note that closeout and sale items are not subject to discount.

NONDISCOUNTABLE MERCHANDISE (Kits, Boards, Pots, Books, CDs, Software)					DISCOUNTABLE MERCHANDISE (Accessories, Connectors, Cable, Tubes, Most Parts)					
QTY.	PART NO.	DESCRIPTION	LIST PRICE	TOTAL	QTY.	PART NO.	DESCRIPTION	LIST PRICE	TOTAL	
					SUBTOTAL					
					SUBTRACT DISCOUNT (\$25-\$75, 10%; >\$75, 15%)					

NONDISCOUNTABLE MERCHANDISE TOTAL	
DISCOUNTABLE MERCHANDISE TOTAL	
<b>TOTAL MERCHANDISE</b>	
IF LINE ABOVE IS LESS THAN \$10, ADD \$2 HERE	
POSTAGE, INSURANCE, SPECIAL SHIPPING	
<b>TOTAL ORDER</b>	
AMOUNT ENCLOSED	

← SUBTOTAL	
← SUBTRACT DISCOUNT (\$25-\$75, 10%; >\$75, 15%)	
← DISCOUNTABLE MERCHANDISE TOTAL	

### PLEASE MAKE PAYMENT IN US FUNDS

**POSTAGE:** In US, add \$1.75 for first book, 50¢ each additional book. In Canada, add \$4.50 to any order for book(s), add 10% to any order for kit(s). Overseas, add 20% to all orders.

**INSURANCE:** Add \$2 if you are unable to receive UPS.

**SPECIAL SHIPPING:** UPS next and second day air sometimes available. Please call for quote.



PETERBOROUGH, NH 03458-0243  
PO BOX 243

# OLD COLONY SOUND LAB

THANK YOU

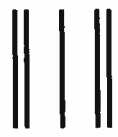

---

---

---

3 FOLD TOP DOWN



2 FOLD BOTTOM UP



**PRICING:** Prices, except as noted, include shipping in the continental USA. The minimum order is \$10. A \$2 service charge will be added to orders of less than \$10. Prices are subject to change as our costs change. WE RESERVE THE RIGHT TO MAKE PRICE CHANGES WITHOUT NOTICE.

**ORDERING:** Please use the ORDER FORM provided and include part number, quantity and price. Please print clearly and include your Magic Number if you are a subscriber. Please include a ZIP code in your address. The ORDER FORM is designed to help us quickly and accurately process your order. We reserve the right to refuse mail orders not made using the ORDER FORM or orders under the \$10 minimum.

**TELEPHONE ORDERS:** Telephone orders are welcome between the hours of 9:00 a.m. and 4:00 p.m. EST, Monday-Friday. Orders for parts are to be made on the ORDER FORM provided. Payment for telephone orders is by MC/VISA only. Our TELEPHONE ORDER NUMBER IS (603) 924-6371 or 924-6526. Our answering machine for MC/VISA orders during non-business hours is (603) 924-6371. FAX: (603) 924-9467 (24 hours).

**PAYMENT:** All remittances **MUST BE IN US FUNDS**. Payment for telephone orders may be made by MasterCard or VISA. Mail order payment may be made by MC/VISA, money order, cashier's check or personal check. If payment is made by personal check, allow up to two weeks for check clearance before your order is shipped. Should a check be returned for any reason, there will be a \$10 service charge.

**SHIPPING: UNLESS NOTED, FREIGHT IS PREPAID BY OLD COLONY.** All orders shipped USPS first class mail or by UPS. Allow two to three weeks for delivery. Include appropriate funds for special handling (UPS next day or second day). UPS requires a street address. If you cannot receive UPS delivery, please include an extra \$2 for insured service via Parcel Post. We cannot accept responsibility for safety or delivery of uninsured Parcel Post shipments. **Absolutely no COD shipments.**

**BOOKS, RECORDINGS, CDs, and SOFTWARE:** The shipping/handling charge is \$1.75, plus 50¢ each additional item. **No returns.** According to the Connecticut Dept. of Revenue Services, Regulation #27, Section 12-426-27, in order to sell software to residents of Connecticut, we must register with the department as well as collect taxes for the state from the purchaser. We regret to inform our customers that we will not sell software to anyone from Connecticut, as it will prove to be too costly and burdensome.

**OVERSEAS ORDERS:** For orders to be shipped outside the US, add 20% to the total order to cover shipping.

**DISCOUNTS:** BOOKS, KITS, BOARDS, POTS, CDs, SOFTWARE, and SUBSCRIPTIONS are not subject to discount. Items identified as qualifying for discount are discounted according to the following schedule: 10% on orders \$25 to \$75 and 15% on orders greater than \$75.

**RETURNS:** If you wish to return all or part of an order for any reason, please call or write first. If we are in error, correction will be made promptly, without charge. If the error is not ours, adjustment will be made at our discretion. We will send you a **return authorization label**. A restocking fee of 20% will be charged on returns. Merchandise considered not fit for resale will be returned without credit or refund. A \$2 fee will be charged on exchanges. All returns must be made within **30 days of invoice date**. Books, software, CDs, and recordings are not eligible for return or refund.

**WARRANTY:** We warrant that all items sold conform to the quality and specifications set forth. We make no representations. We accept no responsibility whatever for further use by the customer. We accept no monetary liability in excess of the original cost or replacement of the material if originally defective or damaged in transit.

4  
TAPE OR STAPLE SECURELY

# J. GORDON HOLT

## If you had to invent a new language, where would you begin?

Back when high quality sound reproduction was a new idea and **J. Gordon Holt** was a staffer at *High Fidelity* magazine, manufacturers and journalists alike depended on the simple technical quality tests which everyone accepted as the yardsticks for performance. As the industry grew, equipment got better, competition fiercer, and technical reviewing became more crucial to sales managers. Before long, **J. Gordon** began to realize that reviewing was becoming more and more accommodating, and where the reviewers continued to rely on the standard tests, the measurement data began to look more and more alike.

Finally, in frustration, **Holt** left Great Barrington and headed for home in Pennsylvania where he founded *Stereophile* magazine in the spare room of his mother's house. He became convinced that although equipment tests and measurements were important, they no longer accounted for the differences he could hear. Two devices could easily measure the same and yet sound quite different.

**Holt** abhorred the tendency of the larger magazines to depend almost entirely on measurements, which he saw as a safe way to review without disturbing the manufacturer with any bad news. Not only that, he realized that not one of the US audio publications was publishing reviews that were critical of equipment. In fact, in some cases they were ignoring some flaws.

However, if the reviewer wishes to review how equipment sounds, he faces a severe problem. Our sense of hearing has the smallest vocabulary of any of our five senses. Thus, **Gordon** faced the difficulty of describing sound differences with all too few words with which to do it. He not only had to invent the techniques and disciplines of

what has become known as "subjective reviewing" but also the language with which to do it.

Today, the magazine he founded has become a major force in audio quality judgments around the world. And almost all the vocabulary definitions are his work.

Seldom will you have the opportunity to purchase a reference work backed by so much primary research and experience. Few reviewers have spent more time and energy in an honest search for a defined, factual account of what matters in good sound reproduction techniques. In audio equipment reviewing, **J. Gordon Holt** is not only a pioneer but a master.

*THE AUDIO GLOSSARY* is the first publication of not only a vocabulary for sound description, but also a comprehensive overview of over 1,900 audio terms: technical and subjective. Your copy is waiting—at your favorite dealer—or order direct using the coupon below.

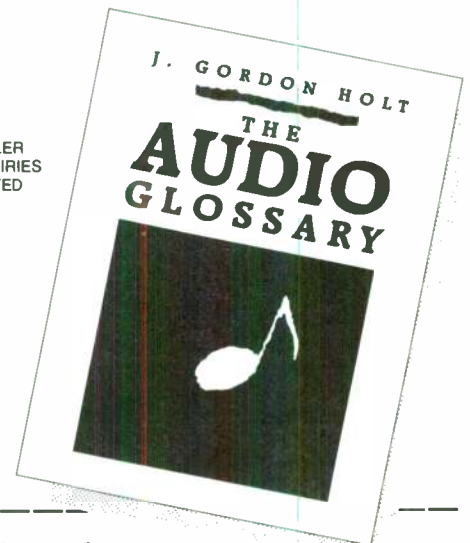

DEALER  
INQUIRIES  
INVITED

**YES!** Please send me *The Audio Glossary!*

\_\_\_\_ Softbound BKA-7/S @ \$9.95 \$\_\_\_\_

\_\_\_\_ Hardbound w/ dust jacket BKA-7/H @ \$17.95 \$\_\_\_\_

\_\_\_\_ Autographed Limited Edition BKA-7/L @ \$30 \$\_\_\_\_

Please add \$1.75 shipping for first book, 50¢ each add'l \$\_\_\_\_

TOTAL ORDER \$\_\_\_\_

TOTAL

CK/MO enclosed  MC  VISA

NAME \_\_\_\_\_

STREET & NO. \_\_\_\_\_

CITY \_\_\_\_\_

STATE \_\_\_\_\_

ZIP \_\_\_\_\_

MC/VISA \_\_\_\_\_

EXP. \_\_\_\_\_

### OLD COLONY SOUND LAB

PO Box 243, Dept. B90

Peterborough, NH 03458-0243 USA

(603) 924-6371 / 924-6526 / FAX: (603) 924-9467

Answering machine for credit card orders only: (603) 924-6371 before 9:00 a.m., after 4:00 p.m., and weekends.  
Have information plus MC/VISA available.

• also available at your favorite audio dealer •

## Ask Speaker Builder

Continued from page 68

like. Each loop of the spring represents a wave of the magnetic force. At the inside of the donut (where the magnet is) the loops are very close together, and the field density is the highest. At the outside, the loops are far apart, and the field density is correspondingly low. Also, the magnetic field must pass radially through the voice coil in order to generate a force along the axis of the coil. All the rest of the components of the magnet come into play here.

These "accessory" pieces help focus and concentrate the magnetic field where we want it. Our typical magnetic circuit, usually has three pieces: the front plate, the rear plate and the pole piece.

The front plate looks like nothing more than a giant washer (and, in some speakers, it is exactly that). It is typically round, usually has about the same outside diameter as the magnet, and its inside diameter is just slightly larger than the voice coil.

The rear plate looks very similar to the front plate, but does not have a hole in it, except what's needed to mount the pole piece. Its outside diameter is also about the same as the magnet's. The rear plate may be flat, or it may be dished to allow more room for the voice coil.

The pole piece is securely fastened to the center of the rear plate (and, ideally, is often physically the same piece of metal as the rear plate). It is a round, solid cylinder whose outside diameter is slightly smaller than that of the voice coil.

The material used to fabricate these materials is usually a low-carbon steel, also referred to as "soft iron" (and it is a little soft, compared to most other steels).

The magnetic circuit is assembled as a sandwich, starting with the rear plate with the pole piece mounted in the center. The magnet is then glued (using a fast setting adhesive) on top of the rear plate, then the front plate is glued to the top of the magnet, taking care to make sure everything is perfectly concentric. Mechanically, the assembly is complete.

### Line Tamer

The magnetically soft iron parts of the magnetic circuit now force the magnetic lines to move, not in their nice neat circles, but rather through them instead. In most cases, the iron does a good job of making the magnetic field go where we intend. Now all of the field is concentrated in the voice coil gap, the narrow cylindrical space between the outer diameter of the pole piece and the inner diameter of the front plate.

If we designed and manufactured our magnet well, making sure the parts have the right composition, and everything mates together perfectly, and everything is the right size, then we will have accomplished our task; the magnetic field will be concentrated right in the gap where we want it. However, even in the best of designs, a portion of the field will not be prevented from doing what it wants to do naturally: travel in nice neat circles. Usually, this part of the field will escape from the rear plate, radiate right out and travel around back into the front plate. Not only is this part of the field wasted and not available for moving the voice coil, it can also affect external magnetically sensitive devices such as video monitors, distorting the picture. Or it can partially erase magnetic tapes and disks. As much as 50% of the total magnetic energy can be wasted this way.

Imperfect fit between parts is another problem. The only place where we do not want a tight mechanical and magnetic junction between parts is at the voice coil gap. Any other gap in the circuit will allow some of the magnetic force to leak out of the circuit. If the front plate and rear plate are not perfectly flat, as well as the faces of the magnet, gaps will be there as well. Surface imperfections are not unusual (such as bumps or warps) of more than 0.006"; a good magnet should be flat to within less than 0.001". Here, another 10% to 25% of the field can be wasted. A poor fit between the pole piece and the back plate can give rise to another 10% wastage.

So adding all these problems together, it is not surprising to find that *most* of the magnetic energy is wasted, and only a minority of the field ever finds its way to the gap to do useful work.

Certainly, a manufacturer can do much to improve the quality of the parts he is using. It makes sense to spend the effort to design the best circuit you can, and to specify very tight tolerance parts. Doing this makes the most use of magnetic material at hand. A very efficiently designed and built magnet system can get as much field in the gap using a small magnet as a poorly designed, sloppily made circuit can with twice the magnet.

The magnet is the most expensive single part in a loudspeaker driver, sometimes accounting for more than 50% of the total parts cost. Unfortunately, most manufacturers use poorer quality parts, and consequently must use bigger and more expensive magnets.

All this is wonderful if you're building drivers, but what can someone do to improve the performance of a driver you already own? Well, one way is to coerce the magnetic field back to where it belongs, and this is where a reversed-polarized "bucking" magnet comes in to play. Remember when you were playing with magnets, and you found that if you placed

the north pole of one magnet next to the north pole of another the magnets pushed each other away? ("Opposites attract, like repel" is true in most of the physical world, save Congress.) Well, the exact same phenomenon is happening here. By placing a magnet on the rear plate so that its force is repulsive, it will, in effect, push the stray, escaping field of the speaker's magnet *back* into the magnetic circuit, where it can now find its way into the voice coil gap.

The combination also significantly reduces the total stray field of the two, so these drivers can now be used in close conjunction with video monitors, and not be quite as dangerous to magnetic tapes and disks.

### Unattractive

In choosing the magnet size, I have all sorts of sophisticated magnetic measurement equipment on hand to determine the best combination. And I have noticed one tendency in selecting the right-sized magnet: the reversed polarized magnet whose repulsive force goes to zero as it approaches and comes in contact with the rear plate seems to be near ideal. In other words, the net force when in contact is neither repulsive nor attractive. One which is attracted at all points is too small or weak; one which is strongly repulsive is too large and strong. I also observe that the reverse-polarized magnet is typically from 60% to 80% the mass of the main magnet.

Reader Kinsley also goes on to say: "I'm not sure I fully understand the function of the metal can, and how it 'completes the circuit'. I assume that the pole piece and gap normally 'complete' the circuit in a normal driver. Is the can required because there is no 'back plate' on a plain magnet.... Why was a cat food can used? Since this is a woofer, I would think the logical choice would be a dog food can! (I'm sorry!)"

Well, as logical as a dog food can might seem, this is a clear indication that Brian Smith likes cats. This further indicates that we might have a terrible problem with tweeters, since I know of no brand of bird seed that comes in metal cans, and we all know what a terrible magnetic material plastic bags and cardboard boxes make! (You should be sorry!)

### Risky Business

However, back to the point. If, as a result of adding the reverse magnet, we still have an excessive external field, then adding a magnetic can will force the field back towards the voice coil gap. Unfortunately, this is a risky venture which I would, in general, not recommend, because of the possibility of now "shorting" out the circuit by causing an easy return path for the magnetic field, robbing energy from the gap.

And Mr. Kinsley continues:



"What effect does the addition of the magnet have on  $V_{AS}$ ? What about the added mass of the polyurethane and/or the BBs?"

In fact, it should have no effect at all.  $V_{AS}$  is determined solely by the stiffness of the surround and spider. Changing either the strength of the field in the gap or adding mass will not affect these parts. Be aware, however, that adding mass in the wrong place or of the wrong type can cause other mechanical problems. I have known of more than one instance where an iron ring was used to increase the mass of a driver. After carefully epoxying the ring in place as close to the voice coil as possible, the owner was very chagrined to discover the cone was now permanently biased inwards by the very

strongly attractive force between the iron ring and the nicely leaking magnetic field from the voice coil gap.

I hope this answered Mr. Kinsley's specific question, as well as provided insight to others on some of the intricacies of magnets.

Since I wrote the column describing anechoic measurement techniques a couple of issues ago, I have received a tremendous and very positive response for which I am most gratified. I think, though, I have unleashed an insatiable monster with that article!

Every reply asked (and, in some cases, demanded) more information on measuring loudspeakers. Many of you who replied showed a very strong interest not so much in actual measurement tech-

niques, but in the basic underlying theory behind measurement in general. You want to know how an FFT works, why windowed measurements have little low frequency information, and so forth. This just goes to show that it's not necessarily wise to underestimate the intellectual curiosity of a *Speaker Builder* reader.

So, I will attempt to prepare a series of articles on basic measurement theory. To help me, please keep your questions coming. Not only will they help me write these articles, but they may provide fodder for other "Ask Speaker Builder" columns. And those other letters, the ones that are just a little bit silly or ridiculous, I'll just forward them to that Dick Fierce character. I'm sure he'll find a use for them!

# SPEAKER COMPONENTS

## CROSSOVER COMPONENTS

DYNAUDIO®

ETON

FOCAL



scan·speak

seas

vifa

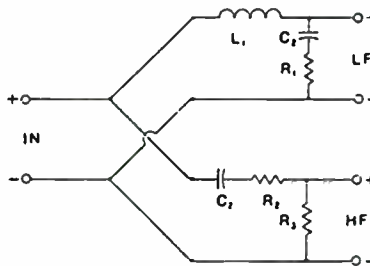
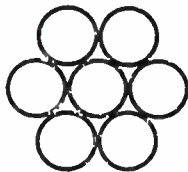
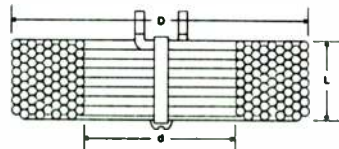
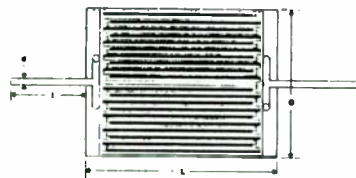

### FAST CAPACITORS

Metallized Polypropylene (Non-Polarized)  
Values from 1.0 mfd to 200 mfd.  
Voltage Rating: 250 VDC / 150 VAC

### SOLENI INDUCTORS

Perfect Lay Hexagonal Winding Air Cored  
Values from .10 mH to 30 mH,  
Wire Sizes from #20 AWG to #10 AWG

### HEPTA-LITZ INDUCTORS

Seven Strands Litz-Wire Constructions  
Values from .10 mH to 30 mH  
Wire sizes from #16 AWG to #12 AWG

### SOLENI CROSSOVERS

Custom Computer Design  
Passive Crossover for Professional, Hi-Fi and Car Hi-Fi, Power up to 1000 Watt.

### CROSSOVER, SPEAKER PARTS

Gold Speaker Terminals, Gold Banana Plugs  
Gold Binding Posts, Crossover Terminals,  
Power Resistors, Mylar Capacitors,  
Plastic Grill Fasteners, Nylon Ty-Wraps  
Grill Cloth, Car Speaker Grills, Misc. Parts.



**SOLENI INC.**  
4470 Thibault Ave.  
St-Hubert, QC J3Y 7T9  
Canada  
Tel.: (514) 656-2759  
Fax: (514) 443-4949

### COMPUTER AIDED DESIGN FOR ENCLOSURE AND CROSSOVER AVAILABLE TO CUSTOMER

Product specifications and prices available upon request.

# Vintage Designs

## Altec-Lansing's 606-Type Cabinet

Courtesy of Sanford Marzel

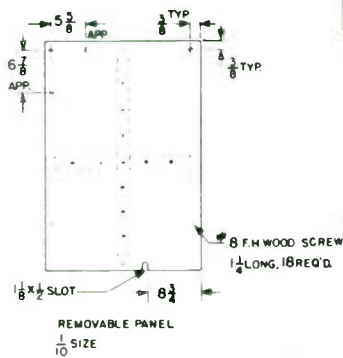

REMOVABLE PANEL  
1/10 SIZE

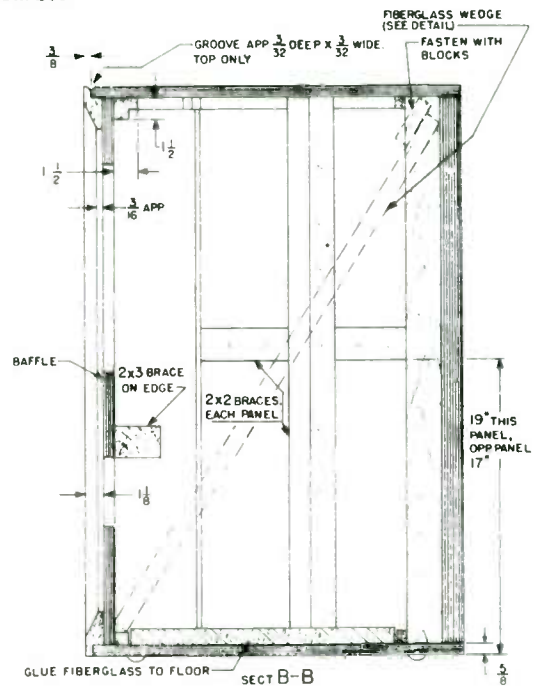
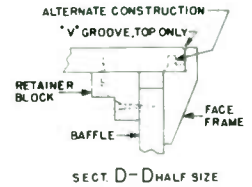
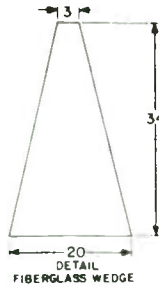
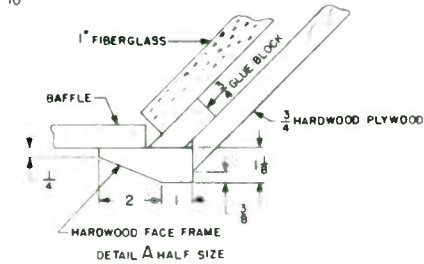

NOTES:

- 1- ALL JOINTS TO BE GLUED AND NAILED OR SCREWED EXCEPT AS SHOWN
  - 2- HARDWARE REQUIRED TO MOUNT LOUDSPEAKER
- 15" SPEAKER - 1/4" - 20x 1/2" MACHINE SCREWS (4 REQ'D)  
12" ... .. 1/4"

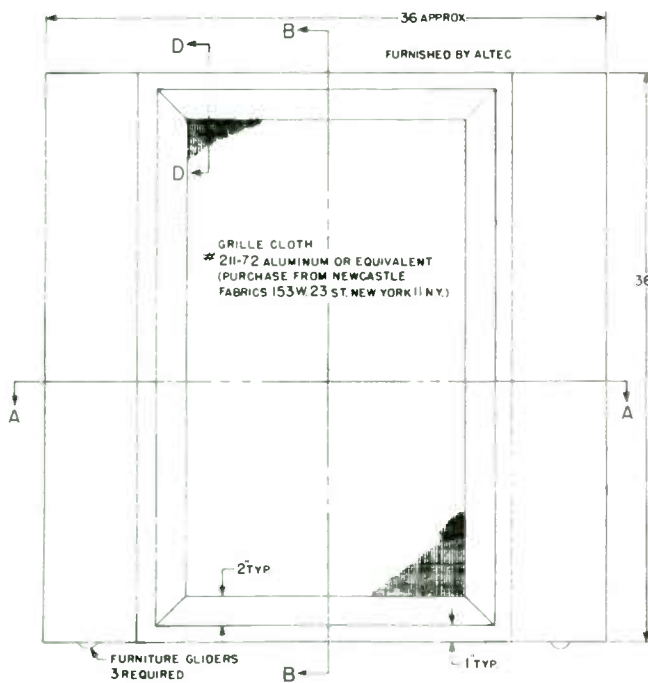
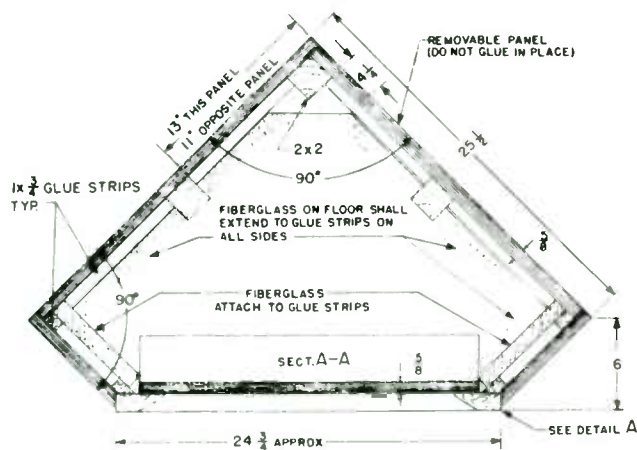

MATERIAL: 3/4" PLYWOOD (EXCEPT AS SHOWN)  
RECOMMENDED GRILLE CLOTHS  
BLONDE CABINETS - NEWCASTLE 211 LT BLONDE  
DARK CABINETS - 211-72 ALUMINUM  
FIBERGLASS PF-617 (OC9) 1" THICK

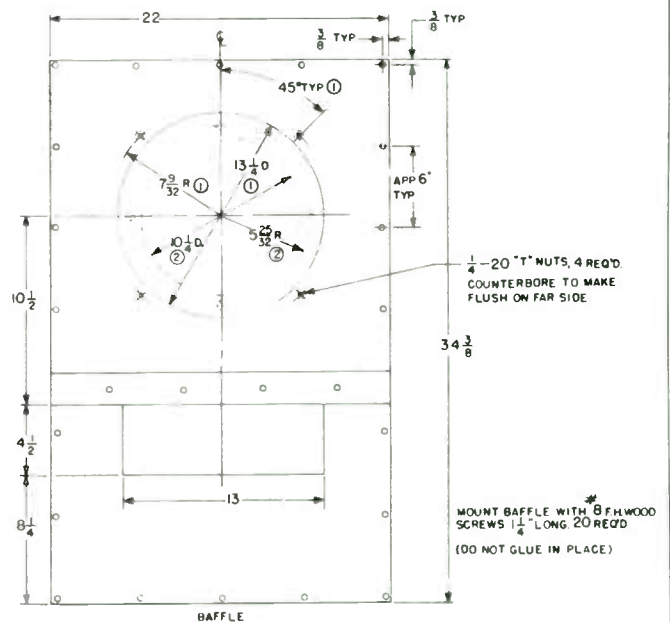

- (1) 606A CABINET (FOR 15" SPEAKER)
- (2) 606B CABINET (FOR 12" SPEAKER)

606 TYPE  
CABINET

## Mailbox

continued from page 4

I have never specifically mentioned this technology, I don't know how he came to this conclusion. Since I have a B.S. in physics from M.I.T., and an M.S. in physics from Caltech, I think I can claim some understanding of mechanics, electricity and magnetism.

As far as his own understanding of the technology is concerned, Hartley's explanation of the physics of restoring force and its magnetic suspension is clearly incorrect. For example, they claim that a goal of loudspeaker designers is to speed up, or increase the restoring force. Since the restoring force, together with the cone mass, dictates the resonance frequency—and hence low frequency rolloff of the speaker—the goal in many woofer designs is to actively decrease the restoring force (increase the compliance) so as to extend the bass. Hartley also claims that the restoring force "restores" the speaker to center after the signal drives it off-center. In fact, the driving amplifier not only pushes the speaker cone off-center, but also pushes it back. If this were not so, there would be horrible distortion, as the restoring cone movement would de-

pend on the inherent characteristics of the driver and not on the audio signal.

Finally, I am dismayed by the tone of some of Mr. Schmetterer's comments. He asserts that he has "refuted" my data without providing any of his own, yet he calls my refusal to blindly accept his unsupported claims as "stubborn" and "closed-minded." Since I do not suppose my unsupported statements are enough to win a technical argument, I have tried to back up all my statements with data, and to provide enough information so others could duplicate them. I do not consider it stubborn or closed-minded to conclude that when all the measurements agree with each other within the framework of a widely accepted theory, that this is strong evidence that the theory explains the data. Indeed, that is how science is done.

If my measurements had turned up any anomalies I would have been more than happy to report them, but none were found. If those data are wrong, then the appropriate response, in my view, is to present better data. Apparently, Mr. Schmetterer would have me disregard my data in favor of his unsupported claims. His attitude seems to be, "Who are you going to believe, me or the facts?" I simply suggest that readers examine the arguments and data presented, and judge for themselves who is correct.

Mr. Schmetterer seems to feel that insults, misstatements of fact and physical theory, and condescension are appropriate refutations of technical data. I disagree, and consider his refusal to address my measurements by providing his own data to refute them, such as frequency response curves, impedance curves, and specific examples of anomalous T/S measurements, an insult to the readers of *Speaker Builder*.

James Lin  
New York, NY 10028

Richard Schmetterer replies:

It seems apparent that Mr. Lin is once again rehashing the same old thing.

Mr. Lin contends that since three people have ascertained similar measurements, those measurements must be true. And therefore, Hartley's measurements must be wrong.

Therefore, I submit to Mr. Lin the following people who have agreed with our measurements:

1. NASA: Professor E. Galanter, head of Psychoacoustics at Columbia University.
2. Professor J. Boyk, Professor of Acoustics at Caltech.
3. Mark Levinson, previously of Mark Levinson Audio.

All of the above have two things in common, namely, fine measuring equipment at their disposal and knowledge in interpreting the readings.

## HOW CAN YOU HAVE PERFECT FIT, CUSTOM CABINETS EVERY TIME?

FOCAL 033  
\$50 Ea.

FOCAL 133  
\$75 Ea.

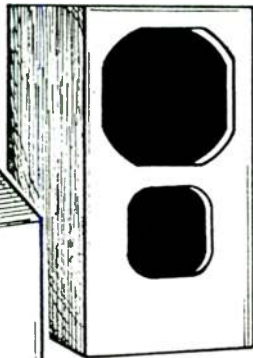
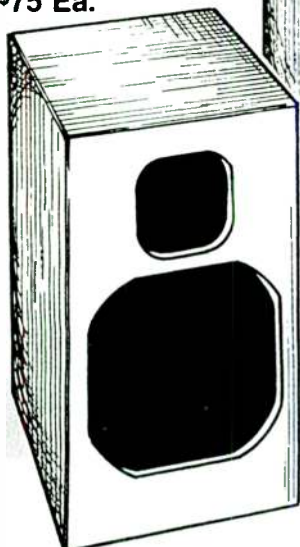

### LET ELLIOT MAKE THEM FOR YOU!!!

Zalytron is proud to introduce our new line of custom made cabinets, designed to accommodate those hobbyist with little time or skill to make their own.

This special line features **1 1/4"-High density particle board** for better sound quality and is available in matte black, gray, oak or walnut laminate, with your choice of black or gray grill. Driver holes are precision cut to meet your exacting needs.

Our line brings the highest raves from Focal America representative, Kimon Bellas

ARIA 5 \$75 Ea.



# ZALYTRON

INDUSTRIES CORP.

469 JERICHO TURNPIKE, MINEOLA, N.Y. 11501

TEL: (516) 747-3515

TOLL FREE: (OUTSIDE N.Y. STATE) 800-645-6098

FAX: (516) 294-1943

Fast Reply #HE151

# LRS ELECTRONICS

## Concave Aluminum 1" Dome Tweeter

Linear Piston Behavior  
from  
1600 Hz to 26000 Hz



(Actual size is 4 7/8" square)

High Power Handling  
and Low Distortion

Team up with eight  
or six inch precision  
hand crafted woofers  
to enjoy a superbly  
articulate and transparent  
loudspeaker system

Full application support  
and design information  
is always available

Please call or write for  
further details:

P.O. Box 1256  
Dover, NH 03820  
(603) 749-1904

Fast Reply #HE387

Finally on this matter, two resonance calculations by Mr. Lin of 28.4MHz and 32Hz are not within "spitting distance." These are over 11% apart.

*Audio Critic* did review a Hartley driver in a homemade box some one-half the recommended size, as we later found out. The box was not 4' x 3' x 2' as Mr. Lin contends. Fortunately, at the time, we did not have to pursue legal avenues because the magazine went dormant.

In our view:

1. A fuse is a non-discriminating device.
2. A fuse is only 70-80% effective.

In other words, it may or may not blow—it doesn't discriminate between incoming transients. Hartley *does not* build fuses for this reason. If Mr. Lin desires to use this untrustworthy technology, I refer him to my previous comments showing a standard power formula as given to me by the chief engineer of Littlefuse.

Hartley has been supplying the amateur home speaker builders since 1956. We have built a solid reputation on this fact. Most people have taken our recommendations and built superb systems—we have files filled with letters of praise!

Since Mr. Lin clearly believes his knowledge of physics and acoustics is superior to ours, we welcome a transducer design from him which he could submit for review.

Mr. Lin, please note the following achievements made by our company:

- A. 1940s—The first attempt of rear-wave filtering using a seven-stage internal acoustic filter, "The Boffle."
- B. 1956—The world's first plastic cone (patent).
- C. 1956—The world's first true coaxial voice coil (patent).
- D. 1956—The world's first voice coil internal servo system, magnetic suspension (patent).
- E. 1960s—The world's first tube trap, The Sound-sorber, used internally for cabinets (copyright).
- F. 1972—The world's first speaker system made with mirror-imaged drivers, The Zodiac '72.
- G. 1970s—The world's first permanent magnetic assembly to yield perfect symmetrical field density.
- H. 1970s—The first gravimetric balance made in the U.S. to measure flux density against the constant of gravity.

Continued on page 80

# MOUTH

Word of mouth helps us grow, and our growth means a stronger publication that can do more of the things that need doing in the pursuit of better speaker systems. If you have friends, associates, relatives or even enemies who share your enthusiasm for *SB*, either let us send you prospectuses to pass along to them or tell us their names and addresses, and we will send the word along. THANKS.

# POWER

## Put a little MAGIC into your life

(and in ours too!)

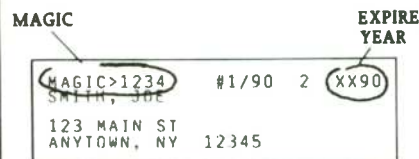

Do you want quick service on orders and subscription requests? If so, make sure you use your "magic number" when corresponding with us. This number, which appears in the upper left corner of your mailing label, is your key to a speedy reply. Use it to help us serve you better.

NEW!



### TIPTOES from The Mod Squad

Made from a special alloy with superior sonic characteristics, these metallic cones are component platforms that you place point down under your audio or video equipment to increase signal clarity, resolution, and detail. With audio components such as amps, CD players, and loudspeakers, they can increase the dynamic range of your system; with video components, they can increase color intensity. 1 1/2" in diam., 1/2" high. 3 per component recommended.

HDTT EACH \$6 THREE FOR \$17

### DISC ADE CD DAMPER from Apature

Users report that the Disc Ade helps enhance virtually every sonic characteristic of CDs. Acceptable by any CD player, the DA is a reusable (and washable) soft vinyl mat which is loaded on top of the CD in the player and stays in place because of its rubbery texture. Complete with CD-style case.

HDDA EACH \$18.95

### OLD COLONY SOUND LAB

PO Box 243, Dept B90, Peterborough, NH 03458  
(603) 924-6371 / 924-6526 / FAX (603) 924-9467

Answering machine for orders only: (603) 924-6371  
before 9:00 a.m., after 4:00 p.m. and weekends.  
Have all information plus MC/VISA available.

# Speaker Builder

THE LOUDSPEAKER JOURNAL

BACK ISSUES

## 1980

Realism Testing • Ambience Reproduction • Upgrade Mods for Small, Cheap Speakers • Diffraction and Cabinet Shape • Speaker Cables: Measurable and Audible Differences • A Three Enclosure System with Active Crossover and Delay (in 3 parts) • Electrostatic Speaker Construction Project (in 3 parts) • Double Chamber Enclosure: Deep Bass from an 8" Woofer • Corner Midrange Horn • Thiele/Small and Vented Speaker Design: Part I •

## 1981

A Testing Unit for Speaker Parameters • Variable-Volume Enclosure • Thiele/Small Theory (in 3 parts) • Easy to Make Enclosure Using Concrete Blocks • The Tractrix Horn: Good Dispersion Bass From an Old Design • Diffuser Port for Small Boxes • Mini-Speaker Made From PVC Tubes • Closed vs. Vented Box Efficiency • Interview with P.G.A.H. Voigt • Dual 8" Symmetrical Air Friction Enclosure • Thiele/Small Calculator Computations • Thiele/Small Parameters for Passive Radiators •

## 1982

Transmission Line Theory • Thiele/Small Sixth-Order Alignments • The Quad 63 • Table Saw Basics • AR-1 Modifications • Active Crossovers and Phase • Three Transmission Line Speakers • A Beginner's First Speaker • How Passive Networks Interact with Drivers • Horn Loaded Heil • Phase Correcting Active Crossover • Wind Your Own Inductors • Series and Parallel Networks • High Performance Corner Speaker • Using Zobel's to Compensate for Driver Characteristics •

## 1983

Building the Two-Way Dynaudio • A Crossover That Offsets Speaker Impedance • Using a Calculator for Box Design • Choosing a Calculator • A Simple Peak Power Indicator • A Small Horn Speaker • Audio Pulse Generator • How to Use Speaker Pads and Level Controls • An Easy-to-Build Voltmeter for Speaker Measuring • Nomograms for Easy Design Calculations • Interview with KEF's Raymond Cooke • Build a Simple Wattmeter • A New Type of Speaker Driver •

## 1984

Build an Aligned Satellite/Woofer System • BOXRESPONSE: A Program to Calculate Thiele/Small Parameters • Casting with Resins • A Phase Meter • An Interview with Ted Jordan • Building the Jordan-5 System • Self-Powered Peak Power Indicator • Closed Box Design Trade-offs • How to Build Ribbon Tweeters • Build a Dual Measurement Impedance Meter • A High-Power Satellite Speaker System • Build and Use a White/Pink Generator • Sound Pressure Level Nomographs •

## 1985

Compact Transmission Line Subwoofer • Bullock Crossovers, Passive and Active, three parts • Drive Attenuator, Computer-Designed • Curved Vertical Array • Sontek Powered Subwoofer • An Isobarik System • Modifying Strathairn's Ribbon • Ambience Systems • Experimental Transmission Line • Small Double-Chamber Reflex • Loose Walled Speaker • Modifying the Daline •

## 1986

The Edgar Midrange Horn • Sand-Filled Stands • Crossover Networks: Passive and Active • 5-Sided Boxes • A 2x4 Transmission Line • The Free-Volume Subwoofer • Notch Filters • Bi-Wiring the LS3/5A • A Push-Pull Constant Pressure System • Current and Power in Crossover Components • The Unbox (Egg) • Upgrade Speakerlab's S-6 Crossover • Measure Speakers with Step Response • A Gold Ribbon System • A Visit with Ken Kantor • A Tractrix Horn Design Program • Reviews: Audio Concepts "G," Seven T.L. Midranges; Focal's Model 280; the Audio Source RTA-ONE •

## 1987

A Compact TL Woofer • Frequency Response and Loudspeaker Modeling (three parts) • A Manual Coil Winder • The Model-One Speaker • Designing a Listening Room • A Sixth-Order Vented Woofer • Tapered Pipe Experiments • Visiting Boston Acoustics • A Vented Compound System • The Octaline • Spreadsheets for Speaker Design • In Memoriam: Richard Heyser (two parts) • Using Non-Optimum Vented Boxes • Building Speaker Stands • Evaluating Driver Impedance Compensation • Tuning Bass-Reflex • Six Woofers Compared • Bullock on Passive Crossovers: Alternate Bandpass Types • Fast, Easy Filter Calculations • A Mobile Speaker • Modifying the Polk 10 •

## 1988

Electronic Turns Counter • Two-Way Design • Minimus-7 Mod • Dome/Midrange/Tweeter Array • Plotting Complex Impedances • A Driver Design Primer • A Cabinet Primer • Tuning Up Old Systems • Low-Cost AR-3 Upgrade • Electronic Time Delay • Enclosure Shapes and Volumes • Minimum-Phase Crossovers • Spot Sound Absorbers • How to Add a Subwoofer • The Swan IV System • Sub-Bass Power Boosting • The Unline: A Short TL • Active Filter Computer Design Program • Low-Cost Two-Way Ribbon • Amp-Speaker Interface Tester and Construction Plans • The QB<sub>3</sub> Vented Box is Best • A Pentagonal Box System • Keith Johnson Profile • Sheathed Conductor ESL • A Symmetrically Loaded System: Part I • Ceramic Enclosure • Inductance Measuring Technique • Polk 10 Mods •

## 1989

A Middle/Side Speaker • A Satellite/Woofer System • A T/S Driver Program • All About Cordless Drills • Symmetrically Loaded System, Part 2 • Adjusting Auditorium Acoustics • The Audio Laboratory Speaker System • A Passively Assisted Woofer • Digital Filter Tutorial • The Listening Arc Alignment • Small IC Power Amp & Crossover • Easy Surround Sound • Building Speaker Spikes • An Isobarik in a Thunderbird • Sheetrock Cabinetry • A Picket Speaker • Servo-Controlling AR-1 • Silent, Safe Muting System • Equalizing the Klipsch Cornwall • A Test Switcher • Visiting the Klipsch Kingdom • Rehab for Kitchen Music • Spreadsheet Design • A Subwoofer/Satellite System • Impedance Measurement as a Tool • Practical Passive Radiators • A Symmetrical Dual Transmission Line Parts 1 & 2 • The Microline • A Voice Coil Wheatstone Bridge • Tweeter Q Problems • A Dipole Subwoofer for the Quad • Adjusting Woofer Properties • Modifying Paradigm's 7se •

## BACK ISSUES ORDER FORM

Please send:

- |                                      |                                      |
|--------------------------------------|--------------------------------------|
| <input type="checkbox"/> 1989 @ \$20 | <input type="checkbox"/> 1984 @ \$12 |
| <input type="checkbox"/> 1988 @ \$20 | <input type="checkbox"/> 1983 @ \$12 |
| <input type="checkbox"/> 1987 @ \$15 | <input type="checkbox"/> 1982 @ \$12 |
| <input type="checkbox"/> 1986 @ \$15 | <input type="checkbox"/> 1981 @ \$12 |
| <input type="checkbox"/> 1985 @ \$15 | <input type="checkbox"/> 1980 @ \$12 |

Check  MO  MC  Visa

Amount enclosed \$ \_\_\_\_\_

MAGIC NUMBER

UPS delivery add \$2 for the first two sets, each additional set 50¢.

Canada add \$4 postage per year. Please make checks payable to Audio Amateur Publications. Checks in US \$ only.

NAME \_\_\_\_\_

STREET & NO. \_\_\_\_\_

CITY \_\_\_\_\_

ST \_\_\_\_\_

ZIP \_\_\_\_\_

CARD # \_\_\_\_\_

EXPIRES \_\_\_\_\_

Speaker Builder Magazine PO Box 494, Peterborough, NH 03458-0494 USA

MC/Visa Phone Orders: (603) 924-9464; FAX: (603) 924-9467

Continued from page 78

I. 1980s—The invention of the air-column, vented cabinet design that uses vent theory and pipe theory (from pipe organ) together.

Now, Mr. Lin, we do our homework, and we have the satisfied customers and many distinguished engineers to back us up.

$Q_T$  and  $V_{AS}$  may vary from unit to unit (of a given model),  $f_S/Q_T$  and  $f_S^3 \cdot V_{AS}$  are more fundamental quantities and should show smaller variances. I applied this to Edgar's data and arrived at the following:

Driver	$F_S$	$Q_S$	$V_{AS}$	$F_S/Q_S$	$F_S^3 \cdot V_{AS}$ 1000	Comment
1	56.4	0.20	3.3	282	10.5	$V_{AS}$ error?
2	53.2	0.19	3.98	280	11.26	
3	55.2	0.21	3.71	263	11.30	
4	54.6	0.20	3.76	273	11.21	
5	55.0	0.22	3.88	250	11.74	
6	52.2	0.23	4.33	227	11.80	$F_S$ or $Q_T$ error?

## PUZZLED BY CUTOFF

Table II of Bruce Edgar's "Show Horn" article (SB 4/90) lists measured EVM-12L parameters. Years ago, Snyder (of SpeakerLab) contended that although  $f_S$ ,

Why didn't you carry  $Q_S$  to three places?

I am puzzled by the abrupt cutoff of horns in general. Is it as much as 24dB/octave? Does distortion get really bad in the cutoff region? If not, isn't it possible to extend the cutoff somewhat by electronic equalization? Do you believe such rapid cutoffs cause excessive ringing?

Will you be providing updates on your small bass horn and midrange horns? What about a tweeter horn?

David J. Meraner  
Scotia, NY 12302

Bruce Edgar replies:

Thank you for your comments. I am familiar with the Sherwood Forester horn design, although I have not personally auditioned one. If there is an SB reader who has one, I would be interested in his comments. The Sherwood has a very nice folding scheme, but the horn is too short and the mouth too small for good smooth bass without resonant peaks.

The list of EVM-12L parameters in Table 2 of the Show Horn article was compiled by myself about six years ago. According to my lab notes, I used good Hewlett-Packard test gear for the meas-

Great designs are never out-of-date

# 25 Classic Loudspeaker Projects from Audio Amateur

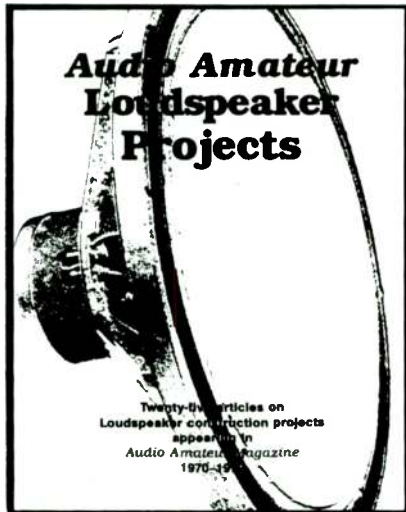

These projects, from the decade of the 70s, are still as challenging and rewarding as the day they appeared.

The complete contents listing features:

Peter J. Baxandall: *The LC/HQ Mark I, Parts 1 & 2*; David P. Hermeyer: *An Electrostatic Speaker System, Parts 1 & 2, An Electrostatic Speaker Amplifier, Mark II, A High Efficiency Electrostatic Speaker System, Parts 1 & 2*; Nelson Pass: *Reduce Speaker Distortion by Tuning a Pipe*; J. Theodore Jastak: *A Transmission Line Speaker, A Jolly Transmission Line Giant*; Edward H. Parker: *How to Photograph Sound*; James Nicholson: *A High Efficiency Mid- and High-Range Horn*; Alan Watling: *Back to the Wall*; B. J. Webb: *A Proven Transmission Line Loudspeaker*; Roger H. Russell: *Speaker Evaluation: Ear or Machine? Parts 1 & 2*; James S. Upton: *In Defense of the Ear*; Lynn B. Neal: *The Compact Tower*; Roger R. Sanders: *The Sanders Electrostatic Speaker, Parts 1 & 2*; Michael Lampton, Robert and William Bowyer: *Design and Build a High Efficiency*

Available in a single bound volume of 135 pages. 8½ × 11.

*Speaker System*; Neil Davis: *The Folded and Stapled Bass Horn, An Amateur's Version of the Heil Air Motion Transformer*; David Reuther: *The Big Bass Box*; C. R. B. Lister: *The Little Big Horn*.

Please send me \_\_\_\_\_ copies at \$20 each \_\_\_\_\_

MC  VISA Shipping \_\_\_\_\_  
 CK/MO TOTAL \_\_\_\_\_

**NOTE: BOOKS ARE NOT RETURNABLE FOR EXCHANGE OR CREDIT.** Please print in clear block capitals quantity needed, name and address. **REMIT IN US \$ ONLY** by MC/VISA, check or money order.

POSTAGE & HANDLING. In US, add \$1.75 for first book and 50¢ each additional book. In Canada, add \$4.50. Overseas, include 20% of total order for shipping. BKAA-1

DEALER INQUIRIES INVITED

NAME \_\_\_\_\_ MAGIC NO. \_\_\_\_\_  
ADDRESS \_\_\_\_\_  
CITY \_\_\_\_\_ STATE \_\_\_\_\_ ZIP \_\_\_\_\_  
MC/VISA \_\_\_\_\_ EXP. \_\_\_\_\_

## Old Colony Sound Lab

PO Box 243, Dept. B90, Peterborough, NH 03458

(603) 924-6371 / 924-6526

FAX: (603) 924-9467

Answering machine for orders only: (603) 924-6371 before 9:00 a.m., after 4:00 p.m. and weekends. Have all information plus MC/VISA available.

A  
LETTER

Asking  
For  
Help  
Without

A  
Self  
Addressed  
Stamped  
Envelope  
Goes  
HERE!!



PLEASE!!

urements. I remember that I was somewhat surprised by the wide variance between samples. The six samples listed were the ones closest to the E-V spec. Four other samples had  $Q_{TS}$  values above 0.4, which is well out of tolerance. The measurements were run twice to make sure I had not made an error. I telephoned E-V and talked to a person on the testing staff about it. He explained that the EVM-12L drivers were made in a plant in Tennessee, and samples were shipped to Michigan for testing. So theoretically, they could miss a production series that went out of spec briefly. To E-V's credit, they assured me that they would replace any new driver that measured out of spec.

I would agree with you that the  $F_s/Q_{ES}$  ratios should show smaller variances. I have found that to be true for drivers with higher  $Q_s$ . But in this case you are dealing with very low  $Q$  drivers which have relatively high  $F_s/Q_{ES}$  ratios (greater than 250). Small variations in  $Q_{ES}$  values will affect the ratio more than with drivers having  $F_s/Q_{ES}$  ratios around 100. I usually don't take  $Q$  calculations beyond two places because the accuracy of the measurement normally won't support any more significant places. In general, you can only measure  $R_f$  to 0.1Ω and frequency to 0.1Hz, even if you have good test gear. So at best, those limitations will hold you to about two-place accuracy, and you could argue about that second decimal place. You would need an Audio Precision test setup to do any better.

With regards to the horn cutoff frequency, the low frequency cutoff can be quite abrupt because the loading goes from resistive to reactive loading at the flare frequency. At the upper cutoff, the mass rolloff will give a 6dB/octave attenuation rate. But folding and front chamber effects can add their own attenuation to produce a steeper rolloff rate. You may be able to improve the bass response near the lower flare cutoff with equalization, but the rapid change in phase below the flare frequency may be hard to compensate for with ordinary equalizers. And the resultant bass may not be all that satisfactory.

As far as updates to my old designs are concerned, I really can't promise any. The small corner horn (SB 2/83) was optimized for the tractrix contour, and a change to a hyperbolic flare would necessitate many changes to accommodate the longer horn length. So I would rather start out with a "clean slate" for a horn design and "let sleeping dogs lie." But I would not rule out any brainstorming, sudden inspirations, or a revolutionary new driver that would spur me on to revise an old design for a new application.

## FOAM RINGS DON'T HELP

I continue to see articles, letters and advertisements in *Speaker Builder* advocating the use of a foam or felt "diffraction ring" around the tweeter. This is a well-named device, since in theory such an addition will usually increase the deleterious effects of diffraction. By absorbing high frequency energy, the diffraction ring causes the overall frequency response to be that of a tweeter mounted

in a disk-shaped baffle the size of the ring's interior. As Harry Olson showed nearly 40 years ago ("Direct Radiator Loudspeaker Enclosures," *Audio Engineering*, November 1951), this is the worst possible case, producing overall frequency response variations of about 10dB and resembling a "comb filter."

One model for diffraction considers the sum of the reflections of the driver's output from each infinitesimal unit of area of the baffle surface. The "drop-off" at the baffle edge has the same effect as an absorbing piece of foam: it produces a discontinuity where sound is no longer reflected. If this discontinuity occurs at an equal distance from the driver in all

directions on the baffle—as with a disk-shaped baffle—the effects of the overall reflected sound wave are compounded greatly. (A popular alternative model for diffraction is that where the baffle edge is considered a secondary radiator of sound. While this model may be easier to visualize, in my opinion it only clouds the issue. With this model, you have to think of the foam, or baffle edge, as a radiator of delayed, out-of-phase sound energy.)

In practice, the effects may be somewhat better, because these problems are reduced significantly by off-axis listening, and because the theory assumes true point-source radiators.

## In April, 1947, D.T.N. Williamson Began the High Fidelity Revolution Singlehandedly



ARTICLES REPRINTED FROM "WIRELESS WORLD"

His power amplifier, using excellent quality push/pull output tubes, a special output transformer and a highly filtered power supply, became an overnight success. In the mid-

1950s, *Wireless World* (now *Electronics World & Wireless World*) gathered all of Williamson's articles, including updates, a preamp design and a radio (BBC) tuner.

The articles in *The Williamson Amplifier* include not only data on winding your own transformers, both output and special radio tuning types, but chassis layout diagrams as well. Williamson takes his reader deep into the design considerations for his power amp and why he made the decisions he did. He offers a lot of practical advice on how to build the units, as well as clear, concise instructions on setting up the new amp.

Few remain today who know very much about the transformer designer's craft. Williamson spends a great deal of time on what size the transformer should be and just how to wind the various segments with which wire, to obtain the proper loads.

His preamp was one of the first ever, and although his design is primitive by today's standards, his updates on accommodating the early recording curves of pre-RIAA standard are a revealing glimpse of what the music lover faced in the early fifties in trying to replay his disks with correct equalization.

Published by exclusive arrangement with *EW&WW*, this booklet is not only a singular resource but also an important historical document which will give the reader unique insights into the tube designer's problems and compromises.

40pp, 7¼" x 9¾" \$4.95

**NOTE: BOOKS ARE NOT RETURNABLE FOR EXCHANGE OR CREDIT.**

Please print in clear block capitals quantity needed, name and address. **REMIT IN US \$ ONLY** by MC/VISA, check or money order. **Charge card orders** under \$10, please include an additional \$2.

POSTAGE & HANDLING: In US, please add \$1.75 for first book and 50¢ each additional book. In Canada, please add \$4.50. Overseas, include 20% of total order for shipping BKA-6

DEALER INQUIRIES INVITED

**Order Today! Only \$4.95**

Send me \_\_\_\_\_ copies at \$4.95 ea.

MC  VISA  
 CK/MO

Shipping \_\_\_\_\_  
TOTAL \_\_\_\_\_

NAME \_\_\_\_\_

STREET & NO \_\_\_\_\_

CITY \_\_\_\_\_

STATE \_\_\_\_\_

ZIP \_\_\_\_\_

MC/VISA \_\_\_\_\_

EXP \_\_\_\_\_

**OLD COLONY SOUND LAB**

PO Box 243, Dept. B90, Peterborough, NH 03458-0243  
(603) 924-6371 / 924-6526 FAX: (603) 924-9467

Answering machine for orders only: (603) 924-6371 before 9:00 a.m., after 4:00 p.m. and weekends.  
Have all information plus MC/VISA available.

## HIGH FIDELITY SPEAKER COMPONENTS

STOCKING THESE  
POPULAR DRIVERS

**AUDAX**

**DYNAUDIO** **ECLIPSE**

**ETON**

**FUTAL**

**morel**

**vifa**

FERRITE/BOBBIN  
LOW DCR  
INDUCTORS

with 18, 16, or 14 gauge

**MENISCUS**

2442 28th St., S.W., Suite D  
Wyoming, MI 49509

(616) 534-9121 FAX: (616) 534-7676

Fast Reply #NE568

## 6000.6 phase correct

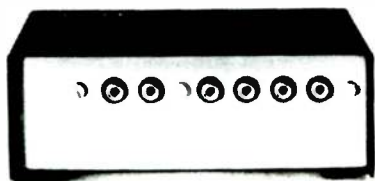

### electronic crossover

The new 6000-6 is designed to improve your system by eliminating crossover errors and passing perfect square waves. A plug-in module allows convenient frequency change from 40-16,000Hz. Level controls on rear, 1% components used. Model 6000-6 \$195. PPD. Other models from \$16.25.

Free folder/reviews

**ACE AUDIO CO.**

532-5th St.  
East Northport, NY 11731-2399

Fast Reply #NE53

I've noticed that speaker manufacturers are now using asymmetrical foam shapes. These restrict the tweeter's dispersion without introducing severe diffraction problems. A rectangular or triangular shape, with the tweeter not quite centered, is a good choice.

Even so, if a tweeter is being used on an ordinary rectangular baffle, there is little to be gained by adding foam to restrict its dispersion. You are simply making the effective baffle area smaller and thus raising the frequency an octave or two, where diffraction comes into play. Such foam is most appropriate when you are trying to avoid reflections from an exposed grille frame or from drivers mounted on the front panel.

Incidentally, the above argument also casts doubt on the popular notion that small loudspeakers have an advantage in soundstaging and imaging quality. There is little reason to believe that diffraction effects are reduced by using a smaller baffle; rather, they are pushed to a higher frequency which may or may not be desirable. Note, on the other hand, that a driver mounted flush on a very large baffle (such as a wall) will not suffer at all from diffraction. I suspect that when small speakers show improved imaging the reason is most often the reduction in enclosure resonances afforded by the small enclosure. This allows the stereo image to "detach" from the speakers.

Ralph Gonzalez  
Wilmington, DE 19803

## WHITE WOOFERS— WHERE?

I am trying to locate a source of white cone subwoofers, woofers, mid-drivers and white encased-dome midranges, tweeters and supertweeters in raw form. Perhaps your wide knowledge of "who has what" can assist me in my search. I would greatly appreciate any assistance you can offer me.

Randy McPhie  
Draper, UT 84020

## DRUM SIZE DATA

Glenn DeMichele's article (SB 1/90) on cylindrical guitar TLs addresses my needs perfectly. Having a Carver PM 1.5 with no suitable speaker enclosures to handle its awesome output, and a recently acquired five-string bass, I would like to duplicate these enclosures. However, I have a few questions.

1. The inner drum seems to be raised from the bottom of the outer drum. What is this dimension?

# CALSOD

Computer-Aided Loudspeaker  
System Optimization and Design  
by Witold Waldman

CALSOD is a new entry into the field of crossover network optimizing software available for the IBM PC desktop computer. It combines the transfer function of an LC network with the acoustic transfer function of the loudspeaker, by using some form of iterative analysis. CALSOD creates, through the process of trial-and-error curve fitting, a suitable transfer function model which it can then optimize. The program is the subject of CALSOD author Witold Waldman's research paper "Simulation and Optimization of Multiway Loudspeaker Systems Using a Personal Computer" which appeared in the Audio Engineering Society Journal for September 1988, pp. 651-663. CALSOD differs considerably from other software since it models the entire loudspeaker output of a multiway system, including the low-end response, and the summed responses of each system driver.

The program performs a lot of tricks. One of the more spectacular of these allows the designer to specify the location of the driver acoustic centers using an XYZ coordinate system. Thus, if the designer expects to mount a driver combination on a flat baffle, the summed response can be optimized to compensate for rearward displacement of a woofer's acoustic center with respect to a tweeter. CALSOD can model up to seven drivers at a time in a four-way system giving the summed response and acoustic phase response of the entire system.

The CALSOD program comes on a single 360K floppy, and requires one directory and two subdirectories in installation, plus access to the DOS GRAB-TABL file, which it uses for a couple of special symbols. The 133-page User Manual, provided on a second disk, is well written, adequately describes the various program functions, and contains an excellent tutorial example, which demonstrates the use of the program. The files for the worked example contained in the manual also come on the program disk, so users can follow the design process and use and modify the files as they learn the procedures.

**NOTE: SOFTWARE IS NOT RETURNABLE FOR REFUND OR CREDIT.** Please print in clear block capitals quantity needed and prices. Total the amounts and **REMIT IN US \$ ONLY** by MC/VISA, check or money order. Postpaid in US. In Canada, please include 10% of total. Overseas, please include 20% of total.

According to the Connecticut Dept. of Revenue, Regulation #27, Section 12-426-27, in order to sell software to residents of Connecticut we must register with the department as well as collect taxes for the state from the purchaser. We regret to inform our customers that we will not sell software to anyone from Connecticut, as it will prove to be too costly and burdensome.

\_\_\_\_\_ **CAL-2B6** (IBM 2.5" 360K DS/DD) \$65 \$ \_\_\_\_\_

\_\_\_\_\_ **CAL-2B4** (IBM 3 1/2" 720K DS/DD) \$67.50 \$ \_\_\_\_\_

**TOTAL \$ \_\_\_\_\_**

Postage if applicable \$ \_\_\_\_\_

**TOTAL ORDER \$ \_\_\_\_\_**

MC  VISA  CK/MO

NAME \_\_\_\_\_ MAGIC NO. \_\_\_\_\_

STREET & NO. \_\_\_\_\_

CITY \_\_\_\_\_ STATE \_\_\_\_\_ ZIP \_\_\_\_\_

MC/VISA \_\_\_\_\_ EXP. \_\_\_\_\_

### OLD COLONY SOUND LAB

PO Box 243, Dept. B90, Peterborough, NH 03458

(603) 924-6371 / 924-6526 / FAX: (603) 924-9467

Answering machine for orders only: (803) 924-6371

before 9:00 a.m., after 4:00 p.m. and weekends.

Have all information plus MC/VISA available.





## Audio Amateur

THE JOURNAL FOR AUDIOPHILE CRAFTS

The innovative, independent audiophile journal for the thoughtful and capable music lover

*Audio Amateur's* articles deal with how audio equipment works, as well as how to build or modify it. Construction and modification articles are plentiful, supplying all needed parts, performance and assembly details for exceptionally high quality designs.

*Audio Amateur* offers a number of features in each issue that abound with useful ideas. The *Letters* column is an open forum for problem solving and information interchange; *Classic Circuitry* reprints schematics of state-of-the-art gear—old and new; *Audio Aids* relates readers' experience with simple modifications to equipment and construction techniques. We also feature many useful and practical hi-fi accessories you can build to further your audio enjoyment.

For a small investment you can make your music system sound better—very probably a lot better.

### AUDIO AMATEUR

- Two years (8 issues) **\$35**  
 One year (4 issues) **\$20**

Canada add \$4 per year postage

NAME \_\_\_\_\_

STREET & NO \_\_\_\_\_

CITY \_\_\_\_\_

STATE \_\_\_\_\_ ZIP \_\_\_\_\_

MC OR VISA \_\_\_\_\_ EXP \_\_\_\_\_

### AUDIO AMATEUR PUBLICATIONS

PO Box 576, Dept. B90  
 Peterborough, NH 03458-0576  
 (603) 924-9464 FAX: (603) 924-9467

Answering machine for credit card orders only—before 9:00 a.m., after 4:00 p.m. and weekends. Have all information plus MC/VISA available.

2. Is there a bottom on the finished cabinet?

3. What are the dimensions of the vent cutouts and speaker cradle openings?

4. What thickness plywood was used for the speaker rings, cradle assembly, and tweeter cabinets?

5. In Fig. 3, p. 27, the woofer polarity appears reversed. Is this correct?

6. Would a taller speaker cradle, with a steeper reflecting cone, cause better midrange dispersion? Your thoughts, please.

Alan R. Erney  
 Perkasio, PA 18944

Glenn DeMichele replies:

1. The spacing between the bottom edge of the inner cylinder and the top face of the bottom of the cabinet is 2.5". This spacing produces a coupling area of 117in<sup>2</sup> between the inner cylinder and the gap between the inner and outer cylinders. This coupling area represents the geometric mean of the two bordering areas.

2. There is a bottom on the cabinet, made of 3/4" plywood. The bottom screws into the ends of the eight pine struts, visible in Photo 7.

3. The square vents near the top are 5.5" x 5.5". Eight of them are evenly spaced around the circumference of the outer cylinder. The four rectangular vents are 2" x 10". These are also evenly

## The Perfect Pitch

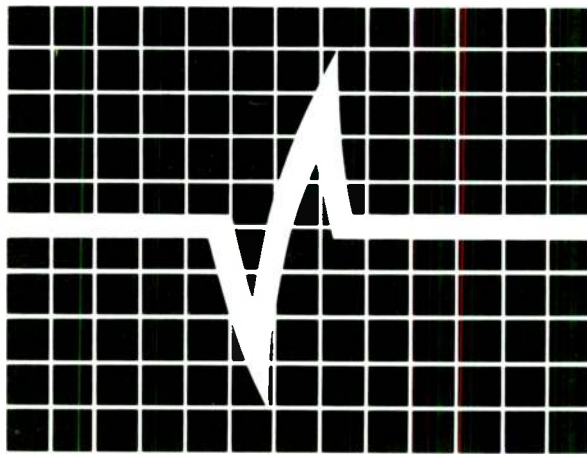

**A ONE YEAR SUBSCRIPTION TO HI-FI NEWS & RECORD REVIEW COSTS £24.80 FOR SURFACE MAIL AND £42.50 FOR AIR MAIL**

**... SUBSCRIBE TODAY!**

Please send me 12 monthly issues of Hi-Fi News & Record Review commencing with the next available issue.

- £24.80 Surface Mail  
 £42.50 Air Mail

I enclose a cheque/International money order payable to Link House Magazines Ltd. or debit my credit card

- VISA  ACCESS/MASTERCARD  DINERS  AMEX

Credit card no. \_\_\_\_\_ Expiry date: \_\_\_\_\_

\_\_\_\_\_

Signature \_\_\_\_\_

(Please print in block capitals)

Name: \_\_\_\_\_

Address: \_\_\_\_\_

(HF02)

To: Hi-Fi News & Record Review, Subscription Department  
 Link House Magazines Ltd.  
 120-126 Lavender Avenue, Mitcham, Surrey CR4 3HP England

I understand that I am committed to one year's subscription and should I wish to cancel no refund will be made.

Registered in England and Wales No 1341560



A LINK HOUSE PUBLICATION

spaced about the circumference, and positioned just below the speaker mounting ring. These vents should line up with the four channels made by the pine spacers.

4. The speaker rings and cradle assembly are constructed from 1/4" plywood. The tweeter cabinets are made if 1/4" plywood.

5. Since the sound radiates from the rear of the woofer, polarity reversal is necessary to keep the woofer radiation in phase with the tweeter radiation.

6. That's a tough one. The midrange dispersion is already 360° in the horizontal plane, and there may not be any point to increasing the dispersion in the vertical plane.

As mentioned in my article, I added the reflecting cones primarily to reduce the effects of the resonance caused by the cavity between the speaker

and the top of the cradle. Making this space larger would certainly de-emphasize the effects of this resonance. Some of the problem may be the E-V drivers, which also seem to have a peaky response. Perhaps trying a set of JBLs would make a positive difference.

## KLIPSCH REMATE

After reading your excellent article on the "Show Horn" (SB 2/90) I am interested in the possibility of mating it with a pair of Klipsch K-400 horns I have on hand. However, I am stumped trying to find the EVM-12Ls you describe in your article.

# CATALOG CORNUCOPIA

**Speaker Builder's** Catalog Cornucopia is designed to make it easy for you to obtain the parts you need for your audio construction projects. Analog multimeters to zener diodes can be shipped directly to your home from the companies featured below.

On the order form simply check the number for each catalog you wish to receive, write down your magic number, and mail the form to us, including a check or money order for the catalog's cost (if applicable) and \$1 for handling. Choose as many different catalogs as you'd like. Your catalog will be sent directly to you from each company.

### 1332: Crutchfield

**FREE** to *Speaker Builder* readers—the Crutchfield catalog featuring the latest stereo and video equipment. Low, discount prices on car and home equipment from Sony, Pioneer, JVC, Proton and more. Plus, raw drivers (MTX, Pyle, etc.), crossovers, and lots of accessories. Video and telephones, too. Over 100 full-color pages complete with descriptions and specs. **Free.**

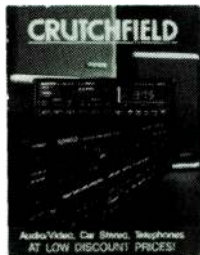

### 1337: Old Colony

In addition to kits, parts and modifications from articles in *Audio Amateur* and *Speaker Builder*, we offer a wide selection of books, loudspeaker design software, test records and CDs, gold-plated connectors and audiophile quality cable. For catalog, use order blank or call (603) 924-6371. **Free.**

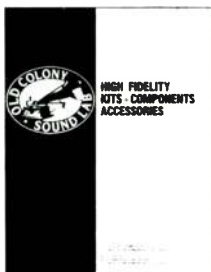

# GLASS AUDIO

Announcing...

The newest publication from the folks who bring you *Audio Amateur* and *Speaker Builder*.

**Glass Audio** features the best vacuum tube designs for audio reproduction—past and contemporary. The new designs take advantage of improved components and control techniques that make the end results far superior to anything possible during the early days of audio's rebirth after World War II.

That's why tubes are having such a renaissance of interest as a perfectionist approach to good sound. And that's why tubes are reappearing in original equipment, in high end consumer and professional audio systems.

Published twice a year, *Glass Audio* will inform you about new innovations in the field and about parts sources. We'll also include modification projects, reviews of technical basics and regular columns such as Tube Troubles, Tube Tips and much more.

Subscribe today!



**GLASS AUDIO**  
PO Box 176, Dept. B90  
Peterborough, NH 03458

- Two years @ \$18 (SAVE \$2 on 4 issues)  
 One year @ \$10 (2 issues)  
Canada add \$2 per year postage

NAME \_\_\_\_\_  
STREET & NO. \_\_\_\_\_  
CITY \_\_\_\_\_  
STATE \_\_\_\_\_ ZIP \_\_\_\_\_  
MC OR VISA NUMBER \_\_\_\_\_ EXPIRE \_\_\_\_\_  
SIGNATURE \_\_\_\_\_

### CREDIT CARD ORDER LINES

VOICE: (603) 924-9464; M-F, 9-4 EST

ANSWERING MACHINE: (603) 924-9464 4 p.m.-8 a.m.

FAX: (603) 924-9467—24 hours

----- You're invited to use this coupon -----

## Catalog Cornucopia, Audio Amateur Publications

PO Box 576, Peterborough, NH 03458

Please send me the catalogs checked below. Enclose \$1 handling charge.

Total enclosed \$ \_\_\_\_\_

1332     1337

NAME \_\_\_\_\_ MAGIC NUMBER \_\_\_\_\_

ADDRESS \_\_\_\_\_

CITY \_\_\_\_\_ STATE \_\_\_\_\_ ZIP \_\_\_\_\_

Not a subscriber

Offer expires December 31, 1990.

Please allow 4-8 weeks for delivery.

They would seem an ideal match for the K-400 which has a flare rolloff of about 300Hz and an efficiency of 106dB.

Incidentally, my wife and I are confirmed horn aficionados. We also have a pair of Celestion SL600s (which are in vogue with the "high end" crowd), but greatly prefer our Klipschorns, especially since we added a Velodyne subwoofer. We may move to another house in the near future and would like to avoid the restriction of corner placement; thus your article comes at a propitious time. Also, the Show Horns look like a challenging and interesting project.

I will appreciate any help you can provide in locating suitable drivers, and any comments you may have on the pairing with the K-400 midrange horns.

George G. Westlake, M.D.  
Kentfield, CA 94904

Bruce Edgar replies:

The K-400 midrange horns should mate well with the Show Horns. The Show Horns will have several dB more output than the K-400 mids, so you will have to pad down the bass horns to equalize the response.

You will probably not find the EVM-12L drivers for the Show Horn in the usual speaker supply house unless they are an E-V dealer. However, your local musical instrument dealer (look in the yellow pages under "Musical Instruments, Retail") may handle E-V since the EVM-12L is a lead guitar speaker. If that fails, call Electro-Voice in Buchanan, MI (616-695-6831) for the nearest supplier. Also, McGee Radio (Kansas City, MO 64108) and Gold Sound (Englewood, CO 80151) sell E-V products by mail.

## FACE-TO-FACE WOOFERS

What are the Isobarik, compound, and push-pull woofer systems that yield a  $V_{AS}$  that is reduced in half? Please elaborate on the reasons why they work. In the face-to-face (I believe it's called a compound push-pull system) woofer configuration, may one of the woofers be moved above the other and still retain the advantage of the  $V_{AS}$  being halved?

What are the formulas for designing four-way crossovers?

May the vent be divided up in length? Example: 3" diameter x 21" long divided into 3 vents, 3" diameter, 7" long? I know that the diameter can be divided up, but my vent size restrictions usually occur in length not diameter. By the time I have the length within my restrictions, the vent diameter is too small.

Jonathan Van Meter  
Huntington, WV 25705

Contributing Editor John Cockroft replies:

Compound systems have been discussed pretty much at length in *SB* over the years, in the letters column. In addition I have written three articles which were published there. There have been articles by others also. Basically a compound loudspeaker system consists of two drivers (usually of the same type) placed face-to-face, with a sealing gasket placed in between, or two speakers sealed together in a short tunnel. The drivers may be both facing the same direction or in opposite directions. The rear driver in all of these configurations faces into an enclosure that is either sealed or vented. In the cases where the drivers face each other, or face away from each other, the system is known as a push-pull system. In these cases the phase of the rear unit must be wired in the opposite polarity from the front one so both move in the same

direction when a signal is pulsed through their voice coils. If this wasn't the case the two speakers would probably destroy each other. (And there would be little sound.)

The reason a compound speaker must be placed in a box that is half the *net* size of a single such driver is that the resistance of the two cone surrounds and spiders adds together to make the combined driver twice as stiff as a single spider. In practice, a good part of the volume saved is used in the construction of the tunnel, or in the case of the face-to-face system, the volume of the cosmetic grille required to hide the outward facing driver.

The compound speaker is less efficient than a single driver (by one half, or 3dB). On the other hand it can handle twice the power of the single unit, so an amplifier with twice the power can bring

INTRODUCING...

## SPEAK

### Acoustic Simulation Software

- Design Double-chamber Bandpass Systems -

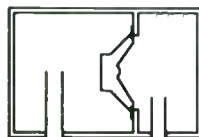

- (A) Bandpass
- (B) Vented
- (C) Sealed

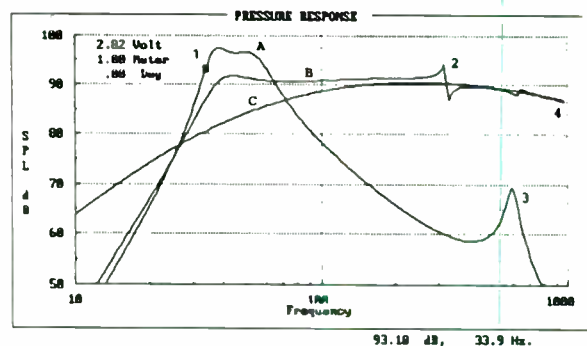

**SPEAK** output in iteration mode comparing 3 designs for the same driver. Note (1) cursor readout. (2), (3) Duct "organ pipe" resonances. (4) Rolloff due to v.c. inductance.

**SPEAK** gives the same results as conventional Thiele-Small based programs for simple designs. But, you can go far beyond.

#### Input Parameter Options

- Full driver specifications
- Front and rear enclosures
- Vents or passive radiators
- Passive crossover/equalizer
- Active filter, order 1-5
- Parametric equalizers
- Driver non-linearities
- Multi-way systems
- More...

#### Plotting Options

- Pressure Response
- Electrical (Z, V, I)
- Diaphragm displacement
- Off-axis Response
- More...

#### Requires

IBM AT class compatible computer with coprocessor and EGA monitor.

30 day full demo.....39.50

Purchase.....395.00

Multi-User.....995.00

#### DLC DESIGN

24166 Haggerty Rd.  
Farmington Hills, MI 48024  
(313) 477-7930

Fast Reply #HE596

## The Cutting Wedge™

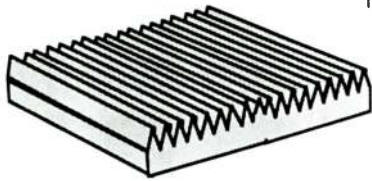

The Cutting Wedge Acoustic foam is available in 2, 3, 4 and 6 inch thicknesses, and in colors of blue, tan, or charcoal. With its patented anechoic wedge design and low cost per unit pricing, it far outperforms all competitors, even at low frequencies.

USES: On walls and ceilings for fine-tuning listening rooms; recording studios; and inside speaker cabinets, to name a few.

### BUILD YOUR OWN INTERCONNECTS

We carry all the best cable and connectors by: WBT • Tiffany • Price Music Post full line of Esoteric & many accessories.

FREE CATALOG



### KRELLFIELD AUDIO PRODUCTS

P.O. Box 8  
Endicott, NY 13760 (607) 797-1829

Fast Reply #HE362

## Mahogany Sound Acousta-Stuf

A SOUND ABSORPTION MATERIAL THAT ELIMINATES STANDING WAVES AND REFLECTIONS WITHIN THE SPEAKER ENCLOSURE TO FOCUS THE ACOUSTIC IMAGE IN THE LISTENER'S MIND.

A MULTI-DIRECTIONAL CRIMP IN EACH STRAND FORMS A COHESIVE MASS WITH A HIGH ABSORPTION COEFFICIENT OVER A WIDE FREQUENCY RANGE. USE IT IN SEALED, VENTED, APERIODIC, AND TRANSMISSION LINE SYSTEMS. IT'S ALSO GREAT FOR SPOT ABSORPTION PANELS AND BASS ATTENUATION TRAPS.

PRICE IS \$7.00 PER LB. PLUS \$1.00 PER LB. FOR SHIPPING (CANADIAN RESIDENTS MAKE THAT \$1.50 PER LB.) IN ALABAMA, ADD 4% SALES TAX. PLEASE PAY BY CHECK OR MONEY ORDER, NO C.O.D. OR CREDIT CARDS.

## Speaker Kits

WE ARE PROUD TO INTRODUCE THREE NEW SPEAKER KITS COMPLETE WITH PRECUT OAK OR WALNUT VENEERED CABINETS BY WOODSTYLE. THESE KITS WILL BE HELPFUL TO THOSE WHO, FOR WHATEVER REASON, HAVE TROUBLE WITH THE WOODWORKING ASPECTS OF HOME CONSTRUCTION. THE LINE FEATURES A 12" PORTED SUB-WOOFER, A DUAL 6 1/2" SYMMETRICALLY ALIGNED APERIODIC FULL RANGE SYSTEM, AND A SMALL 5 1/4" APERIODIC BOOKSHELF SPEAKER. ALL OF THESE SPEAKERS USE ACOUSTA-STUF AS THE DAMPING MATERIAL. WRITE FOR MORE INFORMATION ON THESE NEW KITS.

## Mahogany Sound

2480 Schillingers Rd. #488  
Mobile, Alabama 36695  
(205)-633-2054 After 5 PM CST

Fast Reply #HE73

the compound driver to the same SPL of the single one. I have recently answered other reader's letters regarding compound speakers so perhaps by the time this letter is in print these other letters may also see the light of day and may further help you.

When you move one driver above the other you no longer have a compound system. You have two separate woofers, each acting independently and each claiming its own  $V_{AS}$ . In this case,  $V_{AS}$  is doubled instead of halved, compared to a single speaker. The power handling and SPL is also doubled.

When a duct (for a vented enclosure) is made in multiple units the effective area of the duct is multiplied by the number of units (I am assuming they are all of the same area). This requires a lengthening of the tubes rather than a shortening of them. In the case you mention the tubes would have to be about three times as long. It is just for such situations that passive radiator systems came into being (I guess). Another alternative would be to acquire a woofer designed for use in vented systems. (Your woofer obviously isn't well suited).

I know of no formulas for four-way crossovers. I would assume that you would extend a three-way system by adding a passband filter in place of the tweeter and then add the tweeter to that. Bob Bullock warns of the problems of the interactions of filters in a three-way crossover. I would imagine that a four-way one would have additional problems. I am now in an area where I have had no experience and am probably of very little help. Perhaps someone else will offer help.

## DRUM POWER

Having once experimented with fiber drums myself, I found Glenn DeMichele's SB 1/90 contribution extremely interesting. One question, however, remains on my mind: Given that the Carver PM-1.5 puts out over 700W/channel into 4Ω, why load it with the 8Ω Electro-Voice E-V 18B? Surely there must be something more appropriate.

For my latest project, a flat-sided 10 ft<sup>3</sup> vented enclosure, I am considering the 25-pound 4Ω kilowatt-capable Electro-Voice EVX-184. With an  $X_{MAX}$  rating of 0.40" ( $X_{MAX} = 0.13$ " for the author's woofer), the '184, despite its foam surround, is the finest 18" E-V has ever produced. Or is it?

Several years ago, Electro-Voice introduced a 1.5kW (continuous program) driver—the EVX-1800—whose  $X_{MAX}$  rating was 0.60". (The peak-to-peak displacement limit was 2.2".) Unfortunately, the '1800, which featured an internal tandem disk voice-coil suspension, was recalled and discontinued when, during high-power testing, its carbon diaphragm ignited.

As far as I'm concerned, the '1800 and its 15" counterpart represented the only significant advance in moving-coil technology to appear in ages. If similar improvements are not forthcoming, disen-

# OLD COLONY SOFTWARE

## Speaker Designer™

Release 1.2 by Stuart E. Bonney

A loudspeaker system design aid and modeling tool for use with both closed and vented systems over the frequency range from 10 to 300Hz. Computes and displays system frequency response, power handling capabilities, and relative sound pressure level (SPL) outputs for each of 26 discrete frequencies over this range. Includes one year support by the author when the user registers this Shareware product. Each \$19.50

IBM 5¼" 360K DS/DD

SPD-185

## Loudspeaker Modeling Program by Ralph Gonzalez (SB 1, 2, 3/87)

LMP produces a full-range frequency response prediction for multi-way loudspeakers, including the effect of the crossover, driver roll-offs, interdriver time delay, "diffraction loss," etc. (Includes author support.) Each \$17.50

Specify:

Apple II 5¼" SS/DD

LMP-1A5

Apple Macintosh 3½" SS/DD

LMP-2M3G

IBM PC/XT/AT 5¼" DS/DD

LMP-2B5G

Commodore 64 5¼" DS/DD

LMP-1C5

"Souped-Up" LMP provides professional-quality graphics and a fast, friendly, user interface. Remains compatible with LMP data files and is available for IBM PC (CGA, EGA, VGA, or Hercules graphics) and Macintosh computers. The Macintosh version also provides square wave analysis with audible output.

Each \$44.50 (upgrade price: \$39.50\*)

Specify:

IBM PC/XT/AT 5¼" DS/DD

LMP-3B5G

Apple Macintosh 3½" SS/DD

LMP-3M3G

\*Original LMP disk or sales receipt must be included w/ order.

## Driver Evaluation and Crossover Design

by G. R. Koonce (SB 5/88)

Disk 1 evaluates the suitability of drivers for closed, vented and passive radiator enclosures, and allows detailed designs of vented boxes.

Disk 2, in addition to driver evaluations, allows the design of first-, second-, and third-order crossovers. 5¼" IBM: 360K, DS/DD. Each \$12.50

Specify:

Driver Evaluations

DRI-185

Crossover Design

CRS-185

## Active Filter Design

by Fernando Garcia Viesca (SB 4/88)

Calculates component values for Butterworth filters in four configurations: High- and low-pass in second- and third-order. (Includes author support.) Each \$17.50

IBM 5¼" 360K DS/DD

ACT-185

## Two-Way Active Crossover Design

by Gary Galo (SB 5/88)

Performs the calculations for the eight two-way active crossover designs described by Bob Bullock using formulas exactly as given in the articles; plus a program to calculate  $V_{TH}$ . (Includes one year user support.) Each \$20

Specify:

IBM 5¼" 360K DS/DD

TWO-185

IBM 3½" 720K DS/DD

TWO-183

## Stepped Volume Controls

by Joseph O'Connell (TAA 4/88)

These ready-to-run Mac programs come on a 3½-inch SS/DD disk initialized as a 400K disk for compatibility with all machines. Also included are the Pascal source codes, should you wish to customize them for your own use. Program A. Precisely matches the resistor values to the measured or estimated source and load impedances, yielding great accuracy. Your volume control can have 3 to 99 positions. The program will ask you how many dB each step should be attenuated and has provisions for a standard audio taper or any other taper you devise. Program B. Calculates the taper that will result with your actual resistor values, because you are limited to standard values or with series and parallel combinations. It can also show the effects of different source and load impedances on the taper. Both programs (contained on the same disk) allow you to save their output to a text file and include author support via mail. Each \$23

Apple Macintosh 3½" SS/DD

SVC-1M3

## OLD COLONY SOUND LAB

PO Box 243, Dept. B90, Peterborough, NH 03458  
(603) 924-6371 / 924-6526 / FAX: (603) 924-9467

Answering machine for orders only: (603) 924-6371 before 9:00 a.m., after 4:00 p.m. and weekends.  
Have all information plus MC/VISA available.

chanted audiophiles like myself and professional musicians like Mr. DeMichele will abandon the voice coil altogether, opting for Thomas Danley's Servomotor, which is currently found in several subwoofer systems designed for 5- and 6-string bass guitars.

Philip Singer  
Florham Park, NJ 07932

## BOX LUNCH

I was sitting up last night, unable to sleep. I happened to run across an article in the 2/89 SB, "A Passively Assisted Woofer System," by Tom Nousaine. It was one that I had apparently not looked at too closely when the magazine came out. It's an intriguing article. It states that you take a speaker and increase the mass of its cone by 80%, stick it in a box of about 0.18 the volume of the speaker's  $V_{AS}$  and get good performance, with roughly the same sensitivity as you would with a compound woofer system.

Mr. Nousaine says his system offers the fewest trade-offs. Well, I wouldn't want to buy a horse from Mr. Nousaine. He says it's better than a compound speaker, because it costs only half as much, and then he spends the other half, "justifying" it, because he doesn't "waste" the cone area of the second speaker. In doing so, he manages to double the size of the box that he, just a moment ago, was comparing to the compound system. Come to think of it, I wouldn't want to buy a car from him, either.

Since he uses the Precision TA 305 F in this article, I'll use it for my demonstration. I'll use his actual measured specs of his speaker #4:  $F_5 = 28\text{Hz}$ ,  $Q_T = 0.34$ ,  $V_{AS} = 6.7\text{ ft}^3$ , sensitivity = 89.5dB/W/M music power = 200W,  $R_B = 5.6\Omega$ . The power and sensitivity ratings I looked up. The rest are in the article.

To start things off, we'll take a single unmodified TA 305 and put it in Mr. Nousaine's 1.2 ft<sup>3</sup> box. We begin by determining alpha (or  $V_{AS}/V_B$ ). Divide  $V_{AS}$  (6.7 ft<sup>3</sup>) by  $V_B$  (1.2 ft<sup>3</sup>). This gives about 5.58. From this we can calculate h (h approximates  $Q_{TC}/Q_{TS}$  and  $F_C/F_S$ ). To arrive at h from alpha, add 1 to it and take the square root (the square root of 6.58 is about 2.56).

We can use h to determine  $F_C$  and  $Q_{TC}$ : just multiply  $Q_{TS}$  and  $F_5$  by 2.56. We get 71.8Hz at 0.872  $Q_{TC}$ . With that  $Q_{TC}$ ,  $F_3$  would be about  $0.847 \times F_C$ , or  $0.847 \times 71.8\text{Hz}$ , or 60.8Hz. Sensitivity would be the 89.5dB claimed.

Now he proposes to increase the mass of the cone by 80%. It was actually about 78%, when his figures are examined (1.78). This he does and he reduces the 28Hz  $F_5$  to 21Hz. This causes a change in  $Q_{TS}$ , which will rise from 0.34 to 0.453. The equation for the reduced  $F_5$  is:  $F_5 =$

## LISTEN UP!

**We sell acoustical volume. We sell hysteretic dampening.**

**Your next project** can be half the size or  
can have twice the sensitivity any  
can have extra bass extension combination

The addition of Marrs patented SuperStuff to your speaker will eliminate box talk and other spurious responses. It will enormously expand the front to back soundstage.

**WILD CLAIMS? Maybe. But hear this: We'll refund your entire purchase price for any reason. . .or for no reason at all!**

Invented by a Silicon Valley engineer, SuperStuff™ is patented in six countries here and abroad. Its behavior is totally passive, consisting solely of thermodynamic energy exchange with sound waves. Each SuperStuff package (about the size of a small salami) costs \$16.00 and contributes 4 liters or 250 cubic inches of extra acoustical volume. Hysteretic damping (which INCREASES with lower frequency) is inherent in the system.

Call.

(408) 629-8520



6809 Chateau Court, San Jose, CA., 95120

Fast Reply #HE389

## XOPT V3.0 : LOUDSPEAKER CROSSOVER DESIGN AND OPTIMIZATION PROGRAM

- \* Easy to use pop-up menu driven program with graphics
- \* Design optimized low, high or band pass crossover networks
- \* Optimize the frequency response of a speaker system with up to 5 drivers and 33 interconnected crossover components on any axis or combination of up to 5 axes
- \* Requires user input of magnitudes of driver frequency response in dB and impedance in Ohms at user specified frequencies
- \* Calculates driver impedance phase from a model fit and frequency response phase using a Hilbert Transform
- \* Uses relative locations of driver acoustic centers on the speaker front baffle for system crossover optimization
- \* Used by many of today's top loudspeaker designers

**Why settle for anything less than optimum crossover designs ?**

Send check or money order for \$199.00 (US) to:

Peter Schuck

**Peter L. Schuck Consulting**

1705 Rodin Way, Orleans, Ontario, Canada K1C 4Y9  
(613) 824-3822

For IBM PC, AT, PS/2 and compatibles including 80386's with 640K, Hercules, CGA, EGA or VGA graphics with or without a 80x87 math chip running DOS 2.0 or higher

Fast Reply #NE295

$1/[1.78]^{1/2}$ , or the reciprocal of the square root of the mass increase factor. To arrive at the new  $Q_{TS}$ :  $Q_{TS1} = (1.78)^{1/2}$ , or the square root of the mass increase factor.

Having  $Q_{TS1}$  and  $F_{S1}$ , we can plug them into  $h$  (which remains 2.56, because  $V_{AS}$  was unchanged by the mass increase). This gives  $F_C = 53.76\text{Hz}$  and  $Q_{TC} = 1.16$ . This  $Q$  gives  $F_3$  at about 0.742  $F_C$ , or about 39.9Hz. A  $Q_{TC}$  of 1.16 also gives a peak of about 2.2dB at about 68Hz.

What he doesn't talk about is what happens to the sensitivity of a driver when its cone mass is increased by a factor of 1.78. What happens to it is that sensitivity is reduced by the reciprocal of the

square of the mass increase factor, or  $1/1.78^2$ , which comes to (in this case) 0.3156. To express this in decibels, take the logarithm (to the base 10) of the above answer and multiply it by 20. (The log key on your calculator is handy for this.) In this case, it comes to about -10dB, which is a sizable kick in the old windbag.

This loss would be accompanied, of course, by the inability of the speaker to utilize all of its power potential, because the overweighted cone would be operating in excursion areas well below the cone suspension design. This isn't a bad thing in itself. In fact I make use of this very frequently in my designs where extreme volume isn't an important con-

sideration. It is a sort of no-no here, mainly because high volume and efficiency are probably the two key words to his philosophy, which he has expressed over years in the *SB* Mailbox. It was with these very two words that he attempted to repudiate the compound system as one "having no free lunch." This could of course be said of any system. All are a series of gives and takes aimed toward a certain solution.

I have always felt pleasure that the compound system, in spite of its lack of percs, is still alive and healthy. While I had nothing to do with its invention, I did my part to bring it into the *SB* fold back in the mid 80s, and I still have a soft spot in my heart for it. With this background you can see that while I'm not a vindictive person, still I might feel a moment of quiet pleasure over the fact that Mr. Nousaine has contributed to a system with even less sensitivity than the compound speaker. I believe there is an old proverb to the effect that, "He who lunches last will not be as hungry." I don't understand how he measured "about 89dB/W/M for the pair." It seems to me that it would be more like 82dB/W/M. I think Mr. Nousaine should carry a sandwich around—just in case.

I've looked at his 1,900 $\mu$ F series capacitor with two eyes. First with one eye, then the other eye. I turned it over and looked again. I turned it back and peered at it with a mirror. I bent over and looked at it between my legs. I closed my eyes and felt it with my fingers and all this time it just sits there, looking back at me, looking for all the world just like a first-order high-pass filter. I don't see

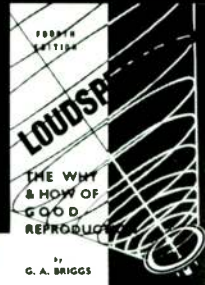

## LOUDSPEAKERS

### THE WHY & HOW OF GOOD REPRODUCTION

by G. A. Briggs

This concise, 88-page introduction to audio basics with special attention to loudspeaker characteristics is something of a classic. Out of print for many years (last revived in 1949), the text goes far beyond consideration of speakers, drivers and boxes. Briggs introduces the reader to such concepts as impedance, phons and decibels, frequency response, response curves, volume and watts, resonance and vibration, cabinets and baffles, horns, room acoustics, transients, crossovers, negative feedback, transformers, Doppler and phase effects, and efficiency. Although these topics are treated in a simple introductory way, they are nonetheless a comprehensive summary of early audio technology.

The author has a light, breezy style and a gift for explaining difficult concepts simply. Briggs quotes liberally from the best sources available including Olson, Henney, Wood, and Seashore. His book also owes much to his fifteen years of speaker manufacture as well as making and hearing live music for most of his life: Briggs was an avid pianist.

The volume is liberally illustrated, and although the hardware is dated, the data is surprisingly germane. A pleasant tour through the early audio years and a provocative survey of the right questions about quality reproduction.

Softbound, 5 1/2" x 8 1/2"

**\$6.95 plus \$1.75 shipping and handling**

---

**NOTE: BOOKS ARE NOT RETURNABLE FOR EXCHANGE OR CREDIT.** Please print in clear block capitals quantity needed, name and address. **REMIT IN US \$ ONLY** by MC/VISA, check or money order. **Charge card orders** under \$10, please include an additional \$2.

POSTAGE & HANDLING: In US, please add \$1.75 for first book and 50¢ each additional book. In Canada, please add \$4.50. Overseas, include 20% of total order for shipping. BKA-A-5

DEALER INQUIRIES INVITED

### Order Today! Only \$6.95

Send me \_\_\_\_\_ copies at \$6.95 ea. \_\_\_\_\_

Shipping \_\_\_\_\_

**TOTAL** \_\_\_\_\_

MC     VISA     CK/MO

NAME \_\_\_\_\_

STREET & NO \_\_\_\_\_

CITY \_\_\_\_\_ STATE \_\_\_\_\_ ZIP \_\_\_\_\_

MC/VISA \_\_\_\_\_ EXP \_\_\_\_\_

### OLD COLONY SOUND LAB

PO Box 243, Dept. B90, Peterborough, NH 03458-0243

(603) 924-6371 / 924-6526      FAX: (603) 924-9467

Answering machine for orders only: (603) 924-6371 before 9:00 a.m., after 4:00 p.m. and weekends. Have all information plus MC/VISA available.

## When you write for HELP!!!

1. Please enclose a self-addressed stamped envelope (SASE).
2. Leave room for replies on your sheet of questions.
3. Don't ask for authors' addresses. They like their privacy too. We will forward your letter if, and only if it contains a reply envelope. If the author lives abroad, enclose an addressed unstamped air-mail envelope and one international postal reply coupon, available at your post office.
4. Please resist the temptation to use us as design consultants, research assistants, product index clerks, project troubleshooters or equipment evaluators. Doing so slows up our editing.
5. If you have a problem with one of our circuits, fully describe the problem and what you have done about it. Include all significant voltage and/or current readings, and don't forget that SASE!

it shooting out power to the speaker below the resonant frequency. I don't see it shooting out power at all. I just see it rolling off power and doing its duty, according to good old  $\frac{1}{2}\pi$  RC which, in the case of his two woofers, would be about  $6.28 \times 3\Omega \times 0.001900$  farads. This comes to 27.9Hz. The capacitor for the single woofer would be half the size for the same frequency.

What we have here is a third-order closed-box system which utilizes a first order (in addition to the normal second-order response of the box) to provide a faster rolloff of the bass frequencies below resonance, to protect the driver cone(s) from excessive excursions due to infrasonic noise. KEF uses (or has used) that principle. (Look in the back pages of Vance Dickason's *Loudspeaker Design Cookbook* for the KEF ad describing this concept.) I believe Neville Thiele used a similar capacitor to lower the  $Q$  of a box with a  $Q_{TC}$  of 1.38m to a  $Q_T$  of 1. By the way, his 1,120 $\mu$ F cap will be down 3dB at about 47Hz when used with his two speakers.

Let's just see what would happen if we put a compound pair of the same drivers into the 1.2 ft<sup>3</sup> box.  $V_{AS}$  would be about half of the single speaker, say 3.55 ft<sup>3</sup>. The other parameters would be about the same. Alpha would be 3.55/1.2, or about 2.79. This means  $h$  would be about 1.95.  $28\text{Hz} \times 1.95 = 54.5\text{Hz}$ .  $0.34 \times 1.95 = 0.66$ .  $F_3$  would be  $1.076 \times F_C$ , or 58.6Hz, which isn't terribly deep, but would be satisfactory for many applications. Sensitivity would be about 86.5dB/W/M, which is certainly practical when you consider the system could handle 400W music power.

It's a pretty small box size for a 12" woofer (even if it is net volume). With that  $Q_{TC}$ , the transient response should be excellent. With the power capacity, it would be no trick at all with an active bass boost filter to obtain another octave of low bass. This should be excellent in rooms requiring a small box in the first place. Just do it—sit back, open your lunch box and enjoy the sound of one helluva woofer. (I've always been a brown-bagger myself.)

What if Tom decided to keep the money for the second driver? He could put his single driver into his 2.4 ft<sup>3</sup> box all by itself and come out with just about the same result as the compound speaker system in the 1.2 ft<sup>3</sup> box. This should appeal to him because he saves his money and regains his efficiency. The specs are just the same, because both  $V_B$  and  $V_{AS}$  are doubled from the compound system. While there is only half the power to be utilized, the system is twice as efficient. It, too, could use the bass boost filter. All he "wastes" is the box size and that doesn't bother him (or me either).

I suggest that since the compound speaker has been named, by some "The

# TARGET B-TECH

## WALL BRACKETS FOR SPEAKERS

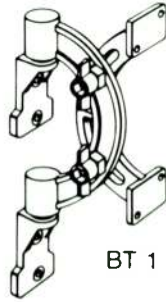

BT 1

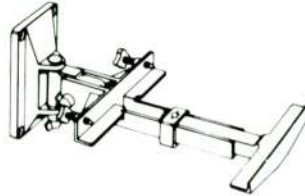

BT 3

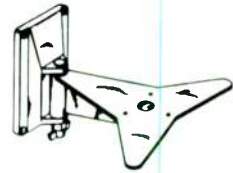

BT 4

For your free copy of our catalogue contact:

**MAY AUDIO MARKETING INC.**

P.O. Box 1048, Champlain, N.Y. 12919 - Tel.: (518) 298-4434

in Canada: (514) 651-5707

Fast Reply #HE661

... from Euphonic Technology

# AccuPower<sup>TM</sup>

... an affordable answer to the degrading effects of power line pollution! **AccuPower** can recover losses in transparency, detail, imaging and dynamics caused by RFI, EMI and equipment interactions

... our audio-optimized and patented\* **AccuPower**

Isolating Line Filter will restore

all your audio and video components to their optimum level of performance!

*Call or write for details.*

**EUPHONIC**  
**technology**



19 Danbury Road, Ridgefield, CT 06877  
(203) 431-6434 • FAX (203) 431-3660

Model AP-4, \$549  
\* US Pat. No. 4,259,705

No-Free-Lunch Alignment," that Tom's system be termed "The Pie-in-the-Sky Alignment."

John Cockroft  
Mountain View, CA 94041

Tom Noursaine replies:

I was surprised by the tone of Mr. Cockroft's response to the CG3 alignment article. In the spirit of free exchange of ideas, let me amplify the areas that concern him. I'll cover the trade-offs with alternative designs, sensitivity of mass-loaded and compound systems, loudspeaker designs using resonant passive networks. I'll also offer thoughts on modeling loudspeakers and measuring the actual performance of your projects.

As the exchanges about compound woofers in SB pointed out, there are no free lunches in designing woofer systems. All of them require a balancing act of enclosure size, bandwidth, output, complexity and cost. The compound is no exception, but many (Mr. Cockroft included) presented strange explanations as to why it was some kind of miracle.

Table 1 describes the approximate alternative designs we considered when making the systems that contained the CG3 alignments. I'll let you be the judge of which entry offers the best value or mix of compromises.

For my purposes, the CG3 offered the best balance of size, bandwidth, cost and complexity. We'll talk about efficiency in a minute.

A study of enclosure shapes and sizes convinces

System Type	$f_3$	$V_D$	Cost	Notes:
Sealed	63	1.4ft <sup>3</sup>		
Sealed EQ	35-44	2.4-1.4	+ Electronic EQ	
Bass Reflex	39	2.0		
Bass Reflex	28	3.3		Misaligned; ripple
Compound	63	1.2	+\$50	Includes 0.5 ft <sup>3</sup> for inside woofer. Reduced Efficiency
Compound EQ	35-44	1.9-1.2	+\$50 Woofer + Electronic EQ	Reduced Efficiency
CG3	27	2.4	+\$50 Woofer +\$18 Caps	Reduced Efficiency Reduced Efficiency

me that compounds are often used where their advantages are least useful. A closer review of Mr. Cockroft's Isobarik article shows that his first system needed about 40% of its internal volume just to house the inside woofer. He reduced  $V_{AS}$  by 50% to attain a size bonus and then spent 80% of his savings making the box large enough for the inside driver.

This approach would seem to have the strongest appeal for very large systems. For example, my primary subwoofer uses a 22ft<sup>3</sup> enclosure. A compound system might enable me to get away with 12-13 ft<sup>3</sup>—a real advantage.

Admittedly, all techniques that add mass to the cone suffer from reduced efficiency. Mr. Cockroft failed to note that the compound woofer doubles the cone mass and so should have a correspondingly

greater reduction in output than the mass-loaded woofer employed in the CG3 system.

However, things are never as simple as they seem. In theory, the mass-loaded woofer suffers from a greater efficiency loss because the other parameters ( $Q_B$  and  $F_S$ ) change as well. For this system, we hoped to restore most of the loss by doubling the piston area and using a parallel connection, reducing system impedance to 4Ω.

As it turns out, we were apparently successful because the measured sensitivity of the system is 89dB SPL 2.8V at one meter. With the compound woofer, only method two is available, and Mr. Cockroft prefers the series connection which doubles system impedance anyway.

The Clark/Geddes paper which describes the CG3 alignment says, in part, "Extending the low-fre-

## NOW IN PRINT AGAIN!

# C. G. McPROUD AT HIS BEST

Three collections of the earliest post-WW II articles from

Audio Engineering Magazine from 1947-49, 1950-52, 1952-55

One of the most important founding fathers of the Audio Engineering Society, C. G. McProud set the standards for the rebirth of high-quality sound reproduction in the US.

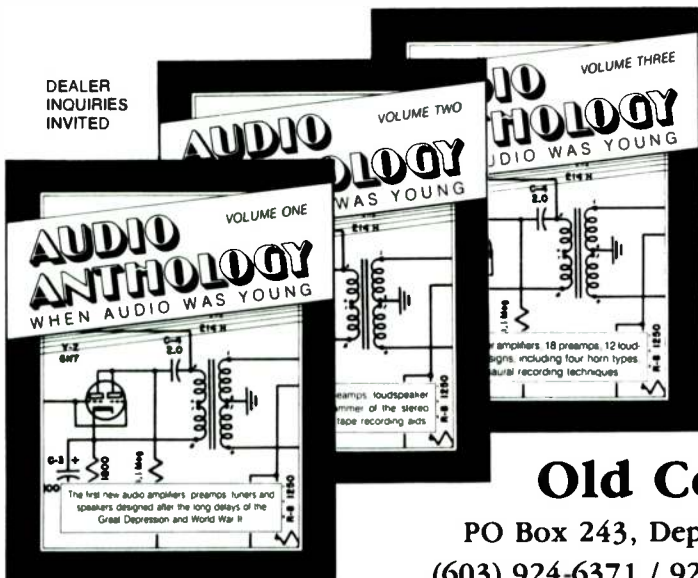

ORDER TODAY—Individually or by sets

QTY.		TOTAL
_____	BKAA-3/1 Audio Anthology: Vol. 1 \$16.95	_____
_____	BKAA-3/2 Audio Anthology: Vol. 2 \$16.95	_____
_____	BKAA-3/3 Audio Anthology: Vol. 3 \$16.95	_____
_____	BKAA-3/S Audio Anthology: (Vol. 1-3) \$42.00	_____
	Postage \$ _____	
	TOTAL \$ _____	

MC  VISA  CK/MO

NAME \_\_\_\_\_ MAGIC NO. \_\_\_\_\_  
 ADDRESS \_\_\_\_\_  
 CITY \_\_\_\_\_ STATE \_\_\_\_\_ ZIP \_\_\_\_\_  
 MASTERCARD OR VISA NUMBER \_\_\_\_\_ EXP. \_\_\_\_\_

NOTE: BOOKS ARE NOT RETURNABLE FOR EXCHANGE OR CREDIT. Prices are subject to change without notice. Please print in clear block capitals quantity needed, book number and price. Total the amount and REMIT IN US \$ ONLY by MC/VISA, check or money order.

POSTAGE & HANDLING: In US, please add \$1.75 for first book and 50¢ each additional book. In Canada, please add \$4.50. Overseas, please include 20% of total order for shipping.

## Old Colony Sound Lab

PO Box 243, Dept. B90, Peterborough, NH 03458-0243

(603) 924-6371 / 924-6526

FAX: (603) 924-9467

Answering machine for credit card orders only: before 9:00 a.m., after 4:00 p.m. and weekends. Have all information plus MC/VISA available.



quency range of sealed-box loudspeakers by means of resonating passive networks between amplifier and speaker is a concept introduced by Benson and Von Recklinghausen. This is an appealing idea when a high quality loudspeaker is constrained by size considerations and source equalization is not desirable. The sealed-box loudspeaker is a natural for having its low-frequency range extended. On the basis of power input rather than voltage input, it is quite efficient at, and just below, its cutoff frequency. This efficiency can be exploited by resonance of driver motional reactance with electrical reactance between amplifier and speaker."

When I originally studied the SAE Preprint 860123 (SAE, 400 Commonwealth Drive, Warrendale, PA 15096), I was impressed by two things. First, the CG3 alignment had been modeled with a "direct simulation of the electro/mechanical/acoustical system rather than an evaluation of the solved transfer function, (which) allows the inclusion of many more variables." The calculator/PC methods we all use generally rely on the latter which, as a friend once said, are most noteworthy for the brilliant use of assumptions. Anyway, the simulation allows the development of novel alignments such as this one. To the best of my knowledge, the only commercial product using this approach is the *Speak* Acoustic Simulation Software from DLC Design. (DLC, 24166 Haggerty Rd., Farmington Hills, MI 48024, [313] 477-5534)

Secondly, the authors actually built and measured the system response of a prototype to confirm their analysis. In my report of the mass-loaded CG3 (mass loading is not mandatory, it was just the only method to get the alignment right) I included design, construction and measured results of final system response. Small signal system parameter measurements and open listening evaluations simply do not provide enough evidence for valid conclusions.

I would very much like to see the actual system response for Mr. Cockroft's goofy little transmission lines and the heavily engineered but lightly designed Isobariks described in his articles. We may find out they are "Egg On Face" or "What Me Worry?" alignments. By the way, I am all out of animals and used cars, but I do have some \$3,500 turntables for sale. ▶

## THE BUD BOX

*continued from page 27*

So you say, "I love the concept, but I really need a larger enclosure." The problem with Bud Boxes is that your limit is probably a D'Appolito design using the 17" x 6" x 3" Bud AC-433. Of course Bud makes larger chassis, such as their 17" x 17" x 4" AC-1431; however, the ratio of the dimensions of these larger units do not lend them to be used as speaker enclosures. The answer is simple: make your own enclosure out of pieces of sheet metal. Cut a piece of sheet metal for each surface of the en-

closure—the lengths and widths equal to the interior dimensions of the enclosure. The pieces are joined at each edge with a piece of aluminum angle stock and secured with pop-rivets or epoxy. Large panels should be stiffened by securing a piece of angle stock diagonally across the panel.

Like everything else in life, "there ain't no such thing as a free lunch." Aluminum is expensive. The 10" x 6" x 3.5" Bud CU-3010A Minibox retails for about \$15—ugh! You might be able to find a wholesale source for sheet aluminum; but if you can't, I have been quoted a

retail price of 8 cents per square inch. Now, perhaps, there is a reason to befriend an aluminum siding salesman. [Cookie sheets from your local discount store might be a good source of metal and aluminum solders are now available as well.—Ed.]

Despite the high cost, I'm convinced that I will use the Bud Box technique for many future enclosures, and I highly recommend the technique to you. I wish that you could see them (you can't hear them: they are inert). They cause those who have seen them to make comments such as, "absolutely the least resonant

# 1000 WATTS!



In 1978, we set the industry on its ear by manufacturing a 6 1/2" woofer that produced clean fundamental bass down to 30 Hz. To this very day our SW 6500 is still the most accurate woofer in the business. Now after 11 more years of experience, improvements and R & D, we are introducing the closest thing yet to the perfect woofer.

This 12" MONSTER SUBWOOFER, the MS 1000-12, incorporates every design feature, technology and refinement known to improve sound regardless of cost. Yet being a small efficient cottage industry manufacturer, we can "create" this MONSTER SUBWOOFER at about the same price as a conventional woofer.



**HIGH FIDELITY SPEAKERS...*simply the best!***

**(206) 852-4049**

IN CANADA (604) 534-4956

# HTA

by

# CIZEK

REPAIRS AND UPGRADES  
TO OLD CIZEK SPEAKERS.  
ALSO NEW DESIGNER SERIES  
SPEAKER SYSTEMS

NOW AVAILABLE DRIVER CATALOG

CUSTOM DRIVERS / SYSTEMS /  
NETWORKS, ON REQUEST

## HTA, INC.

1611 Crenshaw  
Suite 142, Department SB71990  
Torrence, CA 90501  
(213) 539-2469

Fast Reply #NE643



SPEAKER  
X  
WORKS

SPEAKER

The Cure for Speaker Headaches"

- Custom Grilles  
For B.I.C. Formula 6's
- Polypropylene Cones  
For Reconers - 8", 10", 12" & 15"
- Factory Service For ALTEC,  
ADVENT, B.I.C., JBL & RTR
- We buy blown speakers.  
CALL US.
- BUY • SELL • TRADE  
MARANTZ, McINTOSH,  
Tube Equipment
- 22 Years Audio Experience

Call Us For Hard To Find Parts

1-800-526-8879

3115 S. Sheridan • Tulsa, OK 74145

Fast Reply #NE618

enclosure that I have seen." Three of my friends have told me that they plan to use the Bud Box concept in their next projects.

## CD SPEAKER SYSTEM

continued from page 46

naturally occurred to me to put them together with boxes spaced closely for left and right channels. If you have never tried this, and have two sets of similar speakers on hand, you will probably be just as impressed with the results as you were when hearing the CD Speaker System for the first time. For the same amplifier gain setting, you will hear at least 3dB more solid-sounding music. If the two systems differ somewhat, they may well complement each other. Because inputs are paralleled, purists will moan, but the results are worth it.

If you are inclined to bypass, or move beyond, this simplified system approach, buy Vance Dickason's *Loudspeaker Design Cookbook* and the *LEAP* computer program. You'll need them to improve matters over what I have described here.

I have appended a small list of classical CDs to demonstrate your new system effectively. I have also listed my nearby source for drivers and other accessories.

**ADDENDUM.** Further tests with a readily found 8Ω crossover network (12dB/octave) with crossover points at 800Hz and 5kHz gives results equal to the described 1kHz/5kHz network. The Philips midrange driver accommodates to this 200Hz difference with no audible harm at adequately loud levels."—P.H.

### SOURCES

Zalytron Industries Corp.  
469 Jericho Turnpike  
Mineola, LI, NY 11501  
(516) 747-3515  
drivers

### Showcase Discs for a CD Speaker System:

Chandos 8587  
Shostakovich: *Symphony #9*  
Scottish National Orchestra,  
Neeme Jarvi, conductor

MMG MCD 80096  
"Peaches and Cream"  
Cincinnati Pops Orchestra  
Eric Kunzel, conductor  
(Dance music of John Philip Sousa  
Bass drums.)

Telarc CD 80115  
"Orchestral Spectaculars"  
Cincinnati Pops Orchestra  
Eric Kunzel, conductor  
(Try Weinberger's Polka and Fugue from  
*Schwanda*.)

RCA RCD 1919  
*The Planets* (Holst)  
Isao Tomita and Sythesizer  
Philips 400 0742  
Stravinsky, *The Complete Firebird Ballet*  
Music

Amsterdam Concertbouw Orchestra  
Sir Colin Davis, conductor

Philips 42881-2  
Rachmaninov, *Piano Concertos 1 and 2*  
San Francisco Symphony  
Edo de Waart, conductor  
Zoltan Kocsis, piano

Telarc CD 80096  
Jongen, *Symphonie Concertante for Organ and*  
*Orchestra*  
San Francisco Symphony  
Edo de Waart, conductor  
Michael Murray, at the Ruffatti Organ.

## SPEAKER DESIGNER

continued from page 57

Program size is 31K bytes. Printer output is compatible with any printer operating with the above systems. No installation is required. (The latter two points are the main reasons for a decision to omit graphic outputs.)

**CONCLUSION.** The basic Thiele/Small models have been criticized on occasion in light of more recent analytical tools. They do contain certain simplifications and assumptions, but most later work consists of refinements and extensions, not fundamental change. The papers of Thiele and Small make it clear that both authors were well aware of model limits and that they simplified only when there was a reasonable basis, such as minimal effect on practical results. Especially for systems using a single bass driver, potential inaccuracies of the T/S models appear to be a few percent at most, and are often small enough to be lost within typical measurement error margins.

While it may seem obvious, users of models and modeling programs should be aware of what each can and cannot do. The value of a good model rests in its ability to establish a competent design base line, and that of a modeling program is in making this process easy and convenient. But any analytical model, however accurate and detailed, is still an approximation. And model results are not holy writ but are simply a valuable addition to a designer's arsenal of practical design, construction, and measurement techniques.

It's been said that the real-world definition of computer software is "something unfinished." It could be added that a given program is but one expression among a universe of possibilities. Should

"Speaker Designer" prove popular, feedback from users no doubt will stimulate future enhancements.

Finally, the author is indebted to Contributing Editor Robert M. Bullock for illuminating some mathematical fine points of equations presented in the papers of R. H. Small. ▶

#### REFERENCES

1. Small, Richard H., "Direct-Radiator Loudspeaker System Analysis," *Journal of the Audio Engineering Society*, June 1972.

"Closed-Box Loudspeaker Systems—Part 1: Analysis" *JAES*, December 1972.

"Closed-Box Loudspeaker Systems—Part 2: Synthesis" *JAES*, January/February 1973.

"Vented-Box Loudspeaker Systems—Part 1: Small-Signal Analysis" *JAES*, June 1973.

"Vented-Box Loudspeaker Systems—Part 2: Large-Signal Analysis" *JAES*, July/August 1973.

Note: The above papers are also included in the *JAES Loudspeaker Anthology*, Volume 1, 2nd Ed., 1980.

2. Bullock, Robert M., Tabulated alignment data, *Speaker Builder*, 4/80. "Alternative Alignments" *Speaker Builder*, 3/81.

3. Dickason, Vance, *The Loudspeaker Design Cookbook*, 3rd Ed., available from Old Colony Sound Lab.

## Kit Report

Pitts Loudspeaker continued from page 66

tem the woofer is called upon to reproduce most of the human voice, I listened attentively. But I could not hear voice quality deteriorating even when the woofer was reproducing heavy bass. Floppy or underdamped woofers clearly (and annoyingly) modulate critical voice frequencies under this condition. What you *don't* get is killer bass, but this should not be expected from any speaker this size.

The overall sound was effortless throughout its range, with a smooth and gentle crossover. The speakers have good sensitivity, enough so that moderate listening levels may be achieved even with low-power receivers or televisions with outputs. This speaker makes an ideal retrofit for such a system. But the 60W/channel amplifiers could drive the speakers to distortion, so higher-powered amplifiers should be used. The small size of a bookshelf speaker should encourage users to experiment with its placement. Significant response changes will be noted.

#### Customizing the kit

Being a little picky about the quality of non-polar electrolytics, but still trying to maintain a tight budget, I replaced the 2.2 $\mu$ F electrolytic with a parallel combination of a 0.2 $\mu$ F poly cap and a couple of 1 $\mu$ F electrolytics. Admittedly, audible difference was minimal, but this doesn't

## CAPE ACOUSTICS

100 RESERVE STREET  
GLACE BAY, NOVA SCOTIA  
CANADA B1A 6G4

MANUFACTURERS OF QUALITY  
LOUDSPEAKERS

DISTRIBUTORS OF  
SPEAKER KITS, WOOFERS

LOWEST PRICES  
SEND FOR FREE BROCHURE

**(902) 842-0110**

Fast Reply #HE330

## RAMSDELL AUDIO

### 27" SUBWOOFER

MODEL SW2710:

6.3" Edgewound voice coil  
103dB/1W/1M (band limited)  
pink noise—32-150Hz in 15 ft.<sup>3</sup> cabinet)

Power Handling—500W RMS  
1000W Program

Polypropylene cone—Double Roll Cloth Surround  
52 lbs.

Fs 18.5Hz

Qts .275

Qes .293

Qms 4.16

No 4.0%

Re 5.7 $\Omega$

Le 3.0mH

Xmax  $\pm$  4mm

Vas 1720 liters

Piston Dia. 23.3"

**\$1,250**



PO Box 76186

St. Petersburg, FL 33734-6186

(813) 823-8037

**NOW AVAILABLE: 27" Passive Radiator \$145**

Fast Reply #HE163

# BIG COVE RESEARCH

EXCLUSIVELY

# FOTAL

## ● TECHNOLOGIE D'AVANT GARDE

Newest Products : T130K - 5V313 - 10K617  
Great Variety in Inventory  
Studio, Auto and Custom Home Applications

## ● Kits and Enclosures

ARIA 5's and 7's in Black Laquer  
"EGG" Designs  
Subwoofers: 2cf 8" and 3cf 10"  
2 Way Monitors in Oak or Walnut

## ● Crossovers

Introducing: BCR's All-Purpose PC Boards  
Analysis, Design and Production

## ● The Usual Expertise, Advice, and Service!

BIG COVE RESEARCH  
105 Catherine Dr., Owens Cross Roads, AL 35763  
Phone: 205-881-6763 Kevin E. Davis FAX: 205-882-6765  
881-8677 Hugh J. Christian Jr. Ph.D.

mean you should not consider it. In the long run, electrolytics have a nasty habit of drying up and therefore their ESR and ESL may increase substantially with age, degrading performance. And if you're really concerned and can afford it, employ only poly caps.

The brightness of a speaker depends not only on the loudspeaker itself, but also on the listening environment, the music program and, of course, the listener's tastes. Personally, I require some extra brightness and therefore I decreased the series resistor value to 5Ω. While I cannot say that Mr. Kantor's measurements and listening tests were wrong, it still makes sense to have a variable resistor to adjust the tweeter's level to your taste and listening environment. But if you desire a fixed resistor, feel free to play with its value.

By employing well-behaved drivers and a simple crossover network, the response in the crossover area is smooth, with no major defects in imaging or direction loss. But it has been shown that a fourth-order Linkwitz-Riley crossover does make a difference. The easiest way to perform this is with an active crossover and biamping the system.

It makes sense that any small speaker be bass-assisted by means of a subwoofer. This may be added later when your budget allows, and you may achieve a cost size vs. performance not available with other systems. As a matter of fact, I did try this option with a commercially available subwoofer. Without the burden of reproducing the low bass, the outstanding clarity and tightness of this small system is fully appreciated. And you get a compact, very respectable sounding system for less than \$350. Heartily recommended.

## Summing up

Closed-box loudspeakers are nearly fool-proof. And they're certainly much easier to build than folded horns. This simplicity will appeal to the novice builder. Though he won't get the performance of higher-priced or more complicated speakers, the price/performance ratio is irresistible. But more advanced users should also take a good look at this loudspeaker system as a possible complement to their full-fledged main speakers. The reasoning is simple: once your ears get used to good sound, you cannot listen to a \$100 radio, even if you're in your workshop. ▶

## SOURCES

Star Woodworking, Inc.  
1648 Cabot Street  
West Babylon, NY 11704  
(516) 293-7944  
Enclosure kits

Old Colony Sound Lab  
PO Box 243  
Peterborough, NH 03458-0243  
(603) 924-6526  
Woofers, tweeters

Fast Reply #HE333

# LEAP

## Loudspeaker Enclosure Analysis Program

### Graphics Features

- Semilog Graphs ▶
- Absolute Scales ▶
- Auto Scale Set ▶
- Display 3 Designs ▶
- Solid/Dot/Dash Line ▶
- Fast Graphic Paging ▶
- Disk Graph Storage ▶
- EGA Color Graphs ▶
- Cursor Measurements ▶
- Hardcopy Printout ▶

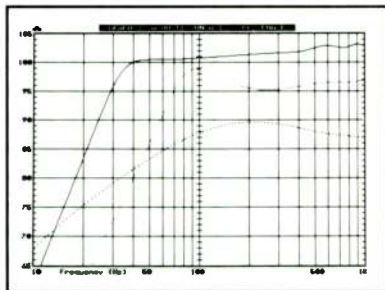

### Output Graphs

- ▶ Acou. On-Axis SPL
- ▶ Acou. On-Axis Phase
- ▶ Acou. Power SPL
- ▶ Acou. Power Phase
- ▶ Cone Excursion
- ▶ Group Delay
- ▶ Impedance Mag.
- ▶ Impedance Phase
- ▶ Current Mag.
- ▶ Current Phase

## Advanced Analysis...Beyond the State of the Art!

Comprehensive true general system model/ Small-Large signal analysis/ Frequency dependent acoustic elements/ Multiple speakers and ports in box/ Full mutual coupling analysis/ Passive radiators/ Parasitic elements: Port loss, Box loss, Lining loss/ Any Power level/ Array Analysis/ Frequency dependent VC resistance/ VC temperature/ Cable resistance/ SPL at any Distance.

PROGRAM FEATURES: Unlimited Speaker, Cabinet, and Design Libraries/ Computer assisted parameter entry and checking/ Library Searches/ Metric or English Cabinet units/ Over 100 Speakers already in library from 3" to 30", JBL to Audax, Pro. Car. HI-FI/ ...Easy operation!

### Computer System

PC/AT/386 and Compatibles  
MS-DOS 2.x/3.x, 512K RAM  
Math Coprocessor Suggested  
Graphics: EGA/ CGA/ HGA



Only...\$199.00!

Free Demo Disks

AUDIO TEKNOLOGY INCORPORATED

7556 SW BRIDGEPORT RD., PORTLAND, OR 97224  
Phone: 503-624-0405 FAX: 503-624-0194

Fast Reply #HE32

# Classified Advertising

## TRADE

**MIT AUDIO CABLES**, Van den Hul, Cardas, MAS Masterlink, OCOS, Magnan, including Teflon insulated hookup wire for rewiring components; Solen polypropylenes to 200vFI WonderCaps-solder-wire; Vishay & Resista resistors; largest selection of Holco resistors in North America; Music Posts and all types of audio connectors; RAM tubes; enclosure damping compounds; tone cones; NAVCOM isolators and sheets; spectrum analyzers, many parts and accessories. \$1 catalog (\$3 overseas) **MICHAEL PERCY**, Box 526, Inverness, CA 94937, (415) 669-7181. T6/90

**MAGNAVOX**. Selected chip sets, \$80; CDB630, \$289; CDB582, \$159; CDB586 changer, \$210; CDB473, \$179; Isodrives, \$79; Navcom silencers, call; Audioquest, Straightwire, Mod Squad, Tweek, \$12.95; Reference, Sheffield, Dorian, DMP, Telarc CDs, \$12.99; Chesky, \$11.99; Fulton LP sets, 5/\$25. Free catalog. **DIGITAL SOUND**, 7634 Kolmar, Skokie, IL 60076, (312) 674-8024. T2/91

**LONG HAIR WOOL** carded, cleaned for stuffing speakers, \$13.50/lb. including shipping. **J. EBBERT**, 431 Old Eagle School Rd., Strafford, PA 19087, (215) 687-3609. T6/90

**SPEAKER KITS**, raw drivers, cabinets crossovers, available from **SPEAKER WORLD**, PO Box 14731, Fremont, CA 94539. Send for free catalog. (415) 490-5842. T2/91



(616) 534-9121

### MENISCUS

HIGH FIDELITY SPEAKER COMPONENTS

**DYNAUDIO MOREL FOCAL ECLIPSE**  
2442 28th St., S.W., Suite D, Wyoming, MI 49509

**MYLAR FILM**. 1/2 mil, genuine DuPont. 48" wide. \$1 per running foot. Also ESL transformers. **ROGER SANDERS**, R1, Box 125, Halfway, OR 97834, (503) 742-5023. T3/91

**SPEAKER DESIGN SOFTWARE for PC and Mac**. **SpeakerCAD**: graphs predict performance, calculates woofer parameters, vents. **FILTERS**: calculates 1-6th-order electronic crossovers. **CROSS-OVERS**: 1-4th-order all-pass, constant power networks. \$40 complete. **QUBIX**, 2302 5th NE, Salem, OR 97303, (503) 363-5143. T6/90

**EPIKITS are here!** **EPIK Monitor Systems** is offering speaker kits that will allow the home builder to assemble satellites and subwoofer systems of uncompromised performance with hand tools only. Epikits feature state-of-the-art drivers, cabinet construction, crossover topology and computer calibrated response. **EPIK Monitor Systems**, 1720 Lilac, Walnut Creek, CA 94595, (415) 930-9104. T6/90

**AMPLIFIERS, SPEAKERS, CABINETS** built to suit. From sound reinforcement to DJs to fine home stereo. Subwoofers, musical instrument, monitors. Built in multi point distribution/remote control systems. Solid state amplifiers: 1W-1200W. Tube amplifiers to your request. Will work with you or your architect for built-in or hidden systems. **ERIK EDWARDS**, 133 Grant Hill Road., Coventry, CT 06238, (203) 742-9783. T4/90

## CLASSIFIED ORDER FORM

PLEASE FILL OUT IN CLEAR BLOCK LETTERS OR TYPE. PLEASE SPELL OUT ENTIRE WORD.

1	2	3	4	5	6	7	8	9	10
11	12	13	14	15	16	17	18	19	20
21	22	23	24	25	26	27	28	29	30
31	32	33	34	35	36	37	38	39	40
41	42	43	44	45	46	47	48	49	50

Private For Sale  Private Wanted  Trade If Trade please indicate # of insertions. \_\_\_\_\_

Private ads are on a one time insertion basis. Must be resubmitted for renewal. Ads cannot be taken over the phone.

**Definition of a word:** A series of letters with a space before and after. Please remember to include your name, address and telephone number when making calculations. In order for Private For Sale and Want ads to be free you must be a current subscriber. Please include your Magic Number. Ten dollar minimum charge for charge card orders and Trade ads.

Any words over 50, 20¢ per word; Trade ads please charge at 70¢ per word and indicate number of insertions. Deduct 10% for a 4x contract in *Audio Amateur* and a 6x contract in *Speaker Builder*; deduct 5% for a 2x contract in *Glass Audio*. Payment must accompany ad.

Please charge to my MasterCard/Visa:

Check/Money Order enclosed

MAGIC NUMBER

NAME \_\_\_\_\_

COMPANY \_\_\_\_\_

STREET ADDRESS \_\_\_\_\_

CITY \_\_\_\_\_

STATE \_\_\_\_\_

ZIP \_\_\_\_\_

CARD NUMBER \_\_\_\_\_

EXP. DATE \_\_\_\_\_

SIGNATURE \_\_\_\_\_

**FALCON ACOUSTICS** is one of the largest independent manufacturers of crossover networks and speaker system accessories in the UK, supplying manufacturers, retailers and export. Your guarantee is the trust our manufacturing customers put in the quality and reliability of our networks. **Inductors:** Ferrite (up to 200W), air-cored and transformer; **Capacitors:** Reversible electrolytic 50V/100V, polyester, polycarbonate and polypropylene; **Networks:** choice of over 70 for different unit combinations; **Components & Accessories:** most except for the wood! Please send for details, \$2 air, \$1 surface, to our mail order retail outlet. **FALCON ELECTRONICS**, Tabor House, Norwich Rd., Mulbarton, Norfolk, England NR14 8JT. T6/90

**PYLE DRIVERS!** Pioneer Industrial Drivers! And now, the incredible 50 to 500W British McKenzie professional drivers. Lowest prices, list on request. Dealer inquiries? VISA/MC/DISCOVER. **SPEAKER SHOP**, 318 South Wahsatch, Colorado Springs, CO 80903, (719) 475-2545. T4/90

In 1988, Madisound Speaker Components processed 20,000 orders.

VIFA	DYNAUDIO
FOCAL	MB QUART
PHILIPS	AUDAX
EUROPA	PEERLESS
MOREL	SOLEN
KEF	ETON

**PERFECT LAY  
SIDEWINDER  
ELECTROVOICE  
SLEDGEHAMMER**

Doesn't your hobby deserve these fine product lines?

---



**Madisound Speaker Components**  
8608 University Green  
Box 4283 Madison WI 53711  
Phone: 608-831-3433  
Fax: 608-831-3771

**ACOUSTICOAT** is a specially formulated acoustical/mechanical vibration damping compound designed for loudspeakers. It is applied as a thick, viscous liquid which dries to a dense, pliable consistency. Coating all internal cabinet surfaces dramatically reduces colorations caused by internal resonances, vibrations, and standing waves. Improves imaging, midrange clarity, and bass definition. A must for speaker building! 1 gallon, \$24; 5 gallon drum, \$89; Includes shipping. **R.D.V.** 113 Knickerbocker Rd., Plainview, NY 11803, (516) 681-4675. T4/90

**ESL BUILDERS.** DuPont Mylar 1/2 mil, 40 inches wide, 75 cents per foot. Ribbon and AMT BUILDERS 1/2 mil aluminum 1/2" wide, 20 cents per foot. **SOUND SUPPLIES**, 419 Appleton, Vernon Hills, IL 60061. T4/90

**DYNACO KIT BUILDERS**—225,000 lb. buyout! Tubes, transistors, metal work, raw speakers, circuit boards, 200/200W amplifier kit, \$299; manuals, any, \$6. Shipping extra. Free parts list. **SOUND VALUES**, Box 551SB, Dublin, OH 43017. (614) 889-2117, 10-4. T2/91

**TUBE AMPLIFIERS REPAIRED.** Any make, model before 1970. Also complete restorations, modifications. **QUALITY WORK ONLY. THE SONIC GALLERY**, 139 Wayneridge Rd., Waynesboro, VA 22980, (703) 949-6727. T4/90

**WHALE COVE AUDIO** is your source for the *SWAN IV* and for complete kits, empty enclosures, the *PEDAL COUPLER*, and Joe Curcio's new elegant rack mount version, the *PEDAL COUPLER II*. Box 356, Swan's Island, ME 04685, (207) 526-4343. T6/90

**D'APPOLITO ARIA 5 AND ARIA 7** cabinets, drivers, crossovers, etc. are available from **WHALE COVE AUDIO**, (207) 526-4343. T6/90

## MERRILL MODIFICATIONS For the AR turntables

Call  
**UNDERGROUND SOUND**  
2125 CENTRAL AVE., MEMPHIS, TN 38104  
(901) 272-1275

**SPEAKER BUILDER INDEXES FOR IBM-PC, 1980-1989.** Articles, letters cross-indexed by subject, enclosure, etc. Drivers listed by type, size, use. Indexes are dBASEIII+ (.DBF) files; software that accesses or imports same required for use. \$16 post-paid. **RUSSELL SCHOOF**, 17777 S. Ramsby, Molalla, OR 97038. T4/90

## FOR SALE

Dynaudio 17W75EXT unused, \$85/pair; Strathearn ribbons, slightly modified (per *Speaker Builder*) with transformers and passive filters, \$90/pair; Triad R-71A power transformer, 900VCT/250MA, 6.3V/4A, 5V/4A, excellent, \$20; new USA caps, 5000µF/75V, 40 PCS available, \$2 each (min 6); all plus UPS. Matthew, (708) 260-1628, 6-9 CST.

Marantz 7T, \$125; dbx 228, \$95; MK IIIs, \$325-\$395; HK-T55C, \$150; Connoisseur BD2, \$60; PAS, \$125; ST-70, \$200; Heath W5, \$95; Heath W4, \$75; AD S-10-01 digital time delay, \$95; Eico HF85, \$25; Eico HF81, \$85; HFT 90, \$25; Fisher 80C, \$49; HK-400, \$45. Joe, (206) 473-3572 PST.

Acoustat 1 + 1 speakers, latest panels, custom cherry frames, updated direct drive, Acoustat amps, \$1,250; Dolby Labs A-301 Dolby-A NR, \$500; Acoustat ELS panels, 4/\$150, includes custom 1 + 1 frame; HP 400H, \$50; HP 412A, \$50; Heath IG-18, needs work, \$40. Tom Sutkowski, 23 Lincoln St., Hartford, CT 06106, (203) 293-2295.

JBL 2245H subwoofer driver, 18",  $f_s = 20\text{Hz}$ ,  $Q_{TS} = 0.27$ , 95dB efficiency, 600W continuous power rating, two MA15 mounting kits, like new, in original packing, less than 100 hours use, over \$400 new, sell for \$250 plus shipping. Ask for Michael or leave message, (708) 357-0535.

Test equipment Bruel & Kjaer 2305 level recorder, \$250; 2112 audio frequency spectrometer, \$200; 1607 distortion bridge, \$100; 2603 microphone amplifier, \$100; General Radio 1523-P2 sweep oscillator/chart recorder, \$250; 1900A Waveform analyzer, \$50. Much more. Ken Kopper, 746 Oak Ave., River Edge, NJ 07661, (201) 599-0499.

New JBL 117H-1 8" woofers, \$45 each; Dynaudio 21W54 8" woofers, \$65 each; Scan Speak 21W/8553 8" woofers, \$50 each; new SEAS P14RCY, \$25 each. Clay Jordan, (404) 969-8319 after 5 p.m. EST.

HP 28C calculator with manuals, mint condition, \$100. Call Neil, (703) 533-7630 evenings before 9 p.m. EST.

Toroidal power transformers; Avel-Lindberg # 40-3021. Dual 22V, 3A secondaries. Dual 115V primaries. Totally epoxy encased. Great for preamps or small power amps. Limited supply at \$16. Jerry McNutt, 801 South Gay St., Auburn, AL 36830.

Rare and unusual KEF model K-2 Celeste MK-2 two-way speakers made in 1966 in England. Solid wood construction, never abused, first class condition, woofer is oval shape, truly collector items. Good deal for the right person, cash price, \$200/pair. I pay shipping. Call Ed, (305) 891-2267.

Stephens Tru-Sonic 102FR full range 15", 16Ω, cast basket, 2.5 Alnico magnet, flawless example of 1960's leading design. Removed from shorthorn enclosure. One only, \$75 includes shipping. E.D. Loesch, 6220-147th Pl. SE, Bellevue, WA 98006, (206) 643-6520.

Velodyne 18 subwoofer system, \$1,800; Altec 604E coaxials, \$750/pair; 604G, \$750/pair; Valencia speakers, \$800/pair; 511 horns with Alnico drivers, \$275/pair; JBL 2405H slot tweeters, \$195/pair; JBL 2425J horn drivers, \$300/pair. Will trade equipment for counterpoint amps or equivalent. All plus shipping. David (914) 688-5024.

Magnecorder 1024, mint, \$250; Pioneer RT707, \$300; Phase Linear DRS-400, \$250; Apature interconnects, 3/\$40; ADC PSX-30 cartridge (\$150 retail), new, \$30; Sennheiser HD-50 phones, new, \$35. Andy Sommersberger, 2506 So. 20th, Sheboygan, WI 53081, (414) 458-2057, 6-9 p.m.

Pair of black Klipschorns, \$950 plus shipping; Pioneer RT1050 open-reel, 15/7.5 ips, 1/4-1/2-track, used only 200 hours, original box and manuals, \$295; Gold Sound model 424 three-way electronic crossover, used only three months, \$375. Ron Meyer, 1508 Cedar Grove Plantation Dr., Savannah, GA 31419, (912) 925-2311.

High-compliance transmission line optimized Focal 10K515s custom made for Epic Audio, very nice, 20 hours, \$120/pair; Pair T90ks, 40 hours at moderate volume, \$40; Four 5K013L midwoofers, same 40 hours, \$85/pair or \$160/4our. Duke, (504) 581-1865 days, (504) 866-0191 evenings.

## ACTIVE ELECTRONIC CROSSOVERS

### MODEL 120 CABINET & NEW 120-R "RACK AND PANEL" DESIGNS

Plug-in Butterworth (maximally flat) filters 6 db., 12 db., or 18 db. per octave slopes, any specified frequency. Model 120 instrument style case or 120-R "Rack and Panel" case with all terminations and regulated power supply.

Made in monaural or stereo bi-amp, tri-amp, or quad-amp with optional level controls, subsonic filters supplies with or without bass boost, and summers for "single woofer" systems. Also available, 500 Series filters, plug-in filters, regulated power supplies.

**New catalog and price sheet. Free!**

*DeCoursey* Eng. Lab.

11828 Jefferson Bl. Culver City, CA 90230  
PHONE (213) 397-9668

Carver ribbon drivers, \$400/pair; SEAS P17RCY, \$15; Woodstyle WS-602, \$20; Duntech electronic crossover, \$300; Carver TL-3100 CD, \$200; SME tonearm, needs repair, \$25; Citation 16 power amp, \$250. Rick Craig, 1613-K North Sharon Amity, Charlotte, NC 28205. Call (704) 536-9714, 9-12 EST.

Counterpoint 3.1, black, 18 months trans. warranty, extra pot, \$600; MAC C-27 preamp (originally \$1,000), \$450; Haffler DH 160 stereo octave equalizer, \$225; Harman-Kardon TV 912 tuner, \$150; MAG CDB 460, \$125. Bart Ecker, (717) 675-2833 or 788-1702 PA, evenings till 10 p.m. EST.

Morel 162, 8 ohm, 6 1/2" woofers, \$45/pair; Scan Speak 3/4" high power domes, \$30/pair; Radio Shack/JVC ribbons, \$10/pair; Vifa D19TD 8 ohm, 3/4" dome, \$10/pair; Madisound 12" passive radiator, \$10/pair; (4) Advent 10" woofers with new foam surround, \$25 each. All in excellent condition. Don, (716) 652-6107.

Used equipment, all in excellent shape with boxes. Hafler DH120, \$200; DH100, \$110; Magnavox CDB473, \$140; FD2040, \$100; Lazarus H1, \$1,000; CB2, \$400. After 6 p.m. Dan, (801) 225-8577 or Doug, 224-7328, PO Box 2088, Provo, UT 84602.

Gold Ribbon Concept drivers, little use, mint, \$675/pair; Altec 902-8A high frequency drivers, mint with boxes and load caps, \$180/pair; E-V T-35, Alnico chrome, \$90/pair; MacIntosh MX-112 tuner/preamp, \$250; Threshold CAS-1 power amp 75W per channel, \$390. Jim Sanford, (206) 466-4614.

(3) pair Jordan modules, professionally modified with ferrofluid for ultimate reliability, \$100/pair. Gary, (212) 888-7135.

## Audiophile Accessories

<b>DBP-2J (5) • Switch Box</b>	<b>\$69.95</b>
<b>DBP-2J (5) AU • Switch Box with Gold Jacks</b>	<b>\$89.95</b>
Selects among up to 5 inputs. When used with DBP-6 or -6MC, allows for selectable loading of cartridges. Alps level control available.	
<b>DBP-10 • Phono Alignment Protractor</b>	<b>\$24.95</b>
Allows adjusting the lateral tracking error of a mounted cartridge to within 1/4 of a degree. Non-technical instructions and case included.	
<b>DBP-16 • 12dB Input Attenuators (pair)</b>	<b>\$12.95</b>
<b>DBP-CK • Cramolin Audio Kit (contact treatment)</b>	<b>\$19.95</b>
<b>DBP-SC • Souther Record Clamp</b>	<b>\$15.00</b>

### Other Accessories

Gold-plated phono plugs/jacks, banana plug/jacks, spade lugs, Y adapters, custom cables, many other useful accessories.

## Test Compact Discs

We carry almost every worthwhile test CD available, including 5 from the Japan Audio Society (tone bursts and stereo pink noise), 2 from Pierre Verany (1/3 octave warble tones), 3 from Denon (*Aurechio Orchestra*), and *Auditory Demonstrations*.

## Electronic Components

We can create electronic crossovers from 6 to 36dB per octave, custom engineered for your application. 24 and 36dB are Linkwitz-Riley "In Phase" design. Models for Snell and Magnepan speakers available.

The renowned DB Systems preamps, power amps, tone controls, head amp, and phase inverter/bridging adapter are also available through dealers or direct.



**DB Systems**  
Main Street, P.O. Box 460  
Rindge Center, NH 03461  
Phone (603) 899-5121

VISA/MasterCard accepted

Two Dynaudio D-76 midrange domes, used, \$50/pair; two Dynaudio D-28AF tweeters, used, \$40/pair. All in excellent shape, never abused. John Lipani, 384 Sanders Rd., Buffalo, NY 14216, (716) 876-6678 after 6 p.m. EST.

Roberts 1740X reel recorder with walnut case, near mint, \$125; Eico HFT 94 AM tube tuners, \$45 each; NAD 7225PE receiver, 3 months old, box, papers, \$245; Onkyo T4090 AM/FM tuner, mint, \$165; Dynaco SCA35, intermittent channel, \$55. Stephen Fritz, (703) 949-6727 VA.

Tandberg 3034 cassette deck, needs help, includes repair manual, \$75; Strathearn MRHF drivers and transformers, \$110; Promethean Green cartridge, 5 hours use, paid \$280, asking \$200. Bill, (215) 481-6181, 9-3 EST.

JBL-077, 2402, 2405, \$250/pair; E110, \$200/pair; 175DLH and N1200, \$250; 2482, \$300; N2400, \$120; 2409 and 2410, \$200; Altec 605A, \$600/pair; N-1000, \$50; 511B horns, \$100/pair. V. Vogt, 330 SW 43rd St. #247, Renton, WA 98055, (206) 251-5420 extension 247.

Velodyne ULD-18 subwoofer system, mint, complete, dark walnut, \$1,650; Altec Valencia speakers, \$700/pair; Phase Linear 3000II preamp, 1000 noise reduction; Technics M-85 rackmount cassette, 8077K tuner; Marantz 170 DC power amp; Soundcraftsman AE2000 EQ/Analyzer; MacIntosh 240 amp; Bozak Alnico coaxials; Altec 604 coaxials; Eumig/Crown preamps. David Rubenstein, (914) 688-5024.

Pair of custom made heavy duty speakers suitable for DJs or other heavy use applications. 150W continuous bass, 120W continuous ribbon tweeter; drivers by MG and Pioneer. Black vinyl exterior with black grille. Also subwoofer/satellite system with Pioneer drivers. Subwoofer suitable for use as an end table. Red mahogany stain with polyurethane surface. Erik Edwards, (203) 742-9783.

Spectrum analyzer, Tektronix 5L4N, \$1,425; Sony PCMF-1, \$950; IQS FFT for Apple, \$590; HP 330C distortion analyzer, \$150; Speakerlab K-Horn, \$250; AR1W, \$125; EV Aristocrat copy, \$125; Cerwin-Vega V31X two-way 15, \$290; 8-channel mixer, \$290; dbx 3 BX, \$150; Dynaco PAT-4, \$75; FM-3, \$75; (2) ST-120, sick, \$75 each. Marshall Buck, (213) 559-3947 or FAX (213) 836-3763.

Pair of Dynaudio 30W54, pair of D76, four Vifa D19s, very light use, assorted Solen caps and coils, will trade for Quad 34, Sumo Delilah, Superphon CD Maxx, Audio Lab 8000A, Richter Scale III, GFT 555, Magnavox CDB630 or will sell for \$200 US. Randy (519) 948-5215 days or 977-0603 evenings.

IQS 401 FFT spectrum analyzer with Apple computer and printer. FFT accessories, ideal for testing loudspeakers, \$900 all or \$600 for FFT. John Miller, (818) 706-9864.

## WANTED

Wood cabinets for Dynaco equipment, both single and double (tuner/preamp); also original manuals for ST-80 and ST-120; unused circuit boards for the Dynaco equipment and Old Colony Sound Lab. Must be reasonably priced. I am on a fixed income. Rich Holmes, 4085 Harlan St. #5B, Wheatridge, CO 80033, (303) 431-7404.

CalTech Music Lab needs gifts of transformers (UTC LS-12X, LS-10X and other models); and tube gear. Write: James Boyk, Director, MIAF, 102-31 Caltech, Pasadena, CA 91125, (818) 356-4590 or 356-6353.

Copy of schematic and service or instruction manual for a Scott 299C tube stereo amp. Please advise copy and postage charge. Steven Sutherland, 278 East 38th St., Brooklyn, NY 11203.

Pioneer Spec II amp; Phase Linear 500, 700, 400 amps, prefer Series II; Altec magnificent furniture VOT speakers; other large Altec and JBL speakers; 411, 416, 515 woofers; Altec crossovers; Audio Research rack ventilator; MacIntosh and Marantz tube equipment. David Rubenstein, PO Box 125, Mt. Tremper, NY 12457, (914) 688-5024.

## PRODUCTION MANAGER/ENGINEER

Small established loudspeaker manufacturer in Midwest requires person with experience in audio electronics and metal working. Key position in company. Submit resume and salary requirements to: *Speaker Builder*, PO Box 494SB, Peterborough, NH 03458-0494.

Dalesford D30 110 4" woofer. Mike Brinkman, 2480 McMillan, Eugene, OR 97405. (503) 342-2378.

Nakamichi NR200 Dolby NR; contact with NR200 users; drivers and crossover for use with 1.5 cubic foot cabinets; 36" stands for mini monitors; amplified subwoofer with line level inputs. Tom Sutkowski, 23 Lincoln St., Hartford, CT 06106, (203) 293-2295.

Wish to trade Dynaco solid state equipment (including original unassembled Dynakits) for tube amplifiers (need not be working). Send list of equipment you wish to trade and SASE for my list. George Koslow, 200 Commercial Ave., New Brunswick, NJ 08901, (201) 828-7737.

Want 3" CDs. Call for prices. Andy Sommersberger, 2506 So. 20th, Sheboygan, WI 53081, (414) 458-2057 evenings 6-9 p.m.

Four Focal 7N501 Neoflex bass midrange speakers. Bob Mehaffey, 13441 Burdette St., Omaha, NE 68164, (402) 493-6971.

Old Klipsch catalogs, components; *Audio Engineering* volumes 1-5; diaphragm for International Projector LU-1000 high frequency driver; JBL 12" circular perforated plate horn/lens; early Poloroid polarizing film ads, literature; book, *The Throne of Merlin*, by R.C. Schaller; *High Fidelity* volumes 1-5. D.R. Schaller, 6704 Schroeder Rd., Suite 6, Madison, WI 53711.

Two JBL 375 compression drivers and two JBL LX5 crossover networks. Gary Hansen, 604 E. 42nd, Austin, TX 78751, (512) 471-8414 work, 454-5448 home.

10" drivers for Cushing transmission line subs; Curcio boards for ST-70; Curcio boards for Daniel; Citation II amp; Edison Price music posts; Tiffany jacks; quality pots. Joe, (206) 473-3572 PST.

Technics SB 7070 speaker systems. Cabinet must be in good condition. Bob Norris, (904) 392-0622.

## musicable

INTERCONNECTS/CABLE

- BETTER SOUNDING
- LOWEST PRICES
- MONEY-BACK RETURN

## The Speaker Factory

Dept SB

9141 Arbuckle Drive  
Gaithersburg, MD 20877-1428

301-840-0747

## CLUBS

**THE INLAND EMPIRE AUDIO SOCIETY** our former name, has now been changed to the **SOUTHERN CALIFORNIA AUDIO SOCIETY (SCAS)**. Our effort is now inviting music lovers, audiophiles, hobbyists and other interested parties throughout the southland to join us in our pursuit for that elusive sonic perfection and truth at our meetings and seminars and through our official speaker, *The Reference* newsletter. For information write or call: Frank Manrique, President, 1219 Fulbright Ave., Redlands, CA 92373, (714) 793-9209.

**THE COLORADO AUDIO SOCIETY** is a group of audio enthusiasts dedicated to the pursuit of music and audiophile arts in the Rocky Mountain region. We offer a comprehensive annual journal, five bimonthly newsletters, plus participation in meetings and lectures. For more information, send SASE to: CAS, 4506 Osceola St., Denver, CO 80212, or call Art Tedeschi, (303) 477-5223.

**CONNECTICUT AUDIO SOCIETY** is an active and growing club with activities covering many facets of audio—including construction, subjective testing, and tours of local manufacturers. New members are always welcome. For a copy of our current newsletter and an invitation to our next meeting, write to: Richard Thompson, 129 Newgate Rd., E. Granby, CT 06026, (203) 653-7873.

**ELECTROSTATIC LOUDSPEAKER USERS GROUP** is now a world-wide network for those interested in sharing valuable theory, design, construction, and parts source information. If you are interested in building, or have built, your own SOTA ESL we invite you to join our loose-knit organization. For information, send an SASE to: Barry Waldron, 1847 Country Club Dr., Placerville, CA 95667.

**AUDIOPHILES IN THE DAYTON/SPRINGFIELD, OHIO AREA:** We are forming an audio club. Please contact me if you're interested in construction, modifications, testing, recording or just plain listening to music. Ken Beers, 462 Bloese St., Tremont City, OH 45372, (513) 969-8402.

**THE HI-FI CLUB** of Cape Town in South Africa sends a monthly newsletter to its members and world-wide subscribers. To receive an evaluation copy of our current newsletter, write to: PO Box 18262, Wynberg 7824, South Africa. We'll be very pleased to hear from you.



## WANTED

### AUDIO CLUB MEMBERS

(Good singing voice not required)

Learn about the latest equipment, techniques and recordings through group meetings, tours and newsletters. Ask questions. Share viewpoints and experiences. *Have fun!*

If there's no club in your area, why not start one? Our club ads are free up to 75 words (\$.20 per word thereafter). Copy must be provided by a designated officer of the club or society who will keep it current.

**THE CATSKILL AND ADIRONDACK AUDIO SOCIETY** invites you to our informal monthly meeting. Join our friendly group of audio enthusiasts as we discuss life, the universe and everything. No matter what your level of interest, experience, or preferences, you are welcome. Meetings are generally held once a month, on a weekday evening. Contact CAAS at 756-9894 (leave message), or write CAAS PO Box 144, Hannacroix, NY 12087. See you there!

**MEMPHIS AREA AUDIO SOCIETY** being formed. Serious audiophiles contact J.J. McBride, 8181 Wind Valley Cove, Memphis, TN 38125, (901) 756-6831.

**AUDIO SOCIETY OF MINNESOTA.** Audiophiles, music lovers, scratch builders, record collectors, tube freaks, digital freaks—we've got 'em all! Monthly meeting, tours, audiophile concerts, special guests, etc. Now in our 12th consecutive year! Write ASM, PO Box 32293, Fridley, MN 55432.

**NEW JERSEY AUDIO SOCIETY** meets monthly. Emphasis is on construction and modification of electronics and speakers. Dues includes monthly newsletter with high-end news, construction articles, analysis of commercial circuits, etc. Meetings are devoted to listening to records and CDs, comparing A-B-ing equipment. New members welcome. Contact Bill Donnally, (201) 334-9412 or Bob Young, 116 Cleveland Ave., Colonia, NJ 07067, (201) 381-6269.

**SOUTHEASTERN MICHIGAN WOOFER AND TWEETER MARCHING SOCIETY (SMWTMS).** Detroit area audio construction club. Meetings every two months featuring serious lectures, design analyses, digital audio, A/B listening tests, equipment clinics, recording studio visits, and audio fun. The club journal is *LC, The SMWTMS Network*. Corresponding member's subscription available. Call (313) 477-6502 (days) or write David Carlstrom, SMWTMS, PO Box 721464, Berkley, MI 48072-0464.

**ORGAN MUSIC ENTHUSIASTS:** If live recordings of fine Theatre Organ Music are your thing, SFORZANDO has room for a few new members. We lend you the music on cassettes. All operation is via the mail. SFORZANDO, c/o E.A. Rawlings, 5411 Bocage St., Montreal, Canada H4J 1A2.

**PACIFIC NORTHWEST AUDIO SOCIETY (PAS)** consists of 60 audio enthusiasts meeting monthly, second Wednesdays, 7:30 to 9:30 p.m. at 4545 Island Crest Way, Mercer Island, Washington. Be our guest, write Box 435, Mercer Island, WA 98040 or call Bob McDonald, (206) 232-8130.

**PIEDMONT AUDIO SOCIETY.** Starting an audio club in the Raleigh-Durham-Chapel Hill area of North Carolina. Interested in designing, building, and modifying speakers and electronics (solid state and tube). Beginners and old hands both welcome. Kevin Carter, 9009 Langwood Drive, Raleigh, NC 27612, (919) 870-5528.

**WANT TO START OR JOIN CLUB IN CENTRAL ILLINOIS** (Peoria, Bloomington, Champaign, Kankakee area). Speaker building and audio in general. Trade info and parts. (815) 657-8488 evenings or weekends.

**WASHINGTON AREA AUDIO SOCIETY** (N. VA, MD and DC) is looking for sincere audiophiles who are eager to devote their time and get involved with the direction of the society and the publication of a monthly newsletter. Please contact: Horacio J. Vignale, 3730 Gunston Rd., Alexandria, VA 22302.

**THE WESTERN NEW YORK Audio Society** (WNY Audio Society) is an active and growing audio club located in the Buffalo area. We issue a quarterly newsletter and hold meetings the first Tuesday of every month. Our meetings have attracted many local and distant manufacturers of audio related equipment. We are involved in all facets of audio—from building to purchasing at discount prices. For a copy of our current newsletter and information regarding our society, please write to M.A. Monaco, WNY Audio Society, PO Box 312, N. Tonawanda, NY 14120.



**Advanced Akustic**  
Loudspeaker Technology Ltd.

DYNAUDIO • Speaker Kits • Cabinetry

4555 North Pershing Avenue • Suite 33•184  
Stockton CA 95207 (209) 477-5045

**THE ATLANTA AUDIO SOCIETY** is dedicated to furnish pleasure and education for people with a common interest in fine music and audio equipment. Monthly meetings often feature guest speakers from the audio manufacturing and recording industry. Members receive a monthly newsletter. The society is hosting the 2-day **SUNBELT AUDIO SHOW** in Atlanta on August 18 and 19, 1990. Call: Chuck Bruce, (404) 876-5659, or Denny Meeker, (404) 872-0428, or write: PO Box 361, Marietta, GA 30061.

**CHICAGO AREA ENTHUSIASTS WANTED** for audio construction club. Call Tom, (312) 558-3377 or (708) 516-0170 evenings for details.

**THE BOSTON AUDIO SOCIETY** invites you to join and receive the bimonthly *B.A.S. SPEAKER* with reviews, debates, scientific analyses, and summaries of lectures by major engineers. Read about Apogee, Nyal, Conrad-Johnson, dbx digital, Snell, music criticism and other topics. Rates on request. PO Box 211, Boston, MA 02126.

**THOSE INTERESTED IN AUDIO** and speaker building in the Knoxville-East Tennessee area please contact Bob Wright, 7344 Toxaway Dr., Knoxville, TN 37909-2452, (615) 691-1668 after 6 p.m.

**TUBE AUDIO ENTHUSIASTS.** Northern California club meets every other month. For next meeting announcement send a self-addressed, stamped #10 envelope to Tim Eding, PO Box 611662, San Jose, CA 95161.

## Advertising Index

FAST REPLY	PAGE
HE639 A & S SPEAKERS .....	29
HE53 ACE AUDIO CO. ....	82
HE27 ACOUSTICAL MAGIC CO. ....	45
HE1061 ADVANCED SOUND .....	45
AUDIO AMATEUR PUBLICATIONS	
AUDIO AMATEUR .....	83
BACK ISSUES .....	79
BOXES & BINDERS .....	58
ELEKTOR ELECTRONICS USA .....	32-33
GLASS AUDIO .....	84
AUDIO CONCEPTS, INC. ....	35
HE123 AUDIO CONTROL .....	4
HE32 AUDIO TEKNOLOGI .....	94
HE333 BIG COVE RESEARCH .....	94
HE330 CAPE ACOUSTICS .....	93
HE392 CARBONNEAU SPEAKERS .....	16
CATALOG CORNUCOPIA .....	84
HE596 DLC DESIGN .....	85
HE370 EQUALITY SCREW CO. ....	101
HE1107 ETON .....	Cover II
EUPHONIC TECHNOLOGY	
FOCAL AMERICA	
HE627 SUBS .....	9
HE564 CABASSE/VIETA .....	63
HE588 CAPACITORS/ARIA 5 & 7 .....	19
HE626 VIETA SUBWOOFER .....	57
HE149 GOLD SOUND .....	62
HE166 GRENIER CABINETS .....	62
HE416 HART PROFESSIONAL MARKETING .....	91
HI-FI NEWS .....	
HE643 HTA .....	92
HE362 KRELFIELD AUDIO .....	86
HE387 LRS ELECTRONICS .....	78
MADISOUND	
HE672 INDUCTORS/CAPACITORS .....	61
HE670 LAST FLING .....	21
HE73 MAHOGANY SOUND .....	86
HE389 MARRS DEVELOPMENT .....	87
HE661 MAY AUDIO MARKETING, INC. ....	89
HE278 McCAULEY SOUND .....	23
HE568 MENISCUS .....	82
HE186 MITEK .....	15
HE142 MOREL ACOUSTICS .....	Cover IV
HE598 NEUTRIK USA, INC. ....	25
OLD COLONY SOUND LAB	
AUDIO ANTHOLOGY I-III .....	90
AUDIO GLOSSARY (HOLT) .....	73
BOOKS	
BULLOCK & WHITE SOFTWARE .....	42
CALSOD SOFTWARE .....	82
CIRCUIT BOARDS .....	67
DISC ADE .....	78
KILLER CAR STEREO .....	69
KITS .....	30
LOUDSPEAKER DESIGN COOKBOOK .....	69
LOUDSPEAKERS (BRIGGS) .....	88
SUMMER SPECIALS .....	70
TAA LOUDSPEAKER PROJECTS .....	80
SOFTWARE .....	86
TIPTOES .....	78
WILLIAMSON AMPLIFIER .....	81
HE81 PARTS EXPRESS .....	Cover III
HE666 PEERLESS AMERICA .....	43
POLYDAX .....	49-56
HE128 PYLE INDUSTRIES .....	17
HE163 RAMSDALL AUDIO .....	93
HE295 SCHUCK CONSULTING .....	87
HE499 SESCOM .....	6
HE1063 SOLEN, INC. ....	75
HE412 SPEAKERS, ETC. ....	66
HE618 SPEAKER WORKS .....	92
HE607 TRANSPARENT AUDIO MARKETING .....	4
HE544 TRUE IMAGE .....	66
VERSATRONICS .....	
HE401 WATTERS SOUND WAVE CO. ....	5
ZALYTRON	
HE151 CABINETS .....	77
HE1131 SURPLUS SPECIALS .....	59



## Good News

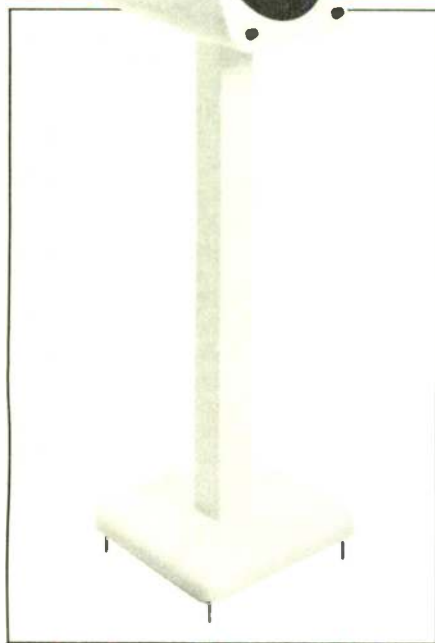

**MacNEIL ENGINEERING AND MANUFACTURING** has released a new loudspeaker measuring 20" x 11" x 12". The enclosure's unconventional dimensions are said to improve stereo imaging and forward soundstaging. A Polydax 1" soft-dome tweeter is utilized along with a heavy-duty, high-resolution woofer mounted in an acoustic suspension enclosure. The design, says MacNeil, provides gradual low frequency rolloff in contrast to the sharp cutoff associated with ported-bass reflex designs.

Frequency response is 34Hz-22kHz. Power requirements are 1 to 100W per channel, and sensitivity is 90dB. A jet black finish, with black grille and rounded outside corners to ease the effects of diffraction are standard. A variety of optional colors and prints is available. List price is \$319 per pair.

For more information, contact MacNeil Engineering and Manufacturing, 417 Temple Rd., Monaca, PA 15061-2843, (412) 375-9203.

**Fast Reply NHE688**



Earlier this year at the *Stereophile* High End Hi-Fi Show, **AUDIO CONCEPTS** unveiled its "Premier" line of assembled speakers. The new line consists of a complete speaker system called Premier System One, and a second, smaller set of satellites (not a system) called the Premier Little Vs.

Specifications on the Premier System One include: frequency response of  $\pm 2.5$ dB, 34Hz-20kHz; sensitivity of 88.5dB, 1W/1 meter; impedance of 8 $\Omega$  nominal, 6 $\Omega$  minimum; and a recommended amplifier power of 50-200W/channel. The woofers are 24"H x 13.5"W x 14.5"D. The satellites are 13"H x 7"W x 13"D. The complete system is priced at \$1,999, with individual components available separately.

The Little V (pictured) takes a "less is more" design approach, says Audio Concepts. The units may be wall-mounted, stand-mounted or placed on bookshelves. The optional metal tube stands are sand-filled and come with carpet-piercing spikes.

Frequency response for the Little V is  $\pm 3$ dB, 70-20kHz. Sensitivity is rated at 89dB, 1W/1 meter. Impedance is 8 $\Omega$  nominal, 6 $\Omega$  minimum. The recommended amplifier power is 20-100W/channel.

For more information, contact Audio Concepts, Inc., 901 South 4th St., La Crosse, WI 54601, (608) 784-4570; FAX: (608) 784-6367.

**MOREL ACOUSTICS** has introduced three new OEM drivers. The MW-1075 is a 10" woofer with double-magnet construction, 3" voice coil, damped polymer composite (DPC) cone and foam surround.

From their car audio division they now offer the MW-142, a 5" midbass driver, unusual for its 3" voice coil, with double-magnet construction with a DPC cone and rubber surround.

Morel considers the MW-1275, a 12" woofer, their most exciting new product. Featuring a 3" voice coil, double-magnet construction with high-damping black polymer composite cone material and polyurethane surround, the MW-1275 is similar in appearance to the popular MW-1252.

All three products will be available August 1990.

For more information, contact Morel Acoustics, 414 Harvard St., Brookline, MA 02146, (617) 277-6663; FAX: (617) 277-2415.

**Fast Reply NHE142**

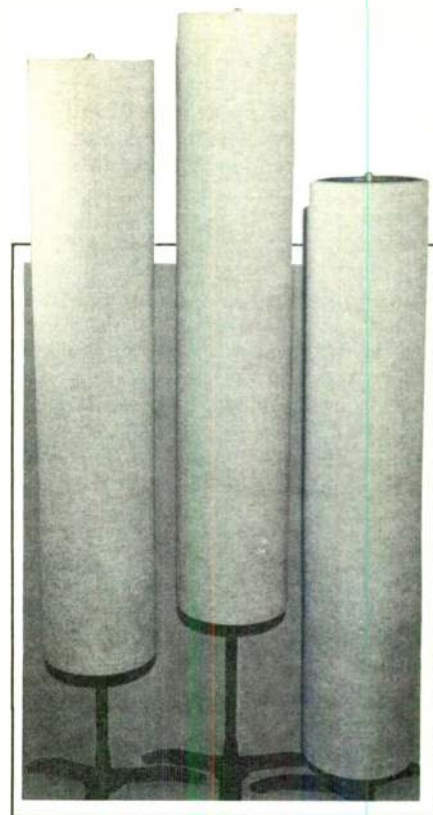

The Studio Trap is a portable, self-contained 9" tube recently released by **ACOUSTIC SCIENCES CORPORATION**. The unit is tripod-mounted with floating suspension. Studio Traps are tuneable, owing to a patented sound diffusion panel that disperses sound above 440Hz. Half of the trap's surface is midrange-reflective while the other half is absorptive. Rotating the unit turns the panel either into or away from the soundfield, thereby changing its brightness. Covered with Guilford 701 fire-resistant fabric, they are available in a range of designer colors. Price is \$255.

For more information, contact ACS, Box 1189, Eugene, OR 97440, (503) 343-9727; FAX: (503) 343-9245.

**Fast Reply NHE280**

**SOUNDINGS-ELECTROTEC** is now North American import agent and distributor for Minim Ambisonic Surround Sound decoders and processors. The AD10 decoder is a full-feature system including a "Loudspeaker Aspect Ratio" control, "Focus," "Position" (the listener may "move" himself forward or backward in the soundfield), and "Stereo Enhance" for normal stereo recordings (variable from central mono image to a complete surround picture).

The AD7 Decoder is a simplified version of the AD10. The AD10 is priced at \$595 and the AD7 lists for \$325.

For further information, contact Nigel Branwell at Soundings-ElectroTec, Inc., Box 10004, Winslow, WA 98110, (206) 842-7128; FAX: (206) 842-5026.

**Fast Reply NHE680**

The T-Cup, an input connector which accepts speaker cables down to #10 as well as banana plugs, is now in stock at **MADISOUND SPEAKER COMPONENTS**. These connectors have dual inputs for bi-amp or bi-wire, gold-plated connectors, bridge strips for single input, airtight gasketing, and accept large solder lugs for multiple connections.

Madisound notes that the T-Cup would be especially useful for bi-wire or bi-amp applications. Additionally, two T-Cups could be used for a dual voice coil subwoofer configuration. Suggested retail price is \$7.50.

For more information, contact your dealer or Madisound Speaker Components, Box 4283, Madison, WI 53711, (608) 831-3433; FAX: (608) 831-3771.

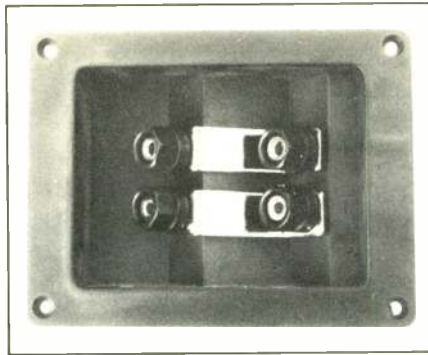

Fast Reply #HE20

Fast Reply #HE20

Studio 0.5, the latest loudspeaker system from **TRANSDUCER DEVELOPMENTS LIMITED**, could be the world's smallest transmission line loudspeaker, according to TDL. Weighing just 59.5 lbs (pair), the Studio 0.5 driver is made with "Kapton" material which allows an increase in the electrical Q and enables it to more easily load the line. The driver is integrated with a metal dome tweeter via a simple crossover.

Other specs include 84dB efficiency; 30Hz-20kHz frequency range; 6Ω impedance nominal; and a power requirement of 30-100W.

More information is available from TDL Electronics, 652 Glenbrook Rd., Stamford, CT 06906, (203) 324-7269.

Fast Reply #HE677

# DON'T COLOR YOUR SOUND

KEVLAR® & WOVEN CARBON DRIVERS  
BY VERSA-TRONICS  
PRESENTS TRUE UNCOLORED REPRODUCTION



### Only Versa-Tronics Presents:

- 4", 5-1/4", 6-1/2", 8", 10" and 12" Woofers
- Die Cast Alloy Baskets
- Rubber Surrounds
- Aluminum & Kapton Voice Coil Formers
- Excellent Damping
- European Cone Materials
- Polymer Dust Caps
- Extremely light cone material

### Available at the following distributors:

**Just Speakers**  
3170 23rd St  
San Francisco, Ca 94110  
(415) 641-9228

**Speakers, Etc.**  
1828 W. Peoria  
Phoenix, Az 85029  
(602) 944-1878

**Toutant Electronics**  
246 E 131st Street  
Cleveland, Ohio 44108  
(216) 451-6325

**Speaker City**  
10615 Vanowen  
Burbank, Ca 91505  
(818) 508-1908

**Speaker Works**  
2539 E Indian School Rd  
Phoenix, Az 85016  
(602) 956-6344

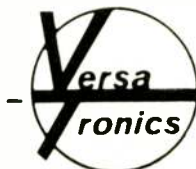

**VERSA-TRONICS INC.**

Amherst, NH 03031

A new 1/3-octave real-time audio analyzer, the Model 30M8, has been introduced by **GOLD SOUND**. According to the company, it is the least expensive and smallest true such test unit available. Standard features include eight memories, 12V internal battery, battery charger and microphone.

The unit's maximum SPL is rated at 123dB, expandable (with option) to 145dB. Its eight memories enable comparisons of speakers, crossovers, phasing and EQ. The weight curve switch has three positions: flat, A&C and SPL. The decay time switch provides settings for FAST (music), SLOW (pink noise) and HOLD (time freeze).

The RTA lists for \$679; the expanded SPL option at \$120.

For more information, contact Gold Sound, Box 141, Englewood, CO 80151, (303) 761-6483.

Fast Reply #HE149

Mike Goldfield of **EUPHONIC technology** has designed a new product for an old problem. AccuPower is a four-channel, isolating power line filter for combating power line pollution.

Applicable to both audio and video, AccuPower features four output channels, each incorporating an independent four-stage LC filter, providing 70dB attenuation for frequencies between 10kHz and 250MHz. Independent isolating filters prevent component interactions, said Mr. Goldfield. Each AP-4 channel can handle 150W of continuous power and surges in excess of 100A, with a spike and surge suppression response time of one picosecond at a peak spike current of 30,000 surge amps.

Housed in an 18-gauge steel chassis with a 3/16" anodized aluminum decorative faceplate, it carries a full five-year warranty.

For more information, contact your local dealer or EUPHONIC technology, 19 Danbury Rd., Ridgefield, CT 06877, (203) 431-6434; FAX: (203) 431-3660.



**MISSION ELECTRONICS** has introduced the Model 764i speaker system, a more sensitive and elegantly styled version of the original Model 764, at no price increase. The two-way reflex has a sensitivity of 90dB. A completely redesigned baffle locates the port higher and the grille covers only the top two-thirds of the cabinet. Available finishes are real walnut, rosewood, and black ash veneer.

Like its predecessor, the 764i incorporates one 8.25" woofer and a 1" dome tweeter and employs Mission's patented double-chamber, impedance-transforming fabric dome tweeter. During operation, the chambers create different air

pressures on each side of the tweeter dome, effectively transforming the speaker impedance sent by the amplifier, the company said. During high-transient operation, this system works to prevent shape distortions in the tweeter dome.

The speakers' floor-standing cabinets are 34" tall, 10" wide and 13.25" deep. Screw-in floor mounting spikes are provided and Mission also installs threaded inserts into the speaker bottoms. Suggested list price is \$1,099 per pair.

For more information, contact Mission Electronics USA, Inc., 18303 8th Ave., Seattle, WA 98148.

**Fast Reply #HE565**

**NEW**



## LITTLE GRIPPER END SPIN OUT!

### PARTICLEBOARD HINGE SCREW

The "Little Gripper" is the answer to your small fastener problems in particleboard and MDF. With the wide spread use of these man made woods the right fastener that works each and every time is essential to your production requirement.

The "Little Gripper" with it's wide spaced angled threads is especially designed for use with your hinge application in particleboard and MDF. Avoid the frustrating and time consuming problem of spin out, so common with sheet-metal screws in these man-made woods. **USE THE RIGHT FASTENER**—Use the "Little Gripper" by Equality Screw Co.

(CUT OUT AND SEND)

call or write  
for your  
**FREE**  
sample

6 x 1/2 phillips flathead

6 x 5/8 phillips flathead

6 x 3/4 phillips flathead

### SPECIALIZED FASTENERS for CABINETS & COUNTERTOPS



**SCREW COMPANY INC.**

P.O. BOX 1645, EL CAJON, CA 92022

1-800-854-2886 800-552-8844 (IN CALIFORNIA)

The Stratus Gold loudspeaker from **PSB** has a power handling capacity of 250W, frequency response of 36Hz-20kHz,  $\pm 1.0$ dB on axis and 36Hz-15kHz  $\pm$  off axis, and a typical-listening-room sensitivity of 90dB.

A new tweeter with an aluminum alloy dome and a polyamide suspension, is stiff, thin and has low moving mass. The dome is said to perform as a true piston up to 20kHz.

The Gold's 6" midrange is less directional at middle frequencies, thus improving its off-axis response. Its mineral-filled polypropylene cone combines stiffness with a high degree of internal damping.

The smaller midrange driver allows a 24dB/octave Linkwitz-Riley crossover to the tweeter. The speaker plays louder without strain and frees the tweeter to reproduce subtle overtones with maximum accuracy.

The Stratus Gold's subwoofer has a 10" driver, 54-ounce magnet and a 2" voice coil. The felted fiber cone is treated with plastic for increased stiffness and is suspended on a rubber surround. The bass reflex cabinet with a computer-tuned port delivers bass down to 25Hz. The Gold's woofer crossover is a 250Hz, 18dB/octave Butterworth network.

For more information, contact PSB International, Inc., 633 Granite Ct., Pickering, Ontario L1W 3K1.

**Fast Reply #HE678**

**Fast Reply #HE370**

Speaker Builder / 4/90 101

# Pox Humana

## Hey, I only wanted to charge you less!

by Dick Pierce

Twelve years ago I ran what became known as a very well-respected repair department specializing in state-of-the-art components. My reputation was as one of the few ReVox wizards who not only did great work, but did it in less than 10 years. I had a very impressive array of equipment and documentation, equalled by almost no other repair agency and exceeding most manufacturers' as well.

Another store in the area (the Music Box, in Wellesley) had a similar reputation. But they had one thing I did not: a legend. One of the sources of their legend was the alignment work they did on the venerable and awesome Marantz 10B tuner.

The Marantz 10B was a tube-based tuner that boasted some very impressive specifications. It had near-infinite alternate-channel selectivity, adjacent channel rejection that bettered most other tuner's alternate channel specs. Its image rejection was phenomenal, audio distortions were

remarkably low, and it had an oscilloscope for a tuning meter (actually a useful thing in those days). What it had as a disadvantage was—tubes.

The tuner did need its periodic alignment. For this the Music Box was legend. The standard price for 10B alignment and setup was \$250. My God, everyone said, this must be the best alignment around! My God, I thought, what could possibly cost that much?

Well, the inevitable happened. Someone brought a Marantz 10B into my shop for alignment. There it was, on my bench. A true deity of audio, and I had to work on it. Was I worthy? Was I able?

I happened to have a 10B service manual, so I sat down to study it. Wait a minute, I thought, this can't be a 10B service manual, it's too simple and straightforward. There's no magic. The only thing different is that they require you to align the IF section for minimum group delay and frequency dispersion. So what?

Well, this first job took an hour or so. When I was done, the tuner met or exceeded every spec. I was most pleased. Hooking it up, it sounded wonderful. In the middle of Boston, no multi-path problems, no birdies.

The gentleman came to pick up his tuner. Out of his pocket he pulled a wad of \$20 bills. "That'll be \$45," I said. "What!" he exclaimed. I calmly explained to him that it took me an hour and a half, and my going rate was \$30/hour. He reluctantly forked over \$45, took his tuner, and immediately marched over to the Music Box, and had them align it for \$250! He then brought it back to me two weeks later and told me to measure how much better it was. It measured exactly the same. He left with his tuner under his arm and his nose quite high in the air.

It occurred to me then that I had severely *undercharged* him. The next time someone brought a 10B in, it took me 20 minutes, and I tried charging \$75 dollars. The customer's comments were, "Well, your not as expensive as the Music Box is, but I guess you get what you pay for." He left, moderately happy.

Well, I thought, why not try playing the game as others do. The next time someone brought in a 10B, I took 20 minutes to align it and charged \$225. The customer was in seventh audio heaven. Finally, he said, someone who can do as good a job as the Music Box, and charges less to boot!

There used to be a local radio program on hi-fi in Boston. The next program, this same guy calls in and can't say enough good things about me. Says I do the best 10B alignment in the world, and I also charge honest prices. Next thing I know, I have more people beating my door down trying to get me to align 10Bs than I know what to do with.

I later met the service man at the Music Box on neutral territory, and compared notes. It turned out that he took the same time I did, he did the same things I did, and he encountered the same response I did. "Why charge \$250 to do such a simple job?" I asked. His reply was most simple: "Because people refuse to pay less."

Here we have, to me, a moral dilemma: I do a \$30 job on a piece of equipment, charge \$30, and people aren't happy. I do the same \$30 job, charge \$225, and people are ecstatic. I did the best job possible, but in my mind, it was not worth \$225.

Is my job to make people happy, or to charge them fair prices? An interesting source of debate material, indeed.

[Perhaps Mr. Pierce has discovered a new form of subjective technology.—Ed.]





### 12" EMINENCE CAST FRAME

170W RMS, 80 oz. magnet. 40-4.5KHz response. #12-3760. Call for complete specs.



#290-147

\$72<sup>90</sup>  
(1-3)

\$69<sup>50</sup>  
(4-up)

### 5" POLYDAX MIDRANGE

Poly cone midrange with rubber surround. 180-10KHz frequency response. #TX11.25JSN. Call for complete specs.



#280-230

\$45<sup>80</sup>  
(1-9)

\$42<sup>90</sup>  
(10-up)

### 15" PIONEER SUBWOOFER

Dual voice coil. 100W RMS. 20-1.2KHz response. Call for complete specs.



#290-190

\$54<sup>50</sup>  
(1-3)

\$49<sup>80</sup>  
(4-up)

### 8" POLYDAX MID/WOOFER

TPX cone with reverse rubber surround. 49-5KHz frequency response. #MTX20.25RSN. Call for complete specs.



#290-035

\$45<sup>50</sup>  
(1-3)

\$39<sup>80</sup>  
(4-up)

### 18" EMINENCE CAST FRAME

200W RMS, 100 oz. magnet. 28-3.5KHz response. #18-1332. Call for complete specs.



#290-230

\$128<sup>90</sup>  
(1-3)

\$124<sup>50</sup>  
(4-up)

### POLYDAX TWEETER



Titanium composite dome. 1K-20KHz frequency response. #DTW100T25.FF6. Call for complete specs.

#270-047

\$27<sup>50</sup>  
(1-9)

\$24<sup>80</sup>  
(10-up)

### CALL TOLL FREE 1-800-338-0531

• 15 day money back guarantee • \$15.00 minimum order • We accept Mastercard, Visa, Discover, and C.O.D. orders. • 24 hour shipping • Shipping charge = UPS chart rate + \$1.00 (\$3.00 minimum charge) • Hours 8:30 am- 7:00 pm EST, Monday - Friday • Mail order customers, please call for shipping estimate on orders exceeding 5 lbs. Foreign customers please send \$5.00 U.S. funds for catalog postage.

340 E FIRST ST  
DAYTON, OH  
45402



### DON'T FORGET



FREE CATALOG

# more

high fidelity  
range



The MDM 85 is a mid range 75mm soft dome unit of extremely high standard, both from a design and technical viewpoint.

It incorporates the renowned Morel double magnet and Hexatech voice coil techniques, and results in a unit of above average sensitivity with extremely low distortion and high power handling capability.

With an output level of 96dB distortion in the area of 400-800Hz is slightly over 1% falling to 0.015% from 1Khz.

There are two different types available, one with a rear enclosure and one without (MDM 85NE). The type with the rear enclosure can be fitted into a cabinet as an integral unit.

The MDM 85NE without the rear enclosure can only be fitted into a system having a separate housing to enclose the unit. A volume of 0.7 litre is recommended for this housing, which is essential to prevent inter-reaction with the bass unit compressions and expansions. This housing must be filled full with damping material, such as fibreglass or rock wool.

The Thiele small parameters are given for both types under specifications. The contribution of this unit to a suitably designed system will be evident in the clarity and detail given in the 500-5000Hz region.

## Specification

### MDM 85 (with enclosure)

Overall Dimensions	Ø - 160mm x 113mm
Nominal Power Handling Din	300W
Transient Power 10ms	1500W
Voice Coil Diameter	75mm (3")
	Hexatech Aluminium
Voice Coil Former	Aluminium
Frequency Response	300-5000 Hz
Resonant Frequency	250 Hz
Sensitivity	92 dB (1W/1M)
Nominal Impedance	8 ohms
Harmonic Distortion for 96 dB SPL	<1%
Intermodulation Distortion for 96 dB SPL	<0.25%
Voice Coil Inductance @ 1 KHz	0.2mh
Air Gap Width	1.05mm
Air Gap Height	3.0mm
Voice Coil Height	6.0mm
Flux Density	1.0T
Force Factor (BXL)	4.6 WB/M
Rdc	5.2 ohms
Rmec	37.90
Qms	0.29
Qes	2.66
Q/T	0.20
Vas	0.33 litre
Moving Mass including Air Load	7.0 grams
Effective Dome Area	63.50 cm <sup>2</sup>
Dome Material	Chemically Treated Fabric
Nett Weight	1.25 kg

### Variations to specification for MDM 85NE (without enclosure)

Overall Dimensions	Ø - 160mm x 60mm
Frequency Response	250-5000 Hz
Resonant Frequency	170 Hz
Rmec	39.3
Qms	0.1
Qes	1.8
Q/T	0.1
Vas	0.7 litre
Nett Weight	1.05 kg

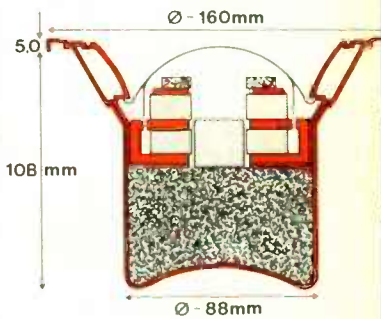

Specifications given are as after 24 hours of running.

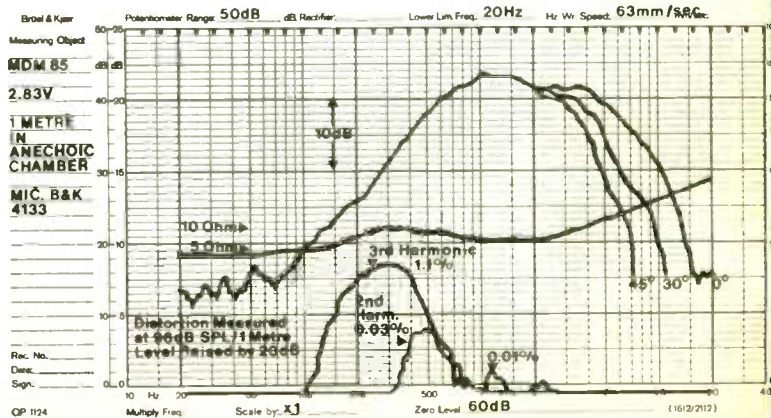

### morel (u.k.) ltd.

11 Foxtail Road  
Nacton Rd (Ransomes)  
Industrial Estate  
Ipswich, IP3 9RT  
England  
Tel: (0473) 719212  
Telex: 987601 Morel G

### morel acoustics USA

414 Harvard Street  
Brookline, MA 02146  
Tel: (617) 277-6663  
FAX: (617) 277-2415



Morel operates a policy of continuous product design improvement, consequently, specifications are subject to alteration without prior notice.

World Radio History

Fast Reply #NE1