

# MIX

MASTER  
DIRECTORY  
OF THE  
**Professional Audio Industry**



# mix•er

**(mik'sēr) noun.** An electronic device used to *mix* music. Must be clean, transparent and punchy. See Alesis 1622 Mixer. Better yet, listen to it.



**B**etter yet, own it. That's what every major music magazine is saying about the Alesis 1622 Mixer, because its radical new design redefines the concept of a professional mixer. Reason enough to make it the center of your studio.

Need more reasons? How about 16 channels with 100mm faders for precise control over all inputs. And 6 independent auxiliary sends on every channel so you can drive all the stereo effects you'll ever need to create masterful mixes.

The 1622's ingenious design uses surface mount technology on a scale that nobody ever thought possible. It's the key to the 1622's incredible value.

We call it the Monolithic Integrated Surface™. Our competition calls it terrifying, because it shatters the price barrier for a pro mixer.

Your mixer is the single most important piece of gear in your studio. It defines the sound of your music. It must be flexible, reliable, and above all, it should have impeccable audio credentials\*. That's why the 1622 is your first choice for a mixer. It might be the only choice. Listening to it will convince you.

Visit your Alesis dealer today and hear the 1622. Better yet, buy it.

Call 1-800-5-ALESIS, 9 AM to 5PM Monday-Friday, and we'll send you a brochure on why Monolithic Surface Technology is important to your music.

\* Total Harmonic Distortion + Noise: too low to measure.\* Keyboard Magazine July 1990.



LOS ANGELES: Alesis Corporation, 3630 Holdrege Avenue, Los Angeles, Ca 90016

LONDON: 17 Letchworth Point, Letchworth, Hertfordshire, SG6 1ND.

World Radio History





# Dolby SR. The sound investment for analog multitracks.

When everyone else was making noise about digital, we quietly developed Dolby SR. But it's no secret: Dolby SR makes analog multitrack recording a cost-effective alternative to digital.

## Improves the preferred sound of analog

At both 15 and 30 ips, Dolby SR dramatically increases headroom, and virtually eliminates tape hiss and modulation noise. Dynamic range is improved by more than 25 dB over unassisted analog, preserving all the warmth and purity of the original sound.

## Increases the return on your investment

Dolby SR upgrades your multitrack at a fraction of digital's cost. Add our Model XP SR (configured for up to 24 channels), or update an existing Dolby mainframe with plug-in SR modules. If you are in the market for a new multitrack, Otari and Studer offer models with Dolby SR built-in.

## Simple to use

Set-up is quick and easy with Dolby SR. A unique

Auto Compare feature lets you instantly verify frequency response and playback calibration.

And editing is as convenient as ever, with no need for special equipment.



## Worldwide acceptance

Tapes recorded with Dolby SR can go anywhere, anytime. In fact, with more than 25,000 channels in over 30 countries, analog with Dolby SR is a firmly-established format you can't afford to ignore.

## Put it to the test

Call your Dolby dealer to arrange for a demo at your facility. Hear for yourself why Dolby SR is

the sound investment for analog multitracks in today's competitive marketplace.



100 Potrero Avenue, San Francisco, CA 94103-4813. Phone 415-558-0200, Telex 34409, FAX 415-863-1373 346  
Clapham Road, London SW9 9AP, Phone 01-720-1111, Telex 919109, FAX 01-720-4118. Dolby and the Double-D symbol are trademarks of Dolby Laboratories Licensing Corp. © Dolby Laboratories Inc., 1989 S89/8676

# MIX

MASTER  
DIRECTORY

OF THE  
Professional Audio Industry

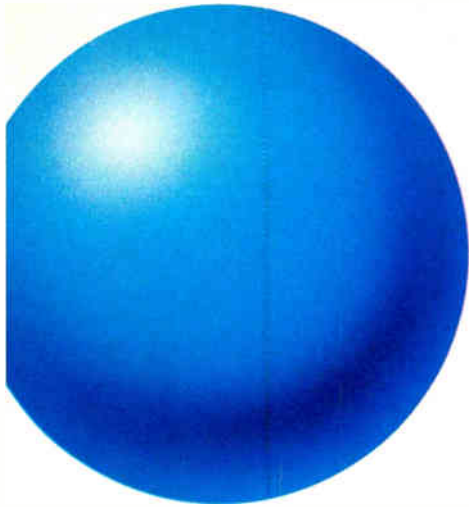

## T A B L E O F

*Trade Events & Conferences* ..... 11

*Industry Organizations* ..... 14

*Record Companies* ..... 16

*Professional Audio Manufacturers* ..... 23

*Professional Audio Manufacturers Cross-Index* ..... 48

*Professional Services* ..... 52

*Advertising Agencies* ..... 52

*Business Consultants/Financial Services* ..... 52

*Graphic Design/Photographic Services* ..... 53

*Legal Services* ..... 53

*Public Relations Firms* ..... 54

*Miscellaneous Services* ..... 55

*Recording & Video Production Facilities, U.S.* ..... 57

|                               |                                |
|-------------------------------|--------------------------------|
| <i>Alabama</i> ..... 57       | <i>Nevada</i> ..... 78         |
| <i>Alaska</i> ..... 57        | <i>New Hampshire</i> ..... 78  |
| <i>Arizona</i> ..... 58       | <i>New Jersey</i> ..... 78     |
| <i>Arkansas</i> ..... 58      | <i>New Mexico</i> ..... 79     |
| <i>California</i> ..... 59    | <i>New York</i> ..... 80       |
| <i>Colorado</i> ..... 67      | <i>North Carolina</i> ..... 84 |
| <i>Connecticut</i> ..... 67   | <i>North Dakota</i> ..... 85   |
| <i>Delaware</i> ..... 68      | <i>Ohio</i> ..... 85           |
| <i>Florida</i> ..... 68       | <i>Oklahoma</i> ..... 86       |
| <i>Georgia</i> ..... 70       | <i>Oregon</i> ..... 86         |
| <i>Hawaii</i> ..... 71        | <i>Pennsylvania</i> ..... 87   |
| <i>Idaho</i> ..... 71         | <i>Puerto Rico</i> ..... 89    |
| <i>Illinois</i> ..... 71      | <i>Rhode Island</i> ..... 89   |
| <i>Indiana</i> ..... 73       | <i>South Carolina</i> ..... 89 |
| <i>Iowa</i> ..... 73          | <i>South Dakota</i> ..... 89   |
| <i>Kansas</i> ..... 73        | <i>Tennessee</i> ..... 89      |
| <i>Kentucky</i> ..... 73      | <i>Texas</i> ..... 91          |
| <i>Louisiana</i> ..... 74     | <i>Utah</i> ..... 93           |
| <i>Maine</i> ..... 74         | <i>Vermont</i> ..... 93        |
| <i>Maryland</i> ..... 74      | <i>Virgin Islands</i> ..... 94 |
| <i>Massachusetts</i> ..... 75 | <i>Virginia</i> ..... 94       |
| <i>Michigan</i> ..... 76      | <i>Washington</i> ..... 94     |
| <i>Minnesota</i> ..... 77     | <i>West Virginia</i> ..... 95  |
| <i>Mississippi</i> ..... 77   | <i>Wisconsin</i> ..... 96      |
| <i>Missouri</i> ..... 77      | <i>Wyoming</i> ..... 96        |
| <i>Montana</i> ..... 77       | <i>Washington, DC</i> ..... 96 |
| <i>Nebraska</i> ..... 78      |                                |







# C O N T E N T S

**Recording & Video Production Facilities, Canada ..... 97**

- Alberta ..... 97
- British Columbia ..... 97
- Manitoba ..... 97
- New Brunswick ..... 97
- Newfoundland ..... 97
- Nova Scotia ..... 97
- Ontario ..... 97
- Quebec ..... 100
- Saskatchewan ..... 100

**Sound Reinforcement & Remote Recording Facilities ... 101**

- Northeast U.S. .... 101
- Southeast U.S. .... 104
- North Central U.S. .... 106
- Northwest U.S. .... 109
- Southern California/Southwest U.S. .... 111
- Canada ..... 114

**Mastering, Pressing & Tape Duplication Facilities ..... 115**

- Eastern U.S. .... 115
- Central U.S. .... 118
- Western U.S. .... 124
- Canada ..... 127

**CD Pressing Plants, U.S. & Canada ..... 128**

**Independent Engineers & Producers, U.S. & Canada ... 129**

**Recording Schools, Seminars & Programs ..... 136**

- Eastern U.S. .... 136
- Central U.S. .... 137
- Western U.S. .... 138
- Canada ..... 139

**Facility Designers & Suppliers ..... 141**

- Northeast U.S. .... 141
- Southeast U.S. .... 144
- North Central U.S. .... 145
- Northwest U.S. .... 147
- Southern California/Southwest U.S. .... 148
- Canada ..... 151

**Mix Trivia ..... 152**

**Advertisers Index ..... 152**

 Circulation independently audited and verified by Business Publications Audit of Circulation since 1985.

Mix magazine is published at 6400 Hollis St #12, Emeryville, CA 94608 and is ©1990 by NBB Acquisitions, Inc. Mix (ISSN 0164-9957) is published monthly. Subscriptions are available for \$46.00 per year. Subscriptions outside U.S.A. are \$61.00 per year. Single copy price is \$4.95, back issues \$6.00. Missed issues within the U.S. must be claimed within 45 days of publication date and abroad, within 90 days. Send subscription applications, subscription inquiries and changes of address to Mix magazine, PO Box 41094, Nashville, TN 37204 or call 1 (800) 888-5139. Outside U.S., call 1 (615) 377-3322. POSTMASTER: Send address changes to Mix magazine, PO Box 41094, Nashville, TN 37204. Address all other correspondence to Mix magazine, 6400 Hollis St #12, Emeryville, CA 94608. (415) 853-3307. Fax: (415) 853-5142. Second Class postage paid at Oakland, CA and additional mailing offices. Mix magazine is distributed in pro audio stores, music stores and other related businesses. If you have a recording or music-related business and would like to distribute Mix, please give us a call at (212) 251-5925. Display advertising rates, specs and closing dates are available upon request. This publication may not be reproduced or quoted in whole or in part by printed or electronic means, without written permission of the publishers.

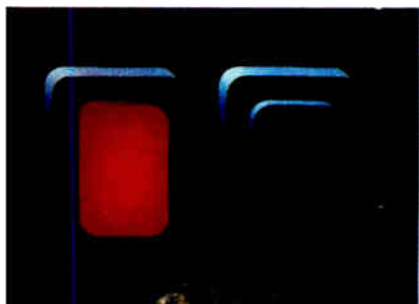

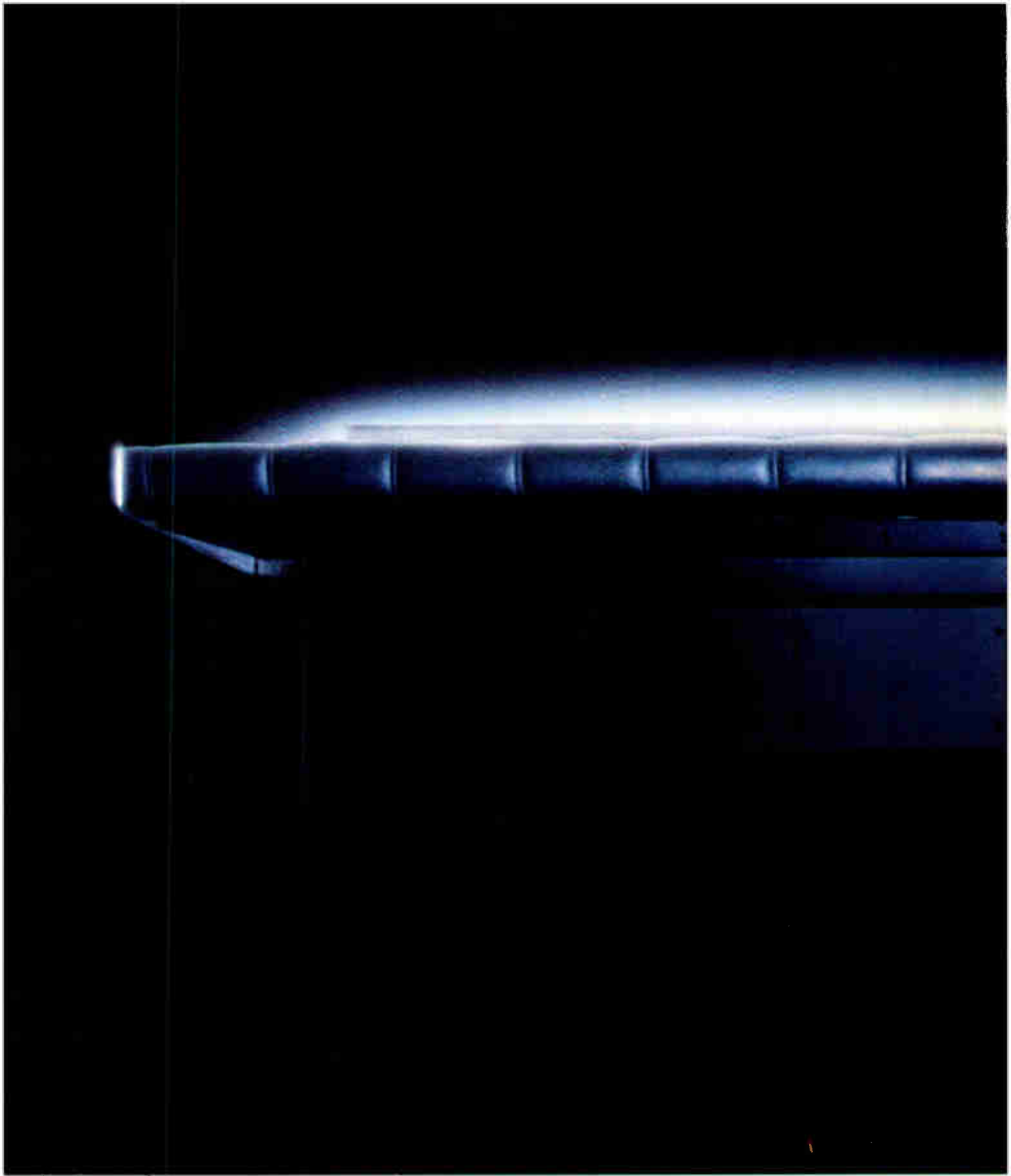

Before you buy *any* mixing console for recording or post-production, we urge you to explore the *Sound Workshop* Series 54 from Otari. You'll discover significant design breakthroughs, reasonable cost, and Otari reliability and product support.

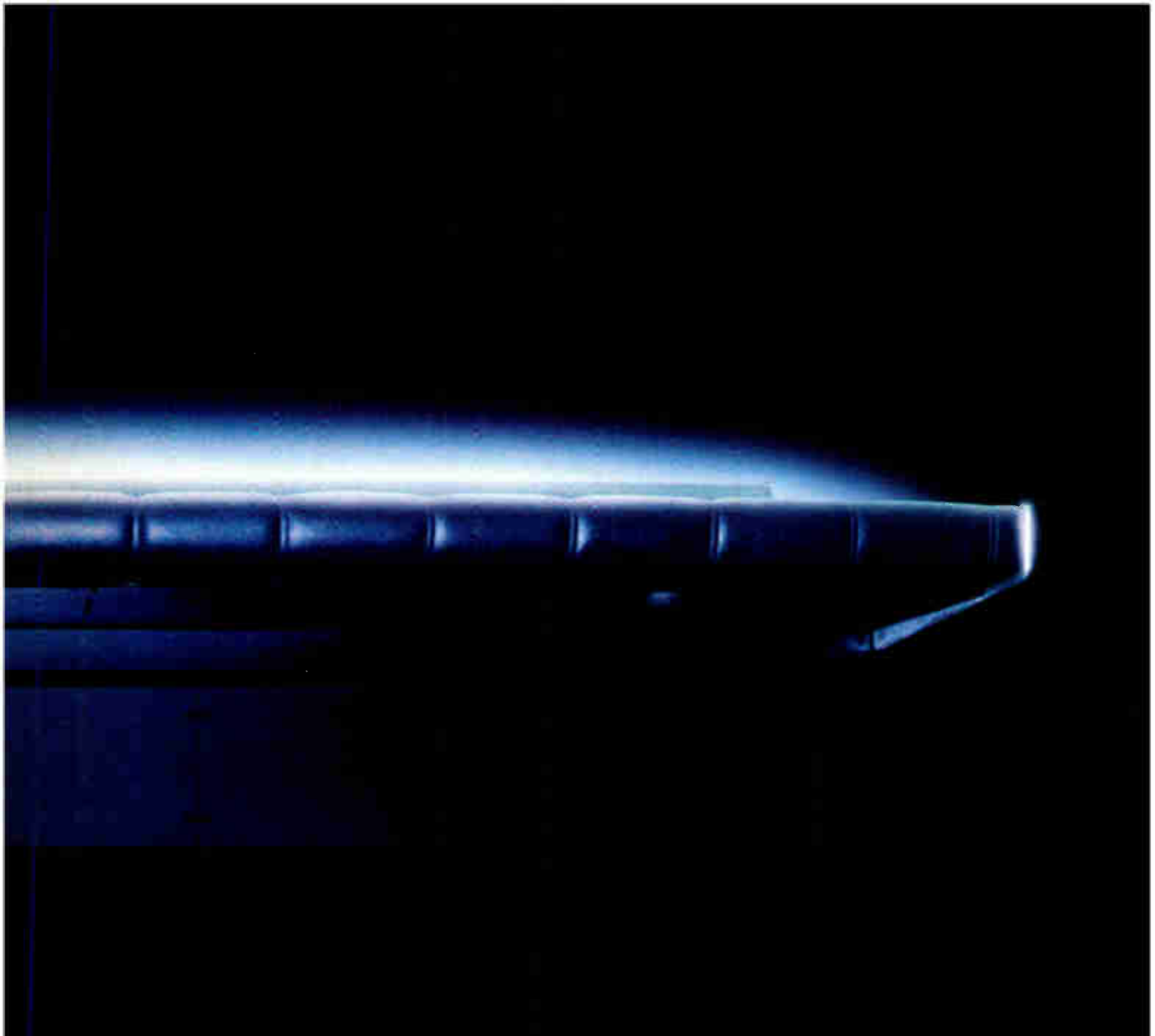

**SONICALLY DEVASTATING.  
FINANCIALLY REWARDING.**

Finally there's a mixing console that sounds great to the engineer, the studio owner, and to the artist! Call Otari at (415) 341-5900 for information.

© Otari 1990

**OTARI**

*Mixing Technologies*



**W**ELCOME to the 1990-91 Mix Master Directory, our annual compilation of facilities and services relating to the professional audio industry. If you are familiar with *Mix* magazine, you already know that the monthly directories form an integral part of our publishing effort. Once a year, we like to put all the names and addresses together to provide you, the audio professional, with an authoritative reference book. After all, contact is the name of the game.

But this is more than a reprint of our monthly directories. In March, we mailed out more than 10,000 questionnaires to people, facilities and manufacturers; more than 3,600 were returned, including more than 2,100 that had never before been listed in *Mix*. If the company has listed in *Mix* previously, it is here as well. Every address in this book is provided free of charge. If your name or company is missing, please give us a call.

We've also greatly expanded one section and added an entirely new category. Our manufacturer's listings now include a list of products manufactured and a product cross-index. If you want to know what companies make 24-track analog recorders, for example, look first in the cross-index, then turn to the manufacturer's listing for the address and contact name.

The new category is labeled Professional Services. For years we've looked for a way to list some of the not-often-talked-about, but essential, professional audio services, including advertising agencies, public relations firms, legal services and business consultants. We don't pretend to have a complete list in this, our first year. You can help by calling in our omissions. It doesn't matter if the company is big or small. If they're involved with audio, we want them in the Mix Master Directory.

Regular readers of the *Mix* directories will notice that the Mix Master Directory contains only boldfaced (name and address) listings—no specialization and credits, no equipment lists. We have, however, included product codes and facility service codes in the appropriate sections. Also, we have marked with a caret (▶) those companies and individuals who have run an extended listing in our monthly directories. Turn to page 8 for a list of the specific monthly issues.

The 1990-91 Mix Master Directory is designed as a reference tool for professionals and amateurs alike. It's been a lot of work and a lot of fun putting it all together. We hope you find it useful.

Enjoy,





 MITSUBISHI

Some manufacturers want  
you to believe filters don't  
make a difference.

But you know better.

That's why so many of you have specifically  
requested Apogee Filters on your Mitsubishi  
32-channel digital audio recorders.

Now every X-880 comes fully enhanced from  
the factory with Apogee 944 Series Digital Audio  
Filter Modules\*.

You can hear the difference.

32-CHANNEL  
PROFESSIONAL DIGITAL  
AUDIO TAPE RECORDER X-880

 Neve  
A Siemens Company

CT: (203) 744-6230 • NY: (212) 956-6464 • CA: (213) 461-6383 • TN: (615) 329-9584 • Toronto: (416) 365-3363  
Apogee Electronics Corporation • (213) 399-2991

\* Standard on X-880's sold in U.S. and Canada only

World Radio History

# HOW TO READ THE 1990-91 MIX MASTER DIRECTORY

## AN INTRODUCTION

*Mix* magazine was founded in 1977 as a studio directory serving the Northern California recording industry. The magazine has grown over the last 13 years and is now the Number One professional audio magazine serving an international market. The directories have grown with the magazine. The 1990-91 Mix Master Directory is the newest version of the popular *Mix* Annual Directory. It is designed to be a permanent reference tool for both amateurs and professionals in the North American audio and video production industries.

## GATHERING THE INFORMATION

The information on the following pages has been gathered from a variety of sources, including existing *Mix* databases and the *Mix* monthly directories. Questionnaires were mailed to more than 10,000 companies and facilities in March 1990; more than 5,000 were returned. Companies that previously listed in the *Mix* monthly directories were included automatically. All information contained herein is listed free of charge. Ultimately, addresses, phone numbers, contacts and services were provided by those individuals and companies listed. *Mix* claims no responsibility for the accuracy of the information provided. However, if you should have problems contacting an individual, company or facility listed here, please call the *Mix* Directories Dept.

## WHAT'S NEW

This year we have included "products manufactured" in our manufacturer listings and added a product "Cross Index." The index allows you, for example, to look up "24-track analog recorders" and have a complete list of companies involved in the manufacture of 24-track analog recorders. You can then refer back to the main manufacturer listings for information on individual companies.

We also have added an entire new category, "Professional Services," which includes advertising agencies, legal services, public relations firms, business consultants, photographic services and marketing-types with some connection to the professional audio industry. We hope you find this section of use; we need your help to expand it for next year.

## ORGANIZATION

All the main categories in the 1990-91 Mix Master Directory are broken down into geographic regions of the U.S. and Canada, except for Recording Studios/Video Production Facilities, which is broken down according to state and province.

## SERVICE CODES

The following categories contain service or product codes to provide more information about the companies and facilities: Manufacturers; Recording Studios/Video Production Facilities, U.S. and Canada; Facility Designers & Suppliers. The key to service and/or product codes is listed on the opening page of each category.

## ► THE CARET

Those companies and facilities that run an extended listing (equipment, services, specialization and credits) or a photo/logo in our *Mix* monthly directories are marked with a caret (►). If you would like more information on these facilities, we refer you to the specific monthly issue of *Mix*:

**January:** Northwest U.S. Recording; **February:** Independent Engineers & Producers; **March:** Southeast U.S. Recording; **April:** Video Production/Post-Production Facilities; **May:** Northeast U.S. Recording; **June:** Remote Recording/Sound Reinforcement Companies; **July:** Recording Schools, Seminars & Programs, Pacific Rim Facilities; **August:** Facility Designers & Suppliers; **September:** Southern California & Hawaii/Southwest U.S. Recording; **October:** New Products/AES Issue; **November:** North Central U.S./Canadian Recording; **December:** Mastering, Pressing & Tape Duplication Facilities.

## ◎ THE STAR

A star (◎) accompanies the listing for all companies that run a display advertisement in the 1990-91 Mix Master Directory. Look to the Advertisers Index in the back of the book for a quick page reference.

## ADDITIONAL COPIES

If you would like additional copies of the 1990-91 Mix Master Directory, please call Mix Bookshelf at (800) 233-9604.

## FOR MORE INFORMATION

If you have questions, comments, corrections or would like to be included in next year's Mix Master Directory, please call the *Mix* Directories Dept. at (800) 344-LIST.



PUBLISHER Hillel Resner

EDITOR-IN-CHIEF David M. Schwartz

ART DIRECTOR Michael Zipkin

MANAGING EDITOR Tom Kenny  
ASSOCIATE EDITORS

Blair Jackson Paul Potyten George Petersen  
ASSISTANT EDITORS

Alexandra Behr Jeffrey Forlenza  
EDITORIAL ASSISTANTS

Eric Bradford Judith Myers Greg Freeman  
PRODUCTION MANAGER Georgia George

PRODUCTION COORDINATOR Ellen Richman  
PRODUCTION ARTISTS

Barbara Gelfand Tori Hernandez Tami Herrick

PROMOTIONS MANAGER Annie Jenkel  
PROJECT CONSULTANT Ron Neilson

DIRECTOR OF ADVERTISING SALES

Jeffrey Turner

SOUTHERN CALIFORNIA/SOUTHWEST AD MGR.

Sue Horwitz

EASTERN ADVERTISING MANAGER

Michele Kanatous

NORTHWEST/MIDWEST AD MGR.

John Pledger

SALES ADMINISTRATOR Neil McKamey

SALES ASSISTANTS Laura Kujubu Tina Spinelli

ASSISTANT TO THE PUBLISHER Jane Byer

CLASSIFIEDS MANAGER Robin Boyce

CLASSIFIEDS ASSISTANTS

Hugh Swarts Mary Cosola

DIRECTORIES ADVERTISING MANAGER

Lauri Newman

DIRECTORIES ASSOCIATES

Jean Mahon Melissa McMillion

Cindy Lukk Annie Acker

DIRECTOR OF CALIFORNIA

OPERATIONS AND PRODUCTION

Anne Letsch

ADVERTISING TRAFFIC COORDINATOR

Donna Burreston

PRODUCTION ASSISTANT Rosanne Marmor

ASSOCIATE CIRCULATION DIRECTOR

Maria Di Placido

ASSISTANT CIRCULATION MANAGER

Gina Lombardino

BUSINESS MANAGER Craig Kennedy

ASSISTANT CONTROLLER Ron LeRouzc

ACCOUNTING CLERKS

Therese Wellington Cathy Woolley

OFFICE MANAGER Barbara Kochiovelos

WAREHOUSE MANAGER Charles Nielsen

RECEPTIONIST Bettye Gardner

ACT III PUBLISHING

PRESIDENT Paul David Schaeffer

CHIEF OPERATING OFFICER

Robert C. Gardner

SENIOR VICE PRESIDENT, OPERATIONS & PLANNING

Martha Lorini

VICE PRESIDENT, FINANCE & ADMINISTRATION

Sam Schechter

DIRECTOR OF MARKETING & COMMUNICATIONS

Jennifer P. Ware

DIRECTOR OF CIRCULATION Steve Wigginton

DIRECTOR OF MANUFACTURING

Craig Balick

ACT III PUBLISHING, TECHNICAL GROUP

ALSO PUBLISHERS OF:

ELECTRONIC MUSICIAN

CORPORATE VIDEO DECISIONS

BME'S TELEVISION ENGINEERING

NATIONAL EDITORIAL, ADVERTISING and BUSINESS OFFICES, 6400 Hollis St. #12, Emeryville, CA 94608. (415) 653-3307. IMC 736. FAX: (415) 653-5142. SOUTHERN CALIFORNIA ADVERTISING OFFICES, 19725 Sherman Way, Suite 380, Canoga Park, CA 91306. (818) 709-4662. EAST COAST ADVERTISING OFFICES, 401 Park Ave. South, New York, NY 10016. (212) 545-5166. DIRECTORIES ADVERTISING, (800) 344-LIST. CLASSIFIEDS ADVERTISING, (800) 747-3703. CIRCULATION OFFICES, 401 Park Ave. South, New York, NY 10016. (212) 251-5925.

*Mix* magazine founded in 1977 by  
David Schwartz and Penny Riker Jacob



# LEXICON THE ART AND SCIENCE OF SOUND

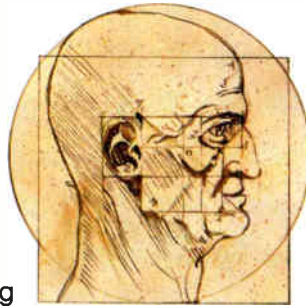

Leonardo Da Vinci was one of those rare individuals to whom both artistic and scientific excellence came easily. The concept of digitally reproducing and shaping analog sounds would have fascinated him.

Achieving excellence in digital audio technology requires a combination of scientific precision and artistic interpretation



that is as rare today as it was in Leonardo's time. It requires mastery of both the art and the science of sound.

Lexicon has devoted nearly two decades perfecting clean, natural digital audio sound without the quirks that digital technology is often accused of. It's called the **Lexicon Sound**, and you'll find it in every product we make.



When Lexicon introduced the world's first digital audio product in 1971, it was heralded as a major technological achievement, a breakthrough. We've built on that reputation with

other achievements, like reverberation and time compression/

expansion, that have earned us more than a dozen awards, including an Emmy.

Today Lexicon products serve more digital audio applications than ever before. There is

OPUS, the world's only fully integrated random

access digital audio production system.

OPUS replaces a room full of equipment with a comfortable

console and single equipment rack. Digital editing and mixing has never been smoother, more accurate, and more natural.

And everyone has a LARC. The Lexicon Alphanumeric Remote Console harnesses the power of the 480L Digital Effects System. The 480L produces a broad variety of superb effects from a growing library of software. It's no wonder you'll find LARC and the 480L in virtually every major recording studio throughout the world.

Lexicon's LXP-1 and LXP-5 effects processors provide a compact, economical way to include the Lexicon Sound in your productions. Each processor provides significant effects capability all by itself. But combined, the number and

breadth of their effects is astonishing.

The CP-1 Digital Audio Environment Processor extends the Lexicon Sound into the living rooms of America. It's been lauded as one of the truly great digital audio products of all time, and



*Stereophile* ranked it as "one of a handful of genuine advances in sound reproduction".

These are just a few samples of Lexicon's digital expertise. Our full range of products serves the needs of recording engineers, musicians, film and video producers, radio and television broadcasters, as well as discerning audiophiles. In each product we've merged



technical excellence and artistic elegance. The result is the Lexicon Sound.

For more information about Lexicon products or a demonstration of their complete capabilities, contact us at (617) 891-6790, FAX (617) 891-0340, or write Lexicon, Inc., 100 Beaver St., Waltham, MA 02154.

**lexicon**  
The Art and Science of Sound

# Even Our Smaller Systems Can Fill A Big Hall.

## SR4700 Series

You've seen and heard our big systems, installed in major venues around the world and on tour with some of the

biggest names in the music business. The SR4700 Series Loudspeaker Systems are equally at home on the road or in the hall.

Their legacy comes from Cabaret® Series, a prime player in small to medium club sound reinforcement since the seventies. Their influence is Concert

Series™, the new standard in packaged JBL systems. With

Cabaret as the starting point and Concert Series as our current direction, we listened to your comments and suggestions, turning them into the sound system of the nineties and beyond.

The SR4700 Series is pure pro audio. Pure JBL components, the same caliber as those in our larger systems, including the Vented Gap Cooling™ low frequency drivers and the 2445J compression driver. Pure JBL enclosures, five times stronger than traditional designs, and protected by plastic-coated steel grills and super-durable fabric-laminated plywood cabinets. Pure JBL sensibility, interlocking enclosures with heavy-duty steel handles and recessed input connectors, so they travel tighter, set-up easier and last longer.

SR4700 Series, pure JBL. Be the first in line to hear them today at your local JBL dealer.

The JBL logo consists of the letters "JBL" in a white, bold, sans-serif font, centered within a solid red square.

JBL Professional  
8500 Balboa Boulevard, Northridge, CA 91329 USA  
A Harman International Company

# TRADE EVENTS & CONFERENCES

1 9 9 0 - 9 1

## SEPTEMBER 1990

*September 12-15*

NAB Radio Show '90  
Boston, Massachusetts  
National Association of Broadcasters  
(202) 429-5300

## JANUARY 1991

*January 10-13*

Winter Consumer Electronics Show  
Las Vegas, Nevada  
Consumer Electronics Group  
(202) 457-4919

*February 19-22*

90th AES Convention  
Paris, France  
Audio Engineering Society  
(212) 661-8528

## MARCH 1991

*March 2-6*

Frankfurt Music Fair  
Frankfurt, West Germany  
(069) 7575 320/357

*March 20-24*

ITA Seminar  
Tucson, Arizona  
International Tape/Disc Association  
(212) 643-0620

## APRIL 1991

*April 15-18*

NAB International Expo  
Las Vegas, Nevada  
National Association of Broadcasters  
(202) 429-5300

## MAY 1991

*May 19-22*

NSCA Contractors Expo '91  
Cincinnati, Ohio  
National Sound & Communications Assn.  
(708) 598-7070

## JUNE 1991

*APRS '91*

(exact date not available at press time)  
London, England  
Assn. of Professional Recording Studios  
(0923) 772907

*June 13-18*

International Television Symposium/  
Exposition  
Montreux, Switzerland  
(021) 963 32 20 or (021) 963 12 12



*September 21-25*

89th AES Convention  
Los Angeles, California  
Audio Engineering Society  
(212) 661-8528

*September 23*

Sixth Annual TEC Awards  
Los Angeles, California  
Mix Foundation for Excellence in Audio  
(415) 420-0144, (415) 653-3307

## OCTOBER 1990

*October 1-5*

CD-ROM Exposition  
Boston, Massachusetts  
(800) 343-6474

*October 13-17*

SMPTE Annual Conference  
New York City, New York  
Society of Motion Picture & Television  
Engineers  
(914) 761-1100

*January 18-20*

NAMM Winter Market  
Anaheim, California  
National Association of Music Merchants  
(619) 438-8001

*January 20-24*

MIDEM '91  
Cannes, France  
(212) 689-4220 (USA)

## FEBRUARY 1991

*February 1-2*

SMPTE Television Conference  
Detroit, Michigan  
Society of Motion Picture & Television  
Engineers  
(914) 761-1100

*February 5-6*

Sound '91  
London, England  
Sound and Communications Federation  
(06) 286-67633



# SCHOEPS

Colette series with interchangeable capsules for a variety of applications

unequalled for expertise  
in design and  
engineering



with a  
constantly  
expanding  
range of products



**BLM 3**  
professional  
boundary layer



**BLM 03 C**  
professional  
boundary layer



**MK 2 S**  
special omni



**MK 21**  
wide  
cardioid

#### Contact

**AUS** Rebel Audio Pty. Ltd.  
286 Great North Road,  
Five Dock, N.S.W. 2046,  
Tel.: (02) 713 6866

**A** Sluder Revox Wien  
Ges. m. B. H., Ludwiggasse 4,  
1180 Wien, Tel.: (02 22) 47 33 09

**B** Heynen N.V., Bedrijfsstraat 2,  
3500 Hasselt, Tel.: 011-22 96 64

**CDN** Elnova Ltd.  
325 Rue Clément Quez,  
Lasalle, Québec H8R 4B4,  
Tel.: (001) 514-364 21 18

**DK** PSS, Aaboulevarden 38,  
2200 Copenhagen N.,  
Tel.: 01-39 00 37

**SF** Lounimaa Electronics Oy,  
Uimahinpolku 27 A, 00330 Hel-  
sinki 33, Tel.: 90-488 556

**F** ELNO S.A., 18-20, rue du  
Val Notre Dame, 95100 Argen-  
teuil, Tel.: (1) 39 82 29 73

**HK** Audio Consultants Co., Ltd.  
58 Pak Tai Street, Tokwawan,  
Kowloon, Hong Kong B. C. C.,  
Tel.: 5-712 52 51

**I** TDS - Tecniche del Suono  
S.r.l., Via Caci Cignoli 8,  
20151 Milano, Tel.: 33 40 03 50

**IL** Kolmor Ltd., 18 Ha'arba'a  
Street, Tel-Aviv, Tel.: 03-26 32 98

**J** Imari & Company Ltd.,  
1-8 Tomihesacho, Shinjuku Tokyo,  
Tel.: (03) 357-0401

**NL** Heynen B.V.,  
P.O. Box 10, 6590 AA Gennep,  
Tel.: 08851-96111

**N** Siv. Ing. Benum A. S., Boks  
145 Vinderen, 0319 Oslo 3,  
Tel.: (02) 14 54 60

**P** G. E. R. Av. Estados Unidos  
da America, 51-5\*, Dto.  
1700 Lisboa, Tel.: 88 40 21

**E** Singleton Productions,  
Via Augusta, 59, Desp. 804  
Edif. Mercuro,  
06006 Barcelona, Tel.: 2 37 70 60

**S** NATAB Akustik AB  
P.O. Box 8016, 55006 Jonkoping,  
Tel.: 036-14 24 80

**CH** TECNAD SA  
- Au Glapin -  
1162 ST-PREX,  
Tel.: (0 21) 8 06 06 06

**GB** Scenic Sounds Equipment  
Marketing Ltd., 10 William Rd.,  
London NW 1 3 EN,  
Tel.: 01-387 1262

**USA** Posthorn Recordings,  
142 West 26th Street, 10th Floor,  
New York City, N.Y. 10001,  
Tel.: (212) 242-3737

Schalltechnik Dr.-Ing. Schoeps GmbH P.O. B. 41 09 70 · Fax: (07 21) 49 57 50  
7500 Karlsruhe · TX. 7 826 902 · Tel.: (07 21) 4 20 16

## Trade Events & Conferences

1990-1991

### JULY 1991

July 18-21

NAMM International Music & Sound  
Expo

New York City, New York

National Association of Music Merchants  
(619) 438-8001

### SEPTEMBER 1991

September 11-14

NAB Radio Show '91

San Francisco, California

National Association of Broadcasters  
(202) 429-5300

### OCTOBER 1991

October 12-18

91st AES Convention

New York City, New York

Audio Engineering Society  
(212) 661-8528

Seventh Annual TEC Awards

(exact date not available at press time)

New York City, New York

Mix Foundation for Excellence in Audio  
(415) 420-0144, (415) 653-3307

October 26-30

SMPTE Annual Conference

Los Angeles, California

Society of Motion Picture & Television  
Engineers

(914) 761-1100



## ANNOUNCING THE BRYSTON TWENTY YEAR WARRANTY

For over a quarter-century Bryston has been committed to designing and producing audio products with reliability, musical accuracy and value as our primary focus. It is widely known that Bryston's policy on the warranty of our products has always been extremely generous if ever required. To further enhance our long term commitment Bryston is instituting a 20 year warranty program as of January 1st, 1990. This, as far as we know, is a first in our industry and as such will further demonstrate our continuing dedication to our customers.

We are able to offer this for several reasons. One is because we consider reliability to be exceedingly important. We have applied techniques and materials in our everyday construction of electronic equipment more



**Bryston 10B electronic crossover**

typically utilized in the military and aerospace industries. All components used in Bryston power amplifiers are specified for continuous duty at maximum power, with typical safety margins of 250%. Also, the power transistors used in all Bryston amplifiers are 100% tested for safe operating area, both before and after installation in the circuit. They are then taken to a "burn-in" table where they are given a

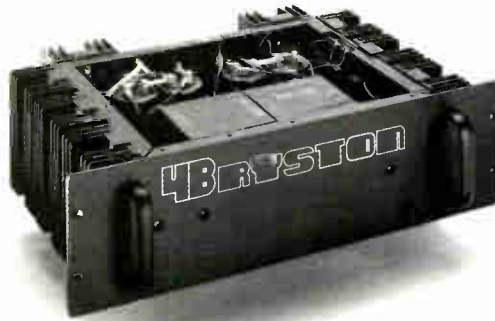

**Bryston 4B amplifier**  
Power amplifiers range from 50-800 watts

capacitor load, a square-wave input signal, and set at slightly under clipping for a period of 100 hours. During this time, the input signal is cycled three hours on to one hour off, to exert additional thermal stress.

Following the burn-in period, the amplifiers are monitored for DC bias stability for approximately another full day. At this point, they are returned to the test bench for another complete checkout of all operating parameters and functions, at which time a test sheet is made, and included in the packing with the unit. At Bryston, we take very seriously the accurate functioning and long term reliability of our products.

This new twenty year warranty is also retroactive. It includes all audio products previously manufactured and sold under the Bryston name. This warranty is also fully transferable from first owner to any subsequent owners.

Bryston has always been dedicated to designing and producing products that deliver uncompromised performance, outstanding reliability and exceptional value. We believe our new 20 year warranty is one more example of our commitment.

**Bryston Marketing Ltd.**  
Tel: (416) 746-0300 Fax: (416) 746-0308  
**Brystonvermont Ltd.** Tel: 1-800-673-7899

# BRYSTON

# INDUSTRY ORGANIZATIONS

UNITED STATES & CANADA

## Academy of Country Music

6255 Sunset Boulevard, Suite 915  
Hollywood, CA 90028  
(213) 462-2315

## Academy of Television Arts & Sciences (ATLAS)

3500 West Olive Avenue, Suite 700  
Burbank, CA 91505  
(818) 953-7575

## American Electronics Association (AEA)

5201 Great America Parkway  
Santa Clara, CA 95054  
(408) 987-4200

## American Federation of Musicians

1501 Broadway, Suite 600  
New York, NY 10036  
(212) 869-1330

## American Loudspeaker Manufacturers Association (ALMA)

3413 N. Kennicott Avenue, Suite B  
Arlington Heights, IL 60004  
(312) 577-7200

## American Music Conference

303 East Wacker Drive, Suite 1214  
Chicago, IL 60601  
(312) 856-8820

## American Society of Composers, Authors and Publishers (ASCAP)

One Lincoln Plaza  
New York, NY 10023  
(212) 595-3050

## American Video Association (AVA)

557 W. Juniper  
Mesa, AZ 85204  
(602) 892-8553

## Association for Multi-Image International

6747 Odessa Avenue, Suite 140  
Chandler, AZ 85225  
(602) 892-8553

## Association of Electronic Distributors (AED)

9363 Wilshire Boulevard, Suite 217  
Beverly Hills, CA 90210  
(213) 278-0543

## Association of Professional Recording Studios (APRS)

163A High Street  
Rickmansworth Herts, UK WD3 1AY  
(0923) 772907  
Fax: (0923) 773079

## Association of Visual Communications (AVC)

900 Palm Avenue, Suite B  
South Pasadena, CA 91030  
(818) 441-2274

## Audio Engineering Society (AES)

60 E. 42nd Street  
New York, NY 10165  
(212) 661-8528

## Broadcast Music International (BMI)

320 West 57th Street  
New York, NY 10019  
(212) 586-2000

## Canadian Academy of Recording Arts and Sciences (CARAS)

124 Merton Street, 3rd Floor  
Toronto, Ontario, M4S 2Z2 Canada  
(416) 485-3135

## Canadian Recording Industry Association (CRIA)

89 Bloor Street E  
Toronto, Ontario M4W 1A9 Canada  
(416) 967-7272

## College Music Society

1444 15th Street  
Boulder, CO 80302  
(303) 449-1611

## Consumer Electronics Group (CES)

2001 I Street, NW  
Washington, DC 20006  
(202) 457-4919

## Country Music Association (CMA)

PO Box 22299  
Seven Music Circle N  
Nashville, TN 37202  
(615) 244-2840

## Directors Guild of America

7950 Sunset Boulevard  
Los Angeles, CA 90046  
(213) 656-1220

## Electronic Industries Association (EIA)

2001 Eye Street, NW  
Washington, DC 20006  
(202) 457-4900

## Electronic Industries Foundation (EIF)

1901 Pennsylvania Avenue, NW, Suite 700  
Washington, DC 20006  
(202) 955-5810

## Electronics Representatives Association (ERA)

20 E. Huron  
Chicago, IL 60611  
(312) 649-1333

## Gospel Music Association (GMA)

PO Box 23201  
Nashville, TN 37202  
(615) 242-0303

## HDTV 1125/60 Group

1615 L Street NW, Suite 650  
Washington, DC 20036  
(202) 659-1992

## Independent Media Producers Council (IMPC)

3150 Spring Street  
Fairfax, VA 22031  
(703) 273-7200

## Intercollegiate Broadcast System (IBS)

Box 592  
Vails Gate, NY 12584  
(914) 565-6710

## International Audiovisual Society (IAS)

c/o Dr. Paul S. Flynn  
Western Carolina University  
Cullowhee, NC 28723

## International Communications Industries Association (ICIA)

3150 Spring Street  
Fairfax, VA 22031  
(703) 273-7200

## International Interactive Communications Society (IICS)

2120 Steiner Street  
San Francisco, CA 94115  
(415) 922-0214

## International MIDI Association (IMA)

5316 West 57th Street  
Los Angeles, CA 90056  
(213) 649-MIDI

## International Tape/Disc Association

505 Eighth Avenue  
New York, NY 10018  
(212) 643-0620

## MIDI Manufacturers Association

2265 Westwood Boulevard, #2223  
Los Angeles, CA 90064  
(213) 649-MIDI

## Music Distributors Association (MDA)

136 West 21st Street  
New York, NY 10011-3212  
(212) 924-9175

## Music Educators National Conference

1902 Association Drive  
Reston, VA 22091  
(703) 860-4000

## Music Industry Educators Association (MIEA)

1435 Bleury Street, Suite 301  
Montreal, Quebec HG3A 2H7 Canada

## Nashville Songwriters Association International (NSAI)

803 18th Avenue, S.  
Nashville, TN 37203  
(615) 321-5004

## National Academy of Recording Arts & Sciences (NARAS)

303 N. Glenoaks Boulevard, M-140  
Burbank, CA 91502  
(213) 849-1313

## National Academy of Songwriters (NAS)

6381 Hollywood Boulevard, Suite 780  
Hollywood, CA 90028  
(213) 463-7178

## National Association of Broadcasters (NAB)

1771 N Street, NW  
Washington, DC 20036  
(202) 293-3570

## National Association of Composers/USA

PO Box 49652, Barrington Station  
Los Angeles, CA 90049  
(213) 541-8213

## National Association of Independent Record Distributors & Manufacturers (NAIRD)

6935 Airport Highway Lane  
Pennsauken, NJ 08109  
(609) 665-8085

## National Association of Jazz Educators (NAJE)

Box 724  
Manhattan, KS 66502  
(913) 776-8744

## National Association of Music Merchants (NAMM)

5140 Avenida Encinas  
Carlsbad, CA 92008  
(619) 438-8001  
(800) 767-6266

## National Association of Recording Merchandisers (NARM)

3 Eves Drive, Suite 307  
Marlton, NJ 08053  
(609) 596-2221

## National Computer Graphics Association (NCGA)

2722 Merrilee Drive, Suite 200  
Fairfax, VA 22031  
(703) 698-9600

## National Sound & Communications Association (NSCA)

501 W. Algonquin Road  
Arlington Heights, IL 60005  
(312) 593-8360

## Recording Industry Association of America (RIAA)

1020 19th Street, NW, Suite 200  
Washington, DC 20036  
(202) 775-0101

## SESAC, Inc.

156 West 56th Street  
New York, NY 10019  
(212) 586-3450

## Society of Cable Television Engineers & Co. (SCTE)

668-669 Exton Commons  
Exton, PA 19341  
(215) 363-6888

## Society of Motion Picture & Television Engineers (SMPTE)

595 West Hartsdale Avenue  
White Plains, NY 10607  
(914) 761-1100

## Society of Professional Audio Recording Services (SPARS)

4300 Tenth Avenue North  
Lake Worth, FL 33461  
(407) 641-6648

## The Songwriters Guild of America (SGA)

276 Fifth Avenue at 30th Street, Room 306  
New York, NY 10001  
(212) 686-6820

## Special Interest Group Graphics (SIGGRAPH)

Association for Computing Machinery  
11 W. 42nd Street  
New York, NY 10036  
(212) 869-7440  
(800) 342-6626

## Women's Independent Label Distribution Network (WILD)

5505 Delta River Drive  
Lansing, MI 48906  
(517) 323-4325



# They make beautiful music together.

Laser-trimmed resistor packs and 18-turn trim-pots maintain precise circuit tolerances.

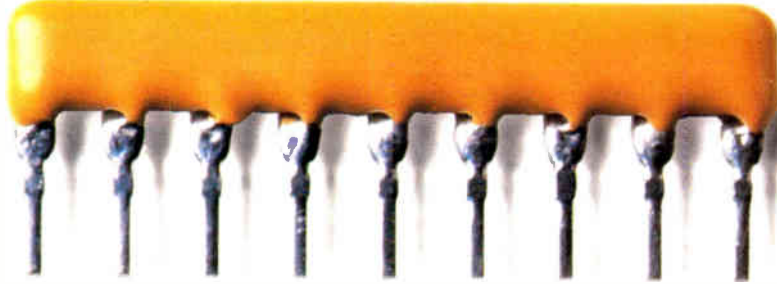

Audiophile-grade capacitors maximize sonic accuracy.



Large crystal oxygen-free cables with gold plated connectors ensure sonic clarity and detail.

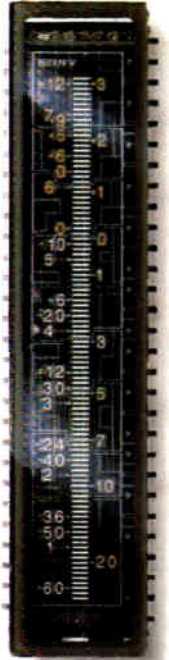

Unique vacuum-fluorescent multi-scale metering shows signal levels as low as -60dB, essential for digital recording.

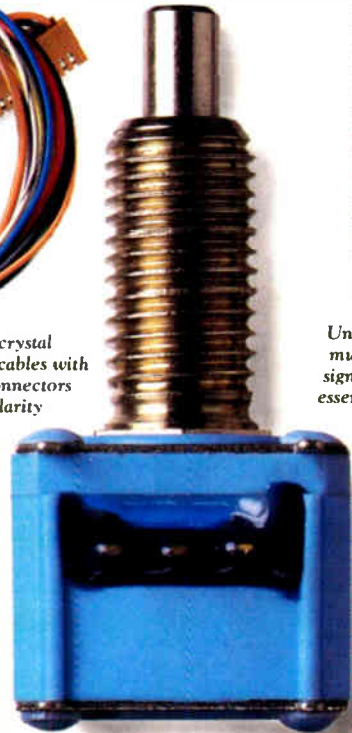

Sealed, steel-shaft potentiometers deliver reliable performance for years.



Sony's own hybrid circuitry makes these consoles among the quietest in the industry.

A wide variety of preamp and EQ modules allows you to easily configure the console to your needs.

Sony marries superior components and intelligent engineering to create the MXP-3000 series consoles.

The result is consoles that offer the same high level of sonic excellence as our digital multitrack recorders, as well as unsurpassed reliability.

To achieve this, we selected only parts that meet the highest standards. Often, this required creating unique components.

This dedication to quality extends throughout the MXP-3000 series.

From our "minimal signal path" architecture to our advanced metal frame

construction. It's why the MXP-3000 delivers performance that satisfies even the most critical users in hundreds of facilities worldwide.



Call us at 1-800-635-SONY, to learn how you and the MXP-3000 series can make beautiful music together.

**SONY**

PROFESSIONAL AUDIO

# RECORD COMPANIES

UNITED STATES & CANADA

**A & M RECORDS;** 1416 North La Brea; Hollywood, CA 90028; (213) 469-2411; 595 Madison Avenue; New York, NY 10022; (212) 826-0477.

**ABKCO RECORDS INC.;** 1700 Broadway, New York, NY 10019; (212) 399-0300.

**ALLEGIANCE RECORDS;** 1419 North La Brea Hollywood, CA 90028; (213) 851-8852.

**ALLIGATOR RECORDS;** PO Box 60234; Chicago, IL 60660; (312) 973-7736.

**ALPHA INTERNATIONAL;** 212 N. 12th Street; Philadelphia, PA 19107; (215) 561-3610.

**ALPHA RECORDS;** PO Box 18287; Memphis, TN 38118; (901) 452-0673.

**ALSHIRE INTERNATIONAL, INC.;** 1015 Isabel Street, PO Box 7107; Burbank, CA 91510; (818) 843-6792.

**ALTERNATIVE TENTACLES;** PO Box 11458; San Francisco, CA 94101; (415) 863-9292.

**AMERICAN CLAVE;** 213 East 11th Street; New York, NY 10003; (212) 925-2121.

**AMERICAN GRAMAPHONE RECORDS;** 9130 Mormon Bridge Road; Omaha, NE 68152; (402) 457-4341.

**ANGEL RECORDS;** 1750 N. Vine Street; Hollywood, CA 90028; (213) 871-5094.

**ANTILLES RECORDS;** 14 E. 4th Street; New York, NY 10012; (212) 477-8000.

**ARHOOLIE RECORDS;** 10341 San Pablo; El Cerrito, CA 94530; (415) 525-7471.

**ARISTA RECORDS;** 8378 Wilshire Boulevard; Beverly Hills, CA 90211; (213) 655-9222; 6 West 57th Street; New York, NY 10019; (212) 830-2183.

**ASYLUM RECORDS;** 75 Rockefeller Plaza; New York, NY 10019; (212) 484-7200.

**ATLANTA INT'L;** 881 Memorial Drive SE; Atlanta, GA 30316.

**ATLANTIC RECORDS;** 9229 Sunset Boulevard, Ste. 710; Los Angeles, CA 90069; (213) 205-7450; 75 Rockefeller Plaza; New York, NY 10019; (212) 484-6000.

**AUDION RECORDS;** 3619 Kennedy Road; S. Plainfield, NJ 07080; (201) 753-6100.

**AVACADO RECORDS;** 1924 Euclid; Santa Monica, CA 90404; (213) 450-1583.

**BANG RECORDS;** c/o CBS Records; 51 West 52nd Street; New York, NY 10019; (212) 975-4321.

**BARKING PUMPKIN RECORDS;** Box 5265; North Hollywood, CA 91616; (818) 794-0777.

**BATISH RECORDS;** 1310 Mission Street; Santa Cruz, CA 95060; (408) 423-1699.

**BAY RECORDS;** 1516 Oak Street, Ste. 315; Alameda, CA 94501; (415) 428-2002.

**BEE HIVE RECORDS;** 1130 Colfax Street; Evanston, IL 60201; (312) 328-5593.

**BEGGARS BANQUET;** 274 Madison Avenue, Ste. 804; New York, NY 10017; (212) 889-9595.

**BESERKLEY RECORDS;** 2054 University Avenue #400; Berkeley, CA 94704; (415) 848-6701.

**BLACKHAWK RECORDS;** 185 Berry Street, Ste. 4801; San Francisco, CA 94107; (415) 974-5616.

**BLIND PIG RECORDS;** PO Box 2344; San Francisco, CA 94126; (415) 526-0373; 1304 W. Schubert; Chicago, IL 60614; (312) 528-5455.

**BLUE HERRON RECORDS;** 525 Brannan Street; San Francisco, CA 94107; (415) 974-5616.

**BLUE NOTE RECORDS;** 810 7th Avenue; New York, NY 10019-5; (212) 603-8733.

**BOMP/VOXX RECORDS;** PO Box 7112; Burbank, CA 91510; (213) 227-4141.

**BUDDAH RECORDS;** 1 Madison Avenue; New York, NY 10010; (212) 757-9880.

**CAMEL RECORDS;** 120 N. Victory Boulevard, Ste. 102; Burbank, CA 91502; (818) 846-8200.

**CAPITOL RECORDS;** 1750 N. Vine Street; Hollywood, CA 90028; (213) 462-6252; 810 7th Avenue; New York, NY 10019; (212) 603-8600.

**CAPITOL/EMI;** 1750 N. Vine Street; Hollywood, CA 90028; (213) 462-6252; 1111 16th Avenue South; Nashville, TN 37212; (615) 320-5009.

**CAROLINE RECORDS;** 114 W. 26th Street; New York, NY 10001; (212) 989-2929; 12410 Foothill Boulevard, Unit B; Sylmar, CA 91342; (818) 890-0309.

**CADENCE RECORDS;** Cadence Building, Redwood, NY 13679; (315) 287-2852.

**CATERO RECORDS;** 1301 Chestnut; San Carlos, CA 94070; (415) 592-2072.

**CBS/COLUMBIA RECORDS;** 1801 Century Park West, Century City, CA 90067; (213) 556-4700; 34 Music Square East; Nashville, TN 37203; (615) 742-4321.

**CD PRESENTS RECORDS;** 1230 Grant #531; San Francisco, CA 94133; (415) 641-7775.

**CELLULOID RECORDS;** 330 Hudson Street; New York, NY 10013; (212) 741-8310.

**CHOPS NOT CHAPS;** PO Box 884273; San Francisco, CA 94188; (415) 282-6924.

**CHRYSALIS RECORDS;** 9255 Sunset Boulevard, Ste. 319; Los Angeles, CA 90069; (213) 550-0171; 645 Madison Avenue; New York, NY 10022; (212) 326-2300.

**CINEMA RECORDS;** 812 West Dachy; Havertown, PA 19083; (215) 642-8646.

**CLEAN CUT RECORDS;** PO Box 16264, Roland Park Station; Baltimore, MD 21210; (301) 467-4231.

**COMBAT RECORDS;** 187-07 Henderson; Hollis, NY 11423; (718) 740-5700.

**COMMODORE RECORDS;** 3 Kensington Oval; New Rochelle, NY 10805; (914) 235-1229.

**COMPLEAT RECORDS;** 21 Music Circle East; Nashville, TN 37203; (615) 255-8855.

**CONCORD RECORDS;** PO Box 845; Concord, CA 94522; (415) 682-6770.

**CRANBERRY RECORDS;** c/o MCA Records; 70 Universal City Plaza; Universal City, CA 91608; (818) 777-4020.

**CRIMINAL RECORDS;** 320 W. 37th Street, 7th Floor; New York, NY 10018; (212) 967-5465.

**CTI RECORDS;** PO Box 705; New York, NY 10113; (212) 674-1111.

**CURB RECORDS;** 3907 W. Alameda Avenue; Burbank, CA 91505; (818) 843-2872.

**CYPRESS RECORDS;** 1525 Crossroads of the World; Hollywood, CA 90028; (213) 465-2711.

**DEF AMERICAN;** 9157 Sunset Boulevard, Ste. 200; Los Angeles, CA 90069; (213) 278-6699.

**DEF JAM RECORDS;** 652 Broadway; New York, NY 10012; (212) 979-2610.

**DELOS RECORDS;** 2210 Wilshire Boulevard, Ste. 664; Santa Monica, CA 90403; (213) 459-7946.

**DENON RECORDS;** 222 New Road; Parsippany, NJ 07504; (201) 575-7810.

**DEUTSCHE GRAMOPHONE;** 137 West 55th Street; New York, NY 10019.

**DISCHORD RECORDS;** 3819 Beecher Street NW; Washington, DC 20007; (703) 243-2454.

**DISNEYLAND RECORDS;** 350 S. Buena Vista; Burbank, CA 91521; (818) 840-1000.

**DJ INTERNATIONAL;** 727 W. Randolph; Chicago, IL 60606; (312) 559-0286.

**DMP/DIGITAL MUSIC PRODUCTIONS;** 94 Southfield Avenue; Stamford, CT 06902; (203) 327-3800.

**DOCTOR JAZZ RECORDS;** 1414 Sixth Avenue; New York, NY 10019; (212) 759-5565.

**DOG GONE RECORDS;** PO Box 1742; Athens, GA 30603; (404) 354-4640.

**DOOR KNOB RECORDS;** 2125 8th Avenue S; Nashville, TN 37204; (615) 383-6002.

**DRG RECORDS;** 157 West 57th Street, Ste. 1403; New York, NY 10019; (212) 582-3040.

**ECM RECORDS;** 825 8th Avenue, 25th Floor; New York, NY 10019; (212) 333-8478.

**EDITIONS EG;** 3619 Kennedy Road; South Plainfield, NJ 07080; (201) 753-6100.

**EKAPA RECORDS;** 222 W. 23rd Street, #314; New York, NY 10011; (212) 255-9485.

**ELEKTRA RECORDS;** 75 Rockefeller Plaza; New York, NY 10019; (212) 484-7201; 9229 Sunset Boulevard, Ste. 718; Los Angeles, CA 90069; (213) 205-7400.

**EMI RECORDS;** 1800 N. Vine, Ste. 250; Hollywood, CA 90028; (213) 960-4600; 810 7th Avenue; New York, NY 10019; (212) 603-8600.

**ENIGMA RECORDS;** 1750 E. Holly Avenue; El Segundo, CA 90245; (213) 461-9141.

**ENJA RECORDS;** 810 Seventh Avenue; New York, NY 10019; (212) 333-8000.

**EPIC/EPA RECORDS;** 1801 Century Park West; Century City, CA 90067; (213) 556-4700; 51 West 52nd Street; New York, NY 10019; (212) 975-4321.

**EVEREST RECORDS;** 2020 Avenue of the Stars, Concourse Level; Los Angeles, CA 90067; (213) 557-0309.

**FANIA RECORDS;** 888 Seventh Avenue; New York, NY 10019.

**FANTASY RECORDS;** 10th & Parker Streets; Berkeley, CA 94710; (415) 549-2500.

**FLIPSIDE;** PO Box 363; Whittier, CA 90608; (213) 693-6971.

**FLYING FISH RECORDS;** 1304 W. Schubert; Chicago, IL 60614; (312) 528-5455.

**FOLKWAYS RECORDS;** 180 Alexander; Princeton, NJ 08540; (609) 683-0090.

**FORTUNA RECORDS;** Box 1116; Novato, CA 94945; (415) 883-9054.

**415 RECORDS;** 245 Hyde Street; San Francisco, CA 94102; (415) 885-4999; 888 7th Avenue; New York, NY 10106; (212) 841-8102.

**4th & BROADWAY RECORDS;** 14 East 4th Street, 3rd Floor; New York, NY 10012; (212) 477-8000.

**FRESH RECORDS;** 1974 Broadway; New York, NY 10023; (212) 724-1440.

**FRONTIER RECORDS;** PO Box 227; Sun Valley, CA 91353; (818) 506-6886.

**FULL MOON RECORDS;** 9044 Melrose Avenue; Los Angeles, CA 90069; (213) 622-6832.



W E C A R E

# AGFA

## Did you know Howard Schwartz uses



Howard Schwartz the man; Howard Schwartz the studio. They've both always done things with a different style.

He's built one of the world's largest recording studios without ever cutting a hit record. Then again, he's always said that audio-for-video was going to be the biggest hit of all.

His competitors laughed, but he laughed last. With eight control rooms in his mid-Manhattan location (including the latest edition — a fully digital editing/mixing suite), Schwartz (the studio) has grown bigger than Schwartz (the man).

But the studio still maintains the creative, warm and friendly character of its founder, who continues to welcome his clients with the finest audio tools, the most innovative engineers, and the best bagels in town.

"People are the only thing you can count on in this business," Howard explains. "I find the talent, I supply them with the best tools, then I let them do what they do best."

One of these tools is AGFA PEM 469 bias compatible mastering tape — the international standard in audio-for-video recording.

"Year after year we have 'shoot-outs,' and AGFA always comes out ahead," he says. "But 'tape...schmape,' people really make the difference. And whatever you need, there's always someone you can talk to at Agfa."

AGFA. The hits are on us...and the bagels are on Howard.



Agfa Corp., 100 Challenger Road  
Ridgefield Park, NJ 07660 Telephone (201) 440-2500

AUDIO VIDEO PROFESSIONAL

World Radio History

**AGFA** 





# THE FIRST CONSOLE THAT TALKS MIDI.

**N**o console is versatile enough to be all things to all people. At Soundtracs, we believe you've got to specialize.

Especially in MIDI recording, where lots of different jobs (and inputs) have to be juggled at once without wasting valuable time.

That, in a nutshell, is the thinking that went into the Soundtracs PC MIDI console.

Its inline design maximizes sonic purity to produce the clear, radiant sound British consoles are famous for.

The PC 24 channel can provide input-hungry MIDI musicians with an impressive 56 inputs to handle all their MIDI gear.

Its MIDI Mute Automation streamlines mixdown with easy, hands-off muting for individual inputs (or groups of inputs) on any of 16 MIDI channels. All of which can be recalled as patches from the PC's master module or a MIDI sequencer.

And the PC is flexible enough to handle 8, 16 and 24 track recording.

Soundtracs PC MIDI. For those who record and mix MIDI, we've designed the first console smart enough to speak your language.

**SOUNDTRACS** 

Soundtracs distributed exclusively in the United States by:  
Sanson Technologies Corp., Hicksville, NY 11801,  
TEL (516) 932-3810 FAX (516) 932-3815

## Record Companies

U. S. & CANADA

**GAIA RECORDS;** 121 W. 27th Street; New York, NY 10001; (212) 645-5252.

**GEFFEN RECORDS;** 9130 Sunset Boulevard; Los Angeles, CA 90069; (213) 278-9010; 75 Rockefeller Plaza, 17th Floor; New York, NY 10019; (212) 484-7170.

**GLOBAL PACIFIC RECORDS;** 180 E. Napa Street; Sonoma, CA 95476; (707) 996-2748.

**GNP/CRESCENDO RECORDS;** 8400 Sunset Boulevard, Ste. 4A; Los Angeles, CA 90069; (213) 656-2614.

**GOLD CASTLE RECORDS;** 3575 Cahuenga Boulevard West, Ste. 435; Los Angeles, CA 90068; (213) 850-3321.

**GOLD MOUNTAIN RECORDS;** 3575 Cahuenga Boulevard West, Ste. 470; Los Angeles, CA 90068; (213) 850-5660.

**GORDY RECORDS;** 6255 W. Sunset Boulevard; Los Angeles, CA 90026; (213) 468-3500.

**GRAMAVISION RECORDS;** 260 West Broadway; New York, NY 10013; (212) 226-7057.

**GREAT AMERICAN MUSIC HALL;** 850 O'Farrell Street; San Francisco, CA 94109; (415) 885-5006.

**GREENSLEEVES RECORDS;** Dalebrook Park; HoHoKus, NJ 07423; (201) 445-5561.

**GRP RECORDS;** 555 W. 57th Street, Ste. 1228; New York, NY 10019; (212) 245-7033.

**HANNIBAL RECORDS;** PO Box 667; Rocky Hill, NJ 08553; (609) 466-9320.

**HARMONIA MUNDI;** 3364 S. Robertson Boulevard; Los Angeles, CA 90034; (213) 559-0802.

**HEARTBEAT RECORDS;** One Camp Street; Cambridge, MA 02140; (617) 354-0700.

**HEARTS OF SPACE;** PO Box 31321; San Francisco, CA 94131.

**HIGHTONE RECORDS;** 220 4th Street, Ste. 101; Oakland, CA 94607; (415) 763-8500.

**HOMESTEAD RECORDS;** 81 N. Forest Avenue; Rockville Center, NY 11570; (516) 764-6200.

**IMPULSE RECORDS;** c/o MCA Jazz; 70 Universal City Plaza; Universal City, CA 91608; (818) 777-5281.

**IRS RECORDS;** 3939 Lankershim Boulevard; Universal City, CA 91604; (818) 508-3130; 445 Park Avenue; New York, NY 10022; (212) 841-8000.

**ISLAND RECORDS;** 8920 Sunset Boulevard, 2nd Floor; Hollywood, CA 90069; (213) 276-4500; 14 East 4th Street, 3rd Floor; New York, NY 10012; (212) 477-8000.

**JEM RECORDS;** 3619 Kennedy Road; South Plainfield, NJ 07080; (201) 753-6100.

**JIVE RECORDS;** 137-139 W. 25th Street; New York, NY 10001; (212) 727-0016.

**K-TEL INTERNATIONAL;** 15535 Medina Road; Plymouth, MN 55447; (612) 559-6800.

**KALEIDOSCOPE;** PO Box O; El Cerrito, CA 94530; (415) 845-9200.

**KING JAY RECORDS;** 414 12th Street; Sacramento, CA 95814; (916) 447-5906.

**LANDMARK RECORDS;** 2600 10th Street; Berkeley, CA 94710; (415) 849-0442.

**LIBRARY OF CONGRESS;** Motion Picture, Broadcasting & Recorded Sound Division; Washington, DC 20540; (202) 287-5705.

**LIVING MUSIC RECORDS;** PO Box 68; Litchfield, CT 06759; (203) 567-8796.

**LONDON RECORDS;** 12th Floor, 810 7th Avenue; New York, NY 10019; (212) 333-8000.

**LOVELY MUSIC LIMITED;** 325 Spring Street, Rm. 225; New York, NY 10013; (212) 243-6153.

**MALACO RECORDS;** PO Box 9287; Jackson, MS 39286; (601) 982-4522.

**MANGO RECORDS;** 14 E. Fourth Street; New York, NY 10012; (212) 477-8000.

**MANHATTAN RECORDS;** 1370 6th Avenue; New York, NY 10019; (212) 757-7470.

**MCA RECORDS;** 70 Universal City Plaza; Universal City, CA 91608; (818) 777-4020; 445 Park Avenue; New York, NY 10022; (212) 759-7500; 1514 South Street; Nashville, TN 37212; (615) 244-8944.

**MERCURY RECORDS;** 3800 West Alameda Avenue, Ste. 1500; Burbank, CA 91505; (818) 955-5200; c/o PolyGram Records; 810 Seventh Avenue; New York, NY 10019; (212) 333-8000; 10 Music Square S.; Nashville, TN 37203; (615) 244-3776.

**METAL BLADE RECORDS;** 18653 Ventura Boulevard, Ste. 311; Tarzana, CA 91356; (818) 981-9050; 1133 Broadway, Ste. 826; New York, NY 10010; (212) 645-6208.

**MILESTONE RECORDS;** 10th & Parker Streets; Berkeley, CA 94710; (415) 549-2500.

**MOBILE FIDELITY;** 1260 Holm Road; Petaluma, CA 94952; (707) 778-0134.

**MONUMENT RECORDS;** 15 Music Square West; Nashville, TN 37203; (615) 790-8709.

**MOSS MUSIC GROUP;** 200 Varick; New York, NY 10014; (212) 243-4800.

**MOTOWN RECORDS;** 6255 Sunset Boulevard; Hollywood, CA 90028; (213) 468-3500.

**MTM RECORDS;** 21 Music Square East; Nashville, TN 37203; (615) 242-1931.

**MUSE/SAVOY JAZZ RECORDS;** 160 West 71st Street; New York, NY 10023; (212) 873-2020.

**MUSIC WEST RECORDS;** 2200 Larkspur Landing Circle, Ste. 100; Larkspur, CA 94939; (415) 925-9800.

**MYRRH RECORDS;** 33 Music Square West; Nashville, TN 37203; (615) 255-1675.

**NARADA RECORDS;** 1845 N. Farwell Avenue; Milwaukee, WI 53202; (414) 272-6700.

**NEMPEROR RECORDS;** PO Box 1111, Lenox Hill Station; New York, NY 10021; (212) 737-1336.

**NEW ALBION RECORDS;** 584 Castro #463; San Francisco, CA 94114; (415) 621-5757.

**NIMBUS RECORDS;** 200 W. 57th Street; New York, NY 10019; (212) 262-5400.

**NONESUCH RECORDS;** 75 Rockefeller Plaza, Suite 1806; New York, NY 10019; (212) 484-7275.

**BMG/NOVUS RECORDS;** 1133 Avenue of the Americas, 10th Floor; New York, NY 10036; (212) 930-4000.

**OLIVIA RECORDS;** 4400 Market St.; Oakland, CA 94608; (415) 655-0364.

**OPEN AIR RECORDS;** 831 High St.; Palo Alto, CA 94301; (415) 329-0647.

**ORIGINAL SOUND RECORDS;** 7120 Sunset Boulevard; Hollywood, CA 90046; (213) 851-2500.

**PABLO RECORDS;** c/o Fantasy Records; 10th & Parker Streets; Berkeley, CA 94710; (415) 549-2500.

**PAISLEY PARK RECORDS;** 3300 Warner Blvd.; Burbank, CA 91510; (818) 846-9090.

**PASHA RECORDS;** 5615 Melrose Avenue; Hollywood, CA 90038; (213) 466-3507.

**PASSPORT RECORDS;** 6600 River Road; West New York, NJ 07093; (201) 868-6400; 1608 Victory Boulevard; Glen Dale, CA 91201; (818) 500-5677.

**PHILADELPHIA INT'L;** 309 S. Broad Street; Philadelphia, PA 19107; (215) 985-0900.

**PHILIPS RECORDS;** 810 7th Avenue, 12th Floor; New York, NY 10019; (212) 333-8000.

**PICANTE RECORDS;** PO Box 845; Concord, CA 94522; (415) 682-6770.

**POLYDOR RECORDS;** 810 7th Avenue; New York, NY 10019; (212) 333-8000.

## FOR BIG LEAGUE RECORDINGS, USE THE BIG LEAGUE BBE 822A!

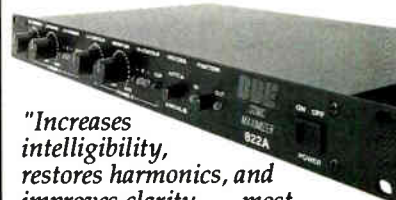

*"Increases intelligibility, restores harmonics, and improves clarity... most impressed with the effect on instrumental tracks of all sorts... recaptured the natural sparkle and punch... an indispensable tool for the audio professional."*

Mix Magazine

▼ 10K ohms input; 600 ohms output

▼ +24dBu clip point

▼ XLR and 1/4" Tip-Ring-Sleeve Balanced/Unbalanced

**BBE** Huntington Beach, CA  
**Sound Inc.** (714) 897-6766

ASK YOUR DEALER FOR A DEMO TODAY

## De Wolfe Music Library

and SFX CD's



Compact Disc  
Hotline  
**1-800-221-6713**



De Wolfe Music Library  
25 West 45th Street  
New York, NY 10036  
**212-382-0220**

FAX 212-382-0278

# Record Companies

U. S. & C A N A D A

**POLYGRAM RECORDS;** 3800 West Alameda Avenue, Ste. 1500; Burbank, CA 91505; (818) 955-5200; 810 7th Avenue; New York, NY 10019; (212) 399-7100.

**PORTRAIT RECORDS;** 51 West 52nd Street; New York, NY 10019; (212) 975-5283.

**PRESTIGE RECORDS;** 10th & Parker Streets; Berkeley, CA 94710; (415) 549-2500.

**PRIVATE MUSIC;** 9014 Melrose Avenue; Los Angeles, CA 90069; (213) 859-9200; 220 E. 23rd Street, 10th Floor; New York, NY 10010; (212) 684-2533.

**PROFILE RECORDS;** 740 Broadway; New York, NY 10003; (212) 529-2600.

**PVC RECORDS;** 3619 Kennedy Road; South Plainfield, NJ 07080; (201) 753-6100.

**QWEST RECORDS;** 3300 Warner Boulevard, 4th Floor; Burbank, CA 91510; (818) 953-3472.

**RALPH RECORDS;** 109 Minna Street, Ste. 391; San Francisco, CA 94105; (415) 585-4379.

**RAS RECORDS;** Gary Himmelfarb; PO Box 42517; Washington, DC 20015; (202) 564-1295.

**RCA RECORDS;** 6363 Sunset Boulevard; Hollywood, CA 90028; (213) 468-4000; 1 133 Avenue of the Americas; New York, NY 10036; (212) 930-4190; 30 Music Square West; Nashville, TN 37203; (615) 664-1200.

**REDWOOD RECORDS;** 6400 Hollis Street #8; Emeryville, CA 94608; (415) 428-9191.

**RELATIVITY RECORDS;** 1830 W. 208th St.; Torrance, CA 90501; (213) 212-0801.

**RELIX RECORDS, INC.;** PO Box 92; Brooklyn, NY 11229; (718) 258-0009.

**REPRISE RECORDS;** 3300 Warner Blvd.; Burbank, CA 91510; (818) 953-3750.

**REPTILE RECORDS;** PO Box 121213; Nashville, TN 37212; (615) 331-7400.

**RESTLESS RECORDS;** 11264 Playa Court; Culver City, CA 90231; (213) 390-9969.

**REUNION RECORDS;** PO Box 25330; Nashville, TN 37202; (615) 329-2611.

**RHINO RECORDS;** 2225 Colorado Avenue; Santa Monica, CA 90404; (213) 828-1980.

**ROCK HOTEL RECORDS;** 740 Broadway; New York, NY 10003; (212) 529-2600.

**ROIR;** 611 Broadway, Ste. 411; New York, NY 10012; (212) 477-0563.

**ROM RECORDS;** PO Box 491212; Los Angeles, CA 90049; (213) 471-5000.

**ROUGH TRADE RECORDS;** 326 Sixth Street; San Francisco, CA 94103; (415) 863-9007; 611 Broadway, Ste. 536; New York, NY 10012; (212) 777-0100.

**ROUNDER RECORDS;** One Camp Street; Cambridge, MA 02140; (617) 354-0700.

**RYKODISC USA;** Pickering Wharf Bldg. C-3G; Salem, MA 01970; (508) 744-7678.

**SCOTTI BROS/ROCK 'N' ROLL RECORDS;** 2114 Pico Boulevard; Santa Monica, CA 90405; (213) 450-3193.

**SEA BREEZE RECORDS;** PO Box 11267; Glendale, CA 91226; (818) 242-2093.

**SHANACHIE RECORDS;** 37 E. Clinton Street; Newton, NJ 07860; (201) 579-7763.

**SIRE RECORDS;** 75 Rockefeller Plaza; New York, NY 10019; (212) 484-6800; 3300 Warner Boulevard; Burbank, CA 91505; (818) 846-9090.

**SIXTEENTH AVE. SOUND;** 1217 16th Avenue S; Nashville, TN 37212; (615) 327-8787.

**SKYWALKER RECORDS;** 3050 Biscayne Boulevard, Ste. 307; Miami, FL 33142; (305) 573-0599.

**SLASH RECORDS;** 7381 Beverly Boulevard; Los Angeles, CA 90036; (213) 937-4660.

**SLEEPING BAG RECORDS;** 1974 Broadway; New York, NY 10023; (212) 724-1440.

**SMITHSONIAN COLLECTION;** Perf. Arts Division; Washington, D.C. 20560; (202) 357-1300.

**SOLAR RECORDS;** 1635 N. Cahuenga Boulevard; Hollywood, CA 90028; (213) 461-0390.

**SONA GAIA;** 1845 N. Farwell Avenue; Milwaukee, WI 53202; (414) 272-6700.

**SOUTHPORT;** 3501 N. Southport; Chicago, IL 60657; (312) 281-8510.

**SPARROW RECORDS;** 9255 Deering Avenue; Chatsworth, CA 91311; (818) 709-6900.

**SST RECORDS;** PO Box 1; Lawndale, CA 90260; (213) 835-8977.

**STASH RECORDS;** 611 Broadway #725; New York, NY 10012; (212) 477-6277.

**STAX RECORDS;** c/o Fantasy Records; 10th & Parker Streets; Berkeley, CA 94710; (415) 549-2500.

**SUBPOP RECORDS;** PO Box 20645; Seattle, WA 98102; (206) 441-8441.

**SUBTERRANEAN;** PO Box 2350; Berkeley, CA 94702; (415) 864-1649.

**SUGAR HILL RECORDS;** 96 West Street; Englewood, NJ 07631; (201) 569-5170.

**SUGO RECORDING COMPANY;** PO Box 1196; El Granada, CA 94018; (415) 726-0696.

**SUN RECORDS;** 3106 Belmont Boulevard; Nashville, TN 37212; (615) 385-1960.

# don't forget your lunch!

## THE 512b MIC PRE:

The new API 512b-  
An all discrete EQ size  
mic preamp/instrument  
direct box in one.

## THE 550b EQ:

The new API 550b-  
The same circuit as  
the famous all discrete  
550A, but with four  
bands and more  
frequencies.

## THE 500-b4:

The new API 500-b4-  
A portable rack for API  
modules, with the  
traveling engineer or  
musician in mind.



api

api audio products, inc.  
7951 TWIST LANE,  
SPRINGFIELD, VA 22153  
703-455-8188 FAX 703-455-4240

### WORLDWIDE DEALER/REPRESENTATIVES:

|                                                             |                                                     |
|-------------------------------------------------------------|-----------------------------------------------------|
| <b>EAST COAST:</b><br>STUDIO CONSULTANTS, INC. 212-586-7378 | <b>MID-US:</b><br>MILAM AUDIO 309-346-3161          |
| <b>WEST COAST:</b><br>WESTLAKE AUDIO 213-851-9800           | <b>EUROPE:</b><br>SYCO SYSTEMS (LONDON) 01-724-2451 |
|                                                             | <b>JAPAN:</b><br>NISSHO IWA (NY) 212-704-6692       |



**SUTRA RECORDS;** 1 Madison Avenue; New York, NY 10010  
(212) 779-1844.

**SWALLOW;** PO Drawer 10; Ville Platte, LA 70586; (318) 363-2184.

**SWAN SONG RECORDS;** 444 Madison Avenue; New York, NY 10022.

**TABU RECORDS;** 9229 Sunset Boulevard; Los Angeles, CA 90069; (213) 276-0523.

**TAKOMA RECORDS;** 1419 North La Brea; Hollywood, CA 90028; (213) 851-8852.

**TBA/TALL TREE RECORDS;** 11026 Ventura Boulevard, Ste. 3; Studio City, CA 91604; (213) 877-5106.

**TELARC RECORDS;** 23307 Commerce Park; Cleveland, OH 44122; (216) 464-2313.

**TERESA GRAMOPHONE CO.;** 1414 Avenue of the Americas; New York, NY 10019; (212) 759-5565.

**THERESA RECORDS;** 800 The Arlington; Berkeley, CA 94707; (415) 524-4908.

**THIRSTY EAR RECORDS;** 310 Madison #1506; New York, NY 10017; (212) 697-7800.

**TIME-LIFE RECORDS;** 541 N. Fairbanks; Chicago, IL 60611; (312) 329-6800.

**TIN PAN APPLE RECORDS;** 250 West 57th Street, Rm. 1723; New York, NY 10017; (212) 757-0521.

**TOMMY BOY RECORDS;** 1747 First Avenue; New York, NY 10128; (212) 722-2211.

**TWIN TONE RECORDS;** 2541 Nicollet Avenue S.; Minneapolis, MN 55404; (612) 872-0646.

**TWIN TONE/COYOTE (EAST);** Box 112 Uptown; Hoboken, NJ 07030; (212) 995-0648.

**UNI RECORDS;** 70 Universal City Plaza; Universal City, CA 91608; (818) 777-8904.

**VANGUARD RECORDS;** c/o Welk Record Group; 1299 Ocean Avenue, Ste. 800; Santa Monica, CA 90401; (213) 451-5727.

**VARESE SARABANDE;** 13006 Saticoy Street; North Hollywood, CA 91605; (818) 764-1172.

**VERVE RECORDS;** 810 7th Avenue, 12th Floor; New York, NY 10019; (212) 333-8000.

**VIRGIN RECORDS;** 9247 Alden Drive; Beverly Hills, CA 90210; (213) 278-1181; 30 West 21st Street; New York, NY 10010; (212) 463-0980.

**VISTA RECORDS;** 350 South Buena Vista; Burbank, CA 91521; (818) 840-1665.

**WARNER BROS. RECORDS;** 3300 Warner Boulevard; Burbank, CA 91510; (818) 953-3481; 75 Rockefeller Plaza; New York, NY 10019; (212) 484-6800; 1815 Division Street; Nashville, TN 37203; (615) 320-7525.

**WAX TRAX RECORDS;** 2445 North Lincoln; Chicago, IL 60614; (312) 528-8753.

**WINDHAM HILL RECORDS;** PO Box 9388, Stanford, CA 94305; (415) 381-3688.

**WORD/MYRRH RECORDS;** PO Box 1790; Waco, TX 76796; (817) 772-7650.

#### Mix Trivia

1. In 1895, he sent and received the first wireless signals in Italy. Alexander S. Popoff did the same in Russia.
2. In 1910, his was the first voice to be broadcast by radiophone—from backstage at the Metropolitan Opera.
3. Factory Records was formed in 1977 to promote the debut album of this band.

Turn to page 152 for question

# “The Hollywood Edge ... the best sound effects library, without a doubt!”

**Oliver Stone, Director**  
(Born on the Fourth of July, Platoon)

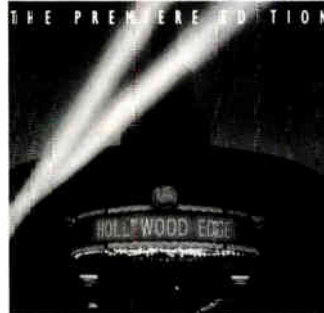

Listen for yourself—If you buy sound effects for your company,  
Call us for a free Premiere Edition demo disc.

Call 800-292-3755 In CA 213-466-6723

7060 Hollywood Boulevard, Suite 700, Hollywood, CA 90028

**No bells, no whistles, no flashing lights...  
no fans, no pots, no meters, no chips, no handles  
no circuit breakers, no trick power supplies  
no global feedback, no mass-production  
no short cuts  
no voodoo**



**Nothing but  
the truth**

**Extending from five hertz to beyond 300 kilohertz  
with lightning speed and high current capability  
there are no details too fine to resolve  
no transients too dynamic to capture  
no blanket on the sound  
no competition exists**



275 Martin Avenue Highland, N.Y. 12528  
TEL 914-691-6077 FAX 914-691-6822



Cardioid  
Capsule

PPC 1000  
Hypercardioid  
Converter

# AKG's C1000S. Two Heads Are Better Than One.

Your stage is an ever-changing environment. As arrangements, acts and performances change from show to show, and from song to song, you'll want a studio quality stage mic that adjusts to each situation. You'll want the AKG C1000. It may be the only stage mic you'll ever need.

This rugged condenser mic is supplied with the snap-on/snap-off PPC 1000 (Polar Pattern Converter), which lets you easily vary the mic's pick-up pattern from cardioid to hypercardioid. So you can use it for instrumentals and/or vocals and not have to worry about picking and choosing mics backstage.

The AKG C1000, with a built in on/off switch, packs power, high sensitivity, low handling noise and sleek good looks into a remarkably easy-to-handle microphone. . . making it as practical as it is versatile.

The C1000 joins AKG's family of microphones, the most widely used in U.S. recording studios, according to a recent *Billboard* survey.\*

And one more thing, the C1000 is also the only music mic that can operate off either phantom power or an internal standard 9-volt battery (not included).

AKG's C1000. When two heads are better than one.



**Focusing on new technology.**

1525 Alvarado St.  
San Leandro, CA 94577  
(415) 351-3500

\*Billboard's 1990 International Recording Equipment & Studio Directory, Oct. 1989.

© AKG 1990 © Akustische und Kino-Geräte GmbH, Austria

# PROFESSIONAL AUDIO MANUFACTURERS

1 9 9 0 - 1 9 9 1

**AB INTERNATIONAL ELECT. INC.;** 1830-6 Vernon St.; Roseville, CA 95678; (916) 783-7800; FAX: (916) 784-1050. Irwin Laskey, vp mktg., Robert Bird, president. Products Manufactured: AMP, SP.

**JOHN ABBOTT MUSIC;** 60 Mason St.; Staten Island, NY 10304; (718) 979-8770. Fanny Abbott, mktg. mgr. Products Manufactured: SOFT, PL.

**ACCURATE SOUND CORPORATION;** 3515 Edison Way; Menlo Park, CA 94025; (415) 365-2843; Telex: 34-8327; FAX: (415) 365-3057. Ronald M. Newdell, president. Products Manufactured: DUP, MIC, REC.

**ACO PACIFIC INC.;** 2604 Read Ave.; Belmont, CA 94002; (415) 595-8588; FAX: (415) 591-2891. N. Lewis, president. Products Manufactured: MIC, SP, TE, OTH.

**ACOUSTICAL PHYSICS LABORATORIES;** 3877 Foxford Dr.; Doraville, GA 30340; (404) 934-9217. William Morrison, principal eng. Products Manufactured: SPKR.

**ADA SIGNAL PROCESSORS, INC.;** 7303D Edgewater Dr.; Oakland, CA 94621; (415) 632-1323; Telex: 470880 ADA UI; FAX: (415) 632-9358. Lorry Marcus, mktg. mgr., Eric Schultheis, East sales, Lisa Gond, west sales. Products Manufactured: AMP.

**ADAMS-SMITH;** 34 Tower St.; Hudson, MA 01749-1721; (508) 562-3801; Telex: 920087; FAX: (508) 568-0404. A. Simon, mktg. mgr., nat'l sales mgr.. Regional Offices: Los Angeles, CA (818) 840-9588, J. Lawrence; New York, NY (201) 671-8768, G. Rotta. Products Manufactured: SYNC.



ADAMSON ACOUSTIC DESIGN  
Pickering, ON

**ADAMSON ACOUSTIC DESIGN;** 817 Brock Rd. #9; Pickering, ON L1W 3L9; (416) 420-6279; FAX: (416) 420-0813. Jerry Placken, mktg./sales mgr. Products Manufactured: SPKR, SP.

**ADC TELECOMMUNICATIONS, INC.;** 5501 Green Valley Dr.; Minneapolis, MN 55437; (612) 893-3431; FAX: (612) 893-3237. Larry Johnson, mktg. mgr.; Patrick Gallagher, nat'l sales mgr.. Regional Offices: Antioch, CA (415) 757-8955, Dick Lawrence; So. Setauket, NY (516) 698-7192, Pat Gallagher. Products Manufactured: CC, OTH.

Information in the manufacturer's listings was supplied by the companies listed. Following each manufacturer's listing are product codes. Products are then cross-referenced in an index beginning on page 48.



ADC TELECOMMUNICATIONS, INC.  
Minneapolis, MN

**ADS, ANALOG & DIGITAL SYSTEMS INC./DELTA LAB;** One Progress Way; Wilmington, MA 01887; (617) 658-5100. Jim Ruse. Products Manufactured: SP.

**ADVANCED MUSIC SYSTEMS;** AMS Industries Park, Billington Rd.; Burnley, Lancs, BB115ES England; 0282 57011. John Gluck. Products Manufactured: SP.

**ADX SYSTEMS;** Omnivue; 274 Madison Ave.; New York, NY 10016; (212) 532-5576. Henry Glass. Products Manufactured: SYNC.

**AEG CORPORATION;** 2201-K 5th St.; Lakeland, NY 11779; (516) 467-1200. Rainer Zophy. Products Manufactured: REC.



AGFA CORPORATION  
Ridgefield Park, NJ

**AGFA CORPORATION;** 100 Challenger Rd.; Ridgefield Park, NJ 07660; (201) 440-2500; Telex: 134410; FAX: (201) 440-2865. Chris Emery, nat'l mktg. mgr.; Andrew Da Puzzo, nat'l sales mgr. Regional Offices: Ridgefield Park, NJ (201) 440-2662, Bob Zamosciany; Oak Brook, IL (312) 242-1951, Joe Tibensky; Los Angeles, CA (213) 552-9622, Walter Bremmer. Products Manufactured: TAPE.

**AIRCRAFT MUSIC LIBRARY;** 77 N. Washington St.; Boston, MA 02114; (617) 367-4962; (800) 343-2514. Products Manufactured: PL.

**AIRFORCE BROADCAST SERVICES;** 216 Carlton St., Ste. 300; Toronto, ON M5A 2L1; (416) 961-2541. Products Manufactured: PL.

**AKAI PROFESSIONAL;** 1316 E. Lancaster; Fort Worth, TX 76102; (817) 336-5114; FAX: (817) 870-1271. Woody Moran, Akai dir.; Larry Volland, v.p. sales. Products Manufactured: DISK, MI, REC.

**AKG ACOUSTICS, INC.;** 1525 Alvarado St.; San Leandro, CA 94577; (415) 351-3500; FAX: (415) 351-0500. Dave Roudebush, mktg. and sales mgr. Regional Offices: Pittsburgh, PA (412) 782-2354, Rowland Powers; Appleton, WI (414) 749-0044, Jeff Radke. Products Manufactured: SPKR, MIC, SP, OTH.

**AKG ACOUSTICS DIGITAL PRODUCTS;** 125 Walnut St.; Watertown, MA 02172; (617) 924-7697. Christopher Moore. Products Manufactured: DISK, SP.

**ALESIS CORPORATION;** 3630 Holdrege Ave.; Los Angeles, CA 90016; (213) 467-8000; FAX: (213) 836-9192. Ralph Goldheim, vp sales/mktg. Products Manufactured: MIXC, MI, SP.

**ALLEN & HEATH USA;** Five Connair Rd.; Orange, CT 06477; (203) 795-3594; FAX: (203) 795-6814. Richard Harris, mktg. mgr.; Chuck Augustowski, sales mgr. Products Manufactured: MIXC.

**ALPHA AUDIO;** 2049 W. Broad St.; Richmond, VA 23220; (804) 358-3852; FAX: (804) 358-9496. Michael Binns, mktg. mgr.; Richard A. Foate, nat'l sales mgr. Products Manufactured: AM, DISK, REC.

**ALTEC LANSING CORPORATION;** 10500 W. Deno, PO Box 26105; Oklahoma City, OK 73126-0105; (405) 324-5311. Karen Treadwell, mgr. mktg. services. Products Manufactured: AMP, SPKR, SP.

**AMBER ELECTRO DESIGN, INC.;** 3391 Griffith St.; St. Laurent, QC H4T 1W5; (514) 735-4105; (800) 361-3697 (U.S.); FAX: (514) 340-1468. Wayne Jones. Products Manufactured: TE.

**AMCO ENGINEERING CO.;** 3801 Rose St.; Schiller Pk., IL 60176; (708) 671-6670; FAX: (708) 671-9469. J.R. Walenda, mktg. mgr.; Floyd Johnson, nat'l sales mgr. Products Manufactured: CRS.

**AMEK/TOTAL AUDIO CONCEPTS;** 10815 Burbank Blvd.; North Hollywood, CA 91601; (818) 508-9788; FAX: (818) 508-8619. Sue Jones, oper. mgr.; Steve Harvey, nat'l sales mgr. Products Manufactured: CRS, AUTO, MSTC, MIXC.

**AMERICAN IMAGE PRODUCTIONS;** 1719 West End Ave., Ste. 603; Memphis, TN 37203; (615) 327-4521; (800) 344-4202. Products Manufactured: PL.

**AMERICAN MULTIMEDIA/CONCEPT DESIGN;** Rt. 8, Box 215-A; Burlington, NC 27215; (919) 229-5554. Robert I. Farrow. Products Manufactured: DUP.

## MANUFACTURER'S PRODUCT CODES

The following codes apply to products developed by manufacturers serving the North American market and was supplied by those companies listed. See the Manufacturer's Cross Index for a more complete breakdown of who makes what.

|      |                                         |      |                                      |      |                             |
|------|-----------------------------------------|------|--------------------------------------|------|-----------------------------|
| AM   | Acoustic Materials                      | SOFT | Computer Software                    | PL   | Production Libraries        |
| AMP  | Amplifiers                              | DISK | Disk-based Recording/Editing Systems | SP   | Signal Processing Equipment |
| TAPE | Audio/Video Tape                        | EM   | Educational Materials                | TH   | Tape Heads                  |
| CC   | Cables & Connectors                     | SPKR | Loudspeakers                         | REC  | Tape Recorders              |
| CRS  | Cases, Racks & Stands                   | MSTC | Mastering Consoles                   | TE   | Test Equipment & Analyzers  |
| DUP  | Cassette Duplication Equipment/Supplies | MIC  | Microphones                          | SYNC | Transport Synchronizers     |
| AUTO | Console Automation Systems              | MIXC | Mixing Consoles                      | VE   | Video Equipment             |
| HDWR | Computer Hardware                       | MI   | Musical Instruments                  | OTH  | Other                       |



## Professional Audio Manufacturers

1990-1991

**AMERICAN VIDEOMATIC INC.;** 1812 Tilghman St.; Allentown, PA 18104; (215) 821-8984; (800) 858-3816. William Pany. Products Manufactured: *TAPE*.

• **AMP SERVICES;** 224 Datura St., Ste. 614; West Palm Beach, FL 33401; (407) 659-4805; FAX: (407) 655-1808. Tom Rappolt, vp sales and mktg. Products Manufactured: *TH*.

• **AMPEX RECORDING MEDIA CORPORATION;** 401 Broadway, M.S. 22-02; Redwood City, CA 94063; (415) 367-3809; Telex: 348464; FAX: (415) 367-4132. Karen Schweikher, mktg. comm. mgr.; Richard A. Antonio, vp U.S. Regional Offices: San Fernando, CA (818) 365-8627, Bob Pellino; Carrollton, TX (214) 960-1162, Arnold Schlinke; Allendale, NJ (201) 825-9600, Jack Becker. Products Manufactured: *TAPE*.

**AMPLIFIED MUSIC PRODUCTS;** 9829 Independence Ave.; Chatsworth, CA 91311; (818) 709-0518; FAX: (818) 709-6816. Russ Allee, mktg./nat'l sales mgr. Products Manufactured: *AMP, SPKR*.



AMS INDUSTRIES INC.  
Petaluma, CA

**AMS INDUSTRIES INC.;** 1180 Holm Rd., Ste. C; Petaluma, CA 94954; (707) 762-4840; FAX: (707) 762-4811; E-Mail: 42:IMC889. Jim Stern, president/CEO. Products Manufactured: *AUTO, DISK, MIC, MIXC, SP*.

**ANALOG DIGITAL SYNERGY, INC.;** 120 SW 21 Terr., C-104; Ft. Lauderdale, FL 33312; (305) 791-1501; FAX: (305) 791-8986. Lutz H. Meyer, president. Products Manufactured: *MIXC, REC*.

**ANALOG SOLUTIONS;** 85 Tasman; San Jose, CA 95134; (408) 433-1900. Bill Clark.

**ANATEK;** 400 Brooksbank Ave.; N. Vancouver, BC V7J 1G9; (604) 930-6850. Products Manufactured: *MI*.

**ANCHOR AUDIO, INC.;** 913 W. 223rd St.; Torrance, CA 90502; (213) 533-5984. Jonathan Peirson, vp marketing. Products Manufactured: *SPKR*.

**R.B. ANNIS CO., INC.;** 1101 N. Delaware St.; Indianapolis, IN 46202; (317) 637-9282; FAX: (217) 687-9282. R.B. Annis, president. Products Manufactured: *OTH*.

**ANT TELECOMMUNICATIONS;** 211 Perry Pkwy.; Gaithersburg, MD 20877; (301) 670-9777. Rick Mattel. Products Manufactured: *SP*.

**ANVIL CASES (UNIT OF ZERO HALLIBURTON);** 4128 Temple City Blvd.; Rosemead, CA 91770; (818) 575-8614. Products Manufactured: *CFS*.

• **APEX MACHINE COMPANY;** 3000 NE 12th Terr.; Ft. Lauderdale, FL 33334-4497; (305) 566-1572; Telex: 271601 APEX UR; FAX: (305) 563-2844. Alfred R. Coningsby, III, mktg./nat'l sales mgr.. Products Manufactured: *DUP*.

**APHEX SYSTEMS;** 11068 Randall St.; Sun Valley, CA 91352; (818) 767-2929. Paula Lintz, sales and mktg. mgr. Products Manufactured: *SP, MI*.

• **API AUDIO PRODUCTS, INC.;** 7951 Twist Ln.; Springfield, VA 22153; (703) 455-8188; Telex: 510-600-1898; FAX: (703) 455-4240. Kevin Raynor, vp; Paul Wolff, president. Products Manufactured: *AUTO, MIXC, SP*.

**APOGEE ELECTRONICS;** 2103 Main St.; Santa Monica, CA 90405; (213) 399-2991; FAX: (213) 828-9720. Betty Bennett, mktg./nat'l sales mgr. Products Manufactured: *SP, REC, TE*.

**APOGEE SOUND, INC.;** 1150 Industrial Ave., Ste. C; Petaluma, CA 94952; (707) 778-8887. Joe Manning, vp sales and mktg. Products Manufactured: *SPKR*.

**APPLE COMPUTER, INC.;** 20525 Mariani Ave.; Cupertino, CA 95014; (408) 996-1010. Products Manufactured: *HDWR*.

**APPLIED RESEARCH & TECHNOLOGY (ART);** 215 Tremont St.; Rochester, NY 14608; (716) 436-2720; FAX: (716) 436-3942. Phil Betette, president; Jim Bonis, nat'l sales mgr.. Products Manufactured: *MI, SP*.

**ARIA MUSIC (USA) INC.;** PO Box 382; Walnut, CA 91788-0382; (800) 645-8465. Products Manufactured: *MI*.

**ARIEL CORP.;** 433 River Rd.; Highland Park, NJ 08904; (201) 249-2900.

**ARIES AMERICA;** 22122 S. Vermont #E; Torrance, CA 90502; (213) 533-5112. Ed Bigger. Products Manufactured: *MIXC*.

**ARSONIC U.S.;** 146 Paoli Pike; Malvern, PA 19355; (215) 647-9426; FAX: (215) 640-4271. Roy Hall mktg./nat'l sales mgr.. Products Manufactured: *AMP, SP*.

**ASC/TUBE TRAPS/ACOUSTIC SCIENCES CORP.;** PO Box 1189; Eugene, OR 97440; (503) 343-9727; FAX: (503) 343-9245. Denise M. Schoonhoven, mktg. mgr.; Arthur M. Noxon, president. Products Manufactured: *AM*.



ASHLY AUDIO, INC.  
Rochester, NY

**ASHLY AUDIO, INC.;** 100 Fernwood Ave.; Rochester, NY 14621; (716) 544-5191; FAX: (716) 266-4589. Robert C. French, sr. vp sales/mktg. mgr. Products Manufactured: *AMP, MIXC, MI, SP*.

**ASSOCIATED PRODUCTION MUSIC;** 6255 Sunset Blvd.; Hollywood, CA 90028; (213) 461-3211; (800) 543-4276. Products Manufactured: *PL*.

**ATARI CORPORATION, MUSIC DIVISION;** 1196 Borregas Ave.; Sunnyvale, CA 94088; (408) 745-2000; FAX: (408) 745-2088. Frank Foster, dir. specialty markets; Bill Crouch, vp sales. Products Manufactured: *HARD, SOFT, MI*.

**ATI—AUDIO TECHNOLOGIES INC.;** 328 W. Maple Ave.; Horsham, PA 19044; (215) 443-0330; FAX: (215) 443-0394. Ed Mullin, vp; Sam Wenzel, president. Products Manufactured: *AMP, MIXC, SP*.

**ATLAS SOUND;** 10 Pomeroy Rd.; Parsippany, NJ 07054; (201) 887-7800. Andi Musci. Products Manufactured: *OTH*.

**ATLAS/SOUNDOLIER;** 1859 Intertech Dr.; Fenton, MO 63026; (314) 349-3110; FAX: (314) 349-1251. Pete Marsac, vp and general mgr.; Bud Waters, nat'l sales mgr. Products Manufactured: *CFS, SPKR*.

**AUDIO CHICAGO, INC.;** 7206 W. Grand Ave.; Elmwood Park, IL 60635; (708) 456-0003. Harman Deletzke, president. Products Manufactured: *DUP*.

**AUDIO ACCESSORIES;** Mill St.; Marlow, NH 03456; (603) 446-3335. Products Manufactured: *OTH*.

**AUDIO ACTION;** 444 Lakside Dr., Ste. 340; Burbank, CA 91510; (818) 845-8020; (800) 533-1293. Products Manufactured: *PL*.



AUDIO ANIMATION, INC.  
Knoxville, TN

**AUDIO ANIMATION, INC.;** 210 W. Magnolia Ave.; Knoxville, TN 37917; (615) 544-0458; FAX: (615) 637-3423. Milton E. McNally, president. Products Manufactured: *MSTC, MIXC, SP*.

**AUDIO CENTRON;** 1400 Ferguson Ave.; St. Louis, MO 63133; (314) 727-4512. Products Manufactured: *SPKR, AMP, MIXC*.

**AUDIO CONTROL INDUSTRIAL;** 22313 70th Ave. W.; Mountlake Terrace, WA 98043; (206) 775-8461; FAX: (206) 778-3166. Rick Chinn, sales and mktg. mgr. Products Manufactured: *SP, TE*.

**AUDIO/DIGITAL, INC.;** 1000 S. Bertelsen Rd. #4; Eugene, OR 97402; (503) 687-8412; FAX: (503) 687-0632. Philip J. DeSantis, mktg./nat'l sales mgr. Products Manufactured: *SP*.

## AudioControl Industrial

AUDIO CONTROL INDUSTRIAL  
Mountlake Terrace, WA

**AUDIO KINETICS UK LIMITED;** Kinetic Centre, Theobald St., Borehamwood; Hertfordshire, England WD6 4PJ UK; (01) 952-8118; (01) 953-1118.

**AUDIO LOGIC;** 5639 S. Riley Ln.; Salt Lake City, UT 84107; (801) 268-8400. Products Manufactured: *SP*.

**AUDIO PRECISION;** PO Box 2209; Beaverton, OR 97075; (503) 627-0832; FAX: (503) 641-8906. Thomas Mintner, dir. sales and mktg. Products Manufactured: *TE*.

**AUDIO PRODUCTIVE/ACE AUDIO ENG.;** 96 Lafayette Ave.; Hawthorne, NJ 07506; (201) 423-4404. Products Manufactured: *MIXC*.

**AUDIOLAB ELECTRONICS, INC.;** 5831 Rosbud Ln., Bldg. C; Sacramento, CA 95841; (916) 348-0200; FAX: (916) 348-1512. Ron Stofan, mktg./nat'l sales mgr. Products Manufactured: *OTH*.



AUDIOMOTION SYSTEMS LTD.  
Stanley, County Durham, England

**AUDIOMOTION SYSTEMS LTD.;** Rockwood House, Barn Hill; Stanley, County Durham, DH9 8AN England; (207) 282-880; Telex: 537642; FAX: (207) 232-023. John B. Williams, president; David Pope, tech. mgr. Regional Offices: Sudbury, MA (508) 443-8053, Richard Vanderslice. Products Manufactured: *AUTO*.

**AUDIO-TECHNICA U.S., INC.;** 1221 Commerce Dr.; Stow, OH 44224; (216) 686-2600; FAX: (216) 688-3752. Buzz Goodwin, nat'l mktg. mgr.; Garry Elliott, nat'l sales mgr. Products Manufactured: *CC, SPKS, MIC*.

• **AUDIO TECHNIQUES;** 1619 Broadway, 4th Fl.; New York, NY 10019; (212) 586-5989.

**AUDITEC OF ST. LOUIS;** 330 Selma Ave.; St. Louis, MO 63119; (314) 965-9005. William F. Carver. Products Manufactured: *TAPE, DUP*.

**AUDIX;** 5653 Stoneridge; Pleasanton, CA 94566; (415) 463-1112; FAX: (415) 463-2149. Clifford Castle, mktg. mgr. Products Manufactured: *SPKR, MIC*.

**AUDRA INT.;** PO Box 38; Silverado, CA 92676; (714) 649-2207; FAX: (714) 649-3064. Algis Renkus, owner. Products Manufactured: *SPKR, MIC*.

**AURATONE CORP.;** PO Box 698; Coronado, CA 92118; (619) 297-2820; FAX: (619) 296-8734. J.A. Wilson, pres./nat'l sales mgr. Products Manufactured: *SPKR*.

**AUSTRALIAN MONITOR (PTY) LTD.;** 53 College St., Gladesville; Sydney, 2111 Australia; Regional Offices: Los Angeles, CA (213) 466-2616, (213) 697-7576. Geoff Kelsner. Products Manufactured: *AMP*.

**AVI;** 1812 Tilghman St.; Allentown, PA 18104; (800) 747-8984; (215) 821-8984. William Pany, mktg. mgr. Products Manufactured: *TAPE*.

**AXE CORPORATION;** 924 15th Ave.; Redwood City, CA 94063; (415) 365-5243. Lynn Duckworth. Products Manufactured: *SYNC, MI*.

**AXCESS UNLIMITED, INC.;** PO Box 8435; Ft. Collins, CO 80525; (303) 482-5656. Greg Long. Products Manufactured: *MI*.

**B & B SYSTEMS;** 28111 N. Avenue Stanford; Valencia, CA 91355; (805) 257-4853. Products Manufactured: *TE*.

**BACCHUS;** 2210 Wilshire, Ste. 330; Santa Monica, CA 90403; (213) 392-1906. Products Manufactured: *SOFT*.



# Engineered For Those With A Passion For Performance.

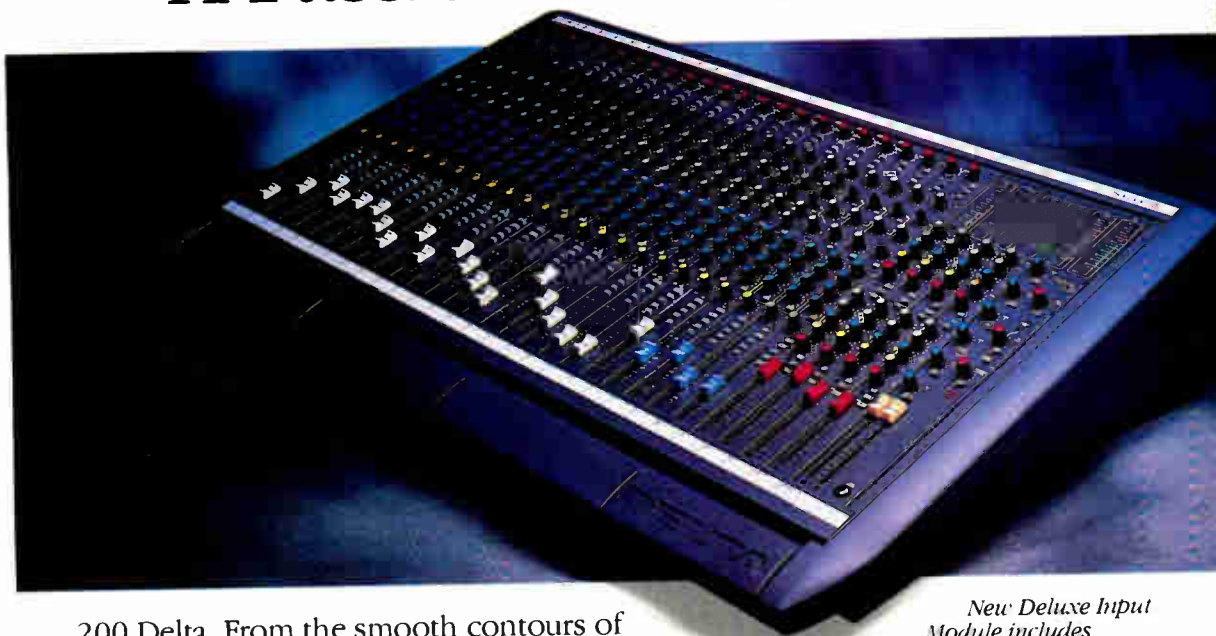

200 Delta. From the smooth contours of its sleekly styled shell to the advanced circuitry that delivers unprecedented performance, Delta is the compact console of the nineties. Expanding on the modular versatility of its 200 Series predecessors, Delta incorporates many innovations unique to Soundcraft. Advances in low profile console design that go well beyond the obvious restyling.

Delta delivers superb sonic quality, with an improved electronic design that incorporates a new microphone preamp and active panpot. And, because Delta selectively bypasses any circuitry not in operation, you can be assured of optimum transparency.

Delta delivers unmatched versatility and control. With Standard, Deluxe, Stereo and Dual-Line Input Modules, Delta can meet a wider variety of applications. By adding up to four Group Modules, configuring just the right console for your application couldn't be easier.

200 Delta. Engineered for those who hunger for perfection.

*New Deluxe Input Module includes expanded 4-band EQ with two mid-sweeps, high pass filter and post-fader direct output. The rackmount Delta, shown below in a 12x2 version using Deluxe Inputs, can be expanded to 24x2 using Dual Line Inputs. Both the streamlined consoles and rackmount models are built to withstand the demands of recording and sound reinforcement.*

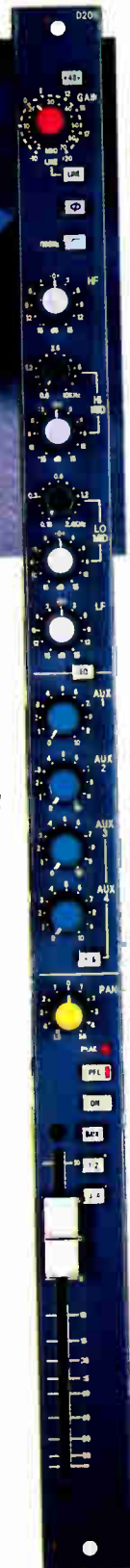

1990  
NOMINEE

## Soundcraft



Soundcraft USA/JBL Professional  
8500 Balboa Boulevard, Northridge, CA 91329

H A Harman International Company

# The best place to keep track of your valuables.

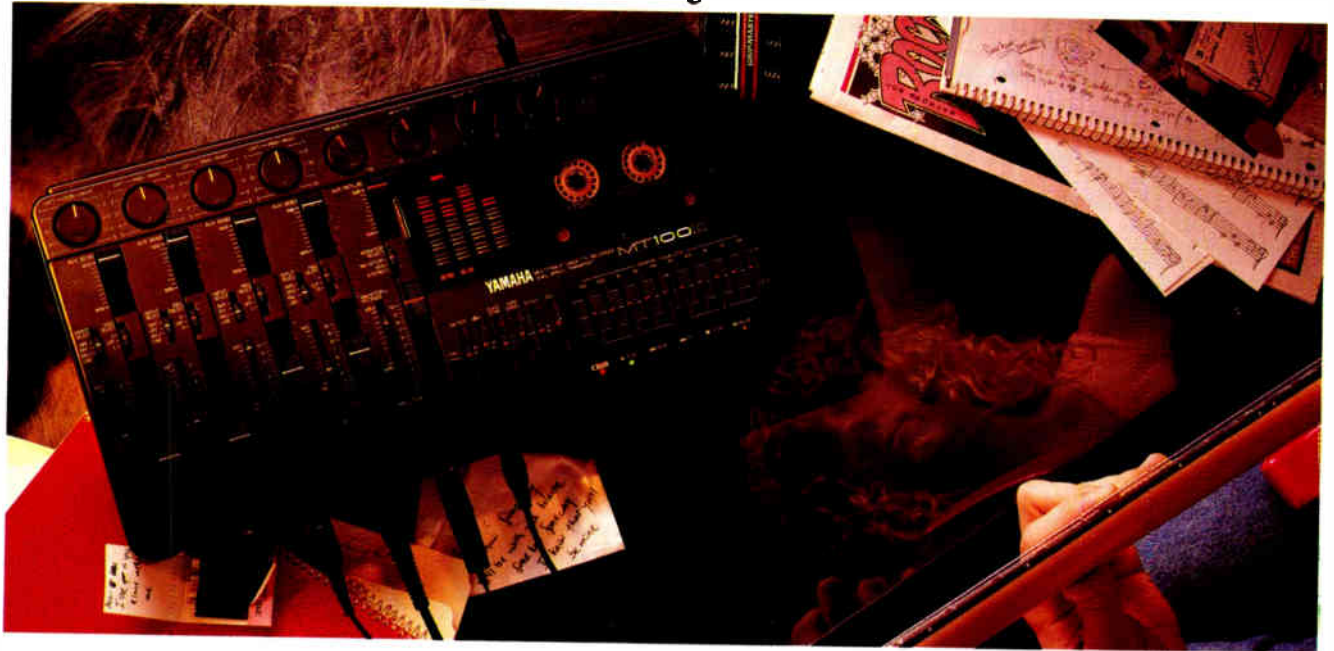

Your most valued possessions had been trusted to cocktail napkins. Biology notebooks. Worse yet, to memory.

But you didn't realize just how important they were till the day you finally got the chance to put all the pieces in place.

It's why Yamaha designed the MT100II Multitrack Recorder. A machine that records on four tracks simultaneously, separately or in any combination. With a dual channel 5-band graphic EQ. Dual stereo outputs. Frequency response up to 18 kHz. And mic/line level inputs on all four channels. All at a price that puts home recording within reach of every aspiring musician.

Visit your nearest Yamaha dealer to find out more about the new MT100II. So the next time you have something as valuable as a great idea, you'll have the perfect place to keep it.

*Personal Studio Series™*

**YAMAHA®**

Professional Audio Division



Yamaha Corporation of America, Professional Audio Division, P.O. Box 6600, Buena Park, CA 90622-6600.



## Professional Audio Manufacturers

1990-1991

**BACKSTAGE PASS PRODUCTIONS, INC.;** 7438 Shoshone Ave.; Van Nuys, CA 91406; (818) 786-8696; Telex: 364412 INTR; FAX: (818) 371-1166. A.J. Erhe, U.S. sales mgr.; Paula Weisberg, vp sales. Products Manufactured: *EM*.

**BAG END;** One Mitek Plaza; Winslow, IL 61089; (312) 382-4550. Will Warnock. Products Manufactured: *SPKR, CRS*.

**BANNER;** PO Box 1803; Shelby, NC 28150; (704) 487-7012. John R. Dellinger. Products Manufactured: *SYNC*.

**BARBETTA ELECTRONICS;** 900 Calle Plano, Unit D; Camarillo, CA 93010; (805) 388-5753. Tony Barbetta.

**B.A.S.E.;** 600 W. Broadway, Ste. 100; Glendale, CA 91204; (818) 500-4171.

**BASF CORPORATION INFORMATION SYSTEMS;** Crosby Dr.; Bedford, MA 01730; (617) 271-4000; Telex: 951856; FAX: (617) 275-2708. Terence D. O'Kelly, dir. sales. Regional Offices: NY, Ed Rafferty; KA, Jerry Shields; CA, Joe Ryan; TN, Larry Repasky. Products Manufactured: *TAPE, TE*.

**BAUER COMMUNICATIONS INC., AUDIO TRANSFORMER DIVISION;** 8840 Valjean Ave.; Sepulveda, CA 91343; (800) 627-7277. Jim Bauer, pres. Products Manufactured: *OTH*.

**BBE SOUND, INC.;** 5500 Bolsa Ave. #245; Huntington Beach, CA 92649; (714) 897-6766; FAX: (714) 895-6728. Fred Coyner, mktg./nat'l sales mgr. Products Manufactured: *SP*.

**BEAVERTON DIGITAL SERVICE;** 1485 N. Bundy Dr.; Los Angeles, CA 90049; (503) 641-6260. John Connolly. Products Manufactured: *SOFT*.

**BELDEN WIRE & CABLE;** Box 1980; Richmond, IN 47375; (317) 983-5294. James Keene. Products Manufactured: *CC*.

**BENCHMARK MEDIA SYSTEMS, INC.;** 3817 Brewerton Rd.; N. Syracuse, NY 13212; (315) 452-0400. Allen H. Burdick. Products Manufactured: *OTH*.

**B.E.S.;** 345 Fischer St.; Costa Mesa, CA 92626; (714) 549-3833. Bill Organ. Products Manufactured: *SPKR*.

**beyerdynamic** 

BEYER DYNAMIC INC.  
Hicksville, NY

**BEYER DYNAMIC INC.;** 5-05 Burns Ave.; Hicksville, NY 11801; (516) 935-8000; FAX: (516) 935-8018. Mike Solomon, mktg. mgr. Regional Offices: Boston, MA (617) 229-6050, Dave Henderson; Chicago, IL (708) 234-6500, Tom Parnell; Dallas, TX (214) 869-0669, Bruce Martin; Los Angeles, CA (818) 840-8327. Products Manufactured: *CC, CRS, SPKR, MIC*.

**BGW SYSTEMS, INC.;** 13130 Yukon Ave.; Hawthorne, CA 90250; (213) 973-8090; FAX: (213) 676-6713. Brian Gary Wachner, mktg./nat'l sales mgr. Products Manufactured: *AMP, HDWR*.

**BIAMP SYSTEMS;** 14270 NW Science Park Dr.; Portland, OR 97229; (503) 641-7287; Telex: 4932491; FAX: (503) 626-0281. Ralph Lockhart, president; Ron Camden, nat'l sales mgr. Products Manufactured: *AMP, MIXC, SP*.

**BIG BRIAR INC.;** Rt. 3, Box 115A1; Leicester, NC 28748; (704) 683-9085. Bob Moog. Products Manufactured: *MI*.

**BIG NOISE SOFTWARE;** 3827 Pizarro Rd.; Jacksonville, FL 32217; (904) 730-0754. Products Manufactured: *SOFT, PL*.

**BOBADILLA CASES, INC.;** 2302 E. 38th St.; Los Angeles, CA 90056; (213) 589-5215. John Bobadella, Jr. Products Manufactured: *CRS*.

**BOGEN COMMUNICATIONS, INC.;** 50 Spring St., PO Box 575; Ramsey, NJ 07446; (201) 934-8500. David Chambers. Products Manufactured: *MIXC, AMP*.

**BOSE CORPORATION;** The Mountain; Framingham, MA 01701-9168; (508) 879-7330. Mark Christensen, sound system software mgr. Products Manufactured: *SPKR, SOFT*.

**BOSENDORFER PIANOS;** 1600 Royal St.; Jasper, IN 47546; (812) 482-1600. Vic Geiger. Products Manufactured: *MI*.

**BOULDER AMPLIFIERS, INC.;** 4850 Sterling Dr.; Boulder, CO 80301; (303) 449-8220; FAX: (303) 449-4806. Marvin D. Farley, nat'l sales mgr. Products Manufactured: *AMP, CC*.



W.H. BRADY CO. SPECIALTY TAPE PRODUCTS DIV.  
Milwaukee, WI

**W.H. BRADY CO. SPECIALTY TAPE PRODUCTS DIV.;** 727 W. Glendale Ave., PO Box 571; Milwaukee, WI 53201; (800) 662-5688; (414) 332-8100; FAX: (414) 332-0861. Products Manufactured: *OTH*.

**BRAINSTORM ELECTRONICS, INC.;** 1515 Manning Ave., Ste. 4; Los Angeles, CA 90024; (213) 475-7570; FAX: (213) 329-9895. L. Bernard Frings, president. Products Manufactured: *SYNC, OTH*.

**BROWN BAG PRODUCTIONS;** 4134 S. Eudora St.; Englewood, CO 80110; (303) 756-9949. Products Manufactured: *PL*.

**BRUEL & KJAER, PRO AUDIO DIV.;** 185 Forest St.; Marlborough, MA 01752; (508) 481-7000; Telex: 7103471187; FAX: (508) 485-0519; E-Mail: (800) 445-1218 ID: 04000. Adrian Weidmann, mktg./nat'l sales mgr. Regional Offices: New York, NY (201) 227-6100, Marty Alexander; Atlanta, GA (404) 422-5200, Wil Kinard; Chicago, IL (708) 358-7582, Fred Fey; Los Angeles, CA (714) 978-8066, Joe Weatherstone. Products Manufactured: *MIC, TE*.

**BRUSH MAGNETICS;** PO Box 638; Sunbury, PA 17801; (717) 286-5611. David Walters. Products Manufactured: *OTH*.

**BRYSTON LIMITED;** 57 Westmore Dr.; Rexdale, ON M9V 3Y6; (416) 746-1800. Brian W. Russell. Products Manufactured: *AMP, OTH*.

**BRYSTON VERMONT;** RFD #4 Berlin; Montpelier, VT 05602; (802) 223-6159. John Russell. Products Manufactured: *AMP, SP*.

**BSS;** 30B Banfi Plaza North; Farmingdale, NY 11735; (516) 249-3660. Harry Klane. Products Manufactured: *SP*.

**C&M RESEARCH GROUP;** 302 Ridgehaven Pl.; San Antonio, TX 78209-3424; (512) 255-1919. Sean Craig, business mgr.

**CAE/LITTLITE;** 10087 Industrial Dr.; Hamburg, MI 48139; (313) 231-9373. Fred Mikeska. Products Manufactured: *OTH*.

**CAIG LABORATORIES, INC.;** 1175-0 Industrial Ave.; Escondido, CA 92025; (619) 743-7143; FAX: (619) 743-2460. Products Manufactured: *OTH*.

**CALIBRATION STANDARD INSTRUMENTS;** PO Box 2727; Oakland, CA 94602; (415) 531-8725. Alison M. Long, mgr.; Edward M. Long, owner. Products Manufactured: *SPKR, SP*.

**CALIFORNIA SWITCH AND SIGNAL, INC.;** 13717 S. Normandie Ave.; Gardena, CA 90249; (213) 770-2330; FAX: (213) 327-2741. Ed Koshinski, sales mgr.; Jo Ann Brown, vp sales mgr. Products Manufactured: *CC, OTH*.

**CALZONE CASE CO.;** 225 Black Rock Ave.; Bridgeport, CT 06605; (203) 367-5766. Vincent J. Calzone, vp sales. Products Manufactured: *CRS*.

**CANARE CABLE, INC.;** 511 5th St., Unit G; San Fernando, CA 91340; (818) 365-2446. Barry Brenner. Products Manufactured: *CC*.

**CAPITOL MAGNETIC PRODUCTS;** 6902 Sunset Blvd.; Hollywood, CA 90028; (213) 461-2701. H.J. "Bud" Jackson, Dianne S. Osborn. Products Manufactured: *TAPE*.

**CAPITOL PRODUCTION MUSIC;** 1750 N. Vine St.; Hollywood, CA 90028; (213) 461-2701. Products Manufactured: *PL*.

**DAVID CARROLL ELECTRONICS;** 805 Gilman St.; Berkeley, CA 94710; (415) 528-8054; FAX: (415) 526-1982. Products Manufactured: *CC, OTH*.

**CARVER CORPORATION;** 201 21 48th Ave. W.; Lynnwood, WA 98046; (206) 775-1202; FAX: (206) 778-9453. Mark Friedman, sr. vp sales and mktg.; Steve Payne, nat'l sales. Regional Offices: Lynnwood, WA (206) 775-1202, Dean Standing; Minneapolis, MN (612) 731-0333, Pat Mountain; Farmington, CT (203) 677-6670, Charlie Boomazian. Products Manufactured: *AMP, SP, REC*.

**CARVIN MFG. CORP.;** 1155 Industrial Ave.; Escondido, CA 92025; (619) 747-1710. Carson Kessel, mktg. mgr. Products Manufactured: *AMP, SPKR, MIC, MIXC*.

**CAS ADVERTISING & PROMOTION;** 377 Hall Ct.; Noblesville, IN 46060; (317) 776-9909. Al Stone. Products Manufactured: *EM*.

**CASIO INC.;** 15 Gardner Rd.; Fairfield, NJ 07006; (201) 575-7400. Bob Larson. Products Manufactured: *MI, REC*.

**DWIGHT CAVENDISH COMPANY;** 2117 Chestnut Ave.; Wilmette, IL 60091; (312) 256-0937. Marshall A. Ruedrhanz. Products Manufactured: *DUP*.

**CELESTION INDUSTRIES, INC.;** 89 Doug Brown Way; Holliston, MA 01746; (508) 429-6706; FAX: (508) 429-2426. Barry Fox, dir. sales and mktg.; Brian Coviello, nat'l sales mgr. Products Manufactured: *SPKR*.

**CENTURY 21 PROGRAMMING;** 14444 Beltwood Pkwy.; Dallas, TX 75244; (214) 934-2121; (800) 937-2100. Products Manufactured: *PL*.

**CERWIN-VEGA;** 555 E. Easy St.; Simi Valley, CA 93065; (805) 584-9332; FAX: (805) 583-0865. Rich Mandella, dir. sales and mktg. Products Manufactured: *SPKR, SP*.

**CETEC GAUSS;** 9130 Glenoaks; Sun Valley, CA 91352; (213) 875-1900. Jim Williamson.

**CETEC VEGA;** PO Box 5348; El Monte, CA 91731; (213) 442-0782. Ken Boume. Products Manufactured: *MIC*.



THOMAS M. CHAFFEE MUSIC ASSOCIATES, CUTTING WEDGE DIV.  
Beachwood, NJ

THOMAS M. CHAFFEE MUSIC ASSOCIATES, CUTTING WEDGE DIV. (Distributed by Systems Development Group); 18601 Darnestown Rd.; Poolesville, MD 20837; (301) 972-7355. Products Manufactured: *AM*.

**CHARVEL/JACKSON;** PO Box 2344; Ft. Worth, TX 76113; (817) 336-5114. Harvey Gerst. Products Manufactured: *MI*.

**CHYRON/CMX;** 265 Spagnoli Rd.; Melville, NY 11747; (516) 845-2000. Isaac Hersty. Products Manufactured: *VE*.

**CINTAS VAC;** 1207 5th St.; Imperial Beach, CA 92032; (904) 445-5545.

**CIPHER DIGITAL, INC.;** 5350 Partners Ct., PO Box 170; Frederick, MD 21701; (800) 331-9066; FAX: (301) 694-5152. Bob Tulloh, mktg. mgr. Products Manufactured: *SYNC, VE*.

**CLARION;** PO Box 507; Bloomfield, CT 06002; (203) 243-6304. Products Manufactured: *REC*.

**CLARITY;** Nelson Lane; Garrison, NY 10524; (914) 424-4071; FAX: (914) 424-3467. Elizabeth Gillespie, mktg. mgr. Products Manufactured: *AUTO, MI, SP*.

**CLUB MIDI SOFTWARE;** PO Box 93895; Hollywood, CA 90093; (818) 788-3963. Richard Shore. Products Manufactured: *SOFT*.

**CMIDI;** PO Box 4903; E. Lansing, MI 48823; (517) 337-2569. Products Manufactured: *SOFT*.

**CMX CORPORATION;** 2230 Martin Ave.; Santa Clara, CA 95050; (408) 988-2000. John Shike, Richard Sirinsky. Products Manufactured: *VE*.

**COLUMBIA AUDIO/VIDEO;** 1741 Second St.; Highland Park, IL 60035; (312) 433-6010. Bruce Berg. Products Manufactured: *OTH*.

**COMMODORE ELECTRONICS;** 1200 Wilson Dr.; Westchester, PA 19380; (215) 431-9100. Dave Archanbaud. Products Manufactured: *HDWR*.



# I N N O V A T I O N



Hear it for yourself. Call for our new demo.

## OMNIMUSIC

52 Main Street Port Washington N.Y. 11050  
1-800-828-6664

## Professional Audio Manufacturers

1990-1991

**COMMUNITY LIGHT & SOUND, INC.;** 333 E. Fifth St.; Chester, PA 19013; (215) 876-3400; FAX: (215) 874-0190. John T. Wiggins, mktg./nat'l sales mgr. Products Manufactured: *SPKR*.

**COMPREHENSIVE VIDEO SUPPLY;** 148 Veterans Dr.; Northvale, NJ 07647; (201) 767-7990. Products Manufactured: *PL*.

**COMPUSONICS CORP.;** 2345 Yale St.; Palo Alto, CA 94306; (415) 494-1184. Jill S. Meioney, Products Manufactured: *REC*.

**CONCEPT DESIGN ELECTRONICS & MFG., INC.;** 1105-A Pomeroy St.; Graham, NC 27253; (919) 229-6500; FAX: (919) 229-0063. Kathleen Farrow, tech. writing/adv.; Robert Farrow, president. Products Manufactured: *DUP, TE*.

**CONNEAUT AUDIO DEVICES (CAD);** Box 120; Conneaut, OH 44030; (216) 593-1111.

**CONNECTRONICS CORPORATION;** 652 Glenbrook Rd.; Stamford, CT 06906; (203) 324-2889; FAX: (203) 324-7027. Richard Chilvers, exec. vp. Products Manufactured: *CC, OTH*.

**CONQUEST SOUND INC.;** RR 2 Box 1AB, PO Box 268; Monee, IL 60449; (800) 323-7671; FAX: (708) 534-0398. Larry Spalla, vp; Ken Bernd, Nat'l sales mgr. Products Manufactured: *CC, OTH*.

**COOPER INDUSTRIES;** 2200 U.S. Hwy. 27 S.; Richmond, IN 47374; (317) 983-5200; Telex: 499-7258; FAX: (317) 983-5294. John Valentine, mktg. mgr.; Rick Guipe, dir. sales and mktg. Regional Offices: Atlanta, GA (404) 934-6767, Ron Madsen; Dallas, TX (214) 788-4300, Chuck Parker; Irvine, CA (714) 474-1200, John Lund; Naperville, IL (708) 717-7300, Jerry Novak; Shresbury, MA (508) 845-5000, Joe Germani. Products Manufactured: *CC*.

**J.L. COOPER ELECTRONICS;** 13478 Beach Ave.; Marina del Rey, CA 90292; (213) 306-4131; FAX: (213) 822-2252. Bob Bentrup, vp sales; Chuck Thompson, nat'l sales and mktg. mgr. Products Manufactured: *HDWR, SOFT, AUTO, DISK, MI, SYNC, VE*.

**COUNTRYMAN ASSOCIATES, INC.;** 417 Stanford Ave.; Redwood City, CA 94063; (415) 364-9988; FAX: (415) 364-2794. Jay Morse, sales mgr. Products Manufactured: *MIC, SP*.

**CREST AUDIO, INC.;** 150 Florence Ave.; Hawthorne, NJ 07506; (201) 423-1300; Telex: 136571; FAX: (201) 423-2977. Craig Hannabury, div. mgr; Paul Shiner, nat'l sales mgr. Products Manufactured: *AMP, MIXC*.

CROWN INT.  
Elkhart, IN

**CROWN INT.;** PO BOX 1000; Elkhart, IN 46515; (219) 294-8000; FAX: (219) 294-8329. Gerry Barclay, mktg. svc. coord.; James Beattie, nat'l sales mgr. Products Manufactured: *AMP, MIC*.

**CRYSTAL SEMICONDUCTOR CORP.;** Box 17847; Austin, TX 78760; (512) 445-7222; FAX: (512) 445-7581. Craig Enslay, vp mktg.; Al Schuele, vp sales. Regional Offices: Raleigh, NC (919) 846-4832, Gary Gay; Austin, TX (512) 445-7222, Jim Westphal; Campbell, CA (408) 856-4456, Jim Schenck. Products Manufactured: *OTH*.

**C-T AUDIO MARKETING INC.;** 3050 SW 14th Pl. #3; Boynton Beach, FL 33426; (407) 738-0622; FAX: (407) 738-0319. Andre Walton, mktg./nat'l sales mgr. Products Manufactured: *MIC, SP*.

**CURRENT MUSIC TECHNOLOGY;** 146 Paoli Pike; Malvern, PA 19355; (215) 647-9426; FAX: (215) 640-4271. Christopher Wurts, mktg. mgr.; Roy Hall, nat'l sales mgr. Products Manufactured: *HDWR*.

**THE CUTTING EDGE;** PO Box 217; Ferndale, NY 12734; (914) 292-5965; FAX: (914) 292-2313. Paul Gerry. Products Manufactured: *AM*.

## MOS-FET Audio Amplifiers

### MORE POWER & FIDELITY FOR LESS MONEY

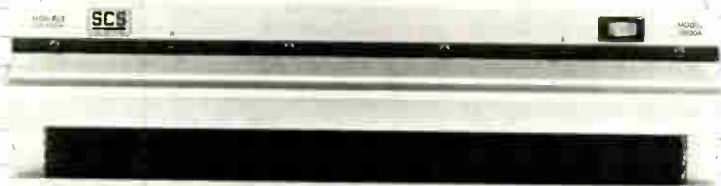

#### Your recordings may be better than you know.

The amplifier in your home studio is no less important than that of a world class studio. High slew rate, high damping factor and high current output are critical for accuracy. This is fidelity and SCS Audio Amplifiers deliver.

#### Avoid over-equalization.

Pull lows out of the mud and put sparkle into your highs. Pump life back into dead vocals, naturally. Call today for the SCS dealer nearest you. Listen to what you've been missing. We'll also send you information explaining MOS-FET applications in audio.

**"The Ultimate No Frills Amplifier"**

SCS, P.O. BOX 2198, GARDEN GROVE, CA (714) 554-0903

In Canada: Audionova (514) 631-5787



**KILLER  
MUSIC**

**KILLER  
TRACKS**

**The Production Music Library  
for the '90s**

**Call for a demo  
1-800-877-0078**

**"No Fillers... Just Killers"**

**6528 Sunset Boulevard, Hollywood, CA 90028**



## Professional Audio Manufacturers

1990-1991

**CYBER-KINETEK SYSTEMS, INC.;** 11839 Starcrest Dr.; San Antonio, TX 78247; (512) 496-0717. Steve Cayce. Products Manufactured: *SPKR*.

**D&R USA;** Rt. 3 Box 184-A; Montgomery, TX 77356; (409) 588-3411; FAX: (409) 588-3299. Paul Westbrook, president. Products Manufactured: *AUTO, MIXC, SP*.

**D DRUM;** 1201 U.S. Highway One; North Palm Beach, FL 33408; (305) 622-001G. Products Manufactured: *Mi*.

**DAGO CASES;** 6945 Indiana Ct. #600; Golden, CO 80403; (800) 342-3246; FAX: (303) 421-7916. Nick Masciotro, mktg. mgr. Products Manufactured: *CRS, Mi, OTH*.

**DALBEC AUDIOLAB;** Red Mill Rd.; Rensselaer, NY 12144; (518) 477-7873; FAX: (518) 272-7099. Products Manufactured: *SPKR, SP, TE*.



**D&R**  
mixing consoles

D&R USA  
Montgomery, TX

**DAUPHIN COMPANY;** 415 N. Lincoln; Springfield, IL 62702; (217) 793-2424. Products Manufactured: *REC*.

**DAUZ DESIGNS LTD.;** 1147 Stanford Ave.; Redondo Beach, CA 90278; (213) 372-0337; FAX: (213) 372-7336. Dan Daut, president. Products Manufactured: *Mi*.

**DAWN SPEAKER SYSTEMS;** 908 W. Fayette Ave.; Effingham, IL 62401; (217) 342-9211; FAX: (217) 347-0316. Don Friedman, product mgr.; Don Mitchell, nat'l sales mgr. Products Manufactured: *SPKR*.



**WE BUILD A BETTER CASE**

DAGO CASES  
Golden, CO

**DBX PROFESSIONAL PRODUCTS A DIVISION OF AKG ACOUSTICS, INC.;** 1525 Alvarado St.; San Leandro, CA 94577; (415) 351-3500; FAX: (415) 351-0500. Dave Roudebush, mktg./nat'l sales mgr. Regional Offices: Pittsburgh, PA (412) 782-2354, Rowland Powers; Appleton, WI (414) 749-0044, Jeff Radke. Products Manufactured: *SP*.

**DDA;** 200 Sea Ln.; Farmingdale, NY 11735; (516) 249-3660; FAX: (516) 420-1863. Sam Spennacchio, nat'l sales mgr. Regional Offices: Marina Del Rey, CA (213) 306-8823, Chris Fichera. Products Manufactured: *MIXC*.

**DE WOLFE MUSIC LIBRARY;** 25 W. 45th St.; New York, NY 10036; (212) 382-0220; (800) 221-6713. Products Manufactured: *PL*.

**DECILLIONIX;** PO Box 70985; Sunnyvale, CA 94086; (408) 732-7758. Dan Retzinger. Products Manufactured: *SOFT*.

**DECUIR CORP.;** 4012 S. Broadway Pl., Los Angeles, CA; 6500 Hickman Rd.; Des Moines, IA 50322; (515) 270-1010; (213) 233-4184; FAX: (213) 233-2957. Products Manufactured: *CRS*.

**DENECKE, INC.;** 5417 Cahuenga Blvd.; North Hollywood, CA 91601; (818) 766-3525. Spike C. Dolomite. Products Manufactured: *VE, OTH*.

**DENON AMERICA, INC.;** 222 New Rd.; Parsippany, NJ 07054; (201) 575-7810; FAX: (201) 808-1608. Ken Furst, mktg. mgr.; Laura Tyson, nat'l sales mgr. Products Manufactured: *AMP, HDWR, TE, OTH*.

**DESIGN DIRECT SOUND;** 6850-35th NE, Ste. 1; Seattle, WA 98115; (206) 527-4371. Bob Rice. Products Manufactured: *SPKR*.

**DESKTOP LOUDSPEAKER SYSTEMS, INC.;** PO Box 14526 WM, Chick Stn.; Kansas City, MO 64124; (816) 531-6722. Paul Gardocki, mktg. mgr.; Bill Cara, western sales mgr. Products Manufactured: *SPKR, OTH*.



DIC DIGITAL  
Fort Lee, NJ

DIC DIGITAL  
Fort Lee, NJ

**DIC DIGITAL;** 222 Bridge Plaza S; Fort Lee, NJ 07024; (201) 224-9344; FAX: (201) 224-9363. Kevin Kennedy, nat'l mktg. mgr. Regional Offices: Philadelphia, PA (215) 388-2075, Russ Brown; Thousand Oaks, CA (805) 373-8800, Jack Valdespino. Products Manufactured: *TAPE*.

**DIGIDESIGN, INC.;** 1360 Willow Rd. #101; Menlo Park, CA 94025; (415) 688-0600; FAX: (415) 327-0777; E-Mail: PAN-DIGIDESIGN. Suz Howells, product mktg. mgr.; Doug Provisor, vp sales. Regional Offices: Chicago, IL (312) 943-0727, Don Jackovich; Los Angeles, CA (213) 467-9061, Ted Bahas. Products Manufactured: *HDWR, SOFT, DISK, Mi, PL, REC*.



DIGITAL AUDIO RESEARCH  
Los Angeles, CA

**DIGITAL AUDIO RESEARCH;** 6363 Sunset Blvd., Ste. 802; Los Angeles, CA 90028; (213) 466-9151; FAX: (213) 466-8793. Bob McNabb, reg. mgr.; U.S. operations. Products Manufactured: *DISK*.



**P**ROSÓNUS, producers of the Studio Reference Disc and the PROSÓNUS Sound Library, announces the first independent, commercially available No NOISE™ system in the United States.

The critically acclaimed Sonic Solutions No NOISE™ System is available for all your audio needs

including:

- Removal of tape hiss...
- Removal of clicks and spikes...
- Removal of SMPTE bleed...
- CD Pre-Mastering... and other Digital Audio Services.

Call Now 1-800-999-6191 for a demonstration and to find out how you can offer your clients No NOISE™



11126 Weddington Street • North Hollywood, CA 91601





## Not your average woofer and tweeter.

Loudspeakers are wholly man-made devices. In the evolutionary calendar of man, the loudspeaker is just milliseconds old. By sheer ingenuity, man has refined a system which is capable of mimicking natural sounds.

The degree of realism, and hence the quality of natural reproduction, can simply be defined as **characteristics added** to the original sound. The quantification of these clues given to the human ear, decipher whether the sound is real

or reproduced by a loudspeaker on the end of an audio system.

The design and production of high quality loudspeakers is dependent on being able to measure, assess and therefore, rank and quantify these **added characteristics**. Having assessed the characteristics, the next and most important step is to select materials and techniques which will minimize or eliminate these

added characteristics altogether.

**Differential Material Technology**- An essential in the realization of Advanced Reference Monitoring.

For more information on Differential Material Technology call or write:

**TANNOY**

Tannoy / TGI North America Inc.  
c/o Bill Calma  
300 Gage Ave., Unit 1, Kitchener,  
Ontario, Canada N2M 2C8  
(519) 745-1158 Telex 069-55328  
Fax (519) 745-2364



## Professional Audio Manufacturers

1990-1991

**DIGITAL AUDIO TECHNOLOGIES (STELLAVOX);** Puits-Godet 20; CH-2000 Neuchatel, Switzerland; (038) 244-400.

**DIGITAL DYNAMICS, INC.;** 270-02 E. Pulaski Rd.; Greenlawn, NY 11740; (516) 271-5600; FAX: (516) 271-5607. James G. McAward, dir. mktg. Products Manufactured: *DISK*.

**DIGITAL MUSIC CORP.;** 5312-J Derry Ave.; Agoura Hills, CA 91301; (818) 991-3888; FAX: (818) 991-4185. Gene Barkin, mktg./nat'l sales mgr. Products Manufactured: *MI*.

**DIGITECH;** 5639 S. Riley Ln.; Salt Lake City, UT 84107; (801) 268-8400; FAX: (801) 262-4966. Richard Bos, mktg. mgr.; Scott Grow, sales mgr. Products Manufactured: *SP*.

**DIMENSION, INC.;** PO Box 1149; Okeechobee, FL 34973-0091; (813) 763-4107; (800) 634-0091. Products Manufactured: *PL*.

**DOD ELECTRONICS CORPORATION;** 5639 S. Riley Ln.; Salt Lake City, UT 84107; (801) 268-8400. Products Manufactured: *SP*.

**DOLBY LABORATORIES, INC.;** 100 Potrero Ave.; San Francisco, CA 94103-4813; (415) 558-0200. Nancy M. Byers, studio applications mgr, mktg. dept. Products Manufactured: *SP*.

**DOREMI LABS, INC.;** 4927 N. Glen Arden Ave.; Covina, CA 91724; (818) 966-2456. Camille Rizko, mktg. mgr.; Emile Rizko, nat'l sales mgr. Products Manufactured: *HDWR, SOFT, VE*.

**DORROUGH ELECTRONICS;** 5221 Collier Pl.; Woodland Hills, CA 91364; (818) 999-1132. Kay Dorrough. Products Manufactured: *OTH*.

**DRA LABORATORIES;** 607 W. Nettletree Rd.; Sterling, VA 22170; (703) 430-2761; FAX: (703) 430-0765.

**DR. T'S MUSIC SOFTWARE, INC.;** 220 Boylston St. #206; Chestnut Hill, MA 02167; (617) 244-6954; FAX: (617) 244-5243. Al Hospers, mktg. mgr.; Jeff Pucci, nat'l sales mgr. Products Manufactured: *SOFT, MI*.

**DRAWNER DISTRIBUTION DIV.;** Charlotte Street Business Centre, Charlotte St.; Wakefield, W. Yorkshire, WF1 1UH England; (0924) 378-669; Telex: 556649; FAX: (0924) 290-460. Jan Phillips, mktg. mgr.; Scott Berdell, nat'l sales mgr. (U.S.A.). Regional Offices: Auburndale, MA (617) 964-9466, Scott Berdell; Smyrna, GA (404) 432-6405, Bill Ray. Products Manufactured: *SP*.

**DREW ENGINEERING COMPANY;** 35 Indiana St.; Rochester, NY 14609; (716) 544-3337; (716) 288-6700. Joseph J. Barone. Products Manufactured: *SP*.

**DRUM WORKSHOP, INC.;** 2697 Lavery Ct. #16; Newbury Park, CA 91320; (805) 499-6863. Don Lombardi, president. Products Manufactured: *MI*.

**DRUMWARE, INC.;** 12077 Wilshire Blvd.; Los Angeles, CA 90025; (213) 478-3956. Scott Morgan. Products Manufactured: *SOFT*.

**DUBNER COMPUTER SYSTEMS, INC.;** 6 Forest Ave.; Paramus, NJ 07652; (201) 845-8900. Emily Dubner. Products Manufactured: *VE*.

**DUKANE CORPORATION;** 2900 Dukane Dr.; St. Charles, IL 60174; (312) 584-2300. Jeff deLacey. Products Manufactured: *OTH*.

**DUPLITRONICS;** 160 Abbott Dr.; Wheeling, IL 60090; (312) 459-6200.

**DYNACORD, ELECTRONIC—UND GERATEBAU GMBH & CO. KG;** Hirschberger Ring 45; Straubing, D-8440 West Germany; (09421) 706-0; Telex: 65520; FAX: (09421) 706-265. Martin Traut, mktg. mgr. Products Manufactured: *AMP, CC, CRS, SPKR, MIC, MIXC, MI, SP*.

**DYNAVOX ELECTRONICS, INC.;** 248 N. Puente Ave.; City of Industry, CA 91746; (818) 336-0516; FAX: (818) 336-3748. Estle Finney, dir. operation. Products Manufactured: *SPKR*.

**EAGLEAR SOUND;** 823 16th St.; Greeley, CO 80631; (303) 356-1464. Products Manufactured: *PL*.

# EAW

EASTERN ACOUSTIC WORKS

EAW INC.  
Whitinsville, MA

**EAW INC.;** One Main St.; Whitinsville, MA 01588; (508) 234-6158; Telex: 7103807630; FAX: (508) 234-8251. Kenneth Berger, president; Frank Loyko, vp sales. Products Manufactured: *SPKR*.

**ECLIPSE TECHNOLOGY INC.;** 500 E. Acapano, Ste. 609; Richardson, TX 75081; (214) 238-5269. Products Manufactured: *MI, SOFT*.

**EDCOR;** 1948 E. Pomona St.; Santa Ana, CA 92705; (714) 258-0777; FAX: (714) 258-7117. L. Weston, mktg. mgr. Products Manufactured: *AMP, MIC, SP*.

**EDITRON USA, INC.;** 748 Seward St.; Hollywood, CA 90038; (213) 464-8723. Jeffrey Greenfield. Products Manufactured: *SYNC*.

**EL MAR PLASTICS;** 840 E. Walnut St.; Carson, CA 90746; (213) 327-3180. Maxine Hesse, sales mgr. Products Manufactured: *OTH, DUP*.

**ELECTRIC SOUND & PICTURE (FAIRLIGHT ESP. PTY. LTD.);** 30 Bay St., Broadway; Sydney, NSW 2007 Australia; (011) 61-2-212-6111; FAX: (011) 61-2-281-5503. Products Manufactured: *DISK, MI*.

**ELECTRO FORCE CORP.;** 727 Oakstone Way; Anaheim, CA 92806-4638; (714) 774-3666. Philip Lindberg, mktg. mgr. Products Manufactured: *AMP*.

**ELECTRO SOUND, INC.;** 160 San Gabriel Dr.; Sunnyvale, CA 94086; (408) 245-6600. Mark Nevejsans. Products Manufactured: *DUP*.

# PERMANENT POWER.

Four new amplifiers from Carver Professional. The PM-120 (40+40W @ 8Ω), PM-300 (110+110W @ 8Ω), PM-600 (200+200W @ 8Ω), and PM-900 (350+350W @ 8Ω).

Each with features you've asked us for. Like barrier strip inputs

(along with TRS & XLR's) and 70 volt capability.

The new PM-600 and PM-900 also include remote/manual sequential power on/off and rear cover card slot for use with Carver add-in options such as our new PG2 Dual-Zone Paging Module.

Call toll-free, FAX, or write us for complete information including Architects' and Engineering Specs on the powerful, accurate, reliable solutions to permanent installation challenges.

## CARVER

PROFESSIONAL

TOLL-FREE 1-800-443-CAVR, FAX 206-778-9453  
P.O. Box 1237, Lynnwood, WA 98046

PM-120 PM-300 PM-600 PM-900



**ELECTROSPACE/PENINSULA MARKETING;** 21213 B Hawthorne, Ste. 5086; Torrance, CA 90503; (213) 373-1009. Products Manufactured: *SP*.

**ELECTRO-VOICE, INC.;** 600 Cecil St.; Buchanan, MI 49107; (616) 695-6831. Keith Clark. Products Manufactured: *SPKR, MIC, MIXC, AMP*.

**ELTEKON TECHNOLOGIES, INC.;** 37491 Schoolcraft Rd.; Livonia, MI 48150; (313) 462-3155; FAX: (313) 462-5922. Laura Barnes, mktg. dir.; Leo Early, nat'l sales mgr. Products Manufactured: *CC, HDWR, DISK, MI*.

**EMILAR CORPORATION;** 1365 N. McCan St.; Anaheim, CA 92806; (714) 632-8500. Richard Guy. Products Manufactured: *SPKR*.

**E-MU SYSTEMS, INC.;** 1600 Green Hills Rd.; Scotts Valley, CA 95066; (408) 438-1921; FAX: (408) 438-8612. Marco Alpert, vp mktg.; Neil RiCharde, nat'l sales mgr. Products Manufactured: *MI*.

**ENGINEERED PERCUSSION;** 23206 S. Normandie Ave.; Torrance, CA 90502; (213) 530-7050. Darrell Johnston. Products Manufactured: *MI*.

**ENSONIQ CORP.;** 263 Great Valley Pkwy.; Malvern, PA 19355; (215) 647-3930. Robin Weber. Products Manufactured: *MI*.

**ENVIRONMENTAL SOUND;** 31220 La Baya Dr. #110; Westlake Village, CA 91362; (818) 706-0228. Ron Glathoffer, mktg. Products Manufactured: *SPKR*.

**ESL (ELECTRONIC SYSTEMS LABORATORIES, INC.);** 3911 SW 47th Ave., Ste. 906; Fort Lauderdale, FL 33314; (305) 791-1501; FAX: (305) 791-8986. Lutz Meyer, president; John Bartz, sales mgr. Products Manufactured: *TE, OTH*.

**EUPHONIX;** 441 Page Mill Rd.; Palo Alto, CA 94306; (415) 325-5003.

**EVENTIDE, INC.;** One Alsan Way; Little Ferry, NJ 07643; (201) 641-1200; FAX: (201) 641-1640. Joseph Shapiro, mktg. mgr.; Gil Griffith, nat'l sales mgr. Products Manufactured: *MI, SP*.

**FENDER MUSICAL INST.;** 1130 Columbia St.; Brea, CA 92621; (714) 990-0909; FAX: (714) 990-3986. Steve Grom, vp mktg.; Don Johnston, nat'l sales mgr. Products Manufactured: *AMP, SPKR, MIXC, MI, SP*.

**FIDELIPAC CORP.;** PO Box 808; Moorestown, NJ 08057; (609) 235-3900; FAX: (609) 235-7779. Larry Lamoray, dir. of mktg.; Jack M. Ducart, dir. of sales. Products Manufactured: *REC, TAPE*.

**FIRSTCOM;** 13747 Montfort Dr., Ste. 220; Dallas, TX 75240; (214) 934-2222. Ceceia M. Garr. Products Manufactured: *PL*.

**FLAG SYSTEMS INC.;** 930 N. Elm #6; Orange, CA 92667; (714) 997-7363; FAX: (714) 997-0748. David M. Forney, mgr. Products Manufactured: *CRS, SPKR*.

**FM ACOUSTICS LTD. OF SWITZERLAND;** Tiefenhofstrasse 17; CH-8820 Waedenswil, Switzerland; 41/1-780-84-44; FAX: 41/1-780-04-88. Manuel Huber, president. Gene Michalski, nat'l sales mgr. Regional Offices: Benicia, CA (707) 745-4444, Gene Michalski. Products Manufactured: *AMP, CC, SP, OTH*.

**F.M. TUBECRAFT;** 1121-20 Lincoln Ave.; Holbrook, NY 11741; (516) 567-8588. Frank Maiella. Products Manufactured: *CRS*.

**FOCUSRITE;** c/o Sonic Image Ltd.; 100 Wheaton Oaks Ct.; Wheaton, IL 60187; (312) 653-4544. Dan Zimbelman, president. Mal Davis, engineering and sales. Products Manufactured: *MIXC, SP*.

**FORAT ELECTRONICS, INC.;** 11514 Ventura Blvd.; Studio City, CA 91604; (818) 763-3007. Ben & Bruce Forat. Products Manufactured: *MI*.

**FORMULA AUDIO, INC.;** Rt. 5, Box 440-3; Zebulon, NC 27597; (919) 269-6441. Jeffrey A. Forsbury, president. Products Manufactured: *SPKR*.

**FORTE MUSIC, INC.;** 1951 Colony St., Ste. X; Mountain View, CA 94043; (415) 965-8880. Steve Salani. Products Manufactured: *MI*.

**FOSTEX CORP. OF AMERICA;** 15431 Blackburn Ave.; Norwalk, CA 90650; (213) 921-1112; FAX: (213) 802-1964. Mark Cohen, vp mktg. & sales. Products Manufactured: *AMP, TAPE, CC, CRS, EM, SPKR, MIC, MIXC, SP, REC, TE, SYNC*.

**FOUR DESIGNS CO.;** 6531 Gross Ave.; Canoga Park, CA 91307; (818) 716-8540. David Riddle, owner. Products Manufactured: *MI, CRS*.

**FRIED PRODUCTS;** 7616 City Line Ave.; Philadelphia, PA 19151; (215) 473-7474.



FURMAN SOUND, INC.  
Greenbrae, CA

**FURMAN SOUND, INC.;** 30 Rich St.; Greenbrae, CA 94904; (415) 927-1225; FAX: (415) 927-4548. Joe Desmond, nat'l sales mgr.; Jim Furman, president. Products Manufactured: *AMP, MIXC, SP, OTH*.

**G F MUSIC;** PO Box 272136; 4417 Stonehenge Rd.; Tampa, FL 33624; (714) 529-0593. Gerald Felderman.

**GAINES AUDIO;** 1237 E. Main St.; Rochester, NY 14609; (716) 266-0780; (800) 442-0780. Jon Gaines, mktg. mgr. Products Manufactured: *SP*.

**GALAXY AUDIO;** 625 E. Pawnee; Wichita, KS 67211; (316) 263-2852; FAX: (316) 263-0642. Products Manufactured: *SPKR*.

**GALLIEN-KRUEGER, INC.;** 504-B Vandell Way; Campbell, CA 95008; (408) 379-3344. Rich Krueger. Products Manufactured: *AMP*.

**GARNER INDUSTRIES;** 4200 N. 48th St.; Lincoln, NE 68504; (402) 464-5911; FAX: (402) 464-6960. Robert A. Bobrowski, dir. of mktg.; Brad Osthus, degausser sales. Products Manufactured: *OTH*.

**GATEWAY SOFTWARE;** 4446 Salisbury Dr.; Carlsbad, CA 92008; (619) 434-0823. Products Manufactured: *SOFT*.

**GAUSS;** 9130 Glenoaks Blvd.; Sun Valley, CA 91342; (213) 875-1900.

**GEFEN SYSTEMS;** 6861 Variel Ave., Ste. C; Woodland Hills, CA 91367; (818) 884-6294; FAX: (818) 884-3108. Hagai Gefen, president. Products Manufactured: *HDWR, SOFT, PL*.

**GENELEC (QUEST MKTG.);** Box 20; Auburndale, MA 02166; (617) 964-9466.



We didn't invent time, but we helped pioneer the use of time on audio and video tape with time code readers, Shadow synchronizers, and friendly Softouch edit controllers. We wrote the book a few years ago — everything we knew about time — and have distributed thousands of copies to schools and individuals. If you don't have a copy of our *Time Code Handbook*, just ask for one. Free. And we'll even pay for the call.

We're still pioneering time with our new family of time code products; the Phantom II VTR Emulator, the Softouch II Edit Controller, plus a new digital random access recorder to be formally announced at AES.

See it in booth 635. But take the time to call us now for your free *Time Code Handbook*.



cipher digital, inc.

5350 PARTNERS COURT, P.O. BOX 170  
FREDERICK, MD 21701  
TOLL-FREE 1-800-331-9066  
(301) 695-0200 FAX: (301) 694-5152 TELEX: 272065



## Professional Audio Manufacturers

1990-1991

**INOVOONICS, INC.;** 1305 Fair Ave.; Santa Cruz, CA 95060; (800) 733-0552; Telex: 3730800; FAX: (408) 458-0554. Jim Wood, president. Regional Offices: London, UK 0-81-991-9152. D. Malovaney. Products Manufactured: *SP, OTH.*

**INTELLIGENT MUSIC;** PO Box 8748; Albany, NY 12208; (518) 434-4110. Joel Chadabe. Products Manufactured: *SOFT.*

**INTERNATIONAL AUDIO, INC.;** 2934 Malmo Rd.; Arlington Heights, IL 60005; (312) 956-6030. Paul Mally.

**INTERNATIONAL CUTTERHEAD REPAIR, INC.;** 571 Boulevard; Hasbrouck Heights, NJ 07604; (201) 288-0106. Moty Mizrahi, mktg. mgr.; Tracey Burch, nat'l sales mgr. Products Manufactured: *DISK.*

**INTERNATIONAL ELECTRO-MAGNETICS;** 350 N. Eric Dr.; Palatine, IL 60067; (708) 358-4622; FAX: (708) 358-4623. Tony Pretto, president. Products Manufactured: *TH.*

**INTERNATIONAL MUSIC CO., ROSS SYSTEMS DIV.;** 1316 E. Lancaster; Fort Worth, TX 76102; (817) 336-5114; Telex: 163203; FAX: (817) 870-1271. Tom Linklater, dir. electronic manuf.; Lamy Volland, vp sales. Regional Offices: Fort Worth, TX, (817) 336-5114, Sales Administration. Products Manufactured: *AMP, CRS, SPKR, MIC, MIXC, SP.*

**INTERSONICS, INC.;** 3453 Commercial Ave.; Northbrook, IL 60062-1818; (708) 272-1772; FAX: (708) 272-9324. Tom Melzer, nat'l sales mgr.; Laura Danley, mktg. mgr. Products Manufactured: *SPKR.*

**INTERVAL MUSIC SYSTEMS;** 12335 Santa Monica Blvd. #244; Los Angeles, CA 90025; (213) 478-3956; FAX: (213) 478-5791. Scott Morgan, president. Products Manufactured: *HDWR, SOFT, MI.*

**INVENTIVE SOLUTIONS;** 469-A Willowbrook Rd.; Clinton Corners, NY 12514; (914) 266-3046.

**INVISIBLE PRODUCTS CORP.;** 159 Commercial St.; Lynn, MA 01905-2909; (617) 592-5992; FAX: (617) 599-1730. Donald Lang, mktg. mgr. Products Manufactured: *CRS.*

**IVIE;** 1366 W. Center; Orem, UT 84057; (801) 224-1800; FAX: (801) 224-7526. Glen Meyer, mktg. mgr. Products Manufactured: *TE.*

**JAN-AL CASES;** 3339 Union Pacific Ave.; Los Angeles, CA 90023; (213) 260-7212. Jan Michael Alejandro. Products Manufactured: *CRS.*

**JAZZY TOY & RECORD COMPANY;** P.O. Box 1137; Concord, MA 01742; (508) 371-3198. Bruce Carroll, CEO. Products Manufactured: *TAPE, SOFT, PL.*

**JBL PROFESSIONAL;** 8500 Balboa Blvd.; Northridge, CA 91329; (818) 893-8411; FAX: (818) 893-3639. Mark Gander, vp mktg.; Ken Lopez, vp sales. Products Manufactured: *AMP, SPKR, SP.*

**JO JEANUS ELECTRONICS;** 2815 Swandale Dr.; San Antonio, TX 78230; (512) 525-0719; FAX: (512) 344-3299. Marius Perron, mktg. mgr.; Jeanine Davis, nat'l sales mgr. Products Manufactured: *TE, OTH.*



**JENSEN TRANSFORMERS, INC.**  
North Hollywood, CA

**JO JENSEN TRANSFORMERS, INC.;** 10735 Burbank Blvd.; North Hollywood, CA 91601; (213) 876-0059; FAX: (818) 763-4574. Bill Whitlock, president; Dave Hill, vp of operations. Products Manufactured: *AMP, SOFT, SP.*

**THE RUSS JONES MARKETING GROUP;** 17700 Raymer St. #1001; Northridge, CA 91325; (818) 993-4091; FAX: (818) 701-7452. Russ Jones, mktg. mgr.; Ron Sorter, nat'l sales mgr. Products Manufactured: *AUTO, MI.*

## THE RUSS JONES MARKETING GROUP

THE RUSS JONES MARKETING GROUP  
Northridge, CA

**JOR-DAN RECORDING, INC.;** 1100 Wheaton Oaks Ct.; Wheaton (Chicago), IL 60187; (708) 653-1919; FAX: (708) 665-4966. Dan Zimbelman.

**JOSEPHSON ENGINEERING;** 3729 Cokerhill; San Jose, CA 95121; (408) 238-6062. David Josephson. Products Manufactured: *MIC.*

**JO JRF MAGNETIC SCIENCES, INC.;** 249 Kennedy Rd.; Greendell, NJ 07839; (201) 579-5773; Telex: 325-449; FAX: (201) 579-6021. John R. French, president. Products Manufactured: *TH, OTH.*

**JUICE GOOSE;** 7320 Ashcroft #302; Houston, TX 77081; (713) 772-1404; FAX: (713) 772-9124. Products Manufactured: *OTH.*

**JVC PROFESSIONAL PRODUCTS COMPANY;** 41 Slater Dr.; Elmwood Park, NJ 07407; (201) 794-3900; FAX: (201) 523-2077. Dave Walton, mktg. mgr.; Tom McCarthy, gen. mgr. sales and mktg. Regional Offices: Pine Brook, NJ (201) 882-0900, Jim Turner; Elk Grove, IL (708) 364-9300, Chuck Evans; Cypress, CA (714) 527-7500, Dennis Nymeyer. Products Manufactured: *TAPE, DISK, SP, REC, VE.*



**KABA RESEARCH & DEVELOPMENT**  
Novato, CA

**JO KABA RESEARCH & DEVELOPMENT;** 24 Commercial Blvd.; Novato, CA 94949; (415) 883-5041; FAX: (415) 883-5222. Ken Bacon, president; Gregg Schnitzer, equip. sales. Products Manufactured: *DUP, EM, REC.*

**KABLE KING;** PO Box 2646; Savannah, GA 31402; (912) 233-8959. Joe Bordeaux. Products Manufactured: *CC.*

**KAT INC.;** 43 Meadow Rd.; Long Meadow, MA 01106; (413) 567-1395. Products Manufactured: *MI.*

**KAWAJI AMERICA CORP.;** 2055 E. University Dr.; Compton, CA 90224; (213) 631-1771; FAX: (213) 604-6913. Dan Hergert, adv. mgr.; Rich Godinez, nat'l sales mgr. Products Manufactured: *MIXC, MI, SP.*

**KDS TECHNOLOGIES;** PO Box 507; Bloomfield, CT 06002; (203) 286-0498; FAX: (203) 286-4122. Doug Goates, div. mgr.; Don Hudson, nat'l sales mgr. Products Manufactured: *AMP, MI, SP, REC, SYNC.*

**KELLER DESIGNS;** 2920 Jefferson; Eugene, OR 97405; (503) 485-3481. Robert Keller.

**KEY CLIQUE, INC.;** 3960 Laurel Canyon Blvd., Ste. 374; Studio City, CA 91604; (818) 905-9136. Bo Tomlyn. Products Manufactured: *MI.*

**KEY ELECTRONICS, INC.;** 7515 Chapel Ave.; Fort Worth, TX 76116; (817) 560-1912; FAX: (817) 560-9745. Charles M. Phelan, president; Lori Wood, sales and mktg. Products Manufactured: *HDWR, SOFT.*

**KIMBER KABLE;** 2675 Industrial Dr.; Ogden, UT 84401; (801) 621-5530; FAX: (801) 627-6980. Jeff Young and Ray Kimber, mktg. mgrs. Products Manufactured: *CC.*



**KING INSTRUMENT CORP.**  
Westboro, MA

# The Good Stuff



Valentino Production  
Music And Sound  
Effects Library Now  
In Our Exclusive  
"Binder Access  
System"

Production Music and Sound Effect Libraries

Free Catalog and Demo Call

TOLL FREE: 1-800-223-6278  
IN NEW YORK: (212) 869-5210

THOMAS J.  
**Valentino, inc**

151 W. 46th Street, New York, NY 10036

**KING INSTRUMENT CORP.;** 80 Turnpike Rd., PO Box 1070; Westboro, MA 01581; (508) 366-9141; Telex: 948485; FAX: (508) 870-5932. Products Manufactured: *DUP, OTH.*

**KLARK-TEKNIK ELECTRONICS;** 200 Sea Ln.; Farmingdale, NY 11735; (516) 249-3660; FAX: (516) 420-1863. Sam Spennacchio, nat'l sales mgr. Products Manufactured: *SP.*

**KLIPSCH & ASSOCIATES, INC.;** PO Box 688; Hope, AR 71801; (501) 777-6751. Woody Jackson. Products Manufactured: *SPKR.*

**KMD SOUND ELECTRONICS;** PO Box 507; Bloomfield, CT 06002; (203) 243-7888. Bud Mayer. Products Manufactured: *MI.*

**K-MUSE;** 18653 Ventura Blvd.; Tarzana, CA 91356; (818) 998-7555. Bob Connelly. Products Manufactured: *SOFT.*

**KORG U.S.A. INC.;** 89 Frost St.; Westbury, NY 11590; (516) 333-9100; Telex: 291407; FAX: (516) 333-9108. Larry DeMarco, dir. mktg. comm.; Joe Bredau, nat'l sales mgr. Regional Offices: Canoga Park, CA (818) 888-2022, Jim Lowman. Products Manufactured: *AMP, MI, SP.*

**KRK MONITORING SYSTEMS;** 19872 Gloucester Ln.; Huntington Beach, CA 92646; (714) 963-9609. Keith Klawitter. Products Manufactured: *SPKR.*

**PHILIP KUBICKI GUITAR TECHNOLOGY;** 720 Bond Ave.; Santa Barbara, CA 93103; (805) 963-6703. Terry Knight. Products Manufactured: *MI.*

**KURZWEIL (YOUNG CHANG AMERICA);** 13336 Alondra Blvd.; Cerritos, CA 90701; (213) 926-3200.

**L.A. AIR FORCE;** 1097 D-Bar K Dr.; Durango, CO 81301; (303) 247-5082. Products Manufactured: *PL.*

**LAKE BUTLER SOUND CO., INC.;** 5331 W. Lake Butler Rd.; Windermere, FL 34786; (407) 656-5515; FAX: (407) 656-5515. Emmett Bradford, president. Products Manufactured: *MI.*

**LAKE PEOPLE;** Rosgartenstr. 13; D-7750 Konstanz, Germany; Fried Reim. Products Manufactured: *AMP, SP, OTH.*

**LEAPING LIZARDS;** 1614-1/2 NE 80th St.; Seattle, WA 98115; (206) 527-3431.

**LEIGHTRONIX, INC.;** 2490 Cedar St., Ste. B; Holt, MI 48842; (517) 694-5589. Rick Todd.

**LEMO U.S.A., INC.;** PO Box 11006; Santa Rosa, CA 94506; (707) 578-8811. Gloria Menzies. Products Manufactured: *CC.*

**LENCO, INC.;** 300 N. Maryland; Jackson, MO 63755; (314) 243-3147; (800) 325-8494. Jim K. Rhodes. Products Manufactured: *AMP.*

**LEONARDO;** 693 Washington St.; Venice, CA 90291; (213) 277-5161. Dale Strumpell. Products Manufactured: *SOFT.*

**LESTER AUDIO LABS;** 1111 W. Mockingbird #1342; Dallas, TX 75247; (214) 637-9311.

**LEXICON;** 100 Beaver St.; Waltham, MA 02154; (617) 891-6790; FAX: (617) 891-0340. Dan Roberts, vp mktg. and sales; Joel Silverman, dir. of sales. Products Manufactured: *DISK, MI, SP.*

**LIGHTHOUSE SOFTWARE;** PO Box 2252; Fairfield, IA 52556; (515) 472-9152; FAX: (515) 472-9152. John Szasz, president. Products Manufactured: *SOFT.*

**LINEAR & DIGITAL SYSTEMS;** 46 Marco Ln.; Centerville, OH 45459; (513) 439-1758. Dale Beard. Products Manufactured: *OTH.*

**LITTLITE/CAE, INC.;** 10087 Industrial Dr., PO Box 430; Hamburg, MI 48139; (313) 231-9373; FAX: (313) 231-1631. Julie Sanders, mktg. mgr.; Fred Mikeska, nat'l sales mgr. Products Manufactured: *OTH.*

**LIVEWIRE AUDIO;** PO Box 561; Oceanport, NJ 07757; (201) 229-2309; FAX: (201) 389-2197.

**L.M. ENGINEERING;** 660 W. Evergreen; Youngstown, OH 44511; (216) 788-7373. Bill LaGuardia. Products Manufactured: *CRS.*

**LONE WOLF;** 1505 Aviation Blvd.; Redondo Beach, CA 90278; (213) 379-2036; (213) 376-8115. Mark Koeng. Products Manufactured: *MI.*

**LORAN CASSETTES & AUDIO PRODUCTS;** 4150 Riverside Dr. #207; Burbank, CA 91505; (818) 955-8577. Sandy Richman. Products Manufactured: *DUP.*

**LT SOUND;** 7980 LT Parkway; Lithonia, GA 30058; (404) 482-4724. Mr. Lacy Thompson, Jr. Products Manufactured: *SP.*

**LYNC SYSTEMS;** Clark Industrial Park; 14 Walker Way; Albany, NY 12205; (518) 452-0891. Products Manufactured: *MI.*

**LYRE, INC.;** 1505 Chemin Ste-Foy, Ste. 101; Quebec, QC G1X 2P1; (418) 527-6901. Louis Belanger. Products Manufactured: *MI.*

**MACPHERSON LOUDSPEAKERS;** 3351 Remy Dr.; Lansing, MI 48906; (517) 321-0700. Jerry Spriggs, sales mgr. Products Manufactured: *SPKR.*

**MAGNA-TECH ELECTRONIC;** 630 Ninth Ave.; New York, NY 10036; (212) 586-7240; FAX: (212) 265-3638.

**MAGNEFAX INTERNATIONAL INC.;** Rte. 1 Box 764; Rogers, AR 72756; (501) 925-1818; FAX: (501) 925-1841. Dennis W. Tallakson, president. Products Manufactured: *DUP, OTH.*

**MAGNETIC MUSIC;** Rd. #5; 227A Myrtle Dr.; Mahopac, NY 10541; (203) 775-7832. Products Manufactured: *SOFT.*

**MAGNETIC REFERENCE LABORATORY;** 229 Polaris Ave., Ste. 4; Mountain View, CA 94043; (415) 965-8187. John G. (Jay) McKnight. Products Manufactured: *TE.*

**MANHATTAN PRODUCTION MUSIC;** PO Box 1268, Radio City Station; New York, NY 10101; (212) 333-5766; (800) 227-1954. Products Manufactured: *PL.*

**MANIAC MUSIC;** 6052 Guilford Ave.; Indianapolis, IN 46220; (317) 251-0470. Products Manufactured: *MI.*

**MARANATHA SYSTEMS;** 17911 NE 101st St.; Redmond, WA 98052; (206) 885-3018.

**MARION SYSTEMS;** 1317 5th St. #200; Santa Monica, CA 90401; (213) 451-8910. Tom Oberheim. Products Manufactured: *MI.*



**Rapidly Gaining A Reputation As THE Source For The Most Extensive Selection Of THE Most Reliable Digital And Analog Recorders, Outboard FX, Microphones, Keyboards, Drum Machines, Sequencers Etc., Etc. On BOTH Sides Of The Atlantic!!**

**If You're Not Renting From Us - Call Us And Tell Us Why!!!**

**Dreamhire New York: 212-691-5544**

**Dreamhire Nashville: 615-321-5544**

**Dreamhire London (UK): 081-451-5544**

**24 Hours.**



## Professional Audio Manufacturers

1990-1991



MARK OF THE UNICORN, INC.  
Cambridge, MA

**MARK OF THE UNICORN, INC.;** 222 Third St.; Cambridge, MA 02142; (617) 576-2760; FAX: (617) 576-3609. Susan Patalano, mktg. mgr.; John Mauraides, sales mgr. Products Manufactured: *SOFT, MI*.

**DEAN MARKLEY ELECTRONICS;** 3350 Scott Blvd. #45; Santa Clara, CA 95050; (408) 988-2456. Thomas G. Dreilbs. Products Manufactured: *MI*.

**MARSHALL AMPLIFICATION;** 89 Frost St.; Westbury, NY 11590; (516) 333-9100; FAX: (516) 333-9100. Products Manufactured: *AMP*.

**MARSHALL ELECTRONIC;** PO Box 438; Brooklandville, MD 21022; (301) 484-2220; FAX: (301) 486-0280.

**MARSHALL ELECTRONICS, INC.;** PO Box 2027; Culver City, CA 90230; (213) 390-6608; FAX: (213) 391-8926. Hugh Neep, mktg. and sales mgr. Products Manufactured: *CC*.

**MARTIN AMERICA;** 21000 Devonshire St. #205; Chatsworth, CA 91311; (818) 718-1031; FAX: (818) 718-2886. Erika Lopez, pr/adv.; Linda Frank, gen. mgr. Products Manufactured: *SPKR, SP*.

**THE MARTIN GUITAR COMPANY;** 510 Sycamore St.; Nazareth, PA 18064; (215) 759-2837. Tina Blum. Products Manufactured: *MI*.

**MAXELL CORPORATION OF AMERICA;** 22-08, Rte. 208; Fair Lawn, NJ 07410; (201) 794-5900; FAX: (201) 796-8790. Products Manufactured: *TAPE*.

**MCCAULEY SOUND, INC.;** 13608 94th Ave. E; Puyallup, WA 98373; (206) 848-0363. Thomas I. McCauley. Products Manufactured: *SPKR*.

**MENLO SCIENTIFIC, LTD.;** 39 Menlo Pl.; Berkeley, CA 94707; (415) 528-1277; FAX: (415) 526-8087. Michael Klasco.

**METALHEAD ELECTRONICS/STUDIOS;** 5707 Cahuenga Blvd.; North Hollywood, CA 91601; (818) 980-1975; FAX: (818) 985-1624. Memran Rami A., mktg. mgr.; Memran Eian L., owner. Products Manufactured: *AMP, MI, SP*.

**MEYER SOUND LABORATORIES, INC.;** 2832 San Pablo Ave.; Berkeley, CA 94702; (415) 486-1166; FAX: (415) 486-8356. Mark Johnson, dir. tech. mktg.; George Douglas, dir. int'l sales and mktg. Products Manufactured: *AMP, SPKR, SP*.

**MICRO ILLUSIONS;** 17408 Chatsworth St.; Granada Hills, CA 91344; (818) 366-8464.

**MICROAUDIO INC.;** 4438 SW Hewett; Portland, OR 97221; (503) 292-8896; FAX: (503) 293-0562. McGarrison, mktg. and sales mgr. Products Manufactured: *SP*.

**MIDCO INTERNATIONAL;** PO Box 748; Effingham, IL 62401; (217) 342-9211. Larry Morton. Products Manufactured: *MI*.

**MIDIMIX;** PO Box 161; Ashland, OR 97520; (503) 488-1023. James. Products Manufactured: *MI*.

**MIDIMOUSE MUSIC;** Box 877; Welches, OR 97067; (503) 622-4034; FAX: (503) 622-2933. Norm Zarr, nat'l sales mgr. Products Manufactured: *SOFT*.

**MIDISOFT CORPORATION;** PO Box 1000; Bellevue, WA 98009; (206) 827-0750. Raymond Bily. Products Manufactured: *SOFT*.

**MILAB;** 200 Sea Ln.; Farmingdale, NY 11735; (516) 249-3660; FAX: (516) 420-1863. Sam Spennacchio, nat'l sales mgr. Products Manufactured: *MIC*.

**MIMETICS;** PO Box 1560; Cupertino, CA 95015; (408) 741-0117. Joy Weigel. Products Manufactured: *HDWR, SOFT*.

**MITSUBISHI DIGITAL;** Berkshire Industrial Park; Bethel, CT 06801; (203) 744-6230. Products Manufactured: *REC*.

**MODULAR SOUND REINFORCEMENT;** PO Box 388; Princeton Junction, NJ 08550; (609) 394-5637. Corrinne Gately. Products Manufactured: *SPKR*.

**MODULAR WOOD SYSTEMS;** 736 12th St.; Wilmette, IL 60091; (708) 251-6401. Robert Sobel. Products Manufactured: *CRS, OTH*.

**MONSTER CABLE;** 274 Wattis Way; San Francisco, CA 94080; (415) 871-6000. Products Manufactured: *CC*.

**MOOG ELECTRONICS, INC.;** 2500 Walden Ave.; Buffalo, NY 14225; (800) 828-7680. Tom Rhea. Products Manufactured: *MI*.

**MOTOROLA SEMICONDUCTOR PRODUCTS;** 6501 Wm. Cannon Dr. West; Austin, TX 79735-8598; (512) 891-2039; FAX: (512) 891-2947.

**MTX LOUDSPEAKERS;** 1 Mitek Plaza; Winslow, IL 61089; (815) 367-3000. Rob Landsberg, Dave Armon. Products Manufactured: *SPKR*.

**MUSIC INDUSTRIES CORP.;** 99 Tulip Ave.; Floral Park, NY 11001; (516) 352-4110. Bernard Mersky. Products Manufactured: *CRS, MI, OTH*.

**THE MUSIC PEOPLE, INC.;** 2074 Park St., PO Box 27-648; West Hartford, CT 06127-0648; (203) 236-7134; Telex: 499734; FAX: (203) 233-6888. Michele Richie, mktg. mgr. Products Manufactured: *CC, CRS, SPKR, MIC, MI*.

**MUSIC QUEST;** 2504 Avenue K, Ste. 500-492; Plano, TX 75074; (214) 881-7408. Susan Hocker. Products Manufactured: *MI, OTH*.

**MUSICODE;** 5575 Baltimore Dr., Ste. 105-127; La Mesa, CA 92042; (619) 469-7194. Meinda Turcsanyi, mktg. and sales mgr. Products Manufactured: *SOFT*.

**NADYSYSTEMS, INC.;** 6701 Bay St.; Emeryville, CA 94608; (415) 652-2411. Products Manufactured: *MIC*.

**NAGRA USA;** 19 W. 44th St., Rm. 715; New York, NY 10036; Products Manufactured: *REC*.

**NAKAMICHI AMERICA CORP.;** 19701 S. Vermont Ave.; Torrance, CA 90502; (213) 538-8150. Jett Logan, vp pro audio. Products Manufactured: *REC*.

**NEOTEK;** 1154 W. Belmont Ave.; Chicago, IL 60657; (312) 929-6699. Laura Chase. Products Manufactured: *MIXC*.

**NETWORK PRODUCTION MUSIC;** 16935 W. Bernardo Dr.; San Diego, CA 92127; (619) 451-6400; (800) 854-2075. Products Manufactured: *PL*.

**GEORG NEUMANN, GMBH (SEE GOTHAM AUDIO)**

**NEUTRIK USA;** 195-53 Lehigh Ave.; Lakewood, NJ 08701; (201) 901-9488; FAX: (201) 901-9608. Bill Dorman, product mgr.; Jim Cowan, gen. mgr. Products Manufactured: *CC, MIC, TE*.

**NEVE;** 7 Parklawn Dr.; Bethel, CT 06801; (203) 744-6230; Telex: 969638; FAX: (203) 792-7863. Lisa Vogl, dir. adv. and promo.; Rich Hajdu, vp sales and mktg. Regional Offices: New York, NY (212) 956-6464 Nigel Toates; Toronto, ON Canada (416) 365-3363. Joseph Naccarato; Nashville, TN (615) 329-9584. Tom Semmes; Hollywood, CA (213) 461-6383. Rick Plushner. Products Manufactured: *AUTO, MSTC, MIXC, SP, VE*.

**NEW ENGLAND DIGITAL;** 49 N. Main St., PO Box 546; White River Jct., VT 05001; (802) 295-5800; FAX: (802) 296-2075. Ted Pine, mktg. mgr.; David Hartley, vp sales. Regional Offices: New York, NY (212) 266-0266, Richard Head; Los Angeles, CA (213) 651-4016, Colin Stewart; Nashville, TN (615) 297-8766, Richard Head. Products Manufactured: *HDWR, SOFT, DISK, MI*.

**NFL FILMS MUSIC LIBRARY;** 330 Fellowship Rd.; Mt. Laurel, NJ 08054; (609) 778-1600; (800) 257-5853. Products Manufactured: *PL*.

**NUMARK ELECTRONICS;** 503 Newfield Ave.; Edison, NJ 08837; (201) 225-3222. Richard Krochmal. Products Manufactured: *MIXC, SP*.

**OBERHEIM/GIBSON LABS;** 13345 Saticoy St.; N. Hollywood, CA 91605; (818) 503-0122; FAX: (818) 503-0124. Mark Ray, dir. mktg.; James Letts, gen. mgr. Products Manufactured: *AMP, MI, SP*.

**OMNI Q INC.;** PO Box L, #8-12th St.; Blaine, WA 98230; (206) 384-1750. HH von Tiesenhausen, president; Garry Musgrave, mgr. Products Manufactured: *TAPE*.

# Critical Acclaim

All CD's produced at U.S.  
Optical Disc Inc. must  
satisfy some of the  
industry's toughest critics ...

our employees!  
Each one is  
committed to  
providing our  
clients with the highest  
quality CD's, on time and  
at competitive prices. From  
Roy Brouwer, company  
president, who co-developed  
CD resins ... to our engineers,  
who handle digital mastering  
in clean room conditions  
meeting semiconductor  
standards ... to our

production staff, who  
were among the in-  
dustry's first to work  
with in-line replica-  
tion systems ... our  
high-caliber team  
ensures you'll receive  
the best replication  
possible. Call Debbie  
L'Heureux, customer  
service specialist, to  
discuss your CD  
replication needs and  
our capabilities.

U.S. Optical Disc Inc.



Route 109 & Eagle Drive, Sanford, Maine 04073 • (207) 324-1124



# GUARANTEED EXCELLENCE.



With the first high quality, high powered, solid state amplifier manufactured by Crown in 1967, we began setting industry standards. Today, with a complete line of amplifiers, Crown is one of the most recognized names in sound amplification in the world.

Our success can be attributed to many people and to many

things. But encompassing all of them is our commitment to excellence... guaranteed excellence. It's found in the engineering details that go into every Crown amplifier from Power Base to our acclaimed Macro series. It's found in stringent manufacturing, precision assembly and a level of support unmatched in the industry.

Proof of Crown's guaranteed excellence is our unprecedented 3+3 No-Fault Extended Warranty... up to six years of transferable protection for all Crown amplifiers.

To experience Crown's tradition in our full line of high quality amplifiers, call us at 1-800-535-6289.

GUARANTEED EXCELLENCE

 **crown**®

Made in America

Exported as Amcron

P.O. Box 1000 • Elkhart, Indiana 46515-1000

World Radio History

While some transformer makers have been standing still...

## We've Been Setting *NEW* Standards

- Computer-controlled Swiss winding machines for previously unattainable uniformity
- Proprietary, custom core alloys for lowest distortion
- Improved wire bonding techniques for long-term reliability in the field
- All materials are 100% inspected to our stringent specifications prior to assembly
- Higher quality, consistency and performance without a higher price
- Efficiencies and improved yields in manufacturing allow more competitive prices in high quantities.



Over the years, superb specifications, outstanding performance, and unsurpassed reliability have earned Jensen a solid reputation as the world's preeminent manufacturer of audio transformers. We recently made major changes in the manufacturing process, with significant improvements in both absolute performance and transformer-to-transformer consistency.

We control every facet of design and construction, from core alloy selection to computerized electronic modeling. Because Jensen transformers are designed to function as an integral part of "real-world" circuits, not as an afterthought, all parameters are optimized. The result is a clearly audible improvement in performance.

Discerning engineers specify our field proven transformers, by the hundreds of thousands, for the most demanding environments – professional recording studios, fixed and mobile broadcast facilities, and touring sound systems. It's no accident that returns and failures are rare; we place strong emphasis on quality control. Transformer performance is verified in our modern, highly automated test lab using Audio Precision and Hewlett-Packard equipment.

We take this extra care because we are dedicated to excellence. We have an experienced technical staff who offer you free transformer applications consultation with the help of our powerful COMTRAN software. This AC circuit analysis and optimization program is one of the engineering tools we use to model and design our high performance transformers. COMTRAN is available for HP computers and 386™ PCs.

Call or write for information or to receive our free newsletters. The next time you need a transformer, remember... insist on the best – insist on a Jensen.

### Choose From a Wide Variety of Transformer Types and Packages

- Microphone Input
- Microphone Splitting
- Line Input
- Direct box
- Line Output
- Electret Mic Output
- Interface of +4 dB to -10 dB circuits
- Repeat Coil
- Special Types

**jensen transformers**  
INCORPORATED

10735 Burbank Boulevard • North Hollywood, CA 91601  
FAX (818) 763-4574 Phone (213) 876-0059

*Visitors by appointment only. Closed Fridays.*

**UK Distribution by:** SSE Marketing Ltd. • Unit 2, 10 William Rd., London NW1 3EN • Telex: 27939 SCENIC G • Phone: (071) 387-1262 FAX (071) 388-0339  
**Australia Distribution by:** Syntec International Pty. Ltd. • 60 Gibbes Street • Chatswood, N.S.W. 2067 • Telex: SYNTEC AA 70570 • Phone (02) 406-4700 FAX (02) 406-6131  
**Far East Distribution by:** Towa International Corp. • 2nd Azuma Bldg. • 1-14 Sakuma-cho, Kanda • Chiyoda-ku, Tokyo 101 • Phone (03) 253-3537 FAX (03) 257-0824  
**New Zealand Distribution by:** Barton Sound Systems, Ltd. • 18 Norwich Street • Auckland 1 • Phone/FAX (09) 732-416

*COMTRAN is a registered trademark of Jensen Transformers, Inc. 386 is a trademark of Intel Corporation.*

World Radio History



## Professional Audio Manufacturers

1990-1991

**OMNIMOUNT SYSTEMS;** 10850 Vanowen St.; North Hollywood, CA 91605; (818) 766-9000. Jim Schaller. Products Manufactured: *OTH*.

**OMNIMUSIC;** 52 Main St.; Port Washington, NY 11050; (516) 883-0121; (800) 828-OMNI. Products Manufactured: *PL*.

**OPCODE SYSTEMS;** 3641 Haven Dr., Ste. A; Menlo Park, CA 94025-1010; (415) 369-8131; FAX: (415) 369-1747. Paul de Benedictis, mktg. mgr.; Keith Borman, nat'l sales mgr. Products Manufactured: *HDWR, SOFT, DISK, MI*.

**OPTI-CASE;** Rte. 6, Box 235; Henderson, TX 75652; (800) 637-6635; FAX: (214) 657-6030. David J. Phipps, owner/mgr. Products Manufactured: *CRS*.

**ORBAN, A DIVISION OF AKG ACOUSTICS, INC.;** 1525 Alvarado St.; San Leandro, CA 94577; (415) 351-3500; FAX: (415) 351-0500. Dave Roudubush, mktg. and sales mgr. Regional Offices: Pittsburgh, PA (412) 782-2354, Rowland Powers; Appleton, WI (414) 749-0044, Jeff Radke. Products Manufactured: *SP*.

**OREVOX USA CORP.;** PO Box 2655, 248 N. Puente Ave.; City of Industry, CA 91746; (818) 333-6803; FAX: (818) 336-3748. Daniel Wu, CEO; Russ Stanford, sales mgr. Products Manufactured: *SPKR*.

**LEE OSKAR HARMONICA CO.;** PO Box 550; Lake Arrowhead, CA 92352; (714) 337-5622. Lee Oskar, Kitt Gamble, Marc Lippert. Products Manufactured: *MI*.

**OTARI CORPORATION;** 378 Vintage Park Dr.; Foster City, CA 94404; (415) 341-5900; Telex: 6503028432 MCI UW; FAX: (415) 341-7200. John Carey, mktg. mgr.; James Goodman, nat'l sales mgr. Regional Offices: Nashville, TN (615) 754-9384, Emil Handke. Products Manufactured: *AUTO, MIXC, REC, TE, VE*.

**OVAL WINDOW AUDIO;** 78 Main St.; Yarmouth, ME 04096; (207) 846-6250. N. Lederman. Products Manufactured: *OTH*.



PACIFIC WOOD WORKS  
Forestville, CA

**PACIFIC WOOD WORKS;** PO Box 244; Forestville, CA 95436; (707) 887-1652; FAX: (707) 887-1652. Products Manufactured: *CRS, SPKR*.

**PACKBURN ELECTRONICS, INC.;** 216 Stratford St.; Syracuse, NY 13210; (315) 472-5644. Richard C. Burns, president. Products Manufactured: *SP*.

**PAIA/SYNCHRONOUS TECHNOLOGIES;** 1020 Wilshire Blvd., PO Box 14; Oklahoma City, OK 73113; (405) 842-0680. Linda Simonton. Products Manufactured: *MI*.

**PALMTREE INSTRUMENTS;** 5666 La Jolla Blvd., #81; La Jolla, CA 92037; (619) 546-8808; FAX: (619) 546-8808. Products Manufactured: *MI*.

**PANASONIC/RAMSA;** 6550 Katella Ave.; Cypress, CA 90630; (714) 373-7277; FAX: (714) 373-7242. Steve Wooley, mktg. and sales mgr. Regional Offices: Cypress, CA (714) 373-7389, James Murray; Arlington Heights, IL (708) 981-7329, Greg Braithwaite; Philadelphia, PA (215) 630-1651, Carla Campbell. Products Manufactured: *AMP, TAPE, SPKR, MIC, MIXC, SP, REC, VE*.

**PASO SOUND PRODUCTS, INC.;** 14 First St.; Pelham, NY 10803; (914) 738-4800; FAX: (914) 738-3954. David Moore, sales mgr. Products Manufactured: *AMP, SPKR, MIC, SP*.

**PASSAC CORPORATION;** 759 Ames Ave.; Milpitas, CA 95035; (408) 946-8989; FAX: (408) 946-0443. Royce Křlanovich, mktg. dir. Products Manufactured: *MIXC, MI*.

**PASSPORT DESIGNS;** 625 Miramontes; Half Moon Bay, CA 94019; (415) 726-0280; FAX: (415) 726-2254. Anastasia Lanier, vp sales and mktg.; Greg Lee, sales mgr. Products Manufactured: *SOFT*.

**PEARL INTERNATIONAL, INC.;** 408 Harding Industrial Dr.; PO Box 111240; Nashville, TN 37222; (615) 833-4477. Ken Austin. Products Manufactured: *MI*.

**PEAVEY ELECTRONICS CORP.;** 711 A St.; Meridian, MS 39301; (601) 484-5365; Telex: 504115; FAX: (601) 484-4278. Lance Schmidt, dir. mktg. and sales. Products Manufactured: *AMP, CC, CRS, DUP, AUTO, SPKR, MIC, MIXC, MI, PL, SP, REC*.

**PENN FABRICATION (NJ) INC.;** Box 506, 29B Ethel Ave.; Hawthorne, NJ 07506; (201) 423-4404. Phil Stratford. Products Manufactured: *OTH*.

**PENNY & GILES, INC.;** 2716 Ocean Park Blvd., Ste. 1005; Santa Monica, CA 90405; (213) 452-4995; Telex: 858866; FAX: (213) 450-9860. David McLain, mktg./nat'l sales mgr. Products Manufactured: *VE, OTH*.

**PERFORMANCE SOFTWARE SYSTEMS;** Box 123; Danville, WA 99121; (504) 442-8362. Hal Tipper. Products Manufactured: *SOFT*.

**PERSONAL COMPOSER;** PO Box 648; Honaunau, HI 96726; (808) 328-9518. Jim Miller. Products Manufactured: *SOFT*.

**PETERSON ELECTRO-MUSICAL;** 11601 S. Mayfield Ave.; Worth, IL 60482; (312) 388-3311. Products Manufactured: *TE, OTH*.

**PHILADELPHIA MUSIC WORKS;** P.O. Box 947; Bryn Mawr, PA 19010; (215) 825-5656; (800) 368-0033. Products Manufactured: *PL*.

**PIGNOSE INDUSTRIES;** 447 E. Gardena Blvd.; Gardena, CA 90248; (213) 770-4444; FAX: (213) 538-9560. Howard Chatt, mktg./nat'l sales mgr. Products Manufactured: *AMP*.

**PITECHNOS, INC.;** PO Box 577; Levis, QC G6V 7E5; (418) 835-1416. Nil Parent. Products Manufactured: *MI*.

**PLAY ROOM SOFTWARE;** 7308-C.E. Independence Blvd.; Charlotte, NC 28212; (704) 536-3093. Products Manufactured: *SOFT*.

**PLAYER SOFTWARE;** 199 N. El Camino Real #323; Encinitas, CA 92024; (619) 753-1498. Products Manufactured: *SOFT*.

**POLYLINE CORP.;** 1233 Rand Rd.; Des Plaines, IL 60016; (312) 298-5300. Sales Department. Products Manufactured: *DUP, OTH*.

**POSTHORN RECORDINGS/SCHOEPS;** 142 W. 26th St.; New York, NY 10001; (212) 242-3737; Telex: 291279; FAX: (212) 924-1243. Michael P. Hesse, mktg. mgr.; Louise A. Bloomfield, nat'l sales mgr. Products Manufactured: *MIC, TE*.

**POWERSOUND PRODUCTIONS;** 1307 W. North Ave.; Pittsburgh, PA 15233; (412) 323-5300. Products Manufactured: *PL*.

**PRELUDE SOFTWARE;** 1200 Riler Ave., Ste. 5-D; Lakewood, NJ 08701; (201) 905-6363. Products Manufactured: *SOFT*.

**PRIDDUS MUSIC CORP.;** 100 E. State; Pleasant Grove, UT 84062; (801) 785-0949; FAX: (801) 785-0949 ext. 9. Shaun A. Heaton, mktg. mgr. Products Manufactured: *DUP*.

**PRISTINE SYSTEMS;** 6515 Sunset Blvd., 201B; Hollywood, CA 90028; (213) 461-2819. Boyce Williams. Products Manufactured: *SOFT*.

**PRO CO SOUND;** 135 E. Kalamazoo Ave.; Kalamazoo, MI 49007; (800) 253-7360; FAX: (616) 388-9681. Products Manufactured: *CC*.

**THE PRODUCTION GARDEN;** 10521 Gulfdale Ave.; San Antonio, TX 78216; (512) 222-8865; (800) 247-5317. Products Manufactured: *PL*.

**PROFESSIONAL AUDIO SYSTEMS;** 1224 W. 252nd St.; Harbor City, CA 90710; (213) 534-3570; FAX: (213) 530-2384. Ray Bond, dir. sales. Products Manufactured: *SPKR*.

**PROMUSIC;** 655 NW 9th Ave. #303; Ft. Lauderdale, FL 33309; (305) 776-2070. Products Manufactured: *PL*.

**PROSONUS;** 11126 Waddington St.; North Hollywood, CA 91601; (213) 463-6191; FAX: (213) 462-7036. Ken Rose, president. Regional Offices: London, England (869) 38794, Ken Rose. Products Manufactured: *PL*.

**PRO-TRONIC SYSTEMS LTD.;** 720 6th St. #227; New Westminster, BC V3L 3C5; (604) 290-1631; FAX: (604) 524-9384. John Weir, president. Products Manufactured: *MI*.

**PUBLISON;** 18 Avenue de la Republique; 93170 Bagnolet; France; (014) 360-8464; FAX: (014) 360-8031.

**PULIZZI ENGINEERING;** 3260 S. Susan St.; Santa Ana, CA 92704-0865; (714) 540-4229. Pete Pulizzi, Sr. Products Manufactured: *OTH*.

**Q SOUND;** 2748 37th Ave. NE; Calgary, Alberta T1Y 5L3 Canada; (403) 291-2492.



QSC AUDIO PRODUCTS, INC.  
Costa Mesa, CA

**QSC AUDIO PRODUCTS, INC.;** 1926 Placentia Ave.; Costa Mesa, CA 92627; (714) 645-2540; FAX: (714) 645-7927. Greg McVeigh, dir. mktg.; Peter Kalmen, nat'l sales mgr. Products Manufactured: *AMP*.

**QUAD EIGHT ELECTRONICS, INC.;** 2771 Avenue Hopkins; Valencia, CA 91355; (805) 295-1324. Bill Windsor. Products Manufactured: *MIXC*.

**QUANTEC TONSTUDIOTECHNIK GMBH;** Clemensstr. 3; D-8000 München 40, West Germany; 4989-333034; FAX: 4989-393161. Dr. Almut Buchleitner. Products Manufactured: *SP*.

**RADIAN;** 4520 Eisenhower Circle; Anaheim, CA 92807; (714) 693-9277.

**RADIO SYSTEMS;** PO Box 356; Edgemont, PA 19028; (215) 356-4700. Bill Wohl. Products Manufactured: *REC*.



RAMSA  
Cypress, CA

**RAMSA;** 6550 Katella Ave.; Cypress, CA 90630; (714) 373-7278; FAX: (714) 373-7242. Steve Wooley, mktg. mgr. Products Manufactured: *AMP, SPKR, MIC, REC*.

**RAMSDELL AUDIO;** PO Box 76186; St. Petersburg, FL 33734; (813) 823-8037. Products Manufactured: *SPKR*.



RANE CORP.  
Everett, WA

**RANE CORP.;** 10802 47th Ave. W; Everett, WA 98204-3400; (206) 355-6000; FAX: (206) 347-7757. Larry Winter, vp mktg.; Ray Bloom, nat'l sales mgr. Products Manufactured: *AMP, MIXC, SP*.

**RAULAND-BORG CORPORATION;** 3535 W. Addison; Chicago, IL 60618; (312) 267-1300. Sales Dept.

**RCA TEST TAPES;** 108 Monticello Rd.; Weaverville, NC 28787; (704) 658-2067; FAX: (704) 658-2008. Charles Johnson, mgr. Q.A. Products Manufactured: *DUP, TE*.

**R-COLUMBIA PRODUCTS COMPANY;** 2008 St. Johns Ave.; Highland Park, IL 60035; (312) 432-7915. Iv Rosack. Products Manufactured: *OTH*.

**RECORTEC, INC.;** 275 Santa Ana Ct.; Sunnyvale, CA 94086; (408) 737-8441. Ron Troxell. Products Manufactured: *DUP*.

**REICHENBACH ENGINEERING CO., INC.;** 6887 Farmdale Ave., Bldg. 10; North Hollywood, CA 91605; (818) 765-6040. Betty Johnson, president. Products Manufactured: *OTH*.

**RENKUS-HEINZ, INC.;** 17191 Armstrong Ave.; Irvine, CA 92714; (714) 250-0166; FAX: (714) 250-1035. Carl Dorwalot, nat'l sales/mktg. mgr.; Mark Duncan, product mgr. Products Manufactured: *AMP, SPKR, SP*.



## Professional Audio Manufacturers

1990-1991

**RESEARCH TECHNOLOGY INTERNATIONAL;** 4700 Chase; Lincolnwood, IL 60646; (708) 677-3000; FAX: (708) 677-1311. Thomas Tisch, vp sales. Products Manufactured: *TE, OTH.*

**RESONATE, INC.;** PO Box 996; Menlo Park, CA 94026; (415) 323-5022. Susan J. Alvare. Products Manufactured: *SOFT.*

**RICHMOND SOUND DESIGN LTD.;** 1234 W. 6th Ave.; Vancouver, BC V6H 1A5; (604) 732-1234; FAX: (604) 734-3901. Damon Wootten, g.m. int'l sales and mktg. Products Manufactured: *AMP, SOFT, AUTO, DISK, MIXC, MI, SP, OTH.*

**RICKENBACKER INTERNATIONAL CORP.;** 3895 S. Main St.; Santa Ana, CA 92707; (714) 545-5574; FAX: (714) 754-0135. Derek Davis. Products Manufactured: *AMP, MI.*

**RIVERA RESEARCH & DEVELOPMENT;** 12316 Branford St., Unit E; Sun Valley, CA 91352; (818) 890-2826; FAX: (818) 890-5202. Paul Rivera, president; Joe Blacker, nat'l sales mgr. Products Manufactured: *AMP, SPKR.*

**ROBIN GUITARS;** 4914 Dickson St., Unit B; Houston, TX 77007; (713) 863-1537. Dave Wintz. Products Manufactured: *MI, SP.*

**ROCKTRON;** 2850 Technology Dr.; Rochester Hills, MI 48309; (313) 853-3055. Jeff Sorna, product specialist. Products Manufactured: *SP.*

**ROH;** 913 W. 223rd St.; Torrance, CA 90502; (213) 533-1498; FAX: (213) 533-6050. Dan Garrigan. Products Manufactured: *SPKR.*

**ROLANDCORP US;** 7200 Dominion Circle; Los Angeles, CA 90040; (213) 685-5141; FAX: (213) 722-0911. Nancy Kewin, vp comm. and education. Products Manufactured: *AMP, HDWR, DISK, EM, MIC, MI, SP, SYNC.*

**ROLLS CORP.;** 7023 S. 400 W., Salt Lake City, UT 84047; (801) 562-5628. Products Manufactured: *SP, AMP.*

**ROSS SYSTEMS;** PO Box 2344; Ft. Worth, TX 76102; (817) 326-5114. Tom Linklater, director of product development. Products Manufactured: *SPKR, MIXC, OTH.*

**RP MICRO;** 400 Main St.; Hickory, PA 15340; (412) 356-4000. Greg Conden. Products Manufactured: *HDWR.*



RPG DIFFUSOR SYSTEMS, INC.  
Largo, MD

**RPG DIFFUSOR SYSTEMS, INC.;** 12003 Wimbledon St.; Largo, MD 20772; (301) 249-5647; FAX: (301) 249-3912. Cynthia Bonavito, mktg. mgr.; Dr. Peter D'Antonio, nat'l sales. Regional Offices: RPG Europe, Embley, UK (11) 44-1-900-0255, Pete Wandless; RPG Japan, Tokyo (11) 81-3-479-8879, Sheen Uchida. Products Manufactured: *AM.*

**RTS SYSTEMS, INC.;** 1100 W. Chestnut St.; Burbank, CA 91506; (818) 566-6700; FAX: (818) 843-7953. Doug Leighton, vp mktg.; Shelley Harrison, sales mgr. Products Manufactured: *SPKR, MIC, TE, OTH.*

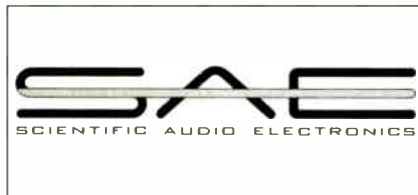

SAE (SCIENTIFIC AUDIO ELECTRONICS)  
Santa Monica, CA

**SAE (SCIENTIFIC AUDIO ELECTRONICS);** 1703 Stewart St.; Santa Monica, CA 90404; (213) 829-2222; FAX: (213) 829-9950. Buzz Delano, vp of sales and marketing. Products Manufactured: *AMP, SP, REC.*

**SAKI MAGNETICS INC.;** 26600 Agoura Rd.; Calabasas, CA 91302; (818) 880-4054; Telex: 244 546; FAX: (818) 880-6242. Trevor J. Boyer, dir. mktg. and sales. Products Manufactured: *TH.*

**SAMSON TECHNOLOGIES CORP.;** 485-19 S. Broadway; Hicksville, NY 11801; (516) 932-3810; FAX: (516) 932-3815. Scott Goodman, mktg./nat'l sales mgr. Products Manufactured: *MIC.*

**SANKEN MICROPHONE;** c/o Developing Technology Dist.; 1032N. Sycamore Ave.; Los Angeles, CA 90038; (213) 469-4773; FAX: (213) 962-2603. Jim Pace, mktg./nat'l sales mgr. Products Manufactured: *MIC.*

**SAUSALITO CRAFTWORKS;** PO Box 1792; Sausalito, CA 94966; (415) 332-3392; FAX: (415) 332-2607. David Holland, sales/custom design consultant. Products Manufactured: *MI, CRS.*

### OSCHOEPS (SEE POSTHORN RECORDINGS)

**SCHOLZ RESEARCH AND DEVELOPMENT, INC.;** Waltham, MA; (617) 890-5211; FAX: (617) 890-3206. Sherri Cohn, coord. adv./promo.; Christine Hansen, sales admin. Products Manufactured: *AMP, SP.*

**SCIENTIFIC DESIGN SOFTWARE;** PO Box 3248; Chatsworth, CA 91313; (818) 718-1201. Linda Telesky, sales/mktg. coord. Products Manufactured: *SOFT.*

**SEAM TECH;** 18 Marsilly; San Francisco, CA 94112; (415) 239-1699. Ruth Jensen. Products Manufactured: *OTH.*

**SECK;** 8500 Balboa Blvd.; Northridge, CA 91329; (818) 893-4351; FAX: (818) 893-3639. David Kimm. Products Manufactured: *MIXC.*



SELLMARK ELECTRONICS LTD., COMPONENTS DIV.  
Stanley, County Durham, England

**SELLMARK ELECTRONICS LTD., COMPONENTS DIV.;** Rockwood House, Barn Hill; Stanley, County Durham, DH9 8AN England; (207) 282-880; Telex: 537642; FAX: (207) 232-023. John Williams, managing dir.; John Marshall, gen. mgr. Regional Offices: Sudbury, MA (508) 443-8053, Richard Vanderslice. Products Manufactured: *SPKR, OTH.*



SENNHEISER ELECTRONIC CORP.  
Old Lyme, CT

**SENNHEISER ELECTRONIC CORP.;** 6 Vista Dr., PO Box 987; Old Lyme, CT 06371; (203) 434-9190; FAX: (203) 434-1759. Al Zang, mktg. mgr. Regional Offices: San Diego, CA (619) 538-6104, John Kenyon; North Hollywood, CA (213) 877-8877, Sennheiser Elec. Corp. of California. Products Manufactured: *SPKR, MIC.*

**SESCOM INC.;** 2100 Ward Dr.; Henderson, NV 89015; (702) 565-3400; FAX: (702) 565-4828. Franklin J. Miller, mktg. mgr. Products Manufactured: *AMP, CRS, SP.*

**SEYMOUR DUNCAN CO.;** 601 Pine Ave.; Santa Barbara, CA 93117; (805) 964-9610; FAX: (805) 964-9749. Cathy Duncan, mktg. mgr.; Gary Castelluccio, sales mgr. Products Manufactured: *AMP, MIC.*

**SHADOW OF AMERICA ELECTRONICS INC.;** 1248 Route 22 W, PO Box 1083; Mountainside, NJ 07092; (201) 654-7516; Telex: 667 944 Shad UW; FAX: (201) 654-7707. Herbert N. Hagel, mktg. mgr. pres. Products Manufactured: *MIC, MI.*

**SHAPE INC.;** PO Box 366, Biddeford Industrial Pa; Biddeford, ME 04005; (207) 282-6155. Tracy Hartman. Products Manufactured: *DUP.*

**SHARP ELECTRONICS CORPORATION (PROFESSIONAL PRODUCTS DIVISION);** Sharp Plaza; Mahwah, NJ 07430; (201) 529-8731; Telex: 134-327; FAX: (201) 529-9636. Bruce Pollack, mktg. mgr.; Ron Colgan, nat'l sales mgr. Products Manufactured: *REC, VE, OTH.*

**SHOWCO, INC.;** 201 Regal Row; Dallas, TX 75247; (214) 630-1188; FAX: (214) 638-3245. Robin Megruder, vp mktg. and operations; Wil Sharpe, vp sales. Regional Offices: Chatsworth, CA (818) 709-0211, Wil Sharpe. Products Manufactured: *SPKR.*

**SHURE BROTHERS INC.;** 222 Hartrey Ave.; Evanston, IL 60202-3696; (708) 866-2200; Telex: 4330191; FAX: (708) 866-2279. J. Phelan, dir. tech. markets, L. Morgan, vp domestic sales. Products Manufactured: *AMP, CC, MIC.*

**SIGNATURE MUSIC;** PO Box 98; Buchanan, MI 49107; (616) 695-3068; (800) 888-7151. Products Manufactured: *PL.*

**SIMON SYSTEMS ENGINEERING, INC.;** 707 Clear Haven Dr.; Agoura Hills, CA 91301; (818) 707-9980. Richard A. Simon, president. Products Manufactured: *SPKR, SP.*

**SKE PUBLISHING;** PO Box 2519; Sedona, AZ 86336; (602) 282-1258. Sherman Keene. Products Manufactured: *EM.*



SMITHLINE AUDIO  
Van Nuys, CA

**SMITHLINE AUDIO;** 15406 Cabrito Rd. #11; Van Nuys, CA 91406; (818) 786-7324; FAX: (818) 892-3262. George Bell, mktg. mgr. Products Manufactured: *SPKR.*



SOLID STATE LOGIC INC.  
New York, NY

**SOLID STATE LOGIC INC.;** 320 W. 46th St.; New York, NY 10036; (212) 315-1111; FAX: (212) 315-0251. Piers Plaskitt, chief exec.; Colin Pringle, mktg. dir. Regional Offices: Los Angeles, CA (213) 463-4444, Andy Wild; Toronto, ON (416) 363-0101, Gerry Eschwiler. Products Manufactured: *AUTO, DISK, MIXC, VE, OTH.*

**SOLID STATE LOGIC;** Begbroke; Oxford, OX5 1RU England; (44) (865) 842300. Noel Bell, publicity mgr. Products Manufactured: *MIXC.*

**SOLID SUPPORT INDUSTRIES;** 10784 Weaver St.; South El Monte, CA 91733; (818) 579-6063. Richard Wilson. Products Manufactured: *CRS.*

**SONIC SOLUTIONS;** 1902 Van Ness #300; San Francisco, CA 94109; (415) 394-8100. Mary Sauer. Products Manufactured: *DISK.*

**SONTEK ELECTRONICS;** Audio Dr.; Goldbond, VA 24094; (703) 626-7256. Burgess Macneal. Products Manufactured: *SP.*

**SONUS CORPORATION;** 21430 Strathern St., Ste. H; Canoga Park, CA 91304; (818) 702-0992. Products Manufactured: *MI.*

**SONY PRO AUDIO;** 1600 Queen Anne Rd.; Teaneck, NJ 07666; (201) 833-5200. Products Manufactured: *MIXC, REC, SP, MIC, TAPE.*

**SOPERSOUND LIBRARY;** PO Box 498; Palo Alto, CA 94301; (415) 321-4022; (800) 227-9980. Products Manufactured: *PL.*

**SOUND ABSORBENT MATERIALS CO. INC.;** PO Box 837; Westwood, NJ 07675; (201) 742-7078. John Lugano, g.m. Products Manufactured: *AM.*

**SOUND AND VISION;** 689 Benson Way; Thousand Oaks, CA 91360; (805) 496-1518. Correl Tannassy. Products Manufactured: *OTH.*

**SOUND CODE SYSTEMS, INC.;** PO Box 2198; Garden Grove, CA 92642-2198; (714) 554-0903; FAX: (714) 554-5643. Kevin Halverson, mktg. mgr. Products Manufactured: *AMP.*

**SOUND DESIGN;** 33 W. Haley; Santa Barbara, CA 93101; (805) 965-3404, Dom Camardella.

**SOUND IDEAS;** 105 W. Beaver Creek Rd., Ste. 4; Richmond Hill, ON L4B 1C6; (416) 886-5000; (800) 387-3030. Products Manufactured: *PL*.

**SOUND QUEST INC.;** 1573 Eglinton Ave. W #200; Toronto, ON M6E 2G9; (416) 256-0466; FAX: (416) 256-0458. Glenn Hayworth, vp mktg. Products Manufactured: *SOFT*.

**SOUNDTECH, DIV. OF WASHBURN, INT.;** 230 Lexington Dr.; Buffalo Grove, IL 60089; (708) 541-3520; FAX: (708) 541-3616. Todd Peden, field sales mgr.; D.J. Beruit, nat'l sales mgr. Products Manufactured: *AMP, CRS, SPKR, MIXC, SP*.

**SOUND TECHNOLOGY;** 1400 Dell Ave.; Campbell, CA 95008; (408) 378-6540. Cindy Alderson. Products Manufactured: *TE*.

**SOUND VISIONERING, INC.;** 396 Dundas St. E, Lower Level; Toronto, ON M5A 2A5; (416) 868-0513. Steve Grandy. Products Manufactured: *TAPE, DUP*.

**SOUNDCRAFT;** 8500 Balboa Blvd.; Northridge, CA 91329; (818) 893-4351; FAX: (818) 893-3639. David Kimm. Products Manufactured: *MIXC*.

**SOUNDCRAFTSMEN;** 2200 S. Ritchey; Santa Ana, CA 92705; (714) 556-6191. Roger Hagemeyer. Products Manufactured: *AMP*.

**SOUNDMASTER USA, INC.;** 900A Hampshire Rd.; Westlake Village, CA 91361; (805) 494-4545; FAX: (805) 494-4936. Andy Staffer, president. Regional Offices: New York, NY (212) 787-5832; Lee Murphy; Markham, ON (416) 479-8101; Curt Smith. Products Manufactured: *HDWR, DISK, SYNC*.

**SOUNDS INTERESTING PRODUCTIONS;** 922 Massachusetts Ave. #12; Cambridge, MA 02139; (617) 876-1646. Products Manufactured: *PL*.

○ **SOUNDTRACS PLC.;** 77 Selleck St., Stamford, CT 06092; 405-19 S. Broadway; Hicksville, NY 11801; (203) 348-2121 (in CT); (516) 932-3810 (in NY); FAX: (516) 932-3815. Products Manufactured: *MIXC*.

**SOUNDTRACS PLC.;** 91 Ewell Rd. Surbiton; Surrey, KT6 6AH UK; (01) 399-3392; Telex: 8951073; FAX: (01) 399-6821. J. Carroll, sales and mktg. dir.. Products Manufactured: *AUTO, MIXC*.

**SOUTHERN LIBRARY OF RECORDED MUSIC;** 677 Hollywood Blvd. #209; Hollywood, CA 90028; (213) 469-9910. Products Manufactured: *PL*.

**SPATIAL SOUND, INC.;** 743 Center Blvd.; Fairfax, CA 94930; (415) 457-8114; FAX: (415) 457-6250. Paul Devlas, mktg. mgr.; Mahanta Devlas, nat'l sales mgr. Products Manufactured: *SP*.

**SPECTRA SONICS;** 3750 Airport Rd.; Ogden, UT 84405; (801) 392-7531. Gregory D. Dilley. Products Manufactured: *AMP, MIXC*.

**SPECTRAL SYNTHESIS, INC.;** 18568 142nd Ave. NE; Woodinville, WA 98072; (206) 487-2931; FAX: (206) 487-3431. Ron Bradshaw, president. Products Manufactured: *HDWR, SOFT, DISK, MI*.

**SPECTRUM DESIGN & DEV. CO.;** 6265 Hamilton Blvd.; Allentown, PA 18106; (215) 395-6934. Lloyd Jones, president. Products Manufactured: *OTH*.

**SPRAGUE MAGNETICS, INC.;** 15720 Stagg St.; Van Nuys, CA 91406; (800) 553-8712 U.S.A.; (800) 325-4243 CA. John Austin. Products Manufactured: *TH*.

**STANDTASTIC;** 1325 Meridian St.; Anderson, IN 46016; (317) 642-5205; FAX: (317) 641-1205. L.J. Mechem, mktg. mgr.; Mike Fox, nat'l sales mgr. Products Manufactured: *CRS*.

**STANTON MAGNETICS INC.;** 101 Sunnyside Blvd.; Plainview, NY 11803; (516) 349-0235. Jean Kapen. Products Manufactured: *SPKR, OTH*.

**STAR CASE;** 648 Superior; Munster, IN 46321; (219) 922-4440. Bernie Fryman. Products Manufactured: *CRS*.

**STATE OF THE ART ELECTRONIC, INC.;** 43-1010 Polytek St.; Ottawa, ON K1J 9J3; (613) 745-2003. Dr. Claude Fortier. Products Manufactured: *SPKR*.



□ Do you need *real* four channel panning to left, center, right, and surround? We have it! . . . and more. Quad Eight Consoles for recording, film, and video post-production.



**quad eight electronics, inc.**

27771 Avenue Hopkins, Valencia, CA 91355 U.S.A.  
PHONE: 805-295-1324 FAX: 805-295-1399 TELEX: 311786

## Audio Noise Problems? ...Your solution is a dynafex® noise reduction system.



Ever wished for a simple, yet effective way to remove audio noise? Our dynafex® system is a unique combination of downward expansion and dynamic audio filtering providing up to 30 dB of noise reduction. To use, set the threshold that you want dynafex® to start working at—then listen to how quiet things get. Plus, because dynafex® is a single ended system, it will remove noise from sources that companded systems cannot. Thought of some noisy applications?

We offer two models: Our DX-1 (mono) is for mic. or line level sources, and features extended threshold range. Our DX-2 (stereo/2 channel) is for line level applications. Find out how much noise dynafex® will make you miss. Call or write for more information. Our units are also available on a two week trial.

cynafex® is a registered trademark of CRL, Inc.



**Circuit Research Labs, Inc.**  
2522 West Geneva Drive  
Tempe, Arizona 85282-3192 U.S.A.  
(800) 535-7648 (602) 438-0888 FAX (602) 438-8227  
Bulletin Board System (602) 438-0459

### Mix Trivia

4. The transistor was invented at this company in 1947.

Turn to page 152 for question



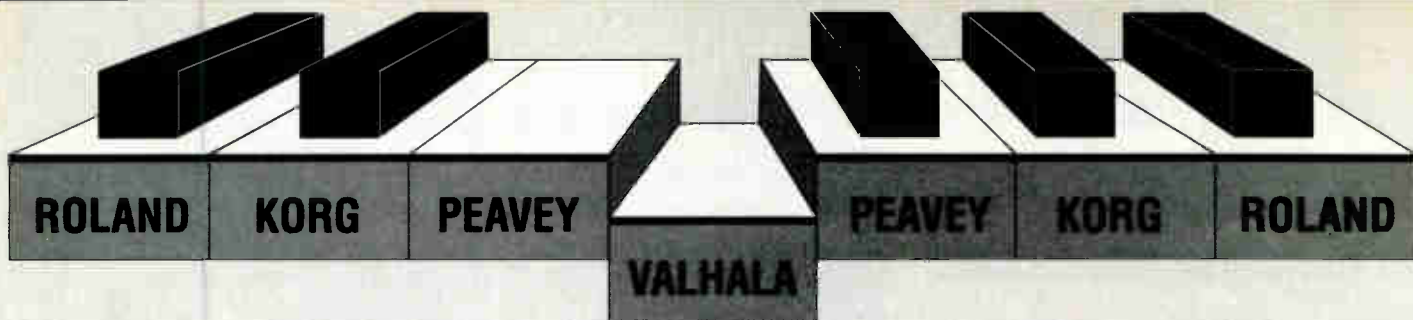

# DISCOUNT ROM and RAM PRICES!

| THE BEST SYNTHESIZER VOICES WORLDWIDE! | ROLAND   |          |       | KORG   |       |          | PEAVEY |
|----------------------------------------|----------|----------|-------|--------|-------|----------|--------|
|                                        | D50/D550 | D10/20/5 | D110  | M1/M1R | M3R   | T1/T2/T3 | DPM3   |
| <b>ROM STYLE</b>                       |          |          |       |        |       |          |        |
| NEW AGE                                | V200     | V210     | V220  | M-103  | M-303 | TD-3     | DP-203 |
| ANALOG                                 | V201     | V211     | V221  |        |       |          |        |
| ORCHESTRAL                             | V202     | V212     | V222  | M-102  | M-302 | TD-2     | DP-202 |
| TOP 40                                 | V203     | V213     | V223  | M-101  | M-301 | TD-1     | DP-201 |
| DIGITAL                                | V204     | V214     | V224  |        |       |          |        |
| PCM                                    | V205     | V215     | V225  |        |       |          |        |
| EFFECTS                                | V206     | V216     | V226  |        |       |          |        |
| ROCK                                   |          |          |       | M-104  | M-304 | TD-4     | DP-204 |
| <b>International Gold</b>              |          |          |       |        |       |          |        |
| BRITISH MIX #1                         | D-501    | D-121    | D-131 | B-101  | B-301 | B-401    |        |
| BRITISH MIX #2                         | D-502    | D-122    | D-132 | B-102  | B-302 | B-402    |        |

## ROMS

Roland Voice ROMS **\$40.00** ea  
 Roland International Gold ROMS **\$45.00** ea  
 Korg Voice ROMS **\$45.00** ea  
 Korg International Gold ROMS **\$50.00** ea  
 Korg TD-1 thru TD-4 disks **\$40.00** ea  
 Korg International Gold disks B-401 & B-402 **\$45.00** ea  
 Peavey Voice ROMS **\$50.00** ea {on disk **\$40.00** ea}

## RAMS

Roland M-246D RAM {same as M-256E} **\$55.00** ea  
 Korg MCR-03 RAM **\$65.00** ea  
 Peavey "Cache Card" RAM **\$65.00** ea  
 RAMS loaded *at time of purchase* for only \$15.00 per RAM (your choice of any one of Valhala's ROM cards)  
 International Gold ROM voices, add \$20.00 per RAM loaded.

**ALL VALHALA PRODUCTS ARE AVAILABLE DIRECT ONLY-NOT IN RETAIL STORES!**

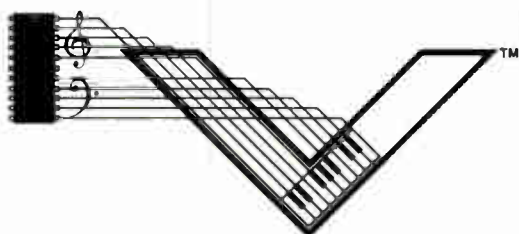

For information, voice listings, assistance or to check on the status of an order call:

**1-313-548-9360**

The number below is for placing Visa or MasterCard **ORDERS ONLY!**  
 When calling, have your card number ready along with the expiration date.  
 Minimum ChargeCard order: \$20.00 Business Hours 9am-5:00pm M-F (EST)  
**ORDERS ONLY** call: 1-800-648-6434 ext. 528



**VALHALA Box 20157-MXD Ferndale, Michigan 48220**

Copyright © 1990 Valhala Music, Inc. All Rights Reserved.

Prices/specs subject to change without notice.

Studio Series, International Gold, Sound Patch Library and ESQ1 Bible are trademarks of Valhala Music, Inc.



# THE ULTIMATE DIGITAL SAMPLING CDs!

## \$59.00 each - Any two for \$110.00, or three for \$160.00

### SONIC IMAGES

**VOL 1: DRUMS, PERCUSSION, MUSICAL EFFECTS**  
288 Sounds organized in 24 Drumsets and 9 instrument categories, includes 24 short demos.

**VOL 2: PERCUSSION SPECIAL {290 Stereo Samples}**  
Asian, African, Latin and Other Percussion Instruments  
(Including: Waterdrum, Surdo, Bougarabou, Dondo, Rain Stick, Djun, Marimbula, Tibetan Crotales, Sourouba, Chinese Opera Gong, and more)

**VOL 3: STACK SOUNDS A {216 Stereo Samples}**  
**VOL 4: STACK SOUNDS B {247 Stereo Samples}**  
Each volume contains 24 stereo stacks consisting of 4 to 8 layers of; Symphonic Orchestra, Strings, Brass, Flutes, Piano, 12 String Guitar, Harpsichord, Choir, Historical Instruments, HighEnd Synth Sounds & more...

**VOL 5: MUSICAL EFFECTS {243 Stereo Samples}**  
Percussive, Acoustical & Electronic Effects. Including; Orchestra Hits, Tibetan Monks, Whale Screams, Japanese Flutes, African Percussion Effects, Cobra Strike, Space Clusters, VCS 3, Moog FX and much more...

**VOL 6: GRAND PIANOS {404 Stereo Samples}**  
Steinway "D".....the classic - no comment needed  
Bosendorfer..... concert grand, rich sounding  
Bechstein "EN".....the famous german concert grand  
Seller MIDI Grand.....very bright sounding  
Klavins Mod. 370.....12-foot upright piano the World's largest stringed instrument!

**SONIC IMAGES Demonstration CD Disk \$10.00 (+ S/H).**  
Features examples from all six volumes.  
(Refundable toward the purchase of 2 or more CDs.)



### MASTER BITS

#### SAMPLING COLLECTION 500

{528 Synth & Drum Samples in Stereo}  
M1 • D-50 • K1 • K5 • DX7II • K-1000 • ESQ-1  
PPG 2.3 • FZ-1 • MiniMOOG • TR-808 • Alesis HR-16  
Simmons SDS-5 • Linn 9000 • plus more.

#### SAMPLING COLLECTION 600

{649 Stereo Digital Studio Samples}  
Waldorf-Microwave • Korg T1 • Proteus-XR  
Akai S-1000 • Kawai K4 • VFX • Prophet VS  
Oberheim X-pander • Roland CR-78 • plus more.

#### SAMPLING COLLECTION 800

{830 Stereo Digital Studio Samples}  
Ensoniq VFX • EMUII • Kurzweil PX-1000 Plus  
Roland R-8 • Oberheim Matrix 1000  
Kurzweil HX-1000 • Casio VZ-1 • Roland MKS-70  
Casio FZ-10M • Korg M1R • plus more.

### CLIMAX-COLLECTION Vol 1 • VOCALS\*

{664 Digital Studio Samples}  
Contains the standard-vocals (ooh, ah, oh, mmh, etc) multi-sampled. Different timbres (clean voice, powerful soul voices, rock lady, etc). The ultimate sampling CD for human vocal sounds - no limits to your creativity!

**\*CLIMAX Vol 1 VOCAL CD \$69.00**  
(Cannot be applied toward multi-purchase CD discounts)

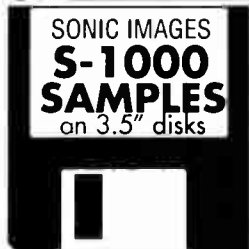

20 diskettes per volume!

#### VOLUME 1

- Symphonic Orch.
- Seiler Autogrand
- Drumset 1+2
- Drumset 3+4
- Bright Guitar Strgs\*
- Glockenflute\*
- Industrial Bamboo\*
- Plug Mix\*
- Full Choirstrings\*
- Rough Stack\*

#### VOLUME 2

- Percussion 1
- Percussion 2
- Bass Stack\*
- Harpsiflute\*
- Bright E-PnoStrgs\*
- Six Pianos\*
- Soft Piano Strings\*
- Spacelanding\*
- Soft Voices\*
- Fast Attack Fuzz\*

#### VOLUME 3

- Musical Effects 1
- Musical Effects 2
- Klavins GrandPiano
- Mystery Pad\*
- JapanFluteOrchestra\*
- Staccato Orchestra\*
- Rainstick Choir\*
- Octave Bellstrings\*
- Piano Orchestra\*
- Piano Strings\*

#### VOLUME 4

20 Drumsets including Percussion in 10 banks & 80 Programs.

#### VOLUME 5

156 Musical Effects and exotic Percussion in 10 banks & 93 Programs.

\* STACK SOUNDS

**\$178.00** per volume  
Each volume contains 70 programs minimum. (for each volume ordered add an extra \$1.50 s/h, for 2nd Day \$2.25 extra. AK, HI, PR & CANADA add \$3.50 extra). This S/H per volume is in addition to the normal S/H prices listed below.

**DIRECT ORDER FORM** Mail to: VALHALA Box 20157-MXD Ferndale, Michigan 48220

| QTY | PRODUCT DESCRIPTION | PRICE | EXTENDED |
|-----|---------------------|-------|----------|
|     |                     |       |          |
|     |                     |       |          |
|     |                     |       |          |

All orders are shipped UPS, a street address is required! \*\* Print or Type Information \*\*

Name \_\_\_\_\_  
Street \_\_\_\_\_  
City \_\_\_\_\_  
State \_\_\_\_\_ Zip \_\_\_\_\_  
Area Code/Daytime Phone \_\_\_\_\_

|                |    |
|----------------|----|
| SUBTOTAL       | \$ |
| Mich 4% Tax    | \$ |
| SHIPPING       | \$ |
| EXTRA SHIPPING | \$ |
| GRAND TOTAL    | \$ |

Phone (313) 548-9360  
FAX (313) 547-5949

#### SHIPPING HANDLING

Continental USA \$4.50 Shipping/Handling. 2nd Day UPS \$8.00 S/H [2nd day air means you will receive your product 2 working days after your order is processed - provided it is in stock]. Mich res. add 4% tax. Alaska, Hawaii, PR, & Canada add \$12.00 S/H. All other Countries add \$25.00 S/H plus \$3.50 for each additional item ordered. All payments must be in USA FUNDS drawn on a USA bank!  
Business hours 9am - 5:00pm Monday - Friday (EST)

Card # \_\_\_\_\_

Exp. Date \_\_\_\_\_

Signature \_\_\_\_\_



Minimum Charge Card order: \$20.00.



# PROMUSIC

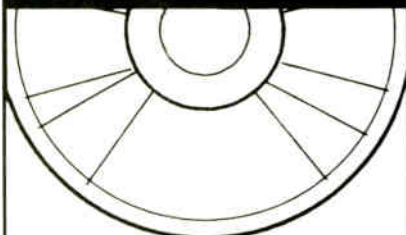

**OVER 230 CDs  
OF THE FINEST IN  
PRODUCTION MUSIC.**

*exclusively representing*

**PARRY • M.C.T. • HIBOU  
CAVENDISH • INTERMEDE  
COLOURSOUND • RED BUS  
FOCUS • STANDARD  
BOOSEY & HAWKES  
MUSIC LIBRARIES**

*Also Classical Series*

For our  
complete information package call  
**1-800-322-7879**

## PROMUSIC inc

6555 N.W. 9th Avenue, Suite 303  
Fort Lauderdale, FL 33309  
Phone 305-776-2070  
Fax 305-776-2074

## AUDIOFORCE

### Your Digital Source...

**NY rental exclusives:**

Mitsubishi X-86HS, Harmonia  
Mundi Sample Rate Converter.

Plus Sony 3324 & 3348,  
Lexicon, AMS, Yamaha...

### With The Best Of Analog.

Call—we've got what you need.

**PACKAGE RENTAL RATES  
24 HOUR SERVICE  
WORLDWIDE DELIVERY  
TECHNICAL SUPPORT**

Call 800-847-4123 toll free in  
USA. (212-741-0919 in NY State).

DIGITAL ASSOCIATES d/b/a

## AUDIOFORCE

### SOUND RENTAL LOGIC

37 West 20th Street, NY, NY 10011

## Professional Audio Manufacturers

1990-1991

# Steinberg JONES

STEINBERG/JONES  
Northridge, CA

**STEINBERG/JONES**; 17700 Raymer St. #1002; Northridge, CA 91325; (818) 993-4091; FAX: (818) 701-7452. Russ Jones, mktg. mgr.; Ron Sorter, nat'l sales mgr. Products Manufactured: *SOFT, AUTO.*

**STEINWAY AND SONS**; Steinway Pl.; Long Island, NY 11105; (718) 721-2600. Products Manufactured: *MI.*

**STELLAVOX (SEE DIGITAL AUDIO TECHNOLOGIES)**

**STEWART ELECTRONICS CORP.**; 11460 Sunrise Gold Cir., Ste. B; Rancho Cordova, CA 95742; (916) 635-3011. Sally Ann Poff, mktg./nat'l sales mgr. Products Manufactured: *AMP, SP.*

**STICK ENTERPRISES, INC.**; 6011 Woodlake Ave.; Woodland Hills, CA 91367; (818) 884-2001; FAX: (818) 883-0668. Yuta Chapman, vp. Products Manufactured: *MI.*

**JOHN M. STORYK**; Walters-Storyk Design Group; 134 Main St.; New Paltz, NY 12561; (914) 255-2255; FAX: (914) 255-2519. Products Manufactured: *AM.*

**STUDER EDITECH**; 1370 Willow Rd.; Menlo Park, CA 94025; (415) 326-7030; FAX: (415) 326-7039.

## STUDER REVOX

STUDER REVOX AMERICA, INC.  
Nashville, TN

**STUDER REVOX AMERICA, INC.**; 1425 Elm Hill Pike; Nashville, TN 37210; (615) 254-5651; FAX: (615) 256-7619. Tore B. Nordahl, president. Regional Offices: New York, NY (212) 255-4462, Jan Hebel; Los Angeles, CA (818) 780-4234, Tom Jenny. Products Manufactured: *SPKR, MIXC, REC, VE.*

**STUDIO C MUSIC LIBRARY**; PO Box 767, Murray Hill Station; New York, NY 10156-0602; (212) 986-2219. Products Manufactured: *PL.*

**STUDIO TECHNOLOGIES, INC.**; 5520 W. Touhy Ave.; Skokie, IL 60077; (708) 676-9177; FAX: (708) 982-0747. Jennifer Shore, mktg. comm. mgr. Products Manufactured: *SP.*

**STUDIOMASTER, INC.**; 3941 Miraloma Ave.; Anaheim, CA 92807; (714) 524-2227; FAX: (714) 524-5096. Paul Reeve, president; Jim Giordano, nat'l sales mgr. Products Manufactured: *AMP, CC, CRS, AUTO, MIXC, MI, SP.*

**SUMIKO, INC.**; PO Box 5046; Berkeley, CA 94705; (415) 843-4500. Frank Smith. Products Manufactured: *OTH.*

**SUNKYONG MAGNETICS**; 4041 Via Oro Ave.; Long Beach, CA 90810; (213) 830-6000; FAX: (213) 830-0646.

**SUNTRONICS**; PO Box 734, 1620 W. Foothill Blvd.; Upland, CA 91786; (714) 985-0701. Ron Sundell.

**SWINTEK ENTERPRISES, INC.**; 587 Division St.; Campbell, CA 95008; (408) 378-8091. Bill Swintek, Teresa Hill. Products Manufactured: *MIC.*

**SWITCHCRAFT/RAYTHEON CO.**; 5555 N. Elston Ave.; Chicago, IL 60630; (312) 792-2700. Herb Klapp. Products Manufactured: *CC.*

**SYMETRIX INC.**; 4211 24th Ave. W; Seattle, WA 98199; (206) 282-2555. Doug Schauer. Products Manufactured: *DISK, SP.*

**SYNHANCE**; PO Box 2744; Norcross, GA 30091; (404) 662-8788. Douglas Kraul. Products Manufactured: *MI.*

**TANDBERG OF AMERICA**; PO Box 58; Aromonk, NY 10504; (914) 273-9150. Allen Cohen. Products Manufactured: *REC.*

**TANNOY NORTH AMERICA, INC.**; 300 Gage Ave., Unit 1; Kitchener, ON N2M 2C8; (519) 745-1158; FAX: (519) 745-2364. Bill Calma. Products Manufactured: *SPKR.*

**TAPE DUPLICATION TECHNOLOGY INC.**; 1830 Wayne Trace; Fort Wayne, IN 46803; (219) 424-1007; FAX: (219) 426-1442. Jim Dunn, exec. vp. Regional Offices: Cleveland, OH (216) 871-1927, Jim Dunn. Products Manufactured: *DUP, TH.*

**TAPEX CORPORATION**; 2999 NE 12 Terr.; Ft. Lauderdale, FL 33334; (305) 565-1617. A sales executive. Products Manufactured: *DUP.*

**TASCAM**; 7733 Telegraph Rd.; Montebello, CA 90640; (213) 726-0303. Products Manufactured: *MIXC, REC, SYNC, SP.*

**TC ELECTRONIC**; 7325 Hinds Ave.; North Hollywood, CA 91605; (818) 503-1292.



TDK ELECTRONICS CORP.  
Port Washington, NY

**TDK ELECTRONICS CORP.**; 12 Harbor Park Dr.; Port Washington, NY 11050; (516) 625-0100; FAX: (516) 625-0171. Ken Kihara, mktg. mgr.; Doug Booth, nat'l sales mgr. Regional Offices: Port Washington, NY (516) 625-0100, Denise Floretti; Mt. Prospect, IL (708) 390-4358, Ed Byrnes; Gardena, CA (213) 538-5259, Doug Booth, Gordon LeSueu. Products Manufactured: *TAPE, DUP.*

**TDM DESIGN, INC.**; Rt. 1, Box 573; Hillsboro, OR 97124; (503) 647-5957. Tim Miller. Products Manufactured: *SP, OTH.*

**TEAC AMERICA, INC., TASCAM DIV.**; 7733 Telegraph Rd.; Montebello, CA 90640; (213) 726-0303; FAX: (213) 727-7635. Gregg Hildebrandt, Tascam div. mgr. Products Manufactured: *AMP, SPKR, MIC, MIXC, SP, REC, SYNC.*

**TECHNICAL AUDIO DEVICES**; 2265 East 220th St.; Long Beach, CA 90810; (213) 816-0415; FAX: (213) 816-0472. Leon Sievers, product mgr. Products Manufactured: *SPKR.*

**TECHNICS**; One Panasonic Way; Secaucus, NJ 07094; (201) 348-7000. Bruce Adams, Mark Knox. Products Manufactured: *REC, OTH.*

**TECHRON INDUSTRIAL PRODUCTS**; 1718 W. Mishawaka Rd.; Elkhart, IN 46517; (219) 294-5571. Products Manufactured: *TE.*

**TELEX COMMUNICATIONS, INC.**; 9600 Aldrich Ave. S.; Minneapolis, MN 55420; (612) 884-4051; Telex: 6879045; FAX: (612) 884-0043. Donald Mersen, dir. mktg.; Rick Peterson, nat'l sales mgr. Regional Offices: Encino, CA (818) 986-6688, Chuck DeNet; Chicago, IL (312) 351-8077, Bill Landon; Marietta, GA (404) 578-0554, Norman Skipper; Lebanon, OH (513) 932-5927, Marshall Miller; Warrenton, VA (703) 347-9589, John Davidson. Products Manufactured: *DUP, MIC.*

**TEMPORAL ACUITY PRODUCTS**; 30D 120th Ave. NE, Bldg. 1, Ste. 200; Bellevue, WA 98005; (206) 462-1007; FAX: (206) 462-1057. Roger McRea, mktg./nat'l sales mgr. Products Manufactured: *SOFT.*

**TENTEL CORP.**; 1506 Dell Ave.; Campbell, CA 95008; (800) 538-6894; (408) 379-1881. Wayne Graham. Products Manufactured: *TE.*

**T.F. BARRETT CO.**; PO Box 130; Westminster Station, VT 05159; (802) 722-9063. Tucker Barrett. Products Manufactured: *MI.*

**THOMPSON AUDIO DEVELOPMENTS LTD.**; PO Box 373, Biggleswade; Bedfordshire SG18 OAT, UK; (0767) 601-655.

**3M**; 3M Center, Bldg. 223-5N-01; St. Paul, MN 55144; (612) 733-1110; FAX: (612) 736-1246. James Hoskins, mktg. devel. mgr.; Joseph Leon, nat'l sales dir. Regional Offices: Atlanta, GA (404) 447-7000, Chuck Kendall; Los Angeles, CA (213) 726-6387, Gordon Menard; Hinsdale (Chicago), IL (708) 920-7382, Daniel Trasatt; Cleveland, OH (216) 362-3224, Daniel Cook; West Caldwell, NJ (201) 575-2089, Mark Fuhner. Products Manufactured: *TAPE.*



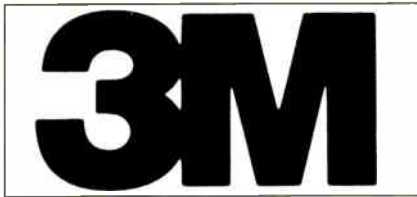

3M  
St. Paul, MN

**360 SYSTEMS**; 18730 Oxnard St.; Tarzana, CA 91356; (818) 342-3127; FAX: (818) 342-4372. Don Bird, dir. mktg.; David Geoghegan, dir. sales. Products Manufactured: *DISK, MI, OTH.*

**TIMELINE, INC.**; 270 Lafayette St.; New York, NY 10012; (212) 431-0330. Josann Block. Products Manufactured: *SYNC.*

**TLM ELECTRONICS, INC.**; 343 Manville Rd. #6B; Pleasantville, NY 10570; (914) 769-6423. Tony Marra.

**TOA ELECTRONICS, INC.**; 601 Gateway; South San Francisco, CA 94080; (415) 588-2538. Rick Kamlet. Products Manufactured: *MIXC, AMP, MIC, SPKR, SP, REC.*

**TRANSCO PRODUCTS CORP.**; PO Box 28; 609 W. Elizabeth Ave.; Linden, NJ 07036; (201) 862-0030. Fred Buehler. Products Manufactured: *DUP.*

**TRF PRODUCTION MUSIC**; 40 E. 49th St.; New York, NY 10017; (212) 753-3234. Products Manufactured: *PL.*

**TRIDENT AUDIO USA**; 2720 Monterey St., Ste. 403; Torrance, CA 90503; (213) 533-8900; FAX: (213) 533-7072. Wayne D. Freeman, president; Phil Wagner, reg. mgr. Regional Offices: New York, NY (914) 591-3741, Phil Wagner. Products Manufactured: *MIXC.*

**TRITON**; PO Box 160493; Cupertino, CA 95016-0493; (408) 253-8547. Kathy Elersich. Products Manufactured: *SOFT.*

**TROISI EDC**; 27 River St.; Westford, MA 01886; (617) 692-7768. P. Troisi. Products Manufactured: *SP.*

**TUBE-TECH (SEE AUDIO TECHNIQUES)**

**TURBOSOUND, INC.**; 30B Banfi Plaza N; Farmingdale, NY 11735; (516) 249-3660. Products Manufactured: *SPKR.*

**TURTLE BEACH SOFTWARES**; 1912 Alcott Rd.; York, PA 17402; (717) 757-2348; FAX: (717) 755-9402. Roy Smith. Products Manufactured: *HDWR, SOFT, DISK.*

**TWELVE TONE SYSTEMS, INC.**; PO Box 760; Watertown, MA 02275; (617) 273-4437; FAX: (617) 273-1494. Jill Foster, dir. mktg.; Pete Halliday, dir. sales. Products Manufactured: *HDWR, SOFT.*

**UHER OF AMERICA**; 7067 Vineland Ave.; North Hollywood, CA 91605; (818) 764-1120; Telex: 887805; FAX: (818) 764-1129. Patricia Belgiomo, vp. Products Manufactured: *REC.*

**ULTIMATE SUPPORT SYSTEMS, INC.**; 2506 Zurich Dr.; Fort Collins, CO 80524; (303) 493-4488; FAX: (303) 221-2274. Thomas B. Kellenberger, mktg. mgr.; Daniel S. Tancik, nat'l sales mgr. Products Manufactured: *CRS.*

**UNIQUE MUSICAL PRODUCTS**; 2031 S. Seneca; Wichita, KS 67213; (316) 264-5204. Bob Wiley. Products Manufactured: *CRS.*

**UREI**; 8500 Balboa Blvd.; Northridge, CA 91329; (818) 893-8411; FAX: (818) 893-3639. Mark Gander, vp mktg.; Ken Lopez, vp sales. Products Manufactured: *AMP, SPKR, SP.*

**U.S. AUDIO**; 100 Boxart St.; Rochester, NY 14612; (716) 663-8820; FAX: (716) 865-8930. Michael Hellman, mktg. coord.; Michael Laiacona, president. Products Manufactured: *AMP, MIXC.*

**VALENTINO, INC.**; 151 W. 46th St.; New York, NY 10036; (212) 869-5210; (800) 223-6278. Products Manufactured: *PL.*

**VALHALA MUSIC**; 205 E. Hazelhurst; Ferndale, MI 48220; (313) 548-9360. Dwight Neeley. Products Manufactured: *SOFT, PL.*

**VALLEY INTERNATIONAL, INC.**; 616 Bradley Ct.; Franklin, TN 37064; (615) 370-7911; FAX: (615) 370-5907. Norman Baker, president; Jon Bosaw, sales mgr. Products Manufactured: *SP.*

**VEGA, A MARK IV COMPANY**; 9900 Baldwin Pl.; El Monte, CA 91731-2204; (818) 442-0782; (800) 877-1771. Kenneth M. Bourne. Products Manufactured: *MIC.*

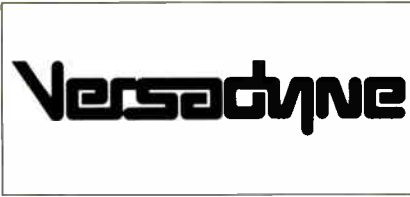

VERSADYNE INTERNATIONAL, INC.  
Campbell, CA

**VERSADYNE INTERNATIONAL, INC.**; 504-D Vandell Way; Campbell, CA 95008; (408) 379-0900; Telex: 288826; FAX: (408) 379-0902. Robert W. Kraitt, president. Products Manufactured: *DUP.*

**VESTAX, PRO AUDIO DIV.**; 908 W. Fayette Ave.; Effingham, IL 62401; (217) 342-9211; Telex: 752299; FAX: (217) 347-0316. Larry Morton, product mgr.; Kevin Cox, product specialist. Products Manufactured: *AMP, SPKR, MIC, MIXC, MI, SP, REC.*

**VIF INTERNATIONAL**; PO Box 1555; Mountain View, CA 94042; (800) 848-4428; (408) 739-9740 (CA only); Telex: 62922869 ESLUD; FAX: (408) 739-0809. Gordon Mackechnie, adviser int'l ops. Products Manufactured: *OTH.*

**VIRTUAL DESIGNS**; 7325 Hinds Ave.; North Hollywood, CA 91605; (818) 503-1292. Jerry Smith. Products Manufactured: *SP.*

**VOYETRA TECHNOLOGIES**; 333 Fifth Ave.; Pelham, NY 10803; (914) 738-4500; FAX: (914) 738-6946. Frederick J. Romano, vp. Products Manufactured: *SOFT, MI.*



WADIA DIGITAL CORP., PRO DIV.  
Hudson, WI

**WADIA DIGITAL CORP., PRO DIV.**; 511 2nd St.; Hudson, WI 54016; (715) 386-8100; FAX: (715) 386-8116. Wayne Olson, proj. mgr. Products Manufactured: *CC.*

**WALKER DIGITAL DRUMS**; PO Box 121; Norman, OK 73070; (405) 364-4981. Stan Walker. Products Manufactured: *MI.*

**WAVEFRAME CORP.**; 2511 55th St.; Boulder, CO 80301; (303) 447-1572; FAX: (303) 447-2351. Steve Krampf, mktg./nat'l sales mgr. Regional Offices: New York, NY (212) 719-0100, Sal Perla; Sherman Oaks, CA (818) 981-9235, Craig Hunter; Copenhagen, Denmark (011) 45-31-2001-46, Craig Damon; Long Beach CA (213) 987-2035, Gary Newell. Products Manufactured: *MIXC, MI, OTH.*

**WESTLAKE AUDIO, INC., MANUFACTURING DIV.**; 2696 Lavery Ct. #18; Newbury Park, CA 91320; (805) 499-3686; FAX: (805) 498-2571. Products Manufactured: *SPKR.*

**DAVID WEXLER & CO.**; 3553 W. Peterson Ave.; Chicago, IL 60612; (312) 478-9800. B.R. Wexler. Products Manufactured: *SPKR, MI.*

**WHIRLWIND**; 100 Boxart St.; Rochester, NY 14612; (716) 663-8820; FAX: (716) 865-8930. Michael Hellman, mktg. coord.; Rick Dunn, sales mgr.. Products Manufactured: *CC, SP.*

**WHITE INSTRUMENTS, DIV. C VAN R, INC.**; PO Box 90099; Austin, TX 78709-0099; (512) 892-0752; FAX: (512) 892-0855. Carl Van Ryswyk, mktg. mgr.; Jeff Van Ryswyk, nat'l sales mgr. Products Manufactured: *SP.*

**WHITE SHEPARD**; PO Box 3121; Santa Ana, CA 92703; (714) 546-3107. Jeff Worthy. Products Manufactured: *OTH.*

**WINSTED CORPORATION**; 10901 Hampshire Ave. S; Minneapolis, MN 55438; (612) 944-8556; FAX: (612) 944-1546. Randy Smith, mktg. mgr.; Judy Ruzek, nat'l sales mgr.. Products Manufactured: *CRS, OTH.*

**WIREWOKS CORPORATION**; 380 Hillside Ave.; Hillside, NJ 07205; (201) 686-7400; FAX: (201) 686-0483. Larry Williams, mktg. mgr.; Angela Kelly, nat'l sales mgr. Products Manufactured: *CC, OTH.*

**WOODWORX AUDIO ENCLOSURES**; 913 S. Chapman St.; Greensboro, NC 27403; (919) 378-0650; FAX: (919) 378-1498. Hugh K. Sarvis, president. Products Manufactured: *SPKR.*

**WORDS & DEEDS, INC.**; 4480 Sunnycrest Dr.; Los Angeles, CA 90065; (213) 735-2009. John Alcock. Products Manufactured: *SOFT.*

**XEDIT CORPORATION**; 218-31 97th Ave.; Queens Village, NY 11429; (718) 464-9400.

**YAMAHA CORPORATION OF AMERICA, PROFESSIONAL AUDIO DIV.**; 6600 Orangefhorpe Ave.; Buena Park, CA 90620; (714) 522-9011; FAX: (714) 739-2680. Gerald W. Tschetter, mktg. mgr.; Robert S. Shomaker, nat'l sales mgr. Products Manufactured: *AMP, HDWR, SPKR, MIC, MIXC, MI, SP.*



YORKVILLE SOUND  
Niagara Falls, NY

**YORKVILLE SOUND**; 4600 Witmer Industrial Estate, Unit 1; Niagara Falls, NY 14305; (716) 297-2920; FAX: (716) 297-3689. Bud Mayer, mktg. mgr. Regional Offices: Toronto, ON (416) 751-8481, Doug Davies. Products Manufactured: *AMP, SPKR, MIXC.*

**ZETA MUSIC SYSTEMS, INC.**; 2230 Livingston St.; Oakland, CA 94606-5221; (415) 261-1702; FAX: (415) 261-1708. Michael Maia, mktg. mgr.; Nicholas Del Drago, nat'l sales mgr. Products Manufactured: *MI.*

**AVEDIS ZILDJIAN COMPANY**; 22 Longwater Dr.; Norwell, MA 02061; (617) 871-2200; Telex: 924478; FAX: (617) 871-3984. Jim Van Dine, vp sales and mktg.; Jerry Donegan, sales/oper. mgr. Products Manufactured: *MIC.*

**ZM SOUND**; 903 Edgewood Ln.; Cinnaminson, NJ 08077; (609) 786-0612. Products Manufactured: *PL.*

**ZOID LIGHT GUITARS**; 736 S. 50th St., Bldg. H-20; Tampa, FL 33619; (813) 247-5268. David S. Stern, mktg./nat'l sales mgr. Products Manufactured: *MI.*

**ZOOM**; 365 Oyster Pt. Blvd. #7; South San Francisco, CA 94080; (415) 873-5885; FAX: (415) 873-5887.

TIGHTEN UP YOUR SOUND WITH A...

# RUSSIAN DRAGON®

The **RUSSIAN DRAGON** measures the timing accuracy of two sounds that were meant to happen at the same time. For example, it shows how closely a drummer is playing along with a click track; it detects the time delay between an acoustic drum and its triggered replacement; it reveals timing inaccuracies in MIDI systems; it checks for the right amount of delay in a delayed loudspeaker system. The **RUSSIAN DRAGON** compares the timing of two events, and gives an instantaneous visual display of who's **rushin'** and who's **draggin'** and by how much.

JANIUS ELECTRONICS / 2815 SWANDALE / SAN ANTONIO, TX 78230 / 512-525-0719



# PROFESSIONAL AUDIO MANUFACTURERS

C R O S S - I N D E X

## ACOUSTIC MATERIALS

Alpha Audio Automation Systems • ASC/Tube Traps/Acoustic Sciences Corp. • Thomas M. Chaffee Music Associates, Cutting Wedge Div. • The Cutting Edge • Illbruck, Inc., Sonex Acoustical Division • RPG Diffusor Systems, Inc. • Sound Absorbent Materials Co. Inc. • John M. Storyk.

## AMPLIFIERS

### Musical Instrument

ADA Signal Processors, Inc. • Amplified Music Products • ATI—Audio Technologies Inc. • Audio Centron • Carvin Mfg. Corp. • Dynacord, Electronic—und Geratebau GmbH & Co. KG • Fender Musical Inst. • Gallien-Krueger, Inc. • International Music Co., Ross Systems Div. • KDS Technologies/Sansui (Kaman) • Korg U.S.A. Inc. • Marshall Amplification • Metalhead Electronics/Studios • Oberheim/Gibson Labs • Peavey Electronics Corp. • Pignose Industries • Rickenbacker International Corp. • Rivera Research & Development • RolandCorp US • Seymour Duncan Co. • Toa Electronics, Inc. • Vestax, Pro Audio Div. • Yamaha Corporation of America, Professional Audio Div. • Yorkville Sound.

### Power

AB International Elect. Inc. • Altec Lansing Corporation • Amplified Music Products • ARSonic U.S. • Ashly Audio, Inc. • ATI—Audio Technologies Inc. • Audio Centron • Australian Monitor (Pty) Ltd. • BGW Systems, Inc. • Biamp Systems • Bogen Communications, Inc. • Boulder Amplifiers, Inc. • Bryston Limited • Bryston Vermont • Carver Corporation • Carvin Mfg. Corp. • Crest Audio, Inc. • Crown Int. • Denon America, Inc. • Dynacord, Electronic—und Geratebau GmbH & Co. KG • Eddor • Electro Force Corp. • Electro-Voice, Inc. • Fender Musical Inst. • FM Acoustics Ltd. of Switzerland • Fostex Corp. of America • Furman Sound, Inc. • David Hafler Company • Hill Audio, Inc. • Industrial Strength Industries • International Music Co., Ross Systems Div. • JBL Professional • Jensen Transformers, Inc. • Lake People • Lenco, Inc. • Metalhead Electronics/Studios • Meyer Sound Laboratories, Inc. • Oberheim/Gibson Labs • Panasonic/Ramsa • Paso Sound Products, Inc. • Peavey Electronics Corp. • QSC Audio Products, Inc. • Ramsa • Rane Corp. • Renkus-Heinz, Inc. • Richmond Sound Design Ltd. • Rickenbacker International Corp. • Rivera Research & Development • Rolls Electronic Corp. • SAE (Scientific Audio Electronics) • Scholz Research and Development, Inc. • Sescor Inc. • Seymour Duncan Co. • Shure Brothers Inc. • Sound Code Systems, Inc. • Sound Tech, Div. of Washburn, Int. • Soundcraftsmen • Spectra Sonics • Stewart Electronics Corp. • Studiomaster, Inc. • TEAC America, Inc., Tascam Div. • Toa Electronics, Inc. • UREI • J.S. Audio • Yamaha Corporation of America, Professional Audio Div. • Yorkville Sound.

## AUDIO/VIDEO TAPE

AGFA Corporation • American Videomatic, Inc. • Ampex Recording Media Corporation • Auditec of St. Louis • AVI • BASF Corporation Information

**F**or complete information on the companies listed here, please turn to the Manufacturer's Listings beginning on page 23.

Systems • Capitol Magnetic Products • Cintas VAC • DIC Digital • Fideipac Corp. • Fostex Corp. of America • JVC Professional Products Company • Maxell Corporation of America • Ormi Q Inc. • Panasonic/Ramsa • Sony Pro Audio • Sound Visioning, Inc. • Sunkyong • TDK Electronics Corp. • 3M.

## CABLES & CONNECTORS

ADC Telecommunications, Inc. • Audio-Technica U.S., Inc. • Belden Wire & Cable • Beyer Dynamic Inc. • Boulder Amplifiers, Inc. • California Switch and Signal, Inc. • Canare Cable, Inc. • David Carroll Electronics • Connectronics Corporation • Conquest Sound Inc. • Cooper Industries • Dynacord, Electronic—und Geratebau GmbH & Co. KG • Eltek Technologies, Inc. • FM Acoustics Ltd. of Switzerland • Fostex Corp. of America • Gotham Audio Corp. • Kable King • Kimber Kable • Lemo U.S.A., Inc. • Lester Audio Labs • Marshall Electronics, Inc. • Monster Cable • The Music People, Inc. • Neutrik USA • Peavey Electronics Corp. • Pro Co Sound • Shure Brothers Inc. • Studiomaster, Inc. • Switchcraft/Raytheon Co. • Wadia Digital Corp., Pro Div. • Whirlwind • Wireworks Corporation.

## CASES, RACKS & STANDS

Amco Engineering Co. • AMEK/Total Audio Concepts • Anvil Cases (Unit of Zero Halliburton) • Atlas/Soundolier • Bag End • Beyer Dynamic Inc. • Bobadilla Cases, Inc. • Calzone Case Co. • Dago Cases • Decuir Corp. • Dynacord, Electronic—und Geratebau GmbH & Co. KG • Flag Systems Inc. • F.M. Tubecraft • Fostex Corp. of America • Four Designs Co. • Hybrid Cases • International Music Co., Ross Systems Div. • Invisible Products Corp. • Jan-AI Cases • L.M. Engineering • Modular Wood Systems • The Music People, Inc. • Opti-Case • Pacific Wood Works • Peavey Electronics Corp. • Sausalito Craftworks • Sescor Inc. • Solid Support Industries • Sound Tech, Div. of Washburn, Int. • Standtastic • Star Case • Studiomaster, Inc. • Ultimate Support Systems, Inc. • Unique Musical Products • Winsted Corporation.

## CASSETTE DUPLICATION EQUIPMENT

Accurate Sound Corporation • American Multimedia/Concept Design • Apex Machine Company • Audico Chicago, Inc. • Auditec of St. Louis • Dwight Cavendish Company • Concept Design Electronics & Mfg., Inc. • Duplitronics • El Mar Plastics • Electro Sound, Inc. • Gauss • KABA Research & Development • King Instrument Corp. • Loran Cassettes & Audio Products • Magnefax International Inc. • Otari Corp. • Peavey Electronics Corp. • Polyline Corp. • Priddus Music Corp. • RCA Test Tapes • Recortec, Inc. • Shape Inc. • Sony • Sound Visioning, Inc. • Tape Duplication Technology Inc. • Tapex Corporation • TDK Electronics Corp. • Telex Communications, Inc. • Transco Products Corp. • Versadyne International, Inc.

## COMPUTER HARDWARE

Apple Computer, Inc. • Ariel Corp. • Atari Corporation, Music Division • BGW Systems, Inc. • Commodore Electronics • J.L. Cooper Electronics • Current Music Technology • Denon America, Inc. • Digidesign, Inc. • Doremi Labs, Inc. • Eltek Technologies, Inc. • Gefen Systems • Hybrid Arts, Inc. • IBM • Interval Music Systems • Key Electronics, Inc. • Mimetics • Motorola • New England Digital • Opcode Systems • RolandCorp US • RP Micro • Soundmaster USA, Inc. • Spectral Synthesis, Inc. • Turtle Beach Recording • Twelve Tone Systems, Inc. • Yamaha Corporation of America, Professional Audio Div.

## COMPUTER SOFTWARE

### Design/test software

Beaverton Digital Service • Bose Corporation • CMIDI • DRA • Fostex Corp. of America • Jensen Transformers, Inc. • Key Electronics, Inc. • Lighthouse Software • Richmond Sound Design Ltd. • Scientific Design Software • Spectral Synthesis, Inc.

### Music Software

John Abbott Music • Atari Corporation, Music Division • Bacchus • Beaverton Digital Service • Big Noise Software • Bose Corporation • ClubMIDI Software • CMIDI • J.L. Cooper Electronics • Decillionix • Digidesign, Inc. • Doremi Labs, Inc. • Dr. T's Music Software, Inc. • Drumware, Inc. • Eclipse Technology Inc. • Gateway Software • Gefen Systems • GF Music • Graphic Notes • Hip Software Corp. • Hybrid Arts, Inc. • Intelligent Music • Interval Music Systems • Jazzy Toy & Record Company • Key Electronics, Inc. • K-MUSE • Magnetic Music • Mark of the Unicorn, Inc. • MIDIMouse Music • Midsort Corporation • Mimetics • Musicode • New England Digital • Opcode Systems • Optical Media International • Passport Designs • Performance Software Systems • Personal Composer • Play Room Software • Player Software • Prelude Software • Resonate, Inc. • Richmond Sound Design Ltd. • Scientific Design Software • Sound Quest Inc. • Spectral Synthesis, Inc. • Steinberg/Jones • Temporal Acuity Products • Triton • Turtle Beach Recording • Twelve Tone Systems, Inc. • Valhala Music • Voyetra Technologies.

### Studio business mgmt. software

Leonardo • Pristine Systems • Words & Deeds, Inc.

## CONSOLE AUTOMATION SYSTEMS

### In-board

AMEK/Total Audio Concepts • AMS Industries Inc. • API Audio Products, Inc. • Audiomatic Systems Ltd. • J.L. Cooper Electronics • D&R USA • GML, Inc. • Harrison by GLW • Harrison Information Technology • Neve • Otari (Sound Workshop) • Peavey Electronics Corp. • Solid State Logic Inc. • Soundtracs PLC • Studiomaster, Inc.

### Out-board

Alpha Audio Automation Systems • Audiomatic Systems Ltd. • Clarity • J.L. Cooper Electronics • The Russ Jones Marketing Group • Otari Corpo-

ration • Peavey Electronics Corp. • Richmond Sound Design Ltd. • Soundtracs PLC • Steinberg/Jones • Studiomaster, Inc.

#### DISK-BASED REC. & EDITING SYSTEMS

Akai Professional • Alpha Audio Automation Systems • AMS Industries Inc. • J.L. Cooper Electronics • Digidesign, Inc. • Digital Audio Research • Digital Dynamics, Inc. • Doremi Labs • Electric Sound & Picture (Fairlight Esp. Pty. Ltd.) • Elitekon Technologies, Inc. • International Cutterhead Repair, Inc. • JVC Professional Products Company • Lexicon • New England Digital • Opcode Systems • Publison • Richmond Sound Design Ltd. • RolandCorp US • Solid State Logic Inc. • Sonic Solutions • Soundmaster USA, Inc. • Spectral Synthesis, Inc. • Studer Editech • Symetrix Inc. • 360 Systems • Turtle Beach Recording.

#### EDUCATIONAL MATERIALS

Backstage Pass Productions, Inc. • CAS Advertising & Promotion • Fostex Corp. of America • KABA Research & Development • RolandCorp US • SKE Publishing.

#### LOUDSPEAKERS

##### Headphones

AKG Acoustics, Inc. • Audio-Technica U.S., Inc. • Beyer Dynamic Inc. • Dynavox Electronics, Inc. • Fostex Corp. of America • RTS Systems, Inc. • Sennheiser Electronic Corp. • Simon Systems Engineering, Inc. • Stanton Magnetics Inc. • Studer Revox America, Inc. • TEAC America, Inc., Tascam Div. • Yamaha Corporation of America, Professional Audio Div.

##### Loudspeaker Components

Adamson Acoustic Design • Atlas/Soundolier • Audix • Audra Int. • Auratone Corp. • Celestion Industries, Inc. • Community Light & Sound, Inc. • Cyber-Kinetek Systems, Inc. • Dawn Speaker Systems • Design Direct Sound • Desktop Loudspeaker Systems, Inc. • Dynavox Electronics, Inc. • EAW Inc. • Emilar Corporation • Flag Systems Inc. • Formula Audio, Inc. • Fostex Corp. of America • JBL Professional • Martin America • McCauley Sound, Inc. • Motorola • The Music People, Inc. • Orevox USA Corp. • Pacific Wood Works • Peavey Electronics Corp. • Professional Audio Systems • Radian • Ramsdell Audio • Renkus-Heinz, Inc. • Sellmark Electronics Ltd., Components Div. • Technical Audio Devices.

##### Sound Reinforcement

Adamson Acoustic Design • Altec Lansing Corporation • Amplified Music Products • Anchor Audio, Inc. • Apogee Sound, Inc. • Atlas/Soundolier • Audio Centron • Auratone Corp. • Bag End • B.E.S. • Bose Corporation • Carvin Mfg. Corp. • Celestion Industries, Inc. • Cerwin-Vega • Community Light & Sound, Inc. • Dalbec Audiolab • Dawn Speaker Systems • Desktop Loudspeaker Systems, Inc. • Dynacord, Electronic—und Geratebau GmbH & Co. KG • Dynavox Electronics, Inc. • EAW Inc. • Electro-Voice, Inc. • Environmental Sound • Fender Musical Inst. • Formula Audio, Inc. • Fostex Corp. of America • Galaxy Audio • G.R.M. • International Music Co., Ross Systems Div. • Intersonics, Inc. • JBL Professional • Klipsch & Associates, Inc. • MacPherson Loudspeakers • Martin America • Meyer Sound Laboratories, Inc. • Modular Sound Reinforcement • MTX Loudspeakers • The Music People, Inc. • Pacific Wood Works • Panasonic/Ramsa • Paso Sound Products, Inc. • Peavey Electronics Corp. • Professional Audio Systems • Radian • Ramsa • Ramsdell Audio • Renkus-Heinz, Inc. • Rivera Research & Development • Ross Systems • Showco, Inc. • Sound Tech, Div. of Washburn,

Int. • Tannoy North America, Inc. • Technical Audio Devices • Toa Electronics, Inc. • Turbosound, Inc. • Vestax, Pro Audio Div. • Woodwork Audio Enclosures • Yamaha Corporation of America, Professional Audio Div. • Yorkville Sound.

##### Studio

Acoustical Physics Laboratories • Altec Lansing Corporation • Auratone Corp. • Calibration Standard Instruments • Celestion Industries, Inc. • Cerwin-Vega • Dalbec Audiolab • Dawn Speaker Systems • Desktop Loudspeaker Systems, Inc. • Digital Designs • Dynavox Electronics, Inc. • EAW Inc. • Electro-Voice, Inc. • Formula Audio, Inc. • Fostex Corp. of America • Gotham Audio Corp. • JBL Professional • KRK Monitoring Systems • MacPherson Loudspeakers • Meyer Sound Laboratories, Inc. • Panasonic/Ramsa • Peavey Electronics Corp. • Professional Audio Systems • Radian • Renkus-Heinz, Inc. • ROH • Smithline Audio • State of the Art Electronik, Inc. • Studer Revox America, Inc. • Tannoy North America, Inc. • Technical Audio Devices • Toa Electronics, Inc. • UREI • Vestax, Pro Audio Div. • Westlake Audio, Inc., Manufacturing Div. • David Wexler & Co. • Yamaha Corporation of America, Professional Audio Div.

#### MASTERING CONSOLES

##### Digital

Audio Animation, Inc. • Gotham Audio Corp. • Neve.

#### MICROPHONES

##### Condenser

Accurate Sound Corporation • ACO Pacific Inc. • AKG Acoustics, Inc. • AMS Industries Inc. • Ariel Corp. • Audio-Technica U.S., Inc. • Audix • Audra Int. • Beyer Dynamic Inc. • Bruel & Kjaer, Pro Audio Div. • CAD • Carvin Mfg. Corp. • Countryman Associates, Inc. • Crown Int. • C-T Audio Marketing Inc. • Electro-Voice, Inc. • Gotham Audio Corp./Neumann • Josephson Engineering • Milab • The Music People, Inc. • Neutrik USA • Panasonic/Ramsa • Peavey Electronics Corp. • Posthorn Recordings/Schoeps • Ramsa • RTS Systems, Inc. • Sanken Microphone • Sennheiser Electronic Corp. • Shure Brothers Inc. • Sony Pro Audio • TEAC America, Inc., Tascam Div. • Telex Communications, Inc. • Toa Electronics, Inc.

##### Dynamic

AKG Acoustics, Inc. • Audio-Technica U.S., Inc. • Audix • Beyer Dynamic Inc. • Carvin Mfg. Corp. • Dynacord, Electronic—und Geratebau GmbH & Co. KG • Electro-Voice, Inc. • Fostex Corp. of America • HM Electronics, Inc. • International Music Co., Ross Systems Div. • Josephson Engineering • Milab • The Music People, Inc. • Paso Sound Products, Inc. • Peavey Electronics Corp. • Sanken Microphone • Sennheiser Electronic Corp. • Shure Brothers Inc. • Sony Pro Audio • TEAC America, Inc., Tascam Div. • Telex Communications, Inc. • Toa Electronics, Inc. • Yamaha Corporation of America, Professional Audio Div.

##### Instrument Pick-ups

AKG Acoustics, Inc. • Beyer Dynamic Inc. • Countryman Associates, Inc. • Crown Int. • C-T Audio Marketing Inc. • The Music People, Inc. • Peavey Electronics Corp. • Seymour Duncan Co. • Shadow of America Electronics Inc. • Avedis Zildjian Company.

##### Wireless (incl. receivers)

AKG Acoustics, Inc. • Audio-Technica U.S., Inc. • Beyer Dynamic Inc. • Cetec Vega • Countryman Associates, Inc. • Eddor • Electro-Voice, Inc. • HM

Electronics, Inc. • Nady Systems, Inc. • Paso Sound Products, Inc. • Peavey Electronics Corp. • RolandCorp US • Samson Technologies Corp. • Sennheiser Electronic Corp. • Shure Brothers Inc. • Sony Pro Audio • Swintek Enterprises, Inc. • Telex Communications, Inc. • Vega, a Mark IV Company • Vestax, Pro Audio Div.

#### MIXING CONSOLES

##### Broadcast 1-20 inputs

Alesis Corporation • Allen & Heath USA • AMEK/Total Audio Concepts • AMS Industries Inc. • ATI—Audio Technologies Inc. • Audio Animation, Inc. • D&R USA • Dynacord, Electronic—und Geratebau GmbH & Co. KG • Gotham Audio Corp. • Harrison by GLW • Neotek • Panasonic/Ramsa • Sony Pro Audio • Soundcraft • Soundtracs PLC • Studer Revox America, Inc. • Trident Audio USA • U.S.Audio.

##### Broadcast 20+ inputs

Allen & Heath USA • AMEK/Total Audio Concepts • AMS Industries Inc. • API Audio Products, Inc. • ATI—Audio Technologies Inc. • Dynacord, Electronic—und Geratebau GmbH & Co. KG • Harrison by GLW • Neve • Panasonic/Ramsa • Quad Eight Electronics • Solid State Logic Inc. • Sony Pro Audio • Soundcraft • Soundtracs PLC • Studer Revox America, Inc. • Trident Audio USA.

##### Recording 1-20 inputs

Alesis Corporation • Allen & Heath USA • AMEK/Total Audio Concepts • AMS Industries Inc. • Audio Animation, Inc. • Audio Productive/Ace Audio Eng. • Biamp Systems • CAD • Carvin Mfg. Corp. • D&R USA • DDA • Electro-Voice, Inc. • Fostex Corp. of America • GML, Inc. • Harrison by GLW • Hill Audio, Inc. • Howe Technologies Corp. • Industrial Strength Industries • Kawai America Corp. • Neotek • Otari Corporation • Panasonic/Ramsa • Peavey Electronics Corp. • Rane Corp. • Seck • Sony Pro Audio • Soundcraft • Soundtracs PLC • Studer Revox America, Inc. • Studiomaster, Inc. • Tascam • TEAC America, Inc., Tascam Div. • Trident Audio USA • Vestax, Pro Audio Div. • WaveFrame Corp. • Yamaha Corporation of America, Professional Audio Div.

##### Recording 20+ inputs

Allen & Heath USA • AMEK/Total Audio Concepts • AMS Industries Inc. • Analog Digital Synergy, Inc. • API Audio Products, Inc. • Aries America • Audio Animation, Inc. • Biamp Systems • D&R USA • DDA • Euphonix • Focusrite • Fostex Corp. of America • Harrison by GLW • Harrison Information Technology • Hill Audio, Inc. • Howe Technologies Corp. • Neotek • Neve • Otari Corporation • Peavey Electronics Corp. • Quad Eight Electronics • Seck • Solid State Logic Inc. • Sony Pro Audio • Soundcraft • Soundtracs PLC • Spectra Sonics • Studer Revox America, Inc. • Studiomaster, Inc. • TEAC America, Inc., Tascam Div. • Trident Audio USA.

##### Sound Reinforcement 1-20 input

Alesis Corporation • Allen & Heath USA • AMEK/Total Audio Concepts • Ashly Audio, Inc. • Audio Centron • Audio Productive/Ace Audio Eng. • Biamp Systems • Bogen Communications, Inc. • CAD • Carvin Mfg. Corp. • D&R USA • DDA • Dynacord, Electronic—und Geratebau GmbH & Co. KG • Fender Musical Inst. • Fostex Corp. of America • Furman Sound, Inc. • Harrison by GLW • Hill Audio, Inc. • International Music Co., Ross Systems Div. • Kawai America Corp. • Numark Electronics • Panasonic/Ramsa • Passac Corporation • Peavey Electronics Corp. • Rane Corp. • Richmond Sound Design Ltd. • Ross Systems • Seck • Sound Tech, Div. of Washburn, Int. •



# Professional Audio Manufacturers

CROSS-INDEX

## MIXING CONSOLES (continued)

Soundcraft • Soundtracs PLC • Studiomaster, Inc. • Tascam • TEAC America, Inc., Tascam Div. • Toa Electronics, Inc. • Trident Audio USA • U.S. Audio • Yamaha Corporation of America, Professional Audio Div. • Yorkville Sound.

### Sound Reinforcement 20+ inputs

Allen & Heath USA • AMEK/Total Audio Concepts • Aries America • Audio Animation, Inc. • Biamp Systems • Crest Audio, Inc. • D&R USA • DDA • Dynacord, Electronic—und Geratebau GmbH & Co. KG • Fostex Corp. of America • Harrison by GLW • Hill Audio, Inc. • Panasonic/Ramsa • Peavey Electronics Corp. • Richmond Sound Design Ltd. • Seck • Sound Tech, Div. of Washburn, Int. • Soundcraft • Soundtracs PLC • Studiomaster, Inc. • Toa Electronics, Inc. • Trident Audio USA • Yamaha Corporation of America, Professional Audio Div.

## MUSICAL INSTRUMENTS

### Acoustic Pianos

Bosendorfer Pianos • Kawai America Corp. • Steinway and Sons • Yamaha Corporation of America.

### Drum machines

Akai Professional • Alesis Corporation • Dynacord, Electronic—und Geratebau GmbH & Co. KG • E-mu Systems, Inc. • Forat Electronics, Inc. • Kawai America Corp. • Korg U.S.A. Inc. • RolandCorp US • Yamaha Corporation of America.

### MIDI hardware etc.

Alesis Corporation • Anatek • Aphex Systems • Atari Corporation, Music Division • Axess Unlimited, Inc. • Casio Inc. • Clarity • J.L. Cooper Electronics • D DRUM • Daz Designs Ltd. • Digidesign, Inc. • Digital Music Corp. • Dr. T's Music Software, Inc. • Drum Workshop, Inc. • Eclipse Technology Inc. • Eltekon Technologies, Inc. • Engineered Percussion • Forat Electronics, Inc. • Forte Music, Inc. • General MIDI • Gentle Electric • Grey Matter • The Russ Jones Marketing Group • Kat Inc. • Kawai America Corp. • KDS Technologies/Sansui (Kaman) • Lake Butler Sound Co., Inc. • Lexicon • Lone Wolf • Lync Systems • Lyre, Inc. • Marion Systems • Mark of the Unicorn, Inc. • MIDIMIX • The Music People, Inc. • Music Quest • New England Digital • Oberheim/Gibson Labs • Opcode Systems • PAIA/Synchronous Technologies • Palmtree Instruments • Passac Corporation • Peavey Electronics Corp. • Pro-Tronic Systems Ltd. • Richmond Sound Design Ltd. • RolandCorp US • Shadow of America Electronics Inc. • Sonus Corporation • Stick Enterprises, Inc. • Studiomaster, Inc. • Synhance • 360 Systems • Vestax, Pro Audio Div. • Voyetra Technologies • Walker Digital Drums • WaveFrame Corp. • Yamaha Corporation of America • Zeta Music Systems, Inc.

### Other musical instr./products

Akai Professional • Aria Music (USA) Inc. • Ashly Audio, Inc. • Atari Corporation, Music Division • Axe Corporation • Big Briar Inc. • Charvel/Jackson • Dago Cases • Daz Designs Ltd. • Eventide, Inc. • Fender Musical Inst. • Four Designs Co. • Gentle Electric • Get Organized • Ibanez • Interval Music Systems • Kawai America Corp. • Key Clique, Inc. • KMD Sound Electronics • Korg U.S.A. Inc. • Philip Kubicki Guitar Technology • Maniac Music • Dean Markley Electronics • The Martin Guitar Company

• Metalhead Electronics/Studios • Midco International • Music Industries Corp. • Oberheim/Gibson Labs • Lee Oskar Harmonica Co. • Pearl International, Inc. • Rickenbacker International Corp. • Robin Guitars • Sausalito Craftworks • Shadow of America Electronics Inc. • Sonus Corporation • Stick Enterprises, Inc. • T.F. Barrett Co. • David Wexler & Co. • Zeta Music Systems, Inc. • Zoid Light Guitars.

### Samplers

Akai Professional • Applied Research & Technology (ART) • Casio Inc. • Digidesign, Inc. • Dynacord, Electronic—und Geratebau GmbH & Co. KG • Electric Sound & Picture (Fairlight Esp. Pty. Ltd.) • E-mu Systems, Inc. • Ensoniq Corp. • Eventide, Inc. • Korg U.S.A. Inc. • Kurzweil • Midco International • New England Digital • RolandCorp US • Spectral Synthesis, Inc.

### Synthesizers & sound modules

Akai Professional • Casio Inc. • J.L. Cooper Electronics • Digidesign, Inc. • E-mu Systems, Inc. • Ensoniq Corp. • Kawai America Corp. • Korg U.S.A. Inc. • Kurzweil • Lyre, Inc. • Midco International • Moog Electronics, Inc. • Music Industries Corp. • New England Digital • Oberheim/Gibson Labs • Peavey Electronics Corp. • Pitechnos, Inc. • RolandCorp US • WaveFrame Corp. • Yamaha Corporation of America.

## PRODUCTION LIBRARIES

### Music

John Abbott Music • AirCraft Music Library • Airforce Broadcast Services • American Image Productions • Associated Production Music • Audio Action • Big Noise Software • Brown Bag Productions • Capitol Production Music • Century 21 Programming • Comprehensive Video Supply • De Wolfe Music Library • Digidesign, Inc. • Dimension, Inc. • Eagle Sound • FIRSTCOM • Gefen Systems • Jazzy Toy & Record Company • L.A. Air Force • Manhattan Production Music • Network Production Music • NFL Films Music Library • Omnimus • Philadelphia Music Works • Powersound Productions • The Production Garden • Promusic • Prosonus • Signature Music • SoperSound Library • Sound Ideas • Sounds Interesting Productions • Southern Library of Recorded Music • Studio C Music Library • TRF Production Music • Valentino, Inc. • Valhala Music • WaveFrame Corp. • ZM Sound.

### Sound Effects

Digidesign, Inc. • FIRSTCOM • Gefen Systems • The Hollywood Edge • Jazzy Toy & Record Company • Prosonus • Valhala Music.

## SIGNAL PROCESSING EQUIPMENT

### Dynamics Processors etc.

Alesis Corporation • Aphex Systems • API Audio Products, Inc. • Applied Research & Technology (ART) • ARSonic U.S. • Ashly Audio, Inc. • ATI—Audio Technologies Inc. • Audio Animation, Inc. • Audio Logic • Biamp Systems • BSS • C-T Audio Marketing Inc. • D&R USA • dbx Professional Products a division of AKG Acoustics, Inc. • Digitech • DOD Electronics Corporation • Drawmer Distribution Div. • Drew Engineering Company • Dynacord, Electronic—und Geratebau GmbH & Co. KG • EDCor • Electrospace/Peninsula Marketing • Furman Sound, Inc. • GML, Inc. • Gotham Audio Corp. • High Fidelity Concepts, Inc. • Inovonics, Inc. • JBL Professional • JVC Professional Products Company • Klark-Teknik Electronics • Korg U.S.A. Inc. • Lake People • LT Sound • Neve • Orban, a division of AKG Acoustics, Inc. • Peavey Electronics Corp. • Rane Corp. • Renkus-Heinz, Inc. • Richmond Sound Design Ltd. • RolandCorp

US • Scholz Research and Development, Inc. • Sescom Inc. • Sound Tech, Div. of Washburn, Int. • Studiomaster, Inc. • TubeTech • Valley International, Inc. • Vestax, Pro Audio Div. • Yamaha Corporation of America, Professional Audio Div.

### Equalizers/Filters

Alesis Corporation • API Audio Products, Inc. • Apogee Electronics • Applied Research & Technology (ART) • ARSonic U.S. • Ashly Audio, Inc. • ATI—Audio Technologies Inc. • Audio Animation, Inc. • Audio Control Industrial • Audio Logic • Biamp Systems • BSS • Cerwin-Vega • D&R USA • dbx Professional Products a division of AKG Acoustics, Inc. • Digitech • DOD Electronics Corporation • Drawmer Distribution Div. • Dynacord, Electronic—und Geratebau GmbH & Co. KG • Fender Musical Inst. • Fostex Corp. of America • Furman Sound, Inc. • GML, Inc. • Gotham Audio Corp. • Ibanez • International Music Co., Ross Systems Div. • JBL Professional • JVC Professional Products Company • Kawai America Corp. • KDS Technologies/Sansui (Kaman) • Klark-Teknik Electronics • Korg U.S.A. Inc. • LT Sound • Martin America • Meyer Sound Laboratories, Inc. • MicroAudio Inc. • Neve • Orban, a division of AKG Acoustics, Inc. • Paso Sound Products, Inc. • Peavey Electronics Corp. • Rane Corp. • Richmond Sound Design Ltd. • RolandCorp US • SAE (Scientific Audio Electronics) • Scholz Research and Development, Inc. • Sescom Inc. • Sontec Electronics • Sound Tech, Div. of Washburn, Int. • Symetrix Inc. • TDM Design, Inc. • TEAC America, Inc., Tascam Div. • TubeTech • UREI • Valley International, Inc. • Vestax, Pro Audio Div. • Virtual Designs • White Instruments, Div. C Van R, Inc. • Yamaha Corporation of America, Professional Audio Div.

### Other Signal Processing

AB International Elect. Inc. • ACO Pacific Inc. • Adamson Acoustic Design • Altec Lansing Corporation • AMS Industries Inc. • Aphex Systems • API Audio Products, Inc. • Applied Research & Technology (ART) • ARSonic U.S. • Ashly Audio, Inc. • ATI—Audio Technologies Inc. • Audio Animation, Inc. • Audio Control Industrial • Audio/Digital, Inc. • B.A.S.E. • BBE Sound, Inc. • Biamp Systems • Bryston Vermont • BSS • Calibration Standard Instruments • Carver Corporation • Countryman Associates, Inc. • D&R USA • Dalbec Audiolab • dbx Professional Products a division of AKG Acoustics, Inc. • Digitech • DOD Electronics Corporation • Drawmer Distribution Div. • Drew Engineering Company • Dynacord, Electronic—und Geratebau GmbH & Co. KG • EDCor • Electrospace/Peninsula Marketing • Eventide, Inc. • Fender Musical Inst. • FM Acoustics Ltd. of Switzerland • Focusrite • Fostex Corp. of America • Furman Sound, Inc. • Gaines Audio • GML, Inc. • G.R.M. • John Hardy Co. • Industrial Strength Industries • JBL Professional • Jensen Transformers, Inc. • LT Sound • Marshall Electronic • Martin America • Metalhead Electronics/Studios • Numark Electronics • Oberheim/Gibson Labs • Orban, a division of AKG Acoustics, Inc. • Packburn Electronics, Inc. • Panasonic/Ramsa • Paso Sound Products, Inc. • Q Sound • Rane Corp. • Richmond Sound Design Ltd. • Rocktron • RolandCorp US • Rolls Electronic Corp. • Scholz Research and Development, Inc. • Simon Systems Engineering, Inc. • Spatial Sound, Inc. • Stewart Electronics Corp. • Studio Technologies, Inc. • Studiomaster, Inc. • Symetrix Inc. • Tascam • Toa Electronics, Inc. • Troisi EDC • UREI • Valley International, Inc. • Vestax, Pro Audio Div. • Virtual Designs • Whirlwind.



### Reverb/Delay/FX Devices

ADS, Analog & Digital Systems Inc./Delta Lab • AKG Acoustics, Inc. • Alesis Corporation • AMS Industries Inc. • Applied Research & Technology (ART) • Audio Animation, Inc. • Audio/Digital, Inc. • Audio Logic • Clarity • D&R USA • dbx Professional Products a division of AKG Acoustics, Inc. • Digitech • DOD Electronics Corporation • Dynacord, Electronic—und Geratebau GmbH & Co. KG • Eventide, Inc. • Fostex Corp. of America • Gotham Audio Corp. • Ibanez • Industrial Strength Industries • Klark-Teknik Electronics • Korg U.S.A. Inc. • Lexicon • LT Sound • Orban, a division of AKG Acoustics, Inc. • Panasonic/Ramsa • Peavey Electronics Corp. • Publison • Quantec Tonstudioteknik GmbH • RolandCorp US • Scholz Research and Development, Inc. • Sony Pro Audio • Studiomaster, Inc. • TCElectronic • Vestax, Pro Audio Div. • Virtual Designs • Yamaha Corporation of America, Professional Audio Div. • Zoom.

### Tape Noise Reduction Systems

ANT Telecommunications • ARSonic U.S. • D&R USA • dbx Professional Products a division of AKG Acoustics, Inc. • Dolby Laboratories, Inc. • Orban, a division of AKG Acoustics, Inc. • Peavey Electronics Corp. • Rocktron • RolandCorp US.

### TAPE HEADS

HRC Magnetics (HIX Rec. Co., Inc.) • International Electro-Magnetics • JRF Magnetic Sciences, Inc. • Saki Magnetics Inc. • Sprague Magnetics, Inc. • Tape Duplication Technology Inc.

### TAPE RECORDERS

#### Analog 2-track

Accurate Sound Corporation • AEG Corporation •

Akai Professional • Carver Corporation • Fidelipac Corp. • Fostex Corp. of America • KABA Research & Development • KDS Technologies/Sansui (Kaman) • Otari Corporation • Peavey Electronics Corp. • SAE (Scientific Audio Electronics) • Sony Pro Audio • Stellavox • Studer Revox America, Inc. • Tandberg of America • Tascam • TEAC America, Inc., Tascam Div. • Technics • Uher of America.

#### Analog Multitrack

AEG Corporation • Akai Professional • Clarion • Dauphin Company • Fostex Corp. of America • KDS Technologies/Sansui (Kaman) • Otari Corporation • Peavey Electronics Corp. • Sony Pro Audio • Studer Revox America, Inc. • Tascam • TEAC America, Inc., Tascam Div. • Thompson Audio Developments • Toa Electronics, Inc. • Vestax, Pro Audio Div.

#### Digital 2-track (incl. DAT)

Alpha Audio Automation Systems • Apogee Electronics • Casio Inc. • Compusonics Corp. • Digidesign, Inc. • Fostex Corp. of America • Gotham Audio Corp. • JVC Professional Products Company • Mitsubishi Digital • Nakamichi America Corp. • Panasonic/Ramsa • Radio Systems • Ramsa • Sharp Electronics Corporation (Professional Products Division) • Sony Pro Audio • Stellavox • Tascam • TEAC America, Inc., Tascam Div. • Technics.

#### Digital Multitrack

Akai Professional • Mitsubishi Digital • Otari Corporation • Sony Pro Audio • Studer Revox America, Inc. • Tascam.

### TEST EQUIPMENT & ANALYZERS

ACO Pacific Inc. • Amber Electro Design, Inc. •

Apogee Electronics • Audio Control Industrial • Audio Precision • B & B Systems • BASF Corporation Information Systems • Bruel & Kjaer, Pro Audio Div. • Concept Design Electronics & Mfg., Inc. • Dalbec Audiolab • Denon America, Inc. • ESL (Electronic Systems Laboratories, Inc.) • Fostex Corp. of America • Geneva Group of Companies, Inc. • Gold Line • Hewlett-Packard • IVIE • Jeanius Electronics • Magnetic Reference Laboratory • Neutrik USA • Peterson Electro-Musical • Posthorn Recordings/Schoeps • RCA Test Tapes • Research Technology International • RTS Systems, Inc. • Sound Technology • Techron Industrial Products • Tentel Corp.

### TRANSPORT SYNCHRONIZERS

Adams-Smith • ADX Systems • Alpha Automation • Audio Kinetics • Axe Corporation • Banner • Brainstorm Electronics, Inc. • Cipher Digital, Inc. • J.L. Cooper Electronics • Fostex Corp. of America • KDS Technologies/Sansui (Kaman) • Otari Corporation • RolandCorp US • Soundmaster USA, Inc. • Tascam • TEAC America, Inc., Tascam Div. • TimeLine, Inc.

#### Mix Trivia

- This company began selling digital audio cassette recorders in 1982, long before anyone heard of DAT.
- From 1988-89, the value of U.S. imports of electronic keyboards from this country dropped from \$321 million to under \$200 million.

Turn to page 152 for question

# The power that Pro's rely on

Discover why more professionals are switching over to the superior sound of Carvin's FET series amps than any other power amp made. It's not just reliability, but the pure sound of Carvin's MOSFET circuitry that makes the difference.

CARVIN sells FACTORY DIRECT giving you more performance for your dollar. Call toll-free 800-854-2235 for information or to order your FET amp today. You be the judge—all FET amps are sold on a money back guarantee!

#### Sound reinforcement / Studio users:

- Derrek Allen (Janet Jackson)
- Jay Azzolina (Spyro Gyra)
- Jennifer Batten
- Jason Becker (David Lee Roth)
- Bob Bradshaw
- Vito Bratta (White Lion)
- Oingo Boingo
- Craig Chaquico (Starship)
- Chris DeGarmo (Queensryche)
- Mick Fleetwood (Fleetwood Mac)
- George Lynch (Dokken)
- Lee Ritenour
- David Rosenthal (Robert Palmer)
- Dave Sabo (Skid Row)
- Steve Vai
- Frank Zappa

list

FACTORY DIRECT

FET400 400 watts ~~895~~ **\$519**

FET900 900 watts ~~1195~~ **\$669**

Outside the USA: See your dealer

## CARVIN

800-854-2235

Write for FREE full color catalog:  
CARVIN, MX28, 1155 Industrial Ave.  
Escondido, CA 92025

Hollywood Store: 7414 Sunset Blvd. (213) 851-4200



#### PERFORMANCE TESTED

"When you compare the performance of the FET power amplifier with that of other amplifiers having similar power output ratings and features you begin to realize just how much of a bargain that price represents...Internal layout of the amplifier was exemplary and was clearly the result of careful design and layout"—Len Feldman db Magazine

# PROFESSIONAL SERVICES

UNITED STATES & CANADA

## ADVERTISING AGENCIES

**ADVANCE ADVERTISING AGENCY;** 606 E. Belmont #202; Fresno, CA 93701; (209) 445-0383. Contact: Martin Nissen, production mgr.

**ANR ADVERTISING, INC.;** 150 River Road, Bldg. F; Montville, NJ 07045; (201) 299-8000; FAX: (201) 299-7937. Contact: David Scelba, vice president.

**ARTISANS PR & ADVERTISING;** 1762 S. Wooster Street; Los Angeles, CA 90035; (213) 837-6008; FAX: (213) 837-2286. Contact: Linda A. Rosner, partner.

**BAROLIN ADVERTISING, INC.;** 134 Kings Highway East; Haddonfield, NJ 08033; (609) 354-6222; FAX: (609) 354-6223. Contact: Roxanne Ciarrocca, account executive.

**BRUCE J. BORGERSON;** 307 Glenn Street; Ashland, OR 97520; (503) 488-5542. Contact: Bruce J. Borgerson.

**CARTER/ELLIOTT ADVERTISING & PUBLIC RELATIONS;** 15720 Winchester Boulevard; Los Gatos, CA 95030; (408) 395-1161; FAX: (408) 395-0544. Contact: Carter Elliott, president.

**CAS PRODUCTIONS;** 377 Hall Court; Noblesville, IN 46060; (317) 776-9909; FAX: (317) 776-9910. Contact: Al Stone, president.

**COMMUNICATIONS PLUS, INC.;** 360 Park Avenue South; New York, NY 10010; (212) 686-9570. Contact: Patricia Phelan, account executive.

**CONCEPT;** 14596 Big Basin Way; Saratoga, CA 95070; (408) 741-1751; FAX: (408) 741-4836. Contact: Deborah Coburn Rice, president.

**COSMIC MUFFIN GROUP;** 12944 Woodbridge Street; Studio City, CA 91604; (818) 986-4643; FAX: (818) 986-4664. Contact: Ronald Bennett, president.

**THE CREATIVE IMAGE GROUP;** 780 Charcot Avenue; San Jose, CA 95131; (408) 434-0490; FAX: (408) 434-0284. Contact: Ed Mongioli, CEO.

**CROSS THE ROAD PRODUCTIONS;** PO Box 801763; Santa Clarita, CA 91380; (805) 254-8069; (818) 953-5099. Contact: Ron Lewis, general manager.

**GARY DAVIS & ASSOCIATES;** 3237 Donald Douglas Loop South; Santa Monica, CA 90405; (213) 397-6625; FAX: (213) 390-9917. Contact: Gary Davis, president.

**STEVE DIGGS & FRIENDS ADVERTISING;** 1110 16th Avenue South; Nashville, TN 37212; (615) 259-4024; FAX: (615) 726-3808. Contact: Jerry Atnip.

**DJM ADVERTISING & PUBLIC RELATIONS;** 22575 E. Birdseye Drive; Diamond Bar, CA 91765; (714) 396-0478; FAX: (714) 860-0255. Contact: Neil R. Heller.

**FILM & VIDEO SERVICE;** 330 Townsend Street, Ste. 102; San Francisco, CA 94107; (415) 495-5015; FAX: (415) 495-0520. Contact: Charles Rucnick, owner.

**GREG YOUNGMAN MUSIC;** PO Box 8102; Long Beach, CA 90808; (213) 425-9597. Contact: Joe Nance, creative director.

**GREINKE, EIRS AND ASSOCIATES;** 2466 N. Oakland Avenue, Ste. 332; Milwaukee, WI 53211; (414) 962-9810. Contact: Arthur J. Greinke, CEO.

**KENNETH HALE CREATIVE SERVICES;** 320 W. Illinois, Ste. 609; Chicago, IL 60610; (312) 222-1667. Contact: Kenneth Hale.

**HARTFERD COMMUNICATIONS;** Sunset Gower Studios; 1438 N. Gower, Box 41; Hollywood, CA 90028; (213) 460-6807; FAX: (213) 460-6831. Contact: Skip Ferderber, president.

**HEART GRAPHIC DESIGN & ADVERTISING;** 501 George Street; Midland, MI 48640; (517) 832-9710. Contact: Clark Most.

**JOHN HENDRIX CO.;** A-6 11900 N. Penn; Oklahoma City, OK 73120; (405) 752-0250. Contact: John H. Hendrix, owner.

**T**his is the first time Mix has gathered listings for Professional Services. We don't pretend to have a complete list. If you would like to be added for next year's directory, please contact us at (800) 344-LIST.

**HEYWOOD FORMATICS & SYNDICATION;** 1103 Colonial Boulevard; Canton, OH 44714-1837; (216) 456-2592; FAX: (216) 456-2592. Contact: Max Heywood, owner.

**HODGES MEDIA GROUP;** PO Box 51483; Palo Alto, CA 94303; (415) 856-7442; FAX: (415) 856-4837. Contact: Ed Hodges, owner.

**IMAGE MAKERS;** 11285 Elkins Road, Ste. H4; Roswell, GA 30076-1259; (404) 442-9474. Contact: Elaine M. Gossett, account director.

**KLAV RADIO;** 364 Convention Center Drive; Las Vegas, NV 89109; (702) 796-1230; (702) 798-4111. Contact: Rae Miller, operator.

**KNAVER COVE SOUND STUDIOS;** 2162 Orchard Park Drive; Schenectady, NY 12309; (518) 370-0698. Contact: Christopher W. Haines, engineer.

**LABOV & BEYOND MUSIC PRODUCTIONS;** 1728 Spy Run Avenue; Fort Wayne, IN 46805; (219) 420-5533; FAX: (219) 422-1443. Contact: Christopher Parker, producer.

**MANIS MONDA ALLEN ADVERTISING;** 330 Clematis Street, Ste. 219; West Palm Beach, FL 33401; (407) 655-8177; FAX: (407) 659-5423. Contact: Robert Manis, president.

**MANIS MONDA ALLEN ADVERTISING;** 490 Route 304; New City, NY 10956; (914) 639-9400; FAX: (914) 639-9456. Contact: Robert Manis, president.

**MEDIA&MARKETING;** 11288 Ventura Boulevard #462; Studio City, CA 91604; (818) 753-9510; FAX: (818) 753-9320. Contact: Mel Lambert, creative director.

**MEDIA MULTISOUND;** 1413 W. 38th Street; Sioux Falls, SD 57105; (605) 335-3368. Contact: Robert Joyce, owner.

**MEDIA/SCAN;** 38 W. 26th Street; New York, NY 10010; (212) 929-6108; FAX: (212) 929-7032. Contact: April Beer, dir. of account svcs.

**MPA EDITORIAL;** 939 Pt. Washington; Pt. Washington, NY 11050; (516) 944-5940; FAX: (516) 767-1745. Contact: Martin Porter.

**MUSICAL IMAGE PRODUCTIONS;** 3013 E. Monte Vista; Denver, CA 95316; (209) 632-8415; FAX: (209) 668-0626. Contact: Gary Shriver, owner.

**NORTON RUBBLE & MERTZ ADVERTISING;** 120 N. Green, Ste. 3F; Chicago, IL 60607; (312) 942-1405; FAX: (312) 942-1487. Contact: Mark R. Miller, account executive.

**MARK OLIVER, INC.;** 1 W. Victoria Street; Santa Barbara, CA 93101; (805) 963-0734; FAX: (805) 966-4281. Contact: Edward De Brava, account executive.

**POINTLINE;** 5690 West Mall; Atascadero, CA 93422; (805) 466-2787. Contact: Royson Parsons, president.

R·E·CLARK  
ADVERTISING

R.E. CLARK ADVERTISING, INC.  
Fullerton, CA

**R.E. CLARK ADVERTISING, INC.;** 285 E. Imperial Highway, Ste. 101; Fullerton, CA 92635; (714) 441-1655; FAX: (714) 441-2374. Contact: Rick Clark, president.

**REDGATE COMMUNICATIONS CORPORATION;** 24 New England Executive Park; Burlington, MA 01803; (617) 229-6500; FAX: (617) 229-6532. Contact: Diane Pardes, account supervisor.

**RICHARD H. ROFFMAN ASSOCIATES;** 697 West End Avenue; New York, NY 10025; (212) 749-3647; (212) 749-3648. Contact: Richard H. Roffman, president.

**STEVEN W. ROSS & ASSOCIATES, INC.;** 1375 Broadway; New York, NY 10018; (212) 819-1170. Contact: Steven Ross, president.

**RPS COMMUNICATIONS;** 520 Arthur Street; Centerport, NY 11721; (516) 423-4038; FAX: (516) 423-6155. Contact: Randolph P. Savicky, president.

**PATRICK WILLIAM SALVO & ASSOCIATES PUBLIC RELATIONS;** 8686 Olympic Boulevard, Ste. 2; Los Angeles, CA 90035; (213) 659-1792. Contact: Patrick Salvo.

**SOUND LAB PRODUCTIONS, INC.;** 1203 Yellowstone Drive; Newark, DE 19713; (302) 731-0204; FAX: (302) 738-7485. Contact: Roger Holman, president.

**TERPIN GROUP;** 3713 Highland Avenue, Ste. 2; Manhattan Beach, CA 90266; (213) 545-1212; FAX: (213) 546-5959. Contact: Mike Terpin, president.

**TULLY COMMUNICATIONS;** 5914 Fremont Street; Oakland, CA 94608; (415) 654-7169; FAX: (415) 654-7169. Contact: Tim Tully, owner.

**WILKERSON ADVERTISING;** 8444 Wilshire Boulevard, 6th Floor; Beverly Hills, CA 90211; (213) 655-6356; FAX: (213) 655-0327. Contact: Ron Wilkerson, president.

## BUSINESS CONSULTANTS/ FINANCIAL SERVICES

**ANR ADVERTISING, INC.;** 150 River Road, Bldg. F; Montville, NJ 07045; (201) 299-8000; FAX: (201) 299-7937. Contact: David Scelba, vice president.

**CAS PRODUCTIONS;** 377 Hall Court; Noblesville, IN 46060; (317) 776-9909; FAX: (317) 776-9910. Contact: Al Stone, president.

**FINK & BLAKELY ASSOCIATES;** 1282 California Street; San Francisco, CA 94109; (415) 441-3777; FAX: (415) 775-4925. Contact: Neil Fink.

**ROBERT E. GRIFFIN, INC.;** 133 W. 19th Street, 8th Floor; New York, NY 10011; (212) 255-8491; FAX: (212) 206-6372. Contact: Bob Griffin, president.

**HARTFERD COMMUNICATIONS;** Sunset Gower Studios; 1438 N. Gower, Box 41; Hollywood, CA 90028; (213) 460-6807; FAX: (213) 460-6831. Contact: Skip Ferderber, president.

**HAWTHORNE COMMUNICATIONS, INC.;** PO Box 1238 Canal Street Station; New York, NY 10013-1238; (212) 475-3227; FAX: (212) 979-0128. Contact: David Hawthorne, president.

**INCORPORATED TECHNOLOGIES;** 110 Morningside Drive #39; New York, NY 10027; (212) 666-5555; FAX: (212) 666-1111. Contact: Imran Anwar, president.

**LA COSTA MUSIC BUSINESS CONSULTANTS;** PO Box 147; Cardiff, CA 92007; (619) 436-7219. Contact: Robert A. Livingston, consultant.

**MEDIA&MARKETING;** 11288 Ventura Boulevard #462; Studio City, CA 91604; (818) 753-9510; FAX: (818) 753-9320. Contact: Mel Lambert, creative director.

**OHIO SONGWRITERS ASSOCIATION;** 27801 Euclid Avenue #30; Euclid, OH 44132; (216) 731-7664. Contact: J.N.A. Wunderle, president.

**PUBLISHING SERVICES MANAGEMENT GROUP;** 309 4th Avenue, Ste. 203; San Francisco, CA 94118; (415) 751-5805; FAX: (415) 751-5805. Contact: Mark Gunther, principal.

**RESOURCE;** 575 Sand Dollar Lane; La Selva Beach, CA 95076; (408) 761-5937; FAX: (408) 761-5937. Contact: Ron A. Nelson, partner.



**RICHARD H. ROFFMAN ASSOCIATES**; 697 West End Avenue; New York, NY 10025; (212) 749-3647; (212) 749-3648. Contact: Richard H. Roffman, president.

**PATRICK WILLIAM SALVO & ASSOCIATES PUBLIC RELATIONS**; 8686 Olympic Boulevard, Ste. 2; Los Angeles, CA 90035; (213) 659-1792. Contact: Patrick Salvo.

**SONGWRITER SERVICES**; 603 W. 13th #1A-167; Austin, TX 78701; (512) 452-6116. Contact: Bill Anderson, owner.

**TERMINAL MARKETING COMPANY, INC.**; 5 Waverly Court; New City, NY 10956; (914) 634-7601; FAX: (914) 634-7813. Contact: Sandy Schneiderman, president.

**GRAPHIC DESIGN /  
PHOTOGRAPHIC SERVICES**

**ADVANCE ADVERTISING AGENCY**; 606 E. Belmont #202; Fresno, CA 93701; (209) 445-0383. Contact: Martin Nissen, production mgr.

**ANR ADVERTISING, INC.**; 150 River Road, Bldg. F; Montville, NJ 07045; (201) 299-8000; FAX: (201) 299-7937. Contact: David Scelba, vice president.

**BAROLIN ADVERTISING, INC.**; 134 Kings Highway East; Haddonfield, NJ 08033; (609) 354-8222; FAX: (609) 354-6223. Contact: Roxanne Ciarrocca, account executive.

**CARTER/ELLIOTT ADVERTISING & PUBLIC RELATIONS**; 15720 Winchester Boulevard; Los Gatos, CA 95030; (408) 395-1161; FAX: (408) 395-0544. Contact: Carter Elliott, president.

**CONCEPT**; 14596 Big Basin Way; Saratoga, CA 95070; (408) 741-1751; FAX: (408) 741-4836. Contact: Deborah Coburn Rice, president.

**COSMIC MUFFIN GROUP**; 12944 Woodbridge Street; Studio City, CA 91604; (818) 986-4643; FAX: (818) 986-4664. Contact: Ronald Bennett, president.

**THE CREATIVE IMAGE GROUP**; 780 Chaucer Avenue; San Jose, CA 95131; (408) 434-0490; FAX: (408) 434-0284. Contact: Ed Mongioli, CEO.

**CYBERTYPE DESKTOP PUBLISHING**; 9920 Jordan Avenue #14; Chatsworth, CA 91311; (818) 718-9244. Contact: Trish Meyer.

**GARY DAVIS & ASSOCIATES**; 3237 Donald Douglas Loop South; Santa Monica, CA 90405; (213) 397-6625; FAX: (213) 390-9917. Contact: Gary Davis, president.

**STEVE DIGGS & FRIENDS ADVERTISING**; 1110 16th Avenue South; Nashville, TN 37212; (615) 259-4024; FAX: (615) 726-3808. Contact: Jerry Atnip.

**EARTHRISE MULTIMEDIA**; PO Box 227; Cotopaxi, CO 81223; (719) 942-4427. Contact: Paul Sadler, owner.

**GOLD-N-Graphics, Inc.**; 1770 Forest Hill Road; Staten Island, NY 10314; (718) 494-6620; FAX: (718) 761-5865. Contact: Stan Zlotnick, creative director.

**GREINKE, EIER & ASSOCIATES**; N168 W20488 Main Street; Jackson, WI 53037; (414) 962-9810 (main ofc); (414) 677-3934. Contact: Arthur J. Greinke, CEO.

**GREINKE, EIER AND ASSOCIATES**; 2466 N. Oakland Avenue, Ste. 332; Milwaukee, WI 53211; (414) 962-9810. Contact: Arthur J. Greinke, CEO.

**ROBERT E. GRIFFIN, INC.**; 133 W. 19th Street, 8th Floor; New York, NY 10011; (212) 255-8491; FAX: (212) 206-6372. Contact: Bob Griffin, president.

**KENNETH HALE CREATIVE SERVICES**; 320 W. Illinois, Ste. 609; Chicago, IL 60610; (312) 222-1667. Contact: Kenneth Hale.

**HODGES MEDIA GROUP**; PO Box 51483; Palo Alto, CA 94303; (415) 856-7442; FAX: (415) 856-4837. Contact: Ed Hodges, owner.

**IMAGE MAKERS**; 11285 Elkins Road, Ste. H4; Roswell, GA 30076-1259; (404) 442-9474. Contact: Elaine M. Gossett, account director.

**MEDIA&MARKETING**; 11288 Ventura Boulevard #462; Studio City, CA 91604; (818) 753-9510; FAX: (818) 753-9320. Contact: Mel Lambert, creative director.

**NORTON RUBBLE & MERTZ ADVERTISING**; 120 N. Green, Ste. 3F; Chicago, IL 60607; (312) 942-1405; FAX: (312) 942-1487. Contact: Mark R. Miller, account executive.

**OHIO SONGWRITERS ASSOCIATION**; 27801 Euclid Avenue #30; Euclid, OH 44132; (216) 731-7864. Contact: J.N.A. Wunderle, president.

**MARK OLIVER, INC.**; 1 W. Victoria Street; Santa Barbara, CA 93101; (805) 963-0734; FAX: (805) 966-4281. Contact: Edward De Brava, account executive.

**POINTLINE**; 5690 West Mall; Atascadero, CA 93422; (805) 466-2787. Contact: Roysen Parsons, president.

**PR GROUP**; 906 N. Doheny, Ste. 405; Los Angeles, CA 90069; (213) 858-7244. Contact: Todd Ritchie.

**R.E. CLARK ADVERTISING, INC.**; 285 E. Imperial Highway, Ste. 101; Fullerton, CA 92635; (714) 441-1655; FAX: (714) 441-2374. Contact: Rick Clark, president.

**STEVEN W. ROSS & ASSOCIATES, INC.**; 1375 Broadway; New York, NY 10018; (212) 819-1170. Contact: Steven Ross, president.

**RPS COMMUNICATIONS**; 520 Arthur Street; Centerport, NY 11721; (516) 423-4038; FAX: (516) 423-6155. Contact: Randolph P. Savicky, president.

**RYDEN & ASSOCIATES**; 655 Grant Street; Denver, CO 80203; (303) 832-4600; FAX: (303) 832-8218. Contact: Mark Flick, visual services manager.

**PATRICK WILLIAM SALVO & ASSOCIATES PUBLIC RELATIONS**; 8686 Olympic Boulevard, Ste. 2; Los Angeles, CA 90035; (213) 659-1792. Contact: Patrick Salvo.

**HOWARD SHERMAN PUBLIC RELATIONS**; 682 Broadway, Ste. 223; New York, NY 10012; (212) 777-4711; FAX: (212) 979-0128. Contact: Howard Sherman, president.

**SHOSHANA**; 145 W. 67th Street, 16F; New York, NY 10023; (212) 721-3093. Contact: Shoshana Kirschenbaum, president.

**SOUND LAB PRODUCTIONS, INC.**; 1203 Yellowstone Drive; Newark, DE 19713; (302) 731-0204; FAX: (302) 738-7485. Contact: Roger Holiman, president.

**TULLY COMMUNICATIONS**; 5914 Fremont Street; Oakland, CA 94608; (415) 654-7169; FAX: (415) 654-7169. Contact: Tim Tully, owner.

**WILKERSON ADVERTISING**; 8444 Wilshire Boulevard, 6th Floor; Beverly Hills, CA 90211; (213) 655-6356; FAX: (213) 655-0327. Contact: Ron Wilkerson, president.

**WORDSWORK**; 3450 Third Street, Bldg. 2A; San Francisco, CA 94124; (415) 648-7334; FAX: (415) 821-9755. Contact: Linda Jacobson, chief scribe.

**LEGAL SERVICES**

**ALABAMA STATE BAR LAWYER REFERRAL SERVICE**; PO Box 671; Montgomery, AL 36101; (205) 269-1515; (800) 392-5660. Contact: Joy Meininger.

**ALASKA BAR ASSOCIATION LAWYER REFERRAL SERVICE**; 310 K Street, Ste. 602; Anchorage, AK 99501; (907) 272-0352.

**MARICOPA COUNTY LAWYER REFERRAL SERVICE**; 333 W. Roosevelt; Phoenix, AZ 85003; (602) 257-4200. Contact: Nan Wilder.

**ARKANSAS BAR ASSOCIATION LAWYER REFERRAL SERVICE**; 400 W. Markham; Little Rock, AR 72201; (501) 375-4605; (800) 482-9406. Contact: C.E. Ransick.

**LOS ANGELES COUNTY BAR ASSOCIATION LAWYER REFERRAL SERVICE**; PO Box 55020; Los Angeles, CA 90055; (213) 622-6700; (213) 627-2727. Contact: Shelley Ackerman.

**CALIFORNIA LAWYERS FOR THE ARTS**; Fort Mason Center, Bldg. C; San Francisco, CA 94123; (415) 775-7200. Contact: Alma Robinson.

**METROPOLITAN LAWYER REFERRAL SERVICE, INC.**; 1301 Pennsylvania Street, Suite 450; Penn Center; Denver, CO 80203; (303) 831-8000. Contact: Barbara A. Arbogast.

**HARTFORD REGIONAL LAWYER REFERRAL SERVICE**; 61 Hungerford Street; Hartford, CT 06106; (203) 525-6052; (800) 842-0067 (CN only). Contact: Janice L. Ambruso.

**DELAWARE STATE BAR ASSOCIATION LAWYER REFERRAL SERVICE**; 706 Market Street Mall; Wilmington, DE 19801; (302) 658-5278; (800) 292-7869.

**THE FLORIDA BAR LAWYER REFERRAL SERVICE**; Tallahassee, FL 32301-8226; (904) 222-5286; (800) 342-8060 (FL only). Contact: Jayne Carrol.

**LAWYER REFERRAL SERVICE OF THE ATLANTA BAR ASSOCIATION**; 606 Equitable Bldg.; 100 Peachtree Street NW; Atlanta, GA 30303; (404) 521-0777. Contact: Diane O'Steen.

**HAWAII STATE BAR ASSOCIATION LAWYER REFERRAL SERVICE**; PO Box 26; Honolulu, HI 96810; (808) 537-9140. Contact: Lorraine Tom.

**IDAHO STATE BAR LAWYER REFERRAL SERVICE**; 204 W. State Street, PO Box 895; Boise, ID 83701; (208) 342-8958. Contact: Dennis Harwick.

**ILLINOIS STATE BAR ASSOCIATION LAWYER REFERRAL SERVICE**; Illinois Bar Center; Springfield, IL 62701; (217) 525-1760; (800) 252-8908. Contact: Cathy L. Workman.

**CHICAGO BAR ASSOCIATION LAWYER REFERRAL SERVICE**; 29 S. LaSalle Street; Chicago, IL 60603-1575; (312) 332-1111. Contact: Jean Paveia.

**INDIANAPOLIS BAR ASSOCIATION LAWYER REFERRAL SERVICE**; 1 Indiana Square; Indianapolis, IN 46204; (317) 632-8240. Contact: Rosalie F. Felton.

**IOWA STATE BAR ASSOCIATION LAWYER REFERRAL SERVICE**; 1101 Fleming Bldg.; Des Moines, IA 50309; (515) 280-7429; (800) 532-1108. Contact: Mary Catterson.

**KANSAS BAR ASSOCIATION LAWYER REFERRAL SERVICE**; PO Box 1037; Topeka, KS 66601; (913) 233-4322; (800) 432-3593. Contact: Marcia Poell.

**KENTUCKY LAWYER REFERRAL SERVICE**; 707 W. Main Street, Ste. 200; Louisville, KY 40202; (502) 583-1576; (800) 372-2999 (KY only). Contact: Deborah C. Reed.

**NEW ORLEANS BAR ASSOCIATION LAWYER REFERRAL SERVICE**; 228 St. Charles Avenue, Ste. 1223; Whitney Bank Bldg.; New Orleans, LA 70130; (504) 525-7453. Contact: Helena Hendersson.

**MAINE STATE BAR ASSOCIATION LAWYER REFERRAL SERVICE**; 124 State Street, PO Box 788; Augusta, ME 04332; (207) 622-1460. Contact: Jacqueline M. Rogers.

**MARYLAND STATE BAR ASSOCIATION LAWYER REFERRAL SERVICE**; 520 W. Fayette Street; Baltimore, MD 21201; (301) 685-7878; (800) 492-1993. Contact: Andrea Dobbs.

**MASSACHUSETTS BAR ASSOCIATION LAWYER REFERRAL SERVICE**; 20 West Street; Boston, MA 02111-1204; (617) 542-9103; (800) 392-6164. Contact: Dorothea Boniello.

**STATE BAR OF MICHIGAN LAWYER REFERRAL SERVICE**; 306 Townsend Street; Lansing, MI 48933; (517) 372-9030; (800) 292-7850. Contact: Michael Franck.

**MINNESOTA STATE BAR ASSOCIATION LAWYER REFERRAL SERVICE**; 430 Marquette Avenue, Ste. 403; Minneapolis, MN 55401; (612) 333-1183. Contact: Nancy Kleeman.

**MISSISSIPPI STATE BAR LAWYER REFERRAL SERVICE**; PO Box 2168; Jackson, MS 39225; (601) 948-5488; (800) 682-6423. Contact: Gale Taylor.

**THE MISSOURI BAR LAWYER REFERRAL SERVICE**; 326 Monroe Street, PO Box 119; Jefferson City, MO 65101; (314) 635-4128; (800) 392-8777. Contact: Keith A. Birkes.

**STATE BAR OF MONTANA LAWYER REFERRAL SERVICE**; PO Box 4669; Helena, MT 59604; (406) 442-7660. Contact: George L. Bousliman.

**OMAHA BAR ASSOCIATION LAWYER REFERRAL SERVICE**; 2133 California Street; Omaha, NE 68178; (402) 341-4104. Contact: Penny Martin.

**STATE BAR OF NEVADA LAWYER REFERRAL SERVICE**; 295 Holcomb Avenue; Reno, NV 89502-1085; (702) 329-4101. Contact: Beulah W. Warren.

**STATE BAR OF NEVADA LAWYER REFERRAL SERVICE**; 500 S. 3rd Street #2; Las Vegas, NV 89119-0139; (702) 382-0504. Contact: Rebecca Pegram.

**LAWYER REFERRAL SERVICES OF THE NEW HAMPSHIRE BAR ASSOCIATION**; 18 Centre Street; Concord, NH 03301; (603) 224-6934; (800) 852-3799 (NH only). Contact: Steven Scudder.

**ATLA NEW JERSEY LAWYER REFERRAL SERVICE**; Bldg. A, Bonhamtown Corners; 15 S. Main Street; Edison, NJ 08837; (201) 906-8444; (800) 367-0089. Contact: Dennis R. Hett.



**LEGAL SERVICES**

**ALBUQUERQUE BAR ASSOCIATION LAWYER REFERRAL SERVICE;** 1210 First Interstate Bldg.; 4th and Gold SW; Albuquerque, NM 87102; (505) 243-2615. Contact: Phyllis D. Hill.

**NEW YORK STATE BAR ASSOCIATION LAWYER REFERRAL SERVICE;** One Elk Street; Albany, NY 12207; (518) 463-3200; (800) 342-3661 (NYS only). Contact: Audrey Ryan.

**VOLUNTEER LAWYERS FOR THE ARTS;** 1285 Avenue of the Americas, 3rd Fl.; New York, NY 10019; (212) 977-9270.

**NORTH CAROLINA BAR ASSOCIATION LAWYER REFERRAL SERVICE;** 1312 Annapolis Drive; Raleigh, NC 27605; (919) 828-1054; (800) 662-7660 (NC only). Contact: Allan B. Head.

**NORTH DAKOTA LAWYER REFERRAL SERVICE;** PO Box 2136; Bismarck, ND 58502; (701) 255-1404. Contact: Sherry L. King.

**CLEVELAND BAR ASSOCIATION LAWYER REFERRAL SERVICE;** 118 St. Clair Avenue; Cleveland, OH 44114; (216) 696-3525. Contact: Thomas J. Brady.

**CINCINNATI BAR ASSOCIATION LAWYER REFERRAL SERVICE;** 35 E. 7th Street, 8th Floor; Cincinnati, OH 45202-2411; (513) 381-8359. Contact: Bernard L. Raverty.

**LAWYER REFERRAL SERVICE OF THE OKLAHOMA COUNTY BAR;** 119 N. Robinson, Ste. 240; Oklahoma City, OK 73102; (405) 235-6022. Contact: John B. Berry.

**OREGON STATE BAR LAWYER REFERRAL SERVICE;** 5200 S.W. Meadows Road, PO Box 1689; Lake Oswego, OR 97304-0889; (503) 684-7636 (local); (503) 620-0222. Contact: Victoria Short Baum.

**PENNSYLVANIA LAWYER REFERRAL SERVICE;** 100 South Street, PO Box 186; Harrisburg, PA 17108; (800) 692-7375. Contact: Eileen Showers.

**RHODE ISLAND BAR ASSOCIATION LAWYER REFERRAL SERVICE;** 91 Friendship Street; Providence, RI 02903; (401) 421-7799; (401) 421-7722. Contact: Veronica A. Holland.

**SOUTH CAROLINA BAR LAWYER REFERRAL SERVICE;** PO Box 608; Columbia, SC 29202; (803) 799-7100. Contact: Eve Moredock Stacey.

**SOUTH DAKOTA LAWYER REFERRAL SERVICE;** 222 E. Capitol; Pierre, SD 57501; (605) 224-7554; (800) 952-2333.

**NASHVILLE BAR ASSOCIATION LAWYER REFERRAL SERVICE;** 311 Stahlman Bldg.; Nashville, TN 37201; (615) 242-6546. Contact: Melinda J. Fish.

**STATE BAR OF TEXAS LAWYER REFERRAL SERVICE;** PO Box 12487, 1414 Colorado Street; Austin, TX 78711; (512) 463-1474; (800) 252-9690. Contact: William C. LaRowe.

**UTAH STATE BAR LAWYER REFERRAL SERVICE;** 425 E. First South; Salt Lake City, UT 84111; (801) 531-9075. Contact: Stephen F. Hutchinson.

**VERMONT BAR ASSOCIATION LAWYER REFERRAL SERVICE;** PO Box 100; Montpelier, VT 05602; (802) 223-2020; (800) 642-3153. Contact: Patricia M. Blake.

**VIRGINIA LAWYER REFERRAL SERVICE;** 801 E. Main Street; 10th Floor, Ross Boulevard; Richmond, VA 23219; (804) 648-4014; (800) 552-7977. Contact: Penny Holloman.

**DISTRICT OF COLUMBIA BAR LAWYER REFERRAL SERVICE;** 1707 L Street, NW, Ste. 600; Washington, DC 20036; (202) 331-4365. Contact: Herman A. Cramer.

**WASHINGTON STATE BAR ASSOCIATION LAWYER REFERRAL SERVICE;** 500 Westin Bldg., 2001 6th Avenue; Seattle, WA 98121-2599; (206) 448-0441; (800) 552-0787. Contact: John Michalk.

**THE WEST VIRGINIA STATE BAR LAWYER REFERRAL SERVICE;** E-400 State Capitol; Charleston, WV 25305; (304) 348-2880. Contact: Hope Gresham.

**STATE BAR OF WISCONSIN LAWYER REFERRAL SERVICE;** Box 7158; Madison, WI 53707; (608) 257-3838; (800) 362-8096. Contact: Shell Goar.

**CANADIAN BAR ASSN. LAWYER REFERRAL SERVICE, B.C. BRANCH;** 202-1148 Homby Street; Vancouver, BC V6Z 2C3; (604) 687-3221. Contact: Alfred J. Eddy.

**LAW SOCIETY OF MANITOBA LAWYER REFERRAL PROGRAM;** 202-379 Broadway; Winnipeg, MB R3C 0T9; (204) 943-2305; (800) 262-8800. Contact: Mary C. Troszko.

**NOVA SCOTIA BARRISTERS' SOCIETY LAWYER REFERRAL SERVICE;** 1475 Hollis Street; Halifax, NS B3J 3M4; (902) 422-1491. Contact: Anne E. Bonang.

**LAW SOCIETY OF UPPER CANADA LAWYER REFERRAL SERVICE;** 206-204 Richmond Street West; Osgood Hall; Toronto, ON M5V 1V6; (416) 947-3330.

**BAR OF MONTREAL LAWYER REFERRAL SERVICE;** Court House, 9th Floor; Montreal, QC H2Y 1B6; (514) 866-9392. Contact: Emée Landry.

**PUBLIC RELATIONS FIRMS**

**ANR ADVERTISING, INC.;** 150 River Road, Bldg. F; Montville, NJ 07045; (201) 299-8000; FAX: (201) 299-7937. Contact: David Scelba, vice president.

**ARTISANS PR & ADVERTISING;** 1762 S. Wooster Street; Los Angeles, CA 90035; (213) 837-6008; FAX: (213) 837-2286. Contact: Linda A. Rosner, partner.

**AUDIANT MARKETING SERVICES;** 21000 Devonshire Street #205; Chatsworth, CA 91311; (818) 773-9497; FAX: (818) 718-2886. Contact: Erika Lopez, owner.

**BAROLIN ADVERTISING, INC.;** 134 Kings Highway East; Haddonfield, NJ 08033; (609) 354-6222; FAX: (609) 354-6223. Contact: Roxanne Ciarrocca, account executive.

**BRUCE J. BORGERSON;** 307 Glenn Street; Ashland, OR 97520; (503) 488-5542. Contact: Bruce J. Borgerson.

**BQ-PR;** 51 Federal Street; San Francisco, CA 94107; (415) 495-2750; FAX: (415) 495-2684. Contact: Nancy Evans, owner.

**BURSON-MARSTELLER;** 3333 Wilshire Boulevard; Los Angeles, CA 90010; (213) 386-8776; FAX: (213) 251-4650. Contact: Sheryl Feuerstein, client svcs. mgr.

**CARTER/ELLIOTT ADVERTISING & PUBLIC RELATIONS;** 15720 Winchester Boulevard; Los Gatos, CA 95030; (408) 395-1161; FAX: (408) 395-0544. Contact: Carter Elliott, president.

**CONCEPT;** 14596 Big Basin Way; Saratoga, CA 95070; (408) 741-1751; FAX: (408) 741-4836. Contact: Deborah Coburn Rice, president.

**COSMIC MUFFIN GROUP;** 12944 Woodbridge Street; Studio City, CA 91604; (818) 986-4643; FAX: (818) 986-4664. Contact: Ronald Bennett, president.

**CREATIVE MEDIA CONSULTANTS;** PO Box 491279; Los Angeles, CA 90049-1279; (213) 204-2262; FAX: (213) 204-0329. Contact: Michael Binstock, president.

**CRN;** 8 Bond Street, Ste. 203; Great Neck, NY 11021; (516) 487-5904; FAX: (516) 487-4056. Contact: Sean Reynolds, account executive.

**DASSINGER CREATIVE SERVICES;** 44 Vernon Terrace; Bloomfield, NJ 07003; (201) 748-7025; FAX: (201) 748-3114. Contact: George Dassinger, president.

**GARY DAVIS & ASSOCIATES;** 3237 Donald Douglas Loop South; Santa Monica, CA 90405; (213) 397-6625; FAX: (213) 390-9917. Contact: Gary Davis, president.

**GREGORY DETOGNE;** 16022 W. Gages Lake Road; Libertyville, IL 60048; (708) 367-8187. Contact: Greg DeTogne.

**JEFF DIAMOND;** 216 4th Avenue #10; San Francisco, CA 94118; (415) 751-3129; FAX: (415) 751-3129. Contact: Jeff Diamond.

**STEVE DIGGS & FRIENDS ADVERTISING;** 1110 16th Avenue South; Nashville, TN 37212; (615) 259-4024; FAX: (615) 726-3808. Contact: Jerry Atrip.

**FILM & VIDEO SERVICE;** 330 Townsend Street, Ste. 102; San Francisco, CA 94107; (415) 495-5015; FAX: (415) 495-0520. Contact: Charles Rudnick, owner.

**GREINKE, EIERS & ASSOCIATES;** N168 W20488 Main Street; Jackson, WI 53037; (414) 962-9810 (main ofc); (414) 677-3934. Contact: Arthur J. Greinke, CEO.

**GREINKE, EIERS AND ASSOCIATES;** 2466 N. Oakland Avenue, Ste. 332; Milwaukee, WI 53211; (414) 962-9810. Contact: Arthur J. Greinke, CEO.

**ROBERT E. GRIFFIN, INC.;** 133 W. 19th Street, 8th Floor; New York, NY 10011; (212) 255-8491; FAX: (212) 206-6372. Contact: Bob Griffin, president.

**HAMMAR COMMUNICATIONS;** 860 Coyote Mtn.; Colfax, CA 95713; (916) 637-4604; FAX: (916) 637-4675. Contact: Peter Hammar, director.

**HARTFERD COMMUNICATIONS;** Sunset Gower Studios; 1438 N. Gower, Box 41; Hollywood, CA 90028; (213) 460-6807; FAX: (213) 460-6831. Contact: Skip Ferderber, president.

**HAWTHORNE COMMUNICATIONS, INC.;** PO Box 1238 Canal Street Station; New York, NY 10013-1238; (212) 475-3227; FAX: (212) 979-0128. Contact: David Hawthorne, president.

**HENDERSON & ASSOCIATES MARKETING COMMUNICATIONS;** 7287 S. Tamarac Street; Englewood, CO 80112; (303) 850-7513; FAX: (303) 694-9628. Contact: David E. Henderson, owner.

**HODGES MEDIA GROUP;** PO Box 51483; Palo Alto, CA 94303; (415) 856-7442; FAX: (415) 856-4837. Contact: Ed Hodges, owner.

**IMAGE MAKERS;** 11285 Elkins Road, Ste. H4; Roswell, GA 30076-1259; (404) 442-9474. Contact: Elaine M. Gossett, account director.

**INTERNATIONAL MEDIA NETWORK;** 3575 Cahuenga Boulevard, Ste. 218; Los Angeles, CA 90068; (213) 969-9914; FAX: (213) 969-9923. Contact: Craig A. Malone, West Coast director of music.

**JOSELL COMMUNICATIONS, INC.;** 185 West End Avenue, Ste. 22C; New York, NY 10023; (212) 877-5560; FAX: (212) 877-6254. Contact: Jessica Josell, president.

**KNAYER COVE SOUND STUDIOS;** 2162 Orchard Park Drive; Schenectady, NY 12309; (518) 370-0698. Contact: Christopher W. Haines, engineer.

**MANIS MONDA ALLEN ADVERTISING;** 330 Clematis Street, Ste. 219; West Palm Beach, FL 33401; (407) 655-8177; FAX: (407) 659-5423. Contact: Robert Manis, president.

**MANIS MONDA ALLEN ADVERTISING;** 490 Route 304; New City, NY 10956; (914) 639-9400; FAX: (914) 639-9456. Contact: Robert Manis, president.

**BOBBI MARCUS PUBLIC RELATIONS;** 1616 Butler Avenue; West Los Angeles, CA 90025; (213) 479-2001; FAX: (213) 479-4615. Contact: Bobbi Marcus, president.

**MEDIA&MARKETING;** 11288 Ventura Boulevard #462; Studio City, CA 91604; (818) 753-9510; FAX: (818) 753-9320. Contact: Mel Lambert, creative director.

**MEDIA MULTISOUND;** 1413 W. 38th Street; Sioux Falls, SD 57105; (605) 335-3368. Contact: Robert Joyce, owner.

**MEDIA/SCAN;** 38 W. 26th Street; New York, NY 10010; (212) 929-6108; FAX: (212) 929-7032. Contact: April Beer, dir. of account svcs.

**MORGAN & MORGAN PUBLIC RELATIONS, INC.;** 12501 Chandler Boulevard, Ste. 107; North Hollywood, CA 91607; (818) 766-1425; FAX: (818) 766-0199. Contact: Marty Morgan, president.



**MPA EDITORIAL**  
Pt. Washington, NY

**MPA EDITORIAL;** 939 Pt. Washington; Pt. Washington, NY 11050; (516) 944-5940; FAX: (516) 767-1745. Contact: Martin Porter.

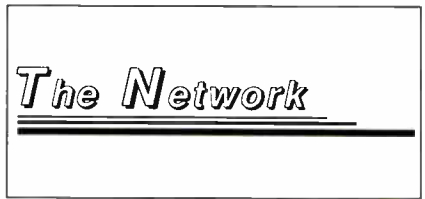

**THE NETWORK**  
Olympia, WA

**THE NETWORK;** 5423 Ramblewood Lane S.E.; Olympia, WA 98503; (206) 493-1153; FAX: (206) 493-1256. Contact: Kathy Arnold.

**NORTON RUBBLE & MERTZ ADVERTISING;** 120 N. Green, Ste. 3F; Chicago, IL 60607; (312) 942-1405; FAX: (312) 942-1487. Contact: Mark R. Miller, account executive.

**PAM LEWIS & ASSOCIATES;** 1109 17th Avenue South; Nashville, TN 37212; (615) 329-9412; (615) 329-9415; FAX: (615) 321-0534. Contact: Pam Lewis, president.

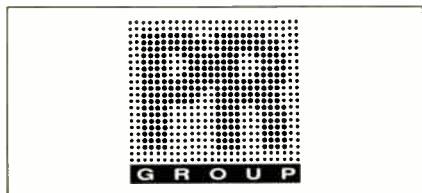

PR GROUP  
Los Angeles, CA

**PR GROUP;** 906 N. Doheny, Ste. 405; Los Angeles, CA 90069; (213) 858-7244. Contact: Todd Ritchie.

**PROMOTIONS;** 13455 Ventura Boulevard, Ste. 212; Sherman Oaks, CA 91423; (818) 990-8070. Contact: Aleon Bennett, president.

**PUBLIC | PUBLICITY SERVICES, INC.;** 928 Broadway, Ste. 1102; New York, NY 10010; (212) 505-8778; FAX: (212) 979-2768. Contact: Ida S. Langsam, president.

**PUBLIC RELATIONS ASSOCIATES;** 1660 S. Albion Street #309; Denver, CO 80222; (303) 756-0508; FAX: (303) 758-9203. Contact: Fred Hobbs, president.

**R.E. CLARK ADVERTISING, INC.;** 285 E. Imperial Highway, Ste. 101; Fullerton, CA 92635; (714) 441-1655; FAX: (714) 441-2374. Contact: Rick Clark, president.

**RESOURCE;** 575 Sand Dollar Lane; La Selva Beach, CA 95076; (408) 761-5937; FAX: (408) 761-5937. Contact: Ron A. Neilson, partner.

**RICHARD H. ROFFMAN ASSOCIATES;** 697 West End Avenue; New York, NY 10025; (212) 749-3647; (212) 749-3648. Contact: Richard H. Roffman, president.

**STEVEN W. ROSS & ASSOCIATES, INC.;** 1375 Broadway; New York, NY 10018; (212) 819-1170. Contact: Steven Ross, president.

**RPS COMMUNICATIONS;** 520 Arthur Street; Centerport, NY 11721; (516) 423-4038; FAX: (516) 423-6155. Contact: Randolph P. Savicky, president.

**PATRICK WILLIAM SALVO & ASSOCIATES PUBLIC RELATIONS;** 8686 Olympic Boulevard, Ste. 2; Los Angeles, CA 90035; (213) 659-1792. Contact: Patrick Salvo.

**HOWARD SHERMAN PUBLIC RELATIONS;** 682 Broadway, Ste. 223; New York, NY 10012; (212) 777-4711; FAX: (212) 979-0128. Contact: Howard Sherman, president.

**S.J. GOLDEN ASSOCIATES;** 300 E. 34th Street; New York, NY 10016; (212) 683-9672.

**SOLTERS/ROSKIN/FRIEDMAN, INC.;** 5455 Wilshire Boulevard, Ste. 2200; Los Angeles, CA 90036; (213) 936-7900; FAX: (213) 933-9874. Contact: Monroe Friedman, vice president.

**SOUND LAB PRODUCTIONS, INC.;** 1203 Yellowstone Drive; Newark, DE 19713; (302) 731-0204; FAX: (302) 738-7485. Contact: Roger Hoilman, president.

**TERPIN GROUP;** 3713 Highland Avenue, Ste. 2; Manhattan Beach, CA 90266; (213) 545-1212; FAX: (213) 546-5959. Contact: Mike Terpin, president.

**TULLY COMMUNICATIONS;** 5914 Fremont Street; Oakland, CA 94608; (415) 654-7169; FAX: (415) 654-7169. Contact: Tim Tully, owner.

**VISIBILITY PUBLIC RELATIONS, INC.;** 611 Broadway, Ste. 709; New York, NY 10012; (212) 777-4350; FAX: (212) 777-5497. Contact: Len Stein, president.

**W3 PUBLIC RELATIONS;** 8380 Melrose Avenue #105; Los Angeles, CA 90069; (213) 852-1043; FAX: (213) 852-7127. Contact: Sharon Weisz, owner.

**WILKERSON ADVERTISING;** 8444 Wilshire Boulevard, 6th Floor; Beverly Hills, CA 90211; (213) 655-6356; FAX: (213) 655-0327. Contact: Ron Wilkerson, president.

## MISCELLANEOUS SERVICES

**ANR ADVERTISING, INC.;** Marketing; 150 River Road, Bldg. F; Montville, NJ 07045; (201) 299-8000; FAX: (201) 299-7937. Contact: David Scelba, vice president.

**BAROLIN ADVERTISING, INC.;** Marketing, Sales Promotion, Scriptwriting; 134 Kings Highway East; Haddonfield, NJ 08033; (609) 354-6222; FAX: (609) 354-6223. Contact: Roxanne Ciarrocca, account executive.

**BRUCE J. BORGERSON;** Technical Writing; 307 Glenn Street; Ashland, OR 97520; (503) 488-5542. Contact: Bruce J. Borgerson.

**CARTER/ELLIOTT ADVERTISING & PUBLIC RELATIONS;** Marketing; 15720 Winchester Boulevard; Los Gatos, CA 95030; (408) 395-1161; FAX: (408) 395-0544. Contact: Carter Elliott, president.

**COMMUNICATIONS PLUS, INC.;** Marketing, Sales Promotion; 360 Park Avenue South; New York, NY 10010; (212) 686-9570. Contact: Patricia Pheian, account executive.

**CONCEPT;** Marketing; 14596 Big Basin Way; Saratoga, CA 95070; (408) 741-1751; FAX: (408) 741-4836. Contact: Deborah Coburn Rice, president.

**THE CREATIVE IMAGE GROUP;** Marketing; 780 Charcot Avenue; San Jose, CA 95131; (408) 434-0490; FAX: (408) 434-0284. Contact: Ed Mongiovi, CEO.

**CREATIVE MEDIA CONSULTANTS;** Marketing; PO Box 491279; Los Angeles, CA 90049-1279; (213) 204-2262; FAX: (213) 204-0329. Contact: Michael Binstock, president.

**CROSS THE ROAD PRODUCTIONS;** Radio Production; PO Box 801763; Santa Clarita, CA 91380; (805) 254-8069; (818) 953-5099. Contact: Ron Lewis, general manager.

**DASSINGER CREATIVE SERVICES;** Marketing, Promotion; 44 Vernon Terrace; Bloomfield, NJ 07003; (201) 748-7025; FAX: (201) 748-3114. Contact: George Dassinger, president.

**GARY DAVIS & ASSOCIATES;** Technical Writing (Instruction Manuals), Desktop Publishing; 3237 Donald Douglas Loop South; Santa Monica, CA 90405; (213) 397-6625; FAX: (213) 390-9917. Contact: Gary Davis, president.

## The Future is within reach

... Introducing a revolutionary advance in audio technology that will change your world ... from ANALOG to LIGHTWAVE



The DIGITAL AUDIO SYSTEM DAS 2000™ series from LAL is a fully integrated "smart" audio system. It provides multipoint-to-multipoint fiber optic sound transmission, distribution and routing with automated SOFT PATCH™ programmable memory control for both real time and pre-programmed changeovers.

The DAS 2000 advanced system technology automates previously manual processes, greatly reduces set-up time, improves sound quality and is compatible with existing analog equipment. This compact, self-diagnostic, modular system features:

- 15,000 ft. Fiber Transmission Distance
- Modular System in 19" Rack Mount
- Expandable to 64 Channels [8 ch./exp. board]
- 16 Return Lines, [optional - 8 ch./exp. board]
- A/D Converter - 16 BIT Delta Sigma
- D/A Converter - 18 BIT PCM
- 94dB Dynamic Range
- Frequency Response 10Hz - 22KHz
- REMOTE CONTROL FEATURES...  
"Soft Patch™" 64 x 64 Routing/Patching,  
Large LCD Backlite Display, 40x8 char., 6 Step Gain Control,  
48V Phantom Powering

Call today (214) 637 9311 or FAX (214) 637 9314

Discover how DAS 2000 can revolutionize your world.

**LAL**  
LESTER AUDIO  
LABORATORIES

## The Future is Now!



## Professional Services

U. S. & C A N A D A

### MISCELLANEOUS SERVICES

**GREGORY DETOGNE**; *Technical Writing*; 16022 W. Gages Lake Road; Libertyville, IL 60048; (708) 367-8187. Contact: Greg DeTogne.

**DJM ADVERTISING & PUBLIC RELATIONS**; *Technical Writing*; 22575 E. Birdseye Drive; Diamond Bar, CA 91765; (714) 396-0478; FAX: (714) 860-0255. Contact: Neil R. Heller.

**EARTHRISE MULTIMEDIA**; *Jingle Writing*; PO Box 227; Cotopaxi, CO 81223; (719) 942-4427. Contact: Paul Sadler, owner.

## FINK & BLAKELY ASSOCIATES

Recruitment Specialists for the Audio, Video & Broadcast Industries

FINK & BLAKELY ASSOCIATES  
San Francisco, CA

**FINK & BLAKELY ASSOCIATES**; *Executive Recruitment Services*; 1282 California Street; San Francisco, CA 94109; (415) 441-3777; FAX: (415) 775-4925. Contact: Neil Fink.

**GOLD-N-GRAPHICS, INC.**; *Marketing*; 1770 Forest Hill Road; Staten Island, NY 10314; (718) 494-6620; FAX: (718) 761-5865. Contact: Stan Zlotnick, creative director.

**GREINKE, EIERS & ASSOCIATES**; *Composition*; N168 W20488 Main Street; Jackson, WI 53037; (414) 962-9810 (main ofc); (414) 677-3934. Contact: Arthur J. Greinke, CEO.

**ROBERT E. GRIFFIN, INC.**; *Technical Writing*; 133 W. 19th Street, 8th Floor; New York, NY 10011; (212) 255-8491; FAX: (212) 206-6372. Contact: Bob Griffin, president.

**HARTFERD COMMUNICATIONS**; *Marketing*; Sunset Gower Studios; 1438 N. Gower, Box 41; Hollywood, CA 90028; (213) 460-6807; FAX: (213) 460-6831. Contact: Skip Ferderber, president.

**HAWTHORNE COMMUNICATIONS, INC.**; *Market Research*; PO Box 1238 Canal Street Station; New York, NY 10013-1238; (212) 475-3227; FAX: (212) 979-0128. Contact: David Hawthorne, president.

**HEYWOOD FORMATICS & SYNDICATION**; *Promotional Consulting*; 1103 Colonial Boulevard; Canton, OH 44714-1837; (216) 456-2592; FAX: (216) 456-2592. Contact: Max Heywood, owner.

**HODGES MEDIA GROUP**; *Marketing*; PO Box 51483; Palo Alto, CA 94303; (415) 856-7442; FAX: (415) 856-4837. Contact: Ed Hodges, owner.

**KLAV RADIO**; *Radio Production*; 364 Convention Center Drive; Las Vegas, NV 89109; (702) 796-1230; (702) 798-4111. Contact: Rae Miller, operator.

**LABOV & BEYOND MUSIC PRODUCTIONS**; *Music Production*; 1728 Spy Run Avenue; Fort Wayne, IN 46805; (219) 420-5533; FAX: (219) 422-1443. Contact: Christopher Parker, producer.

**LA COSTA MUSIC BUSINESS CONSULTANTS**; *Book Publisher, Artist Mgmt.*; PO Box 147; Cardiff, CA 92007; (619) 436-7219. Contact: Robert A. Livingston, consultant.

**LIGHTHOUSE SOFTWARE**; *Software Development*; PO Box 2252; Fairfield, IA 52556; (515) 472-9152; FAX: (515) 472-9152. Contact: John Szasz, president.

**MARTIN AUDIO**; *Broadcast Support*; 642 Holly Avenue; Winston-Salem, NC 27101; (919) 722-0699. Contact: Frank Martin, owner.

**MEDIA&MARKETING**; *Marketing*; 11288 Ventura Boulevard #462; Studio City, CA 91604; (818) 753-9510; FAX: (818) 753-9320. Contact: Mel Lambert, creative director.

**THE NETWORK**; *Marketing, Technical Writing, Consulting*; 5423 Ramblewood Lane S.E.; Olympia, WA 98503; (206) 493-1153; FAX: (206) 493-1256. Contact: Kathy Arnold.

**POINTLINE**; *Radio Production*; 5690 West Mall; Atascadero, CA 93422; (805) 466-2787. Contact: Royson Parsons, president.

**PUBLIC I PUBLICITY SERVICES, INC.**; *Artist Development*; 928 Broadway, Ste. 1102; New York, NY 10010; (212) 505-8778; FAX: (212) 979-2768. Contact: Ida S. Langsam, president.

**PUBLIC RELATIONS ASSOCIATES**; *Scriptwriting*; 1660 S. Albion Street #309; Denver, CO 80222; (303) 756-0508; FAX: (303) 758-9203. Contact: Fred Hobbs, president.

**PUBLISHING SERVICES MANAGEMENT GROUP**; *Print Publication Mgmt.*; 309 4th Avenue, Ste. 203; San Francisco, CA 94118; (415) 751-5805; FAX: (415) 751-5805. Contact: Mark Gunther, principal.

**RESOURCE**; *Publisher's Services, Market Research*; 575 Sand Dollar Lane; La Selva Beach, CA 95076; (408) 761-5937; FAX: (408) 761-5937. Contact: Ron A. Neilson, partner.

**RICHARD H. ROFFMAN ASSOCIATES**; *Talent Representatives*; 697 West End Avenue; New York, NY 10025; (212) 749-3647; (212) 749-3648. Contact: Richard H. Roffman, president.

**STEVEN W. ROSS & ASSOCIATES, INC.**; *Marketing*; 1375 Broadway; New York, NY 10018; (212) 819-1170. Contact: Steven Ross, president.

**PATRICK WILLIAM SALVO & ASSOCIATES PUBLIC RELATIONS**; *Management Consulting, Marketing*; 8686 Olympic Boulevard, Ste. 2; Los Angeles, CA 90035; (213) 659-1792. Contact: Patrick Salvo.

**S.J. GOLDEN ASSOCIATES**; *Marketing*; 300 E. 34th Street; New York, NY 10016; (212) 683-9672.

**SONGWRITER SERVICES**; *Song Registration*; 603 W. 13th #1A-167; Austin, TX 78701; (512) 452-6116. Contact: Bill Anderson, owner.

**SOUND CAT**; *Commercial Writing*; 832 Sansome St., 3rd Floor; San Francisco, CA 94111; (415) 986-0992. Contact: Penny Jacob, partner.

**SOUND LAB PRODUCTIONS, INC.**; *Special Events, Computer Animation*; 1203 Yellowstone Drive; Newark, DE 19713; (302) 731-0204; FAX: (302) 738-7485. Contact: Roger Holman, president.

**SOUNDSCAPES**; *Radio Production*; 3422 Old Cantrell Road; Little Rock, AR 72202; (501) 661-1765. Contact: Brent Walker, owner.

**TERMINAL MARKETING COMPANY, INC.**; *Equipment Leasing*; 5 Waverly Court; New City, NY 10956; (914) 634-7601; FAX: (914) 634-7813. Contact: Sandy Schneiderman, president.

**VISIBILITY PUBLIC RELATIONS, INC.**; *Marketing*; 611 Broadway, Ste. 709; New York, NY 10012; (212) 777-4350; FAX: (212) 777-5497. Contact: Len Stein, president.

**VISUAL SERVICES, INC.**; *Marketing*; 2100 N. Woodward Avenue; Bloomfield Hills, MI 48018; (313) 644-0500; FAX: (313) 646-0888. Contact: Thomas E. Gurka, film/video mgr.

**THE VOCAL REGISTRY**; *Talent*; PO Box 65134; Los Angeles, CA 90065; (213) 969-1607. Contact: Angelo Roman, Jr., director.

**WORDS TO ORDER**; *Desktop Publishing, Technical Writing, Feature Writing*; Los Angeles, CA; (818) 341-1951. Contact: Amy Ziffer, owner.

**WORDSWORK**; *Technical Writing, Promotional Writing, Documentation*; 3450 Third Street, Bldg. 2A; San Francisco, CA 94124; (415) 648-7334; FAX: (415) 821-9755. Contact: Linda Jacobson, chief scribe.

# Edit this:



Not an easy proposition, right? Wrong.

With Sound Tools™, the DAT I/O™ Digital Interface and your Macintosh® II, you've got a desktop DAT editing system.

That's two channels of digital audio. AES/EBU or S/PDIF formats. 48 kHz or 44.1 kHz sampling rates. Fast and flexible editing.

And for less than \$3,300 – it's paid for in about 12 hours of studio time!\*

Sound Tools is the world's best selling direct to disk digital recording system. Find out why. Call 1-800-333-2137 for a free brochure.



\*Sound Tools with DAT I/O, \$3285. Macintosh and hard disk not included.

## digidesign

1360 Willow Rd. #101  
Menlo Park, CA 94025  
415.688.0600

### Mix Trivia

7. By 1991, it is estimated that 30% of the television sets sold in America will contain this built-in feature.

8. This company was the first to sell pre-recorded digital audio cassettes—in 1982, in the EIAJ (F1) format.

Turn to page 152 for question

# RECORDING & VIDEO PRODUCTION FACILITIES

UNITED STATES

## ALABAMA

### 24+ Track Recording Studios

►[24+] **AIRWAVE PRODUCTION GROUP INC.**; AR, AD, APPV, APPF, JCP, MIDI, MP; 1916 28th Ave. S.; Birmingham, AL 35209; (205) 870-3239; FAX: (205) 870-0624.

►[24+] **BATES BROTHERS RECORDING**; RLR; 25 Joy Ave. #101; Birmingham, AL 35023; (205) 491-4066.

[24+] **BOUTWELL RECORDING STUDIOS, INC.**; RLR; 720 S. 23rd St.; Birmingham, AL 35233; (205) 251-8889.

►[24+] **COOK SOUND STUDIOS**; 1419 Scenic Rd.; Fort Payne, AL 35967; (205) 845-2286.

►[24+] **FRONT ROW PRODUCTIONS, INC.**; AR, AD, ATD, JCP, MIDI, MP, RLR; #4 S. 55th Pl.; Birmingham, AL 35212; (205) 592-2222; FAX: (205) 592-2228.

[24+] **KOS PRODUCTIONS AND RECORDING STUDIO**; AR, APPV, JCP, MIDI; 709-25th Ave. E.; Tuscaloosa, AL 35404; (205) 553-7680; FAX: (205) 556-9224.

[24+] **MUSCLE SHOALS SOUND STUDIOS**; AR, AD, JCP; 1000 Alabama Ave.; Sheffield, AL 35660; (205) 381-2060; FAX: (205) 381-6813.

[24+] **SOUND CELL PRODUCTIONS**; AR, AD, ATD, JCP, MIDI, MP, ED, RLR; 601 Meridian St.; Huntsville, AL 35801; (205) 539-1868.

[24+] **SOUND OF BIRMINGHAM RECORDING STUDIO**; AR, AD, APPV, ATD, JCP, MIDI, MP, ED, RLR; 3625 5th Ave. S.; Birmingham, AL 35222; (205) 595-8497.

### 12 & 16 Track Recording Studios

[16] **M.A. BENINGTON CO.**; AR, RLR; 2459 Cuchura Dr.; Birmingham, AL 35244; (205) 988-0707.

[16] **DOGWOOD RECORDING STUDIOS**; AR, AD, APPV, APPF, ATD, JCP, MIDI, MP, RLR; 2813 Springhill Ave.; Mobile, AL 36607; (205) 649-0371; FAX: (205) 479-0364.

►[16] **GRAPEVINE STUDIOS**; AR, RLR; PO Box 8324; Gadsden, AL 35902; (205) 442-3330; FAX: (205) 442-6285.

[16] **JINGLEWORKS**; AR, APPV, APPF, ATD, JCP, MIDI, MP, RLR, SR, VP; 220 St. Michael St.; Mobile, AL 36602; (205) 433-3399; FAX: (205) 433-0014.

►[16] **L.A. EAST, INC.**; AR, VP; PO Box 1205; Ozark, AL 36361; (205) 774-7212.

**R**ecording & Video Production Facilities, U.S., is organized alphabetically by state. Canadian facilities (page 97) are broken down by province. Within each state/province, facilities are listed according to track format, beginning with 24+ track, followed by 12 & 16, then 4 & 8; video production/post-production facilities come after the state's last recording studio. A facility services key is listed on this page and on page 97.

[16] **MONTGOMERY SOUND RECORDERS**; 2038 Upper Wetumpka Rd.; Montgomery, AL 36107; (205) 263-5790.

[16] **OAK BOWERY RECORDING**; AR, APPV, ATD, EIR, JCP, MIDI, MP, RLR, SR, MAST; Rt. 3 Box 185; Lafayette, AL 36862; (205) 749-5879.

[16] **RAINBOW RIVER STUDIOS**; RLR; PO Box 1708; Auburn, AL 36830; (205) 821-4876.

[16] **UNDERGROUND SOUND RECORDING STUDIO**; AR, JCP, MIDI; 3010 Skyland Blvd. E.; Tuscaloosa, AL 35405; (205) 556-0030.

### 4 & 8 Track Recording Studios

[8] **BAMA SOUND**; RLR; PO Box 2001; Decatur, AL 35602; (205) 353-4142.

[4] **THE GENESIS GROUP**; AR, ATD, JCP, MAST; 3315 Demetropolis Rd., Ste. 403; Mobile, AL 36693; (205) 661-8887; FAX: (205) 661-2002.

[8] **LEATHERWOOD SOUND**; AR, SR; 4107 Bynum-Leatherwood Rd.; Anniston, AL 36206; (205) 238-1038.

[4] **RIDGE RECORDING STUDIOS**; AR, MIDI; 399 Cahaba Rd.; Greenville, AL 36037; (205) 382-7800.

[8] **SOUNDWORKS, INC.**; AR, APPV, ATD, JCP, MIDI; 1755 Conti St.; Mobile, AL 36604; (205) 479-3331; FAX: (205) 479-3350.

[8] **STUDIO 6/PERSUASIVE MEDIA**; AR, JCP, MIDI, MP, RLR, VP; 6 S. 55th Pl.; Birmingham, AL 35212; (205) 591-0804.

[8] **WOODRICH RECORDING STUDIO**; AR, MP; PO Box 38; Lexington, AL 35648; (205) 247-3983.

### Video Production & Post-Production Facilities

**AIRWAVE PRODUCTION GROUP INC.**; APPV; 1916 28th Ave. S.; Birmingham, AL 35209; (205) 870-3239; FAX: (205) 870-0624.

**ENSEMBLE PRODUCTIONS**; VPPE, OLVP, VTD; PO Box 2332; Auburn, AL 36831; (205) 826-3045.

**JMI/CREATIVE AUDIO SERVICES**; APPV; 3655 Old Shell Rd. #321; Mobile, AL 36608; (205) 343-2023.

**KUDZU PRODUCTIONS INC.**; VPF, VPPE, OLVP, APPV, VTD; 4415 Evangel Cir.; Huntsville, AL 35816; (205) 830-4332; FAX: (205) 895-9257.

**POWER PRODUCTIONS**; VPF, VPPE, OLVP, APPV; 1967 Government St., Ste. D; Mobile, AL 36606; (205) 478-5530.

**VIDEO ONE TELEPRODUCTIONS**; VPF, VPPE, OLVP, APPV, VTD; 220 St. Michael St.; Mobile, AL 36602; (205) 433-0013; FAX: (205) 433-0014.

## ALASKA

### 24+ Track Recording Studios

[24+] **SURREAL STUDIOS**; AR, APPV, APPF, ATD, JCP, MIDI, MP; 355 W. Potter Dr.; Anchorage, AK 99518; (907) 562-3754.

[24+] **TRUENORTH RECORDING STUDIO**; PO Box 81485; Fairbanks, AK 99708; (907) 456-3419.

### 12 & 16 Track Recording Studios

►[16] **DOMESTUDIOS**; AR, JCP, MIDI, MP; 1912 Gilmore Trail; Fairbanks, AK 99712; (907) 457-1993.

### 4 & 8 Track Recording Studios

[8] **"A" STREET RECORDING STUDIO**; AR, APPV, APPF, JCP, MIDI, MP, SR; 101 E. 9th Ave. #7A; Anchorage, AK 99501; (907) 279-6900.

[8] **FOUNDATION STUDIOS**; AR, MIDI, MP, RLR; PO Box 2192; Soldotna, AK; (907) 262-9847.

►[8] **SOUND INNOVATIONS**; RLR; 5520 Lake Otis Pkwy., Ste. #104; Anchorage, AK 99507; (907) 563-TAPE (8273); FAX: (907) 561-FAXX (3299).

### Video Production & Post-Production Facilities

**VISUART INC., MOTION PICTURE & VIDEO PRODUCTION**; VPPE, OLVP; 5915 Doncaster Drive; Anchorage, AK 99504-3232; (907) 337-5006; FAX: (907) 337-5006.

## RECORDING STUDIOS SERVICES KEY

The following codes refer to the types of services available at the listed recording & video production facilities. Information was supplied by those listed, so please call the facilities directly to verify critical information.

AR Audio Recording  
AD Artist Development Services  
APPV Audio Post-Production for Video  
APPF Audio Post-Production for Film  
ATD Audio Tape Duplicating  
EIR Equipment/Instrument Rental

JCP Jingle/Commercial Production  
MIDI MIDI Music Production  
MP Music Production Services  
ED Recording Education  
RLR Remote/Location Recording  
RS Residential Services

SR Sound Reinforcement Services  
SDS Studio Design/Supply  
MAST Tape/Disc Mastering  
VP Video Production Services

## VIDEO PRODUCTION/POST-PRODUCTION FACILITIES SERVICES KEY

APPV Audio Post-Production for Video  
OLVP On-Location Video Production

VPF Video Production for Film  
VPPE Video Post-Production/Editing

VTD Videotape Duplicating



## Recording & Video Production Facilities

UNITED STATES

ARIZONA

24+ Track Recording Studios



AAZTEC RECORDING & TAPE DUPLICATING, INC.  
Phoenix, AZ

[24+] **AAZTEC RECORDING & TAPE DUPLICATING, INC.**; AR, APPV, ATD, JCP, MIDI, ED, RLR; 1110 E. Missouri, Ste. 400; Phoenix, AZ 85014; (602) 279-0808; FAX: (602) 277-6552.

[24+] **JIM BRADY RECORDING STUDIOS**; AR, APPV, APPF, JCP, MIDI, MP, ED, RLR; 25 E. Glenn St.; Tucson, AZ 85705; (602) 791-3884.

[24+] **CEREUS RECORDING INC.**; AR, APPV, APPF, ATD, JCP, MIDI, MP, ED, RLR; 1733 E. McKellips, Stes. 7 and 8; Tempe, AZ 85281; (602) 990-8163.

> [24+] **CHATON RECORDINGS**; RLR; 5625 E. Nauri Valley Dr.; Scottsdale, AZ 85253; (602) 991-2802.

[24+] **FOXTROT STUDIOS**; AR, AD, APPV, APPF, JCP, MIDI, MP, ED, RLR; 7820 E. Evans Dr. #100; Scottsdale, AZ; (602) 948-8356.

[24+] **GRAVITY RECORDING STUDIO**; 141 Spur Pl.; Nogales, AZ 85621; (602) 281-1746.

[24+] **HUNNICUTT RECORDING STUDIO**; AR, APPV, JCP, MIDI, MP, ED; 737 W. Lynwood; Phoenix, AZ 85007; (602) 254-6000.

[24+] **PANTHEON STUDIOS, INC.**; AR, AD, APPV, ATD, JCP, MIDI, MP, VP; 6325 N. Invergordon Rd., Ste. D; Scottsdale, AZ 85253; (602) 948-5883; FAX: (602) 948-7863.

[24+] **PRODUCTION MASTERS, INC. (PMI)**; AR, APPV, ATD, JCP, MIDI, MP, SR, MAST, VP; 834 N. 7th Ave.; Phoenix, AZ 85007; (602) 254-1600; FAX: (602) 495-9949.

[24+] **THE SOUND FACTORY RECORDING STUDIOS**; AR, ATD, JCP, MIDI, MP; 1120 S. Highland; Tucson, AZ; (602) 622-1265.

> [24+] **VINTAGE RECORDERS**; 4831 N. 11 St., Ste. D; PO Box 17010; Phoenix, AZ 85011; (602) 241-0667.

[24+] **WESTWOOD RECORDING STUDIOS**; RLR; 964 W. Grant; Tucson, AZ 85719; (602) 622-8012.

### 12 & 16 Track Recording Studios

[16] **BPL'S BANJO BRASS STUDIO**; AR, APPV, ATD, JCP, MIDI, MP, RLR; 8088 N. 15th Ave.; Phoenix, AZ 85021; (602) 870-0351.

### Mix Trivia

9. The first variable-pattern condenser mic—the Neumann U47—was introduced in this year.

Turn to page 152 for question

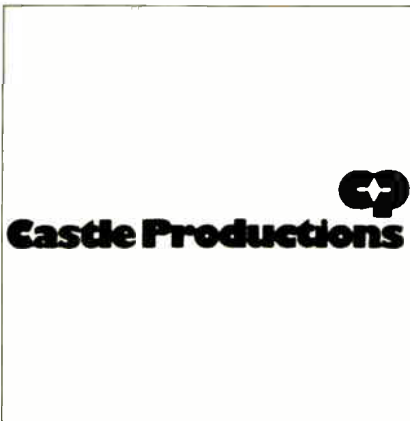

CASTLE PRODUCTIONS INC.  
Scottsdale, AZ

[16] **CASTLE PRODUCTIONS INC.**; AR, APPV, APPF, JCP, MIDI, MP, ED; 4416 N. Scottsdale Rd.; Scottsdale, AZ 85251; (602) 991-5090; FAX: (602) 991-3334.

> [16] **LAMBCHOPS STUDIOS**; AR, APPV, ATD, JCP, MIDI, MP; 323 W. McDowell Rd.; Phoenix, AZ 85003; (602) 254-3849; FAX: (602) 257-8104.

[16] **LAMBCHOPS STUDIOS—NORTH**; AR, APPV, ATD, JCP, MIDI, MP, RLR; 2235 W. Alice; Phoenix, AZ 85021; (602) 257-8104.

> [16] **SCOTTSDALE CONFERENCE RESORT**; RLR; 7700 E. McCormick Pkwy.; Scottsdale, AZ 85258; (602) 991-9000.

[16] **SOUNDTECH STUDIOS AND ENTERPRISES**; AR, ATD, JCP, MP, SR; 2750 W. Osborn Rd.; Phoenix, AZ 85017; (602) 257-0444.

[16] **TEMPEST RECORDING**; AR, AD, APPV, ATD, JCP, MIDI, RLR; PO Box 1007; Tempe, AZ 85281; (602) 968-9506.

### 4 & 8 Track Recording Studios

[8] **ANTHEM RECORDING**; AR, JCP, MIDI, MP; 401 W. Wescott; Phoenix, AZ 85027; (602) 252-5044.

[8] **AUDIO-VIDEO RECORDERS OF ARIZONA INC.**; AR, APPV, ATD, EIR, ED, RLR, VP; 3830 N. 7th St.; Phoenix, AZ 85014; (602) 277-4723; FAX: (602) 274-7416.

[8] **BUNS UP STUDIO**; AR, JCP, MIDI, MP, RLR; Box 2393; Page, AZ 86040; (602) 645-9300.

[8] **CANINE STUDIOS**; AR; 2828 W. Villa Maria Dr.; Phoenix, AZ 85023-1149; (602) 439-3142.

[4] **CLEAR AIRE AUDIO**; AR, RLR, SR; 1704 N. 2nd St.; Flagstaff, AZ 86004; (602) 774-5103.

[8] **FIMECO STUDIOS**; AR, APPV, APPF, ATD, JCP, MIDI, MP, RLR, VP; PO Box 43543; Tucson, AZ 85733; (602) 884-9173.

[8] **HUNT ENTERPRISES**; AR, EIR, MP, SR; PO Box 18023; Tucson, AZ 85731; (602) 885-7836.

[8] **JUNIPER PRODUCTIONS**; AR, JCP, MIDI, MP, RLR, SR; 2726 E. Juniper; Phoenix, AZ 85032; (602) 867-7354.

[8] **TERRY LESSIG SOUND**; AR, ATD, RLR; 1626 N. 7th St.; Phoenix, AZ 85006; (602) 255-0155.

[2] **MOHAVE COMMUNITY COLLEGE**; AR, APPV, ATD, EIR, ED, RLR, VP; 1971 Jagerson Ave.; Kingman, AZ 86401; (602) 757-4331 ext. 214.

[8] **MUDSHARK RECORDING STUDIO**; AR; Rte. 4, Box 882-B; (near) Flagstaff, AZ 86001; (602) 774-7533.

[8] **O-TU STUDIOS/O2 RECORDS**; AR, AD, JCP, MIDI, MP, RLR; 313 E. 15th St.; Tempe, AZ 85281; (602) 967-3220.

[2] **LISA PINERO/SOUND MIXER**; RLR; PO Box 50009; Phoenix, AZ 85076; (602) 759-5330.

[8] **RAPA SOUND**; AR, ED, RLR, SR; Box 1017; Jerome, AZ 86331; (602) 634-9607.

[8] **SUN SWAN STUDIOS**; AR, JCP, MIDI, MP, ED; 1155 N. Silverbell #B; Tucson, AZ 85745; (602) 792-4184.

### Video Production & Post-Production Facilities

**AUDIO-VIDEO RECORDERS OF ARIZONA INC.**; VPF, VPPE, OLVP, APPV, VTD; 3830 N. 7th St.; Phoenix, AZ 85014; (602) 277-4723; FAX: (602) 274-7416.

**JIM BRADY RECORDING STUDIOS**; APPV; 25 E. Glenn St.; Tucson, AZ 85705; (602) 791-3884.

**CEREUS RECORDING INC.**; APPV; 1733 E. McKellips, Stes. 7 and 8; Tempe, AZ 85281; (602) 990-8163.

**DEL SOL PRODUCTIONS**; VPPE, OLVP, APPV; 3028 N. Jackson; Tucson, AZ 85719; (602) 795-0214.

**DOWNSTREAM FILM & VIDEO**; OLVP; PO Box 50009; Phoenix, AZ 85076; (602) 759-5330.

**DUBS INTERNATIONAL—DIV. OF MEDIA COMMUNICATIONS CORP.**; VPPE, VTD; 2727 W. Southern Ave.; Tempe, AZ 85282; (602) 431-0270; FAX: (602) 438-2238.

**PAUL S. KARR PRODUCTIONS/PHOENIX VIDEOFILMS**; VPF, VPPE, OLVP, APPV, VTD; 2949 W. Indian School Rd., PO Box 11711; Phoenix, AZ 85017; (602) 266-4198.

**MOHAVE COMMUNITY COLLEGE**; VPF, VPPE, APPV, VTD; 1971 Jagerson Ave.; Kingman, AZ 86401; (602) 757-4331 ext. 214.

**PANTHEON STUDIOS, INC.**; VPF, OLVP, APPV, VTD; 6325 N. Invergordon Rd., Ste. D; Scottsdale, AZ 85253; (602) 948-5883; FAX: (602) 948-7863.

**PRODUCTION MASTERS, INC. (PMI)**; VPF, VPPE, OLVP, APPV, VTD; 834 N. 7th Ave.; Phoenix, AZ 85007; (602) 254-1600; FAX: (602) 495-9949.

**THE PRODUCTION SOURCE**; OLVP, APPV; 6599 E. Thomas Rd., Ste. 1117; Scottsdale, AZ 85251; (602) 481-0538.



SCOTTSDALE CONFERENCE RESORT  
Scottsdale, AZ

> **SCOTTSDALE CONFERENCE RESORT**; VPF, VPPE, APPV; 7700 E. McCormick Pkwy.; Scottsdale, AZ 85258; (602) 991-9000.

**VIDEO MEDIA PRODUCTIONS—DIV. OF VISUAL COMMUNICATIONS, INC.**; VPF, VPPE, OLVP, APPV, VTD; 2727 W. Southern Ave.; Tempe, AZ 85282; (602) 966-6545; FAX: (602) 438-2238.

**WAG PRODUCTIONS**; VPF; PO Box 1901; Tucson, AZ 85702; (602) 620-1934; FAX: (602) 792-1010.

ARKANSAS

### 24+ Track Recording Studios

[24+] **OMEGA SOUND**; AR, ATD, JCP, MIDI, MP, RLR; 1112 Garrison Ave.; Ft. Smith, AR 72901; (501) 782-1332.

### 12 & 16 Track Recording Studios

[16] **ARCA (AUDIO RECORDING CORPORATION OF ARKANSAS, INC.)**; AR, APPV, APPF, JCP, MIDI, MP; 100 N. Rodney Parham Rd., Stes. 1A and 1B, Little Rock, AR 72205; PO Box 5686; Little Rock, AR 72215; (501) 224-1111; FAX: (501) 224-3329 (3-FAX).

[16] **CHRISTIAN BROTHERS RECORDING**; RLR; 125 Albert Pike; Hot Springs, AR 71913; (501) 623-6512.

[16] **THE PRODUCTION CO.**; AR, ATD, JCP, RLR; 510 N. Mt. Olive; Siloam Springs, AR 72761; (501) 524-4626.

ARKANSAS

12 & 16 Track Recording Studios

[16] **WEBB SOUND**; RLR; Rte. 2, Box 137-D; Hope, AR 71801; (501) 234-5701; (501) 777-5512.

[16] **THE WORKS**; AR, APPV, JCP, MIDI, MP, RLR; 1417 Main; Little Rock, AR 72202; (501) 376-4332; FAX: (501) 376-9603.

[16] **ZANBECK SOUND PRODUCTIONS**; AR, RLR; 20711 Arch St. Pike; Little Rock, AR 72206; (501) 888-7045.

4 & 8 Track Recording Studios

[8] **CRYSTAL RECORDING STUDIOS**; AR; #19 Tanglewood, PO Box 733; Bryant, AR 72022; (501) 847-8215.

[8] **THE SOUND LAB**; AR, AD, ATD, MIDI, RLR, SR; PO Box 785; Hot Springs, AR 71902; (501) 624-3032.

CALIFORNIA

24+ Track Recording Studios

[24+] **A&M STUDIOS**; AR, ATD, MAST; 1416 N. La Brea Ave.; Hollywood, CA 90028; (213) 469-5181; FAX: (213) 856-2600.

[24+] **A & R RECORDING SERVICES**; AR, AD, MIDI, MP, RLR; 71906 Hwy. 111; Rancho Mirage, CA 92270; (619) 345-0075; FAX: (619) 773-0023.

[24+] **A TO Z STUDIOS**; AR; 680 Arrow Hwy.; LaVerne, CA 91750; (714) 599-1301; FAX: (714) 592-9888.

[24+] **ADAMOS RECORDING**; AR; 16571 Higgins Cir.; Huntington Beach, CA 92647; (714) 842-2668.

THEY  
RISE



HIGHEST  
WHO  
LIFT  
AS  
THEY  
GO\*

AN AKASHIC RECORDING

AKASHIC RECORDS GROUP  
Danville, CA

[24+] **AKASHIC RECORDS GROUP**; AR, AD, EIR, MP, RLR; PO Box 395; Danville, CA 94526; (415) 837-7959.

[24+] **AKR RECORDING STUDIO & DUPLICATION SERVICES**; 4313 Valley Fair St.; Simi Valley, CA 93063; (805) 527-4479.

[24+] **ALLIES RECORDING STUDIO (ARS)**; AR, AD, MP, ED; 711 E. Cypress Ave.; Redlands, CA 92374; (714) 798-7375; (714) 354-7034.

[24+] **ALPHA & OMEGA STUDIOS**; AR, AD, MP; 245 Hyde St.; San Francisco, CA 94102; (415) 885-4999.

[24+] **AMERAYCAN STUDIOS**; AR; 5719 Lankershim Blvd.; N. Hollywood, CA 91601; (818) 760-8733; FAX: (818) 760-2524.

[24+] **ANDORA**; AR, APPV, APPF, JCP, MIDI; 3249 Cahuenga Blvd. W.; Hollywood, CA 90068; (213) 851-1244.

[24+] **APEX PRODUCTIONS**; 348 Blossom Hill Rd.; San Jose, CA 95123; (408) 972-9966.

[24+] **ASTRAL SOUNDS RECORDING**; AR, APPV, APPF, JCP, MIDI, MP; 482 Reynolds Cir.; San Jose, CA 95112; (408) 436-1153.

[24+] **AUDIO ACHIEVEMENTS RECORDING STUDIO**; RLR; 1327 Cabrillo Ave.; Torrance, CA 90501; (213) 320-8100.

[24+] **AUDIO PRODUCTION GROUP**; 6884 Atlanta Cir.; Stockton, CA 95209; (209) 473-2345.

[24+] **AUDIO SUITE**; AR, APPV, JCP, MIDI; 1110 A W. Glenoaks Blvd.; Glendale, CA 91202; (818) 241-9099.

[24+] **AUDIOWORKS**; AR, AD, APPV, APPF, EIR, JCP, MIDI, MP, ED, SDS; 3017 Santa Monica Blvd. #316; Santa Monica, CA 90404; (818) 906-4593; (818) 769-7053.

[24+] **B STREET MUSIC**; AR, APPV, ATD, EIR, MIDI, ED, SR, SDS, MAST, VP; 116 S. B St.; San Mateo, CA 94401; (415) 342-2208; FAX: (415) 342-2640.

[24+] **(BABY'O) BRUNSON BROTHERS**; AR, AD, APPV, APPF, JCP, MP; 6525 Sunset Blvd.; Hollywood, CA 90028; (213) 464-0080; FAX: (818) 508-0228.

[24+] **BACK LOT**; MIDI, MP; 5300 Laurel Canyon Blvd. #194; North Hollywood, CA 91607; (818) 506-8516; FAX: (213) 465-8750.

[24+] **THE BANQUET SOUND STUDIOS**; AR, APPV, ATD, EIR, JCP, MIDI, MP, RLR, MAST; 540 E. Todd Rd., Ste. B; Santa Rosa, CA 95407; (707) 585-1325; FAX: (707) 585-1330.

[24+] **BAYVIEW STUDIO**; 1368 S. 49th St.; Richmond, CA 94804; (415) 237-4066.

[24+] **BEAT STREET, INC.**; AR, AD, APPV, APPF, JCP, MIDI, MP, SDS; 5739 Tujunga Ave.; North Hollywood, CA 91601; (818) 769-9966; FAX: (818) 769-9498.

[24+] **BELL SOUND STUDIOS INC.**; AR, APPV, APPF, ATD, JCP, MIDI, RLR; 916 N. Citrus; Hollywood, CA 90038; (213) 461-3036; FAX: (213) 461-8764.

[24+] **BLUE MOON STUDIO**; AR, MIDI, MP; 28205 Agoura Rd.; Agoura Hills, CA 91301; (818) 889-8920; FAX: (818) 889-1208.

[24+] **WALLY BURR RECORDING**; AR, APPV, APPF, JCP, MP; 1126 N. Hollywood Way #203; Burbank, CA 91505; (818) 845-0500.

[24+] **CAN-AM RECORDERS INC.**; 18730 Oxnard St.; Tarzana, CA 91356; (818) 342-2626.

[24+] **CAPITOL RECORDS STUDIOS**; RLR; 1750 N. Vine St.; Hollywood, CA 90028; (213) 462-6252.

[24+] **KEN CARLTON RECORDING**; 11240 Hwy. 41; Madera, CA 93638; (209) 431-5275.

[24+] **CARRERA RECORDING STUDIO**; 1504 Columbia, Ste. 3; Riverside, CA 92507; (714) 784-5777.

[24+] **CAVE RECORDING**; AR, EIR, JCP, MIDI, MP; 11526 Burbank Blvd. #10; N. Hollywood, CA 91601; (818) 763-4966.

[24+] **C.D. PRESENTS, LTD.**; AR, AD, ATD, JCP, MP, MAST; 1317 Grant Ave., Ste. 531; San Francisco, CA 94133; (415) 641-7775; FAX: (415) 641-7889.

[24+] **CHAMELEON RECORDING**; 216 Chatsworth Dr.; San Fernando, CA 91340; (818) 361-9232.

[24+] **CHEROKEE RECORDING STUDIOS**; AR; 751 N. Fairfax Ave.; Los Angeles, CA 90046; (213) 653-3412; FAX: (213) 653-3546.

[24+] **CINESOUND COMPANY INC.**; AR, APPV, APPF; 915 N. Highland Ave.; Hollywood, CA 90038; (213) 464-1155; FAX: (213) 464-1820.

[24+] **CIRCLE SOUND STUDIOS**; 3465 El Cajon Blvd.; San Diego, CA 92104; (619) 280-7310.

[24+] **CLEARLAKE AUDIO**; AR, APPV, APPF; 10520 Burbank Blvd.; N. Hollywood, CA 91601; (818) 762-0707.

[24+] **CLOUD NINE STUDIOS**; AR, JCP, MIDI, MP; 275 Fairchild Ave., Ste. 101A; Chico, CA 95926; (916) 342-7794.

[24+] **COAST RECORDERS**; RLR; 1340 Mission St.; San Francisco, CA 94103; (415) 864-5200.

[24+] **CODA**; AR; 2248 E. 14th; Oakland, CA 94606; (415) 532-3714.

[24+] **THE COMPLEX**; 2323 Corinth Ave.; West Los Angeles, CA 90064; (213) 477-1938.

[24+] **RICK CONRAD MUSIC PRODUCTIONS**; 5550 Wilshire Blvd.; Los Angeles, CA 90036; (213) 937-8096.

[24+] **CONTROL CENTER**; AR, MIDI, MP; 128 N. West-em; Los Angeles, CA 90004; (213) 462-4300.

[24+] **CONWAY RECORDING STUDIOS**; 655 N. St. Andrews Place; Hollywood, CA 90004; (213) 463-2175; FAX: (213) 463-2479.

[24+] **CORNERSTONE RECORDERS**; AR, APPV, APPF, EIR, JCP; 9626 Lurline Ave., Unit K; Chatsworth, CA 91311; (818) 341-1358; FAX: (818) 341-1330.

[24+] **COUNTRY REEL ENTERPRISES**; AR, AD, APPV, ATD, EIR, JCP, MIDI, MP, ED, RLR, SR, MAST, VP; PO Box 99307; Stockton, CA 95209; (209) 473-8050; (209) 473-8090; (800) 662-4432 (in CA).

[24+] **CRYSTAL SOUND STUDIOS**; AR, AD, APPV, APPF, JCP, MIDI, MP, SDS, MAST, VP; 1014 N. Vine; Hollywood, CA 90038; (213) 466-6453.

[24+] **JIM DAVID'S ONE ON ONE STUDIO**; 5253 Lankershim Blvd.; North Hollywood, CA 91601; (818) 761-3882.

[24+] **DENTEN PRODUCTIONS**; AR, AD, MP; PO Box 1709; Alameda, CA 94501; (415) 521-0321; FAX: (415) 521-0368.

[24+] **DEVONSHIRE AUDIO/VIDEO STUDIOS**; AR, APPV, APPF, JCP, VP; 10729 Magnolia Blvd.; North Hollywood, CA 91601; (818) 985-1945; FAX: (818) 985-9915.

[24+] **DIFFERENT FUR RECORDING**; RLR; 3470 19th St.; San Francisco, CA 94110; (415) 864-1967.

[24+] **DIGITAL SOUND AND PICTURE**; AR, APPV, APPF; 2700 S. Lacienege Blvd.; Los Angeles, CA 90034; (213) 836-7688; FAX: (213) 836-7499.

[24+] **DIGITAL SOUND RECORDING**; RLR; 607 N. Ave. 64; Los Angeles, CA 90042; (213) 258-6741.

[24+] **DUBMASTER**; AR, APPV, APPF, JCP, MIDI, MP, RLR; 11110 Magnolia; N. Hollywood, CA 91601-3812; (818) 787-6004; (818) 980-8318; FAX: (818) 989-0877.



ECHO SOUND RECORDING  
Los Angeles, CA

[24+] **ECHO SOUND RECORDING**; AR, MIDI; 2900 Los Feliz Blvd.; Los Angeles, CA 90039; (213) 662-5291.

PER  
PHIL EDWARDS RECORDING

1534 WEST WINTON AVENUE • HAYWARD CA 94545-1311

PHIL EDWARDS RECORDING  
Hayward, CA

[24+] **PHIL EDWARDS RECORDING**; AR, APPV, JCP, MIDI, RLR; 1522 W. Winton Ave.; Hayward, CA 94545; (415) 784-1971.

[24+] **EFX SYSTEMS**; APPV, APPF; 919 N. Victory Blvd.; Burbank, CA 91502-1633; (818) 843-4762; (213) 460-4474; FAX: (818) 848-0706.

[24+] **8 MILE ROAD STUDIO**; 5274 W. Pico Blvd., Ste. 202; Los Angeles, CA 90019; (213) 933-5948.



# Recording & Video Production Facilities

UNITED STATES

CALIFORNIA

24+ Track Recording Studios



ELUMBA RECORDING STUDIO  
Hollywood, CA

[24+] **ELUMBA RECORDING STUDIO**; AR, APPV, APPF; 1538 N. Cahuenga Blvd.; Hollywood, CA 90028; (213) 461-4515; FAX: (213) 461-4622.

[24+] **ENCORE STUDIOS INC.**; AR, EIR; 721 S. Glenwood Pl.; Burbank, CA 91506; (818) 842-8300; FAX: (818) 842-6095.

[24+] **ENHARMONIK STUDIOS**; AR, MIDI, RLR; PO Box 22243; Sacramento, CA 95822; (916) 443-0373; FAX: (916) 446-5661.

[24+] **THE ENTERPRISE, INC.**; AR, AD, APPV, EIR, MIDI, SR, MAST; 4620 W. Magnolia Blvd.; Burbank, CA 91505; (818) 505-6000; FAX: (818) 505-6006.

[24+] **ENTOURAGE STUDIOS**; 11115 Magnolia Blvd.; North Hollywood, CA 91601; (818) 505-0001.

[24+] **EVERGREEN RECORDING STUDIOS**; AR, JCP; 4403 W. Magnolia Blvd.; Burbank, CA 91505; (818) 841-6800; FAX: (818) 841-8931.

[24+] **FANFARE RECORDING STUDIOS**; 120 E. Main St.; El Cajon, CA 92020; (619) 447-2555.

[24+] **FANTASY STUDIOS**; 10th & Parker Sts.; Berkeley, CA 94710; (415) 549-2500.

[24+] **FATHER TIME PRODUCTIONS**; MIDI; 25246 Barton Rd. #4; Loma Linda, CA 92354; (714) 796-6783.

[24+] **FDS LABS/CDM**; AR, MAST; 4007 W. 6th St.; Los Angeles, CA 90020; (213) 383-2155; FAX: (213) 383-2158.

[24+] **FIDELITY STUDIOS**; RLR; 4412 Whitsett Ave.; Studio City, CA 91604; (818) 508-3263.

[24+] **FIESTA SOUND**; AR; 1655 S. Compton Ave.; Los Angeles, CA 90021; (213) 748-2057; FAX: (213) 748-5388.

[24+] **FLOUNDERGASH PRODUCTIONS**; 5102 Vineland Ave.; North Hollywood, CA 91601; (818) 509-8821.

[24+] **FOCUSED AUDIO**; RLR; 544 Natoma; San Francisco, CA 94103; (415) 777-3108.

[24+] **FOR THE RECORD**; 833 W. Collins; Orange, CA 92667; (714) 771-1410.

[24+] **41-B**; 41-B Duesenberg; Westlake Village, CA 91360; (805) 494-3613.

[24+] **4TH STREET RECORDING**; RLR; 1211 4th St.; Santa Monica, CA 90401; (213) 395-9114.

[24+] **FUTURE POST**; APPV, EIR, RLR; 2414 W. Olive Ave.; Burbank, CA 91506; (818) 843-8200; FAX: (818) 842-8713.

[24+] **GALAXY SOUND STUDIOS**; AR, JCP; 1635 N. Cahuenga Blvd.; Hollywood, CA 90028; (213) 461-1971; FAX: (213) 461-9032.

[24+] **PHILIP (ROSCOE) GALLO PRODUCTIONS**; AR, EIR, MIDI, MP; 3112 Laguna; San Francisco, CA 94123; (415) 563-8223.

[24+] **GATEWAY STUDIOS**; 6381A Rose Lane; Carpinteria, CA 93013; (805) 684-8336.



GOLDEN GOOSE PRODUCTIONS  
Costa Mesa, CA

[24+] **GOLDEN GOOSE PRODUCTIONS**; AR, AD, APPV, JCP, MIDI, MP, ED; 2074 Pomona Ave.; Costa Mesa, CA 92627; (714) 548-3694.

[24+] **GOLDMINE RECORDING**; AR, APPV, ATD, JCP, MP; 1393 Callens Rd.; Ventura, CA 93003; (805) 644-8341; FAX: (805) 644-1822.

[24+] **GRANDMASTER RECORDERS LTD.**; AR, AD, APPV, APPF, ATD, JCP, MP, VP; 1520 N. Cahuenga Blvd.; Hollywood, CA 90028; (213) 462-6136; (213) 462-6137.

[24+] **GROUP IV RECORDING, INC.**; AR, APPV, APPF, ATD, MIDI; 1541 N. Wilcox Ave.; Hollywood, CA 90028; (213) 466-6444; FAX: (213) 466-6714.

[24+] **AARON HALLAS PRODUCTIONS**; AR, APPV, JCP, MIDI, MP, ED; 1519 S. Grand Ave.; Santa Ana, CA 92705; (714) 547-3069.



HALLMARK PRODUCTIONS  
Westlake Village, CA

[24+] **HALLMARK PRODUCTIONS**; AR, APPV, MIDI, MP, VP; 31320 Via Colinas, Ste. 118; Westlake Village, CA 91362; (818) 991-4857; FAX: (818) 707-2693.

[24+] **HAMMERSOUND RECORDERS**; AR, APPV, APPF; 9612 Lurline Ave., Unit N; Chatsworth, CA 91311; (818) 998-9641; FAX: (818) 341-1330.

[24+] **CRAIG HARRIS MUSIC**; AR, APPV, APPF, JCP, MP; PO Box 1508; Hollywood, CA 90078; (213) 851-8510.

[24+] **HEADWAY STUDIOS**; 7560 Garden Grove Blvd.; Westminster, CA 92683; (714) 891-8548.

[24+] **HIT CITY WEST**; 6146 W. Pico Blvd.; Los Angeles, CA 90035; (213) 852-0186.

[24+] **HIT SINGLE RECORDING SERVICES**; 3450 College Ave., Lower Ct. #314; San Diego, CA 92115; (619) 265-0524.

[24+] **JOE HOFFMANN STUDIOS**; AR, RLR; PO Box 840; Occidental, CA 95465-0840; (707) 874-2278.

[24+] **HOLLYWOOD SOUND RECORDERS, INC.**; AR, AD, MIDI, MP; 6367 Selma Ave.; Hollywood, CA 90028; (213) 467-1411; FAX: (213) 462-8562.

[24+] **HYDE STREET STUDIOS**; 245 Hyde St.; San Francisco, CA 94102; (415) 441-8934.

[24+] **IMAGE RECORDING**; 1020 N. Sycamore Ave.; Hollywood, CA 90038; (213) 850-1030.

[24+] **INDIAN HILL AUDIO/VIDEO**; RLR; 224 N. Indian Hill Blvd.; Claremont, CA 91711; (714) 625-2396.

[24+] **INDIGO RANCH RECORDING STUDIO-MALIBU**; PO Box 24-A-14; Los Angeles, CA 90024; (213) 456-9277.

[24+] **INFINITE STUDIOS**; AR, AD, APPV, JCP, MIDI, MP, RLR; PO Box 1709; Alameda, CA 94501; (415) 521-0321; FAX: (415) 521-0368.

[24+] **INTERLOK**; AR, AD, APPV, APPF, JCP, MIDI, MP; 1522 Crossroads of the World; Hollywood, CA 90028; (213) 469-3986.

[24+] **INTERSOUND INC.**; AR, APPV, APPF; 8746 Sunset Blvd.; Los Angeles, CA 90069; (213) 652-3741; FAX: (213) 854-7290.

[24+] **INVINCIBLE PRODUCTIONS**; AR, APPV, JCP, MP; 7898 Ostrow St., Ste. I; San Diego, CA 92111; (619) 569-8581; FAX: (619) 569-8727.

[24+] **JDH SOUND**; APPF; 12156 Olympic Blvd.; West Los Angeles, CA 90064; (213) 820-8802; FAX: (213) 207-0914.

[24+] **J.E. SOUND PRODUCTION AND ENTERTAINMENT**; 11323 Santa Monica Blvd.; Los Angeles, CA 90025; (213) 479-7653.

[24+] **JENSEN SOUND PRODUCTIONS**; AR, APPV, APPF, JCP, MIDI, MP; San Francisco, CA; (415) 346-2418; FAX: (415) 346-9544.

[24+] **JINGLE BELLS PRODUCTION CO.**; AR, AD, APPV, APPF, JCP, MIDI, MP, VP; 2873 Lyon Cir.; Concord, CA 94518; (415) 671-2800.

[24+] **JUNIPER STUDIOS**; 719 Main St.; Burbank, CA 91506; (818) 841-1244.

[24+] **KEY PRODUCTIONS**; AR, AD, EIR, JCP, MIDI, MP; 13624 Sherman Way, Ste. 221; Van Nuys, CA 91405; (818) 994-4849.

[24+] **KINGSOUND STUDIOS**; AR, ATD, MP; 7635 Fulton Ave.; N. Hollywood, CA 91605; (818) 764-4580.

[24+] **KREN MUSIC PRODUCTIONS**; AR, AD, MP; 11233 Hortense St.; North Hollywood, CA 91602; (213) 461-9784; (818) 769-2291.

[24+] **LARRABEE SOUND**; 8811 Santa Monica Blvd.; West Hollywood, CA 90069; (213) 657-6750.

[24+] **L'AZUR PRODUCTIONS**; AR, APPV, APPF, JCP, MIDI, MP; PO Box 16201; Encino, CA 91316; (818) 708-1149.

[24+] **LIGHTHOUSE RECORDERS**; AR; 12438 Magnolia Blvd.; North Hollywood, CA 91607; (818) 506-8942; FAX: (818) 506-4170.

[24+] **LION SHARE RECORDING STUDIO**; AR, AD, APPV, APPF, EIR, JCP, MP; 8255 Beverly Blvd.; Los Angeles, CA 90048; (213) 658-5990; FAX: (213) 653-3086.

[24+] **LIVE OAK STUDIO**; AR, APPV, APPF, MIDI, MP; 1300 Arch St.; Berkeley, CA 94708; (415) 540-0177.

[24+] **LOVE PRODUCTIONS**; AR, MP; 17137 Index St.; Granada Hills, CA 91344; (818) 363-0636.

[24+] **LUGANO MUSIC LIMITED**; AR, AD, ATD, JCP, MIDI, MP, RS, MAST; PO Box 56; South Lake Tahoe, CA 95705; (916) 544-4883; FAX: (916) 541-4625.

[24+] **LYON RECORDING STUDIO**; AR, JCP, MP; 2212 Newport Blvd.; Newport Beach, CA 92663; (714) 675-4790; FAX: (714) 675-2139.

[24+] **MAD DOG STUDIO**; 1717 Lincoln Blvd.; Venice, CA 90291; (213) 306-0950.

[24+] **MAD HATTER RECORDING STUDIO**; 2635 Griffith Park Blvd.; Los Angeles, CA 90039; (213) 664-5766.

[24+] **MAGIC SOUND**; AR; 1780 Chanticleer Ave.; Santa Cruz, CA 95062; (408) 475-7505.

[24+] **MARTINSOUND RECORDING STUDIOS**; AR, APPV; 1151 W. Valley Blvd.; Alhambra, CA 91803-2493; (818) 281-3555; FAX: (818) 284-3092.

[24+] **MASTER CONTROL**; 3401 W. Burbank Blvd.; Burbank, CA 91505; (818) 842-0800.

See Page 57 for Facility Services Key

►[24+] **MASTER TRACK PRODUCTIONS**; 1524 W. Winton Ave.; Hayward, CA 94545; (415) 782-0877.

►[24+] **MAXIMUS RECORDING STUDIOS**; 2727 N. Grove Industrial Dr. #111; Fresno, CA 93727; (209) 255-1688; FAX: (209) 255-1755.



**M'BILA RECORDING STUDIO**  
Hollywood, CA

[24+] **M'BILA RECORDING STUDIO**; AR, MIDI; 1800 N. Argyle Ave. #200; Hollywood, CA 90028; (213) 466-7613; FAX: (213) 466-1461.

[24+] **MEDIA RECORDERS**; AR, APPV, APPF, ATD; 748 N. Seward St.; Hollywood, CA 90038; (213) 463-5000; FAX: (213) 467-1499.

►[24+] **MIDLAND**; 1615 Rancho Ave.; Glendale, CA 91201; (818) 507-7982.

[24+] **MILAGRO SOUND RECORDERS**; AR, AD, MIDI, MP; 230 S. Orange St.; Glendale, CA 91204; (818) 545-8398.

[24+] **MIXED MEDIA**; AR, APPV, APPF, JCP, MIDI, MP; 245 Hyde St.; San Francisco, CA 94102; (415) 441-8934; FAX: (415) 441-1496.

►[24+] **THE MIXING LAB**; 11542 Knott Ave., Ste. 9; Garden Grove, CA 92641; (714) 373-0141.



**MOBIUS MUSIC RECORDING**  
San Francisco, CA

►[24+] **MOBIUS MUSIC RECORDING**; AR, RLR; 1583 Sanchez St.; San Francisco, CA 94131; (415) 285-7888.

[24+] **MONTAGE STUDIOS**; AR, JCP, MIDI, MP, ED; 37532 Sycamore St., Ste. 1C; Newark, CA 94560; (415) 794-2992.

►[24+] **MOON RECORDING INC.**; AR; 156 Otto Cir.; Sacramento, CA 95822; (916) 392-5640.

#### Mix Trivia

**10.** At the 1971 AES convention, this company premiered the first commercial digital audio device, the Delta T-101 delay.

Turn to page 152 for question



**MOTHERLODE AUDIO VIDEO**  
Grass Valley, CA

[24+] **MOTHERLODE AUDIO VIDEO**; AR, APPV, JCP, MIDI; 15775 Brooks Rd.; Grass Valley, CA 95945; (916) 272-3278.

[24+] **M.S. STUDIO**; AR, AD, EIR, JCP, MIDI, MP, RLR; PO Box 24182; San Francisco, CA 94124; (415) 282-4806.

►[24+] **MUSIC ANNEX INC.**; AR, APPV, APPF, ATD, JCP, MIDI, MP, RLR, MAST; 69 Green St.; San Francisco, CA 94111; (415) 421-6622; FAX: (415) 391-4995.

►[24+] **MUSIC ANNEX INC.**; AR, MIDI, RLR, MAST; 970 O'Brien Dr.; Menlo Park, CA 94025; (415) 328-8338; FAX: (415) 325-6890.

►[24+] **MUSIC ARTS RECORDING STUDIO (MARS)**; PO Box 1838; Aptos, CA 95001; (408) 688-8435.

►[24+] **THE MUSIC COMPLEX**; AR, APPV, APPF, JCP, MIDI, MP, ED, RLR; 348 Broadway, Ste. 4; Millbrae, CA 94030; (415) 697-4488.

[24+] **MUSIC GRINDER STUDIOS**; AR, APPV, ATD, EIR; 5540 Hollywood Blvd.; Hollywood, CA 90028; (213) 655-2996; FAX: (213) 655-2344.

[24+] **MUSIC LAB INC.**; AR, APPV, APPF, ATD, JCP, MIDI, MP, ED; 1831 Hyperion Ave.; Hollywood, CA 90027; (213) 666-3003.

[24+] **NETWORK MUSIC, INC.**; AR, APPV, APPF, JCP, MIDI, MP; 16935 W. Bernardo Dr., Ste. 100; San Diego, CA 92127; (619) 451-6400; (800) 854-2075; FAX: (619) 451-6409.

[24+] **NORTHERN CALIFORNIA PRODUCTIONS**; AR, ATD, EIR, RLR, SR; PO Box 525; Chico, CA 95927-0525; (916) 895-9120; FAX: (916) 895-1303.

[24+] **NORTHSTAR PRODUCTIONS INTERNATIONAL**; AR, AD, JCP, MP, RLR, SR, SDS; 33082 Washington St.; Lake Elsinore, CA 92530; (714) 678-9109.



**NOVASTAR**  
Hollywood, CA

►[24+] **NOVASTAR**; AR, APPV, APPF, JCP, MIDI, MP, MAST, VP; 6430 Sunset Blvd., Ste. 1400; Hollywood, CA 90028; (213) 467-5021; FAX: (213) 465-8750.

[24+] **JEANNINE O'NEAL PRODUCTIONS**; AR, AD, ATD, MIDI, MP, MAST; 195 S. 26th St.; San Jose, CA 95116; (408) 286-9840.

►[24+] **ONE PASS FILM & VIDEO**; One China Basin Bldg.; San Francisco, CA 94107; (415) 777-5777.

[24+] **OPEN DOOR PRODUCTIONS**; AR, MIDI, MP; PO Box 8556; Berkeley, CA 94707; (415) 527-9311.

►[24+] **OTR STUDIOS**; AR, ATD, EIR, JCP, MIDI, MP, ED; PO Box 874; Belmont, CA 94002; (415) 595-8475; FAX: (415) 598-0915.

[24+] **PACIFIC MOBILE RECORDERS**; RLR; 2616 Garfield Ave.; Carmichael (Sacramento), CA 95608; (916) 483-2340.

►[24+] **PACIFIQUE RECORDING STUDIOS**; 10616 Magnolia Blvd.; North Hollywood, CA 91601; (818) 761-8042.

►[24+] **PARADISE STUDIOS**; RLR; 1020 35th Ave.; Sacramento, CA 95822; (916) 424-8772.

►[24+] **PARAMOUNT RECORDING STUDIO**; AR, MIDI; 6245 Santa Monica Blvd.; Hollywood, CA 90038; (213) 465-4000; FAX: (213) 469-1905.

[24+] **PEACE IN THE VALLEY RECORDING**; AR, APPV, APPF, MIDI, MP, RLR; PO Box 905; South Pasadena, CA 91031; (818) 897-2249.

►[24+] **THE PLANT RECORDING STUDIOS**; AR, AD, APPV, APPF, JCP, MIDI, MP, RLR, RS; 2200 Bridgeway; Sausalito, CA 94965; (415) 332-6100; FAX: (415) 332-5738.

[24+] **POINT BLANK RECORDING**; 19 Lake Way; Scotts Valley, CA 95066; (408) 438-2331.

►[24+] **POOLSIDE STUDIOS**; AR, AD, APPV, APPF, JCP, MIDI, MP, RLR, VP; 2269 Chestnut #310; San Francisco, CA 94123; (415) 931-9390.

[24+] **POST SOUND CORPORATION**; AR, APPV, APPF, RLR, SR; 6500 Sunset Blvd.; Hollywood, CA 90028; (213) 462-0000.

[24+] **POWERHOUSE STUDIOS**; AR, APPV, ATD, JCP, MIDI, MP, RLR, VP; 19347 Londelius St.; Northridge, CA 91324; (818) 993-4778; FAX: (818) 993-3575.

►[24+] **PRAIRIE SUN RECORDING**; AR, AD, APPV, EIR, MP, RS, SDS; PO Box 7084; Cotati, CA 94931; (707) 795-7011.

[24+] **PRESENT TIME RECORDERS**; AR; 5154 Vineland Ave.; N. Hollywood, CA; (818) 762-5474.

[24+] **PUBLIC RECORDING**; AR, JCP, MIDI, MP, ED; 1220 Pioneer I; Brea, CA 92621; (714) 622-7089.

[24+] **QUAD TECK STUDIOS**; AR; 4007 W. 6th St.; Los Angeles, CA 90020; (213) 383-2155; FAX: (213) 383-2158.

[24+] **RADIO RECORDERS**; 7000 Santa Monica Blvd.; Hollywood, CA 90038; (213) 464-7747.

[24+] **RCM STUDIOS**; RLR; 640 S. Glenwood Pl.; Burbank, CA 91506; (818) 845-1760.

►[24+] **RECORD PLANT, INC.**; AR, EIR, RLR; 1032 N. Sycamore Ave.; Hollywood, CA 90038; (213) 653-0240; FAX: (213) 466-8835.

[24+] **RECORD TWO MENDOCINO**; AR, MP, RS; 9680 Docker Hill Rd.; Comptche, CA 95427; (707) 937-0436.

►[24+] **R.O. STUDIOS**; 3359 Walnut Ave.; Concord, CA 94519; (415) 676-7237.

[24+] **ROLLING THUNDER STUDIOS**; AR, AD, JCP, MIDI, MP, SDS; 1500 Farren Rd.; Santa Barbara, CA 93117; (805) 968-3650; FAX: (805) 685-0926.

[24+] **R.P.D. SOUND (FORMERLY FUTURE SOUND)**; RLR; 1842 Burlinson Ave.; Thousand Oaks, CA 91360; (805) 496-2585.

[24+] **THE RUBBER DUBBERS INC.**; APPF; 626 Justin Ave.; Glendale, CA 91201; (818) 241-5600.

►[24+] **RUMBO RECORDERS**; AR; 20215 Saticoy St.; Canoga Park, CA 91306; (818) 709-8080; FAX: (818) 709-4072.

[24+] **RUSK SOUND STUDIOS**; AR, APPV, APPF, JCP, MIDI, MP; 1556 N. LaBrea Ave.; Hollywood, CA 90028; (213) 462-6477; FAX: (213) 462-5684.

#### Mix Trivia

**11.** This engineer mixed more than 20,000 jazz recordings out of his Englewood Cliffs, N.J., studio.

Turn to page 152 for question



# Recording & Video Production Facilities

UNITED STATES

## CALIFORNIA

24+ Track Recording Studios



# Russian Hill Recording

RUSSIAN HILL RECORDING  
San Francisco, CA

> [24+] **RUSSIAN HILL RECORDING**; AR, APPV, APPF, MIDI; 1520 Pacific Ave.; San Francisco, CA 94109; (415) 474-4520; FAX: (415) 474-7190.

> [24+] **SABRE SOUND PRODUCTIONS**; RLR; 413 Trabert Cir.; Riverside, CA 92507; (714) 784-4280.

[24+] **SAGE AND SOUND RECORDING STUDIO**; AR; 1511 N. Gordon St.; Hollywood, CA 90028; (213) 469-1527.

[24+] **SALTY DOG RECORDING, AKA SDR STUDIOS**; 14511 Delano St.; Van Nuys, CA 91411; (818) 994-9973.

[24+] **SANTA CRUZ STUDIOS**; RLR; 1334 Brommer St.; Santa Cruz, CA 95062; (408) 462-9995.

> [24+] **SKIP SAYLOR RECORDING**; 506 N. Larchmont Blvd.; Los Angeles, CA 90004; (213) 467-3515.

[24+] **SCORE ONE RECORDING, INC.**; AR, APPV, JCP, MP; 5500 Cahuenga Blvd.; North Hollywood, CA 91601; (818) 762-6902.

[24+] **SEACOAST RECORDING STUDIO**; AR, APPV, ATD, JCP, MIDI; 926 Turquoise St.; San Diego, CA 92109; (619) 270-7664.

[24+] **7TH STREET SOUND**; AR, MIDI; 688 S. Santa Fe #105; Los Angeles, CA 90021; (213) 627-5392.

[24+] **SIERRA WEST MUSIC**; AR, MP; 13 Winter Creek Ln.; Canyon, CA 94516; (415) 376-6135.

[24+] **SILK'S PORTFOLIO/ENGINEERING AND AUDIO/VIDEO**; AR, AD, APPV, APPF, ATD, EIR, JCP, MIDI, MP, ED, RLR, RS, SR, SDS, MAST, VP; 8635 Somerset Blvd.; Paramount, CA 90723;

> [24+] **SILVERLAKE SOUND STUDIO**; AR, AD; 2413 Hyperion Ave.; Los Angeles, CA 90027; (213) 663-7664; FAX: (213) 664-8677.

[24+] **SKYWALKER SOUND SOUTH, A DIVISION OF LUCASARTS ENTERTAINMENT**; AR, APPV, APPF; 1861 S. Bundy Dr.; Los Angeles, CA 90025; (213) 315-5000; FAX: (213) 447-2630.

[24+] **SKYWALKER SOUND NORTH, A DIVISION OF LUCASARTS ENTERTAINMENT**; AR, APPV, APPF, JCP, MP; PO Box 3000; San Rafael, CA 94912; (415) 662-1000; FAX: (415) 662-2429.

[24+] **SMOKETREE**; AR, APPV, APPF, JCP, MIDI; 9752 Baden Ave.; Chatsworth, CA 91311; (818) 998-2097; FAX: (818) 998-7221.

> [24+] **SOMA SYNC STUDIOS**; AR, APPV, MP; 372 Brannan St.; San Francisco, CA 94107; (415) 546-1374; FAX: (415) 546-1433.

[24+] **SONIC VISION, INC.**; AR, APPV, APPF, ATD, JCP, MIDI, MP, ED, RLR, SDS, MAST, VP; 2217 The Alameda; Santa Clara, CA 95050; (408) 554-1117; FAX: (408) 554-1301.

[24+] **SOUND AFFAIR RECORDING, LTD.**; 2727 Croddy Way, Ste. G; Santa Ana, CA 92704; (714) 540-0063.

[24+] **SOUND CHAMBER RECORDERS**; AR, APPV, APPF, JCP, MIDI, MP; 27 S. El Molino Ave.; Pasadena, CA 91101; (818) 449-8133.

> [24+] **SOUND CITY, INC.**; 15456 Cabrito Rd.; Van Nuys, CA 91406; (818) 787-3722; (213) 873-2842.

> [24+] **SOUND DESIGN**; AR, APPV, EIR, JCP, MIDI, MP, RLR, SR, SDS; 33 W. Haley; Santa Barbara, CA 93101; (805) 965-3404.

> [24+] **SOUND MASTER AUDIO/VIDEO STUDIOS**; RLR; 10747 Magnolia Blvd.; North Hollywood, CA 91601; (213) 650-8000.

[24+] **SOUND MIXER RECORDING**; AR, MIDI; 2301 E. Nutwood; Fullerton, CA 92631; (714) 738-4581.

[24+] **SOUND VENDORS, INC.**; AR, APPV, SDS; 10707 Magnolia Blvd.; North Hollywood, CA 91601; (818) 985-9774; FAX: (818) 985-9592.

[24+] **SOUNDCASTLE RECORDING STUDIOS**; 2840 Rowena Ave.; Los Angeles, CA 90039; (213) 665-5201.

[24+] **SOUNDER RECORDING**; AR, APPV, APPF, ATD, JCP, MIDI, MP; 17021 Chatsworth St.; Granada Hills, CA 91344; (818) 366-0995.

[24+] **SOUNDTEK STUDIOS**; 85 S. 2nd St.; Campbell, CA 95008; (408) 370-3313.

> [24+] **SOUNDWORKS WEST, LTD.**; AR, APPV, APPF, EIR, MIDI, MP, MAST; 7317 Romaine St.; Hollywood, CA 90046; (213) 850-1510; FAX: (213) 874-1420.

[24+] **SPARK PRODUCTION**; AR, APPV, APPF, JCP; 5854 Colby St.; Oakland, CA 94618; (415) 547-3669.

[24+] **STAGG STREET STUDIO**; AR, APPV, APPF, JCP; 15147 Stagg St.; Van Nuys, CA 91405; (818) 989-0511.

> [24+] **STARLIGHT SOUND**; AR, EIR; 617 S. 13th St.; Richmond, CA 94804; (415) 233-7140.

[24+] **THE STUDIO, INC.**; AR, APPV, APPF, JCP, MIDI, MP; 1649 16th St.; Santa Monica, CA 90404; (213) 396-1488.

> [24+] **THE STUDIO**; RLR; 9590 Chesapeake Dr.; San Diego, CA 92123; (800) HIT-SONG.

> [24+] **THE STUDIO**; RLR; 22723 Berdon St.; Woodland Hills, CA 91367; (818) 883-1920.

> [24+] **STUDIO C/CUSTOM RECORDING**; RLR; 2220 Broadridge Way; Stockton, CA 95209; (209) 477-5130.

> [24+] **STUDIO D RECORDING INC.**; 425 Coloma St.; Sausalito, CA 94965; (415) 332-6289.

[24+] **STUDIO 55**; 5505 Melrose Ave.; Los Angeles, CA 90038; (213) 467-5505.

[24+] **STUDIO 56 PRODUCTIONS**; AR, AD, APPV, APPF, ATD, JCP, MIDI, MP, SR, VP; 7000 Santa Monica Blvd.; Hollywood, CA 90038; (213) 464-7747; FAX: (213) 467-8579.

> [24+] **STUDIO MASTERS**; AR, APPV; 8312 Beverly Blvd.; Los Angeles, CA 90048; (213) 653-1988.

[24+] **STUDIO 69**; AR, JCP, MIDI, MP; 2385 Pleasant Acres Dr.; San Jose, CA 95148; (408) 223-0202.

> [24+] **STUDIO II (AFFILIATE OF INDIGO RANCH, MALIBU)**; RLR; 9729 Culver Blvd.; Culver City, CA 90230; (213) 558-8832.

> [24+] **STUDIO ULTIMO**; AR; 1900 S. Sepulveda Blvd.; Los Angeles, CA 90025; (213) 479-6010.

> [24+] **SUMMA MUSIC GROUP**; 8507 Sunset Blvd.; West Hollywood, CA 90069; (213) 854-6300.

> [24+] **SUNBURST RECORDING**; AR, MP; 10313 W. Jefferson Blvd.; Culver City, CA 90232; (213) 204-2222.

> [24+] **SUNSET SOUND FACTORY**; AR; 6357 Selma Ave.; Hollywood, CA 90028; (213) 467-2500; FAX: (213) 465-5579.

> [24+] **SUNSET SOUND RECORDERS, INC.**; AR, APPV, APPF; 6650 Sunset Blvd.; Hollywood, CA 90028; (213) 469-1186; FAX: (213) 465-5579.

[24+] **SUTTON SOUND STUDIO**; AR, ATD; 8390 Curbarit; Atascadero, CA 93422; (805) 466-1833.

> [24+] **SWINGSTREET STUDIOS**; RLR; 620 Bercut Dr.; Sacramento, CA 95814; (916) 446-3088.

[24+] **SYNTASY PRODUCTIONS/ BERNARD XOLOTLI**; AR, APPV, APPF, MIDI, MP; PO Box 6283; San Rafael, CA 94903; (415) 499-8747.

[24+] **TAKE ONE RECORDING STUDIOS, INC.**; 619-B S. Glenwood Pl.; Burbank, CA 91506; (818) 841-8697.

> [24+] **TARPAN STUDIOS**; AR; 1925-G Francisco Blvd. E.; San Rafael, CA 94901; (415) 485-1999; FAX: (415) 459-3234.

[24+] **TELURIDE PRODUCTIONS**; AR, APPV, MIDI, MP, VP; 4074 Fabian St., 2nd Fl.; Palo Alto, CA 94303; (415) 494-1037; FAX: (415) 855-9513.

[24+] **TEMPO RECORDING**; AR, JCP, MIDI, MP; 723 N. Seward St.; Los Angeles, CA 90038; (213) 468-9200.



THAT STUDIO  
North Hollywood, CA

> [24+] **THAT STUDIO**; AR; PO Box 958; North Hollywood, CA 91603; (818) 983-1523.

[24+] **3RD WAVE RECORDING**; AR, MIDI, MP; 1425 Marcelina Ave.; Torrance, CA 90508; (213) 212-0947.

[24+] **38-FRESH RECORDING**; AR, JCP, MIDI, MP; 7940 W. 3rd St.; Los Angeles, CA 90036; (213) 383-7374.

> [24+] **TIKI RECORDING STUDIOS**; AR, AD, ATD, JCP, MIDI, MP, MAST; 195 S. 26th St.; San Jose, CA 95116; (408) 286-9840.

> [24+] **GEORGE TOBIN STUDIOS**; 11337 Burbank Blvd.; North Hollywood, CA 91601; (818) 506-HITS (4487).

[24+] **THE TOLEDO STUDIO**; AR; 5131 The Toledo; Long Beach, CA 90803; (213) 433-2168.

[24+] **TOPANGA SKYLINE RECORDING CO.**; AR, APPV, APPF, MIDI, MP; 1402 Old Topanga Canyon Rd.; Topanga Park, CA 90290; (213) 455-2044; FAX: (213) 455-2774.

> [24+] **TOTAL ACCESS RECORDING**; AR; 612 Meyer Ln. #18; Redondo Beach, CA 90278; (213) 376-0404; FAX: (213) 379-3758.

[24+] **TRAC RECORD CO.**; AR, AD, ATD, JCP; 170 N. Maple; Fresno, CA 93702; (209) 255-1717.

> [24+] **TRACK RECORD, INC.**; 5102 Vineland Ave.; North Hollywood, CA 91601; (818) 761-0511.

> [24+] **TRAX RECORDING**; 1433 Cole Pl.; Hollywood, CA 90028; (213) 856-8729.

[24+] **TRIANON RECORDING**; AR, APPV, APPF, ATD, JCP, MIDI, MP; 1435 South St.; Long Beach, CA 90805; (213) 422-2095; FAX: (213) 428-8250.

[24+] **URBAN STREET STUDIO**; AR, AD, APPV, APPF, JCP, MIDI, MP; 1770 N. Highland #780; Hollywood, CA 90028; (213) 754-3327; FAX: (213) 684-8202.

[24+] **VALENTINE RECORDING STUDIOS**; AR; 5330 Laurel Canyon Blvd.; North Hollywood, CA 91607; (818) 769-1515.

> [24+] **VALLEY CENTER STUDIOS**; AR, MP, SDS; 5928 Van Nuys Blvd.; Van Nuys, CA 91401;

[24+] **THE VILLAGE RECORDER**; 1616 Butler Ave.; W. Los Angeles, CA 90025; (213) 478-8227.

[24+] **VISTA SOUND**; AR, APPV, EIR, JCP, MIDI, MP, ED, VP; 17760 Vista Ave.; Monte Sereno, CA 95030; (408) 395-5946.

[24+] **VMEG (VISUAL MUSIC ENTERTAINMENT GROUP);** AR, AD, APPV, APPF, EIR, JCP, MIDI, MP, RLR, RS, VP; PO Box 7934; Beverly Hills, CA 90212; (213) 655-7933.

►[24+] **VOICE OVER L.A.;** 1717 N. Highland Ave., Ste. 620; Hollywood, CA 90028; (213) 463-8652.

►[24+] **WAVES SOUND RECORDERS;** AR, APPV, APPF, JCP; 1956 N. Cahuenga Blvd.; Los Angeles, CA 90068; (213) 466-6141; FAX: (213) 466-3751.

[24+] **ROBERT WEAVER ENTERPRISES, INC./THE STUDIO;** AR, APPV, APPF, JCP, MIDI, MP, VP; 22723 Berdon St.; Woodland Hills, CA 91367; (818) 883-1920.

[24+] **WEBSTER COMMUNICATIONS;** AR, APPV, ED, VP; 607 N. Ave. 64; Los Angeles, CA 90042; (213) 258-6741.

►[24+] **DAVE WELLHAUSEN STUDIOS;** AR; 1310 20th Ave.; San Francisco, CA 94122; (415) 564-4910.

[24+] **WESTBEACH RECORDERS;** AR, ATD; 1621 Vista Del Mar Ave.; Hollywood, CA 90028; (213) 461-6959.

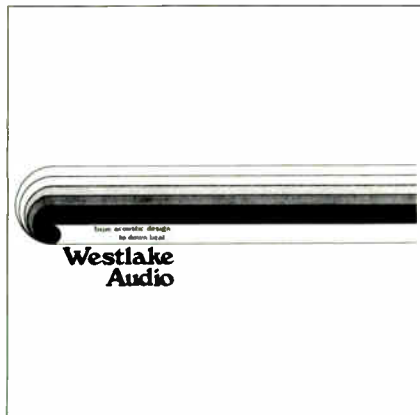

WESTLAKE STUDIOS  
Los Angeles, CA

►[24+] **WESTLAKE STUDIOS;** AR, APPV, APPF, ATD, EIR, JCP, SDS; 7265 Santa Monica Blvd.; Los Angeles, CA 90046; (213) 851-9800; FAX: (213) 851-0182.

[24+] **WESTWORLD RECORDERS;** AR, MP, SDS; 7118 Van Nuys Blvd.; Van Nuys, CA 91405; (818) 782-8449.

►[24+] **WILDCAT STUDIOS;** RLR; 2700 S. LaCienega Blvd.; Los Angeles, CA 90034; (213) 931-3411.

[24+] **WIZARDS AND CECIL B.;** AR, AD, APPV, JCP, MP, RLR, SR, SDS, VP; 1111 Second St.; San Rafael, CA 94901; (415) 453-0335.

[24+] **WORDS & MUSIC;** JCP, MP; 943 N. Cole Ave.; Los Angeles, CA 90038; (213) 464-3070.

### 12 & 16 Track Recording Studios

►[16] **ABC WATERMARK;** 3526 Cahuenga Blvd. W., Ste. 555; Los Angeles, CA 90068; (818) 980-9490; FAX: (213) 850-5832.

[16] **ACROSS THE TRACKS PRODUCTIONS;** AR, ATD, JCP, MP, RLR, SR; PO Box 2612; Garden Grove, CA 92640; (714) 636-3780.

►[16] **ADSONGS;** AR, APPV, JCP, MIDI, MP; PO Box 816; Point Reyes, CA 94956; (415) 669-1111; FAX: (415) 669-7116.

[16] **ART OF EARS;** 1217 A Fell St.; San Francisco, CA 94117; (415) 864-4641.

[16] **AUDIO VISUAL CONCEPTS;** AR, APPV, JCP, MIDI, MP; 1132 N. Vine St.; Hollywood, CA 90038; (213) 466-5253; FAX: (213) 466-2717.

[16] **AUDIO VOYAGE RECORDING;** AR, APPV, EIR, JCP, MIDI, MP, RLR; 2111 Research Dr. #2; Livermore, CA 94550; (415) 449-9820.

[16] **AVID PRODUCTIONS;** AR, APPV, ATD, MIDI, MP, ED, RLR, SR, VP; 235 E. 3rd Ave.; San Mateo, CA 94401; (415) 347-3417.

[16] **BATISH RECORDING ENTERPRISES;** AR, AD, ATD, MIDI; 1310 Mission St.; Santa Cruz, CA 95060; (408) 423-1699; FAX: (408) 423-5172.

►[16] **BAY RECORDS;** AR, JCP, MIDI, MP, RLR; 1741 Alcatraz Ave.; Berkeley, CA 94703; (415) 428-2002.

[16] **BEAR CREEK RECORDING STUDIO;** AR, APPV, MIDI, MP; 1780 Chanticleer; Santa Cruz, CA; (408) 475-8028.

[16] **ROLLAND BEECH FILM PRODUCTIONS;** 255 N. El Cielo Rd., Ste. 511; Palm Springs, CA 92262; (619) 323-8413.

[16] **ROBERT BERKE SOUND;** AR, APPV; 50 Mendell St. #11; San Francisco, CA 94124; (415) 285-8800; FAX: (415) 285-8847.

[16] **THE BLACKHOLE RECORDING STUDIO;** AR, AD, APPV, APPF, ATD, EIR, JCP, MIDI, MP, ED; 4637 Rosecrans Ave.; Hawthorne, CA 90250; (213) 676-1551.

[16] **BUZZY'S RECORDING;** AR, APPV, ATD, JCP; 6900 Melrose Ave.; Los Angeles, CA 90038; (213) 931-1867; FAX: (213) 931-9681.

[16] **CALIFORNIA PRODUCTIONS;** AD, APPV, ATD, JCP, MIDI, MP, ED, VP; 10560 Lakeside, Ste. #E; Garden Grove, CA 92640; (714) 537-4633; (800) 869-1569.

[16] **CANDLEWICK PRODUCTIONS, INC.;** RLR; 1161 N. Highland Ave.; Hollywood, CA 90038; (213) 462-7979.

[16] **STEPHEN CILURZO PRODUCTIONS;** VP; PO Box 879; Cardiff-by-the-Sea, CA 92007; (619) 452-9000; FAX: (619) 452-9059.

[16] **CITY COLLEGE OF SAN FRANCISCO: BROADCASTING DEPT.;** AR, ED; 50 Phelan Ave.; San Francisco, CA 94112; (415) 239-3525.

[16] **COCHRAN PRODUCTIONS;** AR, AD, APPV, APPF, ATD, EIR, JCP, MIDI, MP, ED, RLR, SR, VP; PO Box 37; Norwalk, CA 90650-7808; (213) 863-4605.

►[16] **CREATIVE MEDIA;** AR, APPV, ATD; 11105 Knott Ave., Ste. G; Cypress, CA 90630; (714) 892-9469.

[16] **CREATIVE SOUND STUDIO;** AR, MP, RS; 602 Cree Dr.; San Jose, CA 95123; (408) 224-1777.

[16] **DANCING DOG STUDIOS;** 1500 Park Ave. #B210; Emeryville, CA 94608; (415) 655-6760.

►[16] **DAVIS SOUND STUDIO;** 1205 Oak Ave.; Davis, CA 95616; (916) 758-6661; FAX: (916) 758-9412.

[16] **DEMO HELPERS;** AR, MP, ED; 7741 Beck Ave.; North Hollywood, CA 91605; (818) 764-TRAX.

[16] **DOBER RECORDING STUDIO;** RLR; 13441 Tobiaasson Rd.; San Diego, CA 92064; (619) 748-6771.

[16] **DOUBLE TIME PRODUCTIONS;** AR, MIDI, MP; 9257 Stoyer Dr.; Santee, CA 92071; (619) 448-1717.

[16] **ELECTRO-ACOUSTIC STUDIO;** ED; San Jose State University; 1 Washington Square; San Jose, CA 95112; (408) 924-4673.

[16] **EMERALD CITY PRODUCTIONS;** 512 Lisbon St.; San Francisco, CA 94112; (415) 469-8453.

[16] **EMERYVILLE RECORDING CO.;** AR; 1331 61st St., Unit C; Emeryville, CA 94608; (415) 655-9490.

[16] **EP PRODUCTIONS;** AR, AD, JCP, MIDI, MP, VP; 7455 Lorge Cir.; Huntington Beach, CA 92647; (714) 842-5524; FAX: (714) 841-8752.

►[16] **EVENSONG;** 2621 Sonoma Ave.; El Cerrito, CA 94530; (415) 237-4577.

[16] **FLIGHT 19;** AR, ATD; 5245 Avenida Encinas, Ste. F; Carlsbad, CA 92008; (619) 931-8093.

[16] **FREEWAY RECORDING, INC.;** AR, EIR, SR; 2248 E. 14th St.; Oakland, CA 94606; (415) 532-3700.

[16] **GLIDE STUDIOS;** AR; PO Box 747; La Canada, CA 91011; (818) 902-0435.

[16] **GLOBE STUDIOS;** AR, AD, EIR, JCP, MIDI, MP, RLR; 16 Locust Ave.; Mill Valley, CA 94941; (415) 381-1702; FAX: (415) 383-9951.

[16] **GOLDEN STATE RECORDERS, INC.;** AR, APPV, JCP, MP, ED, RLR; 665 Harrison, San Francisco, CA 94107; 1241 Swordfish St.; Foster City, CA 94404; (415) 781-6306; (415) 574-2552; FAX: (415) 781-0115.

[16] **GRASS RECORDING AND SOUND SERVICES;** AR, APPF, MP, RLR, SR, MAST; 800 Arbor Pl.; Del Rey Oaks, CA 93940; (408) 394-1065.

[16] **HARK'S SOUND STUDIO;** AR, RLR; 1041 N. Orange Dr.; Hollywood, CA 90038; (213) 463-3288.

[16] **HIGHLAND STUDIO;** AR, AD, MP; PO Box 554; Los Gatos, CA 95031; (408) 353-3952.

[16] **HORODKO SOUNDTRAX INC.;** AR, APPV, ATD, VP; 111 Vallejo St.; San Francisco, CA 94111; (415) 956-8729; FAX: (415) 433-7910.

[16] **HOT MIX RECORDING;** AR, AD, JCP, MP; 5892 Los Molinos Dr.; Buena Park, CA 90620; (714) 761-2621.

[16] **HOUSE OF FAITH;** AR; 707 Urban Ln.; Palo Alto, CA 94301; (415) 322-9710.

[16] **JEL RECORDING STUDIOS;** AR, APPV, JCP, MP; 6100 W. Pacific Coast Hwy.; Newport Beach, CA 92663; (714) 631-4880; FAX: (714) 548-1622.

[16] **KITCHEN SYNC STUDIOS;** 5325 Sunset Blvd.; Hollywood, CA 90027; (213) 463-2375.

[16] **LUMBERJACK PRODUCTIONS;** AR, ATD, MIDI; 840 Folsom Ave.; Hayward, CA 94544; (415) 887-6563.

[16] **LUNA PRODUCTIONS;** AR, APPV, APPF, JCP, MIDI, MP, MAST; 909 Sonoma Ave.; Petaluma, CA 94952; (707) 778-1039.

[16] **MASTERSOUND STUDIO;** AR, AD, JCP, MIDI, MP; 15571 Producer Ln., Ste. J; Huntington Beach, CA 92649; (714) 891-3330.

[16] **MAX SOUND;** AR, ATD, JCP, MIDI; 867 E. Walton St.; Long Beach, CA 90806; (213) 424-3121.

[16] **PETER MILLER RECORDING;** AR, AD, APPV, APPF, ATD, JCP, MIDI, MP, ED; PO Box 11013; San Francisco, CA 94101; (415) 567-7040.

[16] **MIND OVER MEDIA;** AR, APPV, APPF, JCP, MIDI, MP, RLR, SR, VP; 911 N. Euclid; La Habra, CA 90631; (213) 691-2776.

[16] **M.I.P. RECORDING & PRODUCTIONS;** RLR; 3013 E. Monte Vista; Denair, CA 95316; (209) 632-8415.

►[16] **NACNUD SOUND;** AR, JCP, MIDI, MP; 6748 Hogan Ln.; Lodi, CA 95240; (209) 334-2845.

[16] **NAKAMOTO PRODS.;** AR, APPV, APPF, JCP, MP; 3054 Gold Canal Dr., Ste. D; Rancho Cordova, CA 95670; (916) 638-7770; FAX: (916) 638-7346.

►[16] **NIGHTWIND PRODUCTIONS;** AR, JCP, MIDI; 60 Monument Plaza; Pleasant Hill, CA 94523; (415) 827-0200; FAX: (415) 827-1390.

[16] **THE NOTE FACTORY;** 5714 Columbus Ave.; Van Nuys, CA 91411; (818) 994-3133.

[16] **OGDEN HOUSE PRODUCTIONS;** AR, APPV, APPF, MIDI, MP; 1511 N. Ogden; Los Angeles, CA 90046; (213) 851-0458.

[16] **ORTEGA RECORDING STUDIO PROD.;** AR, ATD, JCP, MIDI, MP, RLR; 7386 Spring Branch Rd.—M. Gte.; Redding, CA 96003; (916) 275-2213; (916) 275-4631.

[16] **PACIFICA STUDIOS;** AR, ATD, JCP, MIDI, MP; 2620 La Cienega Ave.; Los Angeles, CA 90034; (213) 559-9777.

[16] **PLATINUM SOUNDS RECORDING & TAPE DUPLICATION;** AR, APPV, ATD, MIDI, RLR; 1725 Little Orchard St., Ste. A; San Jose, CA 95125; (408) 971-1310; FAX: (408) 971-1371.

[16] **POWER SUPPLY RECORDING;** AR, MIDI, MP; Napa, CA; (707) 224-7157.

[16] **PROGRESSIVE PRODUCTIONS INC.;** APPV, APPF, MP, VP; 1809 N. Helm, Ste. 6; Fresno, CA 93727; (209) 255-8991.

[16] **PYRAMIND SOUND—A SAN FRANCISCO AUDIO NETWORK RECORDING STUDIO;** AR, APPV, APPF, JCP, MIDI, MP; 39 Gilbert St.; San Francisco, CA 94103; (415) 863-8565.

[16] **BILL RASE PRODUCTIONS, INC.;** AR, APPV, ATD, JCP, MIDI, MP, RLR, MAST, VP; 955 Venture Ct.; Sacramento, CA 95825; (916) 929-9181; FAX: (916) 929-4751.

►[16] **RCM PRODUCTIONS;** AR, APPV; 12478 Washington Blvd. #5503; Los Angeles, CA 90066; (213) 390-5573.

[16] **REDWOOD CREEK RECORDING;** AR, APPV, JCP, MIDI, MP, VP; 5865 Stover Rd.; Blue Lake, CA 95525; (707) 668-4244.

[16] **RISING STAR RECORDING;** AR, MIDI; 655 Berry, Ste. I; Brea, CA 92621; (714) 671-7815.

[16] **ROTUND RASCAL RECORDING;** AR, EIR, JCP, MP; 5654 Natick Ave.; Van Nuys, CA 91411; (818) 901-9636.



# Recording & Video Production Facilities

UNITED STATES

## CALIFORNIA

### 12 & 16 Track Recording Studios

[16] **SILVER SHADOW PRODUCTIONS**; AR, APPV, ATD, EIR, JCP, MP, ED, RLR, SR, SDS, VP; 2170-M Commerce Ave.; Concord, CA 94520; (415) 827-2732.

[16] **SINGLE KICK(R) MUSIC**; AR, AD, APPV, MP; PO Box 747; La Canada, CA 91011; (818) 902-0435.

[16] **HANK SMITH MUSIC**; AR, APPV, APPF, JCP, MIDI; 155 Fell St.; San Francisco, CA 94102; (415) 431-5490.

[16] **S.N.A.P. PRODUCTION SERVICES**; VP; 18653 Ventura Blvd. #295; Tarzana, CA 91356; (818) 343-0283.

[16] **SOUND & VISION**; AR, AD, APPV, ATD, JCP, MIDI, MP, ED, MAST; 684 Indiana St.; San Francisco, CA 94107; (415) 821-2321.

[16] **SOUND CAT SOUND & MUSIC DESIGN**; AR, APPV, APPF, JCP, MIDI, MP; 832 Sansome St., 3rd Fl.; San Francisco, CA 94111; (415) 986-0992; FAX: (415) 986-6894.

[16] **SOUND SOURCE PRODUCTIONS**; JCP, MIDI, MP; PO Box 4596; Santa Rosa, CA 95402; (707) 528-3565.

[16] **SOUNDGRAPHICS**; AR, ATD, JCP, MIDI, MP; PO Box 91133; Long Beach, CA 90809; (213) 498-9135.

[16] **SOUNDWARE & VIDEO PRODUCTIONS**; AR, AD, APPV, EIR, JCP, MIDI, MP, RLR, VP; 1211 Park Ave., Ste. 102; San Jose, CA 95126; (408) 287-8066.

> [16] **SOUTH COAST RECORDING STUDIO**; 1818 1/2 N. Main St.; Santa Ana, CA 92706; (714) 541-2397.

[16] **SPECTRUM STUDIOS**; AR, ATD, EIR, MIDI, RLR; 664 Camino Campana; Santa Barbara, CA 93111; (805) 967-9494.

[16] **SPOT RECORDING**; 1700-P Newport Circle; Santa Ana, CA 92705; (714) 432-8310.

[16] **STANDING ROOM ONLY STUDIOS**; AR, APPV, APPF, ATD, JCP, MIDI, ED; 8228 Beech Ave.; Fontana, CA 92335; (714) 829-1314.

> [16] **STAR FORCE RECORDING, DIV. OF SF AUDIO SOUND & RECORDING**; RLR; 5290 E. Hunter Ave.; Anaheim, CA 92807; (714) 779-6677.

[16] **STARSHINE AUDIO ENTERPRISES**; AR, APPV, ATD, MP, ED; 932 Nord Ave.; Chico, CA 95927; (916) 345-3027.

[16] **KRIS STEVENS RECORDING**; 14241 Ventura Blvd. #204; Sherman Oaks, CA 91423; (818) 981-8255.

> [16] **STUDIO CENTER SAN JOSE**; AR, AD, APPV, JCP, MIDI, MP, RLR, VP; 434 S. First St.; San Jose, CA 95113; (408) 993-1040; FAX: (408) 993-1056.

[16] **STUDIO 9 SOUND LABS**; AR, ATD, JCP, MP; 5504 Hollywood Blvd.; Hollywood, CA 90028; (213) 871-2060; (818) 353-7087.

> [16] **THETA SOUND STUDIO**; RLR; Burbank, CA 91506; (818) 955-5888.

[16] **TIMELESS PRODUCTIONS**; AR, MIDI, MP, RLR, RS; 5050 Traverse Creek Rd.; Garden Valley, CA 95633; (916) 333-1335.

[16] **TOTAL TRAK PRODUCTIONS**; MIDI, MP; 2227 Alsace Ave.; Los Angeles, CA 90016; (213) 931-7508.

[16] **VIDEOSONIC SOUND RECORDING**; AR, MIDI, MP; 503 A Divisadero St.; San Francisco, CA 94117-2212; (415) 922-4382.

> [16] **WAVETECHRECORDING**; AR, APPV, APPF, JCP, MIDI, MP, VP; 3130 Skyway Dr., Ste. 602; Santa Maria, CA 93455; (805) 925-4244; FAX: (805) 349-8842.

[16] **ZACUTO AUDIO**; AR, APPV; 1316 3rd St.; Santa Monica, CA 90401; (213) 394-4932; FAX: (213) 458-7802.

### 4 & 8 Track Recording Studios

[8] **ACOUSTECH**; AR, EIR, JCP, MP, RLR, SR; 2887 Pine Valley Rd.; San Ramon, CA 94583; (415) 551-8300.

> [8] **AFTERHOURS RECORDING CO.**; AR, ATD; 1616 Victory Blvd., Ste. 104; Glendale, CA 91201; (818) 246-6583.

[8] **HANK ALRICH AUDIO SERVICES**; AR, MP, RLR, SR; PO Box 869; Greenville, CA 95947; (916) 284-6929.

[8] **ANGEL PRODUCTIONS**; AR, APPV, VP; PO Box 496; Penngrove, CA 94951; (707) 795-7399.

[4] **ARGUS MANAGEMENT/ S.R.S. MUSIC PRODUCTION**; AR, AD, MP, RLR; 506 S. Myers St.; Oceanside, CA 92054; (619) 966-1121.

[8] **ARTICHOKE PRODUCTIONS**; AR, APPV, MIDI, RLR, VP; 4114 Linden St.; Oakland, CA 94608; (415) 655-1283.

[8] **ASCOT RECORDING STUDIO**; AR; 1654 N. Harvard Blvd.; Los Angeles, CA 90027; (213) 663-6269.

[8] **ASSOCIATED PRODUCTION MUSIC**; APPV, APPF, MP; 6255 Sunset Blvd., Ste. 820; Hollywood, CA 90028; (213) 461-3211; FAX: (213) 461-9102.

[8] **AT&T RECORDING/DUPLICATING**; 501 N. Larchmont Blvd.; Los Angeles, CA 90004; (213) 466-9000.

[2] **ATM AUDIO/VISUAL**; AR, ATD, EIR, RLR, RS, SR, SDS; 17104 S. Figueroa St.; Gardena, CA 90248; (213) 538-2004; (213) 329-0997; FAX: (213) 516-1829.

[8] **AUDIO CYBERNETICS**; AR, APPV, APPF, MP, RLR; 22941 Ventura Blvd.; Woodland Hills, CA 91364; (818) 703-7102; FAX: (818) 999-5576.

[8] **BLACK TIE MUSICAL SERVICES**; AR, JCP, MP, RLR; 7811-B 13th St.; Westminster, CA 92683; (714) 895-9995.

[8] **BOB'S BANDAIDS**; AR, EIR, RLR, SR; 3782 E. Austin Way; Fresno, CA 93726; (209) 227-1224; FAX: (209) 228-0652.

[4] **BOSUSTON VIDEO**; APPV, VP; 3000 Olympic Blvd.; Santa Monica, CA 90404; (213) 315-4888; FAX: (213) 315-4800.

[8] **CANTRAX RECORDERS**; AR, APPV, APPF, JCP, MIDI, ED, RLR; 2119 Fidler Ave.; Long Beach, CA 90815; (213) 498-6492.

> [8] **CANYON RECORDING**; PO Box 13; Canyon, CA 94516; (415) 376-6135.

[8] **CARDINAL RECORDING**; AR, ATD, JCP, MIDI, MP; 623 Calle Tulipan; Thousand Oaks, CA 91360; (805) 493-2718.

[4] **CHONK MOONHUNTER**; AR, APPF, RLR; 484 Lake Park Ave. #289; Oakland, CA 94610; (415) 444-3074.

[4] **COMMAND PRODUCTIONS**; AR, ATD, JCP; 480 Gate 5 Rd., Ste. 107; Sausalito, CA 94965; (415) 332-3161.

[2] **R.E. COPSEY RECORDING**; AR, ATD, RLR, SR; PO Box 367; Camarillo, CA 93010; (805) 484-2415.

[8] **JAMES DANIELS PRODUCTIONS**; AR, APPV, MP, VP; 299 California Ave. #306; Palo Alto, CA 94306; (415) 325-8574.

[2] **DIGIPREP (DIGITAL AUDIO SERVICES) CD PRE-MASTERING**; 1425 N. Cole Pl.; Hollywood, CA 90028; (213) 461-1709.

[8] **DJ MUSIC**; AR, EIR, RLR, SR, VP; 3691 Edgefield Dr.; Santa Clara, CA 95054; (408) 727-7108.

[8] **DON'S STUDIO**; AR, APPV, JCP, MIDI, MP; 146 W. Moltke St.; Daly City, CA 94014; (415) 755-4469; FAX: (415) 882-6452.

[8] **DOYLE VANGOR PRODS.**; AR, APPV, JCP, MIDI, MP, RLR, VP; 9825 Independence Ave.; Chatsworth, CA 91311; (818) 341-8100; FAX: (818) 341-2750.

[8] **DUDKOWSKI-LYNCH ASSOCIATES, INC.**; AR, APPV, JCP, MP, VP; 150 Shoreline Hwy., Bldg. E; Mill Valley, CA 94941; (415) 332-5825; FAX: (415) 332-3436.

[2] **THE DUPLICATOR**; AR, ATD, RLR; 1305 Franklin St., Ste. 200; Oakland, CA 94612; (415) 832-5178.

[8] **ERICH'S MUSICAL ENTERPRIZE**; AR; 411 18th St.; Sacramento, CA 95814; (916) 444-5201.

[8] **FRED FOX MUSIC CO.**; AR, MIDI; 5 Elkwood Dr.; S. San Francisco, CA 94080; (415) 994-5908.

[8] **GILLETTE RECORDING SERVICES**; RLR; 255 N. El Cielo Rd., Ste. 466; Palm Springs, CA 92262; (619) 323-6073.

[8] **GLASS BRICK RECORDING**; AR, AD; PO Box 7632; San Diego, CA 92107; (619) 226-5310.

[4] **GOOD VIBRATIONS RECORDING & PRODUCTION CO.**; ATD, RLR, MAST; PO Box 764; Bonita, CA 92002; (619) 267-0307.

[8] **MARC GRAUE RECORDING**; AR, ATD, JCP, RLR, MAST; 1707 N. Gramercy Pl.; Hollywood, CA 90028; (213) 467-1822; FAX: (213) 467-2013.

[2] **HALF-INCH VIDEO**; AR, APPV; China Basin Building Two; 185 Berry St., Ste. 6501; San Francisco, CA 94107; (415) 495-3477.

[8] **H.M.E.A.'S "STATE-OF-THE-HEART" STUDIO**; AR, ATD, EIR, SR, VP; PO Box 453; Lakewood, CA 90714; (213) 422-4252.

[8] **HUMBOLDT RECORDING**; AR, JCP, MIDI; PO Box 713; Trinidad, CA 95570; (707) 677-3305.

[8] **HUN SOUND**; EIR, RLR, SR; 647 Irwin St.; San Rafael, CA 94901; (415) 454-2911.

[8] **JAMLAND STUDIOS**; 10988 Noble Ave.; Mission Hills, CA 91345; (818) 361-2224.

[4] **JAY MAX GROUP**; APPV, MIDI, MP, RLR, VP; 1680 N. Vine St. #609; Hollywood, CA 90028; (213) 466-6506.

[4] **JESUS IS LORD STUDIOS**; AR, MIDI, MP, SR; 5000 O'Sullivan Dr.; Los Angeles, CA 90032; (213) 222-2304.

[2] **JOHNSON DIGITAL AUDIO**; AR, RLR; 467 Saratoga Ave., Ste. 627; San Jose, CA 95129; (408) 255-5950.

[8] **JUDE PRODUCTIONS**; AR, APPV, APPF, JCP, MIDI, MP; PO Box 90; Dutch Flat, CA 95714; (916) 389-2326.

[8] **KALEIDOSOUND**; AR, APPV, APPF, JCP, MP; 185 Berry St., Ste. 2805; San Francisco, CA 94107; (415) 543-0531; FAX: (415) 543-4858.

[8] **KIRSCHNER COMMUNICATIONS, INC.**; AR, EIR, MP, RLR, VP; 3534 Summerfield Dr.; Sherman Oaks, CA 91423; (818) 906-3534; (818) 906-8806; FAX: (818) 906-8806.

[8] **KTVU RETAIL SERVICES**; AR, APPV, VP; 2 Jack London Square, PO Box 22222; Oakland, CA 94623; (415) 874-0228; FAX: (415) 452-2602.

[4] **LINEAR PRODUCTIONS**; AR, EIR, RS, SR; 1121 Hawthorne Dr.; San Mateo, CA 94402; (415) 349-8780.

[8] **LION TRACKS STUDIO/CREATIVE ENTERPRISES**; AR, MP, RLR, SR; 7720 Isabel Dr.; Cotati, CA 94931; (707) 792-1445.

> [8] **LOST SHEEP RECORDS**; 5777 Madison Ave., Ste. 110; Sacramento, CA 95841; (916) 348-3811.

[8] **CHUCK MARTIN ENTERPRISES**; AR, APPV, APPF, ATD, JCP, MP, VP; 444 N. Red Cloud Dr.; Diamond Bar, CA 91765; (714) 861-8122; FAX: (714) 861-3563.

[2] **MAUROY RECORDS**; AR, RLR, MAST; 1080 Pacheco St.; San Francisco, CA 94116; (415) 665-8480.

> [8] **MCCUNE STUDIOS**; RLR; 951 Howard St.; San Francisco, CA 94103; (415) 777-2700.

[4] **MEDIA LEARNING SYSTEMS**; MAST, VP; 1492 W. Colorado Blvd.; Pasadena, CA 91105; (818) 449-0006; FAX: (818) 449-8376.

[8] **MEDIA SERVICES—SOUNDMAX**; AR, APPV, APPF, EIR, JCP, RLR, SR; PO Box 179; Cameron Park, CA 95682; (916) 676-3342; FAX: (916) 676-3342.

[4] **MISS WHIB, A-BROAD**; RLR; PO Box 185; Greenville, CA 95947; (916) 284-7258.

[4] **THE MUSIC DESIGN GROUP**; APPV, APPF; 7060 Hollywood Blvd. #805; Hollywood, CA 90028; (213) 462-2404.

[4] **NEW LIFE BROADCASTING**; AR, EIR, RLR, SR; P.O. Box 117, 440 Lawrence St.; Quincy, CA 95971; (916) 283-4144.

[2] **NICEPIECE OF FISH**; AR, VP; 449 Marin Ave.; Mill Valley, CA 94941; (415) 381-4679.

[8] **NO BOYFRIEND MUSIC**; AD, JCP, MIDI, MP; 31131 Bailard; Malibu, CA 90265; (213) 457-1850; FAX: (818) 845-8039.

[4] **NORTHERN STUDIOS**; AR, MP, RLR; PO Box 65; Bella Vista, CA 96008; (916) 549-4178.

[8] **ON-TRAX AUDIO**; AR, APPV, ATD, EIR, RLR, SR, VP; 9340 Namia Dr.; Riverside, CA 92503; (714) 687-5506.

[2] **DAVE PELL PRODUCTIONS/DIGITAL**; AR, ATD, MP, MAST; 5635 Corteen Pl. N; Hollywood, CA 91607; (818) 980-1021; FAX: (818) 980-1080.

[8] **PHANTASMA SOUND**; AR, APPV, ATD, MIDI, MP, RLR; 7909 Fremont Ave.; Ben Lomond, CA 95005; (408) 336-2494.

[8] **PINEFOREST STUDIO**; AR, MIDI; PO Box 1445; Aptos, CA 95001; (408) 684-1555.

> [8] **PREGNANT BADGER STUDIOS**; 10010 Biscanewoods Way; Sacramento, CA 95827; (916) 361-8217.

[8] **PRODUCERS POST**; APPV, MIDI, MP, VP; 2625 W. Olive Ave.; Burbank, CA 91505; (818) 841-6750; FAX: (818) 841-0883.

[8] **GARRISON PUTNEY STUDIO**; AR, APPV, ATD, MIDI, MP, VP; 4635 E. Anaheim St.; Long Beach, CA 90804; (213) 494-4552.

[4] **QUALITY SOUND**; AR, APPF, ED, SR; 5625 Melrose Ave.; Los Angeles, CA 90038; (213) 467-7154.

[8] **REAL TO REEL REMOTE RECORDING/STARMAN RECORDS**; AR, AD, APPV, JCP, MIDI, MP, RLR, RS; PO Box 245604; Sacramento, CA 95820; (916) 441-1080.

[8] **RECORDING ETC.**; AR, ATD, RLR; 633 Cowper; Palo Alto, CA 94301; (415) 327-9344; FAX: (415) 321-9261.

[8] **THE RECORDING PLACE, INC.**; AR; 6520 Sunset Blvd.; Hollywood, CA 90028; (213) 461-3693.

[2] **RMS AUDIO/VIDEO PRODUCTIONS**; AD, APPV, ATD, EIR, RLR, SR, MAST, VP; 901 Bauer Dr.; San Carlos, CA 94070; (415) 591-4551.

[8] **SAN FRANCISCO PRODUCTION GROUP**; APPV, MIDI; 550 Bryant St.; San Francisco, CA 94107; (415) 495-5595.

> [8] **RANDALL SCHILLER PRODUCTIONS**; RLR; 1207 Fifth Ave.; San Francisco, CA 94122; (415) 661-7553; FAX: (415) 566-8238.

[8] **SHOAF COMMUNICATIONS**; APPV; 2435 N. Reese Pl.; Burbank, CA 91504; (818) 842-5600.

[2] **ROBERT SHUMAKER RECORDING SERVICES**; RLR; 2321 Russell #1 E; Berkeley, CA 94705; (415) 548-9986.

[2] **SHYNE SOUND**; AR, RLR, SR, SDS; Box 2280; San Rafael, CA 94912; (415) 459-2833.

[8] **SIDESTREAM SOUND**; AR, RLR, SR; 5013-1/2 Narragansett Ave.; San Diego, CA 92107; (619) 222-0238.

[2] **SKYLINE PRODUCTIONS INC.**; AR, EIR, RLR, VP; 1041 N. Orange Dr.; Hollywood, CA 90038; (213) 856-0033; FAX: (818) 894-2625.

[2] **SOUND IDEA PRODUCTIONS**; AR, ATD, RLR; 1305 Franklin St., Ste. 200; Oakland, CA 94612; (415) 832-5178.

[8] **SOUNDS LIKE**; AR; PO Box 914; Port Hueneme, CA 93044; (805) 988-9856.

[8] **THE SOUND SMITH**; PO Box 1567; Monterey, CA 93942; (408) 394-6940.

[8] **SOUNDTRACKS**; AR, JCP, MIDI, MP; 518 Rhode Is. St.; San Francisco, CA 94107; (415) 861-5670.

[2] **SPLIT REEL RECORDING**; APPF; 943 N. Cole Ave.; Hollywood, CA 90038; (213) 466-3817.

[2] **SQUARE ONE**; AR, MIDI, MP, SR; 104 Yosemite Ave.; Santa Cruz, CA 95060; (408) 429-6929.

[8] **STEP ONE STUDIOS**; AR, ATD, EIR, JCP, RS, SR; 432 Church St.; Garberville, CA 95440; (707) 923-3388.

[8] **STUDIO 101**; AR, APPV, JCP, MIDI, MP; 69 Harold Ave.; San Francisco, CA 94112; (415) 585-8770.

[8] **SUNDIAL RECORDING**; AR; PO Box 5426; Montecito, CA 93150; (805) 969-6926.

[8] **SUNSET RECORDING**; RLR; 856 Airport Rd.; Monterey, CA 93940; (408) 375-2861.

[2] **TAPETTE CORPORATION**; AR, ATD; 15702 Producer Ln.; Huntington Beach, CA 92649; (714) 638-7960; FAX: (714) 891-0638.

[8] **THIRD EAR RECORDING**; AR, AD; 143 S. Cedros; Solana Beach, CA 92075; (619) 481-3319.

[8] **TRANSMEDIA, INC.**; AR, ATD, JCP, RLR; 350 Pacific Ave.; San Francisco, CA 94111; (415) 956-3118; FAX: (415) 956-2595.

[8] **TRIANGLE VIDEO PRODUCTIONS**; JCP, VP; 11300 Hartland St.; N. Hollywood, CA 91605; (818) 505-9991; FAX: (818) 505-1811.

[2] **VENICE PRODUCTION & DESIGN**; APPV, EIR, VP; 2013 Walnut Ave.; Venice, CA 90291; (213) 397-6265.

[2] **VIDEO RESOURCES**; EIR, RLR, VP; 1805 E. Dyer Rd. #307; Santa Ana, CA 92705; (714) 261-7266; FAX: (714) 261-5908.

[8] **VIDEOTEL SOUND**; AR, AD, MIDI, MP, RLR, SR, MAST; 4416 Titan Ave.; Lompoc, CA 93436-1027; (805) 733-4416.

[8] **WALLY'S WEST INC.**; AR, JCP, MIDI; 260 E. Mariposa St.; Altadena, CA 91001; (818) 791-5305.

[4] **T. WHYTE & ASSOCIATES**; AR, RLR, SDS; 3549 Becerra Way #2; Sacramento, CA 95821; (916) 487-5364.

[8] **WILD WEST GRAPHICS & COMMUNICATIONS**; AR, AD, ATD, JCP; PO Box 346; Homewood (Lake Tahoe), CA 95718; (916) 525-5201.

[2] **WILLIAMS PRODUCTION CO.**; AR, APPF, RLR; PO Box 82245; San Diego, CA 92138; (619) 260-1950.

[8] **XANDOR RECORDING STUDIOS**; RLR; 407 Camino Sobrante; Orinda, CA 94563; (415) 254-9077.

#### Video Production & Post-Production Facilities

**AARON & LE DUC VIDEO**; VP, VPPE, OLVP, APPV, VTD; 2002 21st St.; Santa Monica, CA 90404; (213) 450-8275; FAX: (213) 396-8265.

**ABBA DABBA VIDEO**; VP, VPPE, OLVP, APPV; 3293 Cahuenga Blvd. W. 101; Hollywood, CA 90068; (213) 969-0910.

**ACTION VIDEO INC.**; VPPE, APPV, VTD; 6616 Lexington Ave.; Hollywood, CA 90038; (213) 461-3611; FAX: (213) 460-4023.

**AJS MEDIA CONSULTANTS**; VPPE, VTD; 7038 Decelis Pl., Ste. 9; Van Nuys, CA 91406; (818) 782-4741.

**ALLIES RECORDING STUDIO (ARS)**; 711 E. Cypress Ave.; Redlands, CA 92374; (714) 798-7375; FAX: (714) 354-7034.

**ANGEL PRODUCTIONS**; VP, VPPE, OLVP, APPV, VTD; PO Box 496; Penngrove, CA 94951; (707) 795-7399.

**ASSOCIATED PRODUCTION MUSIC**; APPV; 6255 Sunset Blvd., Ste. 820; Hollywood, CA 90028; (213) 461-3211; FAX: (213) 461-9102.

**AUDIO VISUAL CONCEPTS**; OLVP, APPV; 1132 N. Vine St.; Hollywood, CA 90038; (213) 466-5253; FAX: (213) 466-2717.

> **AVID PRODUCTIONS**; VP, VPPE, OLVP, APPV, VTD; 235 E. 3rd Ave.; San Mateo, CA 94401; (415) 347-3417.

**BAY AREA VIDEO COALITION**; VP, VPPE, OLVP, APPV, VTD; 1111 17th St.; San Francisco, CA 94107; (415) 861-3282; FAX: (415) 861-4316.

**ROLLAND BEECH FILM PRODUCTIONS**; VP, OLVP, APPV; 255 N. El Cielo Rd., Ste. 511; Palm Springs, CA 92262; (619) 323-8413.

> **ROBERT BERKE SOUND**; APPV; 50 Mendell St. #11; San Francisco, CA 94124; (415) 285-8800; FAX: (415) 285-8847.

**BEVERLY HILLS VIDEO GROUP**; VP, VPPE, VTD; 1749 14th St., Ste. #204; Santa Monica, CA 90404; (213) 452-1511; FAX: (213) 452-2395.

**ERIC BLUM VIDEO PRODUCTIONS**; VP, VPPE, OLVP, APPV, VTD; 41B Duesenberg Dr.; Westlake Village, CA 91362; (805) 495-3237.

**BREENE KERR PRODUCTIONS**; VP, VPPE, OLVP, APPV, VTD; 1235 Pear Ave.; Mountain View, CA 94043; (415) 965-3131; FAX: (415) 965-1587.

**BUENA VISTA SOUND (WALT DISNEY STUDIOS)**; APPV; 500 S. Buena Vista St., (Shorts Bldg. 201; Burbank, CA 91521; (818) 560-2732; FAX: (818) 560-1035.

**BURBANK OFF-LINE EDITING COMPANY**; VPPE; 2000 W. Magnolia Blvd., Ste. 205; Burbank, CA 91506; (818) 953-8919; FAX: (818) 953-9235.

**WALLY BURR RECORDING**; 1126 N. Hollywood Way #203; Burbank, CA 91505; (818) 845-0500.

**CALIFORNIA PRODUCTIONS**; VP, VPPE, OLVP, APPV, VTD; 10560 Lakeside, Ste. #E; Garden Grove, CA 92640; (714) 537-4633; (800) 869-1569.

**CANDLEWICK PRODUCTIONS, INC.**; VP, VPPE, OLVP, APPV; 1161 N. Highland Ave.; Hollywood, CA 90038; (213) 462-7979.

**C.A.V.E. PRODUCTIONS**; VP, VPPE, OLVP, APPV; 14511 Delano St.; Van Nuys, CA 91411; (818) 909-0011.

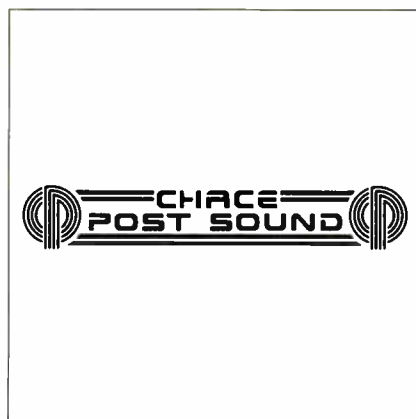

CHACE POST SOUND  
Los Angeles, CA

> **CHACE POST SOUND**; APPV; 7080 Hollywood Blvd. #515; Los Angeles, CA 90028; (213) 466-3946; FAX: (213) 464-1893.

**CHEAP COMPUTER GRAPHICS**; VP, VPPE; 5811 Tujunga Ave. #207; North Hollywood, CA 91601; (818) 769-4986.

**STEPHEN CILURZO PRODUCTIONS**; VPPE; PO Box 879; Cardiff-by-the-Sea, CA 92007; (619) 452-9000; FAX: (619) 452-9059.

**CINESOUND COMPANY INC.**; APPV; 915 N. Highland Ave.; Hollywood, CA 90038; (213) 464-1155; FAX: (213) 464-1820.

**CITY COLLEGE OF SAN FRANCISCO: BROADCASTING DEPT.**; VP, VPPE, OLVP; 50 Phelan Ave.; San Francisco, CA 94112; (415) 239-3525.

**COCHRAN PRODUCTIONS**; VPPE, OLVP, APPV, VTD; PO Box 37; Norwalk, CA 90650-7808; (213) 863-4605.

**COUNTRY REEL ENTERPRISES**; VP, VPPE, OLVP, APPV, VTD; PO Box 99307; Stockton, CA 95209; (209) 473-8050; (209) 473-8090; (800) 662-4432 (in CA).

**CREATIVE MEDIA**; APPV; 11105 Knott Ave., Ste. G; Cypress, CA 90630; (714) 892-9469.

**CROWLEY & ASSOCIATES**; VP, OLVP; 224 Mississippi St.; San Francisco, CA 94107; (415) 621-4477; FAX: (415) 621-7816.

**CRYSTAL SOUND STUDIOS**; VPPE, APPV; 1014 N. Vine; Hollywood, CA 90038; (213) 466-6453.

**JAMES DANIELS PRODUCTIONS**; VPPE, APPV; 299 California Ave. #306; Palo Alto, CA 94306; (415) 325-8574.

**DEVONSHIRE AUDIO/VIDEO STUDIOS**; VP, VPPE, APPV; 10729 Magnolia Blvd.; North Hollywood, CA 91601; (818) 985-1945; FAX: (818) 985-9915.

**DOYLE VANGOR PRODS.**; VP, VPPE, OLVP, APPV; 9825 Independence Ave.; Chatsworth, CA 91311; (818) 341-8100; FAX: (818) 341-2750.

**DUBS INCORPORATED**; VTD; 1220 N. Highland; Hollywood, CA 90038; (213) 461-3726; FAX: (213) 466-7406.

**DUDKOWSKI-LYNCH ASSOCIATES, INC.**; VP, VPPE, OLVP, APPV, VTD; 150 Shoreline Hwy., Bldg. E; Mill Valley, CA 94941; (415) 332-5825; FAX: (415) 332-3436.

> **EFX SYSTEMS**; APPV; 919 N. Victory Blvd.; Burbank, CA 91502-1633; (818) 843-4762; (213) 460-4474; FAX: (818) 848-0706.

> **THE ENTERPRISE, INC.**; VPPE, APPV; 4620 W. Magnolia Blvd.; Burbank, CA 91505; (818) 505-6000; FAX: (818) 505-6006.

**FACE BROADCAST PRODUCTIONS**; VPPE; 115 N. Hollywood Way #102; Burbank, CA 91505; (818) 842-9081; FAX: (818) 842-3708.

**FANFARE STUDIOS**; APPV; 120 E. Main St.; El Cajon, CA 92020; (619) 447-2555.

**FILMCORE POST PRODUCTION & AUDIO SERVICES**; VPPE, APPV; 849 N. Seward St.; Hollywood, CA 90038; (213) 464-7303.

**FINE LINE PRODUCTIONS**; VP, VPPE; 2600 18th St. #205; Berkeley, CA 94717; (415) 548-1745; FAX: (415) 486-2115.

**FIRST CAMERA VIDEO**; VP, VPPE, OLVP; 350 Brannan St., 3rd Fl.; San Francisco, CA 94107; (415) 495-0155.



# Recording & Video Production Facilities

UNITED STATES

CALIFORNIA

Video Production & Post-Production Facilities

**FIRST LIGHT VIDEO PUBLISHING;** *VPF, VPPE, OLVP, APPV*; 374 N. Ridgewood Pl.; Los Angeles, CA 90004; (213) 467-1700; FAX: (213) 461-1085.



525 POST PRODUCTION  
Hollywood, CA

**525 POST PRODUCTION;** *VPPE, APPV*; 6424 Santa Monica Blvd.; Hollywood, CA 90038; (213) 466-3348; FAX: (213) 467-1589.

**> FOCUSED AUDIO;** *APPV*; 544 Natoma; San Francisco, CA 94103; (415) 777-3108.

**FULL FRAME PRODUCTIONS;** *VPF, VPPE, OLVP, VTD*; 363 Brannon St.; San Francisco, CA 94107; (415) 546-0155; FAX: (415) 777-2009.

**> FUTURE POST;** *APPV*; 2414 W. Olive Ave.; Burbank, CA 91506; (818) 843-8200; FAX: (818) 842-8713.

**GELSON VIDEO PRODUCTIONS;** *VPF, VPPE, OLVP, APPV, VTD*; 1536 Hillside Dr.; Glendale, CA 91208; (818) 244-4043.

**> GROUP IV RECORDING, INC.;** *APPV*; 1541 N. Wilcox Ave.; Hollywood, CA 90028; (213) 466-6444; FAX: (213) 466-6714.

**HALF-INCH VIDEO;** *VPPE, APPV, VTD*; China Basin Building Two; 185 Berry St., Ste. 6501; San Francisco, CA 94107; (415) 495-3477.

**HORODKO SOUNDTRAX INC.;** *APPV, VTD*; 111 Vallejo St.; San Francisco, CA 94111; (415) 956-8729; FAX: (415) 433-7910.

**INTERLOK;** *APPV*; 1522 Crossroads of the World; Hollywood, CA 90028; (213) 469-3986.

**INTERNATIONAL VIDEO PREVIEW;** *VPF, VPPE, OLVP, APPV, VTD*; 1177 Quarry Ln.; Pleasanton, CA 94566; (415) 426-1190; FAX: (415) 426-1293.

**INTERSOUND INC.;** *VPPE, APPV, VTD*; 8746 Sunset Blvd.; Los Angeles, CA 90069; (213) 652-3741; FAX: (213) 854-7290.

**JAYMAX GROUP;** *VPPE, OLVP, VTD*; 1680 N. Vine St. #609; Hollywood, CA 90028; (213) 466-6506.

**JM TELEVISION PRODUCTIONS;** *VPF, VPPE, OLVP, VTD*; 2808 Roosevelt St.; Carlsbad, CA 92008; (619) 434-3363; FAX: (619) 434-8958.

**JOHNSON NYQUIST PRODUCTIONS, INC.;** *VPF, VPPE, OLVP*; 24982 Carol Ln.; Laguna Hills, CA 92653; (714) 770-5777.

**KIRSCHNER COMMUNICATIONS, INC.;** *OLVP*; 3534 Summerfield Dr.; Sherman Oaks, CA 91423; (818) 906-3534; (818) 906-8806; FAX: (818) 906-8806.

**KOBAYASHI MEDIA;** *VPF*; 5 Corporate Park, Ste. 220; Irvine, CA 92714; (714) 250-8545; FAX: (714) 250-0822.

**KTVU RETAIL SERVICES;** *VPF, VPPE, OLVP, APPV, VTD*; 2 Jack London Square, PO Box 22222; Oakland, CA 94623; (415) 874-0228; FAX: (415) 452-2602.

**L.A. VIDEOGRAMS;** *VPPE*; 3215 Overland Ave. #6167; Los Angeles, CA 90034; (213) 836-9224.

**LENS TO LENS;** *VPF, VPPE, OLVP, APPV, VTD*; 671 6th Ave.; San Francisco, CA 94118; (415) 668-5778.

**LIMELIGHT PRODUCTIONS;** *VPF, OLVP*; 1724 N. Whitley Ave.; Los Angeles, CA 90028; (213) 464-5808; FAX: (213) 464-3109.

**LUNA PRODUCTIONS;** *APPV*; 909 Sonoma Ave.; Petaluma, CA 94952; (707) 778-1039.

**MEDIA LEARNING SYSTEMS;** *VPF, VPPE, OLVP, APPV, VTD*; 1492 W. Colorado Blvd.; Pasadena, CA 91105; (818) 449-0006; FAX: (818) 449-8376.

**ROLF MENDEZ FILM/VIDEO;** *OLVP*; 11820 Larrylyn Dr.; Whittier, CA 90604; (213) 943-1622.

**STEVE MICHELSON PROD.;** 1749 14th St.; Santa Monica, CA 90404; (213) 452-1511.

**MIND OVER MEDIA;** *OLVP, APPV*; 911 N. Euclid; La Habra, CA 90631; (213) 691-2776.

**> MODERN VIDEOFILM;** *VPPE, APPV*; 7165 Sunset Blvd.; Hollywood, CA 90046; (213) 851-8070.

**MONTEREY POST PRODUCTION;** *APPV*; 29103 Marilyn Dr.; Santa Clarita, CA 91351; (805) 251-4530.

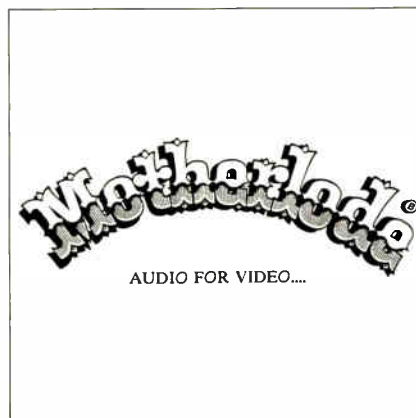

MOTHERLODE AUDIO VIDEO  
Grass Valley, CA

**MOTHERLODE AUDIO VIDEO;** *VPF, VPPE, OLVP, APPV, VTD*; 15775 Brooks Rd.; Grass Valley, CA 95945; (916) 272-3278.

**MTC PRODUCTION CENTER;** *VPF, VPPE, OLVP, APPV*; 4150 Glencoe Ave.; Marina Del Rey, CA 90292; (213) 823-8000.

**> MUSIC ANNEX INC. (AUDIO POST PRODUCTION DIV.);** *APPV*; 69 Green St.; San Francisco, CA 94111; (415) 421-6622; FAX: (415) 391-4995.

**MUSIC LAB INC.;** *VPPE, APPV, VTD*; 1831 Hyperion Ave.; Hollywood, CA 90027; (213) 666-3003.

**NIGHTWIND PRODUCTIONS;** *VPF, APPV*; 60 Monument Plaza; Pleasant Hill, CA 94523; (415) 827-0200; FAX: (415) 827-1390.

**OLIPHANT PRODUCTIONS;** *OLVP*; 77-333 Country Club Dr.; Palm Desert, CA 92260; (619) 345-3737; FAX: (619) 345-5501.

**> ON SIGHT VIDEO;** *OLVP*; 1079 Tennessee St.; San Francisco, CA 94107; (415) 824-5555.

**PACIFIC VIDEO RESOURCES;** *VPF, VPPE, OLVP*; 2339 Third St., Ste. M-4; San Francisco, CA 94107; (415) 864-5679; FAX: (415) 864-2059.

**PEERLESS VIDEO;** *VPF, VPPE, OLVP, APPV, VTD*; 218 Ninth St.; San Francisco, CA 94103; (415) 621-2077; FAX: (415) 626-2166.

**> THE PLANT RECORDING STUDIOS;** *OLVP, APPV*; 2200 Bridgeway; Sausalito, CA 94965; (415) 332-6100; FAX: (415) 332-5738.

**PRODUCERS POST;** *VPF, VPPE, VTD*; 2625 W. Olive Ave.; Burbank, CA 91505; (818) 841-6750; FAX: (818) 841-0883.

**PROGRESSIVE PRODUCTIONS INC.;** *VPF, VPPE, OLVP, APPV*; 1809 N. Helm, Ste. 6; Fresno, CA 93727; (209) 255-8991.

**GARRISON PUTNEY STUDIO;** *OLVP*; 4635 E. Anaheim St.; Long Beach, CA 90804; (213) 494-4552.

**BILL RASE PRODUCTIONS, INC.;** *VPF, VPPE, OLVP, APPV, VTD*; 955 Venture Ct.; Sacramento, CA 95825; (916) 929-9181; FAX: (916) 929-4751.

**REDWOOD CREEK RECORDING;** *VPPE, OLVP, APPV*; 5865 Stover Rd.; Blue Lake, CA 95525; (707) 668-4244.

**RMS AUDIO/VIDEO PRODUCTIONS;** *VPF, VPPE, OLVP, VTD*; 901 Bauer Dr.; San Carlos, CA 94070; (415) 591-4551.

**RUSSIAN HILL RECORDING;** *APPV*; 1520 Pacific Ave.; San Francisco, CA 94109; (415) 474-4520; FAX: (415) 474-7190.

**> SAN FRANCISCO PRODUCTION GROUP;** *VPPE, APPV, VTD*; 550 Bryant St.; San Francisco, CA 94107; (415) 495-5595.

**SCREENMUSIC STUDIOS;** *VPF, VPPE, OLVP, APPV*; 11700 Ventura Blvd.; Studio City, CA 91604; (818) 985-0900.

**SILK'S PORTFOLIO/ENGINEERING AND AUDIO/VIDEO;** *VPF, APPV*; 8635 Somerset Blvd.; Paramount, CA 90723;

**SILVER SHADOW PRODUCTIONS;** *VPF, VPPE, OLVP, APPV, VTD*; 2170-M Commerce Ave.; Concord, CA 94520; (415) 827-2732.

**S.N.A.P. PRODUCTION SERVICES;** *VPF, VPPE, OLVP, VTD*; 18653 Ventura Blvd. #295; Tarzana, CA 91356; (818) 343-0283.

**SONIC VISION, INC.;** *VPF, VPPE, OLVP, APPV, VTD*; 2217 The Alameda; Santa Clara, CA 95050; (408) 554-1117; FAX: (408) 554-1301.

**SOUND CHAMBER RECORDERS;** *APPV*; 27 S. El Molino Ave.; Pasadena, CA 91101; (818) 449-8133.

**SOUNDWARE & VIDEO PRODUCTIONS;** *VPPE, OLVP, APPV*; 1211 Park Ave., Ste. 102; San Jose, CA 95126; (408) 287-8066.

**STAGG STREET STUDIO;** *APPV*; 15147 Stagg St.; Van Nuys, CA 91405; (818) 989-0511.

**STARRION PRODUCTIONS;** *OLVP*; 1305 Stevenson St.; San Francisco, CA 94103; (415) 861-3100; FAX: (415) 861-4212.

**STEREOSCOPE INTERNATIONAL;** *VPF, OLVP*; 1209 N. Hollywood Way; Burbank, CA 91505-2224; (818) 848-9601.

**THE STUDIO, INC.;** *VPPE, APPV*; 1649 16th St.; Santa Monica, CA 90404; (213) 396-1488.

**> STUDIO CENTER SAN JOSE;** *VPF, VPPE, OLVP, APPV, VTD*; 434 S. First St.; San Jose, CA 95113; (408) 993-1040; FAX: (408) 993-1056.

**STUDIO 56 PRODUCTIONS;** *VPF, VPPE, OLVP, APPV*; 7000 Santa Monica Blvd.; Hollywood, CA 90038; (213) 464-7747; FAX: (213) 467-8579.

**STUDIO MASTERS;** *APPV*; 8312 Beverly Blvd.; Los Angeles, CA 90048; (213) 653-1988.

**SUNRISE CANYON PRODUCTIONS;** *VPF, OLVP*; PO Box 10968; Burbank, CA 91358; (818) 845-7473.

**TELEVISION ASSOCIATES, INC.;** *VPF, VPPE, OLVP, APPV, VTD*; 2410 Charleston Rd.; Mountain View, CA 94043; (415) 967-6040; FAX: (415) 964-2453.

**TELURIDE PRODUCTIONS;** *VPF, VPPE, OLVP, APPV*; 4074 Fabian St., 2nd Fl.; Palo Alto, CA 94303; (415) 494-1037; FAX: (415) 855-9513.

**TOPANGA SKYLINE RECORDING CO.;** *APPV*; 1402 Old Topanga Canyon Rd.; Topanga Park, CA 90290; (213) 455-2044; FAX: (213) 455-2774.

**TRIANGLE VIDEO PRODUCTIONS;** *VPF, VPPE, OLVP, APPV*; 11300 Hartland St.; N. Hollywood, CA 91605; (818) 505-9991; FAX: (818) 505-1811.

**VCA TELETRONICS;** *VPF, VPPE, VTD*; 1749 14th St.; Santa Monica, CA 90404; (213) 452-1511; FAX: (213) 452-2395.

**VECTORSCOPE PRODUCTIONS;** *VPPE, OLVP*; 18520 Burbank Blvd.; Tarzana, CA 91356; (818) 708-0922.

**VIDEO GENERAL;** *VPF, VPPE, OLVP, APPV*; 20432 S. Santa Fe Ave., Unit K; Carson, CA 90810; (213) 763-7788; FAX: (213) 763-1367.

**VIDEO-IT, INC.;** *VPPE, OLVP*; 5000 Overland, Ste. 6; Culver City, CA 90232; (213) 280-0505; FAX: (213) 280-0193.

**VIDEO RESOURCES;** VPF, VPPE, OLVP, VTD; 1805 E. Dyer Rd. #307; Santa Ana, CA 92705; (714) 261-7266; FAX: (714) 261-5908.

**VIDEOLADY;** VPPE, OLVP; PO Box 2276; San Bernardino, CA 92405; (714) 882-4057.

**VIDEOWERKS, INC.;** VPF, VPPE, OLVP, VTD; 1316 Third St. Promenade; Santa Monica, CA 90401; (213) 393-8754; FAX: (213) 458-7802.

**VISUAL INFORMATION SCIENCES;** VPF, VPPE, OLVP; 2364 Santa Anita Rd.; Norco, CA 91760; (714) 734-2492.

**VOICE & VIDEO;** VPPE, VTD; 5038 Ruffner St.; San Diego, CA 92111; (619) 560-1166; FAX: (619) 292-1567.

**>VOICE OVER L.A.;** APPV; 1717 N. Highland Ave., Ste. 620; Hollywood, CA 90028; (213) 463-8652.

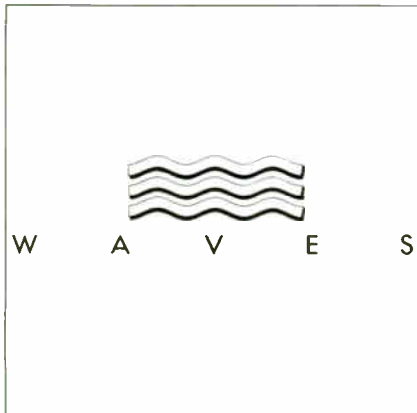

**WAVES SOUND RECORDERS**  
Los Angeles, CA

**>WAVES SOUND RECORDERS;** APPV; 1956 N. Cahuenga Blvd.; Los Angeles, CA 90068; (213) 466-6141; FAX: (213) 466-3751.

**WAVETECH PRODUCTIONS;** VPF, OLVP, APPV, VTD; 3130 Skyway Dr., Ste. 602; Santa Maria, CA 93455; (805) 925-4244; FAX: (805) 349-8842.



**WEBSTER COMMUNICATIONS**  
Los Angeles, CA

**>WEBSTER COMMUNICATIONS;** VPF, VPPE, OLVP, APPV, VTD; 607 N. Ave. 64; Los Angeles, CA 90042; (213) 258-6741.

**>WEST PRODUCTIONS, INCORPORATED;** APPV; 2921 W. Olive Ave.; Burbank, CA 91505; (818) 841-4500.

**WILDCAT STUDIOS;** APPV; 2700 S. LaCienega Blvd.; Los Angeles, CA 90034; (213) 931-3411.

**WILLIAMS PRODUCTION CO.;** OLVP; PO Box 82245; San Diego, CA 92138; (619) 260-1950.

**WIZARDS AND CECIL B.;** VPF, VPPE, OLVP, APPV; 1111 Second St.; San Rafael, CA 94901; (415) 453-0335.

**YURTH STUDIOS;** VPF, VPPE, OLVP, APPV, VTD; 8100 Remmet Ave., Ste. 9; Canoga Park, CA 91304; (818) 999-0080.

**ZEN PLANNING, U.S.A., INC.;** VPF, VPPE, OLVP; 944 Market St., Ste. 712; San Francisco, CA 94102; (415) 433-7145.

**> See monthly issue of Mix for extended listing**

## COLORADO

### 24+ Track Recording Studios

**>[24+] AVALANCHE RECORDING STUDIOS;** AR, APPV; 10650 Irma Dr. #27; Northglenn, CO 80233; (303) 452-0498.

**[24+] BEYOND SOUND;** 6300 Federal Blvd.; Denver, CO 80221; (303) 427-6789.

**>[24+] COLORADO SOUND RECORDING;** AR, APPV, MIDI, MP, RLR; 3100 W. 71st Ave.; Westminster, CO 80030; (303) 430-8811.

**[24+] COMMUNICATIONS, INC.;** AR, APPV, JCP, RLR, VP; 2130 S. Bellaire St.; Denver, CO 80222; (303) 759-1155; FAX: (303) 757-1832.

**[24+] COUPE STUDIOS;** AR, AD, APPV, ATD, JCP, MP, VP; 2539 Pearl St.; Boulder, CO 80302; (303) 447-0551; FAX: (303) 447-8603.

**[24+] DENVER CENTER MEDIA;** AR, APPV, APPF, JCP, MIDI, MP, RLR, VP; 1245 Champa St.; Denver, CO 80204; (303) 893-4000; FAX: (303) 893-3206.

**>[24+] FANFARE RECORDING STUDIOS;** AR, APPV, JCP, MIDI, MP, RLR; 5142 Quaker St.; Golden, CO 80403; (303) 279-2335.

**>[24+] FTM STUDIOS;** RLR; 1111 S. Pierce St.; Denver, CO 80226; (303) 922-3330.

**>[24+] PROFESSIONAL SOUND AND RECORDING;** RLR; 3100 W. 71st Ave.; Westminster, CO 80030; (303) 426-7819.

**>[24+] "THE RANCH";** 15849 Stump Rd.; Westcreek, CO 80135; (719) 687-9531.

**>[24+] SOUND SET RECORDING;** 2125 S. Valencia St., #B; Denver, CO 80231; (303) 671-0572.

### 12 & 16 Track Recording Studios

**[16] AKASHIC RECORDING STUDIO;** AR, MIDI, MP; 1670 Orchard Ave.; Boulder, CO 80304; (303) 444-2428.

**[16] BROWN BAG PRODUCTIONS;** AR, APPV, APPF, JCP, MIDI; 4134 S. Eudora St.; Englewood, CO 80110; (303) 756-9949; FAX: (303) 759-8213.

**[16] EYE IN THE SKY SOUND;** AR, APPV, APPF, ATD, JCP, MIDI, MP, ED, RLR; 4315 N. Hwy. 287, PO Box 642; La Porte, CO 80535; (303) 482-3947.

**[16] G.L.S. MUSICAL SERVICES;** AR, JCP, MIDI, MP; 8143 Route St.; Arvada, CO 80005; (303) 423-2476.

**[16] HIGH KITE PRODUCTIONS;** AR, AD, JCP, MIDI, MP; 1245 Elizabeth St.; Denver, CO 80206; (303) 322-8964.

**[16] HOMETOWN ARTISTS RECORDING;** AR; 120 W. 5th St.; Rifle, CO 81650; (303) 625-3421; FAX: (303) 625-3421.

**[16] PARAGON SOUND;** AR, JCP, MIDI, MP, RLR; 216 Hemlock; Fort Collins, CO 80524; (303) 493-8395; FAX: (303) 482-7593.

**[16] RAINSHADOW STUDIOS;** AR, APPF, JCP, MIDI, RS, SR; 620 E. Bleeker St.; Aspen, CO 81611; (303) 925-2296.

**[16] STARTSONG;** AR, JCP, MIDI, MP; 3218 E. LaSalle; Colorado Springs, CO 80909; (719) 634-2045.

**>[16] TIME CAPSULE RECORDING;** AR, JCP, MIDI, MP, RLR; 1042 Perry St.; Denver, CO 80204; (303) 534-6977.

**[16] XANADU STUDIOS/PRODUCTION;** AR, ATD, JCP, MP, ED; 1163 Lewiston St.; Aurora, CO 80011; (303) 366-6815.

### 4 & 8 Track Recording Studios

**[8] FERGUS SOUND ENTERPRISES;** AR, APPV, ED, RLR, RS, SR, SDS; 1925 Orchard Ave.; Boulder, CO 80304; (303) 442-3939.

**[8] HANK'S BASEMENT AUDIO;** AR, APPV, ATD, RLR, VP; 5665 E. Colorado Ave.; Denver, CO 80224; (303) 756-8777.

**[4] HIGH COUNTRY FILMS;** AR, APPV, APPF, RLR, VP; 6865a E. Arizona Ave.; Denver, CO 80224-1829; (303) 756-8030.

**[8] LAMBDA RECORDS & (LAMBDA PERFORMING ARTS GUILD OF AMERICA);** AR, AD; PO Box 14131; Denver, CO 80214;

**[8] DON MARTIN PRODUCTIONS;** AR, APPV, APPF, SR, VP; 10852 E. Iowa Dr.; Aurora, CO 80012; (303) 755-1746.

**[4] ROCKY MOUNTAIN A/V PRODUCTIONS, INC.;** AR, APPV, ATD, ED, VP; 4301 S. Federal Blvd. #108; Englewood, CO 80110; (303) 730-1100; FAX: (303) 730-0219.

**[8] GARY R. SMITH PRODUCTIONS;** AR, APPV, JCP, MIDI, MP, RLR; 2154 McKinley Ct.; Grand Junction, CO 81503; (303) 243-7551.

**[8] SUNDOWN SOUND;** AR; 832 Parkview Ave.; Louisville, CO 80027; (303) 666-7471.

**[2] SUNRISE SOUND;** AR; 1548 Ingalls; Lakewood, CO 80214; (303) 238-5002.

**[8] VALENTINE PRODUCTIONS;** AR, APPV, JCP, MIDI, MP, ED; 910 16th St. #900; Denver, CO 80202; (303) 893-0912.

**[2] WESTERN AUDIO/VIDEO SERVICES;** AR, ATD, VP; 21 Federal Blvd.; Denver, CO 80219; (303) 937-9306.

### Video Production & Post-Production Facilities

**AVALANCHE RECORDING STUDIOS;** APPV; 10650 Irma Dr. #27; Northglenn, CO 80233; (303) 452-0498.

**>COMMUNICATIONS, INC.;** VPF, VPPE, OLVP, APPV; 2130 S. Bellaire St.; Denver, CO 80222; (303) 759-1155; FAX: (303) 757-1832.

**DENVER CENTER MEDIA;** VPF, VPPE, OLVP, APPV; 1245 Champa St.; Denver, CO 80204; (303) 893-4000; FAX: (303) 893-3206.

**HANK'S BASEMENT AUDIO;** VPF, VPPE, OLVP, APPV, VTD; 5665 E. Colorado Ave.; Denver, CO 80224; (303) 756-8777.

**HIGH COUNTRY FILMS;** VPF, VPPE, OLVP, APPV; 6865a E. Arizona Ave.; Denver, CO 80224-1829; (303) 756-8030.

**MIDTOWN VIDEO PRODUCTIONS;** VPF, OLVP, VTD; 1641 Downing St.; Denver, CO 80218; (303) 894-0181; FAX: (303) 894-0713.

**PM ENGINEERING;** VPF, VPPE, OLVP, APPV, VTD; PO Box 3040, 6448 S. Skyline Dr.; Evergreen, CO 80439; (303) 674-5933.

**ROCKY MOUNTAIN A/V PRODUCTIONS, INC.;** VPF, VPPE, OLVP, APPV, VTD; 4301 S. Federal Blvd. #108; Englewood, CO 80110; (303) 730-1100; FAX: (303) 730-0219.

**THE VISUAL COMMUNICATIONS GROUP;** VPF, VPPE, OLVP, APPV; 3300 Mitchell Ln., Ste. 393; Boulder, CO 80301; (303) 443-6003.

**WESTERN AUDIO/VIDEO SERVICES;** VPF, OLVP, VTD; 21 Federal Blvd.; Denver, CO 80219; (303) 937-9306.

## CONNECTICUT

### 24+ Track Recording Studios

**>[24+] BLANK PRODUCTION AND BLANK TAPES;** RLR; 1597 Hope St.; Stamford, CT 06907; (203) 968-2420; FAX: (203) 329-7193.



**CARRIAGE HOUSE STUDIOS**  
Stamford, CT

**>[24+] CARRIAGE HOUSE STUDIOS;** AR; 119 W. Hill Rd.; Stamford, CT 06902; (203) 358-0065.

**[24+] GRACE RECORDING STUDIO, INC.;** AR, APPV, APPF, ATD, JCP, MIDI, MP, RLR; 159 Pelham Ave.; Hamden, CT 06518; (203) 288-9771; FAX: (203) 248-9442.



## Recording & Video Production Facilities

UNITED STATES

### CONNECTICUT

#### 24+ Track Recording Studios

> [24+] **HORIZON RECORDING**; RLR; 29 Tito Ln.; Wilton, CT 06897; (203) 762-2985.

[24+] **LITTLE BITTY, MIDI CITY, MUSIC COMMITTEE**; MIDI, MP, RLR, VP; 34 Willard Sq. S-416, PO Box 897; Hartford, CT 06104; (203) 548-0212.

[24+] **MEDIA ARTS CENTER/NICKEL STUDIO**; AR, AD, APPV, APPF, ATD, JCP, MIDI, MP, ED, MAST, VP; 753 Capitol Ave.; Hartford, CT 06106; (203) 951-8175.

[24+] **JOE MONTINERI CUSTOM SNARE DRUMS**; EIR; PO Box 3186; Vernon, CT 06066; (203) 646-1366.

> [24+] **PRESENCE STUDIOS**; AR, APPV, APPF, ATD, EIR, JCP, MIDI, MP, RLR, SR, MAST; 461 Main St.; East Haven, CT 06512; (203) 467-9038.

> [24+] **PULSE WAVE UNDERGROUND RECORDING STUDIO**; AR, APPV, APPF, JCP, MIDI, MP; 19 Norwood Terr.; Trumbull, CT 06611; (203) 268-1018.

[24+] **RBV RECORDING & VIDEO**; AR, APPV, ATD, JCP, RLR, VP; 920 N. Main St.; Southbury, CT 06488; (203) 264-3666.

[24+] **SONALYSTS MEDIA CENTER INC.**; AR, APPV, ATD, JCP, MP, MAST, VP; 215 Parkway North; Waterford, CT 06385; (203) 442-4355; FAX: (203) 447-8883.

[24+] **SOUNTEC STUDIOS**; AR, APPV, ATD, JCP, MP, RLR, VP; 25 Van Zant St.; East Norwalk, CT 06855; (203) 853-3433; FAX: (203) 855-1508.

[24+] **STUDIO UNICORN**; AR, AD, ATD, EIR, JCP, MIDI, MP, ED, RLR; 109 Lenox Ave.; Bridgeport, CT 06605; (203) 333-0736.

#### 12 & 16 Track Recording Studios

[16] **FLIGHT PATH RECORDING STUDIO**; AR, ATD, MP; 113 Bushy Hill Rd.; Granby, CT 06035; (203) 653-4468.

> [16] **LIVING SOUND PRODUCTIONS**; AR, APPV, MIDI, MP, RLR, VP; 22 Crescent Rd.; Westport, CT 06880; (203) 226-6908.

[16] **SOUND CONCEPTS**; AR, APPV, APPF, ATD, JCP, MP, RLR, SDS, VP; 80 Great Hill Rd.; Seymour, CT 06483; (203) 888-6712; FAX: (203) 734-3425.

[16] **SOUND SITUATION**; AR, MIDI, RLR; 130 Griswold St.; Glastonbury, CT 06033; (203) 633-1952; FAX: (203) 633-1952.

[16] **STARLITE RECORDING**; AR, AD, ATD, JCP, MP; 28 Starlight Dr.; Norwalk, CT 06851; (203) 847-2321; FAX: (203) 866-5463.

[16] **THREE COMMUNICATIONS PRODUCTIONS**; RLR; 116 Bretton Rd.; Middletown, CT 06457; (203) 347-8439.

#### 4 & 8 Track Recording Studios

[2] **HERITAGE VIDEO PRODUCTIONS**; MIDI; 44 N. Branford Rd.; Branford, CT 06405; (203) 776-1157; FAX: (203) 776-0594.

[8] **NEW ENGLAND TECHNICAL ASSOCIATES**; AR, SR, SDS; 27 Mansion St.; New Haven, CT 06512; (203) 467-8010; FAX: (203) 467-8482.

[2] **REALTY VIDEO**; VP; 213 Middle River Rd.; Danbury, CT 06811; (203) 743-7102.

#### Video Production & Post-Production Facilities

**ALDEN DESIGN IN MOTION**; VPF, VPPE, OLVP, APPV, VTD; 80 Commerce St.; Glastonbury, CT 06033; (203) 633-9481; FAX: (203) 659-4549.

**ANGELSEA PRODUCTIONS, INC.**; VPF, VPPE, OLVP, APPV, VTD; 55 Russ St.; Hartford, CT 06106; (203) 241-8111.

**BLANK PRODUCTION**; APPV; 1597 Hope St.; Stamford, CT 06907; (203) 968-2420; (800) 969-LOLA; FAX: (203) 329-7193.

**HERITAGE VIDEO PRODUCTIONS**; VPF, VPPE, OLVP, APPV; 44 N. Branford Rd.; Branford, CT 06405; (203) 776-1157; FAX: (203) 776-0594.

**IMAGE PRODUCTIONS**; VPF, VPPE, OLVP, APPV; 50 Water St.; South Norwalk, CT 06854; (203) 853-3486; FAX: (203) 853-0951.

**MEDIA ARTS CENTER/NICKEL STUDIO**; VPF, OLVP, APPV; 753 Capitol Ave.; Hartford, CT 06106; (203) 951-8175.

**PALACE PRODUCTION CENTER**; VPPE, VTD; 29 N. Main St.; South Norwalk, CT 06854; (203) 853-1740; FAX: (203) 855-9608.

**RBV RECORDING & VIDEO**; VPF, VPPE, OLVP, APPV, VTD; 920 N. Main St.; Southbury, CT 06488; (203) 264-3666.

**REALTY VIDEO**; VPF, VPPE, OLVP; 213 Middle River Rd.; Danbury, CT 06811; (203) 743-7102.

**RESCO**; 99 Draper Ave.; Meriden, CT 06450; (203) 238-9633.

**SONALYSTS MEDIA CENTER INC.**; VPF, VPPE, OLVP, APPV, VTD; 215 Parkway North; Waterford, CT 06385; (203) 442-4355; FAX: (203) 447-8883.

**SOUND CONCEPTS**; VPF, VPPE, OLVP, APPV; 80 Great Hill Rd.; Seymour, CT 06483; (203) 888-6712; FAX: (203) 734-3425.

### DELAWARE

#### 24+ Track Recording Studios

[24+] **SOUND LAB PRODUCTIONS, INC.**; AR, APPV, APPF, ATD, JCP, MIDI, MP, ED, RLR, VP; 1203 Yellowstone Dr.; Newark, DE 19713; (302) 731-0204; FAX: (302) 738-7485.

#### 12 & 16 Track Recording Studios

[16] **AUDIO VISIONS**; AR, APPV, ATD, JCP, MIDI, MP, RLR, VP; 7 Rockford Rd., Ste. 29 B; Wilmington, DE 19806; (302) 651-7955.

[16] **LYONS PRESENTATIONS**; AR, APPV, ATD, JCP; 715 Orange St.; Wilmington, DE 19899; (302) 654-6146; FAX: (302) 654-6154.

[16] **TARGET STUDIOS**; RLR; 801 Valley Rd.; Newark, DE 19711; (302) 731-4431.

#### 4 & 8 Track Recording Studios

> [8] **APOLLO STUDIOS**; AR, ATD, JCP, MIDI; 2723 Silverside Rd.; Wilmington, DE 19810; (302) 478-5236.

[2] **MOSTLY AUDIO**; AR, ATD, RLR, VP; PO Box 548; Bear, DE 19701; (302) 324-1020.

[8] **MUSICONCEPTS, LTD.**; RLR; 3650 Silverside Rd., Ste. 120; Wilmington, DE 19810; (302) 475-2668.

#### Video Production & Post-Production Facilities

> **AV3 INCORPORATED**; VPF, VPPE, OLVP; 53 McCullough Dr., Southgate Center; New Castle, DE 19720; (302) 324-5300.

**MOSTLY AUDIO**; VPF, VPPE, OLVP; PO Box 548; Bear, DE 19701; (302) 324-1020.

**SOUND LAB PRODUCTIONS, INC.**; VPF, VPPE, OLVP, APPV, VTD; 1203 Yellowstone Dr.; Newark, DE 19713; (302) 731-0204; FAX: (302) 738-7485.

### FLORIDA

#### 24+ Track Recording Studios

[24+] **AFTERHOURS MUSIC, INC./RECORDING STUDIO**; AR, EIR, JCP, MIDI, MP; 1959 NE 149th St.; North Miami, FL 33181; (305) 947-6841.

[24+] **AIRWAVE RECORDING COMPANY**; AR, JCP, MIDI, MP; 1830 NE 153rd St.; N. Miami Beach, FL 33162; (305) 949-9283; FAX: (305) 949-6835.

[24+] **AMERICAN RECORDING CENTER**; AR, AD, APPV, APPF, JCP, MP, RLR, VP; 515 W. 18th St.; Orlando, FL 32805; (407) 425-1342; FAX: (407) 425-8734.

[24+] **PAT APPLESON STUDIOS, INC.**; AR, APPV, ATD, JCP, MP, RLR, RS, SR; 1000 NW 159 Dr.; Miami, FL 33169; (305) 625-4435.

[24+] **AUDIO VISION RECORDING STUDIOS**; AR, AD, APPV, MIDI, MP, SDS; 13385 W. Dixie Hwy.; North Miami, FL 33161; (305) 893-9191; FAX: (305) 895-2647.

[24+] **AUGUST RECORDING STUDIO**; AR, APPV, JCP; 1428 Marcheck St.; Jacksonville, FL 32211; (904) 743-7131; FAX: (904) 743-8851.

> [24+] **CENTURY INTERNATIONAL STUDIO, INC.**; AR, APPV, ATD, MP, VP; 4730 E. 10th Ln.; Hialeah, FL 33013; (305) 685-8409; FAX: (305) 685-9291.

[24+] **CENTURY III AT UNIVERSAL STUDIOS**; AR, APPV, APPF, ATD, JCP, MIDI, VP; 2000 Universal Studios Plaza; Orlando, FL 32819; (407) 297-1000; FAX: (407) 352-8662.

> [24+] **CPN-TV**; AR, APPV, APPF, JCP, MIDI, MP, VP; 14375 Myerlake Cir.; Clearwater, FL 34620; (813) 530-5000; FAX: (813) 536-1864.

[24+] **CRAWFORD PRODUCTIONS, INC.**; AR, APPV, APPF, MP, VP; PO Box 1192; New Smyrna Beach, FL 32170; (904) 427-6626; FAX: (904) 427-7130.

> [24+] **CRITERIA RECORDING STUDIOS, INC.**; 1755 NE 149th St.; Miami, FL 33181; (305) 947-5611.

[24+] **JIM DEVITO'S RECORDING STUDIO**; AR, AD, ATD, EIR, JCP, MP, RLR, SR, SDS; 6249 A1A-S; St. Augustine, FL 32084; (904) 471-0506.



DIGITAL MULTI-MEDIA POST, INC.  
Orlando, FL

> [24+] **DIGITAL MULTI-MEDIA POST, INC.**; AR, APPV, APPF, JCP, MIDI, MP, ED, RLR, VP; 502 N. Hudson St.; Orlando, FL 32811; (407) 293-3390; FAX: (407) 293-4265.

[24+] **EARTHSOONG PRODUCTIONS**; AR, MIDI, MP; 14203 NE 18th Ave.; N. Miami, FL 33181; (305) 940-7972; (305) 962-0633.

[24+] **FLORIDA SOUND**; AR, ATD, JCP, MIDI, MP; 3350 Ulmerton Rd.; Clearwater, FL 34622; (813) 573-5277.

[24+] **GETTINGS PRODUCTIONS**; AR, APPV, APPF, EIR, JCP, MIDI, MP, SR, VP; 275 N. Lakeshore Dr.; Ocoee, FL 34761; (407) 656-8989; FAX: (407) 656-9862.

[24+] **LIMELITE VIDEO INC.**; AR, APPV, JCP, MIDI, MP, VP; 7355 NW 41st St.; Miami, FL 33166; (800) 634-5024; FAX: (305) 593-9785.

> [24+] **LONE PINE RECORDING STUDIOS**; AR, AD, JCP, MP; 5024 Simmons Rd.; Orlando, FL 32812; (407) 281-6881.

[24+] **MAGIC MUSIC & AUDIO**; AR, APPV, APPF, JCP, MIDI, MP; 416 E. Hillcrest St.; Orlando, FL 32803; (407) 648-8666; FAX: (407) 648-8246.

> [24+] **MIDALAN RECORDING STUDIOS**; AR, MIDI; 4041 Laguna; Coral Gables, FL 33146; (305) 444-6222; FAX: (305) 446-5356.

[24+] **MIRROR IMAGE SOUND & RECORDING**; RLR; 619 S. Main St.; Gainesville, FL 32601; (904) 376-8742.

> [24+] **MORRISOUND RECORDING, INC.**; AR, APPV, APPF, MIDI, MP; 12111 N. 56th St.; Tampa, FL 33617; (813) 989-2108.

> [24+] **NEW RIVER STUDIOS, INC.**; AR, APPV, JCP, MIDI; 408 S. Andrews Ave.; Fort Lauderdale, FL 33301; (305) 524-4000; FAX: (305) 524-3999.

> [24+] **PARC STUDIOS, INC.**; RLR; 658 Douglas Ave.; Altamonte Springs, FL 32714; (407) 894-0021.

►[24+] **PLATINUM POST**; AR, APPV, APPF, ATD, EIR, JCP, MIDI, MP, RLR, RS, SR, VP; 3300 University Blvd.; Winter Park, FL 32792; (407) 671-1111; FAX: (407) 671-1112.

[24+] **QUADRADIAL CINEMA CORP.**; AR, APPV, VP; 14203 NE 18th Ave.; North Miami, FL 33181; (305) 940-7971; FAX: (305) 949-6130.

►[24+] **REEL TIME RECORDING**; AR, AD, ATD, JCP, MIDI, MP, RLR; 939 Carswell; Holly Hill, FL 32117; (904) 238-7002.

►[24+] **SATURN SOUND STUDIOS INC.**; AR, APPV, JCP, MIDI, MP, RSR; 515 S. Olive Ave.; West Palm Beach, FL 33401; (407) 832-2148; FAX: (407) 832-1957.

[24+] **SOUND CHECK STUDIOS**; AR, AD, APPV, ATD, JCP, MIDI, MP, RLR, SR; 1635 Jackson St.; Fort Myers, FL 33901; (813) 334-4994.

[24+] **SOUNDSHINE PRODUCTIONS, INC.**; AR, AD, APPV, APPF, JCP, MIDI, MP, SDS; 723 W. Sunrise Blvd.; Ft. Lauderdale, FL 33311; (305) 463-9882.

[24+] **SOUNDTRACK, INC.**; 1975 NE 149th St.; N. Miami, FL 33181; (305) 945-4449.

[24+] **ST. JOHN CREATIVE AUDIO SERVICES INC.**; AR, APPV, JCP, MIDI, MP; 133 Grove St.; Orlando, FL 32811; (407) 578-1211; FAX: (407) 578-1298.



**STUDIO CENTER**  
N. Miami, FL

[24+] **STUDIO CENTER**; AR, APPV, APPF, JCP, MIDI, MP, VP; 14875 NE 20th Ave.; N. Miami, FL 33181; (305) 944-2911; FAX: (305) 826-8615.

►[24+] **TELSTAR**; RLR; 2074 17th St.; Sarasota, FL 33580; (813) 365-0337.

►[24+] **TROPICAL RECORDING STUDIO**; 4842 SW 74 Ct.; Miami, FL 33155; (305) 661-3599.

[24+] **WAREHOUSE RECORDING STUDIO**; AR, AD, APPV, ATD, JCP, MIDI, MP, MAST; 2071-20 Emerson St.; Jacksonville, FL 32207; (904) 399-0424; FAX: (904) 398-9683.

►[24+] **WOLF'S HEAD PRODUCTIONS**; 658 Douglas Ave., Ste. 1112; Altamonte Springs, FL 32714; (407) 682-6669.

#### 12 & 16 Track Recording Studios

[16] **BOBBY COLEMAN STUDIOS**; AR, AD, ATD, JCP, MAST; 3437 Bowden Cir. W.; Jacksonville, FL 32216; (904) 737-9205.

[16] **THE DUNGEON (THE DUNGEON OF LADY SABRE)**; AR, JCP, MIDI, MP; PO Box 1323; Delray Beach, FL 33447; (407) 732-7420.

[16] **FINAL SCORE PRODUCTIONS OF FLORIDA**; AR, AD, APPV, APPF, JCP, MIDI, MP; 3206 S. Conway Rd., Ste. 269; Orlando, FL 32812; (407) 282-5130; FAX: (407) 380-6624.

►[16] **HOLLYWOOD SYNC**; 3130 SW 19th St. #448; Hollywood, FL 33009; (305) 962-1586.

[16] **IMPORTANT RECORDING STUDIO**; AR, JCP, MIDI, MP, RLR; PO Box 352; Estero, FL 33928; (813) 947-0103.

[16] **MANGUM/ALFORD RECORDING STUDIO**; AR, APPV, ATD, EIR, JCP, MIDI, MP, RLR, SR; 3524 Morton St.; Jacksonville, FL 32217; (904) 737-9242.

[16] **MASTERCRAFT RECORDING**; AR, JCP, MIDI, MP, SR; 7145 Rosemary Ln.; Pt. St. Lucie, FL 34952; (407) 878-2041.

[16] **MAW SOUND**; AR, ATD, JCP, MIDI, RLR, SR; PO Box 2305; Largo, FL 34649-2305; (813) 535-4560.

►[16] **MCTAMMANY AUDIO PRODUCTION AND DESIGN**; AR, APPV, APPF, ATD, JCP, MIDI, MP, RLR, SR, VP; 3043 Doctor's Lake Dr.; Orange Park, FL 32073; (904) 264-6475.

[16] **MEDIA MUSIC RECORDING STUDIO**; AR, AD, APPV, JCP, MIDI, MP, ED, RLR, VP; 7902-F W. Waters Ave.; Tampa, FL 33615; (813) 884-5743.

[16] **MUSICLAND PRODUCTIONS RECORDING STUDIO**; AR, AD, ATD, JCP, MIDI, MP, MAST; 1627 E. Silver Springs Blvd.; Ocala, FL 32670; (904) 622-5529.

[16] **OUT OF THE BLUE RECORDING STUDIOS**; AR, JCP, MP, RLR; 901 Duval St.; Key West, FL 33040; (305) 296-0954.

[16] **PINE GROVE STUDIO**; AR, JCP, MIDI, MP; 10985 SW 172 Terrace; Miami, FL 33157; (305) 255-1495.

[16] **PROGRESSIVE MUSIC**; AR, APPV, APPF, ATD, JCP, MIDI, MP, RLR; 2116 Southview Ave.; Tampa, FL 33606; (813) 251-8093.

[16] **RAIN MOON STUDIO**; AR, EIR, MIDI; 85 NW 67th Ave.; Miami, FL 33126; (305) 261-5947.

[16] **STEVE ROGERS PRODUCTIONS**; AR, JCP, MIDI, MP; PO Box 51072; Ft. Myers, FL 33905; (813) 337-4244.

[16] **RON ROSE PRODUCTIONS, INC.**; AR, APPV, ATD, JCP, MIDI, MP, RLR; 3409 W. Lemon St., Ste. 6; Tampa, FL 33609; (813) 873-7700; FAX: (813) 875-6633.

[16] **SOUND DESIGN RECORDING STUDIO**; AR, JCP, MIDI, MP; 1943 NE 148th St.; N. Miami, FL 33181; (305) 945-1728.

[16] **STUDIO L.A.**; AR, AD, JCP, MIDI, MP, ED; 3828 Salmon Dr.; Orlando, FL 32811; (407) 292-9172.

#### 4 & 8 Track Recording Studios

[4] **AUDIO CRAFT**; AR, ATD, RLR, VP; 2701 E. Sunrise Blvd. #408; Ft. Lauderdale, FL 33304; (305) 563-0553.

[8] **AVID, INC.**; AR, APPV, EIR, JCP, MIDI, MP, VP; 130 E. Marks St.; Orlando, FL 32803; (407) 423-9535; FAX: (407) 422-8959.

[2] **DIGITAL 1**; RLR; 658 Douglas Ave.; Altamonte Springs, FL 32714; (407) 682-7790.

[8] **FLORIDA PRODUCTION CENTER**; AR, APPV, APPF, JCP, MIDI, MP, RLR, VP; 150 Riverside Ave.; Jacksonville, FL 32202; (904) 354-7000; FAX: (904) 354-7678.

[8] **FULLSKY RECORDING STUDIO**; AR, ATD, JCP, MP; PO Box 261072; Tampa, FL 33685; (813) 886-8147.

[2] **BARNETT GERSTEIN ASSOC.**; AR, EIR, RLR; 4420 Dunwoody Pl.; Orlando, FL 32808; (407) 290-5747.

[8] **HIRDLER ENTERPRISES, BMI N.S.A.I.**; AR; 2200 Cypress Bend Dr. S. #302; Pompano Beach, FL 33069; (305) 971-1457.

[8] **JUST IN PRODUCTIONS/CMS**; 301 Floral Dr.; Tampa, FL 33613; (813) 962-6175.

[2] **KINURA RECORDS**; MAST; 377 Westward Dr.; Miami Springs, FL 33166; (305) 887-5329.

[8] **LAIN STUDIOS M-349**; 3932 NW 24 St.; Miami, FL 33142; (305) 532-7339.

[4] **LI'L WALLY MUSIC PROD. & SALES**; AR, AD, APPV, MP, VP; 35 NE 62nd St.; Miami, FL 33138; (305) 758-0000.

[8] **MEDIA SOUND, INC.**; AR, APPV, APPF, JCP, MIDI, MP; 1010 W. Platt St.; Tampa, FL 33606; (813) 254-3399; FAX: (813) 228-9460.

[2] **MIAMI TAPE INC.**; ATD, MAST; 8180 NW 103 St.; Hialeah Gardens, FL 33016; (305) 558-9211; FAX: (305) 825-9873.

[8] **THE MIGHTY MIX**; 810 St. Michael St.; Tallahassee, FL 32301; (904) 224-6634.

[8] **MUSICAL REFUGEE STUDIOS**; AR, ATD, JCP, MIDI, MP, RLR, MAST; 6403 Elliot Dr.; Tampa, FL 33615; (813) 885-4881.

[8] **NATIONAL TELEPRODUCTIONS, INC.**; RLR, VP; 5022 50th Way; W. Palm Beach, FL 33409; (407) 689-9271; FAX: (407) 640-4677.

[8] **JOSH NOLAND MUSIC STUDIO**; AR, AD, MP, ED; 760 W. Sample Rd.; Pompano Beach, FL 33064; (305) 943-9865; FAX: (305) 943-9865.

[8] **PERSPECT AUDIO**; AR, JCP, MP, RLR; 2512 Cleveland St.; Hollywood, FL 33020; (305) 925-3629.

[8] **PROFESSIONAL BROADCAST PRODUCTIONS INC.**; AR, APPV, ATD, RLR, VP; 3224 W. Kennedy Blvd.; Tampa, FL 33609; (813) 877-7125.

[8] **PROTOLOG INC.**; AR, APPV, JCP, MIDI, RLR, SDS; 8800 49th St. N, Ste. 210; Pinellas Park, FL 34666; (813) 545-0302; FAX: (813) 545-0403.

►[8] **RADIO ACTIVE PRODUCTIONS RECORDING**; AR, AD, JCP, MIDI, MP, ED, RLR; at Key of Sea Music; 641 U.S. Hwy. 19 S.; Palm Harbor, FL 34684; (813) 787-8822.

[2] **RICH SOUND STUDIOS**; AR, APPV, ATD, MP; 16500 NW 7th Ave.; Miami, FL 33169; (305) 624-5333; FAX: (305) 624-4950.

[8] **SENSELESS PRODUCTIONS**; AR, EIR, RLR, SR; 803 W. Waters Ave.; Tampa, FL 33604; (813) 961-1033; FAX: (813) 935-2254.

[8] **JAY STEVENS PRODUCTIONS**; AR, APPV, JCP; 250 San Lorenzo Ave.; Coral Gables, FL 33146; (305) 442-2821.

[8] **STUDIO HELL**; AR, AD, MP; 321 N. 1st St.; Jacksonville Beach, FL 32250; (904) 249-2610.

[8] **TCC PRODUCTIONS**; AR, AD, JCP; 6331 Bahama Shores Dr. S.; St. Petersburg, FL 33705-5437; (813) 867-8546.

[8] **VIDEO IDEAS, INC.**; APPV, MP, RLR, VP; 3965 N. Federal Hwy.; Ft. Lauderdale, FL 33308; (305) 561-1447; FAX: (305) 564-7795.

[4] **VIDEO PUBLISHING GROUP, INC.**; APPV, EIR, MIDI, MP, VP; 5055 NW 159 St.; Miami, FL 33014; (305) 621-7283; FAX: (305) 621-2815.

[2] **WFSU-FM**; AR, RLR; 2561 Pottsdamer St.; Tallahassee, FL 32310; (904) 487-3086.

#### Video Production & Post-Production Facilities

**ACCORD PRODUCTIONS**; VPF, VTD; 2000 S. Dixie Hwy. #112; Miami, FL 33133; (305) 856-1245; FAX: (305) 856-9101.

**ADVANCED VIDEO COMMUNICATIONS, INC.**; VPF, VPPE, OLVP; 514 SE 11th Ct.; Fort Lauderdale, FL 33316; (305) 761-1178; (305) 379-1178.

**AUDIO CRAFT**; VTD; 2701 E. Sunrise Blvd. #408; Ft. Lauderdale, FL 33304; (305) 563-0553.

**AUGUST RECORDING STUDIO**; APPV; 1428 Marcheck St.; Jacksonville, FL 32211; (904) 743-7131; FAX: (904) 743-8851.

**AVID, INC.**; VPF, VPPE, OLVP, APPV; 130 E. Marks St.; Orlando, FL 32803; (407) 423-9535; FAX: (407) 422-8959.

►**BROADCAST QUALITY, INC.**; VPF, VPPE, OLVP, APPV, VTD; 5701 Sunset Dr. #316; South Miami, FL 33143; (305) 665-5416; FAX: (305) 284-0438.

**CENTURY INTERNATIONAL STUDIO, INC.**; VPPE, APPV, VTD; 4730 E. 10th Ln.; Hialeah, FL 33013; (305) 685-8409; FAX: (305) 685-9291.

**CENTURY III AT UNIVERSAL STUDIOS**; VPPE, OLVP, APPV, VTD; 2000 Universal Studios Plaza; Orlando, FL 32819; (407) 297-1000; FAX: (407) 352-8662.

**G. CIVINS PRODUCTIONS**; VPF; 9900 W. Sample Rd.; Coral Springs, FL 33065; (305) 752-8300; FAX: (305) 755-4255.

**CPN-TV**; VPF, VPPE, OLVP, APPV; 14375 Myerlake Cir.; Clearwater, FL 34620; (813) 530-5000; FAX: (813) 536-1864.

**CYPRESS PRODUCTIONS**; VPF, VPPE, OLVP; 5301 W. Cypress St., Ste. 109; Tampa, FL 33607; (813) 289-6115; FAX: (813) 289-0728.

**DIGITAL MULTI-MEDIA POST, INC.**; VPF, VPPE, OLVP, APPV; 502 N. Hudson St.; Orlando, FL 32811; (407) 293-3390; FAX: (407) 293-4265.

**FLORIDA PRODUCTION CENTER**; VPF, VPPE, OLVP, APPV; 150 Riverside Ave.; Jacksonville, FL 32202; (904) 354-7000; FAX: (904) 354-7678.

**KNOWLES VIDEO, INC.**; VPF, VPPE, OLVP, VTD; 2003 Apalachee Pkwy., Ste. 206B; Tallahassee, FL 32301; (904) 878-2298.

**MAGNETECH CORP.**; VTD; 3941 SW 47th Ave.; Ft. Lauderdale, FL 33314; (800) 683-DUPE; FAX: (305) 791-6788.



## Recording & Video Production Facilities

UNITED STATES

### FLORIDA

#### Video Production & Post-Production Facilities

► **MEDIA PRODUCTIONS**; *VPPE, OLVP, APPV*; 2095 N. Andrews Ave. Ext.; Pompano Beach, FL 33069; (305) 979-6467; FAX: (305) 979-6372.

**MORRISOUND RECORDING, INC.**; *APPV*; 12111 N. 56th St.; Tampa, FL 33617; (813) 989-2108.

**MUVIES**; *VPF, OLVP*; 1918 Harrison St., Ste. 108; Hollywood, FL 33020-5018; (305) 925-6805.

**NATIONAL TELEPRODUCTIONS, INC.**; *VPF, VPPE, OLVP*; 5022 50th Way; W. Palm Beach, FL 33409; (407) 689-9271; FAX: (407) 640-4677.

**NEW RIVER STUDIOS, INC.**; *APPV*; 408 S. Andrews Ave.; Fort Lauderdale, FL 33301; (305) 524-4000; FAX: (305) 524-3999.

**OMNI VIDEO**; *VPF, VPPE, OLVP, VTD*; 1719 Emerson St.; Jacksonville, FL 32207; (904) 396-7744; FAX: (904) 399-0816.

► **PLATINUM POST**; *VPF, VPPE, OLVP, APPV*; 3300 University Blvd.; Winter Park, FL 32792; (407) 671-1111; FAX: (407) 671-1112.

**POST EDGE**; *VPF, VPPE, OLVP, APPV, VTD*; 2040 Sherman St.; Hollywood, FL 33020; (800) 767-3343; FAX: (305) 922-8727.

**PROFESSIONAL BROADCAST PRODUCTIONS INC.**; *VPPE, APPV, VTD*; 3224 W. Kennedy Blvd.; Tampa, FL 33609; (813) 877-7125.

**SHOOTING STAR MOBILE TELEVISION**; *OLVP*; PO Box 3048; Tallahassee, FL 32315; (904) 893-2626; FAX: (904) 893-5193.

**SOUTHERN STAR PRODUCTIONS, INC.**; *VPF, OLVP*; 7201 E. Hillsborough Ave.; Tampa, FL 33610; (813) 623-3653; FAX: (813) 621-0770.

**VAUGHN BROADCAST RENTALS**; 5414 Beaumont Center Dr., Ste. 202; Tampa, FL 33634; (813) 887-3141.

**VIDEO PUBLISHING GROUP, INC.**; *VPF, VPPE, OLVP, APPV, VTD*; 5055 NW 159 St.; Miami, FL 33014; (305) 621-7283; FAX: (305) 621-2815.

**ZIMMER PRODUCTIONS LTD.**; *OLVP*; PO Box 430; Palm Beach, FL 33480; (407) 845-0211.

### GEORGIA

#### 24+ Track Recording Studios

[24+] **ARCADIA**; *RLR*; 425 Windsor Pkwy.; Atlanta, GA 30342; (404) 255-3284.

[24+] **ART NOYES**; *AR, RLR, SR*; P.O. Box 1261; Mapleton, GA 30059; (404) 739-2966.

[24+] **CATSPA W PRODUCTIONS INC.**; *AR, APPV, APPF, ATD, JCP, MIDI, MP, RLR, MAST*; 560 Dutch Valley Rd.; Atlanta, GA 30324; (404) 876-2287; FAX: (404) 881-8409.

[24+] **CHESHIRE SOUND STUDIOS**; *AR, EIR, MIDI*; 2093 Faulkner Rd. NE; Atlanta, GA 30324; (404) 321-3886; FAX: (404) 636-7738.

► [24+] **CRAWFORD POST PRODUCTION**; *AR, APPV, ATD, JCP, MIDI, MP, VP*; 535 Plasamour Dr.; Atlanta, GA 30324; (404) 876-7149; FAX: (404) 876-8956.

[24+] **CREATIVE SOUND CONCEPTS**; *AR, APPV, ATD, JCP, MIDI, MP*; 495 Armour Cir.; Atlanta, GA 30324; (404) 873-6628; FAX: (404) 875-6220.

[24+] **CROSSTOWN AUDIO**; *AR, APPV, JCP, MIDI, MP*; 2135 DeFor Hills Rd. NW; Atlanta, GA 30318; (404) 352-4790; FAX: (404) 352-2143.

[24+] **DAUROY PRODUCTIONS**; *AR, APPV, JCP, MIDI, MP*; 2427 Kingsley Dr., NE; Marietta, GA 30062; (404) 973-9536.

## Atlanta's Heavyweight.

# DOPPLER

DOPPLER STUDIOS, INC.  
Atlanta, GA

► [24+] **DOPPLER STUDIOS, INC.**; *AR, APPV, APPF, ATD, JCP, MP*; 1922 Piedmont Cir.; Atlanta, GA 30324; (404) 873-6941; FAX: (404) 872-2160.

[24+] **BERT ELLIOTT SOUND INC.**; *AR, ADS, APPV, APPF, JCP, MIDI, MP, RLR, VP*; 2080 Peachtree Ind. Ct. #115; Atlanta, GA 30341; (404) 452-1140; FAX: (404) 455-3356.

[24+] **EXOCET STUDIOS & TAPE DUPLICATION**; *AR, ATD, EIR, JCP, MP, SDS*; 3264 D Shallowford Rd.; Chamblee, GA 30341; (404) 455-7256.

[24+] **KALA INC.**; *AR, AD, APPV, ATD, JCP, MIDI, MP*; 2310 Marietta Blvd., Ste. D; Atlanta, GA 30318; (404) 355-0909; FAX: (404) 926-2774.

[24+] **JOHN KEANE STUDIO**; *AR*; 165 Hillcrest Ave.; Athens, GA 30606; (404) 548-4137.

► [24+] **MEDIA ASSOCIATES (FORMERLY NEW AGE SIGHT & SOUND)**; *RLR*; 120 Interstate N. Pwy E., Ste. 164; Atlanta, GA 30339; (404) 956-7956.

[24+] **MUSIPLEX**; *AR, AD, EIR, MIDI, MP*; 2091 Faulkner Rd. NE; Atlanta, GA 30324; (404) 321-2701; FAX: (404) 636-7738.

[24+] **O'CONNELL PRODUCTIONS, INC.**; *AR, AD, APPV, ATD, JCP, MIDI, RLR*; 3954 Peachtree Rd.; Atlanta, GA 30319; (404) 266-0020; FAX: (404) 233-2606.

[24+] **OMI STUDIOS (OLIVIERO MUSIC INC.)**; *AR, APPV, APPF, ATD, JCP, MIDI, MP*; 750 Ralph McGill Blvd., NE; Atlanta, GA 30312; (404) 525-4440; FAX: (404) 525-4545.

[24+] **"THE PEACH" RECORDING STUDIO**; *AR, MIDI, MP*; PO Box 150; Covington, GA 30209; (404) 787-1843.

[24+] **REELTIME**; *AR, APPV, ATD, JCP, MIDI, MP, RLR*; 702 Mail Blvd.; Savannah, GA 31406; (912) 352-9057.

[24+] **RKM STUDIOS**; *AR, APPV, ATD, JCP, MIDI, MP*; 1200 Spring St., NW; Atlanta, GA 30309; (404) 874-3667.

[24+] **RM AUDIO**; *RLR*; 3586 Pierce Dr.; Atlanta, GA 30341; (404) 458-6000.

[24+] **ROOP AUDIO CONSULTANTS & RECORDING**; *RLR*; Rte. 5, Box 428-A; Canton, GA 30114; (404) 479-5181.

► [24+] **SOUNDSCAPE STUDIOS**; 677 Antone St.; Atlanta, GA 30318; (404) 351-1003.

[24+] **SOUTHERN LIVING AT ITS FINEST**; *AR, APPV, APPF, EIR, JCP, MIDI, MP*; 1303 Spring St.; Atlanta, GA 30309; (404) 876-5944.

► [24+] **SOUTHERN TRACKS RECORDING**; *AR, APPV, EIR, MP*; 3051 Clairmont Rd. NE, Studio Complex; Atlanta, GA 30329; (404) 329-0147; FAX: (404) 325-1075.

► [24+] **STUDIO SOUTH**; *AR, APPV, APPF, ATD, JCP, MIDI, MP, ED, RLR*; 2510 Peach Orchard Rd.; Augusta, GA 30906; (404) 793-7800; FAX: (404) 793-9547.

[24+] **TRANSMEDIA STUDIOS**; *AR, AD, JCP, MIDI, MP*; 561-F Thornton Rd.; Lithia Springs, GA 30057; (404) 948-4813.



TWELVE OAKS RECORDING STUDIO  
Smyrna, GA

[24+] **TWELVE OAKS RECORDING STUDIO**; *AR, APPV, ATD, JCP, MIDI, MP, MAST*; 3830 S. Cobb Dr., Ste. 100A; Smyrna, GA 30080; (404) 435-2220.

[24+] **2560 RECORDING STUDIO/TWENTY-FIVE SIXTY, INC.**; *RLR*; 2560 Niskey Lake Rd. SW; Atlanta, GA 30331; (404) 349-7511.

► [24+] **VIDEO TAPE ASSOCIATES**; *AR, APPV, APPF*; 1575 Sheridan Rd. NE; Atlanta, GA 30324; (404) 634-6181; (800) 554-8273; FAX: (404) 321-1078.

[24+] **WRIGHT MONITORS**; *AR, SDS*; 2093 Faulkner Rd., NE; Atlanta, GA 30324; (404) 321-3886; FAX: (404) 636-7738.

#### 12 & 16 Track Recording Studios

[16] **AMAZING MUSIC**; *AR, JCP, MIDI, MP, ED, RLR*; 3795 Mercer Univ. Dr.; Macon, GA 31204; (912) 474-4700.

[16] **MIDI TWIN STUDIOS**; 4002 Ridge Rd.; Smyrna, GA 30080; (404) 434-7145.

► [16] **MR. O AUDIO**; *RLR*; 2035 S. Lumpkin Rd.; Columbus, GA 31903; (404) 687-6221.

[16] **MUSCADINE RECORDING STUDIOS**; *AR, AD, JCP, MIDI, MP*; 3078 Vineville Ave.; Macon, GA 31204; (912) 745-2401.

[16] **ORACLE RECORDING STUDIO**; *AR, MIDI, MP, RLR, SDS*; PO Box 464188; Lawrenceville, GA 30246; (404) 921-7941.

[16] **RISEING STAR RECORDS, INC.**; *AR, AD, ATD, RLR*; 1429 Wessyngton Rd. NE; Atlanta, GA 30306; (404) 872-1431.

[16] **STUDIO Z**; Rte. 2, Box 2265; Maysville, GA 30558; (404) 652-2979.

[16] **UNDERGROUND SOUND RECORDING STUDIO**; *AR, APPV, ATD, RLR*; PO Box 6871; Athens, GA 30604; (404) 549-3117.

[16] **WILLOW CREEK RECORDING STUDIOS**; *AR, JCP, MP*; 2228 Redmond Circle; Rome, GA 30161; (404) 232-6954.

#### 4 & 8 Track Recording Studios

[4] **ACA DIGITAL RECORDING**; *AR, ATD, RLR, MAST*; PO Box 450727; Atlanta, GA 30345; (404) 284-0948.

[8] **EAST AMERICAN ENTERTAINMENT/ ROBINSON STUDIO I**; *AR, AD, APPV, ATD, EIR, JCP, MIDI, MP, ED*; PO Box 582, Norcross, GA 30091 (Mailing); 2945 Stone Hogan Rd.; Norcross, GA 30331; (404) 349-9040.

[8] **EZ PRODUCTIONS**; *AR, AD, EIR, JCP, MP, SR*; 119 Williamsburg Lane; Woodstock, GA 30188; (404) 924-0433.

[2] **HENRY HOWARD**; *AR, RLR*; 228 Greenwood Circle; Decatur, GA 30030; (404) 373-2963.

[8] **HIGH SPIRITS RECORDING**; *AR, VP*; 1705 Cedar Shoals Dr.; Athens, GA 30605; (404) 546-9425.

[8] **JEFF'S BASEMENT STUDIO**; *AR, AD, ATD, JCP, MIDI, MP, ED, RLR*; 150 Sims St.; Carrollton, GA 30110; (404) 830-6222.

[8] **MASTER MEDIA, INC.**; *AR, APPV, ATD, EIR, MP, RLR, SR, VP*; 5097 Chamblee-Tucker Road; Tucker, GA 30084; (404) 491-0330; FAX: (404) 491-0330.

[4] **MONETT MEDIA AMBISONIC DIVISION**; AR, RLR; Ste. 2010, 400 Colony Sq.; Atlanta, GA 30361; (404) 876-3929.

[2] **THE MUSIC DEPOT**; ATD, EIR, SR, SDS; P.O. Box 958; Bremen, GA 30110; (404) 537-4821.

[8] **R&R / BRIEFCASE OF TALENT**; AR, AD, MP, RLR, SR; 1612 Marlbrook Dr.; Atlanta, GA 30307; (404) 371-8583.

[8] **R.W. RECORDING STUDIO**; AR, JCP, MIDI, MP, ED, RLR, SR; 1413 Sugarwood Ln.; Norcross, GA 30093; (404) 381-6629.

#### Video Production & Post-Production Facilities

**ATLANTA VIDEO PRODUCTION CENTER, INC.**; VPF, VPPE, OLVP; 1570 Northside Dr. NW, Ste. 240; Atlanta, GA 30318; (404) 355-3398.

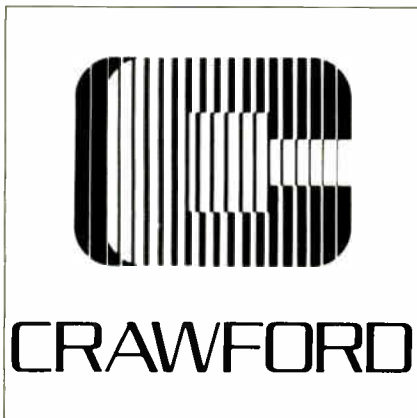

CRAWFORD POST PRODUCTION  
Atlanta, GA

**CRAWFORD POST PRODUCTION**; VPF, VPPE, APPV, VTD; 535 Plasamour Dr.; Atlanta, GA 30324; (404) 876-7149; FAX: (404) 876-8956.

**DOPPLER STUDIOS, INC.**; APPV; 1922 Piedmont Cir.; Atlanta, GA 30324; (404) 873-6941; FAX: (404) 872-2160.

**INDUSTRIAL COMMUNICATIONS**; VPPE, OLVP; 3293 Colony Dr.; Conyers, GA 30208; (404) 929-1514.

**O'CONNELL PRODUCTIONS, INC.**; APPV; 3954 Peachtree Rd.; Atlanta, GA 30319; (404) 266-0020; FAX: (404) 233-2606.

**STUDIO SOUTH**; APPV; 2510 Peach Orchard Rd.; Augusta, GA 30906; (404) 793-7800; FAX: (404) 793-9547.

**VIDEO TAPE ASSOCIATES**; VPD, VPPE, OLVP, APPV, VTD; 1575 Sheridan Rd. NE; Atlanta, GA 30324; (404) 634-6181; (800) 554-8273; FAX: (404) 321-1078.

#### HAWAII

#### 24+ Track Recording Studios

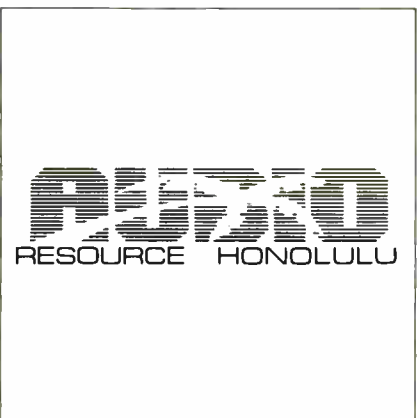

AUDIO RESOURCE HONOLULU  
Honolulu, HI

> [24+] **AUDIO RESOURCE HONOLULU**; AR, APPV, JCP, MIDI, MP, RLR; 1750 Kalakaua; Honolulu, HI 96826; (808) 944-9400.

[24+] **COMMERCIAL RECORDING, HAWAII**; 333 Cooke St.; Honolulu, HI 96813; (808) 536-5439.

[24+] **DOLPHIN SOUND**; RLR; KHNL-TV 150-B Puuhale Rd.; Honolulu, HI 96819; (808) 847-3253.

> [24+] **FORTUNATE SUN STUDIO, INC.**; AR, APPV, MIDI, MP; 720 Iwilei Rd., Box 1; Honolulu, HI 96817; (808) 531-5744.

[24+] **LAHAINA SOUND RECORDING STUDIO**; AR; 840 Wainee St., Lahaina Sq. H-2; Lahaina, HI 96761; (808) 667-2587.

[24+] **LEW MADDOX AUDIO BROADCAST SERVICES**; AR, APPV, EIR, MP, ED, RLR, VP; 46-210 Ahui-Nani Pl.; Kaneohe, HI 96744; (808) 247-5529.

> [24+] **PLATINUM RECORDERS HAWAII**; RLR; 95-11B Hillel Pl.; Milliani, HI 96789; (808) 623-4555.

[24+] **RAIN RECORDING AND PRO AUDIO**; AR, AD, APPV, ATD, EIR, JCP, MIDI, MP, ED, RLR, SR, SDS; Box 297; Mt. View, HI 96771; (808) 968-6346; (808) 968-6042.

[24+] **SEA-WEST RECORDING STUDIOS/HAWAII**; AR, AD, MIDI, MP, ED, RS; PO Box 2063; Pahoa, HI 96778; (808) 965-8841; FAX: (808) 965-8853.

> [24+] **SYSTEMS EXCLUSIVE RECORDING/FLYIN' HAWAIIAN PRODUCTIONS**; AR, AD, APPV, APPF, JCP, MIDI, MP; 4942 Likini St.; Honolulu, HI 96818; (808) 839-5431.

#### 12 & 16 Track Recording Studios

[16] **MELODY LINE PRODUCTIONS**; AR, APPV, JCP, MIDI, MP; 2662 Kaliaiani Cir.; Pukalani, HI 96768; (808) 572-1640.

[16] **SHIRTSLEEVE PRODUCTIONS**; AR, APPV, JCP, VP; Box 23082; Honolulu, HI 96822; (808) 988-2944; FAX: (808) 988-5140.

> [16] **THE SIDEWALK, INC.**; RLR; 84-710 Kili Dr, Ste. 1211; Makaha, HI 96792; (808) 695-8556.

[16] **WEST HAWAII RECORDING**; AR, APPV, EIR, JCP, RLR; PO Box 3172; Kamuela, HI 96743; (808) 883-9383.

#### 4 & 8 Track Recording Studios

[8] **JAGS ENTERTAINMENT**; AR, APPV, ER, JCP, MIDI, MP, ED, RLR, SR; PO Box 935; Captain Cook, HI 96704; (808) 323-3315.

[8] **KOOLAU PRODUCTIONS**; AR, EIR, MP, RLR, SR; 1826 Alewa Dr.; Honolulu, HI 96817; (808) 595-4870.

[2] **STUDIO M PRODUCTIONS UNLTD.**; AR, RLR, SR, VP; 8715 Waikiki Station; Honolulu, HI 96830; (808) 734-3345; FAX: (808) 734-3299.

[8] **STUDIO Q AT QDD**; AR, APPV, APPF, MP, RLR, MAST; 816 Queen St.; Honolulu, HI 96813; (808) 521-6961; FAX: (808) 545-3519.

#### Video Production & Post-Production Facilities

**AUDIO RESOURCE HONOLULU**; APPV; 1750 Kalakaua; Honolulu, HI 96826; (808) 944-9400.

**CAMERA ONE**; OLVP; 1609-D Iwi Way; Honolulu, HI 96816; (808) 732-2590.

**LEW MADDOX AUDIO BROADCAST SERVICES**; VPF, VPPE, OLVP, APPV; 46-210 Ahui-Nani Pl.; Kaneohe, HI 96744; (808) 247-5529.

**STUDIO M PRODUCTIONS UNLTD.**; VPF, OLVP, APPV; 8715 Waikiki Station; Honolulu, HI 96830; (808) 734-3345; FAX: (808) 734-3299.

#### IDAHO

#### 24+ Track Recording Studios

> [24+] **SUN VALLEY AUDIO**; 808 Warm Springs Rd.; Ketchum, ID 83353; (208) 726-3509.

#### 12 & 16 Track Recording Studios

[16] **HORIZON AUDIO RECORDING**; AR, JCP, MIDI, MP; 8185 Meridian Rd. S; Meridian, ID 83642; (208) 888-1723.

[16] **RAP RECORDING STUDIO**; AR, APPV, JCP, MIDI, MP, RLR; 167 S. 3rd E.; Rexburg, ID 83440; (208) 356-8705.

[16] **SHEWBREAD MUSIC COMPANY**; AR; Hwy. 95; Lucile, ID 83542; (208) 628-3663; FAX: (208) 628-3202.

[16] **TONAL MAGIC RECORDING**; AR, AD, MIDI, RLR, SR; 1028 Lakeside; Coeur d'Alene, ID 83814; (208) 765-8023; FAX: (208) 765-3065.

#### 4 & 8 Track Recording Studios

[8] **RICKS COLLEGE RECORDING SERVICES**; AR, APPV, ATD, RLR; Ecom Bldg. 82, Ricks College; Rexburg, ID 83440; (208) 356-2400; FAX: (208) 356-2490.

#### ILLINOIS

#### 24+ Track Recording Studios

> [24+] **ARC RECORDS, INC.**; 2844 W. Eastwood Ave.; Chicago, IL 60625-3710; (312) 478-3008.

[24+] **ARS RECORDING & TAPE DUPLICATION**; AR, ATD, EIR, JCP, MIDI, MP, RLR, SR, MAST; 11626 S. Pulaski; Alsip, IL 60658; (708) 371-8424; FAX: (708) 371-9403.

[24+] **ATTICA RECORDING STUDIO**; 2614 5th Ave.; Rock Island, IL 61201; (309) 786-9832.

[24+] **AUDIO RECORDING UNLIMITED INC.**; AR; 400 N. Michigan #1900; Chicago, IL 60611; (312) 527-7000; FAX: (312) 527-3360.

[24+] **THE AUDIO-VISUAL DEPARTMENT, INC.**; AR, APPV, APPF, ATD, JCP, MIDI, MP, ED, RLR, SR, VP; 5629 N. Milwaukee Ave.; Chicago, IL 60646; (312) 774-3700.

> [24+] **CHICAGO RECORDING COMPANY**; AR, APPV, APPF, ATD, JCP, MP, MAST; 232 E. Ohio St.; Chicago, IL 60611; (312) 822-9333; FAX: (312) 822-9189.

> [24+] **CHICAGO TRAX RECORDING**; AR, APPV, ATD, JCP, MP; 3347 N. Halsted; Chicago, IL 60657; (312) 525-6565; FAX: (312) 525-6942.

[24+] **COACHHOUSE MUSIC**; AR, AD, ATD, MAST; PO Box 1308; Barrington, IL 60011-1308; (708) 382-5295; FAX: (708) 381-1022.

[24+] **CONSORTIUM, LTD. DBA STUDIOMEDIA RECORDING CO.**; AR, APPV; 1030 Davis St.; Evanston, IL 60201; (708) 864-4460.

[24+] **DRESS REHEARSALS LTD.**; 1840 W. Hubbard; Chicago, IL 60622; (312) 829-2213.

[24+] **GRW ASSOC. INC./WARY LION TUNES**; MIDI; 5533 N. Glenwood; Chicago, IL 60640; (312) 561-9652; FAX: (312) 561-9553.

[24+] **JOR-DAN RECORDING, INC.**; RLR; 1100 Wheaton Oaks Ct.; Wheaton (Chicago), IL 60187; (708) 653-1919; FAX: (708) 665-4966.

[24+] **LAKE RECORDING STUDIOS**; 418 Lake St.; Maywood, IL 60153; (708) 344-8760.

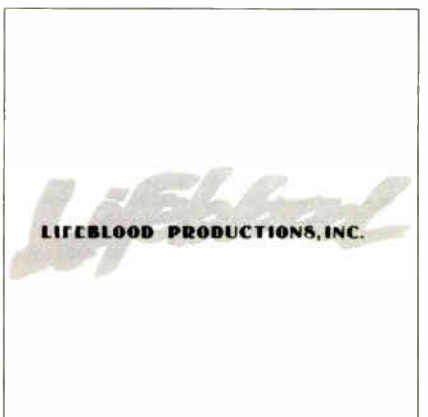

LIFEBLOOD PRODUCTIONS INC.  
Chicago, IL

[24+] **LIFEBLOOD PRODUCTIONS INC.**; AR, AD, ATD, JCP, MIDI, MP; 151 N. Michigan Ave.; Chicago, IL 60601; (312) 819-1717; FAX: (312) 819-0114.

> [24+] **METRO MOBILE LOCATION RECORDING**; RLR; 2097 John's Ct.; Glenview, IL 60025; (708) 998-6420.

[24+] **MIDILAB**; AR, APPV, ATD, JCP, MIDI, MP, ED, RLR, SDS; 610 N. Fairbanks; Chicago, IL 60611; (312) 467-5440; FAX: (312) 467-0867.



# Recording & Video Production Facilities

UNITED STATES

## ILLINOIS

### 24+ Track Recording Studios

[24+] **MIDLAND STUDIOS**; AR, APPV, ATD, JCP, MIDI, MP, RLR, RS, VP; 552 Spruce; Rosewood Heights, IL 62024; (618) 259-6747.

> [24+] **MINDSCAPE STUDIOS INC.**; RLR; 700 N. Green St.; Chicago, IL 60622; (312) 243-7000.

[24+] **OPTIMUS, INC.**; AR, APPV, APPF, VP; 161 E. Grand Ave.; Chicago, IL 60611; (312) 321-0880; FAX: (312) 321-9765.

> [24+] **PARAGON RECORDING STUDIOS**; AR, ATD, EIR, ED, RLR, SDS; 9 E. Huron St.; Chicago, IL 60611; (312) 266-0075; FAX: (312) 242-6688.

[24+] **PRIVATE STUDIOS**; AR, APPV, APPF, ATD, EIR, JCP, MIDI, MP, ED, RLR, SDS, MAST; 705 W. Western Ave.; Urbana, IL 61801; (217) 367-3530.

[24+] **PUMPKIN RECORDING STUDIOS INC.**; AR; 6737 W. 95th; Oak Lawn, IL 60453; (708) 598-3045.

[24+] **QUALITY MEDIA PRODUCTIONS**; AR, ATD, EIR, JCP, MIDI, SR; 1431 B W. Whittaker; Salem, IL 62881; (618) 548-3566.

[24+] **RAINBOW BRIDGE 24-TR. RECORDING**; AR, AD, ATD, VP; 117 W. Rockland Rd., PO Box 615; Libertyville, IL 60048; (708) 362-4060; FAX: (708) 362-4653.

[24+] **RCL RECORDING SERV.**; AR, APPV, APPF, ATD, JCP, MIDI, MP, ED, RLR, VP; 900 Western; Glen Ellyn, IL 60137; (708) 469-4149.

[24+] **RIVER NORTH RECORDERS**; 610 N. Fairbanks Ct.; Chicago, IL 60611; (312) 944-1107.

> [24+] **SEAGRAPE RECORDING STUDIOS, INC.**; AR, ATD, JCP, MIDI, MP; 5740 N. Western Ave.; Chicago, IL 60659; (312) 784-0773; FAX: (312) 784-0773.

[24+] **SKYVIEW FILM & VIDEO**; AR, APPV, APPF, JCP, MIDI, MP; 541 N. Fairbanks, 22nd Fl.; Chicago, IL 60611; (312) 670-2020; FAX: (312) 670-4520.

[24+] **SOLID SOUND RECORDING STUDIO, INC.**; AR, APPV, APPF, ATD, JCP, MIDI, MP, ED, RLR, VP; 2400 W. Hassell Rd., Ste. 430; Hoffman Estates, IL 60195; (708) 882-7446.

[24+] **SOUND/VIDEO IMPRESSIONS**; AR, APPV, ATD, JCP, MP, RLR, VP; 110 River Rd.; Des Plaines, IL 60016; (708) 297-4360; FAX: (708) 297-6870.

> [24+] **STREETERVILLE STUDIOS**; 161 E. Grand Ave.; Chicago, IL 60611; (312) 644-1666.

> [24+] **TONE ZONE RECORDING**; AR, SR; 1316 N. Clybourn; Chicago, IL 60610; (312) 664-5353; FAX: (312) 664-6560.

[24+] **2120 MUSIC RECORDING**; AR, MP; 2120 S. Michigan Ave.; Chicago, IL 60616; (808) 944-9400.

> [24+] **UNIVERSAL RECORDING CORPORATION**; AR, APPV, APPF, ATD, JCP, MP, ED; 46 E. Walton; Chicago, IL 60611; (312) 642-6465; FAX: (312) 642-7126.

> [24+] **ZEM RECORDING STUDIO**; AR, MP; 3709 S. 60th Ct.; Cicero, IL 60650; (708) 656-1544.

[24+] **ZENITH/DB STUDIOS**; AR, APPV, APPF; 676 N. LaSalle St.; Chicago, IL 60610; (312) 944-3600; FAX: (312) 944-2843.

### 12 & 16 Track Recording Studios

> [16] **ACME AUDIO & RECORDING CO.**; RLR; 3821 N. Southport; Chicago, IL 60613; (312) 477-7333; (800) 826-2263.

[16] **BARKER RECORDING STUDIO, INC.**; AR, APPV, APPF, ATD, EIR, JCP, MIDI, MP; 117 S. Rockford Ave.; Rockford, IL 61104; (815) 399-2929.

[16] **BLUE HEARTS RECORDING**; 6450 N. Mozart; Chicago, IL 60659; (312) 764-8735.

[16] **CHARLES BROWN MUSIC, INC.**; JCP; 225 N. Michigan Ave., Ste. 929; Chicago, IL 60601; (312) 565-1115; FAX: (312) 565-1260.

[16] **THE DOMAIN GROUP**; AR, ATD, JCP, RLR; 289 Main Pl.; Carol Stream, IL 60188; (708) 668-5300; FAX: (708) 668-0158.

[16] **FRONTIER RECORDING**; AR, ATD, JCP, MIDI, MP, ED, MAST; Rte. 5, Patterson Dr.; E. Peoria, IL 61611; (309) 266-5504.

> [16] **THE HAIR BEAR STUDIO**; 4817 W. 129th St.; Alsip, IL 60658; (708) 389-3373.

[16] **HUBBARD STREET STUDIOS, INC.**; AR, APPV, APPF, ATD, JCP, MIDI, MP; 11 E. Hubbard St.; Chicago, IL 60611; (312) 670-0110.

[16] **J.G.M. RECORDING STUDIO**; JCP, MIDI; 4121 N. Laramie; Chicago, IL 60641; (312) 545-7388.

[16] **LAKESIDE MEDIA**; AR, ATD; 1437 W. Howard; Chicago, IL 60626; (312) 274-8999.

[16] **LEAVELL STUDIO**; AR, AD, APPV, APPF, ATD, JCP, MIDI, MP, RLR, RS, SDS, VP; 2045 Anderson Snow Rd.; Spring Hill, IL 34609; (904) 799-6102.

[16] **MENDEL-RITCHIE STUDIOS**; 2920 W. Eastwood; Chicago, IL 60625; (312) 588-0100.

[16] **MIDI MAGIC**; PO Box 4443; Northbrook, IL 60065; (708) 498-1180.

> [16] **MIDI PRODUCTIONS**; RLR; 3418 Main St.; Skokie, IL 60076; (312) 677-3550.

[16] **MONKEY'S UNCLE STUDIO**; AR, MIDI, MP; 434 W. Harrison Rd.; Lombard, IL 60148; (708) 620-5338.

[16] **MTH STUDIO & SOUND**; AR, ATD, JCP, MIDI, MP, RLR, SR, SDS; 10000 S. Aberdeen; Chicago, IL 60643; (312) 239-8462.

[16] **OASIS RECORDING**; AR, APPV, MIDI; 2920 W. Eastwood Ave.; Chicago, IL 60625-3722; (312) 588-0100.

[16] **THE PADDED CELL RECORDING STUDIO**; 1567 S. Cora St.; Des Plaines, IL 60018; (708) 803-4832.

[16] **PIECES OF EIGHT RECORDING STUDIO**; 2144 E. Prairie Ave.; Decatur, IL 62521; (217) 429-0295.

[16] **SOTO SOUND STUDIO**; 1215 W. Belmont; Chicago, IL 60657; (312) 549-8664.

[16] **SOUNDMASTER RECORDING STUDIO**; AR, AD, JCP, MP; 21114 94th Ave. N.; Port Byron, IL 61275; (309) 523-3262.

[16] **SPARROW SOUND DESIGN**; AR, JCP, MP, RLR, MAST; 3501 N. Southport; Chicago, IL 60657; (312) 281-8510.

[16] **STUDIO VII**; AR, AD, APPV, ATD, JCP, MIDI, MP, ED, RLR, SR, VP; 101 NW Walnut St., Box 605; Atlanta, IL 61723-0605; (217) 648-2325.

[16] **WOODEN NICKEL SOUND STUDIO**; 6844 Dickison Cemetery Rd.; Dunlap, IL 61525; (309) 243-7658.

### 4 & 8 Track Recording Studios

[4] **A.L.&S. INC.**; AR, ATD, EIR, MIDI, MP, ED, RLR, SR, MAST, VP; 7705 W. Lawrence Ave.; Norridge, IL 60656; (708) 453-0832; FAX: (708) 453-4310.

[4] **ANVIX RECORDING CO.**; AR, ATD, RLR, MAST; PO Box 8130; Bartlett, IL 60103; (708) 837-9840.

[8] **AUDIO MIXERS RECORDING COMPANY, INC.**; AR, APPV, APPF, ATD, MIDI, MP, VP; 230 E. Ontario St.; Chicago, IL 60611; (312) 943-4274.

[8] **CHICAGO AUDIO WORKS, INC.**; AR, APPF, RLR; 1005 W. Webster Ave.; Chicago, IL 60614-3502; (312) 327-5533; FAX: (312) 327-5537.

[4] **CINE CENTER**; AR, APPF, RLR; 1 E. Erie, Ste. 350; Chicago, IL 60611; (312) 266-6198.

[2] **CITY VIDEO PRODUCTIONS, INC.**; JCP, VP; 350 W. Ontario; Chicago, IL 60610; (312) 915-0220; FAX: (312) 915-5990.

[2] **EALING MOBILE RECORDING, LTD.**; AR, ATD, EIR, MP, RLR, MAST; 4906 N. Taiman Ave.; Chicago, IL 60625-2722; (312) 784-1558.

[8] **11-14 PRODUCTIONS**; AR, MP, SDS; 1114 S. Busse; Mt. Prospect, IL 60056; (708) 981-9415.

[2] **MEDIA GROUP TELEVISION**; AR, APPV, ATD, RLR, SR, VP; 7th Ave. & 23rd St.; Moline, IL 61265; (309) 764-6411.

[8] **MPG STUDIOS**; AR, APPV, APPF, ATD, JCP, RLR, VP; 2130 Clear Lake Ave.; Springfield, IL 62703; (217) 544-5244.

[4] **MUSIC EXPRESS CHICAGO**; AR, MP; 55 W. Chestnut, Ste. 101; Chicago, IL 60610; (312) 951-0575.

[8] **NORWEST COMMUNICATIONS INC.**; AR, AD, APPV, ATD, JCP, RLR, VP; 123 S. Hough St.; Barrington, IL 60010; (708) 381-3271; FAX: (708) 381-3584.

[8] **ON SITE VIDEO**; RLR, VP; PO Box 1865; Palatine, IL 60078; (708) 934-0999.

[8] **PACIFIC TALENT**; AR, AD, ATD, JCP, MIDI, MP, ED; 120 Judith Ln.; Chicago Heights, IL 60411; (708) 754-7968.

[8] **PRaise PRODUCTIONS, INC.**; RLR; 15032 S. Minerva; Dolton, IL 60419; (312) 841-7126.

[8] **QUALITY CASSETTE SERVICES**; AR, ATD; 403 S. Woodlawn St.; Wheaton, IL 60187; (708) 668-3785.

[8] **ROSEBUDD PRODUCTIONS**; AR, APPV, ATD, JCP, VP; 300 N. State #2707; Chicago, IL 60610; (312) 222-2500.

[4] **SCHU-MAN STUDIO**; AR, ATD, MIDI, RLR; 1922 W. Hood #1-C; Chicago, IL 60660; (312) 761-1407.

[8] **SOUNDQUEST AUDIO**; AR, APPV, JCP, MIDI, MP, SDS, VP; 322 Fabyan Pkwy.; Batavia, IL 60510; (708) 879-5651.

[8] **STAR SOUND AND RECORDING**; AR, ATD, MIDI, MP, RLR, SR; 618 Georgia; Bethalto, IL 62010; (618) 377-5569.

[8] **STARBEAT RECORDING STUDIOS**; AR, APPV, ATD, JCP, RLR; 9 E. Larkdale Dr.; Deerfield, IL 60015-5055; (708) 945-3555; FAX: (708) 945-9115.

[8] **VECTOR SOUND DESIGN**; AR, APPV, JCP, MIDI, MP, ED; 4747 N. Kenneth #3; Chicago, IL 60630; (312) 685-4815.

### Video Production & Post-Production Facilities

**AIRWAYS VIDEO**; VPF, VPPE, OLVP, VTD; 4025 N. Mannheim Rd.; Schiller Park, IL 60176; (708) 671-3300; FAX: (708) 678-2600.

**A.L.&S. INC.**; OLVP, VTD; 7705 W. Lawrence Ave.; Norridge, IL 60656; (708) 453-0832; FAX: (708) 453-4310.

**ALLOY PRODUCTIONS**; OLVP; PO Box 532; Lake Zurich, IL 60047;

**EDIT EXPRESS**; VPPE; 727 N. Hudson; Chicago, IL 60610; (312) 943-1375.

**INSIDEOUT POST PRODUCTION**; APPV; 3840 Broadway; Rockford, IL 61108; (815) 398-0579.

**JOR-DAN RECORDING, INC.**; APPV; 1100 Wheaton Oaks Ct.; Wheaton (Chicago), IL 60187; (708) 653-1919; FAX: (708) 665-4966.

**MASTerview**; OLVP, VTD; 518 N. Main; Mt. Prospect, IL 60056; (708) 255-2404.

**MEDIA GROUP TELEVISION**; VPF, VPPE, OLVP, APPV, VTD; 7th Ave. & 23rd St.; Moline, IL 61265; (309) 764-6411.

**NORWEST COMMUNICATIONS INC.**; VPF, VPPE, OLVP, APPV, VTD; 123 S. Hough St.; Barrington, IL 60010; (708) 381-3271; FAX: (708) 381-3584.

**ON SITE VIDEO**; VPF, OLVP; PO Box 1865; Palatine, IL 60078; (708) 934-0999.

> **OPTIMUS, INC.**; VPPE, APPV; 161 E. Grand Ave.; Chicago, IL 60611; (312) 321-0880; FAX: (312) 321-9765.

**PRODUCERS VIDEO SERVICE**; VPF, OLVP; PO Box 1865; Palatine, IL 60078; (708) 934-0999.

**PRODUCTION CRAFT, INC.**; VPF, OLVP; 1437 W. Grand Ave.; Chicago, IL 60622-6332; (312) 829-0272; FAX: (312) 829-8936.

**RCL RECORDING SERV.**; VPF, VPPE, OLVP, APPV; 900 Western; Glen Ellyn, IL 60137; (708) 469-4149.

**ROSEBUDD PRODUCTIONS**; VPF, VPPE, OLVP, APPV, VTD; 300 N. State #2707; Chicago, IL 60610; (312) 222-2500.

> **SILVER OAKS**; VPF, VPPE, OLVP, APPV; PO Box 8440; Moline, IL; (309) 797-9898.

**SKYVIEW FILM & VIDEO**; VPPE, APPV; 541 N. Fairbanks, 22nd Fl.; Chicago, IL 60611; (312) 670-2020; FAX: (312) 670-4520.

**SOUND/VIDEO IMPRESSIONS**; VPPE, OLVP, APPV, VTD; 110 River Rd.; Des Plaines, IL 60016; (708) 297-4360; FAX: (708) 297-6870.

> **TRIO VIDEO**; Chicago, IL; (312) 421-7060.

**> UNIVERSAL RECORDING CORPORATION; APPV; 46 E. Walton, Chicago, IL 60611; 32 W. Randolph; Chicago, IL 60601; (312) 642-6465; FAX: (312) 642-7126.**

**VIDEO I-D, INC.; VPF, VPPE, OLVP, APPV, VTD; 105 Muller Rd.; Washington, IL 61571; (309) 444-4323.**

## INDIANA

### 24+ Track Recording Studios

**> [24+] AIRE BORN, INC.; AR, APPV, JCP, MIDI, MP; 4700 Northwest Plaza, W. Dr.; Zionsville, IN 46077; (317) 876-1556.**

**> [24+] HIT CITY RECORDING; RLR; 707 E. 54th St.; Indianapolis, IN 46220; (317) 257-0764.**

**[24+] MIAMI STREET STUDIOS; AR, APPV, JCP, MIDI; 1619 Miami St.; South Bend, IN 46613; (219) 288-TAPE.**

**[24+] PINEBROOK RECORDING STUDIOS, INC.; AR, RLR; PO Box 146; Alexandria, IN 46001; (317) 724-7721; FAX: (317) 724-2811.**

**[24+] SEPTEMBER RECORDING; 5210 E. 65th St.; Indianapolis, IN 46220; (317) 842-4955.**

**> [24+] TRC MID AMERICA RECORDING CENTER; AR, APPV, APPF, JCP, MIDI, MP, RLR; 5761 Park Plaza Ct.; Indianapolis, IN 46220; (317) 845-1980; FAX: (317) 576-1648.**

### 12 & 16 Track Recording Studios

**> [16] ACE MOBILE RECORDING; RLR; 21 Gage Ave.; Elkhart, IN 46516; (219) 293-3913.**

**> [16] AIRBORNE STUDIOS; Scottsburg, IN; (812) 752-3500.**

**[16] AJAX RECORDING TEAM; AR, APPV, JCP, MIDI, MP, RLR; 902 W. Wayne St.; Fort Wayne, IN 46802; (219) 426-0591.**

**[16] INDEPENDENT RECORDING STUDIO; AR, AD, JCP, MP, RLR, SR; PO Box 6487; Kokomo, IN 46902; (317) 455-0308.**

**[16] MIDWEST RECORDING STUDIO; AR, AD, JCP, MP; 11 S. 2nd St., Ste. C; Lafayette, IN 47901; (317) 742-ROCK; (317) 742-7625.**

### 4 & 8 Track Recording Studios

**[4] AUDIO-VISUAL ASSOCIATES; AR, APPV, EIR, RLR, SR, SDS, VP; 4760 E. 65th; Indianapolis, IN 46220; (317) 253-8562; FAX: (317) 255-6457 (call for connection).**

**[8] BRAUNCO VIDEO, INC.; AR, APPV, ATD, JCP, MIDI, MP, SR, VP; PO Box 236, 1125 Huntington Ave.; Warren, IN 46792; (219) 375-3148.**

**[8] BROADCAST PRODUCTIONS OF AMERICA INC.; AR, APPV, APPF, ATD, RLR, VP; 804 E. 38th St.; Indianapolis, IN 46205; (317) 925-7371.**

**[8] COMMERCIAL FEATURES, INC.; AR, APPV, APPF, ATD, JCP, RLR, SR; 1815 N. Meridian St., Ste. 303; Indianapolis, IN 46202; (317) 926-5570.**

**[8] EUROPA PRODUCTIONS; AR, AD, APPV, ATD, JCP, MIDI, MP, RLR, SDS, VP; #217 Main, PO Box 181; Vincennes, IN 47951; (812) 886-0234.**

**[8] VICTORY SOUND; AR, JCP; 1815 N. 7th St.; Terre Haute, IN 47804; (812) 238-9731.**

### Video Production & Post-Production Facilities

**AIRE BORN, INC.; APPV; 4700 Northwest Plaza, W. Dr.; Zionsville, IN 46077; (317) 876-1556.**

**AMERICAN BUSINESS VIDEO; VPF, VPPE, OLVP, APPV, VTD; 804 E. 38th St.; Indianapolis, IN 46205; (317) 925-7371.**

**AUDIO-VISUAL ASSOCIATES; VPF, OLVP, APPV; 4760 E. 65th; Indianapolis, IN 46220; (317) 253-8562; FAX: (317) 255-6457 (call for connection).**

**BRAUNCO VIDEO, INC.; VPF, VPPE, OLVP, APPV, VTD; PO Box 236, 1125 Huntington Ave.; Warren, IN 46792; (219) 375-3148.**

**COVENANT PRODUCTIONS; VPF, VPPE, OLVP, APPV; Anderson University, 1100 E. 5th St.; Anderson, IN 46012; (317) 641-4345.**

**EUROPA PRODUCTIONS; VPPE, OLVP, APPV; #217 Main, PO Box 181; Vincennes, IN 47951; (812) 886-0234.**

**MIAMI STREET STUDIOS; APPV; 1619 Miami St.; South Bend, IN 46613; (219) 288-TAPE.**

**TELEMATRIX; VPF, VPPE, OLVP, VTD; 5635 W. 80th St.; Indianapolis, IN 46278; (317) 872-8801.**

## IOWA

### 24+ Track Recording Studios



**AUDIO ART RECORDING STUDIOS, INC.  
Des Moines, IA**

**[24+] AUDIO ART RECORDING STUDIOS, INC.; AR, AD, APPV, APPF, ATD, JCP, MIDI, MP, RLR, SR, SDS; 403 SW 8th St.; Des Moines, IA 50309; (515) 282-3223; (515) 282-TAPE.**

**[24+] JUNIOR'S MOTEL; AR, AD, APPV, ATD, JCP, MIDI, MP; Rte. 1, Box 138; Otho, IA 50569; (515) 972-4475.**

**> [24+] TRIAD STUDIOS; AR, APPV, APPF, ATD, EIR, MP, RLR, SR; 1910 Ingersoll Ave.; Des Moines, IA 50309; (515) 243-2125; FAX: (515) 243-2055.**

### 12 & 16 Track Recording Studios

**[16] AVATAR PRODUCTIONS; 515 28th St., Ste. 106; Des Moines, IA 50312; (515) 282-9746.**

### 4 & 8 Track Recording Studios

**[8] DAVE'S TRACKS; AR, AD, ATD, JCP, MP, ED, RLR, SDS; 1602 8th Ave. S.; Fort Dodge, IA 50501; (515) 573-3710.**

**[8] HEDQUIST PRODUCTIONS, INC.; AR, APPV, JCP, MIDI, MP; PO Box 1475; Fairfield, IA 52556; (515) 472-6708; FAX: (515) 472-7400.**

### Video Production & Post-Production Facilities

**AUDIO ART RECORDING STUDIOS, INC.; APPV; 403 SW 8th St.; Des Moines, IA 50309; (515) 282-3223; (515) 282-TAPE.**

**BUSBY PRODUCTIONS, INC.; VPF, VPPE, OLVP, APPV; 1430 Locust St.; Des Moines, IA 50309; (515) 244-0404.**

## KANSAS

### 24+ Track Recording Studios

**> [24+] BIG DOG PRODUCTIONS; AR, AD, APPV, ATD, JCP, MIDI, MP, ED, RLR; 412 1/2 E. Douglas; Wichita, KS 67202; (316) 263-4464; FAX: (316) 262-1147.**

**[24+] MILLER RECORDING STUDIO; AR, APPV, APPF, ATD, JCP, MIDI, MP; 203 W. 26th; North Newton, KS 67117; (316) 283-7556.**

**[24+] SOUND TREK STUDIO V; AR, APPV, JCP; 9101 Barton; Overland Park, KS 66214; (913) 541-0302; FAX: (913) 492-3977.**

**[24+] UNITED RECORDING STUDIOS; AR, AD, MP, ED, RLR, SR; 4024 State Line; Kansas City, KS 66103; (913) 262-3555; FAX: (913) 362-2575.**

**[24+] WHEELER AUDIO ASSOCIATES; RLR; 4024 State Line; Kansas City, KS 66103; (913) 362-2500.**

### 12 & 16 Track Recording Studios

**[16] STUDIO Bb; RLR; 9400 E. Lincoln #220; Wichita, KS 67207; (316) 687-5694.**

### 4 & 8 Track Recording Studios

**[8] ALPHA MUSIC PRODUCTIONS INC.; AR, AD, MIDI, MP, RS; PO Box 14701; Lenexa, KS 66215; (913) 441-8618.**

**[8] RAZZBERRY RECORDS; AR, ATD, RLR, SR; RI Box 104; Edna, KS 67342; (316) 922-3582.**

**[8] VIKING SOUND & RECORDING; AR, RLR, SR; PO Box 349, 124 Pine St.; Edna, KS 67342-0349; (316) 922-3827.**

### Video Production & Post-Production Facilities

**ADMARK, INC.; VPF, VPPE, OLVP, APPV; 3630 SW Burlingame Rd.; Topeka, KS 66611; (913) 267-4712; FAX: (913) 267-3218.**

**BIG DOG PRODUCTIONS; VPF, APPV, OLVP; 412 1/2 E. Douglas; Wichita, KS 67202; (316) 263-4464; FAX: (316) 262-1147.**

**MILLER RECORDING STUDIO; VPPE, APPV; 203 W. 26th; North Newton, KS 67117; (316) 283-7556.**

## KENTUCKY

### 24+ Track Recording Studios

**[24+] ADVENT PRODUCTIONS; RLR; 2518 Southview Dr.; Lexington, KY 40503-2250; (606) 278-5852.**



**ALLEN-MARTIN PRODUCTIONS, INC.  
Louisville, KY**

**> [24+] ALLEN-MARTIN PRODUCTIONS, INC.; AR, APPV, JCP, MIDI, MP, VP; 9701 Taylorsville Rd.; Louisville, KY 40299; (502) 267-9658; FAX: (502) 267-9070.**

**> [24+] REVELATION PRODUCTIONS; 715 Hancock Ave.; Corbin, KY 40701; (606) 528-1111.**

**[24+] SOUND ON SOUND; AR, ATD, MIDI; 7109 Apple Orchard Ln.; Crestwood, KY 40014; (502) 241-5115.**

### 12 & 16 Track Recording Studios

**[16] ARTISTS' RECORDING SERVICE; RLR; 980 Barret Ave.; Louisville, KY 40204; (502) 581-9294.**

**[16] DERBYTOWN SOUND STUDIOS; AR; 5900 Outer Loop; Louisville, KY 40219; (502) 968-2320.**

**[16] MID-SOUTH RECORDING STUDIO; AR, APPV, APPF, JCP, MIDI, MP, ED, RLR; 685 Milliken's Chapel Rd.; Woodburn, KY 42170; (502) 542-7340.**

**[16] SIMPLE DREAMS RECORDING; AR, AD, EIR, JCP, MIDI, MP, ED; PO Box 811; Pikeville, KY 41501; (606) 478-9445.**

### 4 & 8 Track Recording Studios

**[4] HOST COMMUNICATIONS, INC./AVS; RLR; 546 E. Main St.; Lexington, KY 40508; (606) 253-3230.**

**[8] KENTUCKY DEPARTMENT OF THE ARTS; AR, APPV, ATD, RLR, SR, VP; Berry Hill Mansion, Louisville Rd.; Frankfort, KY 40601; (502) 564-8076; FAX: (502) 564-7588.**



## Recording & Video Production Facilities

UNITED STATES

### KENTUCKY

#### 4 & 8 Track Recording Studios

[8] **TRUSTY TUNESHOP RECORDING STUDIO**; AR, AD, ATD, JCP, MP, RLR; 8771 Rose Creek Rd.; Nebo, KY 42441; (502) 249-3194.

#### Video Production & Post-Production Facilities

**ALLEN-MARTIN PRODUCTIONS, INC.**; VPF, VPPE, OLVP, APPV; 9701 Taylorsville R.; Louisville, KY 40299; (502) 267-9658; FAX: (502) 267-9070.

**GAMMA PRODUCTIONS**; VPF, OLVP, VTD; 5900 Outer Loop; Louisville, KY 40219; (502) 968-2320.

**KINETIC CORPORATION**; VPF, VPPE, OLVP, APPV, VTD; 240 Distillery Commons; Louisville, KY 40206; (502) 583-1679; FAX: (502) 583-1104.

### LOUISIANA

#### 24+ Track Recording Studios

[24+] **HOLBROOK MEDIA PRODUCTIONS**; AR, AD, APPV, APPF, JCP, MIDI, MP, VP; 108 Exchange Pl., Ste. 1; Lafayette, LA 70503; (318) 234-3768; (318) 276-6267; FAX: (318) 237-6708.

[24+] **KNIGHT RECORDING STUDIO, INC.**; AR, AD, APPV, APPF, ATD, JCP, MIDI, MP, RLR, RS, VP; 3116 Metairie Rd.; Metairie, LA 70001; (504) 334-5711.

[24+] **MASTER-TRAK ENTERPRISES**; AR, AD, APPF, JCP, MIDI, RLR, SR, SDS; 413 N. Parkerson; Crowley, LA 70526; (318) 788-0773; FAX: (318) 788-0776.

[24+] **SOUTHLAKE RECORDING STUDIO**; 3229 8th St.; New Orleans, LA 70002; (504) 833-7926.

[24+] **STUDIO IN THE COUNTRY**; AR; Hwy. 436; Bogalusa, LA 70427; (504) 735-8224; FAX: (504) 732-2211.

## ULTRASONIC Studios

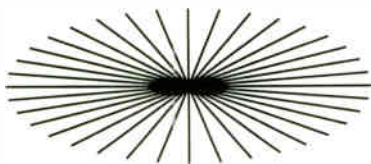

NEW ORLEANS

ULTRASONIC STUDIOS  
New Orleans, LA

[24+] **ULTRASONIC STUDIOS**; AR, APPV, EIR, JCP, MIDI, MP, RLR; 7210 Washington Ave.; New Orleans, LA 70125; (504) 486-4873; FAX: (504) 488-1057.

#### 12 & 16 Track Recording Studios

[16] **FESTIVAL STUDIOS**; AR, APPV, APPF, ATD, EIR, JCP, MIDI, MP, SR; 2112 17th St.; Kenner, LA 70062; (504) 469-4403.

[16] **JY RECORDING**; AR, APPV, JCP, MIDI, MP, VP; 201 Trenton; West Monroe, LA 71291; (318) 323-0805.

[16] **LOYOLA UNIVERSITY RECORDING STUDIO**; AR, MIDI, ED; College of Music; New Orleans, LA 70118; (504) 865-2773.

[16] **RABADASH RECORDING SERVICES**; AR, AD, APPV, EIR, JCP, MIDI, MP, RLR; 4805 Baudin St.; New Orleans, LA 70119; (504) 482-6922.

#### 4 & 8 Track Recording Studios

[4] **CELL SYNCH STUDIO**; AR, MP, RLR; 4551 N. Fairway Dr.; Shreveport, LA 71109-4909; (318) 631-7662.

[8] **RUM PRODUCTIONS**; AR, APPV, DUP; 824 Baronne St.; New Orleans, LA 70113; (504) 522-5979.

[4] **SERVANT STUDIO**; AR, RLR; 24 E. Carmack Dr.; Chalmette, LA 70043; (504) 277-7879.

#### Video Production & Post-Production Facilities

**HOLBROOK MEDIA PRODUCTIONS**; VPF, VPPE, OLVP, APPV; 108 Exchange Pl., Ste. 1; Lafayette, LA 70503; (318) 234-3768; (318) 276-6267; FAX: (318) 237-6708.

**MASTER-TRAK ENTERPRISES**; VPF, OLVP; 413 N. Parkerson; Crowley, LA 70526; (318) 788-0773; FAX: (318) 788-0776.

**VIDEO PARK, INC.**; VPF, VPPE, OLVP, VTD; 11316 Pennywood Ave.; Baton Rouge, LA 70809; (504) 292-0840; FAX: (504) 292-4806.

### MAINE

#### 24+ Track Recording Studios

[24+] **MEGAPHONE**; AR, APPV, APPF, ATD, JCP, MIDI, MP, RLR; 45 Casco St.; Portland, ME 04101; (207) 744-8711.

#### 12 & 16 Track Recording Studios

[16] **TREE FROG PRODUCTIONS**; AR, JCP, ED, MAST; Dyer Rd., Box 360; Hollis, ME 04042; (207) 929-5415.

#### Video Production & Post-Production Facilities

**MEGAPHONE**; APPV; 45 Casco St.; Portland, ME 04101; (207) 744-8711.

**VIDEO WORKSHOP**; VPF, VPPE, OLVP, APPV, VTD; 495 Forest Ave.; Portland, ME 04101; (207) 774-7798; FAX: (207) 773-6687.

### MARYLAND

#### 24+ Track Recording Studios

[24+] **AUDIO MASTER INC.**; AR, APPV, APPF, JCP; 7101 Wisconsin Ave., Ste. LL01; Bethesda, MD 20814; (301) 294-2222.

[24+] **BALANCE SOUND STUDIOS**; 4917 Cordell Ave.; Bethesda, MD 20814; (301) 951-3900.

[24+] **BIG MO RECORDING**; AR, APPV, APPF, RLR; 11264 Triangle Ln.; Wheaton, MD 20902; (301) 946-7364; FAX: (301) 946-1687.

[24+] **CENTRAL STUDIO**; 911 Georgia Ave.; Silver Spring, MD 20910; (301) 565-3734.

[24+] **COOL SPRINGS STUDIO**; AR, AD, APPV, APPF, ATD, MIDI, MP, RLR, RS, SDS; 4 Cool Springs Rd. S.; Charlotte Hall, MD 20622; (301) 884-8484.

[24+] **FLITE THREE RECORDINGS**; AR, APPV, APPF, ATD, EIR, MP, RLR, MAST, VP; 1130 E. Cold Spring Ln.; Baltimore, MD 21239; (301) 532-7500; FAX: (301) 532-5419.

[24+] **GRC STUDIOS**; RLR; 1137 Fillmore St.; Baltimore, MD 21218; (301) 889-4228.

[24+] **HIT AND RUN STUDIOS INC.**; AR, AD, MIDI, MP, ED, VP; 18704 Muncaster Rd.; Rockville, MD 20855; (301) 948-6715.

[24+] **THE MAINFRAME**; AR, ATD, EIR, MIDI, MP, RLR; 2427 Maryland Ave.; Baltimore, MD 21218; (301) 467-1488.



OMEGA RECORDING STUDIOS  
Rockville, MD

[24+] **OMEGA RECORDING STUDIOS**; RLR; 5609 Fishers Ln.; Rockville, MD 20852; (301) 230-9100.



POWER PLANT RECORDING STUDIOS  
Kensington, MD

[24+] **POWER PLANT RECORDING STUDIOS**; AR, AD, APPV, APPF, MP; 10518 Connecticut Ave.; Kensington, MD 20895-2426; (301) 941-9007.

[24+] **PRO AUDIO/BIG MO RECORDING**; RLR; 11264 Triangle Ln.; Wheaton, MD 20902; (301) 946-7364.

[24+] **SHEFFIELD AUDIO-VIDEO PRODUCTIONS**; 13816 Sunnybrook R.; Phoenix, MD 21131; (301) 628-7260.

#### 12 & 16 Track Recording Studios

[16] **ANCIENT SPRINGS STUDIO (PRIVATE)**; RLR; 4 Cool Springs Rd. S., PO Box 590; Charlotte Hall, MD 20622; (301) 884-8484.

[16] **BEBOP PRODUCTIONS INC.**; AR, APPV, JCP, MIDI, MP, RLR; 1006 Brice Rd.; Rockville, MD 20852; (301) 279-0937.

[16] **LAGRANGE STUDIOS**; AR, AD, ATD; 6315 LaGrange Ln.; Baltimore, MD 21212; (301) 377-7705.

[16] **MIDI-TECH RECORDING SERVICES**; AR, APPV, APPF, ATD, JCP, MIDI, RLR, VP; 5904 Char Leigh Cir.; Frederick, MD 21701-7554; (301) 694-0541.

#### Mix Trivia

12. This trio once opened for the Monkees, after Chas Chandler formed the group around its lead guitarist.

13. The first popular rock song to feature a fade-in and fade-out, this George Martin-produced single debuted on 2/20/65 and reached No. 1 on the *Billboard* charts.

Turn to page 152 for question



MULTIMEDIA PRODUCTIONS, INC.  
Baltimore, MD

>[16] **MULTIMEDIA PRODUCTIONS, INC.**; AR, AD, APPV, EIR, JCP, MIDI, MP; 1201 W. Pratt St., Ste. J; Baltimore, MD 21223; (800) 229-0355; (301) 752-0355.

[16] **NOUVEAUZ**; AR, APPV, JCP, MIDI, MP, ED; 731 Roland St., Ste. 429; Salisbury, MD 21801; (301) 543-1100; FAX: (301) 543-1195.

[16] **PARADOX PRODUCTIONS, INC.**; AR, APPV, ATD, JCP, MIDI, MP, RLR, SR, MAST; 50 Anna Ct.; Gaithersburg, MD 20877; (301) 869-9122.

>[16] **RED APPLE WORX INC. RECORDING CONSULTANTS**; AR, AD, EIR, JCP, MIDI, MP, RLR, SR, SDS; PO Box 441532; Fort Washington, MD 20749; (301) 292-4415.

[16] **ROAR PRODUCTIONS RECORDING & MUSICAL SERVICES**; RLR; 6655-H Dobbin Rd.; Columbia, MD 21045; (301) 596-2600.

[16] **STONEWALL RECORDING COMPANY**; RLR; 6783 Stonewall Ct.; Adamstown, MD 21710; (301) 874-2406.

#### 4 & 8 Track Recording Studios

[8] **THE COMMERCIAL REFINERY, INC.**; AR, ATD, JCP, MIDI, MP; 2105 Maryland Ave.; Baltimore, MD 21218; (301) 685-8500; FAX: (301) 685-0313.

[4] **JACK DANIELS PRODUCTIONS**; AR, JCP; 8056 Tuckerman Ln.; Potomac, MD 20854; (301) 983-9595; FAX: (301) 983-8750.

[8] **GROUP TWO PRODUCTIONS, INC.**; AR, APPV, VP; 1 East 24th St.; Baltimore, MD 21218; (301) 467-9000; FAX: (301) 467-5655.

[2] **SMILING EARS SOUND**; AR, ATD, RLR, SR; 5520 Heatherwood Rd.; Baltimore, MD 21227; (301) 242-0409.

[8] **SOUNDS EXQUISITE**; AR, RLR, SR; 12917 Clarion Rd.; Fort Washington, MD 20744; (301) 292-6145.

[4] **SOUNDTRAX INC.**; APPV, RLR, VP; 315-C Howard Ave.; Rockville, MD 20850; (301) 279-0666.

#### Video Production & Post-Production Facilities

**FLITE THREE RECORDINGS**; VPF, VPPE, OLVP, APPV, VTD; 1130 E. Cold Spring Ln.; Baltimore, MD 21239; (301) 532-7500; FAX: (301) 532-5419.

**GROUP TWO PRODUCTIONS, INC.**; VPF, OLVP, APPV; 1 East 24th St.; Baltimore, MD 21218; (301) 467-9000; FAX: (301) 467-5655.

**MED/ART VIDEO & CINEMAGRAPHICS**; VPF, VPPE, OLVP, APPV, VTD; 5904 Char Leigh Cir.; Frederick, MD 21701-7554; (301) 694-0541.

**PRODUCERS VIDEO CORPORATION**; VPF, VPPE, OLVP, VTD; 3700 Malden Ave.; Baltimore, MD 21211; (301) 523-7520; FAX: (301) 669-3347.

**SOUNDTRAX INC.**; OLVP; 315-C Howard Ave.; Rockville, MD 20850; (301) 279-0666.

**TUTMAN PRODUCTIONS**; VPPE, OLVP; 8701 Georgia Ave., Ste. 602; Silver Spring, MD 20910; (301) 589-6111.

## MASSACHUSETTS

### 24+ Track Recording Studios

[24+] **BAY FARM SOUND STUDIO**; AR, AD, JCP, MIDI, MP; PO Box 2821; Duxbury, MA 02331; (617) 585-9470.

>[24+] **BLUE JAY RECORDING STUDIO, INC.**; 669 Bedford Rd.; Carlisle, MA 01741; (508) 369-2200; (508) 369-0766.

[24+] **BOSTON MEDIA PRODUCTION**; AR, APPV, APPF, ATD, EIR, JCP, MIDI, MP, RLR, VP; Congress St., PO Box 1905; Boston, MA 02205; (617) 456-3342; (800) 456-3342 (in MA).

>[24+] **COURTLEN RECORDING**; AR, EIR, MIDI, MP; 149 Maquean St.; Hanson, MA 02341; (617) 294-8316; (617) 294-1218.

>[24+] **DOWNTOWN RECORDERS**; 537 Tremont St.; Boston, MA 02116; (617) 426-3455.

[24+] **EDITEL SOUND**; AR, APPV, APPF, ATD, JCP, MIDI, MP, RLR, VP; 651 Beacon St.; Boston, MA 02215; (617) 267-6400; FAX: (617) 267-4421.

[24+] **FADE TO BLACK ASSOCIATES**; VP; PO Box 971; Cambridge, MA 02238; (617) 491-6817; FAX: (617) 449-8143.

[24+] **JUNKER ASSOCIATES**; AR, APPV, VP; 55 Purdue Dr.; Milford, MA 01757; (508) 473-9101.

>[24+] **LYX MUSIC PRODUCTION & RECORDING STUDIOS**; 25 Foster St.; Worcester, MA 01608; (617) 752-6010.

[24+] **NEW ENGLAND MOBILE RECORDING**; RLR; PO Box 409; Stow, MA 01775; (508) 562-2111.

>[24+] **NEWBURY SOUND, INC.**; 1260 Boylston St., Ste. 202; Boston, MA 02215; (617) 267-4095.

>[24+] **NORTHEASTERN DIGITAL RECORDING**; AR, RLR, MAST; 2 Hidden Meadow Ln.; Southborough, MA 01772-1700; (508) 481-9322; FAX: (508) 624-6437.

[24+] **PSI/PROFESSIONAL SOUND, FILM AND VIDEO, INC.**; AR, APPV, APPF, ATD, ED; 136 Arlington St.; Boston, MA 02116; (617) 423-0007.

[24+] **Q DIVISION, LTD.**; AR, MIDI, MP; 443 Albany St.; Boston, MA 02118; (617) 542-0081.

>[24+] **SOUND TECHNIQUES**; 1260 Boylston St.; Boston, MA 02164; (617) TBA.

>[24+] **SOUNDMIRROR, INC.**; AR, APPV, EIR, RLR, MAST; 76 Green St.; Jamaica Plain, MA 02130; (617) 522-1412; FAX: (617) 524-8377.

[24+] **SYNCO SOUND STUDIOS**; 331 Newbury St.; Boston, MA 02115; (617) 424-1062.

[24+] **RIK TINORY PRODUCTIONS**; AR, ATD, JCP, MP, ED, RLR, VP; PO Box 311; Cohasset, MA 02025; (617) 383-9494.

[24+] **VIDEO ONE, INC.**; AR, APPV, JCP, MIDI, MP; 100 Massachusetts Ave. at Newbury St.; Boston, MA 02115; (617) 266-8200; FAX: (617) 267-8356.

>[24+] **WENDELL RECORDING STUDIO AND SCHOOL OF AUDIO ENGINEERING**; AR, APPV, JCP, MIDI, MP, ED, RS; Box 61; Wendell, MA 01379; (508) 544-8288.

### 12 & 16 Track Recording Studios

[16] **AIR SOUND/PLUM PRODUCTIONS**; AR, APPV, APPF, ATD, JCP, MIDI, MP; 1116 Boylston St. (rear); Boston, MA 02115; (617) 247-4186.

>[16] **DEREK STUDIOS**; AR, APPV, JCP, MIDI, MP, RLR; 850 Main St.; Dalton, MA 01226; (413) 684-0198.

>[16] **FIRST IMPRESSIONS RECORDING STUDIO**; AR, ATD, JCP, RLR; 15 Perkins Ave.; Brockton, MA 02401; (508) 580-1844.

[16] **HBS PRODUCTIONS, INC.**; AR, APPV, APPF, JCP, MIDI, MP, RLR; PO Box 533; Cambridge, MA 02238; (617) 661-1971.

[16] **OPEN EAR RECORDERS**; AR, ATD, RLR, SR; 373 Trapelo Rd.; Belmont, MA 02178; (617) 484-6938.

[16] **PRO LAB**; RLR; 149 North End Blvd.; Salisbury, MA 01952; (508) 462-9020.

[16] **SILVER LININGS, INC.**; AR, APPV, MP; 25 Huntington Ave.; Boston, MA 02116; (617) 262-9289.

[16] **SOUNDWORKS**; AR, ATD, MIDI, ED; 10 Wheeler Ct.; Watertown, MA 02172; (617) 924-0065.

[16] **SYNTONE**; AR, MIDI, MP; 85 Carl St.; Newton, MA 02161; (617) 244-1265.

[16] **WIZZ SOUND**; AR, JCP, RLR, VP; 536 1/2 Main St.; Indian Orchard, MA 01151-1222; (413) 543-8845.

[16] **WOLFMAN'S RECORDING STUDIO**; AR, ED; 1100 Massachusetts Ave.; Arlington, MA 02174; (617) 641-3838.

### 4 & 8 Track Recording Studios

>[8] **AUDIOTRAX**; AR, ATD, RLR; 7 Dana St.; Revere, MA 02151; (617) 289-8044.

[8] **"BIG T" PRODUCTIONS**; AR, JCP, MIDI, MP; 24 Haviland St. #8; Boston, MA 02115; (617) 267-2802.

[8] **EAR-RELEVANT SOUNDS**; AR, SR; 1 Nutting Ln.; Westford, MA 01886; (508) 692-1810.

[2] **EIGER ENGINEERING**; AR, APPV, RLR, SR, VP; 203 Waverley Ave.; Watertown, MA 02172; (617) 924-6514.

[8] **FISHBOWL PRODUCTIONS**; AR, JCP, MIDI, MP; 89 Clinton St. #3; Everett, MA 02149; (617) 389-5816.

>[8] **FOURTH DIMENSION SOUND STUDIOS**; AR, EIR, JCP, MIDI, MP, RLR, SR; 15 Castle St.; Ware, MA 01082; (413) 967-9422; FAX: (413) 967-9537.

[2] **HARRISON DIGITAL AUDIO SERVICES**; AR, ATD, RLR, MAST; 9 Birch Hill Rd.; S. Hadley, MA 01075; (413) 536-3830.



MULTIVISION, INC.  
Needham, MA

[8] **MULTIVISION, INC.**; AR, APPV, MIDI, VP; 161 Highland Ave.; Needham, MA 02194; (617) 449-5830; FAX: (617) 444-6450.

[8] **PROFESSIONAL TECHNIQUES LIBRARY**; AR, ATD, JCP, ED, RLR, SR; Box 527; Cohasset, MA 02025; (617) 545-9273.

[8] **PROPHET SOUND**; AR, JCP, MIDI, MP, RLR; 738 Park St.; Stoughton, MA 02072; (617) 341-8151.

[2] **TAKE 2 INTERNATIONAL**; APPV, MIDI, VP; 59 Orchard St.; Belmont, MA 02178; (617) 484-1654.

#### Video Production & Post-Production Facilities

**BAY FARM SOUND STUDIO**; APPV; PO Box 2821; Duxbury, MA 02331; (617) 585-9470.

**BOSTON MEDIA PRODUCTION**; VPF, OLVP, APPV, VTD; Congress St., PO Box 1905; Boston, MA 02205; (617) 456-3342; (800) 456-3342 (in MA).

**EDITEL SOUND**; VPF, VPPE, OLVP, APPV, VTD; 651 Beacon St.; Boston, MA 02215; (617) 267-6400; FAX: (617) 267-4421.

**FADE TO BLACK ASSOCIATES**; VPF, VPPE, VTD; PO Box 971; Cambridge, MA 02238; (617) 491-6817; FAX: (617) 449-8143.

**FOREMOST FILMS & VIDEO, INC.**; VPF, VPPE, OLVP, APPV, VTD; 7 Regency Dr.; Holliston, MA 01746; (508) 429-8046.

**HELIOTROPE STUDIOS LTD.**; VPF, VPPE, OLVP; 21 Erie St.; Cambridge, MA 02139; (617) 868-0171.



## Recording & Video Production Facilities

UNITED STATES

### MASSACHUSETTS

#### Video Production & Post-Production Facilities

**LAPRIORE VIDEOGRAPHY;** VPPE, OLVP, VTD; 86 Allston Ave.; Worcester, MA 01604-3325; (508) 755-9010.

**MONOCHROME TELEVISION;** VPF; 210 Sidney St., 2nd Fl.; Cambridge, MA 02139-4218; (617) 547-2525.



MULTIVISION, INC.  
Needham, MA

**MULTIVISION, INC.;** VPF, VPPE, OLVP, APPV, VTD; 161 Highland Ave.; Needham, MA 02194; (617) 449-5830; FAX: (617) 444-6450.

**TARGET PRODUCTIONS, INC.;** VPF, VPPE, OLVP, APPV, VTD; 529 Main St.; Boston, MA 02129; (617) 242-1900; FAX: (617) 242-6131.

**TELE-COMMERCIAL PRODUCTIONS;** VPF, VPPE, OLVP, APPV, VTD; 674 Springfield St.; Feeding Hills, MA 01030; (413) 786-8888; FAX: (413) 789-4257.

**TVN—THE VIDEO NETWORK;** VPPE, OLVP; 1380 Soldiers Field Rd.; Boston, MA 02135; (617) 782-1618; FAX: (617) 782-8860.

**VIDEO ONE, INC.;** VPF, VPPE, OLVP, APPV; 100 Massachusetts Ave. at Newbury St.; Boston, MA 02115; (617) 266-8200; FAX: (617) 267-8356.

**WAVE INC.;** VPF, VPPE, OLVP, APPV; 72 Cambridge St.; Worcester, MA 01603; (508) 795-7100.

**WEISMAN VIDEO PRODUCTIONS;** VPF, OLVP; 950 Watertown St., Ste. E; West Newton, MA 02165-2103; (617) 332-2089; FAX: (617) 964-6110.

### MICHIGAN

#### 24+ Track Recording Studios

>[24+] **ALLIANCE RECORDING CO. INC.;** AR, AD, APPV, APPF, JCP, MIDI, MP, RLR, SR, SDS; 8449 Parshallville Rd.; Fenton, MI 48430; (313) 632-5653.

[24+] **AMBIENCE RECORDINGS, INC.;** AR, APPV, ATD, JCP, MP; 27920 Orchard Lake Rd.; Farmington Hills, MI 48018; (313) 851-9766; FAX: (313) 851-9626.

[24+] **AUDIO GRAPH PRODUCTIONS, INC.;** AR, APPV, APPF, JCP, MIDI, MP, VP; 2810 Bennett Rd.; Okemos, MI 48864; (517) 332-3272; FAX: (517) 332-36XX (call first).

>[24+] **BROWN & BROWN RECORDING AND MUSIC PRODUCTION;** AR, AD, ATD, JCP, MIDI, MP, RLR; PO Box 224; Portage, MI 49081; (616) 327-8352; FAX: (616) 323-1518.

[24+] **CREATIONS-OUTSTANDING AUDIO RECORDINGS;** AR, APPV, ATD, JCP, MIDI, RLR, SR, VP; 1347 N. Creyts; Lansing, MI 48917; (517) 323-9595; FAX: (517) 323-2237.

[24+] **DANNY DALLAS PRODUCTIONS—SOUND PATTERNS;** RLR; 3020 E. Grand Blvd.; Detroit, MI 48202; (313) 873-3503.

>[24+] **THE DISCLTD.;** 14611 E. Nine Mile Rd.; East Detroit, MI 48021; (313) 779-1380.

[24+] **FAST TRAX RECORDING STUDIO;** AR, AD, APPV, APPF, EIR, JCP, MIDI, MP; 2737 Baldwin St.; Jenison, MI 49428; (616) 669-3400.

[24+] **JAZZ STUDIOS;** AR, EIR, JCP, MIDI; 941 Wealthy SE; Grand Rapids, MI 49506; (616) 235-3813.

[24+] **K&R RECORDING STUDIOS;** AR, APPV, APPF, ATD, MP, ED, RLR; 28533 Greenfield; Southfield, MI 48076; (313) 557-8276.

[24+] **MASTERPIECE SOUND STUDIO;** RLR; 1611 Webb St.; Detroit, MI 48206; (313) 867-7874.

[24+] **MUSIC MIX MEDIA;** AR, AD, APPV, APPF, JCP, MIDI, MP, ED, MAST, VP; 5781 Grand River; Detroit, MI 48208; (800) SKY-7611.

[24+] **NUMARK, INC.;** AR; 51308 Peachtree Ln.; Utica, MI 48087; (313) 739-6940.

[24+] **PANDEMIC RECORDING STUDIOS;** 161 Ottawa NW, Waters Bldg., Ste. B102; Grand Rapids, MI 49503; (616) 458-4359.

>[24+] **PEARL SOUND STUDIOS;** AR, APPV, EIR, MIDI, MP; 47360 Ford Rd.; Canton, MI 48187; (313) 455-7606; FAX: (313) 455-4910.

[24+] **RIVER CITY STUDIOS, LTD.;** AR, APPV, ATD, JCP, MIDI, MP, RLR; 147 Goodrich SE; Grand Rapids, MI 49503; (616) 456-1404.

[24+] **RON ROSE PRODUCTIONS;** AR, APPV, ATD, JCP; 29277 Southfield Rd.; Southfield, MI 48076; (313) 424-8400; FAX: (313) 424-8622.

[24+] **THE SCHOOLHOUSE STUDIOS;** AR; PO Box 2095; Ann Arbor, MI; (313) 994-9325.

[24+] **SIDESTICK RECORDING STUDIO;** AR, MIDI, MP; 14611 E. Nine Mile Rd.; East Detroit, MI 48021; (313) 779-1388.

[24+] **SOLID SOUND, INC.;** PO Box 7611; Ann Arbor, MI 48107-7611; (313) 662-0667.

[24+] **SOUND SUITE RECORDING STUDIOS;** AR, AD, APPV, JCP, MIDI, MP; 14750 Puritan Ave.; Detroit, MI 48227; (313) 273-3000.

[24+] **SOUNDSTAGE I RECORDING/PRODUCTIONS;** AR, APPV, APPF, ATD, EIR, JCP, MIDI, MP, ED, RLR, SR; 1800 S. 35th St.; Galesburg, MI 49053; (616) 665-7025; FAX: (616) 665-7046.

>[24+] **STUDIO A RECORDING, INC.;** AR, APPV, JCP, MP; 5619 N. Beech Daly; Dearborn Heights, MI 48127; (313) 561-7489; FAX: (313) 561-6736.

>[24+] **STUDIO DELUX;** Sunnycrest Dr.; West Bloomfield, MI 48033; (313) 855-2942.

[24+] **UNDERGROUND PRODUCTIONS;** RLR; 28407 Gilbert; Warren, MI 48093; (313) 775-4670.

>[24+] **UNITED SOUND SYSTEMS;** 5840 Second Blvd.; Detroit, MI 48202; (313) 832-3313.

[24+] **WALL STREET PRODUCTIONS LTD.;** AD, JCP, MIDI, MP; 1189 E. 14 Mile Rd.; Birmingham, MI 48009-2025; (313) 646-2054.

[24+] **ZIRCON SOUND STUDIO INC.;** AR, APPV, JCP, MIDI; 29923 Harper; St. Clair Shores, MI 48082; (313) 776-8410.

#### 12 & 16 Track Recording Studios

[16] **A.L.B.O. FOUNDATION ENTERPRISES;** AR, EIR; 5246 Plainfield NE; Grand Rapids, MI 49505; (616) 364-9273.

[16] **THE BROOKWOOD STUDIO, INC.;** RLR; 1155 Rosewood, Ste. A; Ann Arbor, MI 48104; (313) 994-4992.

[16] **DUCK ANKLES PRODUCTIONS INC.;** AR, AD, JCP, MIDI, MP, MAST; 6515 Hough Rd.; Almont, MI 48003; (313) 798-2308.

[16] **FAR EAST COMMUNICATIONS;** AR, AD, APPV, APPF, ATD, JCP, MIDI, MP, SR, VP; 400 W. Maple Rd., Ste. #200; Birmingham, MI 48009; (313) 642-0830; FAX: (313) 642-1671.

[16] **HATCHERY STUDIOS;** AR, APPV, ATD, JCP, MIDI, MP; 2175 Michael Ave.; Warren, MI 48091; (313) 754-8200.

[16] **MICKEY HOWELL, INC.;** AR, APPV; 5159 E. Main St.; Kalamazoo, MI 49004; (616) 388-5582.

[16] **MILLER M.I.D.I. PRODUCTIONS;** AR, AD, APPV, APPF, JCP, MIDI, MP, ED, RLR, SR; 4662 E. Nine Mile Rd.; Warren, MI 48091; (313) 754-0236.

[16] **SINGLE SOUND ENTERTAINMENT & RECORDING SERVICES;** AR, EIR, RLR, SR; 7555 Orehe; Brighton, MI 48116; (313) 231-9345.

#### 4 & 8 Track Recording Studios

[8] **A&F MUSIC SERVICES;** AR, ATD, MIDI, MAST; 2834 Otsego; Pontiac, MI 48054; (313) 682-9025; (313) 669-3100.

[8] **AL'S AUDIO DINER;** 670 Airport Blvd., Ste. 1; Ann Arbor, MI 48108; (313) 662-0667.

[8] **CLOUD 10 RECORDING;** AR, MIDI, MP, RLR, SDS; 1450 Coler; Ann Arbor, MI 48104; (313) 663-0222.

[4] **GENERAL TELEVISION NETWORK;** AR, APPV, RLR, MAST, VP; 13225 Capital Ave.; Oak Park, MI 48237; (313) 548-2500; FAX: (313) 548-8614.

[8] **HIDDEN CITY RECORDERS;** AR, MIDI; 26769 W. Hills Dr.; Inkster, MI 48141; (313) 563-9350.

[8] **MULTI-MEDIA RECORDING COMPANY;** AR, AD, ATD, MIDI, MP, RLR; 18636 W. McNichols; Detroit, MI 48219; (313) 531-9166.

[8] **NEW DIMENSIONS SOUND STUDIOS;** AR, MIDI; 4217 Highland Rd., Ste. 223; Pontiac, MI 48054; (313) 682-9626.

[8] **PLAYTOWN SOUND PRODUCTIONS;** AR, ATD, JCP, MIDI, SR; 625 Connable Ave.; Petoskey, MI 49770; (616) 347-0063.

>[8] **SONG SKETCHES PRODUCTIONS;** AR, AD, JCP, MIDI, MP, RLR; PO Box 36483; Detroit, MI 48236; (313) 886-3757.

[8] **STAR CITY PRODUCTION STUDIOS INC.;** AR, AD, APPV, APPF, ATD, EIR, JCP, MIDI, MP, ED, RLR, VP; 2786 E. Grand River Ave.; E. Lansing, MI 48823; (517) 351-7827; FAX: (517) 351-5346.

[4] **TAPE II STUDIOS, INC.;** AR, APPV, JCP, RLR, VP; 1999 S. Valley View Dr.; St. Joseph, MI 49085; (616) 428-2021.

[8] **UPPER PENINSULA TRAVELING VIDEO (U.P.T.V.);** APPV, VP; 125 Washington St.; Marquette, MI 49855; (906) 226-2499.

[8] **WJL RECORDING CENTER;** AR, ATD, MIDI, RLR, SR; 8460 Riverview; Dearborn Heights, MI 48127; (313) 563-2623.

#### Video Production & Post-Production Facilities

**ALLIANCE RECORDING CO. INC.;** APPV; 8449 Parshallville Rd.; Fenton, MI 48430; (313) 632-5653.

**CAPTURED LIVE PRODUCTIONS, INC.;** VPF, VPPE, OLVP, VTD; 4911 Fernlee; Royal Oak, MI 48073; (313) 288-4080; FAX: (313) 288-0748.

**FAR EAST COMMUNICATIONS;** OLVP, APPV; 400 W. Maple Rd., Ste. #200; Birmingham, MI 48009; (313) 642-0830; FAX: (313) 642-1671.

>**GENERAL TELEVISION NETWORK;** VPF, VPPE, OLVP, APPV, VTD; 13225 Capital Ave.; Oak Park, MI 48237; (313) 548-2500; FAX: (313) 548-8614.

**K&R'S VIDEO DIVISION;** VPF, OLVP, APPV; 28533 Greenfield; Southfield, MI 48076; (313) 557-8276.

**LIGHT PRODUCTIONS;** VPF, VPPE, OLVP, VTD; 1915 Webster; Birmingham, MI 48009; (313) 642-3502.

**MOBILE IMAGES CORP.;** VPF, VPPE, OLVP, VTD; 21775 Melrose Ave.; Southfield, MI 48075; (313) 350-9300; FAX: (313) 350-0667.

**MOTION PICTURE SOUND, INC.;** APPV; 3026 E. Grand Ave.; Detroit, MI 48202; (313) 873-4655.

**MUSIC MIX MEDIA;** VPF, VPPE, OLVP, APPV; 5781 Grand River; Detroit, MI 48208; (800) SKY-7611.

**MVP COMMUNICATIONS;** VPF, VPPE, OLVP, APPV, VTD; 1075 Rankin; Troy, MI 48063; (313) 588-7600; FAX: (313) 588-1899.

**PANDEMIC RECORDING STUDIOS;** APPV; 161 Ottawa NW, Waters Bldg., Ste. B102; Grand Rapids, MI 49503; (616) 458-4359.

**POSTIQUE, INC.;** VPPE, VTD; 23475 Northwestern Hwy.; Southfield, MI 48075; (313) 352-2610; FAX: (313) 352-3708.

**SOLID SOUND, INC.;** APPV; PO Box 7611; Ann Arbor, MI 48107-7611; (313) 662-0667.

**STAR CITY PRODUCTION STUDIOS INC.;** VPF, VPPE, OLVP, APPV, VTD; 2786 E. Grand River Ave.; E. Lansing, MI 48823; (517) 351-7827; FAX: (517) 351-5346.

**TAPE II STUDIOS, INC.;** VPF, VPPE, OLVP, APPV, VTD; 1999 S. Valley View Dr.; St. Joseph, MI 49085; (616) 428-2021.

**UPPER PENINSULA TRAVELING VIDEO (U.P.T.V.);** VPF, VPPE, OLVP, APPV; 125 Washington St.; Marquette, MI 49855; (906) 226-2499.

**> DAN YESSIAN MUSIC;** APPV; 33117 Hamilton Ct., Ste. 175; Farmington Hills, MI 48018; (313) 553-4044.

## MINNESOTA

### 24+ Track Recording Studios

[24+] **CREATION;** AR, AD, APPV, APPF, ATD, EIR, JCP, MIDI, MP, VP; 2543 Nicollet Ave. S.; Minneapolis, MN 55404; (612) 870-0028; FAX: (612) 870-1704.

[24+] **DANGER STUDIOS;** AR, AD, ATD, JCP, MIDI, MP, RLR; 33 S. 6th St., Ste. 4130; Minneapolis, MN 55402; (612) 338-2510; FAX: (612) 338-2504.

[24+] **LAKESITY RECORDING STUDIOS;** AR, JCP, MP; 2554 Boone Ave. S.; St. Louis Park, MN 55426; (612) 546-8331.

[24+] **METRO STUDIOS;** RLR; 200 3rd Ave. N.; Minneapolis, MN 55401; (612) 338-3833.

> [24+] **PAISLEY PARK STUDIOS;** AR, APPV, APPF, RS; 7801 Audubon Rd.; Chanhassen, MN 55317; (612) 474-8555; FAX: (612) 474-8328.

> [24+] **STUDIO M/WORLD THEATER;** 45 E. 7th St., 10 E. Exchange; Saint Paul, MN 55101; (612) 290-1500; (612) 290-1453.

[24+] **TELE EDIT;** AR, APPV; 10 S. 5th St. #640; Minneapolis, MN 55402; (612) 333-5480; FAX: (612) 333-6927.

### 12 & 16 Track Recording Studios

[16] **BERNETT PRODUCTIONS—STUDIO B RECORDING;** AR, APPV, JCP, MIDI, MP, RLR, RS; Box 691; Wayzata, MN 55391; (612) 475-2900; FAX: (612) 475-2520.

[16] **CUSTOM RECORDING STUDIOS;** AR, ATD, JCP, MIDI, MP, RLR; 4800 Drake Rd.; Golden Valley, MN 55422; (612) 521-2950; FAX: (612) 535-2587.

[16] **FREEDOM SOUND & LIGHT STUDIO;** AR, APPV, MIDI; 1520 9th Ave. NE; Owatonna, MN 55060; (507) 451-1503.

[16] **FULLER PRODUCTIONS;** AR, APPV, APPF, ATD, RLR, SR, VP; 5100 Gamble Dr. #150; Minneapolis, MN 55416; (612) 542-9693; FAX: (612) 542-8611.

[16] **BRAD JOHNSON PRODUCTIONS;** AR, APPV, APPF, JCP, MIDI, MP, RLR, VP; 6603 Meadowlark Ln.; Minneapolis, MN 55369; (612) 424-7878.

[16] **TOM JONES RECORDING STUDIOS;** AR, ATD, JCP, MP, RLR, SDS, MAST; 220 S. Broadway; Rochester, MN 55904; (507) 288-7711; FAX: (507) 288-4531.

[16] **THE MUSIC ROOM;** AR, MIDI; 25328 W. Comfort Dr.; Forest Lake, MN 55025; (612) 462-1667.

> [16] **TOBY'S TUNES, INC.;** AR, APPV, MIDI; 2325 Girard Ave. S.; Minneapolis, MN 55405; (612) 377-0690; FAX: (612) 377-2744.

[16] **TRACK RECORD STUDIOS;** AR, ATD, EIR, JCP, MIDI, MP, ED, RLR, SR, SDS; 1561 Sherburne Ave.; St. Paul, MN 55104; (612) 645-9281.

[16] **THE TRACKING STATION;** AR, APPV, APPF, JCP, MIDI, MP, RLR; 3504 44th Ave. S.; Minneapolis, MN 55406; (612) 729-8712.

[16] **WEST BANK SOUND;** AR, AD, APPV, APPF, EIR, RLR, SR; 1413 Washington Ave. S.; Minneapolis, MN 55454; (612) 370-0098.

## 4 & 8 Track Recording Studios

[2] **BURCH COMMUNICATIONS;** AR, VP; 825 Forest Arms Ln.; Mound, MN 55364; (612) 472-7426; FAX: (612) 472-5565.

[4] **CHRISTIAN RECORDING STUDIOS;** AR, ATD, MIDI, MP, ED, RLR, MAST; 108 8th St. NE; Rochester, MN 55904; (507) 289-2971.

[4] **EMC PRODUCTIONS;** AR, APPV, ATD, MAST; 300 York Ave.; Saint Paul, MN 55101; (612) 771-1555; FAX: (612) 771-5629.

> [8] **PRIME TIME STUDIOS;** AR, APPV, APPF, JCP, MIDI, MP, VP; PO Box 11449; Saint Paul, MN 55111; (612) 454-7673; FAX: (612) 683-0399.

> [4] **SECOND ESTATE PRODUCTIONS;** AR, ATD, EIR, JCP, MIDI, MP, RLR, SRS; 16143 Barth Dr.; Big Lake, MN 55309-9902; (612) 263-3797.

[8] **SOUND 80;** AR, ATD; 4027 IDS Tower; Minneapolis, MN 55402; (612) 339-9313; FAX: (612) 339-9314.

## Video Production & Post-Production Facilities

**BURCH COMMUNICATIONS;** VPF, OLVP, VTD; 825 Forest Arms Ln.; Mound, MN 55364; (612) 472-7426; FAX: (612) 472-5565.

**FULLER PRODUCTIONS;** VPF, VPPE, OLVP, APPV, VTD; 5100 Gamble Dr. #150; Minneapolis, MN 55416; (612) 542-9693; FAX: (612) 542-8611.

**METRO TELEPRODUCTIONS;** VPF, VPPE, OLVP, VTD; 4808 Park Glen Rd.; Minneapolis, MN; (612) 922-3434.

**NORTHWEST TELEPRODUCTIONS, INC.;** VPF, VPPE, OLVP, APPV; 4455 W. 77th St.; Minneapolis, MN 55435; (612) 835-4455.

**PRIME TIME STUDIOS;** VPF, VPPE, OLVP, APPV; PO Box 11449; Saint Paul, MN 55111; (612) 454-7673; FAX: (612) 683-0399.

> **STUDIO M/WORLD THEATER;** APPV; 45 E. 7th St./10 E. Exchange; Saint Paul, MN 55101; (612) 290-1500; (612) 290-1453.

**TELE EDIT;** VPPE, APPV, VTD; 10 S. 5th St. #640; Minneapolis, MN 55402; (612) 333-5480; FAX: (612) 333-6927.

**VAUGHN DUPLICATION SERVICES;** VTD; 7951 Computer Ave. S.; Minneapolis, MN 55435; (612) 832-3150.

## MISSISSIPPI

### 24+ Track Recording Studios

[24+] **PARALLAX RECORDING STUDIO;** RLR; 123 E. State St.; Ridgeland, MS 39157; (601) 856-2525; FAX: (601) 856-9462.

[24+] **ROADHOUSE RECORDING;** AR; 7472 Old Hwy. 78; Olive Branch, MS 38654; (901) 365-1429; FAX: (601) 895-4634.

[24+] **SKYLINE PRODUCTIONS;** AR, ATD, MP, RLR, VP; 2628 State Blvd.; Meridian, MS 39307; (601) 482-8541.

[24+] **THE TERMINAL;** AR; 4747 McWillie Dr.; Jackson, MS 39206; (601) 932-2627.

### 12 & 16 Track Recording Studios

[16] **FERNANDEZ CREATIVE SERVICES;** AR, APPV, APPF, JCP, MIDI, MP; 200 Commerce, Ste. B; Jackson, MS 39201-4405; (601) 353-0266.

[16] **MILLER RECORDING;** AR; Rte. 5, Box 447; Starkville, MS 39759; (601) 323-0728.

### 4 & 8 Track Recording Studios

[4] **GARDEN SOUND STUDIO;** AR, APPV, RLR, VP; PO Box 4870; University, MS 38677-4870; (601) 236-1246.

[8] **MARIAH RECORDING;** AR; 337 N. 25th Ave.; Hattiesburg, MS 39401; (601) 545-1886.

[8] **THE MUSIC ROOM;** AR; 310 Williams St.; Hattiesburg, MS 39401; (601) 545-3322.

## Video Production & Post-Production Facilities

**UNIVERSITY OF MISSISSIPPI COMMUNICATION AND RESOURCE CENTER;** VPF, VPPE, OLVP, APPV, VTD; 201 Bishop Hall; University, MS 38677; (601) 232-5917; FAX: (601) 232-5918.

**WHIPPOORWILL COMMUNICATIONS;** OLVP; PO Box 4870; University, MS 38677-4870; (601) 236-1246.

## MISSOURI

### 24+ Track Recording Studios

[24+] **ANGEL FILMS COMPANY;** AR, APPV, APPF, JCP, MIDI, RLR, VP; Rt. 1, Box 69; New Franklin, MO 65274-9998; (314) 698-3900.

[24+] **CARAVELL RECORDING STUDIO;** AR, AD, APPV, APPF, ATD, JCP, MIDI, MP, RLR, SRS, VP; HCR 5, Box 2400; Branson, MO 65616; (417) 334-7040; FAX: (417) 334-2014.

[24+] **CHAPMAN RECORDING STUDIOS;** AR, AD, APPF, ATD, JCP, MIDI, MP, ED, RLR; 228 W. 5th St.; Kansas City, MO 64105; (816) 842-6854.

[24+] **HOFFMANN MEDIA CENTER;** AR, RLR; 2185 Hampton Ave.; St. Louis, MO 63139; (314) 647-4900; FAX: (314) 647-6923.

> [24+] **ICON STUDIO;** AR, JCP, MIDI, MP; 5089 Waterman Blvd.; St. Louis, MO 63108; (314) 367-3121.

[24+] **PENGUIN PRODUCTIONS;** AR, ATD, EIR, JCP, MIDI, MP; 1026 Carole; St. Louis, MO 63021; (314) 394-0267; FAX: (314) 394-0860.

[24+] **SMITH/LEE PRODUCTIONS, INC.;** AR, APPV, ATD, JCP, MIDI, MP, ED, RLR; 7420 Manchester; St. Louis, MO 63143; (314) 647-3900; FAX: (314) 647-3959.

> [24+] **SOUND RECORDERS, INC.;** AR, APPV, ATD, EIR, JCP, MIDI, MP, RLR, MAST; 3947 State Line Rd.; Kansas City, MO 64111; (816) 931-8642; FAX: (816) 561-3671.

### 12 & 16 Track Recording Studios

[16] **GOLDEN SOUND STUDIO;** AR, ATD; Rt. 5, Box 112; Festus, MO 63028; (314) 937-5873.

[16] **IMAGITRAX RECORDING CO.;** RLR; 7420 Manchester Rd.; Saint Louis, MO 63143; (314) 647-9272.

[16] **REDLINE STUDIO;** AR, ATD, JCP, MIDI, ED, SRS; 1605 Pasty Ln.; Columbia, MO 65203; (314) 446-1692.

[16] **SEPTEMBER MUSIC PRODUCTIONS;** AR, AD, JCP, MIDI, MP; 240 Albert Dr.; St. Louis, MO 63031; (314) 837-4095.

### 4 & 8 Track Recording Studios

[2] **ACSL PRODUCTIONS;** AR, RLR, SRS, VP; 9231 W. Florissant Ave.; St. Louis, MO 63136; (314) 524-6823; FAX: (314) 524-8759.

[8] **LAND RECORDING STUDIO;** RLR; 1912 Herford Rd.; Columbia, MO 65202; (314) 474-8141.

[8] **SUB SOUND;** AR, ATD, EIR, MIDI; 2232 Wengler Ave.; Overland, MO 63114; (314) 429-2858.

## Video Production & Post-Production Facilities

**ACSL PRODUCTIONS;** VPF, VPPE, OLVP, APPV, VTD; 9231 W. Florissant Ave.; St. Louis, MO 63136; (314) 524-6823; FAX: (314) 524-8759.

**ANGEL FILMS COMPANY;** VPF, VPPE, OLVP, APPV; Rt. 1, Box 69; New Franklin, MO 65274-9998; (314) 698-3900.

**CHAPMAN RECORDING STUDIOS;** APPV; 228 W. 5th St.; Kansas City, MO 64105; (816) 842-6854.

> **INNERVISION PRODUCTIONS, INC.;** 11783 Borman Dr.; St. Louis, MO 63146; (314) 569-2500.

## MONTANA

### 24+ Track Recording Studios

[24+] **MAY SCHOOLS PRODUCTION STUDIOS;** AR, JCP, MIDI, MP, ED, VP; 1320 Grand Ave.; Billings, MT 59102; (406) 259-7000; FAX: (406) 252-8120.



## Recording & Video Production Facilities

UNITED STATES

### MONTANA

#### 12 & 16 Track Recording Studios

[16] **IRONWOOD AUDIO**; AR, JCP, MIDI, MP, RLR, SRS; 256 SW Cedar; Lewistown, MT 59457; (406) 538-7078.

[16] **JESTER SOUND STUDIO**; AR, APPV, ATD, JCP, SRS; 423 Kuhlman Dr.; Billings, MT 59105; (406) 248-5896.

[16] **THE RECORDING CENTER**; AR, APPV, ATD, EIR, JCP, MIDI, MP, RLR; 118 W. Pine St.; Missoula, MT 59802; (406) 721-4172.

[16] **WEST SHORE RECORDING**; PO Box 3000; Lakeside, MT 59922; (406) 844-2221.

#### 4 & 8 Track Recording Studios

[4] **HO-HUM SOUND STUDIOS**; AR, SRS; PO Box 217; Colstrip, MT 59323; (406) 748-2040.

[8] **PEAK RECORDING & SOUND**; AR, APPV, APPF, JCP, MIDI, MP; PO Box 1404; Bozeman, MT 59715; (406) 586-1650.

[4] **RAWHIDE RECORDING**; AR, AD, RLR, SRS; W. Bercall Creek; Judith Gap, MT 59453; (406) 473-2242.

[8] **STONNELL ENTERPRISES**; AR, APPV, APPF, RLR; PO Box 217; Bozeman, MT 59715; (406) 586-2443.

[8] **VALTRON RECORDING**; AR, ATD, RLR; 1002 Broadway; Helena, MT 59601; (406) 442-0734.

#### Video Production & Post-Production Facilities

**PRODUCTION WEST, INC.**; VPF, VPPE, OLVP, APPV, VTD; 1001 S. 24th St. W., Ste. 311; Billings, MT 59102; (406) 656-9417; (800) 321-9499; FAX: (406) 656-0124.

### NEBRASKA

#### 24+ Track Recording Studios

[24+] **RAINBOW RECORDING STUDIOS**; AR, AD, EIR, JCP, MIDI, RLR, SDS; 2322 S. 64th Ave.; Omaha, NE 68106; (402) 554-0123.

[24+] **SOUND RECORDERS INC.**; AR, APPV, ATD, JCP, MIDI, MP, RLR, MAST; 206 S. 44th St.; Omaha, NE 68131; (402) 553-1164; FAX: (402) 556-1358.

#### 12 & 16 Track Recording Studios

[16] **AUTHENTIC AUDIO LAB**; AR, APPV; 5147 Pine St., PO Box 6063; Omaha, NE 68196; (402) 553-5334; (402) 553-5327.

[16] **STARTRACKER RECORDING STUDIO**; AR, APPV, ATD, EIR, JCP, MIDI, MP, ED, RLR, MAST; 933 N. 45th; Lincoln, NE 68503; (402) 466-7623.

#### 4 & 8 Track Recording Studios

[8] **BAT'S NEST RECORDING STUDIO**; AR, JCP, MIDI; 814 S. 3rd St.; Albion, NE 68620; (402) 395-6727.

[4] **STY STUDIOS**; JCP; 1101 S. 6th St.; Norfolk, NE 68701; (402) 379-3065.

[8] **TESCO PRODUCTIONS**; AR, AD, ATD, JCP, MP, RLR; 12418 B St.; Omaha, NE 68144; (402) 333-4292.

[8] **TWO-FER'S RECORDING INC.**; AR, AD, ATD, MIDI, MP, RLR; 813 W. "A" St.; Lincoln, NE; (402) 475-4088.

#### Video Production & Post-Production Facilities

**GOURMET IMAGES, INC.**; VPF, VPPE, OLVP, VTD; 144 N. 38th Ave.; Omaha, NE 68131-2302; (402) 558-4985.

**STARTRACKER RECORDING STUDIO**; APPV; 933 N. 45th; Lincoln, NE 68503; (402) 466-7623.

### NEVADA

#### 24+ Track Recording Studios

[24+] **POWERHOUSE RECORDING**; 3111 S. Valley View Blvd., K101; Las Vegas, NV 89102; (702) 871-6200.

[24+] **REFLECTION MUSIC GROUP**; AR, AD, APPV, APPF, ATD, JCP, MIDI, MP, RLR, SDS; 6670 S. Maryland Pkwy., Ste. #110; Las Vegas, NV 89119; (702) 896-6020; FAX: (702) 361-7634.

[24+] **SOUNDWORKS RECORDING STUDIOS**; 2570 E. Tropicana, #18; Las Vegas, NV 89121; (702) 451-6767.

[24+] **STARSOUND AUDIO, INC.**; AR, APPV, EIR, JCP, MIDI, RLR, SR, SDS, VP; 2679 Oddie Blvd.; Reno, NV 89512; (702) 331-1010.

#### 12 & 16 Track Recording Studios

[16] **D.L.R. RECORDING**; AR, ATD, MIDI; 4341 E. Wyoming; Las Vegas, NV 89109; (702) 641-6399.

#### 4 & 8 Track Recording Studios

[8] **LANE CAMERON STUDIOS**; AR, APPV, APPF, JCP, MIDI, MP; PO Box 5267; Incline Village, NV 89450; (702) 831-6516.

#### Video Production & Post-Production Facilities

[24+] **STARSOUND AUDIO, INC.**; VPF, OLVP, APPV; 2679 Oddie Blvd.; Reno, NV 89512; (702) 331-1010.

[24+] **VIDEOACTIVE**; VPF, VPPE, APPV; PO Box 29222; Las Vegas, NV 89126-3222; (702) 365-6467.

### NEW HAMPSHIRE

#### 24+ Track Recording Studios

[24+] **FISHTRAKS**; AR, APPV, RLR; 62 Congress St.; Portsmouth, NH 03801; (603) 431-5492.

#### 12 & 16 Track Recording Studios

[16] **BOB CAT RECORDING STUDIOS**; AR, APPV, JCP, MIDI, MP, ED, RLR; PO Box 2342; Seabrook, NH 03874; (603) 394-7416.

[16] **SUNSET RIDGE RECORDING**; 194 Kensington Rd.; Hampton Falls, NH 03844; (603) 926-2907.

#### 4 & 8 Track Recording Studios

[2] **APERTURA**; AR, APPV, APPF, MP, ED, RLR, VP; Main St., PO Box 12; Orford, NH 03777; (603) 353-9067.

[8] **FULL LOGIC STUDIOS**; AR, APPV, APPF, ATD, JCP, MIDI, MP; 115 Railroad St.; Keene, NH 03431; (603) 352-DISK.

#### Video Production & Post-Production Facilities

**APERTURA**; VPF, VPPE, OLVP, APPV; Main St., PO Box 12; Orford, NH 03777; (603) 353-9067.

**CORPORATE MEDIA SERVICES**; VPF, VPPE, OLVP, VTD; 175 Bunker Hill Rd.; Auburn, NH 03032; (603) 483-2662.

**FULL LOGIC STUDIOS**; VPPE, APPV; 115 Railroad St.; Keene, NH 03431; (603) 352-DISK.

### NEW JERSEY

#### 24+ Track Recording Studios

[24+] **THE BARGE SOUND STUDIO, INC.**; 92 Lionshead Dr. W; Wayne, NJ 07470-4014; (201) 835-2538.

[24+] **BIOYA RECORDING STUDIOS**; 32 Hoxey St.; Paterson, NJ 07501; (201) 742-7704.

[24+] **EPSILON RECORDING STUDIO, INC.**; RLR; 16 Volusia Ave.; Hamilton, NJ 08610; (609) 586-6965.

[24+] **FADE TO BLACK PRODUCTIONS**; VP; PO Box 151; Hillside, NJ 07205; (201) 481-6910; FAX: (617) 449-8143.

[24+] **GET OUT OF THE WAY**; AR, APPV, APPF, VP; 210 Tomahawk Trail; Sparta, NJ 07871; (201) 770-3208.

[24+] **HOUSE OF MUSIC**; 1400 Pleasant Valley Way; West Orange, NJ 07052; (201) 736-3062.

[24+] **LEGEND RECORDING STUDIOS**; AR, APPV, MP, ED; 42 Belmont Ave.; Belleville, NJ 07109; (201) 751-9528.

[24+] **LONDON BY NIGHT POST-PRODUCTION**; AR, APPV, APPF, MP; 502 Gorham Ave.; Woodbridge, NJ 07095; (201) 750-1960.

[24+] **ODYSSEY SOUND STUDIO**; AR, JCP, MIDI, MP; 350 Chelsea Ave.; Long Branch, NJ 07740; (201) 870-3554.

[24+] **P.M. RECORDS, INC.**; AR, AD, APPV, APPF, ATD, EIR, MIDI, MP, ED, RLR, SR, SDS, MAST, VP; 20 Martha St.; Woodcliff Lake, NJ 07675-8027; (201) 930-9149.

[24+] **PYRAMID RECORDING**; AR, ATD, MIDI, MP, ED; 449-51 Central Ave.; Orange, NJ 07050; (201) 678-1663.

[24+] **QUANTUM SOUND STUDIOS**; 512 Paterson Plank Rd.; Jersey City, NJ 07307; (201) 656-7023.

[24+] **REEL PLATINUM STUDIOS, INC.**; 259 Paterson Ave.; Lodi, NJ 07644; (201) 471-3464.

[24+] **STARDUST RECORDING**; AR, AD, MIDI, MP; 615 Valley Rd.; Upper Montclair, NJ 07043-1403; (201) 746-2359.

[24+] **TAYLOR-MADE PRODUCTIONS**; AR, APPV, APPF, AD, JCP, MIDI, MP; Box 309; Caldwell, NJ 07006; (201) 226-1461; FAX: (201) 226-1461.

[24+] **TWAIN RECORDING**; AR, AD, JCP, MIDI, MP; 18 Hiawatha Pass; West Milford, NJ 07480; (201) 697-7540.

[24+] **UBIQUITY MUSIC**; AR, JCP, MP, VP; PO Box 91; Lindenwold, NJ; (609) 783-7650.

[24+] **UNITED MASTERWORKS RECORDING CO. LTD.**; AR, APPV, ATD, JCP; 324 Mills Pl.; Wyckoff, NJ 07481; (201) 848-0468.

[24+] **VAN GELDER RECORDING STUDIO INC.**; AR, MAST; 445 Route 9W; Englewood Cliffs, NJ 07632; (201) 567-4145; FAX: (201) 567-4145.

[24+] **WATER MUSIC RECORDERS**; AR, MP; 201 Grand St.; Hoboken, NJ 07030; (201) 420-7848.

#### 12 & 16 Track Recording Studios

[16] **ATLANTIC CITY ENTERTAINMENT STUDIOS**; AR, JCP, MIDI, MP; 2718 Atlantic Ave.; Atlantic City, NJ 08401; (609) 344-2835.

[16] **C&C STUDIOS**; AR, APPV, SDS, VP; RD #1, Box 581-A; Glassboro, NJ 08028; (609) 881-7645.

[16] **DEKAR STUDIOS**; RLR; 2500 New Rd.; Northfield, NJ 08225; (609) 383-9037.

[16] **GP RECORDING**; AR, APPV, ATD, EIR, JCP, MIDI, MP, RLR; PO Box 133; Ringwood, NJ 07456; (201) 728-3379.

[16] **GREGMAR STUDIOS**; AR, AD, ATD, MIDI, MP, RLR; Eatontown, NJ; (201) 542-5116; FAX: (201) 542-5116.

[16] **MUSIKA RECORDS INC.**; AR, APPV, APPF, ATD, JCP, MIDI, MP, RLR; 35 W. Bayview Ave.; Englewood Cliffs, NJ 07632; (201) 944-5628; FAX: (201) 461-8237.

[16] **RPL, INC.**; AR, AD, ATD, JCP, MIDI, MP, RLR, MAST; 1100 State St.; Camden, NJ 08105; (800) 966-3001; FAX: (609) 963-3854.

[16] **SOUNDBOARD RECORDING**; AR, EIR, JCP, MIDI, MP; 2600 Kennedy Blvd.; Jersey City, NJ 07306; (201) 451-6140.

[16] **STUDIO E**; AR, AD, EIR, JCP, MIDI, MP; 10 Schley St.; Garfield, NJ 07026; (201) 478-5522.

[16] **STUDIO 84**; AR; 84B Forge St.; Jamesburg, NJ 08831; (201) 521-1369.

[16] **TECHNISOUND**; AR, APPV, JCP, MIDI, MP; 140 Madison Ave.; Westfield, NJ 07090; (201) 233-2026.

[16] **T.M.P. RECORDING**; Rt. 73 and Jackson Rd.; Berlin, NJ 08009; (609) 768-2226.

#### 4 & 8 Track Recording Studios

[4] **CREATIVE MEDIA MARKETING, INC.**; AR, JCP, MIDI, MP, SR; 2175 Allen St.; Rahway, NJ 07065; (201) 574-8984; FAX: (201) 574-1830.

[8] **DOUGH PRODUCTIONS & MGMT.**; AR, AD, JCP, MIDI, MP; 1111 Warren Ave., Ste. 5; Cherry Hill, NJ 08002-3260; (609) 795-3471.

[8] **DYNASPEC RECORDING STUDIO (SUB.) DYNA-PRODUCTIONS;** AR, JCP, MIDI, MP; 58 Claypoole Ave.; Moorestown, NJ 08057; (609) 234-4065.

[8] **EAGLE'S NEST SOUND STUDIO;** AR, APPV, APPF, JCP, MIDI, RLR, SR; R-1, Box 35; Asbury, NJ 08802; (201) 479-6899.

[8] **FIREHOUSE STUDIOS;** RLR; 291 Port-Au-Peck Ave.; Oceanport, NJ 07757; (201) 229-3328.

[4] **SCOTT GORDON ENTERPRISES, INC.;** AR, APPV, JCP; PO Box 791; Paramus, NJ 07653-0791; (201) 670-0054; FAX: (201) 680-0054 "5".

[8] **HALOGEN RECORDING STUDIO (ALSO SOUND-TRACKS);** AR, APPV, APPF, JCP, MIDI, MP; 11 Woodbridge St.; New Brunswick, NJ 08901; (201) 545-0422.

[2] **INNOVATIVE VIDEO ASSOCIATES;** VP; 415 Commerce Ln., Ste. 7; Berlin, NJ 08009; (609) 768-5006.

[8] **JOYFUL NOISE STUDIO;** AR, JCP, MIDI, MP, MAST; 47 E. Walnut St.; Metuchen, NJ 08840; (201) 549-7928.

[8] **PHIL MANGO MUSIC PRODUCTION;** APPV, APPF, JCP, MIDI, MP; 11 51st St.; Weehawken, NJ 07087; (201) 866-7109.

[8] **R.J. MARTIN COMPANY;** AR, APPV, ATD, JCP, VP; 315 Rte. 17; Paramus, NJ 07652; (201) 967-0005; FAX: (201) 967-9772.

[8] **MERRICON STUDIOS;** AR, MIDI, MP; 47 Heritage Ln.; Fords, NJ 08863; (201) 634-2809.

[8] **PANETTA STUDIOS;** AR, APPV, JCP, MIDI, MP, VP; 6 Miller Ave.; Elmwood Park, NJ 07407; (201) 791-0254.

> [8] **POLAR BEAR RECORDING;** RLR; 171 Country Club Dr. #3; Union, NJ 07083; (201) 686-1438.

[8] **Q.E.C. RECORDERS;** RLR; 65 Stirling Ct.; Metuchen, NJ 08840; (201) 549-0023.

[2] **BILL QUINN PRODUCTIONS;** JCP, VP; 710 Cookman Ave.; Asbury Park, NJ 07712; (201) 775-0500; FAX: (201) 774-9416.

[8] **RETROMEDIA SOUND STUDIOS, INC.;** AR; 32 W. Front St.; Red Bank, NJ 07701; (201) 842-3853; FAX: (201) 842-3853.

[8] **SHERWOOD FOREST PRODUCTIONS;** AR, AD, APPV, JCP, MIDI, MP; 197 Sherwood Pl.; Englewood, NJ 07631; (201) 569-6445; FAX: (201) 567-7330.

[8] **JACK SKY PRODUCTIONS, INC.;** AR, APPV, APPF, RLR, SDS, VP; 218 N. Church St.; Moorestown, NJ 08057; (609) 234-6095.

[8] **STUDIO 27 (FORMERLY YUKMOUTH BROWN);** AR, JCP, MIDI, MP, SR; PO Box 241; Summit, NJ; (201) 273-0470.

[8] **TPS VIDEO SERVICES;** VP; PO Box 1233; Edison, NJ 08818-1233; (201) 287-3626; FAX: (201) 287-3626 (computer controlled).

[8] **WESTMONT SOUND;** AR, JCP, MIDI, MP; 37 E. Cuthbert Blvd.; Westmont, NJ 08108; (609) 858-8842.

#### Video Production & Post-Production Facilities

**ALLEN, JOHN E., INC.;** VPPE; 116 North Ave.; Park Ridge, NJ 07656; (201) 391-3299; FAX: (201) 391-6335.

**C&C STUDIOS;** VP, VPPE, OLVP, APPV, VTD; RD #1, Box 581-A; Glassboro, NJ 08028; (609) 881-7645.

**CINEMA SERVICE, INC.;** VPPE; 116 North Ave.; Park Ridge, NJ 07656; (201) 391-3299; FAX: (201) 391-6335.

**CREATIVE ASSOCIATES;** VP, VPPE, OLVP, APPV, VTD; 626 Bloomfield Ave.; Verona, NJ 07044; (201) 857-3444; FAX: (201) 857-3278.

**EDIT MASTERS;** VP, VPPE, OLVP, APPV, VTD; 1000 Laurel Oak Corp. Center, Ste. 108; Voorhees, NJ 08043; (609) 784-1177; FAX: (609) 346-2697.

**FADE TO BLACK PRODUCTIONS;** VP, VPPE, VTD; PO Box 151; Hillside, NJ 07205; (201) 481-6910; FAX: (617) 449-8143.

**HOWARD FELD PRODUCTION SERVICES;** OLVP; 637 Penn Ave.; Teaneck, NJ 07666-1610; (201) 836-8489; FAX: (201) 801-0719.

**GET OUT OF THE WAY;** VP, VPPE, OLVP, APPV, VTD; 210 Tomahawk Trail; Sparta, NJ 07871; (201) 770-3208.

**HIGH TECH VIDEO PRODUCTIONS;** VP, VPPE, OLVP, APPV; PO Box 572; Blackwood, NJ 08012; (609) 228-4336.

**INFINITY FOUR VIDEO, INC.;** VP, VPPE, OLVP, APPV; 846 Riverside Ave., Ste. 205; Lyndhurst, NJ 07071; (201) 507-1227.

**INNOVATIVE VIDEO ASSOCIATES;** VP, VPPE, OLVP, VTD; 415 Commerce Ln., Ste. 7; Berlin, NJ 08009; (609) 768-5006.

**LINDAJAY PRODUCTIONS;** OLVP; 832 Rogers St.; Lanoka Harbor, NJ 08734;

**R.J. MARTIN COMPANY;** VP, VPPE, OLVP, APPV, VTD; 315 Rte. 17; Paramus, NJ 07652; (201) 967-0005; FAX: (201) 967-9772.

**MEGAVIDEO PRODUCTIONS;** VP, VPPE, OLVP, VTD; 515 Victor St.; Saddle Brook, NJ 07662; (201) 587-1177; FAX: (201) 587-0385.

**MELOVISION PRODUCTIONS INC.;** VP, VPPE, OLVP; 190 Cold Soil Rd.; Princeton, NJ 08540; (609) 895-1030; FAX: (609) 895-0666.

**P.M. RECORDS, INC.;** VP, VPPE, OLVP, APPV, VTD; 20 Martha St.; Woodcliff Lake, NJ 07675-8027; (201) 930-9149.

**BILL QUINN PRODUCTIONS;** VP, VPPE, OLVP; 710 Cookman Ave.; Asbury Park, NJ 07712; (201) 775-0500; FAX: (201) 774-9416.

**TPS VIDEO SERVICES;** VP, VPPE, OLVP, VTD; PO Box 1233; Edison, NJ 08818-1233; (201) 287-3626; FAX: (201) 287-3626 (computer controlled).

**UBIQUITY MUSIC;** VP; PO Box 91; Lindenwold, NJ; (609) 783-7650.

**UNITED MASTERWORKS RECORDING CO. LTD.;** APPV; 324 Mills Pl.; Wyckoff, NJ 07481; (201) 848-0468.

**VIDEOSMITH, INC.;** VP, VPPE, OLVP; 3 Independence Way; Princeton, NJ 08540; (609) 987-9099; FAX: (609) 987-2449.

#### NEW MEXICO

#### 24+ Track Recording Studios

[24+] **QUINCY STREET SOUND;** AR, AD, APPV, ATD, EIR, JCP, MIDI, MP, ED, RLR; 130 Quincy St. SE; Albuquerque, NM 87108; (505) 265-5689.

> [24+] **JOHN WAGNER RECORDING STUDIOS, INC.;** AR, AD, APPV, JCP, MIDI, MP; 12000 Candelaria NE, Ste. E; Albuquerque, NM 87112; (505) 296-2766; FAX: (505) 296-9374.

#### 12 & 16 Track Recording Studios

[16] **MOONDANCE STUDIOS;** AR; PO Box 3318; Taos, NM 87571; (505) 758-9113.

[16] **NASH ST. MEDIA;** AR, APPV, ATD, JCP, MIDI, RLR, VP; 608 N. Main St.; Roswell, NM 88201; (505) 624-0466; FAX: (505) 624-0466.

[16] **SOMEWHERE RECORDING;** AR; 7517 Tomlinson; Hobbs, NM 88240; (505) 392-4408.

#### 4 & 8 Track Recording Studios

[8] **NEW WEST RECORDING;** AR, APPV, APPF, MIDI; 916 Palomas SE; Albuquerque, NM 87108; (505) 268-3883.

[8] **SUNBURST STUDIOS;** AR; 15287 N. Highway 85; Las Cruces, NM 88005; (505) 522-1837.

[8] **SWORD RECORDS RECORDING STUDIO;** AR, AD, EIR, JCP, MP, RLR, SR; 1019 N. Halagueno; Carlsbad, NM 88220; (505) 887-3825.

#### Video Production & Post-Production Facilities

> **DUKE CITY STUDIO;** VP, VPPE, OLVP; 4121 Cutler NE; Albuquerque, NM 87110; (505) 884-5151; (800) 225-6185.



- Digital Hard Disk Multitrack, Digital Automated Console, Digital Editing, CD Master Prep
- Studer 24track, 2track, lockup to all formats
- Living accommodations, heated pool, two wooded acres near fishing, boating
- Extras included!!

**Call our Studio Manager at 1-800-969-LOLA for rates, info, and advice!!**



**BLANK PRODUCTIONS / BLANK TAPES**  
SECLUDED - COMFORTABLE - STATE OF THE ART



## Recording & Video Production Facilities

UNITED STATES

NEW YORK

24+ Track Recording Studios

[24+] **AAA RECORDING AND VARIETY RECORDING**; AR, AD, APPV, APPF, ATD, JCF, MIDI, MP, MAST; 130 W. 42nd St., Rm. 551; New York, NY 10036; (212) 221-6625; FAX: (212) 382-1241.

[24+] **A STREET MUSIC**; AR, AD, APPV, APPF, MP; 701 7th Ave.; New York, NY 10036; (212) 764-3872.

# ACME

RECORDING STUDIOS INC.

ACME RECORDING STUDIOS INC.  
Mamaroneck, NY

► [24+] **ACME RECORDING STUDIOS INC.**; AR, 112 W. Boston Post Rd.; Mamaroneck, NY 10543; (914) 381-4141; FAX: (914) 381-4543.

[24+] **ACTIVE INC.**; RLR; 270 Lafayette St., Ste. 1203; New York, NY 10012; (212) 925-8150.

[24+] **A.D.R. STUDIOS, INC.**; RLR; Skylight Run; Irvington, NY 10533; (212) 486-0856.

[24+] **ALEXANDROS AUDIO-VISUAL RESEARCH INC. (AVR)**; AR, APPV, APPF, JCF, MIDI, MAST; 78 5th Ave. 10th Fl.; New York, NY 10011; (212) 627-1144; FAX: (212) 727-7497.



ALL AMERICAN COMPOSERS LIBRARY C/O DSM  
PRODUCERS  
New York, NY

[24+] **ALL AMERICAN COMPOSERS LIBRARY C/O DSM PRODUCERS**; AR, APPV, APPF, ATD, JCF, MIDI, MP; 161 W. 54th St.; New York, NY 10019; (212) 247-4707; FAX: (212) 265-5726.

### Mix Trivia

14. This Danish pharmacist and philosopher discovered that an electric current produces a magnetic field. The year was 1820.

Turn to page 152 for question



ARABELLUM STUDIOS  
Albany, NY

► [24+] **ARABELLUM STUDIOS**; AR, APPV, JCF, MIDI, MP, ED, SDS; 654 Sand Creek Rd.; Albany, NY 12205; (518) 869-5935.

► [24+] **ASL MOBILE AUDIO**; AR, APPV, APPF, RLR; PO Box 791; Flushing, NY 11352; (718) 886-6500; FAX: (718) 886-7214.

[24+] **AUDIO-VISUAL RESEARCH (AVR)**; 785th Ave., 10th Fl.; New York, NY 10011; (212) 627-1144.

[24+] **AURASONIC LTD.**; AR, APPV, APPF, MP, RLR; PO Box 791; Flushing, NY 11352; (718) 886-6500; FAX: (718) 886-7214.

► [24+] **AXIS STUDIOS, INC.**; RLR; 254 W. 54th St.; New York, NY 10019; (212) 262-3120; FAX: (212) 262-3942.

► [24+] **BABY MONSTER STUDIOS**; AR, AD, APPV, APPF, ATD, ER, JCF, MIDI, MP, ED, RLR, MAST; 645 Broadway, Top Fl.; New York, NY 10012; (212) 260-5226.

► [24+] **BATTERY STUDIOS**; 137 W. 25th St.; New York, NY 10001; (212) 627-8200.

► [24+] **BAYSIDE SOUND RECORDING STUDIOS, INC.**; PO Box 129; Bayside, NY 11361; (718) 225-4292.



BEARVILLE STUDIOS  
Bearsville, NY

► [24+] **BEARVILLE STUDIOS**; AR; PO Box 135; Bearsville, NY 12409; (914) 679-8900.

► [24+] **BEARTRACKS RECORDING STUDIO**; AR; 278 Haverstraw Rd.; Suffern, NY 10901; (914) 362-1620; (800) 288-2335; FAX: (914) 362-0483.

► [24+] **BLANK TAPES**; AR, APPV, ATD, JCF, MIDI, MP; 225 Rector Pl. #20J; New York, NY 10280; (800) 969-5652; FAX: (203) 329-7193.

► [24+] **BMG STUDIOS**; AR, ATD, RLR, MAST; 11336th Ave.; New York, NY 10025; (212) 930-4055; FAX: (212) 930-4679.

[24+] **CALLIOPE PRODUCTIONS, INC.**; AR, AD, APPV, APPF, JCF, MIDI, MP, ED, VP; 265 W. 37th St., Penthouse; New York, NY 10018; (212) 704-9626; FAX: (212) 768-1798.

[24+] **DON CASALE RECORDING STUDIOS**; AR, AD, ATD, JCF, MIDI, MP; 377 Plainfield St.; Westbury, NY 11590; (516) 333-7898.

[24+] **CBS RECORDS STUDIOS**; AR, ATD, MAST; PO Box 4453; New York, NY 10101-4453; (212) 445-2958; FAX: (212) 755-8311.

[24+] **CEDAR SOUND**; AR, JCF, MIDI, MP; 90 West St.; New York, NY 10006; (212) 227-3896.



CLINTON RECORDING STUDIOS, INC.  
New York, NY

► [24+] **CLINTON RECORDING STUDIOS, INC.**; AR, MIDI, RLR; 653 Tenth Ave.; New York, NY 10036; (212) 246-2444; FAX: (212) 582-3080.

► [24+] **CLUBHOUSE STUDIOS**; AR, ATD, JCF, MIDI, MP, MAST; Box 373; Germantown, NY 12526; (518) 537-6305; FAX: (518) 537-5829.

► [24+] **COVE CITY-SECOND CITY SOUND STUDIOS**; AR, MIDI, MP; 67B Glen Cove Ave; Glen Cove, NY 11542; (516) 759-3709; FAX: (516) 674-4204.



CRYSTAL SOUND RECORDING, INC.  
New York, NY

► [24+] **CRYSTAL SOUND RECORDING, INC.**; AR, AD, ATD, JCF, MIDI, MP, ED, RLR; 220 W. 19th St., 6th Fl.; New York, NY 10011; (212) 255-6745.

[24+] **D&D RECORDING**; AR, AD, MIDI, MP; 320 W. 37th St.; New York, NY 10018; (212) 736-7774.

### Mix Trivia

15. In 1831, this scientist discovered conversely that a magnetic field generates an electric voltage.

16. This Danish engineer is widely known for inventing the Telegraphone in 1898. He also invented the first high-power, continuous oscillator in 1902.

Turn to page 152 for question



DAJHELON PRODUCTIONS, INC.  
Rochester, NY

► [24+] **DAJHELON PRODUCTIONS, INC.;** AR, AD, APPV, APPF, JCP, MIDI, MP, MAST, 234 East Ave.; Rochester, NY 14604; (716) 232-1480.

[24+] **DISCON INTERNATIONAL RECORDING STUDIO INC.;** AR, JCP, MIDI, MP, 91-01 Astoria Blvd.; E. Elmhurst, NY 11369; (218) 507-6368.

► [24+] **DREAMLAND RECORDING STUDIO;** AR, EIR, JCP, MIDI, MP; PO Box 383; Bearsville, NY 12409; (914) 338-7151; FAX: (914) 339-2505.

**Mix Trivia**

17. Working for this company in 1955, Charles Ginburg and Ray Dolby unveiled the rotating head video recorder?

Turn to page 152 for question



D.S.M. PRODUCERS  
New York, NY

[24+] **D.S.M. PRODUCERS;** AR, AD, APPV, APPF, ATD, JCP, MIDI, MP, SR, MAST; 161 W. 54th St.; New York, NY 10019; (212) 245-0006; FAX: (212) 265-5726.

[24+] **DUPLEX SOUND STUDIOS;** AR, AD, EIR, JCP, MIDI, MP; 260 W. Broadway #2E; New York, NY 10013; (212) 334-8444.

[24+] **DYNAMIC RECORDING;** AR, AD, APPV, ATD, JCP, MIDI, MP, ED, RLR, RS, SD, MAST, VP; 235 E. 13th, Ste. 3-D; New York, NY 10003; (212) 505-9281.

► [24+] **EAST SIDE FILM AND VIDEO;** 216 E. 45th St.; New York, NY 10017; (212) 867-0730.

[24+] **EBY;** MP; 476 Broadway; New York, NY; (212) 226-1230.

[24+] **EDGE TRACK;** AR, AD, APPV, APPF, ATD, EIR, JCP, MIDI, MP, ED, RLR, RS, SR, SD, MAST, VP; 235 E. 13th, Ste. 3-D; New York, NY 10003; (212) 505-9281.

► [24+] **EDISON RECORDING STUDIO;** 228 W. 47th St.; New York, NY 10036; (212) 921-0505.

[24+] **EDITEL NEW YORK;** AR, APPV, APPF, ATD, JCP, MIDI, MP, RLR, VP; 222 E. 44th St.; New York, NY 10017; (212) 867-6400; FAX: (617) 267-4421.

► [24+] **ELECTRIC LADY STUDIOS;** 52 W. 8th St.; New York, NY 10011; (212) 677-4700.



EVERGREEN RECORDING, INC.  
New York, NY

► [24+] **EVERGREEN RECORDING, INC.;** RLR; 215 W. 91st St.; New York, NY 10024; (212) 362-7840.

[24+] **FUNKY RECORDS RECORDING STUDIOS;** 244 Lyell Ave.; Rochester, NY 14608; (716) 458-5610.

[24+] **GFI PRODUCTIONS;** AR, AD, JCP, MIDI, MP, RS; 569 County Line Rd.; Ontario, NY 14519; (716) 265-1240; FAX: (716) 265-4653.

► [24+] **GIANT RECORDING STUDIOS—BROADWAY/57 RECORDING;** AR, AD, MIDI, MP; 1776 Broadway; New York, NY 10019; (212) 247-1160; FAX: (212) 265-6143.

[24+] **GNOME PRODUCTIONS;** AR, APPV, APPF, JCP, MIDI, MP; 37 W. 20th St., Ste. 801; New York, NY 10011; (212) 645-9820; FAX: (212) 645-9854.

**“... EVEN MORE POWERFUL ...”**

● **SSL 4040E ... G SERIES**  
A POWER PLAY first. A world class, acoustically designed midi/mix suite—with overdub room—and a large comfortable control room, packed with all the outboard gear and signal processors you could possibly want.

**NEW**

- SONY APR 24
- APR 5002 1/2in.
- PCM 2500 DAT
- MIDI
- 8 NEVE-1079 EQ'S
- APPLE MAC SE
- ATARI 1040
- AND MORE

recent artists:  
Ziggy Marley  
Sly & Robbie  
Steel Pulse  
Keith Virgil  
Shelly Thunder  
Bunny Wailer  
Sugar Minot  
Scientist

37-20 30th Street,  
Long Island City, N.Y. 11101  
(718) 729-1780  
Fax (718) 729-3193

**POWER play studios inc.**

Photo: H. Widoff/Layout: E. Machic



# Recording & Video Production Facilities

UNITED STATES

NEW YORK

24+ Track Recording Studios

> [24+] **GRAMAVISION STUDIO**; AR, 260 W. Broadway; New York, NY 10013; (212) 966-3410; FAX: (212) 925-4253.

> [24+] **GREAT IMMEDIATELY RECORDING**; 423 W. 22nd St.; New York, NY 10011; (212) 206-8561.

> [24+] **GREENE STREET RECORDING**; 112 Greene St.; New York, NY 10012; (212) 226-4278.

[24+] **HEMBERGER PRODUCTIONS/THE LOFT**; AR, APPV, ATD, JCP, MIDI, MP, ED, RLR; 84 Kraft Ave.; Bronxville, NY 10708; (914) 793-8206.

> [24+] **HIP POCKET RECORDING STUDIOS**; 37 W. 20th St.; New York, NY 10011; (212) 255-5313; FAX: (212) 645-1787.

[24+] **THE HIT FACTORY TIMES SQUARE, INC.**; AR, APPV, APPF, ATD, EIR, JCP, MIDI, MAST; 130 W. 42nd St., Ste. 952; New York, NY 10036; (212) 354-2444; FAX: (212) 391-8060.

[24+] **THE HIT FACTORY, INC.**; AR, APPV, APPF, ATD, EIR, JCP, MIDI, MAST; 237 W. 54th St.; New York, NY 10019; (212) 664-1000; FAX: (212) 246-2252.

> [24+] **HOME BASE SOUND STUDIOS**; AR, AD, MIDI, MP; 147 W. 24th St.; New York, NY 10011; (212) 691-7674.

[24+] **IMAGE RECORDING**; 1591 Lockport-Olcott Rd.; Olcott Beach, NY 14126; (716) 778-5683.

> [24+] **I.N.S. RECORDING**; AR, MIDI; 19 Murray St.; New York, NY 10007; (212) 608-1499; FAX: (212) 608-1526.

[24+] **INSTITUTE OF AUDIO RESEARCH/SCHOOL OF AUDIO AND VIDEO TECHNOLOGY**; 64 University Pl.; Greenwich Village, New York, NY 10003; (212) 677-7580.

[24+] **JAZZMARK SOUND (AUDIO) AMETHYST PRODUCTIONS (VIDEO)**; AR, AD, MIDI, MP, RLR, SR, VP; 47-51 43rd St.; Queens, NY 11377; (718) 706-7071.

> [24+] **KAMEN RECORDING STUDIOS**; AR, APPV, JCP, MIDI, MP; 701 7th Ave.; New York, NY 10036; (212) 575-4660.

> [24+] **LAVSKY MUSIC**; 16 E. 42nd St.; New York, NY 10017; (212) 697-9800.



LIEBERT RECORDING STUDIOS, INC.  
New York, NY

> [24+] **LIEBERT RECORDING STUDIOS, INC.**; AR, APPV, ATD, JCP, VP; 16 W. 46th St., 6th Fl.; New York, NY 10036; (212) 840-1350; FAX: (212) 764-0440.

[24+] **THE LIVING ROOM, INC.**; RLR; 59 Franklin St.; New York, NY 10013; (212) 226-8161; FAX: (212) 941-9694.

> [24+] **THE MAGIC SHOP**; AR, ATD, MIDI, MP; 49 Crosby St.; New York, NY 10012; (212) 226-7035.

[24+] **MAGIC VENTURE RECORDING STUDIOS**; AR, APPV, JCP, MP; 111 W. 24th St.; New York, NY; (212) 645-4747; FAX: (212) 645-1028.



MANHATTAN CENTER STUDIOS  
New York, NY

> [24+] **MANHATTAN CENTER STUDIOS**; RLR; 311 W. 34th St.; New York, NY 10001; (212) 279-7740.

> [24+] **MANHATTAN RECORDING COMPANY, INC.**; RLR; 135 W. 14th St.; New York, NY 10011; (212) 929-5960.

> [24+] **MARATHON RECORDING**; 12 W. 37th St., 6th Fl.; New York, NY 10018; (212) 967-1515.

> [24+] **MARK STUDIOS**; AR, ATD, EIR, JCP, MIDI, MP, RLR, MAST; 10815 Bodine Rd.; Clarence, NY 14031-0406; (716) 759-2600.

> [24+] **MASTER SOUND ASTORIA**; AR, APPV, APPF; 34-12 36th St.; Astoria, NY 11106; (718) 786-3400; FAX: (718) 729-3007.

[24+] **MASTERBLASTER SOUND**; AR; 5 E. 22nd St., Ste. 14M; New York, NY 10010;

> [24+] **MEDIA RECORDING STUDIOS**; 841 Sunrise Hwy.; Babylon, NY 11704; (516) 669-1872.

[24+] **METROPOLIS MUSIC LTD.**; AR, AD, APPV, APPF, JCP, MIDI, MP; 315 E. 68th St., Ste. 8C; New York, NY 10021; (212) 628-5551.



THE MIX PLACE  
New York, NY

[24+] **THE MIX PLACE**; AR, APPV, APPF; 663 5th Ave.; New York, NY 10022; (212) 759-8311.

[24+] **MUSIC DOCTORS LTD., INC.**; AR, ATD, MAST; 130 W. 42nd St., Ste. 551; New York, NY 10036; (212) 382-1234; FAX: (212) 382-1241.

> [24+] **THE MUSIC PALACE INC.**; AR, MP; 31-B Nassau Blvd.; West Hempstead, NY 11552; (516) 481-0100.

[24+] **NEVESSA PRODUCTION**; AR, APPV, ATD, EIR, JCP, MIDI, MP, RLR, RS, SR; 1 Artist Rd.; Saugerties, NY 12477; (914) 679-8848.

> [24+] **NEW YORK DIGITAL RECORDING, INC.**; RLR; 253 W. 73rd St.; New York, NY 10023; (212) 874-4660.

[24+] **NRS RECORDING**; AR, JCP, MIDI, MP, RLR; Hurley Mountain Rd.; Hurley, NY 12443; (914) 331-3060.

[24+] **ON BROADWAY INC.**; AR, MIDI; 1123 Broadway; New York, NY 10010; (212) 627-9600.

[24+] **PARIS RECORDING STUDIO**; AR, APPV, ATD, EIR, JCP, MIDI, MP; 466 Hawkins Ave.; Lk. Ronkonkoma, NY 11779; (516) 467-5143; FAX: (516) 471-4026.

[24+] **PHOTOMAGNETIC SOUND STUDIOS**; AR, APPV, APPF; 222 E. 44th St.; New York, NY 10017; (212) 687-9030; FAX: (212) 687-9298.

[24+] **POWER STATION RECORDING STUDIOS**; 441 W. 53rd St.; New York, NY 10019; (212) 246-2900.

> [24+] **PRIME CUTS STUDIOS, INC.**; AR, MIDI, MP; 1600 Broadway, Ste. 704; New York, NY 10019; (212) 265-1800; FAX: (212) 265-3838.

[24+] **PYRAMID SOUND, INC.**; RLR; 105 E. Clinton St.; Ithaca, NY 14850; (607) 273-3931.

> [24+] **QUAD RECORDING**; 723 7th Ave.; New York, NY 10019; (212) 730-1035.

[24+] **QUADRASONIC RECORDING STUDIOS**; AR, MIDI; 723 7th Ave.; New York, NY 10019; (212) 730-1035; FAX: (212) 730-1083.

> [24+] **ROCKIN' REEL RECORDING STUDIO**; RLR; 636 Larkfield Rd.; East Northport, NY 11731; (516) 368-5689.

[24+] **ROOFTOP PRODUCTIONS**; AR, AD, APPV, APPF, JCP, MIDI, MP, RLR; 102 Greenwich Ave. 14-R; New York, NY 10011; (212) 741-5892.

> [24+] **SABELLA RECORDING STUDIOS**; RLR; 49 Oakdale Rd.; Roslyn Heights, NY 11577; (516) 484-0862.

> [24+] **HOWARD SCHWARTZ RECORDING, INC.**; AR, APPV, APPF, ATD, EIR, ED, RLR; 420 Lexington Ave. #1934; New York, NY 10170; (212) 687-4180; FAX: (212) 697-0536.

[24+] **SEAR SOUND**; AR, APPV, APPF, JCP, MP, ED, VP; 353 W. 48th St.; New York, NY 10036; (212) 582-5380; FAX: (212) 581-2731.

[24+] **SECRET SOUND STUDIO INC.**; AR, AD, APPV, ATD, MIDI, MP, ED, RLR; PO Box 4211; Great Neck, NY 11027; (516) 829-8162.

[24+] **SELECT SOUND STUDIO**; AR, ATD, JCP, MIDI, MP, ED; 2315 Elmwood Ave.; Kenmore, NY 14217; (716) 873-2717.

> [24+] **SIGMA SOUND STUDIOS OF NEW YORK**; AR, APPV, ATD, EIR, JCP, VP; 1697 Broadway, 10th Fl.; New York, NY 10019; (212) 582-5055; FAX: (212) 586-9243.

[24+] **SKYLINE STUDIOS**; AR; 36 W. 37th St.; New York, NY 10018; (212) 594-7484; FAX: (212) 239-9776.

> [24+] **SORCERER SOUND**; AR, ATD, EIR, JCP, MIDI, SDS; 19 Mercer St.; New York, NY 10013; (212) 226-0480.

[24+] **SOUND LAB STUDIOS LTD.**; AR, APPV, APPF, JCP, MIDI, MP; 4760 Bedford Ave.; Brooklyn, NY 11235; (718) 934-8585.

[24+] **SOUND ON SOUND RECORDING, INC.**; AR, APPV, APPF; 322 W. 45th St.; New York, NY 10036; (212) 757-5300.

[24+] **SOUNSCAPE PRODUCTIONS**; AR, APPV, APPF, EIR, JCP, MIDI; 284 Ashland Ave.; Buffalo, NY 14222; (716) 884-3576.

> [24+] **SOUNSCAPE RECORDING STUDIOS, INC.**; AR, AD, ATD, JCP, MP, RLR; PO Box 176, 312 Mill St.; Poughkeepsie, NY 12602; (914) 485-2202.

[24+] **SQUIRES PRODUCTIONS, INC.**; AR, APPV, ATD, EIR, JCP, MP, RLR, MAST, VP; 196 Maple Ave.; White Plains, NY; (914) 997-1603.

> [24+] **STUDIO 900, INC.**; AR, AD, APPV, ATD, JCP, MIDI, MP; 900 Broadway, Ste. 905; New York, NY 10003; (212) 529-3190.

> [24+] **SUPERDUPE**; AR, APPV, ATD, MIDI, MP, RLR; 295 Madison Ave.; New York, NY 10017; (212) 683-6854; FAX: (212) 779-1676.

[24+] **SUPERSONIX™—BINAURAL SOUND FOR MOTION PICTURES AND VIDEO**; AR, APPV, APPF, RLR, VP; 195 Hicks St.; New York, NY 11201; (718) 875-3209.

[24+] **SUTCLIFFE MUSIC INC./THE DUBB HOUSE**; AR, APPV, ATD, JCP, MP; 8 W. 19th St., 2nd Fl.; New York, NY 10011-4206; (212) 989-9292; FAX: (212) 989-5195.

> [24+] **SWEETFISH RECORDING STUDIO**; AR, AD, JCP, MIDI, MP, RLR, RS; R. 2 Box 2351; Argyle, NY 12809; (518) 692-2976.

> [24+] **SYNC SOUND, INC.**; AR, APPV, APPF, ATD; 450 W. 56th St.; New York, NY 10019; (212) 246-5580.

[24+] **TAMARAND DIGITAL RECORDING**; Garnerville, NY; (914) 639-1000.

> [24+] **39TH STREET MUSIC**; AR, AD, APPV, ATD, JCP, MIDI, MP, ED, RLR, VP; 260 W. 39th St., 17th Fl.; New York, NY 10018; (212) 840-3285; FAX: (212) 840-3923.



THIS WAY PRODUCTIONS, INC.  
New York, NY

> [24+] **THIS WAY PRODUCTIONS, INC.**; AR, APPV, JCP, MIDI, MP; 503-11 Broadway, Rm. 519; New York, NY 10012; (212) 431-5894.

[24+] **TIKI RECORDING STUDIOS, INC.**; AR, APPV, JCP, MIDI; 186 Glen Cove Ave.; Glen Cove, NY 11542; (516) 671-4555; FAX: (516) 671-1306.



UNIQUE RECORDING STUDIOS, INC.  
New York, NY

> [24+] **UNIQUE RECORDING STUDIOS, INC.**; AR, AD, ATD, EIR, MIDI, MP; 701 Seventh Ave.; New York, NY 10036; (212) 921-1711; FAX: (212) 730-2206.

> [24+] **VIDEOMIX**; 123 W. 18th St., 7th Fl.; New York, NY 10011; (212) 627-7700; FAX: (212) 727-3075.

[24+] **VMEG (VISUAL MUSIC ENTERTAINMENT GROUP)**; AR, AD, APPV, APPF, EIR, JCP, MIDI, MP, RLR, RS, VP; Zeckendorf Towers, 111 E 14th St., Ste. 355; New York, NY 10003; (212) 505-9281.

> [24+] **VOICES RECORDING STUDIOS**; AR, APPV, ATD; 16 E. 48th St.; New York, NY 10017; (212) 935-9820; FAX: (212) 755-1150.

[24+] **VRI SCHARFF RENTALS**; EIR, SR; 599 11th Ave.; New York, NY 10036; (212) 582-2345; FAX: (212) 757-6367.

> [24+] **WESTRAX RECORDING STUDIOS LTD.**; AR, MIDI, MP; 484 W. 43rd St.; New York, NY 10036; (212) 947-0533.

[24+] **WINTHROP PRODUCTIONS**; AR, APPV, APPF, ATD, JCP, MIDI, MP, RLR; 156 W. 94th St.; New York, NY 10025; (212) 662-8685; FAX: (212) 749-8387.

#### 12 & 16 Track Recording Studios

[16] **ABC RADIO NETWORK PRODUCTION GROUP**; AR, APPV, ATD, MIDI; 125 West End Ave., 6th Fl.; New York, NY 10027; (212) 687-5684; FAX: (212) 687-5622.

[16] **AUDIO RECORDING TECHNOLOGY INSTITUTE**; RLR; 756 Main St.; Farmingdale, NY 11735; (516) 454-8999.

[16] **BAIR TRACKS**; AR, APPV, JCP, MIDI; 176 Ludlow St.; New York, NY 10009; (212) 529-1954.

[16] **CABIN FEVER RECORDING**; AR, APPV, JCP, MP, RLR, SR; PO Box 735; Fishers, NY 14453; (716) 924-8408.

[16] **CORELLI JACOBS RECORDING**; AR, APPV, APPF, MIDI, MP; 25 W. 45th St.; New York, NY 10036; (212) 382-0220; FAX: (212) 382-0278.

[16] **COTTON HILL STUDIOS INC.**; AR, AD, APPV, JCP, MIDI, MP, ED, RLR; 18 Walker Way; Albany, NY 12205; (518) 869-1968.

[16] **COUNTDOWN STUDIOS**; 122 W. 26th St., Ste. 2R; New York, NY 10001; (212) 691-9279.

[16] **EASTWIND RECORDING**; AR; 6820 Ellicott Dr.; East Syracuse, NY 13057; (315) 463-6759.

> [16] **ELECTRO-NOVA PRODUCTIONS**; AR, APPV, ATD, JCP, MP, ED, RLR; 342 Madison Ave.; New York, NY 10017; (212) 687-5838; FAX: (212) 687-5924.

[16] **CARLOS FRANZETTI MUSIC**; MIDI, MP; 225 Rector Pl. #20 J; New York, NY 10280; (212) 945-4620; FAX: (212) 945-4620.

[16] **GRAMPA STUDIOS**; AR; 502 Warren St.; Brooklyn, NY 11217; (718) 260-9803.

[16] **LENIS GUESS STUDIO**; AR, AD, MIDI; 612 8th Ave.; New York, NY 10018; (212) 840-8939.

[16] **IN SYNC PRODUCTIONS, INC.**; AR, AD, APPV, JCP, MIDI, MP; 211 W. 79th St.; New York, NY 10024; (212) 496-2636.

[16] **LAUGHING DOG PRODUCTIONS, INC.**; AR, ATD, JCP, MIDI, MP, ED, RLR, MAST; 80 Van Duzer St.; Staten Island, NY 10301; (718) 720-9497.

> [16] **LEVELHEAD RECORDING/STUDIO AT SOUNDSCAPE**; AR, ATD, JCP, MIDI, MP, RLR; 500 W. 52nd; New York, NY 10019; (212) 664-1033.

> [16] **MIDNIGHT MODULATION**; AR, JCP, MIDI, MP, ED, RLR; 2211 Pine Ln.; Saugerties, NY 12477; (914) 246-4761.

[16] **MOTHER'S PRODUCTION**; AR, AD, JCP, MIDI, MP, RLR; 37 Kosciuszko Ave.; Cohoes, NY 12047; (518) 237-7430.

> [16] **THE MUSIC FACTORY**; AR, JCP, MIDI, MP, ED, RLR; 107 Canal St.; Rome, NY 13440; (315) 336-2151.

[16] **NEW YORK AUDIO PRODUCTIONS**; AR, AD, APPV, ATD, JCP, MIDI, MP, RLR, MAST, VP; 140 W. 22nd St.; New York, NY 10011; (212) 243-6826; FAX: (212) 243-7210.

[16] **NOMAD RECORDING**; AR, JCP, MIDI, MP, ED, RLR; PO Box 886; Levittown, NY 11756; (516) 735-2655.

[16] **PHANTOM POWER RECORDING**; AR, AD, ATD, EIR, JCP, MP, MAST; 50 W. 1st St.; Mount Vernon, NY 10550; (914) 667-7908.

[16] **ROBERT POMANN SOUND PRODUCTIONS, INC.**; AR, APPV, ATD, JCP, MIDI, MP, RLR; 2 W. 46th St., The Penthouse; New York, NY 10036; (212) 869-4161.

[16] **P.P.I. RECORDING**; RLR; 147 W. 33rd St., Ste. 308; New York, NY 10001; (212) 279-1631.

[16] **REEL WORLD MUSIC STUDIOS**; AR, AD, ATD, EIR, JCP, MIDI, MP, ED, VP; 12 Bardonia Mall; Bardonia, NY 10954; (914) 627-3025.

[16] **REEVES AUDIO RECORDING**; AR, JCP, MIDI, MP, SDS; 21 Primrose Ave.; Yonkers, NY 10710; (914) 793-6496.

[16] **ROXY RECORDERS, INC.**; AR, JCP, MIDI, MP, ED, RLR, VP; 648 Broadway; New York, NY 10012; (212) 475-6571; FAX: (212) 533-1692.

[16] **SAINTS AND SINNERS SOUND STUDIO**; RLR; 432 Western Ave.; Albany, NY 12203; (518) 454-5278.

[16] **SHUSTER SOUND**; AR, APPV, APPF, ATD, VP; 29 Burt Ct.; Valley Stream, NY 11581; (516) 791-2895.

[16] **SING SING SING STUDIOS, INC.**; RLR; 37 Iroquois Rd.; Ossining, NY 10562; (914) 941-9476.

[16] **SPIDER SOUND STUDIOS**; RLR; Box 1144, Tumpike Rd.; Auburn, NY 13021; (315) 253-7591.

> [16] **STARBASE STUDIOS**; AR, APPV, ATD, EIR, JCP, MIDI, MAST, VP; 41-53 53rd St.; Woodside, NY 11377; (718) 476-0665.

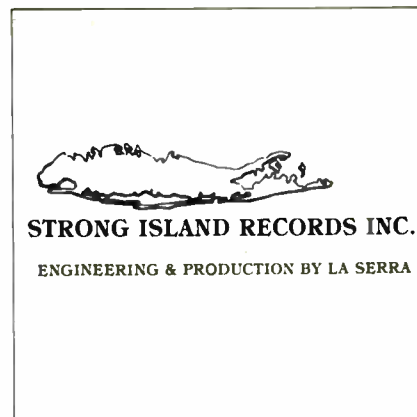

STRONG ISLAND RECORDS, INC.  
Massapequa Park, NY

> [16] **STRONG ISLAND RECORDS, INC.**; PO Box 453; Massapequa Park, NY 11762; (516) 798-2308; FAX: (516) 541-6264.

> [16] **THURSDAY PRODUCTIONS, INC.**; 189 Norman Rd.; New Rochelle, NY 10804; (914) 235-7505.

[16] **TWO PIE ARE MUSIC, INC.**; AR, APPV, APPF, JCP, MIDI, MP, VP; 18 E. 16th St., 3rd Fl.; New York, NY 10003; (212) 645-9290; FAX: (212) 924-0245.

[16] **JEFF VAN NOSTRAND PRODUCTIONS**; AR, JCP, MIDI, MP; 195 Carlton Ave., 2nd Fl.; Brooklyn, NY 11205; (718) 875-3364.

[16] **WALKER AND SIX RECORDING**; AR, APPV, APPF, JCP, MIDI, MP, RLR, SR; 17 6th Ave.; New York, NY 10013; (212) 941-0060; (212) 941-0080; FAX: (212) 982-9446.

[16] **WESTRAX RECORDING STUDIOS LTD.**; 484 W. 43rd St.; New York, NY 10036; (212) 947-0533.

#### 4 & 8 Track Recording Studios

[8] **ALTER EGO STUDIO**; AR, AD, JCP, MIDI, MP; Flushing, NY; (718) 463-5008.

[8] **AUDIO ARTS RECORDING STUDIO**; AR, JCP, MP, RLR; 1110 Emerald Ln.; Endwell, NY 13760; (607) 748-8223.

[4] **AUDIO POST, INC.**; AD, APPV, MAST, VP; 27 E. 21st St.; New York, NY 10010; (212) 475-5791; FAX: (212) 673-0788.

[8] **BOB BALZARIM SOUND SVC.**; AR, EIR, RLR, VP; 48-51 Bell Blvd.; Bayside, NY 11364; (718) 423-7507.

[8] **BLANE & DEROSA PRODUCTIONS INC.**; AR, JCP, MIDI, MP, ED, MAST; 109 W. 27th St., 4th Fl.; New York, NY 10001; (212) 633-1925; FAX: (212) 675-5241.

[8] **CITY SOUND PRODUCTIONS**; AR, JCP, MIDI, MP; 39 E. 7th St., Ste. #2; New York, NY 10003; (212) 228-9494.

[2] **CLASSIC SOUND, INC.**; AR, RLR, MAST; 129 W. 67th St.; New York, NY 10023; (212) 496-7100.

[8] **COSTANZOS COMPOSING / PUBLISHING**; AR, APPV, APPF, JCP, MIDI, MP; 106 Lyn Brook Rd.; Mastic Beach, NY 11951; (516) 399-5479.

[4] **THE CREATORS**; AR, APPV, ATD, VP; 41 Skytop Dr.; Pleasantville, NY 10570; (914) 769-0676.

[8] **FILIPPONE SOUND & VIDEO**; AR; 176 Garner Ave.; Buffalo, NY 14213; (716) 881-4483.

[2] **FILM FRIENDS**; AR, APPF, RLR, VP; 16 E. 17th St.; New York, NY 10003; (212) 620-0084.

[8] **FLASH STUDIOS**; AR, APPV, JCP, MP, SR, VP; 460 St. John St.; Central Islip, NY 11722; (516) 234-0261.

[2] **FRANKFORD/WAYNE MASTERING LABS, INC.**; MAST; 1697 Broadway, Ste. 1404; New York, NY 10019; (212) 582-5473; FAX: (212) 245-2309.

[4] **G.B.R. RECORDING STUDIO**; AR, APPV, JCP, MIDI, MP, VP; 261 Duer St.; Oswego, NY 13126; (315) 343-1993.

[4] **KEWALL REAL-TIME TAPE DUPLICATORS**; AR, ATD, RLR, MAST; 77 Bayshore Rd.; Bayshore, NY 11706; (516) 586-2486; (516) 684-1141 (beeper).

[8] **MC2 STUDIO**; AR, AD, EIR, JCP, MIDI, MP; 31 E. 1st St., Rm. 5 B; New York, NY 10003; (212) 460-9191.



# Recording & Video Production Facilities

UNITED STATES

NEW YORK

4 & 8 Track Recording Studios

[8] **MIDNIGHT CIRCUS PRODUCTIONS**; AR, APPV, JCP, MIDI, MP, VP; 2 Sherbrooke Dr.; Smithtown, NY 11787; (516) 366-4646.

► [8] **MPC RECORDING STUDIOS**; 341 W. 45th St.; New York, NY 10036; (212) 757-6427.

[2] **NARWOOD PRODUCTIONS**; AR, ATD, MP, RLR; 40 E. 49th St.; New York, NY 10017; (212) 755-3320.

[8] **P-FACTOR PRODUCTIONS**; AR, AD, APPV, APFF, JCP, MIDI, MP; 58 E. 80th, Ste. 4A; New York, NY 10021; (212) 734-0109.

[2] **POMEROY AUDIO**; AR, RLR, MAST; 193 Baltic St.; Brooklyn, NY 11201; (718) 855-2650.

[2] **QUEANS STUDIO OF JOE SIEGEL, INC.**; AR, RLR; 45-27 215 Pl.; Bayside, NY 11361; (718) 224-8789.

[8] **RAIL PRODUCTIONS (A DIVISION OF NATIONAL CUSTOM SOUND LTD.)**; AR, JCP, MP, RLR, P.O. Box 976; Ossining, NY 10562;

[4] **REILLY VIDEO COMMUNICATIONS**; ATD, VP; 508 W. 26th St.; New York, NY 10001; (212) 463-0058; FAX: (212) 463-7503.

[8] **SACRED SPIRIT MUSIC (FORMERLY CELESTIAL SPIRIT)**; AR, APPV, ATD, RLR, SR, VP; Box 1030D Shaker Rd.; New Lebanon, NY 12125; (518) 794-7860.

[8] **FRANK SCHEIDT AUDIO PRODUCTIONS, INC.**; AR, APPV, APFF, ATD, RLR; 15 Charlotte St.; Rochester, NY 14607; (716) 232-5210; FAX: (716) 232-5212.

[2] **SELTZER SOUND**; AR, RLR; 185 E. Broadway; New York, NY 10002; (212) 477-2372.

[8] **SOUND LOGIC**; AR, APPV, ATD; 1520 Central Ave; Albany, NY 12205; (518) 456-3086; FAX: (518) 456-2536.

[8] **STREET SOUNDS STUDIO**; AR, APPV, EIR, JCP, MP, RLR, SR; 17 Armonk Rd.; Mt Kisco, NY 10549; (914) 241-0364.

[8] **STROBE-LIGHT SOUND STUDIO**; AR, MP; 1219 Bergen St.; Brooklyn, NY 11213; (718) 771-3411.

[8] **STUDIO C MUSIC LIBRARY**; JCP, MIDI, MP; PO Box 767 Murray Hill Sta.; New York, NY 10156-0602; (212) 986-2219.

► [8] **STUDIO PASS**; AR, APPV, APFF, MIDI, MAST; 596 Broadway #602; New York, NY 10012; (212) 431-1130.

[8] **TANNHAUSER RECORDING**; AR, AD, APPV, APFF, ATD, MIDI, MP; 85-35 Lefferts Blvd.; Kew Gardens, NY 11415; (718) 441-6755.

[8] **TURNING MILL**; AR, AD, APPV, APFF, ATD, JCP, MIDI, ED, RLR, SR, VP; PO Box L; Palenville, NY 12463; (518) 678-9293.

[4] **29TH STREET VIDEO INC.**; VP; 339 W. 29th St.; New York, NY; (212) 594-7530.

[8] **WSKG PUBLIC RADIO**; AR, JCP, RLR; PO Box 3000; Binghamton, NY 13902; (607) 729-0100; FAX: (607) 729-7328.

## Video Production & Post-Production Facilities

**ACTIVE INC.**; APPV; 270 Lafayette St., Ste. 1203; New York, NY 10012; (212) 925-8150.

**ALEXANDROS AUDIO-VISUAL RESEARCH INC. (AVR)**; APPV; 78 5th Ave. 10th Fl.; New York, NY 10011; (212) 627-1144; FAX: (212) 727-7497.

**ALL AMERICAN COMPOSERS LIBRARY C/O DSM PRODUCERS**; APPV; 161 W. 54th St.; New York, NY 10019; (212) 247-4707; FAX: (212) 265-5726.

**ATLANTIC FILM & VIDEO**; VPF, OLVP, VTD; 171 Park Ln.; Massapequa, NY 11758; (516) 798-4106.

**AUDIO POST, INC.**; VPPE, APPV, VTD; 27 E. 21st St.; New York, NY 10010; (212) 475-5791; FAX: (212) 673-0788.

1990-91 MIX MASTER DIRECTORY

**AUDIO VISUAL ARTS, INC.**; VPPE, OLVP, APPV; 146 W. 57th St., Ste. 51F; New York, NY 10019; (212) 397-3733; FAX: (212) 397-1953.

**AUDIO-VISUAL RESEARCH (AVR)**; APPV; 78 5th Ave., 10th Fl.; New York, NY 10011; (212) 627-1144.

**BLANK TAPE SYSTEMS**; VPF, VPPE, OLVP, APPV, VTD; 1619 3rd Ave.; New York, NY 10128; (212) 860-5783.

**BLANK TAPES**; APPV; 225 Rector Pl. #20J; New York, NY 10280; (800) 969-5652; FAX: (203) 329-7193.

**C&C VISUAL, LTD.**; VPPE, VTD; 1500 Broadway, 4th Fl.; New York, NY 10036; (212) 869-4900; FAX: (212) 764-8618.

**CO-DIRECTIONS, INC.**; VPF, VPPE; 560 W. 43rd St., Ste. 8K; New York, NY 10036; (212) 695-7255; FAX: (212) 695-7258.

**COLUMBIA AUDIO VISUAL**; VPF, VPPE, OLVP, APPV, VTD; 701 W. 168th St.; New York, NY 10032; (212) 305-4101; FAX: (212) 305-7959.

**COMMUNICATIONS PLUS VIDEO**; VPF, VPPE, OLVP, VTD; 102 Madison Ave.; New York, NY 10016; (212) 686-9570.

**THE CREATORS**; VPF, VPPE, OLVP, APPV, VTD; 41 Skytop Dr.; Pleasantville, NY 10570; (914) 769-0676.

**EBY**; APPV; 476 Broadway; New York, NY; (212) 226-1230.

► **EDITEL NEW YORK**; VPPE, APPV; 222 E. 44th St.; New York, NY 10017; (212) 867-6400; FAX: (617) 267-4421.

**ENTERTAINMENT PRODUCING GROUP, INC.**; VPF, OLVP; Box 1316, Ansonia Station; New York, NY 10023; (212) 724-8841.

**FAMAVISION/FAMA II PRODUCTIONS, INC.**; VPF, VPPE, OLVP, APPV, VTD; 2750 Richmond Terr.; Staten Island, NY 10303-2314; (718) 273-1780.

**FILM FRIENDS**; VPF, OLVP; 16 E. 17th St.; New York, NY 10003; (212) 620-0084.

**FLASH STUDIOS**; VPF, VPPE, OLVP, APPV; 460 St. John St.; Central Islip, NY 11722; (516) 234-0261.

**MARK L. FORMAN FILM PRODUCTIONS**; OLVP; 300 W. 23rd St.; New York, NY 10011; (212) 633-8482; FAX: (212) 807-0121.

**IKON PRODUCTIONS**; VPF, VPPE, OLVP, VTD; 41 Park Ave.; New York, NY; (212) 685-3671.

**INTER-MEDIA ART CENTER, INC. (AKA IMAC)**; VPF, VPPE, OLVP, APPV, VTD; 370 New York Ave.; Huntington, NY 11743; (516) 549-9666.

**IZEM ENTERPRISES, INC.**; OLVP, VTD; 26 Abby Dr.; East Northport, NY 11731; (516) 368-0615.

**JAZZMARK SOUND (AUDIO) AMETHYST PRODUCTIONS (VIDEO)**; VPF, OLVP; 47-51 43rd St.; Queens, NY 11377; (718) 706-7071.

**JUPITER PRODUCTION SERVICES**; VPPE, OLVP; 201 E. 16th St.; New York, NY 10003; (212) 460-5600.

**LUCAS CHRISTIAAN PRODUCTIONS**; OLVP; 74 Winter Ave.; Staten Island, NY 10301; (718) 720-9383.

**MIDNIGHT CIRCUS PRODUCTIONS**; VPPE, OLVP, APPV; 2 Sherbrooke Dr.; Smithtown, NY 11787; (516) 366-4646.

**MODERN TELECOMMUNICATIONS, INC.**; One Dag Hammarskjöld Plaza; 885 Second Ave.; New York, NY 10017; (212) 355-0510.

**MOYSE & ASSOCIATES, INC.**; VPF, VPPE, OLVP, APPV; PO Box 831, 724B Watervliet-Shaker Rd.; Latham, NY 12110; (518) 783-6221.

**MUSIVISION, INC.**; VPF, VPPE, OLVP, VTD; 185 E. 85th St.; New York, NY 10028; (212) 860-4420.

► **NATIONAL VIDEO CENTER/RECORDING STUDIOS, INC.**; VPF, VPPE, OLVP, APPV; 460 W. 42nd St.; New York, NY 10036; (212) 279-2000.

**NEW YORK AUDIO PRODUCTIONS**; VPPE, APPV; 140 W. 22nd St.; New York, NY 10011; (212) 243-6826; FAX: (212) 243-7210.

**NOT JUST JINGLES/PARADISE STUDIOS**; APPV; 420 W. 45th St., 5th Fl.; New York, NY 10036; (212) 246-6468.

**OUR TOWN TELEVISION**; VPF, VPPE, OLVP; 78 Church St.; New York, NY 12866; (518) 899-6989; FAX: (518) 899-5620.

**PHOTOMAGNETIC SOUND STUDIOS**; APPV; 222 E. 44th St.; New York, NY 10017; (212) 687-9030; FAX: (212) 687-9298.

► **POST PERFECT**; VPPE, VTD; 220 E. 42nd St., 2nd Fl. South; New York, NY 10017; (212) 972-3400; FAX: (212) 972-9085.

**REILLY VIDEO COMMUNICATIONS**; VPPE, APPV, VTD; 508 W. 26th St.; New York, NY 10001; (212) 463-0058; FAX: (212) 463-7503.

**SACRED SPIRIT MUSIC (FORMERLY CELESTIAL SPIRIT)**; VPF, VPPE, OLVP, APPV; Box 1030D Shaker Rd.; New Lebanon, NY 12125; (518) 794-7860.

► **HOWARD SCHWARTZ RECORDING, INC.**; APPV; 420 Lexington Ave. #1934; New York, NY 10170; (212) 687-4180; FAX: (212) 697-0536.

**SCRIPTWRITERS COMPANY, LTD.**; VPF, VPPE, OLVP, APPV; 140 W. 79th St.; New York, NY 10024; (212) 724-8841.

**SEAR SOUND**; VPF, OLVP, APPV; 353 W. 48th St.; New York, NY 10036; (212) 582-5380; FAX: (212) 581-2731.

**SERVISOUND, INC.**; APPV; 35 W. 45th St.; New York, NY 10036; (212) 921-0555; FAX: (212) 869-4296.

**SHERIDAN ELSON COMM. INC.**; VPPE, OLVP; 20 W. 37th St.; New York, NY; (212) 239-2000; FAX: (212) 629-4417.

**SHUSTER SOUND**; APPV, VTD; 29 Burt Ct.; Valley Stream, NY 11581; (516) 791-2985.

**SMA VIDEO INC.**; VPF, VPPE, OLVP; 84 Wooster St.; New York, NY 10012; (212) 226-7474; FAX: (212) 941-0439.

**SOUND LAB STUDIOS LTD.**; APPV; 4760 Bedford Ave.; Brooklyn, NY 11235; (718) 934-8585.

**SOUND ON SOUND RECORDING, INC.**; APPV; 322 W. 45th St.; New York, NY 10036; (212) 757-5300.

**SQUIRES PRODUCTIONS, INC.**; VPF, VPPE, OLVP, APPV, VTD; 196 Maple Ave.; White Plains, NY; (914) 997-1603.

**SUPERONIX™—BINAURAL SOUND FOR MOTION PICTURES AND VIDEO**; VPF, VPPE, OLVP, APPV; 195 Hicks St.; New York, NY 11201; (718) 875-3209.

**SUTCLIFFE MUSIC INC./THE DUBB HOUSE**; APPV; 8 W. 19th St., 2nd Fl.; New York, NY 10011-4206; (212) 989-9292; FAX: (212) 989-5195.

► **SYNC SOUND, INC.**; APPV; 450 W. 56th St.; New York, NY 10019; (212) 246-5580.

► **SYNERGETIC**; VPF, VPPE, OLVP, APPV; 6518 Basile Rowe; East Syracuse, NY 13057; (315) 437-7533; FAX: (315) 437-0324.

**TELETECHNIQUES INC.**; VPPE, VTD; 1 W. 19th St.; New York, NY 10011; (212) 206-1475; FAX: (212) 929-9082.

**TEL-E-VUE PRODUCTIONS**; VPF, VPPE, OLVP, VTD; Box 217; Ferndale, NY 12734; (914) 292-5965; FAX: (914) 292-2313.

**29TH STREET VIDEO INC.**; VPF, VPPE, OLVP, VTD; 339 W. 29th St.; New York, NY; (212) 594-7530.

**VIDEOMIX**; APPV; 123 W. 18th St., 7th Fl.; New York, NY 10011; (212) 627-7700; FAX: (212) 727-3075.

**THE VISUAL IMAGE**; VPPE, OLVP; 3417 Ave. L; Brooklyn, NY 11210; (718) 377-1360.

**VISUAL MUSIC PRODUCTION SERVICES**; APPV; 235 E. 13th St. #3-D; New York, NY 10003; (212) 505-9281.

**VSC POST**; VPPE, VTD; 225 E. 43rd St.; New York, NY 10017; (212) 599-1616; FAX: (212) 697-6387.

**THE WECHSLER GROUP**; VPF, VPPE, OLVP; 185 West End Ave., Ste. 22-C; New York, NY 10023; (212) 787-8699.

NORTH CAROLINA

24+ Track Recording Studios

[24+] **ACOUSTIC CREATIONS RECORDING STUDIO**; AR, AD, JCP, MIDI, MP, RLR; 4813 W. Wendover Ave.; Greensboro, NC 27410; (919) 632-1004.

[24+] **ASSOCIATED SOUND PRODUCTS, INC.**; 3900 Tarheel Dr., Ste. 103; Raleigh, NC 27609; (919) 878-0044.

[24+] **AUDIO, INCORPORATED**; 1917 Cleveland Ave.; Charlotte, NC 28203; (704) 376-3818.

[24+] **DM & DM STUDIO, INC.**; AR, JCP, MIDI, RLR, MAST; 205 Davis Ln.; Belmont, NC 28012; (704) 825-4901.

See Page 57 for Facility Services Key

[24+] **GOSPEL WORLD RECORDING STUDIO**; AR, MIDI, VP; Rte. 2, Box 366; Middlesex, NC 27557; (919) 235-4691.

[24+] **CHARLES HIX STUDIOS**; 2901 Hwy. 70 W.; Hickory, NC 28602; (704) 328-2487.

> [24+] **LAMON SOUND STUDIOS**; RLR; 6870-A Newell Hickory Grove Rd.; Charlotte, NC 28215; (704) 535-7263.

[24+] **THE PROCESS RECORDING STUDIOS INC.**; AR, APPV, ATD, JCP, MIDI, MP, RLR, MAST; 3404 W. Wendover Ave., Ste. E; Greensboro, NC 27407; (919) 855-1941; FAX: (919) 855-0819.

> [24+] **REFLECTION SOUND STUDIOS**; AR, EIR, JCP, MIDI, RLR, SDS; 1018 Central Ave.; Charlotte, NC 28204; (704) 377-4596; FAX: (704) 375-9723.

[24+] **SOUND LAB INC.**; AR, AD, APPV, ATD, JCP, MIDI, MP, RLR; 2319 Fernwood Dr.; Greensboro, NC 27408; (919) 288-0185; FAX: (919) 288-0298.

> [24+] **SOUND TRAX INC.**; AR, APPV, JCP, MIDI, MP; 1626 Glenwood Ave.; Raleigh, NC 27608; (919) 832-9953; FAX: (919) 828-1323.

[24+] **SOUTHWYNDE STUDIO**; RLR; PO Box 4133; Wilmington, NC 28406; (919) 791-1052.

[24+] **STUDIOEAST RECORDING STUDIOS**; AR, AD, APPV, JCP, MIDI, MP, RLR; 5457 Monroe Rd.; Charlotte, NC 28214; (704) 536-0424.

[24+] **T-PORT SONG FACTORY/HIT SOUNDS PRODUCTIONS**; AR, AD, JCP, MIDI, MAST; 1926 E. 7th St.; Charlotte, NC; (704) 338-9970; (704) 393-3012; FAX: (704) 563-0758.

#### 12 & 16 Track Recording Studios

[16] **AUDIOCRAFT SOUND & VIDEO**; AR, APPV, JCP, MIDI, MP, RLR, VP; 1604 W. New Bern Rd.; Kinston, NC 28501; (919) 527-8845.

[16] **BEECHTREE RECORDING STUDIO**; AR, AD, APPV, APPF, ATD, EIR, JCP, MIDI, MP, RLR, SR; 2804 Beechtree Dr.; Sanford, NC 27330; (919) 774-8926.

[16] **CAPITAL MEDIA CENTER**; AR, APPV, APPF, JCP, MIDI, MP, VP; c/o Capital Assoc. Indus.; 2900 Highwoods Blvd.; Raleigh, NC 27604; (919) 878-9222; FAX: (919) 872-6599.

[16] **JAG STUDIO, LTD.**; AR, AD, ATD, MIDI; 3801-C Western Blvd.; Raleigh, NC 27606; (919) 821-2059.

[16] **NEW HORIZON RECORDING STUDIO**; AR, JCP, MIDI, MP, SR; 1490 Union Cross Rd.; Kernersville, NC 27284; (919) 996-2633.

[16] **PYRAMID RECORDING STUDIO**; AR, APPV, APPF, EIR, JCP, MIDI, RLR; Rte. 2 Box 348; Lawndale, NC 28090; (704) 538-7905.

[16] **ROBINSOUND STUDIO**; AR, APPV, ATD, RLR, SR; 4308 Iola Dr.; Charlotte, NC 28213; (704) 598-8738.

[16] **SOUND LOGIC STUDIO**; AR, JCP, MIDI; 1840 Wake Forest Rd.; Raleigh, NC 27608; (919) 856-1441.

[16] **SOUND SOURCE RECORDING STUDIOS**; AR, ATD, JCP, MIDI; 10100 Park Cedar Dr.; Charlotte, NC 28210; (704) 542-9761; FAX: (704) 541-1572.

> [16] **SOUTHLAND AUDIO/VIDEO PRODUCTIONS**; 655 H. Pressley Rd.; Charlotte, NC 28217; (704) 527-7426.

> [16] **THE STUDIO**; RLR; Rte. 8, Box 484-B; Chapel Hill, NC 27514; (919) 967-8470.

[16] **SYNERGEN ENT.—THE GARDEN STUDIOS**; RLR; 800 Bowden Rd.; Chapel Hill, NC 27516; (919) 967-4300.

[16] **CAL WALKER PRODUCTION SERVICES**; AR, ATD, RLR, SDS; Walnut Hollow—1301 Briar Creek Rd.; Charlotte, NC 28205; (704) 376-2949; (704) 376-2864; FAX: (704) 889-4540.

[16] **WESTSTREET RECORDING INC.**; AR, APPV, ATD, MIDI, MP; 612 N. West St.; Raleigh, NC 27603; (919) 833-1303.

#### 4 & 8 Track Recording Studios

> [8] **GRANT BLAIR PRODUCTIONS**; AR, APPV, JCP, MIDI, MP, RLR; 2748 Woodlore Trail; Winston-Salem, NC 27103; (919) 765-5692.

[8] **THE COMMUNICATIONS GROUP, INC.**; AR, AD, APPV, APPF, ATD, JCP, MP, RLR, SR, SDS, MAST, VP; PO Box 50157; Raleigh, NC 27650; (919) 828-4086; FAX: (919) 828-0481.

[8] **FISHER STUDIOS**; AR, APPV, ATD, RLR, VP; 113 Mallette St.; Chapel Hill, NC 27516; (919) 968-4931.

[8] **LENTZ & ASSOCIATES, INC.**; AR; 501 Washington St.; Raleigh, NC 27605; (919) 828-6761.

[8] **MEDIA CONSULTANTS INC.**; AR, ATD, EIR, JCP, VP; 126 W. Chatham St.; Cary, NC 27511; (919) 467-3588.

[8] **MILLER RECORDING STUDIO**; AR, APPV, ATD, JCP, MP, RLR, SR, VP; 2513 S. Scales St.; Reidsville, NC 27320; (919) 349-8911; (919) 342-1892.

[8] **MUSICORD RECORDING STUDIOS**; AR, JCP, MP, RLR, SR; 124 E. Chatham St.; Cary/Raleigh, NC 27511; (919) 469-3336.

[8] **OFFBEAT STUDIO**; AR, JCP, MIDI, RLR; 965 Old U.S. 1 South; Southern Pines, NC 28387; (919) 281-5822.

[8] **SOUND SOLUTIONS—THE COMMUNICATIONS GROUP**; AR, APPV, APPF, JCP, MIDI, MP, VP; 518 W. Jones St.; Raleigh, NC 27601; (919) 832-7797; FAX: (919) 828-0481.

[8] **SOUND SMITH RECORDING**; AR, ATD, RLR; 4537 W. Wendover Ave.; Greensboro, NC 27410; (919) 855-1525.

[8] **SOUTHERN CITY STUDIO**; AR, AD, JCP, MIDI, MP; 7317 Bayhill Ct.; Raleigh, NC 27615; (919) 872-6443.

[8] **VIDEOFONICS INC.**; AR, APPV, VP; 1101 Capital Blvd.; Raleigh, NC 27603; (919) 821-5614; FAX: (919) 821-0902.

[4] **WLM RECORDING**; AR, AD, EIR, JCP, MP, RLR, SR; 2808 Cammie St.; Durham, NC 27705-2020; (919) 471-3086.

#### Video Production & Post-Production Facilities

**AUDIOCRAFT SOUND & VIDEO**; VP, VPPE, OLVP, APPV, VTD; 1604 W. New Bern Rd.; Kinston, NC 28501; (919) 527-8845.

**CAPITAL MEDIA CENTER**; VP, VPPE, OLVP, APPV, VTD; c/o Capital Assoc. Indus.; 2900 Highwoods Blvd.; Raleigh, NC 27604; (919) 878-9222; FAX: (919) 872-6599.

**THE COMMUNICATIONS GROUP, INC.**; VP, VPPE, OLVP, APPV, VTD; PO Box 50157; Raleigh, NC 27650; (919) 828-4086; FAX: (919) 828-0481.

**CORPORATE MEDIA SERVICES, INC.**; VP, VPPE, OLVP, VTD; 632 W. Summit Ave.; Charlotte, NC 28203; (704) 377-1601; FAX: (704) 377-2905.

**GOSPEL WORLD RECORDING STUDIO**; VP, VTD; Rte. 2, Box 366; Middlesex, NC 27557; (919) 235-4691.

**HARRIS-CHEWNING PRODUCTION SERVICES & RENTALS**; OLVP; 79 Polk's Landing Station; Chapel Hill, NC 27516; (919) 942-7997; (919) 933-0545.

**CHARLES HIX STUDIOS**; VP, VPPE, OLVP, APPV; 2901 Hwy. 70 W.; Hickory, NC 28602; (704) 328-2487.

**LENTZ & ASSOCIATES, INC.**; VP; 501 Washington St.; Raleigh, NC 27605; (919) 828-6761.

**MEDIA CONSULTANTS INC.**; VP, VPPE, OLVP, VTD; 126 W. Chatham St.; Cary, NC 27511; (919) 467-3588.

**SOUND SOLUTIONS—THE COMMUNICATIONS GROUP**; VP, VPPE, OLVP, APPV, VTD; 518 W. Jones St.; Raleigh, NC 27601; (919) 832-7797; FAX: (919) 828-0481.

**TELEVISUAL PRODUCTIONS**; VP, VPPE, OLVP, APPV, VTD; 3330 W. Friendly Ave.; Greensboro, NC 27410; (919) 373-0049.

**VIDEOFONICS INC.**; VP, VPPE, OLVP, APPV; 1101 Capital Blvd.; Raleigh, NC 27603; (919) 821-5614; FAX: (919) 821-0902.

#### NORTH DAKOTA

#### 12 & 16 Track Recording Studios

[16] **VIDEOARTS STUDIOS**; AR, APPV, ATD, JCP, MIDI, MP, VP; 1440 4th Ave. N.; Fargo, ND 58102; (701) 232-3393; FAX: (701) 232-9439.

#### Video Production & Post-Production Facilities

**VIDEOARTS STUDIOS**; VP, VPPE, OLVP, APPV, VTD; 1440 4th Ave. N.; Fargo, ND 58102; (701) 232-3393; FAX: (701) 232-9439.

#### OHIO

#### 24+ Track Recording Studios

[24+] **AUDIO RECORDING STUDIOS, INC.**; AR, APPV, JCP, MIDI, MP; 601 Rockwell Ave.; Cleveland, OH 44114; (216) 771-5112.

[24+] **AUDIOCRAFT**; AR, APPV, APPF, ATD, JCP, MIDI, MP, RLR, VP; 915 W. 8th St.; Cincinnati, OH 45203; (513) 241-4304; FAX: (513) 241-3477.

> [24+] **BEACHWOOD STUDIOS**; AR, APPV, ATD, JCP, MIDI, MP, RLR, SR; 23330 Commerce Park; Beachwood, OH 44122; (216) 292-7300; FAX: (216) 292-0545.

[24+] **CHARLES BROWN MUSIC INC.**; 1349 E. McMillan St.; Cincinnati, OH 45206; (513) 281-5212.

[24+] **CYBERTEKNIKS**; 1953 E. Third St.; Dayton, OH 45403; (513) 258-2463.

> [24+] **GENESIS DIGITAL**; RLR; 6500 Southway Rd.; Clayton, OH 45315-9757; (513) 832-3723.

[24+] **GRS, INC.**; AR, APPV, JCP, MP, RLR, VP; 13300 Broad St.; Pataskala, OH 43062; (614) 927-9566; FAX: (614) 927-9543.

> [24+] **LOGOS PRODUCTIONS**; RLR; 6500 Southway Rd.; Clayton, OH 45315; (513) 832-3723.

[24+] **MUSICOL, INC.**; RLR; 780 Oakland Park Ave.; Columbus, OH 43224; (614) 267-3133.



THE RECORDING WORKSHOP  
Chillicothe, OH

> [24+] **THE RECORDING WORKSHOP**; AR, AD, APPV, JCP, MIDI, MP, ED, RS, MAST; 455-X Massieville Rd.; Chillicothe, OH 45601; (800) 848-9900; (614) 663-2510.

> [24+] **REFRAZE RECORDING STUDIO**; AR, APPV, ATD, JCP, MIDI, MP, RLR; 2727 Gaylord Ave.; Dayton, OH 45419; (513) 298-2727.

[24+] **ROME RECORDING CO.**; AR, ATD, MP, ED, RLR; 1414 E. Brood St.; Columbus, OH 43205; (614) 253-4418.

[24+] **RTG MUSIC, INC.**; AR, AD, APPV, APPF, JCP, MIDI, MP; 130 E. 6th St.; Cincinnati, OH 45202; (513) 381-0506; FAX: (513) 381-0909.

> [24+] **SISAPA STUDIOS**; 394 Mt. Vernon; Columbus, OH 43215; (614) 228-2228.

[24+] **SOUND IMAGES, INC.**; AR, APPV, JCP, MIDI, MP; 602 Main St.; Cincinnati, OH 45202; (513) 241-7475; FAX: (513) 241-4791.

[24+] **TECHNIMEDIA STUDIOS**; AR, APPV, JCP, MIDI, MP, VP; 124-126 S. Fifth St.; Steubenville, OH 43952; (614) 282-5315; FAX: (614) 282-TECH (8324).

#### 12 & 16 Track Recording Studios

[16] **ACTION CITY RECORDS**; AR, EIR, MP; PO Box 302; Napoleon, OH 43545; (419) 533-4782.

[16] **AMERICAN WAX SOUND STUDIOS**; AR, APPV, ATD, EIR, JCP, RLR, MAST; 3640 Maplewood Ave.; Youngstown, OH 44505; (216) 759-8592.

> [16] **AXSTUDIOS**; 911 Robinwood Ave., Unit E; Columbus, OH 43213; (614) 848-5232; (614) 272-8452.



## Recording & Video Production Facilities

UNITED STATES

### OHIO

#### 12 & 16 Track Recording Studios

[16] **CEDARWOOD RECORDING STUDIO & PRODUCTION**; AR, ATD, JCP, RLR; 1628 St., Rt. 511 S.; Ashland, OH 44805; (419) 289-1109.

[16] **CLASSIC VIDEO, INC.**; AR, APPV, JCP, MP, RLR, SDS, VP; 5001 E. Royalton Rd.; Cleveland, OH 44147; (216) 838-5377; FAX: (216) 838-1240.

>[16] **CREATIVE ARTWORKS INC./B&W PRODUCTIONS INTERNATIONAL RECORDING**; 705 Taywood Rd.; Englewood, OH 45322; (513) 832-1785.

[16] **CROSSLINK PRODUCTIONS, INC.**; AR, APPV, ATD, JCP, MIDI, MP, SR, VP; 2455 North Star Rd., 3rd Fl.; Columbus, OH 43221; (614) 488-5993; FAX: (614) 488-0286.

[16] **DIAMOND MINE RECORDING STUDIO**; AR, ATD, MIDI, MP; 3115 Bremen Dr.; Columbus, OH 43224; (614) 268-4792.

[16] **LARRY GOLD**; AR, RLR; 20 Broadway; Toledo, OH 43602; (419) 255-6606.

[16] **PRESCO PRODUCTIONS**; AR, ATD, JCP, MIDI, MP, RLR; 4366 W. 66th St.; Cleveland, OH 44144; (216) 749-7244.

[16] **STARGATE MUSIC**; AR, ATD, JCP, MIDI, MP, RLR, SR; 5251 Caleb Hill Rd.; Hillsboro, OH 45133; (513) 393-5518.

[16] **SYNDICATE SOUND**; AR, AD, JCP, MIDI, MP; 311 Poland Ave.; Struthers, OH 44471; (216) 755-1331.

[16] **TOMSICK BROTHERS RECORDING STUDIOS**; AR, APPV, ATD, JCP, MIDI, MP; 21271 Chardon Rd.; Euclid, OH 44117; (216) 481-8380.

#### 4 & 8 Track Recording Studios

[8] **APPLIED COMMUNICATIONS, INC.**; AR, APPV, RLR, VP; 3380 Successful Way; Dayton, OH 45424; (513) 233-0070; FAX: (513) 233-0082.

[8] **ASYNCHRONOUS SOUND CORPORATION**; AR, RLR; 80 Nottoway Ct.; Akron, OH 44313; (216) 836-5274.

[8] **AUDIO SERVICES**; AR, ATD, RLR; Oberlin College, 173 W. Lorain St.; Oberlin, OH 44074; (216) 775-8272.

[8] **D.L. CORBET AUDIO SYSTEMS**; AR, APPV, JCP, MIDI; 2723 Highland Village Ln.; Miamisburg, OH 45342-4575; (513) 435-3049.

[8] **EDGE ENTERPRISES**; AR, MIDI; 2731 Hills-Miller Rd.; Delaware, OH 43015; (614) 369-1476.

[8] **GROUP II AUDIO**; AR, APPV, JCP, MIDI, MP; 1480 Dublin Rd.; Columbus, OH 43215; (614) 488-0621; FAX: (614) 488-0775.

[4] **HEYWOOD FORMATICS AND SYNDICATION**; AR, APPV, APPF, ATD, JCP, MP, VP; 1103 Colonial Blvd.; Canton, OH 44714-1837; (216) 456-2592.

[4] **ICOM INCORPORATED**; AR, ATD, RLR, SR, VP; 294 E. Long St.; Columbus, OH 43228; (614) 224-4400; FAX: (614) 224-4445.

[8] **LOST NATION SOUND**; AR; 6941 S.R. 329; Guysville, OH 45735; (614) 662-5701.

[4] **MCIC VIDEO SERVICES**; 231 Bethesda Ave., Mail Loc. 574; Cincinnati, OH 45267; (513) 558-5676.

[8] **MUSICO TECHNILAB**; AR, APPV, APPF, JCP, MIDI, MP, RLR; 160 N. Park Ave.; Warren, OH 44481; (216) 394-5605.

[2] **PRO RECORDING SERVICE**; AR, MAST; 13709 Mapleleaf Dr.; Cleveland, OH 44125; (216) 662-1435.

[8] **REAL TO REEL RECORDING**; AR; 1120 Garfield Ave.; Springfield, OH 45504; (513) 325-6107.

[8] **STUDIO 95**; AR, JCP, MIDI; 250 W. Court St. #300-E; Cincinnati, OH 45202; (513) 241-9500; FAX: (513) 241-8896.

[8] **TECH-ONE SOUND**; AR, EIR, MIDI, SR, SDS; PO Box 4656; Youngstown, OH 44515; (216) 799-8951.

[8] **V.G.I. PRODUCTIONS (VIDEO GENESIS, INC.)**; AR, APPV, RLR, VP; 4949 Galaxy Pkwy.; Cleveland, OH 44107; (216) 464-3635.

#### Video Production & Post-Production Facilities

**APPLIED COMMUNICATIONS, INC.**; VPF, VPPE, APPV; 3380 Successful Way; Dayton, OH 45424; (513) 233-0070; FAX: (513) 233-0082.

**BEACHWOOD STUDIOS**; VPF, VPPE, OLVP, APPV, VTD; 23330 Commerce Park; Beachwood, OH 44122; (216) 292-7300; FAX: (216) 292-0545.

**BRIGHT LIGHT PRODUCTIONS, INC.**; VPF, VPPE, OLVP, VTD; 602 Main St., Ste. 810; Cincinnati, OH 45202; (513) 721-2574; FAX: (513) 721-3329.

**CLASSIC VIDEO, INC.**; VPF, VPPE, OLVP, APPV, VTD; 5001 E. Royalton Rd.; Cleveland, OH 44147; (216) 838-5377; FAX: (216) 838-1240.

**D.L. CORBET AUDIO SYSTEMS**; APPV; 2723 Highland Village Ln.; Miamisburg, OH 45342-4575; (513) 435-3049.

**CROSSLINK PRODUCTIONS, INC.**; VPF, VPPE, OLVP, APPV, VTD; 2455 North Star Rd., 3rd Fl.; Columbus, OH 43221; (614) 488-5993; FAX: (614) 488-0286.

**THE FILM HOUSE, INC.**; VPF, VPPE, OLVP; 8230 Montgomery Rd.; Cincinnati, OH 45236; (513) 891-0035.

**GRS, INC.**; VPF, VPPE, OLVP, APPV, VTD; 13300 Broad St.; Pataskala, OH 43062; (614) 927-9566; FAX: (614) 927-9543.

**HEYWOOD FORMATICS AND SYNDICATION**; APPV; 1103 Colonial Blvd.; Canton, OH 44714-1837; (216) 456-2592.

**ICOM INCORPORATED**; VPF, VPPE, OLVP, VTD; 294 E. Long St.; Columbus, OH 43228; (614) 224-4400; FAX: (614) 224-4445.

**POST PRODUCTION SERVICES**; VPPE, VTD; 602 Main St., Ste. 900; Cincinnati, OH 45202; (513) 621-6677; FAX: (513) 421-6141.

**STOKES SOUND AND VIDEO**; OLVP, APPV; 100 Stokes Ln., PO Box 398; Hudson, OH 44236; (216) 650-1669.

**TAKE 1 STUDIOS**; VPF, VPPE, OLVP, APPV, VTD; 4900 Euclid Ave.; Cleveland, OH 44103; (216) 431-1444.

**V.G.I. PRODUCTIONS (VIDEO GENESIS, INC.)**; VPF, VPPE, OLVP, APPV, VTD; 4949 Galaxy Pkwy.; Cleveland, OH 44107; (216) 464-3635.

**VIDEO DUPLICATION SERVICES, INC.**; VTD; 10 Granger Rd.; Brooklyn Heights, OH 44131; (216) 741-3827; FAX: (216) 741-3828.

### OKLAHOMA

#### 24+ Track Recording Studios

[24+] **THE CHURCH STUDIO**; AR, JCP, MIDI, MP; 304 S. Trenton; Tulsa, OK 74120; (918) 582-0520.

>[24+] **STUDIO SEVEN**; AR, ATD, JCP; 417 N. Virginia; Oklahoma City, OK 73106; (405) 236-0643.

[24+] **THE TWENTY-FIFTH TRACK**; AR, BR, JCP, MIDI, MP, ED; 309 E. Vicksburg; Broken Arrow, OK 74011; (918) 455-2459.

#### 12 & 16 Track Recording Studios

[16] **A PLACE OF PRAISE**; AR, AD, APPV, JCP, MIDI, MP, VP; 2500 E. Vancouver; Broken Arrow, OK 74014; (918) 355-3020.

[16] **CARUMBO RECORDING**; AR, MP, RLR; 1301 Magnolia St.; Norman, OK 73072; (405) 329-1765.

[16] **COPASETIC SOUND**; AR, AD, JCP, MIDI, MP, RLR, SDS; 403 E. Kerr; Midwest City, OK 73110; (405) 737-7024.

[16] **OPENTRACKS RECORDING STUDIO**; AR, JCP, MIDI, MP, RLR; 1708 K SW; Miami, OK 74354; (918) 542-4562.

[16] **PRODUCER'S AUDIO/VIDEO**; AR, APPV, ATD, EIR, JCP, MIDI, MP, RLR, VP; 7701 N. Broadway A-6; Oklahoma City, OK 73116; (405) 842-3230; FAX: (405) 840-9335.

[16] **WHITE ROSE STUDIO**; AR, AD, EIR, JCP, MIDI, MP, ED, RLR, SR; 1901 Crested Butte; Edmond, OK 73034; (405) 282-2729.

#### 4 & 8 Track Recording Studios

[8] **AMBIENT SOUND PRODUCTIONS**; AR, AD, APPV, JCP, MIDI, MP, ED, SR; 2733 NW 12th St.; Oklahoma City, OK 73107; (405) 949-1602.

[8] **IRVING PRODUCTIONS, INC.**; AR, APPV, ATD; 3202 E. 21st; Tulsa, OK 74114; (918) 744-1221; FAX: (918) 744-1223.

[8] **MISSION PRODUCTIONS**; AR, AD, JCP, MP; 310 Dogwood Dr.; Tahlequah, OK 74464; (918) 456-6344.

[8] **OB STUDIOS**; SR; 5932 N. Grove; Oklahoma, OK 73122; (405) 721-3727.

[8] **RAGUSE RECORDING CO. (EVOLUTION STUDIO)**; AR, MP; Box 470507; Tulsa, OK 74147; (918) 663-1804; FAX: (918) 663-3283.

[8] **SEQUENTIAL LAB STUDIO**; AR, AD, ATD, JCP, MIDI; 3329 NE 20th; Oklahoma City, OK; (405) 424-8612.

#### Video Production & Post-Production Facilities

**THE EDIT SUITE**; VPF, VPPE, OLVP, VTD; 100 W. 5th; Tulsa, OK 74102; (918) 588-7575; FAX: (918) 588-7273.

**GREKEL PRODUCTIONS**; VPF, VPPE, OLVP, APPV, VTD; 7506 N. Broadway, Ste. 501; Oklahoma City, OK 73116; (405) 842-7171; (800) 634-5045; FAX: (405) 848-8422.

**THE TWENTY-FIFTH TRACK**; APPV; 309 E. Vicksburg; Broken Arrow, OK 74011; (918) 455-2459.

### OREGON

#### 24+ Track Recording Studios

[24+] **COLOR BLIND MUSIC™**; AR, AD, APPV, APPF, JCP, MIDI, MP, ED, SDS, MAST; 1128 Alder, Ste. C; Eugene, OR 97403; (503) 342-2844; FAX: (503) 343-9245.

[24+] **DOG FISH SOUND**; AR, APPV, RLR, RS, SR; 17385 NE Hillsboro Hwy.; Newberg, OR 97132; (503) 538-5638.

>[24+] **ENGLAND DESIGN AUDIO (E.D.A.)**; 2115 N. Vancouver Ave.; Portland, OR 97227; (503) 287-1662.

[24+] **FALCON RECORDING STUDIOS INC.**; AR, JCP, MIDI, MP; 15 SE 15th; Portland, OR 97214-1409; (503) 236-3856.

>[24+] **GUNG-HO RECORDING STUDIO**; AR, APPV, APPF, ATD, MP, ED, RLR, MAST; 86821 McMorott Ln.; Eugene, OR 97402; (503) 484-9352.

[24+] **JAH WORKS STUDIOS/THEOCRATIC RECORDS**; AR, JCP, MIDI, MP, ED, RLR, SR, MAST; PO Box 15; O'Brien, OR 97534; (503) 596-2180.



MUSICON  
Wilsonville, OR

[24+] **MUSICON**; AR, APPV, ATD, JCP, MIDI, MP, MAST; 27501 SW 95th Ave., Ste. 930; Wilsonville, OR 97070; (503) 682-8668; FAX: (503) 682-3043.

[24+] **NORTHWEST VIDEO WORKS, INC.**; AR, APPV, ATD, JCP, MIDI, VP; 1631 SW Columbia St.; Portland, OR 97201; (503) 227-7202; FAX: (503) 223-7528.

[24+] **PACE VIDEO CENTER**; AR, APPV, ATD, JCP; 2020 SW Fourth Ave.; Portland, OR 97201; (503) 226-7223; FAX: (503) 224-7413.

[24+] **PLANET EARTH PRODUCTIONS**; AR, APPV, APPF, ATD, EIR, MP, ED, RLR, SR, SDS, MAST, VP; PO Box 525; Cave Junction, OR 97523; (503) 592-2123; FAX: (503) 592-4796.

>[24+] **SOUND IMPRESSIONS**; AR, APPV, MP; 4704 SE View Acres; Milwaukie, OR 97267; (503) 659-5953.

>[24+] **SPECTRUM SOUND STUDIOS**; AR, APPV, ATD, RLR; 1634 SW Alder; Portland, OR 97205; (503) 248-0248; FAX: (503) 274-7684.

[24+] **STARLIGHT RECORDING**; AR, AD, ATD, JCP, MIDI, MP; 21195 SW Jay St.; Aloha, OR 97006; (503) 591-1276.

[24+] **STAUNTON STUDIOS, INC.**; RLR; 5450 Coleman Creek Rd.; Medford, OR 97501; (503) 535-3972.

► [24+] **THEOCRATIC RECORDS/JAH WORKS STUDIOS**; RLR; PO Box 15; O'Brien, OR 97534; (503) 596-2180.

► [24+] **TRIAD RECORDING STUDIOS**; AR, ATD, MIDI, MAST; 352 W. 12th Ave.; Eugene, OR 97401; (503) 687-9032.

#### 12 & 16 Track Recording Studios

[16] **ALPHA COMMUNICATION TECHNOLOGIES, INC.**; AR, APPV, APPF, ATD, EIR, JCP, MIDI, MP, RLR, SR, SDS, MAST, VP; 3930 48th NE; Salem, OR 97305; (503) 779-7906.

[16] **OREGON SOUND RECORDING**; AR, JCP, MIDI, MP, VP; 125 S. Central, Ste. 209; Medford, OR 97501; (503) 773-3292; FAX: (503) 779-8970.

[16] **RAINBOW RECORDING**; AR, APPV, APPF, ATD, JCP, MIDI, MP, RLR, MAST; 6614 SW Garden Home Rd.; Portland, OR 97223; (503) 246-5576.

[16] **DONROSS PRODUCTIONS**; AR, APPV, ATD, JCP, MIDI, MP, RLR; 3097 Floral Hill Dr.; Eugene, OR 97403; (503) 343-2692.

[16] **SIRIUS PRODUCTIONS**; AR, APPV, APPF, JCP, MIDI, MP; 2519 Willow Way; Medford, OR 97501; (503) 772-6031.

[16] **TIAGA RECORDING STUDIO**; AR; PO Box 205; Allegany, OR 97407; (503) 267-2330.

#### 4 & 8 Track Recording Studios

[8] **BIBLE TEMPLE PRODUCTIONS**; AR, ATD, MP; 7600 NE Glisan; Portland, OR 97213; (503) 252-3852.

[4] **FORTE STUDIOS**; AR, ATD, EIR; 12495 SW Summercrest Dr.; Tigard, OR; (503) 620-7849.

► [8] **FULL MOON RECORDING COMPANY**; AR, APPV, ATD, JCP, ED, RLR, SDS; 197 W. 12th Ave.; Eugene, OR 97401; (503) 343-1294; FAX: (503) 686-0248.

[8] **GARY GADWOOD**; AR, ATD, RLR; 11995 NW Kearney; Portland, OR 97229; (503) 644-0683.

[8] **LEON-FORREST PRODUCTIONS**; AR, EIR, JCP, MIDI, MP, RS; 4416 SE Hwy. 101; Lincoln City, OR 97367; (503) 996-2575.

[8] **LIL' OAK SOUND**; AR, MIDI; 2028 SW G St.; Grants Pass, OR 97526; (503) 479-3205.

► [8] **PROJECT ONE AUDIO SERVICES**; AR, APPV, APPF, EIR, JCP, MIDI, MP; 291 Valley River Center; Eugene, OR 97401; (503) 345-6004.

[4] **RADIOACTIVE RECORDS**; AR, AD, ATD, JCP, MIDI, MP; 1075 NW Murray Rd., Ste. 250; Portland, OR 97229; (503) 642-4201.

[2] **SUPER DUPER—AUDIO DUPLICATION SERVICES**; ATD; 3235 SE 39th; Portland, OR 97202; (503) 239-6070.

#### Video Production & Post-Production Facilities

**ALPHA COMMUNICATION TECHNOLOGIES, INC.**; VPPE, VPPE, OLVP, APPV, VTD; 3930 48th NE; Salem, OR 97305; (503) 370-7906.

**NORTHWEST VIDEO WORKS, INC.**; VPPE, APPV, VTD; 1631 SW Columbia St.; Portland, OR 97201; (503) 227-7202; FAX: (503) 223-7528.

**PACE VIDEO CENTER**; VPPE, APPV; 2020 SW Fourth Ave.; Portland, OR 97201; (503) 226-7223; FAX: (503) 224-7413.

**SIRIUS PRODUCTIONS**; VPPE, APPV; 2519 Willow Way; Medford, OR 97501; (503) 772-6031.

**SPECTRUM SOUND STUDIOS**; APPV; 1634 SW Alder; Portland, OR 97205; (503) 248-0248; FAX: (503) 274-7684.

#### PENNSYLVANIA

#### 24+ Track Recording Studios

[24+] **AUDIBLE IMAGES**; AR, JCP, MIDI, MP, RLR; 22 Cambria Point; Pittsburgh, PA 15209; (412) 821-2648.

[24+] **AUDIO INNOVATORS, INC.**; AR, APPV, APPF, ATD, EIR, MP, RLR, SR, SDS; 216 Boulevard of the Allies; Pittsburgh, PA 15222; (412) 471-6220; FAX: (412) 621-9887.

[24+] **AUDIOMATION**; AR, APPV, JCP, MIDI, MP, SDS; 922 W. North Ave.; Pittsburgh, PA 15233; (412) 231-7767.

► [24+] **BRIGHTON RECORDING**; AR, APPV, APPF, ATD, JCP, MIDI, MP, ED, RLR; 1 Mill St.; Plains, PA 18705; (717) 829-7060.

► [24+] **CHESTNUT SOUND, INC.**; AR, AD, APPV, ATD, JCP, MIDI, MP, RLR; 1824 Chestnut St.; Philadelphia, PA 19103; (215) 568-5797.

► [24+] **DAK AUDIO**; AR, AD, ATD, JCP, MIDI, MP, RLR; 315 Rickert Rd.; Sellersville, PA 18960; (215) 723-1167.

[24+] **DSE RECORDING**; AR, RLR, SR, SDS; 557 Bouquin Cir.; Oil City, PA 16301; (814) 676-1060.

[24+] **THE EDITORIUM**; AR, APPV, JCP, MIDI, MP, VP; 100 Ross St., 3rd Fl.; Pittsburgh, PA 15219; (412) 765-3500; FAX: (412) 765-0708.

[24+] **FORGE RECORDING STUDIOS INC.**; AR, ATD, JCP, RLR, MAST; PO Box 861; Valley Forge, PA 19481; (215) 935-1422; (800) 331-0405; FAX: (215) 993-9954.

[24+] **CHRIS GATELY AUDIO SERVICES**; AR, EIR, MP, RLR, SDS; PO Box 526; Bryn Mawr, PA 19010; (215) 525-3605.

[24+] **HOLLAND SOUND STUDIOS**; RLR; 1015 Electric St.; Scranton, PA 18509; (717) 346-8742; FAX: (717) 346-0459.

[24+] **IRIS SOUND STUDIO**; AR, AD, ATD, MIDI, MP, RLR; 237 Main St.; Royersford, PA 19468; (215) 948-3448; FAX: (215) 948-3141.

#### Mix Trivia

18. According to *Billboard*, these four motion picture soundtracks are among the Top 20 best-selling albums of all time.

Turn to page 152 for question

# Do You Know these terms?

**Monitor** — a reference loudspeaker system for the mixing and mastering of recorded music.

**Standard** — a reference from which qualitative judgements can be made.

**Tracks** — (noun) channels on a multi-track recorder (verb) accurately reproduces the audio qualities of another transducer.

**Monitor Standard™** — a close-field recording monitor system from RADIAN. *The only one which accurately tracks large recording monitors.*

## What does all this mean?

RADIAN's new MM-8 Systems are the only close-field monitors to utilize *full-sized compression drivers*.

RADIAN's new MM-8 Systems reproduce explosive transients with clarity and ease. *No more distortion or break-up from fragile domes and cone tweeters.*

RADIAN's new MM-8 Systems provide *coherent, point-source* sound for superior stereo imaging.

RADIAN's new MM-8 Systems eliminate the "sweet spot." Their ultra wide-angle (120°) dispersion delivers *the same tonal balance* to everyone seated at the console.

Call RADIAN to arrange for an audition in your recording studio. RADIAN Monitor Standard™ Systems are sold exclusively thru Authorized Dealers.

**RADIAN**  
AUDIO ENGINEERING, INC.

4520 E. Eisenhower Circle • Anaheim, CA 92807 • (714) 693-9277 • FAX (714) 693-9278



# Recording & Video Production Facilities

UNITED STATES

## PENNSYLVANIA

24+ Track Recording Studios



**KAJEM/VICTORY STUDIOS**  
Gladwyne, PA

>[24+] **KAJEM/VICTORY STUDIOS**; AR, APPV, APPF, ATD, MIDI, MP, EL, JCP, RS; 1400 Mill Creek Rd.; Gladwyne, PA 19035; (215) 642-2346; FAX: (215) 642-3572.

>[24+] **MODERN AUDIO PRODUCTIONS**; AR, APPV, ATD, JCP, MIDI, MP, MAST, VP; 1650 Market St., One Liberty Pl.; Philadelphia, PA 19103; (215) 569-1600; FAX: (215) 569-1685.

[24+] **NEON CITY STUDIOS**; MIDI, MP, RS; 627 Main St.; Simpson, PA; (717) 282-0863; FAX: (717) 282-0863.

[24+] **THE PRODUCTION BLOCK**; AR, AD, APPV, APPF, ATD, EIR, JCP, MIDI, MP, RLR, SR, SDS, MAST; 2833 North Front St.; Harrisburg, PA 17110; (717) 233-4155.

[24+] **PRODUCTION MASTERS, INC. (PMI)**; AR, APPV, ATD, JCP, MIDI, MP, RLR, SR, MAST, VP; 321 First Ave.; Pittsburgh, PA 15222; (412) 281-8500; FAX: (412) 391-7529.

[24+] **QUEEN VILLAGE RECORDING STUDIOS**; AR, AD, MIDI, MP, RS, MAST; 800 S. 4th St.; Philadelphia, PA 19147; (215) 463-2200; FAX: (215) 462-8502.

[24+] **RECORDED SOUND LTD.**; RLR; 922 W. North Ave.; Pittsburgh, PA 15233; (412) 322-7779.

>[24+] **RED ROCK RECORDING**; AR, JCP, MIDI, MP, RLR; RD #4, Box 4135; Saylorsburg, PA 18353; (717) 992-5777.

>[24+] **REMOTE RECORDING SERVICES, INC.**; RLR; PO Box 334; Lahaska, PA 18931; (215) 794-3005.

[24+] **SLOYER SOUND STUDIO, INC.**; AR, JCP, MIDI, MP, RS; 1400 Moravia St.; Bethlehem, PA 18015; (215) 691-5056.

[24+] **STUDIO 4 RECORDING, INC.**; AR, APPV, JCP, MIDI, MP; 444 N. 3rd St.; Philadelphia, PA 19123; (215) 923-4443; FAX: (215) 574-0930.

>[24+] **SUSQUEHANNA SOUND**; RLR; 48 A St.; Northumberland, PA 17857; (717) 473-9733.

### 12 & 16 Track Recording Studios

[16] **ANTHEM PRODUCTIONS**; AR, APPV, JCP, MP, VP; 901 Pine Valley Cir.; West Chester, PA 19382; (215) 431-2963.

[16] **AUDIO-IMAGES, INC.**; AR, APPV, EIR, SR, VP; 200 Jones Pl., Ste. 305; Monroeville, PA 15146; (412) 372-8850; FAX: (412) 372-2424.

[16] **CORPORATE STUDIOS**; AR, AD, JCP, MIDI, MP, VP; 500 Canal St.; Bristol, PA 19007; (215) 785-3669.

[16] **THE CREATIVE INTERFACE RECORDING STUDIOS**; AR, AD, APPV, ATD, EIR, MP, ED, SR; 646 E. Madison St.; Lancaster, PA 17602; (717) 393-9115.

[16] **CREATIVE SOUND STUDIOS**; AR, APPV, JCP; 601 N. Sixth St.; Allentown, PA 18102; (215) 439-8004; FAX: (215) 439-0103.

[16] **FAST TRAX RECORDING STUDIOS**; AR, APPV, JCP, MIDI, RLR, VP; 116 Chestnut Ln.; North Wales, PA 19454; (215) 643-6427.

>[16] **FILMSPACE, INC.**; AR, APPV, JCP, VP; 615 Clay Ln.; State College, PA 16801; (814) 237-6462; FAX: (814) 237-8588.

[16] **HEARTSONG**; AR, AD, MIDI, MP, ED, SR; 2529 Main St.; Pittsburgh, PA 15235-3644; (412) 795-3375.

[16] **HIGHLAND STUDIOS**; AR, APPV, ATD, MP; 225 Ross St.; Pittsburgh, PA 15219; (412) 456-6661; FAX: (412) 471-7319.

[16] **ICE ASSOCIATES, INC.**; AR, APPV, ATD, JCP, MIDI, MP, RLR, RS, SDS, VP; One Bala Plaza, Ste. LL-40; Bala Cynwyd, PA 19004; (215) 668-0714; FAX: (215) 668-0768.

[16] **KENNEDY MUSIC & RECORDING**; AR, ATD, MIDI, MP, RLR, SR; 5253 Montour St.; Philadelphia, PA 19124; (215) 533-2380.

[16] **THE MUSIC FACTORY ENTERPRISES, INC.**; AR, AD, APPV, ATD, EIR, JCP, MIDI, MP, ED, RLR, SR, MAST, VP; Ford & Washington Sts., Ste. 300; Norristown, PA 19401; (215) 277-9550.

[16] **ONE-SHOT PRODUCTIONS**; AR, MIDI; 2264 E. scenic Dr.; Bath, PA 18014; (215) 746-0151.

[4] **GOLDEN SOUND RECORDING**; AR, ATD, RLR; NEC Delaware Ave. and Tasker St.; Philadelphia, PA 19147-5509; (609) 871-0840; FAX: (215) 271-0880.

[8] **HARDMAN EASTMAN STUDIOS INC.**; AR, APPV, APPF, ATD, EIR, RLR, VP; 1400 E. Carson St.; Pittsburgh, PA 15203; (412) 481-4450; FAX: (412) 481-4450.

[8] **HONEY BEAR RECORDING STUDIO**; AR, JCP, MIDI, MP; 2510 Raspberry St.; Erie, PA 16502; (814) 459-BEAR (2327).

[4] **MASTERS BY JOHNSON**; AR, ATD; 832 Montgomery Ave.; Narberth, PA 19072; (215) 664-1188.

[8] **JON MILLER PRODUCTION STUDIOS**; AR, AD, APPV, APPF, ATD, RLR, SR, VP; 7249 Airport Rd.; Bath, PA 18014; (215) 837-7550.

[8] **MUTTLEY MUSIC MACHINE**; AR, ATD, RLR; RD #1, Box 129; Barto, PA 19504; (215) 845-3133.

[8] **NITE DEPOT RECORDING**; AR; 890 5th St.; Beaver, PA 15009; (412) 774-8444.

[8] **PHILADELPHIA MUSIC WORKS, INC.**; AR, APPV, APPF, JCP, MIDI, MP; P.O. Box 947; Bryn Mawr, PA 19010; (215) 825-5656; FAX: (215) 825-8310.

[4] **SHU'BABY MONTEZ MUSIC**; AR, AD, MIDI, MP; 1447 N. 55th St.; Philadelphia, PA 19131; (215) 473-5527.

[8] **TANGENT PRODUCTIONS**; APPV, APPF, JCP, MIDI, MP; 7020 Saybrook Ave.; Philadelphia, PA 19142; (215) 724-9671.

[8] **1020 RPM**; AR, AD, APPV, MIDI, MP, ED; 1020 N. Delaware Ave.; Philadelphia, PA 19125; (215) 427-1020.

[8] **THUNDER MILL**; AR, APPV, MIDI, RLR, RS, SR, SDS, VP; PO Box 127; Center Valley, PA 18034; (215) 965-HDTV.

[2] **WMRG STUDIOS INC.**; AR, EIR, RLR, SR, SDS; PO Box 73; Cheltenham, PA 19012-0073; (215) 635-4815.

### Video Production & Post-Production Facilities

**ACTION VIDEO PRODUCTIONS**; VP, VPPE, OLVP, APPV, VTD; 2466 Litzitz Pike; Lancaster, PA 17601; (717) 560-0605.

**AEROMEDICAL TRAINING INSTITUTE**; VPPE, OLVP, APPV, VTD; 125 James Way County Line Indust. Park; Southampton, PA 18966; (215) 355-9100; FAX: (215) 357-4000.

**ANTHEM PRODUCTIONS**; VP, VPPE, OLVP, APPV, VTD; 901 Pine Valley Cir.; West Chester, PA 19382; (215) 431-2963.

>**ASCENSION VIDEO**; VPPE, OLVP, APPV; 48 A St.; Northumberland, PA 17857; (717) 473-9733.

**AUDIO INNOVATORS, INC.**; APPV; 216 Boulevard of the Allies; Pittsburgh, PA 15222; (412) 471-6220; FAX: (412) 621-9887.

**AUDIO-IMAGES, INC.**; VP, VPPE, OLVP, APPV; 200 James Pl., Ste. 305; Monroeville, PA 15146; (412) 372-8850; FAX: (412) 372-2424.

**B.A.C. PRODUCTIONS**; VP, OLVP; 2034 Fitzwater St.; Philadelphia, PA 19146; (215) 546-5323.

**CINEMA ARTS, INC.**; VPPE; PO Box 70; South Sterling, PA 18460; (717) 676-4145; FAX: (717) 676-9194.

**CLARK PRODUCTION ASSOCIATES, INC.**; VP, VPPE, OLVP, APPV; 601 N. 6th St.; Allentown, PA 18102; (215) 434-6363.

**CSR PRODUCTIONS, INC.**; VP, VPPE, OLVP, VTD; 1 Oxford Valley, Ste. 309; Langhorne, PA 19047; (215) 750-6353.

**THE EDITORIUM**; VP, VPPE, OLVP, APPV; 100 Ross St., 3rd Fl.; Pittsburgh, PA 15219; (412) 765-3500; FAX: (412) 765-0708.

**MARTIN EZRA & ASSOCIATES**; VP, OLVP; 45 Fairview Ave.; Lansdowne, PA 19050; (215) 622-1600; FAX: (301) 275-8009.

**FILMSPACE, INC.**; VP, VPPE, OLVP, APPV; 615 Clay Ln.; State College, PA 16801; (814) 237-6462; FAX: (814) 237-8588.

**GARRETT FILMS INTERNATIONAL**; OLVP, APPV; Box 353 Rt. 3; Berwyn, PA 19506; (215) 488-7552; FAX: (215) 488-9232.



**60 SECOND STREET PRODUCTIONS**  
York, PA

[16] **60 SECOND STREET PRODUCTIONS**; AR, JCP, MIDI, MP; PO Box 3098; York, PA 17402; (717) 757-4989; FAX: (717) 757-5436.

[16] **STRATA STUDIOS**; 1215 MacDade Blvd.; Folsom, PA 19033; (215) 237-8134.

[16] **TRS AUDIO SERVICES**; AR, APPV, ATD, EIR, JCP, MIDI, MP, RLR, RS, SR; 2617 Peach St., Ste. 203; Erie, PA 16508; (814) 453-3032.

[16] **TURTLE BEACH RECORDINGS**; AR, JCP, MIDI; 1912 Alcott Rd.; York, PA 17402; (717) 757-2348; FAX: (717) 755-9402.

[16] **W3 SOUND PRODUCTIONS**; AR, AD, APPV, ATD, JCP, MIDI, MP, RLR; 2309 Babcock Blvd.; Pittsburgh, PA 15237; (412) 821-8273.

### 4 & 8 Track Recording Studios

>[4] **ACCELERATION**; RLR; 5914 Overbrook Ave.; Philadelphia, PA 19131; (215) 473-3757.

[8] **AEROMEDICAL TRAINING INSTITUTE**; AR, APPV, RLR, VP; 125 James Way County Line Indust. Park; Southampton, PA 18966; (215) 355-9100; FAX: (215) 357-4000.

[8] **BREAKFAST COMMUNICATIONS CORPORATION**; AR, JCP, MIDI, MP, RLR; P.O. Box 176; Paoli, PA 19301; (215) 688-4215.

>[8] **CHERRY PRODUCTIONS RECORDING STUDIO**; AR, JCP; RD 2, Box 640; Honesdale, PA 18431; (717) 383-2621.

[8] **CYRUS SOUND**; RLR; 3545 South Park Rd.; Bethel Park, PA 15102; (412) 854-2076.

[4] **GARRETT FILMS INTERNATIONAL**; AR, APPV, APPF, ATD, RLR; Box 353 Rt. 3; Berwyn, PA 19506; (215) 488-7552; FAX: (215) 488-9232.

[8] **GENDORA PRODUCTIONS**; AR, APPV, APPF, JCP, MIDI, MP; 6716 Revere St.; Philadelphia, PA 19149; (215) 332-9074.

**GODDMAN ASSOCIATES, INC.;** *OLVP*; 718 S. 22nd St.; Philadelphia, PA 19146; (215) 546-1448.

**HARDMAN EASTMAN STUDIOS INC.;** *VPF, VPPE, OLVP, APPV*; 1400 E. Carson St.; Pittsburgh, PA 15203; (412) 481-4450; FAX: (412) 481-4450.

**JON MILLER PRODUCTION STUDIOS;** *VPF, VPPE, OLVP, APPV, VTD*; 7249 Airport Rd.; Bath, PA 18014; (215) 837-7550.

**MODERN VIDEO PRODUCTIONS, INC.;** *VPPE, APPV, VTD*; 1 Liberty Pl., 1650 Market St.; Philadelphia, PA 19103; (215) 569-4100; FAX: (215) 569-1885.

**THE MUSIC FACTORY ENTERPRISES, INC.;** *VPF, VPPE, OLVP, APPV, VTD*; Ford & Washington Sts., Ste. 300; Norristown, PA 19401; (215) 277-9550.

**PRODUCTION MASTERS, INC. (PMI);** *VPF, VPPE, OLVP, APPV, VTD*; 321 First Ave.; Pittsburgh, PA 15222; (412) 281-8500; FAX: (412) 391-7529.

**RON SMILEY VISUAL PRODUCTIONS;** *VPF, VPPE, OLVP, APPV*; 58 N. 2nd St.; Philadelphia, PA 19106; (215) 829-9000; FAX: (215) 440-0950.

**E.J. STEWART, INC.;** *VPF, VPPE, OLVP, VTD*; 525 Mildred Ave.; Primos, PA 19018; (215) 626-6500; FAX: (215) 626-2638.

**TANGENT PRODUCTIONS;** *APPV*; 7020 Saybrook Ave.; Philadelphia, PA 19142; (215) 724-9671.

**THUNDER MILL;** *VPF, VPPE, OLVP, APPV, VTD*; PO Box 127; Center Valley, PA 18034; (215) 965-HDTV.

**TULLYVISION STUDIOS;** *VPF, VPPE, OLVP, APPV, VTD*; 465 Main St.; Tullytown, PA 19007; (215) 946-7444.

**VISUAL IMPACT (EAST);** *OLVP*; PO Box 42505; Philadelphia, PA 19101; (215) 923-9533.

**WIX PIX PRODUCTIONS, INC.;** *VPF, VPPE, OLVP, APPV, VTD*; RD #1 Box 266; Mineral Point, PA 15942; (814) 322-1505; FAX: (814) 322-4194.

#### PUERTO RICO

##### 24+ Track Recording Studios

[24+] **E.M.S. RECORDING STUDIO;** *AR, APPV, JCP*; Rio Maravilla AP13 Rio Hondo; Bayamon, PR 00619; (809) 784-5624; FAX: (809) 795-3623.

[24+] **E1212 RECORDING STUDIO;** *AR, APPV, JCP, MIDI, MP*; 769 Andalucia Ave.; Puerto Nuevo, PR 00921; (809) 782-2745; FAX: (809) 781-8194.

[24+] **MELODY RECORDING STUDIO;** *RLR*; De Diego #2, San Francisco; Rio Piedras, PR 00927; (809) 763-3555.

##### 12 & 16 Track Recording Studios

[16] **J.M. RECORDS & SOUND SYSTEMS;** *AR, SR*; 24 St. AU-6 Santa Juanita; Bayamon, PR 00619; (809) 740-7796.

#### RHODE ISLAND

##### 24+ Track Recording Studios

[24+] **CELEBRATION SOUNDS;** *AR, ATD, JCP, MIDI, MP, ED*; 26 Summer St.; Pawtucket, RI 02860; (401) 728-0780.

##### 12 & 16 Track Recording Studios

[16] **LAKEWEST RECORDING STUDIO;** *AR, AD, RLR*; 200 Mishnock Rd.; West Greenwich, RI 02816; (401) 397-4828.

[16] **WINGS AS EAGLES;** *RLR*; 151 Keeley Ave.; Warwick, RI 02886; (401) 738-6914.

##### 4 & 8 Track Recording Studios

[8] **COUNTS & COUNTS;** *AR, APPV, EIR, RLR, SR, MAST, VP*; 181 Warrington St.; Providence, RI 02907; (401) 781-8478.

[2] **THOMAS PAYNE PRODUCTIONS;** *RLR, VP*; 77 Ives St., Ste. 58; Providence, RI 02906; (401) 942-5443.

#### Video Production & Post-Production Facilities

**COUNTS & COUNTS;** *VPPE, OLVP, APPV*; 181 Warrington St.; Providence, RI 02907; (401) 781-8478.

**THOMAS PAYNE PRODUCTIONS;** *OLVP*; 77 Ives St., Ste. 58; Providence, RI 02906; (401) 942-5443.

#### SOUTH CAROLINA

##### 24+ Track Recording Studios

[24+] **EBS, INC.;** 1125 Moore Duncan Hwy., PO Box 66; Moore, SC 29369; (803) 574-6104.

[24+] **MARK FIVE—SANDCASTLE;** *RLR*; 10 Michael Dr., PO Box 7620; Greenville, SC 29610; (803) 269-1111.

[24+] **DN LINE AUDIO;** *AR, AD, APPV, JCP, MIDI, MP*; 701 E. Bay St. #436; Charleston, SC 29403; (803) 724-3506.

[24+] **STRAWBERRY SKYS RECORDING STUDIO;** *AR, APPV, APPF, JCP, MIDI, MP*; 1706 Platt Springs Rd.; West Columbia, SC 29169; (803) 794-9300.

##### 12 & 16 Track Recording Studios

[16] **CHERRY GROVE STUDIO;** *AR, AD, JCP, MIDI, MP, ED, RLR, SR*; 404 7th Ave. N.; Myrtle Beach, SC 29577; (803) 448-6730.

[16] **CUSTOM RECORDING AND SOUND, INC.;** *AR, APPV, ATD, EIR, RLR, SR, SDS, MAST, VP*; 1200 Woodruff Rd., Ste. C-18; PO Box 27109; Greenville, SC 29616; (803) 288-0000; FAX: (803) 234-6519.

[16] **INDEPENDENT PRODUCTION SERVICES;** *AR, APPV, ATD, EIR, JCP, MIDI, MP, RLR, SR, SDS, VP*; 2222 River Rd.; John's Island, SC 29455; (803) 559-1177.

[16] **SILVER STAR RECORDING STUDIO;** *AR, AD, JCP*; PO Box 428; McBee, SC 29101; (803) 335-7703.

[16] **STRAND RECORDS;** *AR, AD, JCP, MIDI, MP, ED, SR*; 404 7th Ave. N.; Myrtle Beach, SC; (803) 448-6730.

[16] **STUDIO 105;** *AR, MIDI, MAST*; 105 Devon Dr.; Mauldin, SC 29662; (803) 288-5908.

##### 4 & 8 Track Recording Studios

[8] **TRACK ONE STUDIOS;** *AR, AD, JCP, MIDI, MP, SR*; PO Box 355; Williston, SC 29853; (803) 266-3410.

[8] **WODTTEN CUSTOM AUDIO PRODUCTIONS;** *AR, APPV, ATD, EIR, JCP, MIDI, MP, RLR, SR*; 1711 Chadsworth Dr.; Cayce, SC 29033; (803) 791-7823.

#### Video Production & Post-Production Facilities

**TRI-COMM PRODUCTIONS, INC.;** *VPF, VPPE, OLVP, APPV*; PO Box 21120; Hilton Head Island, SC 29925; (803) 681-5000; FAX: (803) 681-2945.

#### SOUTH DAKOTA

##### 24+ Track Recording Studios

[24+] **CREATIVE COMMUNICATIONS COMPANIES;** 3700 S. Hawthorne; Sioux Falls, SD 57105; (605) 334-6832.

##### 4 & 8 Track Recording Studios

[8] **FIDDLE STRING PRODUCTIONS;** *AR, JCP, RLR*; HCR 89, Box 46; Hermosa, SD 57744; (605) 255-4235.

#### TENNESSEE

##### 24+ Track Recording Studios

[24+] **ARCHER PRODUCTIONS INC.;** *AR, JCP*; 50 Vantage Way, Ste. 101; Nashville, TN 37228; (615) 254-1149; FAX: (615) 256-6841.

19. According to *Billboard*, this artist has the most platinum albums with 19, is tied for most multi-platinum with 7, and is second to Elvis for most gold albums with 31.

Turn to page 152 for question



ARDENT RECORDINGS, INC.  
Memphis, TN

[24+] **ARDENT RECORDINGS, INC.;** *AR, AD, APPV, JCP, MIDI, MP*; 2000 Madison Ave.; Memphis, TN 38104; (901) 725-0855; FAX: (901) 725-7011.

[24+] **THE BENNETT HOUSE STUDIOS, INC.;** *AR, APPV, RS*; 134 4th Ave. N.; Franklin, TN 37064; (615) 790-8696.

[24+] **BIG MAMA RECORDING STUDIO;** *AR, AD, APPV, APPF, ATD, JCP, MIDI*; 400 Enslay Dr. #14; Knoxville, TN 37920; (615) 577-5597; FAX: (615) 573-1811.

[24+] **MIKE BILLS PRODUCTIONS;** *AR, AD, JCP, MP*; Rte. #1 Box 310; Heiskell, TN 37754; (615) 457-4990.

[24+] **BRADLEY'S BARN INC.;** *AR*; PO Box 120838; Nashville, TN 37212; (615) 244-1060.

[24+] **GENE BREEDEN STUDIOS;** *AR, AD, MP*; 802 18th Ave. S.; Nashville, TN 37203; (615) 242-1421.

[24+] **CAROUSEL PRODUCTIONS;** *AD, APPV, JCP, MIDI, MP, VP*; 114 17th Ave. S.; Nashville, TN 37203; (615) 244-5656.

[24+] **THE CASTLE RECORDING STUDIO;** 1393 Old Hillsboro Rd.; Franklin, TN 37064; (615) 791-0810.

[24+] **CHURCH STREET STUDIO;** *AR, AD, JCP, MP*; 903 Church St.; Nashville, TN 37203; (615) 248-3214; FAX: (615) 244-2928.

[24+] **CLIFTY STUDIOS;** PO Box 15; Paris, TN 38242; (901) 644-7111.

[24+] **COMMERCIAL MUSIC RECORDING COMPLEX;** *AR, ED*; CFA-232 Memphis State University; Memphis, TN 38152; (901) 678-2559.

[24+] **CREATIVE RECORDING INC.;** *AR*; 2806 Azalea Pl.; Nashville, TN 37204; (615) 385-0670.

DIGITAL MIXING  
DIGITAL REMOTES  
DIGITAL EDITING  
DIGITAL RENTALS  
DIGITAL ARCHIVING  
DIGITAL TRANSFERS  
DIGITAL SEQUENCING  
DIGITAL TIME COMPRESSION  
DIGITAL FORMAT CONVERSIONS  
DIGITAL DYAXIS WORKSTATION

Digital Associates

(615) 297-3900  
NASHVILLE

DIGITAL ASSOCIATES  
Nashville, TN

[24+] **DIGITAL ASSOCIATES;** *AR, APPV, ATD, EIR, MP, RLR, MAST*; PO Box 158913; Nashville, TN 37215; (800) 828-0568.

[24+] **DIGITAL RECORDERS;** *AR, ATD, EIR, JCP*; 49 Music Square W., Ste. 101; Nashville, TN 37203; (615) 327-1200; FAX: (615) 327-1272.



# Recording & Video Production Facilities

UNITED STATES

## TENNESSEE

### 24+ Track Recording Studios

[24+] **DOWNSTAGE STUDIO**; AR, APPV, JCP, MIDI, MP; 23 Music Square E.; Nashville, TN 37203; (615) 254-0884; FAX: (615) 254-7030.

[24+] **EASLEY RECORDING**; AR; 3744 Marion; Memphis, TN 38111; (901) 323-5407.

[24+] **ELEVEN-ELEVEN SOUND**; 1111 17th Ave. S.; Nashville, TN 37212; (615) 329-1111.

[24+] **EMERALD SOUND STUDIOS**; AR, JCP; 1033 16th Ave. S.; Nashville, TN 37212; (615) 321-0511; FAX: (615) 329-9417.

[24+] **ENGLISH VALLEY MUSIC**; AR, JCP, MIDI, MP; 383 Forest Retreat; Hendersonville, TN 37075; (615) 822-6341.

[24+] **FANTA MOBILE PROFESSIONAL SERVICES**; RLR; 1213 16th Ave. S.; Nashville, TN 37212; (615) 327-1731.

[24+] **FOX FARM RECORDING**; AR; 2731 Saundersville Ferry Rd.; Mt. Juliet, TN 37122; (615) 754-2444.

[24+] **GERMANTOWN RECORDING STUDIO**; 1209 4th Ave. N.; Nashville, TN 37208; (615) 244-8019.

[24+] **GHL AUDIO ENGINEERING**; AR, RLR, SDS; 2807 Azalea Pl.; Nashville, TN 37204; (615) 269-5183; FAX: (615) 385-0204.

[24+] **GREAT CIRCLE SOUND**; AR; 365 Great Circle Rd.; Nashville, TN 37228; (615) 742-6803.

[24+] **GROUNDSTAR LABORATORY**; AR, MIDI; 12 Music Circle South; Nashville, TN 37203; (615) 256-7575; FAX: (615) 255-5448.

[24+] **HARMONY HOUSE RECORDING STUDIOS**; AR, AD, APPV, APFF, ATD, JCP, MIDI, MP, RLR, SR, MAST, VP; 1441 Guthrie Dr.; Cleveland, TN 37311; (615) 476-6636.

[24+] **HUMMINGBIRD RECORDING**; AR, ATD, JCP, MP; 50 Music Sq. W., Ste. 500; Nashville, TN 37203; (615) 321-4789; FAX: (615) 329-3601.

[24+] **HUMMINGBIRD STUDIO**; AR, JCP; 7 Music Square W.; Nashville, TN 37203; (615) 321-5572; FAX: (615) 255-6831.

[24+] **ILIAD & ODYSSEY**; AR, MP; 144 2nd Ave. N.; Nashville, TN 37201; (615) 244-9305; FAX: (615) 244-9366.

[24+] **JAVELINA RECORDING STUDIOS**; AR, EIR; 808 19th Ave. S.; Nashville, TN 37203; (615) 320-5985.



**KIVA RECORDING STUDIO**  
Memphis, TN

[24+] **KIVA RECORDING STUDIO**; AR, AD, APPV, APFF, ATD, EIR, JCP, MIDI, RS; 904 Rayner St.; Memphis, TN 38114; (901) 278-1888; FAX: (901) 725-1983.

[24+] **MAGIC TRACKS**; AR, JCP, MIDI; 2712 Larmon Dr.; Nashville, TN 37204; (615) 292-5950.

[24+] **MARTIN RECORDING CO., INC.**; AR, AD, APPV, APFF, EIR, JCP, MIDI, RLR, VP; 11 Music Circle S.; Nashville, TN 37203; (615) 244-3700; FAX: (615) 244-6729.

[24+] **MASTERFONICS**; 28 Music Square E.; Nashville, TN 37203; (615) 327-4533.

[24+] **MASTERLINK STUDIO**; AR, MIDI; 114 17th Ave. S.; Nashville, TN 37203; (615) 244-5656.

[24+] **MASTERMIX**; 1808 Division St.; Nashville, TN 37203; (615) 321-5970.

[24+] **MEMPHIS SOUND PRODUCTIONS**; AR, AD, APPV, APFF, JCP, MIDI, MP; 315 Beale St.; Memphis, TN 38103; (901) 525-5500; FAX: (901) 525-5590.

[24+] **MIKRON RECORDING**; AR; 201 Cedar Ave.; South Pittsburg, TN 37380; (615) 837-7151.

[24+] **MR. MORT ENTERPRISES, INC.**; AR, AD, APPV, APFF, JCP, MP, VP; 44 Music Sq. E.; Nashville, TN 37203; (615) 255-2175.

[24+] **THE MONEY PIT**; AR; 622 Hamilton Ave.; Nashville, TN 37203; (615) 256-0311.

[24+] **MUSIC CITY MUSIC HALL**; AR; 30 Music Square W.; Nashville, TN 37203; (615) 244-1060.

[24+] **MUSIC MILL RECORDING STUDIO**; AR, AD; 1710 Roy Acuff Pl.; Nashville, TN 37203; (615) 254-5925.

[24+] **NASHVILLE CARTAGE & SOUND**; EIR, MP, RLR, SR, VP; PO Box 121742; Nashville, TN 37212; (615) 386-3700.

[24+] **NASHVILLE TELEPRODUCTIONS/OAK VALLEY SOUND STUDIO**; RLR; 105 Oak Valley Dr.; Nashville, TN 37207; (615) 262-2600; FAX: (615) 226-4070.

[24+] **NEW MEMPHIS MUSIC/COTTON ROW RECORDING**; AR, AD, JCP, MIDI; 1503 Madison Ave.; Memphis, TN 38104; (901) 276-8518; (901) 276-8520.

[24+] **OAK VALLEY SOUND/A DIVISION OF NASHVILLE TELEPRODUCTIONS, INC.**; AR, AD, APPV, JCP, MP, RLR, VP; 105 Oak Valley Dr.; Nashville, TN 37207; (615) 262-2600; FAX: (615) 226-4070.

[24+] **OMNISOUND RECORDING STUDIO**; AR; 1806 Division St.; Nashville, TN 37203; (615) 321-5526.

[24+] **ON THE SPOT MUSIC PRODUCTIONS, INC.**; AR, APPV, JCP, MIDI, MP; 1443 12th Ave. S.; Nashville, TN 37203; (615) 385-2957; FAX: (615) 386-3638.

[24+] **ONYX SOUND RECORDING STUDIO**; AR, AD, ATD, JCP, MP, RLR, VP; 1646 Bonnie Dr.; Memphis, TN; (901) 346-1483.

[24+] **JIM OWENS COMPANIES**; 815 18th Ave. S.; Nashville, TN 37203; (615) 329-9500.

[24+] **THE POND**; AR; 1203 Holly Hill Dr.; Franklin, TN 37064; (615) 790-9516.

[24+] **THE POWER HOUSE**; AR, AD, APPV, EIR, JCP, MIDI, MP; 431 N. Cleveland; Memphis, TN 38108; (901) 274-2696.

[24+] **PYRAMID RECORDING**; AR, AD, MP; 1208 Lula Lake Rd.; Chattanooga (Lookout Mtn.), TN 37350; (404) 820-2356; FAX: (404) 820-0539.

[24+] **RECORDING ARTS**; AR, APPV, APFF, JCP, SDS; Box 121702; Nashville, TN 37212; (615) 321-5479.

[24+] **THE REFLECTIONS RECORDING STUDIO**; AR; 2741 Larmon Dr.; Nashville, TN 37211; (615) 269-0828.

[24+] **R.I.M. SOUND STUDIOS**; AR, MIDI, ED; Middle Tenn. State Univ. Box 55; Murfreesboro, TN 37132; (615) 898-2578; FAX: (615) 898-5538.

[24+] **SCENE THREE INC.**; AR, APPV, APFF, JCP, MIDI, MP, RLR, VP; 1813 8th Ave. S.; Nashville, TN 37203; (615) 385-2820; FAX: (615) 383-1026.

[24+] **SCRUGGS SOUND STUDIO, INC.**; AR; 2828 Azalea Pl.; Nashville, TN 37204; (615) 383-7994.

[24+] **SIXTEENTH AVENUE SOUND**; 1217 16th Ave. S.; Nashville, TN 37212; (615) 327-8787.

[24+] **SOUND EMPORIUM STUDIOS**; AR, AD, ATD, JCP, MP; 3102 Belmont Blvd.; Nashville, TN 37212; (615) 383-1982.

[24+] **SOUND STAGE STUDIO**; AR; 10 Music Circle S.; Nashville, TN 37203; (615) 256-2676; FAX: (615) 254-7030.

[24+] **SOUNDING BOARD**; AR, MP; PO Box 1072; Hendersonville, TN 37077; (615) 822-7865.

[24+] **SOUNDS UNREEL STUDIOS**; AR, AD, EIR, MP; 1902 Nelson Ave.; Memphis, TN 38114; (901) 278-8346; FAX: (901) 278-8346.

[24+] **SOUNDSHOP RECORDING STUDIOS**; AR; 1307 Division St.; Nashville, TN 37203; (615) 244-4149.

[24+] **STARGEM RECORDS**; AR, JCP, MP, VP; 43 Music Square E.; Nashville, TN 37203; (615) 244-1025; FAX: (615) 255-0419.

[24+] **STUDIO 805**; AR; 805 18th Ave. S.; Nashville, TN 37203; (615) 329-9204.

[24+] **STUDIO 19**; AR, AD; 821 19th Ave. S.; Nashville, TN 37203; (615) 327-4927.

[24+] **SUITE 2000**; AR, AD, MP; PO Box 21272; Nashville, TN 37221; (615) 646-4900.

[24+] **SUN STUDIO**; AR, AD, JCP; 706 Union Ave.; Memphis, TN 38103; (901) 521-0664; FAX: (901) 525-8055.

[24+] **SYNCR0 SOUND RECORDING STUDIO**; AR, APPV, APFF, JCP, MP; 1030 16th Ave. S.; Nashville, TN 37212; (615) 242-2455; FAX: (615) 242-8439.

[24+] **TREASURE ISLE RECORDERS**; 2808 Azalea Pl.; Nashville, TN 37204; (615) 297-0700; FAX: (615) 297-1413.

[24+] **WEST & COMPANY, INC.**; AD, ATD, MP; 1808 West End Ave. #700, PO Box 24281; Nashville, TN 37203; (615) 327-3609; FAX: (615) 329-3801.

[24+] **WESTPARK SOUND**; 3212 West End Ave., Ste. 201; Nashville, TN 37203; (615) 292-5838.

### 12 & 16 Track Recording Studios

[16] **ASI STUDIOS**; AR, SR; 416 S. Union; Bolivar, TN 38008; (901) 658-5700.

[16] **AURAL CANVAS (A DIVISION OF FY PRODUCTIONS)**; AR, AD, JCP, MIDI, MP, RLR; 1407 Allen Ave.; Murfreesboro, TN 37129; (615) 890-1521.

[16] **BEAIRD MUSIC GROUP, INC.**; AR, MP; 107 Music City Cir., Ste. 314; Nashville, TN 37214; (615) 889-0138.

[16] **BEAVERWOOD AUDIO-VIDEO**; AR, AD, APPV, ATD, EIR, JCP, MP, ED, RLR, VP; 133 Walton Ferry; Hendersonville, TN 37075; (615) 824-2820.

[16] **DIVERSIFIED PRODUCTIONS**; AR, AD, APPV, JCP, MIDI, MP, SR, SDS, VP; 6835 Raccoon Valley Rd.; Knoxville, TN 37938; (615) 922-7442.

[16] **ENGLEWOOD STUDIO**; AR, AD, EIR, MIDI, MP, SR; 50 Music Square W., Ste. 410; Nashville, TN 37203; (615) 321-3876.



**MARK HAFFNER MUSIC, INC.**  
MARK HAFFNER MUSIC INC.  
Nashville, TN

[16] **MARK HAFFNER MUSIC INC.**; AD, APPV, APFF, JCP, MIDI, MP; 1701 Church St.; Nashville, TN 37212; (615) 327-3224.

[16] **HEADS OR TAIL MUSIC**; AR, AD, MP; 527 Skyview Dr.; Nashville, TN 37206; (615) 227-8543.

[16] **LAKESIDE RECORDING**; AR, MP; PO Box 24482; Nashville, TN 37202; (615) 329-1119.

[16] **MILEEDGE RECORDING STUDIO**; AR, JCP, MIDI, MP; 5281 Lochinvar; Memphis, TN 38116; (901) 346-8818.

[16] **MUSIC RESOURCES**; AR, APPV, APPF, JCP, MIDI, MP, ED; 50 Vantage Way, Ste. 101; Nashville, TN 37228; (615) 726-3700; FAX: (615) 256-6841.

[16] **GARY MUSICK PRODUCTIONS, INC. (FORMERLY BOOK-ENDS, INC.)**; AR, AD, APPV, EIR, JCP, MIDI, MP, SR, VP; 700 Craighhead St., Ste. 200; Nashville, TN 37204; (615) 297-5314; FAX: (615) 383-0855.

[16] **MUSI-COM PRODUCTIONS**; AR, JCP; 1084 Duncan Ave.; Chattanooga, TN 37404; (615) 622-7509; FAX: (615) 624-7019.

[16] **NELSON ENTERPRISES INC./MADHOUSE RECORDING STUDIO**; AR, AD, MIDI, MP; 50 Music Square W., Ste. 605; Nashville, TN 37203; (615) 320-5255.

[16] **SOUND TRAXX**; AR, MIDI; 3391 S. Perkins; Memphis, TN 38118; (901) 794-6277.

► [16] **SPEC-TRAC-U-LAR**; RLR; 2601 Sunset Pl.; Nashville, TN 37212; (615) 297-4670.

[16] **TOP TRACKS RECORDING STUDIO**; AR, AD, APPV, APPF, ATD, JCP, MIDI, MP; 1019 17th Ave. S.; Nashville, TN 37212; (615) 321-4876.

[16] **T.P. PRODUCTIONS**; AR, AD, APPV, APPF, ATD, JCP, MIDI, MP; 1019 17th Ave. S.; Nashville, TN 37212; (615) 321-4875.

[16] **VIDEO IDEAS PRODUCTIONS, INC.**; AR, APPV, APPF, JCP, MP, RLR, VP; 4762 Hwy. 58, Ste. G; Chattanooga, TN 37416; (615) 894-2677; FAX: (615) 899-1902.

#### 4 & 8 Track Recording Studios

[8] **BRANTLEY SOUND ASSOCIATES, INC.**; AR, APPV, ATD, EIR, RLR, SR; 204 Third Ave. S.; Nashville, TN 37201; (615) 256-6260; FAX: (615) 255-9369.

[8] **CONTINENTAL FILM PRODUCTIONS CORP.**; AR, APPV, APPF, ATD, JCP, RLR, VP; 4220 Amnicola Hwy., PO Box 5126; Chattanooga, TN 37406; (615) 622-1193; FAX: (615) 629-0853.

[2] **GEORGETOWN MASTERS, INC.**; MAST; 33 Music Square W., Ste. 108B; Nashville, TN 37203; (615) 254-3233; FAX: (615) 254-3237.

[2] **GLOBE DUPLICATION**; AR, ATD, RLR, MAST; 321 Hwy. 31-W North; White House, TN 37188; (615) 242-5502.

[8] **HORIZON RECORDING STUDIO**; AR; 2607 Eastland Ave.; Nashville, TN 37206; (615) 226-2227.

[8] **KANSAS VOCATIONAL TECHNICAL CENTER STUDIO**; AR, ED; 80 W. Olive St.; Memphis, TN 38106; (901) 775-7300.



MAGNETIC TECHNOLOGY  
Nashville, TN

[2] **MAGNETIC TECHNOLOGY**; ATD; 816 18th Ave. S.; Nashville, TN 37203; (615) 254-7001.

[8] **MOUNTAIN EAR PRODUCTIONS**; AR, AD, APPV, APPF, JCP, MP, RLR, SR; PO Box 77; Mountain City, TN 37683; (615) 727-5070; FAX: (615) 727-5247.

[8] **RIVER CITY SOUND PRODUCTIONS**; AR, JCP, MIDI; PO Box 750786; Memphis, TN 38175; (901) 794-7277.

[2] **RSVP—RUSS STURGEON VIDEO PRODUCTION**; VP; 916 3rd Ave. S.; Nashville, TN 37210; (615) 255-7787; FAX: (615) 254-7788.

[8] **THE SONGWRITER'S STUDIO**; AR, JCP, MIDI, MP; PO Box 210902; Nashville, TN 37221; (615) 952-2138.

[8] **SPOTLAND PRODUCTIONS, INC.**; AR, ATD; 1443 12th Ave. S.; Nashville, TN 37203; (615) 385-2957; FAX: (615) 386-3638.

[8] **TEMPLE PRODUCTIONS**; AR, JCP, MP; 2214 Metro Center Blvd., Ste. 128; Nashville, TN 37228; (615) 242-7457; FAX: (615) 254-3102.

[4] **TRAXTAR PRODUCTIONS**; AR, AD, EIR, MP; 5183 Darlington Dr.; Memphis, TN 38118; (901) 363-3345.

► [8] **UNDERGROUND RECORDING**; 808 Houston Dr.; Seymour, TN 37865; (615) 573-5269.

[8] **WILKERSON SOUND STUDIOS**; AR, ATD; 3794 Park Ave.; Memphis, TN 38111; (901) 458-1624; FAX: (901) 327-9307.

#### Video Production & Post-Production Facilities

► **ARDENT TELEPRODUCTIONS, INC.**; VPF, VPPE, OLVP, APPV; 2000 Madison Ave.; Memphis, TN 38104; (901) 725-0855; FAX: (901) 725-7011.

**BATES VIDEO PRODUCTIONS**; VPPE, OLVP, APPV, VTD; 4504 Dowdy Dr.; Antioch, TN 37013; (615) 333-SHOW.

**BEAVERWOOD AUDIO-VIDEO**; VPF, VPPE, OLVP, APPV, VTD; 133 Walton Ferry; Hendersonville, TN 37075; (615) 824-2820.

**BIG MAMA RECORDING STUDIO**; VPF, VPPE, OLVP, APPV; 400 Ensley Dr. #14; Knoxville, TN 37920; (615) 577-5597; FAX: (615) 573-1811.

**CONTINENTAL FILM PRODUCTIONS CORP.**; VPF, VPPE, OLVP, APPV, VTD; 4220 Amnicola Hwy., PO Box 5126; Chattanooga, TN 37406; (615) 622-1193; FAX: (615) 629-0853.

**DOWNSTAGE STUDIO**; APPV; 23 Music Square E.; Nashville, TN 37203; (615) 254-0884; FAX: (615) 254-7030.

**HARMONY HOUSE RECORDING STUDIOS**; VPF, VPPE, OLVP, APPV, VTD; 1441 Guthrie Dr.; Cleveland, TN 37311; (615) 476-6636.

**KCAM-TV TELEVISION PRODUCTIONS**; VPF, VPPE, OLVP, APPV; 827 Meridian St.; Nashville, TN 37207; (615) 226-1122; FAX: (615) 227-1268.

**MARTIN RECORDING CO., INC.**; VPF, VPPE, OLVP, APPV, VTD; 11 Music Circle S.; Nashville, TN 37203; (615) 244-3700; FAX: (615) 244-6729.

**NASHVILLE CARTAGE & SOUND**; OLVP; PO Box 121742; Nashville, TN 37212; (615) 386-3700.

**NASHVILLE TELEPRODUCTIONS**; VPPE, OLVP, APPV; 105 Oak Valley Dr.; Nashville, TN 37207; (615) 262-2600; FAX: (615) 226-4070.

**NEAL & REED COMMUNICATIONS, INC.**; VPF, OLVP, APPV; 6949 Charlotte Pike, Ste. 208; Nashville, TN 37209; (615) 353-1946; FAX: (615) 353-1985.

**ONYX SOUND RECORDING STUDIO**; VPF; 1646 Bonnie Dr.; Memphis, TN; (901) 346-1483.

**RSVP—RUSS STURGEON VIDEO PRODUCTION**; VPF, VPPE, OLVP, APPV, VTD; 916 3rd Ave. S.; Nashville, TN 37210; (615) 255-7787; FAX: (615) 254-7788.

**SCENE THREE INC.**; VPF, VPPE, OLVP, APPV, VTD; 1813 8th Ave. S.; Nashville, TN 37203; (615) 385-2820; FAX: (615) 383-1026.

**SIFFORD VIDEO SERVICES, INC.**; VTD; PO Box 101510; Nashville, TN 37224; (800) 251-1009; FAX: (615) 244-5712.

**SOUNDSHOP RECORDING STUDIOS**; APPV; 1307 Division St.; Nashville, TN 37203; (615) 244-4149.

**STARGEM RECORDS**; OLVP, APPV, VTD; 43 Music Square E.; Nashville, TN 37203; (615) 244-1025; FAX: (615) 255-0419.

**RUSS STURGEON VIDEO PRODUCTIONS**; VPF, VPPE, OLVP, APPV, VTD; 916 3rd Ave. S.; Nashville, TN 37210; (615) 255-7787; FAX: (615) 254-7788.

**TEMPLE PRODUCTIONS**; VPF, VPPE, OLVP; 2214 Metro Center Blvd., Ste. 128; Nashville, TN 37228; (615) 242-7457; FAX: (615) 254-3102.

**VIDEO IDEAS PRODUCTIONS, INC.**; VPF, VPPE, OLVP, APPV, VTD; 4762 Hwy. 58, Ste. G; Chattanooga, TN 37416; (615) 894-2677; FAX: (615) 899-1902.

#### 24+ Track Recording Studios

[24+] **ACCESSIBLE SOUND RECORDING STUDIO**; AR, APPV, JCP, MP; 8964 Kirby Dr.; Houston, TX 77054; (713) 723-2777.

[24+] **APRIL RECORDING STUDIOS/CRYSTAL RAM PUBLISHING B.M.I.**; RLR; 827 Brazil Pl.; El Paso, TX 79903; (915) 772-7858.

[24+] **ARLYN STUDIOS**; AR, ATD, EIR, RLR; 200 Academy, Ste. A; Austin, TX 78704; (512) 447-2337; FAX: (512) 441-5525.

[24+] **AUDIO DALLAS RECORDING STUDIO**; AR, JCP, MIDI; 102 Lakeside Dr.; Rockwall, TX 75087; (214) 771-4166.

[24+] **AUSTIN RECORDING STUDIO**; 4606 Clawson Rd.; Austin, TX 78745; (512) 444-5489.

[24+] **BECKS RECORDING STUDIO**; AR, APPV, APPF, JCP, MIDI, MP, RLR; 4817 Karchmer; Corpus Christi, TX 78415; (512) 854-7376.

[24+] **BOYD SOUND STUDIO**; AR, AD; PO Box 682, 103 N. Ballard; Wylie, TX 75098; (214) 442-1620.

► [24+] **BRASSWIND RECORDING STUDIO, LTD.**; AR, AD, APPV, JCP, MP, ED, RLR; PO Box 9895; College Station, TX 77842; (409) 693-5514.

[24+] **BUFFALO SOUND**; AR, APPV, APPF, ATD, JCP, MIDI; 910 Currie St.; Fort Worth, TX 76107; (817) 335-7733; FAX: (817) 335-7736.

[24+] **CARAVAN OF DREAMS**; AR, MIDI; 312 Houston St.; Ft. Worth, TX 76102; (817) 877-3000; FAX: (817) 877-3752.

[24+] **CBD PRODUCTIONS**; AR, AD, APPV, APPF, JCP, MIDI, MP, SDS; 3198 Royal Ln.; Dallas, TX 75229; (214) 350-6945.

► [24+] **CRYSTAL CLEAR SOUND**; AR, ATD; 4902 Don Dr.; Dallas, TX 75247; (214) 630-2957.

► [24+] **DALLAS SOUND LAB**; 6305 N. O'Connor Blvd.; Irving, TX 75039; (214) 869-1122.

► [24+] **DIGITAL SERVICES RECORDING STUDIOS**; RLR; 5805 Chimney Rock, Ste. E; Houston, TX 77081; (713) 664-5258; FAX: (713) 663-6518.

[24+] **EAGLE MOUNTAIN RECORDING STUDIO**; Fort Worth, TX; (817) 489-2226.

[24+] **EMERALD STUDIOS**; AR, APPV, APPF, JCP, MIDI, MP, ED; 2411 NE Loop 410, Ste. 132; San Antonio, TX 78217; (512) 656-2427; FAX: (512) 656-8024.

► [24+] **FUTURE AUDIO**; AR, APPV, JCP, MIDI, MP; 7700 Carpenter Freeway; Dallas, TX 75247; (214) 630-8889; FAX: (214) 630-9433.

[24+] **HIDDEN FOREST STUDIOS**; AR, APPV, APPF, JCP, MIDI, MP, RS; 421 Hidden Forest N.; Longview, TX 75605; (214) 663-3365.

► [24+] **INSIDE TRACK STUDIOS**; AR, APPV, ATD, JCP, MIDI, MP, RLR, MAST; 313 N. Locust; Denton, TX 76201; (817) 566-2367.

► [24+] **JAM CREATIVE PRODUCTIONS, INC.**; AR, APPV, JCP, MIDI, MP; 5454 Parkdale Dr.; Dallas, TX 75228; (214) 388-5454; FAX: (214) 381-4647.

► [24+] **JANUARY SOUND STUDIOS INC.**; AR, AD, ATD, JCP, MIDI, MP, SDS; 3341 Towerwood Dr., Ste. 205; Dallas, TX 75234; (214) 243-3735.

[24+] **KIRKWOOD STUDIO**; AR, APPV, JCP, MIDI, MP; 7027 Twin Hills; Dallas, TX 75231; (214) 692-8332.

[24+] **KNIGHTLIGHT STUDIOS**; AR, AD, ATD, JCP, MIDI, MP; 1609 Tantor Rd.; Dallas, TX 75229; (214) 506-9162.

► [24+] **LIMELIGHT RECORDING STUDIO**; AR, AD, APPV, JCP, MIDI, MP; 5116 34th St.; Dickinson, TX 77539; (713) 337-1272.

[24+] **LOMA RANCH STUDIO**; AR, AD, EIR, JCP, MP, RLR, RS, SR; Rte. 1, Box 97A3; Fredericksburg, TX 78624; (512) 997-3521.

[24+] **MARTIN RECORDING CO., INC.**; AR, APPV, JCP, MP, VP; 120 W. Castellano Dr.; El Paso, TX 79912; (915) 532-2860; FAX: (915) 542-3549.

[24+] **MASTER PRODUCTIONS STUDIO**; 307 S. Missouri St.; Weslaco, TX 78596; (512) 968-5777.

► [24+] **MIDCOM, INC.**; RLR; 3 Dallas Comm. Complex, Ste. 108; 6311 N. O'Connor Rd., LB-50; Irving, TX 75039; (214) 869-2144.



# Recording & Video Production Facilities

UNITED STATES

TEXAS

## 24+ Track Recording Studios

[24+] **NATIONAL RECORDING CO.**; AR, MP, RLR; 1614 Hampton Rd.; Texarkana, TX 75503; (214) 793-4116.

> [24+] **NOMOUNTAIN RECORDING**; AR, AD, JCP, FD; PO Box 9866; Midland, TX 79708; (915) 682-9673.



OMEGA AUDIO & PRODUCTIONS, INC.  
Dallas, TX

> [24+] **OMEGA AUDIO & PRODUCTIONS, INC.**; AR, APPV, APPF, MP, RLR; 8036 Aviation Pl.; Dallas, TX 75235; (214) 350-9066; FAX: (214) 350-8342.

[24+] **ORIGINAL MUSIC MEDIA PRODUCTIONS, INC.**; AR, AD, JCP, MIDI, MP, ED; 8377 Westview; Houston, TX 77055; (713) 465-8563.

[24+] **PANTEGO SOUND STUDIO**; AR, AD; 2210 Paper Blvd.; Arlington, TX 76013; (817) 461-8481.



PLANET DALLAS STUDIOS  
Dallas, TX

> [24+] **PLANET DALLAS STUDIOS**; AR, AD; 3515 Dickason Ave.; Dallas, TX 75219; (214) 521-2216.

[24+] **THE PRODUCTION BLOCK STUDIOS, INC.**; AR, APPV, APPF, ATD, JCP, MIDI, RLR; 906 E. Fifth St.; Austin, TX 78702; (512) 472-8975; FAX: (512) 476-5635.

[24+] **PYRAMID TELEPRODUCTIONS, INC.**; AR, APPV, APPF, VP; 3203 Longmeade; Irving, TX 75039-3510; (214) 869-3330; FAX: (214) 869-2039.

> [24+] **RAMPART STUDIOS**; RLR; 6105 Jessamine; Houston, TX 77081; (713) 772-6939.

[24+] **REELSOUND RECORDING CO.**; RLR; 2304 Sheri Oak Ln.; Austin, TX 78748; (512) 282-0713.

[24+] **RIVENDELL RECORDERS**; RLR; 1195 W. Loop N., Ste. 110; Houston, TX 77055; (713) 686-3558.

[24+] **ROBIN HOOD STUDIOS**; RLR; PO Box 775; Tyler, TX 75710; (214) 592-7677.

[24+] **SOUND ARTS RECORDING STUDIO**; AR, AD, JCP, MIDI, ED, RLR, SDS; 2036 Paskett; Houston, TX 77092; (713) 688-8067.

[24+] **THE SPACE STATION SOUND STUDIO, INC.**; 8377 Westview; Houston, TX 77055; (713) 465-6563.

[24+] **STUDIO D PRODUCTIONS, INC.**; 1700 S. Lamar, Ste. 112; Austin, TX 78704; (512) 441-4001.

[24+] **SUGAR HILL RECORDING STUDIOS**; AR, AD, APPV, APPF, JCP, MIDI, MP, RLR; 5626 Brock St.; Houston, TX 77023; (713) 926-4431; FAX: (713) 926-2253.

> [24+] **TELE-IMAGE, INC.**; 6305 N. O'Connor LB 6, Ste. 103; Irving, TX 75039-3510; (214) 869-0060; FAX: (214) 869-2039.

[24+] **TERRA NOVA STUDIO**; AR, APPV, APPF, JCP, MIDI, MP, ED, RLR, MAST, VP; PO Box 90877; Austin, TX 78709;

[24+] **U.S. SOUND**; AR, AD, ATD, JCP, MIDI, MP, SR, MAST; 8811 Heatherly; Houston, TX 77083; (713) 568-4838; FAX: (409) 588-3501.

[24+] **VOICEOVER STUDIOS**; AR, APPV, ATD, JCP, MP; 8625 King George Dr. 335 C; Dallas, TX 75235; (214) 688-0600.

## 12 & 16 Track Recording Studios

[16] **AUDIO CHAIN RECORDING**; AR, AD, APPV, ATD, JCP, MIDI, MP; 4206 B. Boston Ave.; Lubbock, TX 79413; (806) 792-3804.

> [16] **AUSTIN'S RIVERSIDE SOUND**; RLR; (PO Box 33207, Austin, TX 78764); 7617-A E. Riverside Dr.; Austin, TX 78744; (512) 385-4060.

[16] **AVALON SOUND STUDIO**; AR, MP, RLR, SR; Rte. 3 Box 421 B; Ft. Worth, TX 76140; (817) 483-4722.

[16] **BEE CREEK STUDIO**; AR, JCP, MP; 3403 Crawford Rd.; Spicewood, TX 78669; (512) 264-1379.

[16] **CRITERION RECORDING INC.**; AR, ATD, JCP; 5607 Bell St.; Dallas, TX 75206; (214) 824-5222; FAX: (214) 827-2954.

[16] **JOE DANGER RECORDS**; AR, JCP, MP; 7635 Morley Dr.; Houston, TX 77061; (713) 649-2940.

[16] **MIKE DE LEON PRODUCTIONS**; AR, AD, JCP, MP, RLR; 14146 Woodstream; San Antonio, TX 78231; (512) 492-0613.

[12] **DIGITAL IMAGE RECORDING STUDIO**; 555 Cicero; San Antonio, TX 78218; (512) 656-1382.

[16] **EDEN SOUND OF AUSTIN**; AR, APPV, MIDI, MP; 1030 S. Lamar, Ste. H; Austin, TX 78704; (512) 447-5222.

[16] **EDIT POINT AUDIO AGENCY**; AR, AD, APPV, APPF, JCP, MIDI, MP, SR; 1241 W. French Pl.; San Antonio, TX 78201; (512) 737-3348.

[16] **GEM/LONESTAR RECORDING**; AR, APPV, APPF, ATD, JCP, MIDI, MP, ED, RLR; 1204 N. Lamar; Austin, TX 78703; (512) 478-3141.

[16] **HAI TEX STUDIO**; 2107 S. Edgefield; Dallas, TX 75224; (214) 946-7947.

[16] **HORIZON RECORDING STUDIO**; AR, AD, ATD, JCP, MIDI, MP; Rte. 1 Box 306; Seguin, TX; (512) 372-2923; FAX: (512) 372-2923.

[16] **J.L. PRODUCTIONS**; AR, JCP, MIDI, MP; 3108 N. Lamar #205; Austin, TX 78705; (512) 451-1043.

[16] **M. APPEAL AUDIO AND PRODUCTIONS**; AR, APPV, APPF, JCP, MIDI, MP; 1112 Plantation Dr. N.; Colleyville, TX 76034; (817) 485-7613.

> [16] **PATRICK MCGUIRE RECORDING**; 1402 Rockdale; Arlington, TX 76018; (817) 467-1852.

[16] **MEL MORAN SOUNDTRACK STUDIO**; AR; 2011 N. Alamo; San Antonio, TX 78215.

[16] **MUSIC LANE RECORDING STUDIO**; AR, AD, APPV, ATD, JCP, MIDI, MP, ED, VP; 1100 Music Lane—Terrace Music & Film Complex #5; Austin, TX 78704; (512) 447-3988.

> [16] **NEW AGE RECORDING**; AR, APPV, JCP; 8607 Wurzbach Rd., U-105; San Antonio, TX 78240; (512) 641-9818; FAX: (512) 641-9988.

[16] **OH SO GOOD PRODUCTIONS**; AR, APPV, JCP, MIDI, MP, RLR, SR, VP; 2389 NW Military Dr., Ste. 602; San Antonio, TX 78231; (512) 493-5550.

[16] **PLA-BACK RECORDING**; AR, AD, MIDI; 2404 Salerno Dr.; Dallas, TX 75224; (214) 942-1387.

[16] **POVERTY HILL RECORDING STUDIO**; AR, AD; PO Box 805; Cedar Hill, TX 75104; (214) 775-2222.

[16] **PSALMIST RECORDING STUDIOS**; AR, AD, ATD, JCP, MIDI, MP; PO Box 961; Whitehouse, TX 75791; (214) 581-5461; (800) 63-PSALM.

[16] **SATURN PRODUCTIONS RECORDING STUDIOS**; AR, AD, JCP, MIDI, MP, RLR; 807 E. Faylor; Baytown, TX 77520; (713) 420-3189; (713) 328-6752.

[16] **SMITH SOUND RECORDING**; 7015 Villa Del Sol; Houston, TX 77083; (713) 498-0297.

[16] **TIM STANTON AUDIO**; AR, APPV, JCP, MP, RLR; 1501 W. 5th St., Ste. 103; Austin, TX 78703; (512) 477-5618.

[16] **STUDIO CENTER**; AR, APPV, ATD, ED, RLR, SR, SDS, VP; 6540 Randolph Blvd.; San Antonio, TX 78239; (512) 653-4004.

[16] **STUDIO-WORKS**; AR, APPV, EIR, JCP, MIDI, MP; 7911 Capri Cir.; Houston, TX 77095; (713) 550-3550.

[16] **SULPHUR SPRINGS SOUND**; AR, AD, ATD, JCP, MIDI, MP; PO Box 594; Sulphur Springs, TX 75482; (214) 885-8583.

[16] **SUNSHINE HIGHWAY PRODUCTIONS**; AR, AD, ATD, MIDI, MP; 3483 Coronado Ct.; Ft. Worth, TX 76116; (817) 244-5378; FAX: (817) 244-3834.

[16] **TOMLYN RECORDING STUDIO**; AR, JCP, MIDI; Rte. 3 Box 405; Flint, TX 75762; (214) 894-7713.

[16] **VIDEOMEGA PRODUCTIONS, INC.**; AR, APPV, JCP, MIDI, MP, RLR, VP; 2402 Broadmoor, Ste. 101A; Bryan, TX 77802; (409) 774-7544; FAX: (409) 776-0010.

[16] **WALK ON WATER STUDIOS, INC.**; AR, MP; Rte. 2, Box 566-H; New Braunfels, TX 78130; (512) 629-8008; FAX: (512) 625-2024.

## 4 & 8 Track Recording Studios

[8] **ARARAT SOUND PRODUCTIONS**; AR, MIDI; 23019 Tree Bright; Spring, TX 77373; (713) 443-6947.

[4] **AUDIO GENICS**; AR, JCP, MIDI; 5376 Stewart Ln.; San Angelo, TX 76904; (915) 944-1213; FAX: (915) 942-1027.

[8] **BAND FACTORY**; AR, JCP, MIDI, MP; 1414 W. Rosedale; Ft. Worth, TX 76104; (817) 877-3391.

[8] **BROOKSHIRE SOUND**; AR, EIR, MIDI, MP, RLR, SR; 3839 Maple; Odessa, TX 79762; (915) 362-8777.

[8] **CAPTAIN'S TRACKS STUDIO**; AR, MP; 1 Robin Springs Pl.; The Woodlands, TX 77381; (713) 292-1745.

[8] **CHATEAU PRODUCTIONS**; AR, JCP, MIDI; PO Box 13802; Arlington, TX 76094; (817) 572-7502.

[2] **COLLEGE OF MUSIC, UNIVERSITY OF NORTH TEXAS**; AR, RLR; PO Box 13887; Denton, TX 76203; (817) 565-3769.

[8] **JESS DEMAINE'S SONGWRITER STUDIO**; AR, AD, JCP, MIDI, MP; 7530 N. Lamar #107; Austin, TX 78753; (512) 458-1570.

[4] **THE FAT MAN**; APPV, APPF, JCP, MIDI, MP; 7611 Shoal Creek Blvd.; Austin, TX 78757; (512) 454-5775; FAX: (512) 454-5775.

[8] **FOLKLOEHR PRODUCTIONS**; AR, APPV, APPF, ATD, JCP, MIDI, MP, RLR, MAST, VP; PO Box 166045; Irving, TX 75016; (214) 255-7546.

[8] **FOREST GLEN AUDIO**; AR, MIDI, SR; 200 N. Montclair; Dallas, TX 75208; (214) 942-3781.

[8] **GODEL PRODUCTIONS (A DIVISION OF GODEL MINISTRIES)**; AR, RLR, SR; 330 E. Main St.; Nacogdoches, TX 75961-5258; (409) 560-4282.

> [8] **BOB GREEN PRODUCTIONS, INC.**; AR, ATD, JCP; 7950 Westglen; Houston, TX 77063; (713) 977-1334; FAX: (713) 977-1305.

[8] **J AND L STUDIOS**; AR, APPV, APPF, JCP, MIDI, MP; 4514 Temple Hill; San Antonio, TX 78217; (512) 637-1466.

[8] **LARRCO IND OF TEXAS, INC., KLARRCO SATELITE RADIO & T.V. DIV.**; AR, AD, APPV, ATD, JCP, MP, ED, RLR; PO Box 3842; Houston, TX 77253-3842; (713) 691-0778.

[4] **THE MUSIK FACTORY**; AR, ATD; 1812 Procter St.; Port Arthur, TX 77640; (409) 982-7121.

[4] **NAVARRO COLLEGE**; AR, APPV, ATD, MP, ED, RS, VP; 3200 W. 7th Ave.; Corsicana, TX 75110; (214) 874-6501; FAX: (214) 874-4636.

[4] **NESMAN STUDIOS**; AR, ATD, MAST, VP; 3108 York St.; Wichita Falls, TX 76309; (817) 696-1629.

[8] **OAKRIDGE MUSIC REC. SERVICE**; AR, ATD; 2001 Elton Rd.; Haltom City, TX 76117; (817) 838-8001.

[4] **ON-SITE RECORDING SERVICES**; AR, MP, RLR; 1610 Scottsdale Dr.; Arlington, TX 76018; (817) 472-7256.

[8] **PEAK RECORDING STUDIO**; AR, AD, APPV, ATD, MIDI; 42 Caddo Peak; Joshua, TX 76058; (817) 645-8385.

[4] **PHANTOM PRODUCTIONS, INC.**; AR, AD, MP, RLR, VP; 701 Brazos, Ste. 500, PO Box 4870; Austin, TX 78765; (512) 288-1044; FAX: (512) 288-4748.

[8] **POSTING BROTHERS STUDIOS**; AR, APPV, ED, VP; 6800 Gateway E., Bldg. 5; El Paso, TX 79915; (915) 775-1401.

[8] **REAL TO REEL STUDIOS**; AR, APPV, ATD, JCP, MIDI; 2545 N. Fitzhugh; Dallas, TX 75204; (214) 827-7170; FAX: (214) 827-6107.

[8] **RED SUN RECORDING**; AR, AD, JCP, MIDI, MP; 9907 Harwin; Houston, TX 77036; (713) 977-5781.

[8] **SCRATCH-N-SNIFF STUDIO**; AR, APPV, MIDI, RLR; 232 E. Orchard St.; Clute, TX 77531; (409) 265-7168.

[8] **SOC RECORDING**; 200 N. Montclair; Dallas, TX 75208; (214) 942-3781.

[8] **STELLAR WINDS STUDIO**; AR, ATD, RLR; 2501 Sublett Rd. #995; Arlington, TX 76017; (817) 465-4780.

[8] **STUDIO B, INC.**; AR, ATD; 3405 Mercer; Houston, TX 77027; (713) 622-1948.

[8] **TRASH BAGGS STUDIO**; AR; 4500 Walnut Hill; Flint, TX 75762;

[8] **UNREEL SOUND**; AR, AD, EIR, JCP, MP, RLR, SR; PO Box 426; Decatur, TX 76234; (817) 62-SOUND.

[8] **VIDEO EDUCATION & TRAINING**; AR, APPV, EIR, JCP, MP, VP; 11246 S. Post Oak #122; Houston, TX 77035; (713) 729-7742; FAX: (713) 723-4580.

[8] **THE VIDEO EYE**; AR, APPV, JCP, MIDI, MP, VP; 10960 Millridge N. Dr. #103; Houston, TX 77070; (713) 890-8364; FAX: (713) 890-8735.

[8] **WHITE DOVE STUDIOS**; AR, AD, APPV, APPF, ATD, JCP, MP, SR; 118 Old Windmill Rd.; New Braunfels, TX 78132; (512) 438-7135.

[8] **WING AND A PRAYER MUSIC**; AR, JCP, MIDI, MP, RLR; 1200 S. Gary; Monahans, TX 79756; (915) 943-6524.

#### Video Production & Post-Production Facilities

**ALPHA VIDEO PRODUCTIONS**; VPF, VPPE, OLVP; 2720 Stemmons Fwy., Ste. 200; Dallas, TX 75207; (214) 634-7260; FAX: (214) 631-3335.

**AMS PRODUCTIONS, INC.**; VPF, VPPE, OLVP, VTD; 6221 N. O'Connor, Ste. 109; Irving, TX 75039-3510; (214) 869-4911; FAX: (214) 869-2560.

**AUDIO CHAIN RECORDING**; VPPE, APPV; 4206 B. Boston Ave.; Lubbock, TX 79413; (806) 792-3804.

**AUSTIN CABLEVISION**; VPF, VPPE, OLVP, APPV; 2191 Woodward; Austin, TX 78744; (512) 448-8100; FAX: (512) 448-8191.

**BUFFALO SOUND**; APPV; 910 Currie St.; Fort Worth, TX 76107; (817) 335-7733; FAX: (817) 335-7736.

**BUSINESS IMAGES**; VPF, OLVP; PO Box 161293; Austin, TX 78716; (512) 339-1678.

**FUTURE AUDIO**; APPV; 7700 Carpenter Freeway; Dallas, TX 75247; (214) 630-8889; FAX: (214) 630-9433.

**IN-SYNC**; VPF, VPPE, OLVP, APPV; 1350 Manufacturing, Ste. 120; Dallas, TX 75207; (214) 748-2220.

**KUF-TV7-ACU VIDEO PRODUCTIONS**; VPF, VPPE, OLVP, VTD; 1201 E. Ambler—Don Morris Bldg.; Abilene, TX 79601; (915) 674-2427.

**LARRCO IND OF TEXAS, INC., KLARRCO SATELLITE RADIO & T.V. DIV.**; VPF, APPV; PO Box 3842; Houston, TX 77253-3842; (713) 691-0778.

**MARTIN RECORDING CO., INC.**; VPF, VPPE, OLVP, APPV; 120 W. Castellano Dr.; El Paso, TX 79912; (915) 532-2860; FAX: (915) 542-3549.

**MASTER PRODUCTIONS STUDIO**; VPF, VPPE, OLVP, APPV, VTD; 307 S. Missouri St.; Westlaco, TX 78596; (512) 968-5777.

**NAVARRO COLLEGE**; VPF, VPPE, OLVP, APPV, VTD; 3200 W. 7th Ave.; Corsicana, TX 75110; (214) 874-6501; FAX: (214) 874-4636.

**OMEGA AUDIO & PRODUCTIONS, INC.**; APPV; 8036 Aviation Pl.; Dallas, TX 75235; (214) 350-9066; FAX: (214) 350-8342.

**ON LOCATION VIDEO & POST**; VPF, VPPE, OLVP; PO Box 35657; Houston, TX 77235; (713) 728-1020; FAX: (713) 728-1471.

**ON VIDEO**; VPF, VPPE, OLVP, VTD; 10110 Monroe Dr.; Dallas, TX 75229; (214) 352-9600; FAX: (214) 352-9661.

**PHANTOM PRODUCTIONS, INC.**; OLVP; 701 Brazos, Ste. 500, PO Box 4870; Austin, TX 78765; (512) 288-1044; FAX: (512) 288-4748.

**POSTING BROTHERS STUDIOS**; VPF, VPPE, OLVP, APPV; 6800 Gateway E., Bldg. 5; El Paso, TX 79915; (915) 775-1401.

**PYRAMID TELEPRODUCTIONS, INC.**; VPF, VPPE, OLVP, APPV, VTD; 3203 Longmeade; Irving, TX 75039-3510; (214) 869-3330; FAX: (214) 869-2039.



SOUTH COAST VIDEO & FILM  
Houston, TX

**SOUTH COAST VIDEO & FILM**; VPF, VPPE, OLVP, APPV, VTD; 5234 Elm; Houston, TX 77081; (713) 661-3550; FAX: (713) 661-HELP.

**SPEED OF LIGHT PRODUCTIONS**; OLVP; 1600 Gand St.; Dallas, TX 75215; (214) 421-4693.

**STUDIO CENTER**; OLVP, APPV, VTD; 6540 Randolph Blvd.; San Antonio, TX 78239; (512) 653-4004.

**STUDIO W**; VPF, VPPE, OLVP; 2408 Timberloch Pl., Ste. B-7; The Woodlands, TX 77380; (713) 377-6300; FAX: (713) 367-0615.

**TELE-IMAGE, INC.**; 6305 N. O'Connor LB 6, Ste. 103; Irving, TX 75039-3510; (214) 869-0060; FAX: (214) 869-2039.

**VIDEO EDUCATION & TRAINING**; VPF, VPPE, OLVP, APPV, VTD; 11246 S. Post Oak #122; Houston, TX 77035; (713) 729-7742; FAX: (713) 723-4580.

**THE VIDEO EYE**; VPF, VPPE, OLVP, VTD; 10960 Millridge N. Dr. #103; Houston, TX 77070; (713) 890-8364; FAX: (713) 890-8735.

**VIDEO POST & TRANSFER, INC.**; VPPE, APPV, VTD; 8036 Aviation Pl., Box 53; Dallas, TX 75235; (214) 350-2676; FAX: (214) 350-8342.

**VIDEOMEGA PRODUCTIONS, INC.**; VPF, VPPE, OLVP, APPV, VTD; 2402 Broadmoor, Ste. 101A; Bryan, TX 77802; (409) 774-7544; FAX: (409) 776-0010.

#### UTAH

#### 24+ Track Recording Studios

## BONNEVILLE

MEDIA COMMUNICATIONS

BONNEVILLE MEDIA COMMUNICATIONS  
Salt Lake City, UT

[24+] **BONNEVILLE MEDIA COMMUNICATIONS**; AR, APPV, APPF, ATD, MIDI, MP, RLR, MAST; 130 Social Hall Ave.; Salt Lake City, UT 84111; (801) 237-2400; FAX: (801) 237-2459.

[24+] **MOUNTAIN MEADOW RECORDING**; AR, APPV, ATD, EIR, JCP, MIDI, MP, RLR, SR, SDS, VP; 570 26th St. #1; Ogden, UT 84401; (801) 394-3217.

[24+] **ROSEWOOD RECORDING CO.**; AR, APPV, JCP, MIDI, MP; 2288 W. 300 N.; Provo, UT 84601; (801) 375-5764.

[24+] **TELESCENE INC.**; AR, APPV, APPF, ATD, JCP, MIDI, MP, RLR, VP; 3487 W. 2100 S.; Salt Lake City, UT 84119; (801) 973-3140; FAX: (801) 973-3297.

#### 12 & 16 Track Recording Studios

[16] **ROCKY MOUNTAIN PRODUCTION**; AR, AD, APPV, JCP, MIDI, RLR, VP; 1050 E. 1600 N.; Mapleton, UT 84664; (801) 489-7850; FAX: (801) 375-6880.

[16] **WT RECORDING STUDIOS**; AR, APPV, JCP, MP; 435 S. 300 E.; Salt Lake City, UT 84111; (801) 322-1333; FAX: (801) 322-3221.

#### 4 & 8 Track Recording Studios

[8] **ELBERTA RECORDING STUDIOS**; AR, AD, ATD, EIR, MIDI, RLR; 343 E. Elberta Dr.; N. Ogden, UT 84414; (801) 782-4666.

[8] **ESS PRODUCTIONS**; AR, AD, APPV, ATD, EIR, JCP, MIDI, MP, RLR, SR; 1235 N. 900 E.; Bountiful, UT 84010; (801) 298-7445.

[8] **NORMAN ROSS PRODUCTIONS, INC.**; AR, APPV, ATD, JCP, RLR, VP; 2810 E. Evergreen Ave.; Salt Lake City, UT 84109-3128; (801) 484-0401.

#### Video Production & Post-Production Facilities

**STS PRODUCTIONS**; VPF, VPPE, OLVP, APPV, VTD; 5181 Amelia Earhart Dr.; Salt Lake City, UT 84116; (801) 537-1427; FAX: (801) 596-1194.

**TELESCENE INC.**; VPF, VPPE, OLVP, APPV, VTD; 3487 W. 2100 S.; Salt Lake City, UT 84119; (801) 973-3140; FAX: (801) 973-3297.

#### VERMONT

#### 24+ Track Recording Studios

[24+] **ACTIVE AUDIO**; RLR; PO Box 405; Underhill, VT 05489; (802) 899-9977.

[24+] **SOUNDESIGN**; AR, ATD, JCP, MIDI, MP, ED, RLR; Main Street Gallery, 181 Main St.; Brattleboro, VT 05301; (802) 257-1555.



## Recording & Video Production Facilities

UNITED STATES

### VERMONT

#### 12+ Track Recording Studios



WHITE CROW AUDIO  
Burlington, VT

>[24+] **WHITE CROW AUDIO**; RLR: 19 Marble Ave.; Burlington, VT 05401; (802) 658-6475.

#### 12 & 16 Track Recording Studios

>[16] **BACKTRACKS LOCATION DIGITAL**; AR, MP, ED, RLR, MAST: 5 School Ave.; Montpelier, VT 05602; (802) 223-2551; FAX: (802) 229-1834.

[16] **ISLAND RECORDING STUDIOS**; AR, AD, JCP, MIDI, RS: U.S. Rte. 2 (RR 1 Box 291C); North Hero, VT 05474; (802) 372-5824.

#### Video Production & Post-Production Facilities

**RESOLUTION VIDEO AUDIO & FILM PRODUCTION**; VPFE, VPPE, OLVP, APPV: 19 Gregory Dr.; S. Burlington, VT 05403; (802) 862-8881; FAX: (802) 865-2308.

### VIRGIN ISLANDS

#### 12 & 16 Track Recording Studios

[16] **TONYASH RECORDING STUDIO (T.A.R.S.)**; RLR; PO Box 6104; St. Thomas, VI 00804; (809) 775-5510.

### VIRGINIA

#### 24+ Track Recording Studios

[24+] **ALIVE RECORDINGS**; RLR: 1251 Virginia Ave.; Harrisonburg, VA 22801-2497; (703) 434-6703.

>[24+] **ALPHA AUDIO AUTOMATION SYSTEMS**; AR, APPV, APPF, ATD, JCP, MIDI, MP: 2049 W. Broad St.; Richmond, VA 23220; (804) 358-3852; FAX: (804) 358-9496.

>[24+] **BIAS RECORDING COMPANY, INC.**; AR, MP, RLR: 5400 Carolina Pl.; Springfield, VA 22151; (703) 941-3333.

>[24+] **CUE RECORDING, LTD.**; 109 Park Ave., Ste. E; Falls Church, VA 22046; (703) 532-9033.

[24+] **FLOOD ZONE STUDIOS**; AR, EIR, MP, SR; PO Box 7105; Richmond, VA 23221; (804) 644-0935.

>[24+] **MASTER SOUND RECORDING STUDIO**; RLR: 5249 Challedon Dr.; Virginia Beach, VA 23462; (804) 499-0000; (804) 496-0553.

[24+] **MASTERWORKS STUDIOS**; AR, APPV, ATD: 4024 Williamsburg Ct.; Fairfax, VA 22032; (703) 385-1780.

[24+] **REELPEOPLE RECORDING SERVICES**; AR, APPV, APPF, JCP, MIDI, RLR: 3210 Gary Ct.; Falls Church, VA 22042; (703) 532-7335.

[24+] **SP/TECHSONICS**; AR, JCP, MIDI, MP: 709 Shadowfield Ct.; Chesapeake, VA 23320; (804) 547-4000; FAX: (804) 436-5928.

[24+] **21ST STREET RECORDING**; AR, APPV, APPF, JCP, MIDI: 210 G N. 21st St.; Purcellville, VA 22075; (703) 338-2121; FAX: (703) 338-7319.

[24+] **VIRGINIA ARTS RECORDING**; AR, AD, APPV, APPF, ATD, EIR, JCP, MIDI, MP, ED, RLR, MAST: 512 Stewart St.; Charlottesville, VA 22901; (804) 971-1411.



WINDMARK RECORDING, INC.  
Virginia Beach, VA

>[24+] **WINDMARK RECORDING, INC.**; AR, AD, APPV, APPF, ATD, EIR, JCP, MIDI, MP, RLR, MAST, VP: 4924 Shell Rd.; Virginia Beach, VA 23455; (804) 464-4924; FAX: (804) 464-1773.

#### 12 & 16 Track Recording Studios

>[16] **WALLY CLEAVER'S RECORDING**; AR, APPV, EIR, JCP, MIDI, MP, RLR, SR: 1518 Princess Anne St.; Fredericksburg, VA 22401; (703) 373-6511.

[16] **CRS RECORDING STUDIO**; AR: 113 N. Chestnut St., PO Box 85; Marion, VA 24354; (703) 783-6828.

[16] **DAN-SING RECORDING STUDIO**; AR, EIR, JCP, MP, RLR, SR: 120 Ridgcrest Dr.; Danville, VA 24540; (804) 836-4673.

>[16] **EARWORKS AUDIO, INC.**; AR, AD, APPV, JCP, MIDI, RLR: 5245 Cleveland St., Ste. 210; Virginia Beach, VA 23462; (804) 490-9322.

[16] **GOLDREEL STUDIOS**; RLR: 3611 Centreville Rd.; Chantilly, VA 22021; (703) 481-3453.

[16] **GYPSY STUDIO**; AR, RLR: 3039 Hazelton St.; Falls Church, VA 22044; (703) 241-7445.

>[16] **INNER EAR STUDIOS, INC.**; RLR: 712 S. Ivy St.; Arlington, VA 22204; (703) 892-2123.

[16] **MCCAVITT PRODUCTIONS**; AR, APPV, JCP, MIDI, MP, RLR: 9 W. Grace St.; Richmond, VA 23220; (804) 648-3200.

[16] **MUSIFEX, INC.**; AR, APPV, ATD, JCP, MP, RLR, VP: 2701-C Wilson Blvd.; Arlington, VA 22201; (703) 525-6476; FAX: (703) 525-0949.

[16] **STUDIO NICO**; AR, ATD, JCP: 320 Brook Rd.; Richmond, VA 23220; (804) 648-0306.

[16] **WOODHOUSE RECORDING**; AR, SR: 2900 Brittany Way; Chesapeake, VA 23321; (804) 483-6212.

#### 4 & 8 Track Recording Studios

>[2] **AIRSHOW, INC.**; AR, RLR, MAST: 7021 Woodland Dr.; Springfield, VA 22151; (703) 642-9035; FAX: (703) 642-9035.

[8] **AMBERWOOD SOUND PRODUCTION**; AR, JCP, MIDI: 12538 Cavalier Dr.; Woodbridge, VA 22192; (703) 494-0234.

[8] **AUDIOIMAGE RECORDING**; AR, AD, APPV, APPF, ATD, JCP, MIDI, MP, RLR, MAST: 110 N. Jefferson St.; Richmond, VA 23220-5022; (804) 644-7700; FAX: (804) 644-8801.

[2] **AUTOMATION RESEARCH SYSTEMS, LTD.**; APPV, MP, VP: 4480 King St.; Alexandria, VA 22302; (703) 820-9000; FAX: (703) 820-9106.

[2] **STEPHEN BERRY PRODUCTION SERVICES**; VP: 4512 Southampton Rd.; Richmond, VA 23235; (804) 320-0758.

[8] **EVANSOUND PRODUCTIONS (ESP)**; AR, MP: 5 Wall St.; Fredericksburg, VA 22405; (703) 371-8000.

[4] **HAMPTON UNIVERSITY RECORDING STUDIO**; AR, MIDI, MP, ED, RLR, SR; Dept. of Music; Hampton, VA 23668; (804) 727-5402; (804) 727-5514.

[4] **LINDEN INC.**; AR, APPV, ATD, SR, VP: 229 N. Henry St.; Alexandria, VA 22314-2400; (703) 549-4424.

[8] **L.P. PRODUCTIONS**; AR, ATD, JCP, MP, RLR: Rte. 1, Box 233; Lyndhurst, VA 22952; (703) 943-1108.

[4] **RAP AROUND RECORDING**; AR, MIDI, RLR: 4614 Butte Rd.; Richmond, VA 23235; (804) 320-7250.

[8] **ROLAND HOUSE, INC.**; APPV: 2020 N. 14th St.; Arlington, VA 22201; (703) 525-7000; FAX: (703) 525-7001.

[8] **SHARPSOUNDS MUSIC PRODUCTIONS**; AR, APPV, JCP, MIDI, MP: 1440 Ludlow Dr.; Virginia Beach, VA 23456-5400; (804) 474-2492.

[2] **THE SOUND CATEGORY**; RLR: PO Box 9; Merrifield, VA 22116; (703) 280-9119.

[8] **SOUNDPLUS**; AR, MIDI, MP, RS: Rte. 4, Box 41; Leesburg, VA 22075; (703) 777-7176.

[8] **SOUNDS, REASONABLE!**; AR, ATD, RLR: 10203 Bent Tree Ln.; Manassas, VA 22111; (703) 369-4250; (703) 631-6376.

[8] **WISTARIA INC.**; AR, AD, JCP, MIDI, MP: 607 Piney Point Rd.; Yorktown, VA 23692; (804) 898-8155.

#### Video Production & Post-Production Facilities

>[16] **ALPHA RECORDING CORPORATION**; APPV: 2049 W. Broad St.; Richmond, VA 23220; (804) 358-3852; FAX: (804) 358-9496.

**AUTOMATION RESEARCH SYSTEMS, LTD.**; VPFE, VPPE, OLVP, APPV, VTD: 4480 King St.; Alexandria, VA 22302; (703) 820-9000; FAX: (703) 820-9106.

**AV-TEK PRODUCTIONS**; VPFE, OLVP, VTD: PO Box 35356; Richmond, VA 23235; (804) 359-1421.

**STEPHEN BERRY PRODUCTION SERVICES**; OLVP: 4512 Southampton Rd.; Richmond, VA 23235; (804) 320-0758.

>[16] **ESSEX CORP.**; VPPE: 8300 Boone Blvd., Ste. 440; Vienna, VA 22182-2626; (703) 556-0006.

**LINDEN INC.**; VPPE, APPV, VTD: 229 N. Henry St.; Alexandria, VA 22314-2400; (703) 549-4424.

**MUSIFEX, INC.**; VPPE, OLVP, APPV: 2701-C Wilson Blvd.; Arlington, VA 22201; (703) 525-6476; FAX: (703) 525-0949.

**ROLAND HOUSE, INC.**; VPPE, APPV, VTD: 2020 N. 14th St.; Arlington, VA 22201; (703) 525-7000; FAX: (703) 525-7001.

### WASHINGTON

#### 24+ Track Recording Studios

[24+] **ALPHA CINE LAB'S**; AR, APPV, APPF, RLR, SDS: 1001 Lenora St.; Seattle, WA 98121; (206) 682-8230; FAX: (206) 682-6649.

[24+] **BEAR CREEK RECORDING AND MUSIC PRODUCTION**; AR, APPV, APPF, JCP, MIDI, MP: 6313 Maltby Rd.; Woodinville, WA 98072; (206) 481-4100; FAX: (206) 486-2718.

[24+] **CROW RECORDING STUDIO**; AR, APPV, ATD, JCP, MIDI, MP, ED, RLR: 4000 Wallingford Ave. N.; Seattle, WA 98103; (206) 634-3088.

[24+] **FORUM COMMUNICATIONS INC.**; AR, APPV, JCP, MIDI, MP, VP: 500 108th Ave. NE 24th Fl.; Bellevue, WA 98004; (206) 646-6648; FAX: (206) 646-6522.



**IRONWOOD STUDIOS**  
Seattle, WA

► [24+] **IRONWOOD STUDIOS**; AR, AD, APPV, APPF, MIDI, MP, VP; 601 NW 80th St.; Seattle, WA 98117; (206) 789-7569; FAX: (206) 784-2880.



**KLUB KEV'S RECORDING COMPANY**  
Seattle, WA

► [24+] **KLUB KEV'S RECORDING COMPANY**; AR, MIDI, MP; 3177 NE 82nd; Seattle, WA 98115; (206) 527-2250; FAX: (206) 232-4515.

► [24+] **LAWSON PRODUCTIONS, INC.**; RLR, 2212 4th Ave.; Seattle, WA 98121; (206) 443-1500; FAX: (206) 441-2910.

► [24+] **LONDON BRIDGE STUDIOS INC.**; AR, APPV, MP; 20021 Ballinger Way NE, Ste. A; Seattle, WA 98155; (206) 364-1525.

[24+] **MICHAEL LORD PRODUCTIONS**; AR, MIDI, MP; 9508 17th Ave. NE; Seattle, WA 98115; (206) 527-9002.

[24+] **MILLTREE PRODUCTIONS, INC.**; AR, AD, APPV, APPF, JCP, MIDI, MP, SDS; PO Box 70322; Seattle, WA 98107-0322; (206) 782-3115.

► [24+] **MIRAMAR RECORDING STUDIOS**; PO Box 70127; Bellevue, WA 98007; (206) 747-5233.

► [24+] **THE MUSIC SOURCE**; 615 E. Pike; Seattle, WA 98122; (206) 323-6847.

[24+] **PAGET SOUND VIDEO**; AR, APPV, APPF, ATD, JCP, MIDI, MP, ED, RLR, MAST, VP; 15524 72nd Ave. W.; Edmonds, WA 98020; (206) 745-1427.

► [24+] **PARADISE SOUND RECORDING INC.**; PO Box 117; Index, WA 98256; (206) 793-2614.

[24+] **RECIPROCAL RECORDING**; AR, APPV, ED; 4230 Leary Way NW; Seattle, WA 98107; (206) 782-6411.

[24+] **THE RIGHT TRACK STUDIOS**; AR, ATD, JCP, MIDI, MP, RLR, VP; 218 SW 153rd; Seattle, WA 98166; (206) 241-4850; FAX: (206) 241-4852.

► [24+] **SAGE ARTS**; RLR; Littlefield Farm; 14311 Stehr Rd.; Arlington, WA 98223; (206) 691-5203.

[24+] **STAR TRACK RECORDING**; 19351 23rd NW; Seattle, WA 98177; (206) 542-1041.

► [24+] **TELEMATION**; RLR; 1200 Stewart St.; Seattle, WA 98101; (206) 623-5934.

[24+] **T.J. RECORDING STUDIO, INC.**; RLR; 2718 E. 96th St.; Tacoma, WA 98445; (206) 537-0123.

► [24+] **TRIAD STUDIOS**; AR, AD, APPV, ATD, JCP, MIDI, MP, RLR, VP; 4572 150th Ave. NE; Redmond, WA 98052; (206) 881-9322; FAX: (206) 881-3645.

[24+] **TURTLE MOBILE RECORDING, LTD.**; RLR; 12819 SE 38th, Ste. 250; Bellevue, WA 98006; (206) 641-1406 (Seattle); (604) 872-3447 (Vancouver).

#### 12 & 16 Track Recording Studios

[16] **BEYOND PRODUCTION PRODUCTIONS**; AR, AD, APPV, EIR, JCP, MIDI, MP, ED, RLR, SR, SDS; E. 2804 Nebraska; Spokane, WA 99207-6315; (509) 487-7614.

[16] **C.A.N.A. PRODUCTIONS**; AR, ATD, JCP, MIDI, MP; 7930 Rainier Ave. S.; Seattle, WA 98118; (206) 722-4144; (206) 722-9225.

[16] **JRB MOTION GRAPHICS, LTD.**; AR, APPV, APPF, MIDI, MP, VP; 4117 Stone Way N.; Seattle, WA 98103; (206) 547-2552.

[16] **LAY-A-TRACK RECORDING**; AR; 180 S. Academy Rd.; Bellingham, WA 98226; (206) 733-8824.

[16] **MUSIC EXPRESS**; AR, ATD, EIR, JCP, MP, ED, RLR, RS, SR; 2308 W. 2nd St.; Aberdeen, WA 98520; (206) 532-1858.

[16] **PEDARE TRACKS**; AR, AD, EIR, JCP, MIDI, MP, RLR, SR; 1014 Springwater; Wenatchee, WA 98801; (509) 662-2588.

[16] **RUTHER REMOTE RECORDING**; AR, ATD, EIR, MIDI, MP, ED, RLR, SR, SDS; 108 N. Roosevelt St.; Walla Walla, WA 99362; (509) 522-0438.

► [16] **SOHO STUDIOS**; 6108 Phinney Ave. N.; Seattle, WA 98103; (206) 784-2912.

[16] **STUDIO 5 RECORDING**; AR, APPV, JCP, MIDI, MP; 13400 Northrup Way #5; Bellevue, WA 98005; (206) 643-1755.

[16] **TRI-WEST RECORDING**; AR, AD, JCP, MIDI, MP; 21040 5th Ave. S.; Seattle, WA 98198; (206) 824-6722.

#### 4 & 8 Track Recording Studios

[2] **AERIAL IMAGES**; MIDI, VP; PO Box 2274; Kirkland, WA 98083; (206) 827-7299.

[8] **AUDIO RECORDING, INC.**; RLR; 4718 38th Ave. NE; Seattle, WA 98105; (206) 525-7372; (206) 623-2030.

[8] **CAMERA ONE PRODUCTIONS**; APPV, APPF, VP; 431-A N. 34th St.; Seattle, WA 98103; (206) 547-5131.

[8] **CURRENT-RUTLEDGE**; AR, RLR, VP; 614 12th Ave. E.; Seattle, WA 98102; (206) 324-7530.

[8] **THE DUTCHMAN/MULA PRODUCTIONS**; AR, MIDI, MP; 101 S. Spokane St.; Seattle, WA 98134; (206) 343-9001.

[8] **JB RECORDINGS**; AR, APPV, JCP, MIDI, MP; 6532 5th Ave. NW; Seattle, WA 98117; (206) 783-6579.

[8] **LIGHTHOUSE MUSIC GROUP**; AR, AD, APPV, APPF, JCP, MIDI, MP, SDS; 15514 79th Ave. NE; Bothell, WA 98011; (206) 488-6022.

[2] **REEL CREATIONS**; AR, MP, SDS; E. 11321 37th; Spokane, WA 99206; (509) 924-5055.

[8] **ROMANCE RECORDING STUDIO**; AR; 4215 E. 30th Ave.; Spokane, WA 99223; (509) 534-9529.

[4] **ROSEDALE AUDIO PRODUCTIONS**; AR, APPV, ATD, JCP, RLR; 8602 86th Ave. NW; Rosedale (Gig Harbor), WA 98335-6713; (206) 851-2838.

[8] **ROXOUND STUDIOS/DEM VIDEO PRODUCTIONS**; RLR; 2833 NE 115th; Seattle, WA 98125; (206) 365-7949.

[8] **THE SOUND PRESERVERS CO.**; AR; 911 E. 4th Ave.; Olympia, WA 98506; (206) 352-9097.

[4] **SOUND PRODUCTIONS**; AR, ATD; 713 Fairview Ave. N.; Seattle, WA 98115; (206) 525-9999.

[8] **TDS PRODUCTIONS**; AR, AD, MP, ED; PO Box 31983; Seattle, WA 98103; (206) 284-2399.

[8] **VINEYARD STUDIOS**; AR, MIDI, RLR; PO Box 69522; Seattle, WA 98188; (206) 630-3466.

[8] **WEST SEATTLE RECORDING STUDIO**; AR; 7914 28th SW; Seattle, WA 98126; (206) 935-8197.

[8] **WOODMONT BEACH STUDIOS**; AR, JCP, MP; PO Box 98553; Seattle, WA 98198; (206) 941-2430.

#### Video Production & Post-Production Facilities

**ALPHA CINE LAB'S**; VPPE, APPV; 1001 Lenora St.; Seattle, WA 98121; (206) 682-8230; FAX: (206) 682-6649.

**AMERICAN PRODUCTION SERVICES**; VPF, VPPE, OLVP, VTD; 2247 15th Ave. W.; Seattle, WA 98119; (206) 282-1776; FAX: (206) 282-3535.

**BEAR CREEK RECORDING AND MUSIC PRODUCTION**; APPV; 6313 Maltby Rd.; Woodinville, WA 98072; (206) 481-4100; FAX: (206) 486-2718.

**CAMERA ONE PRODUCTIONS**; VPF, VPPE, OLVP, APPV, VTD; 431-A N. 34th St.; Seattle, WA 98103; (206) 547-5131.

**FORUM COMMUNICATIONS INC.**; VPF, VPPE, APPV; 500 108th Ave. NE 24th Fl.; Bellevue, WA 98004; (206) 646-6648; FAX: (206) 646-6522.

**GFO PRODUCTIONS**; VPF; 432 E. X St.; Tumwater, WA 98501; (206) 352-8028.

**HSN TELEMATION**; VPF, VPPE, OLVP, APPV, VTD; 1200 Stewart St.; Seattle, WA 98101; (206) 623-5934.

**IRONWOOD STUDIOS**; VPF, VPPE, OLVP, APPV; 601 NW 80th St.; Seattle, WA 98117; (206) 789-7569; FAX: (206) 784-2880.

**LIGHTHOUSE MUSIC GROUP**; APPV; 15514 79th Ave. NE; Bothell, WA 98011; (206) 488-6022.

**MUSIC EXPRESS**; APPV; 2308 W. 2nd St.; Aberdeen, WA 98520; (206) 532-1858.

**PAGET SOUND VIDEO**; VPF, OLVP, APPV, VTD; 15524 72nd Ave. W.; Edmonds, WA 98020; (206) 745-1427.

**SOUND PRODUCTIONS**; VTD; 713 Fairview Ave. N.; Seattle, WA 98115; (206) 525-9999.

**VIDEO PRESENTATIONS, INC.**; VPF, VPPE, OLVP, VTD; 2326 6th Ave.; Seattle, WA 98121; (206) 728-9241.

**VTR PRODUCTIONS, INC.**; VPF, VPPE, OLVP, APPV, VTD; 8520 Roberts Dr.; Pasco, WA 99301; (509) 547-3535; FAX: (509) 545-1673.

#### WEST VIRGINIA

#### 24+ Track Recording Studios

► [24+] **CHANDLER AUDIO INC.**; AR, AD, APPV, EIR, JCP, MIDI, MP; 3030 Piedmont Rd.; Huntington, WV 25704; (304) 429-MIXX.

#### 4 & 8 Track Recording Studios

[8] **ACCURATE RECORDING**; AR; 952 Poplar Dr.; St. Albans, WV 25177; (304) 727-4008.

[8] **BLACK DOG RECORDING STUDIO**; AR, JCP, MIDI; 17 3rd St.; Elkins, WV 26241; (304) 636-1758.

[2] **LOU CASINI RECORDING**; AR, ATD, RLR; 1001 Neville St.; Follansbee, WV 26037; (304) 527-1758.

[8] **MEDIA PRODUCTIONS**; AR, AD, ATD, JCP, MIDI, MP; 125 Miller Ave.; Oak Hill, WV 25901; (304) 465-5786.

#### Video Production & Post-Production Facilities

**OMNI PRODUCTIONS**; OLVP; 1117 Virginia St. E.; Charleston, WV 25301; (304) 342-2624.

#### Mix Trivia

20. According to *Billboard*, this producer team is second to George Martin for most gold singles with 18, five of which came from work with the O'Jays.

Turn to page 152 for question



## Recording & Video Production Facilities

UNITED STATES

WISCONSIN

24+ Track Recording Studios



A.D. PRODUCTIONS, INC.  
Milwaukee, WI

>[24+] **A.D. PRODUCTIONS, INC.**; AR, APPV, APPF, JCP, MIDI, MP, ED, RLR, 411 E. Wisconsin Ave., Ste. 1001; Milwaukee, WI 53202; (414) 278-7999; FAX: (414) 278-1159.

>[24+] **BREEZEWAY RECORDING STUDIOS**; AR, APPV, APPF, JCP, MP, ED, 363 W. Main St.; Waukesha, WI 53186; (414) 547-5757.

[24+] **DIGITAL AUDIO RECORDING**; AR, MP, RLR, SR, W9643 Rucks Rd.; Cambridge, WI 53523; (608) 764-8082.

[24+] **HARTWOOD RECORDING**; AR, APPV, ATD, JCP, MP, 4607 Jeffers Rd.; Eau Claire, WI 54703; (715) 834-5122.

[24+] **HG STUDIO**; AR, APPV, JCP, MP, 21332 7 Mile Rd.; Franksville, WI 53126; (414) 425-3885; FAX: (414) 425-3885.

[24+] **MIDWEST RECORDERS, LTD.**; RLR, 807 W. Oklahoma Ave.; Milwaukee, WI 53215; (414) 483-5055.

>[24+] **ROYAL RECORDERS**; AR, Hwy. 50 East; Lake Geneva, WI 53147; (414) 248-9100.

### 12 & 16 Track Recording Studios

[16] **HAGGAR AUDIO PRODUCTIONS**; AR, APPV, ATD, 4902 Hammersley Rd.; Madison, WI 53711; (608) 274-4000; FAX: (608) 274-9357.

[16] **IRISH SAX, INC.**; AR, APPV, ATD, JCP, MIDI, MP, RLR, 1719 W. Washington St.; Appleton, WI 54914; (414) 735-0800; FAX: (414) 735-0874.

[16] **LAUGHING CAT STUDIO**; AR, AD, APPV, JCP, MIDI, MP, RLR, Rte. 4, 256 Walnut; Fort Atkinson, WI 53538; (414) 563-9935; FAX: (414) 563-8342.

[16] **NELSON PRODUCTIONS, INC.**; APPF, VP, 1533 N. Jackson St.; Milwaukee, WI 53202; (414) 271-5211.

[16] **NEW HORIZONS SINGERS RECORDING STUDIO**; RLR, 7722 W. National Ave.; West Allis (Milwaukee), WI 53214; (414) 774-8000.

[16] **RENWOOD RECORDING STUDIO**; AR, AD, JCP, 3510 60th St.; Kenosha, WI 53142; (414) 654-3376.

[16] **TELSTAR STUDIOS**; AR, AD, ATD, JCP, MIDI, MP, ED, MAST, 5225 University Ave.; Madison, WI 53705; (608) 231-6888.

[16] **THIRD COAST PRODUCTIONS**; AR, APPV, APPF, JCP, MIDI, PO Box 93802; Milwaukee, WI 53202; (414) 276-8926.

### 4 & 8 Track Recording Studios

[8] **THE BIG ELECTRIC CAT**; AR, APPV, MIDI, RLR, PO Box 2175; Madison, WI; (608) 255-5995.

[4] **BRAN-TAN ALLEY SOFTWARES**; MIDI, MP, 2139 N. 47th St.; Milwaukee, WI; (414) 444-2404.

[8] **CPI**; AR, APPV, ATD, RLR, VP, 804 N. Milwaukee; Milwaukee, WI 53202; (414) 291-9666; FAX: (414) 291-9585.

[4] **METRO VISUALS**; AR, APPV, ATD, MP, ED, RLR, RS, VP, 2517 N. 68th St.; Milwaukee, WI; (414) 258-9895.

[8] **PANTHER RECORDING STUDIO**; AR, ATD, MIDI, 2350 N. 81st St.; Wauwatosa, WI 53213; (414) 259-3975.

[4] **RSVP, INC.**; AR, APPV, ATD, RLR, VP, 7701 N. Teutonia Ave.; Milwaukee, WI 53209; (414) 354-6400; FAX: (414) 354-7303.

[8] **SOUND SHOP RECORDING STUDIO**; AR, 9250 N. Sleepy Hollow Ln.; Bayside, WI 53217; (414) 678-7766.

[8] **STACK RECORDING**; AR, MIDI, SR, 10260 S. Nicholson Rd.; Oak Creek, WI 53154; (414) 764-9680.

### Video Production & Post-Production Facilities

**CPI**; VPPE, OLVP; 804 N. Milwaukee; Milwaukee, WI 53202; (414) 291-9666; FAX: (414) 291-9585.

**MARX PRODUCTION CENTER**; VPF, VPPE, OLVP, APPV, 3100 W. Vera; Milwaukee, WI 53209; (414) 351-5060; FAX: (414) 351-4652.

**METRO VISUALS**; VPF, VPPE, OLVP, APPV, VTD, 2517 N. 68th St.; Milwaukee, WI; (414) 258-9895.

**NELSON PRODUCTIONS, INC.**; VPF, VPPE, 1533 N. Jackson St.; Milwaukee, WI 53202; (414) 271-5211.

**RSVP, INC.**; VPF, VPPE, OLVP, APPV, VTD, 7701 N. Teutonia Ave.; Milwaukee, WI 53209; (414) 354-6400; FAX: (414) 354-7303.

**RW VIDEO**; VPF, VPPE, OLVP, APPV, 4902 Hammersley Rd.; Madison, WI 53711; (608) 274-4000; (414) 524-8760 (Milwaukee).

WYOMING

4 & 8 Track Recording Studios

[8] **ROUGH CUT RECORDING**; AR, AD, ATD, EIR, JCP, RLR, SR, MAST; 2525 E. 12th St.; Cheyenne, WY 82001; (307) 638-9894.

### Video Production & Post-Production Facilities

**MEDIA WORKS, INC.**; VPF, 1250 Huff Ln.; Jackson Hole, WY 83001; (307) 733-1300.

**ROUGH CUT RECORDING**; VPF, OLVP, VTD, 2525 E. 12th St.; Cheyenne, WY 82001; (307) 638-9894.

WASHINGTON, DC

24+ Track Recording Studios

[24+] **INTERFACE VIDEO SYSTEMS, INC.**; APPV, APPF, 1233 20th St. NW; Washington, DC 20036; (202) 861-0500; FAX: (202) 296-4492.

[24+] **LION AND FOX RECORDING, INC.**; AR, APPV, APPF, ATD, JCP, MIDI, MP, RLR, MAST, 1905 Fairview Ave. NE; Washington, DC 20002; (202) 832-7883; FAX: (202) 636-8779.

>[24+] **POWERHOUSE STUDIOS**; 1155 21st St. NW; Washington, DC 20036; (202) 331-9600.

>[24+] **PREMIER RECORDING, INC.**; 2121 Wisconsin Ave. NW, Ste. 250; Washington, DC 20007; (202) 333-5588; FAX: (202) 337-6928.

>[24+] **SONIC IMAGES PRODUCTIONS, INC.**; RLR, 4590 MacArthur Blvd. NW; Washington, DC 20007; (202) 333-1063.

[24+] **SOUNDWAVE INC.**; AR, APPV, ATD, MIDI, MP, RLR, SR, 2000 P St. NW, 2nd Fl.; Washington, DC 20036; (202) 861-0560; FAX: (202) 466-2377.

### 12 & 16 Track Recording Studios

>[16] **AURA: THE AMERICAN UNIVERSITY RECORDING ASSOCIATES**; Physics Dept., Audio Tech. Program; 4400 Mass. Ave. NW; Washington, DC 20016; (202) 885-2759; (202) 885-2743.

### 4 & 8 Track Recording Studios

[2] **THE EDIT ROOM, INC.**; AR, APPV, APPF, RLR, VP, 2121 Wisconsin Ave.; Washington, DC 20007; (202) 333-1577.

### Video Production & Post-Production Facilities

**THE EDIT ROOM, INC.**; VPPE, APPV, 2121 Wisconsin Ave.; Washington, DC 20007; (202) 333-1577.

**INTERFACE VIDEO SYSTEMS, INC.**; VPF, VPPE, OLVP, APPV, VTD, 1233 20th St. NW; Washington, DC 20036; (202) 861-0500; FAX: (202) 296-4492.

**LION AND FOX RECORDING, INC.**; APPV, 1905 Fairview Ave. NE; Washington, DC 20002; (202) 832-7883; FAX: (202) 636-8779.

>**MICHAEL MOSER/MEDIA**; VPPE, OLVP, 2000 P St. NW, Ste. 301; Washington, DC 20036; (202) 293-1780; FAX: (202) 775-2443.

**POWERHOUSE STUDIOS**; VPF, APPV, 1155 21st St. NW; Washington, DC 20036; (202) 331-9600.

>**SKEHAN TELEVIDEO SERVICE, INC.**; OLVP, 316 F St. NE; Washington, DC 20002; (202) 543-2323; (800) 426-9083.

**SOUNDWAVE INC.**; APPV, 2000 P St. NW, 2nd Fl.; Washington, DC 20036; (202) 861-0560; FAX: (202) 466-2377.

>**TOWNHOUSE POST-PRODUCTION**; VPF, VPPE, 1449 N St. NW; Washington, DC 20005; (202) 462-EDIT.

Mix Trivia

22. In 1947, this company introduced the first commercially acceptable recording tape.

Turn to page 152 for question

## ANOTHER VICTIM OF GALLOPING CONSUMPTION.



Worldwide, fifty thousand acres of rainforest will be destroyed today. Paradise lost at horrendous cost to half the species left on earth. To ensure their survival, we must act now. Learn how by writing us.

**RAINFOREST  
ACTION NETWORK**

300 BROADWAY, SAN FRANCISCO, CA 94133

Public Media Center

# RECORDING & VIDEO PRODUCTION FACILITIES

C A N A D A

## ALBERTA

### 24+ Track Recording Studios

[24+] **METROMEDIA PRODUCTIONS**; AR, AD, APPV, APPF, JCP, MIDI, MP, MAST; 822 11th Ave. SW #301; Calgary, AB T2R 0E5; (403) 265-0258; FAX: (403) 265-4012.

>[24+] **SOUND SHADOW STUDIOS**; RLR; 9336 49 St.; Edmonton, AB T6B 2L7; (403) 468-1748.

[24+] **THE SUNDAE SOUND STUDIO LTD.**; RLR; 3516 1st St. NE; Calgary, AB T2E 3C9; (403) 230-2331; FAX: (403) 276-8187.

[24+] **WEST 11TH AUDIO**; AR, APPV, APPF, JCP, MIDI, MAST; 822 11th Ave. SW, Ste. 306; Calgary, AB T2R 0E5; (403) 265-0258; FAX: (403) 265-4012.

### 4 & 8 Track Recording Studios

[8] **A CAPPELLA/MOST UNUSUAL MUSIC**; AR, ADS, JCP, MIDI, ED, SR; #14 Oriole Rd. N.; Lethbridge, AB; (403) 328-4261.

### Video Production & Post-Production Facilities

**CISA-TV LETHBRIDGE TELEVISION**; VPF, VPPE, OLVP, VTD; 1401 28th St. N.; Lethbridge, AB; (403) 327-1521; FAX: (403) 320-2620.

**STUDIO POST & TRANSFER**; VPF, VPPE, VTD; 5305 104th St.; Edmonton, AB T6H 5B8; (403) 436-4444; Telex: (403) 438-8495.

**THE SUNDAE SOUND STUDIO LTD.**; VPPE, APPV; 3516 1st St. NE; Calgary, AB T2E 3C9; (403) 230-2331; FAX: (403) 276-8187.

**T.V. 6 & 3**; VPF, VPPE, OLVP, VTD; Box 600; Redcliff, AB T0J 2P0; (403) 548-3919; FAX: (403) 548-7253.

**WEST 11TH AUDIO**; APPV; 822 11th Ave. SW, Ste. 306; Calgary, AB T2R 0E5; (403) 265-0258; FAX: (403) 265-4012.

## BRITISH COLUMBIA

### 24+ Track Recording Studios

[24+] **INSIDE TRAK STUDIOS LTD.**; AR; 7490 Edmonds St.; Burnaby, BC V3N 1B4; (604) 525-3422.

[24+] **THE LITTLE MOUNTAIN SOUND STUDIOS LTD.**; 201 W. 7th Ave.; Vancouver, BC V5Y 1L9; (604) 873-4711.

>[24+] **MUSHROOM STUDIOS**; AR, JCP, MIDI, MP; 1234 W. 6th Ave.; Vancouver, BC V6H 1A5; (604) 734-1217; FAX: (604) 734-3901.

[24+] **PHOENIX RECORDERS**; AR, APPV, APPF, ATD, JCP, MIDI; 1295 W. Broadway; Vancouver, BC V6H 3X8; (604) 737-8011; FAX: (604) 737-8433.

[24+] **PINEWOOD STUDIOS**; AR, APPV, APPF, MP; 1119 Homer St.; Vancouver, BC V6B 2Y1; (604) 669-6900; FAX: (604) 669-0040.

[24+] **PROFILE SOUND STUDIO LTD.**; AR, MIDI; 3448 Commercial St.; Vancouver, BC; (604) 875-6821.

>[24+] **SPOT SHOP STUDIO, INC.**; 1720 W. 2nd Ave.; Vancouver, BC V6J 1H6; (604) 736-7474.

[24+] **TURTLE MOBILE RECORDING LTD.**; RLR; 316 E. 1st Ave.; Vancouver, BC V5T 1A9; (604) 872-3447; (206) 453-7875 (Seattle); FAX: (604) 872-1296.

### 12 & 16 Track Recording Studios

>[16] **BULLFROG RECORDING STUDIOS**; RLR; 2475 Dunbar St.; Vancouver, BC V6R 3N2; (604) 734-4617.

[16] **LOWE-KEY PRODUCTIONS**; AR, APPV, APPF, JCP, MIDI, MP, ED; 2550 E. Pender St.; Vancouver, BC V5K 2B5; (604) 253-2096.

[16] **PERRY'S RECORDING STUDIO**; AR, JCP, RLR; Box 731; Chase, BC V0E 1M0; (604) 679-8854.

>[16] **RIDGE ROAD STUDIOS**; 7186 205 St.; Langley, BC V3A 4P7; (604) 534-3415.

[16] **STUDIOPLEX PRODUCTION SERVICES LTD.**; AR, AD, APPV, ATD, EIR, JCP, MIDI, MP, ED, SR, VP; 4429 Juneau St.; Burnaby, BC V5C 4C4; (604) 294-6887; FAX: (604) 294-6887.

### Video Production & Post-Production Facilities

**COMMERCIAL ELECTRONICS LTD.**; VPPE; 1335 Burrard St.; Vancouver, BC V6Z 1Z7; (604) 669-5525; FAX: (604) 669-6347.

**PHOENIX RECORDERS**; APPV; 1295 W. Broadway; Vancouver, BC V6H 3X8; (604) 737-8011; FAX: (604) 737-8433.

**STUDIOPLEX PRODUCTION SERVICES LTD.**; VPF, VPPE, OLVP, APPV; 4429 Juneau St.; Burnaby, BC V5C 4C4; (604) 294-6887; FAX: (604) 294-6887.

## MANITOBA

### Video Production & Post-Production Facilities

**RICK KIZUK VIDEO PRODUCTIONS LTD.**; VPPE, OLVP, VTD; 102 Penne Father Bay; Winnipeg, MB R2G 2T9; (204) 667-6339.

## NEW BRUNSWICK

### 4 & 8 Track Recording Studios

[8] **REEL NORTH RECORDING STUDIOS**; AR, ATD, JCP, MIDI, MP; 741 McEvoy St.; Fredericton, NB E3A 3B8; (506) 450-3299.

## NEWFOUNDLAND

### 12 & 16 Track Recording Studios

[16] **STUDIO 303-B**; RLR; Box 184, Isle Aux Morts; Newfoundland, NF A0M 1J0; (709) 698-3874.

## NOVA SCOTIA

### 4 & 8 Track Recording Studios

[8] **REEL TIME RECORDERS LTD.**; RLR; 1489 Hollis St.; Halifax, NS B3J 3M5; (902) 422-8567.

## ONTARIO

### 24+ Track Recording Studios

[24+] **AIRWAVES AUDIO, INC. RECORDING STUDIOS**; AR, APPV, JCP; 15 Toronto St., Lower Level; Toronto, ON M5C 2E3; (416) 863-6881; FAX: (416) 867-9107.

>[24+] **A.R.P. TRAK PRODUCTIONS**; AR, APPV, APPF, JCP, MIDI, ED; 28 Valrose Dr.; Stoney Creek, ON L8E 3T4; (416) 662-2666.

[24+] **AXON MUSIC PRODUCTIONS, INC.**; 375 Fairlawn Ave.; Toronto, ON M5M 1T7; (416) 781-4065.

>[24+] **BROCK SOUND POST AUDIO**; 576 Manning Ave.; Toronto, ON M6G 2V9; (416) 534-7464.

[24+] **CHERRY BEACH SOUND LTD.**; 16 Munition St.; Toronto, ON M5A 3M2; (416) 461-4224; (416) 461-4607.

>[24+] **COMFORT SOUND**; AR, APPV, ATD, RLR; 26 Soho St., Ste. 390; Toronto, ON M5T 1Z7; (416) 593-7992; FAX: (416) 593-7301.

[24+] **THE COMMAND POST & TRANSFER CORPORATION**; RLR; 179 John St., 8th Fl.; Toronto, ON M5T 1X4; (416) 585-9995; FAX: (416) 979-0428.

## RECORDING STUDIOS SERVICES KEY

The following codes refer to the types of services available at the listed recording & video production facilities. Information was supplied by those listed, so please call the facilities directly to verify critical information.

**AR** Audio Recording  
**AD** Artist Development Services  
**APPV** Audio Post-Production for Video  
**APPF** Audio Post-Production for Film  
**ATD** Audio Tape Duplicating  
**EIR** Equipment/Instrument Rental

**JCP** Jingle/Commercial Production  
**MIDI** MIDI Music Production  
**MP** Music Production Services  
**ED** Recording Education  
**RLR** Remote/Location Recording  
**RS** Residential Services

**SR** Sound Reinforcement Services  
**SDS** Studio Design/Supply  
**MAST** Tape/Disc Mastering  
**VP** Video Production Services

## VIDEO PRODUCTION/POST-PRODUCTION FACILITIES SERVICES KEY

**APPV** Audio Post-Production for Video  
**OLVP** On-Location Video Production

**VPF** Video Production for Film  
**VPPE** Video Post-Production/Editing

**VTD** Videotape Duplicating



## Recording & Video Production Facilities

CANADA

ONTARIO

24+ Track Recording Studios

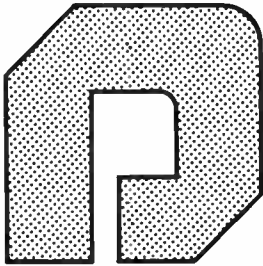

# Discovery Productions

DISCOVERY PRODUCTIONS  
Toronto, ON

[24+] **DISCOVERY PRODUCTIONS**; AR, APPV, APPF, RLR, VP; 50 Widmer St.; Toronto, ON M5V 2E9; (416) 596-8310; FAX: (416) 596-1149.

[24+] **EASTERN SOUND**; AR, APPV, ATD, VP; 48 Yorkville Ave.; Toronto, ON M4W 1L4; (416) 968-1855; FAX: (416) 968-7315.

[24+] **E.M.A.C. SOUND RECORDING STUDIOS**; 343 Richmond St., Ste. 301; London, ON N6A 3C2; (519) 667-3622.

[24+] **EMMANUEL PRODUCTIONS**; AR, APPV, APPF, ATD, MIDI, MP, MAST; 31 B Industrial St.; Toronto, ON M4G 1Z2; (416) 423-7131; FAX: (416) 467-6805.

[24+] **GRANT AVENUE STUDIO (1985) INC.**; AR; 38 Grant Ave.; Hamilton, ON L8N 2X5; (416) 522-5227.

[24+] **INCEPTION SOUND STUDIOS**; 3876 Chesswood Dr.; Toronto, ON M3J 2W6; (416) 630-7150.

[24+] **KEEN COMMUNICATION SYSTEMS INCORPORATED**; AR, APPV, JCP, MIDI, MP; 11 Soho St., Ste. 203; Toronto, ON M5T 1Z6; (416) 977-9845; FAX: (416) 599-9714.

[24+] **KENSINGTON SOUND**; AR, AD, JCP, MIDI, MP, ED; 170 A Baldwin St.; Toronto, ON M5T 1L8; (416) 593-9607; FAX: (416) 593-0461.

[24+] **MAGDER ENTERTAINMENT CORP.**; 189 Church St.; Toronto, ON M5B 1Y7; (416) 866-2121.

[24+] **MAGNETIC FAX**; APPV; 550 Queen St. E., Ste. 205; Toronto, ON M5A 1V2; (416) 367-8477; FAX: (416) 367-8356.

[24+] **MANTA SOUND**; 311 Adelaide St. E.; Toronto, ON M5A 1N2; (416) 863-9316.

[24+] **MARC PRODUCTIONS (1986) LTD.**; AR, APPV, ATD, JCP, MIDI, MP, VP; 1163 Parisien St.; Ottawa, ON K1B 4W4; (613) 741-9851; FAX: (613) 748-0981.

[24+] **MASTER'S WORKSHOP**; AR, APPV, APPF, MIDI, MP, RLR; 306 Rexdale Blvd., Ste. 7; Rexdale, ON M9W 1R6; (416) 741-1312; FAX: (416) 741-1894.

[24+] **MASTERTRACK LTD.**; AR, APPV, JCP, MIDI, MP, SDS; 35A Hazelton Ave.; Toronto, ON M5R 2E3; (416) 922-4004; FAX: (416) 922-8634.

[24+] **MCCLEAR PLACE RECORDING & MASTERING STUDIOS**; AR, APPV, APPF, SDS, MAST; 225 Mutual St.; Toronto, ON M5B 2B4; (416) 977-9740; FAX: (416) 977-7147.

[24+] **METALWORKS RECORDING STUDIOS, INC.**; AR, APPV, APPF, MP; 3611 Mavis Rd., Unit 5; Mississauga, ON L5C 7T7; (416) 279-4008; FAX: (416) 279-4006.



METALWORKS RECORDING STUDIOS, INC.  
Mississauga, ON

[24+] **PHASE ONE RECORDING STUDIOS**; AR, APPV, APPF, EIR; 3015 Kennedy Rd., Unit 10; Scarborough, ON; (416) 291-9553; FAX: (416) 299-1398.

[24+] **POLARIS PRODUCTIONS LTD.**; AR, AD, APPV, APPF, JCP, MIDI, MP, ED, RLR, SR; 1151 Drouilliard Rd.; Windsor, ON N8Y 2R2; (519) 973-4944.

[24+] **QUEST RECORDING STUDIO**; AR; 215 Toronto Ave.; Oshawa, ON L1H 3C2; (416) 576-1279.

[24+] **REACTION STUDIOS**; AR, APPV, MIDI, MP; 72 Stafford St.; Toronto, ON M5J 1M7; (416) 865-9468; FAX: (416) 756-4778.

[24+] **REAL TO REEL SOUND STUDIOS**; 379 Shuter St.; Toronto, ON; (416) 360-7836; FAX: (416) 360-8302.

[24+] **THE RIVER STUDIOS**; RLR; 133 Niagara Blvd.; PO Box 1003, Station B; Fort Erie, ON L2A 5N8; (416) 871-6230; FAX: (416) 871-5273.

98

# Write or Call for FREE CATALOG

Toll Free: 1-800-331-3191  
In USA & Canada

NYC Area: 516-678-4414  
FAX: 516-678-8959



Distributors of **3M** Professional  
Audio and Video Products including:

- Digital Mastering Tape
- Logging Tape
- Leader & Splicing Tape
- Reels, Boxes, Flanges
- All hard-to-get audio & video products
- Custom loaded cassettes
- R-DAT & other packaged cassettes
- Calibration Tape & Splicing Blocks

Shipped From Stock - Priced Right - Immediate Delivery

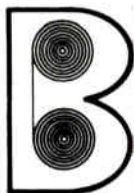

## Burlington Audio / Video Tapes, Inc.

106 Mott Street • Oceanside, New York 11572

[24+] **THE ROOM RECORDING STUDIO, INC.;** 3615 Weston Rd., Unit 10; Weston, ON; (416) 746-8375.

[24+] **ROUND SOUND STUDIOS, INC.;** AR, EIR, MIDI, MP; 357 Ormont Dr.; Weston, ON M9L 1N8; (416) 743-9979; FAX: (416) 463-8233.

[24+] **RPM PRODUCTIONS;** 2196 Dunwin Dr.; Mississauga, ON L5J 2J9; (416) 828-6406.

> [24+] **SOUND IDEAS;** AR, APPV, MP; 105 W. Beaver Creek Rd., Ste. 4; Richmond Hill, ON L4B 1C6; (416) 886-5000; FAX: (416) 886-6800.

[24+] **SOUND RECORDING STUDIOS;** AR, APPV, JCP, MIDI, MP, RLR; 500 Newbold St.; London, ON; (519) 686-5060.

[24+] **SOUNDMIX LTD.;** AR, APPV, APPF; 22 Boston Ave.; Toronto, ON; (416) 462-2222; FAX: (416) 462-2224.

[24+] **SOUNDS INTERCHANGE LTD.;** AR, APPV, APPF, ATD, RLR, SDS; 506 Adelaide St. E.; Toronto, ON M5A 1N6; (416) 364-8512; FAX: (416) 866-7968.

> [24+] **SPENCE-THOMAS PRODUCTIONS LTD.;** 45 Charles St. E.; Toronto, ON M4Y 1S2; (416) 961-3911.

[24+] **SRS SOUND RECORDING STUDIOS;** RLR; 500 Newbold St.; London, ON N6E 1K6; (519) 686-5060.

[24+] **STUDIO 'B';** AR, JCP, MIDI; 983 Victoria Park Ave.; Toronto, ON M4B 2J4; (416) 757-4891.

> [24+] **STUDIO 306;** AR, APPV, APPF; 306 Seaton St.; Toronto, ON M5A 2T7; (416) 968-2306; FAX: (416) 968-3219.

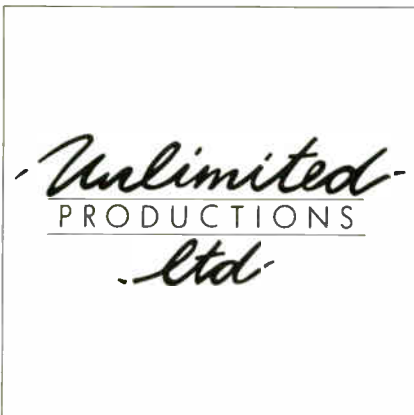

UNLIMITED PRODUCTIONS, LTD. DIVISION, THE UNLIMITED GROUP  
Toronto, ON

[24+] **UNLIMITED PRODUCTIONS, LTD. DIVISION, THE UNLIMITED GROUP;** APPF, APPV, MIDI, MP, RLR, SR; 122 St. Patrick St., Ste. #506; Toronto, ON M5T 2X8; (416) 591-9100; FAX: (416) 591-6375.

[24+] **DON VALLEY SOUND;** AR, MIDI, MP, VP; 210 Don Park Rd., Unit 5; Markham, ON L3R 2V2; (416) 470-9477.

[24+] **WAXWORKS PRODUCTIONS;** AR, APPV, ATC, JCP, MIDI, MP, VP; Box 299; St. Jacobs, ON N0B 2N0; (519) 664-3762; FAX: (519) 664-3554.

[24+] **WELLESLEY SOUND STUDIO, INC.;** RLR; 106 Ontario St.; Toronto, ON M5A 2V4; (416) 364-9533.

[24+] **WINFIELD SOUND;** AR, APPV, APPF, MIDI, MP; 189 Church St.; Toronto, ON; (416) 748-2969; FAX: (416) 869-1267.

#### Mix Trivia

21. Prior to opening a New York studio, then adding an L.A. studio, then adding a San Francisco Bay Area studio, this well-known studio owner was a national sales manager for Revlon Cosmetics.

23. This San Francisco band was the first to record a live album on 16-track. The year was 1969.

Turn to page 152 for question

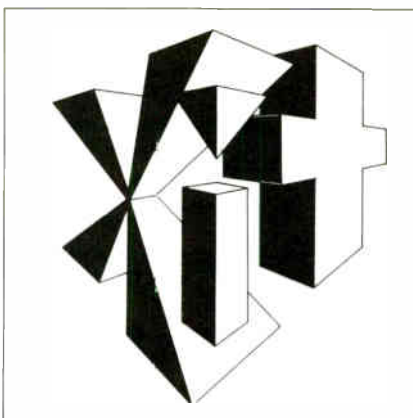

X-IT MUSIC PRODUCTIONS  
Toronto, ON

[24+] **X-IT MUSIC PRODUCTIONS;** AR, AD, APPV, JCP, MIDI, MP, VP; 15 Ossington Ave.; Toronto, ON M6J 2Y8; (416) 533-1861; FAX: (416) 536-1861.

#### 12 & 16 Track Recording Studios

[16] **CERTAIN CIRCLES STUDIOS;** AR, JCP, MIDI, MP, SR; 120B Barbados Blvd. U #4; Scarborough, ON M1J 1L2; (416) 267-3488.

[16] **COLBECK STUDIO;** AR; 120 Colbeck St.; Toronto, ON M6S 1V5; (416) 766-7727.

[16] **THE DEMO FACTORY;** AR, EIR, JCP, MIDI, RLR; 127 Manville Rd. Unit 9; Scarborough, ON M1L 4J7; (416) 288-9967.

[16] **HARLOW SOUND;** AR, AD, JCP; 31 Harlow Cres.; Rexdale, ON; (416) 741-0165.

[16] **HOFFERT MUSIC;** AR, JCP, MIDI, MP, MAST; 73 Brookview Dr.; Toronto, ON M6A 2K5; (416) 781-4191; FAX: (416) 787-7728.

[16] **NEW IMAGE SOUND PRODUCTIONS;** AR, APPV; 150 Longboat Ave., Ste. #709; Toronto, ON M5A 4G4; (416) 360-7940.

[16] **ORCHARD STUDIO;** AR, MP, SR; 8672 Heritage Rd.; Norval, ON L0P 1K0; (416) 451-2804.

[16] **POWERLINES RECORDING STUDIO;** AR, APPV, APPF, JCP, ATD, MIDI, RLR, MAST; 51 Kingspark Blvd.; Toronto, ON M4J 2B9; (416) 466-6517.

[16] **PYRAMID PRODUCTIONS;** AR, AD, APPV, JCP, MIDI, MP; 128 Hartzel Rd.; St. Catharines, ON L2P 1N7; (416) 641-0292; FAX: (416) 641-0292.

[16] **REELS IN MOTION;** AR, RLR; PO Box 71; West Hill, ON M1E 4R8; (416) 282-0655.

[16] **SHAG SOUND STUDIO;** AR, MP; PO Box 518, Postal Station "W"; Toronto, ON M6M 5C2; (416) 652-5485.

[16] **SOUND PROOFS;** AR, APPV, APPF, JCP, MIDI, MP, MAST, VP; 37 Scarborough Rd.; Toronto, ON M4E 3M4; (416) 690-3888.

[16] **STUDIO B RECORDING;** AR, AD, JCP, RLR, SRS; 1029 Tiny Beaches Rd.; Bluewater Beach, ON; (705) 361-2460.

#### 4 & 8 Track Recording Studios

[8] **AIRBOURNE AUDIO;** AR, JCP, MIDI, RLR; 50 Abbeywood Cres.; Bowmanville, ON L1E 1N8; (416) 436-0771.

[8] **COW + HEN PRODUCTIONS;** AR, AD, APPV, EIR, JCP, MIDI, MP, ED, RLR; 439 King St. E. #5; Toronto, ON M5A 1L5; (416) 364-9813.

[8] **MONSTER SOUND;** AR, JCP, MIDI, MP, MAST; 151 Lippincott St.; Toronto, ON M5S 2P3; (416) 921-7698.

[8] **MUSIC GALLERY;** AR; 1087 Queen St. W.; Toronto, ON M6J 1H3; (416) 534-6311.

[8] **VENTURE SOUND PRODUCTIONS;** AR, RLR; 45 Player Cres.; Toronto, ON M4K 1S4; (416) 461-1566.

# FULL SAIL CENTER FOR THE RECORDING ARTS



ORLANDO • LOS ANGELES  
3300 UNIVERSITY BLVD  
WINTER PARK, FL 32792  
800-221-2747  
IN FL: 407-679-6333

1989 TEC AWARD WINNER  
1990 TEC AWARD NOMINEE  
THE INDUSTRY LEADER IN  
AUDIO, VIDEO AND FILM  
EDUCATION SINCE 1979

# SHARPENING THE CUTTING EDGE



## Recording & Video Production Facilities

CANADA

### ONTARIO

#### Video Production & Post-Production Facilities

**ALNDON GROUP PRODUCTIONS INC.;** VPPE, OLVP, VTD; 111 Queen St. E., Ste. 430; Toronto, ON; (416) 361-5800; FAX: (416) 361-3128.

**THE COMMAND POST & TRANSFER CORPORATION;** VPPE, APPV; 179 John St., 8th Fl.; Toronto, ON M5T 1X4; (416) 585-9995; FAX: (416) 979-0428.

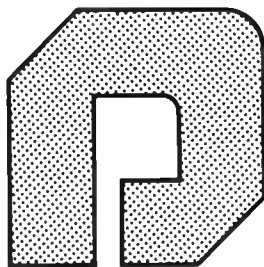

# Discovery Productions

DISCOVERY PRODUCTIONS  
Toronto, ON

**DISCOVERY PRODUCTIONS;** APPV; 50 Widmer St.; Toronto, ON M5V 2E9; (416) 596-8310; FAX: (416) 596-1149.

**ECHOSPHERE PRODUCTIONS;** VPF, VPPE, OLVP, APPV; 37 Scarborough Rd.; Toronto, ON M4E 3M4; (416) 690-3888.

**LALA SOUND;** VPPE, APPV; 322 Oufferin St.; Toronto, ON M6K 1Z6; (416) 534-4211.

**MAGNETIC FAX;** VPPE, APPV; 550 Queen St. E., Ste. 205; Toronto, ON M5A 1V2; (416) 367-8477; FAX: (416) 367-8356.

**MARC PRODUCTIONS (1986) LTD.;** VPF, VPPE, OLVP, APPV, VTD; 1163 Parisien St.; Ottawa, ON K1B 4W4; (613) 741-9851; FAX: (613) 748-0981.

**MASTERTRACK LTD.;** APPV; 35A Hazelton Ave.; Toronto, ON M5R 2E3; (416) 922-4004; FAX: (416) 922-8634.

**MCCLEAR PLACE RECORDING & MASTERING STUDIOS;** APPV; 225 Mutual St.; Toronto, ON M5B 2B4; (416) 977-9740; FAX: (416) 977-7147.

**MCCLEAR PATHE/POST PRODUCTION STUDIO;** APPV; 121 St. Patrick St.; Toronto, ON M4W 3G9; (416) 598-2521; FAX: (416) 598-5247.

**MOTION PICTURE VIDEO CORP.;** VPPE, APPV; 189 Church St.; Toronto, ON; (416) 863-6414; FAX: (416) 863-9401.

**OASIS TELEFACILITIES CORPORATION;** VPPE, APPV; 120 Parliament St.; Toronto, ON; (416) 863-1322; FAX: (416) 369-1072.

**OASIS TELEFACILITIES CORPORATION;** OLVP; 793 Pharmacy Ave.; Scarborough (Toronto), ON; (416) 750-0000; FAX: (416) 750-0001.

**PYRAMID PRODUCTIONS;** APPV; 128 Hartzel Rd.; St. Catharines, ON L2P 1N7; (416) 641-0292; FAX: (416) 641-0292.

**SOUNDMIX LTD.;** VPPE, APPV; 22 Boston Ave.; Toronto, ON; (416) 462-2222; FAX: (416) 462-2224.

**SOUNDS INTERCHANGE LTD.;** APPV; 506 Adelaide St. E.; Toronto, ON M5A 1N6; (416) 364-8512; FAX: (416) 866-7968.

**STUDIO 306;** APPV; 306 Seaton St.; Toronto, ON M5A 2T7; (416) 968-2306; FAX: (416) 968-3219.

**VTR/EASTERN SOUND;** VPF, VPPE, APPV, VTD; 48 Yorkville Ave.; Toronto, ON M4W 1L4; (416) 968-1822; FAX: (416) 968-7315.

**WAXWORKS PRODUCTIONS;** VPF, VPPE, OLVP, APPV, VTD; Box 299; St. Jacobs, ON N0B 2N0; (519) 664-3762; FAX: (519) 664-3554.

### QUEBEC

#### 24+ Track Recording Studios

[24+] **A.R.P. TRACK PRODUCTIONS;** AR, APPV, APPF, JCP, MIDI, ED; 34 Chemin des Ormes; Ste. Anne des-Lacs, QC J0R1B0; (514) 224-8363.

> [24+] **CINAR STUDIOS, INC.;** 1207 St. Andre St.; Montreal, QC H2L 3S8; (514) 843-7070; FAX: (514) 843-7080.

[24+] **KARISMA AUDIO POST VIDEO & FILM;** AR, APPV, APPF, JCP, ED, RLR, SRS; 1565 Iberville, Ste. 203; Montreal, QC H2K 3B8; (514) 522-0802; FAX: (514) 527-2326.

> [24+] **LE STUDIO MORIN HGTS.;** AR, APPV, RS; 201 Perry Rd.; Morin Hgts., QC J0R 1H0; (514) 226-2419; FAX: (514) 226-5409.

> [24+] **LE TUBE;** 225 Rue Roy; Montreal, QC H2W 2N6; (514) 481-2048.

[24+] **MONTREAL SOUND STUDIOS;** AR, AD, APPV, JCP, MIDI, MP; 5000 Buchan St., Ste. 601; Montreal, QC H4P 1T2; (514) 738-1300; FAX: (514) 733-9932.

[24+] **STUDIO MULTISONS, INC.;** AR, APPV, APPF, JCP; 1208 Rue Beaubien Est., Bureau 101; Montreal, QC H2S 1T7; (514) 272-7641; (514) 272-8794; FAX: (514) 272-3191.

> [24+] **STUDIO PLACE ROYALE, INC.;** AR, APPV, APPF; 640 St. Paul W. (6th Floor); Montreal, QC H3C 1L9; (514) 866-6074.

> [24+] **STUDIO SAINT-CHARLES;** 85 Grant; Longueuil, QC J4H 3H4; (514) 674-4927.

#### 12 & 16 Track Recording Studios

[16] **SEQUENCE STUDIO;** AR, AD, APPV, APPF, ATD, JCP, MIDI, MP, RLR; 43 Cote de la Camoterie; Quebec, QC G1K 3X5; (418) 694-0111.

> [16] **STUDIO 270;** 270 Outremont Ave.; Montreal, QC H2V 3M1; (514) 270-4918.

#### 4 & 8 Track Recording Studios

[2] **PAVANNE AUDIO RECORDING;** RLR; Box 7, Place du Parc; Montreal, QC H2W 2M9; (514) 485-7955.

#### Video Production & Post-Production Facilities

**CENTRE DE MONTAGE ELECTRONIQUE;** VPPE; 1600 Est Maisonneuve; Montreal, QC H2L 4P2; (514) 598-2938; FAX: (514) 526-3417.

**GROUPE ANDRE PERRY, INC.;** VPPE; 1501 Rue Barre; Montreal, QC H3C 4J1; (514) 932-3500; FAX: (514) 932-3081.

> **STUDIO PLACE ROYALE, INC.;** APPV; 640 St. Paul W. (6th Floor); Montreal, QC H3C 1L9; (514) 866-6074.

> **STUDIO SAINT-CHARLES;** APPV; 85 Grant; Longueuil, QC J4H 3H4; (514) 674-4927.

**STUDIO TEMPO INC.;** APPV; 0707 Charlevoix St.; Montreal, QC H3K 2Y1; (514) 937-9571.

### SASKATCHEWAN

#### 24+ Track Recording Studios

[24+] **AUDIO ART RECORDING STUDIOS;** RLR; 628 B Broadway Ave.; Saskatoon, SK S7N 1A9; (306) 664-3156.

> [24+] **STUDIO WEST CANADA LTD.;** AR, AD, JCP, MIDI, MP, ED, RLR, RS, VP; 502 45th St. W.; Saskatoon, SK S7L 6H2; (306) 244-2815; FAX: (306) 242-3301.

#### 12 & 16 Track Recording Studios

[16] **RIGHT TRACKS PRODUCTIONS LTD.;** RLR; 226 B Portage Ave.; Saskatoon, SK; (306) 933-4949.

#### Video Production & Post-Production Facilities

**MEDIA HOUSE PRODUCTIONS, INC.;** VPPE; 1174 Winnipeg St.; Regina, SK S4R 1J6; (306) 359-0977; FAX: (306) 569-2240.

# 2 Ways To Duplicate Your Master Audio Tape For Demos Or Retail Sales

## AUDIO CASSETTES:

Eva-Tone is a full-service supplier, offering duplication, labeling, packaging, additional printing and complete mailing services. Write or call for your free copy of "Cassette Talk," our newsletter complete with information, specs, layout sheets and prices.

## SOUNDSHEETS:

Use these thin, flexible vinyl recorded discs as audio pages in magazines, as direct mail inserts, as handouts at concerts or trade shows, or even as retail products. Write or call for your free copy of our Soundsheet Idea Kit, complete with information, samples, specs, layout sheets and prices.

## PRINTING & MAILING:

Ask your Eva-Tone Representative about our commercial printing and mailing services, too. We just may be the full-service promotional supplier you've been looking for!

**EVA-TONE**  
INCORPORATED

P.O. Box 7020-MX, Clearwater, Florida 34618-7020  
Toll-Free 1-800-EVA-TONE



# SOUND REINFORCEMENT & REMOTE RECORDING FACILITIES

UNITED STATES & CANADA

## NORTHEAST U.S.

Connecticut, Delaware, Maine, Maryland, Massachusetts, New Hampshire, New Jersey, New York, Pennsylvania, Rhode Island, Vermont

**A&J REINFORCEMENT;** 3217 Cold Springs Rd.; Baldwinsville, NY 13027-9403; (315) 638-8627.

**ACE AUDIO VISUAL CO.;** *Sound Reinf., Rental, Staging;* 13 E. 31st St., New York, NY 10016; 33-49 55th St.; Woodside, NY 11377; (718) 458-3800; FAX: (718) 899-1995.

**ACE SOUND & LIGHTING;** *Sound Reinf., Rental;* PO Box 1183; Bellmawr, NJ 08031; (609) 456-2774; FAX: (609) 467-5294.

**A.D.R. STUDIOS, INC.;** *Sound Reinf., Audio Recording;* Skylight Run, Taxter Rd.; Irvington, NY 10533; (212) 486-0856.

**ADVENT CONCERT SERVICES;** *Sound Reinf., Lighting, Rental, Staging;* 278 Grant St.; Buffalo, NY 14213; (716) 882-5360; FAX: (716) 885-0533.

**AMERICAN VIDEO PRODUCTIONS;** *Video Recording;* 110 Antwerp St.; Milton, MA 02186; (617) 698-1525; FAX: (617) 698-1521.

**>ANDREWS AUDIO CONSULTANTS;** *Sound Reinf., Rental;* 347 W. 39th St.; New York, NY 10018; (212) 736-9570; FAX: (212) 736-5961.

**APPLIED AUDIO;** *Sound Reinf., Lighting, Staging, Rental;* 2 Townline Cir.; Rochester, NY 14623; (716) 272-9280; FAX: (716) 272-1156.

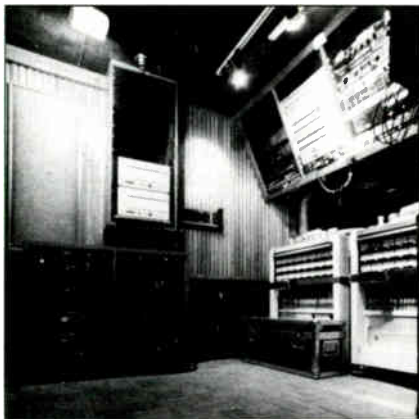

ASL MOBILE AUDIO  
Flushing, NY

**>ASL MOBILE AUDIO;** *Audio Recording;* PO Box 791; Flushing, NY 11352; (718) 886-6500; FAX: (718) 886-7214.

**ATLANTIC PROFESSIONAL STAGE LIGHTING;** *Sound Reinf., Lighting, Rental;* 2900 Whittington Ave.; Baltimore, MD 21230; (301) 525-2525.

**AUDIO ANALYSTS U.S.A., INC.;** *Sound Reinf.;* 13 Industrial Blvd. W.; Plattsburgh, NY 12901; (518) 561-5071; FAX: (518) 561-3617.

**AUDIO ARTISTRY;** *Sound Reinf., Lighting, Rental;* 13909 Saratoga Ave.; Laurel, MD 20707; (301) 498-4145.

**AUDIO PROMEDIA;** *Sound Reinf.;* 114 Old Amherst Rd.; Sunderland, MA 01375; (413) 665-7122; FAX: (413) 665-7122.

**AUDIO SERVICES AND DESIGN;** *Sound Reinf.;* 8 Meadow Pl.; North Haledon, NJ 07508; (201) 427-6503.

**AUDIO TECHNOLOGIES;** *Sound Reinf.;* PO Box 259; Watertown, CT; (203) 274-2202; (203) 274-2072; FAX: (203) 274-2072.

**AUDIO 300, INC.;** *Sound Reinf., Lighting, Rental, Staging;* 60 Dott Ave.; Albany, NY 12205; (518) 489-5848; FAX: (518) 489-8059.

**AUDIOVISIONS;** *Audio and Video Recording;* 7 Rockford Rd., Ste. 29 B; Wilmington, DE 19806; (302) 651-7955.

**THE AUDIO WORKSHOP;** *Sound Reinf., Rental;* 1728 Leishman Ave.; Arnold, PA 15068; (412) 335-7766.

**AUDIOVISUAL COMMUNICATIONS, INC.;** *Audio and Video Recording;* 435 Crooked Ln.; King of Prussia, PA 19406; (215) 272-8500; FAX: (215) 272-8604.

**AURA SONIC LTD.;** *Audio Recording;* PO Box 791; Flushing, NY 11352; (718) 886-6500; FAX: (718) 886-7214.

**>BACKTRACKS LOCATION DIGITAL;** *Audio Recording;* 5 School Ave.; Montpelier, VT 05602; (802) 223-2551; FAX: (802) 229-1834.

**BOB BALZARIM SOUND SVC.;** *Audio and Video Recording;* 48-51 Bell Blvd.; Bayside, NY 11364; (718) 423-7507.



BIG MO RECORDING  
Wheaton, MD

**>BIG MO RECORDING;** *Audio and Video Recording;* 11264 Triangle Ln.; Wheaton, MD 20902; (301) 946-7364; FAX: (301) 946-1687.

**BLACK DIAMOND SOUND;** *Sound Reinf., Lighting, Rental, Staging;* Box 262; Carteret, NJ 07008-0262; (201) 969-2026; (201) 647-0327.

**BRANDYWINE ELECTRONICS LTD.;** *Sound Reinf., Rental;* 432 Ayre St.; Newport, DE 19804; (302) 999-9992; FAX: (302) 998-6203.

**CAPITAL SOUND REINFORCEMENT;** *Sound Reinf., Rental;* 10 Raspberry Dr.; Ballston Spa, NY 12020; (518) 885-0770.

**CAPRON INC.;** *Sound Reinf., Lighting, Rental, Staging;* 278 West St.; Needham, MA 02194; (617) 444-8850; FAX: (617) 444-1408.

**CAPTAIN FIDDLE MUSIC;** *Sound Reinf., Audio Recording;* 4 Elm Ct.; Newmarket, NH 03857; (603) 659-2658.

**CARRAIG PRODUCTIONS;** *Audio Recording;* 69-40 108th St.; Forest Hills, NY 11375; (718) 575-8939.

**CASSETTE STUDIOS OF AMERICA;** *Audio Recording;* 342 Parker Rd.; Point Pleasant, NJ 08742; (201) 892-8834.

**CHILCOTE AUDIO;** *Sound Reinf.;* Box 124; Stony Run, PA 19557; (215) 756-4176; FAX: (215) 965-9034.

**>CLAIR BROTHERS AUDIO, INC.;** *Sound Reinf.;* PO Box 396; Lititz, PA 17543; (717) 665-4000; FAX: (717) 665-2786.

**COLLEGIUM SOUND, INC.;** *Sound Reinf., Rental;* 35-41 72nd St.; Jackson Heights, NY 11372; (718) 426-8555.

**CONCERTTECH TM;** *Sound Reinf., Rental;* 108 W. 17th St., Ste. #7; New York, NY 10011; (212) 255-5986; FAX: (212) 765-5801.

**COUNTS & COUNTS;** *Sound Reinf., Audio and Video Recording;* 181 Warrington St.; Providence, RI 02907; (401) 781-8478.

**CREATIVE STAGE LIGHTING CO., INC.;** *Sound Reinf., Lighting;* PO Box 205; Johnsburg, NY 12843; (518) 251-3302; FAX: (518) 251-2908.

**DELTA PRODUCTIONS;** *Sound Reinf., Lighting;* 135 MacDougal St.; New York, NY 10012; (212) 473-5385.

**DRP RECORDING SERVICES;** *Audio Recording;* 21 Driscoll Ave.; Rockville Centre, NY 11570; (516) 536-2005.

**DSL SOUND, INC.;** *Sound Reinf.;* 4 Manila Ave.; Hagerstown, MD 21740; (301) 797-1070.

**>EAR FORCE SOUND CO.;** *Sound Reinf., Lighting;* 201 Beacon St. (rear); Greensburg, PA 15601; (412) 834-4100.

**EAST COAST LIGHTING AND SOUND COMP.;** *Sound Reinf., Lighting, Rental;* 120 Lawlins Pk.; Wyckoff, NJ 07481; (201) 652-7641; FAX: (201) 670-9390.

**ECHO AUDIO;** *Sound Reinf., Lighting, Rental, Staging;* 3283rd St.; Dunellen, NJ 08812-1140; (201) 968-2871; FAX: (201) 688-2135.

**Effanel Music**  
Location Recording  
Worldwide

EFFANEL MUSIC, INC.  
New York, NY

**>EFFANEL MUSIC, INC.;** *Audio Recording;* New York, NY; (212) 807-1100.



Live Recording  
Remote Broadcasts  
Audio for Video, TV  
& Movie Production  
Reasonable Rates

*Big Mo*

A complete  
48-track,  
state-of-the-art  
recording studio  
on wheels.

Call or write for our free brochure  
and rate card.

Ed Eastridge  
Operations Director  
11264 Triangle Lane  
Wheaton, MD 20902  
**(301) 946-7364**



## Sound Reinforcement & Remote Recording Facilities

N O R T H E A S T U . S .

**EIGER ENGINEERING**; *Sound Reinf., Lighting, Staging*; 203 Waverley Ave.; Watertown, MA 02172; (617) 924-6514.

**EPA AUDIO**; *Sound Reinf.*; 844 Park Ave.; Hoboken, NJ 07030; (201) 795-3339.

**FILIPPONE SOUND & VIDEO**; *Audio and Video Recording*; 176 Garner Ave.; Buffalo, NY 14213; (716) 881-4483.

**THE FLAGRANT UNDERGROUND**; *Audio Recording*; R.J. Casey Industrial Park; Pittsburgh, PA 15233; (412) 322-8001; FAX: (412) 322-5755.

**FOUR CATS STUDIO**; 325 W. 52nd St.; New York, NY 10019; (212) 582-8663; FAX: (201) 327-5428.

**GENESIS SOUND EXPERIENCE**; *Audio Recording*; 134 Manetto Hill Rd.; Plainview, LI, NY 11803; (516) 937-3667.

**G.M. RECORDERS**; *Audio Recording*; 20 Shore Rd.; Andover, NJ 07821; (201) 852-1747.

**>GOIN' MOBILE**; *Audio Recording*; 304 Newbury St. #110; Boston, MA 02115; (617) 232-7969; FAX: Available.

**GRECO MOTORS (CHAIN HOIST RENTALS)**; *Rental*; Trent Bldg.; Irvington, NY 10533; (914) 591-6667; FAX: (914) 591-6832.

**ALFRED B. GRUNWELL**; *Sound Reinf., Rental, Audio Recording*; 157 Gray Rd.; Ithaca, NY 14850; (607) 272-8964.

**GUSSOUND**; *Sound Reinf., Lighting, Rental*; 2809 Lakehurst Ave.; Forestville, MD 20747; (301) 967-7267.

**HAMEL MUSIC**; *Sound Reinf., Rental*; 75 Summer St.; Chelmsford, MA 01824; (508) 256-4051.

**"HANKSOUND"**; *Sound Reinf., Rental, Staging*; 1218 Woodside Rd.; Brunswick, ME 04011; (207) 725-5155.

**TERRY HANLEY AUDIO SYSTEMS, INC.**; *Sound Reinf., Lighting, Staging, Rental*; 329 Elm St.; Cambridge, MA 02139; (617) 661-1520; FAX: (617) 661-3349.

**HARDMAN EASTMAN STUDIOS INC.**; *Audio and Video Recording*; 1400 E. Carson St.; Pittsburgh, PA 15203; (412) 481-4450; FAX: (412) 481-4455.

**HARRISON DIGITAL AUDIO SERVICES**; *Audio Recording*; 9 Birch Hill Rd.; S. Hadley, MA 01075; (413) 536-3830.

**MIKE HEALEY PRODUCTIONS, LTD.**; *Audio and Video Recording*; R-1, Box 35; Asbury, NJ 08802; (201) 479-6899.

**HERCULES SOUND**; *Sound Reinf.*; 26 Poplar Rd.; Piscataway, NJ 08854; (201) 985-4481.

**HIGH TECH INTERNATIONAL**; *Sound Reinf., Rental*; P.O. Box 127; Center Valley, PA 18034; (215) 965-4388.

**>HOLLYWOOD MUSIC & SOUND INC.**; *Sound Reinf., Lighting, Rental, Staging*; 601 Chartiers Ave.; McKees Rocks, PA 15136; (412) 771-3060; FAX: (412) 771-1234.

**IMPACT AUDIO**; *Sound Reinf.*; 208 Stephens St.; Belleville, NJ 07109; (201) 759-0261.

**IN PHASE AUDIO**; *Sound Reinf., Lighting, Rental*; 158 Alton Rd.; Stamford, CT 06906; (203) 348-6052.

**INDEPENDENT CLASSICAL RECORDING**; *Audio Recording*; 170 W. 73 St., #3C; New York, NY 10023; (212) 799-0690.

**INNOVATIVE MUSIC STUDIO**; *Audio Recording*; 147 DeForest Rd.; Dix Hills, NY 11746; (516) 499-7681.

**J. MICHAEL PRODUCTIONS**; *Sound Reinf., Lighting, Rental, Staging*; PO Box 722; Milldale, CT 06467; (203) 628-0635.

**ROBBIE JARVIS SOUND & LIGHTING CO.**; *Sound Reinf., Lighting, Rental*; PO Box 525; Bourne, MA 02532; (508) 759-7973.

**BOB JOHNSON AUDIO ENGINEERING**; *Sound Reinf., Rental, Audio Recording*; 7 Crofut Rd.; Naugatuck, CT 06770; (203) 729-7871.

**>J3 STUDIO**; *Audio Recording*; 120 Simpson Rd.; Ardmore, PA 19003; (215) 642-6558.

**KARIBU VALLEY INDUSTRIES**; *Sound Reinf., Rental*; 1310 Racquet Rd.; Baltimore, MD 21209-2113; (301) 321-6015.

**KC/SATURN SYSTEMS**; *Sound Reinf., Lighting, Rental*; Rd. 7 Box 90; Leighton, PA 18235; (215) 852-2933; FAX: (215) 852-2934.

**KENNEDY MUSIC & RECORDING**; *Audio Recording*; 5253 Montour St.; Philadelphia, PA 19124; (215) 533-2380.

**ROBERT LANCEFIELD RECORDING**; *Audio Recording*; 400 Plaza Middlesex; Middletown, CT 06457; (203) 347-1634.

**WALTER LENK AUDIO**; *Sound Reinf.*; 380 Broadway; Cambridge, MA 02139; (617) 547-7781.

**LIGHT CRAFT PROFESSIONAL LIGHTING SYSTEMS, INC.**; *Lighting*; 166A Cabot St.; W. Babylon, NY 11704; (516) 752-7574; FAX: (516) 752-3988.

**LITTLE ARENA SOUND CO.**; *Sound Reinf.*; P.O. Box 40187; New Bedford, MA 02744; (508) 996-6869.

**>LLOYD SOUND SYSTEMS/WIZARD LIGHTING AND SOUND EQUIPMENT**; *Sound Reinf., Lighting, Rental*; 62 Scammell St.; Cortland, NY 13045; (607) 753-1586; (607) 756-7467; FAX: (607) 849-3119.

**LOCATION RECORDING, INC.**; *Audio Recording*; 1636 Melville Ave.; Fairfield, CT 06430; (203) 371-4757.

**M.A.M. SOUND REINFORCEMENT CO.**; *Sound Reinf.*; Rd. 1 Box 116 John St.; E. Kingston, NY 12401; (914) 336-4864.

**MANOR PRODUCTIONS**; *Audio Recording*; 60 English Plaza; Red Bank, NJ 07701; (201) 530-0040.

**MARTIN RECORDING STUDIOS**; *Audio and Video Recording*; 8710 Patton Rd.; Wyndmoor, PA 19118; (215) 233-1606.

**MARYLAND SOUND INDUSTRIES, INC.**; *Sound Reinf.*; 4900 Wetheredsville Rd.; Baltimore, MD 21044; (301) 448-1400.

**MAX SOUND**; *Sound Reinf., Lighting, Rental, Staging*; 11 Montrose Rd.; Yonkers, NY 10710; (914) 793-9735.

**MAYORS OFFICE OF BUSINESS & CULTURAL DEVELOPMENT-TECHNICAL ASSISTANCE**; *Sound Reinf., Lighting, Rental, Staging*; Room 802, Boston City Hall; Boston, MA 02201; (617) 725-3912; FAX: (617) 523-6966.

**M.B. ENTERTAINMENT PRODUCTIONS**; *Sound Reinf.*; Box 3192 Brick Church Station; East Orange, NJ 07017; (201) 672-4444.

**MERLIN SOUND**; *Sound Reinf., Audio Recording*; 149 Merymeeting Rd.; New Durham, NH 03855; (603) 859-2372.

**METROSOUND**; *Sound Reinf., Lighting, Staging, Rental*; 2647 Broadway, Ste. 2 West; New York, NY 10025-5063; (212) 316-0426.

**MHA AUDIO, INC.**; *Sound Reinf., Rental*; 20 N. Mulberry St.; Hagerstown, MD 21740; (301) 733-9337; FAX: (301) 733-0265.

**MOE CO.**; *Sound Reinf.*; 133 Deerfield Rd.; Sayreville, NJ 08872; (201) 257-3760.

**MOSTLY AUDIO**; *Audio and Video Recording*; PO Box 548; Bear, DE 19701; (302) 324-1020.

**MSA RECORDING**; *Audio Recording*; 52 Bramhall St.; Georgetown, DE 19947; (302) 856-6993.

**MSE AUDIO**; *Sound Reinf., Lighting, Rental, Staging*; 177 Reichold Rd.; Wexford, PA 15090; 5090 Sardis Rd.; New Kensington, PA 15068; (412) 935-6296 (Wexford); (412) 335-2393 (New Kensington); FAX: (412) 856-5765.

**THE MUSIC FACTORY ENTERPRISES, INC.**; *Audio and Video Recording*; Ford & Washington Sts., Ste. 300; Norristown, PA 19401; (215) 277-9550.

**NETWORK SOUND PRODUCTIONS**; *Audio Recording*; 119 Peachwood Drive; Swedesboro, NJ 08085; (609) 467-1682.

**>NEW ENGLAND MOBILE RECORDING**; *Audio Recording*; PO Box 409; Stow, MA 01775; (508) 562-2111.

**NEW LONDON COUNTY RECORDING ARTS**; *Audio Recording*; 229 Pequot Trail; Pawcatuck, CT 06379; (203) 599-5293.

**THE NEW VIRGINIANS**; *Sound Reinf., Lighting, Rental*; 321 Patton Hall, VA Tech; Blacksburg, VA 24061; (703) 231-6456.

**NONCHALANT AUDIO SERVICES**; *Audio Recording*; PO Box 64; Ardmore, PA 19003; (215) 626-4484.

**>NORTHEASTERN DIGITAL RECORDING**; *Audio Recording*; 2 Hidden Meadow Ln.; Southborough, MA 01772-1700; (508) 481-9322; FAX: (508) 624-6437.

When You Need It  
We've Got It

**Switchcraft®**

A Raytheon Company

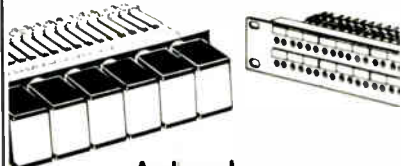

Adapters  
Connectors  
Jack Panels  
Multi-Switch®  
Switches



Call (800) 225-7924

**PRO SOUND**

a division of Cal Switch

13717 S. Normandie Avenue  
Gardena, California 90249

**OFF THE WALL SOUND;** *Sound Reinf., Lighting;* 10 Howland Cir.; West Caldwell, NJ 07006; (201) 228-4099.

**> ONE HAND CLAPPING;** *Sound Reinf., Lighting, Rental, Staging;* 58A Phelps Ave.; New Brunswick, NJ 08901; (201) 545-6533; FAX: (201) 890-5460.

**PIAUDIO/DESIGN;** *Sound Reinf., Rental;* 1637 Alabama Ave. S.; St. Louis Park, MN 55416; (612) 546-4217.

**PIERCE EAR SOUND;** *Sound Reinf.;* PO Box 147; Elm, PA 17521-0147; (717) 626-6099.

**PMA INDUSTRIES, INC.;** *Sound Reinf., Lighting, Staging, Rental, Staging;* 681 Killingly St.; Johnston, RI 02919; (401) 421-6221; FAX: (401) 421-6379.

**TOM POHORILLA AUDIO SYSTEMS;** *Sound Reinf.;* PO Box 31; Devon, PA 19333; (215) 647-1570.

**POMEROY AUDIO;** *Audio Recording;* 193 Baltic St.; Brooklyn, NY 11201; (718) 855-2650.

**PRAGMATECH SOUND CORP.;** *Sound Reinf., Lighting, Rental, Staging;* 4516 Byron Ave.; Bronx, NY 10466; (212) 325-8888; FAX: (212) 515-8996.

**PRISM THEATRICAL SERVICES;** *Sound Reinf., Lighting;* 335 Winfield Terr.; Union, NJ 07083; (201) 687-5477; FAX: (201) 688-2135.

**> PRO SYSTEMS, INC.;** *Sound Reinf., Lighting;* 5 Glen Rd., RD 3; Manchester, CT 06040; (203) 643-8401; (800) 642-TURBO (in state).

**PROMIX;** *Sound Reinf.;* 111 Cedar St.; New Rochelle, NY 10801; (914) 633-7371; FAX: (914) 633-0347.

**LEE QUIMBY RECORDINGS;** *Audio Recording;* 1 Robin Acres, HC 69, Box 607; Wolfeboro, NH 03894; (603) 569-2543.

**R.C. SOUND;** *Sound Reinf., Rental;* 224 12th Ave.; Seaside Park, NJ 08752; (201) 830-4346.

When There's Only  
One Chance to get it  
Right.



Record Plant Remote  
New York City

RECORD PLANT REMOTE  
West Milford, NJ

**> RECORD PLANT REMOTE;** *Audio Recording;* 109 Pinecliff Lake Dr.; West Milford, NJ 07480; (201) 728-1955.

**> REMOTE MEN VISUAL MUSIC ENTERPRIZES;** *Audio Recording;* PO Box 791; Flushing, NY 11352; (718) 886-6500; FAX: (718) 886-7214.

**> REMOTE RECORDING SERVICES, INC.;** *Audio and Video Recording;* PO Box 334; Lahaska, PA 18931; (215) 794-5005.

**RIEDEL AUDIO SERVICES;** *Sound Reinf., Audio Recording;* 109 Commack Rd.; Islip, NY 11751; (516) 277-9418.

**ROCK SYSTEMS AUDIO;** *Sound Reinf.;* 100F Executive Dr.; Edgewood, NY 11717; (516) 242-8008; FAX: (516) 242-8056.

**ROCKET REHEARSAL STUDIO;** *Rental;* 265 W. 37th St.; New York, NY 10018; (212) 944-2699; FAX: (212) 768-1806.

**ROCKIN ROBIN SOUND CO.;** *Sound Reinf., Lighting, Rental;* #3 Allegheny Ct., Ste. 200; Glassport, PA 15045-1698; (412) 673-3663; FAX: (412) 673-3663.

**ROSNER CUSTOM SOUND INC.;** *Sound Reinf.;* 11-38 31st Ave.; L.I. City, NY 11106; (718) 726-5600; FAX: (718) 956-7516.

**RTM AUDIO;** *Sound Reinf., Lighting, Staging, Rental;* 710 North Ave.; Garwood, NJ 07027; (201) 789-9352.

> See monthly issue of Mix for extended listing

## REMOTE RECORDING

# EFFANEL MUSIC NEW YORK

PORTABLE

- ★ DUAL SONY 3348, FORTY EIGHT TRACK DIGITAL
- ★ SOLID STATE LOGIC G SERIES CONSOLE
- ★ DUAL 24 TRACK ANALOG DOLBY SR

PORTABLE

Effanel's modular, 96 channel, 24/48 track system is the only proven system of its kind. All components are designed or modified for efficient shipment and quick set-up.

## WORLD CLASS RECORDING ANYWHERE

JUST LISTEN

- ★ The Who '89 (live album and pay-per-view)
- ★ The Rolling Stones' Steel Wheels '89 (pay-per-view)
- ★ Carly Simon "My Romance" (HBO)
- ★ Kathleen Battle/Jessye Norman (Deutsche Grammaphone)
- ★ Peter Gabriel ("Passion")
- ★ Depeche Mode ("101")
- ★ Suzanne Vega ("Days of Open Hand")
- ★ Keith Jarrett (ECM)
- ★ "Great Performances" (PBS)
- ★ NBC ("Night Music," David Letterman 8th Anniversary, Daytime Emmys)
- ★ MTV (Earth Day, Central Park '90)

Effanel

(212) 807-1100

TEC  
1990  
NOMINEE

RANDY EZRATTY JOHN HARRIS MARK SHANE ADAM PINCH

## 48 TRACK DIGITAL



## Sound Reinforcement & Remote Recording Facilities

N O R T H E A S T U S .

**SAWMILL SOUND CO., INC.;** *Sound Reinf., Lighting, Rental, Staging;* PO Box 2074; Westminster, MD 21157; (301) 346-7550; (717) 633-7475.

**SCAVENGER SOUND, INC.;** *Sound Reinf., Lighting, Staging, Rental;* PO Box 1986; Glen Burnie, MD 21061; (301) 760-2135.

**SCHEMBRI VISION;** *Audio and Video Recording;* 2156 Story Ave.; Bronx, NY 10473; (212) 863-2986.

**>SCORPIO SOUND SYSTEMS, INC.;** *Sound Reinf.;* 56 Manley St.; West Bridgewater, MA 02379; (508) 584-0080; FAX: (508) 588-2117.

**>SEE FACTOR INDUSTRY, INC.;** *Sound Reinf., Lighting, Staging, Rental;* 37-11 30th St.; Long Island City, NY 11101; (718) 784-4200.

**>SEE HEAR EAST;** *Sound Reinf.;* R.D. 2, Box 147; Germantown, NY 12526; (518) 537-4658.

**SELECT SOUND COMPANY;** *Sound Reinf.;* 15 Carteret Ct.; Madison, NJ 07940; (201) 966-0387.

**SHANGRILA SOUND;** *Sound Reinf.;* 625 Berdan Ave.; Wayne, NJ 07470; (201) 694-7867.

**>SHEFFIELD AUDIO-VIDEO PRODUCTIONS;** *Audio and Video Recording;* 13816 Sunnybrook Rd.; Phoenix, MD 21131; (301) 628-7260.

**>SHOWTIME SOUND SERVICES;** *Sound Reinf., Lighting, Rental;* PO Box 3372; Westport, MA 02790; (508) 636-8040.

**SIGNET SOUND;** *Sound Reinf.;* 115 E. 87th St., Ste. 10A; New York, NY 10128; (212) 348-9335.

**SINE WAVE AUDIO GROUP;** *Sound Reinf., Lighting;* 119 Hampton Rd.; Garden City, NY 11530; (516) 248-1263.

**SIRIUS SOUND;** *Sound Reinf., Lighting, Rental, Audio and Video Recording;* 72 Summer St., Apt. 1; Claremont, NH 03743; (603) 542-9388.

**SK SYSTEMS, INC.;** *Sound Reinf., Lighting, Rental, Staging;* 1560-5 Ocean Ave.; Bohemia, NY 11716; (516) 563-7375; FAX: (516) 563-3794.

**SNOW SOUND**

SNOW SOUND  
Middlefield, CT

**SNOW SOUND;** *Sound Reinf., Lighting, Staging, Rental;* 441 Baileyville Rd.; Middlefield, CT 06455; (203) 349-8211; FAX: (203) 349-1966.

**SOUND ARTS;** *Audio Recording;* 52 Welton St.; New Brunswick, NJ 08901; (201) 249-5323.

**>SOUND BY FITCH;** *Sound Reinf.;* RD 2; Pottstown, PA 19464; (215) 469-6082; FAX: (215) 469-0559.

**SOUND FACTOR;** *Sound Reinf.;* PO Box 1255; Lockport, NY 14095; (716) 433-2193.

**SOUND WRITER PUB., INC.;** *Audio and Video Recording;* 223 Washington St.; Newark, NJ 07102; (201) 642-5132.

**SOUNDPORTEAST;** *Sound Reinf., Lighting, Rental;* 31 A Spar Dr.; Erial, NJ 08081; (609) 228-5283.

**SOUNDWORKS, INC.;** *Sound Reinf.;* Rental: 195-12 56th Ave.; Fresh Meadows, NY 11365; (718) 357-6910; (516) 431-6857.

**SPL SOUND, INC.;** *Sound Reinf.;* 27 Temple Rd.; Vineland, NJ 08360-3911; (609) 691-6690; FAX: (609) 692-8439.

**STAGER SOUND SYSTEMS;** *Sound Reinf., Lighting, Rental, Staging;* 159 W. 85th St.; New York, NY 10024; (212) 595-4065; FAX: (212) 595-4065.

**STAGING TECHNIQUES, INC.;** *Sound Reinf., Lighting, Rental, Staging;* 342 W. 40th St.; New York, NY 10018; (212) 736-5727; FAX: (212) 594-0547.

**STAHRR SOUND SYSTEMS UNLTD.;** *Sound Reinf., Lighting, Rental;* PO Box 6887; Syracuse, NY 13217; (315) 446-8785.

**STEED AUDIO, INC.;** *Sound Reinf., Rental;* 1038 Pennsylvania Ave.; Monaca, PA 15061; (412) 728-1234; FAX: (412) 728-1236.

**>PRICE STEVENSON ACOUSTIC RESEARCH;** *Sound Reinf., Rental;* 1591 Broad Run Rd.; Downingtown, PA 19335; (215) 383-1083.

**STL CONCERT LIGHTING;** *Lighting, Rental, Staging;* 305 Washington Ave.; Spring Lake, NJ 07762; (201) 449-2733.

**STUDIO A;** *Audio Recording;* 87 Sherry Ave.; Bristol, RI 02809; (401) 253-4183.

**SUN SOUND AUDIO, INC.;** *Sound Reinf., Rental;* 518 Pleasant St.; Northampton, MA 01060; (413) 586-3465; FAX: (413) 586-5633.

**THE SYSTEM;** *Audio and Video Recording;* 20 Martha St.; Woodcliff Lake, NJ 07675-8027; (201) 930-9149.

**TECHNICAL SUPPORT SERVICES;** *Sound Reinf., Lighting, Staging, Rental;* 275 Middle St.; Middletown, CT 06457; (203) 347-5314.

**TEKCOM CORPORATION;** *Sound Reinf.;* 1020 N. Delaware Ave.; Philadelphia, PA 19125; (215) 426-6700; FAX: (215) 426-7287.

**TLM ELECTRONICS INC.;** *Sound Reinf.;* 1 Hillview Dr.; Pleasantville, NY 10570; (914) 769-6423.

**TONMEISTER RECORDINGS;** *Audio Recording;* 6120 Massachusetts Ave.; Bethesda, MD 20816; (301) 229-1664.

**TPR ENTERPRISES LTD.;** *Lighting;* 644 Fayette Ave.; Mamaroneck, NY 10543; (914) 698-1141.

**TRI-STATE SOUND;** *Sound Reinf., Rental, Staging;* 140 W. Wolfert Station Rd.; Mickleton, NJ 08056; (609) 467-4917; (609) 467-4918.

**TRS AUDIO SERVICES;** *Audio Recording;* 2617 Peach St., Ste. 203; Erie, PA 16508; (814) 453-3032.

**THE TURNING MILL;** *Audio and Video Recording;* PO Box L; Palenville, NY 12463; (518) 678-9293.

**UGLY SOUND PRODUCTIONS;** *Sound Reinf.;* PO Box 752; New Paltz, NY 12561; (914) 255-6148.

**UVM VIDEO-MEDIA SERVICES DEPARTMENT;** *Video Recording;* 232 Rowell Bldg., Univ. of Vermont; Burlington, VT 05405; (802) 656-2927.

**VICTORY RECORDING STUDIOS;** *Audio Recording;* 201 St. James Pl.; Philadelphia, PA 19106; (215) 923-9999; FAX: (215) 923-1280.

**VISUAL MUSIC;** *Sound Reinf., Audio and Video Recording;* 235 E. 13th St. #3-D; New York, NY 10003; (212) 505-9281.

**WABANK AUDIO-VIDEO SERVICES;** *Sound Reinf., Rental;* 1919 St. Regis Ln.; Lancaster, PA 17603; (717) 299-5447.

**WARM BROWN SOUND;** *Sound Reinf., Rental;* PO Box 1888; Brattleboro, VT 05302; (802) 254-4283.

**WESTMINSTER MEDIA;** *Sound Reinf., Lighting, Audio and Video Recording;* Box 27009; Philadelphia, PA 19118; (215) 572-3834.

**WHITE SOUND SYSTEMS;** *Sound Reinf., Rental;* 507 Little Current Dr.; Annapolis, MD 21401; (301) 974-0355.

**WIZZ SOUND;** *Audio and Video Recording;* 536 1/2 Main St.; Indian Orchard, MA 01151-1222; (413) 543-8845.

**WMRG STUDIOS INC.;** *Sound Reinf., Rental, Audio Recording;* PO Box 73; Cheltenham, PA 19012-0073; (215) 635-4815.

**JONATHAN A. WYNER;** *Audio Recording;* 50 Amory St. #1; Cambridge, MA 02139; (617) 547-7973.

**ZALMO SOUNDS;** *Audio Recording;* Ditmas Ave. & E. 8th St.; Brooklyn, NY 11218; (718) 633-4166.

**ZEO BROTHERS PRODUCTIONS, INC.;** *Sound Reinf., Rental;* 429 Lincoln Ave.; Hatboro, PA 19040; (215) 956-0328.

S O U T H E A S T U S .

Alabama, Florida, Georgia, Kentucky, Louisiana, Mississippi, North Carolina, South Carolina, Tennessee, Virginia, West Virginia, Virgin Islands, Puerto Rico

**ACA DIGITAL RECORDING;** *Audio Recording;* PO Box 450727; Atlanta, GA 30345; (404) 284-0948.

**>AIRSHOW, INC.;** *Audio Recording;* 7021 Woodland Dr.; Springfield, VA 22151; (703) 642-9035; FAX: (703) 642-9035.

**ALLSTAR AUDIO SYSTEMS;** *Sound Reinf., Lighting, Rental, Staging;* 149 Space Park S.; Nashville, TN 37211; (615) 834-8242; FAX: (615) 834-8266.

**ALPHA SOUND & LIGHT;** *Sound Reinf., Lighting, Rental, Staging;* 1824 Freedom Dr.; Charlotte, NC 28208; (704) 372-1264; FAX: Call first.

**AMERICAN COMMUNICATION SERVICES;** *Sound Reinf., Rental;* 1885-C NE 149th St.; N. Miami, FL 33181; (305) 948-6510.

**ASSOCIATED SOUND SERVICES, INC.;** *Sound Reinf., Lighting, Rental, Staging;* 7954 Angleton Ct., PO Box 65; Newington, VA 22122; (703) 550-9550; FAX: (703) 550-9551.

**ATLANTA SOUND & LIGHTING;** *Sound Reinf., Lighting, Rental, Staging;* 2368 John Glenn Dr.; Atlanta, GA 30341; (404) 455-7695; FAX: (404) 455-3088.

AUDIO OASIS  
Mobile Recording Services

AUDIO OASIS  
Falls Church, VA

**>AUDIO OASIS;** *Audio Recording;* 3210 Gary Ct.; Falls Church, VA 22042; (703) 532-REEL (7335).

**AUDIOCRAFT SOUND & VIDEO;** 1604 W. New Bern Rd.; Kinston, NC 28501; (919) 527-8845.

Backstage  
INC.  
Richmond, Virginia

BACKSTAGE, INC.  
Richmond, VA

**>BACKSTAGE, INC.;** *Sound Reinf., Lighting, Staging, Rental;* 310 W. Broad St.; Richmond, VA 23220; (804) 644-1433; FAX: (804) 644-4913.

**BKE SOUND;** *Sound Reinf., Lighting;* 834 Talley Rd.; Chattanooga, TN 37411; (615) 622-8788.

**TONY BLANC;** *Sound Reinf.;* Tantivy Farm, Rte. 1, Box 462B; Barboursville, VA 22923; (703) 832-5962.

**BRANTLEY SOUND ASSOCIATES, INC.;** *Sound Reinf., Lighting, Rental, Staging, Audio Recording;* 204 Third Ave. S.; Nashville, TN 37201; (615) 256-6260; FAX: (615) 255-9369.

**CANANWILL SOUND, INC.;** *Sound Reinf.;* PO Box 26283; Jacksonville, FL 32218; (904) 755-8553.

**LOU CASINI RECORDING;** *Audio Recording;* 1001 Neville St.; Follansbee, WV 26037; (904) 527-1758.

**DAVIS PRODUCTIONS;** *Audio and Video Recording;* 1208 Elm Ave.; Americus, GA 31709-4503; (912) 924-2521.

**DIGITAL 1 DUPLICATORS INC.;** *Audio Recording;* 658 Douglas Ave.; Altamonte Springs, FL 32714; (407) 682-7790; FAX: (407) 682-9786.

**DMF STAGE LIGHTING/SOUND AUTHORITY;** *Sound Reinf., Lighting, Rental, Staging;* 4505 LeMans Way; Pensacola, FL 32505; (904) 438-8249.

**DUNCAN LIGHTING & DESIGN, INC.;** *Lighting, Rental, Staging;* 1856 Corporate Dr., Ste. 130; Norcross, GA; (404) 279-2790; FAX: (404) 279-9561.

**BILL EASTERLING PRODUCTIONS;** *Sound Reinf., Lighting, Audio and Video Recording;* 114 Retriever Ln.; Summerville, SC 29485; (803) 873-3246.

**ELECTRAWORKS;** Mitchell St.; Junction City, KY 40440; (606) 854-6756.

**ELECTRIC EAR PRODUCTIONS, INC.;** *Sound Reinf., Lighting, Staging, Rental;* 60 Parish Ave.; Nashville, TN 37210; (615) 255-3821; FAX: (615) 255-3861.

**FBN AUDIO, INC.;** *Sound Reinf., Lighting, Rental;* 6512 Baum Dr., Ste. #15; Knoxville, TN 37919; (615) 588-3209.

**FLORIDA TECHNICAL SERVICES, INC.;** 217 Altamonte Comm. Blvd. #1226; Altamonte Springs, FL 32714; (407) 774-1021.

**BILL FLOWERS PRODUCTION;** *Audio and Video Recording;* 6435 McAdams Dr. E.; Theodore, AL 36582; (205) 653-1470.

**FOX FARM RECORDING;** *Audio Recording;* 2731 Saundersville Ferry Rd.; Mt. Juliet, TN 37122; (615) 754-2444.

**FRIENDLY GROVE STUDIO;** *Audio Recording;* 9279 Russellville Rd. #8A; Rockfield, KY 42274; (502) 782-3892.

**FX SOUNDE CO.;** *Sound Reinf., Lighting, Rental, Staging;* 6247 Holly Bay Dr.; Jacksonville, FL 32211; (904) 744-4663.

**GARRETT SOUND & LIGHTING;** *Sound Reinf., Lighting, Staging, Rental;* 9314 NW 102nd St.; Miami, FL 33178; (305) 884-8339; FAX: (305) 884-8313.

**GEMINI CONCERT SYSTEMS, INC.;** *Sound Reinf., Lighting, Rental;* PO Box 2123; West Monroe, LA 71294-2123; (318) 325-9940.

**GEORGE D. PRODUCTIONS, INC.;** *Audio Recording;* 19300 SW 106 Ave. #3; Miami, FL 33157; (305) 378-2163.

**H&G RECORDED PRODUCTIONS;** *Audio and Video Recording;* PO Box 73991; Metairie, LA 70033-3991; (504) 469-7963.

**HART SOUND AND LIGHTING;** *Sound Reinf., Lighting, Rental, Staging;* 831 SE 14th St.; Ft. Lauderdale, FL; (305) 463-4655.

**IMAGE INTERNATIONAL, INC.;** *Sound Reinf., Lighting, Staging, Rental;* 5858 Lakehurst Dr.; Orlando, FL 32819; (407) 351-7065; FAX: (407) 352-8237.

**INDEX AUDIO;** *Sound Reinf., Lighting, Rental;* PO Box 22654; Nashville, TN 37202; (615) 399-8830.

**INTEGRATED SOUND & LIGHT;** *Sound Reinf., Lighting, Rental;* 13218 Pleasantview Ln.; Fairfax, VA 22033; (703) 378-5409.

**JMI/CREATIVE AUDIO SERVICES;** *Sound Reinf., Rental, Audio Recording;* 3655 Old Shell Rd. #321; Mobile, AL 36608; (205) 343-2023.

**LINDEN INC.;** *Sound Reinf., Rental;* 229 N. Henry St.; Alexandria, VA 22314; (703) 549-4424.

**JACK LINK & ASSOCIATES;** 1729 Cogswell St.; Rockledge, FL 32955; (407) 636-7231; FAX: (407) 636-4857.

**LUNDY RECORDING & CASSETTE DUP.;** *Audio Recording;* PO Box 408; Heidrick, KY 40949; (606) 546-6650.

**MAGNETIC MEMORIES;** *Audio Recording;* PO Box 3373; Kingsport, TN 37664; (615) 246-3452.

**MARIAH RECORDING;** *Audio Recording;* 337 N. 25th Ave.; Hattiesburg, MS 39401; (601) 545-1886.

**MARTIN AUDIO;** *Audio Recording;* 642 Holly Ave.; Winston-Salem, NC 27101; (919) 722-0699.

**MASTERSOUND, INC.;** *Audio Recording;* 7425 Buckland Rd.; Charlotte, NC 28208; (704) 588-2491.

**MD SYSTEMS;** *Sound Reinf., Rental;* 128 Space Park South Dr.; Nashville, TN 37211; (615) 331-9090; (800) MDROCKS.

**MELLOTONE;** *Sound Reinf.;* PO Box 145, 108 E. Church St.; Blacksburg, SC 29702; (803) 839-6341; FAX: (803) 839-2911.

**MR. O AUDIO;** *Sound Reinf., Lighting, Rental, Audio Recording;* 2035 S. Lumpkin Rd.; Columbus, GA 31903; (404) 687-6221.

**MODERN METHOD PRODUCTIONS, INC.;** *Sound Reinf., Lighting, Staging, Rental;* 1333 Meridian St.; Huntsville, AL 35801; (205) 536-8025.

**MUSE PRODUCTIONS;** *Sound Reinf., Lighting, Staging, Rental;* PO Box 43; Auburn, AL 36830; (205) 821-0088; FAX: (205) 821-0088.



MUSE PRODUCTIONS  
Auburn, AL

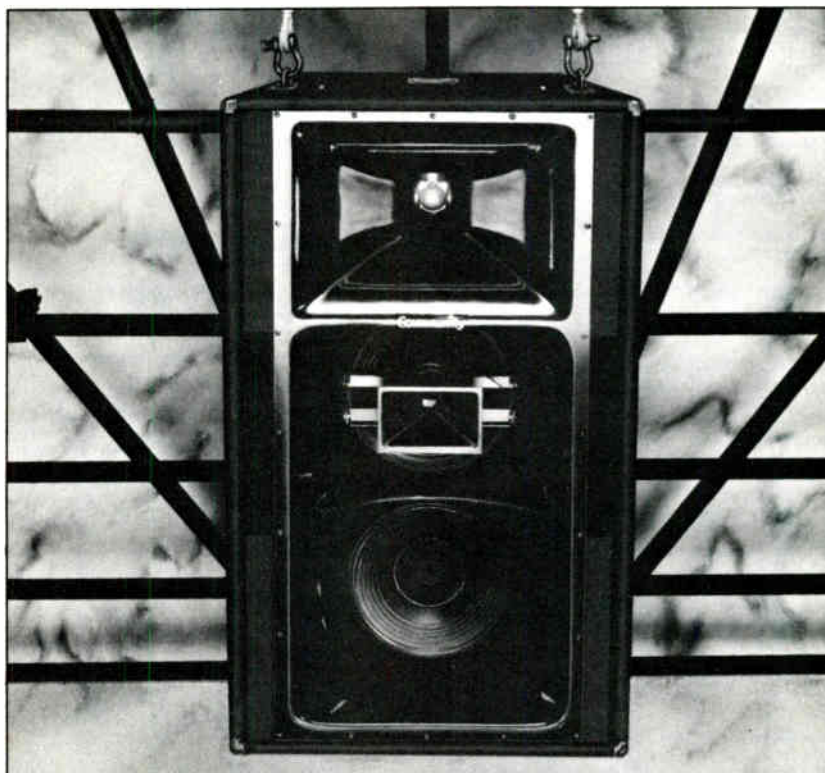

## *Puts the others in perspective...*

*Community's new RS880 loudspeaker system flies heads above all others with its trapezoidal, three-way Wavefront Coherent™ horn-loaded design. Dynamically controlled from a single rack space with our 880EQ, the RS880 additionally features unique feedback-loop sensing circuitry, and reinforced D-rings which can get you off the ground quickly and smoothly. For room-shaking bass response, our VBS415 subwoofer can also be added to extend the system.*



333 East Fifth Street • Chester, PA 19013 • (215) 876-3400 • Fax (215) 874-0190



# Sound Reinforcement & Remote Recording Facilities

S O U T H E A S T U S .

**NOMAD PRODUCTIONS, INC.;** *Audio Recording*; PO Box 6868; Mobile, AL 36660; (205) 460-9099; FAX: (205) 460-2773.

**OFF-THE-WALL SOUND & LIGHTING CO. INC.;** *Sound Reinf., Lighting, Rental, Staging*; 2020 NE 153rd St.; North Miami Beach, FL 33162; (305) 944-3334; (305) 944-2988; FAX: (305) 945-4040.

**ON STAGE AUDIO;** *Sound Reinf., Rental*; 773 Kirkman Rd., Ste. 120; Orlando, FL 32811; (407) 292-0012.

**>OVERLAND SOUND COMPANY, INC.;** *Sound Reinf.;* 3821 Macomb St. N.W.; Washington, DC 20016; (202) 364-6033.

**>PARADISE SOUND;** *Sound Reinf., Lighting, Staging, Rental*; 2721 Forsyth Rd., Ste. 256; Winter Park, FL 32792; (407) 657-0333.

**PARALLAX RECORDING STUDIO;** *Audio Recording*; 123 E. State St.; Ridgeland, MS 39157; (601) 856-2525; FAX: (601) 856-9462.

**PLATINUM POST;** *Audio and Video Recording*; 3300 University Blvd.; Winter Park, FL 32792; (407) 671-1111; FAX: (407) 671-1112.

**PLATINUM SOUND;** *Sound Reinf., Lighting, Rental, Staging*; 3300 University Blvd.; Winter Park, FL 32792; (407) 671-1111; FAX: (407) 671-1112.

**PRO-AUDIO INC.;** *Audio Recording*; 2012 Madison Ave.; Memphis, TN 38104; (901) 278-6000.

**PROMIX;** *Sound Reinf.;* 1713 Acme St.; Orlando, FL 32805; (407) 843-3172; FAX: (407) 843-3329.

**PROPAGANDA PRODUCTION LTD.;** *Sound Reinf., Lighting, Rental*; 5609 A Crawford St.; Harahan, LA 70123; (504) 733-8211; FAX: (504) 733-4532.

**PYRAMID AUDIO PRODUCTIONS, INC.;** *Sound Reinf., Lighting, Rental*; 849 Fulton St.; New Orleans, LA 70130; (504) 522-5473.

**RAM SOUND;** *Sound Reinf., Lighting, Rental, Staging*; PO Box 906; Mary Esther, FL 32569-0906; (904) 664-6859; FAX: call.

**RECYCLED SOUND;** *Audio Recording*; Rt. 1 Box 5; Afton, TN 37616; (615) 639-8569.

**REELSOUND RECORDING CO. EAST;** *Audio Recording*; 1701 Green Hills Dr.; Nashville, TN 37215; (615) 385-0220.

**RELIABLE MUSIC, INC.;** *Sound Reinf., Lighting, Rental, Staging*; 650 E. Stonewall St.; Charlotte, NC 28202; (704) 375-8662; FAX: (704) 332-4829.

**RM AUDIO;** 3586 Pierce Dr.; Atlanta, GA 30341; (404) 458-6000.

**>ROADWORX AUDIO & LIGHTING SPECIALISTS;** *Sound Reinf., Lighting, Staging, Rental*; 913 S. Chapman St.; Greensboro, NC 27403; (919) 378-0650; FAX: (919) 378-1498.

**ROBINETT RECORDINGS;** *Audio Recording*; 3609 Trawick Circle; Raleigh, NC 27604; (919) 231-3760.

**ROCK 'N' ROAD AUDIO;** *Sound Reinf.;* 5238 N. Royal Woods Pkwy., Ste. 170; Tucker, GA 30084; (404) 493-6862; FAX: (404) 493-6559.

**SAM'S TAPE TRUCK;** *Audio Recording*; 2785 Osborne Rd. NE; Atlanta, GA 30319; (404) 237-9075.

**SATURN LIGHT AND SOUND;** *Sound Reinf., Lighting, Rental*; Rte. 1 Box 200-C; Arnoldsville, GA 30619; (404) 742-7446.

**>SERIOUSLY SOUND INC.;** *Sound Reinf., Lighting, Staging, Rental*; 550-C Amsterdam Ave.; Atlanta, GA 30306; (404) 872-0346; FAX: (404) 872-9586.

**SGA PRODUCTION STAGING, INC. (SEE NC LISTING FOR EQUIPMENT);** *Sound Reinf., Lighting, Staging, Rental*; 4187 34th St.; Orlando, FL 32811; (407) 649-4821.

**SOUND AND COMMUNICATIONS, INC.;** *Sound Reinf., Rental*; 5830 N. State St.; Jackson, MS 39206; (601) 957-5830.

**SOUND RESOURCES;** *Audio and Video Recording*; Rte. 5, Box 272; Newport, TN 37821; (615) 623-3371; FAX: (615) 623-1410.

**SPECTRUM SOUND;** *Sound Reinf., Lighting, Rental, Staging*; 1040-C Acorn Dr.; Nashville, TN 37210; (615) 391-3700.

**STAGE AUDIO & LIGHTING PRODUCTIONS;** *Sound Reinf., Lighting, Rental, Staging*; 1846 Long Pond Dr., Longwood, FL 32779; 1714 7th Ave.; Charleston, WV 25302; (407) 333-4325; (304) 345-0834 (in WV); FAX: (407) 333-4328.

**STAGE EQUIPMENT AND LIGHTING, INC.;** *Lighting*; 12231 NE 13th Ct.; Miami, FL 33161; (305) 891-2010; FAX: (305) 893-2828.

**STAGE SOUND, INC.;** *Sound Reinf., Lighting, Rental, Staging*; 103 8th St. SE; Roanoke, VA 24013; (703) 342-2040.

**TENNESSEE CONCERT SOUND;** *Sound Reinf., Rental*; Hwy. 70 E.; Brownsville, TN 38012; (901) 772-2292.

**THOMAS AUDIO SERVICES/LET'S EAT SOUND;** *Sound Reinf., Lighting, Rental, Staging, Audio and Video Recording*; 830 W. Capitol St.; Jackson, MS 39203; (601) 354-9050.

**TOPHAM AUDIO, INC.;** *Audio and Video Recording*; 4403 Vineland Rd., Ste. B-3; Orlando, FL 32811; (407) 649-6444; FAX: (407) 872-3330.



TREETOP SOUND AND LIGHTING  
Portsmouth, VA

**>TREETOP SOUND AND LIGHTING;** *Sound Reinf., Lighting, Staging, Rental*; 4711 George Washington Hwy.; Portsmouth, VA 23702; (804) 487-6671; (804) 487-1321.

**>TURN OF THE CENTURY PRODUCTIONS, INC.;** *Sound Reinf., Lighting, Staging, Rental*; 2629 24th St. N.; St. Petersburg, FL 33713; (813) 327-2496 (St. Petersburg); (813) 221-3317 (Tampa); FAX: (813) 894-4180.

**>UNITED SOUND & ELECTRONICS;** *Sound Reinf.;* PO Box 3000, 309 Broadway Ave.; Clarksburg, WV 26302-3000; (304) 622-6461.

**WEBE TECHNICIANS;** *Rental, Audio Recording*; 209 Gann Dr.; Nashville, TN 37210; (615) 391-5252.

**WHIPPOORWILL COMMUNICATIONS;** *Audio and Video Recording*; PO Box 4870; University, MS 38677-4870; (601) 236-1246.

**WISE ENTERTAINMENT PRODUCTIONS;** *Sound Reinf., Lighting, Staging, Rental, Audio and Video Recording*; PO Box 8656; Columbia, SC 29202; (803) 957-9090.

**WOLF SOUND, INC.;** *Sound Reinf., Lighting, Rental, Staging*; 1881 NE 146th St.; N. Miami, FL 33181; (305) 956-9522; FAX: (305) 949-4496.

**WOODHOUSE RECORDING;** *Sound Reinf., Lighting*; 2900 Brittany Way; Chesapeake, VA 23321; (804) 483-6212.

**WOODY'S PRO SOUND & MUSIC;** *Sound Reinf., Lighting, Rental, Staging*; PO Box 1428, Hwy. 11 W.; Chilhowie, VA 24319; (703) 646-3392; FAX: (703) 646-3392.

**YARBROUGH'S MUSIC, INC.;** 741 N. White Station; Memphis, TN 38122; (901) 761-0414.

**ZEPHYR AUDIO;** *Sound Reinf., Rental*; 5509 Graywood Rd.; Jacksonville, FL 32207; (904) 731-1855.

**N O R T H C E N T R A L U S**  
Illinois, Indiana, Iowa, Kansas, Michigan, Missouri,  
Minnesota, Nebraska, North Dakota, Ohio,  
South Dakota, Wisconsin

**ACCUTRACK RECORDING & SOUND CO.;** *Sound Reinf.;* 298 E. Dennis; Wheeling, IL 60090; (708) 459-0879.

**ACTIVE COMPONENTS;** *Sound Reinf.;* 110 W. Grand River, Ste. B; Howell, MI 48843; (517) 548-6550.

**AERIAL ENTERPRISES, INC.;** 10106 Industrial Dr.; Whitmore Lake, MI 48189; (313) 231-2500.

**AGAPE AUDIO SYSTEMS;** *Sound Reinf., Lighting, Rental, Staging*; 716 Dillingham Ave.; Sheboygan, WI 53081; (414) 457-6863.

**ALLIANCE RECORDING CO. INC.;** *Sound Reinf., Audio Recording*; 8449 Parshallville Rd.; Fenton, MI 48430; (313) 632-5653.

**ALPHA RECORDING;** *Sound Reinf.;* 253 W. Kenworth Rd.; Columbus, OH 43214; (614) 263-4900.

**ANDOVER AUDIO;** 2387 S. Coon Creek Dr.; Andover, MN 55304; (612) 757-6589.

**ANVID RECORDING CO.;** *Audio Recording*; PO Box 8130; Bartlett, IL 60103; (708) 837-9840.

**ARC ELECTRONIC SERVICES INC.;** *Audio Recording*; 2557 Knapp NE; Grand Rapids, MI 49505; (616) 364-0022.

**ARC MINISTRIES, INC.;** *Rental*; 3767 Monroe Rd., Box 181; Allegan, MI 49010; (616) 673-6601.

**ARROW AUDIO, INC.;** *Sound Reinf., Lighting, Staging, Rental*; 101 W. Edison Ave.; Appleton, WI 54915; (414) 731-4888.

**ARS RECORDING & TAPE DUPLICATION;** *Sound Reinf., Lighting, Rental, Staging, Audio Recording*; 11626 S. Pulaski; Alsip, IL 60658; (708) 371-8424; FAX: (708) 371-9403.

**ATAVISTIC VIDEO;** *Video Recording*; PO Box 578266; Chicago, IL 60657-8266; (312) 935-0081; FAX: (312) 944-0925.

**AUDIO & VIDEO ARTS;** *Audio and Video Recording*; PO Box 3340 Rosedale St.; Kansas City, KS 66103; (816) 231-1983.

**AUDIO GRAPHIC SERVICES;** *Audio Recording*; 1516 Ferris Ave.; Royal Oak, MI 48067; (313) 544-1793; FAX: (313) 544-1793 (call first).

**AUDIO PRODUCTIONS;** *Audio Recording*; 1845 N. Fairmount; Wichita, KS 67208; (316) 689-3188.

**AUDIO SERVICES;** *Sound Reinf.;* Oberlin College, 173 W. Lorain St.; Oberlin, OH 44074; (216) 775-8272.

**AUDIO SERVICES COMPANY INC.;** *Sound Reinf., Lighting, Rental, Staging*; 511 E. Colfax Ave.; South Bend, IN 46617; (219) 287-2111; FAX: (219) 232-2220.

**AUDIO TEK USA;** *Sound Reinf., Lighting, Rental, Staging*; PO Box 122; Viroqua, WI 54665; (608) 637-3283.

**AUDIO VISIONS PRO SOUND;** *Sound Reinf., Lighting, Staging, Rental*; 8934 J St.; Omaha, NE 68127; (402) 592-0779; FAX: (402) 592-0997.

**AUDIOCRAFT RECORDING & SOUND;** *Sound Reinf., Audio Recording*; RR 2, Box 1179, E. Long Lake Rd.; Wild Rose, WI 54984; (715) 258-6092.

**AUDIO-PRO;** *Sound Reinf.;* PO Box 1515; Springfield, MO 65801; (417) 882-8404.

**AURAL ATMOSPHERE;** *Audio Recording*; 1623 Sherwood Dr.; Anderson, IN 46012-2829; (317) 642-8371.

**BARWIG RECORDING CO.;** 5254 W. Agatite Ave.; Chicago, IL 60630; (312) 283-2820.

**BELTRON PRODUCTIONS;** *Sound Reinf., Audio Recording*; 3398 Salisbury Rd. N., Ste. #49; Richmond, IN 47374; (317) 966-3781.

**BODDIE RECORDING;** *Audio Recording*; 12202 Union Ave.; Cleveland, OH 44105; (216) 752-3440.

**CHICAGO SOUND;** *Sound Reinf., Rental*; 3530 N. Lincoln; Chicago, IL 60657; (312) 477-3900; FAX: (312) 975-8572.

**CHICAGO MUSIC COMPANY;** *Sound Reinf., Rental*; 3530 N. Lincoln; Chicago, IL 60614; (312) 477-3900.

**CLAYTON STUDIO, INC.;** *Audio Recording*; 1126 S. Big Bend Blvd.; St. Louis, MO 63117; (314) 781-6200; FAX: (314) 781-0524.

**CLEARWING AUDIO & CASE CO., INC.;** *Sound Reinf., Lighting, Staging, Rental*; 3313 N. 124th St.; Brookfield, WI 53005; (414) 781-8383; FAX: (414) 781-8375.

**CMH ELECTRONICS;** *Sound Reinf.;* 6820 Wise Ave. NW; North Canton, OH 44720; (216) 497-8100.

**CONCERT SOUND & LIGHTING PRODUCTIONS, INC.;** *Sound Reinf., Lighting, Rental, Staging*; 3934 S. Hudson, Ste. 125; Tulsa, OK 74135; (918) 744-4181; FAX: (918) 622-9527.



TEC  
1990  
NOMINEE

# Both methods record incredible stereo. Crown's SASS-P makes it fast and easy.

Crown's new Stereo Ambient Sampling System™ (SASS™) and the DAT recorder combine to create a new generation of stereo recording. Unlike traditional recording methods, this powerful new combination is easy to use, more dependable and less expensive. The result is a system that records natural, beautifully imaged stereo just as your ears would hear it.

Crown's SASS-P\* eliminates traditional stereo recording compromises in sound quality, ease-of-use, and cost. No longer do you have to settle for weak low-end or off-axis coloration common to Midside, X-Y and near-coincident pair mics. Assembly and positioning time is also reduced significantly compared with conventional stereo micing techniques.

Lightweight and easy to set up, the SASS/DAT combination is a high-quality portable recording system that goes everywhere.

The SASS-P features switchable battery or phantom power and Crown's finest studio-grade PZM® capsules. You'll enjoy full ambience without coloration, excellent sum to mono, and extraordinary broad frequency response. With SASS's superb imaging capabilities, every sound is audibly reproduced in its precise position, resulting in a stereo experience of uncanny realism.

Readily adaptable to all common stands, the SASS includes a carrying case and accessories.

No matter what your stereo recording requirements—from sampling to electronic news gathering to remote recording of live events—you'll find the SASS-P the clear choice.

See your Crown representative for more information or call toll-free: 1-800-535-6289.

**SASS Sample CD!**  
Now you can hear for yourself just how great SASS sounds. This CD includes a wide selection of live and studio music, stereo sound effects and samples, including A-B comparisons with some of the best stereo mics available. The SASS CD is free, but we must charge \$4.95 for shipping and handling charges. Send check or money order to: Crown SASS CD, P.O. Box 1000, Elkhart, IN 46515-1000. Please allow 3-4 weeks for delivery.



Name \_\_\_\_\_  
Title \_\_\_\_\_  
Company \_\_\_\_\_  
Street \_\_\_\_\_  
City \_\_\_\_\_ State \_\_\_\_\_ ZIP \_\_\_\_\_  
Phone \_\_\_\_\_



Crown International, Inc. • P.O. Box 1000  
Elkhart, Indiana 46515-1000 • 219/294-8000

© 1990 Crown International  
SASS and Stereo Ambient System are trademarks and PZM a registered trademark of Crown International.

\*Also available as SASS-B for use with B & K 4003/4006 microphones (not supplied).



## Sound Reinforcement & Remote Recording Facilities

NORTH CENTRAL U.S.

**CONTINENTAL SOUND CO., INC.;** *Sound Reinf., Lighting, Rental, Staging;* PO Box 388173; Chicago, IL 60638; (312) 284-0418.

**CREATIVE SOUNDZ, INC.;** *Sound Reinf., Lighting, Rental, Staging;* PO Box 375; Mt. Prospect, IL 60056; (708) 299-5522; FAX: (708) 299-5534.

**DIGITAL AUDIO RECORDING;** *Audio Recording;* W9643 Rucks Rd.; Cambridge, WI 53523; (608) 764-8082.

**DODD TECHNOLOGIES, INC.;** *Sound Reinf., Lighting, Staging, Rental;* 10888 Allisonville Rd.; Fishers, IN 46038; (317) 842-4905; FAX: (317) 842-4966.

**EALING MOBILE RECORDING, LTD.;** *Audio Recording;* 4906 N. Talman Ave.; Chicago, IL 60625-2722; (312) 784-1558.

**ECLIPSE CONCERT SYSTEMS, INC.;** *Sound Reinf., Lighting, Rental;* 153 E. Thompson Ave.; W. St. Paul, MN 55118; (612) 451-8878.

**EIGHTH DAY SOUND SYSTEMS, INC.;** *Sound Reinf., Lighting, Staging;* 1305 W. 80th; Cleveland, OH 44102; (216) 961-2900; FAX: (216) 961-5512.

**ELECTRO-VOICE, INC.;** *Sound Reinf.;* 600 Cecil St.; Buchanan, MI 49107; (616) 695-6831.

**EMERALD CITY AUDIO, INC.;** 13136 Martin St.; Minneapolis, MN 55433; (612) 757-6153.

**ENCORE PRODUCTIONS;** *Sound Reinf., Lighting, Rental;* W. 6319 Kampen Rd.; Arlington, WI 53911-9722; (608) 635-2036.

**FIRST CALL SOUND CO., INC.;** *Sound Reinf.;* 96 Witmer Dr.; Chesterfield, MO 63017; (314) 275-2382.

**FIRST TAPE, INC.;** *Audio Recording;* 1925 N. Clybourn; Chicago, IL 60614; (312) 642-7793.

**FORTE AUDIO;** *Sound Reinf., Lighting, Rental;* 1129 W. Rowland; Flint, MI 48507; (313) 238-5043; (313) 238-8228.

**GREAT LAKES SOUND, INC.;** *Sound Reinf., Lighting, Staging, Rental;* 112 Arco Dr.; Toledo, OH 43607; (419) 534-2260; FAX: (419) 534-2261.

**GSI STUDIOS;** *Audio and Video Recording;* 9431 Engel; St. Louis, MO 63132; (314) 993-5713.

**HALF STREET PRODUCTIONS;** *Sound Reinf., Lighting, Rental;* 5835 Victoria Ave.; St. Louis, MO 63110; (314) 644-0992.

**HARMONY SOUND;** *Sound Reinf.;* 5290 Harmony; Willoughby, OH 44094; (216) 942-9361.

**HARTER SOUND;** *Sound Reinf., Lighting, Rental;* PO Box 235; Ney, OH 43549; (419) 658-2955.

**ILLINOIS CONCERT SOUND;** *Sound Reinf., Lighting, Rental;* 906 N. Sheridan; Peoria, IL 61606; (309) 674-5155.

**IVO SOUND RECORDERS;** *Audio Recording;* 539 S. Baltimore; Hastings, NE 68901; (402) 463-5059.

**J.G.M. RECORDING STUDIO;** *Audio Recording;* 4121 N. Laramie; Chicago, IL 60641; (312) 545-7388.

**KLA LABS, INC.;** *Sound Reinf., Rental;* 6800 Chase Rd.; Dearborn, MI 48126; (313) 846-3800; FAX: (313) 846-4179.

**LESCO CONCERT SOUND CO.;** *Sound Reinf., Lighting, Rental;* PO Box 741; Newark, OH 43055; (614) 522-6778 (after 8pm EST).

**LINNEMANN SOUND, INC.;** *Sound Reinf., Rental;* PO Box 452, 1020 Somonauk St.; Sycamore, IL 60178; (815) 895-8219; FAX: (815) 895-7837.

**LITTLITE/CAE, INC.;** *Lighting;* 10087 Industrial Dr.; PO Box 430; Hamburg, MI 48139; (313) 231-9373; FAX: (313) 231-1631.

**C.V. LLOYDE;** *Sound Reinf., Rental;* 102 S. Neil St.; Champaign, IL 61820; (217) 352-7031; FAX: (217) 398-5923.

**LOCATION SOUND RECORDING;** *Audio Recording;* PO Box 1512; Independence, MO 64055; (816) 373-9587.

**MAGIC MASTERS SOUND & LIGHTING;** *Sound Reinf., Lighting, Staging, Rental;* 3008 S. Jefferson Ave.; St. Louis, MO 63118; (314) 771-1115.

**MARKETING INSIGHTS;** *Sound Reinf., Lighting;* 1445 Sunset Ridge Rd.; Glenview, IL 60025; (708) 729-2047.

**M.C.I.C. VIDEO SERVICES;** *Audio and Video Recording;* Univ. of Cinti. College of Medicine; ML #574; Cincinnati, OH 45267; (513) 558-5676; FAX: (513) 558-0758.

**METRO MOBILE LOCATION RECORDING;** *Audio Recording;* 2097 John's Ct.; Glenview, IL 60025; (708) 998-6420.

**MID-AMERICA SOUND;** *Sound Reinf., Audio Recording;* 120 Monroe; Fort Atkinson, WI 53538; (414) 563-3449.

**MIRAGE SOUND & LIGHT;** *Sound Reinf., Lighting, Staging, Rental;* 155 N. Elmwood; Oak Park, IL 60302; (708) 383-6455.

**MIRROR IMAGE PRODUCTIONS;** *Audio Recording;* PO Box 10430; Chicago, IL 60610; (312) 975-0082.

**M.S. ENTERTAINMENT;** *Sound Reinf., Lighting, Rental;* 1001 E. 2nd St. (mailing); 110 Front St. (shipping); Dayton, OH 45402; (513) 461-7734.

**MS PRODUCTIONS;** *Sound Reinf., Rental;* 5971 N. 12th St.; Kalamazoo, MI 49009; (616) 342-6910.

**MUELLER ENTERPRISES;** *Sound Reinf., Lighting, Rental, Staging;* PO Box 34; Goshen, IN 46526; (219) 533-9483.

**NIPTRON SYSTEMS;** *Sound Reinf., Lighting;* PO Box 23124; Richfield, MN 55423; (612) 823-3860.

**NORTH SHORE AUDIO & ENTERTAINMENT SERVICES;** *Sound Reinf., Lighting, Staging, Audio Recording;* 2255 Par Ln. #722; Willoughby Hills, OH 44094; (216) 944-8013.

**NORTHERN LIGHTING & SOUND;** *Sound Reinf., Lighting, Rental, Staging;* 2345 Eifert Rd.; Holt, MI 48842; (517) 694-6664; FAX: (517) 694-6595.

**ON STAGE AUDIO;** *Sound Reinf., Rental;* 2380 Brickvale Dr.; Elk Grove Village, IL 60007; (708) 595-4941.

**OPLAND RECORDING;** *Audio Recording;* Rte. 10, Box 403; Sioux Falls, SD 57104; (605) 335-5940.

**OPUS RECORDING & EQUIPMENT CO., INC.;** *Sound Reinf., Rental;* 4262 Grand Ave.; Gurnee, IL 60031; (708) 336-6787; FAX: (708) 336-6895.

**ORCHARD HOUSE AUDIO;** *Audio Recording;* 224 W. 27th St.; Minneapolis, MN 55408; (612) 872-7943.

**DAVID C. PALMER PRODUCTIONS;** *Sound Reinf., Rental;* 33371 N. Bun Oak Dr.; Solon, OH 44139; (216) 248-4750.

**PASCO SOUND, INC.;** *Sound Reinf., Lighting, Staging, Rental;* 1025 Hill Pl.; Jackson, MI 49202; (514) 787-8917; (514) 787-2428.

**PERFORMANCE SOUND & LIGHTING INC.;** *Sound Reinf., Lighting, Rental;* 41560 Schoolcraft; Plymouth, MI 48170; (313) 420-0203.

**PLANET NIPTRON—NEW MOON MOBILE;** *Audio Recording;* PO Box 23124; Richfield, MN 55423; (612) 823-3860.

**THE PRAIRIE PRODUCTION GROUP;** *Audio and Video Recording;* 111 W. Goose Alley; Urbana, IL 61801; (217) 344-4675; FAX: (217) 344-2638.

**PRESCO PRODUCTIONS;** *Audio Recording;* 4366 W. 66th St.; Cleveland, OH 44144; (216) 749-7244.

**PRODUCERS VIDEO SERVICE;** *Video Recording;* PO Box 1865; Palatine, IL 60078; (708) 934-0999.

**PRODUCTION SUPPORT SERVICES, INC.;** *Sound Reinf., Lighting, Staging, Rental;* 472 Tumulty; St. Louis, MO 63021-6479; (314) 394-1257.

**PRO-TECH SERVICES, INC.;** *Sound Reinf., Lighting, Rental, Audio and Video Recording;* 1922 Fargo; Des Plaines, IL 60018; (708) 699-8937.

**P.S.;** *Sound Reinf.;* RR 2 Box 29; Larned, KS 67550; (316) 285-3458.

**PSYCHOACOUSTICS;** 2968 N. Furwell Ave.; Milwaukee, WI 53211; (414) 962-5853.

**RAINBOW RECORDING STUDIOS;** *Sound Reinf., Lighting, Rental, Audio Recording;* 2322 S. 64th Ave.; Omaha, NE 68106; (402) 554-0123.

**R.D.T. SOUND & ENGINEERING;** *Sound Reinf.;* 1529 Royer; Des Moines, IA 50316; (515) 266-7851.

**RECORDING SERVICES, INTERLOCHEN CENTER FOR THE ARTS;** *Audio and Video Recording;* PO Box 199; Interlochen, MI 49643-0199; (616) 276-9221 x360; FAX: (616) 276-6321.

**RECORDIO PRODUCTIONS;** *Audio Recording;* 6564 Goodman; Merriam, KS 66202; (913) 432-2349.

**REDLINE STUDIO;** *Audio Recording;* 1605 Pasty Ln.; Columbia, MO 65203; (314) 446-1692.

**REELSOUND AUDIO PRODUCTIONS;** *Audio Recording;* 25859 Mulroy Dr.; Southfield, MI 48034; (313) 356-2640.

**RG SOUND AND COMMUNICATIONS;** *Sound Reinf., Lighting, Staging, Rental;* 414 N. Mill St.; Celina, OH 45822; (419) 586-3671.

**RHEA SOUND COMPANY;** *Sound Reinf.;* 208 S. 10th; Bethany, MO 64424; (816) 425-2351.

**RIVERSOUND/FRONTRUNNER PRODUCTIONS;** *Sound Reinf., Lighting, Rental, Staging;* 12527 Robyn Rd.; St. Louis, MO 63127; (314) 842-1276.

**R/J RECORDING & SOUND;** *Sound Reinf., Lighting, Staging, Rental, Audio and Video Recording;* PO Box 302, 530 Lark St.; Geneva, IL 60134-0302; (708) 232-1932.

**ROCKER ENTERPRISES;** *Sound Reinf., Lighting, Rental;* 1280 Echo Ln.; Green Bay, WI 54304; (414) 494-5577.

**RODEWALD SOUND AND LIGHTING, INC.;** *Sound Reinf., Lighting, Rental;* Metro Center, 4700 N. University St.; Peoria, IL 61611; (309) 692-4222.

**TOVAL ROLSTON ENTERPRISES;** PO Box 10937; Chicago, IL 60610; (312) 404-7334.

**SAVAGE SOUND SYSTEMS;** *Sound Reinf.;* 22045 Francis; Dearborn, MI 48124; (313) 561-8059.

**SEGUE SOUND CO.;** *Sound Reinf., Lighting, Staging, Rental;* 805 Ave. F; Dodge City, KS 67801; (316) 227-2078.

**SELECT WARE, INC.;** *Sound Reinf., Lighting, Rental;* 2374 Flora; Cincinnati, OH 45219-1222; (513) 421-5551.

**SGA PRODUCTION STAGING;** *Sound Reinf., Lighting, Staging, Rental;* 2222 Spikes Ln.; Lansing, MI 48906; (517) 372-5278; FAX: (517) 372-1871.

**SILK PURSE SOUND;** *Sound Reinf., Rental;* PO Box 4273; Ann Arbor, MI 48106; (313) 662-7597.

**SLY DOG AUDIO SERVICES;** *Sound Reinf., Lighting, Rental, Staging;* 23415 Ryan Rd.; Warren, MI; (313) 759-0267; FAX: (313) 759-6136.

**SOUND CORE MUSIC;** *Sound Reinf., Lighting, Rental, Audio Recording;* 122 S. Illinois; Carbondale, IL 62903; (618) 457-5641.

**SOUND 80;** *Sound Reinf.;* 4027 JDS Tower; Minneapolis, MN 55402; (612) 339-9313; FAX: (612) 339-9314.

**SOUND IDEAS OF FORT WAYNE;** *Sound Reinf., Audio Recording;* 6803 Salge Dr.; Fort Wayne, IN 46835; (219) 485-3628.

**SOUNDZ MUSIC RENTALS;** 516 N. Milwaukee Ave.; Wheeling, IL 60090; (708) 537-8211; FAX: (708) 537-8563.



SOUTHERN THUNDER SOUND, INC.  
Minneapolis, MN

**SOUTHERN THUNDER SOUND, INC.;** *Sound Reinf., Lighting, Rental, Staging;* 2814 Washington Ave. North; Minneapolis, MN 55411; (612) 521-2356; FAX: (612) 521-2258.

**STANCO AUDIO SYSTEMS;** *Sound Reinf., Lighting, Rental, Staging;* 7754 Bellstone Rd.; St. Louis, MO 63119; (314) 962-9472.

**SUN SOUND SYSTEMS, INC.;** *Sound Reinf., Rental;* 4846 W. Main St.; Skokie, IL 60077; (708) 679-1150.

**TECHNIMEDIA STUDIOS;** *Audio and Video Recording;* 124-126 S. Fifth St.; Steubenville, OH 43952; (614) 282-5315; FAX: (614) 282-TECH (8324).

**TECH-ONE SOUND;** *Sound Reinf., Rental, Audio Recording;* PO Box 4656; Youngstown, OH 44515; (216) 799-8951.

**TIMBECK-TWO-PRODUCTIONS;** *Sound Reinf., Lighting;* 3020 N. Main St.; Dayton, OH 45405; (513) 275-8585.

**TIPTON SOUND & LIGHTING;** *Sound Reinf., Lighting, Rental, Staging;* 950 S. White River Pkwy.; Indianapolis, IN 46221; (317) 631-2703; FAX: (317) 638-6538.

**TKO PRODUCTIONS;** *Sound Reinf., Lighting, Rental, Staging;* 1923 Rutland Ave.; Des Moines, IA 50311; (515) 277-5412.

**TRAX 32 RECORDING STUDIO;** *Sound Reinf., Lighting, Rental, Staging, Audio and Video Recording;* 11249 N. Riverland Rd.; Mequon, WI 53211; (414) 242-9010.

**VIKING SOUND & RECORDING;** *Sound Reinf.;* PO Box 349, 124 Pine St.; Edna, KS 67342-0349; (316) 922-3827.

**WAVELENGTH PRODUCTIONS;** *Sound Reinf.;* 7105 N. Paulina, Ste. #3; Chicago, IL 60626; (312) 973-2477.

**WEST RIVER LIGHT & SOUND;** *Sound Reinf., Lighting, Staging, Rental;* 2907 Wilson, PO Box #33; Sanford, MI 48657; (517) 687-2732; FAX: (517) 687-7800.

**WESTMARK PRODUCTIONS;** *Audio Recording;* 8345 Duluth St.; Golden Valley, MN 55427; (612) 544-3050.

**BOB WHITE ASSOCIATES;** PO Box 39104; Solon, OH 44139; (216) 248-1317; FAX: (216) 247-8892.

**WILD OAT PRODUCTIONS/MUSIC CENTER;** *Sound Reinf.;* 415 W. 2nd St.; Ashland, WI 54806; (715) 682-3505.

**WILLIAMS SYSTEMS;** *Sound Reinf., Lighting, Rental;* PO Box 5901; Lafayette, IN 47903-5901; (317) 447-2435; FAX: (317) 448-6383.

**WIX MIX SYSTEMS;** 3947 Snelling Ave. S.; Minneapolis, MN 55406; (612) 724-2137.

**ZEROBUDGET PRODUCTIONS;** *Sound Reinf., Lighting, Rental, Staging;* PO Box 2044; La Crosse, WI 54602; (608) 786-0037.

#### NORTHWEST U.S.

Alaska, Colorado, Idaho, Montana, Nevada, Northern California, Oregon, Utah, Washington, Wyoming

**AB INTERNATIONAL ELECT. INC.;** *Sound Reinf.;* 1830-6 Vernon St.; Roseville, CA 95678; (916) 783-7800; FAX: (916) 784-1050.

**AKASHIC RECORDS GROUP;** *Audio Recording;* PO Box 395; Danville, CA 94526; (415) 837-7959.

**HANK ALRICH AUDIO SERVICES;** *Sound Reinf., Audio Recording;* PO Box 869; Greenville, CA 95947; (916) 284-6929.

**AMERICAL SYSTEMS, INC.;** *Sound Reinf.;* 30982 Huntwood Ave., Ste. 204; Hayward, CA 94544; (415) 471-7451; FAX: (415) 489-4199.

**AMERICAN AUDIO SYSTEMS, LTD.;** *Sound Reinf., Lighting, Rental;* 1417 Whitecliff Way; Walnut Creek, CA 94596; (415) 934-6151.

**AMERICAN PRODUCTION SERVICES;** *Audio and Video Recording;* 2247 15th Ave. W.; Seattle, WA 98119; (206) 282-1776; FAX: (206) 282-3535.

**AQUARIUS SOUND INC.;** *Sound Reinf.;* 270-15 Beachview; Pacifica, CA 94044; (415) 359-7210; FAX: (415) 359-7817.

**ARMADILLO PRODUCTION SERVICES;** *Sound Reinf., Lighting, Staging, Rental;* 2496 S. Memphis Way; Aurora, CO 80013; (303) 755-5239; FAX: (303) 750-4959.

**ASR;** *Sound Reinf., Rental;* 21169 West River Rd.; Stevenson, CA 95374; (209) 632-7098; (209) 521-8921.

**ASSOCIATED SOUND;** *Sound Reinf.;* 2120 P St.; Sacramento, CA 95816; (916) 443-4773; FAX: (916) 443-4748.

**AUDIO VISIONS;** *Audio Recording;* 6289 Clive Ave.; Oakland, CA 94611; (415) 482-2338.

**AUDIOWORKS RECORDING;** *Audio Recording;* 7479 S. Teller St.; Littleton, CO 80123; (303) 972-4255.

**A-V TECH SERVICES;** *Sound Reinf., Lighting, Audio and Video Recording;* 564 Butler Rd.; Grass Valley, CA 95945; (916) 272-1469.

**BACKSTREET AUDIO;** *Sound Reinf., Lighting, Rental, Staging;* N. 4304 Madison St.; Spokane, WA 99205-1244; (509) 326-2827.

**BOB'S BANDAIDS;** *Audio Recording;* 3782 E. Austin Way; Fresno, CA 93726; (209) 227-1224; FAX: (209) 228-0652.

**BONNEVILLE MEDIA COMMUNICATIONS;** *Audio Recording;* 130 Social Hall Ave.; Salt Lake City, UT 84111; (801) 237-2400; FAX: (801) 237-2459.

**CHERRY RECORDING;** *Audio and Video Recording;* 1235 15th St. SE; Salem, OR 97302; (503) 399-9775.

**CONCERT SOUND;** *Sound Reinf.;* 140 SE 28th; Portland, OR 97214; (503) 223-4600.

**CROSSROAD AUDIO;** *Sound Reinf., Lighting, Rental;* 4029 Goldust Dr.; Modesto, CA 95355; (209) 578-0287.

**DB AUDIO;** *Sound Reinf., Rental;* South 4816 Madelia; Spokane, WA 99223; (509) 448-8740.

**DJ MUSIC;** *Audio and Video Recording;* 3691 Edgefield Dr.; Santa Clara, CA 95054; (408) 727-7108.

**DOG FISH SOUND;** *Audio Recording;* 17385 NE Hillsboro Hwy.; Newberg, OR 97132; (503) 538-5638.

**PHIL EDWARDS RECORDING;** *Audio Recording;* 1522 W. Winton Ave.; Hayward, CA 94545; (415) 784-1971.

**ELECTRONIC ACOUSTIC RESEARCH;** *Sound Reinf.;* Rental; 116-B Center Ave.; Pacheco, CA 94553; (415) 682-7081.



PHIL EDWARDS RECORDING  
Hayward, CA

**FASTTRACK RECORDS;** *Audio and Video Recording;* 4220 Broadway; Denver, CO 80216; (303) 292-2115.

**FERGUS SOUND ENTERPRISES;** *Audio Recording;* 1925 Orchard Ave.; Boulder, CO 80304; (303) 442-3939.

**FM PRODUCTIONS;** *Lighting, Rental, Staging;* 3775 Bayshore Blvd.; Brisbane, CA 94005; (415) 468-6500; FAX: (415) 467-0818.

**FRONT LINE SOUND AND LIGHTING;** *Sound Reinf., Lighting, Rental;* 529 River View Dr.; San Jose, CA 95111; (408) 972-0787.

**GARY GADWOOD CUSTOM RECORDING;** *Audio Recording;* 11995 NW Kearney; Portland, OR 97229; (503) 644-0683.

**GOLDEN STATE SOUND, INC.;** *Sound Reinf., Lighting, Staging, Rental;* 59A Maxwell Ct.; Santa Rosa, CA 95401; (707) 546-7540; (415) 243-8892.

DO THEY SING ALONG BECAUSE THEY KNOW THE WORDS  
OR BECAUSE . . . THEY CAN HEAR THE WORDS.



We're Looking For A Few Clients Who Care

**ULTRASOUND**

70-V WOODLAND AVE.  
SAN RAFAEL, CA 94901

(415) 459-0100  
FAX (415) 457-0264



## Sound Reinforcement & Remote Recording Facilities

NORTHWEST U.S.

**HARBINGER AUDIO;** *Sound Reinf.;* 177 Saranap Ave.; Walnut Creek, CA 94595; (415) 682-7081.

**>HI-TECH AUDIO SYSTEMS, INC.;** *Rental;* 260 Grove St.; Half Moon Bay, CA 94019; (415) 726-2428; FAX: (415) 726-2655.

**HOLLCRAFT STUDIOS;** *Audio Recording;* 1961 Rose Ln.; Pleasant Hill, CA 94523; (415) 689-3444.

**HTS AUDIO AND CONCERT PRODUCTIONS;** *Sound Reinf., Lighting, Rental;* 1025 Idylwood Dr. SW; Issaquah, WA 98027; (206) 392-6342.

**>I.A.M.P.;** *Sound Reinf., Rental;* PO Box 1018; Pacific Grove, CA 93940; (408) 649-4135.

**ISLAND SOUND & LIGHT CORP.;** *Sound Reinf., Lighting, Rental, Staging;* PO Box 218; Camano Island, WA 98292-0218; (206) 387-0826.

**JACOBS AUDIO;** *Sound Reinf., Lighting, Staging, Rental;* 26 Berthe Cir., Colorado Springs, CO 80906; 1850 Folsom #512; Boulder, CO 80302; (719) 635-5335 (Colorado Springs); (303) 442-1533 (Boulder); FAX: (303) 443-9184.

**JUST ROSES, ROSES, INC./MICHAEL EVJE;** *Audio Recording;* PO Box 2002; San Anselmo, CA 94960; (415) 457-8923.

**KINETIC SOUND & LITE;** *Sound Reinf.;* 1415 NE 52nd St. #306; Seattle, WA 98105; (206) 527-5007.

**KUSTOM SOUND SERVICES;** *Sound Reinf., Lighting, Staging, Rental;* PO Box 4902; Missoula, MT 59806; (406) 728-6655.

**LACKEY SOUND AND LIGHT COMPANY;** *Sound Reinf.;* 3425 Stoneway Ave. N.; Seattle, WA 98103; (206) 632-7773; FAX: (206) 547-5971.

**>LINEAR SOUND SYSTEMS;** *Sound Reinf.;* 531 55th St.; Oakland, CA 94609; (415) 351-4693; FAX: (415) 652-8389.

**MATEEL SOUND CO.;** *Sound Reinf., Lighting, Rental, Staging;* 432 Church St.; Garberville, CA 95440; (707) 923-3388.

**MEAD RECORDING/RAINBOW EXPRESS PUB.;** *Audio Recording;* 602 W. Mead Ave.; Yakima, WA 98902; (509) 453-6364.

**MIDNIGHT BLUE PRODUCTIONS;** *Audio Recording;* PO Box 77013; Colorado Springs, CO 80970; (719) 599-0905.

**MILE HIGH SOUND;** *Sound Reinf., Lighting, Rental;* 1399 Revere St.; Aurora, CO 80011; (303) 343-6833.

**COLOSSUS**  
DIGITAL STEREO

**COLOSSUS**  
DIGITAL STEREO

MOBILE FIDELITY PRODUCTIONS OF NEVADA  
Incline Village, NV

**>MOBILE FIDELITY PRODUCTIONS OF NEVADA;** *Audio Recording;* PO Box 8359; Incline Village, NV 89450-8359; (702) 831-4459; FAX: (702) 831-4485.

**MOONLIGHT SOUND;** *Sound Reinf., Rental, Audio Recording;* 4763 Weld County Rd. 32; Longmont, CO 80504; (303) 535-4748.

**NORTH COUNTRY PRODUCTIONS;** *Sound Reinf., Lighting, Rental;* PO Box 103151; Anchorage, AK 99510-3151; (907) 344-4103; FAX: Call.



PACIFIC MOBILE RECORDERS  
Carmichael (Sacramento), CA

**>PACIFIC MOBILE RECORDERS;** *Audio Recording;* 2616 Garfield Ave.; Carmichael (Sacramento), CA 95608; (916) 483-2340.

**PERFORMANCE AUDIO;** *Sound Reinf., Staging, Rental, Audio Recording;* 2358 S. Main St.; Salt Lake City, UT 84115; (801) 466-3196; FAX: (801) 484-1538.

**PHANTASMA SOUND;** *Audio Recording;* 7909 Fremont Ave.; Ben Lomond, CA 95005; (408) 336-2494.

**PLANET EARTH PRODUCTIONS;** *Sound Reinf., Lighting, Audio and Video Recording;* PO Box 525; Cave Junction, OR 97523; (503) 592-2123; FAX: (503) 592-4796.



THE PLANT RECORDING STUDIOS  
Sausalito, CA

**>THE PLANT RECORDING STUDIOS;** *Audio Recording;* 2200 Bridgeway; Sausalito, CA 94965; (415) 332-6100; FAX: (415) 332-5738.

**PM ENGINEERING;** *Sound Reinf.;* PO Box 3040, 6448 S. Skyline Dr.; Evergreen, CO 80439; (303) 674-5933.

**POWER SOUND;** *Sound Reinf., Lighting, Rental, Staging;* 3501 Lathrop St., Unit F; Fairbanks, AK 99701; (907) 452-2226; FAX: (907) 451-8616.

**PRATT SOUND;** *Sound Reinf., Rental;* 840 W. 1700 South #15; Salt Lake City, UT 84104; (801) 973-4222.

**>PRO MEDIA;** *Sound Reinf., Rental;* 3563 San Pablo Dam Rd.; El Sobrante, CA 94803; (415) 222-0307; FAX: (415) 223-9147.

**>PROFESSIONAL SOUND AND RECORDING;** *Audio Recording;* 3100 W. 71st Ave.; Westminster, CO 80030; (303) 426-7819.

**PROJECTS WEST ENTERTAINMENT, INC.;** *Staging;* 2007 W. Hedding St. #202; San Jose, CA 95128; (408) 246-6424; FAX: (408) 246-9342.

**PROSHOW USA;** *Sound Reinf.;* PO Box 3814; Bellevue, WA 98053; (206) 868-5122; FAX: (206) 868-6476.

**>GEORGE RELLES SOUND REINFORCEMENT;** *Sound Reinf.;* 2021 Kincaid St.; Eugene, OR 97405; (503) 686-9325; FAX: (503) 686-9325.

**ROCKET RENTALS;** *Rental;* 51 Federal St. #100; San Francisco, CA 94107; (415) 495-2297; FAX: (415) 495-2684.

**ROSE STUDIOS;** *Audio Recording;* 1098 Rose Ave.; El Centro, CA 92243; (619) 352-5774.

**NORMAN ROSS PRODUCTIONS, INC.;** *Audio and Video Recording;* 2810 E. Evergreen Ave.; Salt Lake City, UT 84109-3128; (801) 484-0401.

**>RANDALL SCHILLER PRODUCTIONS;** *Sound Reinf., Lighting, Audio Recording;* 1207 Fifth Ave.; San Francisco, CA 94122; (415) 661-7553; FAX: (415) 566-6238.

**SELWYN CO.;** *Sound Reinf., Lighting, Audio Recording;* PO Box 610786; San Jose, CA 95161; (415) 881-2738.

**SHYNE SOUND;** *Sound Reinf.;* Box 2280; San Rafael, CA 94912; (415) 459-2833.

**SNAKE RIVER SOUND;** 1008 N. 6th St.; Boise, ID 83702; (208) 386-9276.

# SOUND ON STAGE

SOUND ON STAGE  
Brisbane, CA

**SOUND ON STAGE;** *Sound Reinf.;* 290 Industrial Way; Brisbane, CA 94005; (415) 468-2990; FAX: (415) 468-2622.

**STOTZ'S SOUND;** *Audio Recording;* 576 Cypress St.; Monterey, CA 93940; (408) 375-9718.

**STUDIO Z RECORDING, INC.;** *Audio Recording;* 1030 48th St.; Sacramento, CA 95819; (916) 456-2737; FAX: (916) 456-0606.

**SWANSON SOUND SERVICE COMPANY;** *Sound Reinf., Rental;* 916 75th Ave.; Oakland, CA 94621; (415) 638-4944.

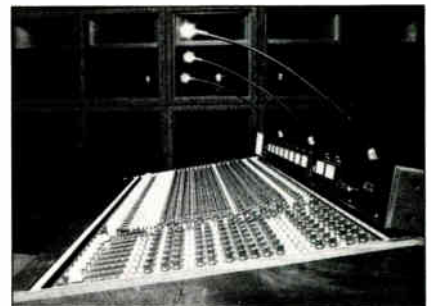

**THIRD EAR**  
SOUND COMPANY

THIRD EAR SOUND CO.  
Richmond, CA

**>THIRD EAR SOUND CO.;** *Sound Reinf., Rental;* 601 S. 8th St.; Richmond, CA 94804; (415) 233-2920; FAX: (415) 233-1638.

**TRAX;** *Sound Reinf., Rental, Audio Recording;* 332 Martin Ln.; Salt Lake City, UT 84107; (801) 262-3601; FAX: (801) 269-8886.

**T.T.S., INC. (TECHNICAL THEATRE & STAGING, INC.);** *Audio and Video Recording;* 1790 Platte St.; Denver, CO 80202-1039; (303) 480-0800; FAX: (303) 480-1733.

**ULTRA SOUND;** *Sound Reinf.;* PO Box 3625; San Rafael, CA 94912; (415) 459-0100.

**>UNITED SOUND ASSOCIATES, INC.;** *Sound Reinf.;* PO Box 9488; Yakima, WA 98909; (509) 452-8686; FAX: (509) 575-6527.

**WHITLO PRODUCTIONS;** *Sound Reinf., Lighting, Rental, Staging;* 1183 Bird Ave. #3; San Jose, CA 95125; (408) 298-0215.

**BOB WILSON RECORDING SERVICES;** *Audio and Video Recording;* 803 Selkirk Pl.; Sunnyvale, CA 94087; (408) 996-9582.

**XXXX AUDIO SYSTEMS;** *Sound Reinf., Rental;* 6384 Freepoint Blvd.; Sacramento, CA 95822; (916) 443-3535; FAX: (916) 427-1455.

**Y-KNOT SOUND;** *Sound Reinf.;* PO Box 444; Eureka, CA 95502; (707) 444-8497.

**ZEPHYRS OF THE MUSE;** *Audio Recording;* 636 Lockhaven Dr.; Pacifica, CA 94044; (415) 355-4359.

#### SO. CAL. / SOUTHWEST U.S.

Arizona, Arkansas, Hawaii, Las Vegas, New Mexico, Oklahoma, Southern California, Texas

► **A-1 AUDIO, INC.;** *Sound Reinf., Rental;* 3780 Scripps Way; Las Vegas, NV 89103-3001; (702) 364-0203; FAX: (702) 362-7607.

#### Mix Trivia

24. In 1965, he had the first rock song more than six minutes in length to be played on commercial radio.

25. A superstar in his own right, this performer wrote the liner notes for Dylan's 1969 *Nashville Skyline*.

Turn to page 152 for question



A-1 AUDIO, INC.  
Hollywood, CA

► **A-1 AUDIO, INC.;** *Sound Reinf., Rental;* 6322 DeLongpre Ave.; Hollywood, CA 90028-8191; (213) 465-1101; FAX: (213) 465-9467.

**ADVANCED AUDIO;** *Sound Reinf.;* 11120 Weddington St.; N. Hollywood, CA 91601; (818) 985-6882.

**ADVANCED AUDIO SYSTEMS;** *Sound Reinf.;* 2445 E. Thomas Rd.; Phoenix, AZ 85016; (602) 956-0580.

► **ADVANCED PRODUCTION SERVICES, INC.;** *Sound Reinf., Rental;* 1035 S. Tyndall; Tucson, AZ 85719; (602) 884-8550.

**ALL NIGHT RECORDS;** *Audio Recording;* 208-1/2 N. Washington; El Dorado, AR 71730; (501) 862-0731.

**ANALOG SYSTEMS;** *Sound Reinf., Lighting, Rental;* 8922 Glacier; Texas City, TX 77591; (409) 935-8137.

**ARIZONA CINE EQUIPMENT, INC.;** *Lighting;* 2125 E. 20th St.; Tucson, AZ 85719; (602) 623-8268; FAX: (602) 623-1092.

**ARX SYSTEMS;** *Sound Reinf.;* PO Box 842; Silverado, CA 92676; (714) 649-2346; FAX: (714) 649-3064.

**ATLANTIS AUDIO;** *Sound Reinf., Lighting, Staging;* 2518 N. 82nd St.; Scottsdale, AZ 85257; (602) 994-9257.

**ATM AUDIO/VISUAL;** *Sound Reinf., Lighting, Rental;* 17104 S. Figueroa St.; Gardena, CA 90248; (213) 538-2004; (213) 329-0997; FAX: (213) 516-1829.

**ATOMIC SOUND;** *Sound Reinf., Lighting, Rental;* 2808 N. Naomi St.; Burbank, CA 91504; (818) 840-9119.

**AUDIBLE SYSTEMS;** *Sound Reinf.;* 1631 Maria St.; Burbank, CA 91504; (818) 843-2121; FAX: (818) 845-7116.

**AUDIO HAWAII INC.;** *Sound Reinf., Lighting, Staging, Rental, Audio Recording;* 981 Kalaanui Rd.; Honolulu, HI 96825; (808) 396-6503; FAX: (808) 396-6052.

**AUDIO HAWAII INC.;** *Sound Reinf., Lighting, Rental, Staging;* 96-1173 Waihana St., Ste. B-4; Pearl City, HI 96782; (808) 455-5875; FAX: (808) 396-6052.

◉ **AUDIO SERVICES CORPORATION;** *Audio and Video Recording;* 10639 Riverside Dr.; N. Hollywood, CA 91602; (818) 980-9891; FAX: (818) 980-9911.

**AUDIO SYSTEMS;** *Sound Reinf., Audio Recording;* 3001 Windy Surf Ct.; Las Vegas, NV; (702) 363-2408.

**THE AUDIO TRUCK;** 46-210 Ahui-Nani Pl.; Kaneohe, HI 96744; (808) 247-5529.

► **AUDIO WEST;** *Sound Reinf.;* 670 S. Jefferson St.; Placentia, CA 92670; (714) 528-2285.

**AUDIOVEND;** *Sound Reinf.;* PO Box 1366; League City, TX 77573; (713) 484-5112.

**BANTAM SOUND SERVICES;** *Sound Reinf.;* 11225 Magnolia Blvd., Unit 308; North Hollywood, CA 91403; (818) 907-5181.

**BEAR COMMUNICATIONS INC.;** *Rental;* 12802 Valley View #9; Garden Grove, CA 92645; (714) 893-3881; FAX: (714) 373-2325.

# 2400 WATTS\* • 40 LBS. • 2 RACK SPACES HAVE WE GOT YOUR ATTENTION?

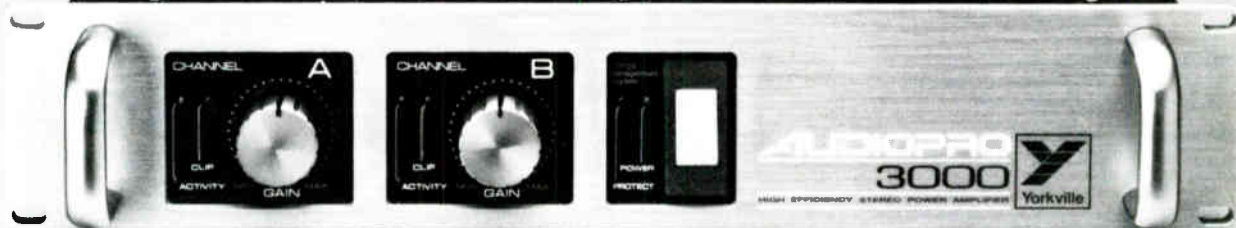

#### CHECK 1 2 3...

New High Efficiency Technology from Yorkville Sound brings you a stereo power amplifier capable of delivering the full dynamic range of today's music. The AUDIOPRO 3000 is an outstanding value in terms of performance, size and reliability.

#### CHECK OUR SPECS

POWER: 1200 W/ch @ 2 ohms, (both channels driven)  
750 W/ch @ 4 ohms, (+2400 W Bridged Mono)  
475 W/ch @ 8 ohms, (1500 W Bridged Mono)

THD: 0.004% full power @ 4 ohms

SLEW RATE: 30V/μ sec. (60V/μ sec. Bridged)

HUM & NOISE: -105 dB Unweighted, -115 dB A-Weighted

DAMPING: >60

#### CHECK OUR FEATURES

- High efficiency power conversion approaches the performance of digital switching, but with the response and low distortion of the best analog designs.
- Energy Management System (EMS). Monitors and regulates line current making it possible to achieve high power from ordinary 15 amp AC line.
- MOSFET drivers eliminate secondary breakdown.
- 2-Year Unlimited Warranty. (Even if you break it!)

#### CHECK IT OUT

If your sound demands no compromises in quality and reliability check out the AUDIOPRO 3000. Watts/\$ and Watts/lb., no other amp matches its performance.



U.S.: 4600 Witmer Industrial Estate  
Niagara Falls, N.Y. 14305  
CANADA: 80 Midwest Rd.  
Scarborough, Ont. M19 4R2



## Sound Reinforcement & Remote Recording Facilities

SO. CAL./SOUTHWEST U.S.

**>BEST AUDIO;** *Sound Reinf., Audio Recording;* 10640 Burbank Blvd.; North Hollywood, CA 91601; (818) 763-2378; FAX: (818) 505-9211.

**>BERNHARD BROWN, INC.;** *Sound Reinf., Lighting, Rental;* 11311 Indian Trail; Dallas, TX 75229; (214) 241-4334; FAX: (214) 241-2841.

**BURNS AUDIO CORPORATION;** *Sound Reinf.;* 11174 Penrose St. #6; Sun Valley, CA 91352; (818) 768-2370; FAX: (818) 768-2414.

**BURNS AUDIO CORPORATION;** *Sound Reinf.;* 5087A S. Arville; Las Vegas, NV 89118; (702) 873-0468; FAX: (702) 873-3078.

**CANTRAX RECORDERS;** *Audio Recording;* 2119 Fidler Ave.; Long Beach, CA 90815; (213) 498-6492.

**CELESTIAL SYSTEMS;** *Sound Reinf., Lighting, Rental, Staging;* 3380 W. Hacienda Ave. #101; Las Vegas, NV 89118; (702) 798-4118; FAX: (702) 798-6818.

**CHICOSLAVAKIA SOUNDSTAGE WEST;** *Audio and Video Recording;* 4640 Danza St.; Woodland Hills, CA 91364; (818) 703-8940.

**CONCERT SOUND CONSULTANTS;** *Sound Reinf.;* PO Box 831; Julian, CA 92036; (619) 765-2220; FAX: (619) 765-2520.

**JOE CONTI PRODUCTIONS;** *Audio Recording;* PO Box 557; Capt. Cook, HI 96704; (808) 328-8106.

**>CROSSROADS AUDIO, INC.;** *Sound Reinf., Lighting, Rental, Audio Recording;* 2623 Myrtle Springs Ave.; Dallas, TX 75220; (214) 358-2623; FAX: (214) 358-0185.

**DALLAS BACKUP, INC.;** *Sound Reinf., Lighting, Rental, Staging;* 12589 Perimeter Dr.; Dallas, TX 75228; (214) 686-4488; FAX: (214) 686-7732.

**DELICATE PRODUCTIONS, INC.;** *Sound Reinf., Lighting, Rental, Staging;* 1390 Flynn Rd. #A; Camarillo, CA 93010; (805) 388-1800; FAX: (805) 388-1037.

**>DIGITAL SERVICES RECORDING STUDIOS;** *Audio Recording;* 5805 Chimney Rock; Houston, TX 77081; (713) 664-5258; FAX: (713) 663-6518.

**>ELECTRIC EAR PRODUCTIONS, INC.;** *Sound Reinf., Lighting, Staging, Rental;* 1616 Ave. F; Lubbock, TX 79401; (806) 763-9794; FAX: (806) 762-0763.

**ELECTROTEC PRODUCTIONS, INC.;** *Sound Reinf.;* 6735 Eton Ave.; Canoga Park, CA 91303; (818) 888-8687; FAX: (818) 703-6254.

**FILAMENT PRO AUDIO;** *Sound Reinf., Lighting, Rental, Staging;* 143 E. Arrow Hwy.; San Dimas, CA 91773; (818) 339-0081; (714) 592-2848; FAX: (714) 592-2840.

**>FITZCO SOUND, INC.;** *Sound Reinf., Lighting;* 912 N. Midkiff; Midland, TX 79701; (800) 292-6877; FAX: (915) 689-8878.

**FRONTIER AUDIO-VIDEO-LIGHTING;** *Sound Reinf., Lighting, Rental, Staging;* 3353 Chicago Ave.; Riverside, CA 92507; (714) 683-5860; FAX: (714) 683-1646.

**GARRISAN AUDIO;** *Sound Reinf., Rental, Audio and Video Recording;* 6103 Kelly-Elliott; Arlington, TX 76017; (817) 478-4368; FAX: (817) 478-4961.

**GUITAR TRADER;** *Sound Reinf.;* 5035 Shawline St.; San Diego, CA 92111; (619) 585-8814.

**GULF COAST SOUND AND LIGHTING;** *Sound Reinf., Lighting, Rental, Staging;* 5733 Savoy; Houston, TX 77036; (713) 784-5363; FAX: (713) 784-5365.

**HARPAZO! MINISTRIES EVANGELICAL ASSOCIATION VIDEO PRODUCTIONS;** *Video Recording;* PO Box 453; Lakewood, CA 90714; (213) 422-4252.

**HG SOUND;** *Sound Reinf., Rental;* PO Box 766; Manhattan Beach, CA 90266; (213) 634-6566.

**BILL HOLFORD SOUND, INC.;** *Audio Recording;* 5418 Grape Rd.; Houston, TX 77096; (713) 665-7554.

**INFOVIDEO PRODUCTIONS;** *Audio and Video Recording;* 11211 Sorrento Valley Rd., Ste. R; San Diego, CA 92121; (619) 452-9000; FAX: (619) 452-9055.

**J.D.S. ELECTRONICS;** *Sound Reinf., Lighting;* 9648 Firestone Blvd.; Downey, CA 90241; FAX: (213) 869-4429.

**JOURNEY PRODUCTIONS;** *Sound Reinf., Lighting, Rental, Staging;* 910 B Ave.; Lawton, OK 73501; (405) 355-1292.

**PITT KINSOLVING, INDEPENDENT SOUND ENGINEER;** *Sound Reinf., Audio Recording;* 686 Arroyo Pkwy., Ste. 260; Pasadena, CA 91105; (213) 303-5362 (pager).

**LA SOUND CO., INC.;** *Sound Reinf.;* 12547 Sherman Way, Unit F; North Hollywood, CA 91605; (818) 765-6900; FAX: (818) 765-8262.

**STAN LAWRENCE PRODUCTIONS;** *Sound Reinf., Lighting, Rental, Staging;* 1131 Alta Loma Rd. #422; West Hollywood, CA 90069; (213) 657-5633.

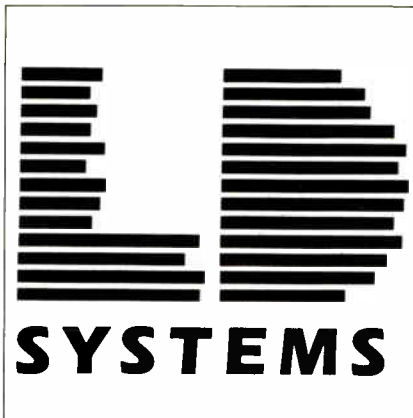

L.D. SYSTEMS, INC.  
Houston, TX

**>L.D. SYSTEMS, INC.;** *Sound Reinf., Lighting, Rental, Staging;* 467 W. 38th; Houston, TX 77018; (713) 695-9400; FAX: (713) 695-8015.

**>LE MOBILE;** *Audio Recording;* 11131 Weddington St.; North Hollywood, CA 91601; (818) 506-8481.

**LEAVENWORTH/SOUND;** *Audio Recording;* 5004 Pendleton St.; San Diego, CA 92109; (619) 274-3566.

**DAVID LEWISTON;** *Audio Recording;* 715 S. Kihei Rd., Ste. 214; Kihei, HI 96753; (808) 879-0156.

**MADISON TAYLOR RECORDERS;** *Audio Recording;* 3628 Pacific Ave.; Long Beach, CA 90807; (213) 424-6010.

**MAGNUM SOUND & LIGHTS;** *Sound Reinf., Lighting;* 7522 E. Poinciana; Tucson, AZ 85730; (800) 678-2456.

**MAUI SOUND SYSTEMS, INC.;** *Sound Reinf., Rental;* 335 Hoohana St. Bay E/R; Kahului, Maui, HI 96732; (808) 871-8383; FAX: (808) 871-5057.

**PENNY L. MCDONNELL;** *Sound Reinf.;* 6214 E. Mockingbird Ln.; Paradise Valley, AZ 85233; (602) 443-1635.

**METROPOLITAN AUDIO-VISUAL INC.;** *Sound Reinf., Lighting, Rental, Staging;* 1039 N. 24th St.; Phoenix, AZ 85008; (602) 244-0494; FAX: (602) 267-8622.

**>MIDCOM REMOTE SERVICES;** *Audio Recording;* 3 Dallas Comm. Complex, Ste. 108; 6311 N. O'Connor Rd., LB-50; Irving, TX 75039; (214) 869-2144.

**MIND OVER MEDIA;** *Audio and Video Recording;* 911 N. Euclid; La Habra, CA 90631; (213) 691-2776.

**MOBILE SOUND & LIGHTING SYSTEMS OF HAWAII;** *Sound Reinf., Lighting, Staging;* PO Box 1380; Kailua, HI 96734; (808) 235-0522.

**>MP PRODUCTIONS, INC.;** *Sound Reinf., Lighting, Rental, Staging;* 6301 Murray St.; Little Rock, AR 72209; (501) 562-7425; FAX: (501) 562-7521.

**THE MUSIC FACTORY;** *Sound Reinf., Lighting, Rental, Staging;* 1264 Monterey St.; San Luis Obispo, CA 93401; (805) 544-8944.

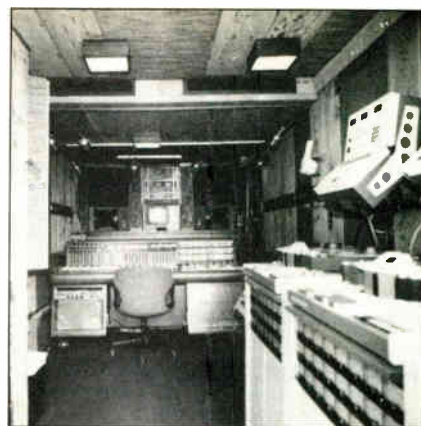

OMEGA AUDIO & PRODUCTIONS, INC.  
Dallas, TX

**>OMEGA AUDIO & PRODUCTIONS, INC.;** 8036 Aviation Pl.; Dallas, TX 75235; (214) 350-9066; FAX: (214) 350-8342.

**ON-SITE RECORDING SERVICES;** *Audio and Video Recording;* 1610 Scottsdale Dr.; Arlington, TX 76018; (817) 472-7256.

**ON-TRAX;** *Sound Reinf., Rental, Audio and Video Recording;* 9340 Namia Dr.; Riverside, CA 92503; (714) 687-5506.

**OPTIMUM SOUND, INC.;** *Sound Reinf.;* 6900 W. 42nd St.; Little Rock, AR 72204; (501) 562-2225.

**ORANGE COUNTY SPEAKER, INC.;** *Sound Reinf., Rental;* 13686 Newhope St.; Garden Grove, CA 92643; (714) 530-3860; FAX: (714) 530-9620.

**PACIFIC SOUNDS;** *Sound Reinf., Audio Recording;* PO Box 4817; Lancaster, CA 93539; (805) 948-4273.

**>PACIFIC AUDIO-VISUAL ENTERPRISES;** *Audio Recording;* 545 Cloverleaf Way; Monrovia, CA 91016; (818) 359-8012; FAX: (818) 357-0602.

**PASHA MUSIC HOUSE;** *Audio Recording;* 5615 Melrose Ave.; Los Angeles, CA 90038; (213) 466-3507; FAX: (213) 469-0122.

**PEAK AUDIO;** *Sound Reinf.;* 4636 McKinney #108; Dallas, TX 75205; (214) 520-0775.

**PROFESSIONAL PRODUCTION ASSOCIATES;** *Sound Reinf.;* 425 W. LaCadena Dr. #8; Riverside, CA 92501; (714) 682-3429; FAX: (619) 747-0276.

IN OUR SECOND DECADE

# QSI QUICKBEAM SYSTEMS INC

Excellence in Audio and Stage Lighting

FEATURING:

**ADGEE**

**SOUND**

Denver: (303) 571-1919  
Albuquerque: (505) 345-9230  
Toll Free: 1-800-227-6239  
FAX: (505) 345-4604

QUICKBEAM SYSTEMS, INC.  
Albuquerque, NM

**>QUICKBEAM SYSTEMS, INC.;** *Sound Reinf., Lighting, Rental, Staging;* 3716 High St. NE; Albuquerque, NM 87107; (800) 227-6239; FAX: (505) 345-4604.

**RAPA SOUND;** *Sound Reinf., Audio Recording;* Box 1017; Jerome, AZ 86331; (602) 634-9607.

**RAT SOUND SYSTEMS;** *Sound Reinf., Lighting, Staging;* 11800 Sheldon St. #D; Sun Valley, CA 91352; (818) 504-2930.

**>RECORD PLANT, INC.;** *Audio Recording;* 1032 N. Sycamore Ave.; Hollywood, CA 90038; (213) 653-0240; FAX: (213) 466-8835.

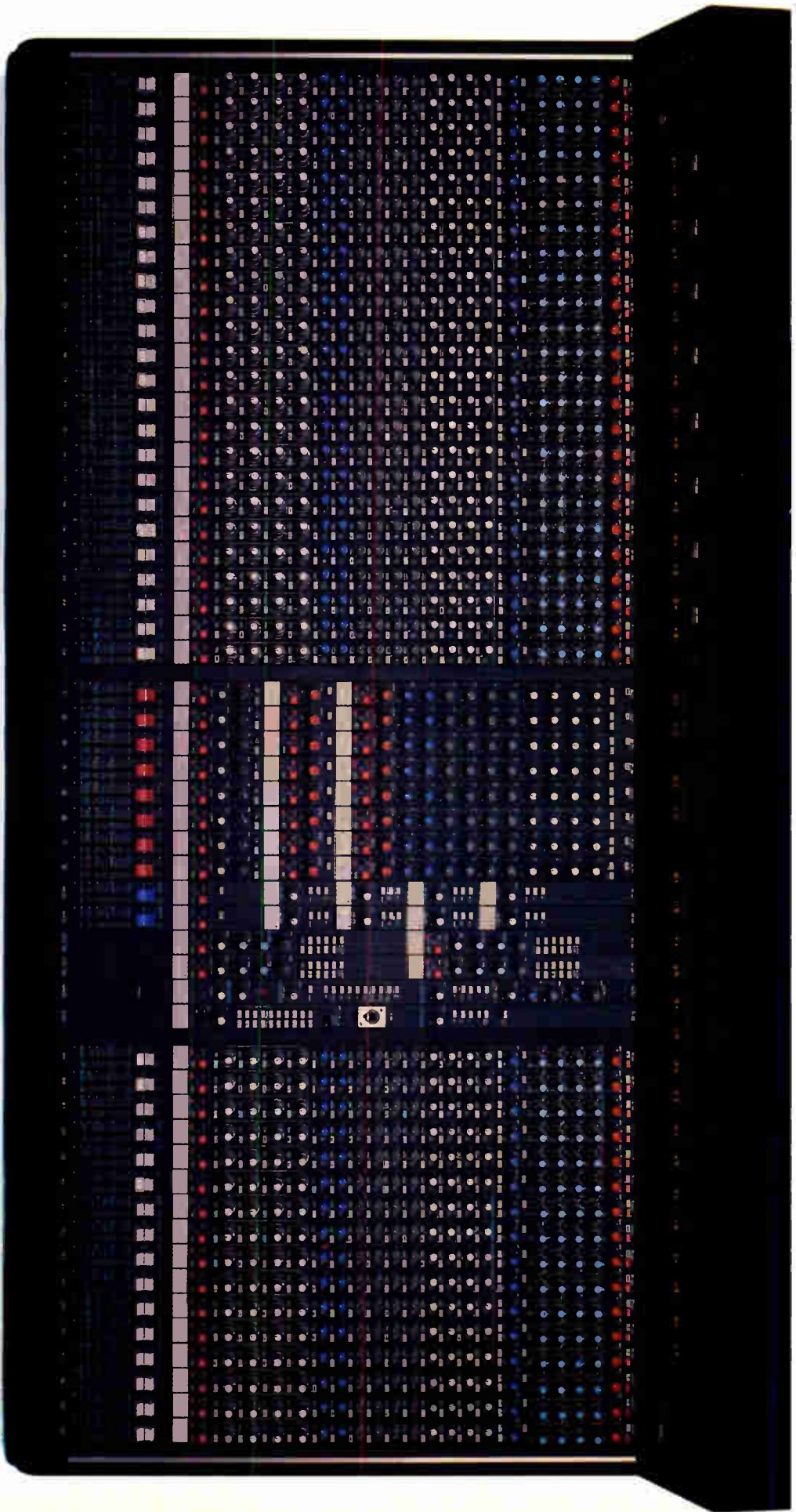

**RAMSA WRS-840 Monitor Console. Just ask these sound companies: AI-Audio** (Frank Sinatra, Liza Minelli, The Temptations, Tony Bennett, K.T. Oslin, Gladys Knight).

**Burns Audio** (Academy Awards, Grammy Awards, Golden Globe Awards, Academy of Country Music Awards, Kennedy Center Honors, San Diego Civic Auditorium (Summer Season), San Diego Starlight Bowl (Summer Season), Soul Train Music Awards, Las Vegas Spring Mountain Ranch (Summer Concert Series), Warner Brothers Re-dedication Ceremonies).

**dB Sound, Chicago** (Aerosmith, Stryper, New Order, P.M.D., Sugarcube, Prince). **Eighth Day Sound** (Erasure, Bad English, Alice Cooper, Lisa Stansfield, Jethro Tull, The Escape Club, The Tom-Tom Club/Deborah Harry/Ramones/Jerry/Harrison Tour, Tom Jones, Kool & The Gang). **Maryland Sound** (David Bowie, Neil Diamond, Debbie Gibson, Anita Baker, Kenny G, Luther Vandross, Hall & Oates, Miami Sound Machine, Neil Young, David Lee Roth, Belinda Carlisle, Melissa Manchester, Patii Labelle, Paul Simon,

George Benson, Steve Miller, Pink Floyd, Roberta Flack, Dolly Parton, Ann Murray, Joe Jackson, Roy George, Stevie Wonder, Earth, Wind and Fire, The Cure, Whitney Houston). **Naked Zoo** (Wayne Newton, The Commodores, Roger Whittaker). **Pro Media** (Luciano Pavarotti). **See Factor**

(Lou Reed, Smokey Robinson, David Byrne). **Sound Image** (Barbara Mandrell, Jackson Browne, John Denver, Jimmy Buffet, The Robert Cray Band). **Sun Sound Audio** (Joe Cocker). For more information, contact: Rainisa, 6550 Katella Avenue, Cypress, CA 90632, 714-373-7278.

**RAMSA**

**Parasonic**

Communications & Systems Company



## Sound Reinforcement & Remote Recording Facilities

S. O. CAL./SOUTHWEST U.S.

**RECORDING SERVICES COMPANY;** *Audio Recording;* 2414 W. Olive Ave.; Burbank, CA 91506; (818) 843-6800; FAX: (818) 842-8713.

**REELSOUND RECORDING CO.;** *Audio Recording;* 2304 Sheri Oak Ln.; Austin, TX 78748; (512) 282-0713.

**>RSC/FUTURE POST;** *Audio Recording;* 2414 W. Olive Ave.; Burbank, CA 91506; (818) 843-8200.

**SCHUBERT SYSTEMS GROUP;** *Sound Reinf.;* 7325 Hinds Ave.; North Hollywood, CA 91605; (818) 503-1234.

**SERIOUS AUDIO;** *Sound Reinf.;* 5839 Silvercreek Rd.; Azle, TX 76020; (817) 281-7988.

**SHADOWFAX AUDIO SYSTEMS;** *Sound Reinf.;* Rental; 841 Barton Ave.; Camarillo, CA 93010; (805) 484-4284.

**SHOWCO, INC.;** *Sound Reinf.;* Rental; 201 Regal Row; Dallas, TX 75247; (214) 630-1188; FAX: (214) 638-3245.

**SLAVESONG SOUND LAB;** *Audio and Video Recording;* PO Box 41233; Dallas, TX 75241; (214) 291-5501.

**SONIC SOUND PRODUCTIONS;** *Sound Reinf.;* Lighting, Rental; 19913 Beach Blvd. #257; Huntington Beach, CA 92648; (714) 722-9505; (213) 465-6509.

**SOUND ARTS RECORDING STUDIO;** *Audio Recording;* 2036 Pasket; Houston, TX 77092; (713) 688-8067.

**SOUND CITY PRODUCTIONS;** *Sound Reinf.;* Rental; 1906 W. Gramercy St.; San Antonio, TX 78201; (512) 733-0091.

**>SOUND SOUTHWEST;** *Sound Reinf.;* Lighting, Staging, Rental; 2611 N. Beltline #117; Sunnyvale, TX 75182; (214) 226-3069.

**SOUTHWEST SOUND/VIDEO;** *Sound Reinf.;* Audio and Video Recording; 2075 Austin; Las Cruces, NM 88001; (505) 522-5630.

**SPECTRATECH SOUND/LIGHTING SYSTEMS;** *Sound Reinf.;* Lighting, Staging; PO Box 13171; Austin, TX 78711; (512) 444-1990.

**SPECTRUM STUDIOS;** *Audio Recording;* 664 Camino Campana; Santa Barbara, CA 93111; (805) 967-9494.

**SPEEDA SOUND;** *Sound Reinf.;* Rental; 5617 W. San Madele; Fresno, CA 93722; (209) 275-7197; FAX: (209) 275-8694.

**SPINNING REEL;** *Audio Recording;* 11929 Windward Ave.; Los Angeles, CA 90066; (213) 313-2776.

**STAGE SOUND, INC.;** *Sound Reinf.;* Lighting, Rental, Staging; 4708 E. Van Buren St.; Phoenix, AZ 85008-6981; (602) 275-6060; FAX: (602) 275-6696.

**STELLAR WINDS STUDIO;** *Audio Recording;* 2501 Sublett Rd. #995; Arlington, TX 76017; (817) 465-4780.

**STEPHEN'S SOUND;** *Sound Reinf.;* Lighting, Rental, Staging; 1801 Pacific Ave.; Norco, CA 91760; (714) 371-4975; FAX: (714) 737-9405.

**>STUDIO FIVE SOUND;** *Sound Reinf.;* Rental, Audio Recording; PO Box 4291; Point Mugu, CA 93042; (805) 485-7454.

**>STUDIO ON WHEELS;** *Audio Recording;* 339 W. Windsor Rd., Ste. 6; Glendale, CA 91204; (818) 243-6165.

**TALUS SOUND;** *Sound Reinf.;* 1248 E. Valerie; Tempe, AZ 85281; (602) 994-5616.

**TAYLOR SOUND CO., INC.;** *Sound Reinf.;* Lighting, Staging; 104 Craigway; Poteau, OK 74953; (918) 647-3287.

**THOMAS GREGOR AUDIO;** *Sound Reinf.;* Rental; 6850 Vineland Ave., Unit D; North Hollywood, CA 91605; (818) 505-9544; FAX: (818) 505-9695.

**>TR&M CO. (TRAM RECORDS);** *Audio and Video Recording;* 8920 Limonite, Ste. 333; Riverside, CA 92509; (714) 783-2653; FAX: (714) 685-6793.

**VIDEO MEDIA PRODUCTIONS-DIV. OF VISUAL COMMUNICATIONS, INC.;** *Video Recording;* 2727 N. Southern Ave.; Tempe, AZ 85282; (602) 966-6545; FAX: (602) 438-2238.

**VJ ELECTRONICS, INC.;** *Sound Reinf.;* Rental; 22127 S. Vermont Ave.; Torrance, CA 90502; (213) 533-5980.

**WALK ON WATER STUDIOS, INC.;** *Audio Recording;* Rt. 2, Box 566-H; New Braunfels, TX 78130; (512) 629-8008; FAX: (512) 625-2024.

**WEST L.A. MUSIC;** *Sound Reinf.;* 11345 Santa Monica Blvd.; Los Angeles, CA 90025; (213) 477-1945; FAX: (213) 477-2476.

**WEST TEXAS PRO AUDIO;** *Sound Reinf.;* PO Box 662; Shallowater, TX 79363; (806) 832-5760.

**WESTWOOD ONE COMPANIES;** *Audio Recording;* 8966 Washington Blvd.; Culver City, CA 90232; (213) 840-4000; FAX: (213) 204-4375.

**EVAN WILLIAMS STUDIOS;** *Audio and Video Recording;* 1519 S. Grand Ave.; Santa Ana, CA 92705; (714) 543-6155.

**WING AND A PRAYER MUSIC;** *Audio Recording;* 1200 S. Gary; Monahans, TX 79756; (915) 943-6524.

**WORKSHOP MUSIC & SOUND;** Rental; 4408 E. Speedway Blvd.; Tucson, AZ 85712; (602) 325-4206; FAX: (602) 327-8773.

### CANADA

Alberta, British Columbia, Manitoba, New Brunswick, Newfoundland, Northwest Territories, Nova Scotia, Ontario, Prince Edward Isle, Quebec, Saskatchewan

**>ALL STAR SOUND EQUIPMENT LTD.;** *Sound Reinf.;* Lighting, Rental; 11212-143rd St.; Edmonton, AB T5M 1V5; (403) 452-2546; FAX: (403) 454-6452.

**>AUDIO CONCEPT (TORONTO);** *Sound Reinf.;* #16-951 Denison St.; Markham, ON L3R 3W9; (416) 940-1820; FAX: (416) 940-1382.

**BAND AID SERVICES;** *Sound Reinf.;* Rental; 371 A Danforth Rd.; Toronto, ON; (416) 690-3343; FAX: (416) 690-3363.

**>COMFORT SOUND;** *Audio Recording;* 26 Soho St., Ste. 390; Toronto, ON M5T 1Z7; (416) 593-7992; FAX: (416) 593-7301.



ALL STAR SOUND EQUIPMENT LTD.  
Edmonton, AB

**COMMERCIAL ELECTRONICS LTD.;** *Sound Reinf.;* Rental, Staging; 1335 Burrard St.; Vancouver, BC V6Z 1Z7; (604) 669-5525; FAX: (604) 669-6347.

**>EASTERN AUDIO;** *Sound Reinf.;* Lighting, Rental; 426 Water St.; St. John's, NF A1C 2L8; (709) 722-0864.

**>FM SYSTEMS;** *Sound Reinf.;* Lighting, Staging, Rental; 16423 117th Ave.; Edmonton, AB; (403) 451-1353; FAX: (403) 451-2868.

**>J.L. SOUND SYSTEMS;** *Sound Reinf.;* Lighting, Staging, Rental; 250 King St. E.; Hamilton, ON L8N 1B7; (416) 527-6863; FAX: (416) 527-5523.

**>KARISMA RECORDING, INC.;** *Audio Recording;* 9 Kirkland Blvd., Ste. 102; Montreal, QC H9J 1N2; (514) 522-0802; FAX: (514) 527-2326.

**>KITSCH AUDIO LTD.;** *Sound Reinf.;* Lighting, Rental, Staging; 1565 Iberville; Montreal, QC H2K 3B8; (514) 527-2323; FAX: (514) 527-2326.

**>L.R. LIGHT AND SOUND;** *Sound Reinf.;* Lighting, Rental; Box 7834; Drayton Valley, AB T0E 0M0; (403) 542-5282.

**MCGILL RECORDING STUDIOS;** *Audio Recording;* 555 Sherbrooke St. W.; Montreal, QC H3A 1E3; (514) 398-8057; FAX: (514) 398-8061.

**PAVANNE AUDIO RECORDING;** *Audio Recording;* Box 7, Place du Parc; Montreal, QC H2W 2M9; (514) 485-7955.

**PIERCE SOUND;** *Sound Reinf.;* Lighting, Rental, Staging; 6-411 Industrial Rd.; London, ON N5V 3L3; (519) 455-7041; FAX: (519) 455-6506.

**POLYAUDIO PRODUCTIONS;** *Audio Recording;* PO Box 2203; Chicoutimi, QC G7G 3W4; (418) 549-7862.

**PRODUCTION LIGHTING;** *Lighting, Staging;* 1405 Lome St.; Regina, SK S4R 2K3; (306) 347-8222; FAX: (306) 565-8772.

**PRODUCTION LIGHTING LTD.;** 615 10th St.; Saskatoon, SK S7H 0G8; (306) 664-0011.

**PRO-LITE PRODUCTIONS LTD.;** *Lighting, Rental, Staging;* #550 42nd Ave. SE; Calgary, AB T2G 1Y6; (403) 243-2688; FAX: (403) 243-2689.

**REELS IN MOTION;** *Audio Recording;* PO Box 71; West Hill, ON M1E 4R8; (416) 282-0655.

**SHOW PRO;** *Sound Reinf.;* Lighting; 2005 Danforth Ave.; Toronto, ON M4C 1J7; (416) 699-9699; FAX: (416) 698-8315.

**SOUND ART PRODUCTIONS;** *Sound Reinf.;* Rental; 134 Brentford Rd.; Winnipeg, MB R2M 5B9; (204) 253-9420; FAX: (204) 257-4087.

**>TURTLE MOBILE RECORDING LTD.;** *Audio Recording;* 316 E. 1st Ave.; Vancouver, BC V5T 1A9; (604) 872-3447; (206) 453-7875 (Seattle); FAX: (604) 872-1296.

**ULTRASTAGE, INC.;** *Sound Reinf.;* Lighting, Rental; 4917 Bridge St.; Niagara Falls, ON L2E 2S2; (416) 356-0499.

**>WATTS GUENETTE PRODUCTIONS;** *Sound Reinf.;* Lighting, Rental; 88 Guay Ave.; Winnipeg, MB R2M 0B9; (204) 233-4479.

**>WESTBURY NATIONAL SHOW SYSTEMS;** *Sound Reinf.;* Lighting, Staging, Rental; 36 Malley Rd.; Toronto, ON; (416) 752-1371.

## Rock 'n Roll will live forever... but your hearing may not.

Some rock concerts exceed tolerable sound levels by as much as 40 decibels. Repeated exposure to loud sound can damage the tiny hairs in your inner ear and slowly destroy your hearing. But you can protect your hearing by wearing ear plugs, or by just turning the volume down. If you already have hearing loss, H.E.A.R. can help you assess the damage and suggest ways to avoid additional problems.

To find out what rockers need to know to protect their hearing, contact:

### H. E. A. R.

Hearing Education and Awareness for Rockers  
Box 460847

San Francisco, California 94146

**24-Hour Hotline:**

**(415) 773-9590**

Send \$7.00 for information packet.

# MASTERING, PRESSING & TAPE DUPLICATION FACILITIES

UNITED STATES & CANADA

## EASTERN US

Alabama, Connecticut, Delaware, Florida, Georgia, Kentucky, Louisiana, Maine, Maryland, Massachusetts, Mississippi, New Hampshire, New Jersey, New York, North Carolina, Pennsylvania, Rhode Island, South Carolina, Tennessee, Vermont, Virginia, West Virginia

► **AGFA CORPORATION**; Mastering, Tape Duplication; 100 Challenger Rd.; Ridgely Park, NJ 07660; (201) 440-2500.

► **AIR CRAFT RECORDING AND REAL TIME DUPLICATIONS SERVICE**; Tape Duplication; Dormont Square; Pittsburgh, PA 15216; (412) 343-5222.

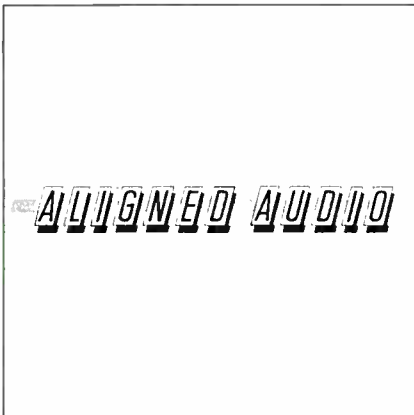

ALIGNED AUDIO INC.  
Brooklyn, NY

► **ALIGNED AUDIO INC.**; Mastering, Pressing, Tape Duplication, CD Services; 151 22nd St.; Brooklyn, NY 11232; (718) 788-6969; (800) 869-6561; FAX: (718) 499-0421.

► **ALPHA RECORDS INC.**; Pressing, Tape Duplication; 1400 NW 65th Ave.; Plantation, FL 33313; (305) 587-6011.

► **AMERICAN HELIX TECHNOLOGY CORPORATION**; Mastering, Pressing, Tape Duplication, CD Services; 1857 Colonial Village Ln.; Lancaster, PA 17601; (717) 392-7840; FAX: (717) 392-7897.

# AMI

American Multimedia, Inc.

**QUALITY**  
Audio, Video and Print

**DAAAD**  
Digital Analog Audio Duplication

Call or Write for a FREE DAAAD Sample & Literature

AMERICAN MULTIMEDIA, INC.  
Burlington, NC

► **AMERICAN MULTIMEDIA, INC.**; Tape Duplication; 2609 Tucker St.; Burlington, NC 27215; (919) 229-5554; FAX: (919) 228-1409.

► **AMERICAN SOUND & VIDEO**; Mastering, Tape Duplication; 3 Fairfield Crescent; W. Caldwell, NJ 07006; (201) 575-8484; FAX: (201) 575-6957.

► **APEX MACHINE COMPANY**; DDP; 3000 NE 12th Terr.; Ft. Lauderdale, FL 33334; (305) 566-1572; Telex: 271 601 APEX UR; FAX: (305) 563-2844.

► **APEXTON RECORDS MFG. CORP.**; Mastering, Pressing, Tape Duplication, CD Services; 44-27 Purves St.; Long Island City, NY 11101; (718) 937-4038; FAX: (718) 786-9730.

► **ASSOCIATED AUDIO SERVICES**; Mastering, Tape Duplication; 914 Arctic St.; Bridgeport, CT 06608; (203) 338-0699; FAX: (203) 338-0522.

► **AUDIO ANTICS WEST**; Tape Duplication; 156 W. 94th St.; New York, NY 10025; (212) 662-8685.

► **AUDIO CRAFT CO.**; Mastering, Tape Duplication; 2701 E. Sunrise Blvd., Ste. 406; Ft. Lauderdale, FL 33304; (305) 563-0553 (Florida); (800) 432-0405.

► **AUDIO PLUS VIDEO INTERNATIONAL**; Tape Duplication; 240 Pegasus Ave.; Northvale, NJ 07647; (201) 767-3800; FAX: (201) 767-4568.

► **AUDIO PRODUCTION SERVICES**; Tape Duplication; RR. 3, Box 15; Bernardston, MA 01337; (413) 648-9071.

► **AUDIO VIDEO TECHNOLOGY, INC.**; 1808 West End Ave., Ste. 700; Nashville, TN 37203; (615) 327-3609; FAX: (615) 329-3801.

► **BLANK PRODUCTIONS**; Mastering, Tape Duplication, CD Services; 1597 Hope St.; Stamford, CT 06907; (800) 969-LOLA; FAX: (203) 329-7193.

► **CASSETTE DUB, INC.**; Tape Duplication; 245 Livingston St.; Northvale, NJ 07647; (201) 767-7077; FAX: (201) 767-3472.

► **CASSETTE EXPRESS (DIV. OF AL JOLSON ENTERPRISES, INC.)**; Tape Duplication; 114 17th Ave. S.; Nashville, TN 37203; (615) 244-5667.

► **CBS RECORDS INC.**; Mastering, Tape Duplication, CD Services; 49 E. 52nd St.; New York, NY 10022; (212) 445-2958; FAX: (212) 755-8311.

► **CINEMA SOUND, LTD.**; Tape Duplication; 311 W. 75th St.; New York, NY 10023; (212) 799-4800.

► **CLASSIC SOUND, INC.**; CD Services; 129 W. 67th St.; New York, NY 10023; (212) 496-7100; FAX: (212) 721-2229.

► **COUNTS & COUNTS**; CD Services; 181 Warrington St.; Providence, RI 02907; (401) 781-8478.

► **CRYSTAL CITY TAPE DUPLICATORS, INC.**; Tape Duplication; 48 Stewart Ave.; Huntington, NY 11743; (516) 421-0222; FAX: (516) 423-2226.

► **CUSTOM RECORDING AND SOUND, INC.**; Tape Duplication; 1200 Woodruff Rd., Ste. C-18; PO Box 27109; Greenville, SC 29616; (803) 288-0000; FAX: (803) 234-6519.

► **THE CUTTING EDGE**; Mastering, Pressing, Tape Duplication, CD Services; PO Box 217; Farmdale, NY 12734; (914) 292-5965; FAX: (914) 292-2313.

► **D&G MASTERING**; Mastering; PO Box 370; Englishtown, NJ 07726; (201) 446-2411.

► **DB PLUS DIGITAL SERVICES**; CD Services; PO Box 694; Lynbrook, NY 11563; (516) 872-2325.

► **DEMO-VOX SOUND STUDIO, INC.**; Mastering, Pressing, Tape Duplication; 1038 Bay Ridge Ave.; Brooklyn, NY 11219; (718) 680-7234.

► **BARRY DIAMANT AUDIO**; Mastering, CD Services; 2728 Henry Hudson Pkwy.; Riverdale, NY 10463; (212) 543-2079.

► **DIGITAL ASSOCIATES**; Tape Duplication; PO Box 158913; Nashville, TN 37215; (615) 297-3900.

► **DIGITAL HOUSE LTD.**; Mastering, Tape Duplication, CD Services; 101 W. 57th St.; New York, NY 10019; (212) 333-5950; FAX: (212) 262-5631.

**MASTERING**

**REPLICATION PRINTING**

COMPLETE CD AND CASSETTE PRODUCTION

**DIGITAL HOUSE**

FOR THOSE WHO HEAR THE DIFFERENCE

**GRAPHIC DESIGN ART STUDIO**

**TOTAL PACKAGING**

**PERSONALIZED EXPERT SERVICE**

**212-333-5950**

101 WEST 57th STREET, NEW YORK, N.Y. 10019

**JEROME BUNKE - HARRY HIRSCH**

DIGITAL HOUSE LTD.  
New York, NY

► **DIGITAL 1 DUPLICATORS**; Tape Duplication; 658 Douglas Ave.; Altamonte Springs, FL 32714; (407) 682-7790.

► **DISC MAKERS, A DIVISION OF AUDIO & VIDEO LABS, INC.**; Mastering, Pressing, Tape Duplication, CD Services; 1328 N. 4th St.; Philadelphia, PA 19122; (800) 468-9353; (215) 232-4140 (in PA); FAX: (215) 236-7763.

► **DISCTRONICS, INC.**; CD Services; 405 Lexington Ave., 47th Fl.; New York, NY 10174; (212) 599-5300; FAX: (212) 599-3227.

► **THE DUPE COOP**; Tape Duplication; 268 W. 23rd St.; New York, NY 10011; (212) 633-6287.

► **DUPLICATION SPECIALISTS**; Mastering, Tape Duplication, CD Services; 4584 Austin Blvd.; Island Park, NY 11558; (516) 432-7107.

► **EASTERN STANDARD PRODUCTIONS, INC.**; Mastering, Tape Duplication, CD Services; 26 Baxter St.; Buffalo, NY 14207; (716) 876-1454; (800) 527-9225; FAX: (716) 877-6395.

► **EUROPADISK, LTD.**; Mastering, Pressing, Tape Duplication, CD Services; 75 Varick St.; New York, NY 10013; (212) 226-4401; FAX: (212) 966-0456.

► **EVA-TONE INC.**; Mastering, Pressing, Tape Duplication; 4801 Ulmertown Rd.; Clearwater, FL 34622; (800) EVA-TONE (382-8663); FAX: (813) 572-6214.

► **EXECUTIVE RECORDING LTD.**; Mastering; 300 W. 55th St., Ste 4P; New York, NY 10019; (212) 247-7434.

► **BILL FLOWERS PRODUCTIONS**; Tape Duplication; 6435 McAdams Dr. E.; Theodore, AL 36582; (205) 653-1470.

► **FORGE RECORDING STUDIOS, INC.**; Mastering, Tape Duplication; PO Box 861, Valley Forge, PA 19481; 119 Great Valley Pkwy.; Malvern, PA 19355; (800) 331-0405; (215) 935-1422; FAX: (215) 933-9954.

► **FRANKFORD/WAYNE MASTERING LABS, INC.**; Mastering, CD Services; 1697 Broadway, Ste. 1404; New York, NY 10019; (212) 582-5473.

► **FULLERSOUND, INC.**; Mastering, CD Services; 1755 NE 149th St.; Miami, FL 33181; (305) 945-6697.

► **GEORGIA RECORD PRESSING**; Mastering, Pressing, Tape Duplication, CD Services; 262 Rio Circle; Decatur, GA 30030; (404) 373-2673; (800) 327-9212; FAX: (404) 373-0950.

► **GRENADIER**; Tape Duplication; 10 Parkwood Ave.; Rochester, NY 14620; (716) 442-6209; (716) 275-2942.

► **ALFRED B. GRUNWELL**; Tape Duplication; c/o Calf Audio; 157 Gray Rd.; Ithaca, NY 14850; (607) 272-8964.



# BILLY PRESTON AND DIC//DAT TAKE MUSIC TO THE Nth DEGREE.

THE DIC//DAT Musician's Musicians Series #2



PHOTOGRAPH: KAREN ANDERSON  
LOCATION: THE VILLAGE RECORDER L.A.

They called him the "Fifth Beatle." When they weren't calling him the first genius of the electronic keyboards.

From the Fab Four to number one on the charts, Billy Preston's career adds up to three decades of pure legend. A musician's musician, he takes charisma and the keyboards to their logical conclusion. And makes music to the *Nth* Degree.

Like DIC//DAT. The definitive digital audio tape.

As sound enters the DAT decade, DIC Digital is emerging as the one metal particle tape expert. Original source manufacturer of the one DAT tape audio pros are choosing more and more.

Proprietary coating and dispersion technology produces a magnetic medium more than three times as dense as conventional tape. Which produces an astonishing range and clarity beyond any way you've ever heard—and recorded—music before.

The sound of the future. Available now to uncompromising audiophiles.  
Call toll-free for the Official DIC//DAT Dealer nearest you: 1-800-DAT-I-DIC.

**DIC//DAT TAKING MUSIC TO THE Nth DEGREE.**



**DIC**  
DIC Digital

© DIC DIGITAL SUPPLY CORPORATION 1990

## Mastering, Pressing & Tape Duplication Facilities

E A S T E R N U S .

**THE HIT FACTORY DMS, INC.;** *Mastering, Tape Duplication, CD Services;* 130 W. 42nd St., 10th Fl.; New York, NY 10036; (212) 768-4141; FAX: (212) 768-9818.

**HMG LTD.;** *Tape Duplication;* 15 Gilpin Ave.; Hauppauge, NY 11788; (516) 234-0200; FAX: (516) 234-0022.

**IAN COMMUNICATIONS GROUP, INC.;** *Tape Duplication;* 10 Upton Dr.; Wilmington, MA 01887; (508) 658-3700; FAX: (508) 694-9957.

**ICCA;** *Tape Duplication;* 429 Briabend Dr.; Charlotte, NC 28209; (704) 523-7219.

**JMI/CREATIVE AUDIO SERVICES;** *Tape Duplication;* 3655 Old Shell Rd. #321; Mobile, AL 36608; (205) 343-2023.



KLARITY CASSETTE, INC.  
Waterville, ME

**KLARITY CASSETTE, INC.;** *Tape Duplication, CD Services;* Main St., Post Office Square; Waterville, ME 04901; (800) 458-6405; FAX: (207) 873-3924.

**THE LACQUER PLACE;** *Mastering, CD Services;* 116 17th Ave. S.; Nashville, TN 37203; (615) 244-5355.

**LAUGHING DOG CASSETTE DUPLICATION;** *Tape Duplication;* 80 Van Duzer St.; Staten Island, NY 10301; (718) 720-9497; (800) 955-4DOG.

**LINDEN INC.;** *Tape Duplication;* 229 N. Henry St.; Alexandria, VA 22314-2400; (703) 549-4424.

**LORAN CASSETTES AND AUDIO PRODUCTS;** *Mastering, Tape Duplication;* 10-48 Clark St.; Warren, PA 16365; (800) 633-0455.

**LUNDY RECORDING & CASSETTE DUP.;** *Tape Duplication;* PO Box 408; Heidrick, KY 40949; (606) 546-6650.

**MAGNETIC MEMORIES;** *Tape Duplication;* PO Box 3373; Kingsport, TN 37664; (615) 246-3452.

**MAGNETIC TECHNOLOGY;** *Tape Duplication;* 816 18th Ave. S.; Nashville, TN 37203; (615) 254-7001.

**MARK CUSTOM RECORDING SERVICE;** *Mastering, Pressing, Tape Duplication, CD Services;* 10815 Bodine Rd.; Clarence, NY 14031; (716) 759-2600.

**MASTER CUTTING ROOM, INC.;** *Mastering, CD Services;* 321 W. 44th St.; New York, NY 10036; (212) 581-6505; FAX: (212) 582-1496.

**MASTER RECORDS INC.;** *Mastering, Tape Duplication, CD Services;* 2819 NW 7th Ave.; Miami, FL 33127; (305) 638-5242.

**MASTERDISK CORPORATION;** *Mastering;* 545 W. 45th St.; New York, NY 10036; (212) 541-5022; FAX: (212) 265-5645.

**MASTERFONICS, INC.;** *Mastering, Tape Duplication, CD Services;* 28 Music Square E.; Nashville, TN 37203; (615) 327-4533; FAX: (615) 242-0101.

**MASTERMIX;** *Mastering, CD Services;* 1808 Division St.; Nashville, TN 37203; (615) 321-5970.

**MASTERWORK RECORDING, INC.;** *Mastering, Pressing, Tape Duplication, CD Services;* 1020 N. Delaware Ave.; Philadelphia, PA 19125; (215) 423-1022; FAX: (215) 423-6020.

**MASTERWORKS STUDIOS;** *Tape Duplication;* 4024 Williamsburg Ct.; Fairfax, VA 22032; (703) 385-1780.

**MIRROR IMAGE SOUND & RECORDING, INC.;** *Tape Duplication;* 619 S. Main St.; Gainesville, FL 32601; (904) 376-8742; FAX: (904) 375-6688.

**THE MIXING BOARD;** *Mastering;* Rte. 6, Box 543; Toccoa, GA 30577; (404) 886-9179.

**MULTITAPE;** *Mastering, Tape Duplication;* 2112 18th St. NW; Washington, DC 20009; (202) 332-1522.

**THE MUSIC CONNECTION INC.;** *Pressing, Tape Duplication, CD Services;* 166 Madison Ave.; New York, NY 10016; (212) 686-9595; FAX: (212) 779-3326.

**MUSIKA RECORDS INC.;** *Tape Duplication;* 163 Amsterdam Ave., Ste. 116; New York, NY 10023; (212) 799-8330; FAX: (201) 461-8237.

**NASHVILLE RECORD PRODUCTIONS, INC.;** *Mastering, CD Services;* 469 Chestnut St.; Nashville, TN 37203; (615) 259-4200.

**L. NIX & CO., INC.;** *Mastering, Tape Duplication, CD Services;* 2000 Madison Ave.; Memphis, TN 38104; (901) 725-0855; FAX: (901) 725-7011.

**NORTHEASTERN DIGITAL RECORDING;** *Mastering, CD Services;* 2 Hidden Meadow Ln.; Southborough, MA 01772-1700; (508) 481-9322; FAX: (508) 624-6437.

**NORTHEASTERN DIGITAL RECORDING, INC.;** *Mastering, CD Services;* 12 Sadler Ave.; Shrewsbury, MA 01545; (508) 753-1192.

**PHILIPS AND DUPONT OPTICAL COMPANY;** *Mastering, CD Services;* 1251 Avenue of the Americas; New York, NY 10020; (212) 512-9350.

**PRC TAPE CO.;** *Tape Duplication;* 422 Madison Ave.; New York, NY 10017; (212) 308-2300; FAX: (212) 308-2306.



**DAT TO COMPACT**  
Digital Audio Tape  **disc**

# TURN YOUR TUNES

Now it's easy to turn your tunes from tape into CD. Optical Media's CD Express service is now offering lower prices and faster turn-around times for getting 1 to 10,000 CDs. And by using our incredible new direct DAT to CD technology, you can get 1 to 10 reference discs in 48 hours.

Also, if you're using Sound Tools by Digidesign, you can save even more by using the special CD prep feature of the new Master List program. Call CD Express at Optical Media for more information.

**COMPACT**  
**disc**  
DIGITAL AUDIO



**OPTICAL MEDIA INTERNATIONAL**

485 ALBERTO WAY, SUITE 115, LOS GATOS, CALIFORNIA 95032 USA  
PH 408 395.4332 **800.DISC.OMI** FAX 408 395 6544



# DAT

## AUDIO GALLERY

AMERICA'S BEST PLACE TO BUY  
DIGITAL AUDIO TAPE RECORDERS

- Best Prices
- Best Service & Best Warranty
- Newest Models in Stock
- Demos Available
- No Commission Sales Staff
- DAT Accessories, PCMs, more

*Don't be deceived by imitators.  
We are the original DAT stereo  
store in the USA! We're the  
1st and we're still the best.*

*Call us before you buy elsewhere*

## AUDIO GALLERY

*"the friendly store"*

**213 • 829 3429**

2716 Wilshire Blvd  
Santa Monica, CA 90403

FAX: 213 • 829 0304

*Ask about the DATMAX 60,  
an attractive solid  
ool DAT tape  
storage unit!*

## Mastering, Pressing & Tape Duplication Facilities

EASTERN U.S.

► **PRODIGITAL, INC.;** *Mastering, Tape Duplication, CD Services* 3400 Pendleton Dr.; Wheaton, MD 20902; (202) 635-5588; FAX: (202) 635-4490.

► **PROGRESSIVE TAPE CORPORATION;** *Tape Duplication;* 40-H Corbin Ave.; Bay Shore, NY 11706; (516) 242-4646.



**PROJECT 70 AUDIO SERVICES, INC.**  
Atlanta, GA

► **PROJECT 70 AUDIO SERVICES, INC.;** *Tape Duplication;* 777 Lambert Dr. NE; Atlanta, GA 30324; (404) 875-7000; FAX: (404) 875-7007.

► **QUIK-CASSETTE CORP.;** *Tape Duplication;* 250 W. 57th St., Ste. 2101; New York, NY 10107; (212) 977-4411.

► **RCA TEST TAPES;** *Tape Duplication;* 108 Monticello Rd.; Weaverville, NC 28787; (704) 658-2067; FAX: (704) 658-2008.

► **RECORDAMATT;** *Mastering, Pressing, Tape Duplication, CD Services;* 506 Kime Ave.; West Islip, NY 11795; (516) 242-1729; (212) 674-6697.

► **ROMABA RECORD PRESSING CORP.;** *Mastering, Pressing;* 33-34th St.; Brooklyn, NY 11232; (718) 499-3060; FAX: (718) 499-3061.

► **RPL, INC.;** *Mastering, Tape Duplication, CD Services;* 1100 State St.; Camden, NJ 08105; (800) 966-3001; FAX: (609) 963-3854.

► **SABELLA RECORDING STUDIOS;** *Tape Duplication;* 49 Oakdale Rd.; Roslyn Heights, NY 11577; (516) 484-0862.

► **SELGER SOUND;** *Tape Duplication;* 6 Sparhawk St.; Brighton, MA 02135; (617) 782-3384.

► **SOUND ARTS CO., INC.;** *Tape Duplication;* 5 Cindy Ln.; Oakhurst, NJ 07712; (201) 493-8666; FAX: (201) 493-0667.

► **SOUND TECHNIQUE MASTERING LAB;** *Mastering, CD Services;* 130 W. 42nd St., 5th Fl.; New York, NY 10036; (212) 869-1323.

► **STERLING SOUND, INC.;** *Mastering, Tape Duplication, CD Services;* 1790 Broadway; New York, NY 10019; (212) 757-8519; FAX: (212) 757-4607.

► **STUDIO MAGNETICS CO., INC.;** *Tape Duplication;* 12 Long Island Ave.; Holtsville, NY 11742; (800) 874-2202; (516) 289-3400; FAX: (516) 289-9150.

► **SUN PLASTICS CO., INC. (DYNAMIC LP STEREO RECORD PRESSING CO., INC.);** *Mastering, Pressing, Tape Duplication, CD Services;* 900 Passaic Ave.; East Newark, NJ 07029; (201) 482-6749; (212) 349-0977; FAX: (212) 349-0977.

► **SUNSHINE SOUND, INC.;** *Mastering, Pressing;* 1650 Broadway; New York, NY 10019; (212) 582-6227.

► **THE TAPE COMPLEX;** *Tape Duplication;* 4 Haviland St.; Boston, MA 02115; (617) 437-9449.

► **TAPEONENTS CO.;** *Pressing, Tape Duplication, CD Services;* 60 Midvale Rd., PO Box 236; Mountain Lakes, NJ 07046; (201) 263-1442; FAX: (201) 263-8640.

► **TAPESOUTH, INC.;** *Tape Duplication;* 1801 1st Ave. S, Ste. 333; Birmingham, AL 35233; (800) 248-2730.

► **TRAXX RECORDING PRODUCTS;** *Tape Duplication;* 24 Crestway KC; New Fairfield, CT 06812; (203) 746-3561.



**STUDIO MAGNETICS CO., INC.**  
Holtsville, NY

► **TRUTONE RECORDS;** *Mastering, Pressing, Tape Duplication, CD Services;* 163 Terrace St.; Haworth, NJ 07641; (201) 385-0940.

► **U.S. OPTICAL DISC, INC.;** *Mastering, CD Services; Rte.* 109 and Eagle Dr.; Sanford, ME 04073; (207) 324-1124.

► **VIDEO DUB, INC.;** *Tape Duplication;* 423 W. 55th St.; New York, NY 10019; (212) 757-3300; FAX: (212) 956-6528.

► **VIDEO SERVICES CORPORATION;** 240 Pegasus Ave.; Northvale, NJ 07647; (201) 767-1000; FAX: (201) 784-9779.

► **VIRTUE RECORDING & VIDEO STUDIOS;** *Mastering, Pressing, Tape Duplication, CD Services;* 1618 N. Broad; Philadelphia, PA 19121; (215) 763-2825.

► **VISUAL MUSIC;** *Tape Duplication, CD Services;* 235 E. 13th St. #3-D; New York, NY 10003; (212) 505-9281.

► **WAREHOUSE RECORDING STUDIO;** *Mastering, Tape Duplication;* 2071-20 Emerson St.; Jacksonville, FL 32207; (904) 399-0424; FAX: (904) 398-9683.

► **WHITE CROW AUDIO;** *Tape Duplication;* 19 Marble Ave.; Burlington, VT 05401; (802) 658-6475.

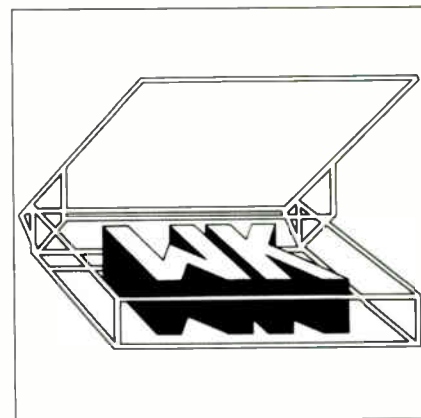

**WK STUDIO**  
New York, NY

► **WK STUDIO;** *Tape Duplication;* 611 Broadway, Rm. 721; New York, NY 10012; (212) 473-1203.

► **ZALMO SOUNDS;** *CD Services;* Ditmas Ave. & E. 8th St.; Brooklyn, NY 11218; (718) 633-4166.

### CENTRAL U.S.

Arkansas, Illinois, Indiana, Iowa, Kansas, Michigan, Missouri, Minnesota, Nebraska, North Dakota, Ohio, Oklahoma, South Dakota, Texas, Wisconsin

► **A&F MUSIC SERVICES;** *Mastering, Tape Duplication;* 2834 Otsego; Pontiac, MI 48054; (313) 682-9025; (313) 669-3100.

► **A + R RECORD & TAPE MFG. CO.;** *Mastering, Pressing, Tape Duplication, CD Services;* 902 N. Industrial Blvd.; Dallas, TX 75207; (214) 741-2027; (800) 527-3472; FAX: (214) 638-6801.

► **AARD-VARK, INC.;** *Tape Duplication;* 335 S. Jefferson; Springfield, MO 65806; (417) 866-4104; FAX: (417) 869-1133.

◀ See Advertisers Index for Display Ad

## EXPERIENCE THE

# "Ultimate Response"

of

# KLIARITY CASSETTE

REAL-TIME  
CASSETTE DUPLICATION

... Find Out How ...

Post Office Square  
Waterville, ME 04901  
1-800-458-6405  
207-873-3911

The **A**lternative



*Product Development*

*Music Licensing*

*Visual Design*

*Pre-mastering*

*Mastering*

*CD Replication*

*High Speed Cassettes*

*Real Time Cassettes*

*Custom Packaging*

*Picture Disc Printing*

*Fulfillment Services*

**Industry**

*Servicing the Compact Disc* 



American Helix Technology Corporation

1857 Colonial Village Lane

Lancaster, Pennsylvania 17601

717 392 7840

800 525 6575

717 392 7897 FAX

**World Radio History**





## MORE ARTISTS GO GOLD ON AMPEX THAN ON ALL OTHER TAPES PUT TOGETHER.



*Every artist pictured here has earned the prestigious Ampex Golden Reel Award for creating a gold album exclusively on Ampex audio tape. Find out what makes Ampex tape right for your sound. Just call or write for a copy of our new 456 Technical Brochure, and see why Grand Master® 456 is engineered like no other tape in the world.*

# AMPEX

A MASTER OF ENGINEERING

Ampex Recording Media Corporation • 401 Broadway, M.S. 22-02A1 • Redwood City, California 94603 • (415) 367-3809

## Mastering, Pressing & Tape Duplication Facilities

CENTRAL U.S.

**A TO Z AUDIO SERVICES, INC.;** *Tape Duplication*; 21929 Lorain Rd., PO Box 26087; Fairview Park, OH 44126; (216) 333-0040.

**> ACME AUDIO & RECORDING CORP.;** *Mastering, Tape Duplication, CD Services*; 3821 N. Southport; Chicago, IL 60613; (312) 477-7333; (800) 826-2263.

**ALL NIGHT RECORDS;** *Mastering, Pressing*; 208 1/2 N. Washington; El Dorado, AR 71730; (501) 862-0731.

**ANVID RECORDING COMPANY;** *Tape Duplication, CD Services*; PO Box 8130; Bartlett, IL 60103; (708) 837-9840.

**ARC ELECTRONIC SERVICES, INC.;** *Mastering, Tape Duplication*; 2557 Knapp NE; Grand Rapids, MI 49505; (616) 364-0022.

**ARS RECORDING & TAPE DUPLICATION;** *Mastering, Tape Duplication*; 11626 S. Pulaski; Alsip, IL 60658; (708) 371-8424; FAX: (708) 371-9403.

**AT THE TOP AUDIO & VIDEO DUPLICATION (A ZIG ZIGLAR CO.);** *Tape Duplication*; 3330 Earhart, Ste. 208; Carrollton, TX 75006; (214) 980-7671; FAX: (214) 991-1853.

**AUDIO GRAPHIC SERVICES;** *CD Services*; 1516 Ferris Ave.; Royal Oak, MI 48067; (313) 544-1793; FAX: (313) 544-1793 (call first).

**AUDIOCRAFT;** *Tape Duplication*; 915 W. 8th St.; Cincinnati, OH 45203; (513) 381-8088.

**AUDIOCRAFT RECORDING & SOUND;** *Tape Duplication*; RR 2, Box 1179, E. Long Lake Rd.; Wild Rose, WI 54984; (715) 258-6092.

**> AUDIO-VIDEOGRAPHICS;** *Mastering, Tape Duplication*; 13801 E. 35 St.; Independence, MO 64055; (816) 254-0400; (800) 322-2832.

**CASSETTE SERVICES INC.;** *Tape Duplication*; 100 N. Hickory Ave.; Arlington Heights, IL 60004; (708) 398-8403.

**C.D.S. CASSETTE DUPLICATING SERVICE;** *Tape Duplication*; 444 Dimmick Ave.; Cincinnati, OH 45246; (513) 851-1956.

**> CENTURY 21 PROGRAMMING, INC.;** *CD Services*; 14444 Beltwood Pkwy.; Dallas, TX 75244; (800) 937-2100; FAX: (214) 392-2121.

**COACHHOUSE MUSIC;** *Mastering, Pressing, Tape Duplication, CD Services*; PO Box 1308; Barrington, IL 60011-1308; (708) 382-5295; FAX: (708) 381-1022.

**CONCEPT PRODUCTIONS, INC.;** *Tape Duplication*; 7878 Big Sky Dr.; Madison, WI 53719; (800) 728-2731; (608) 833-8273; FAX: (608) 833-7893.

# CREATIVE SOUND

HOUSTON

CREATIVE SOUND PRODUCTIONS  
Houston, TX

**> CREATIVE SOUND PRODUCTIONS;** *Tape Duplication, CD Services*; 8383 Commerce Park Dr. #604; Houston, TX 77036; (713) 777-9975.

**> See monthly issue of Mix for extended listing**

# IMPERIAL TAPE Company, Inc.

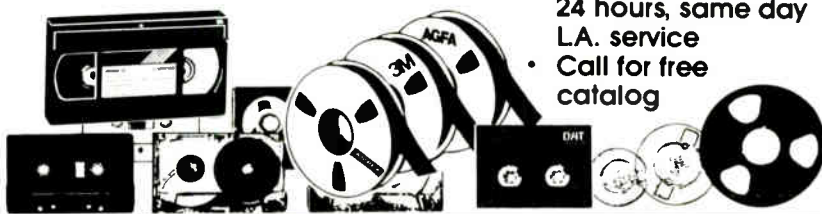

- Manufacturers of custom length blank audio and video cassettes
- Top quality audio and video cassette duplication
- Shipment within 24 hours, same day LA. service
- Call for free catalog

## Service · Quality · Integrity

### Nation's Leading Authorized Distributor AGFA AMPEX 3M MAXELL TDK BASF

1 · 800 · 736 · 8273

FAX 213 · 395 · 8255

213 - 393 - 7131

1928 14TH, SANTA MONICA, CA 90404

121

## COMPLETE DIGITAL SERVICES FOR CD PREPARATION

Music Editing  
Format Conversion

NEVE DTC and HARMONIA MUNDI  
DIGITAL CONSOLES

**KDISC mastering**  
6550 Sunset Blvd., Hollywood, California 90028 • (213) 466-1323 • FAX (213) 466-7237



## COMPLETE MASTERING SERVICES

DMM and Lacquer Cutting



## Mastering, Pressing & Tape Duplication Facilities

CENTRAL U.S.

> **CRYSTAL CLEAR SOUND**; Tape Duplication; 4902 Don Dr.; Dallas, TX 75247; (214) 630-2957.

**DIGITAL AUDIO DISC CORPORATION**; Mastering, Pressing, Tape Duplication, CD Services; 1800 N. Fruitridge Ave.; Terre Haute, IN 47804; (812) 462-8100; FAX: (812) 466-9125.

**THE DOMAIN GROUP**; Mastering, Tape Duplication; 289 Main Pl.; Carol Stream, IL 60188; (708) 668-5300; FAX: (708) 668-0158.

**DUNCAN QUALITY DUPLICATION, INC.**; Tape Duplication; 7113 N. Austin Ave.; Niles, IL 60648; (708) 647-1094.

**EMC PRODUCTIONS**; Tape Duplication; 300 York Ave.; Saint Paul, MN 55101; (612) 771-1555.

**G.O.D.T.E.L. PRODUCTIONS (A DIVISION OF G.O.D.T.E.L. MINISTRIES)**; Tape Duplication; 330 E. Main St.; Nacogdoches, TX 75961; (409) 560-4282.

**BOB GREEN PRODUCTIONS, INC.**; Mastering, Tape Duplication; 7950 Westgen; Houston, TX 77063; (713) 977-1334.

> **INTERNATIONAL AUDIO, INC.**; Tape Duplication; 2934 Malmo Rd.; Arlington Heights, IL 60005; (312) 956-6030.

**INTERNATIONAL CASSETTE CORP.**; Tape Duplication; PO Box 1928; Greenville, TX 75401; (214) 454-9164.

**JEWEL RECORDS**; Mastering, Pressing, Tape Duplication, CD Services; 1594 Kinney Ave.; Cincinnati, OH 45231; (513) 522-9336; FAX: (513) 522-9915.

**JOR-DAN, INC.**; Tape Duplication, CD Services; 1100 Wheaton Oaks Ct.; Wheaton, IL 60187; (708) 653-1919; FAX: (708) 665-4966.

> **THE LITTLE WAREHOUSE, INC.**; Tape Duplication; 5505 Valley Belt Rd., Ste. F; Independence, OH 44131; (216) 398-0022; FAX: (216) 398-9980.

**MIDWEST CUSTOM RECORD & TAPE**; Pressing, Tape Duplication, CD Services; PO Box 92; Arnold, MO 63010; (314) 464-3013; FAX: (314) 464-3015.

**MUSICOL, INC.**; Mastering, Pressing, Tape Duplication, CD Services; 780 Oakland Park Ave.; Columbus, OH 43224; (614) 267-3133.

**NIGHTINGALE-CONANT CORP.**; Tape Duplication; 7300 N. Lehigh Ave.; Niles, IL 60648; (708) 647-0300.

**PLAYTOWN SOUND PRODUCTIONS**; Tape Duplication; PO Box 411, 625 Connable Ave.; Petoskey, MI 49770; (616) 347-0063.

**PRC TAPE**; Tape Duplication; 1600 Rich Rd.; Richmond, IN 47374; (317) 962-9511; FAX: (317) 962-1564.

> **THE PRESSING PLANT**; Pressing, Tape Duplication, CD Services; 111 Oak Lawn; Dallas, TX 75207; (214) 748-6622.

> **PRO DUPE**; Tape Duplication; 1155 Rosewood, Suite A; Ann Arbor, MI 48104; (313) 994-1210.

**PROGRAMMING TECHNOLOGIES, INC.**; Mastering, Tape Duplication; 6666 N. Lincoln Ave.; Lincolnwood, IL; (708) 676-9400; FAX: (708) 679-6761.

> **QCA CUSTOM PRESSING, INC.**; Mastering, Pressing, Tape Duplication, CD Services; 2832 Spring Grove Ave.; Cincinnati, OH 45225; (513) 681-8400.

**REDLINE STUDIO**; Tape Duplication; 1605 Pasty Ln.; Columbia, MO 65203; (314) 446-1692.

> **RICHARDSON TAPE**; Tape Duplication; HC 71, Box 231; Mountain View, AR 72560; (501) 269-3908.



— SINCE 1939 —

# RAINBO RECORDS & CASSETTES

1738 Berkeley Street • Santa Monica, CA • 90404  
(213) 829-0355 • FAX: (213) 828-8765

Still spinning 'Round  
After Fifty Years!

- TAPE: AUDIOPHILE MUSIC QUALITY
- STATE-OF-THE-ART BIN LOOP • HX PRO
- LACQUER MASTERING BY CAPITOL RECORDS
- PRESSED WITH K 588 VINYL

**CREDITS:** Capitol Records for the Beatle releases in the early 1960s. Enigma, Rhino, CBS, RSO, Casablanca, Twin Tone, Tommy Boy, SST, United Artists, Greenworld, Frontier, Pausa, Palo Alto, Celluloid, Metal Blade, Shrapnel, Warner Bros., Elektra, Optimism, Restless, Concord Jazz, Priority, and many, many more including the continuing MCA new releases.

**SPECIAL PROJECTS:** Shaped Records, Picture Records, and other premium record products.



# R.S.R.T. REAL TIME CASSETTE DUPLICATION

by Royal Scanlon



**AUDIOPHILE QUALITY CASSETTES  
DUPLICATED ON THE KABA SYSTEM**

R.S.R.T.  
Kansas City, KS

> **R.S.R.T.**; Tape Duplication; 4020 Stateline; Kansas City, KS 66103; (913) 262-5335.

**SESSION MASTERS, INC.**; Mastering; 25 W. 360 Geneva Rd.; Wheaton, IL 60188; (708) 653-1516.

> **SONIC SCULPTURES**; Mastering, Pressing, Tape Duplication, CD Services; 636 Northland Blvd.; Cincinnati, OH 45240; (513) 851-0055.

**SOUND CORE MUSIC**; Tape Duplication; 122 S. Illinois; Carbondale, IL 62901; (618) 457-5641.

**SOUND IDEAS OF FORT WAYNE**; Tape Duplication; 6803 Saige Dr.; Fort Wayne, IN 46835; (219) 485-3628.

**SOUND RECORDERS**; CD Services; 206 S. 44th St.; Omaha, NE 68131; (402) 553-1164; FAX: (402) 556-1358.

> **SOUND RECORDERS, INC.**; Tape Duplication; 4031 Guadalupe; Austin, TX 78751; (512) 454-8324; (800) 880-0270; FAX: (512) 454-5594.

**SUMA RECORDING STUDIO**; Mastering, Pressing, Tape Duplication, CD Services; 5706 Vrooman Rd.; Painesville, OH 44077; (216) 951-3955; (216) 352-9802.

**VAUGHN DUPLICATION SERVICES**; Tape Duplication; 7951 Computer Ave. S.; Minneapolis, MN 55435; (612) 832-3150.

**WESTMARK PRODUCTIONS**; Tape Duplication; 8345 Duluth St.; Golden Valley, MN 55427; (612) 544-3050.

**WORLD CLASS TAPES**; Tape Duplication; 670 Airport Blvd.; Ann Arbor, MI 48105; (313) 662-0669.

### COMPACT DISCS

#### COMPLETE SERVICE:

- PREPARATION • PACKAGING
- SHRINK • LONG BOX
- GRAPHICS, LAYOUT & DESIGN
- TYPESETTING • INSERTS • BOOKLETS
- FROM ROUGH COPY AND/OR PHOTOS

### AUDIO TAPES

#### MASTERING:

- CHROME ON 1/2" STUDER/DAT BACKUP
- J CARDS • CASSETTES SINGLE • CLEAR BOX
- CHROME • MULTIPLE PACKAGING
- SHRINK/CELLOPHANE WRAP
- GRAPHICS, LAYOUT & DESIGN

### VINYL

- MASTERING • PROCESSING
- LABELS • JACKETS
- INSERTS
- COMPLETE IN-HOUSE ONE-STOP LAYOUT & DESIGN

### \* 1000 12" FULL-COLOR PACKAGE \$1,799

Lacquer mastering — 3-step metal plating — 8 test pressings — 2-color labels (including type) — full-color jackets — white sleeve — shrink wrap — test within 7 working days — completion 15 working days upon receipt of all components REORDER 12 WORKING DAYS — \$1329

\* Does not include composite negatives

### \* 1000 12" ONE-COLOR PACKAGE \$1,599

(same as full-color except one-color jacket)  
REORDERS 10 WORKING DAYS — \$1119

### 1000 7" 45s \$699

Lacquer mastering — 3-step metal plating — 8 test pressings — 2-color labels (including type) — white sleeve — completion 10 working days upon receipt of all components REORDER AS ABOVE — \$359

### 500 7" 45s \$549

Same service as above REORDER — \$229

### \* 1000 FULL-COLOR CASSETTES \$899

Cassette mastering — test cassette — Apex printing direct on cassette — label plate — full-color inserts\* — 1000 additional inserts for reorder — Norelco box — cellophane wrapped — completion 15 working days upon receipt of all components \* Does not include composite negatives  
22 minutes per side maximum REORDER AS ABOVE — \$750

## 500 Cassettes

\$585  
Complete  
(Including)

- Composite Negatives from your Camera Ready Artwork
- Cassette Running Master
- Test Cassette Label Plate
- Apex Printing on Cassette
- 1000 One-Color Inserts (500 for Reorder)
- Norelco Box-Cello Wrapped
- 10-12 Working Days

REORDER ANYTIME

\$385.00

22 minutes per side maximum

WE'RE STILL THE OLDEST AND LARGEST INDEPENDENT CD, AUDIOTAPE AND VINYL DUPLICATING FACILITY WITH ONE STANDARD: MAJOR LABEL QUALITY.

THE ONE STOP CENTER FOR  
CD'S, CASSETTE DUPLICATION  
AND VINYL PRESSING

CD-LIKE  
QUALITY  
ON CASSETTES!!

**KLARITY  
CASSETTE**

REAL-TIME  
CASSETTE DUPLICATION

**"THE  
ULTIMATE  
RESPONSE"**

... Find Out How ...

Post Office Square  
Waterville, ME 04901  
1-800-458-6405  
207-873-3911

# IMPERIAL TAPE

*Company, Inc.*

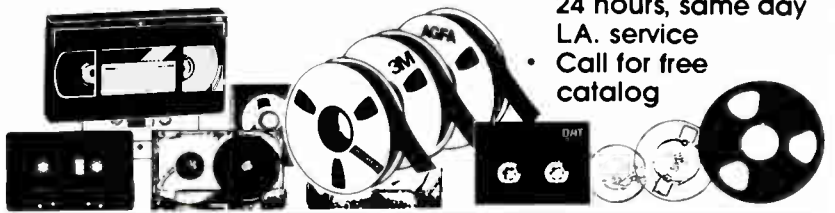

- Manufacturers of custom length blank audio and video cassettes
- Top quality audio and video cassette duplication
- Shipment within 24 hours, same day L.A. service
- Call for free catalog

**Service · Quality · Integrity**

Nation's Leading Authorized Distributor  
**AGFA AMPEX 3M MAXELL TDK BASF**

**1 · 800 · 736 · 8273**

**FAX 213 · 395 · 8255**

213 - 393 - 7131

1928 14TH, SANTA MONICA, CA 90404

123

**CASSETTES  
CD'S  
45's & LP's  
WE DO IT ALL  
FROM START  
TO FINISH**

**Duplication  
Specialists Inc.**

**(516)432-7107**

**VIDEO DUPLICATION  
& EDITING TOO**

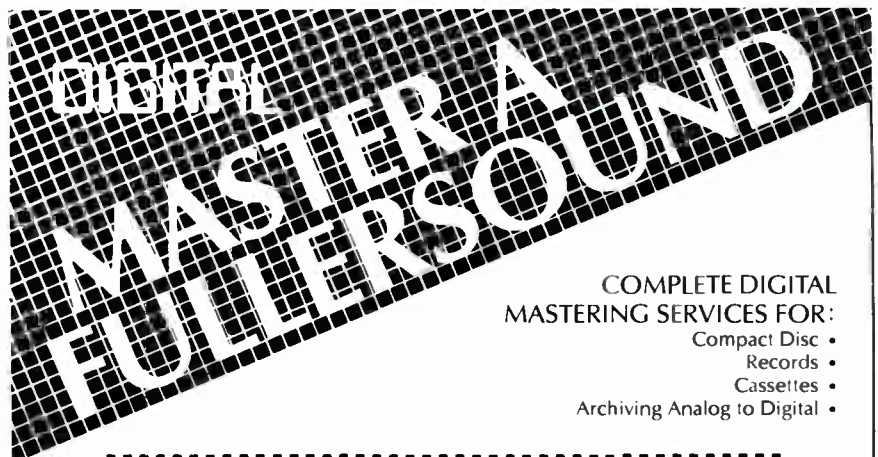

COMPLETE DIGITAL  
MASTERING SERVICES FOR:

- Compact Disc
- Records
- Cassettes
- Archiving Analog to Digital

NEVE DTC DIGITAL TRANSFER CONSOLE:

*All mastering parameters performed completely in the digital domain and fully automated for precise accuracy and repeatability.*

Sony 1630/DMR-4000  
Sony 3202 DASH  
Sony 2500 R-DAT  
Sony 601 (Beta/VHS)  
Mitsubishi X-80

CREDITS: Dirty Dancing Soundtracks, Eric Carmen, Expose, Will to Power, Eric Clapton, Betty Wright, Bee Gees, Judas Priest, Julio Iglesias, and many more.



FULLERSOUND, INC.



Engineer: Michael Fuller

1755 N.E. 149 STREET / MIAMI, FLORIDA 33181 / (305) 945-6697



## Lowest Prices on AMPEX Tape

Ampex 456 Grand Master<sup>®</sup> Studio Mastering Tape

As low as... 2" \$114.08 per reel

As low as... 1" \$ 52.68 per reel

As low as... 1/2" \$ 30.43 per reel

As low as... 1/4" \$ 9.43 bulk

COMPLETE CATALOGUE AVAILABLE UPON REQUEST.

AEG-Telefunken Mastering • Telefunken/Lyrec Duplicating  
3M Audio Distributor • Audio-Video Cassette Duplication  
R-DAT Digital Tape • J-Card Printing  
Sony Pro Video • Custom Video Cassette Loading  
Audio & Video Accessories • Ampex Pro Video

HRC Magnetics 1611 Herring Waco, Texas 76708  
CALL TOLL FREE 1-800-443-8457 Nationwide FAX 817-756-0082

audio cassette printers

video cassette printers

r-dat cassette printers

apex

of course.

since 1903

apex machine company

3000 n.e. 12th terrace ft. lauderdale, fl 33334-4497 u.s.a.  
phone. 305-565-apex telex: 271601 apex ur fax: 305-563-2844

## Mastering, Pressing & Tape Duplication Facilities

WESTERN U.S.

WESTERN U.S.

Alaska, Arizona, California, Colorado, Idaho, Las Vegas, Montana, New Mexico, Nevada, Oregon, Utah, Washington, Wyoming

► **APEX TAPE DUPLICATION**; *Tape Duplication*; 28 Paul Dr., Ste. E; San Rafael, CA 94903; (415) 492-1300; (800) 323-AAPX.

► **AZTEC RECORDING & TAPE DUPLICATING, INC.**; *Tape Duplication*; 1110 E. Missouri, Ste. 400; Phoenix, AZ 85014; (602) 279-0808.

**ABBAC AUDIO**; *Tape Duplication*; PO Box 3376; Costa Mesa, CA 92628; (714) 432-1745.



**ABBEY TAPE DUPLICATORS, INC.**  
Chatsworth, CA

► **ABBEY TAPE DUPLICATORS, INC.**; *Tape Duplication*; 9525 Vassar Ave.; Chatsworth, CA 91311; (818) 882-5210; (800) 346-3827 (outside CA); FAX: (818) 407-5900.

**ADVANCE RECORDING PRODUCTS**; *Tape Duplication*; 7190 Clairemont Mesa Blvd.; San Diego, CA 92111; (619) 277-2540; FAX: (619) 277-7610.

**ALSHIRE INTERNATIONAL, INC.**; *Mastering, Pressing, Tape Duplication, CD Services*; 1015 Isabel St., PO Box 7107; Burbank, CA 91510; (215) 849-4671; (800) 423-2936; FAX: (818) 569-3718.

**AMERICAN PRODUCTION SERVICES**; *Tape Duplication*; 2247 15th Ave. W.; Seattle, WA 98119; (206) 282-1776; FAX: (206) 282-3535.

**AMERICAN SOUND & VIDEO CORPORATION**; *Mastering, Tape Duplication*; 27790 Avenue Hopkins; Valencia, CA 91355; (805) 257-0700; FAX: (805) 257-0715.

**ARTISAN SOUND RECORDERS**; *Mastering, CD Services*; 1600 N. Wilcox Ave.; Hollywood, CA 90028; (213) 461-2751; FAX: (213) 462-5503.

► **ARTIST SOUND**; *Tape Duplication*; 10011 SE Division #306; Portland, OR 97266; (800) 628-5782.

**ASR RECORDING SERVICES**; *Tape Duplication*; 8960 Eton Ave.; Canoga Park, CA 91304; (818) 341-1124.

► **AT&T RECORDING**; *Tape Duplication*; 501 N. Larchmont Blvd.; Los Angeles, CA 90004-1305; (213) 466-9000; FAX: (213) 467-6615.

► **AUDIO CASSETTE DUPLICATOR CO.**; *Tape Duplication*; 12426 1/2 Ventura Blvd.; Studio City, CA 91604; (818) 762-2232; FAX: (818) 508-8077.

► **BAUER COMMUNICATIONS, INC.**; *Tape Duplication*; 8840 Valjean Ave.; Sepulveda, CA 91343; (800) 627-7277.

**BONNEVILLE MEDIA COMMUNICATIONS**; *Mastering, Tape Duplication*; 130 Social Hall Ave.; Salt Lake City, UT 84111; (801) 237-2415; FAX: (801) 237-2459.

► **CAPITOL RECORDS STUDIOS**; *Mastering, CD Services*; 1750 N. Vine St.; Hollywood, CA 90028; (213) 462-6252.

**CASSETTE PRODUCTIONS UNLIMITED**; *Tape Duplication*; 5796 Martin Rd.; Irwindale, CA 91706-6299; (800) 345-0145; (818) 969-6881; FAX: (818) 969-8403.

► **CHRISTIAN CASSETTE**; *Tape Duplication*; 2650 W. Glen Rosa #5; Phoenix, AZ 85017; (602) 246-4976.

► **COMMAND PRODUCTIONS**; *Tape Duplication*; 107 Industrial Center, Harbor Drive; Sausalito, CA 94965; (415) 332-3161.

► **CUSTOM DUPLICATION, INC.**; *Tape Duplication*; 3404 Century Blvd.; Inglewood, CA 90303; (213) 670-5575; FAX: (213) 412-2731.

► **DIFFERENT FUR RECORDING**; *CD Services* 3470 19th St.; San Francisco, CA 94110; (415) 864-1967.

► **DIGIPREP**; *Mastering, CD Services*; 1425 N. Cole Pl.; Hollywood, CA 90028; (213) 461-1709.

► **DIGITAL BROTHERS**; *Mastering, Tape Duplication*; 1731 Bonaire Way; Newport Beach, CA 92660; (714) 645-9702; FAX: (714) 642-7249.

► **DISCTRONICS**; *CD Services*; 3500 W. Olive Ave., Ste. 1020; Burbank, CA 91505; (818) 953-7790; FAX: (818) 953-7791.

► **FANTASY STUDIOS MASTERING**; *Mastering, CD Services*; 10th & Parker Streets; Berkeley, CA 94710; (415) 549-2500.

► **FDS LABS, INC./CDM**; *Mastering, CD Services*; 4007 W. 6th St.; Los Angeles, CA 90020; (213) 383-2155; FAX: (213) 383-2158.

► **52ND STREET AUDIO**; *Mastering, Tape Duplication*; 1741 N. Ivar Ave., Ste. 204; Hollywood, CA 90028; (213) 463-5252; FAX: (213) 465-2079.

► **FUTURE DISC SYSTEMS**; *Mastering, CD Services*; 3475 Cahuenga Blvd. W.; Hollywood, CA 90068; (213) 876-8733.

► **GARRISAN AUDIO**; *Mastering, Tape Duplication*; 6103 Kelly-Elliott; Arlington, TX 76017; (817) 478-4368; FAX: (817) 478-4961.

► **GOOD VIBRATIONS RECORDING AND PRODUCTION CO.**; *Tape Duplication, CD Services*; PO Box 764; Bonita (San Diego County), CA 92002; (619) 267-0307.

► **BERNIE GRUNDMAN MASTERING STUDIO**; *Mastering*; 6054 Sunset Blvd.; Hollywood, CA 90028; (213) 465-6264; FAX: (213) 465-8367.

► **JACKSON SOUND PRODUCTIONS**; *Tape Duplication*; 3897 S. Jason; Englewood, CO 80110; (303) 761-7940; FAX: (303) 789-0557.

► **KABA AUDIO PRODUCTIONS**; *Tape Duplication, CD Services* 24 Commercial Blvd.; Novato, CA 94949; (800) 231-TAPE; (415) 883-5041; FAX: (415) 883-KABA.

► **KDISC MASTERING STUDIOS**; *Mastering, Pressing, CD Services*; 6550 Sunset Blvd.; Hollywood, CA 90028; (213) 466-1323.

► **KM RECORDS, INC.**; *Mastering, Pressing*; 2980 N. Ontario St.; Burbank, CA 91504; (818) 841-3400; FAX: (818) 845-6478.

► **TERRY LESSIG SOUND**; *Tape Duplication*; 1626 N. 7th St.; Phoenix, AZ 85006; (602) 255-0155.

► **LOCATION RECORDING SERVICE, INC.**; *Mastering, Pressing, CD Services*; 2201 W. Burbank Blvd.; Burbank, CA 91506; (213) 849-1321; FAX: (818) 845-8357.

► **MARTIN PRODUCTIONS, INC., DBA MARTIN AUDIO GROUP**; *Tape Duplication*; 1200 Westlake Ave. N., Ste. 414; Seattle, WA 98109; (206) 784-0139; FAX: (206) 783-3284.

► **MASTER TRACK PRODUCTIONS**; *Tape Duplication*; 1524 W. Winton Ave.; Hayward, CA 94545; (415) 782-0877.

► **MELODY PRODUCTIONS**; *Mastering, Tape Duplication*; 7712 23rd Ave. NW; Seattle, WA 98117; (206) 783-8694.

► **METRO DIGITAL**; *Mastering, Pressing, Tape Duplication, CD Services*; 51 Federal St., Ste. 304A; San Francisco, CA 94107; (415) 512-7391.

► **MOBILE FIDELITY SOUND LAB**; *Mastering, Tape Duplication, CD Services*; 1260 Holm Rd.; Petaluma, CA 94954; (707) 778-0134; FAX: (707) 778-6328.

► **MOON VALLEY CASSETTE**; *Tape Duplication*; 10802 N. 23rd Ave.; Phoenix, AZ 85029; (602) 870-3987; FAX: (602) 944-7378.



AUDIOPHILE QUALITY CASSETTES  
DUPLICATED ON THE KABA SYSTEM

MARTIN PRODUCTIONS, INC., DBA MARTIN AUDIO GROUP  
Seattle, WA



MUSIC ANNEX, INC.  
Fremont, CA

► **MUSIC ANNEX, INC.**; *Tape Duplication, CD Services*; 42650 Christy St.; Fremont, CA 94538; (415) 226-0800; FAX: (415) 226-0455.

10 AM - 7 PM DAILY

The **DA** Digital Audio Tape STORE (213) 828-6487 • FAX: (213) 470-6176

2624 Wilshire Blvd. Santa Monica, CA 90403

SPECIALIZING IN  
**DAT RECORDERS**  
**TAPES • ACCESSORIES**

**PROFESSIONAL • PORTABLE • HOME**

FULL WARRANTIES • ENGLISH MANUALS

AmEx VISA MASTERCARD  
Shipping VIA UPS/FED-EX



# AUDIOPHILE QUALITY CASSETTE DUPLICATION PLANT

## TYPICAL EQUIPMENT AND PROCESS FLOW CHART

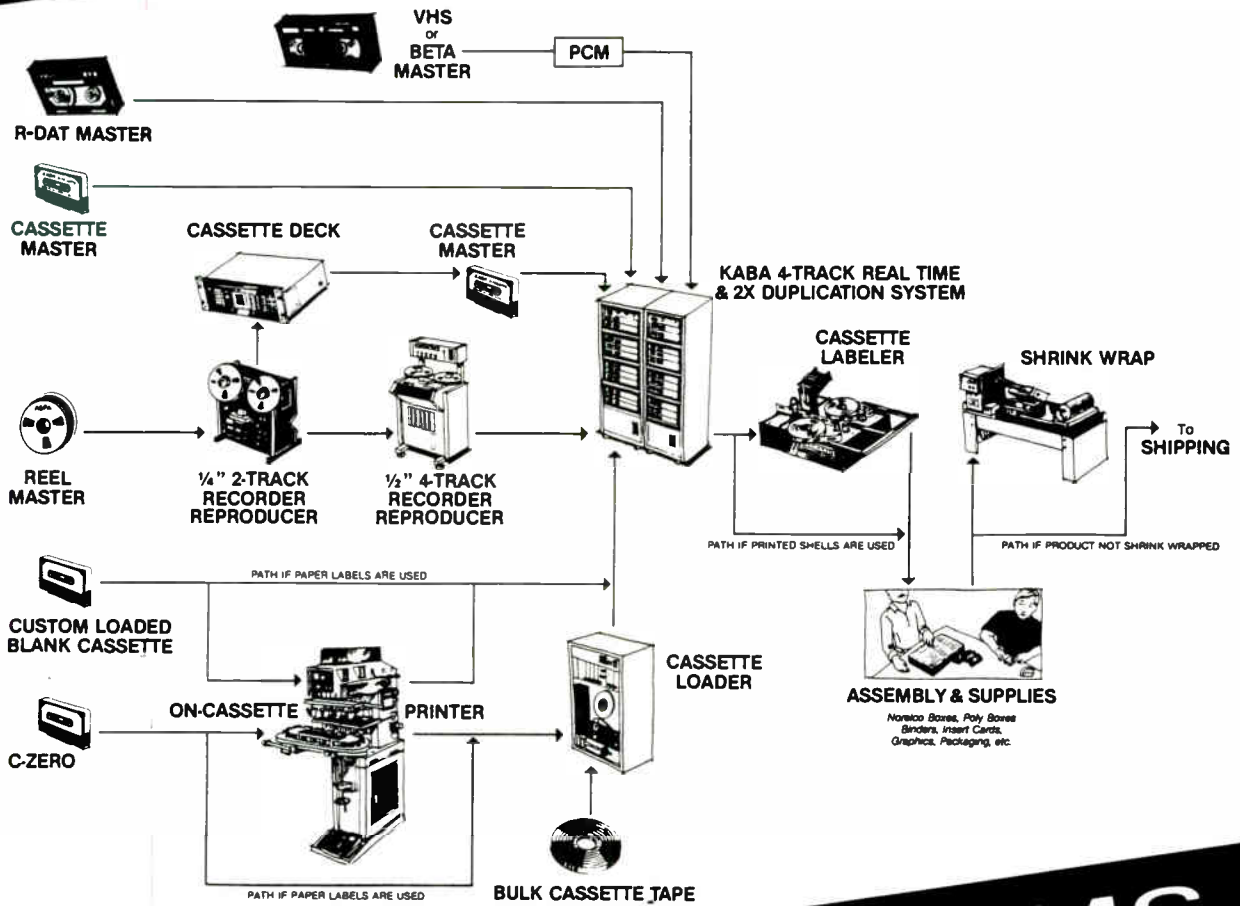

# TURNKEY SYSTEMS CUSTOM DESIGNED BY KABA



**KABA Research & Development**  
Toll Free (800) 231-TAPE

24 Commercial Blvd., Novato, CA 94949  
(415) 883-5041 FAX (415) 883-5222

## Mastering, Pressing & Tape Duplication Facilities

WESTERN U.S.

► **MUSICON**; *Tape Duplication*; 27501 SW 95th Ave., Ste. 930; Wilsonville, OR 97070; (503) 682-8668; FAX: (503) 682-3043.

**ON-TRAX**; *Tape Duplication*; 9340 Namia Dr.; Riverside, CA 92503; (714) 687-5506.

◉ ► **OPTICAL MEDIA INTERNATIONAL**; *Mastering, Pressing, CD Services*; 485 Alberto Way, Ste. 115; Los Gatos, CA 95032; (408) 395-4332; FAX: (408) 395-6544.

► **PENGUIN DIGITAL RECORDING COMPANY**; *Tape Duplication*; 10650 East Bethany Dr., Ste. B; Denver, CO 80014; (303) 755-9978.

**PHYLCO AUDIO**; *Tape Duplication*; 4697 Brooks St.; Montclair, CA 91763; (714) 621-9561; (800) 525-0100; FAX: (714) 626-8183.

► **QUADIM CORPORATION**; *Tape Duplication*; 31542 Rustic Oak Dr.; Westlake Village, CA 91361; (818) 706-8843; FAX: (818) 706-8426.

◉ ► **RAINBO RECORDS AND CASSETTES**; *Mastering, Pressing, Tape Duplication*; 1738 Berkeley St.; Santa Monica, CA 90404; (213) 829-3476.

**RAINBOW CASSETTE STUDIO**; *Tape Duplication*; PO Box 472; Taos, NM 87571; (505) 776-2268.

**BILL RASE PRODUCTIONS, INC.**; *Mastering, Pressing, Tape Duplication, CD Services*; 955 Venture St.; Sacramento, CA 95825; (916) 929-9181; FAX: (916) 929-4751.

**RECORDING ASSOCIATES**; *Tape Duplication*; 5821 SE Powell Blvd.; Portland, OR 97206; (503) 777-4621.

► **REELTIME TAPE DUPLICATION**; *Tape Duplication*; 125 Altana St.; San Rafael, CA 94901; (415) 459-7180.

**THE ROCKET LAB**; *Mastering*; 51 Federal St., Ste. 100; San Francisco, CA 94107; (415) 495-2297; FAX: (415) 495-2684.

► **SAN DIEGO'S AUDIO DUPLICATOR**; *Tape Duplication*; 10536 Pine Grove St.; Rancho San Diego, CA 92078; (619) 670-9598; FAX: (619) 660-9083.

► **SHUR-SOUND & SIGHT, INC.**; *Tape Duplication*; 3350 Scott Blvd. #5; Santa Clara, CA 95054; (408) 727-7620.

► **SONIC ARTS CORP./THE MASTERING ROOM**; *Mastering, CD Services*; 665 Harrison St.; San Francisco, CA 94107; (415) 957-9470; (415) 957-9471.

**SOUNDGRAPHICS**; *Tape Duplication*; PO Box 91133; Long Beach, CA 90809; (213) 498-9135.

► **SOUNDWORKS WEST LTD.**; *Mastering, CD Services*; 7317 Romaine St.; W. Hollywood, CA 90046; (213) 850-1510; FAX: (213) 874-1420.

► **SUPER DUPER**; *Tape Duplication*; 3235 SE 39th; Portland, OR 97202; (503) 239-6070.

**TAPE COMPLEX WEST**; *Mastering, Tape Duplication*; 1606 N. Highland Ave.; Hollywood, CA 90028; (213) 465-2466.

► **TAPE ONE HAWAII, INC.**; *Mastering, Tape Duplication, CD Services*; 1520 Liona St.; Honolulu, HI 96814; (808) 947-8802.

**TRAX**; *Tape Duplication*; 332 Martin Ln.; Salt Lake City, UT 84107; (801) 262-3601; FAX: (801) 269-8886.

**UNIMAGNETICS USA**; *Tape Duplication*; 15136th St. #204; Santa Monica, CA 90401; (213) 393-1572; (800) 366-1176.

**HOWARD VALENTINE SOUND SERVICES**; *Mastering*; 6263 Leland Way; Hollywood, CA 90028; (213) 464-8888.

**WAKEFIELD LAUBER COMPANY**; *Mastering, Tape Duplication*; 6445 S. Maple Ave. #2040; Tempe, AZ 85283; (602) 252-5644; FAX: (602) 252-5645.

**WEA MANUFACTURING, INC.**; *Mastering, Pressing, Tape Duplication, CD Services*; 3601 W. Olive Ave., Ste. 420; Burbank, CA 91505; (818) 953-2941.

**WINTER SUN, INC.**; *Tape Duplication*; 10802 N. 23rd Ave.; Phoenix, AZ 85029; (602) 870-3987; FAX: (602) 944-7378.

► See monthly issue of *Mix* for extended listing

## CANADA

Alberta, British Columbia, Manitoba, New Brunswick, Newfoundland, Northwest Territories, Nova Scotia, Ontario, Prince Edward Isle, Quebec, Saskatchewan

**CANADA CASSETTE DUPLICATION SERVICE**; *Tape Duplication*; 3516 First St. NE; Calgary, AB T2E 3C9; (403) 277-9292; FAX: (403) 276-8187.

**INDUSTRIES MAGRA LTD.**; *Tape Duplication*; 5722 St-Andre; Montreal, QC; (514) 272-8224; FAX: (514) 272-9785.

► **LES INDUSTRIES MAGRA LTEE**; *Mastering, Tape Duplication*; 5722 Rue St-Andre; Montreal, QC H2S 2K1; (514) 272-8224; FAX: (514) 272-9785.

**MCCLEAR PLACE RECORDING & MASTERING STUDIOS**; *Mastering, CD Services*; 225 Mutual St.; Toronto, ON M5B 2B4; (416) 977-9740; FAX: (416) 977-7147.

**MCGILL RECORDING STUDIOS**; *Mastering, CD Services*; 555 Sherbrooke St. W.; Montreal, QC H3A 1E3; (514) 398-8057; FAX: (514) 398-8061.

**PRAISE SOUND PRODUCTION**; *Pressing, Tape Duplication*; 7802 Express St.; Burnaby, BC V5A 1T4; (604) 420-4227.

**R.E.P. SOUND IMAGE RECORDING LIMITED**; *Mastering, Tape Duplication*; 180 Sheldon Dr.; Cambridge, ON N1R 6V1; (519) 623-2269; FAX: (519) 623-4448.

## Mix Trivia

26. A former nuclear engineer, he turned his talents to audio engineering, winning several Grammy Awards in the process.

27. While better known for his work with the Grateful Dead and Jefferson Airplane, he engineered the Grammy-winning *The Chipmunks Sing The Beatles* in 1964.

Turn to page 152 for question

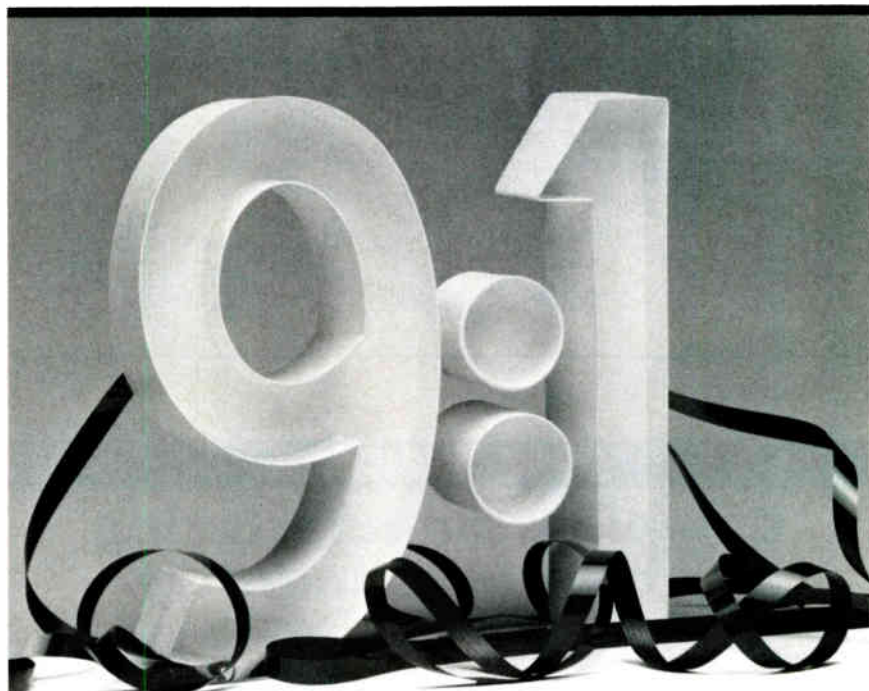

## Electro Sound Systems— an odds-on favorite.

Name a record label and odds are they use Electro Sound systems. It's a matter of trust. For nearly 20 years our systems have been reproducing pure sound. For example, our 4800 and 8000 duplicating systems operate at a ratio of 80:1. That's music for the most discriminating ear.

Our systems work hard to earn that trust. They are the most reliable

in the industry, capable of handling 3 shifts, 7 days a week, year after year, without losing a note. Designed easy to operate and maintain, and backed by our commitment to exceptional service.

You can trust Electro Sound systems to put the odds in your favor. To hear more about reproducing reliable ratios call 408/245-6600.



**electro sound inc.**  
a MARK IV company

160 San Gabriel Dr., Sunnyvale, CA 94086 TEL: (408) 245-6600 FAX: (408) 733-0632 TLX: 34-6324  
Audiomatic Corporation; *International Representative*  
400 Madison Ave., New York, NY 10017 TEL: (212) 308-6888 FAX: (212) 308-5817 TLX: 12-6419



# PRODIGIAL

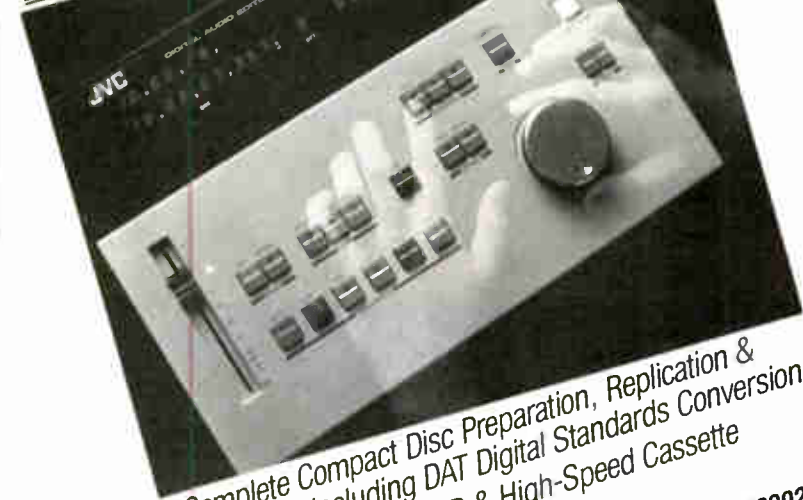

• Complete Compact Disc Preparation, Replication & Packaging, including DAT Digital Standards Conversion  
 • Real Time, DAAD & High-Speed Cassette Duplication & Packaging  
 3400 Pendleton Drive, Wheaton, MD 20902  
 phone 202.319.5588  
 fax 202.319.4490

## CD Pressing Plants

U. S. & C A N A D A

◉ **AMERICAN HELIX**; 1857 Colonial Village Ln.; Lancaster, PA 17601; (717) 392-7840; (800) 525-6575; FAX: (717) 392-7897. Contact: Jim Boyer or Marc S. Feingold. Capacity: 3.5M.

**AMERIC DISC INC.**; 2525 Canadian St.; Drummondville, Quebec, J2B 6V4 Canada; (819) 474-2655. Contact: Claude Fragan. Capacity: 25M.

**CAPITOL EMI**; #3 Capitol Way; Jacksonville, FL 32250; (217) 243-5162. Contact: Larry Tabb, plant mgr.

**CINRAM LTD.**; 2255 Markham Road; Scarborough, Ontario, M1B 2W3 Canada; (416) 298-8190. Contact: Brian Daley. Capacity: 12M.

**DENON DIGITAL INDUSTRIES, INC.**; 1380 Monticello Rd.; Madison, GA 30650; (404) 342-3425; FAX: (404) 342-0637. Contact: K. Fujii, vp sales. Capacity: 36M.

**DIGITAL AUDIO DISC CORP.**; 1800 N. Fruitridge Ave.; Terre Haute, IN 47804; (812) 462-8100; FAX: (812) 466-9125. Contact: Scott N. Bartlett, sales mgr. Capacity: 120M.

**DISCOVERY SYSTEMS**; 7001 Discovery Blvd.; Dublin, OH 43017; (614) 761-2000; FAX: (614) 761-4258. Contact: Mike Ward, vp sales & mktg. Capacity: 10M.

**DISCTRONICS MFG., INC.**; Box 17065; Huntsville, AL 35810; Contact: Sue Simone, regional sales mgr. (818) 953-7790.

**DISCTRONICS**; 1120 Cosby Way; Anaheim, CA 92806; Contact: Sue Simone, regional sales mgr. (818) 953-7790. Capacity: 36M.

**DISCTRONICS**; 2800 Summit Ave; Plano, TX 75086; Contact: Sue Simone, regional sales mgr. (818) 953-7790. Capacity: 15M.

**JVC DISC AMERICA CO.**; #2 JVC Rd.; Tuscaloosa, AL 35405; (213) 274-2221; (212) 768-8413.

**NIMBUS RECORDS, INC.**; Rt. 629 Guildford Farms; Ruckersville, VA 22968; (800) 451-8725, N.Y.; (800) 729-0932, L.A. Contact: Susan High (L.A.); Sandy Richman (N.Y.).

**PHILIPS & DU PONT OPTICAL**; Box 400; Grover, NC 28073; (212) 512-9350, sales.

**SANYO LASER PRODUCTS, INC.**; 1767 Sheridan St.; Richmond, IN 47374; (317) 935-7574; FAX: (317) 935-7570.

**TECHNETRONICS, INC.**; Box 496, Matlack Industrial Park; West Chester, PA 19381; (215) 430-6800; FAX: (215) 460-6804. Contact: Rick Rohall, sales mgr. Capacity: 8M.

**TECHNIDISC**; 2250 Meijer Dr.; Troy, MI 48084; (313) 352-5353; FAX: (313) 435-8540. Contact: Leon Chick, sales mgr. Capacity: 4M.

**3M OPTICAL RECORDING DEPT.**; 1425 Parkway Dr.; Menomonie, WI 54751; (715) 235-5567; FAX: (715) 235-4608. Contact: Jerry Stanton.

◉ **U.S. OPTICAL DISC, INC.**; Rte. 109 & Eagle Dr.; Sanford, ME 04073; (207) 324-1124; FAX: (207) 490-1707. Contact: Debra L'Heureux. Capacity: 10M.

**WEA MFG./SPECIALTY RECORDS CORP.**; 1400 E. Lackawanna Ave.; Olyphant, PA 18447; (717) 383-2471; FAX: (717) 383-2165. Contact: David Brown, vp mktg.

### Mix Trivia

28. This breakthrough rock 'n' roll song was first recorded on April 12, 1954, at Manhattan's Pythian Temple.
29. Producer Manfred Eicher founded this celebrated Munich-based jazz label.
30. This well-known producer also played on records for the Rolling Stones, George Harrison and The Drifters.

Turn to page 152 for question

## DISC MAKERS

### Complete manufacturing for the audio industry.

COMPLETE PACKAGES FOR:  
 Cassette Duplication  
 Record Pressing  
 Compact Disc Replication

All packages are completely retail ready, and include all necessary steps

**SAVE MONEY**  
 Deal Directly  
 With The  
 Manufacturer

In-house art department for complete design, typesetting, film work, and printing.  
 In-house mastering department for a great sounding product.

CALL FOR OUR  
 FREE FULL COLOR  
 CATALOG.  
**1-800-468-9353**  
 (In PA: 215-232-4140)

## DISC MAKERS

1650 Broadway, Suite 1010 New York, NY 10019  
 (212) 265-6662

# INDEPENDENT ENGINEERS & PRODUCERS

UNITED STATES & CANADA

► **GLENN S. ABBEY**; *Engineer & Producer*; SOUND LOGIC STUDIO, 1840 Wake Forest Rd.; Raleigh, NC 27608; (919) 851-4406.

► **M. DAVID ACOSTA**; SILENCE, INC. PO Box 710, Maplecrest Stn.; Maplewood, NJ 07040; (201) 763-0453.

**RANDY ADAMS**; *Engineer & Producer*; FUTURE AUDIO, 7700 Carpenter Freeway; Dallas, TX 75247; (214) 263-0746; FAX: (214) 630-9433.

**RICHARD ADLER**; *Engineer*; RICHARD ADLER RECORDING SERVICES, PO Box 21272; Nashville, TN 37221; (615) 646-4900.

► **MICHAEL AHARON**; *Engineer, Producer & Music/Computer Programmer*; MICHAEL AHARON MUSIC, 1439 S. 2nd St.; Philadelphia, PA 19147; (215) 336-6339; FAX: (215) 248-9115.

**WILLIAM R. ALDRICH**; *Engineer & Producer*; WINDOW DREAMS PRODUCTIONS (FORMERLY H&A PROD.), 4288 Veterans Dr.; Holt, MI 48842; (517) 694-7161.

**GARY J. ALLSEBROOK**; STUDIO III PRODUCTIONS, 16303 Panoramic Way; San Leandro, CA 94578-1116; (415) 276-1536; FAX: (415) 276-3559.

**MIKE ALVAREZ**; *Producer*; NOT RECORDS TAPES, PO Box 29161; Los Angeles, CA 90029; (213) 466-9683.

**TONY ALVAREZ**; *Engineer & Producer*; BOOM SONIC MUSIC, PO Box 218; Cypress, CA 90630; (714) 995-7766.

**TOMMY JOE ANDERSON**; *Engineer, Producer & Music/Computer Programmer*; ACA DIGITAL RECORDING, PO Box 450727; Atlanta, GA 30345; (404) 284-0948.

**PAUL ANTONELL**; *Engineer*; Box 373; Germantown, NY 12526; (518) 537-6305.

**PHIL APPELBAUM**; *Engineer & Producer*; BOGUS THUNDER, 5532 Amistad Rd. NE; Albuquerque, NM 87111; (505) 822-8273.

► **FRANK L. ARN**; *Engineer & Technician*; BANTAM SOUND SERVICES, 11225 Magnolia Blvd., Unit 308; North Hollywood, CA 91403; (818) 907-5181.

► **PATRICK ARNOLD**; *Engineer, Producer & Technician*; PO Box 12; Charleston, WV 25321; (304) 346-6964.

**EDDIE ASHWORTH**; *Engineer & Producer*; ROGUE RECORDINGS, 2629 Manhattan Ave. #202; Hermosa Beach, CA 90254; (213) 372-9327; FAX: (213) 374-5422.

**RUBEN AYALA**; *Engineer & Music/Computer Programmer*; 2302 Joe Field; Dallas, TX 75229; (214) 241-5182; (214) 462-7989; FAX: (214) 241-4037.

**RONALD AYERS**; *Engineer & Producer*; ESSENTIAL SOUND PRODUCTIONS, PO Box 1018; Royal Oak, MI 48068; (313) 548-1185.

**DEAN BAILEY**; *Engineer, Producer & Technician*; 3422 Beech St.; Rowlett, TX 75088; (214) 475-9796.

**STEPHEN M. BAILEY**; *Producer & Music/Computer Programmer*; SYNCARTZ AUDIO PRODUCTION, PO Box 789; Fairview, NJ 07022; (201) 941-0976.

► **DEAN BAILIN**; *Engineer & Producer*; 4 CATS STUDIO, 325 W. 52nd St.; New York, NY 10019; (212) 582-8663; FAX: (201) 327-5428.

**DOUG BAKER**; *Engineer*; WISE ENTERTAINMENT SERVICES, PO Box 8656; Columbia, SC 29202; (803) 957-9090.

**PETER A. BARKER**; *Producer*; STORM PRODUCTIONS, 10016 Balboa Blvd.; Northridge, CA 91325; (818) 886-3924.

**JAMES BARRY**; *Producer*; BARRY PRESERVE, 1223 Paseo Del Mar, South Shores, CA 90731; (213) 832-3944; FAX: (213) 833-0566.

**FREDDY BASTONE**; *Producer*; MAVEN MANAGEMENT, 253 W. 73rd St., Ste. 5J; New York, NY 10023; (212) 769-9120; FAX: (212) 873-1103.

**HAL BATT**; *Engineer, Producer & Music/Computer Programmer*; AFTER HOURS MUSIC, INC. 1959 NE 149th St.; North Miami, FL 33261; (305) 947-6841.

**JEFF BAUGGER**; *Engineer & Producer*; HARD DISK CAFE, 1157 Briarcliff Rd. NE; Atlanta, GA 30306; (404) 875-0215.

► **KEVIN BEAMISH**; *Engineer & Producer*; KEVIN BEAMISH PRODUCTIONS, INC. 4615 Stark Ave.; Woodland Hills, CA 91364; (818) 702-0265; FAX: (818) 713-1629.

**GEOFF BENSON**; *Engineer & Producer*; GEOFF BENSON MUSIC, 233 E. Wacker Dr., Ste. 904; Chicago, IL 60601; (312) 819-0432; FAX: (312) 649-0096.

**RAY BENSON**; *Producer*; BISMEAUX PRODUCTIONS, PO Box 463; Austin, TX 78767; (512) 443-5556; FAX: (512) 447-5282.

► **GLENN BERKOVITZ**; *Engineer*; SPINNING REEL SOUND/SERVICES, 11929 Windward Ave.; Los Angeles, CA 90066; (213) 313-2776.

**JEFFREY BERNSTEIN**; *Producer*; SOUND CHOICE, 125 Bedford Ave. #4L; Brooklyn, NY 11211; (718) 963-0836; FAX: (718) 963-0836.

► **DAVID BIENERT**; *Engineer & Producer*; LO-KEY PRODUCTIONS, 16161 Ventura Blvd.; Encino, CA 91436; (818) 344-0374; FAX: (818) 990-5078.

**MICHAEL BILLINGSLEY**; *Engineer & Producer*; STRAIGHT ARROW RECORDINGS, 5 School Ave.; Montpelier, VT 05602; (802) 223-2551; FAX: (802) 229-1834.

► **MICHAEL BITTERMAN**; *Engineer & Producer*; MID-NIGHT MODULATION, 2211 Pine Ln.; Saugerties, NY 12477; (914) 246-4761.

**TONY BLANC**; *Engineer*; Tantivy Farm, Rte. 1, Box 462B; Barboursville, VA 22923; (703) 832-5962.

► **STEVEN BLANE**; *Engineer & Producer*; BLANE & DEROSA PRODS., INC. 109 W. 27th St., 4th Floor; New York, NY 10001; (212) 633-1925.

► **ROBERT BLANK**; *Engineer & Producer*; BLANK PRODUCTIONS, 1597 Hope St.; Stamford, CT 06907; (203) 968-2420; FAX: (203) 329-7193.

**MICHAEL BODDICKER**; *Producer & Music/Computer Programmer*; 13601 Ventura Blvd.; Sherman Oaks, CA 91423; (818) 981-1136; FAX: (818) 981-2520.

**ROBERT BOLLINGER**; *Music/Computer Programmer*; PLAYTOWN SOUND PRODUCTIONS, PO Box 241, 625 Connable Ave.; Petoskey, MI 49770; (616) 347-0063.

**GENE BORMANN**; *Engineer*; ATLANTIC SATELLITE COMMUNICATIONS, INC. 240 Pegasus Ave.; Northvale, NJ 07647; (201) 784-0555; FAX: (201) 784-9779.

► **ROBERT BOTH**; *Engineer & Producer*; 18 Hiawatha Pass; West Milford, NJ 07480; (201) 697-7540.

**JEFF BOYDSTUN**; *Engineer & Producer*; ARTSONG MUSIC PRODUCTIONS, 4437 Finley Ave.; Los Angeles, CA 90027; (213) 667-0726.

**JAMES H. BOYER**; *Engineer & Producer*; JAMES BOYER COMPANY, PO Box 10306; Lancaster, PA 17605; (717) 898-2234.

**GARY BOYLAN**; *Engineer & Producer*; GARRISON SOUND, 256 Woodbury Rd.; Hicksville, NY 11801; (516) 822-5562.

**RICHARD (RICK) BOYLE**; *Engineer & Producer*; 2126 Avenue J; Wichita Falls, TX 76309; (817) 761-6059.

**ERIC T. BRANDT**; *Producer*; TEAM TAHOE PRODUCTIONS, PO Box 6007; Malibu, CA 90264; (213) 207-3668.

► **JAMIE BRIDGES**; *Engineer & Producer*; 256 State St.; San Mateo, CA 94401; (415) 347-1186.

► **HARRY BROTMAN**; *Engineer, Producer & Music/Computer Programmer*; BROTMAN MUSICAL SERVICES, 19010 Avers Ave.; Flossmoor, IL 60422; (708) 799-7711.

**FIL BROWN, TONY ROBINSON**; *Engineer & Producer*; MODERN SCIENCE MUSIC, PO Box 480213; Los Angeles, CA 90048; (213) 965-7877.

**GLENN J. BROWN**; *Engineer & Producer*; AUDIO GRAPH PRODUCTIONS, INC. 2810 Bennett Rd.; Okemos, MI 48864; (517) 332-3272; FAX: (517) 332-37XX (Call).

**MARK BROWN**; *Engineer, Producer & Technician*; PLANET EARTH PRODUCTIONS, PO Box 525; Cave Junction, OR 97523; (503) 592-2123; FAX: (503) 592-4796.

► **JEFF BRUGGER**; *Engineer & Producer*; 1157 Briarcliff Rd., NE; Atlanta, GA 30306; (404) 875-0215.

► **CHRIS BUBACZ**; *Engineer & Producer*; ON TEN PRODUCTIONS, 87-86 116th St., Apt. D-5; Richmond Hill, NY 11418; (718) 441-5271; (914) 362-1620.

**ERICH T. BUCHOLTZ**; *Engineer*; 2122 Wood St.; Latrobe, PA 15650; (412) 539-1075.

► **RICHARD JAMES BURGESS**; *Engineer & Producer*; 7095 Hollywood Blvd. #106-345; Los Angeles, CA 90028; (213) 850-7337; FAX: (213) 850-5302.

**LELAND BURNS**; *Engineer & Producer*; LELAND D. BURNS AUDIO SERVICES, 10535 Brockbank; Dallas, TX 75229; (214) 350-4398; FAX: (214) 358-0947.

**DEAN BURT**; *Engineer*; A.T.E. PRODUCTIONS, PO Box 18401; Encino, CA 91416-8401; (818) 345-4404.

► **SIDNEY A. BURTON, JR.**; *Engineer*; BURTON SOUND ENGINEERING, 28 Cunningham St. #2; Boston, MA 02125; (617) 427-4376.

► **KEN CAILLAT**; *Engineer & Producer*; CAILLAT PRODUCTIONS, PO Box 1064; Malibu, CA 90265; (213) 456-6047; FAX: (213) 456-5778.

**JEFFREY CALHOON**; *Engineer, Producer, Technician & Music/Computer Programmer*; THE MUSIC FACTORY ENTERPRISES, INC. Ford & Washington Sts., Ste. 300; Norristown, PA 19401; (215) 277-9550.

**DOMINIC P. CAMARDELLA**; *Engineer & Producer*; SOUND DESIGN, 33 W. Haley; Santa Barbara, CA 93101; (805) 962-8489.

► **STEVEN C. CAMPBELL**; *Engineer*; ANYTHING AUDIO/AXSTUDIOS, 1551 Elmwood St.; Clearwater, FL 34615; (813) 441-8975.

► **CARL CANEDY**; *Engineer & Producer*; NEON CITY STUDIOS, 627 Main St.; Simpson, PA 18407; (717) 282-0863; FAX: (717) 282-0863.

► **CARMEN CARAMANICA**; *Producer*; CARMAL PRODUCTIONS, INC. 453 Larchmont Ave.; Utica, NY 13502; (315) 732-0205.

► **STEVE CARR**; *Engineer & Producer*; HIT AND RUN STUDIOS, 18704 Muncaster Rd.; Rockville, MD 20855; (301) 948-6715.

**KEVIN CASEY**; *Engineer & Producer*; 208 Shorebird Circle; Redwood City, CA 94065; (415) 592-8706.

**JOE CASTREJON**; *Engineer, Producer, Technician & Music/Computer Programmer*; SOUND CORE MUSIC, 122 S. Illinois; Carbondale, IL; (618) 457-5641.

**ROBERT CEELY**; *Music/Computer Programmer*; BEEP SOUNDS, 33 Elm St.; Brookline, MA 02146; (617) 731-3785.

**FRED CHESTER**; *Engineer & Producer*; F. CHESTER PRODUCTIONS, 3424 Old St. Augustine Rd. #60; Tallahassee, FL 32301; (904) 878-7975.



*to care enough to  
Sound  
the very best*

- Cassettes of CD-Like Quality on Otari DP-80 w/HX Pro
- Chrome & Ferric Duplication
- Digital & Analog Mastering
- Graphic Design & Printing
- Apex Direct Imprinting
- Full Color Caseliners

**CREATIVE  
SOUND**  
HOUSTON

P.O. Box 720941, Houston, TX 77272  
1-800-451-7034

## Independent Engineers & Producers

U.S. & CANADA

**MARK A. CHILDRESS**; *Engineer & Producer*; ZACATAN PRODUCTIONS. 42301 Carriage Cove Cir.; Canton, MI 48187; (313) 981-2504.

**PHIL CIBLEY**; *Engineer, Producer & Music/Computer Programmer*; STUDIO C MUSIC LIBRARY. PO Box 767 Murray Hill Station; New York, NY 10156-0602; (212) 986-2219.

**ALEX CIMA**; *Engineer, Producer & Music/Computer Programmer*; 1501 E. Chapman Ave. #100; Fullerton, CA 92631; (714) 680-4959.

**SCOTT COCHRAN**; *Engineer & Producer*; MIX'OR MATCH CO. 5143 Bakman #104; North Hollywood, CA 91601; (818) 769-2584; (818) 953-0996 (beeper).

**ANDREW R. COHN**; *Producer*; ARC NEW AGE MUSIC. 2844 W. Eastwood Ave.; Chicago, IL 60625; (312) 478-3008; FAX: (312) 346-9603.

**MICHAEL COLLINS**; *Engineer & Producer*; 2105 Maryland Ave.; Baltimore, MD 21218; (301) 685-8500; FAX: (301) 685-0313.

**KEITH COMPTON**; *Engineer & Producer*; Nashville, TN; (615) 646-5432.

**JOY COOK**; *Engineer, Producer & Music/Computer Programmer*; JAG STUDIO, LTD. 3801-C Western Blvd.; Raleigh, NC 27606; (919) 821-2059.

**"DAN O" CORWIN**; *Producer*; 5839 Silvercreek Rd.; Azle, TX 76020; (817) 281-7988.

**DAVID MILTON COTTRELL**; *Engineer, Producer, Technician & Music/Computer Programmer*; DAVE'S TRACKS. 1602 8th Ave. S.; Fort Dodge, IA 50501; (515) 573-3710.

**TABBY CRABB**; *Engineer, Producer & Music/Computer Programmer*; TCR PRODUCTIONS, LTD. 4 Cool Springs Rd. S., PO Box 590; Charlotte Hall, MD 20622; (301) 884-8484.

**WARREN CRAWFORD**; *Engineer, Producer & Music/Computer Programmer*; CRAWFORD PRODUCTIONS, INC. PO Box 1192; New Smyrna Beach, FL 32170; (904) 427-6626; FAX: (904) 427-7130.

**DAN CUBERT, MARC GODINO**; *Engineer & Producer*; Q-TECH PRODUCTIONS. 246 Morris Ave.; Summit, NJ 07901; (201) 277-1671.

**JERRY CUPIT**; *Producer*; JERRY CUPIT PRODUCTIONS. PO Box 121904; Nashville, TN 37212; (615) 731-0100.

**DAVID DACHINGER**; *Engineer, Producer & Music/Computer Programmer*; DEE PRODUCTIONS. 143 W 78th St.; New York, NY 10024; (212) 496-0049.

**ROBIN DANAR**; *Engineer & Producer*; SQUID PRODUCTIONS. 1689 1st Ave.; New York, NY 10128; (212) 289-5868.

**MAL DAVIS**; *HEARING HEAR*. 730 S. Harvey; Oak Park, IL 60304; (708) 386-7355.

**JIM DEAN**; *Engineer, Producer & Music/Computer Programmer*; MUSIDEO PRODUCTIONS. PO Box 117008; Burlingame, CA 94010; (415) 344-4434.

**LENNY J. DEFRANCO**; *Engineer & Producer*; GENDORA PRODUCTIONS. 6716 Revere St.; Philadelphia, PA 19149; (215) 332-9074.

**GILLIAN G. DELEAR**; *Producer & Music/Computer Programmer*; SUN SWAN STUDIOS. 1155 N. Silverbell #B; Tucson, AZ 85745; (602) 792-4184.

**PETER DENENBERG**; *Producer*; ACME STUDIOS. 112 W. Boston Post Rd.; Mamaroneck, NY 10543; (914) 381-4141; FAX: (914) 381-4543.

**ROBERT DENNIS**; *Engineer & Producer*; PAD PRODUCTIONS. 1049 Military; Detroit, MI 48209; (313) 779-1383.

**MICHAEL DENTEN**; *Engineer, Producer & Music/Computer Programmer*; DENTEN PRODUCTIONS. PO Box 1709; Alameda, CA 94501; (415) 521-0321; FAX: (415) 521-0368.

**JONATHAN DENZENE**; *Engineer, Producer, Technician & Music/Computer Programmer*; NIMZHEAD RUSH AUDIO. 706 E. 1st St.; Fairmont, MN 56031; (507) 238-1035.

**E. DEODATO**; *Producer*; KENYA MUSIC, INC. 60 East End Ave. #2C; New York, NY 10028; (212) 472-2933.

**MARK DERRYBERRY**; *Engineer & Producer*; STARFLIGHT MUSIC PRODUCTIONS. 1848 S. Reed Ct.; Lakewood, CO 80226; (303) 986-7166.

**REGINALD DILL**; *Producer & Music/Computer Programmer*; TRIBE ODX. 3051 Glendale Ct.; Decatur, GA 30032; (404) 284-9268.

**GEORGE A. DONATHAN, JR.**; *Engineer, Producer & Music/Computer Programmer*; GEORGE D. PRODUCTIONS, INC. 19300 SW 106th Ave. #3; Miami, FL 33157; (305) 378-2163.

**HANK DONIG**; *Engineer & Producer*; WIZARD MUSIC GROUP. 8033 Sunset Blvd., Ste. 358; West Hollywood, CA 90046; (818) 905-1703.

**Cecil Quinton Duke**; *Engineer*; 5166 W. Slauson Ave.; Los Angeles, CA 90056; (213) 294-5738.

**DAVID EDWARDS**; *Engineer & Producer*; DB E PRODUCTIONS. 7221 Judson Ave.; Westminster, CA 92683; (714) 892-0877.

**EFRAIN P. ENRIQUEZ**; *Producer & Music/Computer Programmer*; TO THE TOP PRODUCTIONS. 3260 NW 17th St.; Miami, FL 33125; (305) 635-1033.

**DALE EVERINGHAM**; *Engineer, Producer & Music/Computer Programmer*; AUDIO VISIONS. 6289 Clive Ave.; Oakland, CA 94611; (415) 482-2338.

**SHANE FABER**; *Engineer, Producer, Technician & Music/Computer Programmer*; NOW AND THEN MUSIC PRODUCTIONS. 412 E. 78th St. #2A; New York, NY 10021; (212) 879-4667.

**FRANK D. FAGNANO**; *Music/Computer Programmer*; INTEGRATION DIGITAL MUSIC SERVICES. 413 Park Ave.; Fairview, NJ 07022-1116; (201) 941-8528.

**DON FEINBERG**; *Engineer*; 2011 Ocean Ave. #4B; Brooklyn, NY 11230; (718) 376-5776.

**BRADLEY M. FELDMAN**; *Engineer, Producer, Technician & Music/Computer Programmer*; MUSICLAN INTERNATIONAL LTD. 190 6th Ave.; Park Slope, NY 11217; (718) 622-2491; FAX: (718) 622-2491.

**VITO FERA**; *Producer*; NETWORK SOUND PRODUCTIONS. 119 Peachwood Dr.; Swedesboro, NJ 08085; (609) 467-1682.

**JOHN FIELDEN**; *PROFESSIONAL SOUND ENGINEERING*. 1664-C Lusitana St.; Honolulu, HI 96813; (808) 523-2841.

**CHARLES W. FIELDS**; *Producer*; CHARTA RECORDS. 44 Music Sq. E.; Nashville, TN 37203; (615) 255-2175.

**KENN FIN**; *Engineer, Producer & Music/Computer Programmer*; DEEP SPACE RECORDS. 1576 Great Hwy. #307; San Francisco, CA 94122; (415) 566-6701.

**RICK FISHER**; *Engineer*; 560 W. 43rd St. #32E; New York, NY 10036; (212) 594-1990; FAX: (212) 594-1845.

**SAM FISHKIN**; *Engineer & Producer*; SAMSONICS. 1007 Sherman; Evanston, IL 60202-1322; (708) 328-4810.

**S. FITZSTEPHENS**; *Engineer, Producer & Technician*; INDEPENDENT AUDIO SERVICES. 235 W. 76th St.; New York, NY 10023-8214; (212) 580-9825.

**DAVID M. FLAUHER**; *Engineer & Technician*; DMF STAGE LIGHTING/SOUND AUTHORITY. 4505 LeMans Way; Pensacola, FL 32505; (904) 438-8249.



FLETCHER  
Sharon, MA



**YOUR COMPLETE  
SUPPLY SOURCE  
FOR  
AUDIO-VIDEO  
SUPPLIES  
AND  
EQUIPMENT**

- CUSTOM LENGTH AUDIO CASSETTES
- AUDIO CASSETTE BOXES & ALBUMS
- EMPTY REELS AND BOXES
- BLANK & CUSTOM PRINTED AUDIO/VIDEO LABELS
- POST PRODUCTION SUPPLIES

**CALL FOR FREE  
CATALOG  
708-428-2495**

**KOZIN COMMUNICATIONS  
836 GREENWOOD CT.  
CARPENTERSVILLE, IL 60110**

**FLETCHER**; *Engineer & Producer*; MERCENARY AUDIO. 4 Oakland Rd.; Sharon, MA 02067; (617) 784-7610; FAX: (617) 784-9244.

**RICH FLORA**; *Engineer & Technician*; 1049 Fairfax Dr.; Gretna, LA 70056; (504) 393-1932.

**BILLY P. FLOWERS, JR.**; *Engineer, Producer & Technician*; BILL FLOWERS PRODUCTIONS. 6435 McAdams Dr. E.; Theodore, AL 36582; (205) 653-1470.

**LAWRENCE FORDE**; *Producer*; LAWRENCE FORDE ENTERPRISES, INC. 8530 Wilshire Blvd.; Beverly Hills, CA 90211; (415) 363-1000, ext. 1819.

**MATT FORGER**; *Engineer & Producer*; MATT FORGER PRODUCTIONS. 10757 Hortense St. #307; Toluca Lake, CA 91602; (818) 761-5065.

**JAMES E. FOX**; *Engineer & Producer*; LION & FOX RECORDING, INC. 1905 Fairview Ave. NE; Washington, DC 20002; (202) 832-7883.

**N. FRASER**; *Engineer & Producer*; PAVANNE AUDIO RECORDING. Box 7, Place du Parc; Montreal, QC H2W 2M9 Canada; (514) 485-7955.

**JERRELL L. FREDERICK**; *Engineer*; MOTION PICTURE SOUND, INC. 3026 E. Grand Blvd.; Detroit, MI 48202; (313) 873-4655.

**MICHAEL FREEMAN**; *Producer*; 46 Oakdene Rd.; Barrington Hills, IL 60010; (708) 382-5295; FAX: (708) 381-1022.

**ROB FREEMAN**; *Engineer & Producer*; TITLEWAVE PRODUCTIONS. 451 W. Conference Dr.; Boca Raton, FL 33486; (407) 367-0123.

**RONALD GALLAGHER**; *Engineer, Producer & Music/Computer Programmer*; MIND OVER MEDIA. 911 N. Euclid; LaHabra, CA 90631; (213) 691-2776.

**ARTURO M.A. GARCIA**; *Engineer, Producer & Music/Computer Programmer*; MR. CAT PRODUCTIONS. 130 Roycroft, Ste. 307; Belmont Shore, CA 90803; (213) 434-0469.

**FRANK GARFI**; *Engineer & Producer*; GARFI PRODUCTIONS. 4524 Tujunga Ave., Ste. #4; Toluca Lake, CA 91602; (818) 769-7032.

**ERIC GARRISON**; *Producer*; CHINA MOON PRODUCTIONS. 575 Ponus Ridge; New Canaan, CT 06840; (203) 972-3261; FAX: (203) 966-5924.

**TOM GARTLAND**; *Engineer & Producer*; 140 Parker Rd.; Elizabeth, NJ 07208; (201) 351-4522.

**CECIL GASPAR**; *Engineer & Producer*; BREAKING RECORDS. PO Box 50802; Montecito, CA 93108; (805) 969-4589.

**BOB GERARDI**; *Producer*; BOB GERARDI PROD. 160 W. 73rd St.; New York, NY 10023; (212) 874-6436.

**PAUL GERRY**; *Engineer & Producer*; THE CUTTING EDGE. Box 217; Ferndale, NY 12734; (914) 292-5965.

**BOB GIAMMARCO**; SOUNDTRACK. 25 E. 21st; New York, NY 10010; (212) 420-6010; FAX: (212) 533-6758.

**LOU GIORDANO**; *Engineer & Producer*; LG PRODUCTIONS. 312 Cambridge St.; Cambridge, MA 02141; (617) 497-0647.

**VICTOR GIORDANO**; *Engineer*; 657 Bridgeman Terr.; Baltimore, MD 21204; (301) 821-5084.

**TONY GIOVANNETTI**; *Engineer & Producer*; DELTA PRODUCTIONS. 135 MacDougal St.; New York, NY 10012; (212) 473-5385.

**DAVID GLASSER**; *Engineer & Producer*; AIRSHOW, INC. 7021 Woodland Dr.; Springfield, VA 22151; (703) 642-9035; FAX: (703) 642-9035.

**EUGENE GOLD**; 3G'S INDUSTRIES & RECORDING STUDIO "55." 6015 Troost; Kansas City, MO 64110; (816) 361-8455.

**MITCHELL GOLDFARB**; *Producer*; KAJEM/VICTORY STUDIOS. 1400 Mill Creek Rd.; Gladwyne, PA 19035; (215) 642-2346; FAX: (215) 642-3572.

**DANIEL GOMEZ-IBANEZ**; *Engineer & Producer*; DIGITAL AUDIO RECORDING. W9643 Rucks Rd.; Cambridge, WI 53523; (608) 764-8082.

**ART GOTTSCHALK**; *Producer*; DISCOS MM. 5626 Brock St.; Houston, TX 77023; (713) 926-4431; FAX: (713) 926-2253.

► See monthly issue of Mix for extended listing

**BILL GRABOWSKI**; *Engineer & Producer*; A STREET MUSIC. 701 7th Ave., 9W; New York, NY 10036; (212) 764-3872.

**THOMAS M. GRAEFE**; *Engineer, Producer, Technician & Music/Computer Programmer*; T.M. GRAEFE & ASSOC. 6816 NW 26th Ave.; Ft. Lauderdale, FL 33309; (305) 975-8516.

**CHRISTOPHER GRECO**; *Engineer & Technician*; AURAL ACCURACY ENGINEERING SERVICES. 11 Montrose Rd.; Yonkers, NY 10710; (914) 793-9735.

**JERRY GREEN**; *Producer*; MR. WONDERFUL PRODUCTION, INC. 1520 Algonquin Pkwy. U.S.A.; Louisville, KY 40210; (502) 637-1551; (502) 774-1066.

**MARK G. GREGOR**; *Engineer*; G&G MUSIC PRODUCTIONS. 5141 Fairway Lakes Dr.; Westerville, OH 43081; (614) 882-0752.

**JAMES A. GRIFFIN**; *Engineer & Producer*; PARALLAX RECORDING STUDIO. 123 E. State St.; Ridgeland, MS 39157; (601) 856-2525; FAX: (601) 856-9462.

**M.W. GROSSMANN**; *Engineer, Producer, Technician & Music/Computer Programmer*; SELECT WARE, INC. 2374 Flora; Cincinnati, OH 45219-1222; (513) 421-5551.

**ALFRED B. GRUNWELL**; *Engineer & Producer*; CALF AUDIO. 157 Gray Rd.; Ithaca, NY 14850; (607) 272-8964.

**RICHARD M. HAHN**; *Producer*; KEYNOTE PRODUCTIONS, INC. 4322 Mahoning Ave.; Youngstown, OH 44515; (216) 793-7295.

**MICHAEL HALL**; *Engineer, Producer & Music/Computer Programmer*; HAPPY HOUR MUSIC RECORDING, INC. 3408 Lucas & Hunt; St. Louis, MO 63121; (314) 383-7553.

**THOMAS J. HALL**; *Engineer, Producer & Technician*; 4572 150th Ave. NE; Redmond, WA 98052; (206) 881-9322; FAX: (206) 881-3645.

**MARK HALLMAN**; *Engineer & Producer*; SCEPTRE PRODUCTIONS. 7308 S. Congress; Austin, TX 78745; (512) 462-2209.

**TERRY HAMMER**; *Engineer & Producer*; HAMMER PRODUCTIONS. 418 4th Ave.; Mansfield, OH 44905-1994; (419) 524-6968.

**GARY D. HAMPTON**; *Engineer, Producer, Technician & Music/Computer Programmer*; GARRISAN AUDIO. 6103 Kelly-Elliott; Arlington, TX 76017; (817) 478-4368; FAX: (817) 478-4961.

**R. MARK HANSEN**; *Engineer & Producer*; ART OF MUSIC PRODUCTIONS. 6531 S. Owensboro; West Jordan, UT 84084; (801) 967-2993.

**DAVE HARDY, ALEX LEDVIN**; *Engineer & Producer*; UBIQUITY PRODUCTIONS, INC. PO Box 91; Lindenwold, NJ 08021; (609) 783-7650.

**THOMAS HARNED**; *Engineer*; VISUAL SOUND. 2618 Deming Ave., Ste. 4; Columbus, OH 43202; (614) 291-1350.

**MALCOLM H. HARPER, JR.**; *Engineer & Producer*; REELSOUND RECORDING CO. 2304 Sheri Oak Ln.; Austin, TX 78748; (512) 472-3325.

**STEPHEN A. HART**; *Engineer & Producer*; HART PRODUCTIONS. 1690 Creekview Cir.; Petaluma, CA 94954; (707) 762-2521; FAX: (707) 762-2521.

**STEVE HARTLEY**; *Producer*; THE MIXING BOARD. Rte. 6, Box 543; Toccoa, GA 30577; (404) 886-9179.

**MARTY HASSELBACH**; *Engineer & Producer*; NO-HASSELTRACKS PRODUCTIONS. 7675 Osler St.; Vancouver, BC V6P 4C8 Canada; (604) 264-9005.

**WILLIAM HEATH**; *Producer*; OTTO STUDIO. 120 Cimarron; Richland, WA 99352; (509) 627-4939.

**GARY HEDDEN**; *Engineer & Producer*; 2807 Azalea Pl.; Nashville, TN 37204; (615) 269-5183; FAX: (615) 385-0204.

**STEVE HEGER**; *Engineer & Producer*; DARK KNIGHT PRODUCTIONS. PO Box 280073; San Francisco, CA 94128; (415) 753-6993; (415) 566-9322.

**AL HEMBERGER**; *Engineer*; THE LOFT/HEMBERGER PRODUCTIONS, INC. 84 Kraft Ave.; Bronxville, NY 10708; (914) 793-8206.

**JAY HENRY**; *Engineer, Producer & Music/Computer Programmer*; 235 E. 13th St. #3-D; New York, NY 10003; (212) 505-9281.

**MITCH HENS DALE**; *Engineer, Producer & Music/Computer Programmer*; NEW HORIZON RECORDING STUDIO. 1490 Union Cross Rd.; Kernersville, NC 27284; (919) 996-2633.

**EDIE HERROLD**; *Producer*; EDIE HERROLD PRECISION SOUNDTRACKS. PO Box 3546; Ann Arbor, MI 48106; (313) 665-1940.

**DENNIS HETZENDORFER**; *Engineer & Producer*; PROFESSIONAL AUDIO SERVICES. 8795 SW 57th St.; Cooper City, FL 33328-5930; (305) 434-1377.

**WILLIE HILL**; INSPIRE PRODUCTION, INC. 302 E. Pettigrew St.; Durham, NC 27701; (919) 688-8563; (919) 688-8565.

**DANNY M. HILLEY**; *Engineer & Producer*; FRANKLIN INSTITUTE OF RECORDING SOUND TECHNOLOGY. PO Box 1121; Franklin, TN 37065; (615) 794-3660.

**BOB HODAS**; *Engineer & Producer*; PO Box 9485; Berkeley, CA 94709; (415) 649-9254; FAX: (415) 649-1882.

**JEFF A. HOFFBERGER**; *Engineer & Producer*; NATIONAL EVENTS, INC. 12048 Mente Rd.; Lake Jackson, Manassas, VA 22111; (703) 330-0599; FAX: (703) 550-0521.

**WILLIAM D. HOLFORD**; *Engineer*; BILL HOLFORD SOUND, INC. 5418 Grape Rd.; Houston, TX 77096; (713) 665-7554.

**JAMIE HOOVER**; *Producer*; OVO PRODUCTIONS. 2942 Kingsbury Rd.; Clover, SC 29710;

**CHARLES "FROSTY" HORTON**; *Producer*; ROLLING ROAD PRODUCTIONS, INC. 3960 Laurel Canyon Blvd., Ste. 434; Studio City, CA 91614; (818) 506-0050; FAX: (818) 506-0059.

**RICK HORTON**; *Engineer & Producer*; RICK HORTON ENGINEERING SERVICES. PO Box 158913; Nashville, TN 37215; (615) 297-3900.

**CHRISTOPHER HORVATH**; *Engineer & Producer*; BARNARD PRODUCTIONS. 940 NE 27th Ave.; Hallandale, FL 33009; (305) 454-7044.

**MATTHEW C. HOWE**; *Engineer, Producer, Technician & Music/Computer Programmer*; STUDIO CENTER SAN JOSE. 434 S. First St.; San Jose, CA 95113; (408) 993-1040; FAX: (408) 993-1056.

**IAN HUCKABEE**; *Producer*; CLAN HUCBABER PRODUCTIONS. PO Box 609; Albemarle, NC 28002; (704) 983-2526; FAX: (704) 982-0546.

**DAVID IGL**; *Technician*; HUTCHINSON TECHNICAL COLLEGE. 2 Century Ave.; Hutchinson, MN 55350; (612) 587-3636; FAX: (612) 587-9019.

**CHRIS IVEY**; *Engineer & Producer*; KINGDOM PRODUCTIONS. PO Box 500; Conyers, GA 30207; (404) 483-1533.

**DAVID IVORY**; *Engineer & Producer*; DAVID IVORY PRODUCTIONS. 237 Main St.; Royersford, PA 19468; (215) 948-3448; FAX: (215) 948-3141.

**DAVID JACK**; *Engineer & Technician*; PRO-TECH SERVICES, INC. 1922 Fargo; Des Plaines, IL 60018; (708) 699-8937.

**JULIAN JACKSON**; *Producer*; FAZE FOR ENTERTAINMENT/PRODUCTIONS. 1888 Century Park E., Ste. #10; Los Angeles, CA 90067; (213) 301-2807.

**M.L. JACKSON**; *Producer*; PHOTO COMMUNICATION SERVICES, INC. 6410 Knapp NE; Ada, MI 48301; (616) 676-1499.

**ELI JANNEY**; *Engineer & Producer*; CHROME AUDIO. 2718 13th St. NW; Washington, DC 20009; (202) 483-7787.

**ROBERT "ROBBIE" L. JARVIS**; *Engineer, Producer & Music/Computer Programmer*; ROBBIE JARVIS SOUND AND LIGHTING CO. PO Box 525; Bourne, MA 02532; (508) 759-7973.

**STEPHEN G. JARVIS**; *Producer*; AKASHIC RECORDS GROUP. PO Box 395; Danville, CA 94526; (415) 837-7959.

**JARROD JOHNSON**; *Producer & Music/Computer Programmer*; TRIBE ODX. 3051 Glendale Ct.; Decatur, GA 30032; (404) 284-9268.

**STEVE V. JOHNSON**; *Engineer & Music/Computer Programmer*; STEVE JOHNSON ENGINEERING SERVICES. 4853 Cordell Ave., Ste. #822; Bethesda, MD 20814; (301) 654-3163.

**HOWARD JOHNSTON**; *Engineer*; DIFFERENT FUR RECORDING. 3470 19th St.; San Francisco, CA 94110; (415) 864-1967.

**DANIEL G. JONES**; *Engineer, Producer & Music/Computer Programmer*; DANNY JONES PRODUCTIONS. 3252 Grenoble Ln.; Memphis, TN 38115; (901) 365-0021.



# Independent Engineers & Producers

U.S. & CANADA

► **E. KEVIN JONES**; *Engineer & Producer*; SOUND & SOUND ALIKE, 790 Riverside Dr., Ste. MP; New York, NY 10032; (212) 926-8294.

**LOUIS T. JUDSON**; *Engineer & Producer*; INTUITIVE AUDIO, Box 2219; Sausalito, CA 94966; (415) 388-3702.

**DONALD S. KAHLER**; *Engineer, Producer, Technician & Music/Computer Programmer*; DON'S STUDIO, 146 W. Moitke St.; Daly City, CA 94014; (415) 755-4469; FAX: (415) 882-6452.

► **GREG KAMMER**; *Engineer & Producer*; REPLICANT RECORDING, 325 North Rd.; Ashford, CT 06278; (203) 429-4120.

► **KAREN KANE**; *Engineer & Producer*; 396 Broadway; Somerville, MA 02145; (617) 628-6469.

**DAVID KARR**; *Engineer, Producer, Technician & Music/Computer Programmer*; PO Box 127; Center Valley, PA 18034; (215) 965-4388.

► **STEPHEN KAY**; *Engineer, Producer & Music/Computer Programmer*; TECHNISOUND, 140 Madison Ave.; Westfield, NJ 07090; (201) 233-2026.

► **JOHN P. KAYNE**; *Engineer, Producer, Technician & Music/Computer Programmer*; PEPTUNE PRODUCTION SERVICES, 61 Old Bridge Tpk.; East Brunswick, NJ 08816; (201) 254-5583.

**HELEN KEANE**; *Producer*; HELEN KEANE RECORD PRODUCTION/ARTISTS MANAGEMENT, 49 E. 96th St.; New York, NY 10128; (212) 722-2921; FAX: (212) 722-8121.

**KEITH KELLER**; *Engineer & Producer*; 1229 Annunciation St.; New Orleans, LA 70130; (504) 595-8623.

**KURT G. KELLISON**; *Producer*; ATAVISTIC VIDEO, PO Box 57266; Chicago, IL 60657-8266; (312) 935-0081; FAX: (312) 944-0925.

**CHRIS KELLY**; *Engineer, Producer & Technician*; WARM BROWN SOUND, PO Box 1888; Brattleboro, VT 05302; (802) 254-4283.

► **PETER R. KELSEY**; *Engineer & Producer*; 14874 Tyler St.; Sylmar, CA 91342; (818) 367-4445.

**JAMES L. KENNEDY**; *Engineer, Producer, Technician & Music/Computer Programmer*; HEART CONSORT MUSIC—BMI, 410 1st St. W.; Mt. Vernon, IA 52314; (319) 895-8557.

► **PITT KINSOLVING**; *Engineer & Producer*; 686 Arroyo Pkwy., Ste. 260; Pasadena, CA 91105; (213) 303-5362 (paper).

**DUWAYNE KLOOS**; *Engineer & Producer*; WESTMARK PRODUCTIONS, 8345 Duluth St.; Golden Valley, MN 55427; (612) 544-3050.

**JAMES L.R. KLUKOW**; *Producer, Technician & Music/Computer Programmer*; WESTMINSTER MEDIA, Box 27009; Philadelphia, PA 19118; (215) 572-3834.

**BILL KNIGHT**; *Engineer & Technician*; SEGUE SOUND COMPANY, 805 Ave. F; Dodge City, KS 67801; (316) 227-2078.

**MICHAEL R. KOENIG**; *Engineer & Producer*; CRYSTAL STUDIO RECORDING, 92 Kinderkamack; Park Ridge, NJ 07656; (201) 391-0327; (201) 666-4365.

**CARL KOSTER**; *Engineer & Technician*; CONCERTECH TM, 108 W. 17th St., Ste. #7; New York, NY 10011; (212) 255-5986; FAX: (212) 765-5801.

► **MANNY KOUKOULAS**; *Engineer & Producer*; GENESIS SOUND EXPERIENCE, 134 Manetto Hill Rd.; Plainview L.I., NY 11803; (516) 937-3667.

**BILL LACKEY**; *Engineer & Producer*; PLH SOUND, 4140 Gilbert St.; Oakland, CA 94611; (415) 654-0180.

**GEORGE LANDRESS**; *Engineer, Producer & Music/Computer Programmer*; 6138 Glen Holly; Los Angeles, CA 90068; (213) 462-3220.

**JOSEPH L. LANX**; *Engineer & Producer*; JLX PRODUCTIONS, INC. PO Box 10635; Beverly Hills, CA 90213; (213) 281-7189; FAX: (361) 131-3767.

**LEE LAVERGNE**; *Engineer & Producer*; SOUND CENTER RECORDERS, 329 N. Main St., PO Box 233; Church Point, LA 70525; (318) 684-2176; FAX: (318) 684-2176.

**NORTON LAWELLIN**; *Engineer & Producer*; 1561 Sherburne Ave.; St. Paul, MN 55104; (612) 645-9281.

► **ALAN LEININGER**; *Engineer & Producer*; AIR LEININGER PRODUCTION SERVICES, 2506 Coolidge St.; Hollywood, FL 33020; (305) 920-2998.

**ERIC G. LEMMON**; *Producer*; SYNERGY PRODUCTIONS, 4416 Titan Ave.; Lompoc, CA 93436-1027; (805) 733-4416.

► **JEFFREY LESSER**; *Engineer & Producer*; JET LASER PRODUCTIONS, 232 Madison Ave.; Cresskill, NJ 07626; (201) 816-9144.

► **PETER T. LEWIS**; *Engineer & Producer*; LEWIS PRODUCTIONS, 11911 Weddington St., #210; North Hollywood, CA 91607; (818) 769-3334; FAX: (213) 856-0609.

**RONALD C. LEWIS**; *Producer*; MR. WONDERFUL PRODUCTION, INC. 1730 Kennedy Rd.; Louisville, KY 40216; (502) 774-1066.

**DAVID LEWISTON**; *Engineer & Producer*; 715 S. Kihei Rd., Ste. 214; Kihei, HI 96753; (808) 879-0156.

**STEPHEN LINSLEY**; *Engineer & Producer*; SAMURAI MUSIC, 5517 Vallejo St., Ste. A; Emeryville, CA 94608; (415) 653-2985.

► **JOHN W. LINTON**; *Engineer & Producer*; SANS-SERIF PRODUCTIONS, PO Box 492; Haverford, PA 19041; (215) 449-1227; FAX: (215) 828-8879.

**ANDREW LIPINSKI**; *Engineer & Producer*; TONMEISTER RECORDINGS, 6120 Massachusetts Ave.; Bethesda, MD 20816; (301) 229-1664.

► **EUGENE LO, SHARON LEA ERICKSEN**; *Engineer & Producer*; SECOND WIND PRODUCTIONS, 284 Sidney St.; Cambridge, MA 02139; (617) 494-0214.

**JESSE LOMBARDI**; *Engineer, Producer & Technician*; FANTASY PRODUCTIONS, 26 Westminster, Ste. 5; Venice Beach, CA 90392; (213) 392-2344.

**JEFF LORENZEN**; *Engineer, Producer & Music/Computer Programmer*; J.L. PRODUCTIONS, 12830 Burbank Blvd. #320; N. Hollywood, CA 91607-1435; (818) 760-7651.

**WILLIAM (BILL) L. LUCAS**; *Producer*; DELEV MUSIC CO./SIGN OF THE RAM MUSIC AND SURPRIZE RECORDS, INC. PO Box 42707; Philadelphia, PA 19101-2707; 7231 Mansfield Ave.; Philadelphia, PA 19138-1620; (215) 276-8861.

**DAVID C. LUKE**; *Engineer & Producer*; 5186 Argyle Rd.; El Sobrante, CA 94803; (415) 223-4823.

**HOWARD LUKK**; *Engineer, Producer & Technician*; PACIFIC SOUNDS, PO Box 4817; Lancaster, CA 93539; (805) 948-4273.

**NIKO LYRAS**; *Producer*; 1503 Madison Ave.; Memphis, TN 38104; (901) 276-8518.

**DON MACK**; *Engineer & Producer*; AUDIO PRODUCTION SERVICES, 6951 Ranchito Ave.; Van Nuys, CA 91405; (818) 988-3271.

**JOSEPH MAGEE**; *Engineer & Producer*; JOSEPH MAGEE AUDIO ENGINEERING, 4124 Vinton Ave.; Culver City, CA 90232; (213) 840-6925.

**DOMINICK MAITA**; *Engineer*; 496A Hudson St., Ste. D13; New York, NY 10014; (212) 869-9022.

► **JOHN J. MANFREDI**; *Engineer & Producer*; MEGA SOUND PRODUCTIONS, PO Box 3101; Elmira, NY 14905; (617) 732-0913.

**ERIC J. MANNINO**; *Engineer & Producer*; CIRE PRODUCTIONS, 14 Mark Ln.; Deer Park, NY 11729; (516) 667-2969.

► **ERNE MANSFIELD**; *Producer*; MANSFIELD MUSIC GRAPHICS WINDSAILOR MUSIC (BMI), PO Box 737; Berkeley, CA 94701; (415) 652-3647.

**JOE MANZELLA**; *Engineer, Producer & Music/Computer Programmer*; IN SYNC PRODUCTIONS, INC. 211 W. 79th St.; New York, NY 10024; (212) 496-2636.

► **MICHAEL J. MANZO**; *Engineer*; MANZO COMMUNICATIONS, INC. 4 Granite Ave.; Paterson, NJ 07502-1105; (201) 790-6112.

**DEREK MARCIL, JOSH SCHNEIDER**; *Engineer, Producer & Music/Computer Programmer*; MID-SIDE (M-S) PRODUCTIONS, 11684 Ventura Blvd., Ste. 475; Studio City, CA 91604; (818) 763-2028; FAX: (818) 763-3977.

**TONY MARRA**; *Technician*; TLM ELECTRONICS INC. 1 Hillview Dr.; Pleasantville, NY 10570; (914) 769-6423.

**DAVID MARSAC**; *Engineer & Producer*; MARSAC AUDIO SERVICES, PO Box 77; Briarcliff Manor, NY 10510; (914) 279-7945.

**JOE MARTIN**; *Engineer & Producer*; JMI/CREATIVE AUDIO SERVICES, 3655 Old Shell Rd. #321; Mobile, AL 36608; (205) 343-2023.

► **SCOTT MATHEWS**; *Producer*; PROUD PORK PRODUCTIONS, 230 Montcalm St.; San Francisco, CA 94110; (415) 648-9099.

**ROBIN MCBRIDE**; *Producer*; BIRD PRODUCTIONS/VU RECORDS, 1946 N. Hudson Ave.; Chicago, IL 60614; (314) 787-6060.

**JULIAN MCBROWNE**; *Engineer & Producer*; MCBROWNE MUSIC, 23-15 30th Ave. B6; Astoria, NY 11102; (718) 274-8928.

**RANDY B. MCCOY**; *Engineer & Producer*; PO Box 678; Baird, TX 79504; (915) 893-2616.

**PENNY L. MCDONNELL**; *Engineer*; 6214 E. Mockingbird Ln.; Paradise Valley, AZ 85253; (602) 443-1635.

**CHRISTOPHER MCINTOSH**; *Engineer, Producer & Music/Computer Programmer*; METROMEDIA PRODUCTIONS, 822 11th Ave. SW, Ste. 301; Calgary, AB T2R 0E5 Canada; (403) 265-0258; FAX: (403) 265-4012.

**MICHAEL J. MCNAMEE**; *Engineer, Producer & Music/Computer Programmer*; MAC-ATTACK PRODUCTIONS, INC. 14699 NE 18th Ave. #6J; N. Miami, FL 33181; (305) 947-8315.

**ROBERT F. MCNAUGHTON**; *Engineer, Producer & Music/Computer Programmer*; 1040 W. Granville; Chicago, IL 60660; (312) 761-7133.

**THOMAS P. MCWILLIAMS**; *Engineer*; A-V TECH SERVICES, 564 Butler Rd.; Grass Valley, CA 95945; (916) 272-1469.

**ROBERT J. MELLO**; *Engineer, Producer & Music/Computer Programmer*; PO Box 40187; New Bedford, MA 02744; (508) 996-6869.

**FRANK MERWIN**; *Engineer & Producer*; A&F MUSIC SERVICES, 2834 Otsego; Pontiac, MI 48054; (313) 682-9025.

**W. KELLY MILIONIS**; *Engineer, Producer & Music/Computer Programmer*; I.M. ROCK/N. ROLLEN, PO Box 67098; Los Angeles, CA 90067; (213) 473-9793.

► **BRAD S. MILLER**; *Producer*; MOBILE FIDELITY PRODUCTIONS OF NEVADA, PO Box 8359; Incline Village, NV 89450-8359; (702) 831-4459; FAX: (702) 831-4485.

► **JIMMY MILLER**; *Producer*; MILLER VIGLIONE PRODUCTIONS, 5 Strathmore Rd.; Haverhill, MA 01832; (508) 373-3686.

**LEE MILLER**; *Engineer & Producer*; MILLER AUDIO/VIDEO, 1065 Las Gallinas Ave.; San Rafael, CA 94903; (415) 499-0313.

**TOM MILNER**; *Technician*; RECORDING SERVICES COMPANY, 2414 W. Olive Ave.; Burbank, CA 91506; (818) 843-8676; FAX: (818) 842-8713.

**SCOTT MINOR**; *Engineer, Producer & Music/Computer Programmer*; WHITE ROSE PRODUCTIONS, 728 Mallard Ave.; Edmund, OK 73034; (405) 348-2173.

**JOSEPH F. MIRAGLILO**; *Engineer, Producer & Music/Computer Programmer*; FISHBOWL PRODUCTIONS, 89 Clinton St., 3rd Floor; Everett, MA 02149; (617) 389-5816.

**BRIAN MITCHELL**; *Engineer & Technician*; SIRIUS SOUND, 72 Summer St., Apt. 1; Claremont, NH 03743; (603) 542-9388.

► **PETER J. MOORE**; *Producer*; M.D.I. PRODUCTIONS, 116 Beaconsfield Ave.; Toronto, ON M6J 3J6 Canada; (416) 533-1749; FAX: (416) 533-1749.

► **RANDY MOORE**; *Engineer & Producer*; DEER VALLEY PRODUCTIONS, 122 W. Monticello Ave. #13; Madison, TN 37115; (615) 868-6055.

**PAUL MOSER**; *Engineer, Producer & Music/Computer Programmer*; P.M. III PRODUCTIONS, Studio City, CA; (818) 763-3053.

► **TAAVI MOTE**; RUF-MIX PRODUCTIONS, 12966 La Maida St.; Sherman Oaks, CA 91423; (818) 760-0269; FAX: (818) 905-7242.

► **BILL MUELLER**; *Engineer & Producer*; 122 Warren Rd.; Hunt Valley, MD 21031; (301) 666-0196.

► **RICHARD A. MUSK**; *Producer*; MUSK MUSIC, INC. 455 Hope St.; Stamford, CT 06906; (203) 323-7022.

# Sennheiser Microphones

## Excellence Needs No Explanation.

To learn more about the Sennheiser excellence in design and engineering,  
please call or write.



6 Vista Drive, P.O. Box 987  
Old Lyme, CT 06371

Tel # 203-434-9190 FAX # 203-434-1759

MICROPHONES • HEADPHONES • BOOM SETS • RF WIRELESS • INFRA-RED TECHNOLOGY  
Manufacturing Plant: D-3002 Wedemark, Federal Republic of Germany



# Independent Engineers & Producers

U. S. & C A N A D A

**BRUCE NAGEL**; *Producer*; REDLINE STUDIO. 1605 Pasty Ln.; Columbia, MO 65203; (314) 446-1692.

**GASTON NICHOLS**; *Engineer, Producer & Technician*; 5337 5th Terr. S.; Birmingham, AL 35212; (205) 591-7346.

**JOSEPH NICOLETTI**; *Producer*; NICOLETTI PRODUCTIONS INC/CREATIVE NETWORK INC. PO Box 2818; Newport Beach, CA 92663; (714) 494-0181; FAX: (714) 494-0982.

**RALPH NIELSEN**; *Engineer*; MOUNTAIN EAR PRODUCTIONS. PO Box 77; Mountain City, TN 37683; (615) 727-5070; FAX: (615) 727-5247.

**DAVE NODIFF**; *Engineer & Producer*; NF/X. 158 Bishop Dr.; Framingham, MA 01701; (508) 872-6843.

**BILL NOLAND**; *Engineer & Producer*; Pasadena, CA; (818) 398-1417.

**DAVID NORMAN**; *Engineer, Producer & Music/Computer Programmer*; DAVID NORMAN PRODUCTIONS. 639 Garden Walk Blvd. #1832; College Park, GA 30349; (404) 994-1770.

**BILL OHASHI**; *Producer & Music/Computer Programmer*; DANCING BEAR PRODUCTIONS. PO Box 239 Brooklyn Heights Station; Brooklyn, NY; (718) 875-2156.

**RICHARD OLIVER**; *Engineer & Producer*; 854 7th Ave. #9, New York, NY 10019; 37 W. 20th, 8th Floor; New York, NY 10011; (212) 459-9643 (home); (212) 255-5313 (work).

**JAMES OLIVERIO**; *Producer*; OMI STUDIOS. 750 Ralph McGill Blvd. NE; Atlanta, GA 30312; (404) 525-4440; FAX: (404) 525-4545.

**JEANNINE O'NEAL**; *Engineer, Producer & Music/Computer Programmer*; 195 S. 26th St.; San Jose, CA 95116; (408) 286-9840.

**VAN ORBITSON**; *Producer*; GLASS BRICK PRODUCTIONS. PO Box 7632; San Diego, CA 92107; (619) 226-5310; (619) 571-5965.

**JEFF OSTLER**; *Engineer, Producer & Music/Computer Programmer*; TRAX. 332 Martin Ln.; Salt Lake City, UT 84107; (801) 262-3601; FAX: (801) 269-8886.

**DAVE PALMER**; *Engineer*; 1268 Cedar; Birmingham, MI 48009; (313) 646-7532; (313) 540-8231.

**GENE PARCIASEPE**; *G.P. RECORDING*. 47 Lake Riconda Dr.; Ringwood, NJ 07456; (201) 728-3379.

**ROBIN J. PARRY**; *Engineer, Producer & Music/Computer Programmer*; NO BOYFRIEND MUSIC. 31131 Baillard; Malibu, CA 90265; (213) 457-1850; FAX: (818) 845-8039.

**CHRIS PATI**; *Producer*; MODERN VOICES RECORDING. 289 Little Neck Rd.; Centerport, NY 11721; (516) 754-6803.

**CRAIG PATTERSON**; *Engineer, Producer, Technician & Music/Computer Programmer*; PM ENGINEERING. PO Box 3040, 6448 S. Skyline Dr.; Evergreen, CO 80439; (303) 674-5933.

**MARK O. PAUL**; *Producer*; PHUSION. 10120 SW Todd St.; Portland, OR 97225; (503) 297-8720.

**ROBERT PAYNE**; *Engineer & Producer*; SONG SKETCHES PRODUCTIONS. PO Box 36483; Detroit, MI 48236; (313) 886-3757.

**RANDALL PEASE**; *Engineer, Technician*; 2521-1/2 S. Vista Way #186; Carlsbad, CA 92008; (619) 434-9782.

**DAVID PELLOT**; *Engineer, Producer & Music/Computer Programmer*; GUESS WHO??? PRODUCTIONS. 140-23 Einstein Loop N.; Bronx, NY 10475-4973; (212) 465-3355.

**ROBERT "BUB" PHILLIPPE**; *Engineer*; 1405 W. Clark; Champaign, IL 61821; (217) 352-7031; FAX: (217) 398-5923.

**JONATHAN PINES**; *Engineer, Producer, Technician & Music/Computer Programmer*; PRIVATE STUDIOS. 705 W. Western Ave.; Urbana, IL 61801; (217) 367-3530.

**MARK S. PLATI**; *Engineer & Music/Computer Programmer*; MP MUSIC. 80 Montague St. #4F; Brooklyn, NY 11201; (718) 522-5812.

**ED PLUESS**; *Producer*; ED PLUESS PRODUCTIONS. PO Box 6; Tumacacori, AZ 85640; (602) 398-2387.

**JOE PODLESNY**; *Engineer, Producer, Technician & Music/Computer Programmer*; AUDIO PRODUCTION SERVICES. RR 3, Box 15; Bernardston, MA 01337; (413) 648-9071.

**DOUG POMEROY**; *Engineer & Producer*; POMEROY AUDIO. 193 Baltic St.; Brooklyn, NY 11201; (718) 855-2650.

**MICHAEL POPOWSKY**; *Engineer & Producer*; MOTHER'S PRODUCTION. 37 Kosciuszko Ave.; Cohoes, NY 12047; (518) 237-7430.

**WILL RASCATI**; *Engineer & Producer*; FOR THE RECORD MUSIC PRODS. PO Box 1685; Lombard, IL 60148; (708) 932-1120.

**JEFF RAY**; *Producer & Music/Computer Programmer*; 838 Meadowsweet Dr.; Corte Madera, CA 94925; (415) 924-6559.

**GARY REBER**; *Producer*; REBER PRODUCTIONS. 26864 Mandelieu Dr.; Murrieta, CA 92362; (714) 677-6412; FAX: (714) 677-2604.

**JEFF REDEFER**; *Engineer, Producer & Technician*; 382 Ringwald Ave.; Chillicothe, OH 45601; (614) 773-5403; (614) 593-4854.

**JIM REEVES**; *Engineer, Producer, Technician & Music/Computer Programmer*; REEVES AUDIO RECORDING. 21 Primrose Ave.; Yonkers, NY 10710; (914) 793-6496.

**STEVEN REMOTE**; *Engineer & Producer*; REMOTE MEN VISUAL MUSIC ENTERPRISES. PO Box 791; Flushing, NY 11352; (718) 886-6500; FAX: (718) 886-7214.

**RICHARD RIEDEL**; *Engineer*; RIEDEL AUDIO SERVICES. 109 Commack Rd.; Islip, NY 11751; (516) 277-9418.

**JOHN ROBB**; *Engineer & Producer*; HCR 1, Box 11-B; Walnut Shade, MO 65771; (417) 561-4182.

**DON ROBERTS**; *Music/Computer Programmer*; ROBERTS MUSIC. PO Box 110102; Nashville, TN 37222; (615) 834-0169.

**ROB ROBERTS**; *Producer*; OCEANHILLS MUSIC GROUP. 522 Jones Pl.; Walnut Creek, CA 94596; (415) 932-0488.

**DONNA ROBERTSON**; *Producer*; AMERICAN VIDEO PRODUCTIONS. 110 Antwerp St.; Milton, MA 02186; (617) 698-1525; FAX: (617) 698-1521.

**MARK J. ROMERO**; *Engineer & Producer*; JAZZ MARK SOUND (AUDIO) AMETHYST PRODUCTIONS (VIDEO). 47-51 43rd St.; Queens, NY 11377; (718) 706-7071.

**RICK ROONEY**; *Engineer & Producer*; PLANET DALLAS STUDIOS. 3515 Dickason Ave.; Dallas, TX 75219; (214) 521-2216.

**BOB ROSA**; *Engineer & Producer*; OUTLAW PRODUCTIONS. 143 Fingerboard Rd.; Staten Island, NY 10305; (718) 448-1048.

**STEVEN ROSCH**; *Engineer & Producer*; ROAR PRODUCTIONS. 6655 Dobbin Rd., Ste. H; Columbia, MD 21045; (301) 596-2600; FAX: (301) 596-2601.

**JAY ROSE**; *Producer*; SOUND DESIGN. 20 Marion St.; Brookline, MA 02146; (617) 277-0041; FAX: (617) 232-8869.

**MICHAEL K. ROSENMAN**; *Producer*; SAUNA STUDIO. 4514 215th Pl.; Bayside, NY 11361; (718) 229-4864; FAX: (718) 767-1239.

**RICHARD ROSING**; *Engineer, Producer & Music/Computer Programmer*; GENETIC MUSIC. 6017 Bellingham Ave.; N. Hollywood, CA 91606; (818) 763-3742.

**DON ROSS**; *Engineer & Producer*; DON ROSS PRODUCTIONS. 3097 Floral Hill Dr.; Eugene, OR 97403; (503) 343-2692.

**JOHN "ROCK" ROTHROCK**; *Engineer & Producer*; ROTHROCK PRODUCTION ENTERPRISES. PO Box 1624; Boulder, CO 80306; (303) 369-4782.

**THOMAS ROWAN**; *Engineer & Producer*; SOUND LAB, INC. 2319 Fernwood Dr.; Greensboro, NC 27408; (919) 288-0185; FAX: (919) 288-0298.

**IRA CORD RUBNITZ**; *Engineer, Producer & Music/Computer Programmer*; IRA CORD PRODUCTIONS. 13530 Leadwell St., Ste. 5; Van Nuys, CA 91405; (818) 994-0424.

**BARRY RUDOLPH**; *Engineer & Producer*; 5627 Irvine Ave.; North Hollywood, CA 91601; (818) 985-1855.

**JAMES SABELLA**; *Producer*; SABELLA RECORDING STUDIOS. 49 Oakdale Rd.; Roslyn Heights, NY 11577; (516) 484-0862.

**GEORGE ALISTAIR SANGER**; *Engineer, Producer & Music/Computer Programmer*; THE FAT MAN. 7611 Shoal Ck. Blvd.; Austin, TX 78757; (512) 454-5775; FAX: (512) 454-5775.

**RANDY SAPP**; *Engineer & Producer*; MADISON TAYLOR RECORDERS. 3628 Pacific Ave.; Long Beach, CA 90807; (213) 424-6010.

**SILVER JOSE SARGENT**; *Engineer, Producer & Music/Computer Programmer*; SILSAR MUSIC. PO Box 897; Hartford, CT 06104; (203) 548-0212.

**ALWIN SAUERS**; BLUE VELVET ROSE PRODUCTION. Coronado Shores #79; Lincoln City, OR 97367; (503) 764-2411.

**THOMAS SCHAEFER**; *Engineer, Producer & Music/Computer Programmer*; TBL PRODUCTIONS. 3234 N. Cambridge Ave., Ste. F; Milwaukee, WI 53211; (414) 332-1740.

**RANDALL SCHILLER**; *Engineer*; RANDALL SCHILLER PRODUCTIONS. 1207 5th Ave.; San Francisco, CA 94122; (415) 661-7553; FAX: (415) 566-6238.

**JOSH SCHNEIDER, DEREK MARCIL**; *Engineer & Producer*; MID-SIDE PRODUCTIONS. 11684 Ventura Blvd., Ste. 475; Studio City, CA 91604; (818) 763-2028; FAX: (818) 763-3977.

**C.W. (RUSTY) SCHOLLE**; *Engineer & Technician*; POWER SOUND. 3501 Lathrop St., Unit F; Fairbanks, AK 99701; (907) 452-2226; FAX: (907) 451-8616.

**JOHN SCHRADER**; *Engineer & Producer*; 5630 N. Sheridan; Chicago, IL 60660; (312) 784-7072.

**ZAL SCHREIBER**; *Engineer & Producer*; ZALMO SOUNDS. Ditmas Ave. & E. 8th St.; Brooklyn, NY 11218; (718) 633-4166.

**JOHN SCHROEDER**; *Engineer, Producer & Music/Computer Programmer*; JES' MUSIC PRODUCTION. 17830 Sherman Way #368; Reseda, CA 91335; (818) 705-5366.

**ANTHONY SCHULTZ**; *Engineer, Producer & Music/Computer Programmer*; "BIG T" PRODUCTIONS. 24 Haviland St. #8; Boston, MA 02115; (617) 267-2802.

**DENNIS SCOTT**; *Producer & Engineer*; DENNIS SCOTT PRODUCTIONS. 2601 Hillsboro Rd., Ste. N3; Nashville, TN 37212; (615) 292-9459 (Nashville); (516) 829-8747 (NY).

**STEPHEN J. SELTZER**; *Engineer & Producer*; 438 W. 49th #4C; New York, NY 10019; (212) 765-8277.

**WILLIAM W. SETON**; *Producer*; WILLIAM W. SETON & ASSOCIATES. 2006 Naudain St.; Philadelphia, PA 19146; (215) 732-9001.

**PAUL SETSER**; *Producer*; PAUL SETSER CREATIVE. 2930 N. Newhall St.; Milwaukee, WI 53211; (414) 962-9174.

**MARK S. SHEARER**; *Producer*; HARDWAY RECORD COMPANY, INC. PO Box 540; Dearborn Heights, MI 48127; (313) 278-6068; (313) 561-2134 (home).

**BRADLEY SHELTON**; *Engineer, Producer & Music/Computer Programmer*; ENDLESS SUMMER PRODUCTIONS. PO Box 120695; Arlington, TX 76012-0695; (817) 461-0533.

**THOMAS H. SHOEMAKE**; *Engineer & Producer*; 8A 9279 Russellville Rd.; Rockford, KY 42274; (502) 782-3892.

**ALAN SILVERMAN**; *Engineer & Producer*; ARF PRODUCTIONS. 1 Tiffany Pl. #1J; New York, NY 11231;

**BERESFORD SINCLAIR**; *Engineer & Producer*; SINCLAIR BROS. PRODUCTION. 13441 Tobiasson Rd.; San Diego, CA 92064; (619) 748-6771.

**SCOT SKIDMORE**; *Engineer*; BIG TIME PRODUCTIONS. 2823 Brighton Ave.; Los Angeles, CA 90018; (213) 732-5323.

**JOE SKINNER**; *Engineer & Producer*; 1809 Pineview Cir.; Winter Park, FL 32792; (407) 677-6476.

**RONALD A. SKINNER**; *Engineer & Producer*; R.A.S. MUSIC. PO Box 1202, 8 Centennial Crescent; Tilbury, ON N0P 2L0 Canada; (519) 682-0302; (519) 682-2085.

**JERRY SKORA**; *Engineer*; PRODUCERS VIDEO/ON SITE VIDEO SYSTEMS. PO Box 1865; Palatine, IL 60078; (708) 934-0999.

**DOUG JANSEN SMITH**; SOUND CELL PRODUCTIONS. 601 Meridian St.; Huntsville, AL 35801; (205) 539-1868.

**GENE SMITH**; *Engineer, Producer, Technician & Music/Computer Programmer*; PO Box 464188; Lawrenceville, GA 30246; (404) 921-7941.

► **MATTHEW W. SMITH**; *Engineer & Producer*; 3334 Durkin Cir.; Dublin, OH 43017; (614) 889-0995.

**MICHAEL J. SMITH**; *Producer & Music/Computer Programmer*; PROSONICS. PO Box 533; Forestdale, MA 02644; (508) 477-2546.

**CHERYL SOBAS**; *Engineer, Producer, Technician & Music/Computer Programmer*; SCREAMING MONKEY STUDIOS. 655 Carroll St.; Brooklyn, NY 11215; (718) 789-0862.

**PAUL SPECIAL**; *Engineer*; SPECIAL AUDIO SERVICES/SAS CORPORATION. 503-11 Broadway, Ste. 516; New York, NY 10012; (212) 226-6271; FAX: (212) 226-6357.

**ERROL G. SPECTER**; *Engineer, Producer & Music/Computer Programmer*; PHANTASMA SOUND. 7909 Fremont Ave.; Ben Lomond, CA 95005; (408) 336-2494.

**JACK STANG**; *Engineer & Producer*; MEDIA ARTS CENTER. 753 Capitol Ave.; Hartford, CT 06106; (203) 951-8175.

**ART STEELE**; *Engineer, Producer & Technician*; AUDIO PROMEDIA. 114 Old Amherst Rd.; Sunderland, MA 01375; (413) 665-7122; FAX: (413) 665-7122.

**ERIK STEENSEN**; *Engineer, Producer & Music/Computer Programmer*; MULTIMEDIA PRODUCTIONS. 1201 W. Pratt St., Ste. J; Baltimore, MD 21223; (301) 752-0355; (800) 229-0355.

► **MARK STOCKER, HAL SCHWOYER**; *Engineer, Producer & Music/Computer Programmer*; MULTI SOUND IMAGES. 601 N. 6th St.; Allentown, PA 18102; (215) 432-4040; FAX: (215) 439-0103.

► **BOB STONE**; *Engineer & Producer*; BOBCO MUSIC. PO Box 27728; Los Angeles, CA 90027; (213) 250-7625; FAX: (213) 482-3683.

**JAY STONE**; *Producer*; 8306 Wilshire Blvd. #7094; Beverly Hills, CA 90211; (213) 281-0522.

**JOHN STONEMAN**; *Engineer, Producer & Music/Computer Programmer*; ESS PRODUCTIONS. 1235 N. 900 E.; Bountiful, UT 84010; (801) 298-7445.

**HENRY STRASSER**; *Producer*; REALITY RECORDS/PRODUCTIONS. 19 Roxborough Pl.; Willingboro, NJ 08046; (609) 877-7653.

► **RON STREICHER**; *Engineer & Producer*; PACIFIC AUDIO-VISUAL ENTERPRISES. 545 Cloverleaf Way; Monrovia, CA 91016; (818) 359-8012; FAX: (818) 357-0602.

**ERIC J. SUTTMAN**; *Engineer & Producer*; SUTTMAN PRODUCTIONS. PO Box 72; Dayton, OH 45409; (513) 278-4601.

**HILL SWIMMER**; *Engineer & Producer*; UPHILL MUSIC. 1626 N. Wilcox, Ste. 703; Los Angeles, CA 90028; (818) 506-5676.

**KEN TAMURA**; *Engineer, Producer & Music/Computer Programmer*; MAKITO P.D.I. 933 S. Irolo St.; Los Angeles, CA 90006; (213) 380-6629; FAX: (213) 739-5957.

**MIKE THEODORE**; *Engineer, Producer & Music/Computer Programmer*; MIKE THEODORE PRODUCTIONS. 12 Main St.; Garfield, NJ 07026; (201) 340-1248.

► **BILL THOMAS**; *Engineer & Producer*; BILLY TEE PRODUCTIONS. 1293 Aikins Way; Boulder, CO 80303; (303) 369-4660.

**J.T. THOMAS**; *Engineer, Producer & Technician*; PO Box 22928; Lk. Buena Vista, FL 32830; (407) 859-5958.

**PAUL THOMPSON**; *Engineer & Technician*; MOONLIGHT SOUND. 4763 Weld Country Rd. 32; Longmont, CO 80504; (303) 535-4748.

► **THOMAS TOMASELLO**; *Engineer, Producer & Music/Computer Programmer*; TOM TOM PRODUCTIONS. 478 El Cajon Dr.; San Jose, CA 95111; (408) 578-6901.

**ED TREESE**; *Technician*; RECORDIO PRODUCTIONS. 6564 Goodman; Merriam, KS 66202; (913) 432-2349.

**J. BURKE TRIESCHMANN**; *Engineer & Producer*; OPEN DOOR PRODUCTIONS. PO Box 8556; Berkeley, CA 94707; (415) 527-9311.

**MATT TUCKER**; *Engineer & Producer*; MCM GROUP. 7808 Green Lake Rd.; Fayetteville, NY 13066; (315) 637-6656.

**ELLIS B. TURNER**; *Producer*; TURNOUT PRODUCTIONS, INC. 205-24 Murdock Ave.; St. Albans, NY 11412; (718) 217-0080.

**JUAN TURRO**; *Engineer & Technician*; 11872 SW 98th Terr.; Miami, FL 33186; (305) 279-9187.

**SCOTT TUTT**; *Producer*; SCOTT TUTT MUSIC. PO Box 121213; Nashville, TN 37212; (615) 331-7400.

**DAN VAGANEK**; *Engineer & Producer*; 74 West St.; Colonia, NJ 07067; (201) 381-1861.

**FRED S. VAIL/ DAVID SHIPLEY**; TREASURE ISLE PRODUCTIONS. 2808 Azalea Pl.; Nashville, TN 37204; (615) 297-0700; FAX: (615) 297-1413.

**CLIFFORD M. VAN BUREN**; *Engineer, Producer & Music/Computer Programmer*; THE ONYX STAR. PO Box 434; Madison, AL 35758; (205) 656-0426.

**GARY M. VANDY**; *Engineer, Producer & Music/Computer Programmer*; GARY M. VANDY PRODUCTIONS. 1847 Englewood Rd., Ste. 351; Englewood, FL 34223; (813) 475-6125.

**CECIL VAN HOUTEN**; *Engineer, Producer & Music/Computer Programmer*; MUSICWORKS. 405 NW 3rd St.; Earlham, IA 50072; (515) 758-2677; FAX: (515) 758-2517.

► **BRIAN A. VESSA**; *Engineer, Producer & Music/Computer Programmer*; BV PRODUCTIONS. PO Box 3272; Santa Monica, CA 90403; (213) 826-5902.

**JAY VIGNEAU**; *Engineer & Producer*; ON YER TOES PRODUCTIONS. 63 Etna St.; Brighton, MA 02135; (617) 783-3593.

► **DUSTY WAKEMAN**; *Engineer & Producer*; MAD DOG STUDIO. 1717 Lincoln Blvd.; Venice, CA 90291; (213) 306-0950.

**JIM WALKER**; *Engineer*; AUDIO SYSTEMS. 3001 Windy Surf Ct.; Las Vegas, NV; (702) 363-2408.

► **DENNIS WALL**; *Engineer, Producer & Music/Computer Programmer*; OFF THE WALL PRODUCTIONS. PO Box 6182; West Caldwell, NJ 07007; (201) 228-4099.

**SCOTT WARNER**; *Engineer & Producer*; FLAGRANT UNDERGROUND STUDIOS/RECORD COMPANY. RJ Casey Industrial Park; Pittsburgh, PA 15223; (412) 322-8001.

► **ALAN WATTS**; *Engineer & Producer*; TTS PRODUCTIONS, INC. 300 West End Ave. #6B; New York, NY 10023; (212) 595-3908; (212) 972-3561.

► **DAVE WAY**; *Engineer & Producer*; c/o Soundworks; 254 W. 54th St.; New York, NY 10019; (212) 247-3690.

► **JOE WEED**; *Engineer & Producer*; PO Box 554; Los Gatos, CA 95031; (408) 353-3952.

**D.B. WEISS**; *Engineer*; SIGNET SOUND. 115 E. 87th St., Ste. 10A; New York, NY 10128; (212) 348-9335.

**JEFF WELLS**; *Engineer & Producer*; 2036 Paskett; Houston, TX 77092; (713) 688-8067.

**SCOTT L. WHITFIELD**; *Producer & Music/Computer Programmer*; SCOTTSOUND LTD. 17194 Preston Rd., Ste 221-C; Dallas, TX 75248; (214) 248-9006.

**JOHN WIDOFF**; *Engineer*; JOHN WIDOFF, AUDIO. 2888 S. Buchanan St. #C-2; Arlington, VA 22206; (703) 931-9233.

**SANDY WILBUR**; *Producer*; SANDY WILBUR MUSIC, INC. 48 E. 43rd St., 7th Fl.; New York, NY 10017; (212) 949-1190.

**CHARLES WILLER**; *Producer*; AUDIO ARCHITECT. 1655 Wells St., Ste. #100; Fort Wayne, IN 46808-3281; (219) 426-1655.

**DARLEEN WILSON**; *Producer*; BROWNSTONE PRODUCTIONS. 20 Clare Ave.; Roslindale, MA 02131; (617) 325-8904.

**PERRY WINSTON**; *Music/Computer Programmer*; 135 3rd Ave., Apt. 4A; Mineola, NY 11051; (212) 760-0181.

**SUSAN WINTHROP**; *Engineer & Producer*; AUDIO ANTICS WEST. 156 W. 94th St.; New York, NY 10025; (212) 662-8685.

**HOWARD WOLEN**; *Engineer & Producer*; HOWARD WOLEN RECORDING. 733 S. Adams St.; Glendale, CA 91205; (818) 241-3776.

**EDWARD J. WOLFRUM**; *Engineer, Producer & Technician*; AUDIO GRAPHIC SERVICES. 1516 Ferris Ave.; Royal Oak, MI 48067; (313) 544-1793; FAX: (313) 544-1793.

**MARK WOLFSON**; *Engineer, Producer & Music/Computer Programmer*; MARK WOLFSON PRODUCTIONS. 11115 Magnolia Blvd.; N. Hollywood, CA 91601; (818) 505-0001; FAX: (818) 761-7956.

**RICH WOODS**; *Engineer, Producer & Technician*; RICH WOODS SOUND/VIDEO. Ridge Rd.; Marlboro, NY 12542; (914) 236-7885.

► **GEOFFREY WORKMAN**; *Engineer & Producer*; ORIGINAL PROJECTS UNLIMITED, INC. 36 W. 3rd Ave.; Denver, CO 80223; (303) 722-9653.

**CLEVELAND WRIGHT III**; *Producer*; MOTIVATOR MUSIC PRODUCTIONS. 950 Evergreen Ave. #15H; Bronx, NY 10473; (212) 378-7648.

**PHILIP H. WRIGHT**; *Engineer, Producer & Technician*; WEST TEXAS PRO AUDIO. PO Box 662; Shallowater, TX 79363; (806) 832-5760.

**JONATHAN A. WYNER**; *Engineer & Producer*; 50 Amory St. #1; Cambridge, MA 02139; (617) 547-7973.

**ERIC WYSE**; *Producer*; WYSE & ASSOCIATES. PO Box 120882; Nashville, TN 37212-0882; (615) 386-9347.

► **RORY YOUNG**; *Engineer, Producer & Music/Computer Programmer*; ACME STUDIOS. 112 W. Boston Post Rd.; Mamaroneck, NY 10543; (914) 381-4141; FAX: (914) 381-4543.

#### Mix Trivia

31. This Nashville legend produced Paul McCartney's first recording effort in the "Volunteer" state.

32. This artist was the first singer to top the U.S. singles, album and R&B charts at the same time.

33. On September 17, 1931, this company was the first to demonstrate 33-1/3 rpm albums to the world.

Turn to page 152 for question

## Take Your First Step Toward A Career In The Music Business



**TEC**  
NOMINEE  
1989, 1990

- Highly selective, two-year training program
- Current theory mixed with practical hands-on training
- All classes taught by qualified, working professionals
- Job placement assistance
- Financial assistance available



**TREBAS INSTITUTE  
OF RECORDING ARTS**

**(213) 467-6800  
Hollywood**

Vancouver • Toronto • Ottawa • Montreal

Developing people for the music industry since 1979



# RECORDING SCHOOLS, SEMINARS & PROGRAMS

UNITED STATES & CANADA

## EASTERN U.S.

Alabama, Connecticut, Delaware, Florida, Georgia, Kentucky, Louisiana, Maine, Maryland, Massachusetts, Mississippi, New Hampshire, New Jersey, New York, North Carolina, Pennsylvania, Rhode Island, South Carolina, Tennessee, Vermont, Virginia, West Virginia

**KINGSBURY VO TECH CENTER (KINGS STUDIO);** 1328 N. Graham; Memphis, TN 38122; (901) 320-6014.

**>LEBANON VALLEY COLLEGE;** College Ave.; Annville, PA 17003; (800) 223-6181 (PA); (800) 445-6181 (outside PA).

**MEDIA ARTS CENTER/NICKEL STUDIO;** 753 Capitol Ave.; Hartford, CT 06106; (203) 951-8112.

**>MEMPHIS STATE UNIVERSITY—COMMERCIAL MUSIC PROGRAM;** CFA 232—Memphis State University; Memphis, TN 38152; (901) 678-2559.

**>MIAMI SUNSET SENIOR HIGH SCHOOL;** 13125 SW 72nd St.; Miami, FL 33183; (305) 385-4255.

**>MIDDLE TENNESSEE STATE UNIVERSITY—RECORDING IND. MGMT. DEPT.;** PO Box 21; Murfreesboro, TN 37132; (615) 898-2578; FAX: (615) 898-5682.

**MUSIC BUSINESS INSTITUTE;** 3376 Peachtree Rd. NE; Atlanta, GA 30326; (404) 231-3303; FAX: (404) 266-2662 ext. 408.

**THE MUSIC FACTORY ENTERPRISES, INC.;** Ford & Washington Sts., Ste. 300; Norristown, PA 19401; (215) 277-9550.

**>MUSICATION MEDIA;** 1600 Broadway, Ste. 1000A; New York, NY 10019; (212) 957-9100.

**SELECT SOUND RECORDING STUDIOS;** 2315 Elmwood Ave.; Kenmore, NY 14217; (716) 873-2717.

**>SONY PROFESSIONAL AUDIO TRAINING GROUP;** 1400 W. Commercial Blvd.; Ft. Lauderdale, FL 33309; (305) 491-0825.

**SOUND AND RECORDING WORKSHOPS, PENN STATE UNIVERSITY;** 220 Special Services Bldg.; University Park, PA 16802; (814) 863-2911; FAX: (814) 863-2574.

**SOUTHEASTERN LOUISIANA UNIVERSITY;** Electronic Music Lab, SLU; Hammond, LA 70402; (504) 549-2334.

**STATE UNIVERSITY OF NEW YORK COLLEGE AT FREDONIA;** c/o School of Music; Fredonia, NY 14063; (716) 673-3151.

**STATE UNIVERSITY OF NEW YORK AT OSWEGO;** Lanigan Hall; Oswego, NY 13126; (315) 341-2357.

**TIDEWATER COMMUNITY COLLEGE;** 1700 College Crescent; Virginia Beach, VA 23456; (804) 427-7100; FAX: (804) 427-7326.

**TURNING MILL;** PO Box L; Palenville, NY 12463; (518) 678-9293.

**>UNITY GAIN RECORDING INSTITUTE;** 2976-F Cleveland Ave.; Fort Myers, FL 33901; (813) 332-4246.

**>UNIVERSITY OF LOWELL—SOUND RECORDING TECHNOLOGY;** College of Music; Lowell, MA 01854; (508) 934-3850.

**>UNIVERSITY OF MIAMI;** School of Music/Music Engineering; Coral Gables, FL 33124; (305) 284-2439; FAX: (305) 284-6475.

**UNIVERSITY OF NEW HAVEN;** 300 Orange Ave.; West Haven, CT 06516; (203) 932-7102.

**>UNIVERSITY OF NORTH ALABAMA;** Box 5040, Univ. of North Alabama; Florence, AL 35632-0001; (205) 760-4361.



MUSICLAN INTERNATIONAL LTD.  
Park Slope, NY

**MUSICLAN INTERNATIONAL LTD.;** 190 6th Ave.; Park Slope, NY 11217; (718) 622-2491; FAX: (718) 622-2491.

**>NEW YORK UNIVERSITY;** Dept. of Music and Music Education; 35 W. 4th St., Rm. 777; New York, NY 10003; (212) 998-5432.

**JOSH NOLAND MUSIC STUDIO;** 760 W. Sample Rd.; Pompano Beach, FL 33064; (305) 943-9865; FAX: (305) 943-9865.

**>THE OMEGA STUDIOS' SCHOOL OF APPLIED RECORDING ARTS AND SCIENCES;** 5609 Fishers Ln.; Rockville, MD 20852; (301) 230-9100; FAX: (301) 230-9103.

**>PEABODY INSTITUTE OF THE JOHNS HOPKINS UNIVERSITY;** 1 East Mt. Vernon Pl.; Baltimore, MD 21202; (800) 368-2521.

**RECORDING SKILLS WORKSHOP;** 8795 SW 57th St.; Cooper City, FL 33328-5930; (305) 434-1377.

**RELIABLE MUSIC, INC.;** 650 E. Stonewall St.; Charlotte, NC 28202; (704) 375-8662; FAX: (704) 332-4829.

**SCHOOL OF MODERN RECORDING;** 753 Capitol Ave., Media Arts Center; Hartford, CT 06106; (203) 951-8175.



UNIVERSITY OF NORTH CAROLINA-ASHEVILLE  
Asheville, NC

**>UNIVERSITY OF NORTH CAROLINA-ASHEVILLE;** Department of Music; Asheville, NC 28804-3299; (704) 251-6432; FAX: (704) 251-6385.

**UNIV. OF TENN. MUSIC DEPT.;** 1741 Volunteer Blvd.; Knoxville, TN 37996-2600; (615) 974-3241.

**FREDERICK S. VAIL RECORDING INDUSTRY SEMINARS, LTD.;** 2808 Azalea Pl.; Nashville, TN 37204; (615) 297-0700; FAX: (615) 297-1413.

**PHILIP J. WEAVER EDUCATION CENTER;** 300 S. Spring St.; Greensboro, NC 27435; (919) 370-8282.

**>THE AMERICAN UNIVERSITY;** 4400 Massachusetts Ave. NW; Washington, DC 20016-8058; (202) 885-2743.

**>ART INSTITUTE OF FT. LAUDERDALE;** 1799 SE 17th St.; Fort Lauderdale, FL 33316; (800) 327-7603.

**>AUDIO RECORDING TECHNOLOGY INSTITUTE;** 756 Main St.; Farmingdale, NY 11735; (516) 454-8999.

**>THE AUDIO WORKSHOP SCHOOL (DIV. COMMUNICATIONS RESEARCH GROUP);** 119 Fresh Pond Pkwy.; Cambridge, MA 02138; (617) 547-3957.

**>BELMONT COLLEGE;** 1900 Belmont Blvd.; Nashville, TN 37212; (615) 386-4504.

**>BERKLEE COLLEGE OF MUSIC;** 1140 Boylston St.; Boston, MA 02215; (617) 266-1400.

**>CAREER INSTITUTES OF AMERICA;** 1205 Washington Ave.; Miami Beach, FL 33139; (305) 531-3300; (800) 762-4466.

**CAYUGA COMMUNITY COLLEGE—TELECOMMUNICATIONS DEPT.;** Franklin St.; Auburn, NY 13021; (315) 492-1834.

**>CENTER FOR THE MEDIA ARTS;** 226 W. 26th St.; New York, NY 10001; (212) 929-6999; (800) CMA-2297 (outside NYC).

**>COLLEGE OF ST. ROSE;** 432 Western Ave.; Albany, NY 12203; (518) 454-5178.

**COMMUNITY COLLEGE OF THE FINGER LAKES STUDIOS;** Lincoln Hall Rd.; Canandaigua, NY 14424; (716) 394-3500.

**>DARTMOUTH COLLEGE;** Department of Music, Hopkins Center; Hanover, NH 03755; (603) 646-2520.

**>DUQUESNE UNIVERSITY—SCHOOL OF MUSIC;** 600 Forbes Ave.; Pittsburgh, PA 15282; (412) 434-6081.

**>DUTCHESS COMMUNITY COLLEGE;** 53 Pendell Rd.; Poughkeepsie, NY 12601-1595; (914) 471-4500.

**EASTMAN SCHOOL OF MUSIC—DEPARTMENT OF RECORDING ARTS AND SERVICES;** 26 Gibbs St.; Rochester, NY 14604; (716) 274-1130.

**>ELIZABETH CITY STATE UNIVERSITY;** ECSU Department of Music; Elizabeth City, NC 27909; (919) 335-3359.

**>FIVE TOWNS COLLEGE;** 2165 Seaford Ave.; Seaford, NY 11783; (516) 783-8800.

**FRANKLIN INSTITUTE OF RECORDING SOUND TECHNOLOGY;** PO Box 1121; Franklin, TN 37065; (615) 794-3660.

**>FULL SAIL CENTER FOR THE RECORDING ARTS;** 3300 University Blvd.; Winter Park, FL 32792; (407) 679-0100; (800) 221-2747 (outside FL).

**>GEORGIA STATE UNIVERSITY;** University Plaza; Atlanta, GA 30303; (404) 651-3513.

**ALFRED B. GRUNWELL;** c/o Calf Audio; 157 Gray Rd.; Ithaca, NY 14850; (607) 272-8964.

**>INSTITUTE OF AUDIO RESEARCH;** 64 University Pl.; New York, NY 10003; (212) 677-7580; FAX: (212) 677-6549.

**>THE INTERNATIONAL FILM & TV WORKSHOPS;** 2 Central St.; Rockport, ME 04856; (207) 236-8581; FAX: (207) 236-2558.

WERS; 126 Beacon St.; Boston, MA 02116; (617) 578-8892.

WIDENER UNIVERSITY; Chester, PA 19013; (215) 499-4338.

YORK COLLEGE OF PENNSYLVANIA; Country Club Rd.; York, PA 17403-3426; (717) 846-7788; FAX: (717) 846-1274.

CENTRAL US

Arkansas, Illinois, Indiana, Iowa, Kansas, Michigan, Missouri, Minnesota, Nebraska, North Dakota, Ohio, Oklahoma, South Dakota, Texas, Wisconsin

►THE ART INSTITUTE OF DALLAS; 8080 Park Ln.; Dallas, TX 75231; (800) 441-1577.

AUDIO ENGINEERING INSTITUTE; 8535 Fairhaven; San Antonio, TX 78229; (512) 340-8776.

►BOWLING GREEN STATE UNIVERSITY; College of Musical Arts Recording Program; Bowling Green, OH 43403; (419) 372-2181; (419) 372-8405.

►BROWN INSTITUTE; 2225 E. Lake St.; Minneapolis, MN 55407; (612) 721-2481.

►CAPITAL UNIVERSITY CONSERVATORY OF MUSIC; 2199 E. Main St.; Columbus, OH 43209; (614) 236-6234.

CASPER COLLEGE MUSIC DEPT.; 125 College Dr.; Casper, WY 82601; (307) 268-2532; FAX: (307) 268-2682.

►CEDAR VALLEY COMMUNITY COLLEGE; 3030 N. Dallas Ave.; Lancaster, TX 75134; (214) 372-8127.

►THE CLEVELAND INSTITUTE OF MUSIC; 11021 East Blvd.; Cleveland, OH 44106; (216) 791-5000; FAX: (216) 791-3063.

►COLUMBIA COLLEGE; 600 S. Michigan Ave.; Chicago, IL 60605; (312) 663-1600, ext. 354.

►ELMHURST COLLEGE—MUSIC BUSINESS PROGRAM; 190 Prospect; Elmhurst, IL 60126; (708) 617-3515; FAX: (708) 617-3332.

GOODNIGHT RECORDING CLASSES; 2302 Joe Field; Dallas, TX 75229; (214) 241-5182; (214) 462-7989; FAX: (214) 241-4037.

►HOUSTON COMMUNITY COLLEGE SYSTEM; 901 Yorkchester; Houston, TX 77079; (713) 468-6891.

►HUTCHINSON TECHNICAL COLLEGE; 2 Century Ave.; Hutchinson, MN 55350; (612) 587-3636; FAX: (612) 587-9019.

►INDIANA UNIVERSITY SCHOOL OF MUSIC; Bloomington, IN 47405; (812) 855-1582.

KSYM; 1300 San Pedro Ave.; San Antonio, TX 78284; (512) 733-2787; (512) 733-2793; FAX: (512) 733-2204.

►LANSING COMMUNITY COLLEGE—MEDIA DEPARTMENT; 52-Media, PO Box 40010; Lansing, MI 48901-7210; (517) 483-1670.

►MCLENNAN COMMUNITY COLLEGE; Attn: Commercial Music Program; 1400 College Dr.; Waco, TX 76708; (817) 750-3578.

►MICHIGAN STATE UNIVERSITY, DEPARTMENT OF TELECOMMUNICATION; 409 Comm. Arts & Sciences Bldg.; East Lansing, MI 48824; (517) 355-8372 (dept. office); (517) 353-9753.

MIDLAND COLLEGE—AUDIO TECHNOLOGY DEGREE PROGRAM; 3600 N. Garfield; Midland, TX 79705; (915) 685-4648.

MINOT STATE UNIVERSITY; Minot, ND 58701; (701) 857-3186.

►NORTHEAST COMMUNITY COLLEGE; 801 E. Benjamin; Norfolk, NE 68701; (402) 644-0506.

►OBERLIN CONSERVATORY—TIMARA (TECHNOLOGY IN MUSIC AND THE RELATED ARTS); Oberlin, OH 44074; (216) 775-8900; FAX: (216) 775-8942.

►OHIO UNIVERSITY; 9 S. College St.; Athens, OH 45701; (614) 593-4870.

PRIVATE STUDIOS; 705 W. Western Ave.; Urbana, IL 61801; (217) 367-3530.

►RECORDING INSTITUTE OF DETROIT, INC.; 14611 E. 9 Mile Rd.; East Detroit, MI 48021; (313) 779-1380.

► See monthly issue of Mix for extended listing



# LEARN THE ART OF RECORDING

THE RECORDING WORKSHOP IS THE WORLD'S LEADING SCHOOL FOR "HANDS-ON" TRAINING IN MUSIC RECORDING TECHNOLOGY. IN OUR INTENSIVE, 5-WEEK PROGRAM, YOU'LL LEARN THE CREATIVE OPERATION OF PROFESSIONAL RECORDING EQUIPMENT. WE'LL TEACH YOU THE JOB SKILLS NEEDED TO SUCCESSFULLY START YOUR CAREER AS A RECORDING ENGINEER, PRODUCER OR STUDIO MUSICIAN.

- 6 STUDIOS FILLED WITH THE LATEST EQUIPMENT: DIGITAL RECORDING TO HARD DISK, DAT MASTERING, AUTOMATED MIXING, MIDI AND MUCH MORE
- SMALL CLASSES, PERSONAL ATTENTION
- NO PREVIOUS EXPERIENCE REQUIRED
- INTENSIVE, 5-WEEK PROGRAM GIVES YOU MORE QUALITY, IN-STUDIO EXPERIENCE THAN MOST LONG-TERM SCHOOLS
- JOB/INTERNSHIP PLACEMENT ASSISTANCE
- FINANCIAL AID AVAILABLE
- LOW-COST, ON CAMPUS HOUSING

FOR FREE BROCHURE, PLEASE CALL OR WRITE TODAY

**THE RECORDING WORKSHOP**  
1-800-848-9900 1-614-663-2510

455-X MASSIEVILLE ROAD, CHILLICOTHE, OHIO 45601

OHIO STATE BOARD OF SCHOOL AND COLLEGE REGISTRATION #80-07-0696T

©1989 THE RECORDING WORKSHOP



It's not enough to study the "art" of recording. You simply must learn the *technology* of recording. That's the only way to insure your career for today *and* tomorrow!

*"IAR grads are the most highly motivated and best trained of anyone entering the engineering field. I give IAR my highest endorsement."*

Dan Healy, Chief Engineer  
The Grateful Dead

**800-544-2501**

NY, NJ, CT 212-777-8550

Lic. by NYS Ed Dept / HS Diploma or GED Required  
App for Veterans Training / Financial Aid if Eligible



**Institute of Audio Research**

64 University Place, Greenwich Village, New York, New York 10003



CONSERVATORY  
Recording  
Arts & Sciences

**At Last! An Affordable  
Master Recording Program  
Taught by Award-Winning  
Professionals**

If your goal is to succeed in the music and recording industries, our professional training program will give you the hands-on experience and technical know-how you need.

CALL FOR INFORMATION  
AND CATALOG

**1-800-562-6383**

1110 E. Missouri, #400  
Phoenix, AZ 85014

Licensed By The State of Arizona.  
Approved For Foreign Students.

**Recording Schools,  
Seminars & Programs**

CENTRAL U.S.

► **THE RECORDING WORKSHOP**; 455-X Massieville Rd.; Chillicothe, OH 45601; (800) 848-9900; (614) 663-2510.

**RED WING TECHNICAL COLLEGE**; 215 Pioneer Rd.; Red Wing, MN 55066-3999; (612) 388-8271.

► **SMITH/LEE PRODUCTIONS MEDIA SCHOOL**; 7420 Manchester Rd.; St. Louis, MO 63143; (314) 647-3900.

**SOUND ARTS RECORDING SCHOOL**; 2036 Pasket; Houston, TX 77092; (713) 688-8067.

**SOUND CORE MUSIC**; 122 S. Illinois; Carbondale, IL 62901; (618) 457-5641.

► **SOUTH PLAINS COLLEGE**; 1401 S. College Ave.; Levelland, TX 79336; (806) 894-9611.

► **SOUTHERN OHIO COLLEGE**; 1055 Laidlaw Ave.; Cincinnati, OH 45237; (513) 242-3791.

► **TEXARKANA COLLEGE**; 2500 N. Robison Rd.; Texarkana, TX 75501; (214) 838-4541.

**UNIVERSITY OF ILLINOIS AT URBANA—CHAMPAIGN**; Computer Music Project; 2136 Music Bldg., 1114 W. Nevada; Urbana, IL 61801; (217) 244-1207.

► **UNIVERSITY OF WISCONSIN—OSHKOSH**; 800 Algoma Blvd.; Oshkosh, WI 54901; (414) 424-4224.

**VINCENNES UNIVERSITY**; Davis Hall, 1200 N. 2nd St.; Vincennes, IN 47591; (812) 885-4420; FAX: (812) 885-5868.

**WEBSTER UNIVERSITY/MEDIA COMMUNICATIONS DEPT.**; 470 E. Lockwood; Webster Groves, MO 63119; (314) 968-6924; FAX: (314) 968-7112.

WESTERN U.S.

Alaska, Arizona, California, Colorado, Idaho, Las Vegas, Montana, New Mexico, Nevada, Oregon, Utah, Washington, Wyoming

**THE ACADEMY OF RADIO BROADCASTING**; 8907 Warner Ave. #115; Huntington Beach, CA; (714) 842-0100.

**ASPEN MUSIC FESTIVAL—EDGAR STANTON AUDIO RECORDING INSTITUTE**; Box AA; Aspen, CO 81612; (303) 925-3254; FAX: (303) 925-3802.

**BRIGHAM YOUNG UNIVERSITY**; C-550 Harris Fine Arts Center; Provo, UT 84602; (801) 378-3083.

**CALIFORNIA POLYTECHNIC STATE UNIVERSITY**; Music Dept.; San Luis Obispo, CA 93407; (805) 756-2406.

► **CALIFORNIA RECORDING INSTITUTE**; PO Box 2693; Santa Cruz, CA 95063-2693; (408) 722-4658.

► **CALIFORNIA STATE UNIVERSITY, CHICO**; Department of Music—Recording Arts; Chico, CA 95929-0805; (916) 895-5152.

► **CALIFORNIA STATE UNIVERSITY, DOMINGUEZ HILLS**; 1000 Victoria St.; Carson, CA 90747; (213) 516-3543.

**CAREER EDUCATION CENTER/DENVER PUBLIC SCHOOLS**; 2650 Eliot St.; Denver, CO 80211; (303) 455-5966; FAX: (303) 477-2932.

**CITY COLLEGE OF SAN FRANCISCO: BCST. DEPT.**; 50 Phelan Ave.; San Francisco, CA 94112; (415) 239-3525.

**COLLEGE OF MARIN MUSIC DEPARTMENT**; Kentfield, CA 94904; (415) 485-9460.

► **COLLEGE FOR RECORDING ARTS**; Bi-Cultural Foundation Inc.; 665 Harrison St.; San Francisco, CA 94107; (415) 781-6306.

Mix Trivia

34. To keep them in the studio, this producer allegedly held The Ramones at gunpoint.

Turn to page 152 for question

CONSERVATORY  
Recording  
Arts & Sciences

CONSERVATORY OF RECORDING ARTS & SCIENCES  
Phoenix, AZ

► **CONSERVATORY OF RECORDING ARTS & SCIENCES**; 1110 E. Missouri # 400; Phoenix, AZ 85014; (800) 562-6383; FAX: (602) 277-6552.

**CORNISH COLLEGE OF THE ARTS**; 710 E. Roy St.; Seattle, WA 98102; (206) 323-1400 ext. 217.

► **FULLERTON COLLEGE—MUSIC DEPT.**; 321 E. Chapman Ave.; Fullerton, CA 92634; (714) 992-7296.

► **GOLDEN WEST COMMUNITY COLLEGE**; 15744 Golden West St.; Huntington Beach, CA 92647; (714) 895-8780.

**GROSSMONT COLLEGE**; 8800 Grossmont College Dr.; El Cajon, CA 92020; (619) 465-1700.

► **GROVE SCHOOL OF MUSIC**; 14539 Sylvan St.; Van Nuys, CA 91411; (818) 904-9400; FAX: (818) 785-6006.

► **THE INSTITUTE OF AUDIO-VIDEO ENGINEERING**; 1831 Hyperion Ave.; Hollywood, CA 90027; (213) 666-2380.

► **LONG BEACH CITY COLLEGE**; 4901 E. Carson St.; Long Beach, CA 90808; (213) 420-4309; (213) 420-4517.

► **LOS ANGELES CITY COLLEGE, RADIO-TV-FILM**; 855 N. Vermont Ave.; Los Angeles, CA 90029; (213) 669-5545; FAX: (213) 666-4294.

**LOS ANGELES HARBOR COLLEGE—MUSIC DEPT.**; 1111 Figueroa Pl.; Wilmington, CA 90744; (213) 518-1000.

► **LOS ANGELES RECORDING WORKSHOP**; 12268 Ventura Blvd.; Studio City, CA 91604; (818) 763-7400.

► **LOS MEDANOS COLLEGE—RECORDING ARTS PROGRAM**; 2700 E. Leland Rd.; Pittsburg, CA 94565; (415) 439-0200.

► **LOYOLA MARYMOUNT UNIVERSITY**; Comm. Arts Dept.; Loyola Blvd. at W. 80th St.; Los Angeles, CA 90045; (213) 338-3033.

► **MAY SCHOOLS**; 1320 Grand Ave.; Billings, MT 59102; (406) 259-7000; FAX: (406) 252-8120.

**MILLS COLLEGE MUSIC DEPARTMENT**; 5000 MacArthur Blvd.; Oakland, CA 94613; (415) 430-2191.

**NEW MEXICO STATE UNIVERSITY RECORDING LABS**; NMSU Music Dept. Box 30001-3F; Las Cruces, NM 88003; (505) 646-5215.

**PIMA WEST—MEDIA COMMUNICATIONS DEPT.**; 2202 W. Anklam Rd.; Tucson, AZ 85709; (602) 884-6974; FAX: (602) 884-6209.

**PLANET EARTH PRODUCTIONS**; PO Box 525; Cave Junction, OR 97523; (503) 592-2123; FAX: (503) 592-4796.

► **PORTLAND COMMUNITY COLLEGE, MUSIC DEPT., CASCADE**; PO Box 19000; Portland, OR 97219-0990; (503) 244-6111, ext. 5226.

**QUINCY STREET SOUND**; 130 Quincy St. NE; Albuquerque, NM 87108; (505) 265-5689.

► **RECORDING ASSOCIATES**; 5821 SE Powell Blvd.; Portland, OR 97206; (503) 777-4621.

► **RECORDING INSTITUTE**; 14511 Delano St.; Van Nuys, CA 91411; (818) 994-9976.



**Our  
Graduates Work**

A practical education in audio and video recording arts and sciences for anyone who takes recording seriously.

**Institute of  
Audio-Video  
Engineering**

1831 Hyperion Ave., Hollywood, CA 90027

Call Toll-Free: National 1-800-551-8877

Local (213) 666-2380

>R.O.P. (REGIONAL OCCUPATIONAL PROGRAM) MENDOCINO COUNTY OFFICE; PO Box 226; Mendocino, CA 95460; (707) 937-1200.

SALTY DOG RECORDING; 14511 Delano St.; Van Nuys, CA 91411; (818) 994-9973.

SAN DIEGO RECORDING WORKSHOP; PO Box 7632; San Diego, CA 92107; (619) 571-5965.

>SAN FRANCISCO STATE UNIVERSITY MUSIC/RECORDING INDUSTRY CERTIFICATE PROGRAM; SFSU Downtown Center; 814 Mission St., Ste. 201; San Francisco, CA 94103; (415) 338-1372; FAX: (415) 974-6107.

>SKE AUDIO PUBLISHING; PO Box 2519; Sedona, AZ 86336; (800) 284-1258.

SONOMA SOUND; PO Box 1623; Sonoma, CA 95476; (707) 996-4363.

>SONOMA STATE UNIVERSITY; 1801 E. Cotati Ave.; Rohnert Park, CA 94928; (707) 664-2324; FAX: (707) 664-2505.

>SONY INSTITUTE OF APPLIED VIDEO TECHNOLOGY; 2021 N. Western Ave.; PO Box 29906; Los Angeles, CA 90029; (213) 462-1987.

>SOUTHWEST INSTITUTE OF RECORDING ARTS AND SCIENCES; 4831 N. 11th St., Ste. C; Phoenix, AZ 85014; (602) 241-1019.

>TREBAS INSTITUTE; 6464 Sunset Blvd., The Penthouse; Hollywood, CA 90028; (213) 467-6800.

>UCLA EXTENSION; 10995 Le Conte Ave., PO Box 24901; Los Angeles, CA 90024; (213) 825-9064.

>UNIVERSITY OF ARIZONA; Tucson, AZ 85721; (602) 621-1655.

UNIVERSITY OF COLORADO, DENVER, COLLEGE OF MUSIC; 1200 Larimer St., Box 162; Denver, CO 80204; (303) 556-2727.

>UNIVERSITY OF DENVER, LAMONT SCHOOL OF MUSIC; 7111 Montview Blvd.; Denver, CO 80220; (303) 871-6400.

>UNIVERSITY OF NEVADA, LAS VEGAS; 4505 S. Maryland Pkwy.; Las Vegas, NV 89154; (702) 739-0819.

>UNIVERSITY OF SOUND ARTS; 1645 N. Vine St., Ste. 609; Hollywood, CA 90028; (213) 467-5256; (213) 962-5100.

>UNIVERSITY OF SOUTHERN CALIFORNIA; School of Music; MUS 212; Los Angeles, CA 90089-0851; (213) 743-2627.



>THE BANFF CENTRE FOR THE ARTS; Office of the Registrar; PO Box 1020; Banff, AL T0L 0C0; (403) 762-6180; FAX: (403) 762-6444.

BULLFROG RECORDING SCHOOL; 2475 Ounbar St.; Vancouver, BC V6R 3N2; (604) 734-4617.

>COLUMBIA ACADEMY OF RADIO, TELEVISION AND RECORDING ARTS; 1295 W. Broadway; Vancouver, BC V6H 3X8; (604) 736-3316.

>I.C.A. INSTITUTE OF COMMUNICATION ARTS; 5787 Marine Or.; Burnaby, BC V5J 3H1; (604) 430-4092.

>MCGILL UNIVERSITY GRADUATE PROGRAM IN SOUND RECORDING; Faculty of Music, 555 W. Sherbrooke St.; Montreal, QC H3A 1E3; (514) 398-4546; FAX: (514) 398-8061.

>ONTARIO INSTITUTE OF AUDIO RECORDING TECHNOLOGY; 500 Newbold St.; London, ON N6E 1K6; (519) 686-5010.

RECORDING ARTS PROGRAM OF CANADA; 34 Chemin des Ormes; Ste.-Anne des Lacs, QC J0R 1B0; (514) 224-8363.

RECORDING ARTS PROGRAM OF CANADA; 28 Valrose Dr.; Stoney Creek, ON L8T 3T4; (416) 662-2666; FAX: (514) 224-8363.

>TREBAS INSTITUTE; 451 St. Jean St.; Montreal, QC H2Y 2R5; (514) 845-4141.

>TREBAS INSTITUTE; 290 Nepean St.; Ottawa, ON K1R 5G3; (613) 232-7104.

>TREBAS INSTITUTE; 410 Dundas St. E.; Toronto, ON M5A 2A8; (416) 966-3066.

>TREBAS INSTITUTE; 112 E. 3rd Ave., Ste. 305; Vancouver, BC V5T 1C8; (604) 872-2666.

#### Mix Trivia

35. In May of 1971, this Rolling Stones single and LP were Number One simultaneously.

36. In 1968, this band was signed by A&M as the label's first rock 'n' roll act.

37. This New York producer signed Bob Dylan to Columbia in 1961, then produced his debut album.

38. Born in Berlin in 1931, this rock promoter got his start as a business manager with The San Francisco Mime Troupe.

39. Once a member of the pub-rock band Brinsley Schwarz, this producer/artist was the first to release a single on Stiff Records—in 1976.

40. In 1978, he left Island Records to set up his own label, Tuff Gong, in Kingston, Jamaica.

Turn to page 152 for question

Bring  
A Saxophone,  
A Space  
Bass,  
And  
A String  
Quartet To  
Your Next  
Session.

Requires a compatible CD-ROM player available from OMI. ©1990 Optical Media International.

Now you can get a whole universe of professional quality sounds—without the hassles usually associated with sampling.

No hunting for floppy discs or waiting while they load. A single one of our CD-ROMs holds hundreds of instruments. And no tedious mapping and looping, because all our sounds come completely pre-processed. You get looped, normalized samples with a great selection of pre-sets to choose from—and over 20 CD-ROM disc titles!

So the next time you need a funk bass, a bamboo flute, or a flock of birds for your Akai, E-mu, or Roland sampler, please give us a call at:

800-347-2664 or 408-395-4332



OPTICAL MEDIA  
INTERNATIONAL

485 Alberto Way • Los Gatos, CA 95032





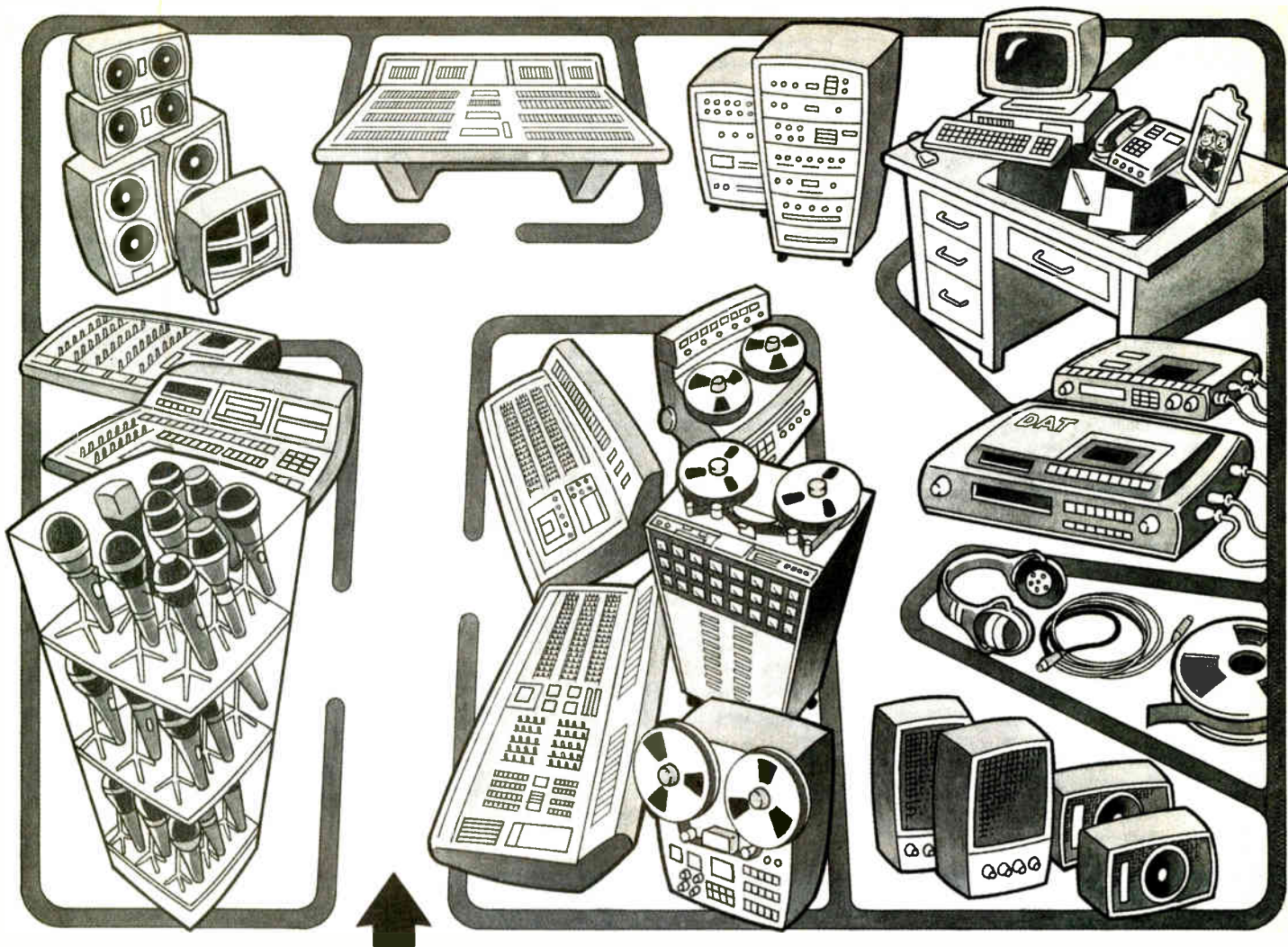

# The best advice in professional audio starts right here.

Walk through Manny's Pro Audio Division. Check out the incredible variety of top brand equipment there is to choose from.

Start with microphones, the first critical link in the audio chain. Notice the world's hottest condenser, ribbon and dynamic mics on display. Plus all types of cables, stands and accessories.

Walk on. You'll be even more amazed by Manny's unmatched selection of the latest in mixing consoles, analog and digital tape recorders, signal processors, power amps, studio monitors, speaker enclosures and more.

But the reason why top audio professionals come to Manny's is not just products. It's *people*. Knowledgeable staff members with the unique combination of ears, instincts and long-term experience in the field to help you find the exact piece of equipment you need—no matter what you're looking for.

Stop by or call Manny's Professional Audio Division. Because when it comes to finding the best professional audio equipment for your needs, it's always better to start right.

**Manny's Music**  
PROFESSIONAL AUDIO DIVISION

156 W. 48th Street, New York City, N.Y. 10036 (212) 819-0576 Fax: (212) 391-9250

# FACILITY DESIGNERS & SUPPLIERS

UNITED STATES & CANADA

## NORTHEAST US

Connecticut, Delaware, Maine, Maryland, Massachusetts,  
New Hampshire, New Jersey, New York, Pennsylvania,  
Rhode Island, Vermont

**ACOUSTILOG, INC.;** SD, EI, AC, MR, SES, ER; 19 Mercer St.; New York, NY 10013; (212) 925-1365.

**ADVANCE MUSIC CENTER;** SD, AC, SES, EI, MR, ER; 61 Main St.; Burlington, VT 05401; (802) 863-8652.

**ADVENT CONCERT SERVICES;** EI, AC, MR, ER; 278 Grant St.; Buffalo, NY 14213; (716) 882-5360; FAX: (716) 885-0533.

**A.F. ASSOCIATES, INC.;** EI, SES; 100 Stonehurst Ct.; Northvale, NJ 07647; (201) 767-1200; FAX: (201) 784-8637.

► **ALACRONICS, INC.;** SD, AC, EI, MR; 192 Worcester St.; Wellesey, MA 02181; (617) 239-0000.

**APPLIED AUDIO;** SD, EI, AC, MR, SES, ER; 2 Townline Cir.; Rochester, NY 14623; (716) 272-9280; FAX: (716) 272-1156.

► **SAM ASH PROFESSIONAL;** SES; 7237th Ave., 3rd Floor; New York, NY 10019; (212) 719-2640; FAX: (212) 302-4289.

**ASSOCIATED IMAGES LTD.;** 25 W. 45th St.; New York, NY 10036; (212) 764-1212; FAX: (212) 764-0232.

**AUDIO & VIDEO ARTS;** SD, AC; 217 Coe Ave.; East Haven, CT 06512; (816) 231-1983.

**AUDIO PROMEDIA;** EI, AC, MR; 114 Old Amherst Rd.; Sunderland, MA 01375; (413) 665-7122; FAX: (413) 665-7122.

► **AUDIO VIDEO RESEARCH GROUP;** SD, AC, SES, EI, MR; 106 Main St.; Watertown, MA 02172; (617) 924-0660; FAX: (617) 924-0497.

**THE AUDIO WORKSHOP;** EI, ER; 1728 Leishman Ave.; Arnold, PA 15068; (412) 335-7766.

◉ **AUDIOTECHNIQUES INC.;** SD, EI, MR, SES, ER; 1600 Broadway; New York, NY 10019; (212) 586-5989; FAX: (212) 489-4936.

**AURA SONIC LTD.;** SD, EI, SES; PO Box 791; Flushing, NY 11352; (718) 886-6500; FAX: (718) 886-7214.

► **AUTERI ASSOCIATES, INC.;** MR; 53 Foreston Cir.; Manorville, NY 11949; (516) 878-6421.

► **BENCHMARK/DOWNTOWN DESIGN;** SD, AC; 425 E. 63rd St.; New York, NY 10021; (212) 688-6262.

**BOSTON LIGHT & SOUND INC.;** EI; 124 Brighton Ave.; Allston, MA 02134; (617) 787-3131; FAX: (617) 787-4257.

◉ **BURLINGTON AUDIO/VIDEO TAPES, INC.;** SES; 106 Mott St.; Oceanside, NY 11572; (800) 331-3191; (516) 678-4414.

**C&S DESIGN;** AC; 92-46 219th St.; Queens Village, NY 11428; (718) 464-8875.



Benchmark Associates  
with Downtown Design

BENCHMARK/DOWNTOWN DESIGN  
New York, NY

**CLARK RESEARCH CO./ AUDIO CONTROL SYSTEMS;** SD, EI, MR; 300-46 Gorge Rd.; Cliffside Park, NJ 07010; (201) 945-0411.

**COMMUNICATION TASK GROUP;** SD, EI, AC, MR, SES; 1 Franklin Park N.; Buffalo, NY 14202; (716) 881-3188; FAX: (716) 884-6879.

**COMPTON CAPITAL CORPORATION;** ER; 245 Livingston St.; Northvale, NJ 07647; (201) 784-0800; FAX: (201) 784-0832.

**CARL CORNELL AUDIO;** SD, EI, AC, MR; 669 Beahan Rd.; Rochester, NY 14624; (716) 328-1152.

**COUNTS & COUNTS;** EI, MR, ER; 181 Warrington St.; Providence, RI 02907; (401) 781-8478.

**CYLINDER SYSTEMS, INC.;** SD, AC, EI, MR; 160 West End Ave., Ste. 17N; New York, NY 10023; (212) 877-4843; FAX: (212) 873-3559.

**FRANCIS DANIEL;** SD, AC; 201 W. 89th St.; New York, NY 10024; (212) 874-0590.

► **DB ENGINEERING/SALES;** 214 Lincoln St., Ste. 103C; Boston, MA 02134; (617) 782-4838 (sales); (617) 782-0648 (service); FAX: (617) 782-4935.

► **DBM TECHNICAL SERVICES;** MR; 124 W. 19th St., 7th Floor; New York, NY 10011; (212) 645-2626.

◉ ► **DREAMHIRE;** ER; 137-139 West 25th St.; New York, NY 10001; (212) 691-5544; FAX: (212) 989-6603.

► **E.A.R.S., INC.;** 90 Windom St.; Boston, MA 02134; (617) 783-5229.

► **ERGO DESIGNS;** SD, EI; 275 Vanderbilt Ave.; Brooklyn, NY 11205; (718) 636-0031.



Francis Daniel  
ACOUSTICIAN

FRANCIS DANIEL  
New York, NY

**EUROPORT-MARBURGER INC.;** SES; 933 E. Orange St.; Lancaster, PA 17602; (717) 392-4199; FAX: (717) 295-7833.

**FOX AND PERLA, LTD.;** SD, EI, AC, MR, SES, ER; 20 Martha St.; Woodcliff Lake, NJ 07675-8027; (201) 930-9149.

**CHRIS GATELY AUDIO SERVICES;** EI, MR, ER; PO Box 526; Bryn Mawr, PA 19010; (215) 525-3605.

**GELNETT & ASSOCIATES;** EI, AC, MR, ER; 247 Wheatley Ave.; Northumberland, PA 17857; (717) 473-3076.

**PETER GEORGE ASSOCIATES, INC.;** AC; 40 Prince St.; New York, NY 10012-3431; (212) 334-9700; FAX: (212) 334-9759.

**ALFRED B. GRUNWELL;** SD, EI, AC, MR, SES, ER; c/o Calf Audio; 157 Gray Rd.; Ithaca, NY 14850; (607) 272-8964.

**HIGH TECH INTERNATIONAL;** SD, EI, AC, MR; P.O. Box 127; Center Valley, PA 18034; (215) 965-4388.

**HIGH TECH SERVICES;** SD, EI, AC, MR; PO Box 572; Blackwood, NJ 08012; (609) 228-4336.

◉ ► **HOT HOUSE PROFESSIONAL AUDIO;** SD, AC, SES, EI, ER; RD. 1, Box 362A; Highland, NY 12528; (914) 691-6077, 11a.m.-6p.m.

**IAN COMMUNICATIONS GROUP, INC.;** SES; 10 Upton Dr.; Wilmington, MA 01887; (508) 658-3700; FAX: (508) 694-9957.

**ICE ASSOCIATES INC.;** SD, EI, AC; One Bala Plaza, Ste. LL-40; Bala Cynwyd, PA 19004; (215) 668-0714; FAX: (215) 668-0768.

**INDUSTRIAL ACOUSTICS COMPANY, INC.;** SD, AC; 1160 Commerce Ave.; Bronx, NY 10462; (212) 931-8000; FAX: (212) 409-0391.

## FACILITY DESIGNERS & SUPPLIERS SERVICES KEY

The following codes refer to services available from the facility designers and suppliers listed here. Information was supplied by those listed, so please call the companies directly to verify critical information.

AC Acoustical Consulting  
EI Equipment Installation

ER Equipment Rentals  
MR Maintenance Repair/Services

SD Studio Design  
SES Studio Equipment Supply



**For the FINEST Tape Recording Heads and the ULTIMATE in Relapping Services.**



We stock a full line of direct replacement heads from mono to 24 track.



We also provide precision relapping and optical alignment of all magnetic recording heads and assemblies.

If you need optimum performance from your tape recording equipment you need our services. Call or write:

**JRF/Magnetic Sciences, Inc.**  
249 Kennedy Road • P.O. Box 121  
Greendell, NJ 07839  
(201) 579-5773 • Telex 325-449  
Fax (201) 579-6021



**Facility Designers & Suppliers**

N O R T H E A S T U S .

**JAFFE ACOUSTICS, INC.;** AC; 114A Washington St.; Norwalk, CT 06854; (203) 838-4167; Telex: (203) 854-5703.

**JEM-FAB CORP.;** SD, AC, EI; 574 Sunrise Hwy.; Baldwin, NY 11510; (516) 867-8510.

**LOGICAL AUDIO SOLUTIONS;** EI, MR; 325 Saude Ave.; Essington, PA 19029; (215) 521-2933.

**MAR-TECH SYSTEMS INC.;** EI; 112 W. Boston Post Rd.; Mamaroneck, NY 10543; (914) 698-3858; FAX: (914) 381-4543.



MARTIN AUDIO/VIDEO CORPORATION  
New York, NY

> **MARTIN AUDIO/VIDEO CORPORATION;** SES; 423 W. 55th St.; New York, NY 10019-4490; (212) 541-5900; FAX: (212) 541-9128.



**MusicLAN**  
INTERNATIONAL LTD.

MUSICLAN INTERNATIONAL LTD.  
Park Slope, NY

**MUSICLAN INTERNATIONAL LTD.;** SD, EI, MR, SES, ER; 190 6th Ave.; Park Slope, NY 11217; (718) 622-2491; FAX: (718) 622-2491.



NASSA DESIGN & MANUFACTURING  
Bearsville, NY

**NASSA DESIGN & MANUFACTURING;** SD; PO Box 367; Bearsville, NY 12409; (914) 679-9544.

> **NEW YORK TECHNICAL SUPPORT, LTD.;** SD, EI, MR; 35 Hardscrabble Hill; Chappaqua, NY 10514; (914) 238-4171.

> **NORTH STAR AUDIO;** SES; 1367 High Ridge Rd.; Stamford, CT 06903; (203) 968-2323; FAX: (203) 322-4993.

> **NORTHEASTERN COMMUNICATIONS CONCEPTS, INC.;** SD, AC; PO Box 1853, Grand Central Station; New York, NY 10163; (212) 972-1320.

**PANDEMONIUM AUDIO;** SD, EI, AC, SES; 16 Dorchester Dr.; Manhasset, NY 11030; (516) 365-7810.

**PARSONS AUDIO**

New England dealers for

Amek \* Sony \* Dolby  
Lexicon 480L \* RPG  
Digidesign \* Otari  
and the rest.

**Facility Design & Installation**

(617)431-8708

PARSONS AUDIO  
Wellesley Hills, MA

**PARSONS AUDIO;** SD, EI, AC, MR, SES; 192 Worcester St. (Rte. 9); Wellesley Hills, MA 02181; (617) 431-8708; FAX: (617) 431-8710.

**PROFESSIONAL AUDIO**

PERFORMANCE

AUTOMATION

BROADCAST

MULTIMEDIA

RECORDING

KEYBOARDS

Our pillars of solid customer support and applications expertise

SALES

SERVICE

CONSULTATION

RENTALS



**Leo's**

**PROFESSIONAL AUDIO SYSTEMS**  
5447 TELEGRAPH AVENUE (415)  
OAKLAND, CA 94609 653-1000



MERCENARY AUDIO  
Sharon, MA

**MERCENARY AUDIO;** SD, EI, SES; 4 Oakland Rd.; Sharon, MA 02067-1912; (617) 784-7610; FAX: (617) 784-9244.

Mix Trivia

41. He helped define the Memphis sound after opening Memphis Recording Service in 1950 and Sun Records in 1952.

42. The long history of New York independent labels began in 1942 with the establishment of these two companies.

Turn to page 152 for question

**PERSONAL RECORDING ENVIRONMENTS, INC.;** SD, AC, SES, EI; 14 Atlas Ct.; Garden City, NY 11040; Box 391, Black Horse Pike; Hammonton, NJ 08037; (516) 741-1965 (in NY); (609) 561-8109 (in NJ).

**POWER PLAY RECORDS, INC.;** SD, AC, EI, ER; 223-225 Washington St.; Newark, NJ 07101; (201) 642-5747.

**PRO-COM SYSTEMS;** 5001 Baum Blvd.; Pittsburgh, PA 15213; (412) 621-1950; FAX: (412) 621-9887.

► **DANIEL QUEEN ASSOCIATES;** SD, AC; 239 W. 23rd St.; New York, NY 10011; (212) 243-6661.

**RELIANCE AUDIO VISUAL CORP.;** EI, MR, ER; 623 W. 51st St.; New York, NY 10019; (212) 586-5000; FAX: (212) 586-6047.

**RIEDEL AUDIO SERVICES;** SD, EI, AC, MR, SES, ER; 109 Commack Rd.; Islip, NY 11751; (516) 277-9418.

► **ROR AUDIO RESEARCH;** SD, AC, SES, EI, MR, ER; 161-14 Union Turnpike; Flushing, NY 11366; (718) 969-3660; (718) 969-3792.



RPG DIFFUSOR SYSTEMS, INC.  
Largo, MD

### Walters-Stork Design Group, Inc.

JOHN M. STORKYK  
DIVISION OF WALTERS-STORKYK DESIGN GROUP  
New Paltz, NY

**ROSNER CUSTOM SOUND INC.;** EI, MR, SES; 11-38 31st Ave.; L.I. City, NY 11106; (718) 726-5600; FAX: (718) 956-7516.

► **TED ROTHSTEIN;** SD, EI, AC, MR, SES; 280 Park Ave. S.; New York, NY 10010; (212) 475-5064; FAX: (212) 475-4877.

◀ **RPG DIFFUSOR SYSTEMS, INC.;** SD, AC, SES; 12003 Wimbledon St.; Largo, MD 20772; (301) 249-5647; FAX: (301) 249-3912.

**WILLIAM W. SETON & ASSOCIATES;** EI, AC, MR; 2006 Naudain St.; Philadelphia, PA 19146; (215) 732-9001.

**SIGNET SOUND;** EI, AC; 115 E. 87th St., Ste. 10A; New York, NY 10128; (212) 348-9335.

**SONEX-SOURCE;** AC, SES; 58 Nonotuck St.; Northampton, MA 01060; (413) 584-7944; FAX: (413) 585-8678.

**SONIX;** MR; 518 Pleasant St.; Northampton, MA 01060; (413) 586-1651.

**STEREO DISTRIBUTORS;** EI, MR, SES; 844 Park Ave.; Hoboken, NJ 07030; (201) 792-3604.

► **JOHN M. STORKYK, DIVISION OF WALTERS-STORKYK DESIGN GROUP;** SD; 134 Main St.; New Paltz, NY 12561; (914) 255-2255.

**STUDIO CONSULTANTS, INC.;** SD, AC, SES, ER; 321 W. 44th St.; New York, NY 10036; (212) 586-7376.

► **TECHNICAL SERVICE SPECIALISTS, INC.;** 187 East Market St., Ste. 190; Rhinebeck, NY 12572; (914) 876-3999; FAX: (914) 876-5432.

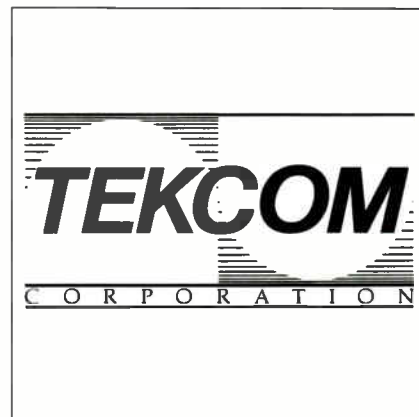

TEKCOM CORPORATION  
Philadelphia, PA

► **TEKCOM CORPORATION;** SD, EI, AC, MR, SES, ER; 1020 N. Delaware Ave.; Philadelphia, PA 19125; (215) 426-6700; FAX: (215) 426-7287.

**JIRI TICHY;** SD, AC; 600 E. Waring Ave.; State College, PA 16801; (814) 237-0512.

► **TLM ELECTRONICS INC.;** SD, EI, MR, SES; 1 Hillview Dr.; Pleasantville, NY 10570; (914) 769-6423.

## At Martin Audio, you're buying more than just a box.

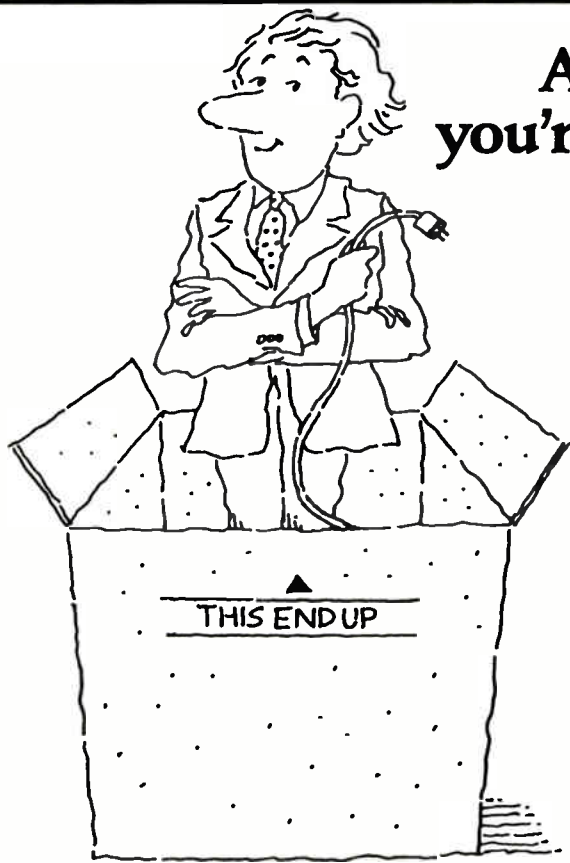

Now, more than ever, you need somebody on your side.

You need a company that realizes that the equipment you purchase today is the investment you make in your future.

You need people who understand that you're in the market for more than just another box.

At Martin Audio, your needs come first. With over 25 years experience in the professional audio business, we can provide you with a level of service and technical support that's simply unmatched—before and after the sale.

We'll show you how to get the best out of all the new technology, and how to make it work with the components you already own. To help you make money today, while preparing you for tomorrow. After all, we're audio professionals.

Let Martin Audio be your bridge to the future.



423 WEST 55TH STREET NEW YORK, N.Y. 10019-4490  
(212) 541-5900

A Video Services Corporation Company



# The source for exceptional monitoring and amplification?

## ... Just ask around New York.

Battery Studios, Bearsville Studios, Chung King House of Metal Classic Sound Studio, Clubhouse Studios, Cotton Hill, Ted Currier Dreamland Recording Studios, Frank Filipetti, Gnome Productions Debbie Gibson Productions, The Hit Factory, Homebase Sound Studios House of Music, The Magic Shop, MSP, Manhattan Center Studios Marathon Recording, Millbrook Sound Studios, Steve Miller, NBC Neve, Neveva Productions, Paradise Studios, Power Play Studios Paul Pesco, Rhythm Street Sound, Right Track Recording, Bob Rosa Rock Video International, Rock America, Rutt Video, Shakedown Sigma Sound Studios, Select Records, Roey Shamir, Sound Hound Skyline Studios, Solid State Logic, Soundscape Studios, Trident Unique Recording Studios, Variety Recording Studios, Videomix

*They can also attest to our world-class FX packages.*



275 Martin Avenue  
Highland, N.Y. 12528  
TEL 914-691-6077  
FAX 914-691-6822



## THOROUGHbred MUSIC



When you deal with us it all clicks together: Every department: guitars, keyboards, pro audio, lighting, percussion, and accessories is wired for your call. We keep turning you on after you plug it in with service after the sale.

2204 E. HILLSBOROUGH AVE. TAMPA, FLORIDA 33610 813-237-5597 OR FAX 813-238-5443



► **THE TOY SPECIALISTS**; SES, ER; 333 W. 52nd St.; New York, NY 10019; (212) 333-2206; (800) 445-3330.

**VIDEO DESIGNERS**; SD, EI, MR; PO Box 212; Somerville, MA 02143; (617) 628-4952.

**VRI SCHARFF RENTALS**; ER; 235 Pegasus Ave.; Northvale, NJ 07647; (201) 768-3181; FAX: (201) 768-1484.

**VRI SCHARFF RENTALS**; ER; 599 11th Ave.; New York, NY 10036; (212) 582-2345; FAX: (212) 757-6367.

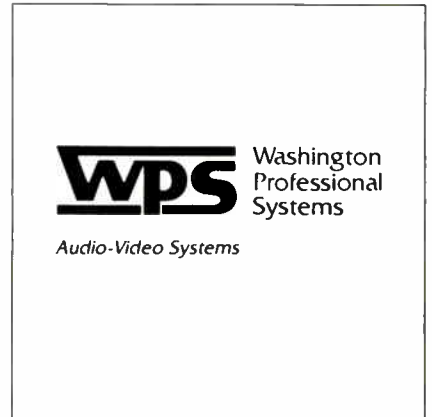

WASHINGTON PROFESSIONAL SYSTEMS  
Wheaton, MD

► **WASHINGTON PROFESSIONAL SYSTEMS**; SD, AC, SES, EI, MR; 11157 Veirs Mill Rd.; Wheaton, MD 20902; (301) 942-6800; FAX: (301) 946-3241.

**WESTMINSTER MEDIA**; AC; Box 27009; Philadelphia, PA 19118; (215) 572-3834.

**WMRG STUDIOS INC.**; SD, EI, AC, MR, ER; PO Box 73; Cheltenham, PA 19012-0073; (215) 635-4815.



► **ACOUSTICAL PHYSICS LABORATORIES**; SD, AC, SES, EI, MR; 3877 Foxford Dr.; Doraville, GA 30340; (404) 934-9217.

**AFTER HOURS MUSIC, INC.**; ER; 1959 NE 149th St.; North Miami, FL 33181; (305) 947-6841.

**AMERICAN AUDIO, INC.**; AC, EI, MR, ER; PO Box 1719; Ruston, LA 71270; (318) 251-0290.

► **API AUDIO PRODUCTS, INC.**; SES; 7951 Twist Ln.; Springfield, VA 22153; (703) 455-8188.



1 (800) 780-4654



FOR FAST SERVICE



ON MOST MAJOR BRANDS

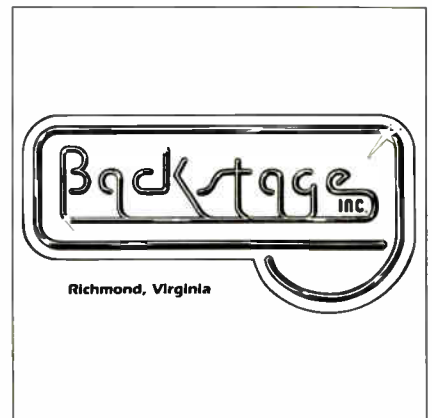

BACKSTAGE, INC.  
Richmond, VA

**BACKSTAGE, INC.**; EI, AC, MR, SES, ER; 310 W. Broad St.; Richmond, VA 23220; (804) 644-1433; FAX: (804) 644-4913.

**M.A. BENINGTON CO.;** *EI, SES;* 2459 Cuchura Dr.; Birmingham, AL 35244; (205) 988-0707.

**BIG BEAR AUDIO VIDEO, INC.;** *SES, EI, MR, ER;* 1419 E. Second St.; Sheffield, AL 35660; (205) 381-6812.

**BLEVINS AUDIO EXCHANGE, INC.;** *SES, EI, MR, ER;* 1717 Elm Hill Pike, Ste. B-8; Nashville, TN 37210; (615) 391-0429; FAX: (615) 391-0456.

**BROADCAST EQUIPMENT SALES AND ENGINEERING, INC.;** *SD, EI, MR, SES;* PO Box 20331; Jackson, MS 39289-1331; (601) 857-8573; FAX: (601) 85-RADIO (857-2346).

**COMMUNICATIONS ENGINEERING, INC.;** *SD, EI, AC, MR, SES, ER;* 8350 Cinderbed Rd.; Newington, VA 22122; (703) 550-5800; FAX: (703) 550-5180.

DIGITAL MIXING  
DIGITAL REMOTES  
DIGITAL EDITING  
DIGITAL RENTALS  
DIGITAL ARCHIVING  
DIGITAL TRANSFERS  
DIGITAL SEQUENCING  
DIGITAL TIME COMPRESSION  
DIGITAL FORMAT CONVERSIONS  
DIGITAL DYAXIS WORKSTATION  
**Digital Associates**  
(615) 297-3900  
NASHVILLE

DIGITAL ASSOCIATES  
Nashville, TN

**DIGITAL ASSOCIATES;** *ER;* PO Box 158913; Nashville, TN 37215; (800) 828-0568.

**DMF STAGE LIGHTING/SOUND AUTHORITY;** *EI, AC, MR, ER;* 4505 LeMans Way; Pensacola, FL 32505; (904) 438-8249.

**DREAMHIRE;** *ER;* 1217 16th Ave. S.; Nashville, TN 37212; (615) 321-5544; FAX: (615) 321-0928.

**STEVEN DURR AND ASSOC.;** *SD, AC;* 6216 Bresslyn Rd.; Nashville, TN 37205; (615) 352-0218; FAX: (615) 352-3346.

**ELECTRAWORKS;** Mitchell St.; Junction City, KY 40440; (606) 854-6756.

**ESL (ELECTRONIC SYSTEMS LABORATORIES);** *SES;* 3911 SW 47th Ave., Ste. 906; Fort Lauderdale, FL 33314; (305) 791-1501; FAX: (305) 791-8986.

**E-TEC INCORPORATED;** *SD, EI;* 2269 Indian Rd.; West Palm Beach, FL 33409; (407) 471-1440; FAX: (407) 478-1007.

**FLAT RESPONSE ACOUSTICAL CONSULTING;** *SD, EI, AC, SES;* PO Box 464188; Lawrenceville, GA 30246; (404) 921-7941.

**BILL FLOWERS PRODUCTION;** *SD, EI, SES;* 6435 McAdams Dr. E.; Theodore, AL 36582; (205) 653-1470.

**FRANKLIN INSTITUTE OF RECORDING SOUND TECHNOLOGY;** *SD, EI, AC;* PO Box 1121; Franklin, TN 37065; (615) 794-3660.

**FREE WORLD AUDIO;** *SD, EI, MR;* PO Box 22928; Lk. Buena Vista, FL 32830; (407) 859-5958.

**HARD DISK CAFE;** *ER;* 1157 Briarcliff Rd., NE; Atlanta, GA 30306; (404) 875-0215.

**D. HAYES & ASSOCIATES;** *SD, AC, SES, EI, MR, ER;* 2922 Monterrey Blvd. #134; Baton Rouge, LA 70814; (504) 275-6463.

**JMI/CREATIVE AUDIO SERVICES;** *ER;* 3655 Old Shell Rd. #321; Mobile, AL 36608; (205) 343-2023.

**LAWSON, INC.;** 2741 Larmon Dr.; Nashville, TN 37204; (615) 269-0828.

**M.L.W. SYSTEMS;** *SD, AC, SES, EI, MR, ER;* PO Box 8651; St. Thomas, VI 00801; (809) 774-7341.

**NATIONAL AUDIO TECHNOLOGY & ELEC. CO.;** *SD, EI, AC, SES, ER;* PO Box 1327; Holly Hill, FL 32117; (904) 255-2240.

**NATIONAL SOUND ENGINEERING;** *SD, AC, SES, EI, MR;* 6500 McDonough Dr., C-9; Norcross, GA 30093; (404) 447-0101; (800) 541-9140; FAX: (404) 447-1355.

**NES NELSON ELECTRONIC SYSTEMS, INC.;** *EI, MR;* 1600 S. Oates St., PO Drawer 2245; Dotham, AL 36302; (205) 793-7797; FAX: (205) 792-8913.

**GASTON NICHOLS PROFESSIONAL AUDIO SERVICES;** *SD, EI, AC, MR, SES;* 5337 5th Terrace S.; Birmingham, AL 35212; (205) 591-7346.

**OMNI TECHNOLOGY, INC.;** *SES;* 3911 SW 47th Ave., Ste. 906; Fort Lauderdale, FL 33314; (305) 583-0626; FAX: (305) 791-8986.

**PROTOLOG INC.;** *SD, EI, AC, MR, SES;* 8800 49th St. N, Ste. 210; Pinellas Park, FL 34666; (813) 545-0302; FAX: (813) 545-0403.

**RELIABLE MUSIC, INC.;** *SD, EI, AC, MR, SES, ER;* 650 E. Stonewall St.; Charlotte, NC 28202; (704) 375-8662; FAX: (704) 332-4829.

**SOUND ADVICE;** *SD, SES, EI, MR;* 111 39th St. N.; Birmingham, AL 35222; (205) 592-4555.

**STAGE & STUDIO CONSTRUCTION SERVICES, INC.;** *SD, AC, SES, EI;* 1002 Wake Forest Rd.; Raleigh, NC 27604; (919) 834-6380.

**STAGE SOUND, INC.;** *SD, EI, AC, MR, SES, ER;* 103 8th St. SE; Roanoke, VA 24013; (703) 342-2040.

**STUDER REVOX AMERICA, INC.;** *SES;* 1425 Elm Hill Pike; Nashville, TN 37210; (615) 254-5651; FAX: (615) 256-7619.

**STUDIO SUPPLY COMPANY;** *SD, AC, SES, EI, MR, ER;* PO Box 305132; Nashville, TN 37230-5132; (615) 391-0050; FAX: (615) 391-4092.

**STUDIOWORKS;** *SD, AC, SES, EI, MR;* 1018 Central Ave.; Charlotte, NC 28204; (704) 375-1053; (800) 438-5921.

**SYNERGETIC SERVICES, INC.;** *SD, EI, AC, MR;* 1926 NE 151st St.; N. Miami Beach, FL 33162; (305) 947-7372; FAX: (305) 685-0879.

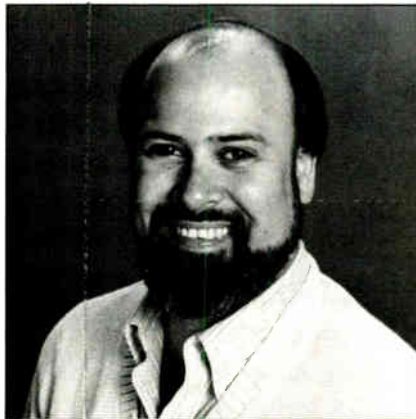

TODRANK RAYMOND ASSOCIATES  
Nashville, TN

**TODRANK RAYMOND ASSOCIATES;** *SD, EI, AC;* 2101 June Dr.; Nashville, TN 37214; (615) 885-6553; FAX: (615) 883-3944.

**TREASURE ISLE "ALIVE" DESIGNS;** *SD, AC, SES;* 2808 Azalea Pl.; Nashville, TN 37204; (615) 297-0700; FAX: (615) 297-1413.

**NORTH CENTRAL US**

Illinois, Indiana, Iowa, Kansas, Michigan, Missouri,  
Minnesota, Nebraska, North Dakota, Ohio,  
South Dakota, Wisconsin

**ANN ARBOR AUDIO;** *SD, EI, MR, SES;* 8486 Winans Lk. Rd.; Brighton, MI 48116; (313) 231-3232.

**ARS RECORDING & TAPE DUPLICATION;** *EI, AC, ER;* 11626 S. Pulaski; Alsip, IL 60658; (708) 371-8424; FAX: (708) 371-9403.

**AUDIO CREATIONS/ALS;** *SD, AC, SES, EI, MR, ER;* 5 West Waterloo; Canal Winchester, OH 43110; (614) 837-1936.

**AUDIO EXPERTS INTERNATIONAL, INC.;** *EI, SES;* 407 E. Center Rd.; Kokomo, IN 46902; (317) 455-1575.

...EVERYTHING for Production Sound!

When it comes to Production Sound and  
Radio Communications Equipment  
your best source is always  
Topham Audio, Inc.



**ASG AUDIO SERVICES CORPORATION** 10630 Riverside Dr. N Hollywood, CA 91602 (818) 980-9911 (800) 228-4429 FAX (818) 980-9911  
**TOPHAM AUDIO, INC.** 4403 Vineland Road, Ste. B-3 Orlando, FL 32811 (407) 648-6444 (800) 486-6444 FAX (407) 872-3330  
SALES \* SERVICE \* RENTAL \* ENGINEERING

# LOOK NO FURTHER!



Ask for R-DAT Specialists

THESE FOUR UNSIGHTLY GENTLEMEN AND THEIR HIGHLY MOTIVATED STAFF ARE WAITING TO GIVE YOU THE BEST PRICES, EXCELLENT SERVICE AND FREE DELIVERY ON ANY PACKAGE PURCHASE OF AUDIO OR VIDEO EQUIPMENT

**CALL NOW!**

**NSE NATIONAL SOUND ENGINEERING**

6500 McDonough Dr.  
Norcross, GA 30093

**1-(800) 541-9140  
or (404) 447-0101**

Circle #128 on Reader Service Card

1990-91 MIX MASTER DIRECTORY

See monthly issue of Mix for extended listing



## Facility Designers & Suppliers

NORTH CENTRAL U.S.

**AUDIO GRAPHIC SERVICES**; SD, EI, AC, MR; 1516 Ferris Ave.; Royal Oak, MI 48067; (313) 544-1793; FAX: (313) 544-1793.

► **AUDIOLINE, INC.**; SD, AC, SES, EI, MR, ER; 2323 J. Bluemound Rd.; Waukesha, WI 53186; (414) 785-9166; FAX: (414) 785-0789.

**AUDIOLINE, INC.**; SD, AC, SES, EI, MR, ER; 368 W. Ontario St.; Chicago, IL 60610; (312) 988-9166.

**AUDIOLINE, INC.**; SD, EI, AC, MR, SES, ER; 4049 Pennsylvania, Ste. 100; Kansas City, MO 64111; (816) 931-9166.

**AVC SYSTEMS/VIDEOMIDWEST, DIVS. VAUGHN COMMUNICATIONS**; SD, EI, MR, SES, ER; 7901 Computer Ave. S.; Minneapolis, MN 55435; (612) 832-3232.

**WALTER J. BANAS, JR.**; SD, EI, AC; 8771 Ida-Maybee Rd.; Monroe, MI 48161; (313) 587-3457.

**C AND C CONSULTANTS**; SD, AC; 2215 C St.; Lincoln, NE 68502; (402) 474-2215; FAX: (402) 474-3140.

**DIVERSIFIED ELECTRONICS GROUP**; EI, SES; 134 Allen Dr.; Mooresville, IN 48158; (317) 831-2294.

**EAST**; SD, AC, MR; 701 Main St.; Evanston, IL 60202; (708) 328-2022; FAX: (708) 328-2122.

**FULL COMPASS SYSTEMS LTD.**; SD, EI, AC, MR, SES, ER; 5618 Odana Rd.; Madison, WI 53719; (608) 271-1100; FAX: (608) 273-6336.

**GALAXY AUDIO**; AC, SES; 625 E. Pawnee; Wichita, KS 67211; (316) 263-2852; FAX: (316) 263-0642.

► **HY JAMES—THE AUDIO PROFESSIONALS**; SD, SES, EI, MR; 24166 Haggerty; Farmington Hills, MI 48024; (313) 471-0027; (800) 875-5550.

► **ICB AUDIO**; SD, EI, AC, MR, SES, ER; 2036 Reading Rd.; Cincinnati, OH 45202; (513) 651-0800.



IRC AUDIO, INC.  
Indianapolis, IN

► **IRC AUDIO, INC.**; SES, EI; 8112 Castleway Ct. West; Indianapolis, IN 46250; (317) 849-6887; FAX: (317) 576-1855.

**JAMIESON AND ASSOCIATES, INC.**; SD, AC; 5200 Willson Rd., Ste. 300; Minneapolis, MN 55424; (612) 920-3770.

**JMS & ASSOCIATES, INC.**; SD, AC; PO Box 14585, 250 W. Court St.; Cincinnati, OH 45214; (513) 621-9292; FAX: (513) 241-8896.

**LINNEMANN SOUND, INC.**; SD, AC, SES, EI, MR, ER; PO Box 452, 1020 Somonauk St.; Sycamore, IL 60178; (815) 895-8219; FAX: (815) 895-7837.

**MARGUERITE'S MUSIC**; 2409 10th St. S.; Moorhead, MN 56560; (218) 233-7546.

**MEDIA SYSTEMS**; SD, EI, AC, MR, SES; 57036 Cedar Rd.; Osceola, IN 46561; (219) 259-2814.

**NORTH STAR SOUND, INC.**; EI, AC, MR, SES, ER; 14061 st Ave. S.; Minneapolis, MN 55403; (612) 871-6016; FAX: (612) 871-6017.

**OPUS RECORDING & EQUIPMENT CO., INC.**; SD, EI, AC, MR, SES, ER; 4262 Grand Ave.; Gurnee, IL 60031; (708) 336-6787; FAX: (708) 336-6895.

**ORCHARD HOUSE AUDIO**; EI, MR, ER; 224 W. 27th St.; Minneapolis, MN 55408; (612) 872-7943.

► **PI KEYBOARDS & AUDIO**; SES, EI, MR, ER; 2121 Brookpark Rd.; Cleveland, OH 44134; (216) 741-1400; FAX: (216) 741-2733.

**PRO CO SOUND**; SES; 135 E. Kalamazoo Ave.; Kalamazoo, MI 49007; (800) 253-7360; FAX: (616) 388-9681.

**PRO-TECH SERVICES, INC.**; SD, EI, AC, MR, SES; 1922 Fargo; Des Plaines, IL 60018; (708) 699-8937.

**PYRAMID AUDIO, INC.**; SES; 450 W. Taft Dr.; South Holland, IL 60473; (708) 339-8014; FAX: (708) 339-8015.

► **QUALITY SOUND DESIGN/CONSTRUCTION**; SD, AC, SES, EI; 3215 Wild Horse Dr., PO Box 128; Foristell, MO 63348; (314) 673-2577.

**RAINBOW RECORDING STUDIOS**; SD, EI, AC, MR, SES, ER; 2322 S. 64th Ave.; Omaha, NE 68106; (402) 554-0123.

**RECORDIO PRODUCTIONS**; EI; 6564 Goodman; Merriam, KS 66202; (913) 432-2349.

**RENT FX/SQ AUDIO, INC.**; ER; 445 W. Erie St., Ste. 201; Chicago, IL 60610; (312) 266-1901; FAX: (312) 266-1904.

**RG SOUND AND COMMUNICATIONS**; SD, EI, AC, MR, SES, ER; 414 N. Mill St.; Celina, OH 45822; (419) 586-3671.

► **SG AUDIO/RENT FX**; SD, EI, AC, MR, SES, ER; 445 W. Erie St., Ste. 201; Chicago, IL 60610; (312) 266-1901; FAX: (312) 266-1904.

**SONIC IMAGE, INC.**; SES; 1100 Wheaton Oaks Ct.; Wheaton, IL 60187; (708) 653-4544; FAX: (708) 665-4966.

**SOUND IDEAS OF FORT WAYNE**; EI, MR; 6803 Salge Dr.; Fort Wayne, IN 46835; (219) 485-3628.

**STEPHCO CONSTRUCTION, INC.**; EI, AC; PO Box 351, 8603 E. 116th St.; Fishers, IN 46038; (317) 849-2844.

► **J.M. STITT & ASSOCIATES, INC.**; SD, AC; PO Box 14585; Cincinnati, OH 45214; (513) 621-9292; FAX: (513) 241-8896.

212 • 333 • 2206  
800 • 445 • 3330



THE INNOVATIVE RENTAL PEOPLE

**TOY** Specialists

## Pro-Audio Rentals

333 W. 52ND ST.

NEW YORK, NY

10019

### WE PROUDLY OFFER:

- The largest selection of synthesizers, drum computers, and MIDI devices anywhere.
- A comprehensive collection of vintage outboard and microphones.
- All the finest in digital recorders:
  - Mitsubishi X-880/X-850/X-86HS/X-86
  - Sony 3348/3324A/3402/1630
  - AMS Audiofile IV • Studer D820X
- 'Round the block support anywhere in the USA
- The best on time record in the industry
- Offices opened 7 days a week
- Service available 24 hours a day

► **WE'RE THE ONLY CALL YOU NEED TO MAKE!** ►

**STUDIO DESIGN COMPANY/TUBE TRAPS;** SD, AC, EI; 2247 Glenview Rd.; Glenview, IL 60025; (312) 657-7787.

**VAUGHN BROADCAST RENTALS;** ER; 7951 Computer Ave. S.; Minneapolis, MN 55435; (612) 832-3131.

**VIDEO MIDWEST/AVC SYSTEMS, DIVS. OF VAUGHN COMMUNICATIONS;** SD, EI, MR, SES, ER; 7901 Computer Ave. S.; Minneapolis, MN 55435; (612) 832-3232.

**WAB SYSTEMS;** SES, EI, ER; 3908 54th St.; Des Moines, IA 50310; (515) 253-9924.



WELTER SYSTEMS, INC.  
Minneapolis, MN

**WELTER SYSTEMS, INC.;** EI, AC, MR, SES; 2814 Washington Ave. N.; Minneapolis, MN 55411; (612) 521-2356; FAX: (612) 521-2258.

**NORTHWEST U.S.**

Alaska, Colorado, Idaho, Montana, Nevada,  
Northern California, Oregon, Utah, Washington, Wyoming

**ACES/TUBE TRAPS;** SD, AC, SES; 1909 Judah St.; San Francisco, CA 94122; (415) 661-4143.

**ACOUSTICAL DESIGN ASSOCIATES;** SD, AC; 3540 Willamette; Eugene, OR 97405; (503) 342-2844; FAX: (503) 343-9245.

**DAN ALEXANDER AUDIO;** SES, ER; 2944 San Pablo Ave.; Berkeley, CA 94702; (415) 644-2363.

**APPLIED CONSTRUCTION TECHNOLOGY;** SD; 1077 Florence Way; Campbell, CA 95008; (408) 370-7710; FAX: (408) 866-1522.

**ARTISTS' ENGINEERING;** SD, EI, MR; 14444 Skyline Blvd.; Woodside, CA 94062; (415) 851-0388.

**AUDIO CONSULTING & ENGINEERING;** AC, SES; 51 Federal St., Ste. 304A; San Francisco, CA 94107; (415) 661-4143.



AUDIO IMAGES CORP.  
San Francisco, CA

**AUDIO IMAGES CORP.;** SD, EI, MR, SES; 70 Oak Grove St.; San Francisco, CA 94107; (415) 957-9131; FAX: (415) 957-1531.

**A-V TECH SERVICES;** EI, MR, SES, ER; 564 Butler Rd.; Grass Valley, CA 95945; (916) 272-1469.

**DAVID CARROLL ELECTRONICS;** SD, EI; 805 Gilman St.; Berkeley, CA 94710; (415) 528-8054; FAX: (415) 526-1982.

**COLOSSUS/BY THE NUMBERS;** SES; PO Box 8359; Incline Village, NV 89450-8359; (702) 831-4459; FAX: (702) 831-4485.

**DELTASONICS;** SD, EI, MR, SES; 50 Mendell St., Ste. 2; San Francisco, CA 94124; (415) 647-8900.

**FRANK HUBACH ASSOCIATES;** SD, AC; 2700 Rydin Rd., Ste. F; Richmond, CA 94804; (415) 528-1505; FAX: (415) 528-1509.

**STEPHEN JARVIS;** ER; 125 Meese Ct.; Danville, CA 94526; (415) 837-7959.

**KIMBER KABLE;** SES; 2675 Industrial Dr.; Ogden, UT 84401; (801) 621-5530.

**LEFT MINUS RIGHT AUDIO;** SD, AC, SES, EI, MR; 510-B S. Murphy Ave.; Sunnyvale, CA 94086; (408) 773-9793; (415) 960-4260.

**LEO'S AUDIO AND MUSIC TECHNOLOGIES;** SD, AC, SES, EI, MR; 5447 Telegraph Ave.; Oakland, CA 94609; (415) 652-1553.

**LISTENUP PROFESSIONAL DIVISION;** SES, EI, MR; 999 S. Logan St.; Denver, CO 80209; (303) 778-0949.

**LUDE BROADCAST ENGINEERING;** SD, EI, MR; 458 Brannan St.; San Francisco, CA 94107; (415) 543-1300.

**MCTECH ASSOCIATES;** SD, EI, MR; 484 Lake Park Ave., Ste. 341; Oakland, CA 94610; (415) 848-7917; FAX: (415) 832-0847.

**MENLO SCIENTIFIC, LTD.;** AC; 39 Menlo Pl.; Berkeley, CA 94707; (415) 528-1277; FAX: (415) 526-8087.

**MILOVICH GENERAL CONTRACTING;** 140 Norlyn Dr.; Walnut Creek, CA 94596; (415) 944-9864.

**MIRROMERE AUDIO;** SD, AC, SES, EI, MR, ER; 7150 W. 38th Ave.; Wheatridge, CO 80033; (303) 431-2348.

**RICHARD J. MOORE, PH.D., ACOUSTICS & TECHNICAL AUDIO;** SD, AC, EI, MR; PO Box 2206; Novato, CA 94948; (415) 897-6462.

**MORGAN SOUND, INC.;** SD, AC, SES, EI, MR, ER; 2004 196th SW, Ste. 2; Lynnwood, WA 98036; (206) 771-7257.

**PAOLETTI ASSOCIATES;** AC; 40 Gold St.; San Francisco, CA 94133; (415) 391-7610; FAX: (415) 391-0171.

**PERFORMANCE AUDIO;** EI, SES, ER; 2358 S. Main St.; Salt Lake City, UT 84115; (801) 466-3196; FAX: (801) 484-1538.

**MICHAEL PFOHL ASSOCIATES DESIGN A.I.A./A.S.I.D.;** SD, AC, EI; 1128 Alder, Ste. C; Eugene, OR 97403; (503) 342-2844.

**PLANET EARTH PRODUCTIONS;** SD, EI, AC, MR; PO Box 525; Cave Junction, OR 97523; (503) 592-2123; FAX: (503) 592-4796.

**POWER SOUND;** EI, MR, SES, ER; 3501 Lathrop St., Unit F; Fairbanks, AK 99701; (907) 452-2226; FAX: (907) 451-8616.

**PRO MEDIA;** EI, SES, ER; 3563 San Pablo Dam Rd.; El Sobrante, CA 94803; (415) 222-0307; FAX: (415) 223-9147.

**RLS ACOUSTICS;** SD, EI, AC; 300 Brannan St., Ste. 610; San Francisco, CA 94107; (415) 541-0818; FAX: (415) 541-7872.

**CHARLES M. SALTER ASSOCIATES, INC.;** SD, AC; 130 Sutter St., Ste. 500; San Francisco, CA 94104; (415) 397-0442; FAX: (415) 397-0454.

**RANDALL SCHILLER PRODUCTIONS;** EI, MR, ER; 1207 Fifth Ave.; San Francisco, CA 94122; (415) 661-7553; FAX: (415) 566-6238.

**SEQUOIA ELECTRONICS;** MR, SES; 1131 Virginia Ave.; Campbell, CA 95008; (408) 866-8434.

**SOUND ADVICE, INC.;** SD, AC; PO Box 278; Cazadero, CA 95421; (707) 632-5911.

# THE CONSOLE COMPANY



• Factory authorized sales and service  
• Widest selection in the industry

Why spend *YOUR* time and money talking to dealers offering *THEIR* limited selection of consoles? One phone call to The Console Company and...  
The choice is *yours*.

**EAR** 2641 E. McDOWELL  
**602-267-0600** PROFESSIONAL AUDIO/VIDEO  
PHOENIX, AZ 85008



TRIDENT

Soundcraft



YAMAHA

TASCAM  
TEAC Production Products



Conneaut Audio Devices



TAC



sound workshop

AMEK

RAMSA



## Facility Designers & Suppliers

NORTHWEST U.S.



Photo: Courtesy of Different Fur

**SOUND RESEARCH ASSOCIATES**  
San Jose, CA

► **SOUND RESEARCH ASSOCIATES**; SD, AC; 1650 Zanker Rd., #120; San Jose, CA 95112; (408) 436-6040; FAX: (408) 436-6012.

**SPECIALIZED COMPUTER SYSTEMS, INC.**; MR, SES; 827 Arnold Dr., Ste. 80; Martinez, CA 94553; (415) 370-8200; FAX: (415) 370-2490.

**TRAX**; SD, EI, SES, ER; 332 Martin Ln.; Salt Lake City, UT 84107; (801) 262-3601; FAX: (801) 269-8886.

**T. WHYTE & ASSOCIATES**; SD, EI, MR, SES; 3549 Becerra Way #2; Sacramento, CA 95821; (916) 487-5364.

► **WILSON, IHRIG & ASSOCIATES, INC.**; AC; 5776 Broadway; Oakland, CA 94618; (415) 658-6719; FAX: (415) 652-4441.

## SO. CAL./SOUTHWEST U.S.

Arizona, Arkansas, Hawaii, Las Vegas, New Mexico,  
Oklahoma, Southern California, Texas

**A TOTAL EFFECT**; ER; PO Box 18401; Encino, CA 91416-8401; (818) 345-4404.

**ACOUSTIC SCIENCES OF CALIF.**; AC; 6709 Ethel Ave.; Los Angeles, CA 91606; (818) 763-9587; FAX: (818) 763-9587 (auto).

**ADVANCED AUDIO**; ER; 11120 Weddington St.; N. Hollywood, CA 91601; (818) 985-6882.

**ADVANCED AUDIO SYSTEMS**; EI, MR; 2445 E. Thomas Rd.; Phoenix, AZ 85016; (602) 956-0580.

► **ADVANCED STUDIO**; SD, AC, SES, EI, MR, ER; 15911 Acre St.; Sepulveda, CA 91343; (818) 892-9810; (213) 856-4533.

**AMEK CONSOLES**; SES; 10815 Burbank Blvd.; North Hollywood, CA 91601; (818) 508-9788.

► **AMOS STUDIO DESIGNS**; SD, AC; 18901 Malden St.; Northridge, CA 91324; (818) 701-0761.

**ARCHIE/WORDS & DEEDS INC.**; SES; 4480 Sunnycrest Dr.; Los Angeles, CA 90065; (213) 255-2887; FAX: (213) 255-6291.

**AUDIO ENGINEERING ASSOCIATES**; SD, EI, AC, MR, SES, ER; 1029 N. Allen Ave.; Pasadena, CA 91104; (818) 798-9127; FAX: (818) 798-2378.

**AUDIOSPECIALTIES CO.**; EI, MR, SES; 13416 Brookgreen; Dallas, TX 75240; (214) 239-2230.

**AUDIO SYSTEMS**; SD, EI, AC, SES; 3001 Windy Surf Ct.; Las Vegas, NV; (702) 363-2408.

**AUDIOWEST**; EI, AC, MR, ER; 670 S. Jefferson St.; Placentia, CA 92670; (714) 528-2285; FAX: (714) 528-9070.

**B & L SALES INC. (TAPE DUPLICATION SUPPLIES)**; SES; 10812-1/2 Magnolia Blvd.; N. Hollywood, CA 91601; (818) 985-1792.



**AMOS STUDIO DESIGNS**  
Northridge, CA

**DEAN BAILEY**; SD, EI, MR; 3422 Beech St.; Rowlett, TX 75088; (214) 475-9796.

**BANTAM SOUND SERVICES**; EI; 11225 Magnolia Blvd., Unit 308; North Hollywood, CA 91403; (818) 907-5181.

**BELCAN ENGINEERING**; SD, AC; 6110 San Fernando Rd. #211; Glendale, CA 91201; (818) 409-1777.

**RUSS BERGER DESIGN GROUP, INC.**; SD, AC; 4004 Beltline Rd. #110; Dallas, TX 75244; (214) 661-5222; FAX: (214) 934-3935.

**THE BERTECH ORGANIZATION**; SES; 14447 Califa St.; Van Nuys, CA 91401; (818) 909-0262.

**BLACK AUDIO DEVICES**; SES; Box 106; Ventura, CA 93002; (805) 653-5557.

► **BOTO DESIGN, INC.**; SD, AC; 321 Hampton Dr.; Venice, CA 90291; (213) 396-3108.

## ANNOUNCING THE RPG DIFFUSOR CEILING SYSTEM



Tent Records, London

### OMNIFFUSOR™

The new 2-D QRD® diffuser is based on 2-dimensional number theory sequences which provide identical performance in the horizontal and vertical planes, for truly omnidirectional coverage.

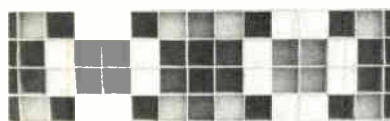

RPG Diffusor Systems, Inc. 12003 Wimbledon Street, Largo, Maryland 20772

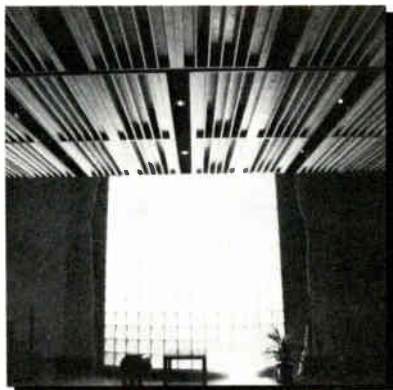

Rhinoceros Recording, Sydney

### NEW ACOUSTICAL CEILING

Now you can have the low installation cost of lay-in ceiling panels and the broad-bandwidth sound diffusion only RPG can offer. Order the 1-D QRD® DIFFUSOR™ for controlled diffusion or the new 2-D QRD® OMNIFFUSOR™ for hemispherical coverage. Both panels are available in 2' x 2' and 2' x 4' standard suspended ceiling grid sizes.



WQXR, New York

### APPLICATIONS

Choose QRD® diffusion to enhance music and traditional absorption to control noise in recording studios, live broadcast studios, rehearsal spaces, music education, band rooms, and performance facilities.



Phone 301-249-5647 Fax 301-249-3912

|                                                     |              |
|-----------------------------------------------------|--------------|
| <b>RUSS<br/>BERGER<br/>DESIGN<br/>GROUP<br/>INC</b> | 4004         |
|                                                     | BELTLINE     |
|                                                     | SUITE 110    |
|                                                     | DALLAS       |
|                                                     | TEXAS        |
|                                                     | 75244        |
|                                                     | 214/661-5222 |
|                                                     | FAX          |
|                                                     | 214/934-3935 |
|                                                     |              |

RUSS BERGER DESIGN GROUP, INC.  
Dallas, TX

**CHRISTY'S EDITORIAL FILM SUPPLY, INC.;** ER; 135 N. Victory Blvd.; Burbank, CA 91502; (818) 845-1755; FAX: (213) 849-1148.

**CISCO SOUND;** EI, MR, ER; PO Box 16583; Lubbock, TX 79490; (806) 792-1662.

➤ **JEFF COOPER ARCHITECTS, A.I.A./SYNERGY GROUP;** 4766 Park Granada, Ste. 106; Calabasas, CA 91302; (818) 887-9100.

➤ **DESIGN FX AUDIO;** ER; PO Box 491087; Los Angeles, CA 90049; (213) 838-6555; (800) 441-4415.

**DP(A) ACOUSTICS;** SD, AC; 1908 University Dr.; Richardson, TX 75081; (214) 644-2130; FAX: (214) 644-2133.

EAR PROFESSIONAL AUDIO/VIDEO  
Phoenix, AZ

○ ➤ **EAR PROFESSIONAL AUDIO/VIDEO;** SD, EI, MR, SES; 2641 E. McDowell Rd.; Phoenix, AZ 85008; (602) 267-0600; FAX: (602) 275-3277.

**E/F & ASSOC.;** SD, AC, EI; 2235 Aspen; Dallas, TX 75227; (214) 388-4205.

**FERRA TECHNICAL SERVICES;** SD, EI, MR; 16755 Mayall St.; Granada Hills, CA 91343; (818) 360-9473.

**GARRISAN AUDIO;** SD, EI, AC, MR, ER; 6103 Kelly-Elliott; Arlington, TX 76017; (817) 478-4368; FAX: (817) 478-4961.

**ALAN GORDON ENTERPRISES, INC.;** ER; 1430 Cahuenga Blvd.; Hollywood, CA 90028; (213) 466-3561; FAX: (213) 871-2193.

➤ **HARDIN ELECTRONICS;** SES; 5635 E. Rosedale; Fort Worth, TX 76112; (800) 433-3203; FAX: (817) 457-2429.

**BILL HOLFORD SOUND, INC.;** SD, AC; 5418 Grape Rd.; Houston, TX 77096; (713) 665-7554.

**INTELLIGENT SERVICES;** SES, EI; 3230 Gallion Circle; Riverside, CA 92503; (714) 359-0619.

➤ **THE JOINER-ROSE GROUP, INC.;** SD, AC; 4125 Centurion Way; Dallas, TX 75244; (214) 392-7800; FAX: (214) 991-3781.

**JUICE GOOSE;** SES; 7320 Ashcroft #302; Houston, TX 77081; (713) 772-1404; FAX: (713) 772-9124.

➤ See monthly issue of Mix for extended listing

**LAKESIDE ASSOCIATES, INC.;** SD, EI, AC; 4790 Irvine Blvd., Ste. 105276; Irvine, CA 92220; (714) 838-3893; FAX: (714) 832-5343.

➤ **LD SYSTEMS, INC.;** EI, MR, SES, ER; 467 W. 38th; Houston, TX 77018; (713) 695-9400; FAX: (713) 695-8015.

**THE MUSIC FACTORY;** EI, AC, MR, SES, ER; 1264 Monterey St.; San Luis Obispo, CA 93401; (805) 544-8944.

**ON-TRAX;** EI, ER; 9340 Namia Dr.; Riverside, CA 92503; (714) 687-5506.

**PACIFIC SOUNDS;** EI, MR; PO Box 4817; Lancaster, CA 93539; (805) 948-4273.

PERCEPTION INC.  
Los Angeles, CA

➤ **PERCEPTION INC.;** SD, AC; PO Box 39536; Los Angeles, CA 90039; (213) 857-4912.

**PROFESSIONAL TAPE & COMMUNICATION SUPPLY;** SES; 3007 N. Lamar; Austin, TX 78705; (512) 459-8677; FAX: (512) 459-8676.

**PROGRESSIVE AUDIO VIDEO;** SD, EI, AC, MR; 534 N. Gardner; Los Angeles, CA 90036; (213) 653-1526.

➤ **RACK ATTACK;** ER; 3249 Cahuenga Blvd. West; Hollywood, CA 90068; (818) 998-1024.

➤ **SOUND INVESTMENT ENTERPRISES;** SD, AC, SES, EI, ER; 3537 Old Conejo Rd. #106; Newbury Park, CA 91320; (805) 499-0539.

**SOUND SOLUTIONS;** SES, EI; 1505 11th St.; Santa Monica, CA 90401; (213) 393-5332.

**SOUND TECHNIQUES;** EI, SES, ER; PO Box 648; N. Hollywood, CA 91603; (818) 764-3355.

STUDIO SUPPLY CO.  
Dallas, TX

**STUDIO SUPPLY CO.;** SD, EI, AC, MR, SES, ER; 9978 Monroe Dr. #304; Dallas, TX 75220; (214) 358-0050; FAX: (214) 358-0947.

**TEXAS STUDIO SUPPLY;** SES; 2036 Paskett; Houston, TX 77092; (713) 682-2722.

**Washington Professional Systems**  
*The Best in Audio & Video Equipment*  
 AKG □ Akai Adam □ Amek/Tac □ Alpha Boss □ Brooke-Sifén □ Bryston □  
 Crown □ Dolby □ Drawmer □ Dyaxis □ Eventide □ Extron □ Focusrite □  
 Genelec □ JBL/UREI □ JVC □ Klark-Teknik □ Lexicon Opus & 480L □  
 Meyer Sound □ Mitsubishi Video □ Nakamichi □ Neumann □ Otari □  
 Panasonic Video □ QSC □ Ramsa □ Rane □ Revox □ Roland Digital □  
 Sennheiser □ Shure □ Sony Pro Audio □ Sony Intelligent Systems &  
 CCTV □ Soundcraft □ Symetrix □ Tannoy □ Tascam □ T.C. Electronics □  
 Timeline Lynx □ UREI □ Yamaha □

**Washington Professional Systems**  
*The Best in Sales Advice and Service*

**Washington Professional Systems**  
 11157 Veirs Mill Rd. Wheaton, MD 20902  
 Tel: 301-942-6800 Fax: 301-946-3241



# AudioTechnique #6:

VISIT US AT OUR  
NEW LOCATION



## THINK SMALL.

At AudioTechniques, maintaining a fully-stocked parts department is one of our most important techniques for supplying and servicing our customers. That's because we realize that keeping your facility up and running is just as important as keeping it up to date.

Whatever part you're looking for — from the smallest fuse to the most obscure relay — AudioTechniques is likely to

have it. We even carry the world's largest supply of MCI parts and accessories (such as the gas-filled, MCI tape recorder relay pictured above).

And because another one of our techniques is knowledge, our staff can quickly help you choose the part you need. Troubleshoot and repair components. Help you create auxiliary hardware setups. And suggest alternative replacement parts.

To some people, an extensive

parts department may be a small thing. To us, it's what customer support is all about. After all, if an audio dealer can't deliver on small items, how can you rely on them for your bigger investments?

So before you make that call to your usual audio supplier, call the audio dealer who specializes in being well-supplied. AudioTechniques. And find out how professional our service can be — in every small detail.

# AudioTechniques

A Manny's Music Company.

AudioTechniques, 1600 Broadway, New York City, N.Y. 10019  
(212) 586-5989 Fax: (212) 489-4936

## Facility Designers & Suppliers

S O C A L / S O U T H W E S T U S

**THEATER DESIGN ASSOCIATES**; SD, AC; 4945 Reforma Rd.; Woodland Hills, CA 91364; (818) 887-9784; FAX: (818) 887-2161.

**THEATRE DESIGN ASSOCIATES**; SD, EI, AC; 2218 W. Olive Blvd., Ste. 284; Burbank, CA 91506; (818) 887-9035; FAX: (818) 887-2161.

**USCO AUDIO ENGINEERING**; SD, AC, SES, ER; 2623 Canyon Dr.; Hollywood, CA 90068; (213) 465-4370.

**PAUL S. VENEKLASEN AND ASSOCIATES**; SD, AC; 1711 16th St.; Santa Monica, CA 90404; (213) 450-1733; FAX: (213) 396-3424.

**VJ ELECTRONICS, INC.**; EI, AC, ER; 22127 S. Vermont Ave.; Torrance, CA 90502; (213) 533-5980.



WATERLAND DESIGN GROUP  
Hollywood, CA

# GET OUT OF THE DARK.



Open your eyes and see just how many subjects are covered in the new edition of the Consumer Information Catalog. It's free just for the asking and so are nearly half of the 200 federal publications described inside. Booklets on subjects like financial and career planning; eating right, exercising, and staying healthy; housing and child care; federal benefit programs. Just about everything you would need to know. Write today. We'll send you the latest edition of the Consumer Information Catalog, which is updated and published quarterly. It'll be a great help, you'll see. Just write:

**Consumer Information Center  
Department TD, Pueblo, Colorado 81009**

U.S. General Services Administration

➤ See monthly issue of Mix for extended listing

**WATERLAND DESIGN GROUP**; SD, AC; 1680 N. Vine St. #608; Hollywood, CA 90028; (213) 469-7754; FAX: (213) 469-6757.

**WEST L.A. MUSIC**; SD, SES; 11345 Santa Monica Blvd.; Los Angeles, CA 90025; (213) 477-1945; FAX: (213) 477-2476.

**WEST TEXAS PRO AUDIO**; SD, EI, AC, MR; PO Box 662; Shallowater, TX 79363; (806) 832-5760.

**WESTERN ELECTRO-ACOUSTIC LABORATORY, INC.**; SD, AC; 1711 16th St.; Santa Monica, CA 90404; (213) 450-1733; FAX: (213) 396-3424.

**WESTLAKE AUDIO**; SD, AC, SES, EI, MR, ER; 7265 Santa Monica Blvd.; Los Angeles, CA 90046; (213) 851-9800.

### CANADA

Alberta, British Columbia, Manitoba, New Brunswick, Newfoundland, Northwest Territories, Nova Scotia, Ontario, Prince Edward Is. Quebec, Saskatchewan

**GENESIS COMMUNICATIONS INC.**; AC, EI, MR; 9650 20th Ave. #137; Edmonton, AB T6N 1G1; (403) 450-6516; FAX: (403) 428-5376.

**GERR ELECTRO ACOUSTICS LTD.**; SD, AC, SES, EI, MR; 363 Adelaide St. E.; Toronto, ON M5A 1N3; (416) 868-0528; Telex: 065-24385.

**GROUP ONE ACOUSTICS, INC.**; SD, AC; 1538 Sherway Dr.; Mississauga, ON L4X 1C4; (416) 896-0988; FAX: (416) 897-7794.

**J-MAR ELECTRONICS LTD.**; SD, EI, AC, MR, SES, ER; 6 Banigan Dr.; Toronto, ON; (416) 421-9080; FAX: (416) 421-2377.

**M.E.S. MUSIC EQUIPMENT SALES LTD.**; SD, EI, AC, MR, SES, ER; 34 Parkdale Ave. N.; Hamilton, ON L8H 5W8; (416) 545-0404.

**NEIL MUNCY ASSOCIATES, LTD.**; SD, AC, MR; CONSULTANTS IN ELECTROACOUSTIC SYSTEMS; 109 Fieldwood Dr.; Scarborough, ON M1V 3G3; (416) 298-3835.

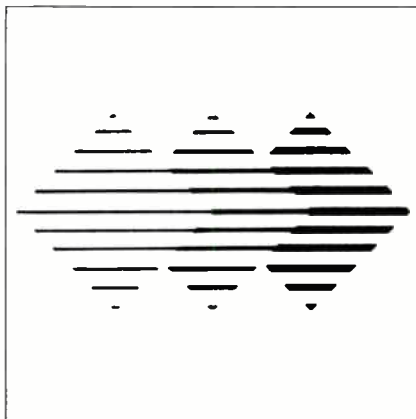

PILCHNER ASSOCIATES ACOUSTICAL PLANNERS  
Toronto, ON

**PILCHNER ASSOCIATES ACOUSTICAL PLANNERS**; SD, AC; 189 Church St.; Toronto, ON M5B 1Y7; (416) 364-2994; FAX: (416) 869-1267.

**RICHARD AUDIO, INC.**; EI, MR, SES, ER; 5703 Ferrier St.; Montreal, QC H4P 1N3; (514) 733-5131; FAX: (514) 733-7960.

**STATE OF THE ART ELECTRONIK, INC.**; 43-1010 Polytek St.; Ottawa, ON K1J 9J3; (613) 745-2003.

**SYNTONY ACOUSTIC SYSTEMS, INC.**; SD, AC; 10010-107 A Ave.; Edmonton, AB T6J 5K7; (403) 493-8156; FAX: (403) 493-8199.

### Mix Trivia

44. After his contract with Capitol ran out in 1960, this performer founded Reprise Records, later a division of Warner.

Turn to page 152 for question



## HEAD RELAPPING

The contour and performance of your heads are restored to factory specifications before a precise optical/digital assembly alignment is performed. Original replacement heads also in stock.



## MOTOR REBUILDING

Your Capstan, Reel, and Tachometer motors are rebuilt to quiet, flutter free perfection.



— Become an AMP SERVICES customer and enjoy a level of quality workmanship and individual attention rare in today's business environment. Call:

Audio Magnetic Professionals



224 Datura Street, Suite 614  
West Palm Beach, FL 33401  
1 (800) 826-0601 In Florida (407) 659-4805

Authorized OTARI, SONY, TEAC Parts Dealers

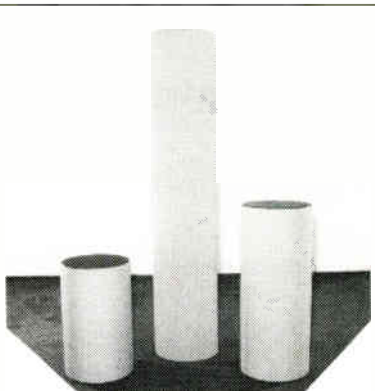

Providing you with architectural acoustic™ products for critical listening and performing environments.

Syntony's lines include three quadratic residue diffuser systems and the complete Column Base Attenuator™ System for low frequency control.



10010 - 107 A Avenue  
Edmonton, Alberta, Canada T5H 4H8  
Ph: (403) 493-8156  
Fax: (403) 493-8199



1. Who is Guglielmo Marconi?
2. Who is Enrico Caruso?
3. What is Joy Division?
4. What is Bell Telephone Laboratories?
5. What is Technics, the SV-P100?
6. What is Japan?
7. What is a stereo decoder?
8. What is Mobile Fidelity?
9. What is 1947?
10. What is Lexicon?
11. Who is Rudy Van Gelder?
12. What is the Jimi Hendrix Experience?
13. What is "Eight Days A Week" by the Beatles?
14. Who is Hans Christian Oersted?
15. Who is Michael Faraday?
16. Who is Valdemar Poulsen?
17. What is Ampex?
18. What are *Saturday Night Fever* (#3), *Dirty Dancing* (#5), *Purple Rain* (#6) and *Grease* (#13)?
19. Who is Barbra Streisand?
20. Who are Kenny Gamble and Leon Huff?
21. Who is Chris Stone?
22. What is Minnesota Mining & Manufacturing (or 3M)?
23. Who is The Grateful Dead? (The album was *Live Dead*.)
24. Who is Bob Dylan? ("Like a Rolling Stone")
25. Who is Johnny Cash?
26. Who is Roger Nichols?
27. Who is Dave Hassinger?
28. What is *Rock Around the Clock*?
29. What is ECM Records?
30. Who is Phil Spector?
31. Who is Chet Atkins?
32. Who is Stevie Wonder?
33. What is RCA Victor?
34. Who is Phil Spector?
35. What is "Brown Sugar" and *Sticky Fingers*?
36. Who are The Flying Burrito Brothers?
37. Who is John Hammond?
38. Who is Bill Graham?
39. Who is Nick Lowe?
40. Who is Bob Marley?
41. Who is Sam Phillips?
42. What are Apollo and Savoy?
43. Who is "Colonel" Tom Parker?
44. Who is Frank Sinatra?

Information contained in Mix Trivia was gathered from a variety of sources, including *Encyclopedia of Rock* (Schirmer Books), *The Billboard Book of Gold and Platinum Records*, the Electronic Industries Association Consumer Electronics Group 1990 Annual Review, the American Music Conference's *Music USA '90*, *The Complete Handbook of Magnetic Recording*, 3rd Ed. (Tab Professional and Reference Books), and the ever-knowledgeable *Mix* magazine staff.

# ADVERTISERS INDEX

| PAGE     | ADVERTISER                                  | PAGE     | ADVERTISER                           |
|----------|---------------------------------------------|----------|--------------------------------------|
| 17       | Agfa                                        | 142      | Leo's Professional Audio Systems     |
| 22       | AKG Acoustics                               |          |                                      |
| IFC      | Alesis Studio Electronics                   | 55       | Lester Audio Laboratories            |
| 119      | American Helix Technology                   | 9        | Lexicon                              |
| 120      | Ampex                                       | 140      | Manny's Professional Audio Division  |
| 151      | AMP Services                                |          |                                      |
| 124      | Apex Machine Company                        | 143      | Martin Audio Video                   |
| 20       | API Audio Products                          | 145      | National Sound Engineering (NSE)     |
| 46       | AudioForce                                  |          |                                      |
| 145      | Audio Services Corporation (ASC)            | 7, BC    | Neve                                 |
|          |                                             | 35       | Northeastern Digital Recording (NDR) |
| 150      | AudioTechniques                             |          |                                      |
| 19       | BBE Sound                                   | 28       | Omni Music                           |
| 102      | Big Mo                                      | 117, 139 | Optical Media International          |
| 79       | Blank Productions                           | 4-5      | Otari                                |
| 13       | Bryston                                     | 81       | Power Play Studios                   |
| 98       | Burlington Audio/Video Tapes                | 128      | Prodigital                           |
| 102      | Cal Switch                                  | 46       | ProMusic                             |
| 32       | Carver Professional                         | 30       | Prosonus                             |
| 51       | Carvin                                      | 43       | Quad Eight Electronics               |
| 33       | Cipher Digital                              | 87       | Radian                               |
| 43       | Circuit Research Labs (CRL)                 | 122      | Rainbo Records & Cassettes           |
| 105      | Community                                   | 113      | Ramsa                                |
| 138      | Conservatory of Recording Arts and Sciences | 137      | The Recording Workshop               |
|          |                                             | 148      | RPG Diffusor Systems                 |
| 130      | Creative Sound Houston                      | 12       | Schoeps                              |
| 39, 107  | Crown                                       | 133      | Sennheiser                           |
| 118      | D.A.T. - Audio Gallery                      | 34       | Solid State Logic (SSL)              |
| 125      | The DAT Store                               | 15       | Sony Professional Audio              |
| 19       | DeWolfe Music Library                       | 25       | Soundcraft                           |
| 116      | DIC Digital                                 | 28       | Sound Code Systems (SCS)             |
| 56       | Digidesign                                  | 18       | Soundtracs                           |
| 128      | Disc Makers                                 | IBC      | Studiomaster                         |
| 1        | Dolby Laboratories                          | 151      | Syntony Acoustic Systems             |
| 37       | Dreamhire                                   | 31       | Tannoy                               |
| 123      | Duplication Specialists                     | 144      | Thoroughbred Music                   |
| 147      | EAR Professional Audio/Video                | 146      | The Toy Specialists                  |
| 103      | Effanel Music                               | 135      | Trebas Institute of Recording Arts   |
| 127      | ElectroSound                                |          |                                      |
| 100      | Eva-Tone                                    | 109      | UltraSound                           |
| 123      | Fullersound                                 | 38       | U.S. Optical Disc                    |
| 99       | Full Sail Center for the Recording Arts     | 36       | Valentino                            |
|          |                                             | 44-45    | Valhala                              |
| 21       | The Hollywood Edge                          | 149      | Washington Professional Systems      |
| 21, 144  | Hot House Professional Audio                |          |                                      |
| 124      | HRC Magnetics                               | 26       | Yamaha Professional Audio            |
| 121, 123 | Imperial Tape                               | 111      | Yorkville                            |
| 137      | Institute of Audio Research                 |          |                                      |
| 138      | Institute of Audio-Video Engineering        |          |                                      |
| 25       | JBL Professional                            |          |                                      |
| 47       | Jeanius Electronics                         |          |                                      |
| 40       | Jensen Transformers                         |          |                                      |
| 142      | JRF Magnetic Sciences                       |          |                                      |
| 126      | KABA Research & Development                 |          |                                      |
| 121      | K-disc Mastering                            |          |                                      |
| 29       | Killer Tracks                               |          |                                      |
| 118, 123 | Klarity Cassette                            |          |                                      |
| 130      | Kozin Communications                        |          |                                      |

# TRACKMIX 24 from

*StuDiomaster*



TRACKMIX 24 is a new 24 or 32 modular input, 12 buss console. Full 24 track monitoring and MIDI controlled muting make TRACKMIX 24 the perfect choice for any modern 12, 16 or 24 track recording studio.

Pictured: 24x12x24x2  
For more information contact:  
STUDIOMASTER, INC.  
3941 Miraloma, Anaheim, CA 92807  
Fax (714) 524-5096  
Phone (714) 524-2227

*StuDiomaster*

the sound experience



# THE POWER PACKAGE



Neve VRP Series  
Post-Production Console,  
Flying Faders Automation,  
MITSUBISHI X-880 w/Apogee filters  
Roger Nichols, and SOUNDWORKS WEST...  
...it doesn't get any better than this!

SOUNDWORKS WEST Ltd.  
West Hollywood, California  
Telephone: 213-850-1515

TEC  
TECHNICAL EXCELLENCE & CREATIVITY  
1990  
NOMINEE

 Neve  
a Siemens Company

Exclusive North American Distributor of

 MITSUBISHI  
DIGITAL PRO AUDIO

CT: (203) 744-6230 ■ NY: (212) 956-6464 ■ TN: (615) 329-9584 ■ CA: (213) 461-6383 ■ TORONTO: (416) 365-3363

World Radio History