

JULY 1987  
U.S. \$4.00  
CANADA \$5.00

THE RECORDING INDUSTRY MAGAZINE

# Mix

Interview: Jerry Garcia

**Directory:  
Southwest  
Recording  
Studios**

**Education  
in Audio  
School Listings**

**Narada  
Michael Walden**

**Microphone  
Techniques  
for Sampling**

**Jim Gaines**

**Synthesizers  
for the Studio**

# Every Bit a Studer



## Introducing the D820X DASH Format Digital Audio Recorder

The wait is over. Digital has finally entered the Studer era.

For over 35 years, Studer has concentrated exclusively on one goal: designing and manufacturing the world's finest audio production equipment. So when it comes down to what professionals want, Studer delivers.

The D820X is no exception. Listen to it—carefully! You'll hear flawless sonic resolution, thanks to proprietary digital processing circuits and uncompromising analog input/output electronics.

Then do a razor-blade edit. Feel how the controls shuttle tape with effortless precision. Note how the meter overbridge panel provides comprehensive control of all operating modes and level adjustments.

Finally, tilt up the transport to examine construction and craftsmanship. No other digital recorder can match what you'll see.

The D820X is built to last. It's every bit a Studer.

**STUDER** REVOX

STUDER REVOX AMERICA, INC.  
1425 Elm Hill Pike, Nashville, TN 37210  
(615) 254-5651

**Offices:**

Los Angeles (818) 780-4234

New York (212) 255-4462

Chicago (312) 526-1660

Dallas (214) 943-2239

San Francisco (415) 930-9866

Circle #002 on Reader Service Card

- Robust Twin-DASH format at 15 ips • 14" reel capacity • PWM auxiliary tracks with configuration for CD subcode mastering data • Fully programmable operating keys • Service diagnostic displays • Internal operating system provides RS232 access to transport and digital audio operations.



# 3. Neve V Series' Necam 96



067682 MXJUN 1299  
 JBL PROFESSIONAL  
 MARK R SAIDER  
 8500 BALBJA BLVD RMX 2200  
 3 CIR  
 FGD

Ibox has it all. Both MIDI and live recording elements tucked away in a secluded Connecticut luxury boarding and day accommodations. An envier's client roster. And when it came to choosing Neve's V Series with 48 inputs and Necam 96

Necam 96, Neve's moving fader automation definitely a deciding factor, says studio owner. "The V series had the finest sound and was by the most uncompromising console for the conditions necessary to set up the MIDI apparatus we

the world's first instinctive moving fader automatable of controlling up to 96 faders. Keyboards, es and other MIDI gear can come into the patching loose cables. And super touch sensitive servo give ultimate control. ent Rollback feature lets you play back the moves

you just made by simply pressing a single key. The tape or film moves back to exactly where you want it, faders move to the right spots and your updates are played for you. The Auto Merge feature will automatically merge changes with the rest of the mix. Easy? You bet.

No need to keep after every pass either. Necam 96 keeps the pass as a Virtual Mix for review or update. But, every so often, it's good to keep the mix for archive purposes.

Plain English instructions presented on a full color, high resolution video display tell you system status quickly, in clear easy-to-read labels. Smart Keys cut down on complexity even more.

But what about the bottom line – sound? "To say it's clean is an understatement. Neve's qualities speak for themselves," says Taylor. "We have been ecstatic with our choice from day one! For the Sandbox, Neve was the best choice. The only choice."

## Neve...Only the Best for the Best!



Rupert Neve Inc.  
 A Siemens Company

RUPERT NEVE INC., BERKSHIRE INDUSTRIAL PARK, BETHEL, CONNECTICUT 06801, U.S.A.  
 TELEPHONE: (203) 744-6230. TELEX: 96 \*683. FACSIMILE: (203) 792-7863.  
 NY: TEL: (212) 956-6464 • CA: TEL: (213) 874-8124 FACSIMILE: (213) 874-1406 • TN: TEL: (615) 383-2727 TELEX: 78 6569  
 NEVE ELECTRONICS INTERNATIONAL LIMITED, MELBOURN, ROYSTON, HERTS SG8 6AU, ENGLAND  
 TELEPHONE: ROYSTON (0763) 40776. TELEX: 81381. CABLES: NEVE CAMBRIDGE. FACSIMILE: (0763) 61886

# Mix

JULY 1987

THE RECORDING INDUSTRY MAGAZINE

VOL. 11, NO. 7



Page 48



Page 168



Page 24



Page 64

## FEATURES

### 24 MIKING TECHNIQUES FOR SAMPLING

by George Petersen *Four samplists share some of their tips for choosing the right microphone.*

### 42 ARTIST STUDIO: NARADA MICHAEL WALDEN

by Linda Jacobson *Spirituality and high technology combine in Walden's Northern California hit factory, Tarpan Studio.*

### 77 RECORDING SCHOOL EDUCATION

**TODAY: Both Roots & Wings**  
by Josh Gressel *Educators around the country discuss the new breed of students in the field and speculate about recording education in the year 2000.*

### 102 PRODUCER'S DESK: JIM GAINES

by Blair Jackson *Straight talk and anecdotes from the celebrated engineer/producer, known for his work with Steve Miller, Huey Lewis, Van Morrison, the Neville Brothers and countless others.*

## AUDIO

- 19 INSIDER AUDIO: Apogee and Discovery** by Ken Pohlmann
- 21 STUDIO VIEW: The New Tax Law & Your Studio** by Tony Thomas
- 37 CONDENSER MICROPHONES, PART ONE** by Al Grundy
- 61 INTERACTIVITY: CD-I at the Village** by Lou CasaBianca
- 64 DARTMOUTH: The Ivy League Goes Digital** by Dan Daley
- 72 AES REPORT: 5th Conference on Music & Digital Technology** by Larry Oppenheimer
- 108 A PROGRAM FOR MIC SENSITIVITY** by Ronald Ajemian & Guillermo Mager
- 114 IN SYNC: On Locking Digital 32-Tracks** by Ben Harris
- 120 A MIDI SOFTWARE TUTORIAL** by Larry Oppenheimer
- 122 FIELD TEST: Alesis Microverb** by Keith Grewell
- 125 FIELD TEST: Electro-Voice N/DYM Mics** by John Schroeder
- 160 AFTER-MIX: Industry Slips Despite CD Boom** by Philip DeLancie
- 168 SOUTHWEST RECORDING: Synths in the Studio** by Linda Jacobson

## MUSIC

- 48 LUNCHING WITH BONZAI: Oingo Boingo's Danny Elfman** by Mr. Bonzai
- 133 MI UPDATE: New Technology** by Craig Anderton
- 136 MUSIC NOTES: Jerry Garcia, The Trio: Dolly, Linda & Emmylou, General Public**
- 154 PLAYBACK: "In the Dark" with the Grateful Dead** by Blair Jackson

## VIDEO

- 164 VIDEO NEWS: NAB Convention Highlights** by Hank Lam

## DEPARTMENTS

- 6** CURRENT
- 8** INDUSTRY NOTES
- 12** SESSIONS/STUDIO NEWS
- 58** PREVIEW
- 201** MIXWORDS
- 203** FEEDBACK
- 206** CLASSIFIEDS
- 210** AD INDEX



# FROM THE EDITOR

## DIRECTORY

- 83** RECORDING SCHOOLS,  
SEMINARS &  
PROGRAMS
- SOUTHWEST  
RECORDING STUDIOS**
- 177** LOCATION INDEX
- 178** 4 & 8 TRACK STUDIOS
- 184** 12 & 16 TRACK STUDIOS
- 188** 24+ TRACK STUDIOS

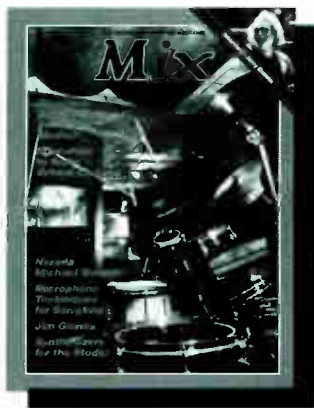

Cover: Providing a comfortable, creative environment with the latest equipment, 24-track Crystal Clear Sound in Dallas offers turnkey album production (with in-house record pressing and jacket printing), as well as jingle, scoring, demo, voice-over and other recording services to a wide variety of clients.

Photo: Michael Wilson

Corner photo of Jerry Garcia:  
by Ron Delany



Mix magazine is published at 2608 Ninth St., Berkeley, CA 94710 and is ©1987 by Mix Publications, Inc. This is Volume Eleven, Number Seven, July 1987. Mix (ISSN 0164-9957) is published monthly. Subscriptions are available for \$38.00 per year. Subscriptions outside U.S.A. are \$50.00 per year. Single copy price is \$4.00, back issues \$5.00. Please address all correspondence and changes of address to Mix magazine, 2608 Ninth St., Berkeley, CA 94710, (415) 843-7901, Fax: (415) 843-9540. Second Class postage paid at Berkeley, CA and additional mailing offices. Mix magazine is distributed in pro-audio stores, music stores and other related businesses. If you have a recording or music related business and would like to distribute Mix, please give us a call. Display advertising rates, specs and closing dates are available upon request. This publication may not be reproduced or quoted in whole or in part by mimeograph or any other printed means, without written permission of the publishers.

**F**requent readers may recall quite a bit of attention being paid to CD-I in these pages of late. More than a powerful new storage device, CD-I has indicated its potential to improve lifestyles, to shape education and to take media boldly where it has never been before. It is also a good bit of science fiction at the moment.

Recently we attended a three-day conference titled "CD-I, The Future." It was almost eerie—a new industry and no products being shown; no hardware, no software. There was a lot of talk and no shortage of concepts being bandied about, but none of the manufacturers, distributors or dealers had any CD-I goodies to display. Everyone seemed to be waiting for chips to be finalized and authoring systems to be developed. Some were referring to it as a vapor industry. Fighting off a little show-and-tell disappointment, I tried to get a fix on what the multi-media messiah was going to look like.

Apparently we're about a year away from introduction of the first CD-I hardware units, according to the experts, with—depending who you ask—perhaps 30 to 100 software titles at launch. How quickly this medium will develop its market was among the controversial topics of discussion at the conference. Will it follow the CD player in sales? Will it snowball? Will it fizzle? Much importance has been placed on the strength of the software titles to make this a boom industry. CD-I can't rely on the marketability of movies at home, as the VCR did; or better sounding records, as with the CD player. CD-I will have to bring new kinds of programs and experiences with it. The creativity, importance and production value of the programs will make or break the new CD-I industry. Once something the scale of "Thriller," *Mash*, *Star Wars*, or "WordStar" comes along for CD-I, we'll know it's finally here.

In a roundabout way, this brings us to the topic of this issue: education. Learning about how to be successful in the recording industry has become very complicated. Not only does the aspiring entry level person require a journeyman's skill at operating the equipment of the recording studio, and good musical chops, but there is an increasing demand for an understanding of digital audio, acoustics, computer programming, video production, business management, MIDI and interpersonal psychology. Now add to all of this something as elusive as a vapor industry and we see that today's recording schools and tomorrow's industry professionals have their work cut out for them.

Keep reading,

David M. Schwartz  
Editor/Publisher



# CURRENT

## **FCC on HDTV**

The National Association of Broadcasters, Association of Maximum Service Telecasters, Association of Independent Television Stations and 55 other broadcast organizations have asked the Federal Communications Commission to issue a Notice of Inquiry on high definition television (HDTV). A separate petition seeks a delay in allocating land mobile spectrum space that is vital to HDTV development.

HDTV is one of several advanced systems under development to improve picture and sound quality of television. Picture quality is equal to that of 35mm film.

"Over-the-air HDTV is not an engineer's dream," says NAB TV Board Chairman Peter A. Kizer of Broadcast Communications of America. "It has been demonstrated successfully at the FCC, Congress and at a Washington DC department store where it was greeted enthusiastically. The viewers will be the losers if the Commission does not preserve the needed spectrum space which is currently allocated to UHF broadcasting."

The petition notes that unless local broadcast stations receive additional spectrum, they will become a second class service and more than 98% of viewers will be affected. The petitioners point out that no other home video delivery service faces the transmission bandwidth or receiver-incompatibility hurdles confronting local broadcasters.

The petition for special relief urges the FCC to postpone consideration of further "sharing" of the UHF band by land mobile radio, and to take steps toward preserving at least part of the 12 GHz band for use by local broadcasters.

## **ATSC Plans HDTV Broadcast Tests**

The Advanced Television Systems Committee (ATSC) announced plans for a series of tests in the UHF and SHF bands capable of delivering high definition television to the consumer. ATSC

has established a technical specialist group to study spectrum availability, conduct field tests and recommend suitable systems for delivering HDTV signals to the consumer via broadcast, cable and satellite.

The tests, scheduled to begin this fall, will study propagation characteristics such as reflection, shadowing and rain attenuation in the selected bands and how they affect wideband video and audio signals. Test sites will include a variety of urban, suburban and rural environments. The group is also working with HDTV researchers to design tests that comply with proposed HDTV standards.

With the prediction that HDTV products will reach U.S. consumers in three to five years, the TV industry is concerned that standards must be developed which will serve the needs of all media and, ultimately, the public.

Terrestrial broadcasting has been given high priority because the FCC is considering a proposal which would allow two-way business radio users to share parts of the UHF television spectrum. (See "FCC on HDTV.") Some engineers have suggested that the SHF band, in particular the 12 GHz band, might be an alternative to UHF. Propagation data in this band, however, is limited to satellite and point-to-point usage. Whether wide-range terrestrial broadcast coverage with sophisticated video and audio signals, can be achieved on a practical basis will be studied in the ATSC tests.

Several systems currently are being developed for the distribution of HDTV signals, via terrestrial and satellite broadcast, cable and video recordings (tape and disc), including the 8.1 MHz MUSE system. Developed by NHK, the Japan Broadcasting Corp., for DBS, tape and disc, it was used by NAB and the Association of Maximum Service Telecasters in a UHF terrestrial broadcast demonstration earlier this year. Other systems currently under development include one by the New York Institute of Technology, which involves using two separate signals, (one is a standard NTSC channel)

and a two-signal system by North American Philips.

ATSC is an industry-wide committee which includes U.S. terrestrial and satellite broadcasters, cable television, program producers and distributors, and manufacturers of professional and consumer equipment. Anyone interested in participating in this work should contact the Advanced Television Systems Committee, 1771 N Street NW, Washington, DC 20036; (202) 429-5345.

## **Recording Academy National Meeting**

Entertainment attorney and former record producer and songwriter Alfred Schlesinger was recently elected national president and chairman of the board of the National Academy of Recording Arts and Sciences by the Academy's National Board of Trustees. The elections were held at the Academy's May meeting in Montego Bay, Jamaica. Also elected were producer/songwriter/musician/vocalist Tim McCabe of Atlanta as first national vice president and veteran record producer and musician Tim Morgan as national secretary/treasurer.

The trustees also voted to increase the number of Grammy Awards from 68 to an all-time high of 73, adding Best Motion Picture Score Album, Best Motion Picture Song and Country Vocal Duet. They also created a new field specifically for blues recording, adding Best Contemporary Blues Recording to the Best Traditional Blues Recording category. Best Instrumental Performances was revived with the designations With Orchestra and Without Orchestra restored.

Schlesinger, a graduate of Loyola Law School and former manager of the group Bread, plans to continue to focus on the Academy's stepped-up educational activities in its outreach programs to bring more members into the Academy, "especially from among the recording field's younger creative participants," and on the Academy's continuing awareness of the importance of music videos. ■



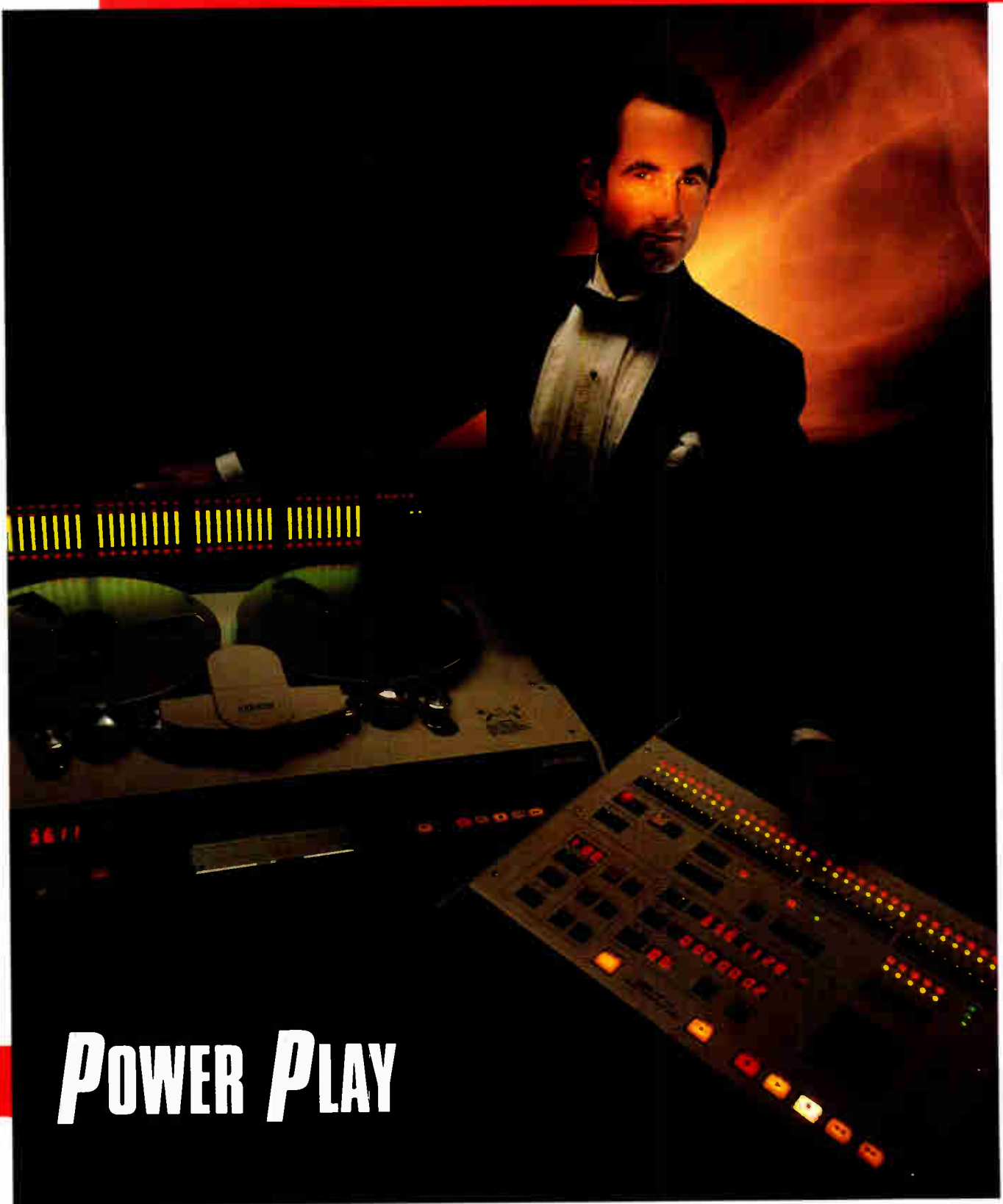

# POWER PLAY

Professional Digital standard recording format ■ 32 tracks ■ Peak-reading LED meter bridge ■ The incomparable ballistics of Otari's renowned pinchrollerless transport ■ SMPTE-EBU time-code synchronization.

When you are ready to create the ultimate recording studio, the Otari DTR-900 awaits. ■ Otari, Technology You Can Trust ■ Otari Corporation, 2 Davis Drive, Belmont, California 94002 ■ (415) 592-8311 TWX 9103764890.



# INDUSTRY NOTES

Equipment exhibit floor space is available for the 129th Technical Conference of the Society of Motion Picture and Television Engineers (SMPTE), to be held at the Los Angeles Convention Center. The conference will run from Oct. 31 to Nov. 4, not as previously published. Exhibitors interested in booth space can contact SMPTE at (914) 761-1100. . . Soundtracs Plc, the audio manufacturer from Great Britain, announced the appointment of John Carroll as sales and marketing director. . . The third Digital Information Exchange seminar series, sponsored by Sony Broadcast, HHB Hire & Sales, Studio Sound and Pro-Sound News is slated for November 23 to 26 in the private member's suite at London Zoo, Regents Park. The four-day exchange will concentrate on use of digital technology in the fields of broadcast, film, video, recording, academic research and industry. Registration inquiries can be made to Peter Woodcock at (0992) 583557. . . The International Confederation of Societies of Authors and Composers (ICSAC), during recent meetings in Sydney, Australia, decided to support the Australian government's proposal for a royalty on blank audio tape. . . CD-ROM Expo, the first exposition and conference for professional users of CD-ROM and other optical information systems and services, will be held Sept. 22 and 23 in New York City. For an Expo exhibitor kit, call Dorothy Ferriter at (800) 343-6474 (in MA (617) 879-0700) or write: CD-ROM Expo, PO Box 9171, 375 Cochituate Rd., Framingham, MA 01701. . . Kazunori Kurata was named president, Sony Professional Products Company and Cary Fischer director of market development for digital audio products for Sony Professional Audio. . . Ted Tripp, Ron Whigham and Nancy Mahl have joined the Pro Media staff in San Francisco, CA. . . Alpha Audio of Richmond, VA, announced the opening of an expanded facility at 2049 West Broad Street. An extensive renovation was performed to meet increased demands from both acoustics and BOSS sales, according to president Nick Colleran. Colleran also announced agreement with Gexco Technology International (Jersey City, NJ) on international marketing representation for the BOSS automated audio editing system. . . Tet-suro Kudo has been appointed executive vice president of LaserDisc Corporation of America. . . Audio Images Corporation has completed their move from Concord, CA to San Francisco. With the acquisition of the Otari, Sound Workshop, Dolby and Trident

lines, Audio Images will be a leading professional audio dealer in the area. . . Tannoy Limited, manufacturers of high-quality speaker systems, has appointed Ed Form as director of engineering, responsible for loudspeaker development and production engineering. . . Scott Grow has been appointed assistant western sales manager for DOD Electronics Corporation, Salt Lake City, UT. . . The Mitsubishi Pro Audio Group appointed David Langford as general manager for its manufacturing/engineering division in San Fernando, CA. . . National Public Radio will hold its 15th and 16th Music Recording Workshops this summer in Fredonia, NY. The folk/jazz workshop will be held July 6 through 13; the classical workshop July 21 through 27. For registration info, call (800) 235-1212, ext. 2734. . . Michael Sayovitz has been appointed president of Spectra Systems, an L.A. manufacturer of state-of-the-art editing systems featuring dual-headed laser disc players. . . Allen and Heath Brenell USA Ltd. presented its award for rep firm of the year to Joe Blacker's Audio Associates of Glenwood, MD. . . Perry Langenstein has been named principal theater consultant at The Joiner-Rose Group, Inc., an acoustical consulting firm in Dallas, TX. . . Magno Sound and Video has relocated to 729 Seventh Ave., New York City, just around the corner from its previous location at 212 W. 48th St. The new seven-floor facility was custom designed to be one of the most complete video and film centers in the nation. . . Great Britain's Total Audio Concepts Ltd. has received the Queens Award for Export Achievement 1987, following a three-year export earnings jump of 695%. TAC sells in 31 countries, including through its U.S. subsidiary company, Amek. . . Australia's Amber Technology announced that Wulf Gray has been named chairman. Amber, formerly the audio division of Rank Electronics, has moved to new Sydney headquarters in Frenchs Forest. . . Digital Audio Disc Corporation has appointed Scott Bartlett director of sales and marketing. . . Tom Lanik announced the formation of North Star Audio Video Corporation in Stamford, CT. The firm will sell and service major professional audio gear to recording and broadcast facilities. . . Rick Rosen, former national accounts manager for Toa Electronics, announces the formation of Intensive Care, a San Francisco music, pro sound and electronic service agency. . . Klark-Teknik Electronics announced the addition of Harry Klane to their staff. . .

## STAFF

EDITOR/PUBLISHER  
David M. Schwartz  
ASSOCIATE PUBLISHER  
Penny Riker Jacob  
ASSOCIATE PUBLISHER/MARKETING DIRECTOR  
Hillel Resner

MANAGING EDITOR  
Blair Jackson  
TECHNICAL EDITOR  
Ken Pohlmann  
MUSIC EDITOR  
David Gans

ASSOCIATE EDITOR  
George Petersen  
SENIOR EDITOR  
John Woram  
EDITOR-AT-LARGE  
Mr. Bonzai

ASSISTANT EDITORS  
Karen Margroff Dunn Lnda Jacobson  
EDITORIAL ASSISTANT  
Josh Gressel  
CONTRIBUTING EDITORS  
Iain Blair Lou CasaBianca Dan Daley  
Philip DeLance Bruce Nazanan  
Larry Oppenheimer Bruce Pilato Tony Thomas

ART DIRECTOR  
Tim Gleason  
ASSISTANT ART DIRECTOR  
Dave Marrs  
DESIGN AND PRODUCTION  
Patsy Messerer Anita Wong  
TYPOGRAPHY  
Linda Dierking Connie Wiggins  
PRODUCTION MANAGER  
Anne Letsch  
PRODUCTION ASSISTANT  
Kathy Badertscher

ADVERTISING DIRECTOR  
Ron Tall  
ASSISTANT ADVERTISING DIRECTOR  
EASTERN AD MANAGER  
Jeffrey Turner  
SOUTHERN CALIFORNIA/SOUTHWEST AD MGR  
Ken Rose  
NORTHWEST/NORTH CENTRAL AD MGR  
Horton Firmin  
SALES ASSISTANTS  
Randy Alberts Donna Burniston  
MARKETING ASSISTANT  
Irene Byer  
TRAFFIC MANAGER  
Neil McCarney  
DIRECTORIES/CLASSIFIEDS MANAGER  
Lauri Newman  
DIRECTORIES/CLASSIFIEDS ASSISTANTS  
Athena Craig Carol McMurray  
CIRCULATION MANAGER  
Nick Clements  
CIRCULATION ASSISTANT  
Judith F. Acton  
CUSTOMER SERVICES  
Lisa Hester

GENERAL MANAGER  
Mark Gunther  
CONTROLLER  
Jerry Cellilo  
ASSISTANT CONTROLLER  
Linda Looper  
ACCOUNTS PAYABLE  
Cathy Boyum  
ACCOUNTS RECEIVABLE  
Lisa Jensen  
CREDIT MANAGER  
Ann Cuadra

BOOK DIVISION GENERAL MANAGER  
Craig Wingate  
ASSISTANT MANAGER  
Camille Coyne  
FULFILLMENT SERVICES  
George Keres Brad Smith

OFFICE MANAGER  
Rachel McBeth  
RECEPTIONIST  
Lea Lewis

MIX PUBLICATIONS INC  
Chairman/CEO . . . . . Rudy Hurwich  
President . . . . . David M. Schwartz  
Executive Vice-President . . . . . Penny Riker Jacob  
Vice-President, Marketing . . . . . Hillel Resner  
Treasurer . . . . . Mark Gunther

NATIONAL EDITORIAL, ADVERTISING  
and BUSINESS OFFICES  
2608 Ninth St., Berkeley, CA 94710  
(415) 843-7901  
SOUTHERN CALIFORNIA ADVERTISING OFFICES  
19725 Sherman Way, Suite 160, Canoga Park, CA 91306  
(818) 709-4662



# Take a Neotek to work for a test drive.

No one judges performance just by reading the specs. To appreciate a recording console you have to put it through its paces. Hear what it'll do in your own studio. With your material. Your room. That's where the rubber meets the road.

We're so sure you'll like what you hear, we want to offer you an easy way to compare our consoles to any others: Borrow a Neotek demo module.

Fleetwood Mac did. They ended up cutting an album on it. We found out when they asked for a second one for stereo tracks.

Check out what's under the hood. Hear our mic pre with the finest condenser mics. That's an easy one; manufacturers already use our consoles to demo their best. Try synth inputs and see why New England Digital uses Neoteks to show off the Synclavier. Drive it with a digital track. You'll hear how our consoles make digital recorders sound their very best.

While you're at it, check the construction quality, the control layout, the flexible signal flow, and our very special equalizer.

Then, if you can wait a few weeks, we'll put you in the driver's seat of a new Neotek console, custom built for your personal requirements. Like we did for Stevie Wonder.

The way we figure it, we haven't come in second in a comparison yet. So we can't lose.

Neither can you.

So if you want to hear for yourself what's so special about a Neotek, drive one at work.

And if you're planning to keep our demo module for your next album tracks . . . well, that's OK too.



## NEOTEK

1154 west belmont avenue  
chicago, illinois 60657  
(312) 929-6699

Circle #005 on Reader Service Card

World Radio History

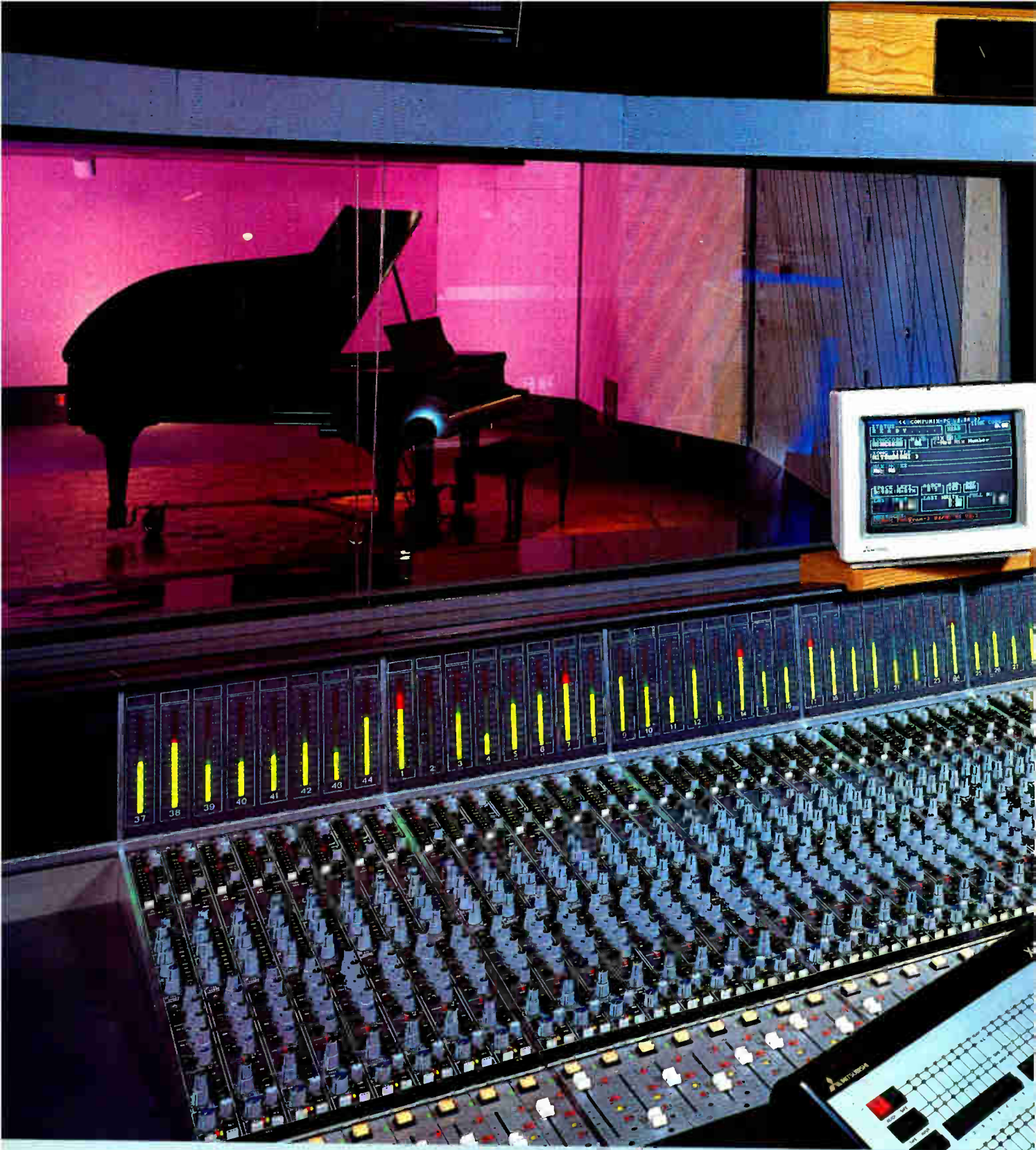

*“This console makes a lot more sense.”*

Spending \$300,000 for a music recording console is a decision professional studio owners can easily regret. There's at least one other place where hard-to-come-by business capital can produce a better return on your

investment—like, owning an X-850 Mitsubishi 32-Channel Digital Multitrack and a Westar console.

That's precisely what Ken Suesov and his partners at Hollywood's new KREN Studios did. There's a new 44 input,



# Mitsubishi Westar 8000 series

KREN STUDIOS  
HOLLYWOOD, CALIFORNIA



Compumix PC automated WESTAR console working side-by-side with an 850; the industry's most powerful combination of recording technology—all for less money than a single console from the familiar high-priced spread.

Contact us now for full information on the Westar and we'll prove how this can make sense to you too. Remember, the Westar console is *fast* achieving a reputation for sonic excellence as the optimum choice for digital recording.

It's a Mitsubishi, Made In the U.S.A.



## MITSUBISHI PRO AUDIO GROUP

DIGITAL ENTERTAINMENT CORPORATION

Headquarters: San Fernando, CA 91340 • ☎(818) 898-2341 • FAX (818) 365-8310

New York: N.Y.C. 10019 • ☎(212) 713-1600

Tennessee: Brentwood, TN 37027 • ☎(615) 371-6602 • FAX (615) 371-6644

Canada: Toronto, ONT. M5A 1J2 • ☎(416) 365-3363 • FAX (416) 365-1044

United Kingdom: St. Albans, Hertfordshire AL4 0JJ • ☎0727-40584 • FAX 0727-67684

# SESSIONS

## SOUTHWEST

*Riverside Sound* (Austin, TX) was host to Clifford Antone's Chicago Blues Festival guests including Howlin' Wolf's original band members: **Hubert Sumlin**, **S.P. Leary** and **Henry Gray**. . . Cutting tracks for Rounder Records at *Arlyn Studios* in Austin was **Duke Roubillard**, featuring Jimmie Vaughan, Fran Christina and Kim Wilson of Austin's **Fabulous Thunderbirds**. **Stuart D. Sullivan** engineered. . . **Dino Lee** cut and mixed tracks at *Lone Star Recording* in Austin for his upcoming New Rose records release, *The New Las Vegas*. Engineers were **Jay Hudson** and **Bill Anderson**. . . Producer/songwriter **Edwin Cohen** was in *Planet Dallas* working on a new series of 24-track dance mix demos for submission to various New York independent dance labels. **Rick Rooney** engineered the sessions. . . A recent remote recording project found the *Omega Audio*'s Dallas-based remote at the site of a **Rita Moreno** concert providing audio recording for a television music special entitled *Postmark: Spring Fashion '87*. Engineering for Omega were **Paul Christensen**, **Pam Irwin**, **Ken Pelic** and **Roger Hudgins**. . . **Yves Vincent**, owner of *Music Media Productions* in Houston, recently produced the second album project for new age songwriter and artist **Cindy Freedman**. . . Chrysalis Records' recording artists **Year Zero** are currently recording their debut album at *Arlyn Studios* in Austin. **Ron Fair** is producing and engineering. . . At *Goodnight Dallas*, New Orleans-based Black Top Records recently completed cutting tracks for the upcoming album by blues artist **Nappy Brown**. Anson and the Rockets were featured on the cuts co-produced by **Ron Levy** and **Hammond Scott**. Artists Earl King and Ronnie Earl also contributed their talents to the project, engineered by Dallas' **Larry Wallace**. . . *Luxury Audio Workshop* (L.A.W.) in Las Vegas played host to the *Pointer Sisters* and producer **Narada Michael Walden**, who cut vocal tracks for the *Beverly Hills Cop II* soundtrack. Engineering the project was **Dave Frazier**, assisted by **Lee Watters**. . .

## NORTH CENTRAL

At *Studio A*, Dearborn Heights, MI, former member of Slave and the George Clinton Organization, **Steve Washington**, produced tracks on *Shiela* for EMP Productions, **Eric Morgeson** engineering. . . At *Sparrow Sound Design* in Chicago, international drummer and percussionist **Famoudou Don Moye** along with trumpet great **Lester Bowie**

and members of *The Art Ensemble* completed the work on their new CD, *Ancient To The Future*. Chief engineer was Sparrow. . . The world broadcast premiere of "Sonata For Harp and Flute"-Opus 406 by composer **Alan Hovhaness** was recorded at *Musico Technilab* in Warren, OH. The engineer was **Gary Boggess**, owner of the studio. . . Over at *Seagrape* in Chicago, the originator of "House" music, **Frankie Knuckles**, has been filling up the rhythm tracks in the studio producing four separate projects. Scheduled for release on D.J. International Records is "I'm Getting Over You" with **Reggie Hall** on vocals and "Only The Strong Survive" featuring **Rickey D** on vocals. For Danica Records, *The Knightriders* tracked "Let the Music Use You." Also, *The It* recorded "Distant Planet." **Tom Haban** engineered the sessions. . . Backstage Productions' **Tom Roberts** was in Detroit working at *Selah Studio* with producer **Loris Holland**. Roberts was recording tracks for the new **Vanessa Bell Armstrong** LP for Jive/RCA Records. . . **Terry "Housemaster" Baldwin** came to *Soto Sound* in Evanston, IL, to do a re-mix on "Future Jack" on Trax Records, performed by the group *Future*. **Jerry "Splicemaster" Soto** was manning the controls. . . At *Sonic Art Studios* in Lake Villa, IL, the *Ohio Players* cut tracks for a reunion album. Producing and engineering was **Richard Brown**, assisted by **Glen Rupp**. . . At *Mus-I-Col Studios* in Columbus, OH, **John Hetrick** engineered the tracks for *Hot Pursuit*, a local band comprised of police officers. It was produced by **Jeff** and **Mary Gillilan**. . .

## NORTHWEST

*Pop Mechanix* was in Seattle's *Steve Lawson Productions* working with engineer **Bruce Calder** on their third album demo. The quartet completed a three-song demo in Studio C. . . Windham Hill artists *Coup d'etat* and *Allaudin Mathieu* were among the first to record in *Different Fur*'s newly redesigned Solid State Logic 4056 studio located in S.F. Also, **Patrick Gleeson** digitally recorded an independent album project entitled *Slide* with **Howard Johnston** engineering and **Mark Slagle/David Plank** assisting. . . At *Studio D Recording* in Sausalito, CA, **Preston Glass** was in co-producing several songs for an *Earth, Wind & Fire* reunion album with **Philip Bailey** and **Maurice White**. **Acar Key** engineered and **Jim Vereecke** assisted. . . At *Bear Creek Studio* in Seattle, local singer **Linda Waterfall** completed her fifth album and is looking forward to national distribution on the Flying Fish label. The album was engineered/co-produced by **Steve**

**Heinke**. . . At *London Bridge Studios* in Seattle, *The Machine* finished their EP and *Eternal Daze* completed their LP, with both projects headed for L.A. for mastering with **Peter Barnes**. . . At *SRO*, the San Francisco-based facility specializing in audio for video and film, Focal Point Productions' **Deborah Shames** finished her video docudrama on emergency dispatchers, *Anonymous Hero*. . . At *Rex Recording* in Portland, basic tracks were cut by *Quarterflash*, engineered by **Jack Barr**, produced by **Cal Scott**. . .

## SOUTHEAST

Activity at *New River Studios* in Fort Lauderdale includes a new LP by the *Everly Brothers*, produced by **Don** and **Phil Everly**, engineered by **Ted Stein**, assisted by **Dave Barton** and **Jim Thomas**. Also, **Stewart Copeland** was in recording music for the TV series *The Equalizer*, with **Jeff Seitz** engineering, assisted by Barton. . . *Emerald Sound Studio* in Nashville was the location for one of the "biggest" studio recording sessions in recent memory. MCA/DOT Records' *Riders In the Sky* draws a crowd wherever they perform, and they brought one to Emerald when they recorded their upcoming album. An audience of nearly a hundred was invited into the large studio to be a part of the "in concert" recording session. . . **Randy Kling** of *Disc Mastering* in Nashville, reports an influx of work in the area of preparation for compact disc mastering. His studio is currently completing seven instrumental Rounder Records projects for artists **Russell Barenberg**, **Jerry Douglas**, **Chet Baker** and **Christopher Mason**. . . At *Cotton Row Recording* in Memphis, **Nikos Lyras** has started production on **Ella Brooks'** upcoming album to be released on Quantum/MCA Records. **Eric Patrick** is second engineer. . . At *Air Studios* in Hendersonville, TN, *Whaling & Dryden* worked with engineer **Dave Cline** on their upcoming British influence LP, *Catch Her In The Rye*. . . At Atlanta's *Soundscape Studios* the local band, *Paper Dolls*, was in cutting and mixing their debut album on Sky Records, with **Rick Brown** producing and engineering. **Edd Miller** assisted. . . At *Criteria Recording Studios* in Miami, FL, the **Bee Gees** were in working on vocal overdubs for their upcoming Warner Bros. release slated for September. Engineering was **Steve Kimball** assisted by **Teresa Verplanck**. . . Capitol Records recording group **Sawyer Brown** completed tracks for a new album at *Muscle Shoals Sound Studios* in Sheffield, AL, with producer **Ron Chancy** and engineer **Les Ladd**. . . At *New Age Sight & Sound* in Atlanta producer/



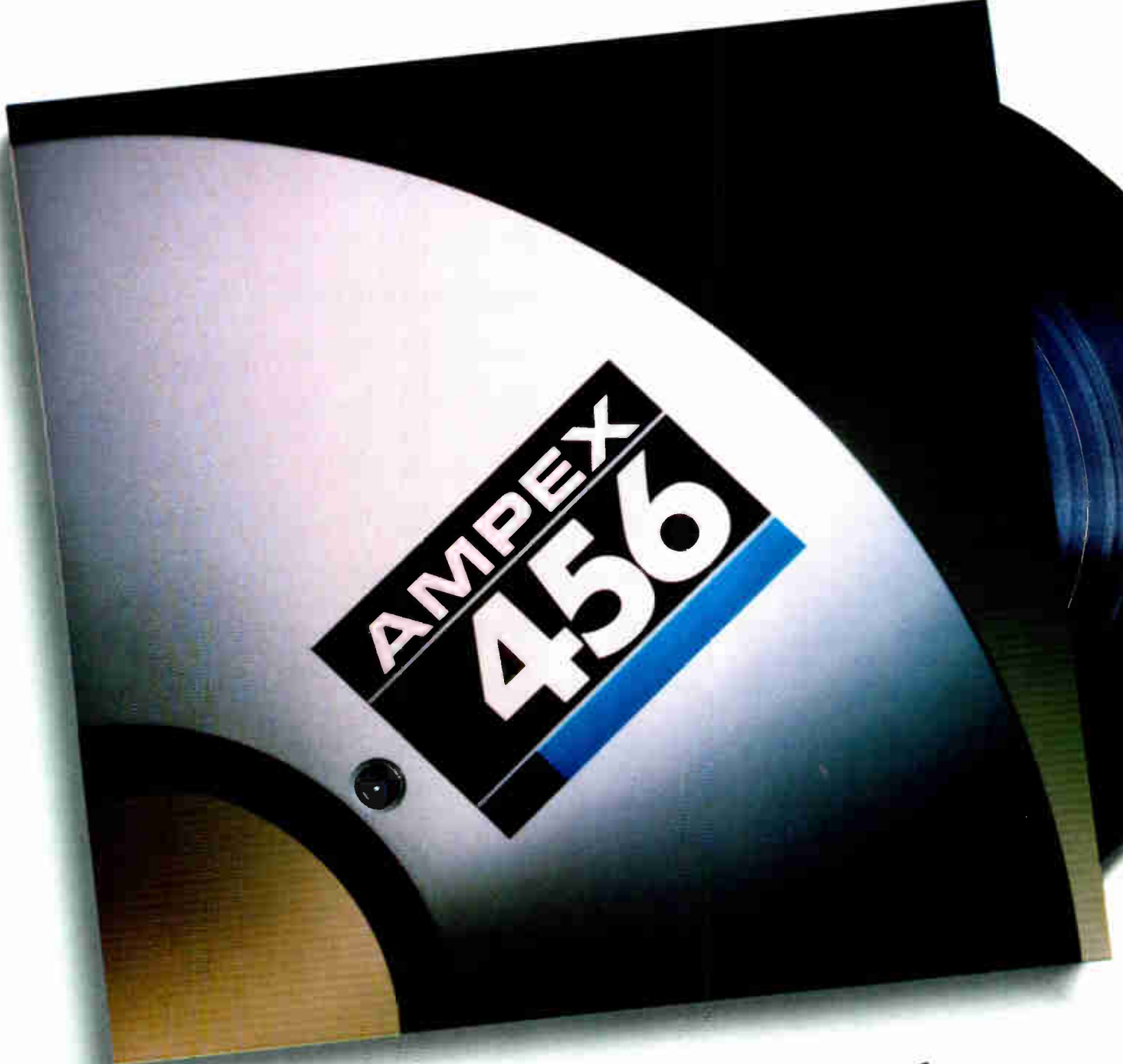

# Sign with a major label

When it comes to hitting the top of the charts, the choice is Ampex Grand Master® 456 studio mastering tape.

It's not surprising, when you consider that our continuing refinements allow Grand Master 456 to always deliver unequalled performance.

No other mastering tape provides such consistent quality and reliability, or commands such respect from musicians and studio professionals alike.

More top performers have signed with Ampex tape than any other tape in the world. While opinion may vary on what it takes to make a hit, there's no argument on what it takes to master one.

## AMPEX

Ampex Corporation, Magnetic Tape Division  
401 Broadway, Redwood City, CA 94063, 415/367-3809

Circle #007 on Reader Service Card



PHOTO: SARAH STEIN

**Kenny Rogers and producer Brown Bannister at Sixteenth Avenue Sound in Nashville.**

songwriter **Tim McCabe** digitally recorded "The Song of the Chattahoochee" with the Cobb Youth Choir for use as a promotional tune for Cobb County. It was engineered by **Bill Allgood**. . . The **Carolina Opry**, based in South Carolina, was in at **Reflection Sound** (Charlotte, NC) recording their show for an upcoming LP. The session was produced by **Jim Rhodes** and **Calvin Gilmore**, engineered by **Steve Haigler**. . . At **Polymusic Studios** in Birmingham, AL, **The Benz** cut tracks for an upcoming release with **William Brown**, **Andy Bray** and **Michael Panepento** flying the ship. . . **The Fabulous Thunderbirds** were in **Ardent Recording** in Memphis cutting tracks and mixing their latest Columbia Records album: **Hot Number**. **Dave Edmunds** produced, **Dave Charles** engineered and **Tom Laune** assisted. . . At **Sound Emporium Studios** in Nashville, independent record producer **Scott Tutt** has been cutting tracks on Music City's rockabilly-blues band, **The Dusters**, with **John D'Amelio** and **Gary Laney** at the board. . .

## SOUTHERN CAL/ HAWAII

At **West Oak Recorders** in Westlake Village, **Peter Wolf** worked with his wife **Ina** doing their own 32-track digital project, to be released by Warner Bros. Co-producing with Peter was **Dennis Lambert** with **Brian Malouf** engineering. . . **T.S.O.L.** cut tracks for their upcoming album at **Preferred Sound** in Woodland Hills. **Howard Benson** produced, **Jim Faraci** engineered, assisted by **Scott Campbell**. . . **Jinni Fontana** was in at **Carrera Studio** (San Bernardino) recording "Scrap Metal For Victory" for her album, **The Game of Love**, on Banana Records. **Gary Mraz** co-produced and **Steve Robertson** engineered. . . **The Bluesbusters** were recently at **Studio Ultimo** in West L.A. completing their new album with **Ricky Keller** producing, **Jimmy Mayweather** engineering and **Mitch Zeleny** assisting. . . Artist **Charlie Sexton** and producer **Keith Forsey** were in at **Larrabee Sound** in L.A. mixing Charlie's new song "In Deep" for **Beverly Hills Cop II**. **Greg Edwards** engineered with the help of **John Hegedes**. . . Artist **Marion McPartland** and her guests, **Patrice Rushen** and Grammy awardee **Diane Shuur**, were

in Hollywood's **Sunset Sound** recording live-to-digital 2-track for South Carolina Educational Radio's program **Piano Jazz**. Producing was **Sherry Hutchinson**, with **David Glover** engineering and **Brian Soucy** assisting. . . Producer **George Duke** was working at **Mama Jo's Recording Studio** (No. Hollywood) mixing a new **Miller Sound Express** commercial and the new **Soul Train** theme for **Soul Train Music Awards**. Engineer **Erik Zabler** was at the controls with **Steven Bradley Ford** assisting. . . **Jennifer Holiday** was recently in at **Group IV Recording** in Hollywood laying vocals for the soundtrack of the film, **In the Mood**. Engineer was **Dennis Sands** assisted by **George Belle**. **Gary Adleson** produced for Kings Road Productions. . . **Jackie Jackson** was in **JHL Studio** in Pacific Palisades cutting his new PolyGram album. Also, the **Manhattan Transfer** worked there on pre-production for their next Atlantic release. . . Producer **Bill Laswell** brought in **Iggy Pop** to do vocals on a new single by artist **Ryuichi Sakamoto** at **Lahaina Sound** in Maui, HI. This project was the first on the studio's new Sony Dash 3324 digital recorder. **Robert Musso** handled controls on the SSL, with **Dave Russell** assisting. . . At **Pacific Sound** in Chatsworth, **Marc Jordan** cut vocal, keyboard and guitar overdubs for his next album with producer **Kim Bullard**. The sessions were engineered by Bullard and **Scott Campbell**. . . **Producers 1 & 2** in L.A. had **Mark Isham** scoring **Made in Heaven** for Lorimar, engineered by **Ben Rodgers**, assisted by **Andy Harper**. . . At **Secret Sound** in L.A., **Chas Sandford** has been producing tracks for A&M recording artist **Maria Vidal**. He has also been producing and remixing two tracks for the upcoming solo album by **Roger Daltry**. **Gary McGachan** has been engineering with **Dave Axelbaum** and **Daren Chadwick** assisting. . . L.A.'s **Jesters Of Destiny** have been recording their second full-length album, **No Laughing Matter**, at **Fiesta Studios** in L.A. It's being produced by **Bruce Duff** and **Ray Violet**. . . **Bob Dylan** has been recording at **Sunset Sound** in Hollywood, doing tracks, overdubs and mixes on material for his self-produced new release. Contributing on Dylan's sessions have been **Randy Jackson**, **Steve Jordan** and **Danny Kortchmar**. Engineering is **Stephen Shelton**, assisted by **Brian Soucy** and **Jeff Musel**. . . **Nancy Sinatra** was in L.A.'s **Skip**

**Saylor Recording** cutting tracks with jazz artists **Don Randi & Quest**. **Sinatra** and **Randi** produced the sessions, with **Tom McCauley** engineering and **Joe Shay** assisting. . . At **Rumbo Recorders**, Canoga Park, recording artist **Marilyn Martin** was in tracking her new album, with **John Astley** producing, **Greg Droman** engineering and **Andy Udoff** assisting. . . At **Sound Image Studio**, North Hollywood, MCA artist **Randy Hall** was in cutting a track for his upcoming release with **John Henning** and **Conley Abrams** at the controls. . . At **Entourage** in North Hollywood, **Max Bennett & Freeway** have been busy recording their latest album in Studio A. . . At **Jake One Recording** in Burbank, Geffen artists **Guns & Roses** finished overdubs on their first album with **Mike Clink** as producer/engineer, assisted by **Micajah Ryan**. Also, producer **Andre Fischer** was in the room with artist **Brenda Russell**. . .

## NORTHEAST

At NYC's **Unique Recording**, **Dan Hartman** produced tracks for the soundtrack of the new Steven Spielberg movie entitled **Harry and the Hendersons**. **Joe Cocker** was in singing on one of the cuts, "Love Lives On." **Chris Lord Alge** engineered, **Matt Hathaway** assisted. . . At **Calliope Productions** in NYC **Kasey** was in recording an album with **Chris Irwin** co-producing and engineering. . . At **Beartracks** in Suffern, NY, **Spyro Gyra** worked on their 11th LP with producer **Jay Beckenstein** and engineer **Larry Swist**. . . At **Downtown Recorders** in Boston, **Aerosmith** was in to record overdubs for a new LP for CBS Records. **Paul O'Neil** produced, with **Jim Ball** at the board. Also **Nils Lofgrin** was in for guitar overdubs for the upcoming **Buddy Guy** album; **Joe Cuneo** engineering. . . At **Greene Street Recording** in NYC **LL Cool J** was in finishing his new Def Jam LP followup to his first LP **Radio**. Producer on the project was **Russell Simmons**; **Rod Hui** engineered. . . At **Media Sound** in NYC were producers **Steve Thompson** and **Mike Barbiero** working on dance mixes for **Whitney Houston**, **Aretha Franklin**, **Huey Lewis**, **Journey** and **Lionel Richie**. **Barbiero** engineered, with **Victor Deyglio** assisting. . . **The Storyboys** were in recording a five-song EP at NYC's **1212 Studios**. **Anthony Pipitone** mixed the project and produced it along with **The Storyboys**. **Mick Oszlewski** assisted. . . At **Azimuth Studio** in Newfield, NJ, the **Ben Vaughn Combo** completed their upcoming album, titled **Beautiful Thing**, with **Ben Vaughn** producing and **Mark Schultz** engineering. . . Producer **Nile Rodgers**, continuing his long running association with NYC's **Skyline Studios**, completed **Duran Duran's** platinum LP **Notorious**, engineered by **Daniel Abrahams**. In addition, **Rodgers** produced album projects for **Al Jarreau** and **Grace Jones**, both recorded and mixed at **Skyline** by engineer **James Farber**. Assisting were **Scott Ansell** and **Knut Bohn**. . . At **Z Studio**

—CONTINUED ON PAGE 119



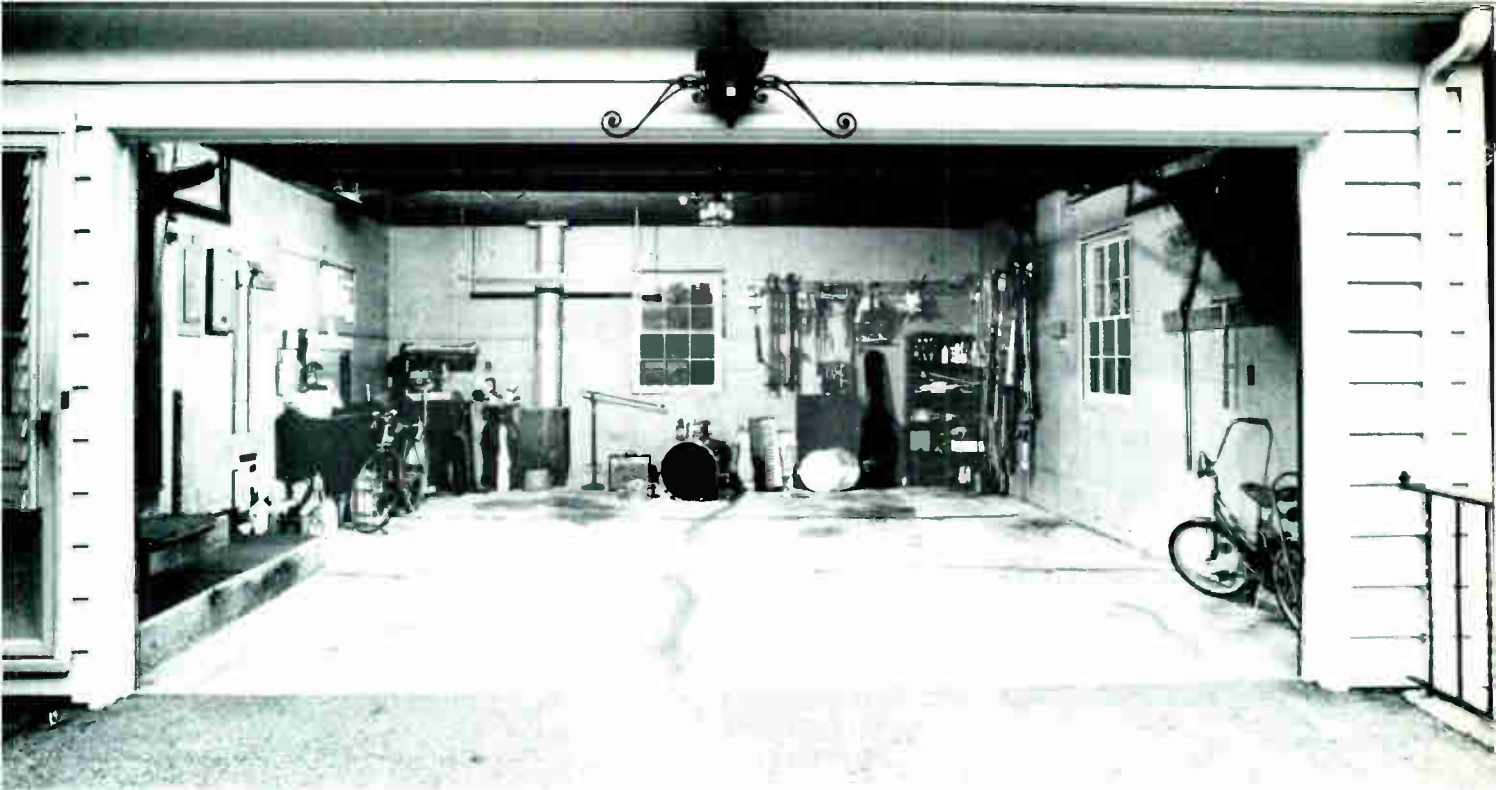

## We designed the Performer Series for studios with a low overhead.

People who spend half their lives waiting until they can afford studio time usually spend the other half trying to make professional recordings at home.

But nowadays, recording in less than totally professional surroundings ain't what it used to be — it's better. Especially when you apply the natural advantages of dbx signal processing to your music.

The dbx 163X Compressor/Limiter is a great place to start for professional sound. Let's say your synth bass patch needs bottom, but you can't add any more without losing definition on top. The 163X lets you get both, along with a punchier, apparently louder overall sound. dbx OverEasy® compression is not only gentle on the sound, it's incredibly easy to use. A single slider and "thumb adjust" level control provide the ultimate in hands-off/ears-on convenience.

At home, noise can be a major problem throughout

the recording chain. The dbx 463X Noise Gate Expander cleans up *all* of the accumulated noise before final mixdown. It's also versatile enough to create those special gated reverb effects found on today's recordings.

You want the vocals up in the mix, but you don't want to hear harsh sibilants (excessive "ess" sounds) or high-frequency distortion. The dbx 263X De-Esser lets you get crisp, detailed vocals that cut through the hottest mixes without any unpleasant side effects.

Now that tape machines (most of which use dbx noise reduction), mikes and consoles for home recording are better than ever, doesn't it make sense to complete the cycle with professional signal processing from dbx? After all, the better your demos are today, the less you'll have to wait until you can get your recording out of the garage and into the studio — where it belongs.

**dbx**®

Professional Products Division, 71 Chapel Street, Newton, Mass. 02195 617/964-3210



## APOGEE & DISCOVERY: New Approaches to Existing Technology

by Ken Pohlmann

Of course, Insider Audio strives to bring you the essential, inside information you need to keep fully informed of dealings in the fast-paced world of professional audio. This month, searching for the quickest pulse, newest angle, slickest idea, we go inside two diverse environments: digital audio tape machines, and a CD manufacturing plant. One offers an after-factory

hardware improvement, and the other offers an in-factory software improvement. Both are unprecedented.

Apogee Electronics Corporation of Santa Monica, California, has attacked a basic stumbling block of PCM digital audio tape recorders: the signal degradation introduced by the brick-wall anti-aliasing and anti-imaging analog filters found at the input and output of most machines (some delta modulation processors use more gentle input filters, and some PCM processors use more gentle input filters, and some PCM processors use over-sampling output filters). Apogee figured that some careful engineering could evolve filters with better specifications, and sonics. Owners of digital tape recorders could thus put new filters in place of the old, and derive an improvement.

The problems with steep analog fil-

ters are well-known: group delay, pass-band ripple, distortion and slew rate are principle among many. The problem, of course, is that the reason for having a filter necessitates having one hell of a filter: in theory, assuming a full bandwidth input signal, an anti-aliasing filter must attenuate below the resolution (over 90 dB) of the A/D converter, across the full audio band. The steep cut-off required to achieve



FIGURE 1

SPECIFICATIONS 944-G

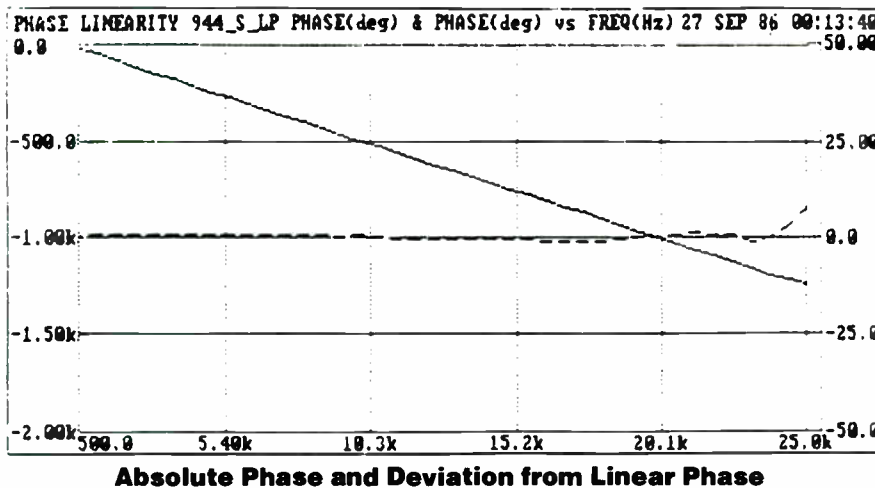
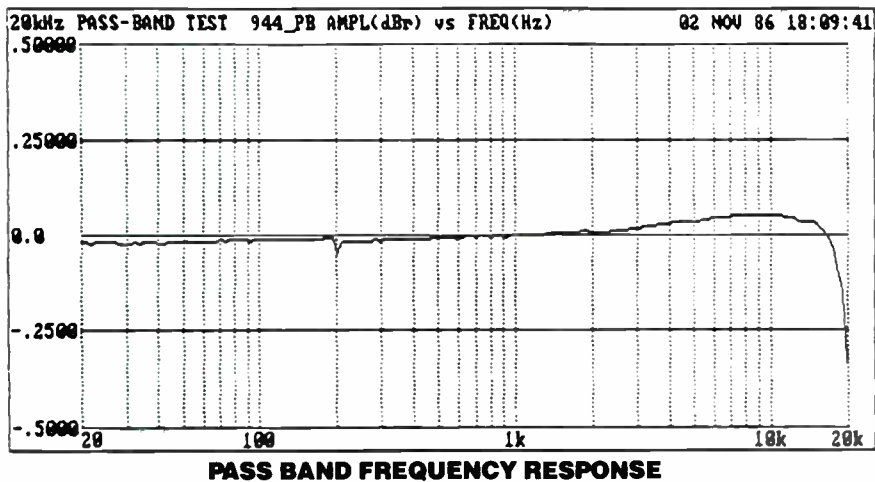

this almost inevitably leads to degradation.

Yet even in the conceptual realm the necessity of a brickwall anti-aliasing filter may be questioned. Real-world signals are not full amplitude, full bandwidth; it would be rare to find full amplitude signals above 10 kHz. In other words, potentially aliasing frequencies are already naturally attenuated, in many cases. Thus researchers such as Lagadec have questioned the use of such "macho" filters; perhaps as little as 40 or 50 dB of filter attenuation would suffice.

Of course, another way of helping the situation is simply careful attention to the design and construction of any filter. Component matching, low tolerances, attention to DC offset and stability with respect to temperature all add up to better performance. With these and other ideas in mind, Apogee set out to build a better filter.

Apogee developed two low pass filters, the 944G and 944S, with G denoting "gentle cutoff" and S denoting "sharp cutoff." The 944G filter is an inverse Chebyshev filter with attenuation of approximately 40 dB at 30 kHz. Deviation from linear phase is  $\pm 5$  degrees from 20 Hz to 20 kHz. Group delay is 142 microseconds. Pass band ripple is claimed negligible. Fig. 1 shows pass band frequency response, and absolute phase and deviation from linear phase.

The 944S filter is an elliptical filter



**PRO-Verb**  
The Leader  
in Digital  
Reverberation.

- 100 Presets
  - 50 Natural Reverb
  - 10 Gated Effects
  - 10 Reverse Effects
  - 10 Chorus Effects
  - 10 Echo Effects
  - 10 Delay Effects
- 1 High Rack Mount Case
- Professional Phone Jacks
- Midi Interface
- Wide Range of Algorithms



It Has To Be A Word Of ...



Applied Research & Technology  
215 Trenton Street  
Rochester, New York 14608  
315-436-2320  
Telex: 4548793 ARTROC

Circle #008 on Reader Service Card

# Westlake Audio

Continuing to earn the privilege

of supplying the equipment for your technical creativity!

A partial listing of recent deliveries to customers who received the best products, on time . . . at the fairest prices.

- **PREMORE Inc.**, North Hollywood (video post production) Sony PCM 3324-24 track digital recorder. Sony PCM 1630-2 track.
- **TREVOR RABIN & PAUL DE VILLIERS** (Producers/Writers/Artists- "Yes!", "Mr. Mister") Sony PCM 3324-24 track digital recorder
- **FDS LABS**, Hollywood (Hank Waring-analog and digital mastering) Complete CD mastering system comprised of Sony PCM-3202, Sony DAE-1100 Digital Editor, DMR-4000(2) & DMR-2000 Digital Master Recorders, PCM-1630 Digital Audio Processor, DTA-2000 Digital Tape Analyzer, and other peripheral gear
- **MODERN SOUND**, Hollywood (video & post production) Trident Series 80B, 30-input mixing console, Sony JH-24-24 track analog recorder, Sony MXP-3000 32 input mixing console, Westlake BBSM-12 monitor systems
- **THIRD WAVE RECORDING**, Torrance, CA (audio recording and post production) Harrison 40-input "Raven" mixing console, Sony JH-24 analog recorder
- **MICHAEL HONIG** (film & album producer; "Jewel of the Nile", "Koyani-sqaati") Soundcraft TS-24 mixing console with Sony JH-24 multitrack recorder
- **CANNON FILMS**, Los Angeles (production and post production for films and video) 1-Sony MXP 3000, 36 input completely automated mixing console, 1-Sony MXP 3000 20-input console
- **WORLD WIDE CHURCH OF GOD**, Pasadena (Ambassador College & Auditorium) 3-Sony MXP 3000 (36 & 20 inputs) mixing consoles
- **KCET-TV**, Los Angeles (TV Station) Sony MXP 3000 36 input mixing console
- **JAMES NEWTON HOWARD** (solo artist & producer) complete studio and acoustic consultation. Equipment including Sony JH-24, Soundcraft 2400 console and peripherals.

**(213) 851-9800**

**Westlake Audio Professional Equipment Sales Group**  
7265 Santa Monica Boulevard  
Hollywood, CA 90046

with attenuation of approximately 85 dB at 30 kHz. Audio band phase deviation is  $\pm 5$  degrees; group delay is 234 microseconds; pass band ripple is  $\pm 0.05$  dB. Fig. 2 shows pass band frequency response, and absolute phase and deviation from linear phase.

With a choice of filter characteristics, a user may select the combination which performs best, for any given program material. A 944S on both the input and output would essentially duplicate the characteristic found in factory tape machines; with the added benefit of greatly reduced dispersion and ripple, and increased slew rate. However a 944G could be used on the input in cases where aliasing does not occur or is not objectionable. In particular, Apogee feels that the 944G can be used safely with 48 kHz sampling, but 44.1 kHz is more critical. Whichever filter is used on the input, Apogee recommends a 944S on the output; downstream equipment can be sensitive to image spectra and other hash, thus a steep output filter is required. In equipment already using oversampling filters to remove image spectra, either a 944G or 944S may improve the anti-aliasing filtering, re-

sulting in high quality throughput indeed.

To find out just how much difference a filter can make, I talked with Apogee principal Bruce Jackson (better known, at least anonymously, to millions of fans as Springsteen's live engineer). Both filters, and their combination of use, were developed with extensive critical listening tests. Apogee used a wide variety of sound sources including some of the toughest (piano notes and chords, chimes, finger cymbals, keys rattling) with a variety of microphones and console preamplifiers. In particular they discovered that the phase distortion of some preamplifiers tends to mask the subtleties of filter design. Not surprisingly, a high quality microphone preamplifier plugged directly into the tape machine yielded the best conditions for critical evaluation.

The 944G filters on both input and output yielded preferred results, perhaps due to its phase linearity extending beyond the audio band into the stop band, and influencing harmonics in the filter roll off. To completely eliminate image spectra, a 944S is

—CONTINUED ON PAGE 202

**FIGURE 2**

SPECIFICATIONS 944-S

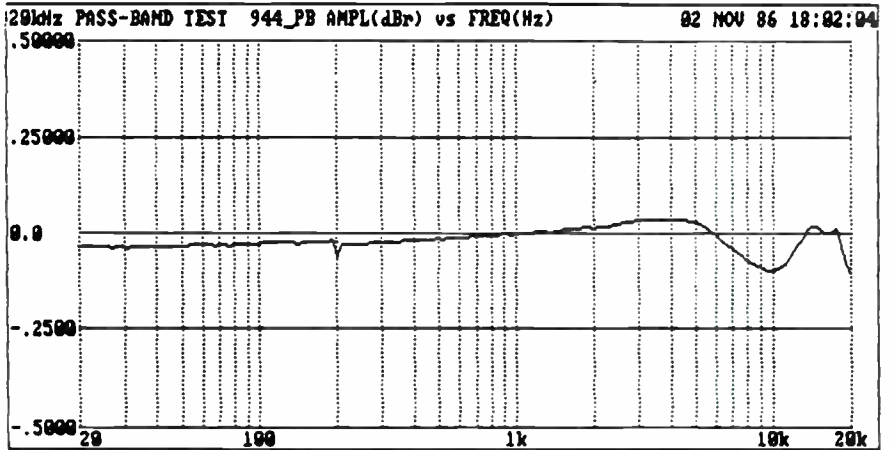

**PASS BAND FREQUENCY RESPONSE**

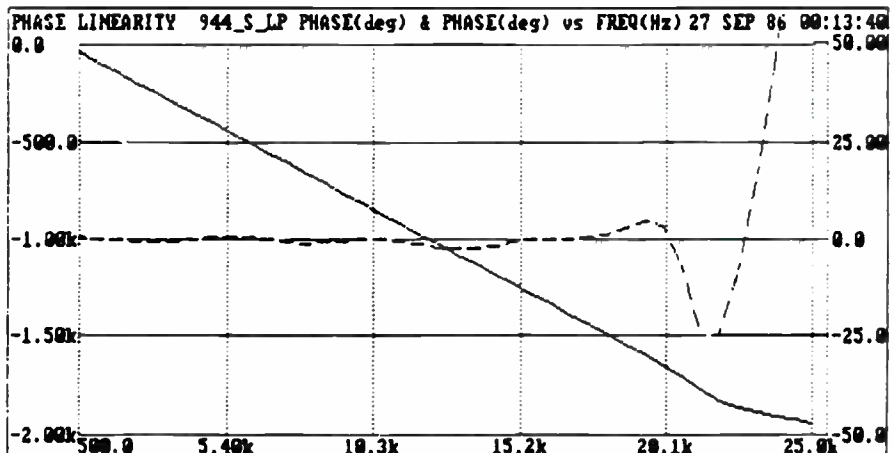

**Absolute Phase and Deviation from Linear Phase**



# OUR NEW EQ SOUNDED GOOD HERE...



The "Bothy" at the bottom of our garden is where we work on advancing console design concepts.

In there the latest improvement to the sonic performance of our consoles — the new EQ — was initially developed.

But we didn't stop there. We took the EQ into our own fully equipped 48 track studio where we tested it and analysed it, but most important of all we listened to it — exhaustively.

It's just one example of the way we continue to enhance the sound of the SL4000 E Series Master Studio System to keep ahead in the technology race. And if you already have an SL4000 E Series you can stay ahead too, as the new EQ is easily retrofitted to all existing consoles.

There is also a new SSL Studio Computer, the G Series, which with its fast processors and vast data storage capacity enables processes that used to take minutes, to be carried out in seconds. The G Series too is fully retrofittable.

With these improvements, and more to come, shouldn't you be using the only totally integrated audio mixing system in the world?

**...AND SOUNDS**  
**EVEN BETTER**  
**HERE**



## **Solid State Logic**

Oxford • Paris • New York • Los Angeles

Begbroke, Oxford, England OX5 1RU • (08675) 4353

1 rue Michael Faraday, 78180 Montigny le Bretonneux, France • (1) 34 60 46 66

101 Park Avenue, Suite 2506 • New York, NY 10178 • (212) 315-1111

6255 Sunset Boulevard • Los Angeles, California 90028 • (213) 463-4444

# QUALITY

*the process begins  
here...*



**A**t OSC, quality is a combination of design, development, manufacturing and distribution, all working from conception to application. It is the process of listening to our customers' knowledge, tailoring that knowledge to their needs and delivering the product they expect and deserve. It is believing in our people and giving them the resources to do their jobs best. And always, it is continually improving ourselves and our performance.

**At OSC, quality is the process.**

Circle #010 on Reader Service Card

OSC Audio Products, 1926 Placentia Ave., Costa Mesa, CA 92627 • 714-645-2540

World Radio History

**OSC**

EXTRUSION END  
SEE SHEET 1 FOR EXTRA INSTRUCTIONS  
ALIGN TO PUNCHING FIXTURE  
BURN/DRAWN SHARP EDGES  
WALK SCREEN FINISH  
RECT HOLES TO FIT TH-4  
CONNETIC BLEPPERS, PLASTIC  
WITHOUT VISIBLE MARKS  
TOP, MUST ACCEPT PRINT  
BOTTOM FREE OF MAJOR  
PRINT AFTER PRINT IS APPLIED.



# STUDIO VIEW

by Tony Thomas

The new tax law has many in the business community very worried, and understandably so. Its overall effect on most industries cannot be predicted, yet its implications are ominous. The rationale behind the new law is relatively simple—shift the tax burden from the individual taxpayer to business and industry—a shift that many legislators feel will create a new tax base equilibrium that has never before existed.

In theory, this law will bring an aura of fairness to the entire tax system, since many large companies have been paying no taxes at all, while most individuals have to pay at least some tax. The reason for this is that Congress has attempted to bolster industrial growth primarily through tax incentives, a policy that at the time seemed good, but after considerable analysis, was deemed to be flawed. Instead of encouraging increased productivity and growth, tax incentives often produced wastefulness, since many companies made investments based solely upon their ability to offset taxes.

While it's still not clear whether this massive tax reform effort will be successful, two things are absolutely certain: it's here and we'll all have to live with it. What does the new law do? First of all, it eliminates the coveted Investment Tax Credit, as well as write-offs of sales taxes. But that's just the tip of the iceberg. Business losses can no longer be used to offset income from other sources. A business must now be profitable three years (vs. two under the old law) out of every five. And there really is no such thing as a free lunch—business entertainment and meal expenses are now only 80% deductible. Many other aspects of tax law have also changed. As a result, you should contact your accountant as soon as possible to determine their effects on your studio.

How will the new law affect the average studio owner? To find out, *Mix* spoke with Dwight Cook, president of CookSound Productions, Inc., a full-service recording studio and production company in Houston. Cook, a veteran broadcaster, established CookSound in 1976 as a broadcast commercial production facility to accommodate his growing advertising client-

## NEW TAX LAW

### A STUDIO OWNER SPEAKS OUT

tele. His company has since expanded to include four studios, from 4- to 24-tracks, specializing in motion picture audio post-production, A/V, jingle production, original music production, and of course, commercial production. Recent projects produced there include the feature film *Soul Man* and the upcoming *Red Duke Story* for Tri-Star Television.

**Mix:** Could you give us an overview of the new tax law and the effects it



Dwight Cook

may have on the recording industry? **Dwight Cook:** First of all, I want to stress that I'm a layman and not a tax expert, so I would advise your readers to seek competent advice from a CPA before jumping to any conclusions based upon my comments. As for the law itself, for the first time, the federal government expects us to make money on every piece of equipment we buy. Years ago, you would buy a console just because you liked it and wanted to have your picture taken standing next to it. Now, the law works against you if you are planning to do something like that. A new piece of gear has to start earning money from day one for it to be a profitable investment. Basically, now it's structured so that you pay a minimum tax as a corporation and it's imperative that you show a profit. They have also limited a lot of things that you can legally deduct as business expenses.

**Mix:** Do you think that the new law is going to make most studios run more efficiently and make them more profit oriented?

**Cook:** Well, anybody who wants to be in the recording business is certainly going to have to do their homework in the future. It is interesting that this business is one of the only businesses that people get into without knowing anything about it. From now on, if a studio is already established and considering a major purchase, they are going to have to project if that piece of equipment is going to give them a return on the dollars they are investing. If not, they are not going to be able to show a big loss and have Uncle Sam bail them out.

It used to be great, to be honest with you, to make major purchases and to be able to take advantage of the Investment Tax Credit. But no more. With the ITC, it was almost as if Uncle Sam was your business partner and he would give you just a little push to get you off the mark. Nobody in the business, that I know of, is really worried about buying something that they really need, like a new console or a multi-track machine. As long as they are able to substantiate that, over a period of time, a piece of equipment is necessary to their operation, then that's well and good. In the past, if there was some doubt, you would buy it anyway.

*Editor's note: For a clear understanding of how the tax laws can affect your studio, consult your accountant.*

Another thing that the tax law is going to do is require that the studio owner buy pieces of equipment that are practical, and not necessarily the latest whiz-bang pieces of technology. They are going to have to help you do the job better and make a profit. To me, without the ITC, you've got to hit the ground running with any piece of gear that you get. When you install it, you'd better be billing it from day one.

**Mix:** Does this mean that studios are going to have to build their operations around bona fide profit centers?

**Cook:** Well, at our studio we have several different profit centers. We have our own production company

---

"As far as the IRS is concerned, if you are going to have a business, you had better run it as a business."

---

that provides creative services such as producing radio spots, television soundtracks, original music and even complete films, including the video aspects. That's one part of our business. Then, there is the studio end,

tape duplication, equipment sales and sales of tape and supplies. So, we do have all those different profit centers. Some areas require more reinvestment than others. For example, our production company is requiring more and more sophisticated gear all the time. In certain cases, if it doesn't make sense to do a project in our studio, we'll go out and rent another facility. If we use that facility enough, it makes sense to build it in-house. I would love to be in the position to build a studio and not have to touch it for ten years, but given the technological climate of this business, that's impossible.

**Mix:** Do you see any positive aspects of the new law?

**Cook:** Yes. The manufacturers of major pieces of equipment I've talked to have been concerned for some time that the new law would have a detrimental effect on their sales, and I think in some ways it has. As a result, they are having to be much more helpful than they've ever been. They are not only having to help you figure out how you can afford to buy a piece of equipment, but how to make it hit the ground running from the day you buy it. I find that very exciting.

**Mix:** Now that the government is not going to help subsidize recording studios through tax credits and write-offs, what operational guidelines would you recommend?

**Cook:** I think that, in the past year, I've seen many studio owners backing off of major purchases. They are really thinking: "Well, should I buy this or not?" Anything we buy from now on is going to have to make sense from a profit standpoint. We're going to have to determine who is going to use each piece of equipment and how often. What will it allow us to do that we couldn't do before? Then we can plug in those kind of figures into our formula and compare them with the industry norms and figure out its relative profitability. If there is a base to support it, then it makes sense to go ahead and buy it. What it boils down to, as far as the IRS is concerned, is that if you are going to have a business, you had better run it like a business. You can no longer run it like a tax shelter. Any studio that has been running at a loss is going to have to be concerned at this point. You are going to have to show a profit. Frankly, the IRS has taken some of the fun out of owning a recording studio. ■

*Tony Thomas is the managing director of Target Communications Intl., an ad agency, broadcast production firm and recording studio.*

## WHERE DREAMS BECOME REALITY

Every studio starts out as somebody's dream. Whether it's an old two-track Roberts w/X-Field heads or a 32 track Digital Mitsubishi, the dream is there — to capture that most elusive of moments, the pure sound of music. As the dream takes shape, the equipment changes to fit the new directions — even the direction can change to take advantage of some new piece of equipment. Concepts, which were once impossible, become real. And through it all the dreamer wanders, spreading magic.

At Ross, we believe in dreams and magic. Our dreams take the shape of new products and ideas for the music industry. Occasionally an idea surpasses its original goal by such a wide margin that it changes the lives of the people touched by it. Ross is proud to introduce just such a product — **The Mic**. **The Mic** is a large studio microphone, 2½" in diameter and 8¼" long, with an 8 point suspension/isolation system.

**The Mic** has 4 switch-selected patterns; Cardioid, Omnidirectional, Hypercardioid, and Bipolar (or Figure 8). **The Mic** has 4 switch-selected positions; Flat, 50Hz Rolloff, -10dB pad, and Both (Pad and Rolloff). **The Mic** is flat from 10Hz to 18,500Hz. Dual Condenser elements are powered from an internal 9V supply or an external 48V Phantom supply. **The Mic** comes in a fitted hardwood case and has a suggested price of \$349.

If you need a professional quality microphone to improve the sound of your recordings, there is no finer microphone available at this price. Please try it against the finest microphone you have. We think you'll be amazed. **The Mic** — where dreams begin.

The Mic is a registered Trademark of ROSS

PO Box 2344 Fort Worth, Texas 76113-2344 Phone (817) 336-5114 Telex 163203 IMCTXUT FAX (817) 870-1271

Circle #011 on Reader Service Card



# Martin Music Technologies isn't for everyone.

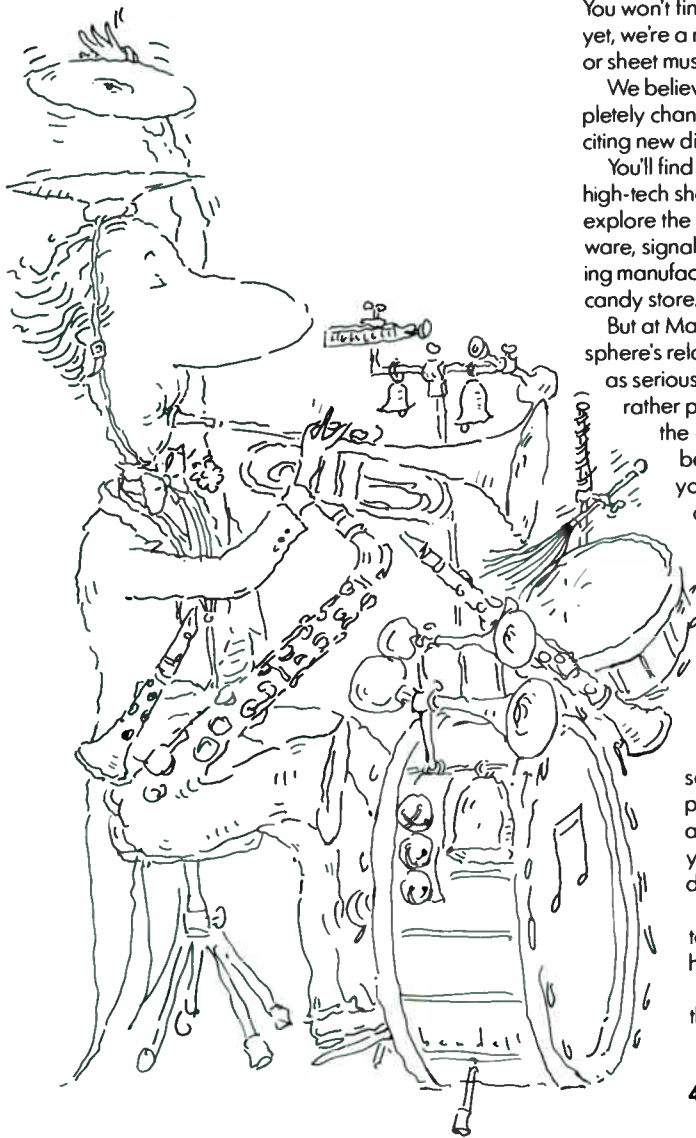

You won't find violins, saxophones or spinets at Martin. And yet, we're a music store. You won't find guitar strings, drumsticks or sheet music, either. And yet, we're a music store.

We believe the very definition of a music store has completely changed today, thanks to microchips, MIDI and the exciting new directions of electronic instruments.

You'll find that kind of excitement in our handsome new high-tech showroom and MIDI demo studio. Here, you can explore the latest synthesizers, samplers, computers, software, signal processors and recording equipment from leading manufacturers. In fact, you may feel a bit like a kid in a candy store.

But at Martin, we'll never treat you like one. The atmosphere's relaxed and professional, so we can take your music as seriously as you do. You'll be guided by a small and rather personable group of experts who'll offer you all the attention you'll need. And when you're ready to be encouraged towards a purchase, they'll quote you prices that are also encouraging. Very encouraging.

Our service doesn't stop with the sale, either. Martin's Product Specialists are always available to tell you how to get the most out of your equipment. And should the equipment itself ever appear at fault, the expert technicians in our in-store Service Department will help set things right.

Martin even sponsors a continuing series of in-house seminars in Synthesis, Sampling, Signal Processing and Recording to help you keep up with the latest developments.

If all this sounds too good to be true, it's only because you haven't been here yet.

So come and see the music store that's not for everyone.

It's for you.

423 WEST 55 STREET NEW YORK, N.Y. 10019-4490

(212) 541-5900



Circle #091 on Reader Service Card

World Radio History

The Shure SM81 cardioid condenser mic includes a built-in -10 dB pad and a three-position bass roll-off switch.



# MICROPHONE TECHNIQUES FOR SAMPLING

by George Petersen

Whenever anyone mentions microphone techniques in the studio, strong opinions by studio pros are offered on this highly subjective topic. Yet today, engineers are just as likely to reach for a favorite box of sample-laden diskettes or EPROMs as they are to open the mic locker when trying to achieve that "ultimate" drum sound. An example of this happened recently, when an associate of mine, a widely respected engineer, recommended AKG's D-112 kick drum mic to another top engineer, who wasn't interested in checking it out, because he had a kick drum sample he liked and only used drum mics to trigger samples.

All of this serves to illustrate another related point—the need for proper microphone techniques when collecting samples. Whether stored on floppies, hard or optical disks, interchangeable chips, cartridges or internal memory, a sample's quality is limited by the quality of the mic, preamp and sampling system used. We talked to a number of samplists who all emphasized the importance of paying attention to the basics of mic techniques and selection when sampling, whether using a \$125 Casio SK-1 or a \$125,000 Synclavier system.

"I'm a great believer in using the best mic possible to get the best possible sound," explains Stuart Allyn, an engineer/producer for jingles and albums in New York City. "Getting the best possible samples requires using really good microphones in as close-to-ideal situations as you can. I tend to use mostly the Sanken CU-41 and the Bruel & Kjaer 4003s. I'll use whichever mic is right, or sometimes I'll use both, if I want some close-up and some ambient sound.

"I own a lot of microphones—about 300—and I'll use anything for a sample that I'd normally use for a recording. The only difference is that I'm usually a little extra cautious about the noise in a sampling situation, because the signal is going through extra generations, and samples are often used more than once, especially with drum and percussion things that repeat over and over during a song. The Sanken and the B&K are among the quietest microphones made, so I opt for those, but I'll grab anything—[AKG] C-12s, [Neumann] M49s, RCA ribbons—depending on what I'm after. Pay a little more attention to your mic selection, because if this is one sample that is repeated 50 times, you don't want it to be wrong. There's nothing worse than hearing a bad sample over and over again."

Bill Cavanaugh, in charge of the Synclavier system at Solar Studios in





## The new SM96. When you don't want home studio tapes to sound homemade.

Your recordings are only as good as the mic you use. Why hurt your chances of selling your song by using an inferior microphone?

### **The first affordable studio-quality vocal condenser microphone.**

The SM96 is especially designed for home studios. It captures vocal subtleties ordinary mics can miss. So the tapes you produce sound crisper, punchier, and smoother.

We've even built in a three-stage pop filter and a precise bass rolloff to compensate for the proximity effect of a close-miked vocal. And, our unique 3-point space frame shock mount totally isolates the SM96 from mechanical noise pickup. Your tapes will sparkle with a sound quality that you would expect only in

professional studio recordings.

### **Works with or without phantom power.**

The SM96 is the first microphone of professional caliber which can be powered by a readily available 1.5 volt AA battery. So you can have the silky-smooth sound of a top quality condenser mic even if your equipment doesn't have phantom power. And you can use the SM96 on stage with any mixing board.

Can you afford to make the modest investment in this remarkable new microphone? If you're serious about your music, a better question is, can you afford not to?

Shure Brothers Inc., 222 Hartrey Ave., Evanston, IL 60202-3696. (312) 866-2553. G. S. A. approved.



# RACKMAX

FOR HIGH PERFORMANCE APPLICATIONS REQUIRING UP TO 16 INPUTS, STUDIO CONSOLE SPECIFICATIONS, IN A PORTABLE, RACK MOUNT DESIGN... THERE IS ONLY ONE RACKMAX

- 16 input channels in a 19-inch rack.
- Velvet-glide 100mm faders
- 48 volt phantom power – switchable each channel.
- Complete solo system.
- 3 auxiliary sends per channel – all jumperable.  
Pre EQ  
Post EQ/pre fader  
Post fader
- EIN: < -128 dBv  
THD: 0.05% any input to any output  
Frequency response: ± 0.5 dB 20 Hz to 20 KHz

**RACKMAX is now available for your review at your favorite Biamp dealer.**

**biamp** AMERICAN SOUND CRAFTSMANSHIP  
Biamp Systems, P.O. Box 2160, Portland, Oregon 97208 (503) 641-7287

Circle #013 on Reader Service Card



*High-end studio condenser mics, such as the Neumann U89 (left) and the Sanken CU-41 (right), are popular choices for sampling applications.*

Howell, New Jersey, has worked on projects ranging from Devo's first film to TV commercials for national clients such as TRW, Glidden and GE. At press time, the studio had ordered two additional Synclavier systems, showing their obviously strong commitment to sampling technology.

Cavanaugh's favorite mics for sampling are "contingent on a lot of things, but range from a Shure SM57 to a Neumann U87, or an AKG C-414 or a Neumann KM84 or KM83, depending on the sounds I want to capture. If I'm doing percussion, I may find myself with a Sennheiser 421 or Shure SM57 on snare, or even an 87, depending on the drum and the person playing it. I also like using the Shure SM81 on percussion: it's one mic I've never been able to blow over.

"For a brass sample, I'd go to a high-end condenser, like a U87, but if I want

a trombone or trumpet with a very loud note or in the bell, where I can't pad the U87 down far enough, the SM81 works very well. I like the U87 on brass sections and the old AKG C-12 is great for horns and vocals, because the Synclavier samples are so accurate and clean, and the C-12 'warms' up the sound of vocal samples. When you get into the digital domain—especially with a Direct-to-Disk™ system—you really have to be careful about the sounds you put in. It's amazing how quiet that system is."

"Loopologist"/engineer/sound designer Tom Metcalf has been responsible for most of the sounds in the Ensoniq Mirage sound library, and by the quality of the stock samples coming out of that 8-bit system, he must have developed some very good methods of gathering samples. "I rely a lot on the engineers at the studios



Combining quality philosophies with new manufacturing methods brings greater choice. In the past, affordable consoles were limited to a narrow range of options. T.A.C. have changed all that. We bring the philosophy of choice together with a competitive pricing policy and an outstanding manufacturing quality. We offer many advantages of a custom console builder with our product range. There are now at least 52 versions of the TAC scorpion, including the new XPB jackfield version. And if a split monitor console is not to your liking, the TAC Matchless series offers an In-Line console with specifications proven in over 200 installations worldwide.

# TAC

## SOUND ENGINEERING

## SCORPION



- Steel Chassis
- 8, 12 or 16 Buss
- 4 or 8 Aux Sends
- Split Monitor Console
- 8, 16 or 24 Track Monitoring
- Comprehensive TT Patchbay
- Printed Circuit Motherboard
- 4 Band Semi Parametric Equaliser
- Wide Variety of Configurations and Options

## MATCHLESS



- 24 Buss ■
- 8 Aux Sends ■
- 2 Mute Groups ■
- 8 Effects Returns ■
- 8 Audio Subgroups ■
- 24 Track In-Line Monitor ■
- 26 + 36 Input Frame Sizes ■
- 19" Switchcraft TT Jackfield ■
- 4 Band Semi-Parametric Equaliser ■
- Dual Signal Paths on Each Input Module ■

World Radio History

# TAC

TOTAL AUDIO CONCEPTS

Sales and Factory  
**TOTAL AUDIO CONCEPTS**  
 Unit 17 Bar Lane Industrial Park  
 Bar Lane, Bostord,  
 Nottingham NG6 0HU  
 Tel 0602 783306

In the USA  
**AMEK CONSOLES INC.**  
 10815 Burbank Blvd.  
 North Hollywood, CA 91601  
 Tel 818 508 9788  
 Telex 662526 AMEK USA

# Behind Every Synclavier<sup>®</sup> There's a Success Story



## Profile: André Perry

C.E.O. and Chairman of the Board of **The André Perry Group** and **Le Studio**

Visionary producer André Perry heads one of the most sophisticated music and video production facilities in the world. Located in a beautiful and secluded Quebec setting, LE STUDIO and THE ANDRE PERRY GROUP have proven that, with the right personnel and equipment, a studio doesn't have to be in a major urban center to stay on top. With his facility constantly booked, it's clear that André's philosophy of total service has paid off. Recent projects range from network TV series to records and videos by such leading artists as Chicago, The Bee Gees, David Bowie, and The Police.

He comments on the success of his first Synclavier Digital Audio System and his future plans: "The Synclavier was so simple to learn and use that two weeks after installing the system we did the music and sound effects for a major network Movie of the Week. It's been so cost-effective that we're already ordering a second system for our new Washington, D.C. facility."



Circle #014 on Reader Service Card





*Tube mics, such as this AKG C-12A, emphasize even harmonics and can add a "warm" sound to digital samples.*

where we work," explains Metcalf, who uses a number of different facilities in the Philadelphia area. "Since those engineers are familiar with the room and know the selection of mics they have available, they can save a lot of time, but the bottom line is me sitting in the control room and listening to see if it sounds right. There's no magic to it. To me, the microphone is only a small piece in the puzzle of getting a good sample.

"Since the Mirage is a mono sampler, a lot of times we'll split what's going into the [Sony PCM-]F1 we use for all our master recordings, with close miking on one channel and an ambient mic on the other. This way, I can later mix the two sounds to get the one I want. Especially with orchestral and medieval instruments, it doesn't sound like the instrument in the room if you only use one mic. I also mic key clicks and add some of the instrument's mechanical noise into the sample, or I may add a second mic up near a mouthpiece to get a breathier sound. You have to use your ears, play a lot of games, and not be afraid to try things that may seem ludicrous."

However, not all sample collecting is limited to the cushy confines of a plush studio control room, and one of Metcalf's most difficult encounters in assembling the Mirage sound library was getting a good pipe organ sample. "We went to this old church in Philadelphia to record this humungous, custom-built pipe organ," he recalls. "We were in a much less than perfect environment, with a lot of traffic noise and the organ had a fair amount of motor noise, yet once you got above the noise floor of the motor, it sounded great. We solved the problem with a lot of ambient miking, with

# SCHOEPS

Colette series with interchangeable capsules for a variety of applications.



## Get the Iron Out!

Since more than 10 years,  
Schoeps has got the transformer out of the microphone.

— Contact —

- AUS Klarion Enterprises Pty. Ltd. P. O. Box 379, South Melbourne, Victoria, 3205, Tel.: (03) 6135 441
- A Studer Revox Wien Ges. m. b. H., Ludwiggasse 4, 1180 Wien, Tel.: (02 22) 47 33 09
- B Heynen B.V., Bedrijfstraat 2, 3500 Hasselt, Tel.: 011-21 00 06
- BR Centelec Equipamentos e Sistemas Eletrônicos Ltda., 20561 Rio de Janeiro/R. J., Tel.: (021) 268-79 48
- CDN Einova Ltd., 4190 Rue Seré, St.-Laurent, Québec H4T 1A6, Tel.: (514) 341-6933
- SF Lounamaa Electronics Oy, Uimarinpolku 27 A, 00330 Helsinki 33, Tel.: 90-488 566
- F ELNO S. A., 18-20, rue du Val Notre-Dame, 95100 Argenteuil, Tel.: (1) 39.82.29.73
- HK Audio Consultants Co., Ltd., 58 Pak Tai Street, Tokwawan, Kowloon, Hong Kong B. C. C., Tel.: 3-712 52 51
- I FDS - Tecnico del Suono S. r. l., Piazza Crivellone, 5, 20148 Milano, Tel.: 46.96.105
- IL Kolinar Ltd., 18 Ha'arba'a Street, Tel-Aviv, Tel.: 03-263298
- J Imai & Company Ltd., 1-6 Tomihisacho, Shinjuku Tokyo, Tel. (03) 357-0401
- NL Heynen B.V., P. O. Box 10, 6590 AA Gennep, Tel.: 08851-56111
- N Siv. Ing. Benum A/S, Boks 145 Vinderen, Oslo 3, Tel.: (02) 14 54 60
- P G. E. R. Av. Estados Unidos da América, 51-5°, Dto. 1700 Lisboa, Tel.: 88 40 21
- E Singleton Productions, Via Augusta, 59 Desp. 804 - Edif. Mercurio, Barcelona-6, Tel.: 237 70 60
- S NATAB Akustik AB, P. O. Box 6016, 55006 Jönköping, Tel.: 036-14 24 80
- CH PAJAC - Jaques Zeller, Morges 12, 1111 Echichens, Tel.: 021-72 24 21
- GB Scenic Sounds Equipment Marketing Ltd., 10 William Road, London NW1, Tel.: 01-387 1262
- USA Posthorn Recordings, 142 West - 26th Street, 10th Floor, New York City, N.Y. 10001, Tel.: (212) 242-3737

Schalltechnik Dr.-Ing. Schoeps GmbH,

Postbox 410970 D-7500 Karlsruhe, Telex 7826902, Tel. (0721) 42016/42011

Circle #155 on Reader Service Card

# Diskmakers

**DISKMAKERS  
MAKES THE  
RECORD  
PRESSING  
BUSINESS  
EASY FOR YOU...**

**DISKMAKERS  
DOES IT ALL!**

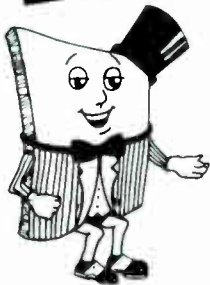

we  
handle the  
jacket  
design,  
printing

and  
color  
seps...



we  
handle the  
pressing  
along with  
mastering,  
plating and

record  
labels...



we  
handle the  
cassette  
duplication

and give  
you the  
complete job...  
it's that easy!

CALL TOLL FREE  
**1-800-468-9353**

Ask For Our  
Complete Price Package

# Diskmakers

NEW YORK • CHICAGO  
PHILADELPHIA

mics on booms to get them up in the air. You have to take each sampling situation as it comes, and try to *listen*, which is the best advice I can offer."

Fred Haas, a product specialist at New England Digital, has done a fair amount of sampling for the extensive Synclavier sound library, although due to the modest size of the company's in-house studio, he focuses his sampling work there on solo instruments rather than larger ensembles. "I basically use B&K [4000 series] mics and I've been very happy with them," says Haas. "I also have a pair of AKG 414s that are nice, but with things like percussion, you can get really close without overloading and get a lot of presence with the B&Ks."

Haas prefers the dry sound obtained

from close miking techniques when collecting samples. "You really have to be careful about the amount of room ambience you get with the sample," he warns, "because as you play the sample up or down the keyboard, you also change the sound of the room. It changes as the pitch of the sample changes, so I use close miking to eliminate the room ambience." This also allows users to add their own reverb or processing later to suit their individual taste.

Another point Haas emphasizes is the need to spend a fair amount of time with the musician he's sampling. "For example, there are things that acoustic bassists do unconsciously, and when you're sampling them, you may not even think of taking a sample

## The Stocking Screen: An Elegant Solution

Whether for sampling or tracking, recording vocals in the studio has always been a tricky business, requiring the right microphone, adept engineering and most important, a good singer. Many vocalists, particularly novices and studio first-timers, start off a session with no small amount of anxiety and more often than not, the recording engineer or producer also has to act as vocal coach. The knowledgeable engineer has plenty of tricks available to fill in the gaps of an inexperienced singer, ranging from adding an extra bit of reverb to the headphone mix, to applying a bit of finger limiting (riding the fader during the take), to careful microphone selection and working with proximity effect to achieve the desired vocal sound.

Using the proximity effect (bringing the singer closer to the mic to accentuate bass notes) works well, but of course carries with it a greater chance of vocal pops and troublesome breath noises. One "old trick" which has found favor with engineers over the years is the practice of using nylon stockings or pantyhose stretched over a coathanger and placed in front of the microphone as a pop filter. While this technique is time-tested and highly effective, the sight of such a gerrymade apparatus is at worst disgusting and at best somewhat incongruous with the high-tech image of the modern recording studio.

Enter the Stocking Screen, a



round, 8-inch diameter pop filter made by Ad Music Concepts of Bel Mar, New Jersey. The Stocking Screen takes the notion of the pantyhose and wire and refines it into a professional-looking unit (available in black, aqua, grey or pink) with two layers of filtering material securely attached to a lightweight wooden ring, which in turn is attached to a standard 5/8-inch mic stand mount, allowing the unit to swivel 180 degrees for easy placement.

We tested the Stocking Screen with a variety of microphones, both recent and vintage dynamics, ribbons and condensers, and it proved to be an admirable performer in reducing breath pops, especially when placed from 3 to 6 inches from the mic. We set it up as a matter of course before a jingle vocals session, and the singer accepted it without question, something which rarely occurs when one gets out the old pantyhose/coathanger combo, something that always seems to require some explanation.

Priced at \$49.95, the Stocking Screen provides an elegant solution to a common problem, and is a worthy addition to any studio's bag of tricks.

—G.P.



**Most mikes  
make you  
sound like  
everybody  
else.**

**You deserve  
something  
a little  
better.**

This little mike gives your talent a big hand. Because it insures that your vocal sound comes through intact. The carefully-tailored response curve anticipates typical sound systems and hall acoustics. With an ATM5R the audience hears more YOU and less microphone.

With its advanced cardioid construction, the ATM5R gives your sound mixer more freedom to raise your vocal level to whatever loudness the music demands. Regardless of nearby monitor or side speakers. And without having to resort to drastic EQ "tricks" that distort your tone. Or the need to "force" your voice, just to be heard.

The ATM5R easily handles your dynamic range. And it doesn't change your vocal sound when you stray a little off mike. Yet it firmly rejects sound coming from the back. The ATM5R concentrates on you, so that you can concentrate on your performance.

Handling and cable noise are also better controlled than with most microphones. And the small size of the ATM5R means less bulk between you and the audience.

You know how great you sound in the studio. Now you can put that same sound on the road. Test sing the ATM5R at your Audio-Technica sound specialist today.

Actual  
size

**The new  
ATM5R  
Condenser  
Cardioid**



**audio-technica**

1221 Commerce Drive, Stow, Ohio 44224  
(216) 686-2600

Circle #017 on Reader Service Card [View Ad History](#)

## OUTPERFORMING THE REST

Why are Audix microphones quietly making their way into the hands of discriminating musicians, performing artists and pro sound companies?

Because Audix microphones are known for sonic quality, unsurpassed noise rejection, excellent frequency response, and better construction and durability than other comparably (and higher) priced mics.

Our "VLM" capsule technology has earned a reputation for providing the lowest handling noise and the highest gain before feedback in the most critical live concert applications.

From the handcrafted quality of our professional microphones to the unprecedented performance of our true diversity wireless system, we encourage you to compare and hear the difference. Write or call us for information or visit an authorized Audix dealer near you.

**NEW! RX-1 True Diversity Wireless for vocal and instruments.**



# AUDIX®

110 Ryan Industrial Ct. • San Ramon, CA 94583 • 415-831-0808

Suggested List Price  
OM1 - \$225.00  
OM2 - \$189.00  
UD 300 - \$159.00

Circle #018 on Reader Service Card

## If It Sounds Great, Don't Change It

**API** kept the sound, but added something new. Imagine an equalizer that *sounds* just like the classic **API 550A** 3-knob eq, but with two 4-band channels in a self-powered package. For their new **5502A** equalizer **API** took the circuit design of the **550A**, added a fourth band, 14 new frequency selections, and put two channels in a single rack unit—and they preserved the sonic excellence that has distinguished their products for 20 years. The **5502A** features all-discrete circuitry using the **API 2520** op amp and +30 dbm balanced output.

Also available from **API**: the original **550A** 3-knob and **560A** 10-band graphic equalizers, the **318A** distribution amp, powered racks, and more. Coming soon: the **940M** motorized servo fader, and a 4-channel all-discrete microphone preamp and mixer.

There's more to an equalizer than a spec sheet—call **Studio Consultants** to find out why we've sold **API** continuously since 1973, and to discuss a demonstration in your facility.

**AMS AudioFile, API, Audio Developments, Audio Digital, Audio Kinetics, Bryston, Fostex Professional, Rane, Valley People, Westlake, White**—and other fine products.

# studio consultants, inc.

321 West 44th Street New York, NY 10036 (212) 586-7376

**Equipment, support, and design services for professional audio facilities and broadcasters.**

Circle #019 on Reader Service Card

"You really have to be careful about the amount of room ambience you get with the sample because as you play it up or down the keyboard, you also change the sound of the room."

of these subtle effects or techniques. For instance, the difference between a G on the E string, and a G open string; changes in the timbres as you go through the dynamic range of an instrument; or the difference between pulling a string with two fingers rather than one. All of these are difficult to get from one set of samples. It's not just a trick—it's taking a half-hour, an hour or two hours to listen to that musician play and stop whenever he does something that makes my ear say 'I want that sound.' I make a list of those, and put together a consistent patch of those different kinds of effects, dynamics, attacks or whatever. This same approach could be applied to wind instruments, with different kinds of tonguings, subtones and overblown notes on the lower octaves."

Finding an experienced player is also essential to good sampling, Haas adds. "When sampling percussion, people seldom use a real drummer or percussionist: a guy who plays piano tries to play cowbell, hits it a few times, and that becomes the cowbell sample. If you asked a good percussionist about that, you'd find out you could hit it with a metal or wood striker—large or small, you could have your hand open or closed on the bell, there are cloth doughnut mutes to go inside the cowbell, and the sound changes when the cowbell is miked from different directions. If you're going to use samples to create realism, you need a lot of variation, because players have a very special, immediate reaction time to change phrasing, attack and tuning in a subtle way, and that's hard to get with any kind of sampling. ■

Mix associate editor *George Petersen* began his music career as a club drummer in Europe during the '60s, and currently resides with his wife and two musical dogs in a 100-year-old Victorian house on an island in San Francisco Bay.



**THE POWER BEHIND THIS DRIVE  
COULD EXPAND YOUR MUSICAL  
HORIZONS BEYOND ANYTHING  
YOU CURRENTLY KNOW**

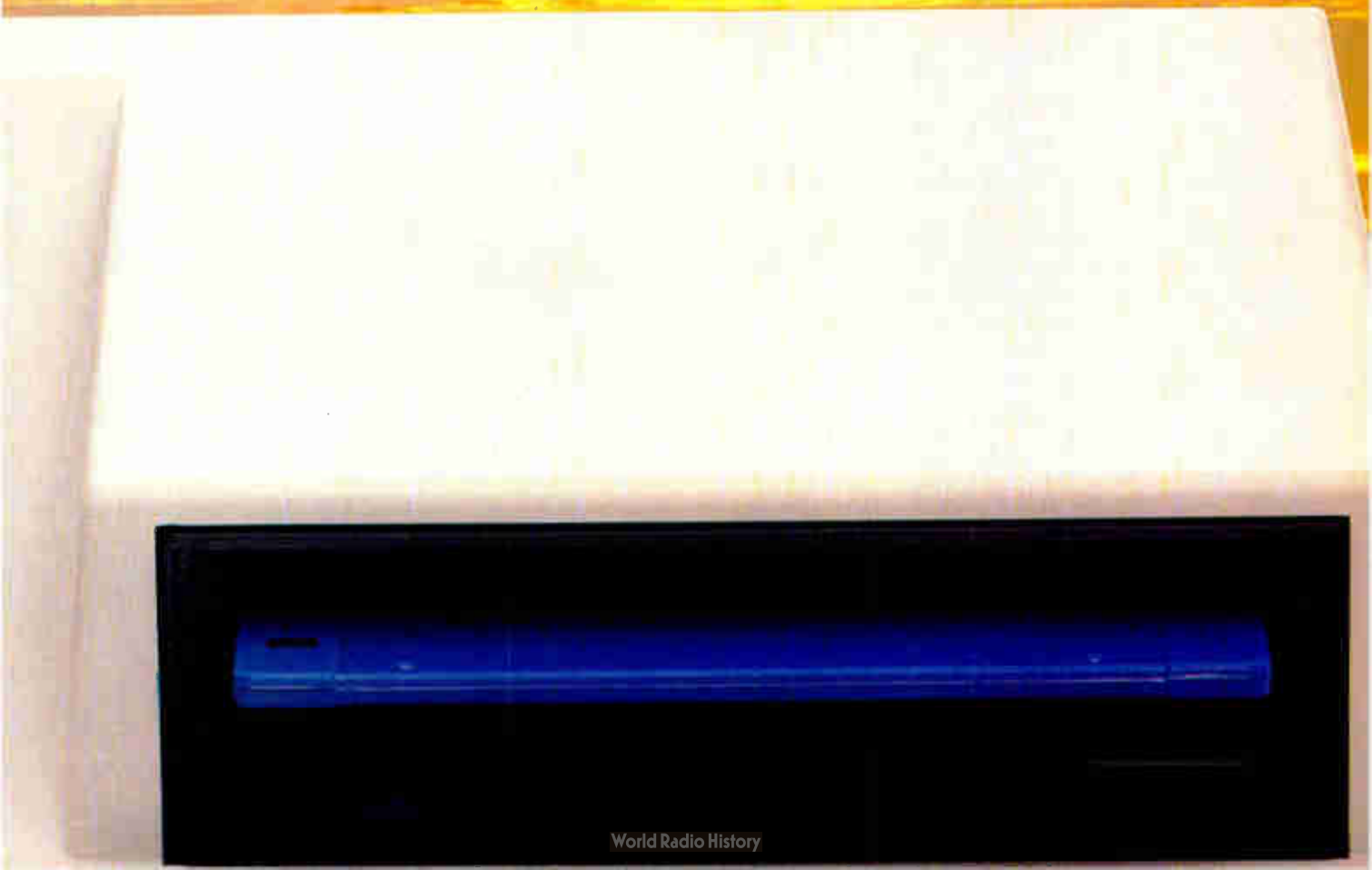

# INTRODUCING THE MC-500

## THE FIRST COMPUTER DEDICATED TO THE

**The Goal: Total MIDI Control/**We'd like you to spend a few minutes reading this ad. Because what we have to tell you takes a little time — but your time will be well spent. Because no matter what kind of music you play, you could play it better with the help of the amazing new MC-500

MicroComposer. The advent of MIDI has made incredible progress possible for all kinds of musicians — giving them power they never had before. But in order to harness that power, musicians need the proper tools. The MC-500 was created to fill that need — to harness the power of MIDI and give all musicians the power to control and use MIDI to their best advantage. In recent years, there have been various alternatives to controlling MIDI music systems. Some people have used personal computers equipped with MIDI software and interfaces. Some have turned to dedicated sequencers. Each has had its disadvantages. For all the power they offer, PC's are built for the businessman's environment, not the musician's, and as such they don't take well to life on the road. Also, they can be quite slow in performing MIDI functions, and as we all know, interfacing a computer to a MIDI system is often clumsy at best. Dedicated music sequencers are built for the musician's environment, but usually lack the features and flexibility of personal computers. Simply put, they can't be upgraded with new software, which means they can become obsolete before you've finished paying for them.

**The MC-500: A Computer with MIDI Jacks/**To solve this dilemma, Roland's engineers have created an engineering masterpiece — a powerful personal computer, with more memory capacity than the average PC, that is designed inside and out (from the front panel controls to the back panel jacks) for the MIDI musician. Like a computer, the MC-500 MicroComposer has no functions of its own — its functions are loaded off a software disk via its disk drive. In this way, depending on the software you load into it, the MC-500 MicroComposer can become almost any type of MIDI control device you require: a sequencer, a sound librarian, a live performance system controller, and a MIDI interface system — all in one compact, roadworthy unit.

**In the Creative Process/**The benefits of this type of engineering become apparent almost immediately, as the MC-500 MicroComposer allows you to create and control music with seemingly effortless keystroke commands. In many ways it's more like working with tape recording than computer sequencing, because the

MC-500 MicroComposer is laid out in much the same logical manner as an advanced digital tape recording system. The beautiful ergonomics of the MC-500 MicroComposer make it apparent that you are working with an instrument that was designed for musicians, from such easily-understood controls as Record/Load, Pause, Play, Stop, to the Alpha dial which speeds you through tasks which might otherwise slow down your creativity, to the speedy 3.5" disk drive, to the back panel — full of MIDI and tape interfaces, as well as footswitch jacks for those tasks too important to tie up your hands. **MRC-500 Software/**The MRC-500 Software Disk is the first in a series of software products for the MC-500

MC-500 BACK PANEL





# MC-500 MICROCOMPOSER

## ULTIMATE IN MUSICAL PERFORMANCE

MicroComposer. It offers the ability to perform highly advanced MIDI sequencing, editing, disk storage of programs, as well as system exclusive control over patching and assigning your MIDI instruments. Simply load the MRC-500 Software Disk into the MC-500 and you're ready to create music exactly as you've imagined it. The MC-500 can hold performance data for roughly 25,000 notes — up to eight songs — in its internal memory, with additional storage of up to 100,000 notes on the Disk. The MRC-500 allows musical data to be entered from either your MIDI instruments, the ten-key keypad or the alpha-dial, which are then played back through your MIDI set-up. Songs can be named, and linked together, while the 40-character LCD prompts your next command. The accuracy with which the

MC-500 records your performance nuance is simply breathtaking. No glitches, no weird or unnatural error-correction, just simply what you've played. The faithful re-creation of your performance is truly one of the hallmarks of this amazing tool. In fact, so good is the quality of the recording, that you'll probably notice aspects of your technique that you never noticed before.

**Recording Tracks/**At first glance, you will see that the MC-500 MicroComposer has four polyphonic recording tracks plus a rhythm track. But, as is the case with most of the MC-500, there is a lot more here than meets the eye. A special Merge function allows you to combine the information on one track with the information on another (similar to "bouncing" tracks on a multitrack recorder). Using this function you can record up to 256 musical parts (16 MIDI channels times 16 voices) and MIDI channel information is retained for each merged track. Later, if you desire, you can un-merge tracks using another function called Extract. The MC-500 allows you to merge and un-merge as many times as you like, and because it is all digital information, none of your performance is ever lost.

**The Rhythm Track/**The rhythm track gives you the programming power of the most advanced rhythm machines, by creating individual rhythm patterns and then organizing them onto a track. In this way you can control sound sources such as Roland Rhythm Composers, Digital Samplers and Drum Modules, as well as most other MIDI-equipped drum machines. Up to ninety different Rhythm patterns can be created in step time, and then combined at will by using the MC-500's Copy, Insert and Delete functions. And, for the first time, you can not only create, but store your rhythm tracks along with the rest of your performance data — all on the convenient disk drive. No more separate loading of rhythm and program data.

**Tempo Control/**The MC-500 MicroComposer allows you to modify freely the tempo of any recorded performance. Using the alpha dial it is easy to change in real time, the tempo of the entire piece (which is displayed in beats per minute). But the MC-500 MicroComposer also contains a separate Tempo Track, which is capable of altering the tempo over the course of the piece. In this way, it is possible to create continuous tempo changes such as *accelerando* (a gradual increase in speed) *ritardando* (a gradual decrease) or even immediate abrupt tempo changes.

SOFTWARE DISK



**Recording a Performance/The MRC-500 Software** allows a performance to be recorded in Real time or in Step time. Overdubs on additional tracks can be made within a few keystrokes of recording the original track, so you can never lose the feel for the music due to complex record set-up. If you make a mistake, the Punch In/Out feature can fix it with minimal fuss (just like on tape) but faster and more reliably than on any tape machine. For sequenced parts or others that are hard to play in Real time, the MC-500 allows Step programming—and since Roland invented this method of programming, you can be sure that it is done here in a manner that is both easy and precise.

**Precision Editing/The distinction between a good and a great**

program comes in the attention to detail, and it is in the editing process where the MC-500's detail shines clearly through. Any performance, whether recorded in Real or Step time can be fully edited down to the most precise detail. (Figure 1) An exclusive feature built into the MC-500's controls is the Microscope function. By entering the Microscope, you can then manually walk through your performance (event by event, forward or backward) simply by turning the alpha-dial.

Microscope can be used to isolate any unwanted notes or MIDI events, and then they can be easily deleted, corrected or re-written.

**Advanced MIDI Implementation/In its MIDI implementation, the MC-500 is perhaps the most advanced MIDI control device ever made. It can receive or send MIDI messages on any or all of the 16 channels, and can receive or filter polyphonic aftertouch, pitch bend, channel aftertouch and system exclusive (even for instruments not made by Roland). (Figure 2)**

The MC-500's system exclusive features alone could save you hundreds of dollars in the cost of memory cartridges.

**In the Studio/On the Road/The MC-500 is designed to be at the heart of any MIDI system, and as such it is**

equally at home in the studio as well as on the road. Because of its flexibility, edits can be made to stored programs with breathtaking ease. Does the producer want you to change your song to drop one verse and add another chorus? It only takes a second. For film work there has never been anything in this class before. By synchronizing the MC-500 to Roland's SBX-80 Sync Box, SMPTE sync is perfect. Plus, the ability of the

MC-500 to allow parameter editing in real time means that you can change parameters while you are watching your performance. On the road, the MC-500 can handle as many keyboards as you can throw at it. Need to change programs and parameters on all your instruments eight times for eight different

songs? With the MC-500's Chain play ability, you can string eight different songs together for access in three keystrokes. And with the speed of the MC-500's disk access, you won't ever wait long for new material.

**The Result: Total MIDI Control/If you need to control a MIDI system, there is no better choice than the MC-500 MicroComposer. For not only will it fill your needs today, but it will fill your needs in the future through software updates and new uses. Plus, at only \$1395.00\* the MC-500 must also rank as one of the**

world's greatest computer bargains, especially when compared to the cost of a

personal computer, software and interfaces. If you think it's time you mastered MIDI, rather than the other way around, the best way to do that is with the incredibly versatile, amazingly affordable MC-500 MicroComposer. The MIDI Computer. RolandCorp US, 7200 Dominion Circle, Los Angeles, CA 90040 (213) 685 5141.

FIGURE 1 EDIT FUNCTION CHART

Performance Editing	Track Editing	Merge		Disk Editing	Rename			
		Extract				Delete		
	Measure Editing	MIDI Channel Reassignment					MIDI Message Editing	Micro-Scope Functions
		Transpose						
		Change Velocity						
		Quantize						
		Erase						
		Delete						
		Insert						
	Copy							
	Note Editing	Micro-Scope Function	Note Name		Note			
			Note Strength					
			Note Length (Gate Time)					
			Delete					
			Insert					
Timing (CPT)								

FIGURE 2 MIDI MESSAGE TRANSMISSION CHART

Setting of Output Assign	Both MIDI Out connectors transmit MIDI messages on all MIDI channels			MIDI channels can be assigned individually for each MIDI Out connector			MIDI Out 1 connector transmits MIDI messages on all MIDI channels and MIDI Out 2 connector transmits only MIDI clock message		
	Timing Clock	Exclusive	Soft-Thru	Timing Clock	Exclusive	Soft-Thru	Timing Clock	Exclusive	Soft-Thru
MIDI Out 1 Connector	On/Off	On/Off	On/Off	On/Off	On/Off	On/Off	On/Off	On/Off	On/Off
MIDI Out 2 Connector	On/Off	On/Off	On/Off	Off	Off	On/Off	On	Off	Off



# CONDENSER MICROPHONES

## PART 1

Some guidance in the interpretation of condenser microphone specifications leading to optimum dynamic range capability.

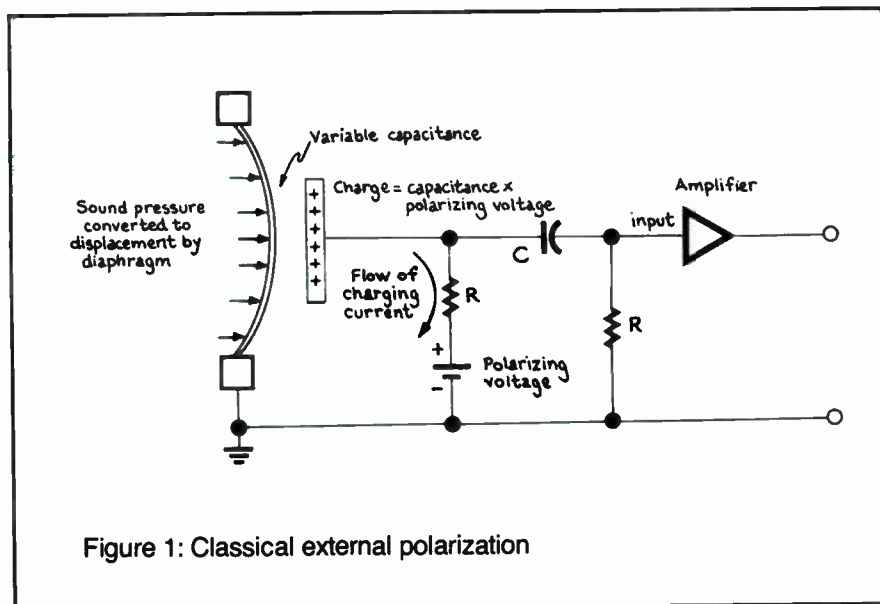

Figure 1: Classical external polarization

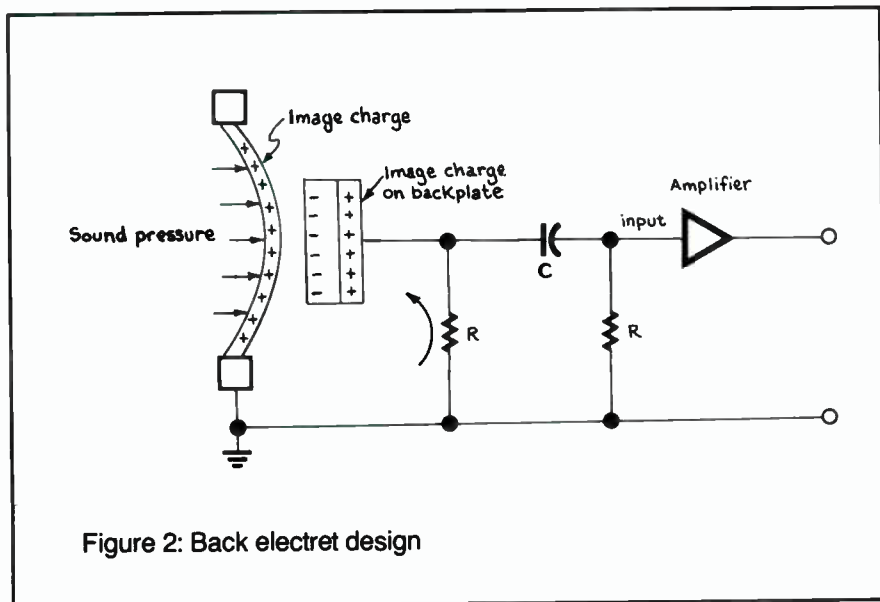

Figure 2: Back electret design

by Albert B. Grundy

Topics in this part include: principles of operation, sensitivity, gain, interface impedances, distortion of amplifiers, overload specifications and attenuators.

Currently, interest in obtaining maximum dynamic range capability in original recordings is running very high. Sixteen-bit quantization provides a limit of about 94 dB (with dither), not counting our ability to hear signals below the broadband noise level. Dolby SR pushes analog systems approximately 10 dB to the 105 to 108 range. All professional condenser microphones can handle at least this and some as much as 20 to 30 dB more.

Analog consoles need not degrade these limits, so theoretically the only noise audible on any recording should be the noise of the condenser microphones. For most professional models, the self-noise of the microphones is within a few decibels of the thermal noise of the air molecules banging against the diaphragm.

Obtaining the maximum distortion-free output is a function of interface impedances and proper attenuator location and impedances. Understanding these limits and the preservation of them in actual use is the objective of this series of articles.

### Operation

The classical externally polarized capsule is shown in Fig. 1. The charging resistor must be in the hundreds of megohms for reasons discussed later. This high resistance insures that once charged, the capsule charge will remain constant. The positive pressure half-cycle of the impinging sound

Figure 3

	SOUND PRESSURE LEVEL dB	SOUND PRESSURE PASCAL Pa.
	160	2000
PEAKS OF CLOSE MIXED DRUMS 1"-2"	150	1000
THRESHOLD OF PAIN	140	200
	130	100
ROCK AND ROLL CONCERT	120	20
	110	10
	100	2
MICROPHONE TEST LEVEL	90	1
	80	.2
	70	.1
	60	.02
	50	.01
AVERAGE RESIDENCE	40	.002
TYPICAL STUDIO BACKGROUND NOISE	30	.001
	20	200 μPa
	10	100 μPa
THRESHOLD OF HEARING	0	20 μPa

Typical sound pressure levels

Figure 4

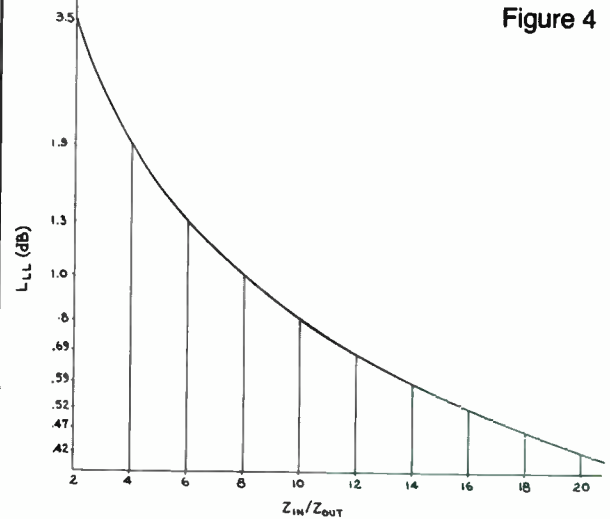

Z<sub>in</sub>/Z<sub>out</sub> ratio vs. loading loss level

wave reduces the diaphragm-backplate spacing, thereby increasing the capsule capacitance. With a fixed charge this reduces the voltage at the capsule. As the sound pressure alternates, the capsule voltage will alternate with this 180-degree polarity reversal.

Some typical values for these parameters are: capsule capacitance, 50 picofarads (50 x 10<sup>-12</sup> Farads); polarizing voltage, 60 volts; charge (fixed), 3 nanocoulombs (3x10<sup>-9</sup> Coulombs). With a sound pressure in the order of 1 Pascal, the variables would have the following approximate values: Δd (diaphragm excursion), 50 nanometers (50 x 10<sup>-9</sup> meters); Δc (capsule capacitance change), 0.025 picofarads (2.5 x 10<sup>-14</sup> Farads), Δv (capsule output), 40 millivolts. These values depend on many factors and are very approximate. The capsule output voltage is in the range of 10 to 15 millivolts RMS, which corresponds to a voltage level in the range of -35 to -40 dBv (re .775 volts).

The prime function of the amplifier at the capsule is to reduce the gigohm impedance of the capsule circuit to a microphone output impedance in the order of 150 ohms. This amplifier need not have much of any gain, often in the order of -8 dB to +8 dB depending on capsule diameter and other factors.

The low end cutoff frequency (f<sub>L</sub>) is given by:

$$f_L = \frac{1}{2 \pi R_o C_o} \text{ Hz}$$

where R<sub>o</sub> is the parallel combination of the charging resistor and the input resistance of the amplifier and C<sub>o</sub> is

the capsule capacitance and the input capacitance of the amplifier. For this cutoff to be in the 20 to 30 Hz range the value of R<sub>o</sub> must be well over 100 megohms.

The back electret design of Fig. 2 operates in essentially the same manner although the charge is fixed in the electret and therefore no polarizing voltage supply is necessary. The diaphragm to backplate polarity is the reverse of the classical design and therefore a positive slope pressure wave will produce a positive slope voltage wave.

### Sensitivity

Typical microphone sensitivity values range from -45 to -30 dBv per 1 Pascal of sound pressure that corresponds to a sound pressure level of 94 dB. Fig. 3 details the range of pressures and pressure levels with some approximate source values noted.

The sensitivity specification should not be misconstrued as some kind of "figure of merit." The sensitivity number quoted is just one point on the transfer characteristic which we expect to be linear over a range greater than 100 dB. The concept of one microphone with a higher sensitivity value than another being able to "pick up sounds" that the second mic cannot is totally fallacious. High sensitivity is of special value in situations such as long cable runs (best noise immunity) and consoles with poor equivalent input noise level specs, where a high level of microphone noise overrides console noise.

### Output Impedance

Most condenser microphone manu-

facturers provide an output impedance (Z<sub>out</sub>) specification, typically ranging from 10 ohms to 600 ohms with an average around 250 ohms. Most console input impedances (Z<sub>in</sub>) range from approximately 1,000 ohms to 10,000 ohms with an average in the order of 2,500 ohms.

There are at least three important aspects to this microphone Z<sub>out</sub>/console Z<sub>in</sub> relationship. The first, but not necessarily the most important, is the question of level loss due to loading. Looking at the extremes we have a range of ratios of Z<sub>in</sub>/Z<sub>out</sub> from less than 2:1 up to more than 250:1, with a 10:1 average. In Fig. 4, loading loss level is the difference between the spec sheet open circuit level and the actual level realized with the microphone connected to the console. The worst case is a 3.5 dB loss for a 2:1 ratio; a ratio of over 20:1 results in less than 0.5 dB loss.

The second aspect of this Z<sub>in</sub>/Z<sub>out</sub> ratio relates to the design of the microphone amplifier circuit and its ability to maintain the spec sheet distortion figures when the ratio is less than the 5:1 that is required to insure operation at or near open circuit conditions. All vacuum tube and all early (and some current) single FET condenser microphone amplifiers, Fig. 5, operate, in their impedance conversion function, as simple voltage amplifiers. They are therefore incapable of driving a load without severe loss of headroom and increase in distortion. Amplifier designs that incorporate additional stages (either discrete or IC opamp), as in Fig. 6, can drive loads with no increase in distortion. The load impedance is simply



# BRYSTON

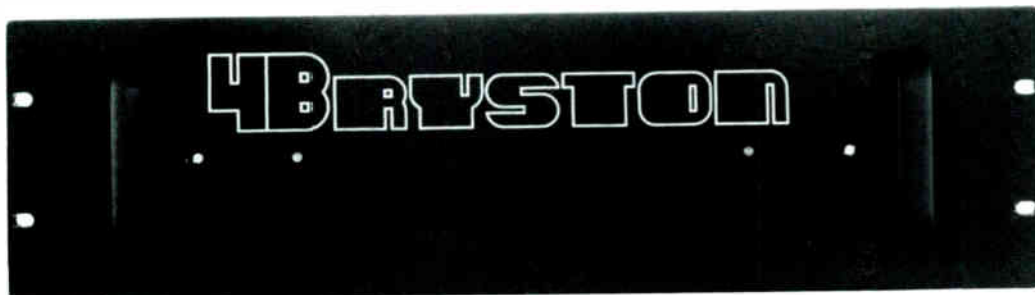

## BRYSTON POWER AMPLIFIERS CONTINUE TO DEFINE THE STATE-OF-THE-ART IN MUSICAL ACCURACY, LONG TERM RELIABILITY AND PRODUCT INTEGRITY.

**B**ryston design philosophy incorporates three general concepts.

1. Musical accuracy
2. Long term reliability
3. Product integrity

### MUSICAL ACCURACY

Musical accuracy is reflected throughout all Bryston power amplifiers and includes the necessity for wide-band transient accuracy, open loop linearity ahead of closed loop specifications, and power supply design as an integral part of the overall sonic and electrical performance of a power amplifier.

We have found that a simple carbon film resistor can contribute more static distortion to a signal than the entire remainder of the amplifiers circuitry combined.

We discovered that some parameters of transistors must be controlled as much as 1000 times more closely before their contribution to audible distortion is rendered negligible.

We discovered that under certain actual conditions of speaker loading amplifiers were incapable of yielding high-power transients without distortion.

Each of the various steps or stages in every Bryston amplifier, from

the input section to the output section, without exception, are designed to optimize the musical experience.

### STANDARDS OF RELIABILITY

**W**e consider this criterion to be exceedingly important. We have applied techniques and materials in our everyday construction of electronic equipment more typically utilized in the military and aerospace industries.

All components used in Bryston power amplifiers are specified for continuous duty at maximum power, with typical safety margins of 250%.

The power transistors used in all Bryston amplifiers are 100% tested for safe operating area, both before and after installation in the circuit. They are then taken to a "burn-in" table when they are given a capacitor load, a square-wave input signal, and set at slightly under clipping for a period of 100 hours. During this time, the input signal is cycled three hours on to one hour off, to exert additional thermal stress.

Following the burn-in period, the amplifiers are monitored for DC bias stability for approximately

another full day. At this point, they are returned to the test bench for another complete checkout of all operating parameters and functions, at which time a test sheet is made, and included in the packing with the unit.

As may be seen, Bryston takes very seriously the correct functioning and long term reliability of its products.

### INTEGRITY

**B**ryston contends that the term 'best' should apply to the honesty, pride and courage with which we conduct our business, as well as to the performance of our products.

For this reason, you will not find Bryston's products being cosmetically "updated" on a regular basis merely in order to keep the customer's interest, in something 'new'. If we make a change in the circuitry, it will be because, and only because, it yields a worthwhile performance or reliability improvement.

We feel that regular sweeping revisions to basic circuit design (accompanied by revised jargon) to be cynical marketing on the part of the manufacturer and insulting to the discerning customer.

In the United States:

**BRYSTON VERMONT**

RFD #4, Berlin, Montpelier, Vermont 05602  
(802) 223-6159

Circle #021 on Reader Service Card

World Radio History

In Canada:

**BRYSTON MARKETING LTD.**

57 Westmore Dr., Rexdale, Ontario, Canada M9V 3Y6  
(416) 746-0300

one leg of a voltage divider and the output voltage level is derated according to the loading loss level of Fig. 4. Without the second stage amplifier a 10:1 ratio is safest for low distortion.

There can be situations in which the  $Z_{in}/Z_{out}$  ratio is many times larger than 10:1 and yet circuit modification is necessary. This third aspect to be considered is the low end frequency response of the console input when connected to very low microphone output impedances. If the  $Z_{out}$  is much lower than the console input source impedance lower limit, building out resistors are necessary as in Fig. 7.

Be sure that these building out resistors are inserted at the console input end of the circuit loop. For greatest immunity to electrostatic (e.g. TV) interference the loop source impedance must be as low as possible. For best immunity to electromagnetic (e.g. hum) interference the total loop impedance should be high.

There are other aspects of this impedance relationship which are beyond the scope of this article.

### Distortion

The nonlinearities that result in harmonic and intermodulation distortion in condenser microphones are almost completely confined to the amplifier in the microphone. This is not to imply that capsules are perfect, but in a well-designed, high quality microphone it is very difficult to detect any measurable distortion at normal and reasonably high sound pressure levels. It is also difficult to measure any distortion at high pressure levels because of the difficulty of generating a sufficiently low distortion signal at these levels. Distortion in the capsule system doesn't begin to be significant until sound pressure levels of approximately 150 dB and then it is almost entirely second harmonic.

All high level distortion and overload limit specifications are stated in terms of sound pressure levels which are calculated from amplifier measurements. The capsule itself is removed from the amplifier and a measuring head with a fixed equivalent capacitance is put in its place (see Fig. 8). A signal from a near zero source impedance generator is injected until the microphone output voltage is equal to the open circuit sensitivity voltage for 1 Pascal or 94 dB SPL.

The easy but not very precise method for finding the overload level is to observe the waveform on a scope and raise the generator output and measure the level difference at the onset of clipping. This level difference, added to the 94 dB is the nominal overload level, usually in the 120 to 140

—CONTINUED ON PAGE 112

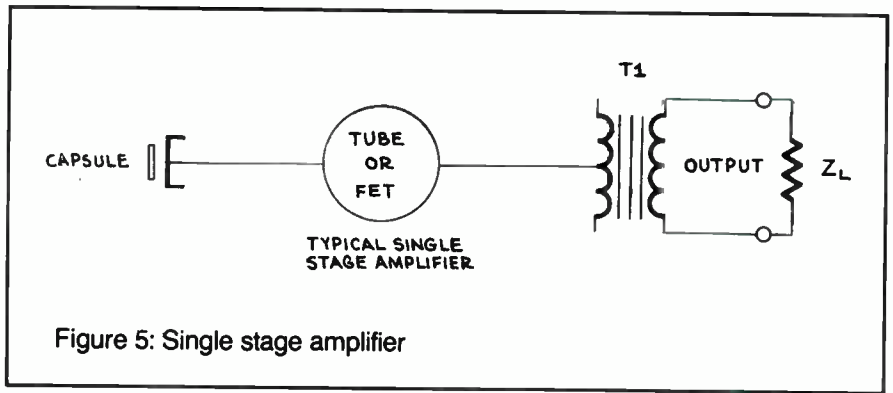

Figure 5: Single stage amplifier

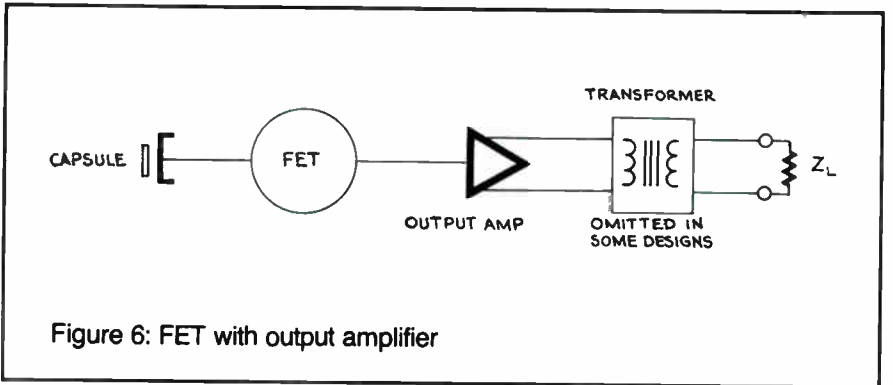

Figure 6: FET with output amplifier

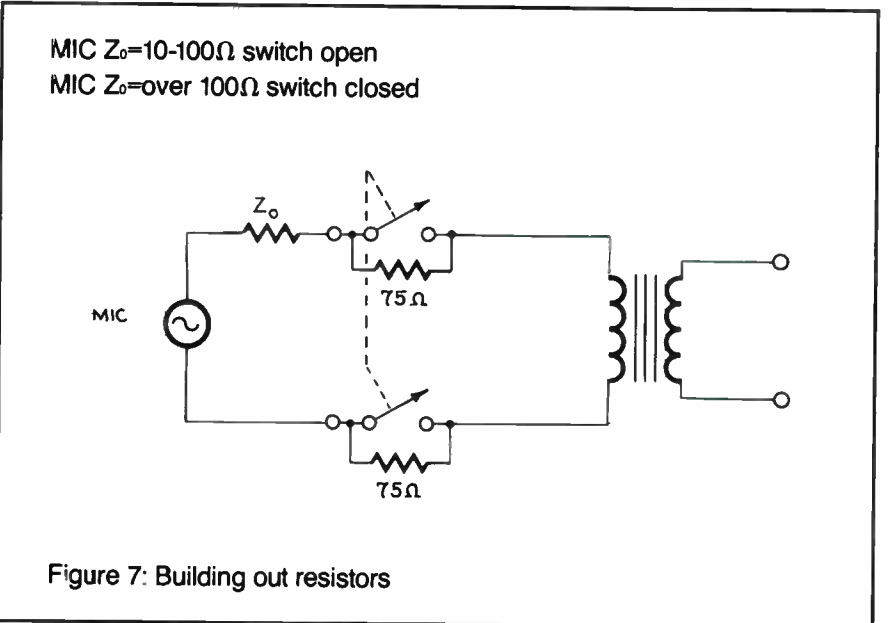

Figure 7: Building out resistors

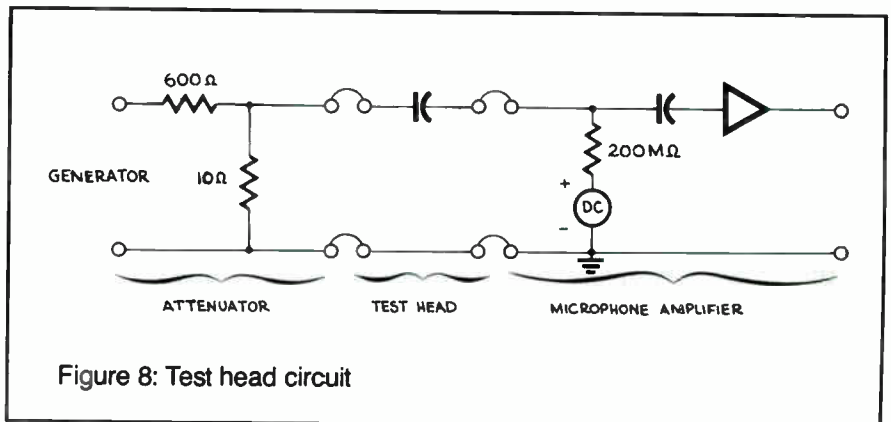

Figure 8: Test head circuit



# This is great.

Model 450, 8 x 4 x 2 Mixer, features phantom powering for professional condenser mics, in-line monitoring, solo, a dedicated stereo mix buss, stereo effects send and four switchable LED bar graph meters. More routing flexibility and performance gusto than anything in its price category. **\$1095.00\***



# This is even greater.

Model 450-16, 16 x 4 x 2, is a 450 with eight more inputs. The perfect 16-track production console with sonic quality you'd expect to cost

three or four times more. Nothing else even comes close. **\$1995.00\***



# And these are the sonic equivalent of duct tape.

Model 2050, 8 x 2 Line Mixer, will save your day when you suddenly need: another cue mix; a keyboard sub-mix or drums sub-mix; a separate monitor feed; a quick vocal reference (there's a mic preamp input, front

panel). For just about any conceivable signal routing problem, latch onto a Fostex 2050 or two, and the problem is solved. These little sonic lifesavers are **\$260.00\*** Each. No audio tool kit should be without one.

## Fostex®

Great mixers at great prices, the best of both.

© 1987 FOSTEX 15431 Blackburn Ave., Norwalk, CA 90650 (213) 921-1112

\*Suggested retail prices are subject to change without notice.

Circle #022 on Reader Service Card

World Radio History



PHOTO: GEORGE PETERSEN

The engineering and production team of Dave Frazer, Walden and Russ Titelman take a minute from working on Walden's solo album to pose in front of Tarpan's Trident TSM console.

# NARADA

## MICHAEL WALDEN'S TARPAN STUDIO

by Linda Jacobson

All is quiet in the control room at Tarpan. Incense waits to be lit, though the air is already sweet with the scent of fresh flowers. Guru Sri Chimnoy's gaze peers from a framed photo above the console meter bridge. Candles flicker, LEDs glow. Suspended between a 2-track machine and some outboard gear is a grinning, stuffed chimp dangling from a parachute. And parked atop each Yamaha monitor is a foot-long pink Cadillac.

Setting up their gear on the other side of the glass are bassist Randy Jackson (just back from touring with Journey) and keyboardist David Sancious (fresh from gigging with Peter Gabriel). Any moment we expect Narada Michael Walden, wearing ever-present smile, to bound in for a rehearsal of "Certain Kind of Lover"—

one of the hits-to-be on his new album for Warner Bros. *Billboard's* "1986 Producer of the Year" and ASCAP's "1986 Songwriter of the Year" has released eight albums before this, none of them million sellers. But then, they weren't cut at Tarpan.

Before Tarpan, there was Tres Virgos. In 1979, a group of musicians and producers set out to build "a super place to make music." They built one from the ground up, in a warehouse in San Rafael, California. Very conscious of the importance of the stereo image, they designed their studio for phase and polarity coherency and acoustical transparency. They called in Chips Davis to incorporate his then-radical Live End, Dead End™ control room design. When the studio was completed, each pecan wood-paneled wall stood independently. The control room sat on its own floating floor system, preventing unwanted sound transmission. The 900-square-foot studio room had two iso booths and a drum booth, with carpeted floor at one end, parquet at the other.

Shortly after opening in 1982, the studio garnered acclaim for its exceptional transparency, variable ambience and minimum mic needs. People talked about how all you could hear in the control room was the *music*, not the shock-mounted, Time-Aligned UREI 813 speakers. Listening with eyes closed, it felt like the performers were standing before you. Because of its clarity, Crown, Aphex, Sequential Circuits, Toa and other manufacturers used Tres Virgos as testing grounds for their products.

Meanwhile, across the Golden Gate Bridge, Narada Michael Walden had settled into San Francisco's legendary Automatt, his recording home. The young percussionist and vocalist had made a name for himself as a drummer, beginning with John McLaughlin's Mahavishnu Orchestra, followed by work with Jeff Beck (*Wired*) and Weather Report (*Black Market*). As a producer and composer, Mr. "Free-way of Love" had worked with Aretha, Stacy Lattisaw, Angela Bofill, Sister Sledge, Herbie Hancock, Patti Austin, and jazz trumpeter Don Cherry, among others. He had lived in the Bay Area for almost eight years when, in October '84, the Automatt closed.

So Walden began working in other studios, including Tres Virgos, near



# MULTI-TRACK MASTERPIECE



**A**t AMR, we understand what you, the recording artist needs. Our **System One** multi-track cassette recording system features simultaneous 4 track recording with 28 dB of headroom, zero-stop/zero-play logic, peak hold level indicators, Dolby B & C noise reduction and more. The mixing console isn't just a toy "afterthought" molded to the side. It's a full feature, stand-alone unit that offers a 6x4 format for tracking and overdubbing (10x2 for mixdown), three band EQ with sweepable midband, independent monitor output with level control, and 6 Low Z XLR inputs as well as 1/4" inputs and patch points. The System One's signal routing and dedicated cabling means overdubbing, bouncing tracks and final mixdown can be done with minimal re-patching. Add the **Overdubber™** remote pedal and you have hands-free control of the rewind, pause, play, record, and punch in/out functions, allowing you to concentrate on making music! The **AMR** component construction is solid, featuring steel cabinetry that's sturdy not heavy. The modular system format has provisions for standard 19" rack mounting if that's the route you prefer . . . it's your option.



**B**esides an excellent recording system, **AMR** manufactures the **PRM™ Series** studio quality phase reference monitors. These highly efficient monitors feature 18 dB per octave crossovers with time correction. Foam acoustic blankets reduce baffle reflections, thereby minimizing comb-filtering colorations. Each monitor exhibits accurate frequency response for true fidelity playback with excellent imaging.

**T**he **AMR** attention to product quality, flexibility and studio-smart functionality carries through as the design criteria for microphones as well. The **ERO™ 10** and **ERC™ 12** condenser microphones exhibit a crystalline transparency like no other mic you've tried before. The **DM™** series dynamic microphones offer hyper-cardioid and specially-tapered cardioid patterns as well as internal hum cancellation coils for low-noise, quality performance. Similarly, the **PMA™ 200**, 100 watt per channel power amplifier produces clean, reliable power with a high slew-rate and .008% THD distortion specs to meet the demands of today's studios.



**A** **AMR** accessories include phantom power supplies, headphone distribution systems, rack mount kits, quality audio cables and other important tools of the trade. Best of all, **AMR** products are made in the USA. Check in at your **AMR** dealer today and check out the gear that can make your audio dreams a successful multi-track reality.

# AMR™

BUILT FOR PROFESSIONALS BY PROFESSIONALS, IN AMERICA

**AUDIO MEDIA RESEARCH**  
P.O. Box 1230 Meridian, MS 39301 (601) 483-5372  
Telex: 504115 Fax: (601) 485-7903

©1987

Circle #023 on Reader Service Card

his Marin County home. He was a client until June of '85, when he made a deal with the owners to take over the studio. He renamed it Tarpan, moved in his favorite console (the Automatt's 48-input Trident TSM), added Yamaha NS-10M monitors to augment the 2,000-watt hyperdecibel UREIs, and installed a MIDI pre-production suite upstairs along with offices for his Perfection Light production company.

Tarpan's first client was Jermaine Stewart (the *Frantic Romantic* LP). Then Mokshagun Clarence Clemons cut basics for *Hero*. Canadian artist Luba flew in to record a film soundtrack cut, and a tune for her *Between*

*the Earth & Sky* LP. Then came *Whitney* (released last month). One after another, the creme de la creme worked at Tarpan: George Benson, Kenny G, Sheena Easton. Last October, Walden produced the current Starship chart-topper "Nothing's Gonna Stop Us Now." Then he produced the Aretha Franklin/George Michael hit, "I Knew You Were Waiting For Me," and Aretha's newest album (on these two he did lead vocal tracks in Detroit; Aretha avoids airplane travel). He flew to Las Vegas to record the Pointer Sisters, then flew back to mix their tune at Tarpan. After writing and recording "Is It Really Love" for Spielberg's new

movie *Innerspace*, Walden finally began cutting his own album. He just finished basic tracks and overdubs; at press time, mixdown is about to begin. It's an exceptionally exciting project for Walden, who recently received a half dozen ASCAP awards including top honor, "Song of the Year," for Whitney's "How Will I Know."

Tarpan, says Walden, is Sanskrit for "satisfaction unparalleled." He recites: "Each heart, each seeker, each mind will have satisfaction unparalleled." Guru gave the name to inspire me."

Guru's influence is pervasive. Scattered on the end table beside the control room couch are several slim volumes by Sri Chinmoy—author, lecturer, marathon runner, meditation group leader for the United Nations, and source of inspiration to world-class musicians and athletes. Walden's been a disciple for 14 years. The books, highlighted throughout with a felt-tip marker, simply and elegantly discuss concepts most important to Walden: beauty, creativity, imagination, humility, gratitude. He says, "To me, the absolute goal of life is to realize God, which takes more than one lifetime. Money doesn't matter—what matters is your love of the Supreme and the Supreme inside yourself. What matters is being grateful for the blessings in your life. If you don't have gratitude, you ain't happening."

Walden looks at the photo of Guru, commenting, "Guru is an endless channel of energy to me. He is so plugged into the Supreme and that higher energy, that when I see his picture, I feel the responsibility to give 110%, because I see how much he gives. When I come to the studio, that gives me a much broader feeling than just working on a particular song."

"Guru has touched so many chords in me that I can identify them, and when I'm with others, I can help them identify those chords. *That's why I was selected 'Producer of the Year.'* There's so many people more talented, but I may be able to make someone smile and think about something in a sweet way, take some pressure off. That's what it's all about. People say, 'Narada, your own records have never been million sellers.' But I made them, and that's also a big part of what's helped me produce for other people. Producers are artists. They're the musicians who have the heartpower, the will, to help serve someone else's needs and cause."

In his role as an artist/producer in the '80s, Walden is considering an SSL purchase, although the Trident satisfies his needs: "This console has such pure, sweet, strong power. Especially for my records. I like to make a record that sounds good but a little raggedy, so



More  
than just  
a matter  
of time

The CDI-750 is a full function reader, generator, character inserter and programmable 16-event controller all rolled into one. In addition to simultaneously generating and reading time code, this intelligent microprocessor-based instrument offers a programmable jam sync mode, built-in time of day clock, and an RS-232/422 computer interface. And with front panel controls, the CDI-750 is an easy unit to operate, affording the user greater flexibility.

Fully compatible with the Shadow II™ and Softouch,™ this system's state-of-the-art software controls make it readily adaptable to future needs.

Each unit carries a 3 year warranty.

For more details contact Cipher Digital today. Call (800) 331-9066.

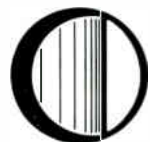

cipher digital, inc.

P.O. BOX 170/FREDERICK, MD 21701  
(301) 695-0200 TELEX 272065

*Timely today, consistent with tomorrow.*

Circle #024 on Reader Service Card



everyone can relate to it. I like the outhouse on the bottom and the penthouse on top, a little stinky but also elegant.

"We just got the Fairlight and a bunch of other stuff. As far as equipment goes, I gotta tell ya. I saw the old Motown in Detroit. The entire console is this big [spreads his hands three feet apart]. The studio is a third the size of this one. It ain't the equipment, it's the *song*. Every musician and producer should go see that console. It will *humble* you. All those great records done on it, in that little room—just hard work, sweat, love and digging for those songs. Just turning those little knobs to

Like Motown, Tarpan relies upon a regular team of musicians and engineers. Chief engineer Dave Frazer has worked with Walden for six years. Dana Chappelle provides engineering assistance. Other long-time cats include Randy Jackson, on bass, vibes and Moog minibass (Randy's wife Liz auditions the boxes of tapes sent to Walden and makes sure he hears the strong ones); keyboardists are Walter Afanasiëff and David Sancious. Corrado Rustici plays guitar and synth guitar, Greg Gonaway plays percussion, and Bob Smith handles drum machine programming. On the business end, vocalist Cynthia Shiloh runs

PHOTO: GEORGE PETERSEN



*Programmer Bob Smith, percussionist Greg Gonaway and Walden work out rhythm tracks with the E-mu SP-12 in the studio at Tarpan.*

make something that sounds presentable to the world."

Another contemporary master of presentable sounds, Russ Titelman, enters the control room. Walden explains how they're co-producing his album (collaboration works well with Walden; he and his songwriting partner, lyricist Jeffrey Cohen, sure have hit upon a winning formula). He says "I'll produce some songs myself, but I like to have someone I respect to bounce ideas off of. I want the record to have my own sound, but when you're doing vocals on yourself, it's good to have someone around to give you moral support."

Asked about his work in the control room, Walden answers, "When I do vocals, I'll do my own composites. But outside of that, when we're cutting tracks, I stay away. I'm more into talking with the cats, trying to understand the arrangements, programming. I leave the rest to the expertise of Dave Frazer and Dana Chappelle."

Perfection Light, and Janice Lee manages Tarpan, which is also homebase for Greg DiGiovine Management.

Walden describes the typical Tarpan setup: "Everything we cut is live. When I cut basics, everyone is in the control room, except me, I play drums on the wood out there. For the live sound, the sound of the '80s. We use no headphones, just go right off the speakers. For the guitars, we go one line direct in, one line out to amps in the hall. All the keyboards—in here. When there are mistakes, later I'll go back over each person and fix it up. But if I want the energy, I gotta. *That's* why the stuff is so tight, and just jumps off the records—because they are playing live. You get good players who really can play with each other, and then let 'em go."

Three years ago, Walden leapt into electronic music-making, layering percussive textures with a Linn II drum machine, Roland TR-808, Simmons kit, and his Pearl acoustic drums

# The BIG MIC SALE

**Bigger  
Better  
Cheaper**

- AKG
- Audio-Technica
- Beyer-Dynamic
- Crown
- Countryman
- Electro-Voice
- HME
- Nady
- Ramsa
- Sarnson
- Sennheiser
- Shure
- Sony
- Stewart
- Teac
- Telex
- Tran
- Toa
- Vega
- Williams

**HELD OVER  
by Popular Demand  
PRICES SO LOW**

**WE PROMISED  
NOT TO  
PRINT THEM!**

**200 Product Lines for the Pro**

**TOLL FREE in 50 States  
1-800-356-5844**  
In Wisconsin 1-800-362-5445  
Consultation: 608-271-1100

**FULL COMPASS SYSTEMS**

6729 Seybold Rd. • Madison WI 53719-1393

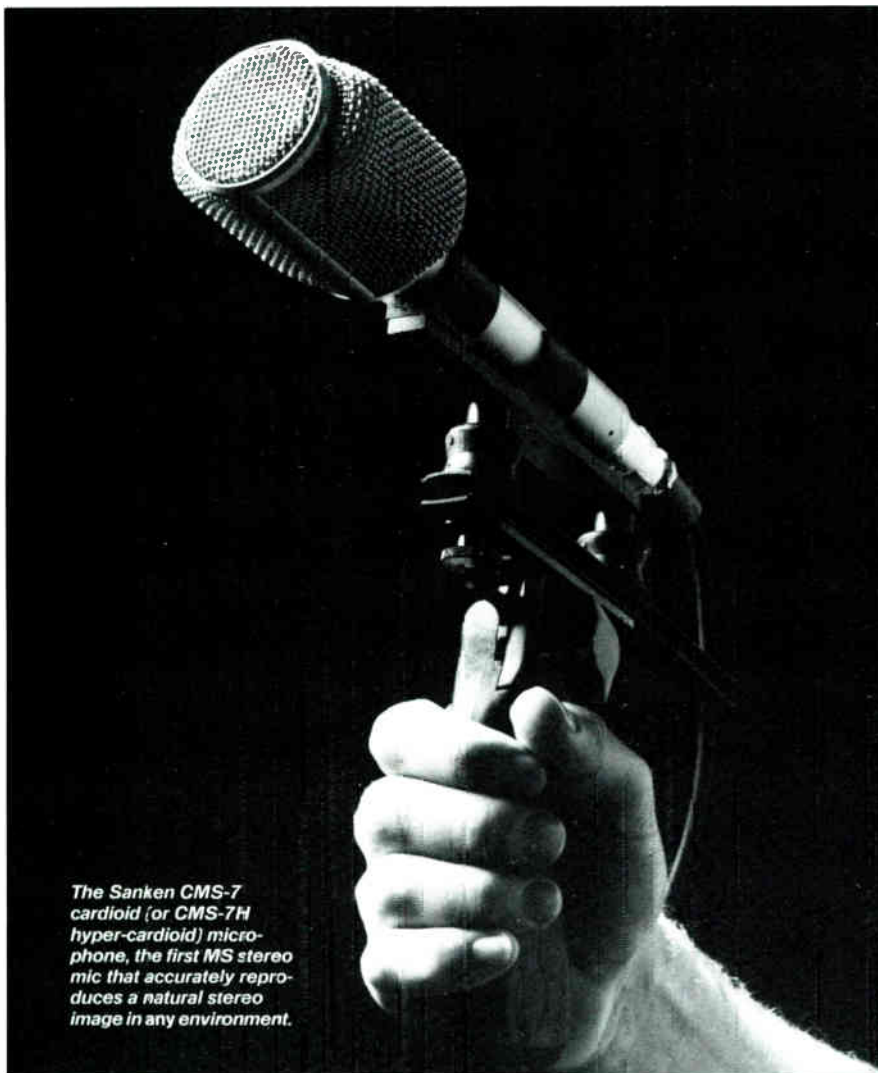

The Sanken CMS-7 cardioid (or CMS-7H hyper-cardioid) microphone, the first MS stereo mic that accurately reproduces a natural stereo image in any environment.

## TRUE STEREO IN A PORTABLE MICROPHONE!

Sanken, maker of the world-acclaimed CU-41 CD-recording microphone, is pleased to announce the new CMS-7, the first portable MS stereo condenser mic that accurately captures a natural stereo perspective in *any* environment. Ideal for TV and radio broadcasting, motion picture making and studio recording. Its corrosion-free titanium diaphragm is immune to temperature and humidity changes, and performs superbly in adverse conditions. Battery power supply/switchable matrix box, which clips to your belt, carries an aperture control for focusing the stereo perspective. For more information, please contact:

**LOS ANGELES** Audio Interview Design  
Tel (213) 469-4773

**NEW YORK** Martin Audio Video Corp  
Tel (212) 541 5900

**NASHVILLE** Studio Supply Co., Inc.  
Tel (615) 366-1890

**CANADA** Gould Marketing, Inc.  
Tel (514) 342-4441

**sanken**

Japan's most original microphone maker

Sole export agent Pan Communications, Inc.  
5-72-6 Asakusa, Taito-ku, Tokyo 111, Japan

Telex 2423934 KNMPCM/Telephone 03-505-5463  
Telefax 03-505-5464/Cable Address PANCOMM JPN

(which remain permanently set up in the studio). Today, everything cut at Tarpan includes drum machine tracks, or samples triggered by live drums. Frazer explains that the Linn, as primary drum machine, is supplemented by the E-mu SP-12 for sampling, as well as the Roland. Walden plays his Pearls and uses the Simmons or a Dynacord unit to trigger SP-12 samples. On tape, Frazer and Chappelle combine the acoustic and electronic results. Chappelle adds, "On all the albums until now, we used the Roland MSQ-700 sequencer. Now we use the Opcode sequencer on the Macintosh. And we do a lot of machine stuff—we use time code to drive the sequencers and drum machines, with the Roland SBX-80 SMPTE/MIDI interface."

Later, in the lounge, the musicians are asked what makes Tarpan different from other studios. They answer in unison "No smoking!" Their joking, relaxed attitude, and resulting productivity, reflect Walden's energy, warmth, and nonjudgmental attitude. His tranquil yet buoyant nature helps maintain a special closeness with artists as well as staff. Along with the musical and technological expertise he and his cats provide, Walden uses flowers, stuffed animals, incense and candles to help make himself and his guests feel comfortable and creative. "I think most people respond to beauty and sweetness. If you want to make beautiful music, you've got to have a beautiful environment."

"Ever since the first time I got to work at the Automatt, I wanted a place where I could have a higher consciousness. Tarpan maintains my consciousness, reinspires me. I think all studios should be a place of sanctuary for artists. People come in raggedy from the world, mud all over their faces, hearts all ripped up. So you nurture and refresh them, so they can give something to the world. If mud's still there and heart's all raggedy, that's what you feel on the record. It's important to wash those rags, dry those tears, wipe off the mud, give a good dose of higher reality, so when they sing they hopefully will sing out of a good experience, out of a cheerful moment."

Narada Michael Walden asserts, "1987 is the year of success. It's the year for people who want to bring even an iota of joy to the world, the year to bring it down." Go for it, Narada—and, in advance, thanks for the joy. ■

Mix assistant editor Linda Jacobson lives in San Francisco and hails from Rockaway Beach, NYC. She owns *Wordswork*, a technical writing service, and publishes a monthly newsletter for the SF Chapter of NARAS.



# The Finest Piece of Quiet



## telcom c4

The widest dynamic range of any noise reduction system.

That is the powerful performance claim made by telcom c4. c4 offers up to 118 dB dynamic range, and so exceeds the limits of a 16 bit digital recording system.

But that's not all. In a straightforward A/B comparison, telcom c4 has been acclaimed as the most natural-sounding noise reduction system, even when compared with its most recent competitors.

Over the past 10 years, telcom c4 has been continuously developed and improved. There are now well over 14000 channels in use Worldwide.

Here are just a few of c4's powerful advantages:

- High gain in dynamic range (up to 40 dB)
- No level alignment necessary
- No dynamic faults (overshoots, pre or post-echo, 'breathing')
- Compatible with any analogue or digital recorder
- Proven reliability

So if you're serious about noise reduction, then isn't it time you knew more, and heard less?



## telcom c4

Silence  
by design

**ANT**  
Telecommunications

ANT TELECOMMUNICATIONS / 205 Perry Parkway / Gaithersburg, MD 20877 USA (301) 670-9777

Circle #027 on Reader Service Card

# Danny Elfman

## THE MYSTIC RITES OF AN OINGO BOINGO

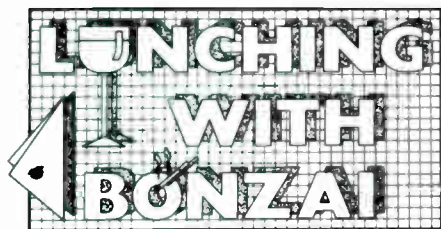

by Mr. Bonzai

**M**y first view of Oingo Boingo was at a Halloween concert in Los Angeles where the band and the fans were dressed to the outer limits. I had spent hours fitting a pair of panty hose on my head and stuffing them with lumps of cloth and cotton. I applied pancake makeup over my enlarged cranium and pasted whips of crepe hair here and there. With cosmetic putty I built up my nose to Charles Bukowski proportions. I tied a sweater over one shoulder to make me a hunchback, and then put on a natty, three-piece, pin-striped suit and a pair of decent wingtips. I was "The Elephant Man," but the film had just come out and nobody recognized me. I overheard a totally punked-out vamp in leathers comment, "Yecch—that's *really* gross." I must admit, there was a certain satisfaction in disturbing an

Oingo Boingo fan.

Their music, of course, was anthemic, encouraging the wild crowd to party with the spirits of the dead. No slouches, Oingo Boingo works hard for their music, employing a horn section that squirts, bleats, honks and sweats. The rhythms chug around the world in less than 80 bars. Danny Elfman (vocals, rhythm guitar), Steve Bartek (guitar), John Avila (bass, vocals), Johnny (Vatos) Hernandez (drums, percussion), Sam Phipps (tenor sax), Leon Schneiderman (baritone sax) and Dale Turner (trumpet) are musical vampires, sucking the blood from any style or period, and bringing it new life. A highlight of the concert was the appearance of dueling six-foot Godzillas appearing from the wings and shooting it out with cowboy six-shooters.

Mrs. Bonzai and I loaded up the Bonzaimobile with beaujolais and the hardware of photo-journalism. We drove into the Santa Monica mountains and stepped into Danny Elfman's woody hideaway. He was out hiking when we arrived so we sat chatting with his daughter Mali, and her au pair, Maria. The two dogs and two cats had discovered a small snake with a crimson band around its neck. Harmless enough, I guessed, but to play it

safe, I swept it into a flowerpot and set it free outside the grounds. Mali was fascinated with the little critter, as were the animals.

We asked the babysitter if we could explore a stream that led into a boulder grotto. We discovered a bona fide little waterfall pouring over the giant stones and paused in the serenity, looking forward to meeting Danny Elfman, the red-haired firebrand of Oingo Boingo.

**Bonzai:** What's the most frightening movie of all time?

**Elfman:** That's hard to say—frightening is all relative to the age at which you see the movie. For me, the most frightening movie I've ever seen is, in retrospect, not frightening at all. It was *The Beast with Five Fingers*, because it had the most profound effect of any scary movie I've seen since then.

It triggered a lifelong series of recurring dreams that I still have to this very day, of being pursued by body parts, especially the hand. I always loved that film—must have seen it a dozen times.

**Bonzai:** Who starred in that?

**Elfman:** Peter Lorre. Now, when I see it on TV, of course it's quite humorous. And by today's standards, the special effects are quite inadequate. But that's a wonderful thing about the mind of a seven- or eight-year-old. Their imagination can do much more to that kind of imagery than any true-to-life special effects.

**Bonzai:** What gifts did you get from your parents? What did they contribute to your life and career?

**Elfman:** They gave me a lot of support. Certainly, they weren't pleased with my choice of careers. . . .

**Bonzai:** Are they now?

**Elfman:** Oh, yeah, but I think any parent would have been a little bit upset. They're both schoolteachers—and they saw their child take a non-academic road in life, one that seemed so totally without any possible means of security, which it really doesn't have. Starting a band, working in a theater group for years—that kind of stuff. They always said, "I know you

*In his home studio.*



PHOTO: Mr. Bonzai for Pecichbridge



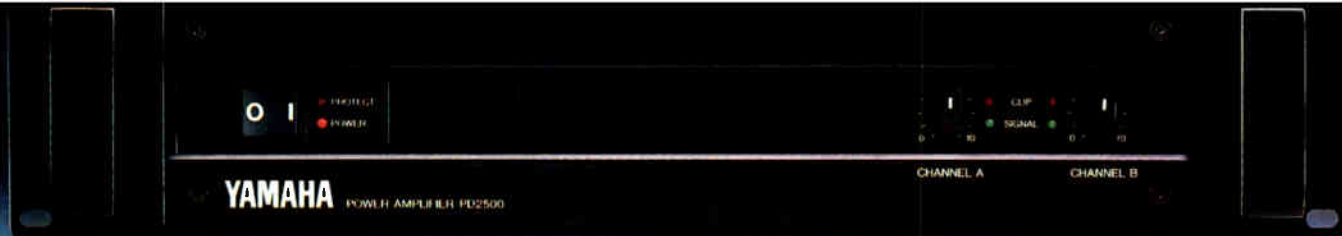

# We're not big in power amps anymore.

At just 26½ lbs., our new PD2500 power amplifier makes light work of large-scale sound reinforcement.

But unlike previous attempts to reduce the bulk of high power, Yamaha's doesn't reduce performance.

You get an impressive 500 watts RMS per channel into 2 ohms; 250 watts into 8 ohms. And 1000 watts into a 4-ohm bridged mono load.

All in a very compact 3½-inch by 19-inch rack space.

Yet while it carries like a briefcase, it still sounds like a Yamaha.

The newly designed high-frequency switching power supply is more stable and better regulated than conventional designs. We also increased the switching frequency to 125kHz. For an

improvement you can hear, especially in the low frequencies.

We added a better forced cooling system, and independent dB-calibrated attenuators for precise level balancing.

The PD2500 is even listed by Underwriters Laboratories.

There's more you should know about this elegant combination of high power and easy handling. So write: Yamaha International Corporation, Professional Audio Division, P.O. Box 6600, Buena Park, CA 90622. In Canada: Yamaha Canada Music Ltd., 135 Milner Avenue, Scarborough, Ontario, M1S 3R1.



**YAMAHA**<sup>®</sup>  
Engineering Imagination™

Circle #028 on Reader Service Card



Oingo Boingo

love doing this, but how are you going to earn a living?"

**Bonzai:** Were you born in California?  
**Elfman:** Yes, I was born and raised in L.A. I think I got a good sense of logic from my father. He always looked at things very analytically. I have always done that throughout my life. When things ever get real bad, or tough, I'm able to step back and analyze the situation calmly. That's been a major factor in my enduring against all odds in many long-term ventures.

My mom was more artistically inclined. So, that might have something to do with certain artistic inclinations I have. She wrote stories for children when I was growing up. She was a good puppeteer and was a great storyteller. She ended up quitting teaching and became a novelist, and that took a lot of guts. She's written romance and mystery and actually done OK for herself. I suppose both artistic and analytical influences are there.

**Bonzai:** Elfman is your real name?

**Elfman:** Yes, but we've never been able to trace the roots, because my ancestry is Polish-Russian Jew. Elfman, to the best of our knowledge is a German name, "elf" meaning eleven. Anything could happen to Jews in that part of the world over a hundred-year period. It's very difficult to trace—could have been German for some generations. My great-grandparents came from the old country.

**Bonzai:** Can you remember a first profound musical experience?

**Elfman:** Well, I remember becoming aware of music in the prime of my sci-fi horror infatuation—the ages of

ten to 13. I went to the movies practically every weekend. I realized at one point that all of my favorite science fiction movies had the same film composer—that seemed to be important. *The Day the Earth Stood Still*, *Time Machine*, *Jason & the Argonauts*, *Seventh Voyage of Sinbad* were all scored by Bernard Hermann. At the time I didn't realize who he was, but someone told me that the same person did all the music. He also did many of the Hitchcock scores. He was a very big influence, and later I became infatuated with the Hitchcock films.

It was a dream of mine to be able to score films, but I had no musical talents or inclinations. I imagined that if I worked in film it would be as an editor, or a cinematographer. Funny how it all wrapped around two decades later, and there I was a film composer.

**Bonzai:** Who gave you instruction in music?

**Elfman:** I'm self-taught completely.

**Bonzai:** Besides Bernard Hermann, did you have any other musical heroes?

**Elfman:** Nino Rota was my big musical hero—that's probably why I got the job to score *Pee-wee's Big Adventure*. I was infatuated with Nino Rota, and they had toyed with the idea of a score that would touch on Nino Rota's influence. When I said that he was my main musical hero, along with Bernard Hermann, I think that really clicked. What got me the job certainly wasn't my musical experience.

**Bonzai:** What is your most important musical tool?

**Elfman:** That depends. When I'm doing orchestra scoring, I'm not using

much technically except for the SBX-80, my most important musical tool, because I lock all my timings directly from SMPTE time code through the SBX-80. There are my bars and I map out all my hit points that way. With the use of that, I've never had to use the Knudsen click book or any of the old-fashioned methods of making the music fall where I want it to. For orchestra scoring, the SBX-80 has been my single most valuable tool. In fact, I couldn't have done most of what I've done without it.

For the synth scoring I've done, the Macintosh has been the most important overall tool—the Performer, Mark of the Unicorn software.

**Bonzai:** How about just sitting down and coming up with a song?

**Elfman:** That's kind of split. Half of it is just playing guitar, and half of it would be the Performer. Even though it has flaws, it still seems to be the best on the market. There are a few things that would make it so much better, but I'm sure they know they have the most versatile program on the market today. Still, I couldn't have done a lot of what I've done without that program.

**Bonzai:** Originally the group was called "Mystic Knights of the Oingo Boingo?"

**Elfman:** No, not actually. Mystic Knights was an entirely different ensemble. It was not a band, it was a theatrical troupe that played music, although the music was very diverse and non-contemporary. It ran its course, and the ensemble ended in late '78. The only link to the band is that we kept the name Oingo Boingo, after we buried the Mystic Knights. There were several of us in the Mystic Knights who felt we had taken it as far as we liked. We were starting to get bored and talked for about a year about how much fun it would be to have a band. "Ah, we don't have the guts to do that, things are going so well for us—we'd have to start from scratch." Finally, at a certain point, we just said, "What the hell? If we're going to do it, let's do it right now." Half the group left, and half started Oingo Boingo.

**Bonzai:** Does Oingo Boingo have some special meaning?

**Elfman:** None whatsoever.

**Bonzai:** Do you believe in magic?

**Elfman:** I don't know too much about magic. I've never dallied in the Black Arts. The closest I've come to it was my experiences in West Africa. No matter how skeptical one starts out, you start believing in the ju-ju, because it's such a very strong part of





## TAKE CONTROL OF A MAJOR RECORDING STUDIO.

It's time to seize power.

Tascam's Studio 8 puts all the power of a professional recording facility into an 8-track production system that's as easy to handle as your own instrument.

Forget bewildering patch bay jungles. The fully assignable 8 buss mixer sends your signals anywhere you want them with the flick of a switch.

Forget open reel headaches. The unique Load feature loads the tape, senses the end automatically and never lets it run off the reel. And because Studio 8 uses 1/4" tape, you'll never be stuck trying to find someone's rare proprietary tape format.

Forget video hassles. The "One Plug" SMPTE/EBU interface gives you easy synchronizer or editor connections.

But there's something more. Something that's greater than the sum of the features. Startling sound. No other system has Tascam heads. Which means that no other system has the impact and clarity that come from Tascam's thirty years of recording experience.

Quality production is what you do. Do it with a major recording studio. Take control of a Tascam Studio 8.



# TASCAM

© 1987 11 AC Corporation of America, 7733 Telegraph Road, Montebello, CA 90640 213/726 0303

# In sound reinforcement, there are no insignificant details.

## An infinite capacity for taking pains

It's an apt description of genius, especially in the arena of sound reinforcement. Each job comes with its own endless list of minor obstacles, all ready to become major headaches at a moment's notice. That would be reason enough for us to design every section of D Series consoles for maximum performance; even if we weren't committed to finding out just how good sound reinforcement consoles can be.

## Technical advances are raising audience expectations

CDs, digital recording and related developments have created higher fidelity in the home - and higher standards for live sound reinforcement. Still, some consider our approach to console engineering extremist. They think it unnecessary to reduce crosstalk between groups to a level typically 17 dB below conventional mixing consoles. Or to utilize a military multiple grounding system that virtually eliminates hum generation. To offer transformer balanced mic inputs and line outputs as options, or use rigid steel center trusses and



**DETAIL:** Auxiliary modules have three band EQ with variable Mid frequency for more usable functional outputs.

**DETAIL:** Standard inputs have LED level meters next to input faders for accurate, timely signal monitoring.

**DETAIL:** All input modules give positive LED visual indication of EQ in/out status.

flexible "mother loom" wiring harnesses to minimize mechanical stress on circuit cards.

We consider all these steps essential, because exceptional performance is the most reliable way to deliver accurate sound under less than ideal conditions. We share that attitude with Klark-Teknik, our parent company.

## Options for job-specific configurations

Your live sound console must have the flexibility to do the job your way — and the versatility to cope with unexpected difficulties. The informed, insightful design of D Series consoles gives you a selection of eleven different module types, each optimized for a different job. Configure 36-, 48- or 56-space frames with any combination of Standard, Monitor, Theater or Stereo inputs, Recording, PA or Matrix outputs and Stereo, Monitoring or Auxiliary Master modules. All achieve audio performance that is equal to the most demanding applications, including live-to-digital recordings. D Series consoles are presently used by major British sound companies and studios for reinforcement and remote recording applications.

The extensive features and functions of D Series modules and consoles are detailed in an eight page brochure. To get one, send your business card or letterhead to:

**DIDA D SERIES**

Klark-Teknik Electronics Inc., 30B Banfi Plaza North  
Farmingdale, NY 11735 (516) 249-3660  
Unit #1, Inwood Business Pk., Whitton Rd.  
Hounslow, Middlesex, UK TW3 2EB

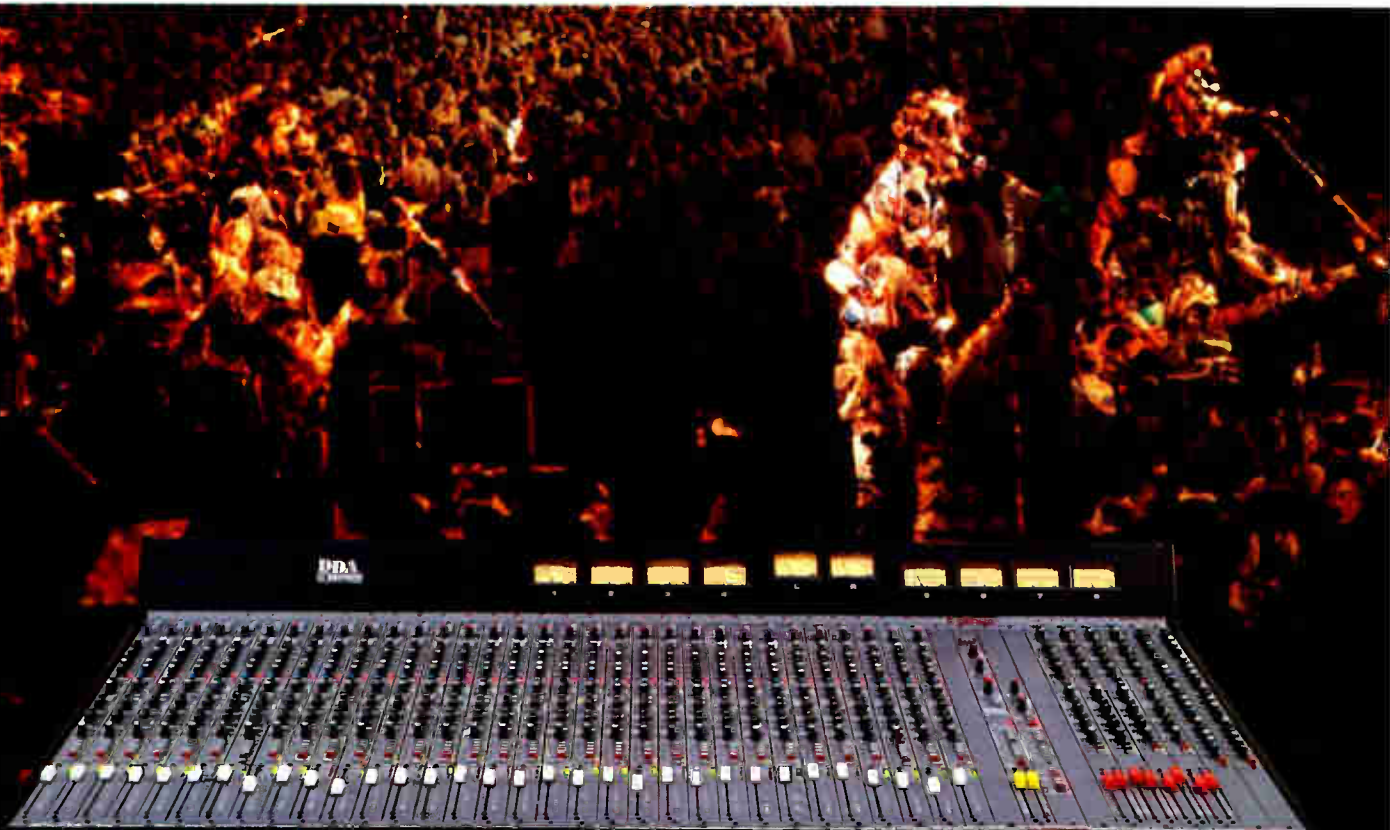



the culture. It's difficult to explain, but it's probably similar to what you would find in aboriginal culture. I brought back some wonderful little objects. At first, I tried to collect some, but people wouldn't let me have them at any price. They looked at me and thought I was a white devil. And the white skin represented the devil for a lot of people. Finally, I found this one lovely woman who saw me looking. There's a ju-ju section in every marketplace, with barrels of multi-colored powders and lots of bird beaks, claws, and more rarely, monkey paws and digits of monkey fingers. Each one has a different function. I always wanted a monkey paw but it wasn't until I met this woman—I pointed, she held it up and said, "This is yours, right?" No problem.

**Bonzai:** Kinda spooky having it around?

**Elfman:** No, I don't think it's brought me any bad luck.

**Bonzai:** That reminds me of your brother's film, *Forbidden Zone*. You played the devil.

**Elfman:** Yes, my brother wrote it, directed, produced and financed it. He's working on another one now.

**Bonzai:** Was that your first film score?

**Elfman:** Yeah—I would call it an illegitimate film score. I wasn't scoring with my traditional techniques, but it was the first time I put music to film.

**Bonzai:** Who's the most amazing artist you've worked with?

**Elfman:** I've hardly worked with anybody. I've never been in another band; I've never worked with any outside musicians; I've never collaborated on a song, so it's difficult to answer that question. The only collaborative types of endeavors I've had were film projects. Band work is all very personal and very private. In film work, I'm turning to something that someone else started and I supplement and finish. When it comes to songwriting, the guys in the band are the only ones I've ever worked with. Steve Bartek, our guitarist, is my partner and does all my orchestrations for film. We work both sides of the fence together. He's worked with me on every film score I've done, and also has been there since the very beginning of Oingo Boingo. He's been a part of every song, arranging and structuring the tunes.

**Bonzai:** Do you have any advice about the music business? Any interesting business tricks?

**Elfman:** Not really. It's so unpredictable and difficult to figure it out. If one thinks logically, it can be very frustrat-

ing to figure out why and how record companies work the way they work, and come to the decisions they come to. You'd almost think there was more ju-ju involved, than just pure and simple gut feeling, or logic. I have learned a lot in the seven years that I've been with MCA and A&M. In the early years I was involved in representing the group's business, so I sat in on the business meetings, and was also on the band side. That was educational, but aside from that there is an enormous amount of luck involved. Any company can be horrible or great, depending on who you are and what your relative experience is with them. There is no single company that's always good, or always bad. A company can seem very open and free, and creative and good with one artist and be very restrictive and manipulative with another.

We've been lucky to have good relationships with our record companies, but then again, we are the type of artists who keep control over everything we do. Maybe it's because we don't allow ourselves to be manipulated. Nobody's ever tried to. Or maybe they come to bands like us because we are a self-sufficient entity, and they don't need to or want to manipulate all the time. No one at any record company has ever asked us or told us to do anything we didn't want to do.

**Bonzai:** Can you imagine yourself as a working musician in another period in history?

**Elfman:** The '30s, the actual roots of the Mystic Knights, both in terms of early Duke Ellington, Cotton Club-style big band jazz and French neoclassic European type of music. That to me was the single most exciting period, musically, of the century—between what was happening with Gershwin and the incredible revolution in jazz here, and what Stravinsky and the European composers were doing there. There was a double musical revolution happening simultaneously, and sometimes they would overlap, as they did with Gershwin and Darius Milhaud. He did a wonderful piece called "The Cow on the Roof," which reminds one of "Rhapsody in Blue," and they were written at the same time. Both of them used to sit in at the Cotton Club in the balcony and had similar influences. A wonderful mingling of cultures, and that created a clash—nothing has ever come close to it. To me, the so-called musical revolution in the '60s in rock and roll was a drop in the bucket compared with what came out of the '30s. Fifty years later, the music is still relevant. For me, the music of the '60s, with a few exceptions, had lost its relevance

Otari's compact EC-201 SMPTE/EBU time-code reader is a natural for field or studio operation, and it costs only \$495. It offers 1/20 to 60X playspeed reading, 40 hour continuous use on battery power, and re-shaping circuitry on the loop output.

This advanced reader features a full hexadecimal user bits display (with a hold-button for edit logging), a -10 to +10 dBV input range, balanced XLR inputs/outputs, and includes an AC adapter, belt clip and batteries. It measures 1.5" x 4.2" x 5" and weighs 18 oz.

Contact Otari at (415) 592-8311 for your nearest dealer. From Otari: Technology You Can Trust. Otari Corporation, 2 Davis Drive, Belmont, CA 94002.

**OTARI.**

**TIME OUT!**

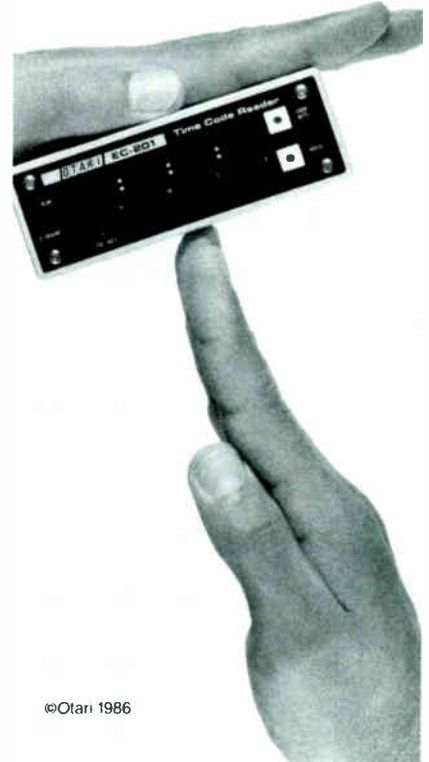

©Otari 1986

Circle #031 on Reader Service Card

## You know how low-quality tape winds up, right?

### Why be bothered with it?

Count on United Group—manufacturers of expertly wound highest quality custom loaded and custom length video and audio cassettes and more!

Authorized distributors of:

- AMPEX
- SCOTCH/3M
- TDK
- BASF
- CAPITOL
- TEAC/TASCAM
- DISCWASHER
- AUDIOLAB

Forget garbage forever!

For information, call or write:

**UNITED GROUP**

6855 Vineland Ave. • No. Hollywood, CA 91605  
 To call in California: 818/980-6700  
 or dial toll free 1-800/247-8606  
 From outside California: 1-800/433-4271

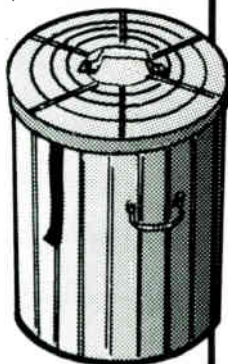

Circle #032 on Reader Service Card

# api

a reputation of quality—

- custom products
- equalizers
- the 2520 OP-AMP
- distribution amplifiers
- microphone pre-amps
- replacement parts

Flat Use  
 CRO/CPM

Plus these new products:

- 5502 Dual Four Band Rack Mount 550A EQ
- 940M Motorized Servo Fader
- 318a distribution amplifier

**api audio products, inc.**

7953 Twist Lane, Springfield, VA 22153  
 (703) 455-8188 fax: 510-6001-898

**studio consultants, inc.**

321 West 41st Street, New York, NY 10036  
 (212) 596-7376

eastern representative



16055 Ventura Blvd., Suite 1001  
 Encino, California 91436  
 (213) 276-1414

western representative



PHOTO: Mr. Bonzai for Pochter/K&E

by the '70s. Although, someone may say in the future that the Moody Blues were as relevant as Stravinsky.

O! course, there was also a great jazz revolution in the '50s and '60s in America, and other individual contributions, but the '30s were unique.

**Bonzai:** As a performer, is there any star of the silver screen that you identify with? **Peter Lorre?**

**Elfman:** No, I don't think I ever felt that frustrated. He did represent the extremely frustrated, twisted personality. If I was to identify with an actor from that period it would be Vincent Price's character, someone with a twisted imagination but definitely more in control. He'd be the one doing the torturing, as opposed to the one being tortured. Since I've always been somewhat of a control freak in my own life, I would identify more with that character.

**Bonzai:** If we could arrange a luncheon with anyone in the world, living or dead, who would you invite?

**Elfman:** I'd love to have Ellington, Stravinsky, Gershwin, Django Reinhardt (with a French translator), John Coltrane, Bertolt Brecht, Kurt Weill (he was another big influence on me), Nino Rota, Bernard Hermann, Jean Cocteau....

**Bonzai:** Who is the Salvador Dali of music?

**Elfman:** Certainly no one today that I am aware of. I would think of one of the post-classical, or neo-classical composers somewhere in the middle of the century, someone with wild abstractions, but realistically portrayed with the orchestra in the same way that Dali realistically portrayed with paints. Perhaps Stravinsky. His wild abstractions were presented in extremely il-

legitimate well-formed style—extremely stylized, very difficult to duplicate exactly, realistically. No shortcuts were taken. That's what I think of with Salvador Dali; all the detail is there. You can magnify any portion of his paintings and it will look very real and distinct, as you can magnify any eight bars of one of Stravinsky's pieces and it will have this enormous amount of detail and subtlety and layers.

**Bonzai:** What is your most normal human characteristic?

**Elfman:** The family life is my anchor, the normal side—my wife, my children.

**Bonzai:** What's the biggest mistake of your life?

**Elfman:** I don't know; I don't really totally regret anything that I've done. It's easy to say, "Well, gee, if I'd have started Oingo Boingo the rock band in '72 instead of '79, I'd be that many years ahead." But on the other hand, the experience I gained from the theatrical ensemble is in many ways invaluable. I treasure that stuff, so they're not lost years.

I hate the way some of my early records sound. If I could go back in time, I wish I could go back with what I now know about recording, and make those first records sound the way I wanted them to sound. That was a very frustrating period artistically. The records always ended up sounding just the opposite of the way we intended them to sound. The sound was so one-dimensional on the early recordings. They still play them on the radio and it drives me up the wall. I wanted a big, open, dimensional sound and I got a very flat sound with no perspective. We didn't capture the live energy that we wanted. If I could go back, I would record much more live and try to get the spirit and feeling



that we have on stage. It took three albums to start to learn how to get that type of sound.

**Bonzai:** What's the most important question that you can ask yourself?

**Elfman:** The same question I ask myself all the time. Could I be doing better? Could I be working harder? All of us in the band are our own worse critics. We drive ourselves pretty hard. I drive myself especially hard. When is enough enough? When is a song finished? The discipline in my mind, especially in pop music, is to work quickly. We have been forcing ourselves to work very quickly in the studio, because it seems that the quicker we work, the happier we are with the outcome. We spent three times longer on our first three albums, and everyone is telling me that the production qualities are so much better on the last two. In fact, we put a lot less production into the last two.

**Bonzai:** What about music video?

**Elfman:** We used to be much more into videos. When we started out, they were much cheaper; it was more fun and wild and crazy. Each year we would do one, but over the last few years I've started to pull out of it. It's more of a pressure, the budgets are four times higher to pull off the same thing. For the first time, with our latest single, we decided not to do a video.

**Bonzai:** Do you have any long-range visual goals for Oingo Boingo?

**Elfman:** Not really. Occasionally, when we have the facility, we'll use a little animation, or this or that, but I can't ever see relying on it too heavily. Then it becomes a crutch. The challenge of a band is that the music should be able to support itself.

**Bonzai:** Didn't the new album debut at 30 in *Billboard*?

**Elfman:** No, no, we're not that high yet. We're in the 70s, and we've never even broken the top 100 before. We need to have a few big hits off the album before we get to the 30s. We have one major hurdle to overcome—radio. There is resistance from programmers. Once we accomplish that, we'll make some headway. We're chipping away with a chisel on a concrete wall. There's light poking through here and there but there's a way to go before the bricks start to fall.

**Bonzai:** Doesn't your film work add fuel to the machine?

**Elfman:** No, not really. They seem to have their own personal way of dealing with image and it's very hard to shake a negative image. They're just getting over seeing us as this very

## AUTOMATION . . . NATURALLY

Adding automation to a mixing console has never been easier.  
Using automation has never been more natural.

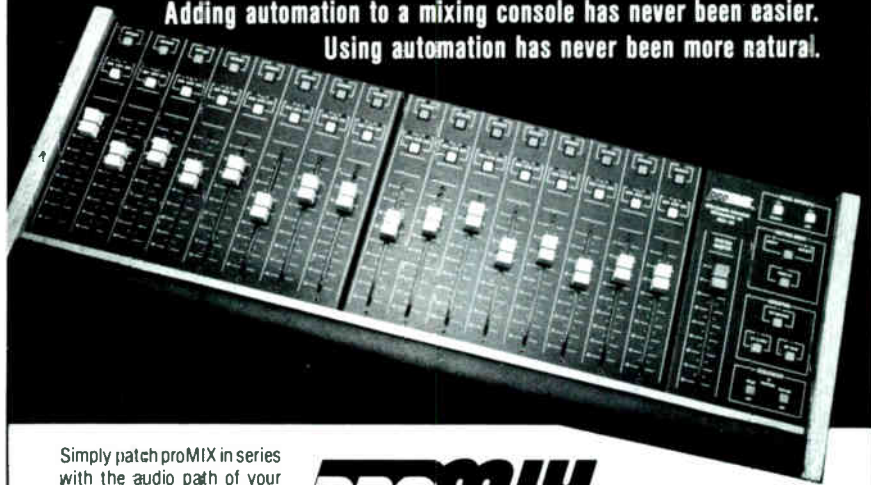

Simply patch proMIX in series with the audio path of your existing console and connect it to your MIDI sequencer. No computer is needed.

# promix™

editing can be done on any or all channels simultaneously

Now do your mixdown using the proMIX panel in MANUAL mode — just as you would use your existing board. Because proMIX is recording every subtle movement of faders and mutes, you are hearing your mix just as it will sound when you play it back in the AUTO mode. With proMIX, what you hear is what you get.

If changes are needed, the EDIT mode allows you to either modify or replace fader moves using the unique proMIX Auto Splice system. And with a fader dedicated to each channel,

proMIX is a modular system that can grow with you. The basic system can be expanded up to 64 channels in any multiple of 8. Prices start under \$2000.

There is much more to the proMIX story. Call or write today for more information on the most comprehensive, easiest to use automation system you can add to your mixer.

Microsystems, Inc.  
2500 E. Foothill Blvd., Suite 102  
Pasadena, CA 91107 • (818) 577-1471

Circle #033 on Reader Service Card

# CAKE and PUNCH!

**SERVODRIVE WISHES  
THE 63-YR. OLD VOICE-COIL  
"HAPPY BIRTHDAY"**

The SDL subwoofers produce the most punch for their compact size. And, they deliver a solid, clean, effortless sound that is unachievable with voice coil speakers.

Consider the new Servo-Drive loudspeakers, featuring the powerful SDL-4 and SDL-5. We offer the best in bass for professional sound reinforcement, and the ultimate in low-frequency reproduction.

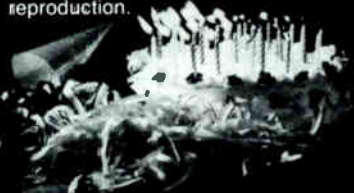

# SERVODRIVE

INTERSONICS, INC. 3453 Commercial Ave. Northbrook, IL 60062 312-272-1772

Circle #034 on Reader Service Card

**Bill Dykes**  
 & ASSOCIATES

**"TOTAL MUSIC MANUFACTURING COMPANY"**

- Record Pressing
- Tape Duplication
- CD's
- Video Duplication

SEND THIS AD WITH YOUR ORDER AND RECEIVE A \$200 DISCOUNT

1011 16th Ave. S.  
 Nashville, TN 37212  
 (615) 329-3737

Circle #035 on Reader Service Card

## The art of shaping sound.

SONEX is a high-performance acoustical foam that upgrades your studio inexpensively. Ideal for a temporary isolation booth, it can also eliminate slap echo and harsh resonances in the main room or silence noisy tape equipment in the control booth.

Write for our color brochure today.



**Alpha Audio**®

2049 West Broad St.  
 Richmond, VA 23220 (804) 358-3852

Circle #036 on Reader Service Card

wild, enormously uncommercial entity—a West Coast oddity.

**Bonzai:** "Weird Science" did well, didn't it?

**Elfman:** It did pretty well, but being our way, we did not follow it up with another "Weird Science." If we had followed with two or three imitations—that's the way that radio works. We are hopeful that we will break through this year, but it's still an uphill battle.

**Bonzai:** Will you be touring heavily?  
**Elfman:** A lot more than in previous years.

**Bonzai:** You seem to have arrived at a pastoral place in your life here, up in the mountains.

**Elfman:** Yes, and we're out and far away from neighbors to avoid problems with noise. I can play in my studio as much as I want, all night long and nobody seems to hear anything. I went to great lengths with double glazing on the windows and a lot of insulation in the walls, and until I get my Rancho de Elfman, I'm quite content.

**Bonzai:** Let's take a tour of your studio. . . .

**Elfman:** The system here was really designed as much, if not more, by Steve Bartek than myself, in terms of the MIDI flow, which is quite complicated. Although I do most of my master keyboard playing from the KX-88, I can switch to the Octopad, to the DX7, or send data in from the Prophet 2002s, or a drum machine from this optional space.

Then from here I'll split from my masters, either the KX-88 or the computer, which would be patched through when I'm using stuff in conjunction from the computer. So I just switch from record to any MIDI channel that I'm working on, and that will instantly change the instrument without pushing any buttons.

And here is my selection of slaves, once I have the master selected. I like this system much better than the computerized switching boxes, because I don't have to memorize presets. I just hit on whatever combination I want, on or off. The Roland MPU-105s will select which instruments will play and the MPU-104s are the master selection boxes. Essentially, the difficulty was in finding a system in which anything can control anything else. I came up with the initial system. Actually, when I was in the studio, I had a vision of the MIDI flow chart and I wrote it all down. However, it had a lot of holes in it, and Steve took it and elaborated on it quite a bit, and made it much more elegant, added some nice refinements and twists, and simplified it.

As you can see, I could have the keypad here or if I'm not using the computer, I could have some music paper sitting up here on the SBX-80, which I use constantly. I have two Prophet 2002s, which I use a lot. I have several hundred disks which I am still sorting out.

When I'm doing a synth score, I'll bring in the third 2002. I have the Prophet VS rack, which is just in to replace the Prophet VS keyboard. I have the DX7 II Plus, the new one with disk drive, which is going out on the road as a backup for the band. And five more DX7 modules down here tucked away. I got the Roland digital piano, MKS-20—which I use constantly. That's my most used instrument, because when I'm writing I just use the piano. And I love the MKS-30 Planet-S. I'm looking for a second and they don't make them anymore, so I'm looking for a used one. Still one of my favorite Roland keyboards was a very early model, one of the first five-voiced digital keyboards. This is the rack-mounted version, which I like quite a bit. And my console is a modified Soundcraft 1600. All the channels have been regrounded and all the IC chips replaced. All the wiring in my Octopus box and everything else was designed by John Dressel, the Sunset Sound Factory tech who helped me put all this together, and wired up the Sony 24-track.

And here's my Fostex half-inch 2-track, which I got for playback and editing, so I could do all my sequencing and editing here. We don't actually mix here, so in a way I didn't need a 2-track. I only do the direct recording here and then finish up the tapes with live recording and mixing in the studio. On the other hand, I couldn't play the tapes, so I got that recently. Now I can play any of the masters that have accumulated and do all my editing here at home. Everything we do now is on half-inch. Occasionally, I have used it—when we did *Pee-wee's Playhouse*, we mixed right here. And I recently did music for a wonderful animator, Sally Cruikshank, and mixed it all here.

**Bonzai:** And the punching bag is for getting rid of studio tension?

**Elfman:** Yeah, but I work out more on the rings. Jump up there and hang upside down. It does wonders for the back, especially when I'm scoring. That's when I spend 12 to 14 hours a day bent over the piano. ■

*Mr. Bonzai, a 15-year veteran of the music industry, is former manager of a major Southern Cal recording studio, and author of Studio Life: The Other Side of the Tracks (Mix Publications).*



# The NEW Eq. system featured on the CONCEPT 2200 - 3200 - 4400 - 6400 and 8400 range of consoles

'Sidetraker' 6 fixed frequency active filters with centres at:  
12.5kHz, 4.5kHz, 1.5kHz, 500Hz, 150Hz and 60Hz.  $\pm 12$ dB  
AND  
1 high-Q filter sweepable from 50Hz to 5kHz and adjustable  
from -24dB to +6dB

Although varying in performance and complexity, most Eq. designs have followed either of two classic principles:

**parametric:** or more usually 'semi-parametric equalisers are almost universally used on console input channels. Normally comprising four filters, two (or sometimes four) of the filters can be 'swept' up or down the audio band to centre on the exact frequency needing attention. Proven to work very well, semi-parametric eq's have two major disadvantages:

1. A tendency for audible phase shift 'ringing'
  2. A limited ability to control the entire audio band at one time
- For example: having used the 'high mid' to suppress the 'edge' on a singer's voice, there is no facility left to boost the critical 'presence' frequencies that lie either side of the unwanted frequencies that have just been cut.

**graphic:** normally used for system and room equalisation, graphic equalisers use multiple, fixed frequency, fixed bandwidth filters, to generate gentle, essentially phase-free control over the entire audio band.

The graphic principle has one major disadvantage:

1. A limited ability to control narrow band problems.
- For example: although frequencies in the 'presence' band can be easily and cleanly boosted, that annoying 'edge' to the singer's voice gets boosted as well.

Up until now Hill Audio has uniquely offered the graphic solution on their consoles, believing the ability to keep good control over the entire audio band is preferable to having greater control over just part of it.

## Now Hill Audio has the best of both worlds! 'Sidetraker'

The 'Sidetraker' Eq. system provides continuous control over the entire audio band via multiple, phase-coherent, fixed frequency active filters, PLUS a sidetracking, high-Q filter that can be swept over 7 octaves, enabling narrow band 'spot' frequency correction without any effect or compromise of the main Eq.

## Now you can cut the 'edge' AND boost the 'presence' at the same time!

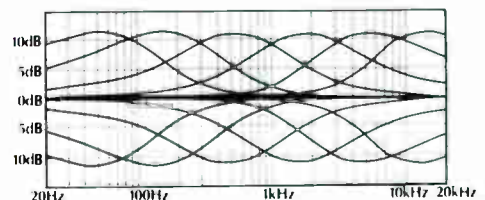
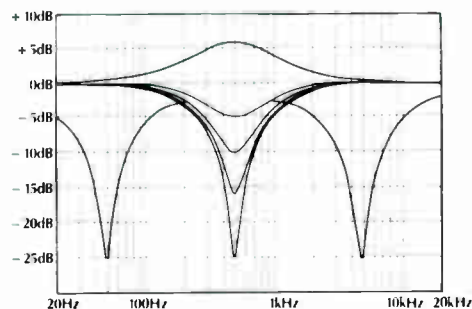

## Total Audio Transparency

Manufactured in the UK:

Hill Audio Ltd., Hollingbourne House, Hollingbourne, Kent ME17 1QJ England  
Tel: (062 780) 555/6/7 Tlx: 966641 HILL

U.S. Sales Office:

Hill Audio Inc., 5002B N. Royal Atlanta Dr., Tucker, GA 30084 USA  
Tel: (404) 934-1851 Tlx: 293827 HLAD



# P R E V I E W

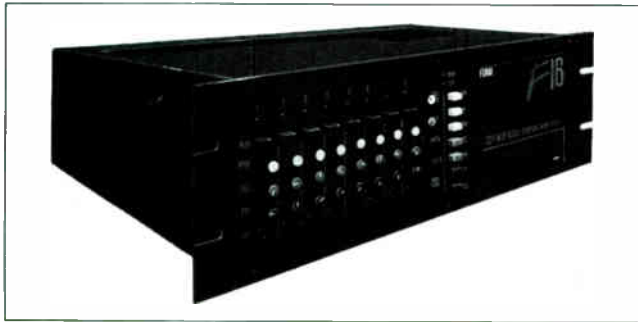

## Forat 16-bit Sampling Drum Computer

Unveiled at the summer NAMM show is the F16 from Forat Electronics (Studio City, CA), a 16-bit sampling drum computer. Each of its 16 voices has tuning, volume and pan controls, and is available through direct outputs or the stereo mixer. Other features include mic and line inputs, editing commands for easy trimming and moving, a built-in, high-capacity floppy disk drive, and MIDI-in, out and thru connectors. The F16's memory stores up to half a billion bytes for each sound, allowing individual samples to 6 seconds long at full audio bandwidth, or as long as 25 seconds. Drum pads, recorded drum tracks, or drum machines can trigger the F16, with 100-microsecond trigger response time. The F16's list prices start at under \$2,500.

Circle #112 on Reader Service Card

correction, is -6 dB at 120 kHz. Slew rate is 55 volts per microsecond. Features include separate, stepped level controls, variable reference meters that display actual power available with respect to mains voltage and load impedance, and XLR inputs (actively balanced) and outputs. The 8000C mounts in a 19-inch rack and requires four spaces. It is available in the U.S. through GMI Distributors of Newport Beach, CA.

Circle #157 on Reader Service Card



## Black Audio Mic Clamp

Glendale, California's Black Audio Devices had designed the Mic Clamp to simplify live miking. It holds light- to medium weight mics in setups where a regular stand is not practical. The Mic Clamp can be clipped to any surface up to 7/16-inch thick. Tipped with a plastic coating for extra grip without scratching, the Mic Clamp costs \$7.50, or \$6.50 each in quantities of six or more.

Circle #158 on Reader Service Card

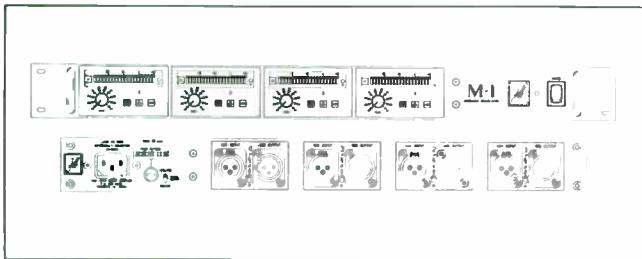

## Hardy M-1 Mic Preamp

The M-1 series from the John Hardy Company, Evanston, IL, offers one to four high-performance mic preamps in a single package. Features include a 990 discrete op-amp design, Jensen JE-16-B input transformer, and DC servo circuitry, while backlit LED switches are provided for selecting: 48V phantom power, high/low gain range, phase reverse and peak/VU meter ballistics. Units are priced from \$675 to \$2,352, depending on the number of mic channels and options selected, such as output transformer versions and metering choices.

Circle #156 on Reader Service Card

## Perreux Power Amp

The new Perreux Professional Power Amplifier, Model 8000C, is a dual-channel unit rated at 1,000 watts RMS per channel, each channel driven into a 4-ohm speaker load, or 500 W/channel into 8 ohms, both rating at 0.09% THD/1M. Open loop frequency response, prior to signal



## Soundtracs PC MIDI Consoles

The Soundtracs PC MIDI Series Console is available as a 16- or 24-input/output mainframe with 16-track monitoring and 16 sub groups, and is designed primarily for keyboard and electronic music setups. The console, which may be designated to any of the 16 MIDI channels, includes 32 or 48 MIDI-controlled inputs and four MIDI-controlled auxiliaries, plus optional MIDI-controlled effects returns (8). The built-in microprocessor enables console programming and control of external MIDI effects, without requiring an external computer.

Circle #159 on Reader Service Card



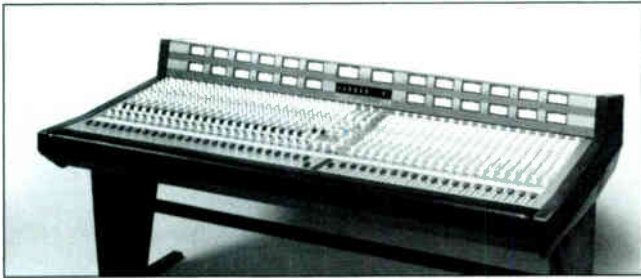

## AHB Sigma Consoles

Allen & Heath Brenell (Orange, CT) presents the Sigma Console Series, available in configurations for 16-, 24-, or 32-track recording, first-generation MIDI recording, or sound reinforcement. Sigma features a wide variety of input and output modules and the ability to locate or relocate any module anywhere without modification. The console has 4-band sweepable EQ with high-pass filter and three types of solo circuitry. Silent FET mute switching allows external muting control, by MIDI or manually. Sigma also allows sequencer patch control of any MIDI effects devices. List prices range from \$24,000 (16-input, 8-output) to \$52,000 (56-input, 44-output).

Circle #160 on Reader Service Card



## Roland DEP-3 Multi-Effects Processor

The Roland DEP-3 provides digital reverb, digital 3-band equalization, delay functions and programmability in one single-rack unit. The digital reverb incorporates 16-bit A/D-D/A conversion and 28-bit signal processing for optimum simulation. It provides three rooms, three halls and two plates, with reverb time up to 99 seconds. Gated reverb time of up to ten seconds, in normal or reverse mode. The delay mode offers delay times up to 450 milliseconds at 12kHz. The DEP-3 provides a separate knob for every programmable parameter, and allows one-button recall of up to 99 setting-storage locations—which can be recalled by remote MIDI control.

Circle #161 on Reader Service Card

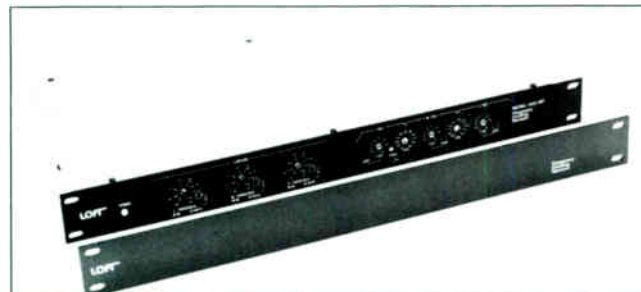

## Loft Crossover/Limiters

Gold Line (W. Redding, CT) debuts two Loft frequency dividing systems with built-in limiters. Loft models 603MP (mono 3-way crossover) and 602SP (stereo 2-way) each required a single rack space. Both feature internal limiters, preset to different attack/release times. These contin-

uously adjustable crossovers use 24dB/octave "Linkworth-Riley" filters, low-noise, high-slew rate circuitry and output LEDs. Power transient suppression is included to protect speakers and drivers. Both models are available with knobs or recessed controls.

Circle #162 on Reader Service Card



## Peavey PEP 4530

Peavey Electronics has added the programmable PEP 4530 digital effects processor to their MIDI program series. It features continuously adjustable delay settings from 0.1 to 4095 ms and includes 530 programs. Every operating parameter is programmable. The PEP 4530 provides synchronization with MIDI time clock signals, and accepts external sync signals (drum machine click tracks, foot-switch, etc). Suggested retail price is \$699.50.

Circle #163 on Reader Service Card

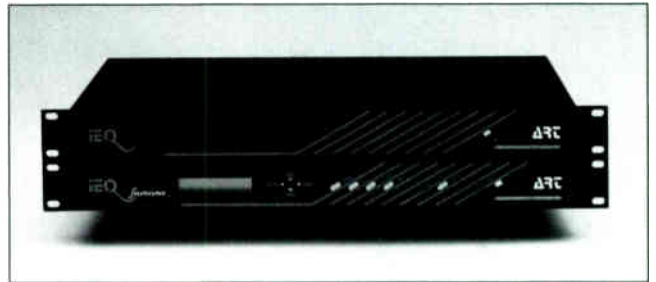

## ART IEQ

Now available from Applied Research and Technology, the new Smart Curve Intelligent Equalizer (IEQ) is a micro-processor-controlled, 15-band, 2/3-octave graphic EQ for studio and live applications. The IEQ, which employs digital control of analog circuitry, provides front panel controls for changing any parameter, and an LCD display of modes and parameter settings. The IEQ is available in master and remote versions: the master or a computer can program the remote for curve settings. It stores up to 128 curve memories, which can be recalled via MIDI. The unit's composite video output allows a monitor to display frequency response as well as fader positions and system status.

Circle #164 on Reader Service Card



## Audix OM-2

Audix (San Ramon, CA) have brought out their OM-2 hypercardioid microphone for live performance and re-

—CONTINUED ON PAGE 129

# 16-BIT DIGITAL REVERBS



**THREE AT A TIME, \$770\***  
including Rack Adapter

This full 16-bit no-compromise PCM processor is only **\$249**. —your absolute **best** buy in professional quality stereo digital reverb. Period.

**Serious** professional sound engineering requires multiple digital reverb effects. Now you can afford one for each main input channel, a couple dedicated to the cue lines, definitely a spare for mixdown and assembly.

Chances are, you have a fully programmable *expensive* digital processor. We think that's great. But we know the high cost of such processors usually won't permit having as many as you'd like to **satisfy** your demands for more extensively processed sound... and to **maximize** your **competitive** edge. MICROVERB captures the sound you're used to. Dense, rich, dynamic

reverb. Plates, rooms, chambers, halls, special effects like gated and reverse reverb. 16 programs, 10kHz bandwidth. All **super quiet** and in **full stereo**. A breeze to use, and, most important, *useable*.

If you haven't heard the **Alesis Microverb** yet, do it today. Microverb is fast becoming the utility reverb standard in equipment racks **everywhere**.

*\*Suggested retail price for three MICROVERBS and the Micro Rack Adapter. To hear this startling breakthrough in technology, contact your Alesis dealer; where, yes, you can purchase one at a time.*



**ALESIS**  
STUDIO ELECTRONICS

Rugged extruded aluminum case with interlocking construction.

Circle #039 on Reader Service Card

FOR MORE INFORMATION WRITE: **ALESIS CORPORATION** • P.O. BOX 3908 • LOS ANGELES • CALIFORNIA • 90078

World Radio History



# INTERACTIVITY

## CD-I AT THE VILLAGE

by Lou CasaBianca

In the October '86 issue of *Mix*, we assembled a panel of experts and presented a comprehensive look at the most recent incarnation of the laser disc—Compact Disc-Interactive (CD-I). So-called "smart systems" have been used in advanced research, military and scientific applications for years. The possibilities of CD-I can also be expressed by thinking of the "I" as standing for Instructional, Integrated and Intelligent, because for the first time we have all the recorded communication media on one user-responsive and user-friendly format. Interactive CD players will be available around mid-1988, at a price that should bring this extremely powerful technology into the hands of the average person.

A special interest group, CD-I SIG, has been formed to help disseminate information and network developers and manufacturers interested in this new medium. Recently, American Interactive Media and *Mix* magazine co-sponsored a conference, hosted by The Village Recorder in Los Angeles, specifically to introduce CD-I technology to the audio recording and music community in L.A. Professionals were invited to ask questions and make suggestions about developments in CD-I. The meeting was chaired by *Mix* publisher/editor David Schwartz, and the featured speakers were Mark Fine and Mark Dillon of AIM. The following comments from that conference are part of a series of articles that will be presented in "Interactivity," dealing with audio and music production for laserdisc and CD-I.

**David Schwartz:** We're probably all in different positions relative to CD-I; some people here know very little about it, some may be experts. CD-I is an interesting concept at this point. It's a little bit like, if you remember in the movie *Close Encounters*, there was a group of people who started to see a



*Addressing the AIM/Mix CD-I forum at LA's Village Recorder were (L to R) Rodney E. Wood, digital design engineer for AIM; David Schwartz, Mix editor/publisher; Mark Dillon, AIM vice president of technical and creative services; and Mark Fine, vice president of program development for AIM.*

kind of a vision. They couldn't tell quite what it was. And through a kind of sixth sense, they frequently would see a shape or hear a sound that would remind them of the vision. More and more there are people who feel there's something different or something special about CD-I—not just another format, not just another way of doing something we've already been able to do before, but something beyond that.

It was about a year ago that Sony and Philips decided to essentially map out what CD-I was, and agreed and essentially promoted it as an international standard. Besides digital audio, CD-I presented a way of integrating computer instructions, text, graphics and a limited amount of motion video on one compact disc. What that did was open the door to what some of us here feel is a revolutionary development in the media recording and information dissemination industry. The potential is truly staggering.

There are samples of different elements of the different technology that can be seen or heard, but there is no CD-I disc today and no CD-I playback unit. That's one of the reasons we're

here to talk to the organization that was set up by the developers of CD-I—to get a little bit of information from them on where it is, what it is, how it's going to work. Also, they would like some information from us, people from the music and recording industry. AIM, American Interactive Media, was set up by Philips and PolyGram in order to be the catalyst organization in this new industry. We'll first hear from Mark Fine, who is AIM's vice president of program development, specializing in the music and entertainment side of CD-I.

**Mark Fine:** Humans are control freaks. Our first formal skill is manipulating every adult within wailing range. Now, one form of control I think most of us are familiar with in this room is creative control.

Artists demand it, executives insist on it and I believe if given the option, the consumer would desire it. However, to date we all find ourselves restricted by the inflexibility of the linear mode. This isn't our fault; seldom are we faced with revolutionary technologies. First there was radio, then TV, the computer and now compact disc

interactive. CD-I is a hybrid and is an evolution of the audio, computer and visual industries. Surely the CD-I applications that we develop will be revolutionary. Finally, we can lift those linear restraints and explore new avenues of shared experiential entertainment.

Briefly, my organization, American Interactive Media, known as AIM, was established as a catalyst company by PolyGram Records and Philips N.V., co-developers of the CD-I standard. It is our mandate to work with the appropriate content providers and develop, produce and distribute CD-I titles in the areas of entertainment and education. AIM needs to stimulate and create a sufficient critical mass of CD-I titles to support the player, the proverbial razor blades to justify the razor. In addition, we've been a valuable conduit for feedback to the standard designers, a prime purpose for this gathering. You are all welcome to join us at this unique moment, a moment not for the timid, one which has been likened to producing a movie before the projector was invented.

We are all aware of the spectacular success of the compact disc. It has revolutionized the record industry. Based on this foundation, Philips and Sony developed the new CD-I standard. . . . What is CD-I? Visually identical to the audio compact disc, it contains 600 megabytes—equivalent to 1,500 floppy discs. A single CD-I may contain the combination of 5,000 full-color pictures and 300,000 pages of type-written text.

The audio may be 72 minutes to 20 hours in length, depending on bandwidth of choice. CD-I can sustain animation and limited screen full-motion video. All this data can be manipulated by a real time multi-tasking microprocessor operating system. This is a very impressive technology, but surely the world isn't waiting for another complex computer, targeted for our homes.

This, however, is the sheer brilliance of the CD-I concept. CD-I is a consumer appliance. It must be perceived as an upscale, future-proof, CD audio player capable of playing the myriad music titles available. It will plug into the back of your friendly TV set and receiver possibly bearing the nameplates of Philips, Sony, Panasonic, Hitachi or even Gold Star and Samsung, rather than IBM, Apple or Commodore. The CD-I player will be the ultimate Trojan horse, with its microprocessor discreetly hidden beneath its skin. Also, we must not underestimate the power of the standard. The CD-I is a universal standard and is compatible with PAL, NTSC and 220V/110V systems, insuring disc and player

compatibility. As you can appreciate, this inherently avoids the consumer confusion plaguing the home computer industry.

It is fascinating how various industries are responding to AIM's overtures regarding CD-I. The conservative print publishing corporations are ecstatic. Electronic publishing is surely the wave of the future. Educators acknowledge the need for electronic tutoring in mathematics and the sciences especially. Computer software companies are dizzy with the prospect of dabbling with all those bits and bytes. But the music industry?

CD-I is a marvelous new medium to exploit existing music repertoire. This is important. One of the major reasons for the success of CD audio was all those existing titles. We must use those massive libraries of existing materials in some form of interactive mode. As an industry we must be receptive to the varied ways music will be used, as support in educational programs and as underscore for interactive fiction adventure games. CD-I electronic liner notes may include lyrics, publishing, production and technical credits, fan magazine information, discography and even live interviews. Add in multi-lingual vocals, lyrics translations and music score on demand. And, a CD-I disc is copy resistant—it would be difficult and costly to replicate this multi-faceted gem in its entirety.

For some of you in this room, compact disc-interactive may be a tool to produce and create, an efficient means of storing a multitude of sampled sounds or a unique composing tool. For others, this may be the ultimate form of artistic expression. No longer inflexible, a musician's creation could be constantly buoyant and rejuvenated.

Concepts, ideas and applications are the driving force behind this new technology. People ask me to define what CD-I can do. This is distressing because it would be tragic if my vision or understanding of the medium defines its outer limits. I'd rather you challenge us with unique and audacious applications and let us see if *collectively* we can make CD-I comply.

Let me outline some music programs for you. The titles are generic by nature but the possibilities are indeed sensational. First, the "Sidekick Series," a miraculous travel through time finds that you are the friend, mentor or confidant of a significant music personality—for example, Mozart. You are encouraged to become involved in all aspects of his life, both creative and personal. However, be warned your council may not always be well received—after all Amadeus is sub-

ject to the foibles of his own genius.

"The "Music Spectrum" creates a unique link between visual images and the music. The user will be able to alter the music by his or her selection, of images or vice versa. For example, a cool acoustic composition may be accompanied by serene winter scenes. The user can then insert a springtime scene from the available clip-art file, the musical arrangement shifts accordingly by adding an uplifting trumpet fanfare. The transparent computer controller ensures that the original theme remains musically intact, albeit enhanced. Thus, the listener is constantly delighted by numerous variations on the theme by simply shuffling the deck of images.

More challenging is the "Elastic Music" concept, whereby the same composition could be heard a variety of ways subject to the listener's mood or taste. The artist provides the palette, delineates the outer perimeters, then invites the listener to arrange and rearrange the orchestration. Instrumental solos can be introduced at will. Also, without pre-programming, the computer controller may randomly alter the arrangement every time the disc is played, thereby creating the temperament of a live performance.

For a title to justify the CD-I logo, besides conforming to the standard, it must combine characteristics that are unique to the medium. The degree of interactivity isn't the sole criteria, computers already are interactive. Superior audio/visual capabilities alone do not suffice; CD, laserdisc, and video already perform these functions. However, it's the unique combination of all these elements at a reasonable consumer price that makes CD-I special.

Regarding production, obviously as a multi-media format it's Mission Impossible time assembling that special team of computer, video and audio experts to produce CD-I. I believe a team leader will be dictated by the content on a project-by-project basis.

I think the challenge facing all of us today is how to make music bend around corners, seamlessly and on demand. A very important message worth repeating: CD-I must not be perceived as a computer. We must not use its great capacity as an excuse for user complexity. The player must be "transparent." The user must not detect the complex computing algorithms at work. Every title must have a linear core function immediately accessible with a push of the play button. None of those hassles of booting will be tolerated.

The desktop computer approach may well be limiting; probably most people will sit within 20 feet of their TV screen and employ remote point-



ing devices, voice prompted interface, magnified icons, etc.

You should be able to switch on the player and your first reaction should be comfort. The machine should respond by being inviting.

Artistically, a CD-I program should be constantly dynamic, a living creation that achieves levels of involvement, experience and intimacy with the creator. Please join us in shaping this machine and, more importantly, in shaping the future of the disc.

Now I'd like to introduce you to Mark Dillon, vice president of Technical and Creative Services who's been chairing the International Technical Committees relating to CD-I.

**Mark Dillon:** Whenever we get into a new technology, banner headlines about how it's going to change the world come out of the public relations department. One of the things that I hope makes AIM different from a lot of other CD-I evangelicals (and we are CD-I evangelicals) is that our parent is PolyGram, and one thing that PolyGram recognizes above everything else is that content is what counts. Technology should be transparent.

The final specifications have just been defined, now called the "green standard." Red was the CD-audio standard. It was called the red standard because it came in red binders. Then they had the CD-ROM standard that came in yellow binders. And on my desk there's a green binder and that's the CD-I standard. There are emulations and prototypes in various labs in Japan and Eindhoven, and even down the street here at the offices of AIM, but the final configurations really won't be out for a year. So, what I've got to do is show you through the Marcel Marceau product demonstration technique what CD-I is all about.

It's going to look just like a compact disc audio player—same form factor, same front piece, same dimensions. Only you turn it around to the back and it's going to be different because it says, "video out." In fact it says video in a couple flavors, like you get off your VCRs or your video disc, or RGB, just like you get off your computer. It also has two audio ports, appropriately enough, so what you need is an extra set of cables that will come in the box. You'll stick it up there in your home entertainment console and you take your left and right channels and put that into your amplifier. You'll take your video out and put that into your monitor or into your receiver or hopefully you've gone out and bought one of these new combination RGB monitor setups.

One more thing you get—your remote control unit. Only this remote

control unit has a joystick coming out of it, because this is interactive. It may not necessarily be a joystick, it may be a little pad or something that will allow you to move a cursor on the screen. What makes this interactive is that you can tell the program material what to do. You have to talk to the machine, you have to talk to the program, so there must be some way for you to communicate with the device. The technical spec allows for XY device such as a track-ball, a joystick or the arrow keys on a keyboard and two click buttons.

By the way, CD-I players can play all your CD audio discs that you've bought already, it's reverse compatible. What makes it different is you open up the top and look inside and there's a Motorola 68000 family computer chip, a megabyte or more of ROM, and you realize not only did you get a CD audio player but you got an Atari computer. This is really a computer posing as a turntable, but we want the computer part to be so transparent that nobody thinks about it.

There's another turntable that came into the home that had the word interactive in front of it, called the videodisc. Many of you may even have videodisc players because they tend to have better pictures than tape, and now with the digital audio tracks it's a phenomenal home entertainment device. But that is a dumb terminal. The trouble was when the interactive videodisc entered the home; it was marketed as interactive video but it had no smarts, there was no computer in it, and it was just a turntable, so it *couldn't* be interactive.

As a consequence, it was very frustrating. To make a videodisc player interactive, you have to plug it into an IBM PC or an Atari or something like that. You can do it. You can take a videodisc player and plug it into a home computer and get your hard disk drive and get all the cables and strap it all together and you can have something that operates a lot like a CD-I player.

But very few are going to do it and that's what the CD-I standard is all about. This is a consumer appliance, so they tucked this computer inside and said they don't want the person at home to worry about the problems you have dealing with the computer.

*To be continued.* ■

*Lou CasaBianca's primary interests lie in the areas of advanced music, motion picture and television production, with emphasis in interactive authoring and visual design, and the application of computer systems in media production.*

7" SLEEVES • RECORD JACKETS • LABELS  
CASSETTE INSERTS • COMPACT DISC • PRESSURE SENSITIVE

OUT OF THIS WORLD PACKAGING FOR EARHTLY EAR PRODUCTS

KEYSTONE Printed Specialties Co., Inc.

RT. 247 • MOOSIC LAKE RD. • JESSUP, PA. • 18434 • U.S.A. • EARIH • SOLAR SYSTEM • MILKY WAY • 717-383-3280

Circle #040 on Reader Service Card

# IVY LEAGUE

## *Goes Digital*



PHOTO: JONATHAN SA'ADAH

*Above: professor Jon Appleton in the classroom.*

by Dan Daley

**T**hey like to say, "You can't get there from here," up in New England. But Dartmouth College is on the way to Boston or Montreal or New York City—if you're not in a big hurry. Nestled among the White Mountains on the western edge of New Hampshire, it's also on the way to Ascutney, White River Junction and Cornish Flat, which is to say it's not on a British Airways schedule. If you fly there, expect to be asked by the pilot of the little Precision Airlines Dornier 228 to please sit further back because the airplane needs ballast. It's not the

sort of thing that inspires confidence in someone used to 747s. The weather up there in the collegiate hamlet of Hanover, NH, is predictable: winter is blue-steel cold, spring is mud city, summer is mosquitos and heat and the fall is beautiful.

Nonetheless, if you're interested in the future of music, there is reason to go to Dartmouth, because there are a few things down east, as they say thereabouts, that are a bit less than predictable.

Under the guiding hands of Professor Jon Appleton, abetted by the technology of New England Digital's powerful Synclavier system and Apple

Computer's Macintosh family, Dartmouth has implemented what is perhaps the most ambitious electronic music technology course available on the college level. In a well-appointed, multi-tiered classroom-cum-laboratory, up to 16 students sit at workstations supplied with Mac Plus mega-K computers and Casio CZ-1 keyboards. The room also holds an Otari M80 24-track deck, a 32-channel Neotek Elan console and outboard gear including a Lexicon PCM 70 and dbx comp/limiters. At the center is the latest generation of the Synclavier digital music system.

—CONTINUED ON PAGE 69



# What Does The Human Clock Do?<sup>T.M.</sup>

## Ask Roy Thomas Baker.



Roy Thomas Baker's magic has touched such artists as: Queen, The Cars, Journey, Foreigner, Alice Cooper, Cheap Trick, Devo, Slade, Nazareth, and more recently T'PAU. His hit albums have generated over 80 million in sales, and that figure is still climbing.

"At last, there's a device that will allow me to use sequencers without losing the integrity of the music. It was the first time ever I was able to sync a sequencer to an existing track. Because of the time saved by using this device, I feel that it should be standard equipment in **every** studio."

Roy Thomas Baker

- **THE HUMAN CLOCK IS FOR PRODUCERS:** Capture all the MAGIC from your artist's demo tapes by using the Human Clock to sync all the additional hit-making touches they need, WHETHER OR NOT THE DEMO WAS RECORDED WITH SYNC. With the Human Clock's exclusive **ADVANCE** function, you can also move sequences ahead or behind the beat to create even more feel.
- **THE HUMAN CLOCK IS FOR ENGINEERS:** Re-lay lost sync tracks with the Human Clock. Or better yet, create an indestructible sync tone with a Human Clock and a bass drum. The Clock can rescue weeks of work.
- **THE HUMAN CLOCK IS FOR A NEW WAY TO MAKE RECORDS:** Use sequencers and drum machines for what they do best . . . great sound, reliable performance. But **DRIVE THEM** with a **living, breathing and feeling** musician to make the music come alive. The best of both worlds!

Visit Our NAMM Booth #4124

 APM, P.O. Box 9305,  
Anaheim, CA 92802

Want to know more? Send us this coupon and we'll send you a FREE brochure on the Human Clock.

Name \_\_\_\_\_  
Address \_\_\_\_\_  
City \_\_\_\_\_ State \_\_\_\_\_ Zip \_\_\_\_\_



PAT. APPL'D FOR  
Circle #041 on Reader Service Card





As a singer, songwriter, producer, and musician, Gavin Christopher has worked with the best in the business: Herbie Hancock, Chaka Kahn, Huey Lewis, Carlos Santana, Teddy Pendergrass. But after five years in New York, he moved home to Chicago to get the Royal Treatment.

Why? Because Gavin found out Royal Recorders has everything he needs to get the job done, plus a whole lot more.

As a producer, he knows our complete 80-input SSL audio console combines 2 state-of-the-art Mitsubishi 32-track digital recorders with an impressive assortment of outboard gear. As a musician, he's comfortable in our spacious studio. And as a songwriter, he likes our flexible acoustics and studio annex which can create the perfect sound quality, from hushed chamber to large concert hall.

Between sessions, Gavin relaxes in one of the most beautiful of settings. Only minutes away from the city, the Americana Lake Geneva Resort is host to the finest in dining and leisure activities including golf, tennis, horseback riding and a complete Nautilus center.

"I have everything I need to do my best work," says Gavin. "That's why I brought Mick Murphy and David Frank here to record for Manhattan Records. And that's why I'm staying on."



# Gavin Christopher



PHOTO-DESIGN SANDOZ CHIC © 1997

## gets the Royal treatment.



LAKE GENEVA, WI (414) 248-9100

Circle #042 on Reader Service Card

World Radio History



Today's tougher audio requirements demand a new choice

# Telex *Pro Series* 6120 XLP

A new duplicator with 8X speed and tougher specs.

Improved frequency response plus less distortion and crosstalk are just a few of the technical gains achieved in the new Telex Pro Series duplicator. This means that you'll make duplicates that are **true to the master** than with any comparable tape duplicator on the market today.

Yes, here's a system with all the advantages of the famous 6120 high speed duplicator plus enhanced specifications. Features that made the 6120 popular such as compact size, unlimited expandability, track select, audio

level monitors and easy one-button operation remain distinct Telex advantages. But, by developing the 6120XLP with 8X speed, Telex gives you the advantage of improvements in many **important professional specifications** such as distortion, frequency response, speed accuracy and crosstalk. And, the new cassette transport speed allows you to duplicate directly from 15 ips open reel masters for the ultimate in quality and convenience.

The Pro Series 6120 uses a newly developed, highly effi-



New XL LIFE cassette head.

cient **XL LIFE™** cassette head featuring ultra-hard physical characteristics for **extra long life** (10X normal) plus a satin smooth surface that resists excessive oxide build-up preventing the need for frequent maintenance. Its advanced engineering, precision design and painstaking manufacturing techniques contribute immensely to the Pro Series improved specs including an **unmatched frequency range** of 50 to 13KHz. For further technical details and the name of your nearest 6120 dealer, call or write Telex Commu-

tions, Inc., 9600 Aldrich Ave. So., Minneapolis, MN 55420.

### Up to 12 months to pay with no interest!

The entire Telex 6120 duplicator series is available with special **NO INTEREST** financing through participating Telex dealers. Yes, with only 10% down and up to 12 months to pay, you could be eligible for special **NO INTEREST** financing. Think of it! You could pay for your 6120 out of the savings or income generated.



## TELEX®

Call Toll Free in U.S. 800-828-6107 • In Minnesota Call (612) 887-5531

Circle #043 on Reader Service Card

World Radio History



All the workstations are tied to a central computer and into the Synclavier. Students boot up the previous week's assignments, then Professor Appleton, from the master terminal, assigns an individual student's Mac as the lead or "active" computer. As everyone listens, students explain why they chose a particular sound or waveform and the class then makes suggestions for edits accomplished and realized through the menu-driven Synclavier system and played back through Westlake monitors.

### Electronic Luthiers

Where 20 years ago, students sat out on the oval and wrestled with Dylan tunes on the battered Aria acoustics, alternately trying to vent political frustrations and impress girls, now they sit in this high-technology environment and diddle with equipment that is beyond the reach of many mid-line studios. What happened?

"I feel that the whole musical culture is changing," says the tweed-clad, bespectacled Appleton, putting the program into a larger context. "In 1983 there were 392,000 digital keyboards sold. Last year there were 1,800,000. In the same period of time the sales of traditional instruments have been cut in half; band programs can't get funded; five symphony orchestras have gone bankrupt. People are afraid that in the future only machines will make music and that's wrong. The reality is that digital instruments are the folk instruments of our time. That's what people are making music on today. The designer of digital instruments is the luthier of our time. And these instruments are making music more accessible. That's the way kids see it. Older people don't and what's frightening to me is to see music education in universities today: how many out of 3,000 music departments teach electric guitar? Yet that's the most widely played instrument in our culture up till now."

Appleton feels that colleges need to be state-of-the-art to adequately service the needs of the real world: "We're moving into a new musical culture and universities are not keeping up. They're not training people as composers, as performers, as engineers or as [music business] executives. It's because the teachers were trained to view music from a narrow point of view—from the classics—and they don't take popular music very seriously. There is this assumption that music was made by these great masters from the past, that an ordinary human can't compose great music. That there's something mystical about the process

---

"The designer of digital instruments is the luthier of our time. And these instruments are becoming more accessible. . . ."

---

and that's just not true. Also, pop music is back to an oral tradition and academics like to see things on paper. People today don't go out and buy sheet music. It's funny: we went years ago from an oral tradition for thousands of years to a written one and now we're back to an oral one. The worlds of music and of education have never been so far apart as they are today. We are obligated to teach people about the culture in which they live; we cannot go on living in the past."

### Computerized Campus

The title of the course Appleton has devised—"Music and Technology"—sums up not only his approach to the future of music, but also reflects the college's commitment to computers in general. Former Dartmouth president John Kemeny was the author of BASIC, still one of the most widely used computer programming languages. Under his leadership 25 years ago, the college installed a large mainframe computer with 100 terminal points throughout the campus. Since then, no student has graduated the school without first having worked at least once on the computer. Three years ago, in a move that made news nationally, Dartmouth—founded in 1769 by the Reverend Eleazar Wheelock "for the education of youth and of the Indian tribes"—made ownership of a personal computer mandatory for all students. Apple provided Macintosh 128K units at a special price and the school had computer I/O ports installed throughout the campus.

Appleton, an electronic composer himself with over 30 of his compositions recorded on the Folkways and Flying Dutchman labels, notes ironically that some of the students in his class are more facile at operating the Synclavier than he is because they are already adept programmers. "Dartmouth has always been on the leading edge of computers, has always

promoted computer literacy and its applications to other disciplines, and that fits in very nicely with music," he says. "About half the students who major in music at the college also co-major with computer science or computer engineering. The purpose of this course is to teach them about music that has been made and is being made with electronic devices and computers and to teach them to compose on them. You see, it's very hard for the music industry to find young people who are very well educated in this sort of technology. Here we have kids who know a lot about computers and electronics and who are learning a lot about music."

### The Synclavier Connection

The presence of the powerful Synclavier and its auxiliary equipment, including the digital 8-track Tapeless Studio™, also reflects an association that predates the course. Combining careers as a composer and a teacher, Los Angeles-native Appleton first came to Dartmouth 20 years ago as an instructor in the music department at the age of 28. There he met Sydney Alonso, an engineer at the school. Between 1973 and 1976, they developed a digital sound generator which was run by a mini-computer and which could speak to musicians in a common language. "We got the computer to talk in other than assembly languages," recalls Appleton. "We gave it a vocabulary."

Then-student Cameron Jones came along and enhanced the device's (which came to be known as the Dartmouth Digital Synthesizer) programming. In 1976, Alonso and Jones crossed the nearby Connecticut River and founded New England Digital in Norwich, Vermont. During that year Appleton worked with them, their collaboration eventually giving birth to the Synclavier, which the company says was the first commercial digital



## WANTED

Talented personnel to fill position of student engineer in the Midwest's most rapidly growing audio/recording program. Training includes the latest techniques in audio engineering, sound design, room acoustics, MIDI, and musical study.

Comprehensive 2-year Associate degree program emphasizing hands-on training and realistic work experience for a solid foundation in the recording industry. Our students work! To find out more circle our number on the reader service card!

# Northeast

Community College

801 East Benjamin Avenue  
P.O. Box 469, Norfolk, NE 68701  
Phone: (402) 371-2020

See School Listings

Circle #044 on Reader Service Card

RTW Digital Peakmeter 1150 DA

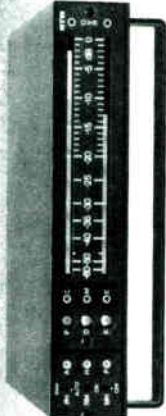

RTW products are available exclusively in the U.S. from ESL.  
120 S.W. 21st Terrace, C-104 Fort Lauderdale, FL 33312  
Tel: (305) 791-1501, TLX (WU) 75 3027 ESL FTL UD

**ESL**  
Electronic Signal Laboratories, Inc.

- Peak program meter for digital audio signals
- Connection to the status port of PCM 1510/1530 processors
- All data processing is carried out in the digital domain
- Indication of all error flags and preemphasis
- Additional overload indicator
- High resolution through 201 element plasma display
- Adjustable headroom marker

HORIZONTAL AND VERTICAL SCALES SUPPLIED

Circle #045 on Reader Service Card

musical instrument.

"At the end of that year, I returned to teaching at Dartmouth," Appleton writes in an essay entitled, *The Computerization of Musical Culture*. "Alonso and Jones, with the help of Bradley J. Naples, went on to build the company into the most respected manufacturer of advanced digital musical equipment in the world today. I am often asked if I do not regret my decision to return to composing and teaching. These activities are what I love the most, and while I have no financial interest in New England Digital, I continue to perform and compose on the Synclavier because it is the instrument of my musical dreams. As I have learned to use the instrument, and the improved models that New England Digital has created, I have continually shared my discoveries with my students. Little did I think, ten years ago, that our work would not only change my own work but actually have a monumental impact on our musical culture."

Not surprisingly, Appleton's feelings on the future of digital music found receptive ears at both Apple Computer and with the Dartmouth alumni at New England Digital, who donated the Synclavier as the centerpiece of the course. With resources like these, Appleton proceeded to put together what has to be considered the Cadillac of electronic music courses. In addition to the Mac Plus computers (soon to be upgraded by Apple to the new PC-compatible Mac II), Apple also donated a Laserwriter printer which nicely complements the Synclavier's new and extensive Music Printing Option, a software package that accurately transcribes any piece played on the Synclavier, up to a 128th-note resolution.

Neotek and Casio came on board with the console and the keyboards, the latter about to be interfaced via MIDI. The studio, specifically designed for this course, and the outboard gear were funded by the college. Appleton puts the start-up cost of the entire program at around three quarters of a million dollars.

Since the master computer is a PC-type and the workstations utilize the Macintoshes, New England Digital engineer Jaimie Robertson was called upon to devise a combination serial/parallel computer interface between the two systems. In the computer-rich environment of Dartmouth, however, it isn't surprising that the students themselves get in on the programming, too. "One of the important parts of a course like this is to let the students do some of the teaching," Appleton says. "I learn a lot from them, particularly in terms of manipulation of equipment.

They're much faster than I am; I'm a composer and some of these kids are computer programmers."

## Pass the Waveform

Student reaction to the course has been overwhelmingly positive. The two-hour, twice-weekly class doesn't seem to have attendance problems; all 16 workstations were occupied on a recent visit. The ambience is light; students—who earn a third of a semester's credits for participating in the course—banter among each other while listening to various pieces their classmates have worked on. There is a palpable sense of students and teacher discovering something together here, whether it's an odd combination of notes, rhythms and sounds on the Synclavier or figuring out the right sequence of instructions to make the occasionally balky computer respond. "I can teach what is a very complex system—the Synclavier—to a whole group of students at once with this arrangement," says Appleton, "where before I had to sit them down one at a time. They learn much faster when they can see what each one of us is doing."

Students are permitted—encouraged, actually—to sign up for non-classroom time on the Synclavier system. The integration of disciplines that is the foundation of a liberal arts program is ostensibly the point behind all this, Appleton agrees, but if some students opt for a career in music, he'll be the last to discourage them, given his views that technology is inextricably intertwined with music from now on. "The reality is that New England Digital and its competitors have created more and more complex digital systems that require an expertise that more traditional sound engineering programs do not provide. These are the tools that people will be working with routinely five years from now."

New England Digital's director of marketing, Mark Terry, a former audio engineer, acknowledges that he is already seeing a shortage of musical technicians in the marketplace.

"Whether or not these students go on to be composers," says Appleton, "if they do go into music they'll be better studio engineers or better instrument makers or whatever they want to be because they're aware of what the problems are in music composition."

*Dan Daley is a contributing editor of Mix and owner of Pyramid Recording Studios in Manhattan, where we ask the musical question, "Kenneth, what is the frequency?"*





In the 23 years since Robert Moog's presentation to an Audio Engineering Society Convention of voltage-controlled modules for music synthesis, the technology of electronic music has advanced by leaps and bounds, with the introduction of digital integrated circuits, especially microprocessors, causing particularly large waves. The changes that synthesizers and associated equipment have wrought have been so vast that even devoting entire papers sessions at AES conventions to these topics has been woefully inadequate in keeping the audio community at large informed on the state of the art. MIDI, the personal computer and greater integration of digital circuitry have compounded the information problem until it has approached critical mass.

John Strawn, long a mainstay of the computer music community, was approached by the AES to create a conference that would go some distance in bringing the audio community up to speed on current and future directions in the application of digital technology to music. Strawn's mandate required him to define a level and scope that would cover a great deal of territory in a manner understandable to a wide variety of attendees. To this end, he decided that there should be no concurrent sessions (thus eliminating the problem attendees often face of choosing what to see and what to miss) or manufacturer's exhibits, and insisted that speakers briefly explain basic terms and principles cited in their presentations. Further, he and his planning committee (Robert Moog, Dominic Milano and Curtis Roads) attempted to include speakers from both the academic and commercial worlds. The resulting conference, described here, was a very intensive (27 papers, a concert and four social events in a little more than two days) and well-rounded meeting which left attendees with a great deal to think about.

Following Strawn's introduction to the conference, the first session featured *Computer Music Journal* editor Curtis Roads and *Keyboard* editor Dominic Milano looking at the history and possible future of digital music-making. Roads' paper primarily addressed the origins of and fundamental issues in the field, and was liberally peppered with very rare recorded examples of early work in computer music. In a sense, Roads' job was easy compared to Milano's, who was placed in the position of having to summarize the present and future in a half-hour paper. In the course of his projections, Milano mentioned the term, "vapor-

## REPORT ON THE

# AES

# 5TH

by Larry Oppenheimer

## INTERNATIONAL CONFERENCE ON MUSIC AND DIGITAL TECHNOLOGY

ware," commonly used in the computer world in reference to products which have been announced and often hyped to the limit but are not yet sufficiently complete to ship or, in the worst cases, not existent at all. This term recurred with great frequency during the conference, underscoring the magnitude of the problem in the market today.

With this perspective, the next session, chaired by *Electronic Musician* editor Craig Anderton, went on to talk about some of the tradeoffs and considerations involved in design of instruments in the real world. Technical and economic factors usually dictate that many limitations be set in the de-

sign stage of a digital musical instrument, but deciding which areas can be compromised with the least objectionable deleterious effects on fidelity and marketability is a complicated juggling act. Dave Rossum, co-founder and chief engineer of E-mu Systems, explained his approach to this touchy subject. This theme was extended in the next paper, presented by William Mauchly of Ensoniq, which addressed the choices made in the design of the 5502 digital oscillator chip, used in Ensoniq's Mirage sampler and ESQ-1 synthesizer, as well as the new Apple IIGS computer. Mauchly showed that Very Large Scale Integration (VLSI) presents physical design problems, but can allow greater freedom in system design when coupling the VLSI with other components. Finally, Steven Misek of WaveFrame discussed aspects of software design for a multitasking operating system (such as prioritization, resource management and communications) as implemented in their AudioFrame digital audio workstation. WaveFrame, desiring to avoid any charges of vaporware, will not actually announce their product until they are able to ship it, which meant that Misek was neither allowed to describe the environment in which this software is intended to operate, nor able to demonstrate or substantiate his points with a working system.

WaveFrame's Adrian Freed chaired the third session, in which the idea of digital audio workstations was tackled. F. Richard Moore, a computer music pioneer who now directs the music workstation project at University of California at San Diego, gave the first of several definitions of a digital audio workstation provided in the session. Moore placed special emphasis on the distinction of real time vs. non-real time functions, calling for greater consideration of the advantages of non-real time operation. Finally, as an aside to his talk, Moore addressed the ongoing raging controversy over the perceptibility of millisecond delays by presenting recorded examples of computer-generated clicks with such delays, clearly demonstrating their audible effects.

Bruce Pennycook presented a more specific discussion of the real world considerations involved in digital audio workstations: hardware demands, bandwidth requirements, etc., and demonstrated one possible solution to these issues by explaining the Image and Audio Systems I/O and processing board that he has helped to develop. Making use of off-the-shelf DSP chips and communications buses,



such as SCSI, the Image and Audio board represents a complete subsystem which, when properly coupled to a suitable host/control computer, can constitute a workstation. Apple's Mark Lentzner was forced to give a very abbreviated talk on personal music workstations. It is most unfortunate that his time was so very limited as his talk was one of the most thought-provoking of the conference. Lentzner contended that a truly personal workstation is not simply a smaller version of a large system, but an entity unto itself with unique demands and capabilities, and strongly stated the necessity of accounting in the design phase of a personal computer for possible future applications such as music.

In the day's final session, chair Robert Moog presided over presentation of three fascinating perspectives on digital technology applied to music composition. Paul Lansky from Princeton University began by singing to show the independence of pitch, duration and timbre in the human voice. This independence is readily exploited through the use of Linear Predictive Coding, a particularly complex and compute-intensive form of analysis/synthesis. Lansky used recorded examples to show how alterations of the LPC model can allow significant manipulation of a speech sound.

## Wendy Carlos stressed that tunings, timbres and timing are now completely under the composer's control.

Composer/writer Chris Yavelow displayed a panoply of software available, mostly off-the-shelf, for the Apple Macintosh. Using his Kurzweil 250 for demonstration, Yavelow breezed through quite a few programs, including Mark of the Unicorn's Performer, Intelligent Music's M and Jam Factory, David Levitt's HookUp!, Laurie Spiegel's Music Mouse and even Music Moose (a spinoff on the mouse control

aspect of Spiegel's program). Yavelow's paper clearly showed how diverse the spectrum of tools available to the composer has become.

Following Yavelow, Wendy Carlos discussed the compositional ramifications of digital synthesis from the viewpoint of the need to intelligently consider how to use the massive resources that they offer. In particular, she stressed that tunings, timbres and timing are now completely under the composer's control, but best musical use of this control requires a reevaluation of the working methods that have been employed to this point.

With Carlos' words still resonating in the conference attendees' consciousness, a concert was presented in the evening which provided the most effective demonstration of all of how current technology is affecting music. Michael McNabb combined saxophone, piano, synthesis, signal processing (through a Lexicon PCM70) and even a robotic arm into a graceful selection of pieces from his ballet, "Invisible Cities." Paul Lansky's "Idle Chatter" allowed the audience to experience the results of his experiments with LPC, while Dexter Morrill's "Getz Variations" paid homage to the great jazz saxophonist, Stan Getz, with a combination of recorded instruments

—CONTINUED ON PAGE 199

## HANDS ON.

Orban's 424A Gated Compressor/Limiter/De-Esser is a versatile and economical production tool. It offers a wide range of hands-on controls to facilitate difficult level control chores where maximum flexibility is required.

Features include:

- Fully-adjustable compression ratio, attack and release time, release shape, idle gain, and de-esser for unmatched versatility
- Astonishingly transparent control action, even under extreme situations—no pumping, breathing, or processing artifacts
- Can be utilized as a hard or soft peak limiter or as a gentle "soft-knee" compressor plus full-function de-esser

**Orban Associates Inc.** 645 Bryant St.,  
San Francisco, CA 94107 (415) 957-1067 Telex: 17-1480

Circle #047 on Reader Service Card



If all these Fairlights look the same it's because they are.

Each one is designed and hand-built to the same exacting standards, with the same 16 bit sound quality, as our much-praised 16 voice, 14 megabyte Series III.

The difference is, now there's a Fairlight to suit your exact need and budget.

We call them e-x-p-a-n-d-a-b-l-e Fairlights. Not a set model range, instead it's a series of compatible options that allow you to choose any configuration and expand its capabilities.

Right on up to an 80 voice, 140Mb RAM Series III with Gigabytes of Hard Disc and Optical WORM Disc Storage.

# How much Fairlight do you need?

There are no limitations. You don't pay for features you don't need. But you do get the exact Fairlight for the job.

Just decide what you require for your composition, arrangement or production role and we'll build the Fairlight to suit.

*Even our basic Fairlight  
is far from basic.*

For \$39,950\* you will start with a rack-mounted or portable Fairlight, that is unchallenged by anything near its price.

16 bit Digital audio quality with over-sampling capability ensures the sound that

has made Fairlight the world's leading digital audio production system.

Eight voices provide the versatility required for most session work. And, if required, Fairlight's multi-port MIDI capability allows the control of up to 64 external, sampled or synthesized voices.

## *Advanced software.*

This is sampling in its purest form from the people who invented it.

Stereo sampling, Page R and CAPS Sequencers, Waveform Editing, FFT analysis and resynthesis, and an extensive sound library are all included.

SMPTE chase/lock provides the ideal setting for structuring musical scores, laying-in sound effects, and synchronizing to multi-track tape and disks.

A time-code trigger/event generator also lets you program complex SMPTE cue lists for film and video post-production.

Real-time effects allow complete control of attack, decay and vibrato for a realistic acoustic feel.

You have at your command every major section of the orchestra, and just about any synthetic and composite sound you could ever have reason to use.

## *Design your own Fairlight.*

For full details and a demonstration of the new e-x-p-a-n-d-a-b-l-e Fairlights, call your nearest Fairlight office.

Los Angeles (213) 470 6280, New York (212) 219 2656, Toronto (416) 964 1885.

Fairlight dealers — Chicago: Gand Music and Sound (312) 446 4263. Miami: Limelite Video (305) 593 6969. San Francisco: AIC (415) 686 6493.



\*Prices and specifications are subject to change without notice. Systems above 16 voice require external rack mount units (not shown), delivery late 1987. \$39,950 system does not include music keyboard.





**\$39,950\***

8 VOICE/4Mb RAM  
DUAL 20Mb FLOPPY



**\$75,000\***

16 VOICE/14Mb RAM  
150Mb DISC, 60Mb TAPE



**\$175,000\***

40 VOICE/50Mb RAM  
600Mb DISC, 400Mb WORM

■

# G R E A T C O M P A N Y



Recent technical advances have led to a new generation of low priced, analog, multi-track recorders. Yet recording consoles have not followed this trend... until now.

Trident pioneered sophisticated recording systems decades ago and in our spirit of innovation we have refined technology to bring Trident consoles into the range of affordability.

*It is this spirit that gave breath to the Trident 24.*

Featuring 24 discrete bus outputs, solo in place, auto muting and 24 monitor returns with EQ, the Trident 24 enhances its mechanical counterpart.

No matter which of the available machines you select, the Trident 24 is the perfect console choice.

Consider the Company you keep.

TRIDENT AUDIO USA  
2720 MONTEREY ST. #403  
TORRANCE, CA 90503  
(213)533-8900 / Telex (255)510 6000019



G R E A T C O M P A N Y

recorder: courtesy of Otari Corp.



# The Recording School

## BOTH ROOTS & WINGS Education Today

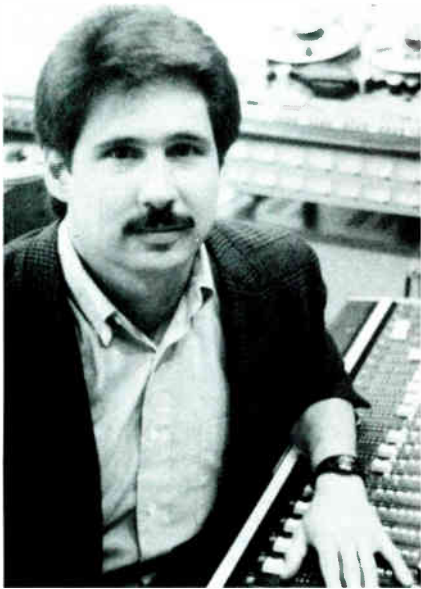

**“Education is stressing that the students have to take the risk of failing.”**

Timothy Miller, director of the Audio Recording Program at the Northeast Technical Community College in Norfolk, Nebraska and race car driver.

by Josh Gressel

**T**his is not rock and roll high school, this is business,” says Louis Lewow, academic department director of the Music Business Institute in Atlanta, Georgia. “The kids who think that the idea of working in rock and roll is hanging out backstage at a Def Leppard concert



**“There will come a point where operators who can’t maintain the equipment will not have work.”** Miriam Friedman, Institute of Audio Research, New York City, NY.

realize during the first term that this is not a school where you can sit around and listen to cassette tapes.”

Sounds pretty serious. Well it is, though there’s more to it than just discipline. We talked to some 15 recording school educators across the country to see what’s happening in the schools that are playing an ever more important role in preparing tomorrow’s studio engineer.

One of the central themes that emerged is best summarized in the famous Zen phrase: you need both roots and wings. (If journalists could write as succinctly as Zen masters talk, we’d save a lot of newsprint.) In this dual but complementary message,



**“Sound itself will never change.”** Brian Ingoldsby, president of Sound Master Recording Engineer School in North Hollywood, California.

Side A states: this is a highly technical profession. Learn your basics, and learn them well, because a great many musicians and artists will depend on you to interface between their creativity and all those knobs and buttons. To this end, recording schools have become more demanding in their standards for accepting potential students and more comprehensive in course content for those who do enroll. And the flip side, no less important: learn how to take chances, to change, to adapt. Today’s new toy is tomorrow’s museum piece. The equipment you learn to use in school today will probably not be what is being used a few years down the road. In an industry where technological change is the only constant, an engineer must know

**Masters  
of  
Duplication.**



**CASSETTE WORKS**  
Audio & Video Duplication

Call or Write for Free Services Kit  
PO Box 158 Pasadena, CA 91102  
1-800-423-TAPE & 1-800-972-TAPE

Circle #049 on Reader Service Card

**Elliot Easton of the Cars  
for DMU**



"The Digital Music Center is a long time coming. Steve Friedman and his extremely patient staff go a lot further than just selling equipment, they are educators who take the fear out of using MIDI technology, which seems to be taking over the music world."

Photo by L. Sullivan

**EDUCATION:** Hands-On Workshops, Classes and Private Lessons for Musicians and Recording Engineers in the use of MIDI + SMPTE Equipment and Software, Support Hot Line

**SALES:** Consultation and Design of Complete Digital Music Systems; Computers, Software and Synths; Total Music • Digidesign • Opcode • Hybrid Arts • Performer/Composer

**DIGITAL STUDIOS:** Fairlight • PPG • E-Mu • Photon Guitar • Kurzweil • Akai • Yamaha • Roland (reg. trademarks)



155 WEST 46TH ST. NYC, NY 10036  
212/302-4606 OR 221-5281

Circle #050 on Reader Service Card

how to change as well.

"One of the most important things we can give our students, and we tend to lose sight of this when we get into the career-oriented colleges, is how to *think*, how to solve problems," says David P. Leonard, president and founder of the Trebas Institute of Recording Arts, based in Montreal, with branch campuses in Toronto, Ottawa, Vancouver and Los Angeles. "And even more important, particularly for the sound engineer and producer as the technology becomes more and more complex, we have to be able to adapt to change."

To this end, the Trebas Institute offers courses such as "Creativity Development and Problem Solving" alongside the more traditional "Disc Cutting and Mastering" class.

Sound kinky? Not really—it's just the recording schools responding with new age philosophy to new age music.

"I think a fundamental concept of education is stressing that the students have to take the risk of failing," says Timothy Miller, director of the Audio Recording Program at the Northeast Technical Community College in Norfolk, Nebraska. No stranger to risk-taking (his hobby is race car driving), Miller allows his students 24-hour access to the in-house studio. "They're allowed to come in and work on their own stuff; have that freedom of experimentation to explore new techniques. If you never dare to fail you never dare to grow intellectually or emotionally."

Miller also believes in stressing another area which might not come quickly to mind when thinking of recording school curriculum—getting along with people.

"It's not just equipment that you have to learn," he says. "It's how to work with both people and equipment."

While the Northeast Technical Community College doesn't offer courses specifically geared toward social dynamics, Miller describes the "human factors" lesson he tries to convey within the technical course work:

"When you see a client struggling with something you need to have that insight to say: 'I've got to tweak a piece of equipment, why don't you take five and we'll come back to it?' You have to let them get the space and perspective."

"In some instances, I rate the ability to deal with people above the technical abilities," says Paul Goldfield, head of the recording and engineering program at the Grove School of Music in Studio City, California. "You can teach somebody to 'press this button and the sound goes there' pretty quickly. The hard part is to teach them how to deal with artists and musicians: the things that you say and *don't* say."

When asked how his school trains its students in the art of dealing with artists, Goldfield replies: "They come in and they do recording sessions. They learn just by opening their mouth and getting flak from the people they're working with. They understand real quickly that you don't talk about the vocalist when she's in the room and you don't mention the fact that the guitar player is out of tune because his brother may be sitting there."

Still, we are dealing with training recording engineers, not social workers. Are today's students prepared for the complexity of the technology? The educators were nearly unanimous in their appraisal of today's student: more motivated, more experienced, more serious than those of even a few years ago.

Roy Pritts, dean of the College of Music at the University of Colorado at Denver: "There are more musicians who are looking to a formal technical education and fewer street musicians. There was a brand of student with stars in their eyes who wanted to use a program like ours as a quick way into the fast lane and they didn't understand the discipline it takes: educational discipline, musical discipline, technical discipline. They weren't willing to pay their dues. The attrition rate five years ago was greater than it is now."

"The students coming to us now come to us from a higher level of academic structure, more transfer students than new freshman, more students who are headed toward a well-disciplined career, even graduate studies, as opposed to: 'Give me a couple of quick courses, I'm going right back out into the streets.'"

Brian Ingoldsby, president of Sound Master Recording Engineer School in North Hollywood, California, draws on his 17 years' experience at the school for perspective in comparing today's student: "We're getting a more serious vein. The technology has become such that the education format is mandatory if they wish to enter into the industry."

Ingoldsby adds a new category of students to those previously described. As he bluntly characterizes them: "We're now getting students who are in the industry who really don't know what they're doing. They have gotten into the industry, whether by friends or some of them even starting their own facility, which gives them the license to go ahead and perform. But what they're finding is that because they don't have the basic roots of common understanding of the electronics and the sophistication of our equipment, they're not able to operate it. They disguise themselves [pretending they have no prior experience] and come to us now to educate them."

Many people who have bought so-



phisticated equipment are coming to school to learn how to run it. As Ingoldsby tells it: "We have a doctor that we just graduated. He plays cello, and gets together with his other doctor friends to release a record once a year. He's built an inexpensive studio in his home. Every year, for Christmas presents, they give a record of Bach, Beethoven and so forth to their friends and relations. He does all of his own recording. He came here to the school out of his frustration of not knowing what he was doing with all of the equipment he purchased. He went through the whole program.

"Now that's the furthest extreme that anyone would come to us for. But there are quite a few people who do have

home environment recording facilities, and they don't understand the acoustics, they don't really understand proper microphone techniques and/or equipment usage, or even how to align the equipment. They try to do demos, but find themselves not really understanding because they merely went out and bought a bill of goods from some guitar store. Still, the more common interest is professionally directed, for film, video and of course recording."

### Recording Schools in the Year 2000

Finally, I asked everyone to speculate on what they thought their recording school program would need to

—CONTINUED ON PAGE 131

### STEVE SERGEANT: SPARS SUCCESS STORY

The path from a small Midwest market to the big leagues in Los Angeles was a long and winding road for Steve Sergeant. Eleven years as a gifted, part-time student at the University of Iowa with a grand assortment of hands-on audio jobs culminated in the SPARS studio exam. The testing program, originally funded by Sony and designed by the Educational Testing Service, is now established as the only industry gauge for determining a working knowledge of professional audio. Steve's top score drew national attention and prompted a call from SPARS director Gary Helmers.

"To tell the truth, I was pretty unhappy at the time," Steve recalls. "I had taken a rather degrading job as a salesman at a consumer electronics store and then, out of the blue, I got a call from Gary Helmers. He just asked, 'What are you doing with your life?' I answered, 'Not much.' Gary set up some interviews, which went very well, and in three weeks I started work here at Mitsubishi Pro Audio as a digital field service manager."

In retrospect it all seems very simple, but let's backtrack to discover the real secrets of Steve's "overnight success." The son of school teachers in Bettendorf, Iowa, his father was an electrical engineer and his mother was involved with local theatrical productions.

"My father always had lots of electronic toys to play with," Steve recounts. "He was a ham radio operator and encouraged my fascination with audio gear, video and eventually, computers. I wasn't really an exceptional student, be-

—CONTINUED ON PAGE 80



# VIDEO DISCOUNTS

MISCELLANEOUS	\$ Call
Sachtler Tripods	\$5,590
Chyron VP2 Char. Gen.	\$4,700
JVC (For-a) TBC Digital Freeze Frame	\$4,490
For-a FA410 TBC Demo.	\$4,290
Quanta Q-7B (16 Fonts) Demo	\$1,075
Fast Forward Time Code Gen	\$290
Panasonic WR450 Mic Mixer Demo	
Panasonic Monitors	
NEC Monitors	
JVC Monitors	

} 30% OFF  
ALL MODELS

### EDITORS & RECORDERS

JVC CR850 3/4" Time Code Demo	\$5,500
JVC 3/4" Edit Sys Demo	\$6,990
Panasonic 1/2" Edit Sys	\$2,290
Panasonic AG6200 VHS Rec	\$1,290
Panasonic AG1800 Hi-Fi VHS	\$550
JVC BR6200 VHS Stereo Port Demo	\$750
Panasonic AG6400 VHS Hi-Fi Port	\$1,295
Panasonic NV8420 VHS Portable	\$685
Panasonic AG6300 VHS Recorder	\$1,425
JVC CP-5200 3/4" Player	\$975
Panasonic NV8950 (Dyn. Tracking) Demo	\$1,050

### COLOR CAMERAS

	\$ Call
Ikegami 730A	\$7,290
Hitachi Z31	\$3,190
Panasonic 555B with Lens	\$2,890
JVC BY110/16 Demo	\$1,090
JVC GXS700 Demo.	\$1,325
Panasonic AG160.	\$2,650
Panasonic V3 with Lens	\$799
Panasonic D5000-Chip	

CALL FOR ALL  
**SONY**  
PRICING

## Center Video Industrial Co., Inc.

5615 W. Howard Street  
Niles, Illinois 60648

"OUTSIDE ILLINOIS"

**1-800-621-4354**  
(312) 647-8700

We will beat any bona fide dealers quote.  
All merchandise subject to prior sale.  
Prices subject to change.

Circle #051 on Reader Service Card

# RCA Test Tapes

*A Sound Measure*

- Cassettes
- Open Reel up to 1"
- Custom Formats

For a catalogue of standard test tapes or further information contact:

**RCA TEST TAPES**  
DEPT M  
6550 E. 30th St.  
Indianapolis, IN 46219  
(317) 542-6427

Circle #052 on Reader Service Card

CAREER STUDY IN ATLANTA

## Learn music video and recording studio production ...and much more!

The Music Business Institute offers you professional training in all phases of the music industry. Learn video/concert/recording studio production, artist representation/management, promotion/marketing, publishing/copyright law, much more. Acquire important career skills and techniques from a faculty of experienced industry professionals. Employment assistance and financial aid available to qualified students.

**Free career booklet: call 800-554-3346.**

Name \_\_\_\_\_  
Address \_\_\_\_\_  
City \_\_\_\_\_ State \_\_\_\_\_ Zip \_\_\_\_\_  
Phone (\_\_\_\_) \_\_\_\_\_ Yr. H.S. grad. \_\_\_\_\_

### THE MUSIC BUSINESS INSTITUTE

A DIVISION OF THE ART INSTITUTE OF ATLANTA  
3376 Peachtree Rd., Dept. Mx,  
Atlanta, GA 30326

Circle #053 on Reader Service Card

—FROM PAGE 79, SERGEANT

cause I was selective. I was interested in math and science, and we had good teachers in those fields. My parents gave me a good background in technology and entertainment."

After high school, Steve made the move to Iowa City and the University of Iowa where he enrolled to become an electrical engineer. "But I soon realized I didn't want to learn how to design ground avoidance systems for Cruise missiles." He got involved with local theatrical productions, and began to learn about audio by engineering for garage bands. This led to part-time jobs with an audio rental company and supervising portable disco setups for parties and social functions. His education took a back seat and his employment led him to work as a repairman with the university's computer center and eventually, a job as a stagehand at the school's 2,600-seat Hancher Auditorium.

"We had Broadway shows on tour, rock and pop acts—all sorts of theatrical challenges. I also worked as a recording technician for the school of music. I began to wonder why I was in college. I had all these interesting jobs and realized I was heading in the direction of becoming an audio engineer.

"Now, my reasons seem stupid. I was interested in the glamour aspect; I was looking for album credits instead of a fulfilling career. Anyway, a job opened up for full-time staff engineer at the Hancher Auditorium. I got the job and worked for three-and-a-half years, learning about audio, repairs, stagecraft and diplomacy. It was an education in the real world."

Next came a job as staff engineer with the university's recording studio, under the direction of Lowell Cross. "It was a wonderful experience. I had the chance to work with top equipment, and I engineered half a dozen albums. I also started a little remote recording company and made deals with studios to use their equipment in return for maintenance and alignment."

After a decade as a part-time student, Steve decided it was time to wrap up his education. The university had a room reserved for a new class in Advanced Audio Production. He met with school officials, who were impressed with his self-education. He was offered a position as instructor for three semesters, given a budget of \$160,000 to set up a studio and curriculum, and attended the necessary courses to

complete his degree.

After graduation, funding cut-backs brought an end to Steve's teaching career. He chanced on an announcement of the new SPARS exam and drove to the University of Minnesota, where it was being administered for the first time. "I just figured it would be one more tool in my resume arsenal for getting a job. They gave us four hours to complete the test, which focused on technical operations, maintenance and music theory/production. I finished in two-and-a-half hours and quibbled with maybe six questions out of 200. I wrote comments in the margins, and those questions seem to be the ones I answered incorrectly.

"I sent out hundreds of job applications, letting people know that my score was available on request, but I think it was just too new at the time. Now, the exam is much more established. I was invited to drop in at studios in major markets, but had no money to travel around. I took the job as a retail salesman, thinking I would be working with audio, but instead, they had me selling TVs. Like I said, it was pretty depressing."

The call from Gary Helmers changed Steve's life dramatically. As a field service engineer for Mitsubishi, he is now involved with the fast-paced, big money world of Los Angeles professional audio. But he has no regrets about his circuitous path to the big leagues.

"It's very easy to deride the small markets, but that's where I had the opportunity to develop my skills. If you start out in a big market you might miss the chance to learn in depth because you're always under the gun to perform. You don't have the chance to experiment and discover various solutions to real life problems.

"I have also rethought my goals in audio. It's important to identify what your reasons are for pursuing a career in audio. Originally, my reasons came from the glamour of this business. Now, my reasons are more intellectual, coming from a fascination with audio as an art and a science. Of course, I'm interested in making a good living, but if money is your only goal you might as well be a stockbroker. I'm pleased with the way things have worked out. I enjoy dealing with technology that is new and still evolving, and I also want to continue my involvement with actual production."

—David Goggin



# GO GOLD LINE!



**4 gates plus 4 limiters complete the 4 key inputs**  
*The ideal machine for*  
**RECORDING, BROADCAST, or SOUND REINFORCEMENT applications.**

*Some reasons you will want to own a LOFT 400B:*

- You can GATE without LIMITING, or LIMIT without GATING. You can GATE AND LIMIT at the same time and achieve a wide variety of special effects.
- The limiting is hard enough to limit but will not cause pumping (Softknee). The limiters include threshold controls, attack and release settings and threshold LED indicators.
- The four Key Inputs allow you to use the limiters to suppress a sound with a separate sound source (Ducking). You can address the gates with a Key Input to emphasize a signal, open a gate for a sustained signal, or key ambient microphones.
- All signals within the limit and gate thresholds are passed with the fidelity of a single high performance operational amplifier.
- Manufactured and serviced by GOLD LINE, a U.S. company in business for 26 years.

**Loft Model 400A Quad Gate with Key Inputs**

The model 400A is the same superb gate as the 400B without the limiters. Offered for those applications where a superior gate is required but limiting is not necessary.

**Model 400A — Gates only at \$419.95**  
**Model 400B — Gates with Limiters at \$599.95**



**Gold Line Model 30 Digital Analyzer**

A top of the line professional analyzer for use in the studio, on tour or setting up sound systems. Simple keypad entered instructions address 30 super accurate switched-capacitive filters. Select:

- 1, 2, or 3 dB steps
- Average or peak
- Flat or A weight
- 3 decay rates and storage of 6 memories (up to 30 with interface option)
- Built in pink noise
- Line level from -88dBm to +18dBm
- 3 expansion ports for printout

**MODEL 30 — \$2150.00**



TS-1

**Oscillator • Frequency Counter • dB Meter**

Three audio test instruments combined in one unit. Features include:

- Low distortion audio oscillator with frequency range 10Hz to 30KHz.
- Frequency counter with response of 1Hz to 99.99 KHz.
- DB meter with range of -50 to 24dB from 20Hz to 20KHz.

**MODELS: TS-1** - Balanced In **\$299.95**  
**TS-1RM** - Rack Mount Balanced In **\$359.95**  
**TS-1RMX** - Rack Mount Balanced In **\$399.95**  
*and Out with XLR Connectors*

**CONTRACTOR PRICES**

**Audios' Gold Medal Line.**

**GOLD LINE**

Enclose \$2.00 for postage and handling for full literature line.

P.O. Box 115, West Redding, CT 06896, (203) 938-2588

Circle #054 on Reader Service Card

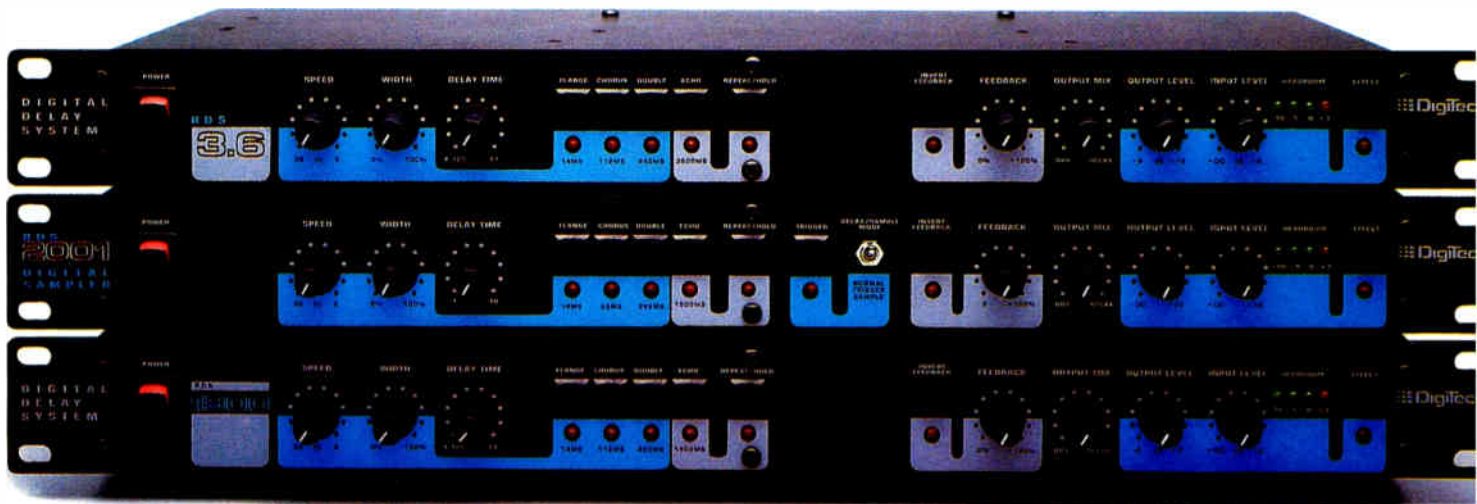

# We can't seem to leave well enough alone.

How did we improve something that didn't need improving? Take it from us, it wasn't easy. In fact, improving our rack mount digital delays was a team effort involving a lot of very, *very* picky people. But the result is something to behold.

Introducing the new RDS series of rack mount digital delay systems, exclusively from DigiTech.

First, our design engineers stripped each product back to the chassis. Using sophisticated computer-aided design techniques, they added a more dependable modular circuit board along with a stronger transformer that delivers 15% more power. They included a unique -10dB/-30dB two-position input sensitivity switch on the rear panel that lets you match input level to the source.



They even managed to squeeze out more headroom, and incorporate an invert feedback function that gives you maximum phasing control at the push of a button. And just for



fun, they included micro-touch switching for even cleaner, more reliable operation.

Then our graphic artists took over and turned one of the best sounding digital delay lines into one of the most beautiful looking.

Finally, we let the folks in accounting have their way. The result is an awesome display of technical achievement at a downright frivolous price.

Try out all three of the new RDS rack mount digital delay systems at your authorized DigiTech dealer. By now it should be perfectly obvious: they're as close as audio technology ever gets to perfection.

For a full-color product sheet, write DigiTech, 5639 South Riley Lane, Salt Lake City, Utah 84107. Or call (801) 268-8400.

**DigiTech**  
Start at the top.

Circle #152 on Reader Service Card

DigiTech is a registered trademark of DOD Electronics Corporation. © 1987 Electronics Corp. Manufactured in the U.S.A.



M I X 1 9 8 7

# DIRECTORY OF RECORDING SCHOOLS, SEMINARS & PROGRAMS

## WESTERN

### ACADEMY OF AUDIO VIDEO ARTS

Course/Program Title: Recording Technology/Video Technology

7430 Melrose Ave.  
Los Angeles, CA  
(213) 467-5256

Chief Administrator: Poonam Bali

Program: A comprehensive "hands-on" training program in recording engineering, video technology, recording studio maintenance and professional video maintenance. One- and two-year complete programs available. Also complete programs in music industry computer and MIDI programming. Small classes and emphasis is given to hands-on projects.

### THE ACADEMY OF RADIO BROADCASTING

Course/Program Title: Radio Broadcast Training

8907 Warner Ave., #115  
Huntington Beach, CA 92647  
(714) 842-0100

Chief Administrator: Tom King

### ASPEN MUSIC FESTIVAL AND SCHOOL

Course/Program Title: Aspen Audio Recording Institute

Box AA  
Aspen, CO  
(303) 925-3254

Chief Administrator: Dan Craik

### AUDIO ARTS (AUDIO RECORDING ARTS ACADEMY)

Course/Program Title: The "Art" of Audio Recording (the subjective, intuitive Audio Crafts)

PO Box 8398  
Salt Lake City, UT 84108  
(801) 581-1400

Chief Administrator: Tracy H. Jorgensen

### KEARNEY BARTON'S AUDIO RECORDING SCHOOL

Course/Program Title: Audio Recording Techniques, "Hands On"

4718 38th Ave., NE  
Seattle, WA 98105  
(206) 525-7372

Chief Administrator: Kearney W. Barton

Following is a briefly annotated list of schools and programs offered in the areas of audio and music education, compiled from questionnaires received from those institutions earlier this year. The courses vary greatly in scope, intent and cost and we urge those interested in attending any program to investigate very carefully before making their decisions. *Mix* claims no responsibility for the accuracy of the information provided by the institutions.

### BRIGHAM YOUNG UNIVERSITY

Course/Program Title: Sound Recording Technology C-550 HFAC

Provo, UT 84602  
(801) 378-3083

Chief Administrator: James F. Anglesey

### CALIFORNIA POLYTECHNIC STATE UNIVERSITY

Course/Program Title: Music minor-Recording Arts & Electronic Music Music Dept.

Cal Poly State University  
San Luis Obispo, CA 93407  
(805) 546-2406

Chief Administrator: Dr. Antonio G. Barata

### CALIFORNIA STATE UNIVERSITY DOMINGUEZ HILLS

Course/Program Title: Audio Recording and Music Synthesis (ARMS)

Music Dept., Victoria St.  
Carson, CA 90747  
(213) 516-3543

Chief Administrator: David Champion, John Hill, David Bradfield

Program: CSUDH offers two music B.A. degrees and two



CALIFORNIA STATE UNIVERSITY  
DOMINGUEZ HILLS  
Carson, CA

certificate programs in audio recording and music synthesis. These programs are accredited by NASM, AES and SPARS. The studio complex features four interconnected rooms with 24-, 8-, 4-, and 2-track analog and digital recorders by Sony/MCI, Otari, Nakamichi and Tascam. Advanced MIDI-based project work and instruction utilizes synths and related gear by Synclavier, Yamaha, Oberheim, Korg, Casio and Arp. Apple-based MIDI software includes a variety of screen editors, patch librarians and sequencers. We invite potential students to visit the campus in person or contact us by mail or telephone for further information.

### CALIFORNIA STATE UNIVERSITY, FULLERTON

Course/Program Title: Beginning and Advanced Audio Techniques

800 N. State College  
Fullerton, CA 92634  
(714) 773-3442

Chief Administrator: John R. Fisher

### CALIFORNIA STATE UNIVERSITY, LOS ANGELES

Course/Program Title: Recording Arts Program

5151 State University Dr.  
Los Angeles, CA 90032  
(213) 224-3348  
(213) 224-3448

Chief Administrator: Michael Fruchter

**CASPER COLLEGE**  
 Course/Program Title: Associate Degree in Music  
 125 College Dr.  
 Casper, WY 82601  
 (307) 268-2532  
 Chief Administrator: Terry Gunderson

**CITY COLLEGE OF SAN FRANCISCO**  
 Course/Program Title: Broadcasting Dept  
 50 Phelan Ave.  
 San Francisco, CA 94112  
 (415) 239-3575  
 Chief Administrator: Phillip Brown

**CLAWS-ON PRODUCTIONS**  
 Course/Program Title: An Introduction to Multi Track Recording  
 1355 "C" Bear Mtn. Dr.  
 Boulder, CO 80303  
 (303) 499-1144  
 Chief Administrator: Lisa Clawson

**CMX CORPORATION**  
 2230 Martin Ave.  
 Santa Clara, CA 95050  
 (408) 988-2000  
 Chief Administrator: Susan Dressler

**COLLEGE FOR RECORDING ARTS**  
 Bi-Cultural Foundation Inc.  
 665 Harrison St.  
 San Francisco, CA 94107  
 (415) 781-6306  
 Chief Administrator: Leo De Gar Kulka  
 Program: One year course for recording engineers and others intending on a career in the music/recording industry. C.R.A. is accredited by the National Association of Trade and Technical Schools (NATTS), approved by the California Superintendent of Public Instruction, approved for veteran training and authorized under federal law to enroll non-immigrant alien students. Semesters start the first full week of June, October, or February. Over ten years of providing quality graduates to the music/record industry.

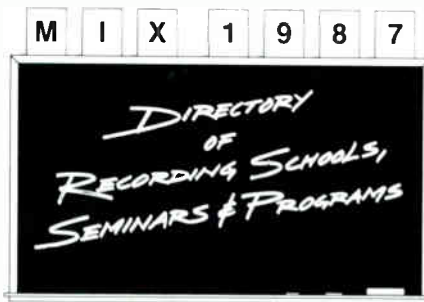

**CONTINUING EDUCATION PGM.**  
 Course/Program Title: Advance Courses in Audio & Video  
 357 S. Curson, #9D  
 Los Angeles, CA 90036  
 (213) 871-6941  
 Chief Administrator: Amnita Singh

**CROW RECORDING STUDIOS**  
 Course/Program Title: Recording Workshops  
 4000 Wallingford Ave. N.  
 Seattle, WA 98103  
 (206) 634-3088  
 Chief Administrator: Tod Crooks

**EVERGREEN COLLEGE**  
 Course/Program Title: Beginning & Advanced Record Engineering & Production  
 Olympia, WA 98505  
 (206) 866-6000 ext. 6268  
 Chief Administrator: Ken Wilhelm

**FOOTHILL COLLEGE**  
 Course/Program Title: Commercial Music Program  
 12345 El Monte Rd.  
 Los Altos Hills, CA 94022  
 (415) 960-4262  
 Chief Administrator: Elizabeth Barkley

**FORT LEWIS COLLEGE**  
 Course/Program Title: Basic TV Production Classes  
 College Heights  
 Durango, CO 81301  
 (303) 247-7412  
 Chief Administrator: Gary Penington

**FULLERTON COLLEGE**  
 Course/Program Title: Music Recording/Production  
 321 E. Chapman Ave., Music Dept.  
 Fullerton, CA 92634  
 (714) 871-8000 ext. 336  
 Chief Administrator: Alex Cima  
 Program: 1985 Mix TEC award nominee. The college offers a one-year certificate in Music Recording/Production encompassing two semesters of audio recording, two semesters of electronic music, one semester of music business and other relevant music courses. The Music Dept. has a fully equipped 24-track studio w/automated board, digital reverb, digital mixdown and the usual complement of signal processors (Harmonizer, compressors, etc.) and microphones. Fullerton College is a public California Community College with minimal tuition for California residents. A great way to receive a college education and learn professional audio recording.

**GABRIEL'S ARIZONA REMOTE RECORDERS**  
 Course/Program Title: Recording Class  
 833 W. Main St.  
 Mesa, AZ 85201  
 (602) 834-9511  
 Chief Administrator: Wayne Mitchell  
 Program: Four week recording studio techniques seminar. The classes meet twice a week for 2 1/2 hours. Topics covered in the class are: Introduction to the recording chain. Sound and instruments that produce sound. Microphones and speakers. Recording consoles. Signal processing. Tape machines. Student recording (hands-on emphasized). Student mix down. Also classes are taught in remote recording truck. Most classes start for under \$200.



**GOLDEN WEST COMMUNITY COLLEGE**  
 Huntington Beach, CA

**GOLDEN WEST COMMUNITY COLLEGE**  
 Course/Program Title: Recording Arts/Commercial Music  
 15744 Golden West St.  
 Huntington Beach, CA 92647  
 (714) 895-8780  
 Chief Administrator: Scott Steidinger, Evan Williams  
 Program: A fully comprehensive 12 year-old program of national reputation. The program features extensive "hands-on" experiences in our three well-equipped studios. Studio A features MCI 24 track recorder, 40 channel Neotek Elite automated console, Q lock synchronizer, Lexicon 224XL reverb plus extensive outboard signal processing. Studio B features Neve 16-channel mixer, MCI 16-track recorder, analog and digital signal processing. Studio C features: Ramco WRT 820 mixer, Tascam Model 58 8-track recorder, extensive signal processing and an array of 20 MIDI-sequenced synthesizers (Yamaha DXs, TF modules, Kurzweil 250, Roland Juno, etc.) controlled by Macintosh computer and various software programs. Highlighting each year is a student composed/arranged/engineered and produced CD. Each two year certificate program cycle begins with the first semester in mid August. Interested students are encouraged to apply as early as possible!

**GROSSMONT COMMUNITY COLLEGE**  
 Course/Program Title: Telecommunications  
 8800 Grossmont College Dr.  
 El Cajon, CA 92020  
 (619) 465-1700  
 Chief Administrator: Dr. Elaine McLevie

**Fred Munch Larry B. Cook**

**TRUST THESE GUYS  
 WITH YOUR EDUCATION.**

During the past five years as Director and Chief Administrator of a Los Angeles-area recording school, Fred and Larry have guided the education and placement of recording engineers, studio managers and video technicians. The culmination of their experience has resulted in the Recording Academy.

**For Information Call:  
 (213) 254-1756**

**Career training for the recording industry.  
 Audio and Video**

**Recording  
 ACADEMY**

Los Angeles, California

Circle #055 on Reader Service Card



For making & duplicating cassettes for:

- ▶ BROADCAST AUTOMATION
- ▶ QUALITY SYNDICATION
- ▶ A/V SLIDE SYNC
- ▶ MULTI-MEDIA

No. 4 of a series—

# AUDIOPHILE QUALITY DUPLICATION SYSTEMS

24 Commercial Blvd., Novato, CA 94947  
in CA call (415) 883-5041



KENNETH A. BACON ASSOCIATES  
Toll Free (800) 231-TAPE

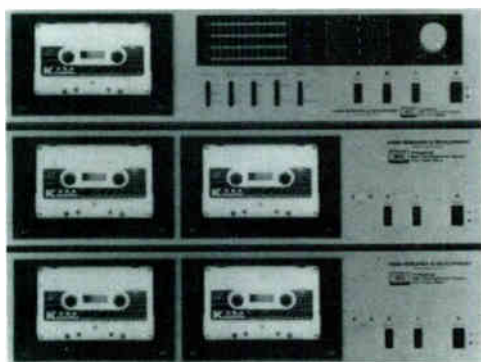

RTDS-4TM  
master control deck

RTDS-4TS  
dual-transport  
slave decks,  
add-on to  
24 stations  
per master

No standard cassette deck or high-speed in cassette duplication system can match the performance of the **KABA 4-TRACK REAL TIME AND 2x DUPLICATION SYSTEM**

- ▶ 20-20KHz frequency response
- ▶ 10,000 hour transport life
- ▶ Transient response faithfully reproduces control signals
- ▶ Exact time sync with master program
- ▶ Separate 4-track level controls
- ▶ Flawless reproduction
- ▶ Cost-effective

Now—

Your audio can be as good as your visuals...

Your audio can satisfy the most demanding broadcast standards...

WRITE OR CALL THE NUMBER ABOVE FOR COMPLETE SPECIFICATIONS AND PRICES

Circle #056 on Reader Service Card

**GROVE SCHOOL OF MUSIC**  
 Course/Program Title: Recording & Engineering Program  
 12754 Ventura Blvd.  
 Studio City, CA 91604  
 (818) 985-0905  
 Chief Administrator: Peter Donald

**HORIZON RECORDING STUDIO**  
 Course/Program Title: Basic and Advanced Recording Engineering  
 1317 S. 295th Pl.  
 Federal Way, WA 98003  
 (206) 941-2018  
 Chief Administrator: Roger Wood, Bill Gibson



**INSTITUTE OF AUDIO-VIDEO ENGINEERING**  
 Hollywood, CA

**INSTITUTE OF AUDIO-VIDEO ENGINEERING**  
 Course/Program Title: Recording Engineering (Audio & Video)  
 1831 Hyperion Ave.  
 Hollywood, CA 90027  
 (213) 666-2380  
 Chief Administrator: Ted Shreffler  
 Program: The Institute of Audio-Video Engineering offers concise, expert instruction in audio and video engineering and is housed in a state-of-the-art recording studio, actively engaged in servicing the local community. The school is an accredited member, National Association of Trade and Technical Schools. The eight-month, state-approved diploma program includes audio recording, video production, editing and studio maintenance. Elective classes offer students an opportunity to further their understanding and skills in specialized areas such as sound reinforcement, advanced mixing, advanced video editing and use of the CMI Fairlight music computer. New terms start approximately every ten weeks. The cost of the entire program ranges from \$4,880 to \$5,500, depending on electives selected. Approximately \$175 will be needed for books and supplies for the whole program. Classes are scheduled primarily during evening or weekend hours since instructors are working professionals currently active in the entertainment fields. Students are required to complete 72 hours of internship prior to graduation, as well as completing 492 clock hours of classes with 314 of those hours being hands-on experience. The Institute of Audio-Video Engineering has been established since 1980.

**LOS ANGELES CITY COLLEGE**  
 Course/Program Title: Recording Arts and Sciences Program  
 855 N. Vermont Ave.  
 Los Angeles, CA 90029  
 (213) 669-5545  
 Chief Administrator: Dr. J. Robert Stahley

**LOS ANGELES HARBOR COLLEGE-MUSIC DEPT.**  
 Course/Program Title: Recording Arts Certificate/16-track  
 1111 Figueroa Pl.  
 Wilmington, CA 90744  
 (213) 518-1000  
 Chief Administrator: Robert H. Billings

**LOS ANGELES RECORDING WORKSHOP**  
 Course/Program Title: Recording Engineering Certificate Program  
 12268 Ventura Blvd.  
 Studio City, CA 91604  
 (818) 763-7400  
 Chief Administrator: Christopher Knight

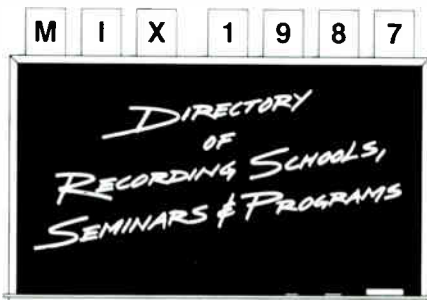

**LOS ANGELES RECORDING WORKSHOP**  
 Studio City, CA

Program: Our five-week Recording Engineering program, with hands-on training in four different major L.A. 24-track studios, is designed specifically to train you as a music recording engineer. This program offers over 200 hours of comprehensive training in every aspect of professional studio recording, including synthesizer and MIDI computer sequencing, live concert sound, SMPTE lock-up, and extensive ear training. Our curriculum is approved by the California Department of Education and five-week, ten-week and 20-week schedules are available. Tuition is \$1,395 plus \$55 materials. Dorm-style housing is available, plus free trip to Disneyland. Job placement assistance and internships available. Write or call for free catalog. 12268-M Ventura Blvd., Studio City, CA 91604 (818) 763-7400.

**LOS MEDANOS COLLEGE**  
 Course/Program Title: Recording Arts  
 2700 E. Leland Rd.  
 Pittsburg, CA 94565  
 (415) 439-0200  
 Chief Administrator: Frank Dornie

Program: Los Medanos College in Pittsburg, California, offers a degree program in Recording Arts, including courses in Multi-Track Recording, Sound Reinforcement, Acoustics, MIDI-Sound Synthesis, Producing and Trouble-Shooting, Theory, hands-on experience, a state-of-the-art recording studio and a faculty honored with ten Grammy nominations make the Los Medanos Recording Arts Program the finest in Northern California. Fees: California residents \$5 per unit (\$50 max. per semester), out-of-state \$82 per unit. For further information, call (415) 439-0200.

**LOYOLA MARYMOUNT UNIVERSITY**  
 Course/Program Title: Bachelor's degree in Recording Arts  
 Dept. of Communication Arts,  
 Loyola Blvd. at W. 80th St.  
 Los Angeles, CA 90045  
 (213) 642-3033  
 Chief Administrator: Don Zirpola

Program: B.A. in Communications. The Communications department of Loyola Marymount University is offering a Bachelor's program in Recording Arts. This program is designed to provide an intensive theoretical and practical knowledge related with sound recording for film, TV, video and disc. The dept. has state-of-the-art facilities that include a 24-track studio, digital processors, a 16-track studio to mix film in video, a variety of mics and other related equipment. The department is also planning to offer a M.F.A. program in Video and Recording Arts. For more information call Donald Zirpola, division head or Vinay Shrivastava, Recording Arts Track Advisor.

**MARIN COMMUNITY COLLEGE**  
 Course/Program Title: Music Department  
 Kentfield, CA 94904  
 (415) 485-9466  
 Chief Administrator: Tara Flandreau, Myrna Miller

**MAY SCHOOL OF BROADCASTING & TECHNOLOGY**  
 Course/Program Title: Radio/TV Broadcasting with Multi-Track Recording  
 PO Box 127  
 Billings, MT 59103  
 (406) 248-4888  
 Chief Administrator: Michael May

**MEDIA SCIENCES INSTITUTE**  
 Course/Program Title: Audio Engineering  
 3465 El Cajon Blvd.  
 San Diego, CA 92104  
 (619) 280-7454  
 (619) 280-7310  
 Chief Administrator: Richard Bowen

**MILLS COLLEGE CENTER FOR CONTEMPORARY MUSIC**  
 Course/Program Title: MFA in Electronic Music and Recording Media  
 5000 MacArthur Blvd.  
 Oakland, CA 94613  
 (415) 430-2191  
 (415) 430-2171  
 Chief Administrator: David Rosenboom

**MIRACOSTA COLLEGE MUSIC DEPARTMENT**  
 Course/Program Title: Hi-Tech Music Program  
 One Barnard Dr.  
 Oceanside, CA 92056  
 (619) 757-2121 ext. 446  
 Chief Administrator: Dave Megill

**MIXMASTERS RECORDING SCHOOLS**  
 Course/Program Title: Recording Engineering  
 4877 Mercury St.  
 San Diego, CA 92111  
 (619) 569-7367  
 Chief Administrator: Garth Hedin

**PACIFIC LUTHERAN UNIVERSITY**  
 Course/Program Title: Music & Technology/Recording Techniques  
 121st and Park Ave.  
 Tacoma, WA 98447  
 (206) 535-7268  
 Chief Administrator: Bob Holden

**PIMA COMMUNITY COLLEGE**  
 Course/Program Title: Media Communications  
 2202 W. Anklam Rd.  
 Tucson, AZ 85709  
 (602) 884-6974  
 Chief Administrator: David L. Wing

**QUINCY STREET WORKSHOP**  
 Course/Program Title: Multi-Track Recording-Level 1  
 130 Quincy St. NE  
 Albuquerque, NM 87108  
 (505) 265-5689  
 Chief Administrator: Eric Larson

It's our tenth anniversary!  
 Celebrate with us in our August issue. Special features will include ten years in review and the future of recording.



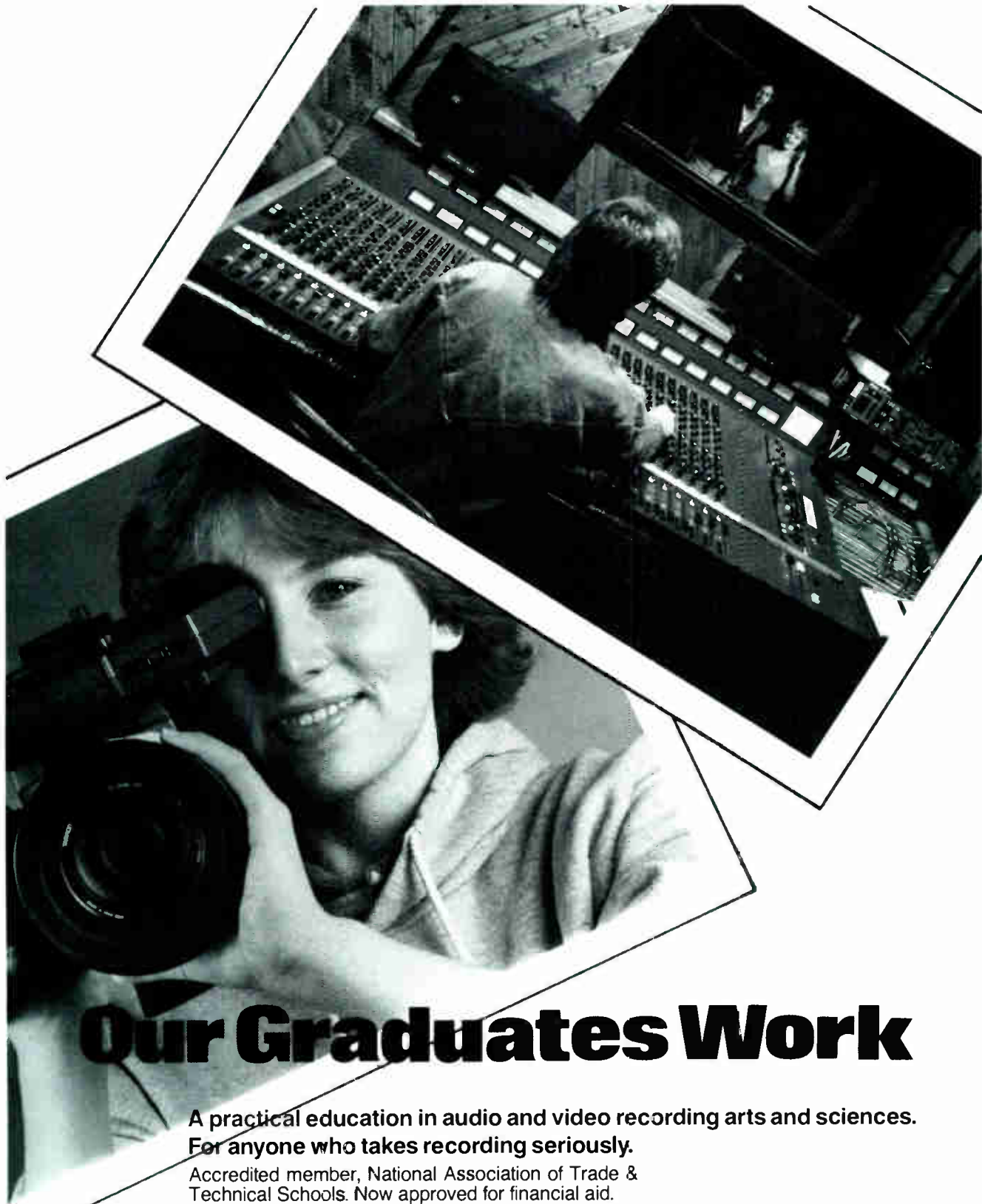

# Our Graduates Work

A practical education in audio and video recording arts and sciences.  
For anyone who takes recording seriously.

Accredited member, National Association of Trade & Technical Schools. Now approved for financial aid.

Approved for Foreign students.

NATIONAL 1-800-551-8877  
STATE 1-800-972-1414  
LOCAL 213-666-2380



**Institute of  
Audio-Video  
Engineering**

1831 Hyperion Ave., Hollywood, CA 90027  
Dept. E

Circle #057 on Reader Service Card

World Radio History

# Recording ACADEMY

**RECORDING ACADEMY**  
Los Angeles, CA

## RECORDING ACADEMY

Course/Program Title: Recording Specialist Course  
Los Angeles, CA 91411  
(213) 254-1756

Chief Administrator: Fred Munch, Larry Cook  
Program: Eight-month program starting every ten weeks. Approximately \$6,000. 24-track recording, video production and editing, sound reinforcement, electronics, and audio-for-video. 65% hands-on. Instructors are professional recording engineers, producers, directors and video technicians. Placement assistance for graduates. Call for a free catalog and studio tour. (213) 254-1756

## SADDLEBACK COLLEGE

Course/Program Title: Sound Recording Theory and Practice  
28000 Marguerite Pkwy.  
Mission Viejo, CA 92692  
(714) 582-5727  
Chief Administrator: Greg Bishop

## SAN FRANCISCO STATE UNIVERSITY

Course/Program Title: Music/Recording Industry  
Extended Education  
1600 Holloway Ave.  
San Francisco, CA 94132  
(415) 469-1372

Chief Administrator: Mary Pierat  
Program: Music/Recording Industry. An accredited music industry program for students and professionals, with courses that range from record engineering, mixing, artist management, publicity, concert production and booking, industry history, and field internships to seminars like songwriting, record distribution and music video. Expand skills with one or two workshops, or earn a professionally recognized certificate with completion of a structured academic program taught by Bay Area pros. Formal university application is not required. Call (415) 469-1372 for information.

## SAN JOSE STATE UNIVERSITY

Course/Program Title: Electro-Acoustic Program  
1 Washington Sq.  
San Jose, CA 95192  
(408) 277-2905  
Chief Administrator: Allen Strange



**SKE PUBLISHING**  
Sedona, AZ

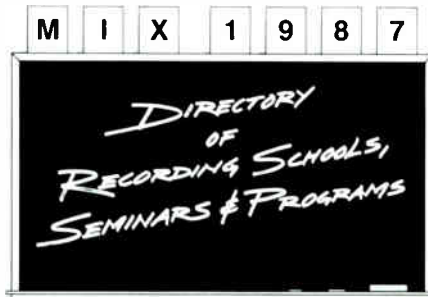

## SKE PUBLISHING

PO Box 2519-M  
Sedona, AZ 86336  
(602) 282-1258

Program: Recording School Curriculum Service. We publish a complete curriculum for schools and recording studios wishing to teach sound engineering. Based on the book *Practical Techniques for the Recording Engineer* (400 pp., over 350,000 words), these course materials are already in use by over 75 universities, colleges and studios throughout the world. The text (\$24.95), Teacher's Manual (\$45), Answer Key (n/c), Student's Workbook/Supplement (\$14.50) and three final exams (n/c) make up a 24-module course in three levels. Progressively intensive coverage. Homework questions in each module for verbal or written review. Suggested session content for hands-on studio work. Three comprehensive final exams. Course features real-world, practical, useful content. Text covers techniques and skills while Workbook/Supplement covers conventional subjects. Write for more information.

Program: Sound Engineering Home Study Course. A faster, more affordable way for the sound enthusiast to study the high-powered sound engineering course offered by SKE. Our home study program works faster and costs less because it does not include the dialog feature. Work on your own to master the musical and technical concepts of sound engineering. The home study cassette packages for Basic, Intermediate, or Advanced levels require the student also have the P.T.R.E. text and Workbook/Supplement. The cassette package contains the audio portion of an entire course level (Basic, Intermediate, or Advanced) on (12) 60-minute audio cassettes (\$145). Microphones, recorders, session and stage set up and breakdown, alignments, noise reduction, sound and audio theory, acoustics, editing, mixing techniques, tracks-of-the-trade, grounding, special effects and much more all covered in great detail. The eight lecture cassettes expand on the information in the books while the four answer cassettes complete the learning experience.

## SONOMA SOUND

Course/Program Title: Sound Engineering/Record Production  
PO Box 1623  
Sonoma, CA 95476  
(707) 996-4363  
Chief Administrator: Arnon Johnson



**SONOMA STATE UNIVERSITY**  
Rohnert Park, CA

## SONOMA STATE UNIVERSITY

Course/Program Title: Recording & Electronic Music  
1801 E. Cotati Ave.  
Rohnert Park, CA 94928  
(707) 664-2324

Chief Administrator: Joann E. Feldman, Warren Dennis, Ron Pellegno

Program: Three semesters of recording studio plus tutorial. Career minor in Recording Technology also includes internship. One semester of Recording Studio Performance and Production and Commercial Songwriting. All programs incorporate hands-on usage of a new fully outfitted one-inch 8-track multi-track studio with two full isolation booths. Electronic music studio; courses in sound synthesis with computers and digital, hybrid and analog synthesizers. All courses have hands-on work with the DX7, Juno 106, AlphaSyn-taur, Decillionix, DX11 drum machine, MSQ-700 keyboard recorder, and microcomputer controlled MIDI-networking. Studio includes two 4-channel tape machines and outboard processing gear.

## SOUND INVESTMENT ENTERPRISES

Course/Program Title: Sound Shop I, Sound Shop II  
PO Box 4139  
Thousand Oaks, CA 91359  
(805) 499-0539  
Chief Administrator: Jim McCandliss

# SOUND MASTER



## RECORDING ENGINEER SCHOOLS

**SOUND MASTER ENGINEER SCHOOLS,  
AUDIO/VIDEO INSTITUTE**  
North Hollywood, CA

## SOUND MASTER ENGINEER SCHOOLS, AUDIO/VIDEO INSTITUTE

Course/Program Title: Recording Engineer & Video Production  
10747 Magnolia Blvd.  
North Hollywood, CA 91601  
(213) 650-8000

Chief Administrator: Brian D. Ingoldsby  
Program: Basic Theory/Recording: a beginning course in multi-track recording technology. Beginning Studio Workshop: using equipment to perform duties of the recording process. Advanced Audio Theory: audio technology dealing with advanced recording techniques. Advanced Studio Workshop: hands-on experience 24-track recording equipment and its operation. Disc Mastering: the basic principles of disc recording techniques. Recording Studio Maintenance: basic electronics and trouble-shooting studio equipment and maintenance of equipment. Sound Reinforcement: live sound mixing sessions held with live groups. Solving, setting up and operating equipment; mixing the live concerts and breakdown of equipment. Video Production: a five-level course dealing with the technical operation for all phases of color video pre- and post-production, including camera operation, editing, lighting, scenery and special effects. Underwater video dealing with techniques for all underwater photography. Must be a certified scuba diver. Call for free brochure. Sound Master Recording Engineer Schools is approved by the California State Department of Education/Superintendent of Public Instruction and the Department of Immigration.

## SOUTHWEST INSTITUTE OF RECORDING ARTS AND SCIENCES

Course/Program Title: Audio Recording Engineering I, II, III/Business of Music  
4831 N. 11th St., Ste. A  
PO Box 17010  
Phoenix, AZ 85014  
(602) 241-0667

Chief Administrator: Merel Bregante  
Program: Audio Recording Engineering I, II, III: beginning thru advanced recording techniques with emphasis on microphones, analog and digital processing, analog and digital recording. Total hands-on training. Small lab classes. Fully equipped 16- and 24-track recording studios (advanced classes include audio production). Business of Music: music business with emphasis on the musician and his relationship with the business, legal as well as practical. Sound Production I, II: beginning and advanced sound reinforcement and



lighting with emphasis on the club band. Tour Management: take your band on the road. From rehearsal thru budgets, thru hotels, complete overview of bands on the road.

**TREBAS INSTITUTE OF RECORDING ARTS**

Course/Program Title: Recording Arts & Sciences, fully accredited by The Accrediting Commission of CNCE.  
6602 Sunset Blvd.  
Los Angeles, CA 90028  
(213) 467-6800  
Chief Administrator: David P. Leonard



*UCLA EXTENSION  
Los Angeles, CA*

**UCLA EXTENSION**

Course/Program Title: Professional Designation in Recording Engineering  
10995 Le Conte Ave.  
Los Angeles, CA 90024  
(213) 825-9064  
Chief Administrator: Loren Stephens  
Program: The UCLA Extension Professional Designation in Recording Engineering is a rigorous training program which prepares the student in both the art and science of sound recording. Drawing on the talent and studio facilities of Los Angeles, one of the music industry capitol of the world, we have created a sequential curriculum of required and elective courses which covers both theory and practice in audio technology, equipment, musicianship and business practice. All classes are taught by working professionals in the recording industry who bring a wealth of practical knowledge to the classroom and studio workshops. The objective of the program is to enable future engineers to acquire vision and problem-solving techniques that meet the challenge of rapidly evolving technology and a dynamic sound recording market. Prerequisite courses include basic physics, math and electronics plus ear training and sight singing or a music performance background. All prerequisite classes are available through UCLA Extension, the continuing education arm of UCLA. The Professional Designation certificate is a State of California approved recognition of significant educational accomplishment in a professional field. All classes are held at night or on weekends, enabling working adults as well as full-time students to attend. Class fees range from \$175 to \$895 per quarter. Scholarships are available. A complete program brochure and class schedule may be obtained by calling or writing (213) 825-9064, UCLA Extension, Performing & Integrated Arts, PO Box 24901, Los Angeles, CA 90024.

**UNIVERSITY OF APPLIED TECHNOLOGY**

Course/Program Title: M.S. & B.S. Degree in Audio/Video Sciences  
6363 Sunset Blvd., #920  
Hollywood, CA 90028  
(213) 469-9944  
Chief Administrator: Dr. Wills

**UNIVERSITY OF ARIZONA**

Tucson, AZ 85721  
(602) 621-1655  
Chief Administrator: Jeff Haskell  
Program: A recording studio production class is offered to music and RTV students. The class includes a basic overview of studio equipment use and terminology, in addition to music production and music law. Courses in computer and MIDI applications are offered. The recording studio features an audiophile quality 24-track facility with numerous signal processing equipment including: Lexicon PCM70, Drawmer gates, dbx 165A compressors, Pultec EQP 1A EQ, Prime Time delay, etc. The recording studio is very accessible to students for gaining experience writing, producing and performing in professional quality recordings.

**UNIVERSITY OF CALIFORNIA, SANTA CRUZ**

Course/Program Title: Electronic Music Program  
133 Communications Bldg.  
Santa Cruz, CA 95064  
(408) 429-2369  
Chief Administrator: Peter Eisea



*UNIVERSITY OF COLORADO AT DENVER: COLLEGE OF MUSIC  
OF MUSIC  
Denver, CO*

**UNIVERSITY OF COLORADO AT DENVER: COLLEGE OF MUSIC**

Course/Program Title: B.S. degree in Music  
1100 14th St.  
Denver, CO 80202  
(303) 556-2727  
Chief Administrator: Roy Potts  
Program: The College of Music of the University of Colorado at Denver is located in downtown Denver near the major broadcast and recording industry activities for the Rocky Mountain region. Bill Porter and Roy Potts direct the program which offers Bachelor of Science in Music, Master of Business Administration, Master of Educational Technology degrees for the professional practitioner and educator.

Four studios support 16, 8, 4, 2- and full track recording with NEVE, Audionics and Quantum consoles. A gift of over \$200,000 in studio equipment from Jim Guercio of Caribou Ranch also adds SMPTE, video, EMT, Neumann and similar professional holdings to the studios. An extensive MIDI facility and PC lab complements this unique educational facility.

**UNIVERSITY OF NEVADA, LAS VEGAS**

Course/Program Title: Intro & Advanced Recording/MIDI for the Engineer  
4505 S. Maryland Pkwy.  
Las Vegas, NV 89154  
(702) 739-0819  
Chief Administrator: Curt Miller



**UNIVERSITY OF SOUND ARTS**

*UNIVERSITY OF SOUND ARTS  
Hollywood, CA*

Course/Program Title: Audio/Video Technology  
6363 Sunset Blvd., 8th Floor  
Hollywood, CA 90028

—LISTING CONTINUED ON NEXT PAGE



# LOS ANGELES RECORDING WORKSHOP

**EXTENSIVE HANDS-ON TRAINING  
IN FOUR 24 TRACK RECORDING STUDIOS**

**FULL &  
PART TIME  
SCHEDULES  
AVAILABLE**



**STUDENT  
HOUSING  
AVAILABLE**

**10 Week Hands-On  
Recording Engineering Program**  
Classes Start March 16th  
Open House Studio Tour Saturday, March 7th

**CALL FOR FREE CATALOG AND  
OPEN HOUSE RESERVATIONS**

**(818) 763-7400**

**LOS ANGELES RECORDING WORKSHOP**  
12268 Ventura Blvd., Studio City, CA 91604

Circle #058 on Reader Service Card

— CONTINUED FROM PAGE 89

(213) 467-5256

**Chief Administrator:** Raghu Gadhoke

**Program:** University of Sound Arts has been the leader in the music & video industry education since 1976. Programs include: Audio Video Technology, Professional Video Production, Electronic Music and Music Business Management. Students may complete programs in six to nine months attending five nights a week. Day and night classes are available.

#### UNIVERSITY OF SOUTHERN CALIFORNIA

**Course/Program Title:** Recording Arts Workshop  
MUS 102 A, Univ. of Southern Ca.,  
School of Music

University Park, CA 90089

(213) 743-2627

**Chief Administrator:** Richard McIlvey

**Program:** The Recording Arts Workshop at USC offers a one-year graduate certificate program consisting of 35 units taken over two semesters. Courses are taught by both university professors and outside industry professionals in Los Angeles and include one-semester classes in Recording Theory, Mixing Consoles, Acoustics and Speaker Design, Tape and Tape Recoding (analog), Digital Recording and Equipment, Reverb and Outboard Equipment Basic Recording Techniques, Advanced Recording Techniques, Remote Recording, Recording Studio Maintenance (two semesters). Enrollment is limited to 20 students per year who hold a bachelor's degree from an accredited college or university. Call or write for information.

#### VIDEO TECHNICAL INSTITUTE

**Course/Program Title:** Video Technology Program  
2828 Junipero Ave.

Long Beach, CA 90806

(213) 595-1660

**Chief Administrator:** Scott H. Jucha

## CENTRAL

#### ABILENE CHRISTIAN UNIVERSITY

**Course/Program Title:** Journalism-Mass Communication  
(Radio-Television Division)

1600 Campus Ct.

Abilene, TX 79699

(915) 674-2311

**Chief Administrator:** Dr. Larry Bradshaw

#### ALVIN COMMUNITY COLLEGE

**Course/Program Title:** Communications Dept. (Recording and Sound Reinforcement)

3110 Mustang Rd.

Alvin, TX 77511

(713) 331-6111 ext. 379, ext. 388

**Chief Administrator:** Cathy Forsythe

#### ANDERSON COLLEGE

**Course/Program Title:** Music/Business (B.A./Music Industry Minor)

1100 E. Fifth St.

Anderson, IN 46012

(317) 649-9071

**Chief Administrator:** F Dale Bengtson

#### BALL STATE UNIVERSITY

**Course/Program Title:** Music Engineering Technology

Muncie, IN 47306

(317) 285-5537

**Chief Administrator:** Cleve L. Scott

#### BEACHWOOD STUDIOS

**Course/Program Title:** Music Production Workshop

23330 Commerce Park

Beachwood, OH 44122

(216) 292-7300

**Chief Administrator:** George A. Sipl

#### CAPITAL UNIVERSITY CONSERVATORY OF MUSIC

**Course/Program Title:** Commercial Music

2119 E. Main St.

Columbus, OH 43209

(614) 236-6474

**Chief Administrator:** Paul Forno

**Program:** Bachelor of Arts degree with a major in commercial music is a new, four-year program designed to provide undergraduates with a solid base of traditional and commercial musical training. This music core is supplemented with extensive studio recording techniques taught in conjunction with "The Recording Workshop" in Chil-

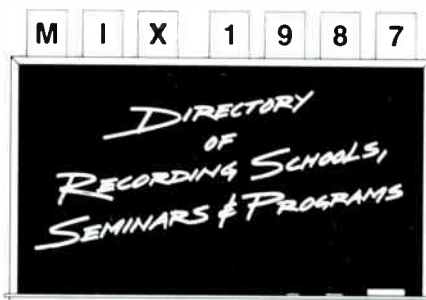

llothe, Ohio and a minor in business administration, computer science, or radio and television broadcasting

#### CEDAR VALLEY COMMUNITY COLLEGE

3030 N. Dallas Ave.

Lancaster, TX 75134

(214) 372-8120

**Chief Administrator:** Division of Communications/Humanities chairperson

**Program:** Commercial Music Recording Technology (two-year Associate's degree). This two-year program is designed to provide the technical and musical skills necessary in the field of recording technology. In addition to preparing the student in vocal and instrumental commercial music techniques, training is provided in basic recording skills such as microphone selection and placement, mixdown techniques, master tape production, studio techniques, troubleshooting and session procedures. Emphasis is placed on the specific needs of the commercial musician in the field of recording

#### CENTRAL HIGH SCHOOL

**Course/Program Title:** Central Studios

275 N. Lexington

St. Paul, MN

(612) 293-8700

**Chief Administrator:** Ben James

#### CHAPMAN RECORDING WORKSHOP

**Course/Program Title:** Recording Workshop

228 W. 5th

Kansas City, MO 64105

(816) 842-6854

**Chief Administrator:** Chuck Chapman

#### CLEVELAND INSTITUTE OF MUSIC

**Course/Program Title:** B.M., Double Major in Recording Engineering

11021 East Blvd.

Cleveland, OH 44106

(216) 229-7290

**Chief Administrator:** David Cerone, Thomas Knab

**Program:** The Cleveland Institute of Music Recording Engineering Program offers studies in professional audio recording skills as an adjunct to a conservatory major of performance, composition, theory or eurhythmics studies. Bachelor of Music degree. Sixteen courses in full Audio and Synthesis Program, as well as a professional internship are offered. Fully equipped 8- and 16-track studios, including automated mixdown, video sync, digital 2-track, Lexicon reverb, Synclavier II, and extensive MIDI implementation. Strong musical qualifications required. Joint program with Case Western Reserve University. Particularly strong in classical music recording with our in-house symphony orchestra and adjunct Professor of Recording Engineering, Jack Renner, TELARC

#### COLUMBIA COLLEGE OF CHICAGO

600 S. Michigan Ave.

Chicago, IL 60605

(312) 660-1600

**Chief Administrator:** Al Parker

**Program:** Columbia College has recently expanded its audio engineering curriculum, and installed a multi-departmental Bachelor's degree in Recording Arts and Sciences. This degree is offered by three departments: Radio, Arts Management and Music. Required specialist courses for the engineering degree are Sound Engineering 1 and 2, and Acoustics for Microphones. Sound Engineering 1 is a classroom course in basic audio electronics, the technology and language of recording. Sound 2, held in an independent multi-track recording and film studio, involves the explanation and demonstration of each link in the recording chain, as well as studio setup, basic maintenance, audio quality standards, editing, and so forth. Optional courses offered to the engineering candidate are: Advanced Acoustical Design, Digital Audio Systems, Console Systems, Basic Sound Practices, Stereo Broadcast Techniques, Recording Studio Management and MIDI as well as production and music courses in other departments.

#### EAST TEXAS STATE UNIVERSITY

**Course/Program Title:** Recording Techniques I, II, III

Music Department-E.T. Station

Commerce, TX 75428

(214) 886-5302

**Chief Administrator:** Dr. Ronald Yates

#### ELMHURST COLLEGE

**Course/Program Title:** Music Business

190 Prospect

Elmhurst, IL 60126

(312) 279-4100 ext. 357

**Chief Administrator:** Tim Hays

**Program:** Located in the Chicago metropolitan area, Elmhurst College is an accredited institution that offers both a B.S. and a B.M. in Music Business. In addition to class work in music, business and the business of music, students get hands-on industry experience through internships, industry speakers and course tours to locations such as Los Angeles or New York City. Resources include a new 12-track studio facility, an artist faculty of over 30, and support from numerous music industry associations and corporations. Offering students individualized instruction in music business for over 16 years, Elmhurst provides a specialized career track integrated within a four-year degree.

#### HENRY FORD COMMUNITY COLLEGE

**Course/Program Title:** Mass Communication

5101 Evergreen Rd.

Dearborn, MI 48128

(313) 845-9634

**Chief Administrator:** Jay B. Konnek

#### GOODNIGHT DALLAS ENGINEERING SCHOOL

11260 Goodnight Ln.

Dallas, TX 75229

(214) 241-5182

**Chief Administrator:** Ruben Ayala

#### HOUSTON COMMUNITY COLLEGE

**Course/Program Title:** Audio and Recording Technology

901 Yorkchester

Houston, TX 77079

(713) 468-0955

**Chief Administrator:** Aubrey Tucker

**Program:** Commercial Music Department, Audio and Recording Technology. Fully accredited college offering two-year Associate degree and certificate programs in Audio Engineering. Cost of instruction is extremely competitive in this field, consisting of normal tuition and fees. Great emphasis is placed on practical hands-on experience. Two fully equipped studios: Studio A features MCI JH-536 automated console and JH-114 24-track recorder, Dolby A noise reduction, Lexicon 224 digital reverb, Scamp rack, digital processing, and full complement of professional microphones. Studio B contains Tascam 520 20-channel mixing console, Fostex 16-track recorder and similar outboard equipment and microphones. New inventory of keyboards, synthesizers, drum machines and sequencers. Complete video studio.

#### HUTCHINSON VOCATIONAL

**TECHNICAL INSTITUTE**

**Course/Program Title:** Audio Technology

200 Century Ave.

Hutchinson, MN 55350

(800) 222-4424 in MN

(612) 587-3636

**Chief Administrator:** Dick Lennes, David Igl

**Program:** Audio Technology. Two-year intensive technical audio program. Extensive hands-on training in audio electronics (analog and digital), studio and remote recording systems design and installation, acoustics, signal processing and sound reinforcement for pro sound market. Music television training option available. Heavy on lab and practical applications. Personalized instruction allows students to enter throughout year, receive credit for previous experience, and work at accelerated pace. Graduates available throughout year. Extensive cooperation with employers for internships and supervised work experience. Students active in AES. State school, low tuition. Our graduates have the mix of technical and production skills for today's pro sound market

#### INDIANA UNIVERSITY

**Course/Program Title:** Associate of Science in Audio

Technology

School of Music MU 4C

Bloomington, IN 47405

(812) 335-1613

(812) 335-1900

**Chief Administrator:** Ted W. Jones, David A. Pickett

**Program:** The Associate of Science in Audio Technology, lasting approximately five semesters, offers training in audio recording, reinforcement and media production with emphasis on classical music recording techniques. Students



record all official concerts ranging from solo and chamber music through symphony orchestras, jazz ensembles and opera. In total, about 1,000 performances are produced annually in a 500-seat recital hall and the 1,460-seat Musical Arts Center. Classes in recording techniques, electronics, acoustics, maintenance and musical styles. Professional equipment includes a 2-track digital and up to 16-track analog. University financial aids and some work scholarships available. Departmental assistance offered in job placement.

**INVER HILLS COMMUNITY COLLEGE**

Course/Program Title: Independent Record Production/Marketing  
8445 E. College Trail  
Inver Grove Hqts., MN 55075  
(612) 450-8501  
Chief Administrator: Walker Pierce

**IVS SCHOOL OF MUSIC**

Course/Program Title: Audio Recording Techniques  
722 Lake St.  
Oak Park, IL 60301  
(312) 848-3008  
Chief Administrator: Wm. Messner

**KEN-KHORT MUSIC SCHOOL**

Course/Program Title: Pre-Recording (Music Ed: Theory; Piano)  
1923 FM 2234  
Missouri City, TX 77459  
(713) 499-9301  
(713) 530-3290  
Chief Administrator: Jeanie J. Rodgers, L.I. Rodgers

**LARR COMPUTER CORP OF DEL.  
KLARR BROADCASTING NETWORK DIV.  
(KLARR SATELLITE RADIO & TV)**

Course/Program Title: Education Dept. for Broadcasting & Recording Training  
PO Box 3842  
Houston, TX 77253  
Chief Administrator: Dr. Lawrence Herbst

**LINCOLN INSTITUTE**

Course/Program Title: Audio Engineering/Video Production  
7622 Louetta Rd.  
Spring, TX 77379  
(713) 376-9679  
Chief Administrator: J.E. Lincoln

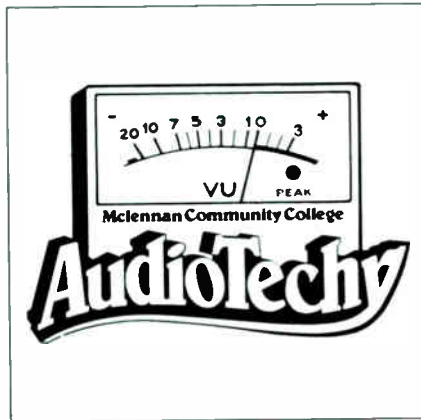

**MCLENNAN COMMUNITY COLLEGE**  
Waco, TX

**MCLENNAN COMMUNITY COLLEGE**

Course/Program Title: Audio Technology  
1400 College Dr.  
Waco, TX 76708  
(817) 756-6551  
Chief Administrator: David Hibbard  
Program: A comprehensive degree program in Audio Technology, part of the McLennan Community College Commercial Music Program. Students will study all aspects of sound, acoustics, production, engineering and music business. Learn to work in our new state-of-the-art 24-track analog-digital studio, engineering and producing actual sessions with country, rock, jazz and classical groups. Fully accredited degree includes approximately 480 hours of studio experience, a portfolio of your recordings, music theory, performance and music business training. For more information contact program director, Commercial Music Program.



**MILLIKIN UNIVERSITY**  
Decatur, IL

**MILLIKIN UNIVERSITY**

Course/Program Title: Commercial Music  
1184 W Main  
Decatur, IL 62522  
(217) 424-6300  
Chief Administrator: Dean A. Wesley Tower  
Program: Millikin University School of Music is the first accredited university in the Midwest to offer a Bachelor of Music degree program in Commercial Music with a vocal and instrumental emphasis. In addition to the traditional aspects of professional music training, course concentration includes Commercial Music Performance, Commercial Music Arranging, Commercial Music Ensembles, Traditional and Commercial Studio Ensembles, Recording Studio Engineering, Record Producing, Jingle Writing and Producing, Commercial Vocal Styles, Commercial Music Theory, Improvisation Techniques and Commercial/Jazz History and Forms. Scholarships, talent awards and financial aid are available.



**NORTHEAST COMMUNITY COLLEGE**  
Norfolk, NE

**NORTHEAST COMMUNITY COLLEGE**

Course/Program Title: Audio and Recording Technology  
801 E. Benjamin Ave., PO Box 469  
Norfolk, NE 68701  
(402) 644-0506  
Chief Administrator: Timothy Miller  
Program: Offering a two-year Associate of Arts and/or Associate of Applied Science in Audio and Recording Technology. The Audio and Recording Technology program is a balanced mix of music, audio theory, application and hands-on experience in a recently updated control room and sound studio. NTCC is accredited by the North Central Association of Colleges and Schools and the Nebraska State Department of Education.

**OBERLIN COLLEGE**

Course/Program Title: Electronic Music Workshops  
Conservatory of Music  
Oberlin, OH 44074  
(216) 773-8200  
Chief Administrator: Conrad Cummings

**Qualified Technicians!**

**Minnesota Audio Techs:**

- Technically competent
- Strong work ethic
- On time
- Aggressive learners

**Competency based curriculum:**

- Audio electronics, analog & digital
- Studio & live sound theory & practicals
- System design, installation, troubleshooting

Hands On Video Program Also Available

Education designed with you in mind.

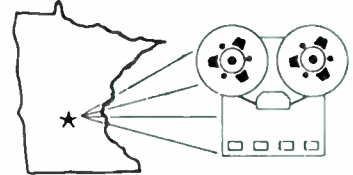

**HUTCHINSON AREA VOCATIONAL TECHNICAL INSTITUTE**

200 Century Ave  
Hutchinson, MN 55350  
Phone (612) 587-3636  
Toll Free (MN only) 1-800-222-4424

A fully accredited tax supported non-profit institution



ASSOCIATE

Circle #059 on Reader Service Card

**BERTECH DELIVERS!**

**THE BERTECH ORGANIZATION**  
Your National Clearinghouse for Fine Used Audio and Video  
For the right equipment at the right price, **THINK BERTECH FIRST!**  
With thousands of sellers nationwide, we can find what you're looking for — consoles, tape machines, mikes, outboard, parts and components... you name it. Call now and put us to work for you. And if you've got equipment to sell, we'll list it FREE in our mailers!

**BERTECH**  
1447 CALIFA STREET  
VAN NUYS, CA 91401  
(818) 909-0262  
Toll Free Outside CA  
(800) 992-2272

**THINK BERTECH FIRST!**

Circle #060 on Reader Service Card

**OKLAHOMA STATE UNIVERSITY**  
 Course/Program Title: Introduction to Music Business  
 132 Sereteau Center  
 Stillwater, OK 74078  
 (405) 624-6133  
 Chief Administrator: Dr. Gerald Frank



**OPUS RECORDING AND EQUIPMENT COMPANY**  
 Gurnee, IL

**OPUS RECORDING AND EQUIPMENT COMPANY**  
 Course/Program Title: Recording, Engineering and Acoustics  
 4262 Grand Ave.  
 Gurnee, IL 60031  
 (312) 336-6787

Chief Administrator: Tony Pettinato

Program: Students will gain exposure to the latest advances in audio equipment, including Amek consoles, Ampex and Otari recorders, Cexec Gauss monitors, four reverb units, three digital delays, 7'4" Yamaha conservatory grand piano, over 50 microphones. Hands-on instruction on operational theory and application. Pro-audio showroom, 24-track and 8-track recording facilities on premises. College affiliated or

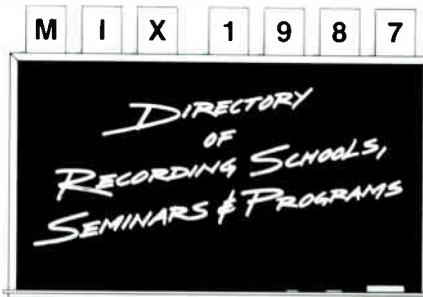

private courses available. Topics include: multi-track recording, disc mastering, record pressing, audio/visual productions, acoustics, microphone techniques, tape recorder maintenance, peripheral equipment. Our students have graduated to become sound and broadcast engineers in radio, recording studio and TV industry

**FRANK PHILLIPS COLLEGE**  
 Course/Program Title: Radio Television  
 PO Box 5118  
 Borger, TX 79008  
 (806) 274-5311  
 Chief Administrator: Bob Ramsey

**PURDUE UNIVERSITY**  
 Course/Program Title: Creative Arts/Communication Dept.  
 B-10 Stewart Center  
 West Lafayette, IN 47907  
 (317) 743-8150  
 Chief Administrator: Rick Thomas

**RECORDING INSTITUTE OF DETROIT, INC.**  
 Course/Program Title: Recording Techniques  
 14611 E. 9 Mile Rd.  
 East Detroit, MI 48021  
 (313) 779-1380  
 Chief Administrator: Robert Dennis

Program: A state-licensed, ten-month, four-step program in audio training. 222 clock hours of courses and internship. Steps include a Basic Recording course, an applied Music Theory course, Advanced Recording course and a 100-hour internship in a specialty of the graduate's choosing. The program includes six recording projects to expose different musical styles and recording techniques. Actual experience as a 24-track second engineer is provided. Twenty-one start dates per year, evening and weekend schedule. Job placement assistance, vocal workshops and remedial study courses offered. \$1,650 base tuition. Scholastic testing or high school diploma required for acceptance.

**RECORDING STUDIO WORKSHOP**  
 Course/Program Title: Recording Studio Workshop  
 117 W. 8th  
 Hays, KS 67601  
 (913) 625-9634  
 Chief Administrator: Mark Meckel

# THE RECORDING WORKSHOP

**THE RECORDING WORKSHOP**  
 Chillicothe, OH

**THE RECORDING WORKSHOP**  
 Course/Program Title: Recording Engineering & Music Production Program  
 455-X Massieville Rd.  
 Chillicothe, OH 45601  
 (614) 663-2544  
 (800) 848-9900

Chief Administrator: Jim Rosebrook

Program: The Workshop's primary goal is to prepare qualified assistant recording engineers, but the training is also very useful for the aspiring recording artist or producer. The curriculum for the main program is an effective combination of 75 hours of in-depth lectures and 125 hours of hands-on experience in the Workshop's fully equipped six studios, including music recording sessions, mixing, media production utilizing SMPTE synchronization, MIDI seminars and editing techniques. Classes for this intensive program start seven times annually. To supplement the main program, two optional courses are available: the Studio Maintenance & Trouble-shooting program (40 hours) and the Advanced Recording Engineering & Music Production program (60 hours). In addition, students can earn a Bachelor of Music/Commercial Music degree through the Workshop's association with Capitol University in Columbus, Ohio.

**RED WING TECHNICAL INSTITUTE**  
 Course/Program Title: Electronic Music Technology  
 AVTI  
 Red Wing, MN 55066  
 (612) 388-8271  
 Chief Administrator: Chuck Munson

**ROSE STATE COLLEGE**  
 Course/Program Title: Introduction to Recording  
 6420 SE 15th  
 Midwest City, OK 73110  
 (405) 733-7426  
 (405) 733-7380  
 Chief Administrator: Dr. Larry Nutter, Craig C. White

**ST. MARY OF THE PLAINS COLLEGE**  
 Course/Program Title: Bachelor of Science in Music/Business  
 San Jose Dr.  
 Dodge City, KS 67801  
 (316) 225-4171  
 Chief Administrator: Bill Chrstny

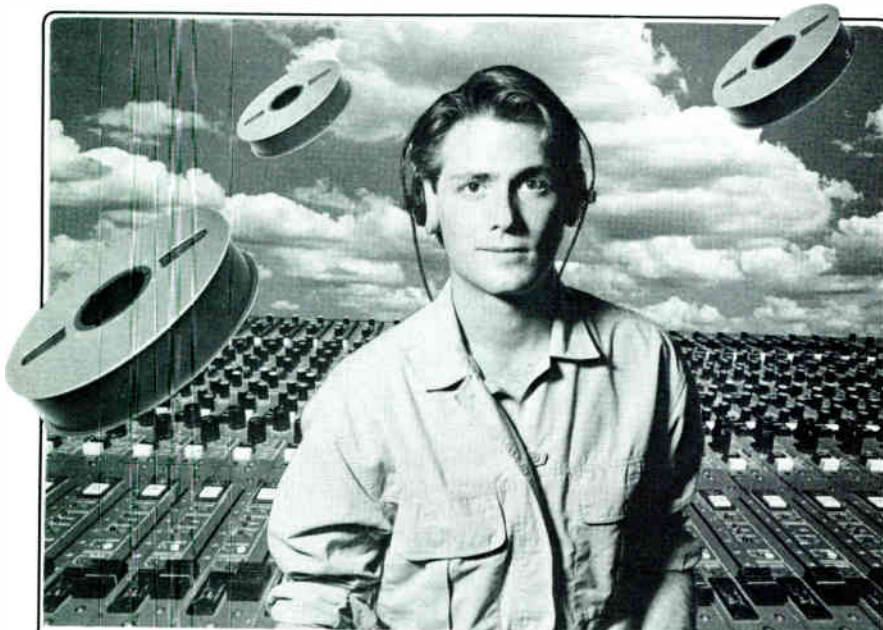

## LEARN THE ART OF RECORDING

LEARN CREATIVE RECORDING SKILLS ON THE LATEST EQUIPMENT, FROM THE LEADING 'HANDS ON' TRAINING PROGRAM FOR SOUND ENGINEERS, PRODUCERS AND STUDIO MUSICIANS. WITH OR WITHOUT PREVIOUS EXPERIENCE, IF YOU'RE SERIOUS ABOUT A CAREER IN MUSIC, OUR INTENSIVE, SIX WEEK PROGRAM CAN GET YOU STARTED AND PUT YOU AHEAD. FOR FREE BROCHURE, PLEASE CALL OR WRITE TODAY.

**THE RECORDING WORKSHOP**

**THE RECORDING WORKSHOP**  
 455-X MASSIEVILLE ROAD, CHILLICOTHE, OHIO 45601  
 (800) 848-9900 (614) 663-2544

OHIO STATE BOARD OF SCHOOL AND COLLEGE REGISTRATION #80-07-0696T

Circle #061 on Reader Service Card



## THE SCHOOL OF THE OZARKS

Course/Program Title: Mass Media-Sound Rec. (Intro. & Adv.)

Jamison Bldg.  
Pt. Lookout, MO 65726  
(417) 334-6411 ext. 397

Chief Administrator: Prof. Robert Lake

## SOLID SOUND RECORDING STUDIO

Course/Program Title: Recording Engineer Class

2400 W. Hassell Rd., Ste. 430  
Hoffman Estates, IL 60195  
(312) 882-7446

Chief Administrator: Judd Sager

## SOUND TRAX+

Course/Program Title: Basic Recording  
1000 W. 17th St.

Bloomington, IN 47401  
(812) 332-7475

Chief Administrator: Joseph T. Wilson

## SOUTH PLAINS COLLEGE

Levelland, TX 79336

(806) 894-9611

Program: Performing Arts Production Technology Program at South Plains College, Levelland, Texas. Innovative educational program trains you to work as production technician or production manager of video production houses, entertainment and convention facilities, civic centers and theaters. Program provides training in sound reinforcement and recording equipment, audio and video production, lighting, stage crafts and business aspects. Training facilities include 5,000 sq. ft. Tom T. Hall Recording and Production Studio with 24-track, multi-track audio capabilities synchronized to high-grade 3/4" video. Studio features Strand-Century lighting system with automated light board and Sony digital video cameras. Two-year program awards Associate of Applied Science Degree. Contact Randy Ellis, South Plains College, Levelland, Texas 79336. Telephone (806) 894-9611.

Program: Sound Technology Program at South Plains College, Levelland, Texas, trains you for careers in the recording industry as recording engineers, sound reinforcement specialists, studio technicians. Excellent training facilities include the 5,000 sq. ft. Tom T. Hall Recording and Production Studio with 24-track, multi-track audio capabilities synchronized to high-grade 3/4" video. Professional gear includes full 36-channel automated console. Plus, the Waylon Jennings Recording Studio with 16-track, multi-track recording capabilities. Two-, 4- and 8-track learning studios complement training opportunities. Two-year program awards Associate of Applied Science Degree. Contact Randy Ellis, South Plains College, Levelland, Texas 79336. Telephone (806) 894-9611.

## SOUTHERN ILLINOIS UNIVERSITY

Course/Program Title: B.A. & M.F.A. Programs

Department of Cinema & Photography  
Carbondale, IL 62901

(618) 453-2365

Chief Administrator: David Gilmore

## SOUTHERN OHIO COLLEGE

Course/Program Title: Audio/Video Production  
Broadcasting Dept.

1055 Laidlaw Ave.  
Cincinnati, OH 45237

(513) 242-3791

Chief Administrator: Gordon S. Johnson

Program: Southern Ohio College offers a two-year Associate Degree in Audio/Video Production w/emphasis on hands-on learning of video and audio production skills. SOC is accredited by North Central Association of Colleges and Schools and by Association of Independent Colleges and Schools. Video equipment includes Hitachi 2-31 cameras, Convergence editing system w/AB roll, SMPTE time code and auto assembly, Grass Valley 100 switcher and an extensive lighting package. Updated audio labs have just been completed that include a Fostex 16-track recorder, Allen Heath console and a wide variety of signal processing equipment. Focus of the program is to prepare students for the corporate and production house environment.

## STATE UNIVERSITY OF NORTH DAKOTA-MINOT

Course/Program Title: Recording Arts Minor

SUND-Minot

Minot, ND 58701

(701) 857-3186

Chief Administrator: Robert L. Larson

## STUDIO PRODUCTION TECHNIQUES

Course/Program Title: Studio Production Techniques

Box 741444

Dallas, TX 75374

(214) 426-3766

Chief Administrator: Terry Pope

## TARRANT COUNTY JUNIOR COLLEGE

Course/Program Title: Media Communications

828 Harwood Rd.

Hurst, TX 76054

(817) 281-7860

Chief Administrator: Dr. Herman Crow

## TEXARKANA COLLEGE RECORDING STUDIOS

2500 N. Robison Rd.

Texarkana, TX 75501

(214) 838-4541 x257 or 360

Chief Administrator: Murry L. Alewine

Program: Two-year Associate Degree in Commercial Music, one-year certificate in Recording Studio. A four-semester Associate Degree in commercial music or a two-semester certificate in recording studio. A state-sponsored college with two 16-track studios. Each 16-track studio has complete facilities with modern up-to-date equipment. Professional quality equipment with professional faculty. Classes begin each September, January and June. Fees/tuition schedule available on request. Hands-on instruction and lab time for all students beginning first semester. Fourth semester students have access to professional 24-track studio in city. Many clubs, lounges, restaurants available in vicinity for employment.

## TEXAS CHRISTIAN UNIVERSITY

Course/Program Title: Radio/TV/Film

PO Box 30793

Ft. Worth, TX 76129

(817) 921-7630

Chief Administrator: Terry Ellmore

## TRANS AMERICAN SCHOOL OF BROADCASTING

Course/Program Title: Comprehensive Broadcasting

108 Scott St.

Wausau, WI 54401

(715) 842-1000

Chief Administrator: Chris Hutchings

## UNIVERSITY OF DETROIT

Course/Program Title: Communication Studies Dept.

3800 Puritan

Detroit, MI 48238

(313) 927-1173

Chief Administrator: Dr. Vivian Dicks

## THE UNIVERSITY OF IOWA

Course/Program Title: Recording Techniques (Academic

Year); Seminar in Audio Recording (Summer Sessions)

Recording Studios, School of Music

2057 Music Building

Iowa City, IA 52242

(319) 335-1664

Chief Administrator: Prof. Lowell Cross

## UNIVERSITY OF MISSOURI-KANSAS CITY

CONSERVATORY OF MUSIC

Course/Program Title: Audio Recording

4949 Cherry St.

Kansas City, MO 64110

(816) 276-2964

Chief Administrator: Tom Mardikes

## UNIV. OF WISCONSIN-OSHKOSH

Course/Program Title: Music Merchandising-Recording  
Emphasis

800 Algoma Blvd.

Oshkosh, WI 54901

(414) 424-4224

Chief Administrator: Charles Isaacson

Program: The Recording Technology emphasis is an option of the Music Merchandising Program, one of the Music majors offered by the University of Wisconsin-Oshkosh. This is a four-year program covering all aspects of the recording process; mixing to mixdown, production and contractual agreements. The final semester is spent in the work-field as an intern at a professional recording studio. The Music Department is accredited by NASM. Early application for admission to the University is advised. Classes begin after Labor Day.

# EASTERN

## AMERICAN INSTITUTE OF TECHNOLOGY

Radio/Television Division

1101 Kermit Dr., Ste. LL-5

Nashville, TN 37217

(615) 360-3300

Chief Administrator: Ed Sheppard

Program: The Radio/Television Division of the American Institute of Technology provides training programs in specialized areas of electronic communications. Offers six months intensive hands-on training in either radio or video (12 months for both). Television course teaches video production, including switching, lighting, studio and location camera operation, and electronic editing. Radio course teaches discjockey skills, newscasting, commercial production, programming and station operations. Financial aid is available to those who qualify. Job placement assistance is provided to our graduates. Accredited by the Association of Independent Colleges and Schools and licensed by Tennessee Higher Education Commission.

## ASPEN MUSIC FESTIVAL

Course/Program Title: Aspen Audio Recording Institute

250 W. 54th St., 10th Floor East

New York, NY 10019

(212) 581-2196

Chief Administrator: Daniel Craik

Program: In the splendor of the Rocky Mountains, the Aspen Audio Recording Institute offers four intensive hands-on workshops in live recording techniques. Faculty is drawn from noted professionals of the recording industry. Using state-of-the-art equipment, students record daily rehearsals and concerts of the Festival presenting a full range of recording experience from orchestra to opera, contemporary to jazz. For further information write for a brochure.

## THE AUDIO WORKSHOP SCHOOL

(DIV. COMMUNICATIONS RESEARCH GROUP)

Course/Program Title: Studio and Stage Sound Production—SSP 301/302

119 Fresh Pond Pkwy.

Cambridge, MA 02138

(617) 547-3957

Chief Administrator: Steve Langstaff

Program: Founded in 1972, the program offers comprehensive career-oriented training in Theory and Techniques of Sound Engineering, in cooperation with several 24- to 48-track area studios. Includes all the critical basics, plus digital, MIDI, acoustics, equipment interfacing, vinyl and packaging production, business and financing guidance, and considerable 24-track production access, with students choosing their own artists for final projects. State-certified principal instructor Steve Langstaff (Harvard, SynAudCon, Blue Jay Recording) is a respected engineer, designer and consultant with over 10,000 hours of teaching experience. Noted specialty guest speakers also participate. No prerequisites for SSP-301. Licensed by the Massachusetts Department of Education.

## BELMONT COLLEGE

Course/Program Title: B.B.A., Music Business

School of Business, Belmont College

Nashville, TN 37203

(615) 385-6483

Chief Administrator: Richardson R. Lynn

## BERKLEE COLLEGE OF MUSIC

Course/Program Title: Music Production and Engineering

1140 Boylston St.

Boston, MA 02215

(617) 266-1400

Chief Administrator: Donald A. Puluse

Program: The Music Production and Engineering major at Berklee College of Music builds upon each student's musical foundation and adds the practical, professional-level skills of a producer, engineer or post-production specialist. Within Berklee's six-studio recording complex, students receive extensive hands-on training and have access to the very best, professional-grade equipment. Studios contain the latest analog and digital recording equipment, with complete digital post-production capacity, sampling synthesizers and SMPTE interlock systems. Our goal is to provide the music industry with highly skilled, disciplined and responsible producers and engineers who possess strong musical skills and a thorough understanding of modern recording and editing techniques, in both 8-track and 24-track formats. The MP&E program also emphasizes sound management and business practices. Berklee is a fully accredited, independent college of music and offers a Bachelor of Music degree and the Professional Diploma.

**BUCKS COUNTY COMMUNITY COLLEGE**  
 Course/Program Title: Audio Production; Music Synthesis; Electronic Tape Composition  
**Media & Performing Arts Department**  
 Newton, PA 18940  
 (215) 968-8085  
 Chief Administrator: William Brenner

**CAYUGA COMMUNITY COLLEGE/TELECOMMUNICATIONS DEPT.**  
 Course/Program Title: Television Production & Broadcast Technology  
 Franklin St.  
 Auburn, NY 13021  
 (315) 255-1743  
 Chief Administrator: Coordinator Telecommunications Department

**CENTRAL CONNECTICUT STATE UNIVERSITY**  
 Course/Program Title: Masters Program in Instructional Media and Technology  
 1615 Stanley St.  
 New Britain, CT 06050  
 (203) 827-7263  
 Chief Administrator: Leroy E. Temple

**COLLEGE OF SAINT ROSE, MUSIC DIVISION**  
 Course/Program Title: Studio Music  
 432 Western Ave.  
 Albany, NY 12203  
 (518) 454-5178

Chief Administrator: J. Robert Sheehan, M.A. Nelson  
 Program: The College of Saint Rose's Studio Music program leads to a B.S. degree in music with a concentration in studio music. The studio music component focuses on strong musical performance, writing, arranging and improvisation, as well as studio production, recording technology and television production. Admission by audition. Catalog and application information: CSR Admissions Office (518) 454-5150.

**COMMUNITY COLLEGE OF THE FINGER LAKES**  
 Course/Program Title: Music Recording  
 Lincoln Hill  
 Canandaigua, NY 14424  
 (716) 394-3500  
 Chief Administrator: Frank Verget



**DIGITAL MUSIC CENTER**  
 New York, NY

**DIGITAL MUSIC CENTER**  
 Course/Program Title: MIDI/SMPTÉ Recording Studio  
 155 W. 46th St.  
 New York, NY 10036  
 (212) 302-4606  
 Chief Administrator: Steve Friedman  
 Program: NY's digital music center is a state-of-the-art MIDI recording studio offering numerous services for musicians working with computers and the new technology. In-house equip. includes: Kurzweil Emulator II, PPG Wave 2.3 w/Waveterm, Khroma, Akai S900, SP-12, Prophet 2000, TX-816, Mirage, and the new Photon MIDI guitar and bass. All sequencing and sound library work is performed on a full array of MIDI software for the Macintosh, IBM-XT and Atari ST computer systems. Sync your film or video to music and sound effects in a variety of analog and digital recording formats. Experienced programmers are available for private or group training in the use of music software and hardware. We also offer a practical, hands-on, two-week class (a MIDI/SMPTÉ recording studio) in which each student completes a recording project utilizing the techniques

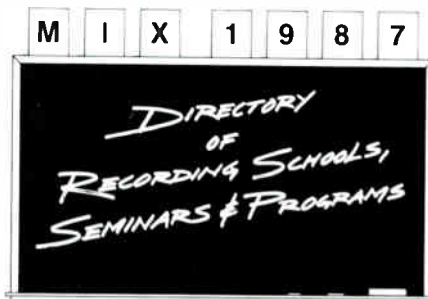

learned in the course. Each student receives their tape recording and the sequence data for his/her sequence. We also offer expert consultation in MIDI/SMPTÉ system design. With sales, training and installation available.

**EASTERN ARTISTS RECORDING STUDIO**  
 Course/Program Title: A.E.C. (Audio Engineering Course)  
 36 Meadow St.  
 East Orange, NJ 07017  
 (201) 673-5680  
 Chief Administrator: Howard Kessler

**EVERGREEN RECORDING ARTS AND SCIENCE SEMINARS**  
 1373 McLaughlin Run Rd.  
 Pittsburgh, PA 15241  
 (412) 221-2737  
 Chief Administrator: Thomas J. Kikka  
 Program: Evergreen offers a variety of courses dealing with recording arts and science. The three formats are a 25-hour course dealing with basic recording theory and techniques, a 45-hour course geared for college communications and music majors, and a 150-hour course structured as a full-time seminar for preparation as a secondary engineer. All courses emphasize hands-on training in professional, fully equipped 8-, 16- and 24-track studios. Subjects include physics of sound, acoustics, transducer theory, music theory, microphone placement, console routing, tape recorder theory and operation and signal processing. College credit is offered through Duquesne University.

**FIVE TOWNS COLLEGE**  
 Course/Program Title: Audio Recording Technology  
 2165 Seaford Ave.  
 Seaford, NY 11783  
 (516) 783-8800  
 Chief Administrator: Dr. Stanley Cohen  
 Program: The A.A.S. degree program in Business Management with a concentration in Audio Recording Technology is intended for those students who wish to enter the recording field directly after completion of their studies at the college. Students will acquire a knowledge of the technical equipment and processes used in recording studios; the ability to produce both an artistically and commercially acceptable master recording for a record company, publishing company, broadcasting company, etc; and an understanding of the various financial aspects involved in establishing and operating a recording studio business. All courses are taught in the new 24-track state-of-the-art recording studio.



**FULL SAIL CENTER FOR THE RECORDING ARTS**  
 Altamonte Springs, FL

**FULL SAIL CENTER FOR THE RECORDING ARTS**  
 Course/Program Title: Recording Arts Comprehensive Program  
 658 Douglas Ave.  
 Altamonte Springs, FL 32714  
 (800) 221-2747  
 (305) 788-2450, in Florida  
 Chief Administrator: Jon Phelps, Garry Jones  
 Program: Hands-on training courses, from three to five weeks each, explore behind-the-scenes aspects of the music industry: Recording Engineering, Music Video, Live Sound & Remote Recording, Studio Maintenance, Music Business and Advanced Recording. The Recording Engineering Comprehensive Program combines these six courses with a six-week internship providing students with practical working knowledge and on-the-job experience. This diploma course, accredited by National Association of Trade & Technical Schools, includes over 500 hours of 24- and 48-track studio time in addition to classroom instruction. Job placement assistance and financial aid available. Call today for free catalog.

**GEORGE WASHINGTON UNIVERSITY**  
 Course/Program Title: Electronic Music (Studio)  
 Music Department  
 Washington, DC 20052  
 (202) 994-9037  
 Chief Administrator: Ulf Grahn

**GEORGIA STATE UNIVERSITY**  
 Dept. of Commercial Music/Recording of the College of Public and Urban Affairs  
 University Plaza, Atlanta, GA 30303  
 (404) 658-3513  
 Chief Administrator: Carter D. Thomas  
 Program: The Dept. of Commercial Music/Recording offers training that is both academically sound and responsive to the industry needs. Students may pursue either an Associate of Science degree or a Bachelor of Science degree in the field of commercial music/recording with a concentration in business or recording/production. (The program has a 24-track recording studio.) A student may complete an A.S. degree and transfer directly to the B.S. degree program. These programs have won widespread support in the music industry and a vigorous endorsement by the National Academy of Recording Arts and Sciences. Day and evening classes offered. Telephone or write.

**HUMPHREY OCCUPATIONAL RESOURCE CENTER**  
 Boston Public Schools  
 75 New Dudley St.  
 Boston, MA 02115  
 (617) 442-5200 ext. 535  
 Chief Administrator: Philip Worrell, Tessel Collins

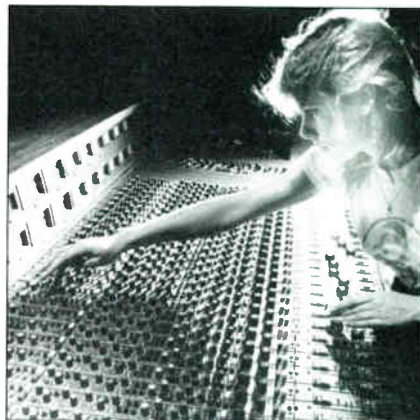

**INSTITUTE OF AUDIO RESEARCH**  
 New York, NY

**INSTITUTE OF AUDIO RESEARCH**  
 Course/Program Title: Multi-track Recording Technology Program  
 64 University Pl.  
 Greenwich Village  
 New York, NY 10003  
 (212) 677-7580  
 Chief Administrator: Philip Stein, Albert B. Grundy, Miriam Friedman  
 Program: The Institute of Audio Research offers a nine-month program in Multi-track Recording Technology. Students learn the technology and techniques of the professional state-of-the-art studio. The Institute boasts a 13,000 sq. ft. facility in the heart of Greenwich Village with labs and  
 —LISTING CONTINUED ON PAGE 96



# THE REFERENCE GUIDE YOU'VE BEEN WAITING FOR!

**N**ow for the first time in one convenient, easy-to-use volume—the listings that the recording industry has relied upon for the past ten years.

The first **Annual Directory of Recording Industry Facilities and Services** now brings together **all** the *Mix* Studio Directories, as well as video production/video post, mastering/pressing/duplication houses, studio designers, equipment manufacturers and other essential services.



Featured in this premier directory are articles covering the year in audio and music technology, MIDI in the studio and 1986 products in review. Also, for the first time, *Mix* has compiled and organized a wealth of market data and industry statistics for professionals.

This indispensable resource guide for audio/video production professionals retails for \$24.95. Order yours today and have *all* these valuable listings at your fingertips:

## **Recording Studios of the U.S. and Canada**

Over 2,000 studio listings, broken down by geographical region, including equipment, size of studios and control rooms, personnel, areas of specialization, rates and other useful information.

## **Audio, Video and Music Manufacturers**

The names, addresses and phone numbers of over 500 manufacturers of equipment for professional applications in audio, video and music production.

## **Video Production and Post-Production Facilities**

Nearly 1,000 video production companies, including post-production/editing, on-location production, and audio post-production for video. Listings give personnel, rates, and equipment.

## **Studio Designers and Equipment Suppliers**

More than 500 studio designers, acoustical consultants, audio/video equipment dealers and installers. The most comprehensive directory of its kind.

## **Mastering, Pressing, Duplication Facilities**

Over 450 listings of mastering houses, pressing plants, and tape duplicators. Includes rates, production capacity, equipment used.

Important note: At the request of listees, some entries in the Directory include only company name, address, phone and person to contact. However, the majority of facilities include detailed information.

# YES

Please send me \_\_\_\_\_ copies of the 1987 *Mix* Annual Directory of Recording Studios and Services at \$24.95. (Please add \$2.50 per copy postage and handling. California residents add 6.5% sales tax.)

I enclose \$ \_\_\_\_\_  Check  Money order

Please charge to my  Mastercard  Visa

Exp. Date \_\_\_\_\_ # \_\_\_\_\_

**SPECIAL OFFER: SAVE 46% WHEN YOU ORDER FIVE OR MORE COPIES AT \$13.50 EACH! WE BILL YOU FOR SHIPPING.**

Signature \_\_\_\_\_

Name \_\_\_\_\_

Company \_\_\_\_\_ Title \_\_\_\_\_

Address \_\_\_\_\_ City \_\_\_\_\_ State \_\_\_\_\_ Zip \_\_\_\_\_

Mail to: MIX ANNUAL, PO Box 2526, Berkeley, CA 94702. Allow three weeks for delivery.

—LISTING CONTINUED FROM PAGE 94

classrooms for audio technology, circuit construction, digital, editing, recording, mixing and more. At the heart of the facility is the Institute's exciting control rooms and studio complex with automated 32 x 24 console, full complement of analog and digital outboard gear, and MIDI studio with 32-track digital sequencer. The Institute of Audio Research is licensed by the state of New York, approved for veterans training and nationally accredited. Financial aid is available for eligible students.

**INSTITUTO HISPANO DE AUDIO**

Course/Program Title: Recording Engineering-taught in Spanish  
130 W. 42nd St. (Room 551)  
New York, NY 10036  
(212) 221-6625  
Chief Administrator: Jose Gallegos

**IRIS SOUND STUDIO**

Course/Program Title: Workshops in Recording and Music Technology  
237 Main St.  
Royersford, PA 19468  
(215) 948-3448  
Chief Administrator: David Ivory

**JERSEY CITY STATE COLLEGE**

Course/Program Title: Music-Theatre  
2039 Kennedy Blvd.  
Jersey City, NJ 07305  
(201) 547-3151  
Chief Administrator: Richard Scott

**JTM WORKSHOP OF RECORDING ARTS**

Course/Program Title: Learn Recording Engineering  
Best Ave., Box 686  
Knox, PA 16232  
(814) 797-5883  
Chief Administrator: Frank T. Battista

**LEBANON VALLEY COLLEGE**

College Ave.  
Annville, PA 17003

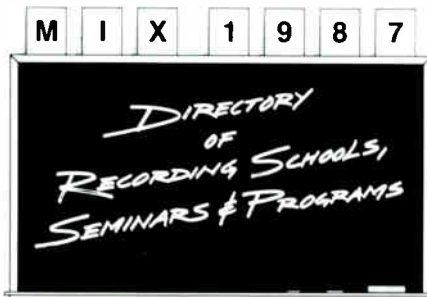

(717) 867-6200

Chief Administrator: John J. Uhl

Program: The Sound Recording Technology program at Lebanon Valley College is a comprehensive course of study combining the art, science and philosophy of recording. The students follow a variety of disciplines involved in the field of audio engineering including: recording technology, music, physics, electronics, mathematics, computer science, business administration and selected courses in the liberal arts. Emphasis is placed on student usage of equipment in laboratory and level 500 courses. All applicants to the program must pass a musical audition for acceptance. The degree conferred is a Bachelor of Music: Sound Recording Technology, and meets NASM standards.

**MEMPHIS STATE UNIVERSITY**

Course/Program Title: Commercial Music  
Dept. of Music  
Memphis, TN 38152  
(901) 454-2559

Chief Administrator: Larry Lipman

Program: Bachelor of Fine Arts in Commercial Music, concentrations in Recording/Engineering or Music Business. Bachelor of Music in Commercial concentrations in Composition/Arranging or Studio/Live Performance. The CMUS faculty have been carefully selected to provide students with a balance between successful professionals actively working in the music industry, and dedicated, experienced educators with a broad knowledge of music industry prac-



**MEMPHIS STATE UNIVERSITY**  
Memphis, TN

tics. Modern production facilities include: 24-track MCI studio, electronic music lab and a complete video production facility. The Memphis music industry offers a dynamic, growing environment providing students with diverse internship opportunities. CMUS students can become involved in the University's own production and publishing companies. Enrollment is limited and based on selective procedures.

**MIAMI SUNSET SENIOR HIGH SCHOOL**

Course/Program Title: TV Production, Electronic Music  
13125 SW 72 St.  
Miami, FL 33183  
(305) 385-4255

Chief Administrator: Daniel B. Sell

Program: Sunset offers a three-year curriculum in television production and electronic music (recording engineering). Students in TV work in a four-camera color studio with computer-assisted editing, telecine and interformat dubbing. Students produce commercials, live closed circuit broadcasts, daily news and record schoolwide events including four-camera remotes. Students involved in audio use the 8-channel Tascam/Tapco studio complete with dbx and many outboard accessories. Students also study sound reinforcement using our Yamaha P.A. system. Most projects include combining the TV, recording and sound reinforcement equipment. These programs are open to all full-time students in the school.

**MIDDLE TENNESSEE STATE UNIVERSITY**

Course/Program Title: Music Industry  
PO Box 47-MTSU  
Murfreesboro, TN 37132  
(615) 898-2469

Chief Administrator: Dr. Tom Naylor

**MIDDLE TENNESSEE STATE UNIVERSITY**

Course/Program Title: Recording Industry Management  
PO Box 21, MTSU  
Murfreesboro, TN 37132  
(615) 898-2813

Chief Administrator: Geoffrey Hull

Program: Recording Industry Management (RIM) is a four-year Bachelor of Science degree program in music business and audio engineering. RIM offers 54 semester hours of courses in audio and the recording industry ranging from acoustics and maintenance and survey of the record industry to concert promotion. Audio students work in two studios on campus, a 24-track digital room and a 16-track analog room. Internships are available for senior level students in audio and the music business. Approved minors include Mass Communications, Business, Music and Electronics. Video instruction is also available.

**MUSIC BUSINESS INSTITUTE**

Course/Program Title: Music-Entertainment Management  
3376 Peachtree Rd. NE  
Atlanta, GA 30326  
(404) 231-3303

Chief Administrator: Mert Paul

**MUSICATION**

Course/Program Title: Computer Based MIDI Technology  
1600 Broadway, Ste. 1000A  
New York, NY 10019  
(212) 957-9101

Chief Administrator: J. Blackman

Program: Musication offers courses for the professional musician, composer and engineer on exploring and under-

# Gold & Platinum Recording Careers



Music Video • Recording Engineering  
Music Business Management  
Studio Maintenance • Sound Reinforcement

Join the successful graduates of this multi-million dollar educational studio complex in Orlando, Florida.

Learn from well-known professionals and gain hands-on experience in the most comprehensive course available. Internship placement, career guidance and employment assistance included.

Over 19 gold and platinum records awarded to Full Sail alumni. And more than 83% of graduates employed in the music industry.

*Full Sail*

CENTER for the RECORDING ARTS  
For your FREE Career Guide call

**800-221-2747**

In FL. Call 305-788-2450  
or write

658 Douglas Avenue, Altamonte Spr., FL 32714

Accredited by the Accrediting Commission of the National Association of Trade & Technical Schools. Licensed by the Florida State Board of Independent Postsecondary Vocational, Technical, Trade and Business Schools. #414

Circle #062 on Reader Service Card



standing the new music technology in depth. Participants receive hands-on experience with state-of-the-art synthesizers, digital samplers, complete MIDI systems, computers and software. These mini courses are conducted over two days. They are scheduled on a regular basis. Individual and group instruction is also available for all microcomputer systems, software programs and MIDI equipment. For a free catalog please call or write Musication Technology Center (212) 957-9100; 1600 Broadway, Suite 1000A, New York, NY 10019.

**NEW SCHOOL/MEDIA STUDIES PROGRAM**  
Course/Program Title: Sound Theory and Production  
2 W. 13th St.  
New York, NY 10011  
(212) 741-8903  
Chief Administrator: Peter L. Haratonik

**NEW YORK UNIVERSITY**  
Course/Program Title: Music, Business and Technology Music and Music Education,  
35 W. 4th St., Rm. 777  
New York, NY 10003  
(212) 598-3491  
(212) 598-3492  
Chief Administrator: Professor Richard Brodenck  
Program: NYU offers a four-year program leading to a Bachelor of Music degree with an emphasis in music technology. Courses are offered in multi-track recording, MIDI, electronic music, electronics, audio/video interfacing, sound sampling and other newly emerging technologies. NYU, a member of SPARS, offers internships at some of the nation's leading recording studios and record companies. The NYU recording and electronic music studios are continually being expanded and upgraded. Currently the facilities include five studios. All are equipped. One of the two SMPTE-equipped studios features a Fairlight Computer Music Instrument.

**NICKEL RECORDING MODERN TECHNIQUES**  
Course/Program Title: 1-Basic, 2-Intermediate, 3-Advanced.  
168 Buckingham St.  
Hartford, CT 06106  
(203) 524-5656  
Chief Administrator: Jack Stang

**OMEGA STUDIOS' SCHOOL OF APPLIED RECORDING ARTS AND SCIENCES**  
Course/Program Title: Basic, Intermediate, Advanced and Advertising Production Courses  
5609 Fishers Ln.  
Rockville, MD 20852  
(301) 946-4686  
Chief Administrator: Bob Yesbek  
Program: The Omega Studios' School, presently in its tenth year, offers a Basic program (32 hours, \$595), Intermediate program (32 hours, \$795), Advanced program (40 hours, \$995) and an Advertising Production program (24 hours, \$695). The courses include comprehensive coverage of acoustics, microphones, signal processors, operation of various consoles, magnetic tape machine theory and operation, MIDI, SMPTE, audio-for-video, radio and TV commercial and jingle production, and extensive hands-on session and mix experience. Students learn in Omega's three professional control room/studio complexes using all professional equipment. Approved by the Maryland State Board for Higher Education and approved for veterans training.

**PEABODY CONSERVATORY OF MUSIC**  
Course/Program Title: Bachelor of Music in Recording Arts and Sciences  
1 E. Mt. Vernon Pl.  
Baltimore, MD 21218  
(301) 659-8136  
Chief Administrator: Alan P. Kelaiver  
Program: Sound recording has broken new barriers of technological and artistic achievement, creating a demand for a breed of skilled audio producer/engineers who combine technical expertise with a sophisticated knowledge of music. Peabody provides a unique five-year degree program that is conceived as an American counterpart to the European Tonmeister training. The degree draws its strength from the engineering program of the Whiting School of Engineering of the Johns Hopkins University and the entire theory and performance curriculum of the Peabody Conservatory of Music. For further information, contact the Admissions Office at 1-800-368-2521 (toll free).

**PENN STATE UNIVERSITY**  
Course/Program Title: Sound & Recording Workshop/  
Annual Three Day Seminar-July  
220 Special Services Bldg.  
University Park, PA 16802  
(814) 863-2911  
Chief Administrator: Peter Kiefer

**RECORDING INSTITUTE OF AMERICA**  
Course/Program Title: Modern Recording Techniques  
10 George St., Box 57  
Wallington, CT 06492  
(203) 269-4465  
Chief Administrator: Richard P. Robinson

**ROSS CREATIVE MUSIC**  
Course/Program Title: Instruction in Synthesizers, Recording & Mixing  
51 Barton Pl.  
Port Chester, NY 10573  
(914) 939-0317  
Chief Administrator: Dr. Mark A. Ross

**SELECT SOUND RECORDING STUDIO**  
Course/Program Title: Recording Workshops I (Music 250), Workshop II (Music 350), Workshop III (Music 450)  
2315 Elmwood Ave.  
Kenmore, NY 14217  
(716) 873-2717  
Chief Administrator: Chuck Mandrell

**SLIPPERY ROCK UNIVERSITY DEPT. OF MUSIC**  
Course/Program Title: Recording and Electronic Music Studios  
Swope Music Building  
Slippery Rock, PA 16057  
(412) 794-7276  
Chief Administrator: Andrew W. Glowaty

**SONY PROFESSIONAL AUDIO TRAINING GROUP**  
1400 W. Commercial Blvd.  
Ft. Lauderdale, FL 33309  
(305) 491-0825  
Chief Administrator: David L. Moore  
Program: We maintain a two part curriculum 1-Technical/Service Training Classes designed to provide technical people with the ability to repair and maintain specific Sony products in the field. A two-year technical degree is required. 2-Applications Engineering Classes designed to provide the Sales Engineer or Service Technician with the knowledge necessary to effectively recommend, demonstrate and specify Sony Professional Audio equipment. Courses offered: APR-5000 Technical/Service; PCM-3102/3202 Technical/SerDigital Audio Basics; PCM 3324 and Peripherals Technical/Service; MXP-2000 Technical Service; MXP-3000 Technical/Service; Large Console Applications; PCM processor/editor/recorder. Call registrar for course prerequisites, tuition fees and latest schedule information: (305) 491-0825, ext. 186.

**SOUNDSHINE PRODUCTIONS, INC.**  
Course/Program Title: Recording Engineering Basics  
723 W. Sunrise Blvd.  
Ft. Lauderdale, FL 33311  
(305) 463-9882  
Chief Administrator: Paul Avakian

**STATE UNIVERSITY COLLEGE AT ONEONTA**  
Course/Program Title: Music Industry Major  
115 Fine Arts Center  
Oneonta, NY 13820  
(607) 431-3415  
Chief Administrator: John P. Mazarak

**STATE UNIVERSITY OF NEW YORK, COLLEGE AT FREDONIA**  
Course/Program Title: Bachelor of Science in Sound Recording Technology  
School of Music, Mason Hall  
Fredonia, NY 14063  
(716) 673-3151  
Chief Administrator: David Peele

**STATE UNIVERSITY OF NEW YORK AT PLATTSBURGH**  
Course/Program Title: Television and Radio Production  
Dept. of Communication  
103 Yokum Hall  
Plattsburgh, NY 12901  
(518) 564-2111  
Chief Administrator: Jerry Supple

**SYRACUSE UNIVERSITY**  
Course/Program Title: Television-Radio-Film  
Newhouse School of Public  
Communications  
Syracuse, NY 13244  
(315) 423-4004  
Chief Administrator: Dr. Ernest Martin  
Program: Through the Television-Radio-Film Department a  
—LISTING CONTINUED ON NEXT PAGE

## CAREER OPPORTUNITY IN AUDIO, VIDEO, ELECTRONIC MUSIC

Develop techniques in Production, Engineering, Video, Digital Synthesis, Music and Music Business

- Obtain a full two year college degree
- Hands-on experience
- 24-track state-of-the-art recording studio
- Fully equipped MIDI studio
- Elaborate Sony Video facility
- Many other majors to choose from

### FIVE TOWNS COLLEGE



2165 Seaford Avenue  
Seaford, NY 11783  
(516) 783-8800

Circle #001 on Reader Service Card

## MOVING?

FOR UNINTERRUPTED SERVICE  
MAIL TO:  
**MIX PUBLICATIONS**  
2608 NINTH STREET  
BERKELEY, CA 94710

(PLEASE ATTACH OLD ADDRESS LABEL HERE)

(PLEASE PRINT NEW ADDRESS BELOW)

NAME \_\_\_\_\_ ZIP \_\_\_\_\_  
COMPANY \_\_\_\_\_ STATE \_\_\_\_\_  
ADDRESS \_\_\_\_\_  
CITY \_\_\_\_\_

concentration in audio production leading to a B.S. degree is available. Core studies include beginning and advanced courses in music recording and sound production for TV and film. Courses complementary to the study of audio production are available in the Schools of Music, Engineering, and Arts & Sciences. Areas of study may include: marketing and economics of the recording industry; history of classical, jazz and rock music; film music; music theory; electronic music; perception; aesthetics; physics of music; acoustics; technical theory.

#### TIDEWATER COMMUNITY COLLEGE

Course/Program Title: Media Production Technology  
1700 College Crescent  
Virginia Beach, VA 23456  
(804) 427-7294  
(804) 427-7183  
Chief Administrator: Samuel Ebersole

#### UNIVERSITY OF LOWELL-COLLEGE OF MUSIC

Course/Program Title: Sound Recording Technology  
One University Ave.  
Lowell, MA 01854  
(617) 452-5000 ext. 2844  
Chief Administrator: Dr. William Moylan  
Program: Sound Recording Technology Programs: Bachelor of Music degree, minor in SRT for Electrical Engineering majors, minor in SRT for Computer Science majors. All disciplines within the audio recording industry are addressed by one of the three curricula. Fifteen recording-related courses form the core around courses in music, the sciences and math. Facilities include multi-track recording studio, 2-track recording studio/sound reinforcement facility, Sound Synthesis & MIDI studio, editing studio, Equipment Design and Repair laboratory.

#### UNIVERSITY OF MIAMI

Course/Program Title: Music Engineering  
School of Music  
Coral Gables, FL 33124  
(305) 284-2439  
Chief Administrator: Ken Pohlmann  
Program: The Music Engineering program at the University of Miami offers a four-year Bachelor of Music Engineering degree, with a minor in Electrical Engineering, as well as a two-year Master of Music Engineering degree. Courses in the undergraduate curriculum include recording engineering, digital audio, acoustics and studio design, studio main-

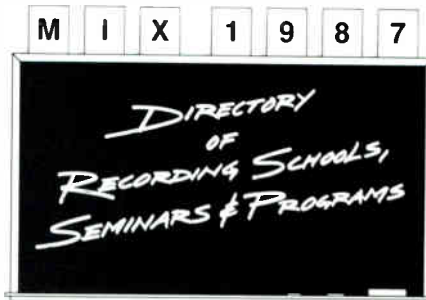

tenance, video production, computer programming, circuit theory, music business, music theory, arranging and performance. The graduate curriculum includes study in advanced digital audio, video, psychoacoustics, logic design and a research thesis. The principle recording studio houses an automated Sony MXP-3036 console, MCI 24- and 2-track recorders, 3M and Mitsubishi digital recorders, dbx digital audio processor, Audio Kinetics synchronization system, Sony 3/4" video recorders, a Synclavier and other equipment. Our graduates enjoy a 100% placement rate in the professional audio industry, and have engineered gold, platinum and Grammy-winning albums.

#### UNIVERSITY OF NORTH ALABAMA

Course/Program Title: Bachelor of Arts/Science in Commercial Music  
Box 5183, Univ. of North Alabama  
Florence, AL 35632  
(205) 760-4361  
Chief Administrator: Dr. James K. Simpson  
Program: General Studies: 44 to 55 semester hours. Music Core: Music Theory 12 to 15 sem. hrs., Music Literature & Music History 9 sem. hrs., Conducting 2 sem. hrs., Orchestration 2 sem. hrs., Musical Activities 5 sem. hrs., Class and/or Applied Music 7 sem. hrs., Music Electives 4 sem. hrs.; Prescribed Business Administration minor and supporting courses (24 semester hours): Accounting 291, 292 (6) Elementary Accounting, Business Law 280 (3) Business Law I, Management 330 (3) Principles of Management, Marketing 360 (3) marketing, Marketing 373 (3) Principles of Advertising, Math & Computer Science (6); Commercial

Music (18 semester hours); Music Publishing (3), Record Company I & II (6), Studio Techniques (3), Production (3), Commercial Music Production (3), Music Dept. is a member of the National Assoc. of Schools of Music.

#### UNIVERSITY OF NORTH CAROLINA ASHEVILLE

Course/Program Title: Music with Recording Arts  
Music Department, Lipinsky Hall,  
One University Heights  
Asheville, NC 28804  
(704) 251-6432  
(704) 251-6433  
Chief Administrator: Dr. Wayne J. Kirby  
Program: Located in the beautiful Blue Ridge Mountains, UNCA is within driving distance of Atlanta and Nashville. The Music with Recording Arts Program, designed for aspiring musicians primarily interested in the creative aspects of the music recording profession, leads to a Bachelor of Science degree. The program features hands-on experience in newly renovated facilities which house a pre-production/project studio and music synthesis laboratory. Studies include MIDI, audio-for-video, digital recording, synthesis, sound sampling, multi-track recording, electronics, acoustics and studio performance. Internships available to qualified students. In-state tuition for one semester, approximately \$175; out-of-state, approximately \$1,600.

#### PHILIP J. WEAVER EDUCATION CENTER

Course/Program Title: Electronic Music I, Electronic Music II/Audio Engineering  
300 S. Spring St.  
Greensboro, NC 27401  
(919) 370-8282  
Chief Administrator: Dr. Howard Braxton

#### YORK COLLEGE OF PENNSYLVANIA

Course/Program Title: Radio/Television Production  
Country Club Rd.  
York, PA 17403  
(717) 846-7788  
Chief Administrator: Dr. Thomas V. Hall

## OUTSIDE U.S.

#### GEORGE BROWN COLLEGE APPLIED

ARTS & TECHNOLOGY  
Course/Program Title: Audio Equipment and Systems  
PO Box 1015, Station B  
Toronto, Ontario, Canada  
(416) 967-1212  
Chief Administrator: Bill Dykstra

#### I.C.A. INSTITUTE OF COMMUNICATION ARTS

Course/Program Title: Audio Engineering/Production, Video Production, Commercial Music  
12-12840 Bathgate Way  
Richmond, BC, V6V 1Z4 Canada  
(604) 278-0232  
Chief Administrator: Niels Hartvig-Nielsen, Shannon Barker  
Program: Two year programs and part-time studies in: Audio Recording, Music Production, Commercial Music Performance, music, video and entertainment business courses, Audio Production Technique for Video, Electronic Music and Synthesizers, Video Production, Music Theory and Arranging, Audio Electronics, Writing for Radio, Television and Film, Effective Communications, Interviewing Techniques, Dance for Musical Performance, Instrument tutorials. Student financing available, tuitions from \$1,170 (U.S. funds) per semester. Semesters commence February, June, October. Call or write for further information.

#### INTER AMERICAN UNIVERSITY OF PUERTO RICO

Course/Program Title: Educational Media Center  
PO Box 1293  
Hato Rey, PR 00919  
(809) 758-8000 ext. 184  
Chief Administrator: Sylvia E. Rodriguez

#### MCGILL UNIVERSITY

Course/Program Title: Graduate Program in Sound Recording  
555 Sherbrooke St. W.  
Montreal, Quebec, Canada  
(514) 392-4501  
Chief Administrator: Dean J. Rea

#### ONTARIO INSTITUTE OF AUDIO RECORDING TECHNOLOGY

Course/Program Title: Audio Engineering  
500 Newbold St.  
London, Ontario, N6E 1K6 Canada

**Professionals demand the best tools available.**

**Manny's supplies the best support systems necessary to help achieve excellence—professional tools to assist in creating that excellence.**

**Manny's—the professional's choice.**

**MANNY'S MUSIC**  
156 W. 48th Street  
NYC, NY 10036  
**(212) 819-0576**  
**Mon.-Sat. 9:00-6:00**



(519) 686-5010  
Chief Administrator: Geoff Keymer

**RECORDING ARTS PROGRAM OF CANADA**  
Course/Program Title: Recording Arts Program  
28 Valrose Dr.  
Stoney Creek, Ontario, Canada  
(416) 662-2666  
Chief Administrator: Nick Keca

**SCHOOL OF AUDIO ENGINEERING (SAE)**  
263 North Tce. Adelaide SA  
Adelaide, Australia  
(08) 223-3535

**SCHOOL OF AUDIO ENGINEERING (SAE)**  
22 Heussler Tce. Milton QLD 4064  
Brisbane, Australia  
(07) 369-8108

**SCHOOL OF AUDIO ENGINEERING (SAE)**  
80-86 Inkerman St.  
St. Kilda VIC 3182  
Melbourne, Australia  
(09) 994-4409

**SCHOOL OF AUDIO ENGINEERING (SAE)**  
42 Wickham St. East Perth WA  
Perth, Australia  
(09) 325-4533

**SCHOOL OF AUDIO ENGINEERING (SAE)**  
420 Elizabeth St., Surry Hills 2010  
Sydney, Australia  
(02) 699-7931  
Chief Administrator: Tom Misner

Program: The SAE offers a hands-on training program whereby all students are guaranteed practical time on a weekly basis in the SAE studios. The SAE now operates over 40 recording studios of which 12 are 24-track fully automated. The courses range from a short one-week introductory course to one full 18-month program. Other courses include: six-month broadcast and audio assistants course, short broadcast operator courses, video effects courses. The SAE can now also offer the Tonmeister course, a recognized standard worldwide. SAE also provides students with all tape material and our own text book, 400 pages. The courses are instructed in English, German, Dutch, Spanish and Italian (in each relevant country).

**SCHOOL OF AUDIO ENGINEERING (SAE)**  
Mayerhoffgasse 4  
1040 Wien  
Vienna, Austria  
(222) 65-27 18

**SCHOOL OF AUDIO ENGINEERING (SAE)**  
St. Marks Building  
Chillingworth Rd.  
London N7, U.K.  
(01) 609-2653  
Chief Administrator: Sharon Quinn

Program: The SAE offers a hands-on training program whereby all students are guaranteed practical time on a weekly basis in the SAE studios. SAE now operates over 40 recording studios of which 12 are 24-track fully automated. The courses range from a short one-week introductory course to one full 18-month program. Other courses include: six-month broadcast and audio assistants course, short broadcast operator courses, video effects courses. The SAE can now also offer the Tonmeister course, a recognized standard worldwide. SAE also provides students with all tape material and our own text book, 400 pages. The courses are instructed in English, German, Dutch, Spanish and Italian (in each relevant country).

**SCHOOL OF AUDIO ENGINEERING (SAE)**  
Beehive Mills, 5th Floor  
Manchester M1, U.K.

**SCHOOL OF AUDIO ENGINEERING (SAE)**  
Taunus Str. 44  
Frankfurt 1, West Germany  
(069) 23-61 79

**SCHOOL OF AUDIO ENGINEERING (SAE)**  
Weissenburger  
8000 Munich 80  
Munich, West Germany  
(089) 48-71 45

**TREBAS INSTITUTE OF RECORDING ARTS**  
Course/Program Title: Recording Arts & Sciences  
1435 Bleury, Ste. 301

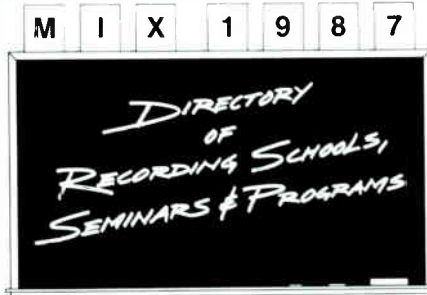

Montreal, Quebec, H3A 2H7 Canada  
(514) 845-4141  
Chief Administrator: David P. Leonard

**TREBAS INSTITUTE OF RECORDING ARTS**  
Course/Program Title: Recording Arts & Sciences  
290 Nepean St.  
Ottawa, Ontario, K1R 5G3 Canada  
(613) 232-7104  
Chief Administrator: David P. Leonard

**TREBAS INSTITUTE OF RECORDING ARTS**  
Course/Program Title: Recording Arts & Sciences  
410 Dundas St. E.  
Toronto, Ontario, M5A 2A8 Canada  
(416) 966-3066  
Chief Administrator: David P. Leonard

**TREBAS INSTITUTE OF RECORDING ARTS**  
Course/Program Title: Recording Arts & Sciences  
34 W. 8th Ave.  
Vancouver BC, V5Y 1M7 Canada  
(604) 872-2666  
Chief Administrator: David P. Leonard  
Program: Record Producing, Sound Engineering, Music Industry Management, Music Video Production. Two year programs (one-year basics; second year, specialization). Diploma in Recording Arts and Sciences with specialization.



**TREBAS INSTITUTE OF RECORDING ARTS**  
Vancouver BC

(in one of the four programs above) diploma. One entrance scholarship at each of the three campus locations, valued at \$3,500 to \$4,000 each. Dr. Peter C. Goldmark Memorial Scholarship for second year studies (value \$3,500 to \$4,000) at each location. Other awards of merit also available. Consult the Admissions Office of the Institute. Facilities: 24-track professional recording studio in each location. Electronic music studio, electronics lab and disc mastering rooms in selected locations. Full time day or evening studies. 140 courses offered in four programs of specialization. Limited number of internships available. Eighty percent of graduates placed. Limited financial assistance available. Government approved, industry recognized.

**UNIVERSAL INSTITUTE OF RECORDING ARTS**  
Course/Program Title: Audio/Engineering—24 Track Studio  
2190 W 12th Ave.  
Vancouver, BC, V6K 2N2 Canada  
(604) 734-2922  
Chief Administrator: Robert Leong

# The Right Mix

**The music recording industry demands skilled professionals. Trebas Institute of Recording Arts gives you the right mix of theory and practice... a two year training program that prepares you for success in this dynamic industry.**

**Apply now for Management, Record Producing, or Sound Engineering... full or part-time program, day or night classes.**

**Choose the mix that's right for you.**



**TREBAS INSTITUTE OF RECORDING ARTS**

"developing people for the music industry since 1979."

6602 Sunset Blvd.  
Los Angeles, CA  
USA 90028  
(213) 467-6800

34 West 8th Avenue  
Vancouver, B.C.  
Canada V5Y 1M7  
(604) 872-2666

410 Dundas St. East  
Toronto, Ontario  
Canada M5A 2A8  
(416) 966-3066

290 Nepean Street  
Ottawa, Ontario  
Canada K1R 5G3  
(613) 232-7104

1435 Bleury, #301  
Montreal, Quebec  
Canada H3A 2H7  
(514) 845-4141

Circle #066 on Reader Service Card

# BEYER RIBBON MICROPHONES AND

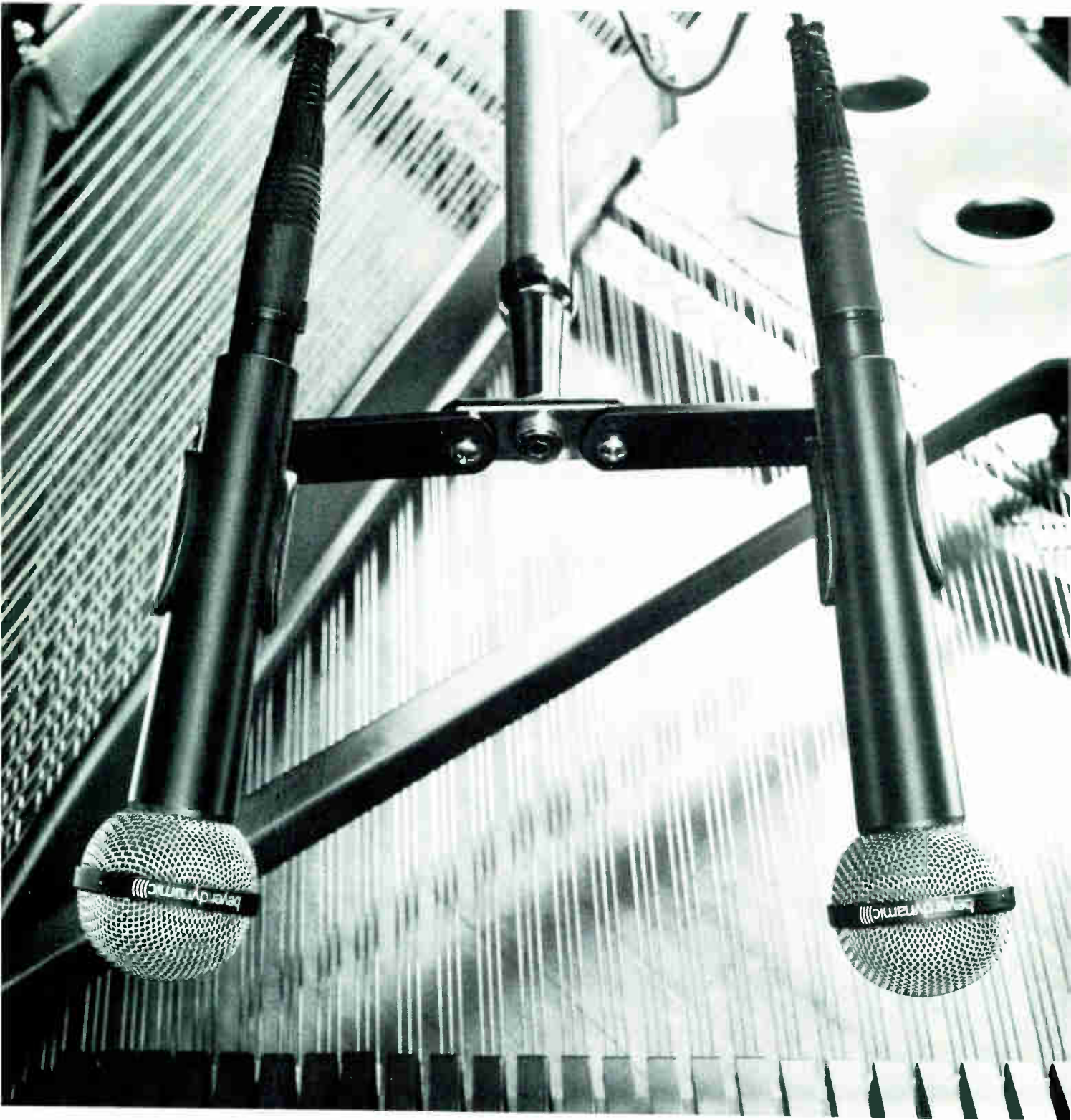

**THE DYNAMIC DECISION**



# THE DIGITAL RECORDING PROCESS

## *Digital technology holds forth the promise of theoretical perfection in the art of recording.*

The intrinsic accuracy of the digital system means any recorded "event" can be captured in its totality, exactly as it happened.

Naturally, the ultimate success of digital hinges on the integrity of the engineer and the recording process. But it also depends on the correct choice and placement of microphones, quite possibly the most critical element in the recording chain. This can make the difference between recording any generic instrument and a particular instrument played by a specific musician at a certain point in time.

The exactitude of digital recording presents the recordist with a new set of problems, however. The sonic potential of total accuracy throughout the extended frequency range results in a faithful, almost unforgiving, recording with no "masks" or the noise caused by normal analog deterioration. As digital recording evolves, it places more exacting demands on microphones.

**Ribbon microphones are a natural match for digital because they are sensitive and definitively accurate.** The warm, natural sound characteristic of a ribbon mic acts as the ideal "humanizing" element to enhance the technically perfect sound of digital.

Beyer ribbon mics become an even more logical component of digital recording due to an exceptional transient response capable of capturing all of the nuances and dynamic shifts that distinguish a particular performance without the self-generated noise and strident sound generally

attributed to condenser mics.

*Beyer is committed to the concept of ribbon microphones. We manufacture a full range of ribbon mics for every vocal and musical instrument application.*

The Beyer M 260 typifies the smoothness and accuracy of a ribbon and can be used in stereo pairs for a "live" ambient recording situation to record brass and stringed instruments with what musicians listening to a playback of their performance have termed "frightening" accuracy.

Because of its essential double-ribbon element design, the Beyer M 160 has the frequency response and sensitive, transparent sound characteristic of ribbons. This allows it to faithfully capture the sound of stringed instruments and piano, both of which have traditionally presented a challenge to the engineer bent on accurate reproduction. Axis markers on the mic indicate the direction of maximum and minimum pickup. This allows the M 160 to be used as a focused "camera lens" vis a vis the source for maximum control over the sound field and noise rejection.

Epitomizing the warm, detailed sound of ribbon mics, the Beyer M 500 can enhance a vocal performance and capture the fast transients of "plucked" stringed instruments and embouchure brass. Its diminutive, durable ribbon element can also withstand extremely high sound pressure levels.

The Beyer M 130's bi-directional pattern enables the engineer to derive maximum ambience along with clean, uncolored noise suppression. Two M 130s correctly positioned in relationship to each other and the source can be used as part of the

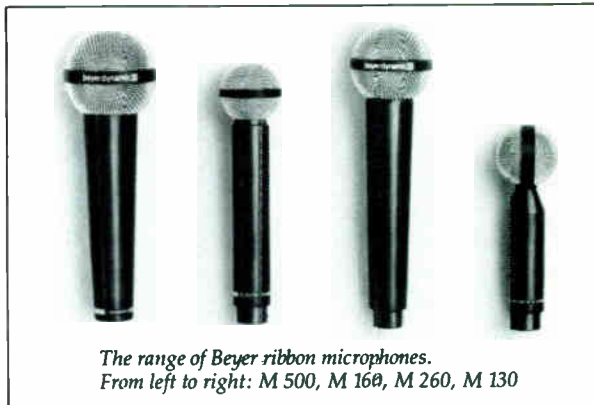

The range of Beyer ribbon microphones. From left to right: M 500, M 160, M 260, M 130

Mid-Side miking technique. The outputs from the array can be separated and "phase-combined" via a matrix of transformers to enable the most honest spatial and perceptual stereo imaging — sound the way we hear it with both ears in relationship to the source.

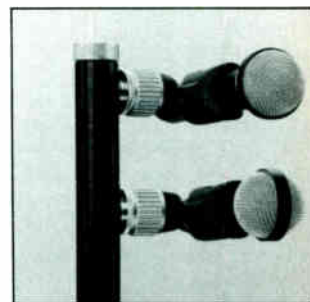

**Given the high price of critical hardware used in digital recording, the relative price of microphones is nominal.** Realizing that microphones are the critical sound "source point," no professional can allow himself the luxury of superficial judgements in this area. Especially when one considers the value of ongoing experimentation with miking techniques. For this reason, we invite you to acquaint yourselves with the possibilities of employing Beyer ribbon technology to enhance the acknowledged "perfection" of digital recording technology.

Beyer Dynamic, Inc.,  
5-05 Burns Avenue, Hicksville,  
New York 11801

**beyerdynamic** 

# PRODUCERS-DESK

## Jim Gaines

IN TUNE WITH HIS TIMES

by Blair Jackson

Over the course of nearly three decades in recording, engineer/producer Jim Gaines has had the good fortune to work with some of the best in the business. From his days as an assistant engineer for Stax Records in Memphis during that label's prime, to his long tenure with Wally Heider Recording in San Francisco and his eventual rise to the top of the pack of independent engineers in Northern California, Gaines has always managed to surround himself with great musicians. Through the years he's aided projects by a staggering roster of greats, including Otis Redding, Isaac Hayes, The Bar-Kays, Van Morrison, Steve Miller, Journey, Huey Lewis & the News, Santana, Tower of Power, The Neville Brothers and the Kantner,

Balin, Casady Band.

"These days I seem to be the guy they go to for that not-so-slick rock sound," he quips. Maybe so, but a lot of hits have come from sessions he's engineered and produced. "I just try to go with the flow and bring out the best in the artists I work with," he notes. Though he's been away from Memphis for nearly two decades now, Gaines still retains an air of Southern gentility—a slight drawl and an easygoing manner. It's no wonder his services are in such demand in the Bay Area. We caught up with Gaines at The Plant Studios in Sausalito, scene of so many of his greatest recording triumphs.

**Mix:** I understand that you got into music through jingles originally, back in your Memphis days.

**Gaines:** Right. The people at Stax Rec-

ords, which was my first record business job, knew me because of the sessions I was cutting over at the jingle house [Pepper-Tanner]. We used to hire Booker [T. Jones] to play trombone on sessions. He was a real good trombone player, too. We used to use a lot of those guys on sessions. So when Stax needed someone to do some part-time engineering, they gave me a call, and then when Steve Cropper got his own studio, TMI, I went to work for him as his chief engineer.

**Mix:** What can you tell me about the jingle business in the '60s?

**Gaines:** When I was at Pepper-Tanner, we were the second largest jingle production house. We actually turned out about \$20 million worth of product a year. I had under my control three studios in Memphis, two production rooms, two mixdown rooms, two edit rooms and two rooms in Dallas, Texas—satellite studios. I had ten engineers working for me when I left. We turned out from 15 to 20 one-minute jingles and another ten to 15 station ID-type things a day. Most of it was regional; the national stuff, even then, was mainly New York, Chicago and L.A.

Technically, I started on an Ampex 3-track. The only person that had something bigger—an 8-track—was Sun Records, but they mainly used their 4-track. My first session, which was a jingle session, I had 15 guys, nine microphones, no EQ, 3-track! But even later, at Stax, the equipment was just as antiquated. We had the first Audio-tronics board built, a 12- or 14-input board with 4-out. Stax Records was an old theater. The stage was the control room and they took the stage and cut it in half and put a concrete wall down the middle to make "Studio A" and "Studio B." The huge Voice of the Theater speakers were in each control room, and that's what you'd cut on! And then there were four smaller

Jim Gaines at The Plant

PHOTO: BLAIR JACKSON





speakers to mixdown stereo if you had to. But you cut listening on the one speaker. And that's how all those great records were made.

**Mix:** Did you have any sense of being part of the great Memphis musical legacy, from Cannon's Jug Stompers on to the present?

**Gaines:** No, I didn't. I was young and just glad to have a job in a field I loved. It never occurred to me that these people I knew and worked with and who were my friends, really, were such a big deal. . . .

**Mix:** You knew Isaac Hayes before he wore chains!

**Gaines:** I knew Isaac Hayes when he made \$100 a week. He was a staff writer there and he and Little David Porter would be there at night, writing till three in the morning. My job, as a part-time guy, was to record whatever they wrote that night—to demo it so they wouldn't forget it. So if there was an artist coming to town, Hayes and Porter would write tunes for them, and play on these rough versions that I'd record, and then the next day, the rhythm section—maybe the MGs, maybe the Bar-Kays—would come in and cut it for real.

At that point, Steve Cropper was the big guy. He was the hottest producer, hottest arranger, a great player. (Actually, he was just a nice old boy from Missouri.) But I had no sense he'd become what he did. At that point he was building his legend.

**Mix:** It must have been traumatic for the Memphis scene when Otis Redding and the Bar-Kays went down in that plane crash [in 1967].

**Gaines:** Let me tell you, it was heavy duty. It was just devastating. I was actually doing a session that night when we got the phone call.

About a week prior to that, Otis had been in cutting and I had even met the pilot that night. And I have to say, he seemed a little out of it then, so I've always wondered if maybe the pilot made some mistake when the plane went down. The Bar-Kays were in the studio around the same time and they were sounding great. They'd just come off the big European Stax/Volt tour and they were so "up."

Otis was one of the most dynamic people I ever met in my life—real nice guy, super talented. When he'd come to town, he and Steve Cropper would book a room at the Lorraine Motel—that's where Martin Luther King got shot—go in with a bottle of tequila, a bottle of rum, couple of guitars and just stay in there for two days and write.

**Mix:** You came out to San Francisco in 1970 to work with Wally Heider. That must have been quite a culture shock.

**Gaines:** Oh man, I'm telling you, it was a real shock. I'd never been here before so I didn't have too good an idea of what to expect. It was sort of at the end of the whole flower child period and there were a lot of leftover hippies. I walked into Heiders and the Airplane were cutting and the Dead were in and out. Well, I'm a country boy, pretty clean-cut. Back in Memphis there were no drugs in the studio. You couldn't get close to a studio with drugs in those days. But out here it was like, "These guys are doing

what?" I almost went right back. Wally had brought me out as assistant manager and I think he was grooming me to eventually be the manager, but at first I didn't think I was going to be able to handle the recording environment, which was totally foreign to me. Wally said, "C'mon Jim, give it six months." Well, in six months' time I was doing so much business I didn't even think about it anymore. I was doing three albums at once.

**Mix:** Aside from the environment, was the recording style considerably different than what you were used to?

**Gaines:** Oh yeah. See, in Memphis we took one artist at a time and worked



## You will recognize this kid . . .

He (or she) is an outstanding player.

He is also a whiz at math and science.

He will probably not choose music as a career . . . and you hesitate to push the issue.

There is a solution :

Consider the Bachelor of Recording Arts and Sciences Degree at The Peabody Conservatory.

He will earn a Bachelor of Music at Peabody. He will study Electrical Engineering at The Johns Hopkins University. Both will support an intensive program of recording theory and hands-on experience with up-to-the-minute facilities.

When he (or she) graduates, he will be at home wherever technology is used to create, support, or preserve music.

## The Bachelor of Music in Recording Arts and Sciences

For further information, contact :

OFFICE OF ADMISSIONS

The Peabody Institute  
of The Johns Hopkins University

One East Mt. Vernon Place, Baltimore, Maryland 21202

Telephone 800/368-2521 Toll Free 301/659-8110 in Maryland



Circle #068 on Reader Service Card

# STRATE GATE

- Attack time from 2 microseconds to 0.4 seconds
- World's fastest gate
- Hold time between 5 milliseconds and 5 seconds
- Release between 5 milliseconds and 3 seconds
- Audio inputs and outputs are via electronically balanced XLR's
- Internal or external sourcing
- VCA-based gates

BUILT LIKE A BRICK  
HOUSE

**Electronspace**  
Electronspace Developments Limited The Sound of Quality

Exclusive U.S. Agent:  
Peninsula Marketing & Imports  
21213 B Hawthorne Blvd., Suite 5086  
Torrance, California 90509 USA  
Telephone:  
(213) 373-1009

Circle #069 on Reader Service Card

## CALL FOR OUR NEW CASSETTE CATALOG

### THE OPUS

AUDIO, VIDEO, COMPUTER  
& CASSETTE TAPE

LOW PRICE, ONE STOP  
CATALOG!



RECORDING & EQUIPMENT CO. 4202 Grand Avenue, Gurnee, IL 60031  
312-336-(OPUS)-6787

**OPUS RECORDING  
&  
EQUIPMENT**  
Gurnee, IL  
**312-336-6787**

Circle #070 on Reader Service Card

with them. Here, I would work with three different artists in three different rooms every day. It was geared up for big city recording: 9 a.m. to noon was one session; 1 p.m. till 7 p.m. was another and then 8 p.m. till God-knows-when was the other. I wasn't used to getting things done so we could get everything out of the studio to get ready for the next guy. In one hour you'd stop, tear down one session and set up for the other. We didn't do that in Memphis. There, you'd stay pretty much setup and work with the artists for as many days as the record would take. We weren't geared up for studio rental; we were geared up for each album project that came in. Luckily, by the time I was going through this at Heider's I had ten years experience and I could do it all pretty quickly.

**Mix:** Heider's was 16-track at that point?

**Gaines:** Yes, they had the old 3M 58s. We didn't go to 24-track until the second year I was there. They got some of the first 3M 24-tracks that came out. Wally was really on top of everything that came out. I've got to say something about Wally—when I came out here, he was known as a real tyrant, somebody who fired people left and right, and all that kind of stuff. But to me he was like an uncle. For two years he tried to get me to come out here and I wouldn't and then I did and he was basically really great with me. If you did your job and took a serious interest in the company, he was OK. He was tough, but I had fun working with him. And of course he had the vision to know what kind of equipment we'd need to stay on top of things. He wanted to be the first one with everything and if that meant spending a lot of money, well, he was going to do it. We were the first ones in town to go 24-track, the first ones in town to get the old Gotham DVLs, Cooper Time Cubes. Outboard gear in those days was almost nonexistent compared to today. Wally is really the reason I stayed out here; otherwise I probably would have gone back to Memphis.

**Mix:** Can you contrast the producer-artist relationship that existed in Memphis and California?

**Gaines:** Here, it seemed more like business. In Memphis it seemed like the attitude—at least at that time—was "C'mon down and we'll make some good music!" It's that Southern attitude of friendliness and openness. Here, I found that most things were treated like "a project." "We'll do this project and then move on to the next one." It was a little colder. But that's happening all over now. I was back in Nashville and it seemed very business-like

compared to years ago.

**Mix:** In your early days in the Bay Area you worked with a lot of different kinds of groups, from Tower of Power to Cold Blood to Van Morrison (on St. Domenic's Preview). Is your job as an engineer different when you're working with an artist like Van, who relies so much on inspiration? You're not in there with Van telling him he missed a note and that sort of minutia, are you?  
**Gaines:** Oh no, of course not. Van likes to cut live in the studio; he's going after a certain kind of performance, so as an engineer you just let it happen. He's only going to do a song a couple of times usually. You might punch in something later, but he's going for a feeling when he's in the studio. It's not like he doesn't care about the performance on a technical level, but it's not the main thing. The main thing is the feeling. He had the band, the background singers, everybody going live right there. With an artist like Van, you just want to make sure he's as comfortable as he can be and not really intrude on the feeling he's going for. He's a very soulful guy.

**Mix:** You had a long relationship with Steve Miller, doing *Fly Like an Eagle* and *Book of Dreams*, which a lot of people think are his two best records. He has a reputation for being nice but slightly autocratic—

**Gaines:** That's a good word.

**Mix:** He has a pretty clear idea of what he wants to hear. What does an engineer do in a case like that?

**Gaines:** Well, I'll tell you what I did. On *Fly Like an Eagle*, they cut most of the tracks over at CBS and they got to the point where they were ready to start mixing. I was at Kaye Smith Studios in Seattle then and had actually cut some of the tracks there. He called me and said, "Man, we got a problem at Capitol. These guys don't understand what's going on. Can you work me in?" I was finishing a project with The Spinners and had another one coming up, but I told him I had a couple of days free. So he brought the tapes up and we got into this incredible flow where we were mixing and re-overdubbing at the same time. We ended up working 17 days, 14 to 20 hours a day. We actually had two rooms going. I had my assistant doing some things in the other room while Steve and I worked on effects—things like the rising synth on "Fly Like an Eagle" which was a little Roland synthesizer which he didn't know a damn thing about, but we played with it and this great stuff came out.

What happened with me is he found someone who was really interested in



his music. I'd say "Let's try this!" and we'd just experiment. "How about this effect here?" He was into that. He was totally open to it and he just let me go. I was into delays and putting stuff on his voice and echoes and he just loved all of it. So though he was very demanding on a certain level—he's a real perfectionist—he's also into trying new things and for looking for the perfect thing, which made it exciting for both of us. I guess a lot of his experience on the record before that was working with union mixers down at Capitol, where his record was treated more like just another job.

I ended up working for Steve for about two years. I was on a retainer to do whatever he wanted, to be at his beck and call. I was paid a great salary to be on call, plus when he wasn't working I was free to do other records. We actually did some of *Book of Dreams* right here in this room—"Jungle Love" and a few other tunes. I also toured with him, mixing his live shows and what a band that was!

Here's an ironic twist to my relationship with Steve. I was down at Capitol mastering my new Neville Brothers single recently and someone told me I got engineering credits on Steve's new album [*Living in the 20th Cen-*

*tury*]. I said, "What are you talking about? I haven't worked with him in six years!" It turns out the record has some cuts we worked on back then.

**Mix:** Miller had his own studio in the Northwest, right?

**Gaines:** Yes, we had high expectations for that. He and I were planning to form a production team. There were some blues guys we wanted to record, and at one point we were going to try to produce Boz Scaggs. But we had problems with the studio because of zoning, so we never could get it together. It was working but we couldn't use it because the neighbors threatened to have it torn down if they saw people going in there to play. So he got disenchanted and moved from Oregon up to Seattle.

It was quite a studio, too. This was back in '77, and he had two 24-track MCIs, the big automated MCI board, two EMT 250s, every kind of outboard gear that was imaginable—like four Harmonizers, six DDLs. It was great.

**Mix:** What did you do after your recording relationship with Miller ended?

**Gaines:** I came back to the Bay Area and worked for about half a year at

the Automatt. I helped David Kahne with Pearl Harbour's album and I also cut the demo that got Huey Lewis signed. In fact, people from the record company came up the night we were finishing the last playback. They sat in the control room and said, "We want to do this with Jim Gaines. We want to do it here," and so forth and so on. Great. But I lost that project to Bill Schnee because of politics. I cut demos on Tommy Tutone and lost that project to Ed Thacker because of politics. And I cut demos on Pablo Cruise and lost that one to Tom Dowd. So I said "That's it. I'm out of this business. I'm tired of fighting."

And I did quit, too. I moved back to Oregon with my family for two years. I was really disenchanted. I had a couple of different businesses up there, and I would run off to do the occasional session. But for all intents and purposes, I was not really in the business anymore.

Then I got a call from Huey Lewis. "We're doing our next album and we'd like you to do it. We've tried out ten producers. We want to do it ourselves, but we want you to help us." So I went down, and we did *Picture This* and we had a real good time. And while I was

—CONTINUED ON PAGE 118



## Small Change, Big Difference Lexicon Software

Some things are timeless. Like the elegance of Lexicon digital processing, the clarity of Lexicon sound. The effects you create with digital processors, however, have to change to keep up with the times.

That's why the sounds of Lexicon processors are based in software. With a few chips like this one, you can change the sounds and functions of your PCM 60 or 70 — without abandoning the valuable hardware that makes those sounds so superior (that means you aren't boxed in to one set of sounds). They're our latest Lexicon optional software packages: Version 3.0 for the PCM 70 and the PCM 60's Version 2.0.

Both of these new software packages will open fresh directions to explore. Discover them at your Lexicon dealer. The sounds are surprising. The Lexicon quality is everything you'd expect.

Lexicon Inc., 100 Beaver Street, Waltham, MA 02154 (617) 891-6790

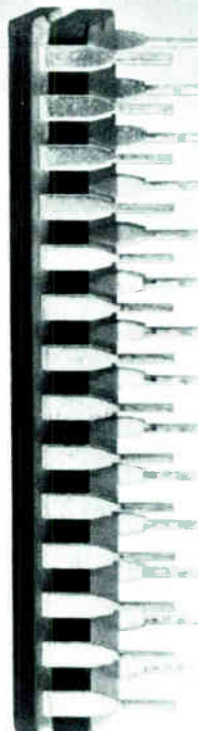

### PCM 70 Version 3.0

- Adds new Inverse Room programs
- 40 totally new presets
- Combination echo/chorus programs
- MIDI System Exclusive for personal computer interfacing
- Expanded *Dynamic MIDI*®
  - Control reverb & effects parameters in real time from any MIDI controller.
  - MIDI Clock patches to beats per minute, reverb decay, delay time, etc.
- New owner's manual with complete MIDI documentation

### PCM 60 Version 2.0

- Inverse Room and Room programs
- Gated and reverse effects
- Fast, intuitive operation
- 128 sounds, all instantly usable
- Unmatched Lexicon processing quality

# ONE FOR ALL

## BROADCASTING CONTRACTING

"This industry needs companies like Crown, that pay attention and design products to help solve our problems."

The broadcast industry shares many common needs with others in the audio business, but the special needs outweigh the commonalities. For ENG, studio news, broadcast variety and entertainment, broadcasters have special problems, special needs.

Crown spends a great deal of time working with professional broadcasters at both network and local levels to develop specific products that solve the problems, meet the needs, make sense. That's why top audio pros like Ron Estes of NBC's Tonight Show enjoys his relationship with Crown for developing and testing new products that are specifically aimed at

helping him get the job done.

"We tested the very first of the new Crown Hand Held mics on the show, and quite frankly they were astounding.

"All the sonic excellence you expect from Crown is there, the new **CM™** Series will definitely put Crown at the forefront of the hand held market."



Ron Estes, NBC  
Burbank, California

"If I can pick only one mike supplier it will be Crown — they just always work."

Over the last 38 years, Crown has become known for high-technology, high quality, reliable products. Crown microphones have been used all over the world by demanding professionals in the kinds of conditions that really test a product's ability to perform. Crown continues to pass the test with flying colors. That's why a professional like Tom Durell, with the experience of 14 years in the Disney organization, independent credits such as the audio for the opening and closing ceremonies of the 1984 Olympic Games and full audio project coordination, 1986 Liberty Weekend, chooses Crown.

"When you live by the motto 'no go, no show', you have to depend on reliability as well as quality. Crown puts those two attributes together better than any manufacturer I have seen. I can depend on consistent, reliable, quality performance from Crown every time."



Tom Durell,  
Tom Durell Enterprises, Inc.  
North Hollywood, California



**CROWN**® INTERNATIONAL, INC.



# ALL FOR ONE.

## FILM SOUND

"I've always enjoyed using Crown products because of their reliability. In the motion picture industry, down-time is very expensive and Crown helps us keep that to a minimum."

In the motion picture industry Crown has been a fixture ever since the introduction of the legendary **DC-300**. From powering the speakers behind the screen to providing **GLMs**®, **PZMs**® and other mics, Crown has been involved in this field for years. As in many other businesses, there is a direct correlation between a company's success and its ability to listen to the pros for designing products that meet their needs.

"Crown's accuracy and reliability make it the natural choice where down-time is so costly. In my job I have used Crown in many wide-ranging applications and have never had cause for disappointment."



Ken Wilson,  
Sound Engineer/  
Film Production  
Hollywood, California

## LIVE SOUND

"Crown's commitment to putting new technology to practical use has given me products that make a real difference."

At Crown the philosophy is the product must be specifically designed to meet the rigorous demands of the end user.

Achieving this design philosophy is a matter of being innovative in putting new technologies to work. Always searching for new ways to gain efficiency of performance results in products such as **PZM**®, **PCC**® and **GLM**®. Unique and well developed to satisfy discriminating professionals like David Andrews.

David's success and reputation in the audio business is widely known, his live sound productions are a standard that others look to and his choice of mic is Crown.

"Live sound has to be intimate and real yet deal with the realities of gain before feedback, temporary set-ups, less than optimum placement, etc.

"If a microphone cannot perform correctly I don't need it — I can't use it. I have tested and utilized every mic in the Crown line and have always been extremely satisfied with the consistency and accuracy of reproduction."

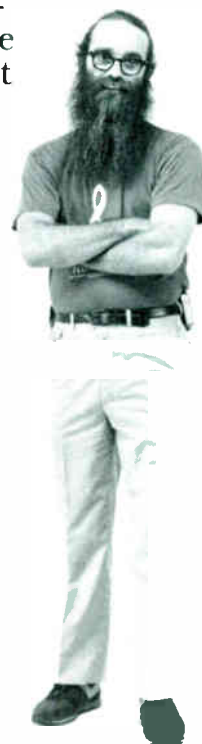

David Andrews,  
Andrews Audio  
Consultants  
New York, New York.

1718 W. MISHAWAKA ROAD, ELKHART, INDIANA 46517

Circle #072 on Reader Service Card

World Radio History

# A BASIC PROGRAM FOR MICROPHONE SENSITIVITY

by Ronald Ajemian  
and Guillermo Mager

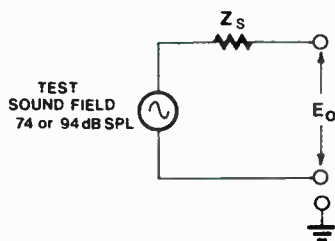

Figure 1: Microphone open circuit voltage diagram.

## EQUATIONS :-

$$E_o = E_r(10)^{L_v/20} \text{ volts}$$

$$* E_o = \sqrt{(P_A \cdot 4 Z_s)} \text{ power matched}$$

$$P_A = 1\text{mW}(10)^{L_p/10}$$

One of the most confusing pieces of information that one can find in spec sheets is that of the microphone sensitivity. The main reason for this is the fact that the main microphone manufacturers do not seem to agree on a single standard for measurement for either the input or the output of microphones.

Basically, microphone sensitivity is a measurement of the "efficiency" of the microphone, that is, the ratio between the output and the input. As you know, a microphone is what we call a transducer, which is a device that transforms energy from one form into another. The input of a microphone is expressed in terms of acoustical energy (of which one of the components is sound pressure), and the output is expressed in terms of electrical energy.

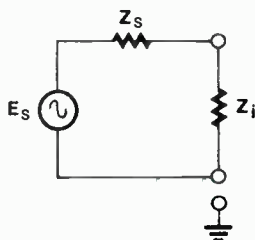

Figure 2: Microphone plugged into console diagram.

$$L_3 = L_1 - L_2 \text{ dB}$$

$$E_s = E_o(10)^{L_3/20} \text{ volts}$$

$$* V_i = E_s Z_i / (Z_s + Z_i) \text{ volts}$$

$$* P_i = V_i^2 / Z_i \text{ watts}$$

$$L_{v_i} = 20 \text{ LOG}(V_i / .775) \text{ dBv}$$

$$L_{p_i} = 10 \text{ LOG}(P_i / 1\text{mW}) \text{ dBm}$$

$$L_{l_e} = 20 \text{ LOG}(E_s / V_i) \text{ dB}$$

## So, what's the problem?

The main problem is that there are several units that are commonly used to express the input of a microphone. Some are units of sound pressure and one unit (the decibel) is used to express the *level* of the sound pressure. Some units of sound pressure are derived from the "cgs" (centimeter-gram-second) system. One of them is the dyne-per-centimeter-squared (dyne/cm<sup>2</sup>) and the other is the microbar. Two other units are derived from the "MKS" (meter-kilogram-second) system. These are the Newton-per-meter-squared (N/m<sup>2</sup>) and the Pascal.

Another way of expressing the input of a microphone is in terms of the Sound Pressure Level. The unit is the dB-SPL and is a measurement of the level between the sound pressure at the input of the microphone and the pressure of the average human threshold of hearing; .00002 Pa at 1 kHz.

definitions:	$E_o$ open circuit voltage at $L_2$	$L_1$ studio SPL
	$E_s$ source voltage at $L_1$	$L_2$ test reference SPL of mic spec
	$E_r$ ref. voltage 1 or .775	$L_3$ SPL difference
	$Z_s$ source impedance of mic	$V_i$ input voltage at console
	$Z_i$ input impedance of console	$P_i$ input power at console
	$L_v$ voltage level of mic	$L_{v_i}$ input voltage level at console
	$L_p$ power level of mic	$L_{p_i}$ input power level at console
	$L_{l_e}$ loading effect level at console	$P_A$ available power

\* NOTE: All impedances are assumed to be resistive at 1KHz.

Drawn by Ron Ajemian



The relation between all these units is given in the following chart:

1 dyne/cm<sup>2</sup> = 1 microbar (\*)  
1 Newton/m<sup>2</sup> = 1 Pascal  
1 Pa (Pascal) = 10 microbars = 10 dyne/cm<sup>2</sup>  
1 microbar is equivalent to 74 dB-SPL  
1 Pascal is equivalent to 94 dB-SPL

(\*) Actually, the conversion is 1 microbar = 1.013 dyne/cm<sup>2</sup>, however, for most practical purposes, they are considered to have the same numerical value.

### What about the output?

The most useful unit in which the output of a microphone can be expressed is the open circuit voltage (Fig. 1). Unfortunately, microphone manufacturers do not always include this information in their spec sheets. Sometimes the output is expressed as a voltage level (dB reference to either 1 volt or .775 volts).

One of the most common ways to express the output is the power level derived from the available power (P<sub>A</sub>) which, by definition, is the power transferred to the load in an "impedance matched" (also called "power matched") situation.

### So, why a program?

With the program (Fig. 3), we attempt not only to make some sense out of all this madness, but to provide a way to use all this information in a practical situation. That means, to find out what happens when a microphone with certain specifications is plugged into a console (or a tape machine, or an amplifier).

All one needs to run the program is the microphone's spec sheet from the manufacturer, the estimated studio sound pressure level (in dB-SPL) and the input impedance of the console. The program calculates the tedious mathematics to find the microphone's open circuit voltage at test Sound Pressure Level (E<sub>o</sub>), the mic's source voltage at estimated studio SPL (E<sub>s</sub>), the voltage at the console's input (V<sub>i</sub>), the power at the console's input (P<sub>i</sub>), the voltage level at the console's input (L<sub>vi</sub>), the power level at the console's input (L<sub>pi</sub>) and the loading effect of the console, which is an indication of the voltage level drop (in decibels) from the level of the source voltage to the level of the voltage at the input of the console. See Figs. 1 and 2 for circuit diagrams and equations used in the program.

### The program

The program starts with line 100 and ends with line 780. Lines 100 to 170 instruct the program to go to the different subroutines, while lines 190,

# EFFECTS AUTOMATION

NOW FOR THE 224XL, 480L, RMX-16, REV1 AND QRS

The CLARITY XLV is the professional interface for effects automation.

Whether you are an independent producer or large automated facility, that signature sound or time saving edge couldn't be more affordable.

The XLV uses MIDI, the primary cross/company control protocol, to bring automation to Lexicon, Yamaha, AMS, Quantec and other high-end signal processors.

*Fairlight, Synclavier and MIDI sequencer owners note: Use the XLV as your link to the analog world with eight channels of MIDI to control voltage conversion. Check with your dealer or call us for a demo.*



**CLARITY** : MIDI FOR THE PROFESSIONAL

Available in North America only through CLARITY • Nelson Lane, Garrison, NY 10524 • 914-424-4071 • Telex 4930810

Circle #073 on Reader Service Card

Introducing

# CHAMPION

The new compact disc  
music library from  
American Image.



Call for a demo today.  
1-800-251-2058

Circle #074 on Reader Service Card

**Figure 3: Microphone sensitivity BASIC program.**

```

100 GOSUB 180'           lto print opening menu
110 GOSUB 340'           lto enter impedance
120 ON Q GOSUB 380, 430, 480' lto enter other data
130 GOSUB 510'           lto enter SPL, Z
140 GOSUB 560'           lto do calculations
150 GOSUB 650'           lto display calculations
160 GOSUB 750'           lto quit, or
170 GOTO 100'           lto do another one
180 CLS
190 ' - - - - - Opening Screen Display - - - - -
200 PRINT "*****"
210 PRINT "      MICROPHONE SENSITIVITY      "
220 PRINT "*****"
230 PRINT
240 PRINT " notes: 1dyne/cm2=1microbar equiv.to 74dB SPL "
250 PRINT "      1Pa=1Pascal=1N/m2=10microbar=10dyne/cm2 equiv.to 94dB SPL "
260 PRINT
270 PRINT "Press a key to indicate the following:          KEY"
280 PRINT "Microphone output is expressed as a VOLTAGE LEVEL - 1"
290 PRINT "                                POWER LEVEL (re 1mW) - 2"
300 PRINT "                                OPEN CIRCUIT VOLTAGE - 3"
310 INPUT "                                Please indicate your choice - ",Q
320 RETURN
330 ' - - - - - Enter Impedance - - - - -
340 CLS:PRINT "Please enter the following information:"
350 INPUT "      Microphone impedance in ohms: ",ZS
360 RETURN
370 ' - - - - - Enter VOLTAGE LEVEL data - - - - -
380 INPUT "      Voltage level in dB: ",LV
390 INPUT " Reference voltage in volts ( 1 or .775 ): ",ER
400 EO=ER*10^(LV/20)
410 RETURN
420 ' - - - - - Enter POWER LEVEL data - - - - -
430 INPUT "      Power level in dB: ",LP
440 PA=.001*10^(LP/10)
450 EO=(PA*4*ZS)^.5
460 RETURN
470 ' - - - - - Enter OPEN-CIRCUIT VOLTAGE data- - - - -
480 INPUT "      Open circuit voltage in volts: ",EO
490 RETURN
500 ' - - - - - Enter SPL, Z - - - - -
510 INPUT "      Studio Sound Pressure Level (dB SPL): ",L1
520 INPUT "Microphone test level in dB SPL (74 or 94): ",L2
530 INPUT "      Input impedance of console in ohms: ",Z1
540 RETURN
550 ' - - - - - Do Calculations- - - - -
560 L3=L1-L2
570 ES=EO*10^(L3/20)
580 VI=ES*Z1/(ZS+Z1)
590 PI=VI^2/Z1
600 LVI=20*LOG(VI/.775)*.4342945
610 LPI=10*LOG(PI/.001)*.4342945
620 LLE=20*LOG(ES/VI)*.4342945
630 RETURN
640 ' - - - - - Display Calculations - - - - -
650 LOCATE 10
660 PRINT "Open circuit voltage          Eo =";EO;"volts"
670 PRINT "Source Voltage                    Es =";ES;"volts"
680 PRINT "Voltage at Console Input             V1 =";V1;"volts"
690 PRINT "Power at Console Input                P1 =";P1;"watts"
700 PRINT "Voltage Level at Console Input        Lv1 =";LVI;"dBv"
710 PRINT "Power Level at Console Input          Lp1 =";LPI;"dBm"
720 PRINT "Loading Effect of Console             Lle =";LLE;"dB"
730 RETURN
740 ' - - - - - Do Another One? - - - - -
750 PRINT:PRINT "Press ESC to quit (any other key to continue). "
760 K$ = INKEY$: IF K$ = "" THEN 760
770 IF K$ (<) CHR$(27) THEN RETURN
780 CLS:END

```

**Figure 4:**

```

*****
      MICROPHONE SENSITIVITY
*****

notes: 1dyne/cm2=1microbar equiv.to 74dB SPL
      1Pa=1Pascal=1N/m2=10microbar=10dyne/cm2 equiv.to 94dB SPL

Press a key to indicate the following:          KEY
Microphone output is expressed as a VOLTAGE LEVEL - 1
                                POWER LEVEL (re 1mW) - 2
                                OPEN CIRCUIT VOLTAGE - 3
                                Please indicate your choice -

!LIST  2RUN  3LOAD" 4SAVE" 5CONT 6,"LPT" 7TRON BTROFF9KEY  0SCREEN

```

330, 370, 420, 470, 500, 550, 640 and 740 instruct the programmer on the purpose of these subroutines.

Lines 240 and 250 enter a few notes to remember about the microphone test reference Sound Pressure Levels of 74 or 94 dB-SPL. Lines 270 to 310 prompt the user to pick the unit at the output of the microphone. Lines 350, 380, 390, 430, 480 and 510 through 530 input microphone's specs, studio SPL and console's input impedance.

*Microphone manufacturers do not seem to agree on a standard for measuring either the input or the output of microphones.*

Lines 400, 440, 450 and 560 through 620 perform the calculations indicated by the equations. Line 650 positions the cursor and lines 660 to 720 display the results. Line 750 prompts the user to decide to either start over again or end the program, and lines 760 and 770 execute these functions.

The program was developed for IBM DOS version 2.0 or higher (or compatible). If you are running other than DOS BASIC, notice lines 600 to 620. The LOG function in IBM DOS is really the *natural* log to the base  $e=2.718$ . Therefore, a conversion factor(.4342945) has to multiply the LOG function in order to obtain the common log to the base 10.

If your BASIC has the common log function (base 10), *do not multiply by .4342945!* Check your user manual for LOG function. In line 450 the SQR function (square root) could have been used in the program but we chose ( )<sup>.5</sup> instead. Some versions of BASIC do not have SQR, so this is your alternative. ■

The authors would like to thank Albert B. Grundy, president of the Institute of Audio Research in New York City, for his help during the preparation of this article. Ajemian and Mager are both members of the faculty at the Institute.



Please enter the following information:  
 Microphone impedance in ohms: 250  
 Voltage level in dB: -38  
 Reference voltage in volts (.1 or .775): 1  
 Studio Sound Pressure Level (dB SPL): 184  
 Microphone test level in dB SPL (74 or 94): 94  
 Input impedance of console in ohms: 2500

Open circuit voltage  $E_o = 1.258925E-02$  volts  
 Source Voltage  $E_s = 3.981071E-02$  volts  
 Voltage at Console Input  $V_1 = 3.619155E-02$  volts  
 Power at Console Input  $P_1 = 5.239314E-07$  watts  
 Voltage Level at Console Input  $L_{V1} = -26.61389$  dBm  
 Power Level at Console Input  $L_{P1} = -32.88726$  dBm  
 Loading Effect of Console  $L_{Le} = -.6278532$  dB

Press ESC to quit (any other key to continue).

Please enter the following information:  
 Microphone impedance in ohms: 150  
 Power level in dB: -56  
 Studio Sound Pressure Level (dB SPL): 182  
 Microphone test level in dB SPL (74 or 94): 94  
 Input impedance of console in ohms: 1500

Open circuit voltage  $E_o = 1.227654E-03$  volts  
 Source Voltage  $E_s = 3.083726E-03$  volts  
 Voltage at Console Input  $V_1 = 2.883387E-03$  volts  
 Power at Console Input  $P_1 = 5.23932E-09$  watts  
 Voltage Level at Console Input  $L_{V1} = -48.83238$  dBm  
 Power Level at Console Input  $L_{P1} = -52.88725$  dBm  
 Loading Effect of Console  $L_{Le} = .8278532$  dB

Press ESC to quit (any other key to continue).

Please enter the following information:  
 Microphone impedance in ohms: 150  
 Open circuit voltage in volts: .89E-3  
 Studio Sound Pressure Level (dB SPL): 120  
 Microphone test level in dB SPL (74 or 94): 74  
 Input impedance of console in ohms: 1800

Open circuit voltage  $E_o = .00089$  volts  
 Source Voltage  $E_s = .1775783$  volts  
 Voltage at Console Input  $V_1 = .1639184$  volts  
 Power at Console Input  $P_1 = 1.492736E-05$  watts  
 Voltage Level at Console Input  $L_{V1} = -13.49348$  dBm  
 Power Level at Console Input  $L_{P1} = -18.26817$  dBm  
 Loading Effect of Console  $L_{Le} = .6952418$  dB

Press ESC to quit (any other key to continue).

ILIST 2RUN 3LOAD 4SAVE 5CONT 6,"LPT" 7TRON 8TROFFSKEY 9SCREEN

## SOME EXAMPLES FOR USING THE MICROPHONE SENSITIVITY PROGRAM

1

1) Microphone: Sony C-76 condenser  
 Output impedance:  $Z_o = 250$  ohms  
 Open circuit output: -38 dB (0 dB = 1V/10 microbar)  
 (remember, 10 microbar is equivalent to 94 dB-SPL)

Input impedance of console:  $Z_i = 2500$  ohms  
 Estimated studio SPL: 104 dB-SPL

2

2) Microphone: E-V RE15 dynamic  
 Output level: -56 dB (0 dB = 1mW/1Pa)  
 (remember, 1 Pa is equivalent to 94 dB-SPL)

Impedance: Low (150 ohms)  
 Input impedance of console:  $Z_i = 1500$  ohms  
 Estimated studio SPL: 102 dB-SPL

3

3) Microphone: Sony C-48  
 Open circuit voltage:  $E_o = .89$  mV/microbar

Output impedance:  $Z_o = 150$  ohms  
 (remember, 1 microbar is equivalent to 74 dB-SPL)

Input impedance of console:  $Z_i = 1800$  ohms  
 Estimated studio SPL: 120 dB-SPL

See Fig. 4 for a look at the screen of the computer as we ran these three examples.



*Fader/VCA Packages Available Soon!*

# Affordable AUTOMATION

Finally there is an inexpensive, simple-to-operate, flexible modular Automation System to retrofit any console. SAM™ (SMPTE Automation Manager) and MIDI MUTE truly constitute a breakthrough in console automation. Now you can automate your studio starting for as little as \$549 for full mute automation, or \$1398 for a full SMPTE self-locked automation system. And, like all JLC Cooper products, these grow with you — up to 24 channels. Best of all, SAM and MIDI MUTE require no modification of your console, just plug them in and you're ready to go.

**JL COOPER ELECTRONICS**

1931 Pontius Avenue • West Los Angeles, CA 90025  
 (213) 473-8771 • TLX: 5101001679 JL COOPER

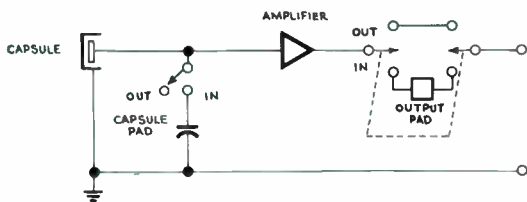

Figure 9: Attenuator types

—FROM PAGE 40, CONDENSER MICS  
dB range. The lack of precision stems from the fact that the waveform can be 3 to 5% distorted before clipping is noticed, depending on the observer.

Measurement with a THD meter is more quantitative, but no standard specifying frequency or acceptable limits exist. The most common specification is 0.5% THD at 1 kHz. This level is

usually 4 to 6 dB below the clipping level.

### Overload Reduction

Attenuation of the signal at the capsule is simply a matter of paralleling the capsule with a fixed capacitance. The output voltage ( $\Delta V$ ) is dependent on  $C_o$  and  $\Delta C$ . When  $C_o$  is larger,  $\Delta C$  becomes a smaller percentage of total  $C$ . Some systems utilize a built-in two- or three-position switch providing attenuations of 0 dB, approximately 10 dB and, if available, 20 dB. Other systems require removal of the capsule with the attenuator screwed in between the capsule and the amplifier.

A capsule attenuator reduces the noise contribution of the capsule (which may be small), but it has little effect on the noise output of the amplifier. Therefore, the capsule attenuator improves the headroom at the sacrifice of the signal-to-noise ratio and the overall dynamic range capability remains the same.

Attenuators within the microphone other than parallel C capsule pads take many different forms. Some of these are:

1. Simple audio resistive pad at the output. (Fig. 9)
2. Changes in amplifier gain via changes in negative feedback.
3. Changes in overall gain via changing number of amplifier stages.
4. Reduction of sensitivity via reduction of polarizing voltage.

Information on these variations must be obtained from manufacturers' specifications.

Attenuators inserted in the microphone line must not interfere with phantom powering. This is usually not a problem considering the low attenuator circuit impedances and the relatively high power supply circuit impedances. Supply currents are seldom more than 5 mA producing drops of only a few volts.

An important consideration, particularly at the high levels where attenuators are necessary, is that the attenuator retains the impedance relationships at the interface. If the console input impedance ( $Z_i$ ), is ten times the microphone  $Z_{out}$ , then the attenuator  $Z_{in}$  should be the same. If the microphone presents a low source  $Z$  to the console then the attenuator should have the same  $Z_{out}$ . For a typical 150 ohm source and 1,500 ohm input the attenuator should have about 675 ohms in each leg and a 150 ohm shunt across the output. This is a 10:1 voltage divider with a minimum loss of 20 dB.

Part II will cover the low end of the dynamic range, i.e. noise. ■

## Valhala

the sound choice of professionals!

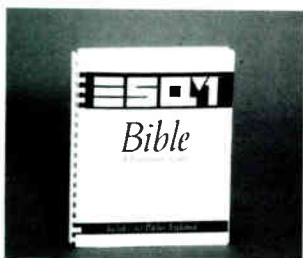

### ESQ1 PROG. REF. GUIDE

Only \$24.95

- All prog. aspects explained.
- Enhance programming skills
- Learn acoustic sound programming
- For novices thru professionals
- Includes 40-patches explained

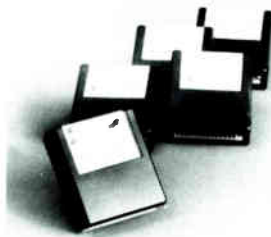

### ESQ1 ROM CARTRIDGE

- 320 New Professional ESQ1 Voices
- ROM3201 (320 voices) \$169.95. The Ultimate ROM (like 4-80 voice ROMs in one!)
- ROM1601/ROM1602 (160 voices) \$116.95ea.
- ROM801/802/803/804 (80 voices) \$59.95ea.
- Featuring: Top 40, pianos, orchestral, synths & more!



### ESQ1 VOICE/SEQ. LIBRARIAN

- Store 400 patches in computer memory.
- Holds 3 banks of sound w/sequence memory.
- Supports swapping of sounds between banks.
- Supports both single & all sequence memory.
- For Commodore 64/128 with 1541/1571 drive.



### 757 NEW TX812 VOICES

- Vol. 1/Vol. 2 (380 voices ea.) \$44.95ea.
- Complete library (757 voices) \$79.95
- TX812 voices come set-up for velocity

DX7 PATCH LIBRARY - \$39.95 (Demo - \$7.50 U.S., \$10.00 Foreign) • DRUM PATTERN LIBRARIES (Cass.) - \$29.95 - RX11, RX15, RX21 & TR707 • DTR SOFTWARE LIBRARY - \$99.95 - DX7, TX7, DX5, DX21, DX27/100 - C64 w/1541 Dr. • ESQ1 CASSETTES (40 voices) - \$19.95ea. - 4 ESQ1 SOUND DISK (80 voices) - \$39.95ea. (Send for product information.)

DEALER INQUIRES WELCOME. If not available at your local music store, please order direct

Continental USA Add \$3.00 Shipping/Handling. Michigan residents add 4% sales tax. Canada, Alaska, Hawaii add \$7.50 Shipping/Handling for surface, \$12.00 for airmail. All other countries, \$10.00 Shipping/Handling for surface, \$15.00 for airmail plus \$3.00 for each additional article. All payments must be in U.S. Funds. Prices/Specifications subject to change without notice. VISA/MC orders less than \$15.00 add \$1.00 service fee.

ESQ-1 is a trademark of Ensoniq, Inc.

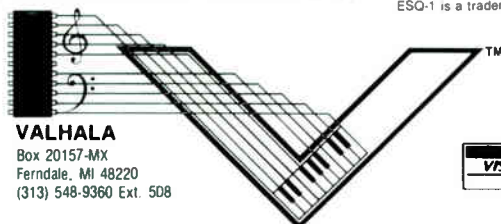

### VALHALA

Box 20157-MX  
Ferndale, MI 48220  
(313) 548-9360 Ext. 508



Circle #076 on Reader Service Card

Author Albert B. Grundy is the founder and president of Institute of Audio Research, New York City.



# Telex Autoloader

The Extra Margin In Video Duplicating

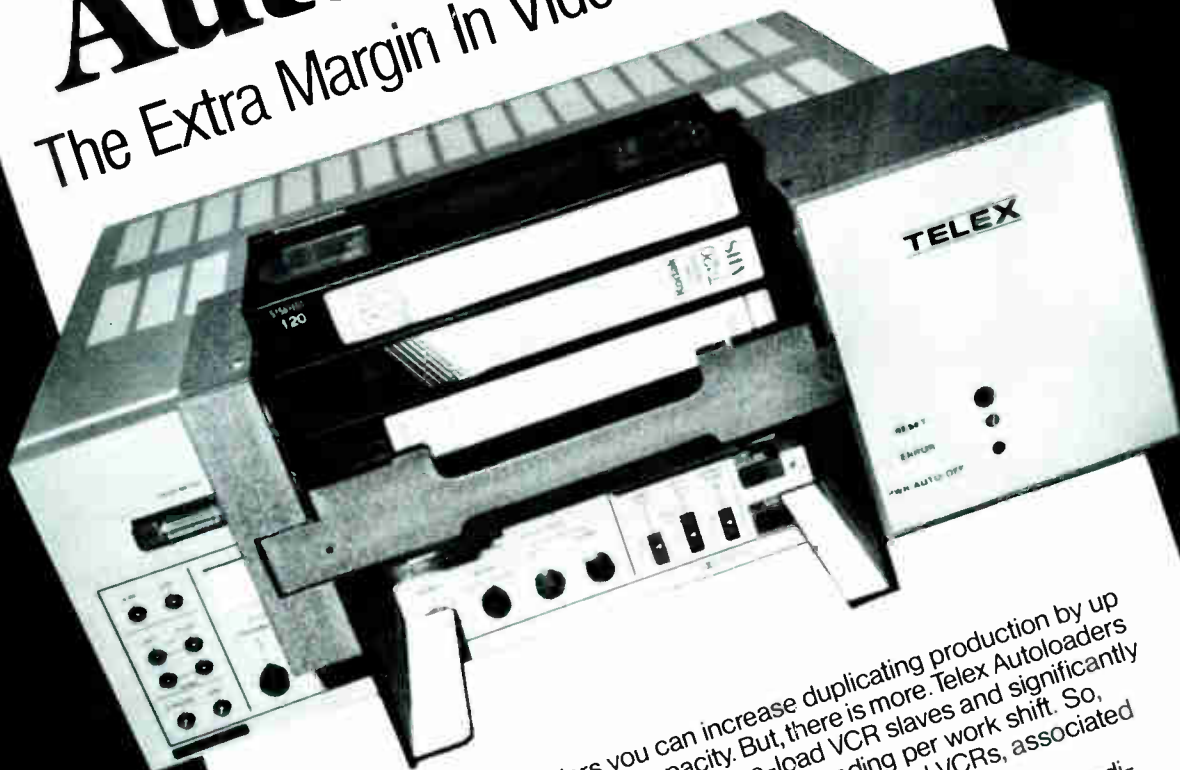

With Telex Autoloaders you can increase duplicating production by up to 25%, depending on present capacity. But, there is more. Telex Autoloaders also reduce the manpower required to re-load VCR slaves and significantly reduce the total downtime for loading and unloading per work shift. So, production is up, costs are down. All without additional VCRs, associated electronics or racks.

To install Telex Autoloaders, you don't have to make any VCR modifications. In fact, you don't even need tools. The VCR controls and meters remain accessible. And, Autoloaders are so compact they fit the majority of aisles or change spacing between slaves. In most cases there's no need to widen the access.

Microprocessor controlled with built-in diagnostics, the Autoloaders operate off the VCR power supply and interface with the master command station via remote connectors on the VCR slaves. In other words, the operation of the system remains the same.

Telex Autoloader models are available for Panasonic models 6200, 6800 and 6810 or JVC model BR 7000UR video cassette recorders. For complete information, please contact Gary Bosicki, Pro-Audio Division, Telex Communications Inc., 9600 Aldrich Avenue South, Minneapolis, Minnesota 55420. Phone 612-884-4051.

**TELEX**<sup>®</sup>  
TELEX COMMUNICATIONS, INC.

Panasonic is a registered trademark of Matsushita Denki Sangyo Kabushiki Kaisha  
JVC is a registered trademark of JVC Company of America



(L to R) Bob Galbraith, Ronnie Mil-  
sap, Ben Harris (standing), Randy  
Gardner

## ON LOCKING DIGITAL 32-TRACK

by Ben W. Harris

The age of multi-track digital recording is upon us, probably much sooner than many of us expected. And along with this new technology have come new methods and ideas about how music is recorded, edited and eventually remixed. We at GroundStar Studios, Nashville, TN, have just installed two Otari DTR-900 32-track digital recorders. The transition from dual 24-track analog to dual 32-track digitals was not without its problems. Perhaps our learning experience can be of use to you, but first, some background as to why we opted for dual 32-track digitals over the conventional single 32-track in the first place.

Our owner and primary client is the well-known entertainer Ronnie Milsap. Ronnie's abundant talent, keen musical ear, and knowledge of the recording process is respected throughout the music industry. For several years now, Ronnie has been compiling 24-track masters from various "cuts" or "takes" for any one particular song. That is to say, when we record for an

upcoming album, we record as many as seven or eight "takes" of one particular song and since almost all Milsap's music is tracked to a click, editing between cuts is rarely a problem. By selecting the best musical performances from each take, a master can then be compiled by razor blade editing the pieces together. SMPTE time code would then be striped onto this edited master and simultaneously onto a blank slave tape.

It would sometimes be necessary to make many slave tapes for forthcoming overdubs. These slave tapes would normally have mixed down versions of the edit master for cue purposes on future overdubs. For instance, on the hit "Lost In The '50s" we had a master tape, a slave tape for remix, and two work slaves for lead and backup vocal overdubs. When these work slave overdubs were completed they were "bounced" over to either the master or the remix slave most often in stereo pairs. On the work slaves, we originally had 44 tracks of background voices, that were combined and bounced to some six tracks on the "remix slave."

Also, because all choruses were identical, we only had to record one full chorus of backup vocals, which eventually became SMPTE offset into each successive chorus. The sheer logistics of 44 tracks times seven choruses was overwhelming, therefore, the ability to use one chorus of backup vocals for the entire song saved an enormous amount of work and studio time. At any rate, no matter how many tapes any one song was spread out on, we only remixed with the master and one slave tape. The drawback to all of this was not only the loss of analog generations, but also the hassle of dealing with two machines in the mix-down situation. Anytime two machines are used, it requires more time and patience on everyone's part.

Keeping our methods for editing and overdubs intact while eliminating many of the problems of dual 24-track analog required forethought and research that I hadn't quite prepared for. We wanted to remix with only one Otari DTR-900, yet do the majority of overdubs on a second tape or "slave reel." Also, we still needed to edit between takes to compile masters. The Otaris are capable of error-correcting razor blade edits, but the process is fragile, and requires that the edit be perfect the first time. The only safe editing on digital formats is electronic editing, digital-to-digital, without having to re-enter the analog domain.

Digital-to-digital pings are quite easy via the dub cables Otari provides, yet assemble editing requires accurate lock-up to offset time code addresses between various takes, and the ability to punch in the new material at wherever the edit needed to occur. This was at first virtually impossible due to the Adams-Smith 2600 synchronizer itself. Not because it worked improperly but because it worked so well!

Let me explain. Locking two analog decks is a mechanical lock, using the synchronizer to maintain lock between SMPTE tracks, one from each deck. On digital decks, if you maintain a mechanical lock, the synchronizer will ramp the capstan of the slave to



# PERFORMANCE NOT PROMISES

Valley products are designed and engineered to set the standard for excellence when processing audio signals for the desired effect.

The processing circuitry in our equipment does not come from an electronics textbook. We invent it!



Fresh, new terms such as Linear Integration, Detection, Peak Reversion Correction, Automated Program Dependency, Auto Slope, and Program Variable Release Shape, appearing in conjunction with our products are indicative of our commitment to deliver unequalled performance, instead of merely conforming to accepted practice.

The heart of our signal processors, the VCA (Voltage Controlled Amplifier), is not purchased elsewhere. We created it and patented it! Its employment in our products yields our distinctive clean, pure sound.

Experience the exhilarating performance capabilities of a Valley signal processor. Call us today at **1-800-367-2879** to get a demonstration.



P.O. Box 40386 • 2817 Erica Place  
Nashville, TN 37204 • (615) 383-4737  
TELEX 3785499 • NASH AUDIO  
BRIEF GEICO INTERNATIONAL, INC. FSC  
James O. Buchanan (1971) GEICO

---

"With this setup, it is now possible to insert digital-to-digital material from one DTR-900 to the other, and still maintain a referenced lock, either in real time or offset time."

---

maintain a subframe accurate lock, and with each minute change in capstan speed, the internal clocks of the digital machine will be ramped as well, and digital garbage will dump from one deck to the other.

Also, on the Otaris and the X850 Mitsubishis, to perform a digital-to-digital ping, requires that the "M" button on the ping-pong panel be selected, thus enabling the clock one board of the receiving machine to obtain its clock information from the sending deck through connections in the dub cables (therefore, preventing the clock garbage discussed earlier). For simple D-to-D transfers, this works quite well, but for assemble editing, locked with SMPTE code, it is virtually impossible. (More on this later.)

We have already established that a conventional SMPTE mechanical lock will not work with digital decks. What must be done is for the synchronizer unit to use SMPTE address to locate the two transports to within a couple of subframes, and then relinquish control of the slave deck to an external reference such as house sync or video sync, whichever terminology you prefer.

To this end I installed a video reference generator into our Adams-Smith 2600 rack. I then referenced the LTC generator, and each DTR-900 from this external reference. On the Otari 32-track recorders, this requires selecting "video ref" on the clock one boards. The Adams-Smith constant "04" was changed to allow the change-over from 9.6kHz capstan speed control, to the video reference. The "external ref" switch on the ping-pong panel of the DTR-900s was also selected to enable the decks and the Adams-Smith to all be referenced from one source.

This worked quite well for locking the two machines together, but still did not allow D-to-D pings to occur,

for even though both decks were referenced to house sync, the clocks were still not locked together tight enough for digital transfers. Selecting the "M" switch on the ping-pong panel did lock the clocks, but allowed the decks to drift apart mechanically, because selecting "M" defeats the external reference from house sync.

First, house (video) sync is sent to the master DTR-900 "video in" BNC jacks. The clock one board of this deck is then selected to "video" and the external reference switch on the ping-pong panel is selected to receive the house sync signal. The "clock out" BNC on the master is then sent to the slave DTR-900 "external clock in" BNC jacks. Its respective clock one board is set to receive "FS" (frequency select), which is the 48kHz clock of the master machine. "External reference" on the ping-pong panel is switched to reflect this input. Now for all practical purposes, there is but one 48kHz clock controlling two DTR-900 transports.

Also, to complicate matters still more, GroundStar's Adams-Smith rack is a Neve Necam 96 version which required some special considerations. Within the Necam/A.S. rack there is a serial and a parallel interface, a synchronizer and a generator jam sync, which provides corrected code back to the Necam 96 computer frame. Because of Neve's unconventional use of the Adams-Smith 2600, the aux V bus, normally used to transmit frame edge to all modules within the 2600 rack, becomes corrupted and non-useable for outside sync functions. It therefore became necessary to isolate the Necam portion from the optional synchronizer, house sync and reader that was to be used with the slave machine. This isolation of the Adams-Smith modules was accomplished by physically cutting the ribbon cable that interconnects the vari-

ous Adams-Smith components, allowing only power supply bi-polar, ground and ground-related buses to remain common to all Adams-Smith components within the rack.

Direction sense and tach pulses were jumpered from the "master" Necam portion of the rack to the reader on the secondary portion within the Adams-Smith assembly. Master time code was fed directly into the reader, and "sliced" code from the reader was fed into the code of the master synchronizer input for Necam use only.

SMPTE code from the slave was sent to its respective synchronizer and it received tach updates and play speed code via the now "isolated" aux V bus, being broadcast from the reader. Believe it or not, it really works!

With this setup, assemble editing can easily and quickly be accomplished by obtaining rough estimated offsets, and then fine tuning those offsets by comparing click tracks from both decks. It now is possible to insert digital-to-digital material from one DTR-900 to the other, from slave to master or master to slave, and still maintain a referenced lock, either in real time or in offset time.

To explain this further, let's assume we've recorded five separate takes of a particular tune. We wish to assemble the best performances from each of these takes to compile a "master" take. We have determined that cut #5 has the best intro and first verse, cut #3 is the better first chorus, cut #2 has the best second verse and second chorus, cut #5 again the better solo, cut #4 the best bridge, and the last chorus from cut #1 is best.

First, on one of the 32-track digitals, we will "format" and stripe time code onto a blank tape from the beginning to the end of the reel. Secondly, we will D-to-D cut #5 across from one machine to the other, in a non-locked mode, as it is not necessary nor desirable to SMPTE lock the first "piece" put over. One thing worth mentioning at this time—all 32 tracks and time code tracks should not be in "record" at one time, as this will request "format" from the PD deck receiving the signal. Only those track numbers used on the source tape need be in "record" on the receiving deck. This, of course, assumes all 32 PCM tracks would not have been recorded on the basic tracks.

Next, using a known point, such as the downbeat of the first chorus on both the assembled master and the next piece in succession (in this case cut #3), we obtain two time code addresses. Subtracting the smaller number from the larger, we derive a rough offset. Then, to fine tune this offset into a useable tight offset, we lock the two



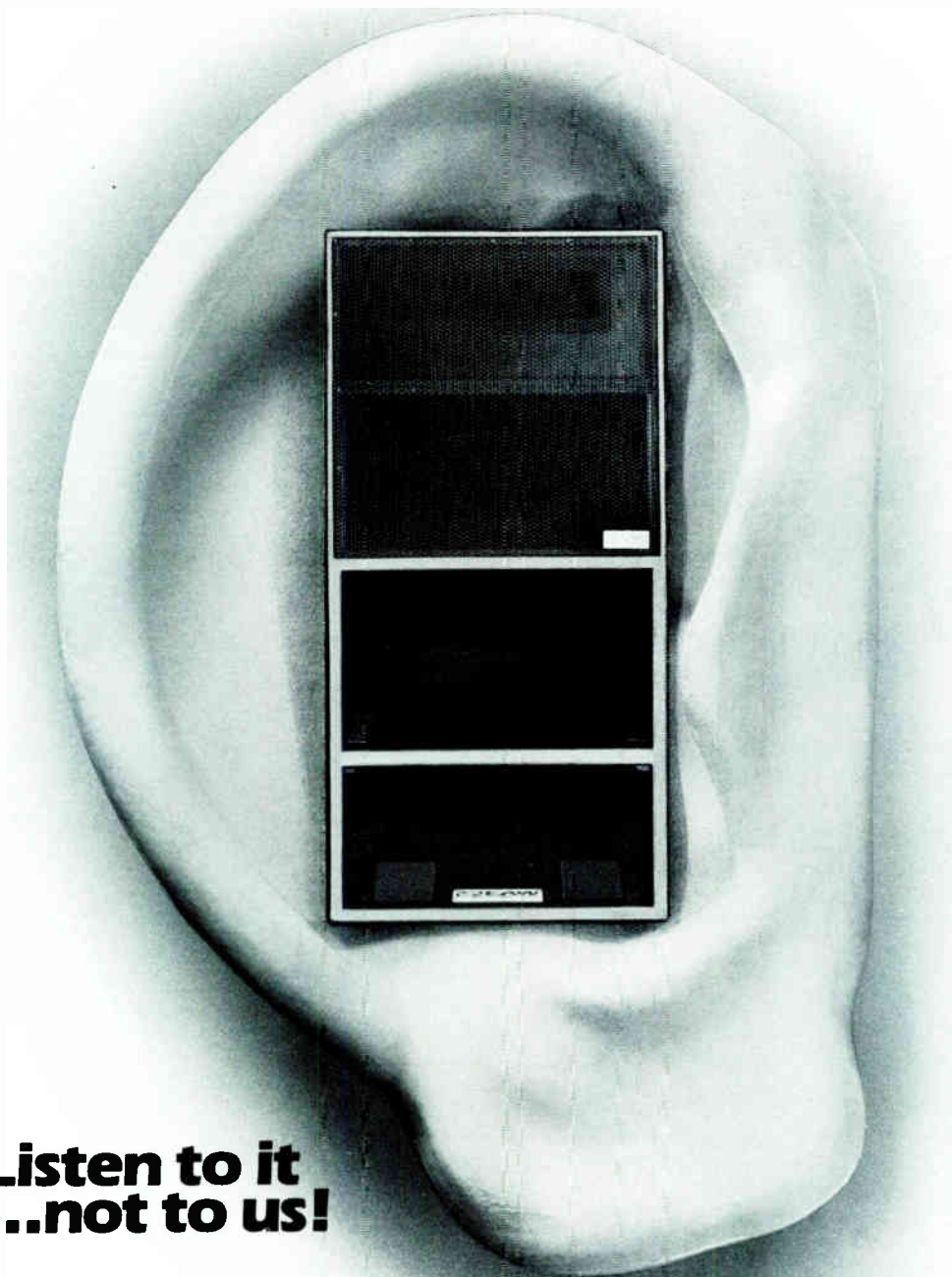

## Listen to it ...not to us!

Really, there's nothing we can say about our JF-500 that will induce you to buy it except this: try it. Because the evidence provided by your own two ears will be, as it should be, far more convincing than anything you'll read here.

True, we invented the horn-loaded single-box reinforcement system over a decade ago. True,

we continually refined it to stay well ahead of our imitators. And, true, our single-box system is still the qualitative standard of the industry.

But, enough words. You can buy anybody's single-box reinforcement system you choose. We're utterly confident you'll choose the one that sounds best to you. Our JF-500.



**Eastern Acoustic Works, Inc.**, 59 Fountain Street, Framingham, MA 01701 • (617) 620-1478

Circle #079 on Reader Service Card  
World Radio History

# CASE AND CABINET HARDWARE

## OVER 300 DIFFERENT PRODUCTS IN STOCK

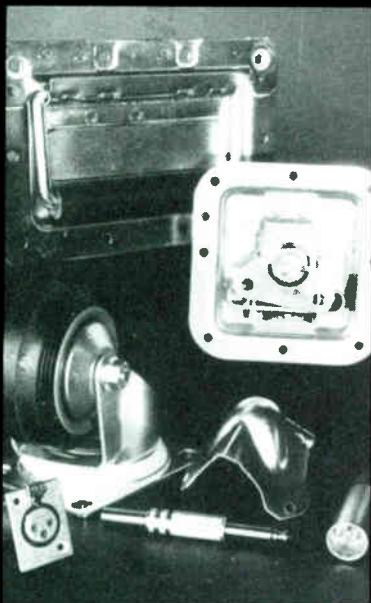

### 3 DEPOTS

#### NEW JERSEY:

29 B. Ethel Avenue  
Hawthorne, New Jersey 07506  
Telephone: (201) 423-4404

#### DETROIT:

2144 Woodbridge Avenue  
Detroit, Michigan 48207  
Telephone: (313) 961-9111

#### LOS ANGELES:

1111 Rancho Conejo Blvd.,  
Unit 303  
Newbury Park, California 91320  
Telephone: (805) 499-5932

**PENN FABRICATION  
(USA) INC.**

Circle #080 on Reader Service Card

decks, and by soloing the click tracks from either tape, we can now adjust the offset until the two clocks are perfectly in sync. (Alternately, a scope could be used to compare the timing of the two clicks.) This new offset now becomes our adjusted SMPTE offset to be used for the electronic edit.

Next we play the assembled master (with the slave machine playing cut #3 locked to the master via the adjusted offset). At the predetermined edit point, we enable "record," in effect attaching cut #3 to cut #5 at the downbeat of the chorus. It should be noted here that a "butt" splice or electronic edit as it is, is not necessarily desirable. With digital assemble edit techniques, one can stagger the point of transfer to accommodate any track configuration deemed pertinent. (Horizontal editing selected tracks is quite possible.)

The remaining segments of our master are then compiled in the same manner as that discussed for cut #5 and cut #3, until it is completed. This process is actually easier to accomplish than it sounds in print.

There are other benefits of dual locked digital 32-tracks as well. One is the ability to make D-to-D slaves and safety copies, which are for all practical purposes, clones of the original. From these copies or clones you can now make, back to the master, time corrected edits.

For example, let's say that the bass guitar hit the last note of a retarded ending, a split second early, making the track feel loose. With a clone of the original, one can "lock" the two tapes together, offset the slave by some predetermined subframe quantity, and lay the offensive bass note back to the master so that it now appears at the proper time, thus tightening the overall quality of the particular cut.

Any instrument or vocal can be done in this fashion. A hot vocal lick too far in the fade to be heard can be moved into an earlier position on the tape without ever having the vocalist redo his or her part, therefore preserving the fragile performance and attitude, that at times can be very difficult to come by at a later time.

Although we purchased Otari DTR-900s, the preceding techniques will work equally well with other digital multi-tracks. If you come up with some hot digital technique of your own, I would appreciate hearing from you. Lots of luck with your ones and zeros! ■

*Ben Harris is the chief engineer for GroundStar Studios in "Music City."*

—FROM PAGE 105, JIM GAINES

working on that, Ronnie Montrose said, "Hey, when you're done with that can you help me with mine?" So I did that, too, and then from that I got a call from Santana. I went home for three or four days, came back to do a test session with Santana, and never went back home! I still have a house in Oregon! I've been busy ever since.

**Mix:** As an engineer and producer, to what degree do you feel it your responsibility to keep up with what you hear other artists trying in the studio? In other words, when you heard The Eagles and others getting that sort of "dead" studio sound, did you investigate it for yourself? Are you intrigued by the booming drums that are all over the radio now and obviously selling a lot of records? How do you decide what's right for a project and commercial?

**Gaines:** The way I approach it now is that when I'm looking at a project and the songs in front of me, the first thing I tell everybody—the artist, the manager, whoever—is "I want to hear some songs that sound like radio." Now when I flip on the radio, there's a little of this, a little of that, but there's also a certain sound to it. There's an edge, a sparkle, a groove, that lift-energy. And that's what I go for. If I hear a song and I can't picture it on the radio, I try to make it so I do. I love the new modern stuff, and I think that's a reason I've managed to stay as busy as I have. I love all the new technology. I try to be the first one to buy things when they come out.

**Mix:** What are your current favorite "toys"?

**Gaines:** Several things. The SPX90 is a very versatile piece of gear for the price. I love the REV7. I just got to use the DEP-5 Roland reverb: I love it. Right now, I'm looking for the right sampling units. I'm looking for something that will give me the flexibility to sample voices or drums or whatever I want and trigger with audio triggers, which is not easy to find. Everything is MIDI triggers. I know it's right around the corner. I don't get to work with Synclaviers or Fairlights or things like that much because of the bands I work with. Most of the groups I work with are self-contained rock and roll bands, not techno-bands.

Sampling is a very exciting area for me. I have tons of drum samples with my SP-12 which I've been using for a couple of years now. I used it on the Journey album and the last Huey record and on the KBC record. I'll tell you—Darryl Verduco, the drummer in KBC, is one of the best players

—CONTINUED ON PAGE 127



—FROM PAGE 14, SESSIONS

in Brooklyn, *Jellybean* produced a track for *Stacy Lattisaw* that was used in the movie *Police Academy IV* and also produced the title song for the new Mel Brooks movie, *Space Balls*. Jellybean also produced another track for his upcoming album on Chrysalis. *Fred Zarr* arranged and played keys on all three tunes. "*Doc*" *Dougherty* engineered and *Don Feinberg* assisted. . . *Dave & Dennis Williams* were in Lodi, NJ's *Reel Platinum* producing various acts for their new label Dreamstar Records. Also there, *Thalion* cutting their latest rock EP. . . At *Shakedown Sound* in NYC *Arthur Baker* re-mixed *Rose Royce's* last release, which Baker also produced. It was engineered by *Dave Sussman*, assisted by *Rick Novak*. . . At *Pyramid Sound* in Ithaca, NY, producer *Scott Warner*, along with engineer *Alex Perialis* will begin work on the second, as yet untitled, album from Pittsburgh-based *Iron Cross*. . . Chrysalis recording artist, *V Corp* were in NYC's *D&D Recording* with producers *Michael Baker* and *Axel "Axman" Kroll* of Simple Simon Productions, working on several tracks for their upcoming debut album release. *Douglas Grama* engineered and *Michael Rogers*, *John Leposa* and *Kiren Walsh* assisted. . . Producer/engineer *Dave Ogrin* has been busy at *Quad Recording* in NYC working on re-mixes for *Ochi Brown*, *Kathy Mathis*, *Cameo*, *Princess* and *The Blow Monkeys*. . .

and *Whitefield Studios*. . . *Mobius Music Studio* has re-opened its 24-track recording facility with expanded control room capabilities and enlarged studio space at its Noe Valley location in San Francisco. The studio has added two iso-booths to their 600-square-foot studio. . . *Kren Studios* in Hollywood has installed a Mitsubishi Westar music recording console at its facility, which was previously owned by Marvin Gaye. . . *Peter Gabriel* has recently purchased a 40-input NEOTEK elite console system for his home studio in England. Gabriel's elite console is equipped with an additional eight stereo submasters and stereo line inputs, as well as MIDI Direct automation. . . Recent installations of the NEOTEK elan console system include the *Bregam Electronic Music Studio* on the

campus of Dartmouth College in Hanover, NH, *Scientel Audio* in Milan, Italy, and *New England Digital Corporation's* Chicago studio and Synclavier demonstration/test facilities in White River Junction, VT. . . The Audio Suite at *Editel/Chicago* was the recent recipient of the first AMS AudioFile in the USA. The AudioFile is a digital recording/editing/playback system which stores, records, edits and conforms audio on computer hard disks. . . *Albert's Home Studio* in El Paso, TX, has purchased a new Neve 8232 console. . . *Reeltime Audio Production*, formerly located at 205 Television Circle, Savannah, GA, has moved to recently completed facilities at 702 Mall Blvd. Suite A. Equipment upgrades include a TAC Scorpion board and a Fostex E-16 with a 4050 Autolocator. . .

## STUDIO NEWS

*Protolog Inc.* has opened its new recording studio in St. Petersburg, FL. The facility is geared towards SMPTE-MIDI controlled synthesis, digital sampling and special effects for records, jingles and videos. . . *Spectrum Studios* in Portland, OR, has installed an MCI JH-500 automated mixing console. . . *Eastern Sound & Video* in Methuen, MA, recently received the first Otari MX-80 32-channel recorder in New England. Eastern has also modified their Sony/MCI console to accept the new 32-track format and expanded its capabilities to 76 channels during mix-down. . . The *North Carolina School of the Arts* has purchased a Sony PCM F1, Sony SL2000 field recorder, and Sony SL-HF 1000 recorder. The system is being used for location digital master recording and editing of the school's classical and jazz music series. . . *Red Zone Studios* has announced the grand opening of its new facility, located at 623 S. Glenwood Place, Burbank, CA 91506. Owners *Denis Degher* and *Frank Riessen* worked for six months to open the studio, located in the former site of Kendun Recorders' "Studio A." The Tom Hidley-designed facility has had control room updating by architect-designer Vincent A. van Haaff. . . DDA, the English manufacturer of high quality mixing consoles for recording and sound reinforcement applications, has sold two of its AMR 24 consoles to Los Angeles studios: *Interlock Studios*

# PROFESSIONAL audio



**Learn the techniques and technology of the professional recording studio.**

- Recording and Mixing ■ Editing Techniques ■ Signal Processing ■ Disc Recording ■ Console & Outboard Gear
- Digital Logic ■ Audio Systems Design ■ Professional Studio Internships ■

Classes filling now – Call Today:  
**(212) 777-8550**



Established 1969

## Institute of Audio Research

64 University Place, Greenwich Village, New York, NY. 10003  
Licensed by N.Y. State Dept. Education  
Approved for Veterans Training  
**Financial aid for those who qualify**

Circle #081 on Reader Service Card

# A MIDI SOFTWARE TUTORIAL

by Larry Oppenheimer

**T**he marriage of personal computers and musical instruments (through MIDI) has been a very fruitful one. Many tasks in composition and electronic production are now simplified, or even possible where they were not before. Now that both personal computers and MIDI are out of their infancy, it is worthwhile to survey the territory of their union.

There is a multitude of software programs available that perform MIDI functions. To use any of these one must have a computer to run them on and an appropriate MIDI interface for the computer. The general-purpose nature of most of the microcomputers for which MIDI software is written allows a great many different types of programs and a range of approaches and potency within each type to be put on the market. With that thought in mind, here are the classes into which MIDI software will more or less fall: composition, including sequencing/transcription, notation and algorithmic composition; sound design, including voicing, sample editing and software synthesis; and utility, including bulk storage (patch librarian), MIDI data stream analysis/editing and event transformation. Of these, the most popular and first to appear was sequencing software.

## Composition

Sequencing software records and plays back performances on MIDI controllers, and allows some amount of editing of the recorded tracks, as do stand-alone hardware sequencers. They also allow synchronization to an external clock, as do stand-alone hardware-based sequencers. The differences come primarily in degree: software sequencers typically have greater note capacity, more detailed editing functions and, perhaps most significantly, much better display capabilities than stand-alone sequencers. Some of the most popular sequencing packages so far have been: on the Macintosh—

Mark of the Unicorn's Performer, Opcode's Sequencer 2.5 and Southworth's Total Music; on the IBM and "compatibles"—Jim Miller's Personal Composer, Roger Powell's Texture and Passport's Master Tracks; Dr. T's Keyboard Controlled Sequencer for the Commodore 64 and Passport's MIDI/8 and Master Tracks for the Apple II.

Most sequencing packages mimic in some fashion the operation of a multi-track tape recorder. The most convincing reason for doing this is that multi-track tape composition is a well-established and widely understood working method, especially in popular music. Thus, popular programs like Mark of the Unicorn's Performer have "tracks" and onscreen "buttons" for functions like "play," "record," "stop," "pause," "fast forward," "rewind" and so on. Tracks are typically polyphonic and often multi-channel; that is, an entire multiple instrument composition can be stored on one track. The number of tracks is of interest primarily as work room for layering, splitting and bouncing tracks, and for saving alternate "takes" of a piece. Enhancements to the multi-track gestalt are often made, especially automatic punch-in/out functions, which are fairly easy to provide in software, and looping, which can be tricky and does not appear on all programs. And, of course, there's always quantizing of rhythms (autocorrection).

Editing functions for large areas (sometimes known as a region or phrase) typically include cut-and-paste operations, usually with an option to determine whether the pasted material will replace or merge with previous information, and selective filtering operations. Microediting facilities vary more widely between different programs, ranging from ones with basic insertion/deletion of notes only, to those which have detailed editing

of any MIDI information. As with recording and playback, some programs offer enhancements to the basics, such as Roland's MPS and MESA programs, which contain an "assume" function that retains the duration and velocity of any note in the score and applies that information to subsequently inserted notes.

Sequencing programs commonly incorporate features designed to support and enlarge upon the basic recording and playback functions. A number of utilities, such as filtering of selected MIDI message types and re-channelization of incoming and/or outgoing data appear in most sequencing packages. Some sequencers have bulk dump facilities for storing patch data, or even patch editors.

The interface which is used with the computer can also be an issue with sequencing software. With a "dumb" interface—one whose only function is to provide the appropriate electrical conversion—the program must do all of the work, whereas a "smart" interface—one containing its own microprocessor (like the Roland MPU-401)—can perform some of the basic input/output functions, thus relieving the host computer (and the sequencing program) of some overhead. Although this can be advantageous in many ways, it also means that a program must be written specifically for a given interface and must work within that interface's limitations. One example of this is time-tagging. A sequencer remembers the timing of incoming data by "tagging" each event as it arrives with the current value of an elapsed-time counter. The speed of this counter, then, determines the resolution of the time-tagging and the rhythmic accuracy of the sequencer. With a dumb interface, this resolution can be set to any value the programmer wishes (although higher resolution may require trade offs in other places), but a smart interface may

—CONTINUED ON PAGE 166



# ACOUSTAFOAM



**APPLICATIONS:** STUDIOS, STORES, INDUSTRY, DATA PROCESSING, BROADCASTING.

**SPECIFICATIONS:** 2" THICK - 13.5"x13.5" TILE  
3" THICK - 13.5"x13.5" TILE  
2" THICK - 54"x54" SHEET  
3" THICK - 54"x54" SHEET

Suggested Retail	Call for Details
\$ 4.00	
6.00	
30.00	
52.00	

**COLORS:** BLUE, BROWN, RED, GREY.

**MATERIAL:** POLYESTER FOAM.

— **EXCELLENT SOUND ABSORPTION & DEFLECTION CHARACTERISTICS** —  
**AN AFFORDABLE ALTERNATIVE FOR ANY ACOUSTICAL APPLICATION**



SUPPORT  
SYSTEMS  
INC

1121-26 LINCOLN AVENUE, HOLBROOK, NY 11741  
Phone: (516) 567-8588 • Telex: 4972655FM TUBE

Circle #082 on Reader Service Card

world radio history



## Alesis Microverb

by Keith Grewell

It's hard to believe that a few years ago a good reverberation system consisted of a six-foot metal plate concealed in a large unsightly box at a cost of \$3,000. With the advent of digital technology, reverb units decreased considerably in size but simultaneously increased in cost. Now, with the introduction of the Alesis Microverb, quality reverb has certainly reached a minimum in both size and cost.

For those of you who are familiar with the MIDIverb, the Microverb's predecessor, I'd describe the Microverb as a selection of the best MIDIverb programs. It provides clean, 16-bit linear PCM digital reverberation, and at only \$249!

The Microverb's breakthrough in size (6 x 5.5 x 1.5 inches) is made possible by Alesis' RISC (Reduced Instruction Set Computer) architecture. The entire digital processing system is contained on a single chip. By using high speed, complementary-metal-oxide semiconductor (CMOS) silicon processing, the Microverb eliminates the need for several circuit cards of components, hence its small size and low power consumption. The Microverb, as part of Alesis' Micro Series, is mountable in the Micro-rack adapter, which holds three units and occupies one rack space. It is possible to lock just one unit in the rack adapter, which

can easily be done with a single screw. One thing that impressed me about the Microverb was its sturdy construction. You don't have to baby it in a padded case when transporting it; just toss it in a gym bag and take it to a gig. It sits nicely on top of a mixer, it's a cinch to set up and it's simple to use.

The unit contains 16 preset programs, of which six are small room settings, seven are large room settings (both arranged in order of increasing size and decay time), two gated reverb programs and one reverse program. The front panel has four controls: input gain, output level, mix ratio between the direct signal and effect, and one to dial up the desired program. A nifty three-color LED displays operating status: orange indicates that power is on, green indicates a sufficient signal level and red cautions overload. I found that it was very hard to overload this little unit and the red can flash quite a bit before audible distortion occurs.

The rear panel connectors are all 1/4-inch jacks with stereo inputs and outputs. The left input alone may be used for mono if desired. There is also an input for a defeat switch (not supplied by Alesis) and a jack which accepts a 9-volt AC power supply. Having an external power supply helps to keep the hum levels low and the unit cool. Microverb's wide-ranging input

characteristics handle any signal from low-level electric guitars, keyboards and microphones to +4 line levels without rear panel switching.

I scarcely got a chance to try out the Microverb when the demo unit first arrived, because everyone I knew wanted to borrow it for live sound gigs and recording sessions. I was happy to pass it around, anxious to hear people's responses for the sake of a fair evaluation. They were, without exception, enthusiastic. One listener felt the effect seemed a little bit "grainy," but he was comparing it to a \$20,000 studio reverberation unit. I never encountered any problems with the Microverb except a faulty power supply and Alesis was very agreeable about sending me another right away.

I found that the room programs were all tailored to be distinctly different and not just mild variants of other settings. On the biggest large-room settings, I found myself wishing that I had some parameter adjustment control, particularly for reverb time. Also, I didn't care much for the reverse effect, which wasn't at all like the "backwards" reverb effect so popularly used to enhance snare sounds. It was more like a gated reverb program with a discrete echo of the input at the end. It could, if used, create some tempo problems since there is no way to vary the length of the echo. Very weird, but I still had fun with it as a special effect. I loved the gate programs and used them several times on both live drum kits and drum computers, but for these settings, too, I found myself wanting more control of parameters such as gate time and delay. In fact, this was my only major complaint about the Microverb—the lack of all the parameter controls I'm used to manipulating on other units I have used. This is one reason to keep that \$20,000 unit after all.

Overall, there were plenty of suitable settings that I found useful for my purposes (mainly home recording and live sound), and the Microverb provides a nice alternative for those whose needs are not so varied as to warrant a large expenditure. It's so inexpensive that even a 4-track studio can afford to own several. Whatever its intended use and whatever your budget, you should consider the Microverb next time you're shopping for a quality reverb unit. I think you'll find it the most cost-effective reverb yet. ■



# Wave goodbye to one-color sound



**T**he full-color sound of the ESQ-1 Digital Wave Synthesizer makes other synths sound... well... black and white by comparison.

After all, a broad palette of sound is your first criterion for a synthesizer. And the major international music magazines who've reviewed the ESQ-1 seem to agree.

The tone colors possible with 3 digital wave oscillators, 4 envelopes, 4 DCA's, 3 LFO's and 15 routable modulation sources for each ESQ-1 voice impressed *KEYBOARD* magazine's Jim Aikin. "The ESQ's voice offers far more than what you'll find on a typical synthesizer—even on some instruments costing twice as much".

In somewhat colorful comparative terms, Peter Mengaziol of *GUITAR WORLD* wrote, "The ESQ-1's sound combines the flexibility and analog warmth of the Oberheim Matrix-6, the crisp ringing tones of a DX-7, the realism of a sampler, the lushness of a Korg DW-8000 and polytimbral capacity of the Casio CZ-1".

There are hundreds of ESQ tone colors available on cartridge, cassette and disk. And now, each ESQ-1 includes an Ensoniq Voice-80 Program Cartridge. Added to the 40 internal programs, that's 120 great keyboard, acoustic, electronic, percussive and special effect sounds right out of the box.



MUSIC TECHNOLOGY's Paul Wiffen had a great time mixing colors with the ESQ-1's 32 on-board waveforms and 3 oscillators per voice. "After a few minutes of twiddling, you can discover that, for example, an analog waveform can make the piano waveform sound more authentic, or that a sampled bass waveform can be the basis for a great synth sound. Fascinating stuff!"

Even though its flexibility is unmatched in its class, creating sounds on the ESQ-1 is simple and intuitive. Mix a little blue bass with some bright red vocal and pink noise and get a nice deep purple tone color.

But there's one color you won't need a lot of to get your hands on an ESQ-1—long green. The ESQ-1 retails for just \$1395US.

There are sound librarian programs for the ESQ and most personal computers, so you can save and sort your creations quickly and easily. If you'd rather just plug it in and play, there are hundreds of ESQ sounds on ROM cartridges, cassettes and disks available from Ensoniq and a host of others.

The easiest way to see the possibilities for yourself is to follow the wave to your authorized Ensoniq dealer for a complete full-color demonstration.

For more information and the name of your nearest Ensoniq dealer call: **1-800-553-5151**

**ensoniq®**

ENSONIQ Corp, Dept. X, 155 Great Valley Parkway, Malvern, PA 19355 □ Canada 6969 Trans Canada Hwy Suite 123, St. Laurent, Que. H4T 1V8 □ ENSONIQ Europe BV, Domplein 1, 3512 JC Utrecht, Holland □ Australia: Electric Factory, 188 Plenty Rd., Preston, Vic. 3072

Tired of excuses from "third party" synchronizer companies? Studer, the world's premier tape transport maker, now offers two new intelligent SMPTE/EBU bus controllers.

**SC 4008: Dedicated and Expandable** – The basic SC 4008 system controls four audio, video or film machine transports via Studer TLS 4000 synchronizers. For more sophisticated applications, an optional expansion board extends SC 4008 control to as many as eight machines. The operating panel has a full array of dedicated keys logically grouped according to function.

Optional features include take count-down unit, VITC reader/translator, video character inserter, and event controller with outputs to trigger up to 10 additional non-synchronous sources.

**SC 4016: Soft Alternative to Hard Production Tasks**– The SC 4016 top panel shows a radical departure from the SC 4008 concept. Instead of dedicated keys, the SC 4016 employs eight "soft keys" with internal alphanumeric LED

displays. The software menu assigns functions to the keys according to selected system mode, and keys are automatically re-labelled to indicate currently assigned function.

The SC 4016 controls up to 16 synchronous transports, providing complete control (including shuttle and cue functions where applicable) as well as comprehensive machine status displays. Master and slave machine designations may be re-programmed at any time. And, for advance EDL preparation, the SC 4016 provides floppy disc data exchange with personal computers.

**In Sync with Swiss Timing** – Studer system controllers are made in Switzerland, the country famous for being in control and precisely on time. Every time. For more information on Studer system controllers, please contact your nearest Studer office.

**STUDER REVOX**

Circle #084 on Reader Service Card

STUDER REVOX AMERICA, INC.  
1425 Elm Hill Pike, Nashville, TN 37210, (615) 254-5651

Offices: Los Angeles (818) 780-4234/New York (212) 244-4462/  
Chicago (312) 526-1660/Dallas (214) 943-2239  
San Francisco (415) 930-9866

# Machine Control from a Machine Maker



SC 4008



SC 4016

STUDER SMPTE BUS CONTROLLERS



Synchronizing complex, Austrian Broadcasting Center, Vienna. Studer SC 4016 system controller, Studer mixing console, Studer tape machines.



## Electro-Voice N/DYM Microphones

by John Schroeder

**E**lectro-Voice seems to be making a lot of impressive claims for their new N/DYM series of unidirectional dynamic microphones, and if you've seen the advertisements, your curiosity was probably aroused as much as mine. The heart of this new design, "the most significant advance in dynamic microphone design in decades," according to E-V, is their "neodymium aligned technology," which employs a rare earth magnet (neodymium) with four times the strength of conventional magnets.

The output of a dynamic microphone depends on the velocity of the sound pressure (which of course can't be changed by altering design characteristics) as well as the size of the voice coil and the flux density of the magnet the coil passes through. With this new design, E-V was able to considerably reduce the size of the magnet while still maintaining unusually high flux density, and in conjunction with a larger diaphragm, this new shallower assembly delivers more output than conventional designs. Also, distortion caused by high sound pressure levels forcing the voice coil outside the gap is reduced because the flux density here is more uniform due to the strength of the magnet. As the coil is lower in mass, high frequencies can move the diaphragm with less effort, which improves their response, and truer polar response results, since a more shallow assembly allows more off-axis sound information to correctly cancel at the diaphragm.



Naturally, it follows that these microphones are also noticeably lighter than comparable mics; a definite plus for hand-held applications. By now it should be pretty easy to see what all the fuss is about.

The N/DYM line (pronounced N-dime) consists of four vocal microphones (the 757, 457, 357 and 257) and two instrument microphones (the 408 and 308). The N/D757 is the top-of-the-line vocal mic, a supercardioid, and the N/D457 is a hypercardioid vocal mic whose specialty is feedback control, ideally allowing 6 dB of additional gain before feeding back. The N/D408 is a supercardioid instrument mic, mounted in a configuration which allows the capsule to pivot with respect to the shaft. These three mics have slightly better specs than the others in the series, which explain why they're also somewhat more expensive. The remaining two vocal mics

are the N/D357 and the N/D257, which are supercardioid and cardioid, respectively. The 257, in particular, is the economy model of the N/DYM series. The last of the six is the N/D308, a cardioid instrument mic with that same pivoting configuration.

I must admit that for dynamic microphones, E-V's new N/DYM line sounds good. They are indeed noticeably brighter than other dynamics, as suggested by the close response specifications, but in far field (greater than 12 inches), the response bandwidth becomes somewhat more narrow due to lack of proximity effect. I was pleasantly surprised when I found that each mic includes a "certificate of performance" that charts the actual frequency response of that particular microphone. E-V actually calibrates each one in an anechoic chamber to make sure it meets specifications, and the curves for the mics we tested varied only

slightly from the published data.

Typically, the sensitivity of dynamic mics is around -56 dB at a reference of 10 microbars. The N/DYM specs give values of -53 dB and -50 dB, and when tested in a number of live and studio situations, these mics did yield considerably more output than did other dynamic mics.

In their literature, Electro-Voice boasts that the N/DYM design offers a considerable advantage in high-level monitor situations due to high directionality (supercardioid or hypercardioid), and due to the mics' polar patterns remaining true over a wide range of frequencies. According to the specs, the directionality does vary to a certain degree but is maintained at higher frequencies, where feedback is more

likely to take place. On the contrary, more standard designs tend to become more omnidirectional at higher frequencies, which would suggest that they are more susceptible to feeding back. However, the fact that the N/DYMs are more sensitive at high frequencies might slightly negate their improved feedback control abilities.

As far as construction goes, Electro-Voice did a nice job with the N/DYM series. When I first picked up one of the vocal mics, I was shocked when the shaft, which has the slate-gray look of tempered steel, compressed ever so slightly as I gripped it. In fact, all the vocal mics employ a rubber-like grip which is quite comfortable, and E-V says the mic assemblies are all cradled in this same material. This com-

bination is supposed to eliminate handling noise, which isn't completely the case, although it does help considerably, and they all sport a rubber guard around the windscreen which helps damp any contact noise.

My biggest complaint concerns the vocal mic clips. They're made of a flexible, virtually unbreakable plastic—however, they're cylindrical rather than conically shaped like the mics, which makes it almost impossible for a performing vocalist to easily "slip" a mic back into the clip. They hold quite well, but the design could be better. The instrument mic clips are slightly difficult to get on, although once attached, they won't come off by accident.

The N/DYM series contains a few noteworthy additional features which include humbucking coils in the 757, 457, 357 and 408, and as the top-of-the-line, the 757 also sports a bass roll-off switch, which helps reduce the influence of proximity effect. This switch can't be thrown without some kind of pointed tool, a design which was obviously employed so that the response can't accidentally be changed during a performance. The mounting configuration of the instrument mic capsules is extremely helpful for getting them into tight places, and also quite convenient for hanging the mics over a guitar amp, for instance, without using a stand. Besides slightly flatter response, this is the only difference between the instrument mics and the vocal mics.

In conclusion, the new N/DYM series mics have all the advantages of conventional dynamic microphones, such as durability and the freedom from phantom powering requirements, as well as some new advantages like extended high frequency response, more consistent polar response, significantly higher output, less handling noise and reduced weight. If you're considering a N/DYM for general purpose recording applications, the N/D408 is probably your best bet, due to its flexible mounting configuration and relatively flat response. If you're in the market for a vocal performance mic, the N/DYM vocal mics are definitely worth considering. Electro-Voice does make some pretty impressive claims, but that's because these are some pretty impressive microphones. ■

#### E-V N/DYM LIST PRICES

N/D757.....	\$297
N/D457.....	\$222
N/D357.....	\$174
N/D257.....	\$126
N/D408.....	\$228
N/D308.....	\$186

## NEW COMPACT DISCS!



### Introducing DIGIFFFECTS, The world's first and *only* real Digital SFX Library.

- **REAL-LIFE SOUNDS** — Maybe we shouldn't call them sound 'effects' because only Digiffects sounds as real as real-life sounds. The reason is crystal clear. Digiffects perfectly duplicates real sound, because *only Digiffects is digitally recorded, mixed and mastered.*
- **10 CATEGORIES OF SOUND** — City, Domestic, Rural, Transportation, Industry, Office, Leisure, Sports, Human, and Special
- **1,000 SOUNDS JUST SECONDS AWAY** — Many cuts are up to 2½ minutes of continuous environments.
- **FREE 10-DAY TRIAL** — Compare DIGIFFFECTS and you'll agree . . .

**'If it sounds real, it must be**

**DIGIFFFECTS®**

**CALL NOW 1-800-858-8880**

In Texas/Alaska call collect (214) 934-2222

and ask for complete information on DIGIFFFECTS and the  
DIGITAL PRODUCTION LIBRARY.



FirstCom/13747 Montfort Drive/Suite 220/Dallas, Texas 75240 © 1985 Jim Long Companies, Inc.

Circle #085 on Reader Service Card



—FROM PAGE 118, JIM GAINES

I've ever worked with. I'll work with him anytime. He loved all the new technology.

**Mix:** How was working with them? I'd think Kantner and Balin are pretty idiosyncratic in the studio.

**Gaines:** Well, let's say it was a challenge. I think we made a pretty good record. They're a good band that's going to get even better. The band has two sides to it. It has Marty, Paul and Jack [Casady] which is 20 years one way, and then the other guys, who are basically young cats with young ideas. So I was trying to bring those two sides together and make a modern-sounding record. Now I love Paul and Marty, but in the studio they're still a little behind the times and I had to really convince them that it was OK to try out all these reverbs and drum sounds. That wasn't easy because Paul and Marty, in particular, are really into live music—performance. But to their credit they were basically very open. They called me "iron ears." I don't know if they enjoyed it, but they did the work and I respect them for that. Paul came through like a champ. He worked the hardest he's ever worked on vocals because I wouldn't let him out till it was right.

**Mix:** Huey's *Sports* record was done in a relatively short period wasn't it?  
**Gaines:** We did it in about six weeks, most of it right here, with some also done at Fantasy. We had [Bob] Clearmountain mix it. It went like clockwork. I had a good feeling about it always.

**Mix:** Of course it's hard to really predict whether something will be a hit.  
**Gaines:** Always, but I'd thought the previous record should have been bigger. "Workin' for Livin'" should have been a big single for them. When we made *Sports*, I knew "Heart of Rock and Roll" and "Heart and Soul" were hits. I loved "I Want a New Drug" but we were all deathly afraid of it because of the lyric content. But what a great song! And of course the lyrics didn't end up being a problem. You just never know. Sometimes you'll work for weeks on a song and it doesn't have it. Then you cut "Power of Love" in three days and it's a smash.

**Mix:** Your most recent big project was the Neville Brothers' record. Where did you cut that?

**Gaines:** A small studio called South Lake Studios in Metairie, which is a suburb of New Orleans. It's a brand new little studio. We were the first al-

bum project down there. It worked out fine. They didn't have much outboard gear, so I ended up taking a lot of my own stuff down there. I ended up doing four sides, and Richie Zito did four sides and then two sides were done by Clive Langer and Alan Winstanley, who are singles producers from England. It's pretty interesting, actually, though it is three different approaches. They're a great band—really good musicians, and man, what singers! They had the best vocal performances of any band I've ever worked with. You do one take and it's great, and another and it's as great, and then what do you do? I remixed some of Richie Zito's stuff to make it all a little more compatible. But he was a great guy to work with. I like Richie.

The Nevilles are going to break one day 'cause they're just so damn good. I don't know if this'll be the album. I hope so. As a producer you're always thrilled when you can work with people that good. Hell, that's why you do it! ■

---

*Blair Jackson, managing editor of Mix, has been writing about rock, folk, jazz and ethnic music in the San Francisco Bay Area for the last 15 years. Miraculously, he still has his hearing.*

# Hear the great wireless sound.



## Consider the size advantages...

Cetec Vega's R-33 PRO PLUS wireless microphone receiver mounts inconspicuously on a camera. Or on a tiny corner of your sound cart. Or in your pocket. Or on your belt, providing you with program-quality headset audio.

With the R-33 you have a wide choice of transmitters...any Cetec Vega DYNEX® II bodypack or handheld. A full complement of useful accessories is included.

The R-33 provides 8 hours of operation on a single 9-volt battery. Audio is studio-quality (e.g., over 100 dB S/N).

All this, in a rugged package less than 12 ounces, and only 3/4 x 3-1/4 x 5-5/8 inches (HWD). Available in two colors... PRO Brown/Cream or Camera Black.

 **Cetec Vega**

...the professional's wireless  
9900 Baldwin Place  
El Monte, CA 91731-2204  
(818) 442-0782

Circle #086 on Reader Service Card

# GIVE ME FIVE



No jive, Clive. It's Rane's PE 15. And it's the first and only parametric equalizer and notch filter with five filters, all in one box.

That's a lot, Scott. Five separate, completely independent bands. So you have significantly greater control capabilities than the traditional four band designs.

But that's not all, Paul. Each band has a full, four-octave frequency sweep range, and an individual LED-indicated bypass



switch on each band.

Don't settle for less, Jess. At the suggested list price of \$389, the PE 15 is easily the most flexible, powerful, compact, high-performance and cost effective parametric equalizer you can get.

So what do you say, Jay? Rane Corporation, 6510 216th Southwest, Mountlake Terrace, WA 98043. 206/774-7309.



Circle #092 on Reader Service Card  
World Radio History



—FROM PAGE 59

ording. The OM-2 combines a moving coil with a new "VLM" capsule, said to allow a 40 to 20k Hz response and the ability to handle over 140dB SPL without distortion or coloration. The mic features low handling noise and a tight hypercardioid pickup pattern with off-axis rejection of over 30 dB. The die-cast zinc body mic, equipped with a shock-absorbent steel mesh grille screen and pop filter, is available in black, matte gray and satin. It comes with a padded carrying pouch and stand adapter for a suggested list price of \$189.

Circle #165 on Reader Service Card

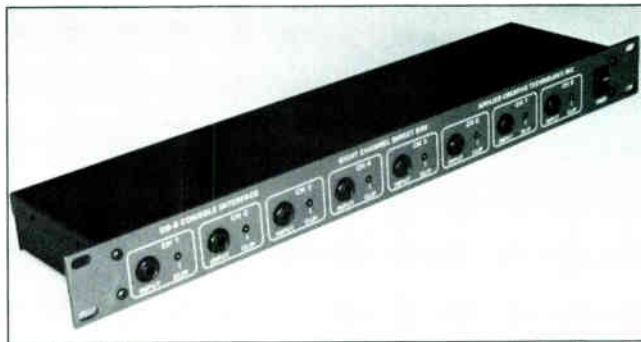

## ACT DB8 Direct Box

The Dallas firm of Applied Creative Technology has combined eight active direct boxes in a rack mount device, the transformerless DB8 8-channel direct box. The low-cost unit allows connection of drum machines and keyboards to the mic inputs on a mixing console, by converting their high impedance, unbalanced signals into low impedance, balanced signals: Each DB8 provides eight 1/4-inch phone inputs and eight XLR outputs. Currently available direct from the factory (800-433-5373 outside Texas), the DB8 retails for \$595.

Circle #168 on Reader Service Card



## 3rd Generation G162 Mixer

3rd Generation, distributed by Tek Trak, Voluntown, CT, introduces the versatile G162 stereo mixing console, designed for live performance, home recording and permanent installations. Some of the features of the new G162 include 16 mic/line inputs, 100mm Alps faders, four aux sends, Baxandall 3-band EQ and external power supply. Suggested retail price is \$1,599, or with flight case for \$1,850.

Circle #166 on Reader Service Card



## Telex Miniature Mic

In response to musician and public speaker demand, Telex (Minneapolis) presents the very compact LM-300 unidirectional mic system with a cardioid polar pattern. The system consists of a miniature lapel mic and in-line phantom power supply. The mic, model WLM-60, contains a studio-quality condenser element for full, natural sound, a pick-up pattern that controls background noise and feedback, and a tailored response to eliminate low frequency chest tones. Both mic and power supply feature a black, non-glare matte finish, and three styles of mounting clips for attachment to clothing or instruments. The LM-300's suggested list price is \$225.

Circle #169 on Reader Service Card



## AKG Vocal Headset Mic

AKG Acoustics, Stamford, CT, announces the C-410, a lightweight, low impedance, pre-polarized condenser microphone designed specifically for the vocalist who needs mobility and the use of both hands during performance. Featuring a 20-20k Hz bandwidth and a frequency response optimized for the singer, the C-410 weighs less than one ounce and can be worn for long periods without fatigue. Its shock-mounted capsule has a tight cardioid pattern for rejecting unwanted sounds, while a removable, washable windscreen minimizes breath pops. The C-410 is priced at \$195; another version, with stripped leads for installing into a wireless system, is \$150.

Circle #167 on Reader Service Card

## Kurzweil Sound Modeling Program

Kurzweil (Waltham, MA) offers their free Sound Modeling Program (SMP) as an enhancement to their 150 Fourier Synthesizer. The 150FS provides a range of factory voices, and SMP lets the user view representations of these sounds, or synthesize all new ones, on the Apple IIe computer. The 150FS contains 240 separate oscillators, or "partials"; SMP allows the envelopes of up to 64 partials per sound model to be manipulated in data table or graphic display format. SMP requires 150FS Version 1.6 software (also a free factory upgrade). Another no-charge upgrade for the 150FS is Kurzweil's Voice Block B, which adds five instrument voices and 23 programs.

Circle #170 on Reader Service Card

# 24 TRACK RECORDING FOR LESS THAN \$700 PER TRACK

Akai ML14 Autolocator

Akai MG14D Recorder

ADAMS SMITH ZETA III

Akai MG14D Recorder

Akai ML14 Autolocator

Combine Akai Professional's MG14D ML14 Multitrack Recorders and an Adams Smith Zeta III Synchronizer and you have the ultimate 24 track recording studio.

**The MG14D features:**

12 Audio Tracks  
1 Time Control Track  
1 Sync Track  
SN 94 db  
EIN - 128  
Dynamic Range 115 db  
Frequency Response:  
19 cm 50Hz to 20KHz  
9.5 cm 50Hz to 16KHz

**ADAMS SMITH ZETA III**  
Audio/Video/MIDI/SMPTE  
Synchronizer  
2 full range time code  
readers  
SMPTE/EBU time code  
generators  
RS232/422/MIDI  
communication

**AKAI**  
professional

**Creative at Heart.**

For a complete demonstration, see your locally authorized Akai Professional Dealer or write:  
Akai Professional, P.O. Box 2344, Fort Worth, TX 76113



Circle #087 on Reader Service Card  
World Radio History



—FROM PAGE 79, SCHOOLS

offer in the year 2000 (it occurred to me the third or fourth time I asked it that it's only 13 years from now). Will the recording engineer be outmoded? Will recording schools develop to the point that they're leading the industry in research and development, setting the trends rather than breathlessly trying to keep up with them? As might be expected, I got different answers from everyone.

Trebas' Leonard thinks the time for recording schools to take a more pioneering role is now: "I believe that an educational institution, to be true to its students, has to teach not just what's current, but what's going to happen. If you're looking today, especially in a larger bureaucracy of a large college—and we can respond a lot quicker—by the time you sit down and work out the course based on what's happening today, teach your first group of students and they graduate, you're a half a dozen years behind the times. So you've got to anticipate, which isn't easy to do.

"It's a matter of plugging into the points—not at the marketing once it's already out there—but at the research level, which today is hard to do because a lot of it's happening in Japan.

"We're kind of proud of the fact that if you look at our brochure from 1979, you'll see digital audio. We're teaching years ahead. In 1979, we had our new video recording technology course."

Christopher Knight, director of admissions at the L.A. Recording Workshop, thinks the role of the recording engineer can only become more important in the years ahead: "The engineer will become more and more the interface between the musician and the technology and so he must know both. The straight technician/engineer, with no musical abilities or capabilities, is at a disadvantage. The musician is talking in musical terms, the technology is demanding technical terms and you have to be able to translate from one to the other."

Miriam Friedman, of New York City's Institute of Audio Research, feels learning equipment maintenance will be ever more important in the future:

"There will come a point where operators who can't maintain the equipment will not have work. The technology is getting to the point where you have to be in control of it, as opposed to it being in control of you."

"Sound itself will never change," says Sound Master's Ingoldsby. "The job characteristic of a professional recording engineer is this: we take what exists in a controlled environment, we preserve it and we recall it at any time. It's easy to say that, but it's a very

complex statement."

Ingoldsby reasons that the sound engineer in the year 2000—instead of being stereotyped as a rock engineer, a country engineer or a country/punk engineer—will be able to record any kind of a sound, simply by having the understanding of sound itself.

"As we progress, we grow," Ingoldsby continues. "As you're in the industry, and as the changes come, just like when the first engineers went from mono to stereo, from common mono to multi-track, we all had to go through these learning curves. We write the book as we go.

"If you don't know what you're reading, if you don't have the foundation on which you can grow, then you only become more and more confused. And that's what we provide for the



**"One of the most important things we can give our students . . . is how to think."** David P. Leonard, President, Trebas Institute of Recording Arts.

student: the foundation to keep with what is state-of-the-art so that when they enter the industry they grow with it as we grow." ■

*Josh Gressel, a Mix editorial assistant, recently returned to the U.S. to do graduate study in psychology following eight years on a kibbutz in Israel. He is a Pisces, with a Sagittarian moon and Capricorn rising.*



*On location at Roland Corporation's Learning Center in Los Angeles.*

## **Roland: Educating the Salesperson**

There is nothing worse than entering a store and finding that the salesperson knows less about the product you're interested in than you do. And yet, how can your average music store employee be expected to keep abreast of the nuances involved in the latest piece of MIDI gear, when he just figured out the knobs of the one it's replacing?

Roland Corp. has attempted to address this issue with its new "Learning Center." Located at Roland's U.S. headquarters in Los Angeles, the center holds three- and four-day seminars designed to familiarize Roland dealers with just what it is they're selling.

"We've had 100 or more dealers sending their sales people in for training," says Barbi Clark, of Roland Communications. "They go over the product with tests and lectures, and there's also hands-on lab training following."

While the curriculum has been organized to cover most all Roland products, emphasis is placed on sampling keyboards, the Super JX and Alpha Juno synthesizers and the MIDI products. Clark reports that several hundred sales representatives have attended the Learning Center since it opened in late '86.

Given the diversity of products and the dizzying pace with which they appear in (and disappear from) store windows, one can only hope that Roland's Learning Center is an idea other manufacturers will emulate.

—J.G.

The SP-1200 Sampling Percussion System.

# Serious Repercussions.



**P**articularly among serious musicians. Because the new SP-1200™ Sampling Percussion System has more features for serious creative possibilities.

It's the latest refinement of the SP-12,™ the sampling percussion system by which all others are measured. Accordingly, the SP-1200 offers a full 10 seconds of sampling time. In a 12-bit linear data format for sounds of unsurpassed brightness and clarity.

Then the SP-1200 adds new features to make programming and performing go even faster and easier. There's an internal 3.5" disk drive that loads sounds and sequences in seconds.

Which could significantly improve the rhythm of an entire performance. There's more flexible segment editing plus MIDI Song Pointer, so when you're running with an idea, you won't have to wait for your hardware to catch up. And there's an abundance of other features, too.

Not the least of which is the formidable and ever-expanding SP-1200 library of sounds. And complete compatibility with all SP-12 sounds, whether from E-mu or anyone else.

To fully appreciate the new SP-1200, you need to play it. You'll discover the SP-1200 has the power to send repercussions through the most important music you may ever hear.

Yours.

For more information, see the SP-1200 at your dealer. Or call E-mu Systems at 408-438-1921.



**E-mu Systems, Inc.**  
1600 Green Hills Road  
Scotts Valley, CA 95066

**Applied Magic**



## NEW TECHNOLOGY

by Craig Anderton

Every now and then, it's fun to fire up the old crystal ball and see what it has to say about the future. On a general level, I think we can expect a period of major change about a year from now, similar to what happened about four years ago when sampling and FM synthesis stole the spotlight. Of course, putting predictions in print is always a gamble; you can come out looking really good, or really dumb. In any event, it is fun, so let's get into some specifics.

### Hard disk recording

About a year and a half ago, I upgraded my CompuPro computer by adding a 40 Meg hard disk drive. The extra speed and convenience it brought to word processing was really quite something. Now, with the growth of *Electronic Musician*, it was time for another upgrade, this time to 80 Megabytes. I was surprised to find that 80 Megs didn't cost that much more than 40 Megs did just 18 months ago, and worked equally fast (if not faster). But I was also told that 300 Meg drives weren't far away at all, and would not cost that much more than 80 Meg drives! This kind of mass storage makes it economically practical to digitize audio and store it on hard disk, just like you would on tape. Sure, systems like that exist today (Synclavier, PPG); but one would not call them commonplace (or inexpensive).

A hard disk recording system does a lot more, though, than just put pro tape manufacturers out of business. Hard disk recording systems invite software that give you all the control over acoustic sounds that MIDI sequencers give to electronic sounds. Imagine being able to cut and paste (or transpose) vocals, for starters; this kind of system makes it possible to do bouncing and splicing with none of the stress or signal degradation associated with analog tape, and in a much more natural way than editing with

## ON THE HORIZON

"Guitar players had the 1960s, keyboard players the 1970s, electronic percussionists the 1980s... will wind players take over the 1990s?"

traditional digital recorders.

I expect most systems will use multiple hard disks coupled with a pretty decent-sized RAM buffer to allow for smooth transitions when accessing the hard disk. The cost should be well under \$10,000 when these systems become "mature" in a couple of years.

### Stereo sampling

Pretty soon your sampler just isn't going to be part of the modern world unless it's stereo. And I don't mean separate assignment/output type stuff. I mean recording sounds in two channels, left and right. Here finally is a way to sample ambience as part of a sound, and create more realistic sound effects. And of course, you'll be able to record really long samples if you're willing to record in mono.

### The virtual console

They did it to synths, and they'll do it to mixers next. Expect to see highly automated mixers with perhaps only eight sliders, but 40 or more channels. The remaining 32 channels would be "virtual channels" which would be

programmed for level, EQ, send and panning changes in groups of eight, using the sliders. The advantages would be the ability to squeeze lots of channels in a small physical space (a necessity for MIDI studios) and low cost. The disadvantage, of course, would be having to program your mixes. It's tedious with synths, and it wouldn't be any less tedious with a mixer. But people can put up with a fair amount of tedium in order to save a fair amount of bucks.

### The MIDI studio

Speaking of the MIDI studio, that's a trend that will gather momentum at a logarithmic rate. Studios that aren't planning to add a pre-production (or full-blown) MIDI room are going to be at a competitive disadvantage compared to those studios that do offer a selection of sequencers, instruments and MIDI gear.

### Algorithmic composition

With algorithmic composition, a computer not only sequences or processes your work, but creates part or all of it. Now I must admit that I don't think computers are very good songwriters. But like the saying about enough monkeys and typewriters coming up with Webster's dictionary, every now and then the computer comes through with something cool. This is probably the type of thing that will be a fad and peak rapidly, but then fall into the hands of serious experimenters who turn it into more of a tool and integrate it into the mainstream of music making.

### The next generation of Macintosh software

I think that this is what's going to blow the lid off of music software in general. Yeah, I like the Amiga and ST a lot, and even IBM is getting pretty hip with their music card; but the Mac took an early lead as the musician's computer, so now programmers are getting pretty familiar with the beast. For example, Passport's Master Tracks

## MASTER A FULLERSOUND

Rod Stewart  
The Bee Gees  
Kenny Loggins  
Eric Clapton  
Allman Brothers  
Trinere  
Betty Wright  
America  
The Bus Boys

**AFTER TEN YEARS OF MASTERING HIT RECORDS  
FULLERSOUND IS NOW ESTABLISHED**

Kenny Rogers  
The Romantics  
Barry Manilow  
Eddie Money  
Julio Iglesias  
Dionne Warwick  
Bellamy Brothers  
George Clinton  
John Cougar

Eng: Michael Fuller

(formerly Criteria Cutting Center)



**FULLERSOUND, INC.**

1755 N.E. 149 STREET / MIAMI, FLORIDA 33181 / (305) 945-6697

COMPLETE MASTERING  
SERVICES FOR  
RECORD,  
COMPACT DISC  
AND CASSETTE

Circle #089 on Reader Service Card

## ATTENTION MANUFACTURERS!

# THE AES NEW PRODUCTS DIRECTORY FOR 1988

Don't miss this free opportunity to inform over 65,000 professionals about your new audio, video or music product(s)! The 1988 New Products Directory will appear in the October issue of *Mix*, with 3,000 copies to be distributed at the AES Convention.

**Just call or write: Mix New Products Directory  
2608 Ninth Street  
Berkeley, CA 94710  
(415) 843-7901**

**DEADLINE: JULY 13**

Pro (which is available as of this writing) is a well-crafted Mac program that retains much of the approach of the first generation of Mac software, but cleans up the loose ends and smooths out the rough edges. Meanwhile, Southworth has just released a preliminary version of Midipaint, which looks far more streamlined, and reliable, than Total Music, its predecessor. Mark of the Unicorn, whose Performer is one of the most popular Mac sequencers, is close to releasing their second generation software. (Opcode's Sequencer 2.5, while considerably enhanced over their first products, is not a true second generation program; that will arrive with Sequencer 3.0, which sounds very promising based on early rumors.) Now with the release of the Mac II, which is causing programmer friends of mine to salivate at its very mention, we can expect the Mac to continue its position as the most significant musical computer.

### Woodwind-to-MIDI

Whatever happened to sax players? If you watch MTV, you know that brass and wind instruments are making a comeback. What's more interesting, though, is that several manufacturers are planning to leap in the fray virtually simultaneously, and that most of them are using dedicated controllers. Yamaha's BMC1 (Breath MIDI Controller), previously shown at the winter '87 NAMM, is scheduled for formal release this summer... which is also when Akai will begin shipments of their EWI (Electronic Wind Instrument), based on Nyle Steiner's original design. Meanwhile, a company up in Oregon called Artysyn is working on a controller; and in Switzerland, saxophonist Martin Hurni wires existing saxophones for MIDI note and controller (modulation) data. It requires no change in technique from a standard sax. Finally, for the pitch-to-voltage fan who doesn't want to mess with a new controller, Roland's VP70 will convert your pitch to MIDI information. If it works as well as their guitar-to-MIDI converter, you can expect a pretty nice piece of gear. Guitar players had the '60s, keyboard players the '70s, electronic percussionists the '80s... will wind players take over the '90s?

Well, we'll find out then. I hope you enjoyed this gaze at the future; we'll return to the present next time. ■

*Craig Anderton is the editor of our sister publication Electronic Musician, and is guitarist/keyboardist for the synth band Transmitter, as well as author of numerous books and articles for MIDI users.*



# 16 BITS



1. The ADR 68K is a full-featured digital reverb
2. And digital signal processor
3. And sampler
4. With a RAM cartridge for additional, portable preset storage.
5. And over 100 factory presets, with room for 100 more of your own.
6. It's an 8 second/16 bit/15kHz sampler, expandable to 32 seconds.
7. Its sample memory can be broken into 4 segments, with separate recording, editing and triggering of each segment
8. And the samples can be triggered by audio inputs, trigger jacks, or MIDI
9. And the samples can be processed internally with reverb and/or effects during playback.
10. The ADR 68K has comprehensive MIDI implementation, with program changes, sample triggering, and preset send/receive.
11. Audio processing parameters, including program changes, change in real time without glitches or muting.
12. The two inputs, four-outputs, MIDI jacks, and four pedal/trigger jacks are all programmable in software.
13. AKG is committed to software development, creating not only new sounds, but also new features on an ongoing basis.
14. The ADR 68K's 68000 processor is a full-fledged computer
15. With a large display in plain English (160 character LCD)
16. With a unique, context sensitive HELP feature that tells you about any parameter just when you need to know.



77 Selleck Street  
Stamford, CT 06902

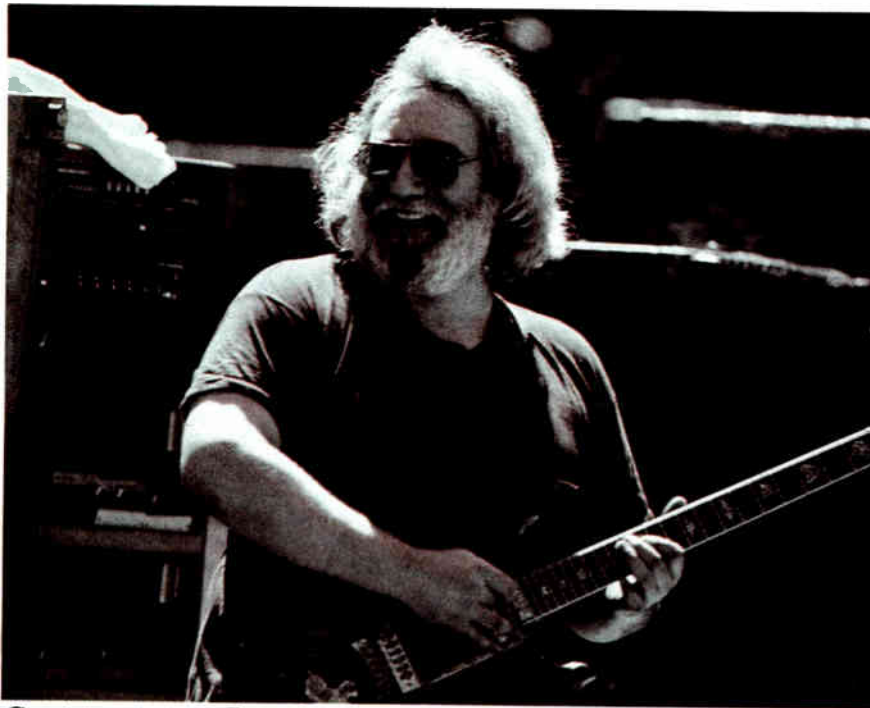

PHOTO: RON DELANY

an audience.

We've been treating it as kind of a hybrid between a live record and a studio record. We've overdubbed the vocals—that's the thing that makes it a studio record—but apart from that, it's pretty much the way we played it. There are eight tunes, if we can get 'em all on there. We have a time problem. All the tunes are long, just like they always are.

**Mix:** This is the group's first album of new material in eight years, and the last one owed Arista. What's next, recording-wise?

**Garcia:** Who knows? The band's been playing really well, and we've also just finished up a video project.

**Mix:** Like a live concert, or documentary?

**Garcia:** No, it's another effort to make a single, *seamless* piece, which in this case is 55 minutes long.

**Mix:** More of a work of art?

**Garcia:** [laughing] Yeah, you could call it a work of art. A work of *something*. We actually did almost the same thing for this that we did for the album. We rented the same room over a year ago, and we played live with no audience, and derived the basic footage of the band live—sort of playing for the cameras. But that's not what it's about, really—it's just the basic *spine* of the thing. It is pretty effective. It's another one of those things—well, I'm too close to it; I've lived with it too long to be able to judge adequately. It's one of

## THE FAR SIDE

By GARY LARSON



16th-century Mana wanna-bes.

## Jerry Garcia Is Taking Better Care of Himself

by Rip Rense

Jerry Garcia sat, smoking Pall Malls, in the '40s-esque lobby of the Sheraton Town House Hotel near downtown Los Angeles. The ornate mirrors, crushed velvet couches, the old red-suited bellhops, looked like something out of Raymond Chandler, but Garcia, Cheshire-like behind dark, aviator-frame glasses, looked more like something out of Kurt Vonnegut. Kilgore Trout meets Philip Marlowe. . . .

It was a wonder that Garcia was there at all, really—let alone that he was happily chatting away about the current state of affairs with the Grateful Dead and other ongoing experiments. Last July he was rushed to a Marin County hospital in a diabetic coma, the result of exhaustion coupled with less-than-perfect health maintenance. He lay for three days at the brink of death, friends and family at his bedside, then quite miraculously pulled out of it. "Grateful to Be Alive," the headlines read.

Garcia was released from the hospital at the end of July, just before his

44th birthday, and subsequently completed what doctors termed a remarkable recovery. He resumed music again with his own Jerry Garcia Band in October; the Grateful Dead set up shop anew in December.

To look at the white-bearded guitarist, you wouldn't guess any of this. He seemed, in fact, healthier than he has in several years, and decidedly less overweight. He was almost merry, a few hours before going on stage at the Wiltern Theatre for what was to be a memorable concert with the Jerry Garcia Band. (His ever-lyrical guitar was as chipper as he was.)

**Mix:** I can boil all the questions down to one, I think. What's new?

**Garcia:** Ahhh, well, let's see. . . I think probably the newest thing is we've got a new record that's almost done. [See "Playback" this issue—ed.] All I can tell you is that it's all of our most recent material; it's all original, and it sounds really pretty good. We rented the Marin County Civic Center auditorium, which is a small, tasty room. We went in there for a couple of weeks and set up as though we were going to play live—didn't do any baffling, didn't make any studio-type preparations, and we just *played*. The point is that we approached it as though we were playing live, but we didn't have



# CARVIN MX2488 \$3995!

The American made mixer that leads in value!



The CARVIN MX2488 console offers the features, specs and performance you expect from a professional recording console—at a price that's unexpected. That's because CARVIN sells DIRECT, saving you about half the retail price—no commissioned sales men or store overhead to pay.

The MX2488 is versatile. It handles every recording requirement with ease, from basic tracks to overdubs and mixdowns.

The MX2488 is professional—right down to its modular design and outboard rack power supply. A recent MX1688 test review quoted: "Total harmonic distortion at mid freq. measured only .025% while line inputs measured only 0.01%—very low for a console of this type."

If you want a transparent sound that fits into today's "digital" recording world, then the MX2488 is worth considering. Write for literature and a recent test review or send \$10 for the complete manual (100 pages) including schematics and circuit layouts.

## MX2488 RECORDING FEATURES

- Eight track studio control center
- Quick tape playback & rough mix capability
- Three band parametric EQ with defeat
- Complete cue mixing facilities
- Four auxiliary busses with pre-post switching
- Two effects returns with panning and soloing
- Patch jacks and direct outputs on each channel
- Solo & mute on all input & output channels
- Built-in talkback system & monitor diming

## FACTORY PRICES

		LIST	DIRECT
MX2488	24x8x2	\$8995	\$3995
MX1688	16x8x2	\$6950	\$2995
MX1644	16x4x2	\$4595	\$1695
AN-16	16ch Anvil case	\$ 395	\$ 269
AN-24	24ch Anvil case	\$ 469	\$ 299

Made in USA

*"Having lived with the Carvin MX1688 for a couple of weeks before reluctantly sending it back to the manufacturer, I can attest to the fact that it is truly targeted at the professional recording engineer or sound reinforcement engineer."*  
*"It is obvious that the people who designed this unit spent a lot of time in both recording studios and at concerts where sound reinforcement is both critical and complex."*  
 Len Feldman—db magazine  
 September/October—1986

# CARVIN

Dept. MX77, 1155 Industrial Ave.,  
Escondido, CA 92025

Order Direct Today—Visa, MasterCard  
Factory Hours: Mon.-Fri. 8:00-4:30 Calif. Time

Call TOLL-FREE  
800-854-2235 (Calif. 800-542-6070)

World Radio History

Free Catalog \$10 enc. for MX88 manual  
 Name \_\_\_\_\_  
 Street \_\_\_\_\_  
 C. V. \_\_\_\_\_  
 State \_\_\_\_\_ Zip \_\_\_\_\_ MX77

# YOU'VE NEVER HEARD DRUMS LIKE THIS.



## THE F16 DRUM COMPUTER.

**F16** Now, through the power of 16 bit digital sampling technology, there is a drum computer capable of reproducing any sound with the clarity and brilliance of a compact disk: sounds so amazingly precise it's shocking.

The F16 provides from one to sixteen modular voices that will alter your percussive perspective forever. Full 16 bit samples with 96 dB of dynamic range. Imagine a crash cymbal sampled at 50 KHz that plays for 6 startling seconds; or a tom that booms for 22 seconds or more.

Each voice has independent tuning, volume and pan controls, and is available through direct outs or the stereo mixer. Mic and line inputs make your sampling easy, and editing commands allow you

to trim and move samples at will. Save your sounds on the super fast high capacity floppy disk drive.

Driving the F16 from pads, pre-recorded drum tracks or your drum machine's trigger outs, the response time is a blinding 100 microseconds! It's dynamic sensitive, of course, with MIDI in, out and through.

The F16 is rugged, reliable, and simple to use. And, it sounds incredible.

Best of all, prices start at under \$2,500 and voice modules are easy to add.

Prepare yourself. Forat Electronics is about to propel you and your music into dimensions of sound that previously existed only in the farthest corners of your imagination.



### FORAT ELECTRONICS

11514 Ventura Boulevard—Unit 1, Studio City, CA 91604 (818) 763-3007



those things: a Grateful Dead effort at describing the indescribable. The fact that it's in the video medium is coincidental. Other than that, there is no relation to the commercial concept of a video. There are songs, working one into the next, but not with normal segues. It has familiar things, but they're put together in an unfamiliar way. I really don't know exactly how it's gonna come out. It may be a little hard to look at; it has some powerful images.

**Mix:** Anything you want to say about your adventures of the last year?

**Garcia:** Oh, you mean my *illness*? [He laughs here, a bit like Ed Wynn.] Oh, well... Yeah, it changed me. I'm definitely a different person than I was before that. I came out a little scrambled.

**Mix:** How?

**Garcia:** Well, being in a coma is a weird thing. When I came out of it, I had the sense of *not knowing* stuff. I had to kind of put everything back together again. It was as though all my information and my memories and everything had been dumped into the random access tank and stirred up. So there was a lot of fishing around. I still do it sometimes: I have to fish for words, and concepts, sometimes—things that used to come real fast. I haven't been able to find any huge open holes, so I don't think there's anything permanent involved. At my age, it's a reminder of my own mortality—like hey, uh, you could *die*. The most surprising thing was the way it crept up on me. I didn't really feel like I was sick at all, then I woke up in the hospital. That was the weirdest thing about it.

**Mix:** Can't imagine.

**Garcia:** Yeah, me neither! *It was a long way from what I was thinking at the time*. Now I think I know what to listen for, what to look for. If it started to happen to me again, I think I would know. Apparently, I've recovered pretty thoroughly, and it hasn't left anything permanent—not so you could tell.

When I was in the hospital, the thing I found myself thinking was, "Boy, when I get out of here I'm going to play as much as I possibly can." I mean, I'd rather be doing anything else than lying in a hospital. It was that kind of experience for me: a time to possibly realign some priorities.

**Mix:** How did you feel at the first concert back with the Grateful Dead last December?

**Garcia:** There wasn't a dry eye in the house, man. It was exciting; it was great to be able to play again. And the

—CONTINUED ON PAGE 148

## Tired of Shopping?

Whether it's consoles, 24 track recorders, signal processing or video gear, we are in the business of helping you define your needs, equipping you with the best products available and being on hand to help you complete your project.

Over 180 major lines and a capable staff makes us a company you can rely on to meet your audio and video needs.

**NATIONAL SOUND & VIDEO ENGINEERING**  
A Step Ahead

1756 Wilwat Drive, Suite A  
Norcross, Georgia 30093  
(404) 447-1717



Circle #094 on Reader Service Card

## The Stocking Screen

... A twin membrane system providing excellent breath-pop protection and superior transparency throughout the vocal bandwidth. Standard 5" mount. Colors in Pink, Aqua, Black, or Studio Grey.

**For the dealer nearest you: (201) 739-9162  
or make check for \$49.95 payable to:**

*The Stocking Screen* Box 635, Keyport, New Jersey 07735

USA MasterCard

(NJ credits add 6% tax)

Circle #095 on Reader Service Card

# Nobody gives you more sound for less than Sam Ash.

**Y**ou'll find everything you need to make music at Sam Ash at consistently low prices. It's a fact that Sam Ash has been filling America's playing and recording needs for more than 60 years. So whatever your needs may be, you'll find that the helpful and expert people at Sam Ash will bring music to your ears.

YOUR SOURCE FOR MUSIC AND SOUND

Call Toll Free: 1-800-4-SAM-ASH  
OR 1-718-347-7757



124 FULTON AVENUE HEMPSTEAD, N.Y. 11550 **MUSIC STORES**

Circle #098 on Reader Service Card

## MegaMix™

### FINALLY!

A High Quality, Professional AUTOMATION System at an AFFORDABLE Price.

Easily interfaces to your existing console.

- Full fader automation
- Mute and solo
- 8 Subgroups
- Real time and step edit
- Mix merge
- Copy, bounce, delete fades
- SMPTE compatible
- Runs on IBM and compatibles and
- Macintosh 512 & Plus

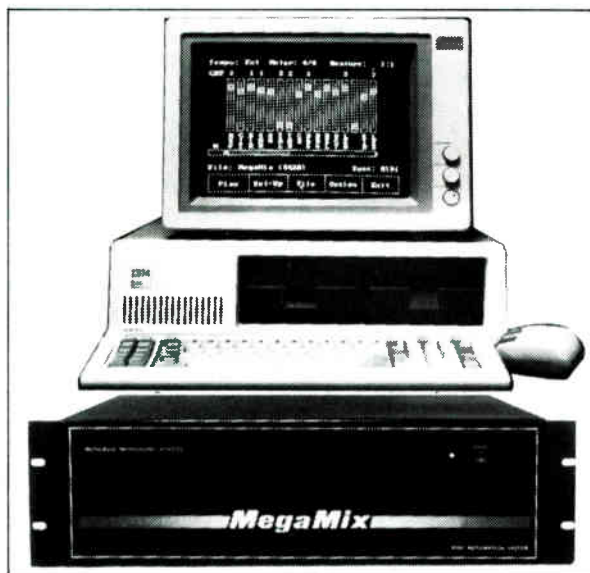

PATENT PENDING

## MIDI BASED MIXING BOARD AUTOMATION ON YOUR PC

Musically Intelligent Devices  
3 Brian Street, Commack, NY 11725

516 864-1683

Circle #099 on Reader Service Card

was flat, without any echo or electric enhancement," Ronstadt reports. "I kept listening to it and going, 'It sounds a little dead, doesn't it?'"

"I was in the studio with the engineer because I mixed it, and I was saying to him 'Why does it sound so flat?' He says, 'Well, I was trying to make it sound acoustic . . .'" So I said, 'But, we used electric instruments on it—just mix it like an electric record. Mix it for what it is.' As soon as we did that, we threw on all the extra echo and the EQ and fun stuff, it really just blossomed."

The three took great pains to find material that was in keeping with the album's old-timey, acoustic feel. Many of the songs are country classics; others are more recent. If Porter Wagoner & Dolly Parton's "The Pain of Loving You" is already a country favorite, a song like Kate McGarrigle's "I've Had Enough" is one that might otherwise have gone unheard.

Ronstadt was the chief orchestrator of the antique song notion; yet for the dark-eyed singer it was Linda Thompson's recent "Telling Me Lies" that stood out as the embodiment of the project. "In a sense, we were singing something that would date from 1907 to 1987. We wanted music that would be able to span that time without any real problems, and this song sums that music up in a way and brings the music to today, which I really liked. It's kind of like time travel in a song."

"Emmy found the song. Linda Thompson is a friend of mine, but Emmy is an admirer of her voice and her songs, as I am. But I was thinking more in terms of old, old, old songs and Emmy is the one who had the insight to realize that Linda is a traditional singer and even when she's writing contemporary songs, stylistically those songs contain so many traditional elements that there's no way she could escape it."

Given these three women's high profile in the public eye, their collaboration may help reintroduce traditional country music to the masses who may have been turned off by the glut of glop during the reign of the Urban Cowboy. That makes Emmylou happy.

"I love Porter Wagoner, and he's represented on this record," she says. "I can't imagine anyone hearing 'If Tears Were Pennies and Heartaches Were Gold' by Porter and Dolly, and deciding that it's not the most wonderful thing they've ever heard. But they don't play it on the radio any more, and they should. Maybe if they play us, then they'll go back and add some of those old Dolly and Porter songs."

Jean Richie's "Dear Companion," which the trio debuted on the Country Music Association Awards show last fall, holds special significance for



Harris. "I've had it on my favorite-songs cassette since 1979, but I hadn't had a project it was right for," she explains. "So when Linda said, 'Let's get together and talk about songs,' that was the first song I put on my tape. It was also the first song we listened to and the first song we decided to do. It sounds like it's centuries old."

Ronstadt continues, shedding some light on the threesome's underlying motives: "What makes me sad is that there are so many good acoustic players and songwriters. 'Dear Companion' is a modern song, even though it sounds like it could've been written in 1910—that's a *new* song that somebody was writing out there that might otherwise have been swept under the carpet. But we felt it was a beautiful song that deserved to be heard."

But there's more to *Trio* than just a platform for the pro-acoustic country movement. "We did it for the most self-ish reasons: we enjoyed it," says Ronstadt. "But it's nice in that it's serendipitous—something has emerged from our enjoyment of each other. By doing this record, we're validating the traditional acoustic music that we've always loved and felt wasn't getting the spotlight it deserved."

Another factor in the constant battle for authenticity was Parton's Smokey Mountain roots. There's no one in this world who'd ever try to deny that Dolly is country—especially given her aching delivery of "Those Memories of You."

"Somebody said 'Oh, it must be nice getting back to your roots...,'" Parton recounts with mock indignance. "But I never left 'em! My roots are my roots; that's just so much a part of me."

"I contributed the old mountain songs like 'Farther Along' and 'Rosewood Casket'—songs my mother had always loved and sung. Plus, I was helping with the phrasing on those traditional songs, helping them with certain phrasing they liked and thought was real honest."

The list of players on *Trio* is a veritable who's who: Albert Lee, Ry Cooder, Mark O'Connor, Leland Sklar, Russ Kunkel, Herb Pedersen, Kenny Edwards and Steve Fishell—and the musical anchorman, multi-instrumentalist David Lindley.

"It was so-o-o exciting getting to work with musicians we've admired for years," Ronstadt enthuses. "We knew all the musicians and how they play, so we knew exactly who to call for each little stylistic thing. We know that if we want an odd instrument like dulcimer or autoharp, you call David Lindley because he's got every instrument in the world—and he brought them all!"

"It was so amazing. We walked in

the first day and there was a whole room where David had all his instruments spread out: Hungarian saws, Swedish harpolecks, hurdy gurdys and fiddles, mandolins and banjos, plus every kind of steel guitar you can imagine. We just walked around going *plink-plonk* on all of them. It was like being in a musical museum, seeing them all spread out like that."

Though there's some talk of concert dates, things remain up in the air because trying to get the three women's schedules to mesh is nearly impossible given their commitments for the coming months. Parton has her first CBS pop album to record (followed by a straight country LP), as well as the opening of Dollywood and her own

TV show; Ronstadt is working on collaborations with New Orleans R&B legend Aaron ("Tell It Like It Is") Neville and Lindley as well as her own album of traditional Mexican songs from the first half of the century; and Harris has an album of spirituals due out in the spring, to be followed by a tour with the Hot Band.

Though nothing is definite, nothing has been ruled out and fans of these women individually and collectively can take heart from that fact. Talking about "Calling My Children," an a capella song popularized by the Country Gentlemen which didn't make it to *Trio*, Harris may have just tipped the group's hand.

"We've got it in our hip pocket if

# FROM CONCEPT TO REALITY...



## ...BUILT TO PERFECTION

### VIP-50

Multi-pattern transformerless condenser. Unique rectangular dual membrane capsule. Switchable pre-attenuation pad and high pass filter. For professional studio use.



Distributed by:

### EXP

11288 Ventura Blvd., Suite 304  
Studio City, CA 91604  
(818) 843-1830  
TELEX 4900006950 E - MAIL IMC 2140

# RECORDING EQUIPMENT

—All Major Brands—

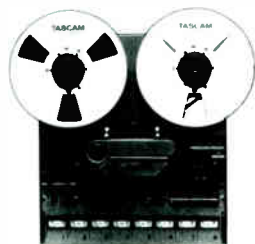

## FOR STUDIOS/HOMES CHURCHES/CLUBS

- Reel to Reel Decks (2-4-8-16 Track)
- Cassette Decks • Mixing Boards
- Mikes • Studio Monitor Speakers
- Special Effects Units Accessories

**TASCAM**  
Hi-Fi Production Products

- VOLUME DEALER
- NEW & USED
- QUALIFIED LEASING
- ALL MAJOR CREDIT CARDS
- PROFESSIONAL ADVICE



## RHYTHM CITY

287 East Paces Ferry Road N.E.  
Atlanta, Georgia 30305  
1-404-237-9552 • 1-404-237-8526  
CALL TOLL-FREE IN GA 1-800-282-7995

Circle #101 on Reader Service Card

there's another record," Harris confesses. "If there isn't, that's okay, too, because this album is what we wanted it to be. And if we do another album that's fine, too. We'll have plenty of material because we started a list during the recording of this album."

Ronstadt echoes Harris' satisfaction: "For once I'm totally pleased with the way a record came out. This is exactly the record we wanted to make. We had the support and help of all those people who were rooting for a real good acoustic record and had always had it in their dreams to see an all-acoustic record featuring traditional material without any attempt to make a record that's commercial enough for the Top 40."

Pausing for a moment, she continues unapologetically, "I've got nothing against that kind of music—I've made my living singing Top 40 songs, but it's nice to have the luxury of being able to simply consider only what we want to do in our hearts." ■

## Birthin' Music With General Public

by Moira McCormick

Recording your second album with the specter of a sophomore jinx looming above can be nerve-racking enough. Imagine trying to crank out LP number two when you, your band-mate, your producer, and a pair of engineers all become fathers during the process.

Strange but true. It happened to General Public, whose latest IRS Records offering, *Hand To Mouth*, was released last October. The album took ten weeks of actual recording to put together (and three weeks of repair work—more on that later), but the time span encompassed January through July 1986. According to Dave Wakeling, singer and rhythm guitarist (who co-founded the group with fellow ex-English Beat member Ranking Roger, who sings, toasts, and handles keyboards and percussion), recording sessions were regularly interrupted by the ringing of their special maternity telephone.

"We had a 24-hour, no-interruptions phone called the Birth Line," Wakeling relates. "As soon as it rang, we all knew we'd got a week off. We'd pick it up and go, 'Hello, who's gone into labor now?'"

By album's completion, not only was Wakeling a proud new pa, but Ranking Roger had his second child, and the stork had also visited producer

## One Stop Service Quality Products Timely Deliveries

Let the quality of your graphics reflect the excellence they can expect to find in your music.

Stoughton Printing can provide all your record and video related printing and packaging. Direct board record jackets, 7 and 12 inch sleeves, labels. The finest in UV Coatings. All done in house. CD booklets and inlay cards, posters, box wraps and any other graphic material you may need to promote your products.

If it's worth doing, it's worth doing right. Come to the source . . . We're there when you need us.

## stoughton printing co.

130 N. Sunset Avenue, City of Industry, CA 91744  
From Los Angeles: (213) 686-2753  
(818) 961-3678

Quality Printing For The Record Industry Since 1965

© 1986 Stoughton Printing Co.

Circle #102 on Reader Service Card



# RANDOM SAMPLING

Volume I

Notes and News from Kurzweil Music Systems

Issue No. 1

Introducing **RANDOM SAMPLING**—from Kurzweil Music Systems. **RS** really isn't an ad or an editorial. It's a synthesis of the two...with a touch of fun so we don't get bored. You'll be seeing **RS** in music magazines everywhere...and at your local Kurzweil dealer...so you can keep up with all the special news from Kurzweil! **SPEAKING OF SPECIAL**... how about the new **Sound Modeling Program™** for the Kurzweil 150 Fourier Synthesizer? Using the 150's additive synthesis capabilities, **SMP** manipulates the frequencies and amplitude envelopes of up to 64 partials right on the screen of your Apple IIe. The result: an infinite number of **new** sounds! **SMP's** price is just as incredible...**FREE!** You do need Version 1.6 software for your 150FS...but that's free too. If you haven't checked out **SMP**... well... what can we say? **TAKE FIVE**... a quick five... because **Patrick Moraz** is joining the **Moody Blues** tour June 12-July 17...fully "**Kurzweiled**"... and again August 24-September 6. Can't catch the tour? Patrick's "**Human Interface**" solo album is due out in early June...and like he says, it's "about 90% Kurzweil." Now that's music to your ears! **TAKE FIVE, TOO**...with Advanced Electronic Music Production's **Phil Shenale**. Using a Kurzweil K250, Phil's programmed keyboard

and percussion parts for movies like **Little Shop of Horrors**... major studios like **NBC** and **Tri-Star**... stars like **Rick Springfield** and **Barry Manilow**... and **Jack-in-the-Box** and other commercials. Phil starts a new **Olivia Newton-John** album in June. He says, "The Kurzweil is at every session—always." Next on Phil's list? "I want to expand **AEMP** to 24 tracks... and add one or two **250RMX's!**" **DID SOMEBODY SAY 250RMX?**... All right. We knew the **250RMX** would be hot...but how hot can you get?! We've kicked production right in the ROMs to meet the demand. So if you've already ordered a **250RMX**, don't worry. It's on the way...**soon!** After all, our ROM wasn't built in a day. **KURZWEIL OWNERS ... WHERE ARE YOU?**... What?!! You haven't sent in your warranty card? How are we supposed to send you our quarterly newsletter and update notices? Send your name, address, and Kurzweil serial number to: **Kurzweil Music Systems, Inc., 411 Waverley Oaks Rd., Waltham, MA 02154**. And if you need to locate a Kurzweil User Group let us know and we'll help you find one. ... So what do you think about **RS**? We want your **feedback!** We want to hear from you! Who knows? You might just see your name in print! Now wouldn't that be news?!?

# OUTSTANDING

- SOUND REINFORCEMENT SERVICES
- RETAIL PRO-AUDIO EQUIPMENT
- REMOTE RECORDING SERVICES
- STUDIO RECORDING SERVICES
- AUDIO SYSTEMS CONSULTANT
- CUSTOM AUDIO SYSTEMS DESIGN
- SOUND CONTRACTING SERVICES
- AUDIO SYSTEMS MANUFACTURER

**ATM AUDIO**  
**[213] 375-7673**

#6 Masongate Drive, Rolling Hills Estates, CA 90274

Circle #104 on Reader Service Card



**The Masters  
of Sound  
Sculpture**

When it comes to quality record manufacturing and cassette duplication, QCA has no equal.

2832 Spring Grove Ave.,  
Cincinnati, Ohio 45225  
513/681-8400



Circle #105 on Reader Service Card

David Leonard (who's engineered Prince and the Bangles) and engineers John Shaw and Sidney Burton. When *Hand To Mouth* was finally released, it had been two years since General Public's well-received debut, *All The Rage*, had come out.

Despite Wakeling's concurrence with Stevie Wonder's statement that "anyone who can bring out an LP quicker than two years after the one before obviously doesn't know what he's doing" (Wakeling's paraphrase), he says he's aware that two-year gaps don't sit well with record companies. Fortunately, IRS "manages to deal with the commercial aspects" of making albums "and still treat you as a human being," according to Wakeling. "They understand there's lots of human situations that can come between you and a release schedule.

"I mean, we did have some arguments," Wakeling continues. At one point, IRS president Jay Boberg hopped on a plane to the band's home base of Birmingham, England, in order to get some kind of commitment on the album's completion.

"At least in human terms, it was very easy to talk to Jay," Wakeling says. "I said, 'Look, if you're not satisfied, go and have a cup of tea with my wife Dominique, she'll put you straight. She'll tell you, as soon as she starts getting contractions, I'm off. And if I miss it, you can make me a multimillionaire, and still my life's gonna be a misery.'

"I don't think I could have had that sort of conversation with a lot of record companies I've visited," Wakeling reflects, "where a lot of people don't care much about you."

Wakeling says he's more pleased with the end product, *Hand To Mouth*, a shiny chunk of rock and R&B and reggae, than he would have hoped during the fairly excruciating recording process. And we're not talking babies now—we're talking an uncomfortably (for Wakeling at least) high-tech atmosphere, and a maddening snafu that set them back three weeks.

The band (which in addition to Wakeling and Roger includes former Specials bassist Horace Panter, ex-Dexy's Midnight Runner Mickey Billingham [both original members], and new guitarist Gianni Minardi and his drummer brother Mario, both of Laguna Beach, CA) had just settled into Martin Rushent's Genetic Studios near Reading. They'd put down basic tracks at UB40's facility, the Abattoir, in Birmingham (which actually was a slaughterhouse decades ago—Wakeling says his father used to "go there and get free buckets of maggots to go fishing").

General Public proceeded to record three weeks' worth of instrumen-



tal overdubs at Genetic. When they mixed the two sets of tracks together after laying down vocals, they found to their horror that they weren't in tune with each other. "Depending on which slave tape you preferred in the rough mix, I was either in tune beautifully or sounding like a dog," Wakeling grimaces.

Turns out the spindle on one of Genetic's recorders was too big, resulting in the mismatched tuning. "It was only a few guitar bits, a few keyboard bits, bass on a couple of the tracks, but we had to redo everything that was out of tune," says Wakeling.

As it happened, re-recording the tracks proved an unexpected boon in some ways. "In places where I had to do the guitar track again, it was good, because by the time I'd finished the overdub, I knew how to play it properly," says Wakeling. "So having to do it a second time really wasn't that bad. We got a free three weeks from the studio."

What struck Wakeling as most ironic about that situation was that it occurred in an ultra-high-tech environment, where sound was evaluated by number rather than by ear. "You'd say, 'It doesn't sound right,'" he recalls. "Somebody'd whip out a calculator



Dave Wakeling (top) and Ranking Roger.

## Piano still sound less than grand?

C-ducer contact mikes capture the true sound of acoustic instruments.

C-ducer picks up virtually no ambient noise on piano, drums, and acoustic stringed instruments, with no problems of feedback or spillage. The C-ducer tape is supplied with a choice of preamp offering studio compatibility, 24-48V phantom powering or a hi-z output from the battery-powered range.

The Acoustic Percussion Trigger enables drummers to achieve an excellent mike sound from their kit while simultaneously triggering electronic drums - **Now with MIDI!**

From the Moody Blues to Opryland and from Abbey Road Studio to your home studio, C-ducer makes miking easy!

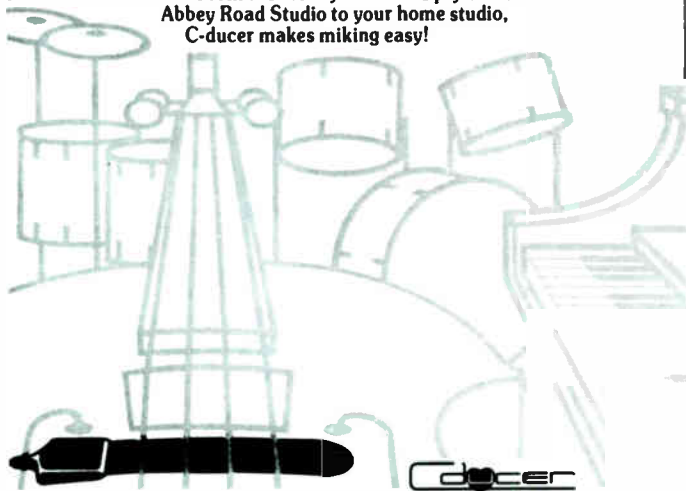

## Noise Gates Should be Seen & Not Heard

With its unique application of optical switches (rather than the noisier VCA's used conventionally) the Omni Craft offers very low noise & high performance - at an affordable price.

Just \$395.00 buys you four noise gates in an AC powered/rack-mounting package, with facilities to "key" the gates from external triggers as well as adjustable Range, Threshold and Release Time.

Also available are plug-ins for most popular rack systems. Studio performance for the budget-conscious! Call us for literature & information.

**Omni Craft - - - the quiet one!**

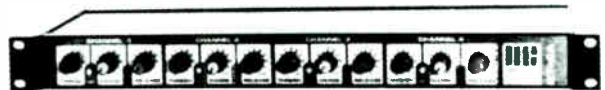
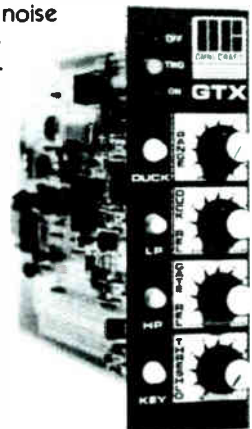

**CALL 1-800 CT AUDIO**

**C-T Audio, South Tech Industrial Plaza, 3050 SW 14 Place, Suite 3, Boynton Beach, FL  
in FL call: 1-305-738-0622**

Circle #106 on Reader Service Card

## Puzzled about Pro Audio? Leo's has the solutions.



Recording & Midi Systems  
for Stage or Studio.



**leo's audio  
and music  
technologies**

Anticipating the needs of musicians  
and audio professionals since 1956.

5447 TELEGRAPH AVENUE  
OAKLAND, CA 94609 • (415) 852-1553

Circle #107 on Reader Service Card

## CLEAN PATCH BAYS NO DOWN TIME

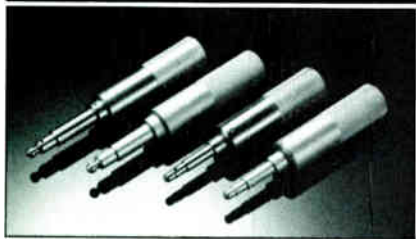

### VERTIGO BURNISHERS AND INJECTORS RESTORE ORIGINAL PERFORMANCE TO YOUR PATCH BAYS

**VERTIGO 1/4" TRS AND TT BURNISHERS:**  
Each used to eliminate noise caused by contamination  
of main contacts in normal patching situations

**VERTIGO 1/4" TRS AND TT INJECTORS:**  
Each allows injection of cleaning solvent in breaking  
contacts (normals), to eliminate intermittency that  
occurs when patch cord has been removed

**STILL ONLY \$29.95 Ea.** (Cont. USA)  
Please write for additional information and order form  
Used by Professionals Worldwide Patent Pending

### VERTIGO RECORDING SERVICES

12115 Magnolia Blvd #116  
North Hollywood, CA 91607  
Telephone: 818/769-5232  
Telex: 5106006748 VERTIGO RECRD

Circle #108 on Reader Service Card

and go, 'Well, it is .9527 Dave.' I'd say, 'Yeah, but it sounds like shit, doesn't it?' 'Well, I'll check it for you again on the calculator.' That's not what I mean!

"There were rooms full of people with calculators going, 'It's .9527 Dave, it should be in tune.' I know, but it's not in tune, is it! We should really have had a tuning note in the studio, but we didn't."

Wakeling indicates that if he could do it all over again, he'd want more of an old-fashioned approach in general. He lets on exactly how unimpressed he was with the welter of "metronomes, click tracks, sequencers, sampling—oh sampling, that's the best bit, that is. Seven hours of the same snare drum, and then you put it in the mix and it sort of sounds like a snare drum. But actually isn't as good as somebody going in there and hitting the drum with a stick."

Following the success of *All The Rage*, which boasted 1984's top dance hit "Never You Done That"/"Tenderness," General Public tried to do it one better by hiring L.A. hit engineer David Leonard as co-producer, and taking the machine approach, Wakeling admits. "It's the modern way of making records," Wakeling says airily, with more than a hint of sarcasm. "We wanted to try and get character, but as Rimbaud says, you should always be modern.

"That's why we wanted David Leonard. He seemed to be somebody who could combine technology with feeling, to try and get somewhere between the two. A lot of machine-generated tracks are, for me, completely soulless.

"Sampling, unless it's very cleverly done, can never be as expressive as the emotional dynamic that a group of musicians who feel for each other can do.

"I think one of the reasons I loved so many songs from the '60s," Wakeling continues, "was because they're almost exactly twice the speed at the end as they are at the beginning. You can [do that with machines]—putting your chorus up .7351—but it ain't the same as stamping your foot once and the drummer seeing it."

"We only used sampling on one song—'Too Much Or Nothing' [the first single]," David Leonard notes. "The band loved it, but David hated it from the first minute."

"The more technology you put between you and the piece of plastic, the more chances it's got of going wrong," Wakeling reasons. "Yet it's not the machines' fault—it's really the people using 'em who don't have a clue." Wakeling's partner, Roger, he notes, is his polar opposite when it comes to matters of technology. "His songwriting is modern in Rimbaud's sense,"

he says. "He writes to machines, whereas I tend to write melodies on acoustic guitar."

"We remixed 'Too Much Or Nothing' three times," says Leonard, "first with Roger—which is the one we ended up using—and twice more with Dave. He liked it, but the record company didn't."

Wakeling notes that some of the problems inherent in using sampling—such as lack of ambience in drum sounds—were made up for in different ways. "We had a drum kit playing along with the drum machines," he describes, "so we kept the ambience that the kit created in the room."

However, he says, "I think I preferred it on the first LP, where it had a definite backing track that sounds like your drummer sounds." All the gadgets, he says, sometimes had the effect of "making me feel real old-fashioned. Suddenly in the middle of a 48-track studio, blinking lights, I felt like going to the nearest 16-track and wailing me 'ead off."

Wakeling promises he'll never go through another album relying on calculators and blinking lights. Next time around, he says, General Public will take a "more primitive" approach. "Most of my favorite records have got feel," he says. "It's a very interesting operation, trying to artificially create feel. I think I'd rather just sit there and feel it, thanks a lot." ■

### —FROM PAGE 139, MUSIC NOTES

Grateful Dead is like nothing else. You never know whether you can do it or not; you can't rehearse for it, you know. We rehearse, but there's nothing that amounts to the kind of energy involved. You cannot get up for it; only doing it makes you able to do it—no amount of preparation. It was a situation where we hadn't played for a long time. I think it was the longest we'd ever laid off. *What's it gonna be like, what's it gonna be like?*

It worked out pretty well. The first night, I think [guitarist Bob] Weir forgot maybe 80% of the lyrics [laughter]. But then the next couple of nights were great.

**Mix:** At last night's [Garcia Band] show you played a lot of Dylan material—more than I'd ever heard you play before.

**Garcia:** I love his tunes. They're the kind of tunes you can sing and make your own, you know what I mean? I can sing them because there's some emotional reality in them. I have a hard time singing lame lyrics. Dylan has that thing of being able to say what you mean so eloquently; you can



grab his songs and sing them and it's *real*. He just has a real high percentage of those songs. I love 'em and I do a lot of 'em.

**Mix:** I know you've long been partial to a few Beatles tunes. Last night you did that driving version of "Dear Prudence"—

**Garcia:** I'll tell you where *that* comes from. [Garcia Band bassist] John Kahn and I were driving somewhere when we heard this rhythm and blues version of "Dear Prudence" on the radio. It had the most incredible groove to it. Years went by, and we were talking about tunes one day and remembered that. We didn't know anything about it—who recorded it or anything. We started looking around, but we never found it. So we were trying to reconstruct what we felt it was sort of like. It's really our interpretation of an event that may or may not have happened. It's a great tune, and I had never thought about it as a tune until we heard this incredible R&B version with this amazing and relentless groove [laughter]. So that's sort of a musical hallucination.

**Mix:** You've owned the movie rights to Kurt Vonnegut's novel *The Sirens of Titan* for many years. What's the status?

**Garcia:** We finally have a good, good second-draft script. Tom Davis of *Saturday Night Live* wrote it, and I'm real happy with it now. So we're down here [in L.A.] periodically, flogging it. The script has definitely gotten to a place where it's getting yummy. I don't care how long it takes. I'm not in any rush about it. It's one of my favorite projects. I really got involved in it to protect it as much as anything else, because I loved the book so much. I think it could be a wonderful movie, and I want to prevent it from being a bad movie. Maybe we'll have some action on it in the next year or so.

[Ken] Kesey said this great thing about scripts. He said he had his people conduct this informal survey while they were in Hollywood, just asking people on the street how their script was doing. Eighty-nine percent of the people said, "Oh, pretty good, you know." So it's one of those things. There's a virtual thunderstorm of scripts, so you have to do a real song and dance to get any attention at all.

**Mix:** Of all Vonnegut's books, this one would seem to have the most *linear* story.

**Garcia:** It's a much more cinematic thing than the others. Of all of Vonnegut's stories, this one actually has an A to B to C sequence, which makes it more adaptable for movies. We've man-

## Record Engineering & Video Courses

Complete courses in Record Engineering, Disc Mastering and Video Production taught in Professional 24 Track Recording Studios and Color Video Production Center.

**Free Seminar** including Studios tour

Job Placement Assistance  
Upon Graduation

SOUND MASTER



RECORDING ENGINEER  
SCHOOLS  
Audio/Video Institute

FOR FREE BROCHURE &  
SEMINAR RESERVATION  
CALL (213) 650-8000  
or write Sound Master  
10747 Magnolia Blvd.  
N. Hollywood, Calif. 91601



Circle #109 on Reader Service Card

## 2 Ways To Duplicate Your Master Audio Tape For Demos Or Retail Sales

### AUDIO CASSETTES:

Eva-Tone is a full-service supplier, offering duplication, labeling, packaging, additional printing and complete mailing services. Write or call for your free copy of "Cassette Talk," our newsletter complete with information, specs, layout sheets and prices.



### SOUNDSHEETS:

Use these thin, flexible vinyl recorded discs as audio pages in magazines, as direct mail inserts, as handouts at concerts or trade shows, or even as retail products. Write or call for your free copy of our Soundsheet Idea Kit, complete with information, samples, specs, layout sheets and prices.

### PRINTING & MAILING:

Ask your Eva-Tone Representative about our commercial printing and mailing services, too. We just may be the full-service promotional supplier you've been looking for!

**EVA-TONE**  
INCORPORATED

P.O. Box 7020-MX, Clearwater, Florida 33518-7020  
Toll-Free 1-800-EVA-TONE (In FL: 813-577-7000)

Circle #110 on Reader Service Card

# flexibility!

## Littlite®

Gooseneck Lamps & Accessories

mixing consoles, amps,  
turntables, effects racks,  
multi-tracks, synthesizers,  
music stands, drum machines,  
keyboards, orchestras,  
d.j. consoles



Littlite/CAE, Inc.  
P.O. Box 430  
Hamburg, MI 48139  
313/231-9373

Circle #111 on Reader Service Card

## MIX 10TH ANNIVERSARY ISSUE

August  
1987

# Help Us Celebrate!

**Mix**, the world's #1 professional recording magazine, celebrates ten years of serving the industry with a very special August issue. Features will include:

- The Future of Recording
  - Acoustics, Design & Installation Supplement
  - Directory of Designers and Suppliers
- Whether you've been reading *Mix* for ten years or six months, you'll want to read—and save—the Tenth Anniversary Issue.

- **Weird Sessions:** Producers, engineers & artists talk about strange days (and nights) in the studio
- **100 Years of Disc Recording:** A tip of the hat to pioneer Emile Berliner

aged to structure it, pare it down, retain the tone—the Vonnegut tone—without annihilating the weird humor of it.

**Mix:** Have you talked to him about it?

**Garcia:** No, never have, but I'm really anxious to get him to look at the new script. I'm proud of it. I think he would like it. We've got a lot of fascinating nibbles so far, but no real big bites. I don't care how long it takes. I'll wait.

**Mix:** The current lineup of the Garcia Band has been together about eight years now. I take it there has been some growth there, as well as with the Grateful Dead.

**Garcia:** We've been learning lots of different material lately. That's the main thing. The band has just been playing so well. Melvin [Seals] is just a monster keyboard player, and everyone in the band has been really loving it. It's taken a long time to dial it in—a lot of personnel changes. It started off with my own theory about a four-piece band—that you can make a lot of music with just four pieces, provided everyone is thinking conceptually the same way. With four pieces, you can play just about as much as is possible to play and still hear everything. It's like a string quartet or something like that: it's conversational. So the band is starting to really *play*. It works.

It took a long time before I started playing with Melvin to get that thing of being able to make that transition from background to foreground without any loss of energy. It used to be that I could play a solo and go back to playing rhythm and feel the energy fall out. It makes you play stiff. But Melvin has this thing of being able to play really *wide*. He can support a solo no matter what the intensity is, or conversely, no matter how sensitive it is. He really listens and is able to maintain that sense of energy. So the changes from instrumental parts to singing parts, etcetera, are all smooth. Melvin is able to cross all that stuff. Effectively, he's like an orchestra, in terms of what he's able to provide for me to play against.

**Mix:** Has your playing changed since the illness?

**Garcia:** Hopefully, it's always changing some. I don't think it's a result of [the illness]; I think it's just a result of being a musician and liking music. I've been turned on to some great music, incidentally, since I got out of the hospital. I've also started playing around with David Nelson and Sandy Rothman, two bluegrass musicians I used to play with in the early '60s. We've been pokin' around some. That may turn into something. But I've just been ready to be turned on to anything.



**Mix:** Such as?

**Garcia:** I love Peter Gabriel; I'm a fan. I think his music has something real special about it—a certain kind of soulfulness. It's hard to pin down—it's so personal. It takes a little while to get into it, but it's striking. And also his performance is amazing. I don't know where he gets the nerve to do that stuff.

There are a lot of people whose music I like right now. This is kind of a nice moment. I like the Paul Simon album [*Graceland*—a great album with some great players. Also, [Grateful Dead percussionist] Mickey Hart and I did some stuff with some African players. We did some stuff with Olatunji, who is really a remarkable person. He's got a lot of world-class drummers with him. It's really exciting to play with these African musicians, really fun.

And Los Lobos has a good sound. Dave Hidalgo has some wonderful tones in his guitar, steel playing, and that accordion. He's really a tasty musician, a champ—plus he's got a fine voice. It's his taste that I think is sensational. A lot of people play as well as he does, but the choice of what he plays knocks me out.

**Mix:** What other music are you listening to these days?

**Garcia:** All kinds of things. The Allen Brothers. Red Allen, a bluegrass singer, had these three sons—and there's some stuff I've heard of them, well, I've never heard anything so beautiful, man. It's soulful and good. I play the Allen Brothers for all my musician friends.

I always listen to Charlie Parker. He's one of the guys I go to, like for a drink of water. There's this great record store in Mill Valley [in Marin County, CA] called Village Music, and the guy who runs it is a collector's collector. I went there to get some Billie Holiday records, and the bin was full of records! I couldn't believe it. Some I'd never heard of, that had been out of print for years. I came away with a couple hundred dollars' worth of records.

I'm a Charlie Ives fan, too. I like that American stuff. It's weird, but it's all full of all these bits and pieces of American music running through—band music, hymns—it's like listening to 19th century madness or something. I love it. I think America has trouble with that thing of *classical composers*. Charlie Ives is like the soul of America in classical music. Now, slowly, people are starting to appreciate him. He'll never be a Beethoven, but—

**Mix:** Which brings up an anecdote I

heard. You made some reference to Beethoven—something like "I'm not Beethoven"—when you first came out of the coma, right?

**Garcia:** I *heard* that. I don't remember it. It was, like, a bit of cross-patching. Robert Hunter [Garcia's lyricist] was there for that. I think what I *meant* to say was that I may not be great, but I'm alive. I think that's what I meant. When I woke up in the hospital, I was *wired*—I had tubes everywhere—so it was like "*Whatever this is, it's serious.*" I think I was really thinking of Mozart—not so much Beethoven. [Garcia cracked a smile here and chuckled.] I think I was thinking of somebody who was more of a *flash*. Beethoven was a struggler; he had to work for his music. Mozart was *easy*. I was, like I say, pretty scrambled. But the sense of it was that I meant that I may not be great, but I'm alive.

**Mix:** And you're feeling pretty good these days?

**Garcia:** I feel *pretty* good. I should take better care of myself, generally speaking. Plus I've got the kids [two daughters], and they're on my back all the time. I think I'm slowly improving. I'm having fun playing, that's for sure. And I have no desire to be sick for the rest of my life. ■

The book that you've been waiting for --  
Completely revised and updated!

## HANDBOOK FOR SOUND ENGINEERS: THE NEW AUDIO CYCLOPEDIA

Glen Ballou, Editor

By far the most authoritative audio reference on the market, this book offers the professional audio engineer comprehensive and up-to-date coverage in a new revised format.

Its more than 1,260 pages include the most advanced, state-of-the-art information in seven sections that deal thoroughly and completely with an individual technology, taking the subject from the basics to advanced engineering including:

- Room Acoustics--Rollins Brook, Ted Uzzle, and F. Alton Everest
- Loudspeakers and Microphones--Cliff Henricksen, Glen Ballou, and Bill Swintek
- Test and Instrumentation--Don Davis
- Audio Electronics--Mahlon Burkhard, Steve Dove, Glen Ballou, and Gene Patronis
- Disc/Disk/Tape Recording and Playback--George Alexandrovich and Dale Manquen
- Design Applications--Chris Foreman, Doug Fern, Rollins Brook, Glen Ballou, and Lawrence Philbrick

Save time and money and consult with 14 highly respected audio professionals on your day-to-day projects and audio problems. Join over 500,000 owners of the first *Audio Cyclopedia*.

Available through MIX Bookshelf, 2608 Ninth Street, Berkeley, CA 94710. Add \$3 for shipping. California residents add sales tax.

**ORDER TOLL FREE 1-800-233-9604, in CA 1-800-641-3349**

Circle #113 on Reader Service Card



Item #1595, \$79.95

"*Audio Cyclopedia* is the most stolen book I own. It has saved many arguments here at the studio. I really look forward to the new book!"

Terry Howard  
Studio Support Services

HS

HOWARD W. SAMS & COMPANY

# BEFORE CONGRESS PUTS IN TAPE RECORDERS, A FEW



B, G, E, B-flat, F-sharp and D-sharp to name just a few.

Powerful new evidence suggests that the anti-taping system that Congress might require in the new digital recorders (DATs) will severely affect notes up and down the scale.

For these scanner devices to do their job—

stopping consumers from using their DATs to record—the machines will respond to encoding that will literally “suck out” some of the beautiful sounds that artists and engineers have tried so hard to create. The result? Ringing, phase shift and corruption of sound quality on *playback* of records, tapes and discs.

And these aren't sounds out in some

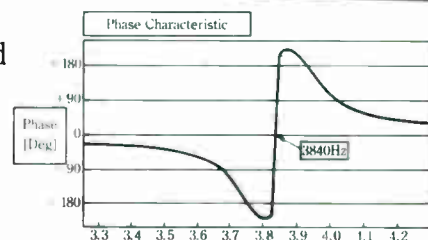

*The effect of anti-copy chip encoder upon stereo imaging and accuracy. Source: Congressional Testimony by Leonard Feldman, April 2, 1987.*

supersonic region where they won't be missed. They're smack dab in the middle of the audio spectrum.





# ANTI-TAPING CHIPS THINGS OUGHT TO BE NOTED.

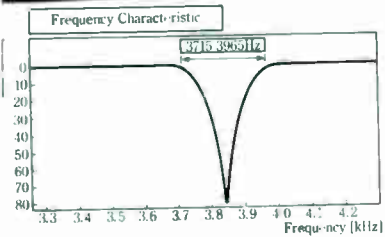

The effect of anti-copy chip encoder upon tonal content of music.  
Source: Congressional Testimony by Leonard Feldman, April 2, 1987.

If you help create these sounds, you've got a lot to lose. Like the richness and integrity of your performance.

But don't let words on paper convince you. Send the coupon and we'll send you a free cassette that shows you the kind of distortion we've described.

You won't like what you hear. But you'll be glad you heard it.

Let us hear from you today.

**HOME RECORDING RIGHTS COALITION**  
1-800-282-TAPE

A coalition of consumers, retailers and manufacturers of audio products dedicated to preserving your right to use these products free of private taxes or government interference.

Mail to: MX 7-87  
 The Home Recording Rights Coalition  
 Box 33705  
 1145 19th Street, N.W.  
 Washington, D.C. 20033

*I oppose any bills that would require anti-taping chips in DAT recorders.*

Name \_\_\_\_\_  
 Address \_\_\_\_\_  
 City \_\_\_\_\_ State \_\_\_\_\_ Zip \_\_\_\_\_  
 Phone \_\_\_\_\_

Send me a free cassette to help me take note of the roles the anti-taping chips will affect.

Circle #114 on Reader Service Card



# PLAYBACK

*Cincinnati, 1986: (L to R) Phil Lesh, Bob Weir, Bill Kreutzmann, Jerry Garcia.*



PHOTO: RON DELANY

# G IN THE DARK WITH THE GRATEFUL DEAD

by Blair Jackson

The Grateful Dead has always been a music business anomaly. They basically tour year-round with an ongoing repertoire of some 100 songs that they never play the same way twice, and almost never in the same order. They have no real "hits" to speak of, so they're not even bound by the convention of performing their best known songs. When a new Dead album

---

Twenty-two years into this long, strange trip, the Dead's time has finally come. Just watch.

---

comes out, they don't automatically highlight the new tunes in their shows. If the songs come up, they come up. If not, well, they'll pop up another time. Always fiercely independent (for several years in the '70s they even had their own record company), they simply do whatever they want, regardless of "industry" opinion, safe in the knowledge that their devoted and ever-growing legion of followers, the Deadheads, will support their decisions. In 1987,



the Grateful Dead are one of the world's most popular touring acts—up there with Neil Diamond, Bob Seger and all the other heavies—yet they haven't released an album of new studio material in close to eight years. You figure it!

The rap on the Dead has been that they make bad albums that don't sell, but that has been grossly overstated through the years—primarily by the band, who have been frustrated by their inability to capture their live sound in the studio. Actually, they have several platinum albums to their credit, and all you have to do is check the FM band in any major city and you'll hear Dead classics bouncing lightly between tracks by Bryan Adams and this week's haircut band. The Dead are more respectable than you (or they) think, and with their new album, *In the Dark*, they are poised for bona fide mega-success. You may laugh at that assertion, but the fact is, 22 years into this long, strange trip, the Grateful Dead's time has finally come. Just watch.

For this studio effort, the band returned to self-producing for the first time in 12 years. This has its up and down sides. On the one hand, because the players have worked together so long, they are accustomed to progressing at an idiosyncratic pace—in fits and starts, between tours, at the whim of the individual members. That makes discipline something of a problem. Someone's got to crack the whip to get things moving, yet the bandmembers are so anti-authoritarian that it's difficult to get anyone to fill that "cop" role. There were a couple of false starts on this record, but following the near-death in 1986 of guitarist and reluctant leader Jerry Garcia, the band returned to the wars with a new spirit and determination, and managed to record the LP in just a few months, a remarkable accomplishment for this band afflicted with (in the words of rhythm guitarist Bob Weir) "legendary studiophobia."

The genesis of the album dates back nearly two years before it was recorded. The Dead decided to produce a long-form video highlighting their most recent material (as well as some older nuggets) and shot it live (but with no audience) at the Marin Veteran's Memorial Auditorium in their home city of San Rafael, California. Utilizing Guy Charbonneau's Le Mobile remote unit, long-time GD tech wizard John Cutler recorded the band over a three-day period in April '85. Amazingly, the tracks had more punch and energy than the Dead usually mustered in a conventional studio situation. So when the band got serious

about making a record, Cutler rented the Marin facility for two weeks this past January, brought in Le Mobile once again, and managed to get solid basics on eight new tunes. Overdubbing and mixing were done primarily at the Dead's own Front Street studio in San Rafael in the early spring.

"These guys have an awful lot of experience recording and a lot of life experience, and I think all of us are getting a little more, shall we say, 'mature,'" says a slightly bemused Cutler, trying to explain the sudden surge of excitement that allowed the album to finally get made. "We did basics in two weeks. A few years ago they went to Fantasy, did a month-

long lock-out, and got nothing. The Dead is most successful as a live band. There's no reason why they *can't* be successful as a recording band, but I think it's apropos that they do their basic tracks in a live situation—as if they were playing live—because that's where their expertise lies. We had them set up on stage in the same places they would be for a concert, and I think that helped a lot. But it's definitely a studio recording."

So much so that all the electric instruments were plugged direct into Le Mobile and, unlike the video sessions, there were no mics to pick up room ambience. In effect, the band tricked themselves into believing they

## You don't have to search for studio automation software any more!



### Introducing the A/V 3000 automated management system for audio and video studios.

A/V 3000 software tracks sessions from the initial phone call through invoicing, and beyond. It keeps your studio's schedule, records session setups, tracks equipment rentals, maintains inventory, keeps a tape library, generates reports, interfaces with accounting, and more. The system is modular and menu-driven. Both single and multi-user configurations are supported. Available for PC-XT's ATs, and compatibles.

With Micro-Point's extensive knowledge of the audio/video industry and 20 years of experience you can count on the highest level of customer service and support. Finally! Studio automation software backed by an industry leader.

- Computer Hardware and Software at Discounts up to 45%
- Automated Test Systems Using the GPIB standard
- Custom Programming and Consulting
- Specialized, Hard To Find, Industry Specific Products

## Computer Products for Audio and Video Professionals

**MICRO-POINT INC.**

45 Kensico Dr. Mt. Kisco, N.Y. 10549 Phone (914) 241-4439, Telex 353664  
Call our computer bulletin board 24 hours a day at (914) 241-8529

Circle #115 on Reader Service Card

# Masters at Work

- Fast turn-around\*
- Custom printing
- No minimum runs
- Extensive quality control
- Lowest prices
- From any master

Resolution brings you the Revox B-215 and a cassette of superior quality. The B-215 features Dolby HX Pro. Unlike high speed duplicators, we cut direct from digital masters. Resolution manufactures cassettes for some of the most demanding producers and labels in the country, all in real-time, all on time. Phone now toll free 1-800-862-8900 and ask about our special test cassette offer and free catalogue. We now provide Hi Fi video duplication, as well.

All work is 100% guaranteed  
\*24-hour service available



**RESOLUTION**  
VIDEO AUDIO AND FILM  
Chace Mill  
One Mill Street  
Burlington, Vermont  
05401-1514

Circle #116 on Reader Service Card

**deal'er** (de'ler) *n.* 1. merchant, one who represents; see MIDCOM

**ser'vice** (ser'vis) *n.* 1. duty performed or needs supplied; see MIDCOM

**fol'low-up** *n.* 1. to sustain the effectiveness of an act; see MIDCOM

**pro-fes'sional** *adj.* 1. engaged in a professional act; see MIDCOM



*The definitive  
dealership in  
the Southwest*

6311 N. O'CONNOR RD., IRVING, TX 65039  
(214) 869-2144

Circle #117 on Reader Service Card

were playing live onstage. In the truck, Cutler and Guy Charbonneau were undertaking another experiment: *In the Dark* was the first album to be recorded using Dolby's new SR (Spectral Recording) system, the company's long awaited "answer" to the quiet of digital recording.

"When we were going to start this project," Cutler says, "I'd heard some rave reviews of the Dolby SR from friends of mine at the Power Station and other places. Then I spoke to Guy and he raved about it. So we got a couple of cards from Dolby and tried them out at Front Street while recording some rehearsals, just 2-track. We were favorably impressed, so one day Mickey Hart [one of the Dead's two drummer/percussionists] and I did an experiment with his drum kit—because my complaint with the old Dolby A was it squashed drums a bit, though it was good for most other things. I had Mickey play on his kit and I mixed to mono but to two tracks—one with SR, one without. When we played it back, we could hear virtually no difference between them except that the SR track was a lot quieter. And it wasn't squashed—it didn't mess with the drums—and that's what finally sold me on it."

Until using SR, Cutler and the Dead preferred recording with 16-track machines for greater track separation, "but the SR allows me to go 24-track because you don't have to record it as hot," Cutler comments. "The nature of the system is such that crosstalk is reduced between channels and its dynamic range is increased. So I don't have to pull two tape machines all the time, which means you use half as much tape, which is nice economically. And from a hassle point of view, you don't have to wait to lock things up."

Despite their deserved reputation as sound innovators, the Dead have yet to embrace digital recording, though Cutler says, "when we shot our video, we ended up mixing the video to the PCM 1630 digital format and I was real pleased with it. Some of the band members had mixed opinions about it—there were comments about the high end; the usual digital story. In my way of thinking, SR will be a chance for studios with a large investment in analog equipment to compete with the digital world. There's still a lot of controversy over the merits of digital and a lot of people are wary of it. I think SR could save the analog business for many years. It is transparent. Listen at the end of this tune," Cutler says as a take of the song "My Brother Esau" plays back in *Le Mobile*, "and the only hiss you'll hear is the hiss off Jerry's amplifier."

A native of New York, Cutler moved





*John Cutler:  
"I think it's  
apropos that  
they did their  
basic tracks in  
a live situation  
because that's  
where their  
expertise lies."*

to the West Coast in 1970 to pursue his interest in electronics. "I've been a radio amateur all my life, basically, and I got my taste for custom electronics working as an apprentice for Ron Wickersham and Alembic [the ultra-progressive '70s sound and instrument company]," he says. He studied electrical engineering, calculus and physics at City College of San Francisco and was just a few credits shy of entering the University of California at Berkeley, when he quit school to do tech work for his brother Bill's once-

popular Bay Area band, Heroes. "I tried to build custom stuff for them," he notes, "but our budget was zero."

Around about 1975, he set up his own electronics workbench at a company called Hard Truckers and began doing repair work for local bands. "One day, Dan Healy [then and now the Dead's live sound mixer] came in and said, 'Hey, I've got 25 MacIntosh amps that need fixing in a week because we've got these gigs coming up. Can you fix them?' So I got a little crazy and stayed up a few nights in a row fixing them and then ended up helping put up a P.A. system for the Dead."

That led to other work with the band. He built the headphone system and other custom equipment for the then-budding Front Street studio "and after a while I was building so much equipment for the Dead that my other clients were suffering. It got down to an either/or situation and fortunately they put me on salary, and I've been at Front Street ever since." Working closely with Dan Healy, he's had a hand in building almost all of the microprocessor-based effects the Dead employ in their live show ("I enjoy making smart things," he says with a smile), and he is in charge of keeping Front Street in top shape and up-to-date. Generally, he does not go out on the road, preferring to stick close to the studio and work on electronics projects there.

Before this record, Cutler had relatively little studio engineering experience, but he had proven himself an able live mixer the last few years, working primarily on the Dead's occasional radio concert broadcasts, and doing some live sound for Dead spin-off groups like the Jerry Garcia Band and Bobby & the Midnights. It was his exceptional work mixing for the Marin Vets video sessions, however, that made him the obvious candidate to engineer *In the Dark*. And as work progressed on the album, his role took on more importance and he ultimately ended up sharing the producer credit with Garcia.

When the Grateful Dead make a record, it is essentially a democratic process, with each of the six band-members responsible for his own parts. "The ultimate yes-no producer is generally the writer of the tune," according to Bob Bralove (best known for his programming work with Stevie Wonder), who helped the players with sampling. "At the same time, Garcia and Cutler saw just about every track go down and they ultimately shaped the record. Still, when it's a tune by Brent [Mydland, the band's keyboardist], he has to be happy with it.

## THE BOTTOM LINE

Keeping it under control can make or break you. We at Pristine Systems can help with our

### STUDIO MANAGEMENT SYSTEM

- Bookings & Work Orders
- Tape Library
- Billings and Receivables
- Accounts Payable
- General Ledger, Financial Reports
- Inventory Control
- and More!

This unique software is available as individual packages or as a completely integrated solution for any MS-DOS microcomputer in either hard disk or diskette versions.

If you've had your fill of trying to adapt a general system to fit your needs—  
**CALL US NOW!**



### Pristine Systems, Inc.

6515 Sunset Blvd. #201B  
Hollywood, CA 90028  
(213) 461-2819

In Canada: Tele-Tech  
920 Denison St., Unit 11  
Markham, Ont L3R 3K5  
(416) 499-3242

Circle #118 on Reader Service Card

**EUROPADISK, LTD.**



**Direct Metal Mastering**  
U.S. Only Complete  
DMM Facility—

- Disk Mastering Suite
- Hi-Definition Plating
- State-Of-The-Art Pressing

For  
brochure & pricing,  
call or write

**EUROPADISK, LTD.**

75 Varick St.  
N.Y. 10013  
(212) 226-4401

Circle #119 on Reader Service Card

"Jerry is really an incredible guy," he continues. "He has a very clear concept of what he wants the tracks to be like musically. Here are people who don't record that much and who for the past six years haven't concerned themselves with definitive versions of their tunes, yet Jerry is very clear about the recording. He goes for a certain emotional quality and he knows when he has it and he knows when he doesn't. The details are brought in by a lot of different people."

"I was really impressed with the democracy in this band. They were making Mickey 16-track slave copies and saying, 'Go ahead. Track if you want, and we'll deal with it when it

---

*Bob Bralove: "I think there's a reaction against over-synthesized, over-computerized music, and that may work in their favor."*

---

comes back in.' That's pretty amazing. Everyone is allowed to do that. Most of his tracks went down at Front Street, but he used the 16-tracks up at his studio to explore the kinds of processing he wanted, to perfect the sounds he wanted."

The advantage of that approach, Cutler explains, is "they can work as much as they want, do whatever kind of experiments they want, without having to keep playing the master tape. Then, later, the tapes come back to Front Street with the overdubs and we marry them to the 24-track basic."

Even when the Dead were out on the road this spring, work continued on the album long distance. Cutler continually sent out different mixes for the players' review, and they would study the mixes and discuss their different parts, relaying comments back to Cutler in San Rafael. "And in the studio, the lines of communication were always open," Bralove says. "Billy [Kreutzmann, drummer extraordinaire] and Mickey would bring in lists of things they wanted to discuss about the mixes, and everyone seemed to go out of their way to accommodate the others. It's great to see that."

Bralove's primary contribution was in the areas of sampling and programming, assisting Hart and Kreutzmann in their search for the truly strange (such as re-pitching virbraslaps, shakers and the like), and working with Mydland's Emulator and Kurzweil. "Mickey, in particular, is a very ambient artist," Bralove says. "He's looking for a particular emotional quality of sound. Actually, that's true of *all* of them."

*In the Dark* is going to catch a lot of skeptics off guard. The quality of the performances and the crispness of the sound are going to surprise people who still think of the Dead as a laid back-bordering-on-sloppy country-rock band. It's a typically eclectic set from a band whose concerts span a range of styles from driving rock and roll and country polkas to aching folk ballads, blues, jazz and the strangest space music this side of Sun Ra's Arkestra.

There's the lead-off single, "Touch of Gray," a whimsical, rolling rocker that finds Garcia (and lyricist Robert Hunter) coming to grips with middle age and an imperfect world: "The cow is giving kerosene/Kid can't read at 17/The words he knows are all obscene/but it's all right/I will get by . . ." Weir and his writing partner John Barlow contribute a multi-rhythmic condemnation of the arms race in "Throwing Stones." "Hell in a Bucket" finds them humorously skewering a mistreating woman. Brent Mydlands'

## — DO IT RIGHT! —



"We teamed up with Pro Audio to create a great studio."

Denis Degher, Owner, Red Zone Studios  
Burbank, CA (818) 955-8030

**PROFESSIONAL  
AUDIO SERVICES  
AND  
SUPPLY CO.**

619 South Glenwood Place  
Burbank, CA 91506 • (818) 843-6320

Circle #120 on Reader Service Card



locomotive allegory, "Tons of Steel," has the most country feeling of any song on the album. Garcia's "West L.A. Fadeaway" is a blues-tinged piece that seems to ooze with the paranoia of a small-time hustler. Rounding out the album are a pair of brand-new Hunter-Garcia songs, "When Push Comes to Shove," which is in the tradition of such bouncy Dead songs as "Ramble on Rose" and "Tennessee Jed," and the beautiful, brooding "Black Muddy River," an existential ballad that is among the most exquisite the Dead have recorded. In short, there are seven styles, seven very different moods, held together by the strength of the group's playing and the shimmering quality of the recording. It was worth the wait.

"There are great songs on this record," comments Bralove, "and it's very different from the stuff that's out there in the market. I think there's a reaction against over-synthesized, over-computerized music, and that may work in their favor. At the same time, there's some amazing and innovative sound experiments on this record. John [Cutler] captured them really well—better than any of their last records, certainly."

For Deadheads who listen primarily



PHOTO: RON DELANY

**Bob Weir and Jerry Garcia at Alpine Valley WI, 1986.**

to live tapes of the band [the Dead are the only major group that not only allows their concerts to be taped, but actually has a taping section at shows!], the textural richness—some might say slickness—of the record may come as something of a shock. In the keyboard area, particularly, there is much more depth than when the Dead play live,

thanks to the successful collaboration of Mydland and Bralove. Where the record does resemble a live performance is in the punch that Garcia and Cutler have captured so well. Phil Lesh's bass lines jump out of the tracks and the drum parts crackle with energy. It's still a quirky record in the grand scheme of things, however; the Dead have not mellowed or conformed all of a sudden. But there's definitely something happening in the grooves of this record that wasn't on the Dead's last several, and there was genuine excitement in the air at Front Street as the project drew to a close in mid-May. John Cutler's custom T-shirt drew laughs the first time he wore it at a gig months ago, but now its message seems downright prophetic: **THINK PLATINUM.** ■

*Blair Jackson, managing editor of Mix, is the author of Grateful Dead: The Music Never Stopped (Delilah/Putnam). He lives in Oakland and owns more Grateful Dead tapes than any sane human should have.*

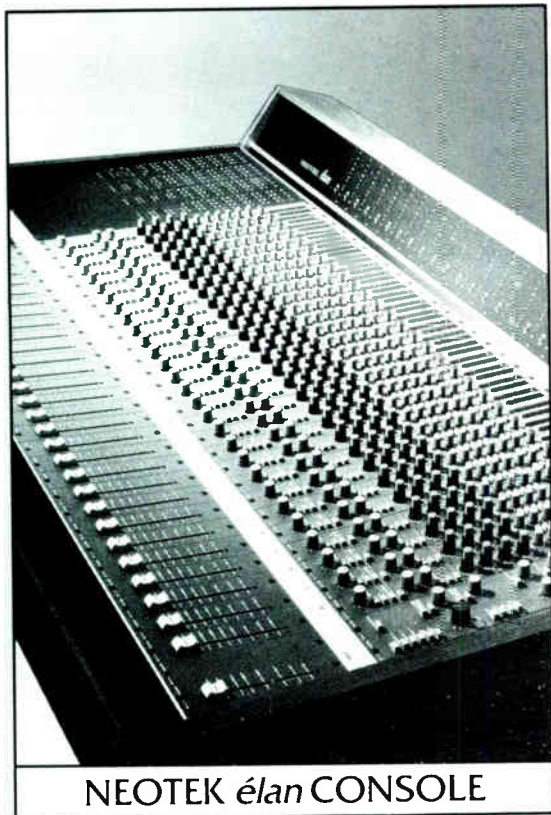

**NEOTEK élan CONSOLE**

# STUDIO LEASING

from

## AMERICAN AUDIO SYSTEMS

All studio equipment from a single piece of gear to a complete digital 24-track studio

'Why Should I Lease?'

- Keep your cash in the bank
- Tax deduction as an operating expense
- Sell your used gear and keep the cash
- Allow your bank Credit Line to stay open.

'Mini Lease'

- \$5,000-\$20,000
- 48 hour approval
- Application over the phone.

**CONTACT DICK McCALLEY**

**612-866-1868**

AMERICAN AUDIO SYSTEMS, 6021 LYNDALE AVE. S., MINNEAPOLIS, MN 55419.

Circle #121 on Reader Service Card

## RIAA Report: Industry Slips Despite CD Boom



by Philip De Lancie

Figures for 1986 net shipments of prerecorded music products, as reported by the Recording Industry Association of America (RIAA), appear to confirm trends suggested by the RIAA's 1985 report. As expected, the only significant growth was in the area of CDs, with unit and dollar value increases over 1985 of 134% and 139% respectively. Prerecorded cassettes posted only modest gains of 2% in units and 4% in value, while singles and LPs registered declines in the 20 to 25% range. Overall, unit shipments fell 5% to 618.3 million, but the increased market share held by CDs, the highest priced configuration, resulted in a dollar value increase of 6% to \$4.651 billion.

Despite the rapid rise in CD sales, the configuration still accounts for less than 9% of the total units shipped. Singles and LPs, with shares of about 15% and 20% respectively, combine for a black vinyl total of over 35%. Prerecorded cassettes continue to dominate the market with more than 55% of units shipped. Thus the CD, while performing with great promise, is still quite far from establishing itself as the primary configuration for music product distribution. But with CD manufacturers finally lowering their prices as more plants come on line, it looks as if the CD will continue to wrest market share from the ailing LP if present trends continue.

The big question mark hanging over these trends is, of course, DAT. While the immediate future of this new con-

figuration in the U.S. is unclear, recent developments suggest that DAT may be debuting in the RIAA prerecorded shipments figures by 1988. Sony has announced that it is nearing the introduction of a real time duplication system for DAT. The hardware is designed to interface with existing CD mastering systems incorporating the PCM-1630 processor and DMR-4000 digital master recorder. Up to 50 DAT slave recorders will be operable simultaneously, and each copy will be monitored for errors during duplication. The real time system is apparently viewed as an interim step by Sony, which concurrently announced that its high speed magnetic contact print duplicator for DAT (see "After-Mix," September 1986) has "passed the prototype stage and is now on its way to commercialization."

Paving the way for high speed duping of DAT is Sony's existing high speed contact printing system for video, known as Sprinter. Maxell Professional Industrial division has put forward a tape specifically designed for Sprinter use, called TF20-2134. Available in 7,000-foot lengths, the new tape has been formulated for high output and low coercivity. Such a formulation would presumably be adaptable for DAT use when the demand arises.

Meanwhile, Agfa-Gevaert, one of the world's largest suppliers of tape to the duplication industry, has been expressing a positive view of the impact of DAT. Thomas Huebner, marketing manager for Audio Tape Duplication Products, suggested at a recent International Tape/Disc Association meeting that DAT has the potential to increase the overall size of the international tape duplication business. Huebner's remarks were based on studies conducted by Agfa in the West German marketplace. He forecast that West German compact (analog) cassette sales will rise from 59 million in 1985 to 67 million in 1990, at which time prerecorded DAT will just be getting established with sales of about 1 million. By the year 2000, however, he sees compact cassette sales declining to the 50 million range, while DAT sales climb to 25 million.

Internationally, Huebner expects the prerecorded cassette market to develop the same 2:1 ratio of analog



to DAT as in West Germany. He forecast worldwide DAT sales of up to 30 million within four years of the new configuration's debut, with one-third of those units duplicated in the U.S. Huebner noted that "Agfa will be ready with a new DAT tape formula once the industry decides the time is right to launch the format internationally." He expects to see only real time DAT duplication for the first several years.

#### News and Notes

In last month's interview with Herb Belkin of Mobile Fidelity regarding the Ultradisc, Belkin referred to a CD quality checking device manufactured in England by Cambridge Audio. This device is available in the U.S. from



Cambridge CD-1 and CD-1QA

Sumiko, Inc. of Berkeley, CA. Dubbed the Cambridge CD-IQA (for Quality Assurance), the unit is designed to allow assessment of the physical quality of CDs by measuring the effects of surface damage, abrasions or manufacturing defects. The CD-IQA features three 4-digit event counters which, in normal mode, measure during playback the number of disc reading errors which were corrected, the number of errors which could not be corrected and the number of complete dropouts of recorded information. An alternative mode allows a comparative count of various degrees of dropouts. The unit, retailing at \$1,400, is offered by Cambridge as a companion to their "price is no object" (\$2,800) CD player, the CD-1, which features dual suspension for reduced vibration induced reading error, as well as three DACs per channel and four-times oversampling. Sumiko hopes to market these Cambridge products to CD manufacturers and retailers in addition to consumers.

January's "AfterMix" featured the observations of ElectroSound, Inc. president Bob Barone, who spoke of a "technology scare" which was inhibiting investment in new equipment by cassette duplicators. In a recent news

wireworks professional audio wireworks  
 microphone cable tester wireworks cable  
 television production wireworks coaxial  
 cable assemblies wireworks broadcast  
 studios wireworks audio/video multicable  
 systems wireworks professional theatre  
 wireworks eng wireworks multi-channel  
 microphone splitting systems wireworks  
 live performance wireworks hardwired  
 multicables wireworks post-production  
 facilities wireworks microphone cables  
 wireworks hotels and casinos wireworks  
 performing arts centers wireworks custom  
 designed products wireworks churches  
 wireworks recording studios wireworks

Nobody puts it together like Wireworks.

## wireworks

Wireworks Corporation

380 Hillside Avenue, Hillside, New Jersey 07205 201-686-7400  
 TOLL FREE: 1-800-624-0061 and in NJ: 1-800-235-9473

Circle #122 on Reader Service Card

# It's About TIME!

## DIMENSION MUSIC LIBRARY

- World's Only Music Library  
Containing  Holophonic's™
- Digitally Mastered
- Lifetime Blanket License  
(No Needle Drop or Annual Renewal Fee)
- Available in C.D.'s or L.P.'s

FOR FREE CASSETTE SAMPLER, CONTACT:

P.O. BOX 1561 • JUPITER, FLORIDA 33468 • PHONE: 305/746-2222

(HOLOPHONICS IS A TRADEMARK OF ZUCCARELLI HOLOPHONICS, INC.)

Circle #123 on Reader Service Card

# EQUIPMENT FOR SALE?

If you have equipment to sell—whether it's a single microphone or an entire studio—**Mix Classifieds** are the place to advertise. **Mix Magazine's** classified section is the biggest in the industry, and more than 75,000 audio and music pros read **Mix** every month!

When professionals need equipment, **Mix** is the first place they look. So if you've got gear you absolutely must sell, advertise in the magazine you can count on to get results. To place your ad, call Lauri Newman at **(415) 843-7901**, or use the order form in the back of this issue.

THE RECORDING INDUSTRY MAGAZINE

2608 NINTH STREET, BERKELEY, CALIFORNIA 94710 (415) 843-7901

## Mix

release from ESI, Barone states that this procurement paralysis by major producers may actually have worked to the advantage of independent duplicators, who were able, he says, to pick up some of the overflow work from demand that the majors had not anticipated. The release provides little in the way of documentation to back up Barone's view, and is certainly intended to stimulate demand for ESI equipment by dispelling fears of reduced demand for duplicated product. But others in the industry appear to share Barone's expressed confidence in the duplication market, as evidenced by continued expansion and new product activity in this area.

Nightingale-Conant Corporation, for instance, a leading publisher/manufacturer of spoken word cassettes, has completed transition to an all-stereo product line with a 20-slave ESI 8000 system featuring Multi-Master Switching Control.

Pacific Cassette Laboratories has relocated and expanded its computer controlled duping operations in Torrance, CA. The company uses modified Nakamichi ZX-9 cassette decks for real time duplication on TDK metal tape in Reference Standard housings. All products are available with either Dolby B or C encoding.

Duplication Specialists has been formed in Long Beach, NY, by David Schwartz, formerly of Burlington Audio Tapes. The firm is equipped to accept or generate analog or EIAJ (F1, Beta or VHS) masters, which are duped in real time on 32 remote controlled Onkyo TA-2028 cassette decks with Dolby B or C. Available signal processing includes Dynafex DX-2 single ended noise reduction, Aphex Type-C Aural Exciter and Sound Shaper programmable EQ.

Two new labelers have been introduced for the duping market. The Model 2100 from CST Manufacturing of Atlanta, GA allows fully automatic double side labeling of 2,100 to 2,400 audio cassettes per hour. The Model L-3 from Investment Technology of Bellevue, WA is a semi-automatic (hand fed) labeler for audio and video cassettes as well as floppy disks and envelopes. Claimed capacity is 1,200 applications per hour.

For those duplicators reluctant to invest in new equipment at this time, Tape Duplication Technology (TDT, Inc.) is offering several products designed to update existing high speed duplicating gear with an eye toward reducing maintenance costs. For example, TDT has developed a Pinch Roller Conversion Kit which allows the Ampex BLM-200 to be operated at 240 ips without the problem of

## Print label copy right on your cassette with the apex printer



Forget about paper labels. Print over 7,000 units per hour. Save time, money, trouble, space. Eliminate inventory problems, costly label overruns. Save 4¢ or more per cassette.

Five models to choose from. One manual single color labeler. Two semi-automatic one color labeler models. Two high production multi-color consoles that print up to three colors in one pass.

Manufactured and distributed in U.S.A. by

### apex

apex machine company  
3000 n.e. 12th terrace  
fort lauderdale, fl 33334 u.s.a.  
telephone: (305) 566-1572

Distributed internationally

### audio

audiomatic corporation  
400 madison avenue  
new york, new york 10017 u.s.a.  
telephone: (212) 308-6888  
telex: 12-6419

Circle #125 on Reader Service Card



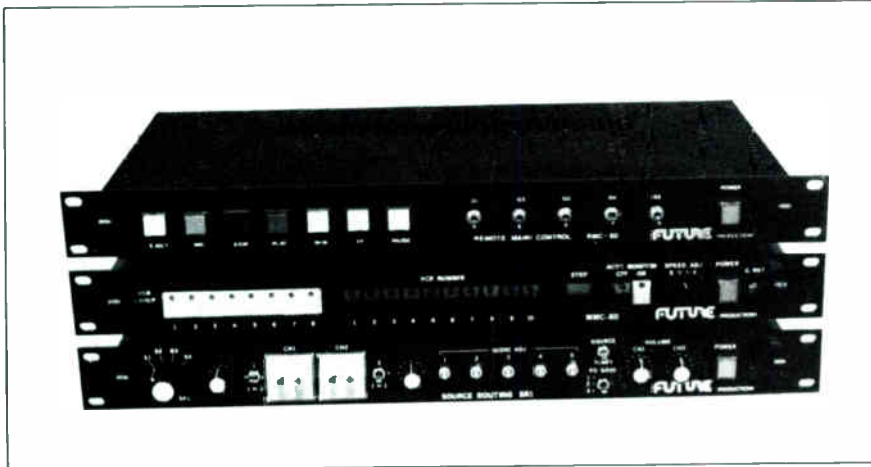

**FP80 DUPLICATOR (up to 80 VCRs)**

excessive roller wear. The new four roller assembly, including all replacement hardware and mounting brackets, may be self installed, and is expected to increase roller life to three years.

Other products offered by TDT, based in Fort Wayne, IN, include micro-processor-based controller and cue tone generators for replacement of existing relay logic control systems and speed conversion kits for popular master and slave machines. A Dolby HX-PRO retrofit kit is also planned. In addition, TDT offers custom refurbishing and rebuilding of duplication equipment, as well as rebuilt machines for sale.

Otari Corporation of Belmont, CA has announced an agreement with King Instruments of Boston, MA which will enable Otari to resume U.S. sales of their full line of industrial loading, leadering and tailoring equipment for audio and video duplication.

Also, in video duping, Mycomp Technologies Corporation (MTC) of Costa Mesa, CA has released the Bidrex Serial Machine Control System, which incorporates a closed loop serial machine control scheme. Bidrex is said to allow duplicators to delegate, control and monitor any number of banks of recording VCRs assigned to various source VTRs. The operator is updated on system activities via a computer interface utilizing IBM-PC compatible hardware. Bidrex is designed to pick up and isolate errors with minimal user intervention. Up to seven signals (video, video RF, audio RF, normal audio left and right, hi-fi left and right) may be checked simultaneously on all completed tapes in 30 seconds. Tapes at variance with user defined values are ejected. MTC has already placed Bidrex with facilities representing 13% of professional video duplication recorders.

Two other new video duping systems, designed by a duplication house, have been introduced by Future Productions of New York City. Featuring machine control, monitoring control, source routing and broadcast quality signal distribution, the FP 200 duplicator is targeted at the 100 to 1,000 VCR duplicator. Similarly equipped, but packaged more compactly, is the FP 80 for up to 80 VCRs. The company also offers the AVD-10 and AVD-24 distribution amplifiers for video with stereo audio.

The Capitola, CA firm which markets the CD Publisher, formerly Video Tools, has changed its name to Meridian Data, Inc. CD Publisher is an IBM-PC based premastering and simulation subsystem for CD-ROM development which integrates all the tasks necessary to produce a formatted pre-master tape ready for replication. Tapes are in standard CD-ROM file structure compatible with mastering facility formats. The simulation feature supports real time interactive testing of retrieval times. CD LINK, a companion software package, allows PC users' standard MS DOS to access 550 megabyte CD ROM discs mastered on the CD publisher through any manufacturer's drive. CD Publisher is available for sale or as a service.

Optical Disc Corporation of Cerritos, CA is offering a Recordable Laser Videodisc (RLV) using a glass substrate which is said to significantly improve the quality available from RLVs. ODC has been delivering standard plastic RLVs since 1984, but the company expects that the glass RLV will open up new applications for recordable videodiscs. ■

*Philip De Lancie is a mastering engineer at Fantasy Studios in Berkeley, California.*

# A P M

u a l i t y

**EXCLUSIVE REPRESENTATIVES**

**FOR FREE CASSETTE & BROCHURE CALL OR WRITE NOW!**

**NEW COMPACT DISCS**

**ASSOCIATED PRODUCTION MUSIC**

888 Seventh Avenue  
New York, NY 10106  
(212) 977-5680

6255 Sunset Blvd  
Hollywood, Ca. 90028  
(213) 461-3211

Circle #126 on Reader Service Card

**Burlington**

**Audio/Video Tapes Inc.**  
106 Mott St. Oceanside, N.Y. 11572

**Toll Free 1-800-331-3191**  
**In N.Y. (516) 678-4414**

**Scotch® Audio/Video Tape**

**Call for Free Catalog**  
In Stock and Priced Right.  
Reels, Boxes, Custom Cassettes,  
Leaders and Splicing Tapes.

**HARD TO GET ACCESSORY ITEMS**

106 Mott Street, Oceanside, New York 11572

Circle #127 on Reader Service Card

by Hank Lam

The NAB Convention is traditionally a time to renew old friendships with colleagues, manufacturers' reps and local suppliers. It is also a time to view the latest in electronic wizardry. And although I saw nothing that I presently "just can not live without," there was plenty of technology representative of the shape and trends to come in the broadcast industry. Abbreviations like HDTV, R-DAT and DVTR have arrived, and are for sale. The lack of a mutual standard, and/or perhaps the lack of an ability to practically apply these technologies is all that stands between wholesale distribution and their appearance at your front door.

If you haven't seen High Definition Television, HDTV, get ready! Remember when you heard digital audio, and realized how great it sounded, how it redefined your whole view, like you cleaned out your ears? Well, it will happen again to your eyes. Words cannot express the terrible feeling you'll have when you return home, after viewing HDTV, to see your regular, tired, old, vanilla NTSC TV.

Major manufacturers, such as Toshiba, Sony, Pioneer, Kloss, Matsushita and Hitachi have made their commitment, and are now selling HDTV systems. There are, as of April, at least 80 Sony High Definition Video Systems in the marketplace, according to Craig Tanner, product manager for their Broadcast High Definition Division.

Although HDTV is envisioned as the broadcast television standard of the near future, its quality has made other applications apparent; in fact, the applications will be in use before the broadcast standard becomes reality. Estimates are that a 15% cost savings can be realized working in HDTV rather than 35mm film. Complete program production, with a picture matching or even surpassing that of 35mm film, is now possible. Producing theatrical release should be easier and more convenient, and in some ways video surpasses film as an artistic medium (for instance, on the spot confidence-head playback, eliminating dailies, electronic editing under computer control and video chroma-keying, superior to film color matting).

A complete HDTV system is capable of program origination, post-production, program transfer and image display. Envisioned is the video projection theater, with HDTV large

screen projection. Programming can be transmitted directly to theaters via the new Direct Broadcast Satellite Service, to be recorded for playback. Or, museum art can be "databased," for study and distribution. Today, David Niles, of 1125 Productions and Rebo &

## NAB Convention & FUTURE TRENDS

Associates, both of New York, is producing in the HDTV format and transferring to film, or downconverting to NTSC for current broadcast. On display at the show, as a visible example of current HDTV production, was Herb Alpert's music video "Keep Your Eye On Me." The Canadian Broadcast Company is using the HDTV system to shoot a 13-hour mini-series, and Italy's state-owned network used HDTV to shoot the feature, *Giulia and Giulia*.

High Definition is a wide-band (20 MHz) recording and display system, offering more than double the number of scanning lines (1,125), improving brightness and color fidelity, and an aspect ratio (5.3:3) which resembles a theatrical stage more than the current TV "tube" (it widens the screen by one-third). Add up to four channels of digital stereo sound, then, project this HDTV image onto a 240-inch diagonal screen, and there is *no* graininess—the detail and contrast remain. Depth-of-field can be replicated naturally, and sophisticated video image compositing and special effects, such as Ultimatte, or Paintbox, are enhanced with HDTV.

Earlier this year, in Washington DC, NHK (Japan Broadcasting Corp.) and the NAB co-sponsored a UHF terrestrial broadcast demonstration of HDTV using the MUSE transmission system on channels 58 and 59. Muse employs bandwidth compression to jam a 30

MHz signal into 8.1 MHz, or about 1.5 standard 6 MHz broadcast channels. Japan plans to inaugurate DBS with HDTV service in 1991. Major regulatory and economic challenges, in the area of frequency spectrum allocation, will surface as HDTV seeps into the U.S. broadcast market. Compatibility with existing NTSC receivers is also a matter in design consideration (just as color compatibility was in the days of black and white).

Just when you thought your compact disc player would settle all questions of quality control and put your home stereo into the 21st century, along comes R-DAT (the rotating head digital audio recorder that is causing such a stir because of its ability to create "perfect" copies). I spoke with Jerry Smith, VP of pro-audio for Sony Corporation, where he was displaying their portable digital audio tape recorder. Designed with an AES/EBU digital I/O interface, with a SMPTE time code track capable of external sync, this nine-pound, battery operated beauty could be the "digital Nagra." Equipped with a 120-minute cassette, with 16-bit linear quantization and two sampling rates, one could theoretically slave units together and multi-track. And the cost—about \$7,000.

But, there's a catch! The present Sony view on this product is that it's for research and development, not for sale. The portable at the show was considered a prototype; they were taking no orders, and if it should go into production, it wouldn't be available until the end of 1987. Well, back to your PCM.

But wait, at the Otis Conner Company booth, Steve Arnold was showing their custom music production library, available on CD and mastered, through their Harrison board and JH-24, directly on to their Aiwa XD001 Digital Audio Cassette decks, which they are importing and selling for under \$1,500! It has no interlock ability, only semi-pro signal handling capability, and no four heads for a confidence channel, but it is R-DAT.

In step with the evolution of the digital audio studio, the video world is witnessing the reality of the component digital video system. With a standardized format known as 4:2:2, the video signal is routed and processed only in the digital domain, and is not converted to analog at any stage of production. The luminance signal is sampled at four times the frequency



subcarrier, and color difference signals are sampled at two times the frequency subcarrier (thus 4:2:2). With all elements of the digital studio conforming to this 4:2:2 standard, both digital interface and a complete digital environment are possible. Basically, the analog red, green and blue signals are digitized and stored separately from the sync and luminance signals, as 8 bits plus a clock. Thomson, Sony and others are now shipping 4:2:2 systems, which sample 243 megabits of picture data per second.

With component digital video, every editing maneuver can be fed back into the master scene to yield a first-generation master tape—there is no multi-generation loss. On display were Ultimatte, Quantel Harry and Paintbox-composed composites, completely clear of any artifacts, such as blue tint and edging, or edge crawl. The multi-layered, blue screen effects I saw on display are so realistic, that it is difficult to distinguish multiple background and foreground elements. This is the closest embodiment of the "set-less" studio yet—backgrounds can be prerecorded, or special visual effects "blown in" time after time, with no loss of detail, and no evidence of matting.

Sony is also working on the standardization of an Intelligent Device Controller, presumably to simplify present interlock systems, which require an interface specific to each slave. The Sony IDC can read any standard time and control code, from any slave, and offers full learn capability to control dynamic motion and two-way interactive switching, for both machine control and effects.

In conclusion, perhaps it can be said that technology continues to outpace the marketplace. Lack of standardization has led to the proliferation of one-of-a-kind black boxes—machines which have function, but limited application. As in the case of AM radio, although some would like government regulation or accreditation, the FCC maintains that the marketplace is the best judge of the survivability of any format or technology. Every year computers increase in their visible numbers, saving time and providing information. And, as the computer—the invisible brain behind most of the new products—continues to decrease in size, we should expect the improvement of more methods, and the development of more smart devices. *That is progress.* ■

*Hank Lam, Jr. owns Associated Productions of Texas, where he is involved in entertainment and communication system design, audio/video/film production, data telecommunications and digital voice encryption.*



## WE OFFER

- ★ The Latest-State-of-the-Art Reproduction Equipment
- ★ Reliable Personal Service
- ★ Short Turn Around Time
- ★ Quality That's Second to None

### Complete Manufacturing For Record Pressing & Tape Duplication

24 Track Recording Studio	Color Separation	Cassettes Inserts
Mastering	Labels	Typesetting
Plating	Albums	Printing And Fabrication
Jackets	Singles	

**For a Sound Investment with your Recorded Product call us: We want to work for you.**

**JERRY WEST**  
54 Music Square East—Suite 300  
Nashville, TN 37203

P.O. Box 24281  
Nashville, TN 37202-4281  
(615)242-5588

Circle #128 on Reader Service Card

# Professional SOUND recording & duplicating SUPPLIES



#### POLYLINE

- Blank-loaded audio cassettes
- Empty reels and boxes
- Audio cassette boxes and albums

#### AUDIO TAPE and CASSETTES from

- Agfa
- Ampex
- 3M
- BASF
- FUJI
- Maxell
- TDK

#### POST-PRODUCTION and MAINTENANCE SUPPLIES

**SHIPPED FROM STOCK WITHIN 24 HOURS**  
under normal circumstances

**ASK FOR OUR FREE CATALOG**

Call Polyline  
**312 / 298-5300**  
8:30 am - 5 pm Central Time

**Polyline Corp.**  
1233 Rand Road  
Des Plaines, IL 60016

Circle #129 on Reader Service Card

have its own time-tagging, which may or may not be what the programmer wanted.

Furthermore, some interfaces, notably for the Macintosh, can be connected to two ports on the back of the computer, resulting in the ability to simultaneously receive MIDI clock messages and note events from different sources, and/or transmit two independent MIDI data streams which can carry completely separate information. Although this is often billed as "32 MIDI channels" (1 to 16 in each data stream), it is, in fact, superior to 32 channels in one data stream (which is not defined in MIDI anyway) because it reduces the density of the data in each stream. In other words, the information for a sequence which involves perhaps eight simultaneous polyphonic parts with controllers (pitch bend, mod wheel, footpedals) could be enough to cause perceptible delays. Splitting four of the parts onto a different data stream goes a long way towards alleviating this MIDI "clutter." Of course, the fact that an interface is capable of this kind of operation does not necessarily mean that any program can do these things, unless it is written to take advantage of these features.

The display of a personal computer has the ability to show much more information at one time than a stand-alone sequencer, but determining and creating the all-important user interface is a challenging proposition. Many sequencers make use of this display power by also providing conversion from MIDI data to Common Music Notation (CMN), with varying degrees of success. The reason for this is that transcription of a recorded performance is a task which encompasses interpretation of the recorded data and translation into CMN (which is, in part, dependent on the timing resolution of the program), the amazing complexity of notation conventions (along with the inevitable legion of exceptions), and the difficulty of generating very high resolution graphics on personal computers. This last situation is improving with advances in display and printing technologies and graphics software, and as larger amounts of screen memory become more practical. The first two problems, however, require a level of software which is still years away from perfection (if perfection, even in a pragmatic sense, is possible). Until Expert Systems and other artificial intelligence applications become considerably faster and more mature, it will still be necessary to do a great deal of hand-tweaking of computer-generated transcriptions.

*The display of a personal computer has the ability to show much more information at one time than a stand-alone sequencer, but determining and creating the all-important user interface is a challenging proposition.*

In addition to transcription provided by some sequencing programs, there are also several programs devoted solely to notation, such as Electronic Arts' Deluxe Music Construction Set (which supports the Adobe Sonata laser font) or Mark of the Unicorn's Composer. Although notation programs have some graphic demands, they do not require the interpretive abilities required by transcription. In some cases, the notation generated using a computer keyboard and mouse can be transferred back to a sequencing program for playback. The level of tweaking allowed by MIDI notation packages ranges from high, in products like Composer (a notation-only program from MOTU which is a companion to Performer) or MESA, to the bare essentials in Southworth's Total Music (although Southworth's new product, MIDIPaint, seems to promise more).

The difficulties of transcription and notation are more than many sequencer authors care to tangle with. In the absence of notation, the most common display options are alternative graphic approaches like player-piano roll-type notation, or user-designed symbols (which Jim Miller's Personal Composer offers as an enhancement to CMN), or simply numeric data, as in Performer.

Sequencing was an obvious compositional approach to try with personal computers, but it is by no means the only one. Other kinds of software tools for music composition have just recently started to appear, and more are sure to follow as composers working in every area, commercial or not, continue to search for new methods. Among these programs are: Intelligent Music's M and Jam Factory, Laurie Spiegel's Music Mouse (distributed

by Opcode Systems), and Dr. T's Algorithmic Composer.

Algorithmic composition is a technique in which a process is described and configured, then applied by the computer to generate the music. (Note that a computer is not necessary to algorithmic composition, but it is a tool well-suited to the technique.) The musicality comes in the devising and manipulation of the process. Dr. T's takes the most classic approach to algorithmic composition, providing the ability to perform motifs in retrograde, inversion and so forth. M and Jam Factory are interactive composing/performing environments, where the computer manipulates material fed into it in an interactive fashion according to processes and variables, some of them random, which are selected by the user. The results can be recorded into MIDI files which are readable by both programs and Opcode's Sequencer 2.5, thus allowing editing and overdubbing in a more traditional fashion to be performed.

Music Mouse is also a composing/performing tool which fits most of the above description (other than the randomness and ability to record into MIDI files), but it takes a completely different approach. In Music Mouse, the mouse is moved about on a grid to create melodies, which are automatically harmonized (according to selected parameters) by the computer, while other performance parameters (level, tempo, etc.) can be manipulated from the computer keyboard, all in real time. Music Mouse turns the Macintosh into an instrument, but its sophisticated features, such as automatic harmonization, bring it firmly into the realm of a compositional tool. Opcode's MIDIMAC Sequencer 2.5 also contains an interesting feature called Generated Sequences, which uses some of the concepts that were later expanded on to create Jam Factory.

These new programs offer the possibility of breaking new musical ground by breaking old musical habits—it is not possible to compose with one of these programs in even remotely the same way as one does with a sequencer. This is an exciting and powerful possibility, but learning to think differently is easier said than done. (For a more detailed examination of these compositional alternatives to sequencing, see my upcoming article in *Electronic Musician*.)

## Sound Design

Voicing programs make use of MIDI instruments' SysEx implementations to allow remote programming of sounds. Voicing programs once again make use of a computer's superior



display capabilities for the patch editing process to let more parameter information be simultaneously viewed and/or represent this information more clearly than on the instrument itself. The interaction of rates and levels in the "new" envelope generators, for example, is much more clearly perceived when viewed graphically than when seen as a list of numbers. These programs are especially useful with instruments like the DX/TX7 or the Oberheim Matrix 6 which have a large number of variable parameters. Where sequencing and transcription programs deal mostly with MIDI information which is common to virtually all MIDI devices, voicing programs use SysEx, which is unique for each instrument. Therefore, a voicing program must be purchased for each specific instrument. Furthermore, each program uses its own file format for storing the data, which means that files created by a voicing program are usually only readable by that program. Of course, voicing programs also make it easy for good synth programmers to market their sounds by selling disks of sounds stored in the format of a popular voicing program.

Sample editing and software synthesis packages are based on the growing number of sampling instruments that have the ability to transmit and receive actual sound data in digital form (out of real time) via MIDI or other computer bus (such as the E-mu II's RS422). Sample editing programs let the user manipulate the samples in many ways, including cut-and-paste waveform editing within and between sound files, "pencil" waveform editing, Fourier analysis, reversal and digital signal processing (filtering, gain change, sample merging). After all this processing, the samples may be returned to the instrument and/or stored onto disk, from which sample libraries can be built. Perhaps the best known example of this type of program is Digidesign's Sound Designer, but there are a number of others, especially for the Ensoniq Mirage.

Different samplers have much more in common with each other than different synthesizers may; all samplers are storing and reproducing digital audio, whereas many synthesizers have unique architectures and synthesis techniques. This creates the tempting possibility of converting samples from one machine's format to another's and interchanging libraries. Digidesign has effectively achieved this with Sound Designer by offering versions of the program for a number of different samplers, and having all versions convert incoming sound files to a common file format of their own

**Overall, the variety and number of MIDI software packages available today already cover enough ground that most musicians can find something to help them realize the music they want to hear.**

design. Any version of Sound Designer can access files created by any other version. In fact, one of the great features of Blank Labs' Drum File (a program for the Macintosh and the E-mu SP12) is the ability to port sound files between the SP12, Sound Designer and Sound Lab (their own sample editing software for the Mirage). This same idea has engendered software synthesis programs, like Softsynth (Digidesign again), which utilize non-real time synthesis methods to compute a waveform, then transmit it to the instrument for playback as if it were a sampled sound. This is an inexpensive, if somewhat limited, method of gaining the considerable power of additive and other forms of digital synthesis without the specialized hardware usually required, through the resources of a sampler and personal computer.

### Utility

Librarian programs receive and transmit SysEx dumps of an instrument's program memories and usually allow the user to name and organize the sounds. When compared to expensive RAM cartridges or the pain of finicky and excruciatingly slow cassette interfaces, the advantages of disk-based storage become obvious. There are "dumb" librarian programs, which merely receive and regurgitate bulk dumps without offering organizational features, but will receive dumps from any instrument equipped to perform one. Bulk dump storage features that are included on some pieces of hardware or software, like the DX7II or the Roland MC500, fall into this category. There are also "smart" librarians, such as those from Opcode (those clever guys), which, in addition to naming and organizing features, have

random patch generation. Given specific patches as input, the Opcode programs will either randomly select parameter values from amongst the source patches and construct a "Frankenstein" patch, or take two patches and create new ones which bridge the differences between them. Take this string sound and this horn sound and give me five or six crosses between them. Or (using the new librarian for the PCM70), here's a fat chorus and a tight one, let me have a few in-betweens.

Drum File is a good example of a program which does not fit neatly into a pigeonhole. It is a librarian for a sampler, providing storage and organizing features for the SP12, but no editing or processing facilities. In this case, sequences and actual digital audio sound files are stored, as opposed to synthesis and performance parameters.

Data stream analysis/editing programs let the user look at MIDI data coming out of an instrument and, in some cases, modify it. Some sequencers include the ability to view and edit the MIDI data stream. Event processing programs are related to algorithmic composition but may be less oriented to generating MIDI data and more towards processing existing data according to a specified process.

One area of MIDI software which is just coming to the forefront now is that of languages and programming tools. Altech's MIDI Basic is the only commercially available programming language with MIDI utilities: a set of Basic routines for manipulating MIDI data and files. MIDI-Lisp, an adaptation of a dialect of Lisp created by a French company, has been developed at IRCAM, while Mills College has come up with HMSL (Hierarchical Musical Structural Language). David Levitt has written a program currently known as HookUp!, which allows a programmer to graphically construct an algorithm by connecting icons representing a variety of functions.

Overall, the variety and number of MIDI software packages is increasing at a very rapid rate. In fact, the existing tools already cover enough ground that most musicians can find something to help them realize the music they want to hear. And aiding in the realization of goals, of course, is the true use for which computers are intended. ■

*Larry O is a musician, sound engineer, electronics technician, and consultant, as well as a writer. His company, Toys in the Attic, is based in San Francisco and offers consulting services in the fields of MIDI, product documentation, and signal processing.*

# SOUTHWEST • FORUM

## SYNTHS IN THE STUDIO

by Linda Jacobson

**Liz Harrah, the in-house programmer at Houston's Digital Services Recording, poses with part of the studio's MIDI arsenal: E-mu SP-12 Turbo, Emulator II+, Yamaha KX88, Fairlight CMI Series III, Yamaha DX7-IIFD and TX816 rack, and Roland Juno 60.**

At the *Mix* office the other day, we were talking about what new synths and MIDI gear would dazzle showgoers at the summer NAMM gathering. Our associate editor mused, "Remember when it used to be that every studio *had* to have a drum kit?" He wondered what piece of electronic music wizardry is *the* studio must-have these days. So we made a couple calls to find out.

Since this issue contains our annual exploration of the Southwest studio scene, we posed our question to facility owners and managers in that part of the country. Throughout the region, thriving, not just surviving, is the order of the day. One big reason is the rampant application of cost-effective synthesis, sampling and sequencing. New and improved instruments pop out so regularly that buying a bunch isn't feasible, so some studios buy the few synth and MIDI units they consider

essential. Some studios seem to have 'em all. Either way, the stuff is ensconced in the studio status quo.

Dallas Sound Lab invested heavily in electronic music and MIDI gear, which isn't to say they don't use (or prefer to use) their 40-piece orchestral recording capability. But when they score to picture, handle dialog replacement, or assemble effects for commercials and films, it sometimes makes more fiscal sense to go with their Synclavier. Or their Kurzweil 250 and any combination of their Yamaha, Oberheim, Korg, Linn, Sequential and Moog instruments.

Studio manager Johnny Marshall relies a lot upon the Synclavier for scoring, and notes the Lab's recent completion of a Synclavier score for the award-winning *China Run* documentary. "For sessions that need more acoustic orchestration," adds Marshall, "and especially if the client can't afford the Synclavier, we use our Kurzweil. It's got great reproduction of acoustic timbres. If the client wants a good, well-rounded rack for analog-type synthesis, we use the Oberheim. In lower budget projects, we also use analog *and* FM digital synthesis, a really nice combination that provides high-quality orchestration. But the item we rent out more than anything is the DX7—it's inexpensive, good quality, great for jingles, for rhythm sections, stuff that doesn't require elaborate synthesis."

No doubt *that* doesn't surprise anyone. The DX7 is the Rhodes of the '80s. Every studio offers one, if not nine of them (DX7 + TX816), along with at least one sampling device, perhaps other manufacturers' synths and related gear, and usually one or two





vintage Moogs.

Downtown Sound's Jonathan Cluts concurs, "Everyone can afford a DX7. You hardly have a studio business if you *don't* have one, whether you're doing electronic music or not." The two-room, 24-track Downtown Sound is Dallas' newest studio. It's managed by Cluts, a musician, engineer and former Tandy software analyst. Their inventory is too large to list here, but it includes Yamaha's KX88 keyboard controller, QX1 sequencer, and CX5M music computer, Akai S900 and Oberheim DPX1, samplers, Adams-Smith Zeta 3 MIDI/SMPTE interface box, and three computer systems: IBM XT clone, Apple II+ and Macintosh, with many sequencing, librarian, editing and sampling programs (all Cluts-customized). So far their clients are industrial film and jingle producers who appreciate the time-saving approach to making music.

Continues Cluts, "You can go with one single full-blown system, a Synclavier or Fairlight, but it only has certain sounds, they are the way they are, and that way you control the customer. Going with MIDI stuff, you can get virtually all the capabilities, digital and analog, and your client may have any piece of gear you have. Half your clients call and say, 'I always use a DX7, do you have one?' Yeah, we got eight of them, we got an 816. Or they'll call and say 'I don't like the sound of digital synthesis, do you have analog?' 'Yeah, I got Roland and Oberheim.' You can build up your system piece by piece, and you can make everybody happy."

Goodnight Dallas Recording makes many commercial producers happy, and also has a hand in pleasing various blues and rock artists. This 24-track facility has collected a Kurzweil 250, Oberheim DMX, Prophet-600, LinnDrum, Casio CZ-101, Yamaha DX7, and Yamaha RX5 drum machine. The staff usually uses the Kurzweil as main controller, their brand new E-mu Emax as main sampler. Bands who come in often bring their own MIDI gear, so Goodnight Dallas uses the setup primarily for commercial work.

Manager/engineer Don Seay reports that client demand led to Goodnight Dallas' purchase of the new Yamaha DX7-IIIFD, the aforementioned Emax (Seay anticipates many forays into the field with that, a VCR, and PCM converter to sample "real" sounds), and an Apple Macintosh with



Seated left to right are *Chuck Sugar* and producer/synthesist *Paul Mills* of *Rivendell Recorders*

Mark of the Unicorn software. "It's uncommon *not* to use MIDI," says Seay. "Lately people are going back to live drums and triggered sounds, not just using straight drum machine. Sam-

pling effects is big, everybody's hot for that. Clients like having access to a vast library of original sounds. We also belong to a MIDI user's group and download a lot of sounds by modem.

## "A FACILITY THIS GOOD IN HOUSTON?"

**Studio A:** 48 ch. SSL with Total Recall, Sony 24 trk. Digital, Otari 24 trk. Analog Audio/Video Synchronization for 3/4" and 1" video.

Tracking • Automated Mixing • Post Production

**Studio B:** Amek/TAC, Fairlight CMI III, Emulator II+, E-mu SP-12, Yamaha TX-816, DX7-IIIFD, KX-88, Macintosh Plus Computer, Extensive Sound Libraries.

Scoring to Picture • MIDI • Rehearsal  
• Pre-Production

### Digital Services

Recording Studios

5805 Chimney Rock • Houston, Texas 77081 • (713) 664-5258

Circle #130 on Reader Service Card



One of the newer synthesizers being used in some of the studios today is this Yamaha DX7-IIFD FM digital synthesizer with a floppy disk drive.

The trend here is towards creating large music and sound libraries, knocking off three to six cuts in a day."

Ten minutes from downtown Dallas is Studio Southwest, which has handled the *True Stories* soundtrack, the last Talking Heads album, other groups' records (especially Texas blues and rock), plus audio for national and regional TV/radio spots. This 24-track studio offers its studio clients an IBM clone with System Design's Promidi software, Yamaha's DX7 and TX816,

Akai S900 and Korg DSS-1 samplers, Sequential's Prophet-5 and Prophet-600, LinnDrum and a Simmons drum kit. Because the complex is also a retail outlet and rental firm, Studio Southwest can get almost any device a client could possibly request.

Co-owner Jimmy Wallace says their large MIDI collection in the studio accommodates the many clients who pre-produce at home. He asserts that a studio's main requirement is a sampling keyboard. "Working with sampling in rhythm and blues is real interesting," notes Wallace. "The artists try

to fuse the old original R&B guitar sound with that '80s quality recording. We take a step back to get that authentic R&B sound, perhaps by doing a particular snare drum sound. It's easy to sample a pop-type technical sound, but we try to go for that smoky bar-room kind of feeling."

Over in Houston, Digital Recording Services handles mostly major music projects and also devotes some time to audio for TV and film. One of their

# Source or sampling?

"There is no better sampling" \*)



The TC 2290 is the first sampler/delay in the world to give you 100% accurate sampling up to 32 seconds. Make an A/B comparison with any analog or digital master tape or compact disc, and you will notice there is no difference.

The new TC 2290 digital delay is based on a totally new converter principle. With a linear frequency response up to 20KHz +0/ ± 0.5

dB an additional roll-off up to 33KHz and a unique 100 dB dynamic range, the TC 2290 is very warm, transparent, crystal-clear, musical... with absolutely no noise. It has 18 bit resolution - better sound quality than a compact disc, and many new innovative effects.

Ask your dealer for a demonstration of the new world standard of delay + programmable sampling. Just a few features are: delay with

ducking, chorus and delay simultaneously, automatic panning 100 presets and MIDI feature making it possible to control the TC 2290 from a computer.

**Big studios will like the extras, small studios will love the price**

\*) "There is no better sampling" is a quote from Bob Schwall - Right Track Studio in N.Y.C.

OF DENMARK

# t.c. electronic

P.O. BOX 5039, 52 WOODBINE STREET, BERGENFIELD, N.J. 07621, PHONE: (201) 384-4221

WEST GERMANY: 08157/7677, DENMARK: 06262800, GREAT BRITAIN: 010456262800, SWEDEN: (031) 134950, NORWAY: (033) 26798, HOLLAND, BELGIUM, LUXEMBURG: 003110-4588166, AUSTRIA: 00498157/7677, ITALY: (02) 5084.1, FRANCE: (91) 498728, SPAIN: 91-4426426, USA: (201) 384-4221, CANADA: (416) 727-1951, JAPAN: (03) 329-8051, AUSTRALIA: (03) 6992388, FINLAND: 90-814133, GREECE: 01-3628541, SWITZERLAND: 073/226616.

Circle #131 on Reader Service Card



## The Mic Preamp you've been wishing for is here!

two large studios is set up for rehearsal and off-line pre-production. It hosts an Emulator II, E-mu SP-12 drum machine, Yamaha DX7-IIFD, TX816 and KX88, Oberheim Matrix 12, a one-meg Macintosh computer with Mark of the Unicorn and DigiDesign software, and a modem (for access to various musical bulletin board services). Digital's programmer/synthesist is classically trained pianist Liz Harrah (niece of the hotel/casino owner). She's developed a huge sound library the studio makes available to clients.

When asked what clients request most, owner/engineer John Moran responds "Help! They're not so much after a specific instrument, but they've got an idea for a sound and don't know how to create it. 'Hey, I need a drum sound.' Fine, here's the SP-12, here's the Macintosh, here's the Drum File, what would you like? That's probably the most common thing, because everybody uses a drum machine. Lots of people are just glad when they see all our stuff, or they come in because we have something specific. Or a producer will come in to tie his Commodore 64 and custom patches into our equipment and library." Moran describes how a local radio station came in to develop an on-air "signature" and used his Emulator, Mac and DigiDesign Sound Designer software to modify the voiceover. Say Moran, "They came in and said, 'we're after a sound, we don't quite know what we want, but when we hear it we'll know it.' That's usually how it goes."

The 24-track Rivendell Recorders, home to major contemporary Christian artists and "secular" big name acts, recently moved to new headquarters in northwest Houston. Before doing so they sold their non-sampling Synclavier and Emulator II and bought Akai's S900 polyphonic sampler. Manager/engineer Chuck Sugar plans to buy a second S900 just for drum sounds. Their clients like using it to sweeten scores with string and horn sounds or as the foundation for entire MIDI'd albums. Hoping now to move more into the jingle market, Rivendell just opened a MIDI/keyboard room with an E-mu SP-12 drum machine, Yamaha DX5, Roland Super Jupiter, E-mu Drumulator, the Akai S900, and Macintosh SE with Southworth's Total Music sequencing software.

Rivendell's in-house synthesist/arranger Paul Mills says today's studio must offer enough sound-producing

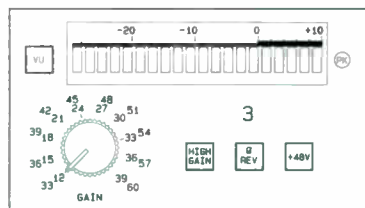

## The M-1 Mic Preamp

The John Hardy Company M-1 Mic Preamp gives you superior quality of sound at a very affordable price. Features include:

- 990 discrete op-amp
- Jensen JE-16-B mic input transformer
- DC servo circuitry



THE JOHN HARDY COMPANY

*The Manufacturer of High-Quality Audio Equipment*

P.O. Box AA631  
Evanston, IL 60204

(312) 864-8060

TELEX: 910-380-4670  
(JOHN HARDY CO)

Circle #132 on Reader Service Card

## "A FACILITY THIS GOOD IN HOUSTON!"

**Compact Disc Services:** Transfers to Sony PCM 1610 from all analog/digital formats. Digital Editing and Compact Disc tape mastering with the Sony DAE 1100 Digital Editor and Sony DTA-2000 Digital Tape Analyzer.

**Remote Recording Services:** 30' Remote Truck with MCI 636 console, JBL monitors, 2 ch. video, 2-24 track analog or digital, Time Code and Audio Distribution.

**Digital Services**  
*Recording Studios*

5805 Chimney Rock • Houston, Texas 77081 • (713) 664-5258

Circle #133 on Reader Service Card

al audio and film scores. According to Alexander, "An Emulator is a studio's smallest requirement. The DX7—on every list. We have both of those, the TX7, and a Mac Plus package with Sound Designer (by DigiDesign) for scoring. Those are always useful for any studio. Otherwise, you never know what's the next big thing. I think a studio should have older synthesizers too, strange things with different sounds that you can couple with the new digital devices—we have an ARP Axe."

Alexander notes, "Most people coming through have their own different little pets or are trying something new, that they MIDI up with our stuff. Glen Campbell has been in working on things, he's done everything in country music and he's into experimenting. His players use Casios and Rolands in tandem with our stuff, and it sounds great." The Fairlight or Synclavier, he adds, are great if a studio can afford to rent one, but the purchase price may be prohibitive. He says, "A good player can couple together the lower-priced things and get great sounds."

On the Mexican border 60 miles south of Tucson is the town of Nogales, home of Gravity Recording and owner/engineer Miguel Crisantes. Gravity has a sales office in Mexico City and primarily produces and engineers albums for the large Mexican record companies, although it's not unusual for them to work with major American artists. "Definitely what people ask for most," says Crisantes, "is the Kurzweil 250 with the Macintosh. It's the main controller for our keyboards, or by it-



*Omega Audio and Productions, Inc. is a 48-track music recording and audio-for-video facility located at Dallas Love Field, Texas*

self just with its own excellent sound banks." When Gravity's programming expert Oscar Bazan is not developing basic synth and rhythm tracks with their Kurzweil/Mac/MIDI setup (Yamaha DX7, TX7, Roland JX-8P, Synergy, Oberheim OB-8, LinnDrum and Linn 9000), the studio focuses on standard 24-track recording. Crisantes explains that they started synthesizing in the early '80s, "to do the sounds of strings, brass, things like that, because there aren't a lot of musicians in Nogales. We went for the Kurzweil two years ago for sampling, because we needed the next best thing to the real thing. We eventually want to MIDI it up to an Emulator IIHD, with the hard disk."

In the desert to the west, at Powerhouse Recording of Las Vegas, you'll find a Yamaha DX7 and RX7, Sequential Drumtraks, Memorymoog and Korg MS20 keyboards. Powerhouse deals out audio and original jingles for TV and radio commercials, industrial programs, plus plenty of pop, rock, heavy metal and funk recording.

They're also the audio homebase for the Royal Viking Cruise Line, and handle projects for many artists who pass through Vegas.

Owner/manager/engineer Paul Badia says, "Virtually every one of us who works in studios in Las Vegas is also out gigging, generally one of the major shows. It's a real small community among the players, ad agencies, everybody knows everybody." Badia himself is an orchestra musician at the Sands Hotel, where he has a permanent setup of two Yamaha 816 racks, some Yamaha QX1s, sampling equipment, Linn 9000, etc. Badia says, "The guys coming into the studio generally like to find the same gear they use on gigs. A studio here doesn't have to stock every piece of gear; if a client asks for anything you can get ahold of it in a day.

"The hotels are getting really high tech and we exchange everything," continues Badia. "We've had a community DX7 library for years. You see a lot of 816 racks, Mirages and Emaxes, a few Emulators, a couple of Kurzweils. We've seen a lot of Mark of the Unicorn software and Macintoshes, but most of our customers still use dedicated or onboard sequencers, whether it's a QX1, ESQ-1, Emulator, Emax, Linn 9000, for a while we saw a lot of Korg SQD-1s.

"We see a lot less live playing these days," Badia remarks, "except for guitar players, vocalists and acoustic piano. I've got a drum room with a set of Yamaha Recording Series drums that gets pretty dusty. Sure, certain producers want a real orchestral sound, and we'll go live horns and strings. But if they're budgeted smaller or want a techno-pop feel to their jingle, we go synth from the ground up. Use the Emax and Emulator to dump in background vocals and sound effects. But virtually every jingle uses drum machine. People prefer the RX7 over Drumtraks, and we see a lot walking in with the little Roland 505. Of course, the Emulator and Emax are used often instead. 'Drum machines' per se will be used less and less as samplers get more interesting and usable for building onboard custom sounds. Then you're taking more of your tracks off a single instrument. This whole thing sure makes setup a lot easier." ■

*John Wagner of John Wagner Recording Studios, Albuquerque, New Mexico*





# SOUTHWEST

---

## STUDIO DIRECTORY

---

The information in the following directory section was supplied by those listed and

Mix claims no responsibility for the accuracy of this information.

People, equipment and rates may change, so please verify critical information with the studios.

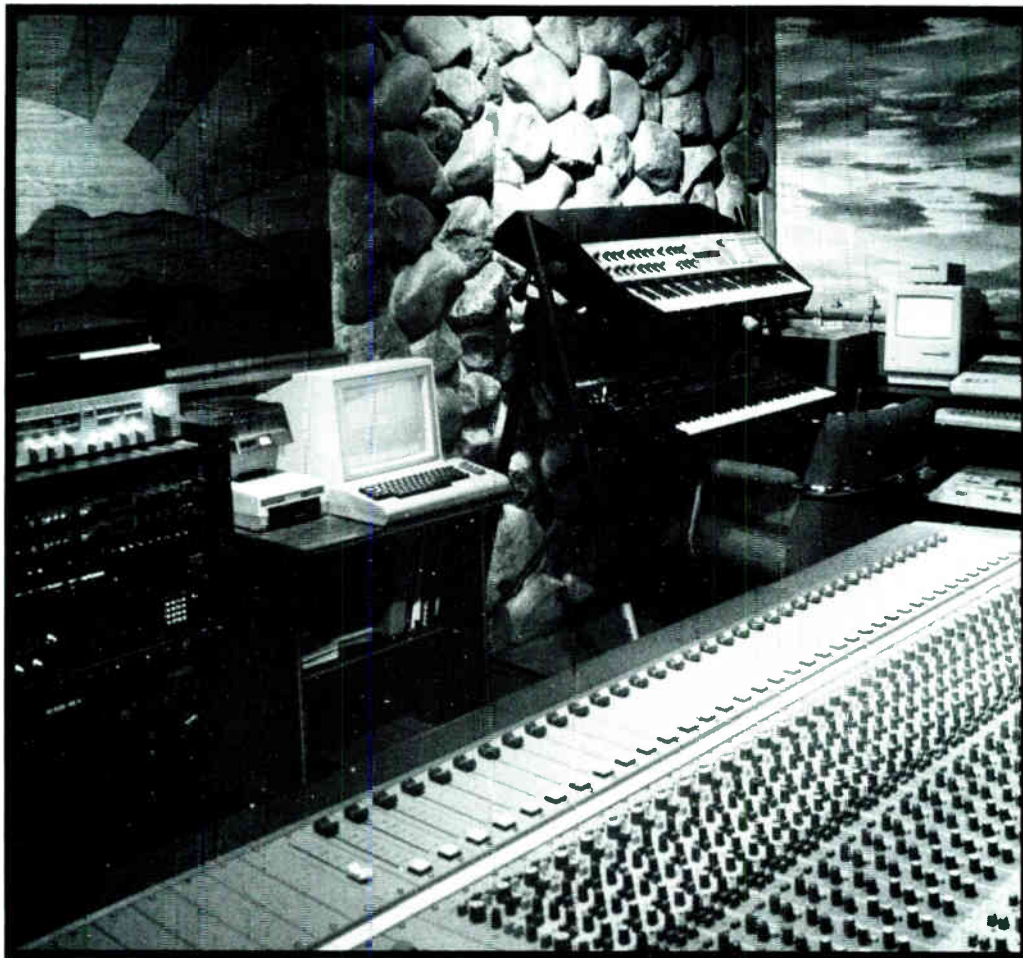

Sunrise Sound Studios is a 24-track and 8-track facility located in southwest Houston. Specializing in synthesizer and computer capabilities, their latest clients include The Jetts, Stephanie Mills, Jean-Michel Jarre and Kirk Whalum.

---

### ■ CONTENTS ■

---

177	STUDIO LOCATION INDEX
178	4 & 8 TRACK STUDIOS
184	12 & 16 TRACK STUDIOS
188	24+ TRACK STUDIOS

---

*Mix listings procedure: Every month, Mix mails questionnaires to recording studios and/or other vital facilities and services for the recording, sound and video production industries. Basic listings (name, address, contact) are provided free of charge. Extended listings (equipment, credits, specialization), and photographs or company logos may be included at a nominal charge. If you would like to be listed in a Mix Directory, write or call the Mix Directories Department, 2608 Ninth Street, Berkeley, CA 94710, (415) 843-7901.*

---

#### **Upcoming Directory Deadlines:**

New Products Directory: **July 13, 1987**

North Central/Canadian Studios: **August 3, 1987**

Mastering, Pressing and Tape Duplication: **September 3, 1987**

Northwest Studios: **October 1, 1987**

---



I TOSSED MY 421'S AND  
PUT IN 408'S. THEY'RE GREAT!!  
ACOUSTICALLY THEY'RE VERY FULL.  
AESTHETICALLY THEY CLEAN UP  
THE DRUM SET APPEARANCE.\*

Drums, cymbals, brass and woodwind, and even voice applications. The N/D408 and N/D308 instrument mics do it all.

We designed them as instrument mics, but believe it or not we're also getting great response from vocal performers who think they're fantastic.

Actually, the N/D408 and N/D308 represent a radical departure from conventional instrument microphone designs. Both employ N/DYM™ technology, and only the N/D Series mics from Electro-Voice have it. And both offer a pivoting yoke configuration for maximum flexibility in positioning the microphone near

the sound source while maintaining optimum pick up angle. They're N/DYM hot, and there is no better mic for live sound reinforcement of instruments.

Try them at your Electro-Voice dealer and in concert. Then let us know what you think.

**Electro-Voice**  
  
a MARK IV company

*To learn more about N/D Series microphones, see your Electro-Voice dealer or write Electro-Voice, Inc., Dept. N, 600 Cecil Street, Buchanan, MI 49107.*

\*Actual N/D408, 308 user comments are kept on file at the Electro-Voice Corporate headquarters in Buchanan, Michigan.

Circle #137 on Reader Service Card

World Radio History



# Southwest Studio LOCATION INDEX

## ARIZONA

Flagstaff	
8 Dnoseur Tracks	178
Mesa	
16 Arizona Remote	
Recorders	184
12 Doug Nolle Ent	186
16 Orangewood Rec.	186
Nogales	
24 Gravity Rec.	191
Page	
8 Buns-up Studio	178
Phoenix	
4 Artronix	178
24 Audio Video Rec.	
of Arizona	188
8 BPL's Benjo Brass	178
8 Canine Studios	178
8 Eightraz	179
8 Jimmers Audio Serv.	179
8 Juniper Prod.	179
8 Lambchops Studios	179
8 Nestone Studio	180
4 Snowbird Junction	182
4 Sound Idea Prod.	182
16 S.W.I.R.A.S.	187
24 Vintage Recorders	200
Prescott	
16 Creative Audio/Video	184
Scottsdale	
24 Chaton Rec.	188
24 Pantheon Rec.	194
16 Scottsdale Conference	
Resort	186
8 Steggerwind Prod.	182
Tempe	
24 Cereus Rec.	188
8 O-Tu Studios	180
8 Seashell Sound Studios	182
8 Tempest Rec.	183
Tucson	
24 Jim Brady Rec.	188
8 B.T. Prod.	178
4 Dubwise-Otherwise	179
8 Fimeco Studios	179
4 Golden Rec.	
Audio/Video	179
8 Headroom Audio Prod.	179
16 Marsound	186
2 Preadio Film Group	182
24 Sound Factory	197
8 Soundings of the Planet	182
8 Westwood Rec Studios	201

## ARKANSAS

Bryant	
8 Crystal Rec. Studio	178
El Dorado	
8 Metal Prod.	180
Eureka Springs	
16 Sound Investments	187
Fort Smith	
16 Omega Sound	186
Little Rock	
16 ARCA	184
8 Mix Media Prod	180
16 Zanbeck Sound	187
Monticello	
4 Gold Lena Sound	179
Mountain Home	
8 Cedar Crest	178
No. Little Rock	
4 Com-Pro Studio	178
Russellville	
4 Dunamis Prod.	179
Siloam Springs	
8 The Production Co.	182

## NEVADA

Las Vegas	
24 Around Town Prod	188
24 Powerhouse Rec.	196
24 RMS Rec.	197
8 Swillsound	183
24 University of Nevada	200
24 Vale Rec.	200

## NEW MEXICO

Albuquerque	
24 Alta Vista Rec. Studio	188
8 BJ and M. Rec.	178
8 Hi-Que Audio	179
4 New Mexico	
Ambisonics	180
4 Nyema Network	180
16 Quincy Street Sound	186
24 John Wagner Rec.	201
Carlsbad	
12 Sword Records Rec.	187
Cerrillos	
24 Kludgit Sound	192

## Las Cruces

24 Emmit Brooks Rec.	188
8 Sunburst Studios	183
Portales	
8 Lamblight Rec.	179
Roswell	
8 Nash St. Media	180
Santa Fe	
4 Xaviatronix	183
Teco	
8 Moondance Studios	180

## OKLAHOMA

Afton	
8 Monkey Island Rec.	180
Broken Arrow	
8 The 25th Track	183
8 Wasa Newer Quit Prod.	183
Duncan	
16 The Ranch Rec.	186
Edmond	
8 White Rose Studio	183
Midwest City	
16 Copesetic Sound	184
4 Rose State Rec. Lab.	182
Norman	
8 Carumbo Rec.	178
24 The Rock Studio	197
16 World Win Rec.	187
Oklahoma City	
24 Benson Sound	188
24 Cornerstone Rec. Co.	189
8 OB Studios	180
12 Producers Sound Studio	186
8 S and E Audio Prod.	182
24 Studio Seven	192
Skiatook	
8 Al Clauser Rec.	178
Tulsa	
16 B.Y. Prod.	184
4 Horizon Studios	179
16 ITTI Studios	185
24 Long Branch Studios	192
8 Southern Rec.	182
24 Universal Music & Post	200

## TEXAS

Arlington	
8 Chateau Prod	178
16 Patrick McGuire Prod.	186
4 On-Site Rec. Serv.	180
8 Stellar Winds Studio	182
Austin	
24 Arlyn Studios	288
24 Crystin Rec.	188
16 Austins Riverside Sound	184
24 Cedar Creek	188
8 Doctor Audio	179
24 Europe Sound Centre	190
24 Fine Arts Media	190
12 Jaggy Mountain Studio	185
24 Jasper Sound	192
16 Lone Star Rec.	185
8 Media Sound	180
8 Music Lane	180
8 Parrot Tracks	182
4 Phantom Prod.	182
16 Production Block	186
24 Reelsound Rec.	196
16 Sound Recorders	187
24 SR Inc.	197
16 Tim Stanton Audio	187
24 Studio D	197
24 University of Texas	200
Beaumont	
24 Gulf Coast Creative	191
Brazoria	
8 Sound Trax	182
Bryan	
16 Texas Music Studio	187
Burleson	
8 Center Stage Prod	178
Cedar Hill	
16 Poverty Hill Rec.	186
Channelview	
8 Chanel 8	178
Clyde	
24 Longhorn Sound	192
College Station	
24 Brasswind Rec.	188
2 J.R. Prod.	179
Corpus Christi	
16 Gary Beck's	184
Crowley	
8 Edwards Hill Rec.	179
Dallas	
24 Cecca Sound	188
16 Community Video	184
24 Crystal Clear Sound	189

16 Digital Dynamics	185
24 Downtown Sound	190
24 Edenwood Rec	190
4 David Flack Quorum	179
24 Future Audio	190
24 Goodnight Audio	191
16 Hai Tex	185
24 Jam Creative Prod.	191
24 January Sound Studios	192
24 Knightlight Studios	192
24 Luv Sound & Rec	192
16 Noisemaker	186
24 Omega Audio & Prod.	194
8 Parallel Images	182
8 Pla-Back Rec.	182
24 Planet Dallas	194
24 Precision Audio	196
24 Producers Studio	182
4 Reel to Reel	196
8 Reelworks Rec.	186
24 Rosewood Sound	197
16 RSV P. Rec.	186
12 Shade Tree	187
8 SOC Rec.	182
24 Studio Centre	197
24 Studio Studio	198
8 Studio 3	182
24 Sunset-Bemet Sound	198
Jocatur	
8 Unreel Recorders	183
Denton	
8 D.S.I. Audio	179
24 Inside Track	191
8 J and L	179
16 Prodigal Sound	186
Dickinson	
24 Lmelight Rec	192
Edinburg	
16 Texas Sunrise Rec.	187
El Paso	
16 April Rec.	184
24 El Adobe Rec.	190
24 Martin Rec. Co.	192
8 Posting Brothers	182
Euleasa	
8 Ambassador Audio	178
Flint	
16 Tomlyn Rec.	187
8 Trash Bags	183
Flowermond	
16 Heads Up Studios	185
Worth	
16 Altim Studios	184
4 Apollo Studios	178
16 Avalon Sound	184
8 Band Factory	178
24 Buffalo Sound	188
24 Caravan of Dreams	188
24 Eagle Audio	190
8 Oakridge Music	180
16 Strawberry Sounds	187
24 Texas Rec. Center	200
Fredericksburg	
24 Gamma Ranch	192
Garland	
8 Tandem Prod	183
Garland	
8 Left Abbey Prod	178
8 Demos & More	178
16 Garland Sound	185
24 Sound Logic Rec.	197
Gladewater	
8 R.O.K. Studio	182
Grapevine	
12 North Star Music	186
Greenville	
8 Lazer Prod	180
Houston	
24 Accessible Sound	188
24 Cooksound Prod.	188
24 Digital Services	189
24 Digital Services Remote	190
8 Good Sound Serv.	179
16 Jihad Music	185
8 Jus-Fresh Studio	179
8 Larr Comp Corp.	180
16 Mushroom Station	186
24 Music Media	194
24 Rampart Studios	196
24 Rivendell Recorders	197
8 Dan Sessions Prod	182
8 Smith Sound	182
24 Sound Masters	197
16 Southwest Rec	187
16 Studio Mobile	187
24 Studio West	198
8 Studio Works	182
8 Sugar Hill	198
24 Sunrise Sound	198
16 Track Designs	183
8 TSB Rec.	183
8 Twin Palms	183

## Irving

24 Dallas Sound Lab	189
24 Midcom	192
24 Tele-Image	200
Joshua	
8 Peak Rec.	182
Laguna Vista	
8 Creative Audio	178
Lake Jackson	
8 Lost Person Prod	180
Lamesa	
16 C and L Prod	184
Lancaster	
8 Foxfire Studios	179
Levelland	
2 Paragon Audio	180
Longview	
8 Hidden Forest	179
Lubbock	
8 Audio Chain	178
McAllen	
16 Salt Rec	186
Mesquite	
16 Mesquite Rec.	186
16 South Winds	187
Midland	
8 J-Rox Rec.	179
Missouri City	
16 Power House Sound	186
Monahans	
4 Grant Sound	179
8 Wing and a Prayer	183
Nacogdoches	
8 G.O.D.T.E.L. Prod.	179
8 Dana Woods Rec.	183
New Braunfels	
8 Positive Sound	182
16 Walk on Water	187
New Caney	
16 Sounds Right	187
Newark	
8 Eagle Mountain	190
Odessa	
8 Brookshire Sound	178
Port Arthur	
4 Musik Faktorey	180
Richardson	
8 Lakedog Studios	179
Richwood	
16 Musicians Sound Lab	186
Roanoke	
16 Lake Sound	185
Saginaw	
8 Taylor's	183
San Angelo	
4 Audio Genics	178
16 Jencho Sound	185
San Antonio	
16 Mike DeLeon Prod.	185
16 Demo Studio	185
8 First Video	179
24 Garzabelli Int.	191
16 Dubby Hankins Studio	185
8 Major Mix	180
8 Southsayer Rec.	187
8 Sound Cube	182
16 Soundtrack Rec.	187
16 Studio Center	187
16 Studio One	187
24 United Audio	200
Spicewood	
8 Pedemales Rec.	194
Spring	
8 Ararat Sound	178
16 Lincoln Inst.	185
Stephenville	
8 Parham Sound	182
Sunnyvale	
24 Studio Southwest	198
Temple	
24 Versatronics Group	200
Texarkana	
24 National Rec.	194
16 Texarkana College	187
Tyler	
16 Palmist Rec.	186
24 Robin Hood Studios	197
Van Alstyne	
4 Sellars Co.	182
Waco	
4 Azbell Video	178
Weelaco	
16 Calvary Rec.	184
16 Master Prod.	186
Wichita Falls	
16 Blair Sound	184
16 Lure Maie Prod.	185
4 Nesman Studios	180
Wimberley	
16 Action Sound	184
Wylie	
24 Boyd Sound	188



Page, AZ 86040  
(602) 645-9300  
Owner: Jerry Edwards

[8] CANINE STUDIOS  
2828 W. Villa Maria Dr.  
Phoenix, AZ 85023  
(602) 439-3142  
Owner: Roy Kim Weinberg  
Studio Manager: Roy Kim Weinberg

[8] CARUMBO RECORDING  
1301 Magnolia St.  
Norman, OK 73072  
(405) 329-1765  
Owner: Michael McCarty  
Studio Manager: Michael McCarty

[8] CEDAR CREST STUDIO  
also REMOTE RECORDING  
PO Box 28  
Mountain Home, AR 72653  
(501) 425-9377  
Owner: Bob Ketchum  
Studio Manager: Susan Ketchum

[8] CENTER STAGE PRODUCTIONS  
also REMOTE RECORDING  
301 Linda  
Burleson, TX  
(817) 295-7654  
Owner: Wes Redden  
Studio Manager: Deb Redden

[8] CHANNEL 8  
15350 Peachmeadow Ln.  
Channelview, TX 77530  
(713) 452-7477  
Owner: Buford Noris  
Studio Manager: Buford Noris

[8] CHATEAU PRODUCTIONS  
PO Box 13802  
Arlington, TX 76094  
(817) 572-7502  
Owner: Jeff G. Peters

[8] AL CLAUSER RECORDING (ALVERA)  
402 S. Broadway  
Skiatook, OK 74070  
(918) 396-1333  
Owner: Al Clauser  
Studio Manager: Al & Jim Clauser

[4] COM-PRO STUDIO  
4809 N. Cypress St., PO Box 4197  
N. Little Rock, AR 72116  
(501) 758-4907  
Owner: D.C. McCree  
Studio Manager: D.C. McCree

[8] CREATIVE AUDIO PRODUCTIONS  
326 Santa Isabel Blvd.  
Laguna Vista, Port Isabel, TX 78578  
(512) 943-6278  
Owner: Ben McCampbell  
Studio Manager: Ben McCampbell

[8] CRYSTAL RECORDING STUDIOS  
PO Box 733, #19 Tanglewood  
Bryant, AR 72022  
(501) 847-8215  
Owner: Roy Brooks  
Studio Manager: Roy Brooks

[8] "DEMOS & MORE"  
1119 Main St.  
Garland, TX 75040  
(214) 276-4971  
Owner: Gene Huddleston  
Studio Manager: Gene Huddleston

[8] DINOSAUR TRACKS  
Rt. 4, Box 706  
Flagstaff, AZ 86001  
(602) 774-0474  
Owner: Dan Costello

[8] JEFF ABBEY PRODUCTIONS  
405 San Maria  
Garland, TX 75043  
(214) 240-2520  
Owner: Jeff N. Abbey  
Studio Manager: Jeff N. Abbey

[8] AMBASSADOR AUDIO  
only REMOTE RECORDING  
PO Box 271  
Euless, TX 76039  
(817) 451-8967  
Owner: Walt Beaulieu  
Studio Manager: Walt Beaulieu

[4] APOLLO STUDIOS  
3001 W. Normandale, #1089  
Ft. Worth, TX 76116  
(817) 244-5408  
Owner: Steven J. Apollo  
Studio Manager: Steven J. Apollo

[8] ARARAT SOUND PRODUCTIONS  
23019 Tree Bright  
Spring, TX 77373  
(713) 443-6947  
Owner: David Forbus  
Studio Manager: David Forbus

[4] ARTRONIX  
only REMOTE RECORDING  
7544 N. 28 Dr.  
Phoenix, AZ 85051  
(602) 864-9761  
Owner: Darrell DeMarco  
Studio Manager: Darrell DeMarco

[8] AUDIO CHAIN RECORDING  
also REMOTE RECORDING  
PO Box 5236  
Lubbock, TX 79417  
(806) 792-3804  
Owner: Dwaine Thomas, Rocky Johnson  
Studio Manager: Rocky Johnson, Dwaine Thomas

[4] AUDIO GENICS  
also REMOTE RECORDING  
Rte. 5, Box 5207  
San Angelo, TX 76904  
(915) 944-1213  
Owner: Rick Peeples  
Studio Manager: Rick Peeples

[4] AZBELL VIDEO PRODUCTIONS  
also REMOTE RECORDING  
1813 Speight  
Waco, TX 76706  
(817) 754-4689  
Owner: Billy Azbell Sr.  
Studio Manager: John Wheeler

[8] BAND FACTORY  
also REMOTE RECORDING  
1414 W. Rosedale  
Ft. Worth, TX 76104  
(817) 877-3391  
Owner: Edward R. Stradley  
Studio Manager: Edward R. Stradley

[8] B.J. AND M. RECORDING STUDIO  
also REMOTE RECORDING  
5604 Drake NW  
Albuquerque, NM  
(505) 898-6761  
Owner: Fred & Tere Baca  
Studio Manager: Fred & Tere Baca

[8] BPL'S BANJO BRASS STUDIO  
also REMOTE RECORDING  
8088 N. 15th Ave.  
Phoenix, AZ 85021  
(602) 870-0351  
Owner: Bruce P. Leland  
Studio Manager: Shirley Leland

[8] BROOKSHIRE SOUND  
3839 Maple  
Odessa, TX 79762  
(915) 362-8777  
Owner: Gary Brookshire  
Studio Manager: Gary Brookshire

[8] B.T. PRODUCTIONS  
also REMOTE RECORDING  
2133 Sindle Pl.  
Tucson, AZ 85746  
(602) 883-7044  
Owner: Bob Tripp  
Studio Manager: Bob Tripp

[8] BUNS-UP STUDIO  
also REMOTE RECORDING  
Box 2393



**[8] DOCTOR AUDIO**  
also *REMOTE RECORDING*  
6707 Willamette Dr.  
Austin, TX 78723  
(512) 926-6222  
Owner: Kenneth Epstein  
Studio Manager: Kenneth Epstein

**[8] D.S.I. AUDIO**  
also *REMOTE RECORDING*  
2604½ N. Locust  
Denton, TX 76201  
(817) 383-0110

Owner: James F. Vincent  
Studio Manager: James Vincent  
Engineers: James Vincent, Tim Morris  
Dimensions: Studio 30 x 15, control room 12 x 15, drum room 12 x 12, vocal booth 6 x 6.  
Mixing Consoles: Tascam M-520 20 x 8.  
Audio Recorders: Tascam 48 8-track, Tascam 32 2-track.  
Cassette Recorders/Duplicators: TEAC cassette, JVC cassette.  
Noise Reduction Equipment: (2) Tascam DX-4D (dbx I), Echo, Reverb, & Delay Systems: Yamaha REV7, Lexicon PCM60, Yamaha SPX90, Korg SDD-3000.  
Other Outboard Equipment: (2) dbx 160X compressor/limiter.  
Microphones: AKG 414, (2) Sennheiser 421, Sennheiser 441, E-V PL20 and PL6, (3) Shure SM57.  
Monitor Amplifiers: Carver PM-200, NAD 2150.  
Monitor Speakers: JBL 4312, Yamaha NS-10, Auratones.  
Musical Instruments: Yamaha DX7, Korg DW-8000, Sonor 5-piece SDS9 kit, Simmons SDS9, Fender Strat, Gibson Les Paul, Peavey Foundation bass, Korg DDD-1 drum machine.  
Other MIDI Equipment: Atari 1040ST computer w/full software pkg.  
Rates: Call for rates.

**[4] DUBWISE-OTHERWISE**  
also *REMOTE RECORDING*  
528 E. Mabel  
(PO Box 50252, Tucson, AZ 85703)  
Tucson, AZ 85709  
Owner: Steve Weizenecker  
Studio Manager: Steve Weizenecker

**[4] DUNAMIS PRODUCTIONS**  
also *REMOTE RECORDING*  
407 N. Joplin Ave.  
Russellville, AR 72801  
(501) 968-6247  
Owner: John L. Terry III  
Studio Manager: John L. Terry III

**[8] EDWARDS HALL RECORDING**  
409 Tims  
Crowley, TX 76036  
(817) 731-9374  
Owner: Dan Edwards  
Studio Manager: Dan Edwards

**[8] EIGHTRAX**  
also *REMOTE RECORDING*  
1441 E. Edgemont  
Phoenix, AZ 85006  
(602) 266-5513  
Owner: Jose G. Esparza  
Studio Manager: Sam Esparza

**[8] FIMECO STUDIOS**  
also *REMOTE RECORDING*  
PO Box 43543  
Tucson, AZ 85733  
(602) 881-2073  
Owner: Fimeco Inc.  
Studio Manager: Jeff Robins

**[8] FIRST VIDEO PRODUCTIONS**  
also *REMOTE RECORDING*  
4235 Centergate  
San Antonio, TX 78217  
(512) 655-1111  
Studio Manager: Glenn Duchaine

**[4] DAVID FLACK QUORUM STUDIO**  
also *REMOTE RECORDING*  
PO Box 470007  
Dallas, TX 75247  
(817) 261-6619 metro  
Owner: David Flack  
Studio Manager: David Flack

**[8] FOXFIRE STUDIOS**  
1220 Cedarbrook  
Lancaster, TX 75146  
(214) 227-2727  
Owner: Keith Croxton  
Studio Manager: Dennis Armstrong

**[8] G.O.D.T.E.L. PRODUCTIONS (GP STUDIOS)**  
also *REMOTE RECORDING*  
330 E. Main St., PO Box 604  
Nacogdoches, TX 75963  
(409) 560-4282  
Owner: Brother June Gentry  
Studio Manager: Rick Smith

**[4] GOLD LENA SOUND PROD.**  
also *REMOTE RECORDING*  
PO Box 555  
Monticello, AR 71655  
(501) 367-3076  
(501) 367-5809

Owner: J.D. Orrell, Don Orrell  
Studio Manager: J.D. Orrell, Don Orrell

**[4] GOLDEN RECORDING, AUDIO/VIDEO**  
9321 E. 27th St.  
Tucson, AZ 85710  
(602) 885-6132  
Owner: Eddie Golden  
Studio Manager: Eddie Golden

**[8] GOOD SOUND SERVICES**  
also *REMOTE RECORDING*  
8918 Bissonnet St., Ste. 406  
Houston, TX 77074  
(713) 988-5750  
Owner: Alan W. Clarke  
Studio Manager: Alan W. Clarke

**[4] GRANT SOUND**  
also *REMOTE RECORDING*  
905 S. Gary  
Monahans, TX 79756  
(915) 943-3724  
Owner: Bill Grant  
Studio Manager: Bill Grant

**[8] HEADROOM AUDIO PRODUCTION**  
also *REMOTE RECORDING*  
1710 E. Missouri St.  
Tucson, AZ 85714  
(602) 889-4759  
Owner: R.D. McIntyre  
Studio Manager: R.D. McIntyre

**[8] HI-QUE AUDIO**  
also *REMOTE RECORDING*  
12325 Morocco NE  
Albuquerque, NM 87111  
(505) 296-4985  
Owner: Chris Romero  
Studio Manager: Jim Aurla

**[8] HIDDEN FOREST STUDIO**  
also *REMOTE RECORDING*  
421 Hidden Forest N.  
Longview, TX 75605  
(214) 663-1817  
Owner: Gary & Pam Boren  
Studio Manager: Gary Boren

**[4] HORIZON STUDIOS**  
also *REMOTE RECORDING*  
2015D E. 51st Pl.  
Tulsa, OK 74105  
(918) 749-4155  
Owner: Ray Shank  
Studio Manager: Ray Shank

**[8] J AND L STUDIOS**  
also *REMOTE RECORDING*  
216 E. Congress  
Denton, TX 76201  
(817) 566-1181  
Owner: Jodie Lyons  
Studio Manager: Jodie Lyons

**[8] J-ROX RECORDING CO.**  
1407 E. Golfcourse Rd.  
Midland, TX 79705

(915) 685-0675  
Owner: Mr. J.  
Studio Manager: Mr. J.

**[8] JIMMERS AUDIO SERVICES**  
2926 E. Highland  
Phoenix, AZ 85016  
(602) 956-6963  
Owner: James Holm, Russ Graves  
Studio Manager: Russ Graves  
Engineers: Russ Graves, James Holm  
Dimensions: Studio 14 x 12, control room 14 x 14  
Mixing Consoles: (2) Tascam M-312B 12 x 4  
Audio Recorders: Tascam 38 8-track, Tascam 22 2-track.  
Cassette Recorders/Duplicators: Mitsubishi, (2) IVC.  
Noise Reduction Equipment: dbx 150 Type I.  
Synchronization Systems: Roland SB-10 MIDI sync to tape interface.

Echo, Reverb, & Delay Systems: Yamaha SPX90 reverb and effects, ART DR-2 reverb, ART Pro-verb digital effects, Roland SDE-2000 digital delay, ADA D640 digital delay.  
Other Outboard Equipment: Symetrix 522 comp./limiter, dbx 166 gated comp./limiter, GateX 4-channel noise gate, Tascam PE-40 4-channel parametric EQ, Furman PQ-3 parametric EQ/pre-amp  
Microphones: E-V BK1, (3) E-V PL80, (4) Shure SM58  
Monitor Amplifiers: Soundcraftsmen 2500  
Monitor Speakers: (2) JBL 4408, (2) Auratone Super 8C, (2) Realistic Minimus 0.3  
Musical Instruments: Roland S-50 sampling keyboard, Roland S-10 sampling module, Yamaha TX817 FM generator, Yamaha FB01 FM generator, Yamaha TX7 FM generator, Yamaha RX11 drum computer, Roland TR505 drum computer, Fender Stratocaster guitar, Fender Mustang guitar, Dean Elite guitar, Rickenbacker 5001 bass, (3) Guild 6- and 12-string acoustic guitars, GK RL-250 guitar amp.  
Other MIDI Equipment: Apple Macintosh w/Total Music software, Roland SB-10 sync box, Korg programmable MIDI patchbay.  
Other: Hand-made Hawaiian ukulele, Hawaiian double-necked steel guitar  
Rates: \$30/hr. plus programming and musicians' fees.

**[2] J.R. PRODUCTIONS**  
only *REMOTE RECORDING*  
Ste. 329, 1501 FM 2818  
College Station, TX 77840  
(409) 696-8822  
Owner: Jeff Cowan

**[8] JUNIPER PRODUCTIONS**  
also *REMOTE RECORDING*  
2726 E. Juniper  
Phoenix, AZ 85032  
(602) 867-7354  
Owner: John Benson  
Studio Manager: John Benson

**[8] JUS-FRESH STUDIO**  
also *REMOTE RECORDING*  
1106 Brenford  
Houston, TX 77047  
(713) 433-1276  
Owner: Clay Adams  
Studio Manager: Clay Adams

**[8] LAKEDOG STUDIOS**  
also *REMOTE RECORDING*  
2116 E. Arapaho, #167  
Richardson, TX 75081  
(214) 853-2574  
Owner: A.M. Johnson  
Studio Manager: A.M. Johnson

**[8] LAMBCHOPS STUDIOS**  
also *REMOTE RECORDING*  
323 W. McDowell  
Phoenix, AZ 85003  
(602) 254-3849  
Owner: Rick Lamb  
Studio Manager: Shelley Standing

**[8] LAMPLIGHT RECORDING**  
also *REMOTE RECORDING*  
Rte. 1, Box 66L  
Portales, NM 88130  
(505) 359-1883  
Owner: Dean O'Hare  
Studio Manager: Brack Morrow

# THE DALLAS RECORD PRESSING PLANT SINCE 1967!

## TAPE DUPLICATION

Any quantity,  
large or small  
Custom Packaging  
Demo tapes  
(real time copies)  
Blank tapes—  
ANY length needed

## RECORD PRESSING IN HOUSE

- Custom Albums • 45 RPM Singles
- Stereo Mastering with Neumann VMS70  
Lathe & SX74 Cutter
- Plating with Europa Film Equipment

1000—7" 45 RPM Record Package • \$469.  
1000—1 color • 12" Album Package • Records & Printed Covers • \$1372.

**A+R RECORD & TAPE MFG. CO.**  
902 North Industrial Blvd.  
Dallas, Texas 75207  
214-741-2027  
Toll Free: 1-800-527-3472

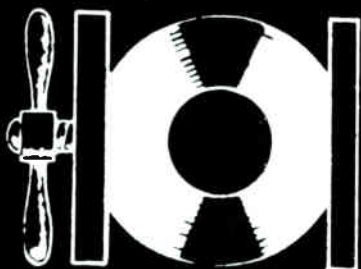

Circle #138 on Reader Service Card



[8] LARR COMPUTER CORP. OF DELAWARE/KLARR  
BROADCASTING NTRWK. DIV.

also *REMOTE RECORDING*  
Broadcast & Recording School Dept.  
PO Box 3842  
Houston, TX 77253  
Owner: Dr. Lawrence Herbst  
Studio Manager: Larry

[8] LAZER PRODUCTIONS  
also *REMOTE RECORDING*

2518 Rolling Hills  
Greenville, TX 75401  
(214) 454-7339  
Owner: Sam Loy  
Studio Manager: Sam Loy

[4] LOST PERSON PRODUCTIONS

2102 Bayou Dr.  
Lake Jackson, TX 77566  
(409) 798-5462  
Owner: Gregory R. Leach  
Studio Manager: Gregory R. Leach

[8] MAJOR MIX STUDIO

10502 Breeds Hill  
San Antonio, TX 78245  
(512) 674-3469  
Owner: J. Mark Major  
Studio Manager: J. Mark Major

[8] MEDIA SOUND

also *REMOTE RECORDING*  
6448 Hwy. 290 E., Ste. D-109  
Austin, TX 78723  
(512) 467-2788  
Owner: Glenn Wolfe

[8] METAL PRODUCTIONS

4414 W Hillsboro  
El Dorado, AR 71730  
(501) 863-5946  
Owner: Randy & Jane Matthiessen  
Studio Manager: Randy Matthiessen

[8] MIX MEDIA PRODUCTIONS

7628 Mabelvale Pike  
Little Rock, AR 72022  
(501) 565-5632  
Owner: Joe & Randy Gillespie  
Studio Manager: Joe Gillespie

[8] MONKEY ISLAND RECORDING

Rte. 3, Box 1625  
Alton, OK 74331  
(918) 257-5755  
Owner: Ace & Carolyn Moreland  
Studio Manager: Ace Moreland

[8] MOONDANCE STUDIOS

also *REMOTE RECORDING*  
PO Box 3318  
Taos, NM 87571  
(505) 758-9113  
Owner: Morten Nilssen  
Studio Manager: Morten Nilssen

[8] MUSIC LANE RECORDING STUDIOS

PO Box 3829, Austin Opera House #5  
Austin, TX 78764

(512) 447-3988  
Owner: Wayne Gathright  
Studio Manager: Wayne Gathright

[4] THE MUSIK FACTORY

1812 Procter St.  
Port Arthur, TX 77640  
(409) 982-7121  
Owner: Lois & Floyd Badeaux  
Studio Manager: Floyd Badeaux

[8] NASH ST. MEDIA

also *REMOTE RECORDING*  
603 N. Kentucky  
Roswell, NM  
(505) 622-6295  
(505) 624-0466  
Owner: Carl F. Erdmann  
Studio Manager: Carl F. Erdmann

[4] NESMAN STUDIOS

also *REMOTE RECORDING*  
3108 York St.  
Wichita Falls, TX 76309  
(817) 696-1629  
Owner: Lewis Nesman  
Studio Manager: Sally Nesman

[8] NESTONE STUDIO

6801 N. 30th Dr.  
Phoenix, AZ 85017  
(602) 433-2923  
Owner: Joe "Crow" Corrao  
Studio Manager: "Crow"

[4] NEW MEXICO AMBISONICS

also *REMOTE RECORDING*  
PO Box 40316  
Albuquerque, NM 87106  
(505) 265-1660  
Owner: Kevin Campbell  
Studio Manager: Kevin Campbell

[4] NYEMA NETWORK PRODUCTIONS, LTD.

also *REMOTE RECORDING*  
916 Palomas SE  
Albuquerque, NM 87108  
(505) 268-3883  
Owner: Jerry Douglas Geist, Jr.  
Studio Manager: Jerry Douglas Geist, Jr.

[8] O-TU STUDIOS

1101 E. Lodge Dr.  
Tempe, AZ 85283  
(602) 831-6488  
Owner: Robert W Lewis  
Studio Manager: Robert W Lewis

[8] OAKRIDGE MUSIC RECORDING SERVICE

also *REMOTE RECORDING*  
2001 Elton Rd., Haltom City  
Fort Worth, TX 76117  
(817) 838-8001  
Owner: Homer Sewell  
Studio Manager: Homer Sewell

[8] OB STUDIOS

also *REMOTE RECORDING*  
5932 N. Grove  
Oklahoma City, OK 73122  
(405) 721-3727  
Owner: Larry G. O'Rear  
Studio Manager: Larry G. O'Rear

[4] ON-SITE RECORDING SERVICES

only *REMOTE RECORDING*  
1555B Latrium Pl.  
Arlington, TX 76010  
(817) 275-4253  
Owner: Gary D. Ballard  
Studio Manager: Gary D. Ballard

[2] PARAGON AUDIO PRODUCTIONS

only *REMOTE RECORDING*  
119 Holly  
Levelland, TX 79336  
(806) 894-9238  
Owner: David Noles  
Studio Manager: David Noles



**MIX BOOKSHELF INTRODUCES**

# Pro Sound Libraries for The Sound Professional

Explore the possibilities with the Sound Ideas compact disc Sound Effects Libraries Series 1000 and Series 2000! Now you can have state-of-the-art digital sound quality on everything from Indian dance drums to rocket take-offs and landings.

The professional audio/video producer will never look back!

COMPACT  
**disc**  
DIGITAL AUDIO



## **SERIES 1000**

■ Over 3000 original stereo sound effects on 28 compact discs.

■ This library was nominated for a 1986 Mix TEC (Technical Excellence and Creativity) award in the area of Broadcast Sound Technology by *Mix* subscribers.

**\$1250** (plus \$7.50 S&H)

## **SERIES 2000**

■ Over 2000 digitally mastered and recorded stereo sound effects on 22 compact discs.

■ Includes long ambience effects and special European sound effects.

**\$975** (plus \$7.50 S&H)

Both the Series 1000 and the Series 2000 are incorporated in the Sound Ideas catalog which provides both a fully cross-referenced alphabetical listing and a CD track and index listing included in the purchase of each Library. And both libraries come complete with their own carrying cases for easy handling and storage.

These CD Libraries provide easier access to tracks, greater durability and superior sound reproduction to the analog media. Together, the Series 1000 and Series 2000 offer a selection of over 5000 sound effects, the largest CD library of digital sound effects in the world!

## **SPECIAL BOOKSHELF INTRODUCTORY OFFER**

for both the Series 1000 and the Series 2000 Sound Libraries—\$1850 (plus \$12 S&H).

Order through the Mix Bookshelf, 2608 Ninth Street, Berkeley, CA 94710 or call toll free (800) 233-9604, in California (800) 641-3349.

[8] PARALLEL IMAGES LTD.  
also REMOTE RECORDING  
15215 Berry Trail, #706  
Dallas, TX 75248  
(214) 490-3613  
Owner: John L. Hurd  
Studio Manager: John L. Hurd

[8] PARHAM SOUND STUDIO  
Rt. 3, Box 243-B  
Stephenville, TX 76401  
(817) 965-4132  
Owner: Carroll Parham  
Studio Manager: Carroll Parham

[8] PARROT TRACKS STUDIO  
5201 Meadow Creek Dr.  
Austin, TX 78745  
(512) 441-4314  
Owner: George Coyne  
Studio Manager: George Coyne

[8] PEAK RECORDING STUDIO  
also REMOTE RECORDING  
42 Caddo Peak  
Joshua, TX 76058  
(817) 645-8385  
Owner: Yvonne Mann  
Studio Manager: Gary Mann

[4] PHANTOM PRODUCTIONS, INC.  
only REMOTE RECORDING  
PO Box 4870  
Austin, TX 78765  
(512) 288-1044  
Owner: Martin Theophilus  
Studio Manager: Chris Theophilus

[8] PLA-BACK RECORDING  
also REMOTE RECORDING  
2404 Salerno Dr.  
Dallas, TX 75224  
(214) 942-1387  
Owner: Lew Blackburn  
Studio Manager: Lew Blackburn

[8] POSITIVE SOUND  
354 Landa  
New Braunfels, TX 78130  
(512) 629-9451  
Owner: Will Willard  
Studio Manager: Carl Nowotny

[8] POSTING BROTHERS STUDIOS  
also REMOTE RECORDING  
6800 Gateway E., Bldg. 5  
El Paso, TX 79915  
(915) 775-1401  
Owner: Paul Newell, Buzz Mayfield  
Studio Manager: John A. Weitz

[2] PRESIDIO FILM GROUP  
only REMOTE RECORDING  
PO Box 27790  
Tucson, AZ 85726  
(602) 624-4240  
(602) 884-6976

[4] THE PRODUCERS STUDIO  
also REMOTE RECORDING  
1909 Abrams Pkwy.  
Dallas, TX 75214  
(214) 823-7137  
Owner: Dave Yonley  
Studio Manager: Dave Yonley

[8] THE PRODUCTION CO.  
also REMOTE RECORDING  
510 N. Mt. Olive  
Silosam Springs, AR 72761  
(501) 524-4626  
Owner: Ken Flory  
Studio Manager: Norma Flory

[8] REELWORKS RECORDING STUDIO  
11819 Lippitt Ave.  
Dallas, TX  
(214) 328-3912  
(214) 343-3431  
Owner: Jimmy Lowrance, Steve Dupuis  
Studio Manager: Jimmy Lowrance



[8] R.O.K. STUDIO  
also REMOTE RECORDING  
Rt. 1, Box 144G  
Gladewater, TX 75647  
(214) 984-4146  
Owner: Dennis McDonald  
Studio Manager: Joel Hall

[4] ROSE STATE RECORDING LAB  
also REMOTE RECORDING  
6420 SE 15th  
Midwest City, OK 73110  
(405) 733-7426  
Owner: Rose State College  
Studio Manager: Craig White

[8] SAND E AUDIO PRODUCTION & DEVELOPMENT  
also REMOTE RECORDING  
PO Box 12445  
Oklahoma City, OK 73157  
(405) 942-6156  
Owner: Gregory S. Smith, Graham Easterly  
Studio Manager: Gregory S. Smith

[8] SEASHELL SOUND STUDIOS  
Tempe, AZ 85283  
(602) 820-8413  
Owner: Karl Miller  
Studio Manager: Karl Miller

[4] SELLERS COMPANY-RECORDING STUDIOS  
also REMOTE RECORDING  
122 S. Main St.  
Van Alstyne, TX 75095  
Owner: Jack Sellers  
Studio Manager: Jack Sellers

[8] DAN SESSIONS PRODUCTIONS, INC.  
also REMOTE RECORDING  
202 Knox, Ste. D  
Houston, TX 77007  
(713) 863-0056  
Owner: Daniel Sessions  
Studio Manager: Daniel Sessions

[8] SMITH SOUND RECORDING  
7015 Villa Del Sol  
Houston, TX 77083  
(713) 498-0297  
Owner: Dennis Smith  
Studio Manager: Dennis Smith  
Engineers: Dennis Smith  
Dimensions: Studio 8 x 12, control room 13 x 13.  
Mixing Consoles: Tascam Model 512 12 x 8 console.  
Audio Recorders: Tascam Model 58 8-track, Tascam Model 52 2-track, Sony PCM-501ES 2-track digital processing.  
Cassette Recorders/Duplicators: Tascam 122, Sony TC-WR730  
Noise Reduction Equipment: (3) Tascam DX-2Ds, dbx Type 1 NR, (2) Tascam DX-4Ds, dbx Type 1 NR.  
Echo, Reverb, & Delay Systems: Yamaha REV7 digital reverb, Roland SDE-1000 digital delay.  
Other Outboard Equipment: dbx 160X compressor/limiter, Aphex Type B Aural Exciter.  
Microphones: (3) Shure SM58, Sennheiser 441.  
Monitor Amplifiers: QSC 3350.  
Monitor Speakers: (2) JBL 4411 studio monitors, (2) Aura-tone SC monitors.  
Musical Instruments: E-mu SP-12 drum machine, Akai S-900 digital sampler, Oberheim X-pander, Yamaha DX7, Yamaha TX7, Roland Juno 2.  
Other MIDI Equipment: Akai ME-30P MIDI patchbay, Macintosh Plus computer w/sequencing software.  
Rates: Upon request.

[4] SNOWBIRD JUNCTION  
REMOTE RECORDING SERVICE  
only REMOTE RECORDING  
PO Box 61882  
Phoenix, AZ 85082  
(602) 265-6663  
Owner: Mike & Tina Craig  
Studio Manager: Mike Craig

[8] SOC RECORDING  
200 N. Montclair  
Dallas, TX 75208  
(214) 942-3781  
Owner: Dave Hughes  
Studio Manager: Dave Hughes

[8] SOUND CUBE  
401 Willow Dr.  
San Antonio, TX 78109  
(512) 658-4356  
Owner: Ronald Thomas  
Studio Manager: Ronald Thomas

[4] SOUND IDEA PRODUCTIONS  
also REMOTE RECORDING  
1620 W. Surrey Ave.  
Phoenix, AZ 85029  
(602) 942-7363  
Owner: James Larson  
Studio Manager: James Larson

[8] SOUND TRAX STUDIO  
also REMOTE RECORDING  
Rt. 5, 110 Queens Ct  
Brazoria, TX 77422  
(409) 798-8672  
Owner: Glenn & Ann Tate  
Studio Manager: Glenn Tate

[8] SOUNDINGS OF THE PLANET  
also REMOTE RECORDING  
PO Box 43512  
Tucson, AZ 85733  
(602) 883-1784  
Owner: Dean Evenson

[8] SOUTHERN RECORDING  
56 E. 53rd Pl.  
Tulsa, OK 74105  
(918) 747-7380  
Owner: John Southern  
Studio Manager: John Southern

[8] STAGGERWING PRODUCTIONS  
also REMOTE RECORDING  
7837 E. Moreland St.  
Scottsdale, AZ 85257  
(602) 947-3891  
Owner: Christopher House  
Studio Manager: Chnstopher House

[8] STELLAR WINDS STUDIO  
also REMOTE RECORDING  
2501 Sublett Rd., #995  
Arlington, TX  
(817) 465-4780  
Owner: Joe & Mira Shaw  
Studio Manager: Joe Shaw

[8] STUDIO 3  
2800 Routh  
Dallas, TX 75201  
(214) 871-2933  
Owner: Theatre Three  
Studio Manager: Tnstan Wilson

[8] STUDIO WORKS  
also REMOTE RECORDING  
2058 Western Village  
Houston, TX 77043  
(713) 461-1961  
Owner: Danny Erdeljac  
Studio Manager: Danny Erdeljac  
Dimensions: Studio 30 x 20  
Mixing Consoles: Biamp 2442 2B x 4.  
Audio Recorders: Tascam 8-track, TEAC 3340 4-track.  
Cassette Recorders/Duplicators: Aiwa, BIC 2-speed deck.  
Noise Reduction Equipment: (10) dbx.  
Synchronization Systems: MIDI/Sync 24, SMPTE.  
Echo, Reverb, & Delay Systems: Ibanez digital delay, Alessis XT digital reverb, Biamp Pro Reverb



Other Outboard Equipment: Rocktron imager/exciter/Hush II, Quad limiter/compressor, (4) Parametric EQs, (2) graphic EQs.

Microphones: (8) AKG, (3) Shure SM58, (2) TEAC, Tele-dyne.

Monitor Amplifiers: IVC.

Monitor Speakers: Yamaha NS-10M, Auratone 5C, TEAC, Acoustic.

Musical Instruments: Emulator EMAX, Oberheim DPXI, Ensoniq Mirage, (2) Yamaha DX7s, Roland MKS-30, Casio CZ1, Casio CZ101, 360 Systems MIDI bass, Roland TR-707, Roland TR-727, Oberheim XK controller, Roland GM70 guitar/MIDI controller, Simmons 6-piece electronic MIDI drum controllers.

Other MIDI Equipment: Roland Octa Pad percussion controller, 360 Systems MIDI merger.

Video Equipment: VHS Hi-fi deck, affiliated with full function Beta SP video studio.

Other: IBM personal computer, Compaq personal computer, Texture 2.5 MIDI sequencing software, 24-track, Prolib voice librarian for all synths, hundreds of samples and thousands of synth patches.

Rates: \$25 - \$35/hr.

[8] TAYLOR'S  
524 S. Saginaw Blvd.  
Saginaw, TX 76179  
(817) 232-1833  
Owner: Robert & Donald Taylor  
Studio Manager: Robert & Donald Taylor

[8] TEMPEST RECORDING  
also REMOTE RECORDING  
PO Box 1007  
Tempe, AZ 85281  
(602) 968-9506  
Owner: Clarke Rigsby, Andy Beade  
Studio Manager: Andy Beade, Clarke Rigsby

[8] TRASH BAGGS STUDIO  
12 Walnut Hill Rd.  
Flint, TX 75762  
Owner: John Lassater  
Studio Manager: Shannon Lassater

[8] TSB RECORDING  
3013 Fountain View, Ste. 210  
Houston, TX 77057  
(713) 974-7481  
Owner: Corporation  
Studio Manager: Tom Wolfenberger

[8] THE 25TH TRACK  
also REMOTE RECORDING  
309 E. Vicksburg  
Broken Arrow, OK 74011  
(918) 455-2459  
Owner: Walt Bowers  
Studio Manager: Walt Bowers

[8] TWIN PALMS RECORDING STUDIO  
8814 Reamer St.  
Houston, TX 77074  
(713) 988-7500  
Owner: Russell Lewandowski  
Studio Manager: Russell Lewandowski

[8] UNREEL RECORDERS  
also REMOTE RECORDING  
PO Box 426  
Decatur, TX 76234  
(817) 62-SOUND  
Owner: Barry Eaton, Kenneth Wilson  
Studio Manager: Barry Eaton

[8] WEE NEVER QUIT PRODUCTIONS  
1817 N. 15th  
Broken Arrow, OK 74012  
(918) 355-2144  
Owner: Jack Brady  
Studio Manager: Jack Brady

[8] WHITE ROSE STUDIO  
also REMOTE RECORDING  
1901 Crested Butte  
Edmond, OK 73034  
(405) 348-2173  
Owner: Craig C. White  
Studio Manager: Scott Minor

[8] WING AND A PRAYER MUSIC  
also REMOTE RECORDING  
1200 S. Gary  
Monahans, TX 79756  
(915) 943-6524  
Owner: Walter L. Black  
Studio Manager: Walter L. Black

[8] DANA WOODS RECORDING  
also REMOTE RECORDING  
PO Box 2509  
Nacogdoches, TX 75963  
(409) 569-1485  
Owner: Dana Keith Woods  
Studio Manager: Gary Goss

[4] XAVIETRONIX  
555 E. Garcia  
Santa Fe, NM 87501  
(505) 983-8604  
Owner: Frank X. Cordero  
Studio Manager: Dean Armstrong

[8] SUNBURST STUDIOS  
1906 Westmoreland Ave.  
Las Cruces, NM  
(505) 522-1837  
Owner: Daniel V. Bishop  
Studio Manager: Daniel V. Bishop

[8] SWILLSOUND  
1801 Ardmore St.  
Las Vegas, NV 89104  
(702) 641-6116  
Owner: Bill Bauman Jr.  
Studio Manager: Bill Bauman Jr.

[8] TANDEN PRODUCTIONS  
PO Box 382  
Gainesville, TX 76240  
(817) 665-6756  
Owner: Bobby Dennis  
Studio Manager: Bobby Dennis

## IF ONLY YOUR EARS COULD SEE

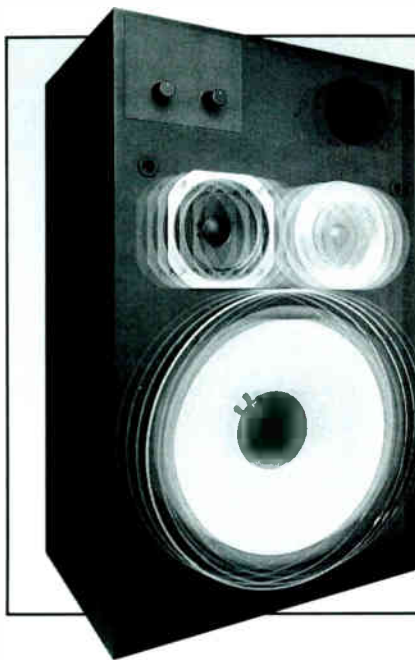

If you could see what your ears can hear, the precision which makes Tannoy monitors different would stare you in the face.

On most monitors you would see the phase incoherence and the time difference in high and low frequencies.

Put a Tannoy with SyncSource™ under the magnifying glass. Look at the phase perfection and the way in which the correct time relationships of fundamentals and harmonics are maintained.

Then look at the practical advantages. More complete audio information, and greater freedom of movement behind the recording console without being restricted to an on or off axis listening position.



**TANNOY**  
The Name for Loudspeakers



For more information on Dual Concentric Point Source monitor systems with SyncSource™ contact:

**TANNOY NORTH AMERICA INC.**

(519) 745-1158 • 300 Gage Ave., Unit #1, Kitchener, Ont., Canada N2M 2C8

Circle #139 on Reader Service Card

# SOUTHWEST STUDIOS



## 12 & 16 TRACK

[16] ACTION SOUND STUDIO  
also REMOTE RECORDING  
10 Summit Dr. W  
Wimberley, TX 78676  
(512) 847-3853  
Owner: Marc Kingston  
Studio Manager: Skyvan Kingston

[16] ALTIM STUDIOS  
PO Box 330271  
Fort Worth, TX 76163  
(817) 346-1012  
Owner: Tim Hood, Bill Gardner  
Studio Manager: Tim Hood

[16] APRIL RECORDING STUDIOS/CRYSTAL RAM PUBLISHING BMI  
also REMOTE RECORDING  
827 Brazil Pl.  
El Paso, TX 79903  
(915) 772-7858  
Owner: Harvey Marcus  
Studio Manager: Del Marcus  
Engineers: Harvey Marcus, Deanna Hernandez, Danny Castellano, Ruben Castillo  
Dimensions: Studio 10 x 18, control room 6 x 9  
Mixing Consoles: Peavey MC-12 12 x 6, Peavey MK-IV 24 x 10  
Audio Recorders: Tascam/TEACMS16 16-track, Tascam/TEAC 80-8 8-track, Dokorder 7140 4-track  
Cassette Recorders/Duplicators: (2) MCS 3551 2-track  
Noise Reduction Equipment: dbx DX-8 Tascam, dbx 150, dbx DX-16 Tascam  
Synchronization Systems: Roland SBX-10  
Echo, Reverb, & Delay Systems: Roland SRE-555 chorus/echo  
Other Outboard Equipment: Roland MKS-100 digital sampler, MXR 2/3-octave EQ  
Microphones: Entire Shure line available upon clients request  
Monitor Amplifiers: Peavey CS 800  
Monitor Speakers: Peavey SP-3, (2) ESS Performance Series monitors  
Musical Instruments: ARP Omni/MIDI, Yamaha DX100, Fender Rhodes Mark I 88/MIDI, Yamaha MR10 drum machine, Roland TR-505 drum machine  
Other MIDI Equipment: IBM PC MIDI link-up, Apple IIe MIDI link-up  
Other: We use all types of software for layering and mixing automation, such as Mark of the Unicorn and Hybnd Arts  
Rates: Call for rates. Depends on complexity of project.

[16] ARCA (AUDIO RECORDING CORPORATION OF ARKANSAS)  
100 N. Rodney Parham Rd., Ste. 1A/1B  
PO Box 5686, Little Rock AR 72215  
Little Rock, AR 72205  
(501) 224-1111  
Owner: Dick Marendt, Clyde Snider  
Studio Manager: Clyde Snider

[16] ARIZONA REMOTE RECORDERS  
also REMOTE RECORDING  
833 W. Main  
Mesa, AZ 85201  
(602) 834-9511  
Owner: Brent Gabnelsen  
Studio Manager: Wayne Mitchel

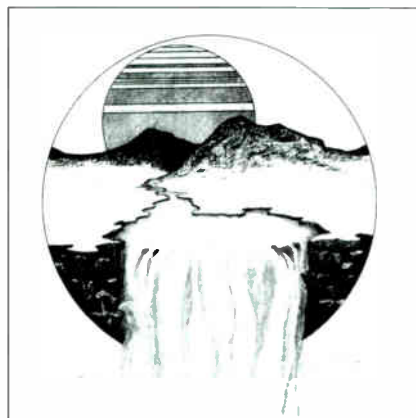

AUSTIN'S RIVERSIDE SOUND  
Austin, TX

[16] AUSTIN'S RIVERSIDE SOUND  
also REMOTE RECORDING  
7617-A E. Riverside Dr.  
PO Box 33207 Austin TX 78764  
Austin, TX 78744  
(512) 385-4060  
Owner: Herschel Cunningham, Richard Mullen  
Studio Manager: Herschel Cunningham, Lowell Smith  
Engineers: Richard Mullen, Layton DePenning, Eddie Habib, Andy Salmon, Bill Johnson

Dimensions: Room 1: main cutting room 30 x 40, Room 2: live corridor 30 x 30, Room 3: live sound room 14 x 30, Room 4: control room 15 x 20  
Mixing Consoles: Ramco WR-8816 16 x 16  
Audio Recorders: MCI JH-24-16 16-track, MCI JH-110B-14-2 2-track, Sony PCM-701 2-track digital  
Echo, Reverb, & Delay Systems: Lexicon 224, MXR digital delay  
Other Outboard Equipment: (4) Dyna-Mite noise gates, EXR Exciter, (4) dbx compressor and de-essers, (2) UREI 530, (3) UREI 535, (2) UREI 1176 LN peak limiter, UREI LA-4 compressor, (2) parametric EQs  
Microphones: Neumann U87, Neumann U47, (2) AKG 414, (5) Sennheiser 421, E-V RE20, (4) Shure SM57, (3) Beyer M88, Beyer 201, AKG 451, (2) Countryman, (3) Shure SMSB, Beyer M500  
Monitor Amplifiers: Crest, Biamp  
Monitor Speakers: E-V Sentry 500, Yamaha NS-10M, JBL 4311  
Musical Instruments: Yamaha acoustic grand piano, Hammond organ w/ Leslie, other instruments available for rental  
Rates: Available upon request. Ask for Herschel or Lowell.

[16] AVALON SOUND RECORDING STUDIO  
also REMOTE RECORDING  
PO Box 2691  
Ft. Worth, TX 76113  
(817) 483-4722  
Owner: David Hughes  
Studio Manager: Coral Hughes

[16] GARY BECK'S  
also REMOTE RECORDING  
4817 Karchmer  
Corpus Christi, TX 78415  
(512) 854-7376  
Owner: Gary Beck, Jada Vaughan  
Studio Manager: Jerry "G" Hernandez

[16] BLAIR SOUND STUDIO  
1501 5th St.  
Wichita Falls, TX 76301  
(817) 322-5012  
Owner: Earl Blair  
Studio Manager: Rick Blair

[16] B.T. PRODUCTIONS INCORPORATED  
also REMOTE RECORDING  
5807 S. Garnett, Ste. J  
Tulsa, OK 74146  
(918) 252-4779  
Owner: Bret Teegarden  
Studio Manager: Beth Teegarden

[16] C AND L PRODUCTIONS  
1511 N. 11th  
Lamesa, TX 79331  
(806) 872-7933  
Owner: Lyle & Collin Roberts  
Studio Manager: Collin Roberts

[16] CALVARY RECORDINGS  
Rt. 1, Box 11  
Weslaco, TX 78596  
(512) 968-2902  
Owner: Enrique Garza  
Studio Manager: Elias Garza

[16] COMMUNITY VIDEO SERVICES  
also REMOTE RECORDING  
4500 W. Davis St.  
Dallas, TX 75211  
(214) 263-8485  
Owner: CCSD  
Studio Manager: Chris Cavnar

[16] COPESETIC SOUND  
also REMOTE RECORDING  
403 E. Kerr  
Midwest City, OK 73110  
(405) 737-7024  
Owner: Dave Copenhaver  
Studio Manager: Lisa Copenhaver

[16] CREATIVE AUDIO/VIDEO ENGINEERING (CAVE PRODUCTIONS)  
114 E. Union  
Prescott, AZ 86303  
(602) 445-0413  
Owner: Jay C. Robertson  
Studio Manager: Joe P. Robertson  
Engineers: John D. Wilson, Joe Robertson



Dimensions: Studio 21'6" x 19', control room 15'6" x 12'4".  
**Mixing Consoles:** Soundcraft 1600 20 x 16.  
**Audio Recorders:** Tascam MS-16 16-track w/AQ-65 auto loc., Tascam 32 2-track.  
**Cassette Recorders/Duplicators:** Nakamichi MR-2.  
**Noise Reduction Equipment:** (2) DX-8Ds dbx Type I units, 16 channels.  
**Echo, Reverb, & Delay Systems:** Yamaha REV7, Yamaha SPX90, Lexicon PCM41.  
**Other Outboard Equipment:** dbx 166 2-channel, Yamaha Q2031 31-band graphic EQ.  
**Microphones:** (2) AKG C414 EBs, Sennheiser 421s, Shure SM57s.  
**Monitor Amplifiers:** Crown DC-300A Series 2, Rane HC-6.  
**Monitor Speakers:** UREI 809s, Auratones, AKG K141 headphones.  
**Musical Instruments:** Emulator II+ dual drive, TX-7, Oberheim Matrix 6, Gretsch 5-piece Blackhawk set w/Zildjian cymbals, Gibson Les Paul, Fender Precision bass (pre-CBS), Martin D-28 acoustic guitar, Mesa/Boogie (S.O.B.), assorted percussion, LinnDrum.  
**Video Equipment:** Sony DXC-3000 3-chip video camera w/16.1 Fujinon lens, Sony BVU-150 3/4" portable VTR, Sony VO-5850 3/4" U-matic editing system w/VO-5800 and RM-440 auto edit control, (2) PVM-8020 video color monitors.  
**Other:** JVC HR-D470U VHS 4-head VCR 1/2", NEC VC-9307 3/4" VCR, Sony SL-5800 1/2" Beta VCR.  
**Rates:** Audio: 16-track \$35/hr., 2-track \$25/hr., includes engineer and instruments. Bulk rates available. Video: production \$70/hr., editing \$45/hr. Block rates available.

**[16] MIKE DE LEON PRODUCTIONS**  
 also **REMOTE RECORDING**  
 14146 Woodstream  
 San Antonio, TX 78231  
 (512) 492-0613  
 Owner: Mike De Leon  
 Studio Manager: Mike De Leon

**[12] THE DEMO STUDIO**  
 555 Cicero  
 San Antonio, TX 78218  
 (512) 656-1382  
 Owner: Jim Waller  
 Studio Manager: Jim Waller

**[16] DIGITAL DYNAMICS**  
 15790 Dooley, Ste. 200  
 Dallas, TX 75244  
 (214) 934-8000  
 Owner: John Scott  
 Studio Manager: Greg Gray

**[12] FLAGG MOUNTAIN STUDIOS**  
 also **REMOTE RECORDING**  
 3108 N. Lamar, Ste. 104  
 Austin, TX 78705  
 (512) 323-2100  
 Owner: Greg Forest  
 Studio Manager: James Lampley

**[16] GARLAND SOUND STUDIO**  
 1119 Maine  
 Garland, TX 75040  
 Owner: C. Norms  
 Studio Manager: Gary Hogue

**[16] HAI TEX STUDIO**  
 2107 S. Edgely  
 Dallas, TX 75224  
 (214) 946-7947  
 Owner: Andy Chiles  
**Studio Manager:** Andy Chiles  
**Engineers:** Jeff Wenn, Andy Chiles  
**Dimensions:** Studio 35 x 15, control room 17 x 15.  
**Mixing Consoles:** Tascam M16 24 x 16  
**Audio Recorders:** Tascam 8516B 16-track, Tascam 32 2-track, Sony PCM-501ES 2-track digital.  
**Cassette Recorders/Duplicators:** Nakamichi MR-2.  
**Noise Reduction Equipment:** dbx.  
**Echo, Reverb, & Delay Systems:** Yamaha REV7, DeltaLab Effectron II.  
**Other Outboard Equipment:** dbx 166 compressor, Symetrix CL100 limiter, UREI 1176L peak limiter.  
**Microphones:** Neumann U89, Sennheiser 421s, Shure SM57s and 58s, Audio-Technica ATM 41, E-Vs.  
**Monitor Amplifiers:** Crown DC-300, Crown D-150, Symetrix A-220.  
**Monitor Speakers:** JBL 4312, Auratones.  
**Musical Instruments:** Fender bass and guitars, Roland JC-120, Fender and Carvin amps, Sequential Circuits 6-Trak synthesizer.  
**Other MIDI Equipment:** Sequential Circuits 6-Trak, Drum Traks and sequencer, Commodore 64 computer.  
**Video Equipment:** Complete video production and photo-

graphy services available. Call for rates and other information.  
 Rates: \$30/hr., block rates available at discount.

**[16] DUBBY HANKINS STUDIO**  
 also **REMOTE RECORDING**  
 2389 NW Military Hwy., Ste 602  
 San Antonio, TX 78231  
 (512) 493-5550  
 Owner: Dubby Hankins  
 Studio Manager: Dubby Hankins

**[16] HEADS UP STUDIOS**  
 also **REMOTE RECORDING**  
 8601 Cross Timbers Rd.  
 Flowermond, TX 75028  
 (817) 430-1003  
 Owner: Dave Love, Timothy Gilpin  
**Studio Manager:** Dave Love  
**Extras & Direction:** Heads Up Prod./Heads Up Records owners: Dave Love, Tim Gilpin, Chief Eng: Martin Walters, eng: Terry Slemmons, office manager: Sarah Pevsner. One of the busiest prod. co. in No. Texas. Album projects include: Joe McBride *Need Somebody to Love*, David Liebman and Heads Up *Better Leave it Alone*, Maurice Anderson and Heads Up *Untitled, Eyce Too Cold to be Cool*, Debutante *Untitled*. Singles: Ty Haynes & Electric Rainbow "Texas Girls," Romy Knight "Bungalow By a Limbo Jungle." All above records on Heads Up Records & Tapes have been recorded since December of 1986. Other record projects include: Into the Void "Dreaming Atlantis" on Rising Tide Records, Promise "Love has no Barriers" on Promise Records. Complete multi-track recording studio, record co., and publishing co. Producers, composers, arrangers and musicians on staff. AF of M and ASCAP affiliated.

**[16] ITTI STUDIOS/INTERNATIONAL**  
**TEACHING TAPES**  
 also **REMOTE RECORDING**  
 4305-A S. Mingo  
 Tulsa, OK 74146  
 (918) 663-7700  
 Owner: Sonny Gray  
 Studio Manager: Judy Pendergrass

**[16] JERICHO SOUND & PRODUCTION CO.**  
 also **REMOTE RECORDING**  
 1401 W. Beauregard  
 San Angelo, TX 76901  
 (915) 658-8767  
 Owner: Steve Breazeale  
 Studio Manager: Kathy Breazeale

**[16] JIHAD MUSIC STUDIOS**  
 419 Willard, #2  
 Houston, TX 77006  
 (713) 529-0039  
 Owner: Harry Leverette  
 Studio Manager: Harry Leverette

**[16] LAKE SOUND**  
 Rt. 2, Box 552  
 Roanoke, TX 76262  
 (817) 431-1405  
 Owner: Rex Lake  
 Studio Manager: Rex Lake

**[16] LINCOLN INSTITUTE**  
 7622 Louetta Rd.  
 Spring, TX 77379  
 (713) 376-9679  
 Owner: Lincoln Foundation  
 Studio Manager: Joe Lincoln

**[16] LONE STAR RECORDING**  
 also **REMOTE RECORDING**  
 1204 N. Lamar  
 Austin, TX 78703  
 (512) 478-3141  
 Owner: Ed Guinn, Stan Coppinger  
 Studio Manager: Bill Anderson

**[16] LURA MAIE PRODUCTIONS, INC.**  
 Rte. 5, Box 355  
 Wichita Falls, TX 76301  
 (817) 761-1123  
 Owner: Charles W. Rouzer  
 Studio Manager: Charles W. Rouzer



**You Be The Judge!**  
**800-553-8712**  
**800-325-4243 N. CA**  
**RECORDER PARTS**  
**REPLACEMENT**  
**HEADS**  
**REFURBISHMENT**  
**AMPEX**  
**MCI/SONY**  
**3M**  
**OTARI**  
**REVOX**  
**TEAC**

**SPRAGUE MAGNETICS INC.**  
 15720 STAGG ST., VAN NUYS, CA 91406  
 818-994-6602 TLX: 754239

Circle #140 on Reader Service Card

**AT LAST!**  
**TURN YOUR STUDIO INTO**  
**A MONEY MACHINE!**

If you want to make money in the studio business, this book shows you how--step by step.

**A COMPLETE BUSINESS PLAN**  
**FOR THE SMALL STUDIO**

by Al Stone  
 (Publishing June, 1987)

Loaded with practical, proven methods:

How to get started  
 How to advertise  
 How to turn inquiries into sales  
 How to develop repeat business  
 How to get into the jingle business  
 How to expand your profit base and much, much more!!!

Send \$75.00 (plus \$5.00 shipping/handling) to:

C.A.S. PRODUCTIONS  
 7108 FREMONT COURT  
 INDIANAPOLIS, IN 46256  
 (Indiana residents add 5% sales tax)  
 (Or for a cassette description of the book, send \$5.00)

Circle #141 on Reader Service Card

**[16] MARSOUND**  
915 N. Main  
Tucson, AZ 85705  
(602) 628-1554  
Owner: M. Reinhard  
Studio Manager: M. Reinhard

**[16] MASTER PRODUCTIONS**  
407 S. Nebraska  
Weslaco, TX 78596  
(512) 968-5777  
Owner: Joe Leal  
Studio Manager: Joe Leal

**[16] PATRICK MCGUIRE RECORDING**  
1402 Rockdale  
Arlington, TX 76018  
(817) 467-1852  
Owner: Roy B. Watson  
Studio Manager: Patrick A. McGuire  
Engineers: Patrick McGuire  
Dimensions: Studio 20 x 22, control room 10 x 12  
Mixing Consoles: Ramso WR8118 18 x 4  
Audio Recorders: Fostex B-16 16-track, Otari 5050 BII 2-track.  
Cassette Recorders/Duplicators: Tascam 122 2-track.  
Noise Reduction Equipment: 16 tracks of Dolby C (internal on B-16).  
Echo, Reverb, & Delay Systems: ART 01A digital reverb, DeltaLab 1024 digital delay.  
Other Outboard Equipment: dbx 160X compressor/limiter, Aphex Type B Aural Exciter, Rane RA27 room analyzer/graphic EQ, Rane GE27 graphic EQ.  
Microphones: AKG 414EB-P48, AKG D12-E, AKG D1200, E-V RE11, Shure SM57, (2) Crown P2M 30GP, (3) Audio-Technica ATM 63, (2) Audio-Technica ATM 10R, (2) Audio-Technica ATM 11R, Sennheiser MD431.  
Monitor Amplifiers: Crown D150A, Rane HC-6.  
Monitor Speakers: JBL 4411, Auratone 5C.  
Musical Instruments: Yamaha G3 6' grand piano, Yamaha DX7-IIFD (Super DX7), Yamaha RX5 digital drum synthesizer, Yamaha FG335E acoustic/electric guitar, Alembic bass.  
Other: Marshall Lead 20 amplifier, Stewart ADB-1 direct boxes, Fostex T-20 headphones.  
Rates: \$35/hr. plus tape.

**[16] MESQUITE RECORDING STUDIO**  
3129 N. Hwy 67, Ste. H-1  
Mesquite, TX 75150  
(214) 270-7453  
Owner: Don McKnight  
Studio Manager: Don McKnight

**[16] MUSHROOM STATION STUDIOS & SHARE-A-VISION**  
also REMOTE RECORDING  
1913 Hoskins  
Houston, TX 77080  
(713) 973-7733  
(713) 868-9724  
Owner: J.C. Freeman  
Studio Manager: Joshua C. Freeman

**[16] MUSICIANS SOUND LAB**  
also REMOTE RECORDING  
1241 N. Hwy. 288  
Richwood, TX 77531  
(409) 265-9177  
Owner: Dennis Blair, Buddy Morrow  
Studio Manager: Dennis Blair, Buddy Morrow  
Engineers: Robert Kelley, Buddy Morrow, Dennis Blair  
Dimensions: Room 1: studio 10 x 20, control room 13 x 12. Room 2: 11 x 6 and iso booth. Room 3: studio, 10 x 6. Room 4: 4 x 6 iso booth.  
Mixing Consoles: Studiomaster 16 x 16 x 2, Ramso 8816 (remote recording) 16 x 4 x 2.  
Audio Recorders: Fostex E-16 16-track, Tascam 38 8-track (remote recording), Tascam 32 2-track (1/4" master).  
Cassette Recorders/Duplicators: Tascam 122 cassette, Aiwa F-990.  
Noise Reduction Equipment: Dolby C, Tascam DX.  
Synchronization Systems: Fostex 4050 SMPTE autolocator.  
Echo, Reverb, & Delay Systems: Lexicon PCM42 delay, Alesis MIDiFlex, Yamaha R1000 digital reverb, Lexicon PCM60 digital reverb, DeltaLab Effectron II 1024, Alesis Microverb, ADA delay.  
Other Outboard Equipment: dbx 160X compressor/limiters, Aphex Aural Exciter Type C, Symetrix Model 544 noise gates, Rane headphone bay, Barcus-Berry.  
Microphones: Shure SM81, SM58, SM57, AKG D-112 kick drum mic, Realistic P2M mics.  
Monitor Amplifiers: Crown DC 300.  
Monitor Speakers: JBL 4412s.  
Musical Instruments: Gibson Les Paul custom guitar, Fender Strat, Ovation custom Balladeer acoustic guitar, Sigma acoustic guitar, Peavey Foundation bass guitar, Peavey Hydra double neck 6- and 12-string guitar, Washburn banjo,



Sonor, Rogers, Premier, Paiste and Zildjian acoustic drums, Simmons SDS-9 electronic drums, Yamaha RX11 drum machine, Korg DW-8000 synth, Yamaha DX7 synth, Roland Juno 106, (2) Casio CZ-101 w/RAM cart.  
Other MIDI Equipment: Ensoniq Mirage, Atari 520ST and Commodore computer sequencer systems, Dr. T 48-track disk software, MIDI through boxes.  
Other: Fostex T-20 headphones, TEAC and Fostex patch-bays, Kawai EP-308 electric grand piano, Peavey amplifiers, Gallien-Krueger amplifiers.  
Rates: On request.

**[16] NOISEMAKER STUDIO**  
also REMOTE RECORDING  
4123 Killion Dr.  
Dallas, TX 75229  
(214) 350-0290  
Owner: Randy Canada  
Studio Manager: Greg Rardin

**[12] DOUG NOLTE ENTERPRISES**  
also REMOTE RECORDING  
Mesa, AZ  
(602) 969-6569  
Owner: Douglas R. Nolte  
Studio Manager: Douglas R. Nolte

**[12] NORTH STAR MUSIC CO.**  
also REMOTE RECORDING  
PO Box 1299  
Grapevine, TX 76051  
(817) 481-5658  
Owner: Will Johnson  
Studio Manager: Mark Joeger

**[16] OMEGA SOUND**  
1112 Garrison  
Fort Smith, AR 72901  
(501) 783-1131  
Owner: Randy McFarland

**[16] ORANGEWOOD RECORDING**  
2626 N. Horne  
Mesa, AZ 85203  
(602) 835-7605  
Owner: Michael Coleman  
Studio Manager: Michael Coleman  
Engineers: Michael Coleman  
Dimensions: Studio 20 x 25, control room 10 x 17.  
Mixing Consoles: Indent 65-16 24 x 16.  
Audio Recorders: Tascam MS-16 16-track w/dbx, Otari 5050-MK III 8-track, Otari 5050 2-track, Toshiba VCR w/Sony 601-ESD digital processor.  
Cassette Recorders/Duplicators: Aiwa cassette deck.  
Noise Reduction Equipment: (5) dbx 150.  
Echo, Reverb, & Delay Systems: Lexicon PCM70, Lexicon PCM60, Yamaha REV7, Yamaha SPX90, Lexicon PCM42 delay, ART 1500, Roland SDE-2000.  
Other Outboard Equipment: (2) Tristech FX rack II, Tristech FX 200 gates, Orban 424 compressor/lim/de-esser.  
Microphones: Neumann U87 and U89, Sennheiser MD421, E-V RE20, ATM 63, TEAC PE-120, mini cubes, Tristech RM-400a multi-channel direct box.  
Monitor Amplifiers: BGW 250d, Pioneer.  
Monitor Speakers: Tannoy LGM12B, JBL 4312, Auratones.  
Musical Instruments: Yamaha Conservatory 6' grand, Rogers drum kit, DX7, Emulator II, Mirage, Roland SH-3.

**[16] POVERTY HILL RECORDING STUDIO**  
PO Box 805  
Cedar Hill, TX 75104  
(214) 775-2222  
Owner: Mark Giles  
Studio Manager: Mark Giles

**[16] POWER HOUSE SOUND STUDIOS**  
also REMOTE RECORDING

1906 Overbrook Cir.  
Missouri City, TX 77459  
(713) 433-5096  
Owner: Lloyd E. Hughes  
Studio Manager: Kenneth Smith, Leon Yarbough

**[16] PRODIGAL SOUND RECORDING**  
also REMOTE RECORDING  
PO Box 1443  
Denton, TX 76202  
(817) 566-5555  
(817) 566-0869  
Owner: Greg Ellenwood  
Studio Manager: Greg Ellenwood

**[12] PRODUCER'S SOUND STUDIO**  
also REMOTE RECORDING  
7701 N. Broadway, Ste. A-6  
Oklahoma City, OK 73116  
(405) 842-3230  
Owner: Steve Garman  
Studio Manager: Janie Dion

**[16] THE PRODUCTION BLOCK**  
906 E. Fifth  
Austin, TX 78702  
(512) 472-8975  
Owner: Joel Block, Bill Harwell  
Studio Manager: Deleine Whiddon

**[16] PSALMIST RECORDING STUDIO**  
also REMOTE RECORDING  
6611 S. Broadway  
Tyler, TX 75703  
(214) 581-5461  
Owner: J.W. Baker  
Studio Manager: J.W. Baker

**[16] QUINCY STREET SOUND**  
also REMOTE RECORDING  
130 Quincy St. NE  
Albuquerque, NM 87108  
(505) 265-5689  
Owner: Eric C. Larson  
Studio Manager: Eric C. Larson

**[16] THE RANCH RECORDING STUDIO**  
"MOBILE ONE"  
also REMOTE RECORDING  
Rte. 2, Box 53  
Duncan, OK 73533  
(405) 255-9037  
Owner: Mark Edwards  
Studio Manager: Anne Edwards

**[16] R.S.V.P. RECORDING STUDIOS & VIDEO PRODUCTIONS**  
also REMOTE RECORDING  
PO Box 742001  
Dallas, TX 75374  
(214) 231-2198  
Owner: David Singer  
Studio Manager: David Castell

**[16] SALT RECORDING**  
PO Box 3041  
McAllen, TX 78501  
(512) 686-9513  
Owner: Sonny Salinas

**[16] SCOTTSDALE CONFERENCE RESORT**  
also REMOTE RECORDING  
7700 E. McCormick Pkwy.  
Scottsdale, AZ 85258  
(602) 991-9000  
Owner: Scottsdale Conference Resort  
Studio Manager: Brian Court  
Engineers: Brian Court, Russ Graves, John Haro, Scott Meyer  
Dimensions: Studio 21 x 26, control room 20 x 18.  
Mixing Consoles: TAC Scorpion 24 x 16, TAC Scorpion 16 x 8, Tascam M50 12 x 8, (2) Tascam M312B 12 x 4, Tascam M5 8 x 4.  
Audio Recorders: Otari MX7 16-track, Tascam Model 38 8-track, Otari MTR 12 2-track w/center track time code, Otari 5050 MKIII 2-track, Otari 5050 B 4-track, TEAC 3440 4-track.  
Cassette Recorders/Duplicators: Tascam 122, Nakamichi MR1, Tascam 234.  
Noise Reduction Equipment: (4) dbx 150X Type 1.  
Synchronization Systems: (2) Adams-Smith 2600 synchronizer, Adams-Smith reader, Adams-Smith writer.  
Echo, Reverb, & Delay Systems: Lexicon 200, (4) Yamaha SPX90, Lexicon PCM42, Roland SDE-2000, ADA D640.  
Other Outboard Equipment: Eventide H949, (3) Gates noise gates, (3) dbx 166 comp/limiter, (2) Symetrix 522, Scamp rack, Tascam PE40 parametric EQ, Aphex Aural



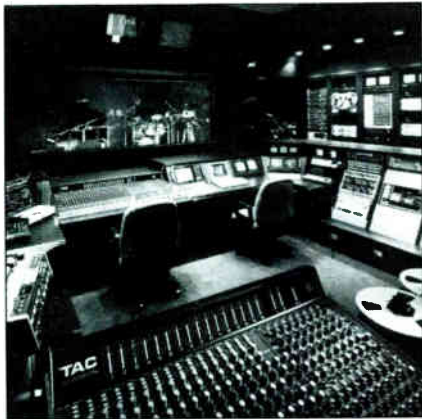

**SCOTTSDALE CONFERENCE RESORT**  
Scottsdale, AZ

Exciter Type B, Studio Technologies AN-2 stereo simulator, (20) dbx 903 comp/limiters, (3) Klark-Teknik DN360 graphic equalizers, (3) 10-band EQs, (2) comp/limiters, para EQ. Microphones: (2) Neumann U89, Neumann U47, (4) Shure SM61, (2) Shure SM85, (2) Sennheiser 421, (2) E-V RE20, (2) E-V PL80, (30) Shure SM58, (3) Shure SM57, (2) Crown PZM, E-V BK1.

Monitor Amplifiers: (2) Crest 3000, (3) UREI 6300, (3) Symetrix A220.

Monitor Speakers: (2) JBL 4430, (2) Tannoy SRM12B, (2) JBL 4408, (2) JBL 4311, (6) JBL 4401, (2) Auratone 5C.

Musical Instruments: Roland 550, Roland 510, Yamaha RX11, Roland TR505, Yamaha DX7, Yamaha TX7, Yamaha TX812, Yamaha FBO1, (3) Fender guitars, GK guitar amp, Fender Pro reverb, Ludwig custom drum set, (2) Steinway 6' grand pianos.

Other MIDI Equipment: Apple Macintosh, Total Music software, Korg MIDI patchbay.

Video Equipment: Grass Valley 1600IL switcher w/interface, Convergence 204 editor, (3) JVC CR 850U 1/4" recorders, (3) Sony 5850 recorders, Ikegami HL79, Ikegami ITC730.

Other: (18) Projector multi-image show, (2) AVL Genesis multi-image computer, complete darkroom, color, E-6, C41, printing, Oxberry Pro 3 pin-registered cam-ra, 7-watt Argon laser.

Extra: & Direction: Specializing in original music composition, commercial production, audio/visual soundtracks, post-production audio-for-video, and voice-over production. Also complete video production and industrial multi-image staging. Located in luxurious resort setting with golf, tennis, complete health spa and fitness center, and easy access to Sunbelt activities.

**[12] SHADE TREE STUDIOS**

also REMOTE RECORDING

9323 Esplanade Dr.

Dallas, TX 75220

(214) 351-2935

Owner: Ray H. Marr

Studio Manager: Jerry Caraway

**[16] SOOTHYSAYER RECORDING**

114 Barbara

San Antonio, TX 78216

(512) 826-5983

Owner: A.G. Pinson

Studio Manager: Enc L. Pinson

Engineers: Enc L. Pinson

Dimensions: Studio 18 x 23, control room 13 x 22.

Mixing Consoles: AGP Engineering console 24 x 24 w/4-band parametrs per channel.

Audio Recorders: Fostex B-16 16-track w/4050 autolocator, Tascam 38 1/2-track, Dokorder 1140 4-track, Tascam 32 2-track.

Cassette Recorders/Duplicators: TEAC C-3RX, (3) TEAC R-40.

Noise Reduction Equipment: Dolby and dbx Type I.

Synchronization Systems: Fostex 4050 MIDI synchronizer w/SMPTE.

Echo, Reverb, & Delay Systems: Roland SRV-2000, Lexicon PCM41, Yamaha SPX90, ADA Digitizer 4, Furman RV1.

Other Outboard Equipment: Orban 536-A de-esser, dbx 160X compressor/limiter, (2) Ashly SC-50 comp/limiter, GateX 4-channel gate/expander, Ashly SC-33 stereo noise gates, Aphex Aural Exciter Type B, (3) DOD R-831B 1/3-octave EQs.

Microphones: AKG C-414EB-P48, (4) Sennheiser MD-421, Sennheiser MD-441, E-V RE20, Audio-Technica ATM-813R, (5) Shure SM57, (2) Shure SM58, Countryman Type 85 direct box.

Monitor Amplifiers: Crown DC-300A II, (2) Cerwin-Vega A-2CD, Roland SPA-240.

Monitor Speakers: JBL 4411, Auratone 5C, AKG K-240 headphones.

Musical Instruments: Roland TR-707 drum computer, Roland TB-303 bass computer, Epiphone 6- and 12-string guitars, Gibson Les Paul Artisan, Roland Juno 106 synthesizer, Carvin X-60B guitar amplifier, Fender Stratocaster, TAMA 10-piece drum set w/Evans heads, (2) Acoustic enclosures, 1 w/Celestions, one w/Vegas, Simmons SDS-8 electronic drums, ARP Quartet, assorted percussion.

Other: AWS 20 MHz oscilloscope, Loftech TS-1 test set, Audiosource RTA w/pink noise, Sony CDP-203 compact disc player, Stewart PM-2 and PS-1 phantom power supply.

Rates: \$25/hr.

**[16] SOUND INVESTMENTS**

10 Amity

Eureka Springs, AR 72632

(501) 253-8837

Owner: Ted Snow

Studio Manager: Ted Snow

**[16] SOUND RECORDERS STUDIO INC.**

also REMOTE RECORDING

4117 Guadalupe

Austin, TX 78751

(512) 452-6125

Owner: Sam Watson, Ben Blank

Studio Manager: Ben Blank

**[16] SOUNDS RIGHT STUDIO**

also REMOTE RECORDING

Rt. 4, Box 354

New Caney, TX 77357

(713) 354-6055

Owner: Robert Clinkscales

**[16] SOUNDTRACK RECORDING STUDIO**

2011 N. Alamo St.

San Antonio, TX 78215

(512) 224-4107

Owner: Mike Hettler, Jr.

Studio Manager: Mike Hettler, Jr.

**[16] SOUTH WINDS/REMOTE RECORDING**

only REMOTE RECORDING

4061 Samuel

Mesquite, TX

Owner: Carl & Diane Dunlap

Studio Manager: Diane Dunlap

**[16] SOUTHWEST RECORDINGS**

2031 Libbey

Houston, TX 77018

(713) 681-7565

Owner: Jeff Smith

Studio Manager: Jeff Smith

**[16] TIM STANTON AUDIO**

also REMOTE RECORDING

1501 W. Fifth St., Ste 103

Austin, TX 78703

(512) 477-5618

Owner: Tim Stanton

Studio Manager: Sarah Cnxeil

**[16] STRAWBERRY SOUNDS**

5500 E. Loop 820

Ft. Worth, TX 76119

(817) 483-8611

Owner: Sam Stone

Studio Manager: Ron Calvert

**[16] STUDIO CENTER**

also REMOTE RECORDING

6540 Randolph Blvd.

San Antonio, TX 78233

(512) 653-4004

Owner: Timothy K. Gressler

Studio Manager: Timothy K. Gressler

**[16] STUDIO MOBILE**

also REMOTE RECORDING

11226 Sagevale

Houston, TX 77089

(713) 481-2551

Owner: Erik Sweet

Studio Manager: Erik Sweet

**[16] STUDIO ONE**

also REMOTE RECORDING

8535 Selendine

San Antonio, TX

(512) 650-0442

Owner: Timothy H. Gressler

Studio Manager: Tim Gressler

**[16] S.W.I.R.A.S.**

4831 N. 11th St., Ste. A

PO Box 17010

Phoenix, AZ 85011

(602) 241-0667

Owner: Billy Moss

Studio Manager: Merel Bregante

**[12] SWORD RECORDS RECORDING STUDIO**

also REMOTE RECORDING

1019 N. Halagueno

Carlsbad, NM 88220

(505) 887-3825

Owner: Rees Lucas

Studio Manager: Rees Lucas

**[16] TEXARKANA COLLEGE STUDIOS**

also REMOTE RECORDING

2500 N. Robison

Texarkana, TX 75501

(214) 838-4541

Owner: Texarkana College

Studio Manager: Dr. Murry Alewine

**[16] TEXAS MUSIC STUDIO**

also REMOTE RECORDING

4001 Aspen

Bryan, TX 77801

(409) 846-6439

Owner: Greg Phelps

**[16] TEXAS SUNRISE RECORDING STUDIO**

Rt. 4, Box 615

1.5 mi. N. Jackson Rd.

Edinburg, TX 78539

(512) 381-0077

Owner: Mike Lopez, Domingo Porras

Studio Manager: Mike Lopez

**[16] TOMLYN RECORDING STUDIO**

also REMOTE RECORDING

Rt. 3, Box 405

Flint, TX 75762

(214) 894-7713

Owner: Tom Russell

Studio Manager: Jim Phillips

**[16] TRACK DESIGNS**

also REMOTE RECORDING

315 W. Alabama St.

Houston, TX 77006

(713) 524-8982

Owner: Danny Henderson

Studio Manager: Dave Marcellin

**[16] TRUE COLOURS RECORDING STUDIO**

201 Cordoba

Arlington, TX 76014

(817) 467-2280

Owner: Barry Dickey

Studio Manager: Pam Dickey

**[16] WALK ON WATER STUDIOS, INC.**

also REMOTE RECORDING

Rt. 2, Box 566-H

New Braunfels, TX 78130

(512) 629-4396

Owner: Ken Brazle, Bruce Weldy

Studio Manager: Ken Brazle

**[16] WORLD WIN RECORDING**

also REMOTE RECORDING

1707 High Meadows

Norman, OK 73071

(405) 321-1900

Owner: Kenneth R. Hughes

Studio Manager: Kenneth R. Hughes

**[16] ZANBECK SOUND PRODUCTION**

also REMOTE RECORDING

Rt. 4, Box 1249

Little Rock, AR 72206

(501) 888-7045

Owner: Faye Beck, Chuck Bailey, Bobby Gibson

# SOUTHWEST STUDIOS



## 24+ TRACK

Dimensions: Studio 18 x 28, control room 13 x 16.  
 Mixing Consoles: MCI 536-28 LM automated  
 Audio Recorders: (2) MCI JH-24 24-track, Tascam 122B, MCI JH-110B-VP 2-track, Sansui PC-X1 Tricode 2-track PCM.  
 Cassette Recorders/Duplicators: Nakamichi MR-1 cassette deck, (2) Telex 6210 stereo cassette duplicator.  
 Echo, Reverb, & Delay Systems: Lexicon 224 XL, Urso Major 8 x 32 digital reverb, AKG BX10, DeltaLab Effectron, ADM 1024 digital delay, Eventide H949 Harmonizer.  
 Other Outboard Equipment: dbx 160X and 161 compressors, Valley People Dyna-Mite stereo, Ashly parametric EQ, White 1/3-octave EQ w/active electronic crossovers.  
 Microphones: AKG, Beyer, C-ducer, Crown PZM, E-V, Neumann, Sennheiser, Shure, Sony.  
 Monitor Amplifiers: Crown: PSA-2 and D-75.  
 Monitor Speakers: JBL 4430, Auratone cubes.  
 Musical Instruments: Kurzweil 250, Yamaha DX7, Roland Juno 60 synthesizer, LinnDrum, Fender Precision Bass, Gibson Les Paul Artisan guitar, Princeton Reverb II amp, Sonor Signature Series drums (8-piece kit).  
 Other MIDI Equipment: Prof. Performer & Composer software by Mark of the Unicorn, Total Music software by Southworth.  
 Video Equipment: Audio post-production for video, Adams-Smith Zeta 3 synchronizer.  
 Rates: Rates available upon request.  
 Extras & Direction: Brasswind Rec. Studio invites you to become a part of a growing tradition... excellence. Excellence in recording for album, demo, audio-visual, jingle and audio-for-video prod. Excellence in personnel, equip., facilities and location. If you are a musician, band, business or other organization and are interested in excellence, then call (409) 693-5514 and join the Brasswind tradition... excellence.

[24+] EMMIT BROOKS RECORDING STUDIO  
 115 E. Idaho Ave.  
 Las Cruces, NM 88005  
 (505) 524-1889  
 Owner: Emmit Brooks  
 Studio Manager: Emmit Brooks

[24+] BUFFALO SOUND STUDIOS  
 910 Currie St.  
 Ft. Worth, TX 76107  
 (817) 335-7733  
 Owner: Jim Hodges  
 Studio Manager: Buff Haskin

[24+] CARAVAN OF DREAMS RECORDINGS  
 312 Houston St.  
 Ft. Worth, TX 76102  
 (817) 877-3000  
 Owner: Caravan of Dreams, Inc.  
 Studio Manager: Robert Wechsler

[24+] CECCA SOUND  
 3198 Royal Lane, Ste. 104  
 Dallas, TX 75229  
 (214) 350-6945  
 Owner: Charley Pride  
 Studio Manager: Bob Pickering

[24+] CEDAR CREEK  
 5012 Brighton Rd.  
 Austin, TX 78745  
 (512) 444-0226  
 Owner: Austin Media Prod.  
 Studio Manager: Fred Remmert

[24+] CEREBUS RECORDING INC.  
 also REMOTE RECORDING  
 1733 E. McKellips, #7  
 Tempe, AZ 85281  
 (602) 990-8163  
 Owner: Allen Moore  
 Studio Manager: Dianne Moore

[24+] CHATON RECORDINGS  
 also REMOTE RECORDING  
 5625 E. Nauni Valley Dr.  
 Scottsdale, AZ 85253  
 (602) 991-2802  
 Owner: Ed & Marie Ravenscroft  
 Studio Manager: Marie Ravenscroft

[24+] COOKSOUND PRODUCTIONS, INC. (SPARS)  
 also REMOTE RECORDING  
 4801 Woodway, Ste. 355W  
 Houston, TX 77056

[24+] ACCESSIBLE SOUND  
 5146 Kingfisher  
 Houston, TX 77035  
 (713) 723-2777  
 Owner: Kenneth Bujnoch  
 Studio Manager: Herman Eale

[24+] ALTA VISTA RECORDING STUDIO  
 also REMOTE RECORDING  
 PO Box 12754  
 Albuquerque, NM 87105  
 (505) 836-5747  
 Owner: Herman Martinez  
 Studio Manager: Herman Martinez

[24+] ARLYN STUDIOS, INC.  
 also REMOTE RECORDING  
 200 Academy Dr., Ste. A  
 Austin, TX 78704  
 (512) 447-2337  
 Owner: Fred N. Fletcher  
 Studio Manager: Stuart D. Sullivan

[24+] AROUN' TOWN PRODUCTIONS  
 also REMOTE RECORDING  
 2312 San Jose  
 Las Vegas, NV 89121  
 (702) 457-3875  
 (702) 457-7790  
 Owner: Aroun' Town Productions, Inc.  
 Studio Manager: Gigi Copeland

[24+] AUDIO VIDEO RECORDERS OF ARIZONA  
 also REMOTE RECORDING  
 3830 N. 7th St.  
 Phoenix, AZ 85014  
 (602) 277-4723  
 Owner: Floyd Ramsey  
 Studio Manager: Tim Ramsey

[24+] AUSTIN RECORDING STUDIO  
 4606 Clawson Rd.  
 Austin, TX 78745  
 (512) 444-5489  
 Owner: W. Tyler  
 Studio Manager: Wink Tyler

[24+] BENSON SOUND, INC.  
 3707 S. Blackwelder  
 Oklahoma City, OK 73139

(405) 634-4461  
 Owner: Larry Benson  
 Studio Manager: Larry Benson

[24+] BOYD SOUND STUDIO  
 PO Box 682, 103 N. Ballard St.  
 Wylie, TX 75098  
 (214) 442-1620  
 Owner: Anthony D. Boyd  
 Studio Manager: Anthony D. Boyd

[24+] JIM BRADY RECORDING STUDIOS  
 25 E. Glenn St.  
 Tuscon, AZ 85705  
 (602) 791-3884  
 Owner: F. James Brady  
 Studio Manager: Diane J. King



**Brasswind**  
 Brasswind Recording Studio  
 A growing tradition . . . EXCELLENCE

BRASSWIND RECORDING STUDIO, LTD.  
 College Station, TX

[24+] BRASSWIND RECORDING STUDIO, LTD.  
 2551 Texas Ave.  
 Shiloh Pl., Ste. F  
 College Station, TX 77840  
 (409) 693-5514  
 Owner: David O. Cooper  
 Studio Manager: David O. Cooper  
 Engineers: David O. Cooper, James Haislet, Jeff Cowan



(713) 960-8222  
Owner: Dwight L. Cook  
Studio Manager: Ted Mason

**[24+] CORNERSTONE RECORDING COMPANY**  
also REMOTE RECORDING

100 W. Wilshire/C-2  
Oklahoma City, OK 73116  
(405) 848-8400  
Owner: Kenneth A. Sarkey  
Studio Manager: Ken Sarkey  
Engineers: Ken Sarkey, Dave Thomason, independents.  
Dimensions: Room 1: studio 30 x 45 x 14 w/ five iso booths, control room 18 x 20. Room 2: studio 12 x 13, control room 14 x 15.  
Mixing Consoles: Tangent 3216 28 x 24, Tascam 10 12 x 8, Mega-Mix computer automated mix-down.  
Audio Recorders: Stephens 821 24- and 16-track w/Q II Autolocate computer, MCI JH-110B 2-track w/Autolocate, Otari 5050B 2-track, Otari 5050A 2-track, Sony TC-630 1/4-track.

**Cassette Recorders/Duplicators:** Nakamichi, Technics cassette, Sony CCP-13B high speed cassette duplicating system.

**Noise Reduction Equipment:** dbx.

**Echo, Reverb, & Delay Systems:** Lexicon 224 digital reverb, EMT 140 tube stereo reverb, AKG BX-10 reverb, Lexicon Prime Time delay, Yamaha SPX90.

**Other Outboard Equipment:** UREI LA 4 compressor/limiters, dbx 160 compressor/limiter, dbx 165 compressor/limiter, EXR Exciter, PAIA dual limiter (cue), Valley People DynaMite stereo limiter/gate/de-esser, Crown EQ-2, Dynaco graphic EQ, Omni Craft noise gates, Audio Control Real Time analyzer and graphic EQ, phase and flangers, UREI 1176 comp/limiter, Orban 536A dynamic sibilance controller, Orban 245E stereo synthesizer, Technics SL1200 MKII broadcast turntable, Rocktron 2X2H exciter/imager, Hush II.

**Microphones:** Neumann, Sennheiser, Sony, Shure, Beyer, E-V, Altec, Crown P2M, AKG, RCA, Countryman.

**Monitor Amplifiers:** Hafler D4-500, (2) Crown D-150, Crown D-60, Technics SU 8600.

**Monitor Speakers:** JBL 4435 Bi-Radials, Auratone 5C, JBL 4311s, RTRs, Yamaha NS-10s.

**Musical Instruments:** Yamaha 75" grand piano, Fender Rhodes stereo electric piano, Wurliizer electric piano, Hammond B-3 w/Leslie, Yamaha DX7, Chroma Polaris, Mini-moog synthesizers, Rogers drum kit w/double bass, Yamaha drum set w/five concert, five double-headed toms, Yamaha and Fender guitar amps, LP congas, complete percussion/effects, Linn 9000 digital sampling drums and 32-track MIDI keyboard recorder, 360 Systems MIDI-Bass, Emulator II digital sampling keyboard, I.V.L. Pitchdrizer pitch-to-MIDI converter, Hamlet 4 x 8 MIDI patcher, Kramer MIDI guitar system.

**Other MIDI Equipment:** Opcode editor librarian for Yamaha DX7, Chroma Polaris and Matrix 6, Opcode Sequencer 2.5, Deluxe Music Construction Set (music scoring and printing), Apple/Macintosh computer system.

**Video Equipment:** JVC GX-N704 color camera w/direct access color character generator, Pentax PVR1000A 1/2" VHS stereo video recorder (five heads), Ikegami HL-79D camera, Sony and JVC 1/4" decks, Mole Richardson light kit, SMPTE time code interlock/sync, Sonyo AVM 260 25" color video monitor/receiver.

**Rates:** 24-track recording and mixing: \$50-\$80/hr., including engineer and studio instruments. Discount block and producer rates available.

**[24+] CRYSTAL CLEAR SOUND**

4902 Don Dr.  
Dallas, TX 75247  
(214) 630-2957

Owner: Merle D. Baker  
Studio Manager: Keith Rust

Engineers: Keith Rust

Dimensions: Studio 45 x 35, control room 23 x 17.

Mixing Consoles: MCI JH636 automated 28 x 24.

Audio Recorders: MCI JH-24 24-track, MCI JH-110B 2-track, Studer A-810 2-track, Ampex 440 2-track.

Cassette Recorders/Duplicators: Denon DR-M3, KABA system.

Noise Reduction Equipment: Dolby SP Series 24-track, dbx 410 Series 24-track, Dolby 361 Series 2-track.

Echo, Reverb, & Delay Systems: Lexicon 200 digital reverb, Yamaha SPX90, Lexicon PCM41 delay, Korg SDD-3000 delay, Eventide H910 Harmonizer.

Other Outboard Equipment: (2) Orban 526A de-esser, dbx 160X compressor, (2) dbx 165 comp./limiter, (4) Kepex gate, (4) Gain Brain compressor, Orban 622 parametric 2-channel.

Microphones: (3) Neumann U87, (2) AKG 414, (2) Shure SM81, (2) Sennheiser 421, (2) Sennheiser 441, (4) Shure SM57, (2) E-V RE15, E-V RE20, (3) Sony ECM-33, (2) AKG 452, (2) Neumann KM84.

Monitor Amplifiers: BGW 750, (2) Crown D-150A, (2) Crown D75.

Monitor Speakers: (2) UREI 811, (2) Yamaha NS-10, (2) JBL 4311, (2) Auratone T-5.

Musical Instruments: Baldwin SD-10 9' concert grand, Fenzler precision bass, misc. percussion, Hammond B-3 w/Leslie cabinet.

Other: Very friendly calico cat (Tanna).

Rates: Very reasonable! Please call.



**DALLAS SOUND LAB**  
Irving, TX

**[24+] DALLAS SOUND LAB**

6305 N. O'Connor Blvd.  
Irving, TX 75039  
(214) 869-1122

Owner: Russell Whitaker

Studio Manager: Johnny Marshall  
Engineers: Rusty Smith, Tim Kinsey

Dimensions: Room 1: studio 46 x 52, control room 24 x 21. Room 2: studio 10 x 8, control room 16 x 14. Room 3: studio 24 x 12, control room 28 x 26.

Mixing Consoles: SSL 6056 48 x 32 automated w/Total Recall, MCI JH-636 24 x 24, MCI JH-536 28 x 24 automated.

Audio Recorders: Sony PCM-3324 24-track digital, Citeri MTR 90 24-track, MCI JH-114 24- and 16-track, MCI JH-110 3-track 1" video layback recorder, (2) Otari MTR-10 4- and 2-track, (2) MCI JH-110 4- and 2-track.

Cassette Recorders/Duplicators: Studer Revox B710, Sony TC K444, (8) Sony TCFX-45.

Noise Reduction Equipment: Dolby 56 channels, dbx: 24 channels.

Synchronization Systems: BTX Softouch, Audio Kinetics Q-Link 3.10.

Echo, Reverb, & Delay Systems: AMS RMS-16 digital reverb, AMS DMX-1580S digital delay/harmonizer/sampler, Lexicon 224 digital reverb, (2) Yamaha SPX90 digital processor, Yamaha REV7 digital reverb, Lexicon PCM41 digital delay, Lexicon PCM42 digital delay, Lexicon PCM70 digital reverb, Lexicon PCM60 digital reverb, Quantec room simulator.

Other Outboard Equipment: Compressors, limiters, gates, expanders, EQs and exciters by: UREI, Allison, dbx, SSL, Valley People, Dietz, Aphex and Yamaha.

Microphones: Full array of mics by: Neumann, Sennheiser, Sanken, AKG, RCA, E-V, Sony, Crown, Beyer, Shure; vintage tube mics by: Neumann, AKG, RCA.

Monitor Amplifiers: Crown Delta Omega 2000, assorted amp: by Yamaha, Crest, Crown and BGW.

Monitor Speakers: (2) UREI 813-B, (2) Sierra, (6) Yamaha NS 10, (2) Tannoy SRM-12, (6) Auratone 5L, (2) JBL 4330.

Musical Instruments: Steinway 9' concert grand piano, Synclavier 48-voice digital production system, Hammond B-3 w/Leslie, (2) Yamaha DX7 w/DX-pro software, Yamaha QXS RX21, TX7, Yamaha TX816, Kurzweil 250, Oberheim Xpander, Linn 9000, LinnDrum, (2) Prophet-5 w/1005 sequencer, Korg Poly 800, (2) Minimoogs.

Video Equipment: Video monitors by: Sony, NEC, MGA, Bencor.

Other: 16/35mm high-speed projectors, dubbers, and master recorders by MTM.

Rates: \$50-\$235/hr. (block/bulk rates available upon request).

Extras & Direction: Studio A: up to 48-track digital/analog recording with interlock to video or film. Services include 40-piece capacity orchestra scoring to picture, ADR, SFX assembling, video sweetening, and album/jingle production with audio and video tie-lines to three sound stages (15,000/6,000/3,000 sq.ft.) for live TC shows, concerts etc. Studio B: up to 24 track recording capability with iso-booth for voice-over work, overdubs and mixing. Studio C: up to 24 track digital/analog recording capability with interlock to video or film with large iso-booth. Services include synthesizer scoring to picture, ADR, SFX assembling, video sweetening and mixing to picture. Studio D: Synclavier hard-disk based digital music production system with 32-voice stereo synthesis/16-voice stereo sampling. System includes MIDI, SMPTE and guitar interface with up to 200-track capability. Dallas Sound Lab is designed to meet the

complete needs of clientele dealing with any aspect of audio-production ranging from simple voice-over recording to complex 48-track digital/analog recording to video or film.

# Digital Services

**DIGITAL SERVICES RECORDING**  
Houston, TX

**[24+] DIGITAL SERVICES RECORDING**

5805 Chimney Rock Rd.  
Houston, TX 77081  
(713) 664-5258

Owner: John A. Moran

Studio Manager: Lisa Williams

Engineers: Gary Moon, Trent Burns, Robin Scott, John Moran, David Kealy, Bobby Ginsburg.

Dimensions: Room 1: studio 35 x 30 x 20, booth 10 x 15 x 9, control room 22 x 25. Room 2: studio 30 x 40 x 20.

Mixing Consoles: SSL 6000 48 x 32 w/full automation/Total Recall, Neve 5442.

Audio Recorders: Digital: (2) Sony PCM-3324s 24-track, (2) Sony PCM-1610 2-track, Sony DAE-1100 editor, (2) Sony/RTW F-1 2-track, Sony PCM-100 2-track; Analog: Otari MTR-9011 24-track, Otari MTR-12 2-track/4-track 1/2", Otari MTR-10 2-track 1/4", Otari 5050 B 2-track 1/4".

Cassette Recorders/Duplicators: Sony and Nakamichi decks.

Synchronization Systems: Adams-Smith 2600, 5 machines controlled by SSL 76-track computer lock-to-video, Lynx Time Line modules.

Echo, Reverb, & Delay Systems: Lexicon 224XL w/LARC reverb, (3) Lexicon PCM70 reverb, Sony DRE-2000 reverb, AMS DMX 1580-S harmonizer/delay/sampler, Yamaha REV7 reverb, Yamaha SPX90 reverb, Lexicon Prime Time II delay, Eventide 969 Harmonizer, A: Scamp analog delay, DeltaLab 1024 delay, MIXMIX spring reverb, live chambers.

Other Outboard Equipment: Audio Design Vocal Stresser, Klark Teknik graphic EQ, (2) Tube Tech EQP-1A EQ, (3) dbx 160X comp., (2) dbx 166 comp/gates, (2) UREI 1176 limiters, Orban parametric EQ, EXR Exciter, Scamp rack with (8) noise gates, (2) de-essers, (4) compressors, (2) lo-frequency expanders, (2) sweep EQs.

Microphones: Full selection of Neumann, AKG, Sennheiser, Beyer, Shure, Countryman, Crown, Sony, E-V

Monitor Amplifiers: Crown PSA-2, Crown D-75, QSC 3500, Phase Linear 400.

Monitor Speakers: Meyer 83#34, UREI 813, JBL 4311, JBL 4411, MDM-4, Yamaha NS-10, Auratone 5-C, Klein & Hummel.

Musical Instruments: E-mu Emulator II+, E-mu SP-12 sampling drum machine, Yamaha DX7 IIIFD, Yamaha TX816, Yamaha KX88, Oberheim Mellotron 12, Kawai 7' grand piano, Baldwin bass amp, Mellotron (upon request).

Other MIDI Equipment: Macintosh Plus computer w/1MB RAM, Mark of the Unicorn Performer, (sequencer), Composer (music printing), Drum File (librarian for SP12), DX/TX librarian, MacPaint, Hayes Modem 1200 w/Smart Com program, PAN and music BBS on line, DigIDesign Sound Designer for Emulator II+, SMPTE interlock, new things daily.

Video Equipment: Sony BVU-800 1/4" for scoring and mix-to-picture.

Rates: \$30-\$225/hr. Quotes upon request, block rates available. Call for info.

Extras & Direction: Complete compact disc master tape preparation with digital tape analysis. We are the only studio in the Southwest to offer this service. Complete production services including scoring, mixing, synchronization, Foley and dialogue replacement. Audio services for record, television, film. Film credits: *Red Headed Stranger*, *Stop Making Sense*, *Yentl*, *For All Mankind*, *Red Hot and Blue*. Television credits: *Culture Club for Cinemax*, *Houston Knights*, *Texas 150 Celebration*, *Willie Nelson's Greatest Hits Live*, *Hands Around Houston*. Record/CD credits: Willie Nelson, Eurhythms, The Natives, La Mafia, Johnny Nash, Talking Heads.

**RTS-321**



EVERY AUDIO PROFESSIONAL NEEDS THIS VERSATILE PHONE / XLR ADAPTER IN THEIR TOOL KIT

**RTS-321 FEATURES**

- 1/4 RTS Male Phone and 3 pin Cannon Female XLR
- 32 position switch instantly changes the internal wiring to match your specific interconnection needs

ASK YOUR DEALER FOR A DEMONSTRATION  
CALL OR WRITE FOR FREE BROCHURE

**FOUR** DESIGNS COMPANY 6531 GROSS AVENUE • CANOGA PARK, CA 91307  
(818) 716-8540

**SOUTHWEST STUDIOS**



**24+ TRACK**

**[24+] DIGITAL SERVICES REMOTES**  
only REMOTE RECORDING

2001 Kirby Dr.  
Houston, TX 77019  
(713) 520-0201  
Owner: John A. Moran  
Studio Manager: Lisa Williams  
Engineers: Trent Burns, Gary Moon, Robin Scott, James Kling

Dimensions: Remote facility, control room 8 x 20 x 8.  
Mixing Consoles: MCI 636 36 x 24 (automated).  
Audio Recorders: Sony PCM-3324 24-track digital, Otari MTR-90II 24-track, Otari MTR-12 4- and 2-track, Sony PCM-1610 2-track digital.  
Cassette Recorders/Duplicators: Nakamichi.  
Echo, Reverb, & Delay Systems: Lexicon PCM70, Yamaha REV7, others available.  
Other Outboard Equipment: dbx 160X and 166 compressors, RTS 12-channel dist. amp, RTS intercom, additional equipment as specified for job.  
Microphones: Full array of Neumann, AKG, Shure, Sennheiser, E-V, Countryman, Sony, Crown.  
Monitor Amplifiers: QSC 3500 w/White 1/3-octave EQ.  
Monitor Speakers: JBL 4411, Yamaha NS-10, Auratone 5-C.  
Video Equipment: 2-channel color video monitoring w/cameras, Lynx Time Line synchronizer, time code generator, Sigma video sync generator, color bar generator, video distribution amp.

**Extras & Direction:** 300' 54-pair snake plus 200' 9-pair snake, 16-line outputs from truck, 3-way mic split box using Jensen transformers. Truck can run on 208VAC or 240VAC, 1 or 3 phase and distribute transformer isolated power. The truck is configured for each remote per the client's needs. We have done remote audio for live satellite feeds, multi-track recording for record and video and mixing. Credits: 7th Van Cliburn Piano Competition, Edwin Hawkins Music and Arts Seminar, Red Hot and Blue, Norway in Texas PBS Special, *La Motie Live!* more credits on request. Our rates are very competitive.

**[24+] DOWNTOWN SOUND**  
also REMOTE RECORDING

1701 N. Market St., Ste. 203  
Dallas, TX 75202  
(214) 699-5333  
Owner: Oasis Productions, Inc.  
Studio Manager: Jonathan Cluts  
Engineers: Jonathan Cluts, Brad McQuiddy  
Dimensions: Room 1: studio 14 x 20, control room 14 x 30.  
Room 2: studio 14 x 20, control room 14 x 12.  
Mixing Consoles: Soundcraft Producer Series 1600 24 x 24, Studiomaster 16 x 8 x 2.  
Audio Recorders: Otari 24-track, Studer A-80 Mark I 16-track, Sony/MCI JH-110 2-track (1/4" and 1/2"), Sansui Tricorde PCM 2-track (F1-compatible), JVC VHS Hi-fi video cassette, Beta Hi-fi video cassette.  
Cassette Recorders/Duplicators: Tascam 122B, Nakamichi BX-1, Yamaha MT44 4-track.  
Noise Reduction Equipment: dbx 8 channels, access to Dolby SR.  
Synchronization Systems: Adams-Smith Zeta 3 System w/custom software.  
Echo, Reverb, & Delay Systems: Klark-Teknik DN-780, Lexicon PCM60, Yamaha REV7, Yamaha SPX90, Lexicon Prime Time II w/digital delay, ADA 1.28i digital delay, (2) Effectron II 1024 digital.  
Other Outboard Equipment: LA-2A tube comp./limiter, dbx 900 rack, (2) para. EQs, (2) de-essers, (2) noise gates, comp./gate, UREI 1176LN, (4) Valley People Dyna-Mites (8 channels), Klark-Teknik dual 1/3-octave EQ, Klark-Teknik dual octave EQ, (2) dbx 165A comp./limiter, (2) dbx 160X comp./limiter, Eventide 910 Harmonizer, rack mount Scholz Rockman.  
Microphones: (2) AKG C-12s tube, (2) Neumann U67s tube, Telefunken U47 tube, Neumann 249C tube, Neumann 269C tube, Neumann UM54 tube, (2) Neumann UM53 tubes, (2) AKG 414, (2) Neumann U87s, (4) Sennheiser

421s, plus assorted AKG, Sony, Shure, Countryman.  
Monitor Amplifiers: (2) Crown Microtech 1000s, Crown DC 150, Rane headphone amp.  
Monitor Speakers: Westlake BBSM 10s (A), Westlake BBSM 6s (B), JBL 4401, Yamaha NS-10s w/issue of your choice, JBL 4312, (2) Auratone.  
Musical Instruments: Yamaha DX7, Yamaha TX816 rack, Oberheim DPX1 sample player, Oberheim OB-Xa w/MIDI, Roland digital piano module, Roland Planet 5 module, Akai S900 sampler, Casio CZ 1000, Yamaha KX88 keyboard controller, E-mu SP-12 w/Turbo and drum filler, Yamaha RX11, Roland DDR30 w/pads, Roland 727, Octa Pad, Linn-Drum, Fender Rhodes suitcase 73 w/pre-amp  
Other MIDI Equipment: Yamaha QX1, Apple/Macintosh 512, IDS/XT PC (IBM compatible), Apple II Plus w/memory expansion, Yamaha CX5M music computer, all software. All computers are fully equipped and MIDI compatible. We have numerous sequencing programs available. We also have custom software with MIDI/SMPTE synchronization. Rates: Call for rates.

**Extras & Direction:** Downtown Sound is a full service recording studio offering everything from sampling and MIDI sequencing to live band recording. We have an in-house equipment rental company so that we can service whatever needs a client has.

**[24+] EAGLE AUDIO, INC.**

911 S. Main St.  
Ft. Worth, TX 76104  
(817) 877-4338  
Owner: Mike McColm, Curtis Butts, David Peloubet  
Studio Manager: Mike McColm

**[24+] EAGLE MOUNTAIN STUDIOS**

PO Box 699  
Newark, TX 76071  
(817) 489-2226  
Owner: Kenneth Copeland Ministries  
Studio Manager: Win Kutz

**[24+] EDENWOOD RECORDING STUDIOS**

7319-C Hines Pl.  
Dallas, TX 75235  
(214) 630-6196  
Owner: Jerry Swafford  
Studio Manager: Jerry Swafford

**[24+] EL ADOBE RECORDING**

5301 El Paso Dr.  
El Paso, TX 79905  
(915) 772-7333  
Owner: J.O.S. Enterprises  
Studio Manager: Robert Hernandez

**[24+] EUROPA SOUND CENTRE**

101 W. 38th St.  
Austin, TX 78705  
(512) 450-0663  
Owner: Peter S. Butcher

**[24+] FINE ARTS MEDIA SERVICES**

also REMOTE RECORDING  
College of Fine Arts  
The University of Texas at Austin  
Austin, TX 78712  
(512) 471-6223  
Owner: Ken Dickensheets  
Studio Manager: Bob Roberts

**[24+] FUTURE AUDIO**

7700 Carpenter Freeway, Ste. 1000  
Dallas, TX 75247  
(214) 630-8889  
(214) 263-0746 (metro)  
Owner: Marcos Rodriguez  
Studio Manager: Randy Adams  
Engineers: Randy Adams, Tony Rodriguez  
Dimensions: Room 1: studio 42 x 51, control room 34 x 37  
Room 2: 13 x 8. Room 3 studio 20 x 35, control room 14 x 16  
Mixing Consoles: NEOTEK Series III 28 x 24  
Audio Recorders: Stephens 821B 24-track, Ampex ATR 102 2-track, Otari 5050 2-track  
Cassette Recorders/Duplicators: (2) Technics M85 MKII 2-track.  
Echo, Reverb, & Delay Systems: (2) Ursa Major 8 x 32 digital reverbs, Ecoplate III reverb, Lexicon Super Prime Time DDL, Ursa Major Space Station, Alesis XTC digital reverb, (2) Alesis MIDiverbs, Ursa Major MSP 126 stereo processor, Harmonizer.  
Other Outboard Equipment: (2) Barcus-Berry 802 processors, Aphex B processor, (2) ADR stereo pan modules, (2) ADR compressor/limiters, ADR parametric EQ, (2) UREI LA-4A compressor/limiters, UREI 1176 compressor/limiter.  
Microphones: AKG C-24 stereo tube, (5) Sennheiser 421,

**RACK**

ECONOMICAL 19" RACK MOUNT "FURNITURE" FOR THE PROFESSIONAL OR HOME STUDIO

**FX RACK FEATURES:**

- Holds up to 18 "spaces" of equipment.
- Attractive black textured vinyl laminate.
- Shown with optional wheels.

ASK YOUR DEALER FOR A DEMONSTRATION  
CALL OR WRITE FOR FREE BROCHURE

**FOUR** DESIGNS COMPANY 6531 GROSS AVENUE • CANOGA PARK, CA 91307  
(818) 716-8540



Circle #153 on Reader Service Card

**Specializing in Magnetic Audio Head Services**

Complete Precision Head Relapping; Recontouring and Optical Alignment

Free Evaluation

24 Hour Turnaround

New Replacement Heads Available

**AUTERI Associates Inc.**  
(516) 331-5022

AUTERI ASSOCIATES, INC.  
9 HENEARLY DRIVE,  
MILLER PLACE, NEW YORK 11764

Circle #154 on Reader Service Card



(2) AKG 414, (4) AKG 451, Beyer 201, AKG D-12, (4) Shure SM57, Neumann U87, (2) PZM, (4) Countryman DI boxes, Crown GLM.  
**Monitor Amplifiers:** UREI 6500, (2) Crown PS-200, Crown 75.  
**Monitor Speakers:** (2) UREI 813, (2) Auratone cubes, (2) Yamaha NS1000, (2) JBL 4311.  
**Musical Instruments:** Kawai 7'4" grand piano, Fender Rhodes, Prophet 5, assorted Yamaha and Casio synths.  
**Other MIDI Equipment:** Complete MIDI studio available in fall of '87.  
**Other:** Complete radio production room available in fall of '87.

**[24+] GARZATIELI INTERNATIONAL MUSICAL PROD.**  
**6326 Sovereign, Ste. 160**  
**San Antonio, TX 78229**  
**(512) 341-0443**  
**Owner:** Xavier Garza  
**Studio Manager:** David Martin

**[24+] GOODNIGHT AUDIO INC.**  
**11260 Goodnight Ln.**  
**Dallas, TX 75229**  
**(214) 241-5182**  
**Owner:** Gordon Perry  
**Studio Manager:** Don Seay

**[24+] GRAVITY RECORDING STUDIO**  
**141 Spur Pl.**  
**Nogales, AZ 85621**  
**(602) 281-1746**  
**Owner:** Miguel Cnsantes  
**Studio Manager:** M. Cnsantes  
**Engineers:** Miguel Cnsantes, Manuel Altumada, independents  
**Dimensions:** Studio 19 x 39, control room 19 x 23.  
**Mixing Consoles:** Neve V-36 custom 36 x 48.  
**Audio Recorders:** Otari MTR-90 24-track, Otari MTR-10 2-track, Tascam 36 2-track.  
**Cassette Recorders/Duplicators:** Tascam 122 cassette, Technics M95 cassette.  
**Echo, Reverb, & Delay Systems:** Lexicon 224 w/all programs, Lexicon 200 w/all update, Lexicon Prime Time 95, Lexicon Prime Time II, Yamaha SPX90, Sound Technology Ecoplate II, Eventide H949 Harmonizer.  
**Other Outboard Equipment:** DeltaLab DL-1, Valley People limiter/gate, UREI 1178 limiter, Aphex Compellor, dbx 165, dbx 162, MXR double flanger, EXR Exciter.  
**Microphones:** Assorted AKG, Sennheiser, E-V, Beyer, Neumann, Sony and Shure.  
**Monitor Amplifiers:** UREI 6500 w/UREI filters, Macintosh 2200.  
**Monitor Speakers:** UREI 811, Tannoys, E-V Sentry 100s.  
**Musical Instruments:** Kurzweil 250 w/, Macintosh computers, Yamaha: DX7, TX7; Roland: JX 8P, JX-10P; Synergy Kimball 6'9" grand piano, Hammond B-3 w/Leslie, Oberheim OB-8, assorted guitars and bass guitars, assorted percussion equipment.  
**Rates:** Call for rates.

**[24+] GULF COAST CREATIVE GROUP**  
**PO Box 12039**  
**Beaumont, TX 77706**  
**(409) 899-9160**  
**Owner:** Gulf Coast Creative Group Inc.  
**Studio Manager:** Paule Lagush

**[24+] INSIDE TRACK, INC.**  
**313 N. Locust**  
**Denton, TX 76201**  
**(817) 566-2367**  
**Owner:** Jay & Lynne Miller  
**Studio Manager:** Lynne Miller  
**Engineers:** Jim Vincent  
**Dimensions:** Studio 20 x 30, drum booth 10 x 10, vocal booth 10 x 10.  
**Mixing Consoles:** Trident Series 70.  
**Audio Recorders:** Sony 701-ES 2-track digital, MCI JH-24, Technics 1500 2-track, Harman Kardon CD91 2-track, TEAC 122B 2-track.  
**Echo, Reverb, & Delay Systems:** Lexicon 200 digital reverb, Master-Room XL305 reverb, Tapco 4400 reverb, Eventide H910 Harmonizer, DeltaLab 256 and 1024 DDLs.  
**Other Outboard Equipment:** Aphex Aural Exciter, Orban "Optimod" stereo comp/limiter/de-esser, UREI LA-4As, Tapco stereo 10-band graphic EQ, Technics turntable, dbx 160 limiters, dbx 900 noise gate rack.  
**Microphones:** Neumann, AKG, Sennheiser, Crown, Shure, Beyer, TEAC, E-V.  
**Monitor Amplifiers:** Crown, Aka.  
**Monitor Speakers:** JBL 4411, Auratones.  
**Musical Instruments:** Kawai 6' grand piano, vintage acoustic and electric guitars by Gibson, Guild, Ovation and Washburn, Fender guitar amps, Linn 9000, Oberheim Xpander,

Yamaha DX7 and DX Pro computer package, LinnDrum 9000.  
**Other MIDI Equipment:** Atan ST computer.  
**Video Equipment:** Beta and VHS single camera "live" recording.  
**Rates:** \$75/hr. with block rates available.

**[24+] JAM CREATIVE PRODUCTIONS, INC.**  
**5454 Parkdale Dr.**  
**Dallas, TX 75227**  
**(214) 388-5454**  
**Owner:** Jonathan & Mary Lyn Wollert  
**Studio Manager:** P. Craig Turner  
**Engineers:** P. Craig Turner, Brian Hamilton, Jonathan Wollert, Vicki Jasper  
**Dimensions:** Room 1: studio 36 x 41, control room 24 x 21. Room 2: studio 24 x 32, control room 18 x 15. Tom Hidley designs.  
**Mixing Consoles:** Harrison MR4-52 44 x 24 automated, MCI JH-636 32 x 24 automated.  
**Audio Recorders:** Studer A-820 24-track, MCI JH-24 24-track, (3) Studer A810 2-track (one w/center ch. SMPTE), MCI JH-110A 4- and 2-track 1/2", (4) MCI JH-110 A/B 2-track, MCI JH-110A 1-track.

**Cassette Recorders/Duplicators:** Yamaha C200 various Technics, Aka! cassette machines, Ampex 3200 high speed reel to reel duplication system.  
**Noise Reduction Equipment:** (61) dbx 911 NR cards in dbx 900A main frames.  
**Synchronization Systems:** Adams-Smith 2600 synchronizer/reader/generator.  
**Echo, Reverb, & Delay Systems:** Lexicon 200, (2) Klark-Teknik DN780, Lexicon Model 93 DDL, (2) Yamaha SPX90, Yamaha REV7, EMT gold foil plate.  
**Other Outboard Equipment:** (8) dbx 903 compressor/limiters, (4) dbx 902 de-essers, (4) Gain Brains, (2) Kepex, (2) UREI 1176LN, (2) Valley People Dyna-Mite, Orban 621B parametric equalizer, (2) Symetrx TI-101 telephone interface, (2) UREI 527-A graphic equalizers, Orban 526A de-esser.  
**Microphones:** (3) Neumann TLM170i, (3) Neumann U87, (4) Neumann U47, (2) Neumann KM88, (2) Neumann KM84, (4) AKG 414, (5) Sennheiser MD421, (5) Shure SM57, E-V RE20.  
**Monitor Amplifiers:** (5) Hafler P500, (2) Crown D60 (alternates), (2) BGW 250C.  
**Monitor Speakers:** (4) Hidley-Kinoshita System 2, (2) Westlake BBSM 6, (2) JBL 4331, (2) JBL 4313, (4) Auratone 5-C.  
**—LISTING CONTINUED ON NEXT PAGE**

# Aphex Aural Exciter® Type C It's for Anyone Who Performs, Records or Listens to Music.



*"I recommend Aural Excitement to those of you looking for that extra 'zing'."*  
**Eddie Ciletti, MUSIC & SOUND OUTPUT**



Aphex Systems Ltd. • 13340 Saticoy St. • North Hollywood, CA 91605  
 (818) 765-2212 • TWX: 910-321-5762

Aural Exciter is a registered trademark of Aphex Systems Ltd

© 1987 Aphex Systems Ltd

Circle #142 on Reader Service Card

—CONTINUED FROM PAGE 191

**Musical Instruments:** Yamaha DX7, Roland Jupiter 8, (2) Kawai 6' pianos, TX7, Minimoog.

**Video Equipment:** Proton 602M 25" monitor, Sony KV-1954R 19" monitor, Sony VO-5600 ¾" video recorder, JVC HR-7100U VHS VCR.

**Rates:** Call for rates.

#### [24+] JANUARY SOUND STUDIOS INC.

3341 Towerwood Dr., Ste 205

Dallas, TX 75234

(214) 243-3735

**Owner:** January Sound Studios Inc.

**Studio Manager:** Dennis Lowe

**Engineers:** Chns Green, Dennis Lowe, Robert Wechsler, Kenny Berge, Russ Alvey

**Dimensions:** Room 1: studio 22 x 35, control room 18 x 22. Room 2: studio 12 x 15, control room 14 x 20. Room 3: control room 15 x 17.

**Mixing Consoles:** (2) MCI 536 D AF/LM 36 x 32.

**Audio Recorders:** 3M M-81-32 32-track digital, (2) 3M M-81-4 4-track digital (w/digital editing), MCI/Sony JH-24 24-track, (4) MCI JH-110B 2-track (½" and ¼" heads), MCI JH-110A 4-track, (2) PCM digitals (Sony F-1 2-track, Sansui X-1) 2-track.

**Cassette Recorders/Duplicators:** (10) Akai GX A5X, TEAC 224, Technics M95.

**Noise Reduction Equipment:** Dolby A 54 channels, dbx 30 channels.

**Synchronization Systems:** JH 45/48 interlock and SMPTE time code generator.

**Echo, Reverb, & Delay Systems:** Lexicon 224, Klark-Teknik DN 780, TC Electronics TC 2290, EMT 140, EMT 240 (Gold Foil), Sequential Circuits Pro-FX 500, ART 01A, ART DR1, Eventide 1745M, Eventide H-949, Eventide H-910, Space Station SST 282, Marshall 5002 Time Modulator, Ecoplate, Lexicon PCM70.

**Other Outboard Equipment:** (2) dbx 165As, (2) dbx 165s, (2) dbx 160Xs, (6) Valley People Dyna-Mites, UREI 535 graphic EQ, UREI 530 graphic EQ, UREI 546 parametric, Teletronix LA-2A, UREI LA-3As, Orban 621B parametric EQ, US Audio Gate, Barcus-Berry BBE 202R, ADR F769 X-R Vocal Stressor, Burwen TNE 7000A, Burwen DNF 1210A.

**Microphones:** (3) Neumann U87s, Neumann U47, Neumann M49, AKG C-24 stereo tube, (5) AKG C-414-EBs, (2) AKG C-451-Es, AKG The Tube, (6) E-V CS15Es, (2) E-V RE20s, (2) Schoeps MK-4s, (2) RCA 77DXs.

**Monitor Amplifiers:** (2) McIntosh MC 2300, (2) Crown Micro-Tech 1000, (4) Crown 510As.

**Monitor Speakers:** Custom Sierra control monitors w/TAD components, JBL 4430s, JBL 4313s, (2) JBL 4401, Westlake BBSM-6s, Yamaha NS-10Ms, Auratone 5Cs.

**Musical Instruments:** Stein way 9' grand piano, (2) Fender Rhodes (1 w/Dyno-Myo-Piano modifications), Kawai acoustic piano w/track piano modifications, Yamaha DX7, Yamaha TX7, Akai AX 60, Akai AX 80, (3) Casio CZ series, Casio RZ drum machine, Linn 9000, Linn LM-1, LinnDrum, Roland GR-700, Pitch Rider 7000, (4) Pitch Rider 4000, MIDI bass, Akai S 900 sampler.

**Other MIDI Equipment:** IBM 286 MIDI computer, Macintosh MIDI computer, Amiga and C-64 MIDI computers.

**Video Equipment:** Sony BVU-800 ¾" record/play, Sony U-matic player, (2) JVC VHS ½" decks, Sony KX-1901A video monitor.

**Rates:** Call for standard and block rates.

#### [24+] JASPER SOUND STUDIO

3401 Harper's Ferry

Austin, TX 78745

(512) 282-2734

**Owner:** Gordon Garnson

**Studio Manager:** Gordon Garnson

#### [24+] KLUDGIT SOUND, INC.

also REMOTE RECORDING

Box 171

Cerrillos, NM 87010

(505) 471-0051

**Owner:** Baird Banner

**Studio Manager:** Busy McCarroll Banner

**Engineers:** Baird Banner

**Dimensions:** Studio 35 x 22 w/oak floors, control room 18 x 15.

**Mixing Consoles:** Sound Workshop 4036 30 x 24 w/32-channel, ARMS automation, Soundcraft 24-2 24 x 2.

**Audio Recorders:** Otan MTR-90 24-track, Otan MTR-12 2-track, Otan MX 5050 2-track, Pioneer RT701 2-track.

**Cassette Recorders/Duplicators:** (2) Tascam 122B cassettes.

**Echo, Reverb, & Delay Systems:** Lexicon 224 digital reverb, Ecoplate reverb, Lexicon Super Prime Time, Lexicon 102 stereo digital delay, Eventide Clockworks 910 Harmonizer, Roland Space Echo RE201, Mutron Bi-Phase, MXR phase, MJCMI, Lexicon PCM70, Roland SRV 2000.

**Other Outboard Equipment:** (2) UREI 539 room EQs, UREI 527 1/3-octave EQ, (4) Valley People Kepex IIs, (2) UREI LA-2 tube limiter/compressors, dbx 162 stereo compressor/limiter, Dolby A noise reduction, dbx effects rack



w/sibilance compressor, UREI 545 parametric EQ, (2) UREI 1176 LN limiters.

**Microphones:** Shure: SM81, SM57, 58, 59s; Neumann: U47, U48s; Crown PZMs, AKG 451, E-V RE20s, Beyer dynamic, Beyer ribbon, Sennheiser 421 and 441, AKG "The Tube."

**Monitor Amplifiers:** (2) BGW 500/250, UREI 6500 power amp.

**Monitor Speakers:** JBL 4430 Bi-Radials, UREI 828 Time Aligned, Auratone, Spica, Tannoy SC 50s.

**Musical Instruments:** LinnDrum LM2 synthesizer, Kawai grand piano, Wurliizer electric piano, assorted drums and percussion, S-50 sampler, other instruments available by appointment.

**Video Equipment:** Engineers have extensive experience in audio recording for video, we will in the near future have sweetening capabilities.

**Rates:** \$80/hr. 24-track; please call for more information on block discounts and accommodations.

**Extras & Direction:** Kitchen, sauna, guest houses, quiet country atmosphere. The only full production 24-track studio currently in New Mexico, we also offer P.A., consultation and installation services to regional clubs and theaters. Partial credits include: Flora Punm & Airtro Moreira, Bow Wow Wow for RCA Records, The Grandmothers, Michael Murphy.

#### [24+] KNIGHTLIGHT STUDIOS

1609 Tantor

Dallas, TX 75229

(214) 869-9405

**Owner:** Tim Miner

**Studio Manager:** Jerry Smith

#### [24+] LIMELIGHT RECORDING STUDIO

also REMOTE RECORDING

5116 34th St.

Dickinson, TX 77539

(713) 337-1272

**Owner:** Don Westmoreland

**Studio Manager:** Don Westmoreland

**Engineers:** Doug Groover, Terry Westbrook, Matt Westmoreland

**Dimensions:** Studio 30 x 26, control room, 24 x 16, drum room 10 x 8.

**Mixing Consoles:** Soundcraft Senes 1600 24 x 24.

**Audio Recorders:** Soundcraft Series 760 24- and 16-track, Tascam 80-BB-track w/dbx NR, TEAC 3340S 4-track, Otan 5050 BII 2-track.

**Cassette Recorders/Duplicators:** (3) Tascam cassette decks, (4) Technics cassette decks.

**Noise Reduction Equipment:** dbx, 8 tracks.

**Synchronization Systems:** SMPTE: Hybrd Arts/Atan SMPTE Mate ST, FSK computer.

**Echo, Reverb, & Delay Systems:** Lexicon 200 digital reverb, Lexicon PCM70 digital reverb, Ursa Major Space Station, Lexicon Prime Time II, MXR digital delay, MasterRoom XL-305.

**Other Outboard Equipment:** Orban 622B parametric EQ, Tapco graphic EQ, (2) dbx 163 compressor/limiter, (2) Ashly SC-50 compressor/limiter, MXR pitch transposer, Omni Craft noise gate, Aphex Aural Exciter.

**Microphones:** (3) AKG 414, Neumann TLM170, AKG 452, Shure SM81, (2) Shure SM98, (4) Shure SM57, Shure SM53, (4) Sennheiser 421, Sennheiser 441, Beyer M500, E-V RE15, (2) Audio-Technica 811, (2) Audio-Technica 813.

**Monitor Amplifiers:** (2) McIntosh MC 240

**Monitor Speakers:** JBL 4311B, Auratone cubes.

**Musical Instruments:** Yamaha DX7, Ensoniq Mirage, Tama Super Star 6-piece drums, Wurliizer studio piano, Yamaha DX100, Korg EX-800, (2) Roland TR-707, Roland TR-727, Fender Precision Bass, Fender Telecaster guitar, acoustic guitars 6- and 12-string, Fender tube amp, Akai S900 sampler.

**Other MIDI Equipment:** Atan 1040 ST computer w/60-track SMPTE Track, Commodore 64 computer w/Syntech 8-track, Lexicon PCM70.

**Video Equipment:** JVC HR-D725 VHS video recorder, Panasonic VHS video recorder, Panasonic PK 958 video camera.

**Rates:** Call.

#### [24+] LOMA RANCH STUDIO

Rt. 1, Box 97A3

Fredericksburg, TX 78624

(512) 997-3521

**Owner:** John & Laune Hill

**Studio Manager:** Laune Hill

**Engineers:** John Hill, Laune Hill, Ron Woods, Riley Osbourn

**Dimensions:** Studio 24 x 24, control room 14 x 12.

**Mixing Consoles:** NEOTEK Series II 28 x 24.

**Audio Recorders:** Studer A80VU MKIII 24-track, Studer A810 2-track.

**Cassette Recorders/Duplicators:** (2) Sony TC-81.

**Noise Reduction Equipment:** dbx 150.

**Echo, Reverb, & Delay Systems:** Lexicon 200, Lexicon PCM70, Roland SRV-2000, MXR 01A, DeltaLab DL1.

**Other Outboard Equipment:** Roland CE-300 Super chorus, Aphex Compellor, Gatex Quad gate, (2) dbx 165 compressors, (3) dbx 163 compressors, Studer Vanspeed for multi-track, Valley People line interface.

**Microphones:** Neumann TLM-170, (2) AKG 414 P48, (4) Beyer Soundstar, (6) Shure SM81, (4) E-V PL80, E-V PL20, (4) Shure SM57, (3) Shure SM58, Shure SM56, (4) Countryman direct boxes.

**Monitor Amplifiers:** QSC 3500, (2) Yamaha P2100, Crest 3501P.

**Monitor Speakers:** (2) JBL 4410, (2) Auratone.

**Musical Instruments:** LinnDrum w/custom trigger pads, Knabe baby grand piano, Gretsch drum set, Roland JX8P, Roland RD-1000 digital piano.

**Rates:** Call for rates.

#### [24+] LONG BRANCH STUDIOS

also REMOTE RECORDING

6314 E. 13th St.

Tulsa, OK 74112

(918) 832-7640

**Owner:** Walt Banfield, Bill Belknap

**Studio Manager:** Gregg Gardner

#### [24+] LONGHORN SOUND PRODUCTIONS

Box 630, 209 N. 1st

Clyde, TX 79510

(915) 893-2616

**Owner:** Laurence T. Goya

**Studio Manager:** Jun Cabus

**Engineers:** Randy McCoy, Brad Busby

**Dimensions:** Studio 25 x 38 x 12 LEDE, control room 20 x 17 x 10 LEDE.

**Mixing Consoles:** Sound Workshop Senes 34 28 x 24.

**Audio Recorders:** MCI JH-24 24-track, MCI JH-110C 2-track, Technics 1500 US 2-track, Tascam 80-BB-track, Tascam A3340S 4-track.

**Echo, Reverb, & Delay Systems:** Ursa Major 8 x 32, Yamaha R1000, Orban, Roland echo/chorus.

**Other Outboard Equipment:** Valley People Dyna-Mite, dbx 162 stereo comp/limiter, dbx 160 comp/limiter, Aphex B Aural Exciter, White 4001 room 1/3-octave EQ, Symetrix parametric EQ, Lexicon Prime Time, DeltaLab DL1 delay, DeltaLab acoustic comp, Omni Craft GT-4

**Microphones:** Neumann U87, Neumann KM84, AKG, Sennheiser, Shure, Audio-Technica, Beyer

**Monitor Amplifiers:** Yamaha, Crown, Crest, BGW, Marantz.

**Monitor Speakers:** JBL 4430, Sentry 100, Auratone, Bi-amp main monitors.

**Musical Instruments:** Kawai 6' grand, DX7, Prophet 500, Fender Rhodes, Apple IIe computer w/Passport software, Drumulator drum machine, Fender Telecaster, Precision Bass, Rickenbacker bass.

**Rates:** On request

#### [24+] LUV SOUND AND RECORDING STUDIO

3784 Realty

Dallas, TX 75244

(214) 241-7854

**Owner:** Luv Consolidated Inc

**Studio Manager:** Ken Hughes

#### [24+] MARTIN RECORDING CO., INC.

also REMOTE RECORDING

120 W. Castellano

El Paso, TX 79912

(915) 532-2860

**Owner:** Scott Martin

**Studio Manager:** Howard Steele

#### [24+] MIDCOM, INC.

only REMOTE RECORDING

3 Dallas Comm. Complex, Ste. 108

6311 N O'Connor Rd., LB-50





**MIDCOM, INC.**  
Irving, TX

Irving, TX 75039  
(214) 869-2144

Owner: Mike Simpson

Engineers: Mike Simpson, Jeff Jones, Jim Reese, Bob Singleton, David Roberts, Don Worsham

Dimensions: Remote facility 8 x 20.

Mixing Consoles: Soundcraft Series 800B 32 x 3 x 2 custom version, Soundcraft Series 800B 32 x 3 x 2

Audio Recorders: (2) Otari MTR 9011 24-track Otari MTR-10C 2-track w/center track timecode, Studer A-810 2-track w/center track timecode, (2) Otari MX 5050BII 2-track, Otari DTR-90C 32 track digital multi-track (available on special request), dbx Model 700 digital mastering processor.

Cassette Recorders/Duplicators: Nakamichi MR-1B cassette recorder.

Noise Reduction Equipment: 24 channel, "TTM" noise reducer, frame excerpts Dolby, dbx or Telcom.

Synchronization Systems: Cipher Digital Shadow II w/Shadowpad, Cypher time code generator/reader.

Echo, Reverb, & Delay Systems: Lexicon 480-L digital audio main frame, Lexicon 224XL digital reverb, both w/LARC, Lexicon Model 95 Prime Time II digital audio processor, Eventide H-910 Harmonizer, Lexicon PCM70 digital reverb.

Other Outboard Equipment: (2) dbx 160X compressor/limiters, (2) Aphex Compellors, dbx 900 frame: equipped w/903 comp/limiters, 904 noise gates, 905 parametric EQs.

Microphones: Neumann: U89e, TLM170s, KM84s; AKG: C414, EBP/48; Schoeps: CM5, MK5s; Sennheiser: MD441s, MD42s; Beyers: M65s, M88s, M500s, M201s, MC734s; Shure: SM58s, SM57s, SM81s, SD85s; Crown: PZM GP330s, 2 L's; Celec Vega R42 hand-held and lavaliere wireless microphone systems available at an extra charge.

Monitor Amplifiers: Hafler P-505, Hafler P-225 operating in a bi-amped mode. BGW 150 for Auratones.

Monitor Speakers: (2) JBL 4430 Bi-Radial monitors w/White 1/6-octave EQ, (2) Auratone 5C monitors for near field.

Video Equipment: Sony CVM-1900 19" NTSC monitor/receiver, (2) Ball 9" E&W monitors, (2) Panasonic 12 x 1 routing switchers, (3) ADC "Humbuckers", (5) external inputs, Sony VO-5800 3/4" U-matic, Panasonic AG-6800 1/2" VHS Hi-Fi.

Other: RTS 3-channel/dual listen intercom, Clear Com 2-channel intercom, both interrelated to full duplex FM on-board repeater system w/business band and monitor, picture service, frequency synthesized remote radios, Ten line key telephone system, FCC and cellular mobile telephones, RTS 414 and 41E distribution amplifiers, Primus distribution amplifiers, custom 1 x 1 buffer/distribution amplifier capable of driving at 29 dbm, Telco interface via 48-pair, ADC Ultrapatch to dedicated patch panel, each pair w/separate resistive termination and/or capacitive coupling, Four RDLs on board for auto answer stand-by program feeds, 400' power and 42-pair snake on DC motor-driven reels.

Rates: Call for very competitive rates.

Extras & Direction: Over the five-plus years since its creation, the Midcom remote audio truck has served the needs of hundreds of clients. Listed below are a few highlights: George Strait, MCA Records/PIL Video, MCA home video; 7th Van Cliburn Competition, American Public Radio, APR/KERA Radio; "Memorial Candles" by Benjamin Lees, American Public Radio, APR/KERA Radio; "Texas" production at Palo Duro Canyon, Dramaflex, new score; "Fasion Hit Revue," Sanger Hains, live TV special; Seminar 1985 and 1986, Mary Kay Cosmetics, industrial; Democratic Presidential Candidates Debate 1984, League of Women Voters, PBS Network special; "Face of the '80s," Bob Banner Associates, syndicated TV special; "Country Crossroads," ACTS TV Network, two 13-week series; "Stars Salute The U.S. Olympic Team," Bob Stivers Productions, NEC prime-time

—LISTING CONTINUED ON NEXT PAGE

# HUSH!



There is only one **HUSH**. But there are three models, and all three come from Rocktron. We call them the **HUSH II Series**. If you aren't using a **HUSH II**, you aren't getting peace and **QUIET!**

Ask the pros. They're already using **HUSH IIs** to quiet their guitars, and their guitar effects, and keyboards, and keyboard effects, and amplifier pre-amps, and p.a. systems, and monitors, and studio tracks, and tapes, and records, and single-coil pickups, and to eliminate unwanted feedback, and to quiet mixdowns, recording systems, compressors, digital delays and anywhere else they have a noise problem.

With an effective single-ended noise reduction of greater than 30dB, nothing can compare to a **HUSH II**, or a **HUSH IIB**, or a **HUSH IIC**.

All products patent pending.

See Your Rocktron Dealer.



1633 Star Batt Dr.

Rochester, Michigan 48063

(313) 853-3055

Circle #143 on Reader Service Card

## If You Supply A Product or Service...

### MIX CLASSIFIEDS

are the best way to reach thousands of professionals in the audio-video industry! Find out why Mix Classifieds are the most cost-effective way to advertise—see the Classified section in the back of this issue for categories and complete details.

**FOR MORE INFORMATION,  
OR TO PLACE A MIX CLASSIFIED AD,  
CALL (415) 843-7901. DEADLINE: 15TH OF MONTH,  
6 WEEKS PRIOR TO PUBLICATION.**

# MIDI MADE AFFORDABLE



**CMS-Visual Sequencing System** includes 12" Monitor & AT Style Keyboard

**CMS has done it again** with their new road worthy 19", **easy to operate**, rack enclosure. This Visual Sequencing System, (CMS-VSS), includes a Roland compatible interface with 1 input and 4 outputs, tape in and out, and metronome out, (not shown). The CMS-VSS is designed around a 8mhz turbo motherboard with 640K RAM. Software includes an IBM sequencing program and MS/DOS 3.1. It will also run all IBM music software and 99.9% IBM business and application programs.

Desktop unit available

**Rackmount your current IBM or compatible computer with the CMS 19" conversion kit.**

**Call Toll Free 800/322-MIDI**



382 N. Lemon Ave., Walnut, CA 91789  
**714/594-5051**

Circle #144 on Reader Service Card



—CONTINUED FROM PAGE 193

special; Bugs Henderson, Bugs Henderson, live album project; The Vocal Majority, Jim Clancy, two live albums; Miss Texas USA Pageant, Guy/Rex Productions, network special; "Carman in Concert," WORD Records, WORD home video.

**[24+] MUSIC MEDIA PRODUCTIONS & RECORDING STUDIOS**  
8377 W. View  
Houston, TX 77055  
(713) 465-6563  
Owner: Yves Vincent  
Studio Manager: Yves Vincent

**[24+] NATIONAL RECORDING CO.**  
I-30 at Summerhill Rd.  
Texarkana, TX 75503  
(214) 793-4116  
Owner: V.E. Howard  
Studio Manager: Chuck Richardson



**OMEGA AUDIO AND PRODUCTIONS, INC.**  
Dallas, TX

**[24=] OMEGA AUDIO AND PRODUCTIONS, INC. also REMOTE RECORDING**  
8036 Aviation Pl.  
Dallas, TX 75235  
(214) 350-9066  
Owner: Paul A. Christensen, Charles R. Billings  
Studio Manager: Donna Christensen  
Engineers: David Buell, Philip Barrett  
Dimensions: Room 1: studio 35 x 40. Room 2: studio 12 x 15. Control room 22 x 20. Remote recording truck: 8 x 20.  
Mixing Consoles: Amek M2500 36 x 24, custom 24 x 24, API 2098 32 x 16 x 24.  
Audio Recorders: (3) Otari MTR-90 24-track, (3) Otari MTR-10 2- and 4-track w/CSTC, Mitsubishi X-80 digital recorder, Sony PCM-1630 w/DMR 4000 Digital Master Recorder, Harmonia Mundi Acoustica digital conversions interface (PCM-F1/501/701/1610/1630/X-80), Audio & Design Recording Pro PCM-701, Otari MX 5050B 2-track.  
Cassette Recorders/Duplicators: Eumig cassettes, Technics cassettes, Autogram stereo cart.  
Echo, Reverb, & Delay Systems: Lexicon 224X digital reverb w/LARC remote, Yamaha SPX90, LP140 reverb plate, Master-Room reverb, (2) EXR digital reverb, DeltaLab DL-2 digital delay, (4) DeltaLab 2048.  
Other Outboard Equipment: CMX CASS I audio editing system w/disk-based mixing console automation, Eventide H-949 Harmonizer w/DeGitch card, Scamp rack w/17

modules, Gotham TTM NR rack w/dbx K9-22 cards or Dolby K9-22 cards, UREI 565T Little Dipper, UREI digital metronome, RTS stereo phone preamp, Denon DP110 turntable, Aphex Compellor, Bercus-Berry Aural Exciter, Technics compact disc players.

**Microphones:** Varied selection of over 95 mics including: Neumann U87, U47, KM84; AKG C12A, 414, 451, D12E, CK8; Shure SM81, 57, 53, 58; Beyer M201; Sennheiser 441, 421; E-V RE20; Sony 22-P, ECM-50, ECM-21; Crown PZM.  
**Monitor Amplifiers:** (2) Crown PSA-2, (4) Crown D-150A, Crown D-40, (2) Yamaha 2200.

**Monitor Speakers:** JBL 4435 Bi-Radial, JBL 4430, JBL 4313, JBL 4311, Visonik David and Auratone

**Musical Instruments:** Baldwin 7' grand, full range of instruments available by special arrangement.

**Video Equipment:** Co-located and interlocked with Video Post & Transfer, state-of-the-art 1" CMX video editing and film transfer facility. Omega offers CMX 46-track interlock to picture for computerized audio editing and mixing to picture.

**Rates:** Studio: audio only 24-track \$110/hr., 48 track \$175/hr.; audio/video interlock 24-track \$135/hr., 48-track \$200/hr.; CD mastering: quoted per project; remote recording: \$2,400/day for 48-track plus expenses.

**Extras & Direction:** Five RIAA Certified Gold Records, two Grammy nominations, four Ampex Golden Reel Awards, three Dove Awards; partial credits: Talking Heads, Pnnc, Helen Reddy, Anne Murray, Al Jarreau, Spyro Gyra, Willie Nelson, The Oak Ridge Boys, Quarterflash, Hall & Oates, NBC-TV, CBS-TV, PBS-TV (WNET), New Edition, Ray Charles, Paul Shaffer, Roy Orbison, Molly Hatchett, Cameo, Joe Jackson, Rita Moreno, Amy Grant, Johnny Cash, Bob Hope.

**[24+] PANTHEON RECORDING STUDIOS**  
6325 N. Invergeon Rd.  
Scottsdale, AZ 85253  
(602) 948-5883  
Owner: Dennis Alexander  
Studio Manager: Tony Di Maria

**[24+] PEDERNALES RECORDING STUDIO**  
Rt. 1, Briarcliff 2  
Spicewood, TX 78669  
(512) 264-2064  
Owner: Willie Nelson  
Studio Manager: Larry Greenhill

**[24+] PLANET DALLAS STUDIOS**  
PO Box 215029  
Dallas, TX 75221  
(214) 521-2216  
Owner: Planet Dallas Inc.  
Studio Manager: Rick Rooney  
Engineers: Rick Rooney, freelance  
Dimensions: Studio 40 x 45, control room 20 x 15.  
Mixing Consoles: MCI JH-528 28 x 24 w/JH-50 automation.  
Audio Recorders: MCI JH-24 24-track, Sony/MCI JH-110C 2-track, Tascam 42 2-track.  
Cassette Recorders/Duplicators: (2) Tascam 122.  
Noise Reduction Equipment: dbx.  
Echo, Reverb, & Delay Systems: Master-Room XL305 reverb, (2) Lexicon PCM60 reverbs, (2) Yamaha REV7s, Yamaha SPX90 effects processor, DeltaLab DL-4 delay, Lexicon Prime Time delay, Lexicon 224X processor.  
Other Outboard Equipment: (2) Dynamite stereo compressor/limiters, (2) Orban 622B stereo parametric EQs, dbx 160X compressor/limiter, Dietz stereo parametric EQ, Brooke-Siren Dynamic processor.  
Microphones: Neumann 87s and 47s, (3) AKG 414, (2) AKG D-12E, (3) AKG 461, (2) Sennheiser 441, (8) Sennheiser 421, (8) Shure SM57, (2) E-V DS35, E-V RE20, (2) Beyer 500.  
Monitor Amplifiers: Yamaha Pro Series PC 2002.  
Monitor Speakers: (2) Lakeside custom monitors w/TAD components, (2) Yamaha NS-10s, (2) Auratone cubes, (2) Quadraflex 204L.  
Musical Instruments: Yamaha Recording Series 8-piece drum kit, Simmons SDS7 5-piece electronic drum kit, Yamaha BB300 bass guitar, Oberheim DMX drum machine, Gibson Les Paul custom 6-string guitar, Kramer Pacer Series 6-string guitar, Ensoniq Mirage, Casio CZ, Simmons EPB.  
Other: Sony CDP-110 compact disc player.  
Rates: \$65/hr., including engineer. Call for block rate.

**DO YOU HAVE EQUIPMENT TO SELL? MIX CLASSIFIEDS GET RESULTS! SEE PAGE 206.**



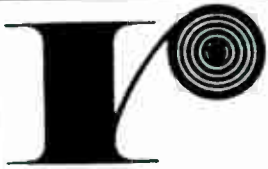

— SINCE 1939 —

WORK DIRECTLY WITH THE WEST'S LARGEST  
INDEPENDENT RECORD AND CASSETTE DUPLICATING  
FACILITY FOR MAJOR LABEL QUALITY AND SERVICE.

# RAINBO RECORDS & CASSETTES

1738 Berkeley Street, Santa Monica, CA 90404

## — LIMITED OFFER —

### \* RECORD PRICES

**\* 1000 12" FULL-COLOR PACKAGE \$1666<sup>00</sup>**

Lacquer mastering — 3-step metal plating — 8 test pressings — 2-color labels (including type) — full-color jackets — white sleeve — shrink wrap — test within 5 working days — completion 10-15 working days after test approval.

*Does not include composite negatives.*

**\* 1000 12" ONE-COLOR PACKAGE \$1444<sup>00</sup>**

Same as above package except One-Color Jacket. 10 to 15 working days.

*Does not include composite negatives.*

**\* 1000 7" 45's \$595<sup>00</sup>**

Lacquer mastering — 3-step metal plating — 8 test pressings — 2-color labels (including type) — white sleeve — completion 10 working days.

**\* 500 7" 45's \$475<sup>00</sup>**

As above

**CASSETTE PRICES \$888<sup>00</sup>**

**\* 1000 FULL-COLOR CASSETTES**

Cassette mastering test cassette — Apex printing direct on cassette — label plate — full-color inserts\* — 1000 additional inserts for reorder — Norelco box — cellophane wrapped

*Does not include composite negatives.*

### REORDER

**\$1222<sup>00</sup>**

FULL-COLOR  
PACKAGE AS ORIGINAL  
10-12 working days

**\$999<sup>00</sup>**

ONE-COLOR  
PACKAGE AS ORIGINAL  
10 working days

**\$333<sup>00</sup>**

As Original  
7-10 working days  
7" 45

**\$200<sup>00</sup>**

As Original  
7-10 working days  
7" 33½

**\$777<sup>00</sup>**

As Original  
7-10 working days  
\*1000 full-color inserts

### COMPACT DISC PACKAGING AVAILABLE

**Lacquer Mastering by: EMI America, Capitol Records, Inc.**

**Pressed with: KEYSOR 588 Translucent Select Quality Vinyl**

**Tape: BASF-LHD Audiophile Music Quality—State-of-the-Art Bin Loop—HX PRO**

**Pressing Credits:** Capitol Records for the Beatle Releases in the early 1960's, Enigma, Rhino, CBS, RSO, Casablanca, Twin Tone, Tommy Boy, SST, United Artists, Greenworld, Frontier, Pausa, Palo Alto, Celluloid, Metal Blade, Shrapnel, Warner Bros., Elektra, and many, many more including the recently completed MCA's Miami Vice.

**Special Projects:** Include Shaped Records, Picture Records, and other premium record products that must remain anonymous.

(Please mention "LIMITED OFFER" when ordering)

**(213) 829-3476 (213) 829-0355**

SMALLER QUANTITIES AVAILABLE



**POWERHOUSE RECORDING STUDIO**  
Las Vegas, NV

**[24+] POWERHOUSE RECORDING STUDIO**

3111 S. Valley View, Ste. K101  
Las Vegas, NV 89102  
(702) 871-6200

Owner: Paul Badia, Vanda Milligan

Studio Manager: Paul Badia

Engineers: Paul Badia

Dimensions: Studio 35 x 30, control room 21 x 30.

Mixing Consoles: AFI 24 x 16 x 24 monitor.

Audio Recorders: Stevens 821A 24- and 16-track, Scully 280 2-track, Ampex ATR-700 2-track, Studer Revox A77 2-track

Cassette Recorders/Duplicators: (2) Nakamichi MR1B Echo, Reverb, & Delay Systems: EMT 240 gold foil, Yamaha REV7, AKG BX-10, Korg SDD-2000 sampling delay, Lexicon M93 Prime Time, Roland SDE-3000

Other Outboard Equipment: (2) Spectra Sonics 610 comp/limiters, Eventide 910 Harmonizer, Eventide instant phaser, dbx 500 sub-harmonic generator, ADR scamp rack, (2) S01 compressor/limiters, S23 auto-panner, S06 noise gates, Dynamic noise fillers; Orban 516EC de-esser, Dyno-My Electronics Model 618 in-stereo chorus.

Microphones: (2) Neumann U87, (2) AKG 414 PB, (4)



Sennheiser 421, (2) Sennheiser 441, Neumann U47, (2) E-V RE20, (2) AKG 451, (2) Crown PZMs, E-V 635, lots of Shure SM57s and 58s.

Monitor Amplifiers: BGW 700, (3) Crown D-300.

Monitor Speakers: Fostex LS3B, Yamaha NS-10, Auratone. Musical Instruments: Yamaha Recording Series drum kit, Kawai 6'4" grand piano, Memorymoog synth, MS-20 synth, Yamaha DX7.

Other: Pacific Audio USO.

Rates: By request, blocks available.

Extras & Direction: Powerhouse is a young, aggressive studio dedicated to producing the finest possible product. Associated with some of Las Vegas' finest musicians, writers and producers. We specialize in very personal and individual service to our clients.

**[24+] PRECISION AUDIO, INC.**

11171 Harry Hines, Ste. 119  
Dallas, TX 75229  
(214) 243-2997

Owner: Precision Audio, Inc.

Studio Manager: Rick Sheppard

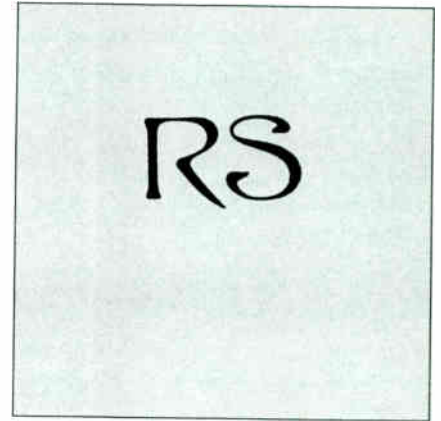

**RAMPART STUDIOS**  
Houston, TX

**[24+] RAMPART STUDIOS**

also **REMOTE RECORDING**

6105 Jessamine  
Houston, TX 77081  
(713) 772-6939

Owner: Steve Ames

Engineers: Steve Ames, Dan Yealey

Dimensions: Studio 40 x 24 (drum room, vocal booth, iso room), control room: 12 x 18.

Mixing Consoles: Soundcraft 1624 16 x 24 x 2 56-channel remix.

Audio Recorders: Soundcraft 24-track, 3M 2-track, Ampex 2-track.

Cassette Recorders/Duplicators: Revox PR99, Nakamichi cassette decks.

Echo, Reverb, & Delay Systems: Lexicon 200 digital reverb, EMT 140 plate, Lexicon PCM41, Lexicon 91, Lexicon PCM60, Korg SDD-2000

Other Outboard Equipment: Eventide Harmonizer, Aphex Aural Exciter, Aphex CX-1, UREI 1176 comp/limiter, UREI comp/limiters, Orban Para EQ, Orban de-esser, dbx and GT-4 noise gates, MXR flanger, Gold Line RTA, Dyna-Mite exp/comp, Crown SL 2 pre amp, Denon TT.

Microphones: Neumann: U67s, U87s, KM84s; AKG: 414s, 451s; Sennheiser: 421s, 441s; E-V RE20s, Beyers 201s, Sony 22Ps, RCA 77s.

Monitor Amplifiers: Crown, Yamaha NS-10Ms

Monitor Speakers: JBL 4430s, Auratone.

Musical Instruments: Kawai grand piano, DX7, TX7, Mirage sampler, LinnDrum, Oberheim OB-8 synth, Oberheim Prommer, Yamaha drums, Drumulator, Fender amps, LP congas, percussion, etc.

Other MIDI Equipment: Sonus software.

Video Equipment: Scoring, sweetening, etc.

Extras & Direction: Coffee bar, lounge area, etc. Rampart is a creative environment for both artists and producers, with an experienced professional staff. Specialists in record, jingle and demo projects. Clients include: ZZ Top, Night Ranger, The Judy's, Shake Russell Band, Kings X, XOJ, Ghetto Boys, Jefferson Ink, Tokyo, Columbia Records, Atlantic Records and many more.

**[24+] REAL TO REEL STUDIOS INC.**

2545 N. Fitzhugh  
Dallas, TX 75204  
(214) 827-7170

Owner: Real to Reel Studios Inc.

Studio Manager: Ron Morgan

**[24+] REELSOUND RECORDING CO.**

only **REMOTE RECORDING**

2304 Sheri Oaks Ln.  
Austin, TX 78748  
(512) 472-3325

Owner: Malcolm H. Harper, Jr.

Studio Manager: Deborah Harper

Engineers: Malcolm H. Harper, Jr., Mason Harlow

Dimensions: 45' tractor-trailer Sierra/Hidley design remote unit

Mixing Consoles: MCI 636LM 36 x 36 disk-based automation, Ampex MX110 4 x 2 tube mixer, API 8 x 8 pre-amps.

Audio Recorders: MCI JH-24 24-track, MCI JH-110B 2-track, PCM 2-track digital, Sony PCM-3324 24-track (on request).

Cassette Recorders/Duplicators: Nikko-2.

Noise Reduction Equipment: (8) Drawmer 201 gates

Synchronization Systems: Q-Lock 4.10.

Echo, Reverb, & Delay Systems: Ursa Major 8 x 32, AMS RMX116, DL-1, DL-2, Yamaha SPX90.

Other Outboard Equipment: (10) API 550A EQ, dbx 900 rack; (4) limiters, (2) DS, (2) parametrics; (2) Drawmer 1960 limiters, (4) UREI LA-3As; (4) Valley People Dyna-Mites, UREI Teletronix LA-2a, (2) API 525 limiters, (8) Drawmer 201

**THOROUGHBRED MUSIC HAS FREE DELIVERY.**

**RECORDERS**  
**MONITORS**  
**AMPS**  
**MICROPHONES**  
**SIGNAL PROCESSING**  
**TASCAM**  
**FOSTEX**  
**KURZWEIL**  
**E-MU**  
**ENSONIQ**  
**AKAI**  
**UREI**

20,000 Square Feet Of State-Of-The-Art Pro Audio Shipped Daily

**THOROUGHBRED MUSIC**

2204 E. Hillsborough Ave.  
Tampa, FL 33610  
(813) 237-5597

\* Mail orders only shipped in continental U.S. via U.P.S.

Circle #146 on Reader Service Card



gates, RTS intercom system.

**Microphones:** Beyer, E-V, AKG, Neumann, Shure, Countryman, Sennheiser.

**Monitor Amplifiers:** Crown, Akai.

**Monitor Speakers:** Westlake BBM-6, Auratone, JBL 4430, Radio Shack #9.

**Video Equipment:** Sony TV system and switcher, Panasonic camera and recorder.

**Other:** 600' mic snakes, Jensen 80-input transformer/splitter system and stage distribution.

**Rates:** Call.

**Extras & Direction:** Clients: Westwood One, DIR, Word Records, Savoy Records, Capitol Records, Epic, Warner Bros., PBS network, MTV, StarSong Records. Artists: Tears for Fears, AC/DC, Ted Nugent, Journey, ZZ Top, Triumph, The Gap Band, Patti LaBelle, Kool and The Gang, Franky Beverly and Maze, Willie Nelson, Lee Greenwood, Ricky Skaggs, Merle Haggard, Ray Charles, Amy Grant, Dave Perkins, Servant, Ric Cua, Enc Johnson, Jay Aaron, Petra. We offer complete and total dedication to the clients' needs, from live recording for records, radio, TV and film to album projects in those out-of-the-way places. With 17 years of experience we have the best to offer in remote services.

**[24+] RIVENDELL RECORDERS**

also REMOTE RECORDING

1195 W. Loop N., Ste. 110

Houston, TX 77055

(713) 686-3558

Owner: Rivendell Recorders Inc.

Studio Manager: Chuck Sugar

**[24+] RMS RECORDING STUDIOS**

4620 W. Blue Diamond Rd.

Las Vegas, NV 89118

(702) 361-1559

Owner: Lou & Joe Carto

Studio Manager: Lou Carto

**[24+] ROBIN HOOD STUDIOS**

also REMOTE RECORDING

PO Box 775

Tyler, TX 75710

(214) 592-7677

Owner: Robin Brans

Studio Manager: Robin Brans

**[24+] THE ROCK STUDIO**

430 Kansas

Norman, OK 73069

(405) 329-8431

Owner: David Moore

Studio Manager: David Moore

**[24+] ROSEWOOD SOUND**

4307 Merrell Rd.

Dallas, TX 75229

(214) 350-0905

Owner: Jimmy Kelley

Studio Manager: Lana Kelley

**[24+] THE SOUND FACTORY RECORDING STUDIOS**

1120 S. Highland

Tucson, AZ 85719

(602) 622-1265

Owner: Steve & Kimberly English

Studio Manager: Steve English

Engineers: Steve English, Taylor Smith, Bob Collins

Dimensions: Room 1: studio 34 x 16, control room 25 x 16.

Room 2: studio 12 x 12 and drum booth. Room 3: studio 10 x 10 and iso booth. Room 4: studio 18 x 20 control room 12 x 14.

**Mixing Consoles:** Wheatstone Audioarts 8X 24 x 24 w/27

LED metering, Amek/TAC Scorpion 16 x 16, Tascam M-5 20

x 20 w/expander, (8) Tascam M-1 8 x 8 mixers.

**Audio Recorders:** MCI JH-16 24-track, w/ALIII (transformer-

less), TEAC 85-16B 16-track w/autolocator, TEAC 38 8-

track, TEAC 34 4-track, TEAC 32 2-track, TEAC 3300 2-

track.

**Cassette Recorders/Duplicators:** (2) TEAC V-44, (20)

Technics.

**Noise Reduction Equipment:** dbx 16-track, w/85-16B,

Dolby A 2 channels.

**Synchronization Systems:** Passport Systems, various

SMFTE on request.

**Echo, Reverb, & Delay Systems:** Lexicon 200, Roland

SRV-2000, Yamaha SPX90, Alexis MIDIverb, Furman RV-1,

(4) Ibanez DM-1000, Yamaha E1010 delay, live chamber (30

x 10 x 4), DOD stereo delay.

**Other Outboard Equipment:** (4) UREI LA-4 compressor/

limiters, (4) Valley People Dyna-Mite, (2) Ibanez HD-1000

Harmonizer, DOD R-870 stereo flanger, MXR flanger/dou-

bler, Rane SM-26, (3) dbx 163, (4) Omni Craft gates, (4)

Tascam EQs, various 31-band EQs.

**Microphones:** Neumann U87, Sony C-37A, AKG 414EB.

AKG 451EB, Sennheiser 421, E-V RE20, Shure SM57, Sony

ECM-70, Beyer M500, Beyer M160, Audio-Technica 813.

**Monitor Amplifiers:** Crown, Q.S.C., Sony

**Monitor Speakers:** UREI 811B, JBL 4311, JBL 4301, Aural-

tones.

**Musical Instruments:** Roland S-50 sampler keyboard

w/edit monitor, (2) Yamaha DX7 w/DX Pro libraries and

editors, Yamaha DX21 w/libraries, Roland Juno 106, Roland

Juno 60, Korg Poly 800, Roland Octapad, Roland TR-707,

E-mu Drumulator w/chips, Yamaha CP70 piano, Fender/

Gibson guitars, all major drum machines on disks.

**Other MIDI Equipment:** Apple II+ computer w/modem

and printer, Passport Mastertracks and 8Plus sequenc-

er/edit programs, Polywriter, DX-Pro, DX Heaven,

Passport editors/libraries, sampling editors, effects li-

braries.

**Video Equipment:** Panasonic VHS camera, (2) RCA 1/2"

VHS recorders.

**Other:** All test and alignment equipment, computer disk

storage, "real time" cassette duplicating/editing studio.

**Rates:** On request

**[24+] SOUND LOGIC RECORDING**

1404 Forest Ln.

Garland, TX 75040

(214) 276-3986

Owner: W.A. Grugle, J. Grugle, T. Grugle, D. Brown

Studio Manager: Tim Grugle

**[24+] SOUND MASTERS RECORDING STUDIO**

9717 Jensen Dr.

Houston, TX 77093

(713) 695-3648

Owner: Jim Johnson

Studio Manager: A.V. Mittelstedt

**[24+] SR INC**

also REMOTE RECORDING

PO Box 18626

Austin, TX 78760

(512) 441-5322

Owner: R. Aarons

Studio Manager: M. Kron

**[24+] STUDIO CENTRE**

also REMOTE RECORDING

4131 Hockaday Dr.

Dallas, TX 75229

(214) 350-3434

Owner: VTS Music

Studio Manager: Les Studdard

**[24+] STUDIO D**

1700 S. Lamar, Ste. 112

Austin, TX 78704

(512) 441-4001

Owner: Audio Production Services, Inc.

Studio Manager: Dennis Davis, Patti D. Blodgett

**[24+] STUDIO SEVEN**

also REMOTE RECORDING

417 N. Virginia Ave.

Oklahoma City, OK 73106

(405) 236-0643

Studio Manager: John F. Rohloff

The third annual  
TEC Awards are  
slated for October  
in New York City.  
For reservations or  
information, call  
(415) 843-7901.

**Naturally we're MIDI.  
We have a reputation  
to live up to.**

You expect up-to-the-moment technology at L.D. Systems. In this industry, that means MIDI. So of course we have the gear. But as you'd expect, we went further than "MIDI-izing" our showroom. We brought on a MIDI expert. He knows computers, software, sampling, accessories, applications—anything MIDI. That's why we hired him.

**So we can maintain our reputation.**



467 West 38th Street, Houston, Texas 77018  
(713) 695-9400

We can be contacted electronically on IBM's Esi Street and the "PAN" network.

Professional Sound and Lighting Sales, Services, Rentals

A complete line of software for Atari, Commodore, IBM, Macintosh, Apple IIC, IIE and GS, by:

- Bacchus
- Club MIDI (Pro MIDI)
- Digi Designs (Sound Designer)
- Doctor T
- Hybrid Arts
- Mark of the Unicorn (Performer, Professional Composer)
- Magnetic Music (Texture)
- Jim Miller (Personal Composer)
- Octave Plateau (Sequencer Plus, Patch Master)
- Opcode
- Passport Designs
- Sonus

We have cables, patchers, mergers, blenders and a full line of MIDI peripherals by:

J.L. Cooper  
Garfield  
360 Systems



**STUDIO SOUTHWEST**  
Sunnyvale, TX

[24+] **STUDIO SOUTHWEST**  
2611 Beltline Rd.  
Sunnyvale, TX 75182  
(214) 226-1789

Owner: Jimmy Wallace, Matt Tapp, Richard Martinez  
Studio Manager: Jimmy Wallace, Janeen Slazyk  
Engineers: Mike McClain, Ion Early, Tom "Gordon" Gondolf, Matt Tapp

Dimensions: Studio 27 x 23. Isolation booth A: 10 x 11, booth B: 10 x 12, booth C: 7 x 6. Control room 25 x 17.  
Mixing Consoles: MCI 556 48 x 32 automated (spectra VU).

Audio Recorders: MCI JH-24 24-track, MCI JH-110B 2-track 1/4", MCI JH-110B 2-track 1/4", Studer A-820 2-track, Technics 1500 2-track.

Cassette Recorders/Duplicators: Tascam 122B cassette recorder.

Echo, Reverb, & Delay Systems: AMS reverb, Lexicon 200, Lexicon PCM70 reverbs, Audi-Ence 7 plate reverb, Lexicon PCM42 delay, (2) DeltaLab DL4 delays, Eventide H910 Harmonizer.

Other Outboard Equipment: (2) UREI LA-4 compressor/limiters, dbx 900 rack, dbx 160 compressor/limiter, (2) Valley People Dyna-Mite stereo limiters, UREI 535 graphic EQs, Aphex Aural Exciter, Dolby A 24 channels.

Microphones: Neumann, AKG, Sennheiser, Beyer, Shure, E-V, Crown PZM.

Monitor Amplifiers: (2) UREI 6500, UREI 6250, (3) Crown 300.

Monitor Speakers: UREI 813s, Yamaha NS-10s, Auratone T-6s, Auratone cubes.

Musical Instruments: Yamaha conservatory 7 grand piano, Yamaha CP70 and CP80 electric grand pianos, Fender Rhodes piano, Hammond B-3 organ w/ Leslie, Prophet-5, Prophet 600, Yamaha DX7, Yamaha TX816 rack, LinnDrum, Ludwig (wood) drum kit, Simmons drum kit, Marshall 50- and 100-watt amps, Fender Twin reverb, Latin Percussion congas, full percussion kit and Seymour Duncan amps.

Video Equipment: (2) Sony 3/4" video machines, Sony monitors, custom audio-to-video dubs (24-hour turn-around in most cases).

Rates: Available upon request. Exceptional block rates.

Extras & Direction: In-house production: JP Productions—commercial, syndicated TV, radio, and album production; Southwest Music Company, Inc.—music production and publishing; M.G. Audio—voiceover and commercial production; Sound Southwest—rental, design and installation and retail sales facility. Recent album products include: David Byrne's *True Stories* soundtrack, Johnny Nash, Grammy nominee Douglas Miller and Leslie Phillips, Texas Blues Compilation LP with Willie Nelson, Jimmy Vaughn, Johnny Winter, Van Wilkes and Bugs Henderson and Seymour Duncan. Nationally syndicated programs: *Dallas Cowboys Weekly*, *NBA Weekly*, *Celebrity Motor Sports*, *Today in Music History*, and Gabriel Award winner, *Gospel America*. Custom radio packages for: KLTJ and KPBC, Dallas; WYCA, Chicago; WDCN, New York; WMUZ, Detroit; WCTN, Washington D.C. and KBRT Los Angeles.

[24+] **STUDIO STUDIO**  
4801 Spring Valley, #105B  
Dallas, TX 75244  
(214) 386-6847

Owner: The Otis Conner Co's  
Studio Manager: Tony Griffin

[24+] **STUDIO WEST**  
4010-1 Hwy. 6 S., Ste. 457  
Houston, TX 77082  
(713) 530-7298



**STUDIO WEST**  
Houston, TX

Owner: Tom Pena, Steve Headley, Mike Teague, J.R. Kuzniar  
Studio Manager: J.R. Kuzniar

Engineers: J.R. Kuzniar  
Dimensions: Large room 22 x 16 x 11, drum booth 11 x 10 x 8, vocal booth 10 x 7 x 8, control room 20 x 12 x 8.

Mixing Consoles: Soundcraft 2400 w/bargraph metering and spectrum analyzer 28 x 24 52-input in mixdown, Carver.

Audio Recorders: Otari MTR-9CII 24-track (w/autolocator), Otari MTR-12 1/2-track (w/autolocator), Tascam 32 1/2- and 2-track, TEAC A-3440 4-track

Cassette Recorders/Duplicators: TEAC U-850 2-track stereo cassette deck, TEAC V-4RX stereo cassette deck.

Echo, Reverb, & Delay Systems: Lexicon 200, Yamaha REV7 and Lexicon PCM60 digital reverbs, Korg SDD-3000, Effectron II, ADM 1024, Roland SDE 3000 digital delays.

Other Outboard Equipment: dbx 180A Type I noise reduction system on multi-track and 1/2-tracks, Aphex Aural Exciter, Orban 536A de-esser, (2) dbx 160X compressor/limiters, Ashly SC-55 stereo peak limiter/compressor, Fush IIC noise reduction system, eight channels of GateX noise gate, Roland Dimension "D", Yamaha 31-band graphic EQ (2 channels), Rane cue amps.

Microphones: (10) Sennheiser MD421s, AKG 414s, AKG C452 EBs, E-V PL76As, Shure SM57s, Shure SM58s.

Monitor Amplifiers: Crown PSA-2, HMA-6500, Carver.

Monitor Speakers: JBL 4430s, Minimus 7s, Yamaha NS-10s.

Musical Instruments: Emulator II, Roland Juno-106, ARP Odyssey. Synthesizers: 360 System's MIDI bass, Oberheim DMX drum machine w/extra cards (including custom Linn kick card), Tama complete drum kit, Fender "Elite" Stratocaster, Gibson Les Paul guitars, Gibson acoustic, Höfner and Rickenbacker basses, Fender acoustic, Marshall amps, complete percussion section, including Roto-toms, bell trees, triangles, etc., Scholz Rockman and Bass Rockman, Simmons SDS9 drums.

Rates: Please call.

Extras & Direction: Located in West Houston, Studio West has complete live-in accommodations, including cable TV and full kitchen facilities. Studio musicians, jingle writers and record publishing are also available.

[24+] **SUGAR HILL STUDIOS**  
also **REMOTE RECORDING**  
5626 Brock St.  
Houston, TX 77023  
(713) 926-4431

Owner: Modern Music Ventures  
Studio Manager: David Thompson

[24+] **SUMET-BERNET SOUND STUDIOS**  
7027 Twin Hills Ave.  
Dallas, TX 75231  
(214) 691-0001  
Owner: Ed Bernet  
Studio Manager: Mike Pletzsch

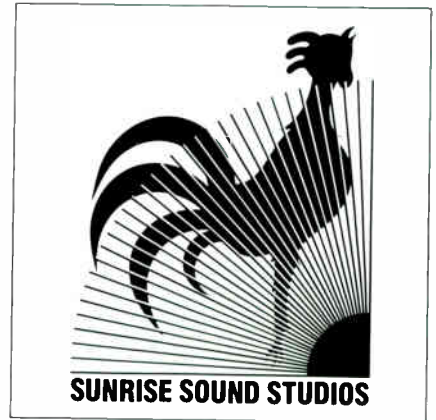

**SUNRISE SOUND STUDIO**  
Houston, TX

[24+] **SUNRISE SOUND STUDIO**  
3330 Walnut Bend  
Houston, TX 77042  
(713) 977-9165

Owner: Chip Stanberry, Les Williams, David Goldstein, Alan Taylor

Studio Manager: David Goldstein  
Engineers: Les Williams, Randy Miller

Dimensions: Studio 29 x 32 x 12, control room 17 x 22 x 10.

Mixing Consoles: Sony MXP-3036 36 x 24.

Audio Recorders: Otari MTR-90 24-track, Otari MTR-10 2-track, Studer/Revox A-700 2-track, MCI JH-110 2-track, Pioneer RTU-11 4-track, Tascam 234 4-track.

Cassette Recorders/Duplicators: Nakamichi 480.

Echo, Reverb, & Delay Systems: Lexicon 224 digital reverb, Lexicon 200 reverb, AMS RMX 16 reverb, Eventide 2016 reverb and delay, Lexicon PCM42 delays, (2) DeltaLab DL-2 delay/acoustic computer, AMS RMX 16, Lexicon PCM70.

Other Outboard Equipment: Orban de-esser, Aphex Aural Exciter, (2) dbx 165 compressor/limiter, (2) dbx 160X, dbx 166, Roland Dimension "D" 24-track, dbx noise reduction/gates, computerized sequencing and programming w/Commodore, Macintosh and IBM hardware, MSQ 700 sequencer, automated console, (2) dbx 263X, Dynacord CLS222, (8) noise gates, Roland Dimension "D".

Microphones: (2) Neumann U87, AKG (2) C414 EB, C-451, C-452; Sennheiser: 421, (2) 441; E-V: PL20, PL77, PL91; (2) Crown PZM; Shure: SM57, SM58; RCA B77

Monitor Amplifiers: (2) Haller 500, QSC 1080, Crown D75.

Monitor Speakers: JBL 4430, (2) Yamaha NS-10, Auratone, Yamaha NS-25, Fostex RM780.

Musical Instruments: Yamaha C-7B 74" grand piano, Kurzweil 250 w/sampling, complete voice library and Macintosh interface, Prophet-5, Oberheim DMX, Tama drum set, Yamaha DX7s, Roland Jupiter 6, PPG Wave 2.2, 360 Systems MIDI bass, Fender Rhodes, Oberheim Matrix 12, Oberheim Xpander, Prophet 2000, Prophet VS, Minimoog, DMX drum machine (MIDI).

Other MIDI Equipment: Roland MSQ-700, Roland SBX-80, Mark of the Unicorn Performer/Composer software, Syntech Studio 1 software, 360 Systems MIDIbass, Macintosh 512 computer, Commodore 64 computer, ITT extra computer.

Video Equipment: SMPTE-based automated and time code generation.

Rates: Upon request.

Extras & Direction: Kitchen/lounge area, shower, convenient Southwest location, complete production, arranging and copywriting services in-house, award-winning jingle production. Our newly remodeled and re-equipped studio reflects our renewed commitment to bring state-of-the-art recording to Houston at a reasonable rate. Everything you need is already here, at no extra cost. Building on our extensive experience in album, jingle and demo production, we hope to provide first-quality service and product to our friends in Houston while attracting new artists and producers from around the country. Most recent clients include: Jean Michel Jarre, Kirk Whaldron, Bob James, CBS Records, Olympic Sports Festival, Eric Tagg and La Mafia.



—FROM PAGE 73, AES

and synthesis, plus live performance by Bruce Pennycook on saxophone. The second half of the concert was highly dramatic, starting with excerpts from Carlos' "Beauty in the Beast" CD. These pieces were enthusiastically received by the audience and proved quite thought-provoking, largely due to the tunings, which sounded foreign at first. The musical importance of such aural challenges cannot be overstated.

The last piece of the concert was a performance by Michael Waisvisz using his controller, the Hands, and a battery of Yamaha FM synthesizers. This piece was almost as theatrical as it was musical. Don't miss the chance to see Waisvisz if he comes to your town.

Saturday morning began with a session on computer networks for computers, aka MIDI. Session chair Chris Yavelow unleashed Craig Anderton with a tutorial on MIDI for those unfamiliar with its basic structure, followed by Jim (J.L.) Cooper's explanation of MIDI time code, a recent enhancement to the MIDI specification. Perry Leopold concluded the session by discussing the effect that telecommunications via personal computers has on music. Using the PAN network, which he operates, as an example, Leopold showed many benefits of such a link: data transfer (sequences, sound files, synthesizer patches), interaction between manufacturers and users, communications between developers, forums for general discussion of issues, and so forth.

Bruce Pennycook chaired the late morning session on music software for personal computers. Kimball Stickney of Notation Research took a look at the numerous and difficult issues surrounding the production of high-quality music notation. Stickney proposed a system of classifying types of objects as iconic or algorithmic, and information domains as physical (such as MIDI data), logical (such as notation) or graphical (such as page formatting and the like) to allow the complex problems of notation to be grasped. Digi-Design's Evan Brooks pointed out the necessity of integrating the components of a modern electronic production facility into a functioning whole. Specifically, assorted MIDI tools and SMPTE time code have come into common use and must be made to work together with each other and for the artist and engineer. The last paper of the session was more of a demonstration than a paper. This was Adrian Freed's presentation of MacMix, a Macintosh program providing a front end for a hardware digital audio system (the example used being Integrated Media Sytem's Dyaxis) to make it into a workstation environment.

The first afternoon session dealt with controller systems, starting with Waisvisz' explanation of The Hands. Using a complement of buttons on each hand controller combined with mercury switches to detect orientation and sonar to detect proximity, The Hands provides intimate control of a large synthesis system. Pat Downes of Palm-tree Instruments gave a somewhat technical explanation of issues in motion sensing, using his Airdrums con-

---

## **IRCAM's David Wessel showed MIDI-LISP, an adaptation of LISP dialect to allow intelligent, real time control of MIDI systems.**

---

trollers as an example. Although the Airdrums have not yet sold many units, they are having a significant impact on the music industry's ideas of usable controllers. Finally, Robert Moog discussed three advanced keyboard systems: the Kurzweil MIDIBoard, Key Concepts Notebender and another keyboard which he declined to name specifically. All of these keyboards offer more control than the standard velocity-sensitive synthesizer keyboard, with one (on the MIDIBoard), two (on the Notebender) or three (on the mystery keyboard) continuous parameters controllable per key.

The day's final session dealt with musical applications of advanced computer techniques. IRCAM's David Wessel, chair of the previous session, showed MIDI-LISP, an adaptation of a LISP dialect to allow intelligent real time control of MIDI systems. Applications ranged from interactive composition to virtual front panel control systems. Brian Schmidt's paper dealt with his work at Northwestern University on the creation of a natural language interface (in plain English that means a system that accepts commands in plain English) for a music system. At this point the system requires typed input, but Schmidt projected voice recognition as a logical next step. Fin-

ishing the day on a lively note, Bill Buxton gave his usual forceful presentation in proposing a Local Area Network scheme that would be placed between a personal computer and a MIDI system to circumvent some of MIDI's limitations. Discussion following Buxton's paper brought out the idea that his scheme may prove to be the most practical step in evolving from MIDI to a less limited interface with the least amount of pain and obsolescence.

Saturday evening was filled with a banquet highlighted by John Chowning's entertaining and enlightening revelation of the methodology by which digital music technology has historically evolved: one part science, one part creative intuition, one part serendipity.

By Sunday morning, the attendees were nearly saturated by the 24 papers, two receptions, one concert and one banquet that had occurred. Nonetheless, it was difficult to not be excited by the subject of the last session: Music and the CD-I. Readers of *Mix* are probably already aware of the incredible possibilities presented by this truly new medium, but the conference provided a more graphic demonstration of some of them. University of Miami's Ken Pohlmann, also the technical editor of *Mix*, zipped through a technical explanation of the CD-I; no mean feat in a half-hour's time. Larry Lowe of American Interactive Media pointed out that CD-I is more than the sum of its parts, audio and visuals, and pressed for the industry to devise entirely new concepts to fully exploit CD-I's potential. Finally, Stan Cornyn of the Record Group rendered his thoughts on CD-I's potential impact on the record industry. Cornyn's thoughtful insights and strong opinions provided a strong conclusion to the conference.

Conferences like this present both the organizers and the participants with the dichotomy of brevity in presentation versus depth of material; if you've only got 25 minutes it's pretty hard to explain a wholly new technology. It is also impossible to summarize the state of an exploding area of technology in two-and-a-half days, but the Fifth AES conference certainly gave an impressive overview and provided a valuable opportunity for interested members of the industry to meet and discuss issues and developments. Overall, it was one of the best executed conferences of its type that this writer has attended. ■

---

*Larry the O is a musician, sound engineer, consultant and writer. His company, Toys In the Attic, is based in San Francisco, where he is also currently affiliated with Russian Hill Recording.*

*Dallas' Mall for Musicians*

**STUDIO**

**SOUTHWEST**

DALLAS' PREMIER 24 TRACK  
CREATIVE ENVIRONMENT

(214) 226-1789



**SOUND**

**SOUTHWEST**

*Dallas' Most Competitive Prices on  
Rental, Sales, Design, & Installation  
of Quality Sound Systems  
Pro Audio Equipment Sales  
Large Selection of New & Vintage  
Guitars & Amps*

**ALL UNDER ONE ROOF**

2611 N. Beltline Rd., Suite 113,  
Sunnyvale, Texas  
75182

(214) 226-3069

Circle #148 on Reader Service Card

**ATTENTION**

**Studios  
Sound Companies**

**FILAMENT PRO AUDIO** is  
your connection for the best  
deal on audio equipment

**200 LINES OF THE BEST**

- Amps • Mixers
- Speakers • Recorders
- Processors • Mics
- Wireless • Cases
- Lighting

**Everything you  
need for PA and  
recording**

**FILAMENT PRO AUDIO**

143 E. Arrow Highway  
San Dimas, CA 91773  
714-592-2848  
Visa, MC, Amex

Circle #149 on Reader Service Card

**SOUTHWEST  
STUDIOS**



**24+ TRACK**

[24+] **TELE-IMAGE, INC.**  
6305 N. O'Connor LB 6, Ste. 103  
Irving, TX 75039  
(214) 869-0060  
Owner: Bob Schiff  
Studio Manager: Diane Barnard  
Engineers: Gary French, Gerry Crivello, Oliert Kempff,  
Don Clark  
Dimensions: Studio 28 x 35, control room 25 x 27.  
Mixing Consoles: SSL 4000E 34 x 32.  
Audio Recorders: Studer A800 24-track, (2) Studer A800  
8-track, (3) Studer A810 2-Center Timecode, Studer A820  
2-Center Timecode.  
Cassette Recorders/Duplicators: Nakamichi MR1.  
Noise Reduction Equipment: Dolby SP (24), (14) dbx 411  
modules, (5) Dolby 361.  
Synchronization Systems: (6) Lynx TimeLine, (3) Cipher  
Digital/BTX Shadow, Cipher Digital/BTX Softouch control-  
ler, Alpha "Boss" controller.  
Echo, Reverb, & Delay Systems: (2) Lexicon 224XL, Lexi-  
con PCM60, (2) Lexicon 97 MEO, DeltaLab CE1700.  
Other Outboard Equipment: (6) dbx 902 de-esser, (2) dbx  
903 compressors, (2) dbx 904 noise gates, (3) dbx 905  
parametric EQ, (2) Aphex 9001 Exciter, Dolby Cat.43, (3)  
UREI 565 DipFilter, (2) UREI 535 graphic EQ, (2) Studio  
Technology AN-2 stereo simulator.  
Microphones: (2) Neumann U87, (4) AKG C414-EBP-48,  
(4) AKG C460-CKI, (6) Beyers M-201, (2) Sennheiser 416, (2)  
Crown PZ-6LPG, (4) Crown P2M-65, (2) Sennheiser ME-  
88/ME-80/ME-40, (2) Beyers M88, (2) Tram TR-50.  
Monitor Amplifiers: (9) Crown Micro-Tech 1000, Crown  
DC 300A, (2) Crown 150, (2) Crown D75, (2) Crown D60.  
Monitor Speakers: SOTA (Claude Fortier), Time-Align  
MDM-TA3, Westlake BBSM-6, JBL 4425, Auratone 5C.  
Other MIDI Equipment: Studer A725 CD player, (2) Dyna-  
max CTR100 broadcast cart, Foley SFX setups, Magna-Tech  
600 16/35mm mag dubber, 1/4 track.  
Video Equipment: Video Tape Recorders: (10) Sony BVH  
2000/2500, (7) Sony BVU-800/820, (2) Sony BVW-10/40;  
Switchers/Editors: GVG 300, 1680 and 100 switchers, GVG  
51, 41 (2) editors; Video cameras: (2) Ikegami 357A, (2)  
Ikegami HL79EAL, (2) Sony CCD DXC-3000; Video Effects  
Devices: (2) Ampex ADO w/Infinity, Abekas A-53D, Abekas  
A-42 still store, Abekas A-62 digital disc recorder, Sony BVX  
30 digital noise reduction; Additional Equipment: Chyron  
RGU 2, 4 channels.  
Rates: \$160/hr. with Ptx., \$130/hr. without Ptx., \$80/hr.  
voice.

[24+] **TEXAS RECORDING CENTER**  
also REMOTE RECORDING  
829 N. Sylvania  
Ft. Worth, TX 76111  
(817) 838-0036  
(817) 838-0722 after 8 p.m.  
Owner: Charlie Taylor  
Studio Manager: David Mitchell  
Engineers: David Mitchell, Larry Goodnight, Shirley Good-  
night, Wanda Taylor  
Dimensions: Room 1: studio 24 x 30, control room 12 x 18.  
Room 2: studio 24 x 30, control room 12 x 18. Room 3: studio  
5 x 7.  
Mixing Consoles: Neve/Tangent custom 24 x 24 (studio  
A), ElectroDyne custom 16 x 16 (studio B), Neumann custom  
4 x 2 (disc room).  
Audio Recorders: Ampex MM1200 24-track w/perk cards,  
Ampex MM1200 16-track w/perk cards, Scully 280 8-  
track, Scully 280 4- and 2-track, Ampex reel copier w/3  
slaves, 2 tracks each studio, (2) Ampex AG440 2- and  
4-track.  
Cassette Recorders/Duplicators: Nakamichi 1000 cas-  
sette, Nakamichi 600 cassette, Sanyo duplicator.  
Noise Reduction Equipment: (4) Dolby 361 w/K cards.  
Synchronization Systems: Yamaha DX7 w/over 200 card  
of instruments, (2) Oberheim drums, bass, ARP string en-  
semble.  
Echo, Reverb, & Delay Systems: EMT plate stereo, MICMIX  
Master-Room XL500 stereo, Orban 111B stereo, AKG BX10

stereo, Eventide 949 Harmonizer, Eventide 1747 digital de-  
lay, Cooper time cube, UREI Little Dipper filter set, Audioarts  
parametric EQ stereo, Ibanez AD230 delay/flanger.  
Other Outboard Equipment: (6) UREI 1176 limiters LN, (2)  
UREI 339 1/3-octave EQ Room EQ, UREI dual ten-band  
graphic EQ, Micmix stereo exciter, DeltaLab Effectron dou-  
ble effects flanger, (2) Teletronix LA2 limiter (line amps)  
(tube), (4) Valley People Kepex limiters, (8) 4-VP. Kepex  
noise gates, (4) Mayer noise gates, Orban 516 EC-3-channel  
sibilance control, (2) Vocal Stressors.  
Microphones: Telefunken tube 447, Neumann 467 tube,  
(6) Neumann U87 Fet, Neumann KM86, (3) Sennheiser  
421, Sennheiser 441, RCA 77DX, (2) Sony M50, (3) Beyers  
160, 260, 500; (11) Shure: (4) SM57, (4) SM58, (2) SM59,  
SM7; (8) AKG: (4) D-200, (2) E-V RE20.  
Monitor Amplifiers: (3) Crown D-300, Crown D-150, (2)  
McIntosh 240, McIntosh 250.  
Monitor Speakers: (2) Altec (Big Reds) w/Masterlab cross-  
overs, (2) Altec 9845A studio monitors, (4) Auratone 5C  
cube monitors, (2) JBL 4430 monitor Bi-Radial.  
Musical Instruments: Baldwin 9' grand piano, Steinway 7'  
grand piano, Biddle upright tack piano, Rhodes electric  
piano, Sonor drums w/percussion syndrums, Zildjian cym-  
bals, Fender precision bass, (10) rhythm and electric guitars,  
(8) a variety of pro amps, instruments at no extra charge,  
Hammond B-3 w/Leslie, Century musser vibes.  
Other: Fully equipped remote truck available for audio or  
film service.  
Rates: On request.

[24+] **UNITED AUDIO RECORDING STUDIOS**  
8535 Fairhaven  
San Antonio, TX 78229  
(512) 690-8888  
Owner: Robert H. Bruce  
Studio Manager: Laura A. Calderon

[24+] **UNIVERSAL MUSIC & POST, INC.**  
also REMOTE RECORDING  
5840 S. Memorial, # 210  
Tulsa, OK 74145  
(918) 622-6444  
Owner: Rod Slane  
Studio Manager: Bruce Randall

[24+] **UNIVERSITY OF NEVADA,  
LAS VEGAS RECORDING STUDIO**  
also REMOTE RECORDING  
4505 S. Maryland Pkwy.  
Las Vegas, NV 89154  
(702) 739-0819  
Owner: UNLV  
Studio Manager: Curt Miller

[24+] **UNIVERSITY OF TEXAS  
AT AUSTIN COFA MEDIA SERVICES**  
also REMOTE RECORDING  
PO Box 7818, E. Campus Dr.  
Austin, TX 78713  
(512) 471-6223  
Owner: State of Texas  
Studio Manager: Bobby Roberts

[24+] **VALE RECORDING, INC.**  
also REMOTE RECORDING  
1478 E. Reno Ave.  
Las Vegas, NV 89119  
(702) 736-6496  
Owner: The Vale Organization, Inc.  
Studio Manager: Robert Vale

[24+] **VERSATRONICS GROUP**  
1118 S. 41 St.  
Tempe, TX 76501  
(817) 773-4000  
Owner: Lester G. Boutwell  
Studio Manager: Larry Brown

[24+] **VINTAGE RECORDERS**  
4831 N. 11 St., Ste. D  
PO Box 17010  
Phoenix, AZ 85011  
(602) 241-0667  
Owner: Billy Moss  
Studio Manager: Merel Bregante  
Engineers: Paula F.T. Wolak, Steve Counter, Billy Moss.  
Dimensions: Room 1: studio 30 x 22, control room 18 x 21.  
Room 2: studio 15 x 18, control room 18 x 26. Room 3: studio  
6 x 10, control room 12 x 14.  
Mixing Consoles: Trident "B" range (The Davlen Trident)  
28 x 24, Tascam Model 15 24 x 16, Studer 189-080 20 x 8.  
Audio Recorders: Studer A-80 MKII 24- and 16-track  
w/close punch heads, Tascam 85-16 16-track 1" w/dbx  
and autolocate, Tascam 80-8 8-track, Ampex ATR100 2-



# MIX WORDS

track 1/2", 2-track 1/4", 4-track 1/2", Sony PCM-701es digital, 3/4" U-matic also Beta.

**Cassette Recorders/Duplicators:** Revox B-215, TEAC 122, TEAC C-1.

**Noise Reduction Equipment:** dbx 16 in studio 2.

**Echo, Reverb, & Delay Systems:** Yamaha REV1, Yamaha REV7, Lexicon 200, Lexicon PCM70, EMT 140 plate (tube/stereo), (2) Micro-verbs, Lexicon Prime Time, Eventide 949 Harmonizer, (2) Eventide 910 Harmonizers, UREI cooper time cube.

**Other Outboard Equipment:** (2) ITI ME-230 parametric stereo (Massenberg), (2) Aengus graphic, (2) Pultec EQP-1, (2) Pultec EQH-2, (2) Teletronix LA-2A, (4) dbx 165 over easy, (6) Dyna-Mites stereo, Drawmer noise gate stereo, UREI 545 parametric, (4) Aphex CX-1 compressor/expanders, (2) API 525 compressors, Klien-Hummel UE 100 tube EQ, (7) Roger Mayer noise gates, (2) Studer compressors stereo, (2) dbx 160 compressors.

**Microphones:** Neumann: (4) M49b, (2) U47 tube and FET, (2) U67, (4) U87 and U89, (6) KM64; (6) RCA: 77DX, 44BX, 77A; AKG: (3) C-12, (2) 414eb, (4) 452/451; Sennheiser: (8) 421s and 441s, (4) Sony 37A.

**Monitor Amplifiers:** UREI 6500, Klark-Teknik DN-27, BGW 750C, Crown EQ-2, Belles Research "A".

**Monitor Speakers:** John Meyer "833" w/Augsburger curve, Yamaha NS-10M, UREI 813 w/Altec 604s, Westlake BBSM-6.

**Musical Instruments:** Yamaha C7 7'4" grand piano (ivory keys), Hammond B-3 w/Leslie 122rv, Roland Jupiter-8 synth., E-mu SP-12 drum machine, Simmons SDS5 drums, Gretsch large drum set, Fender '55 Stratocaster, (5) Fender Pre-CBS Precision Basses, Rickenbacker '64 12-string, Marshall 1/2-stack 100-watt, Ludwig copper tympani, Fender '64 Esquire, Fender tweed champ.

**Video Equipment:** Sony VO-2600 3/4" U-matic, Sony Beta.

**Extras & Direction:** Stevie Nicks, Mick Fleetwood, Richard Dashut, Christine McVie, Billy Burnett, George Hawkins, Glen Campbell, Crusaders, Wilton Felder, Tom Kendzia, Peter McLean, Dear Enemy, Alice Cooper, Lindsey Buckingham, Steve Smith, Jimmy Iovine, Tubes, Tim Manion, Goose Creek Symphony, Huey Lewis, *Entertainment Tonight*, *Friday Night Videos*, Making It Big, Joe Jackson Prod., Rocket 88s, Norbert Putman, Shayla, Kim Robertson, Peter Kater, The Monkees (Davy Jones), Cliff Sarde.

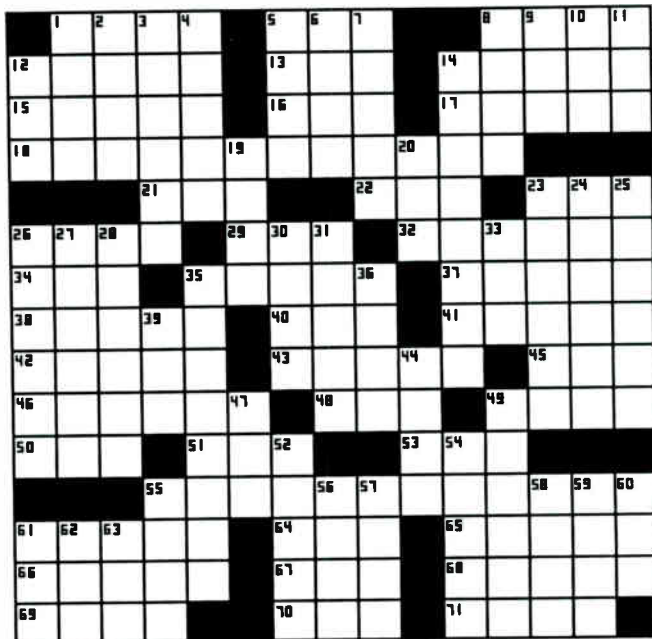

©1987 Armand E. St. Martin

## MY STORMY VALENTINE

### ACROSS

1. Girl's name
5. Aware
8. Casino game
12. More arctic
13. Forty thieves leader
14. His emblem is 35D
15. Half a Crescent City celebration
16. \_\_\_ de France
17. Alpha to \_\_\_
18. Isobar area and mic
21. Eternity, to poets
22. California fort
23. Metric measure
26. European pop band
29. Small amount
32. Reliable
34. Tumeric
35. Brings back
37. Ruth's mother-in-law
38. Dragonflower
40. "Norma \_\_\_"
41. French governing body
42. Sheik type
43. Pool problem
45. King Sunny \_\_\_
46. Put down
48. Abbr. after a name
49. Ran
50. Redactors, for short
51. Seeing spots
53. Home of baseball
55. Weather and mics have this
61. Isle of \_\_\_
64. \_\_\_ favor
65. Heart chambers
66. Hair style
67. Ike's command
68. European \_\_\_
69. Joined the chorus
70. Chop
71. Buffer

### DOWN

1. Rocky outcropping
2. English river

3. Something once parted
4. Get up
5. Musical ala 60's
6. French fashion mag.
7. \_\_\_-electric
8. Stew
9. Pongid
10. Gear
11. Harem room
12. Elf
14. What clouds and some mics do
19. Pakistani language
20. Scrap
23. Musically vague
24. Covered an oldie
25. Blue penciled
26. Video \_\_\_
27. Smiled and used a COMSAT
28. Farm implements
30. Tapestry
31. Memphis blues street
33. Not metric
35. Like some greeting cards and 55A's
36. Pieces of TV shows
39. Island garland
44. Sea shade
47. Building addition
49. Of wits and Titans
52. Lavalier location
54. \_\_\_ paper
55. Fussy one
56. Sunday section
57. Support
58. Emerald Isle
59. Outer skin
60. Horse
61. Media giant
62. Parseghian
63. Stereo positioning

[24+] JOHN WAGNER RECORDING STUDIOS, INC.  
12000 Candelaria NE, Ste. 1  
Albuquerque, NM 87112  
(505) 296-2766

Owner: John Wagner, Laura Zachery  
Studio Manager: John Wagner

**Extras & Direction:** John Wagner Recording Studios is the only full service 24-track recording studio in New Mexico capable of SMPTE interlocked audio post-production for video. We recently installed the Adams-Smith SMPTE synchronizing system with compact computer controller. Our 23 years' experience in all aspects of audio recording along with our fully equipped 24-track studio have enabled us to produce product for the following major record labels: RCA, Capitol, MCA, Motown, CMH; create numerous award-winning jingle campaigns; record two Grammy-nominated albums, and be the only studio in New Mexico with the audio/video interlocked capabilities necessary for sophisticated audio post-production. Recent post-production clients have included Sunn Classic Pictures, *Miss USA Pageant*, Wilson Learning Center IT Group, L.A. Law, Chevron.

[24+] WESTWOOD RECORDING STUDIOS  
also REMOTE RECORDING  
964 W. Grant Rd.  
Tucson, AZ 85705  
(602) 622-8012

Owner: Fred Porter, Roger King  
Studio Manager: Linda Porter

The new Summer 1987 Mix Bookshelf, with the latest and the best audio, video and music industry texts from over 40 publishers, is now available. For your free copy, call (800) 233-9604 or (800) 641-3349 (in CA).

## Solution to June Mix Words





Custom pressing, tape duplication and packaging.

1,000

7"-45<sup>s</sup>

including mastering, metal parts and processing, white sleeves, labels, pressing.

12" Albums with jackets

including mastering, metal parts and processing, poly dust sleeves, labels, pressing and printing of full colour ultra high gloss board jackets from customer supplied process film.

\$439.00

\$1,390.00

(F.O.B. DETROIT)

- 2 - 3 WEEK SERVICE
- VIRGIN VINYL
- HIGH GLOSS BOARD JACKETS
- Cr<sub>2</sub> CASSETTES
- CUSTOM 7" SLEEVES
- INHOUSE ART & TYPESETTING

Call Toll Free Continental U.S.A.

1-800-263-7798

Canada's Largest Custom Producers



WORLD RECORDS

BASELINE ROAD WEST, BOWMANVILLE, ONTARIO L1C 3Z3

Circle #150 on Reader Service Card



REMOVES VOCALS FROM RECORDS!

Our VOCAL ELIMINATOR can remove most or virtually all of a lead vocal from a standard stereo record and leave most of the background untouched! Record with your voice or perform live with the backgrounds. Used in Professional Performance yet connects easily to a home component stereo system. Not an equalizer! We can prove it works over the phone. Write or call for a free brochure and demo record.

Listen..



Before You Buy!

- Time Delay
- Reverberation
- Crossovers
- Noise Reduction
- Compressor/Limiters
- Expanders
- Spectrum Analyzers
- Parametric EQ

Don't have regrets about paying too much for a lesser product. In demos and comparisons, we'll show you why we're Better! Our Factory Direct sales allow us to produce a Superior product and offer it to you at a Lower price. Call or write for a free full length Demo Album and 24 page brochure.

LT Sound, Dept. MX-9, 7980 LT Parkway Lithonia, GA 30058 (404) 482-4724 24 HOUR PHONE DEMO LINE: (404) 482-2485

-CONTINUED FROM PAGE 18, INSIDER recommended at the output; the user is thus free to experiment between 944S and 944G at the input.

The differences (empirical and sonic) between filters is apparent when several filters are chained, to duplicate multiple conversions to perform track bouncing etc. Fig. 3 shows 1 kHz and 2 kHz square wave responses with six filters chained, representing, for example, an audio chain from multi-track through mixdown to 2-track, to CD mastering and playback. The top traces are from six filters found in a popular digital multi-track; the bottom traces are from three 944G filters on the A/D and three 944S filters on D/A.

Apogee filters are potted in a black anodized metal case with integral heat dissipating fins for low temperature rise, and electrostatic shielding. They are compatible with the specifications and dimensions of the filters currently used in digital multi-track tape recorders. Filters can be exchanged by swapping modules; no additional changes in the circuitry are required.

Leaving the confines of the tape machine, let's switch topics and locales to Discovery Systems, in Dublin, Ohio. This CD manufacturing plant has an annual production capacity of 6 million discs, with plans to expand to 15 million. A sampling of customer names includes JEM, Chrysalis, Dunhill and Word. The first CDs produced by Discovery; digital tracks were processed by the E.R.I.C. (Emotional Responsive Impulse Computer) system to remove tape hiss and restore S/N ratio.

But Discovery has diverged from the typical CD facility business plan. In the fall of 1985 they acquired a full service AV production house as a first step in producing their own labels for CD-Audio and CD-I. In February, Discovery formed their first music group, Discovery Artists, with plans to announce labels in a number of different music markets. Pure Prairie League was simultaneously signed by Discovery Artists, with a new album planned for release later in the year.

Discovery is the only CD manufacturer in the U.S. with an in-house digital studio offering its facilities to clients outside the CD manufacturing process. The studio offers 24-track digital recording and digital mastering. As opposed to the typically piecemeal process of recording, mastering and replication, Discovery offers all of those services under one roof to labels and producers. Along with greater control of budget, faster turnaround should result.

In addition to audio, Discovery has merged video into its operation with a

FIGURE 3

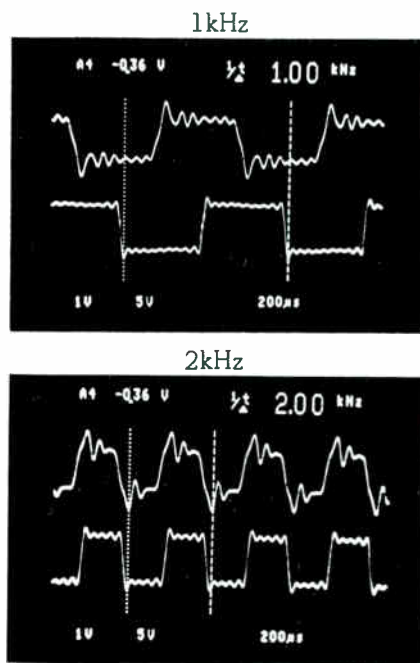

Grass Valley Kaleidoscope system, the second such system installed anywhere. The Kaleidoscope interfaces with other Grass Valley production equipment such as the ISC series 51 editor and GV300-3A switcher for comprehensive digital video effects and signal processing.

With such audio and video production facilities integrated into the CD mastering and replication operation, Discovery has thus aligned itself toward the next growth phase of the compact disc industry. Now that CD replication problems are diminished (disc cost has dropped to \$2 per disc) the next flurry of activity could be in product development activities for CD-I. In that market an independent such as Discovery has the same chance as the giants; success in CD-I will hinge on creativity of the product. Talking books? Speaking pictures? Education? Entertainment? Games? Interactive fiction? All of those may be possible as the CD-I format comes on-line. With in-house audio and video production, and disc manufacturing, Discovery may have an exciting edge over the competition.

Do you have industry or product information for Insider Audio? Send it to Ken Pohlmann, University of Miami, PO Box 248165, Coral Gables, FL 33124.

Ken Pohlmann is an associate professor of music and heads the Music Engineering Program at the University of Miami in Coral Gables. He is author of Principles of Digital Audio and The Compact Disc Handbook, and a consultant to the digital audio industry.



# FEEDBACK



## Dear Mix,

Richard C. Heyser, born in 1931, was a man of unique genius. On March 14, 1987, the world lost this wonderfully gifted human being after a heroic fight against cancer.

Dick founded an entirely new school of mathematical analysis. His "transform," while controversial, relates to a math that transcends dimension. He helped to advance the science of audio in many ways, including his discovery of the more general form of the Fourier transform. His contributions to audio and acoustics are beyond measurement, though his early papers on time delay spectrometry (TDS) greatly helped to describe the important delay characteristics of loudspeaker performance.

He had a deep spiritual yearning and was totally comfortable around committed religious beliefs, though he was not a member of any church. He once expounded with fervor that his understanding of the truth was that "there is an is." Heyser once said in a technical paper for an Australian journal, "We may have been casting our analytical gaze on the ground all this time, not realizing we could look upward to the heavens."

Audio was merely Dick's hobby. He earned his daily bread as a senior scientist at California Institute of Technology's Jet Propulsion Laboratory (JPL), operated by NASA. He was intimately involved in deep space probes, underwater sound exploration, ultrasonic analysis and many other scientific endeavors. He operated as a consultant to nearly every department at JPL.

Dr. Emanuel Tward, who worked closely with Dick for 20 years at JPL,

writes of Dick, "His great love of acoustics allowed him to use his theory to derive measurable quantities which verified his concepts. The validity of the concepts being attested is at the most practical level by the growing number of users of commercial products based on TDS."

Dick Heyser was a renaissance man in my eyes. He questioned everything, had to understand everything and knew so much about everything. He delighted all who surrounded him with his ingenuity, his kindness and his modesty.

In today's world, the term "genius" is so often used so tritely as to despoil the real sense of the word. The company Dick is now with is surely Archimedes, Descartes, Newton, Leibniz, La Place, La Grange, Fourier, Euler, Gauss and Hilbert. Heyser's transform is a fact that cannot be ignored. It may take another century before its full importance is realized and understood.

The special Heyser disk for TEF analyzers, allows one to create the display shown in Fig. 1. Only one of the curves shown in Fig. 1 originated with Heyser, however, easy access to all of them did originate with Heyser. The beautiful mathematics of his transform that detail the geometry seen here are a series of complex exponential expressions.

Heyser once said to a Syn-Aud-Con class, "The axioms and postulates of that which we call common sense is math. When it's dried up and withered and appears as little chicken tracks on a piece of paper, that isn't math! That's just the residue of it, just the shorthand that lets people know that a mind went past here on this page."

A special duty falls to those of us who knew and respected Dick. It is to further his work, protect his ideas from being unlawfully exploited by others, and to come together when we can to explore how to complete his unpublished energy theorem.

We are all saddened by the passing of such a giant. But, the memorial he would have most preferred would be the full and complete utilization of his ideas in the world of engineering and science. We can all help bring that to pass. It's the least we can do.

With loving memories,  
Carolyn Davis  
Synergetic Audio Concepts  
PO Box 1239  
Beford, IN 47421

**Editor's note: A scholarship program has also been set up in Dick's name by the Audio Engineering Society. For more information, write to the AES at 60 East 42nd Street, New York, NY 10017.**

Figure 1

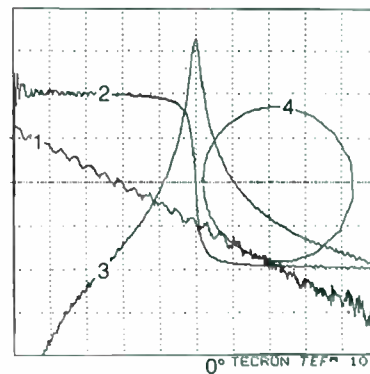

These plots are:

1. The ETC of a bandpass filter.
2. The phase response of the bandpass filter.
3. The amplitude response of the bandpass filter.
4. The Nyquist phase plot.

## Corrections Part II, The Final Chapter:

In our Corrections section of the April *Mix*, we brought attention to our inadvertent omission of the Amek Matchless 26x24x16x2 console (modified for 68 returns) with Roland Compueditor, owned by Sound Impressions, a 24-track studio in Milwaukie, Oregon. Unfortunately, that correction blurb erroneously identified them as being in Milwaukee, Wisconsin. Hope-

fully this will clarify things somewhat. Sorry guys.

**Dear Mix:**

At the end of an otherwise fascinating article on Joe Smith's career (*Mix*, April 1987), I was distressed to see him quoted as saying, "The only thing that people are going to record on digital audio tape is something that's digitally recorded to begin with. And the only way to get that is from a compact disc." This assertion is simply not true. Former RIAA president Stanley Gortikov's "Open Letter to Japan" (*Billboard*, December 27, 1986) was disturbing enough, but Joe Smith's blatant insult to consumer sensibilities offends me.

Let me first mention that I do not oppose a device that would prevent copy-coded material from being recorded onto DAT. To me this seems a much fairer way to hinder piracy than to tax blank tape, which is such a necessary item for original songwriters and musicians. What I do object to is the contention that the only music worth recording in a consumer-oriented digital format is on compact disc, made by artists of the record industry's choosing. Perhaps I'm taking at face value a statement that has some other intention, but I cannot stand idly by while top record industry officials continuously decry DAT's threat to artist royalties and ignore the larger issue: at last digital recording can be made available in a consumer price-range!

Working as I do in a hotbed of unsigned musical effort, namely Boston, I am witness to a lot of good, innovative music happening that merits digital recording whether or not the financial resources are there. Among the myriad possibilities for DAT is that budding musicians, songwriters, engineers, and enthusiasts could have added flexibility if they were to mix tracks to DAT and bounce them back to 4- or 8-track, thus sustaining one less generation-loss than if they were to mix to analog and bounce back. Or consider the analog-to-digital mix-down itself, which is currently the popular recording trend of pop and rock artists. Certainly recordings that end up digitally mixed for compact disc do not always begin in the digital format.

Now, our unsigned artists might have access to a simplified form of what is available to signed artists: the digital mixdown. It's high time someone addressed the finer possibilities for DAT, and considered applications beyond copyright infringement.

Sincerely,  
Tracey Pope  
Boston, Massachusetts

**Dear Mix:**

In your April interview with Stephen Paul, Mr. Bonzai asks Paul, among other things, "Who made the first mic?" and "What type of microphone came before the condenser?"

*Mix* and other publications over a period of decades have included articles listing my grandfather, Emile Berliner, as the inventor of the microphone. In fact, AT&T (formerly the Bell System) credits Emile Berliner as the inventor of the microphone, even though interviewee Paul believes it was Dr. Bell. AT&T has good reason for its attitude, for its purchase of the Berliner microphone for \$50,000 in 1877 paved the way for AT&T's becoming the world's largest corporation. My grandfather's loose-contact design has been used in all the world's telephones for the ensuing 100 years.

Edison filed a patent application for a loose-contact microphone. Unfortunately for him, he was two weeks too late. Nonetheless, the then-powerful Western Union Telegraph Co., anxious to get into the new phone business, acquired it and sued to destroy the fledgling Bell Company. WU's attorneys, after examining Bell's Berliner microphone and its patent application, went back to WU and told them not to sue for money, but to sue—for peace; because the Edison design was a copy of my grandfather's, whose patent application preceded Edison's. The result was that WU agreed never to enter the telephone business. The rest is history.

Sincerely,  
Oliver Berliner  
Beverly Hills, CA

**Dear Mix:**

There *is* a way to have both choruses described in the Stevie Wonder/Quincy Jones/Nile Rodgers "Stop, Don't Pass Go" session sing simultaneously in a satellite hookup ("Lunching with Bonzai," 5/87). Assuming the basic tracks and a scratch vocal have been previously recorded on multi-track, and that this multi-track tape has a SMPTE time code track on it (if not, record one on an open track and proceed), lay a mono scratch mix of these basic tracks onto a track of a second multi-track machine. During this same pass, also regenerate new time code referenced to the original track, but with an offset (delay) of exactly the double-hop satellite delay (520 ms), and lay this on another track of the new multi-track tape. Then go back and copy all the other basic tracks from the original to the new multi-track tape with the two time code tracks locked. You now have a new multi-track master with a scratch

mix that *leads* its individual tracks by 520 ms.

During the bicoastal overdub session, the "local" chorus—i.e. the singers in the studio where the multi-track recorder is (let's call this NY) hears a normal monitor mix from the basic tracks of this new multi-track tape, plus the incoming live feed from the "remote" chorus (call this L.A.), which will be in sync, since the L.A. chorus hears the ("advanced") scratch mix only, via satellite. Only one of the choruses can hear the other while they record (NY hears L.A.), but they can both sing to the same accompaniment at the same time and be recorded in sync.

Applying this further to the actual case discussed, the video feed from L.A. to NY would be in lip-sync without further compensation. There is no way to lip-sync L.A.'s live video feed from NY. However, the conductor could be live in L.A. using the satellite audio feed (scratch and click) as reference, with NY watching him/her on video. In this case, L.A.'s video feed from NY is just for schmoozing between tunes, producer's notes and encouragement, and general atmosphere, not for any real visual synchronization. There are other ways of doing the video setup, but this is the easiest arrangement. In any event, the NY location has its own live performance synchronized with the live audio and video feeds from L.A., and L.A. has a live performance synchronized with the audio feed from NY and the conductor for *both* ends of the overdub session. Something for everyone, and interesting to watch on both ends (a bit better in NY, though).

While this may seem to be only semantically different from what was actually done, and still not a *wholly* interactive performance, it is at least partially so, and would have made a bit more of an impressive showcase for the audiences on hand.

Variations: 1) When preparing the overdub master tape, do not include click track in the scratch mix, but dub it onto a separate track during the same pass. (Of course, dub it again when you copy all the other original tracks synched to the offset time code.) The new master will then have two click tracks, one synched to the basic tracks and one synched to the "advanced" scratch mix. During the overdub session, send the "advanced" click to L.A. on a separate satellite channel from the scratch mix. The mixer in L.A. then has the ability to vary the click-to-scratch levels in the monitor mixes there.

2) When fiber optic lines become widely available (soon), there will still be delays, but unlike satellite delays which are pretty much the same wher-



ever the two ends of the circuit are, depending only on the number of hops (and the quality of the malt and barley), fiber optic delays will vary relative to terrestrial distance between points. NY to Philly, for example, would be an almost negligible amount, but NY to L.A. would definitely require some compensation for musical synchronicity. As with satellite hookups, a test period to determine the actual amount of delay is necessary (especially due to the less predictable results with fiber optics, since actual circuit routing is often unknown by the user), far enough in advance of the actual session to prepare the overdub master tape described above.

3) With either satellite or fiber optic hookups, if the delay *changes* significantly between test and session (not likely, but possible, especially with temporary fiber optic circuits) such that the "advance" of the scratch/click tracks is wrong, if the actual delay is *shorter* than expected, the problem can be corrected by running the scratch/click feeds through a DDL during the overdub session as it is fed to the bird, thus reducing their lead. If the actual delay turns out to be *longer* than the offset, you're out of luck.

Maybe *Mix* should start a feature similar to the old "Brain Twizzlers" in the back of the Sunday supplements. The topic of satellite delay could appear in it frequently. Now, if train A leaves New York at 6:15, heading south at 50 mph, and train B...

Sincerely,  
Skip Pizzi  
Training Coordinator  
National Public Radio

#### Dear Mix:

It's ironic that Brian Graifman's letter (May, 1987) appears in the same issue as your intriguing George Martin interview. Martin should not be discredited for leaving the Beatles' masters alone. The real value of these compact discs is having the early recordings as they were meant to be heard: in mono, using the British LP's chronology.

I, for one, would melt my cochlea if I had to listen to the butchered "stereo" releases from Capitol—especially through a headset! While Graifman is thanking Martin for his contributions in the past, he should also be grateful that we won't have to experience the crass, market-oriented packages offered by Capitol for so many years.

Capitol (EMI?) has finally acted responsibly on behalf of the Beatles' catalog—let it be.

David Bassett  
Center for Popular Music

Middle Tennessee State University  
Murfreesboro, TN

#### Dear Mix:

Being responsible for the integration of Bruel & Kjaer expertise in microphone development and manufacturing, I am compelled to respond to the article entitled, "Stephen Paul, Doctor Microphone" (April, 1987).

Mr. Paul's interest and work on microphones is admirable. However, there are several points I would like to clarify with regard to the "perfect" microphone. Bruel & Kjaer has committed 30 years of expertise to be able to produce 32 different types of microphones which encompass a frequency response window from 0.0065 Hz to 140 kHz and noise floor from -2.6 dB(A). Does this mean Bruel & Kjaer is better than the "perfect" 0dB(A) mentioned by Stephen Paul? It is also important to note that of these 32 microphones, the one capable of capturing 0.0065 Hz is only 1/2-inch in diameter, dispelling the notion that a capsule has to be 32 mm in diameter to get "bass response."

The Bruel & Kjaer series 4000 professional studio microphones are the result of years of research and development in both design and manufacturing in the "not-so-perfect" world. Mr. Paul seems convinced that Bruel & Kjaer microphones are not exciting when used on vocals. I suspect Ms. Jennifer Warnes would disagree with him as her latest award-winning release on Cypress Records, *Famous Blue Raincoat*, used a Bruel & Kjaer 4006 on all of her vocal tracks.

All in all, Mr. Paul's work on restoring old microphones is commendable, but in the development of the "perfect" microphone, I feel a second opinion should be sought before being operated on by the doctor.

Best regards,  
Adrian Weidmann, Manager  
Bruel & Kjaer Pro Audio Group  
Naerum, Denmark

#### Dear Mix:

Just a quick note to let you know how much Larry Oppenheimer's articles have done for us. We have a small 8-track MIDI studio used for demos, and Larry Oppenheimer's articles on the SRV-2000 and the state of programmable signal processors seem to always hit the nail on the head, in layman's language. We applaud you *Mix* and Larry, keep up the great work.

Sincerely,  
Burt Teague  
E. Granby, CT

---

# NEXT IN MIX

---

## AUGUST

- Tenth Anniversary Issue
- Future of Recording
- Acoustics & Design Supplement
- Directory: Designers & Suppliers

## SEPTEMBER

- Southern California & Hawaiian Studios
- Radio Production Technology
- Analog 2-Track Recorders
- Hawaiian Advertising Supplement

### AD CLOSING:

JULY 7

### MATERIALS DUE:

JULY 15

## OCTOBER

- AES Special Issue
- New Products Directory
- Engineers Forum: Maintenance & Testing

### AD CLOSING:

AUGUST 7

### MATERIALS DUE:

AUGUST 15

---

**Only *Mix* has a BPA-audited circulation of over 42,000 copies each month!**

**Call (415) 843-7901 for space reservations and complete advertising information.**

---

# CLASSIFIEDS

## Employment Offered

### TECHNICAL WRITER

with musical/electronics background to write operators and service manuals and other product-oriented material. Please send a sample and history of earnings to:



PERSONNEL DIRECTOR  
P.O. Box 2898  
Meridian, MS 39301

TOP BAY AREA 24-TRACK STUDIO HAS OPENING FOR EXPERIENCED, MOTIVATED STAFF ASSISTANT ENGINEER. HIGH-STRESS, LOW-PAY. PO BOX 7139, BERKELEY, CA 94707.

BRILLIANT PRODUCTIONS accepting resumes for top level First Engineer. Label projects, future looks bright. SERIOUS & EXPERIENCED ONLY. PO BOX 7139, BERKELEY, CA 94707.

Audio For Video/Film Post-Production Engineer. Must have strong background in video/film sound, SMPTE time code based systems, 1" C-Format and 3/4" Umatic VTRs. A.K. Q-Lock experience a plus. Send resume to: Music Annex, Inc., 69 Green Street, 2nd Floor, San Francisco, CA 94111.

Est. Rec. Studio/prod. house seeking adventurous, creative, aggressive exper. prof. to set up and operate a marketing business plan. Write to: RTP, Box 51, 810 Broadway, Vancouver, BC, Canada V5Z 4C9.

AUDIO ENGINEER for 2-track mastering to oversee bin-loop cassette duplication. Pleasant, relaxed work environment. Send letter or resume to: GRI INC.

Attn: Jonathan Parker  
PO Box 41, Ojai, CA 93023

## Equipment For Sale

### SIGMA SOUND STUDIOS GREAT EQUIPMENT BUYS:

2, 4-trk recorders, synchronizers, hi speed dupe equip plus lots of audio processing gear.

Call or Write:

212 N. 12th St., Phila., PA 19107  
(215) 561-3660

LOW OVERHEAD MEANS LOWEST PRICES. We carry most major lines of pro audio & recording equipment. **Get your best price, then call me.** 3M Tape and accessories at factory prices.

S.C.M.S.

East U.S. Toll Free:  
**(800) 438-6040**  
N.C. Watts: (800) 221-SCMS  
(704) 889-4508

### VINTAGE TUBE MIKES

Call Bill Bradley  
(312) 751-1216

### Reliable Music

Serving the Southeast for 25 years offering an excellent selection of musical instruments, pro sound and recording equipment in a hands on environment. We have a progressive, experienced sales staff, factory trained technicians, and our prices are competitive.



**704/375-8662**

Hours: Mon-Fri 10-6 • Sat 11-6  
650 E. Stonehill Street, Charlotte, NC 28202

KURZWEIL, AKAI, TANNOY & AUDIO-TECHNICA. Best prices on the new Kurzweil 250 & Akai MG1212. Complete studio and sound system packages available. New & used, buy and sell. SOUND ADVICE (205) 592-4555, (800) 826-6552.

IF YOU'RE NOT USING IT  
—SELL IT!

Your national clearinghouse for used audio and video! Call for free copy of our latest listings, or to list your used gear free.

The Bertech Organization  
Call toll free: (800) 992-2272  
In Calif. call: (818) 909-0262  
THINK BERTECH FIRST!

### NEW, USED, DEMO SALE RECORDERS, CONSOLES, OUTBOARD EQUIPMENT

Soundcraft 2400LED 28x24, 200SEQ 243X4, Trident 24, Tascam MS-16, 80-8 w/dbx, Roland D-50s, S-50, JL Cooper, MIDI-Paint, Performer, Jambox 4, UREI 813C monitors, Yamaha SPX90, DMP7, NS-10M monitors, Tascam MS-16, -8 w/dbx, dbx900 w/type II NR, loaded Scamp rack, JVC 3/4"-1/2" video.

E.A.R. PROFESSIONAL AUDIO  
(602) 267-0600

24 TRK: \$19,800. 16 TRK: \$5,900.  
British-made ACES equipment fea-

tures 24 TRK, 2", 30&15 ips, 50% vari, remote, a solid deck. 32 input, 24 subgroup mixer, \$13.7k. 16 TRK 1/2", built-in NR, ind. bypass, O-search, nice! 2 YR warranty. Factory distributor ROCK STUDIO SUPPLY, Box 5997, Norman, OK 73070, (405) 329-8431.

### USED EQUIPMENT Bought & Sold



Summit  
Audio  
Inc.  
P.O. Box 1678  
Los Galos  
CA 95031  
408-395-2448

### LEASE/BUY/SELL

Great prices and great service on over 200 lines including Otari, Harrison, Soundcraft, Tascam, JBL, Lexicon, AMS, Akai, Fostex, KT, dbx and all the rest for the best in new or used. Call for our latest listing. **AVC SYSTEMS (800) 323-0281**, in MN call (612) 729-8305.

4 trk, 8 trk and MIDI studio gear. Best prices—courteous, knowledgeable staff. Most major lines of pro audio keyboard and studio equipment. Call our toll free watts line 1-800-354-7252 when you're ready. Mike, Bill, Terry or Marty.

New Used & Demo Soundcraft Neotek, Otari, Akai, Klark-Teknik, dbx, E-V, LEXICON. **USED NEOTEK CONSOLES**, microphone sale, over 200 mics in stock. E-V, AKG, Beyer, Sennheiser, etc. New E-V N-DYM mics in stock. Call **Pyramid Audio Inc (312) 339-8014**.  
Call Us Last!

### 48 TRACK CONSOLE:

Sphere Eclipse C—48 inputs, outputs, & monitor, plus 12 returns. Automated, 4-band parametric EQ, plasma meters—many other features. Asking \$75,000. Call Arthur Stoppe at Sigma Sound, (215) 561-3660.

### API CONSOLE

Original Sound Factory Studio A console. 28 input, 16 bus, 24 monitor. 2520s & 550A EQs. \$27,500. (213) 467-2500.

**SIDEREAL KAP.** The Sidereal Kap was designed from its inception to be the finest sounding capacitor available for audio today. Find out what the music lover's capacitor doesn't sound like. Free literature and price information upon request.

Dealer inquiries invited. **SIDEREAL AKUSTIC**, 1969 Outrigger Way, Oceanside, CA 92054, (619) 722-7707.

Yamaha RM-1608 console 16x16. UREI 528 1/3 oct. cut filters. Tascam 32 2-trk. Other accessories available. Call Rick (214) 521-2216.

### OMNI SOUND AND VIDEO INC.

JBL	Telex Wireless
Bose	Lavalier Microphone
Kloss	System \$699
Crown	—
Fostex	Biamp 1624
Yamaha	16 x 4 x 2 Mixer
Mitsubishi	\$2195
Cinema Beam	—
	Shure SM-58
	\$109

Orders (USA) (800) 443-7058  
Orders (NC) (800) 662-3401  
Info and Catalogs  
(919) 876-8432

P.O. Box 58126  
Raleigh, NC 27658

### PCM

PCM-501-ES & PCM-701ES in stock!!  
PCM-F1 & PCM601ES - Call for info!!

### DAT

We have the first DAT recorders available in the U.S. Call for brochure & pricing.

### LC-OFC

Absolutely the finest wire for Pro use. Studios or musicians: This new technology will make an audible difference!

Micro Seiki Turntables  
SAEC Tonearms - Cartridges  
**Audio Gallery (213) 829-3429**  
2718 Wilshire Bl., Santa Monica, CA 90403

SYNCON A 28 x 24 console 496. Patchbay w/twin producers desk. Immediate availability. Excellent condition \$12.5K or b/o. (203) 467-9038.

32x24 SOUND WORKSHOP SERIES 34 Automated console, full A.R.M.S. Automation, 2 yrs. old, stereo solo-in-place, grouping, fader-rip, max. patch points, very clean & EC, used in home studio. Bob (312) 682-9735.

MCI JH-24 16-trk 2" recorder, exc. condition, \$15,000 or b/o—3 yrs. old. Studiomaster 16x16x2 recording console exc. cond. \$3,500 or b/o. **POWER RECORDING STUDIOS (216) 238-9426.**



World's Best Prices on quality used equipment. Super savings on ATR-100 and multi-track heads. We buy-sell-trade. Get on our mailing list and buy where the pros SAVE. AUDIO VILLAGE, PO Box 4692, Palm Springs, CA 92263, (619) 320-0728.

#### MCI/SONY PRODUCTS

JH-24 recorder, MXP-3000 mixing console, ARR 5003 center track recorder, Sony PCM-3324 digital. Cash, lease or finance—Quick service call Dick McCalley (612) 866-1868.

Westlake studio monitors, MegaMix console automation, Yamaha NS-10M reference monitors, Yamaha SPX90 effects processor, call Dick McCalley at (612) 866-1868.

**STUDIO FINANCING** and leasing plans for qualified buyers. Quick service, 36-60 month terms. 5K to 200K—for information call Dick McCalley at (612) 866-1868.

We have lots of used Showco P.A. speakers, components, raw drivers & misc. electronics for sale.

#### PACIFIC MUSIC

3829 Bluegrass Lane  
Ft. Worth, TX 76133  
(817) 924-5152

#### DO YOURSELF A FAVOR

If you're ready to buy any type of recording gear or musical instrument, do yourself a favor and call us before you buy. We have most name brands at some of the lowest prices you'll find anywhere. Call us before you buy, you won't regret it. (318) 234-5021.

Trident Series 75 console 28x24, 8 sends, 4-band EQ, EQ on monitors, 1½-yrs-old, exc. cond. \$21,900. Call (201) 653-6389 or 653-6729.

CONSOLE-MCI 416 24x24 \$12K, modified. Standard I/O config. expertly maintained and on-line. Call Jerry (415) 794-2992 or Will (408) 779-0390.

SOLID STATE LOGIC model SL-6000E console, six months old. Large 48 frame, 32 inputs, total recall and Adams-Smith synchronizer. Forced to liquidate. Contact David Pofner (301) 298-1200.

#### NOW IN STOCK

**SONY PCM-F1** Digital Processor 1987 Prod. Models. First come first serve. **SONY JH-24** 24-trk Recorder New & Demos avail. **STUDIOWORKS** 1-800-438-5921 (NC) (704) 375-1053

(2) Stephens Portable 24-trk 821-B (matched pair). Good cond, in current use. Anvil cases. Spares. Blueprints. \$25,000 for BOTH. Sound Workshop Series 34, 36-input (wired for 40), hi-res meters, full bay, very good cond. \$29,000. Efanell Music (212) 807-1100.

#### KABA DUPLICATION SYSTEM

(1) master control deck RTDS-4TM, (2) dual transport slave decks RTDS-

4TS, (3) rack mount kits, deck road case less than 20 hours use—\$3,440. Call John (303) 444-5035.

3M-79 (24-trk) \$10,500. (2) WE ARE GOING... "DIGITAL" SEND FOR A LIST OF EQUIPMENT AND PRICES... Hollywood Sound Recorders, Inc. 6367 Selma Ave., Hollywood, CA 90028... (213) 467-1411.

SOUND IDEAS Sfx Library on 7½ IPS reel to reel, complete, \$700. NETWORK Production Music Library on 7½ IPS reels, complete, stereo, \$400. ORBAN 424A gated compressor/de-esser, 2 channels, brand new, \$500. Call Michael Hamilton at (213) 466-8517.

ACES TR-16 16-trk—2", New, 30 ips w/remote \$9,500, ACES ML32-32, new, 32 inputs in line console w/PB., LED VU meters, 5. EQ \$11,000. Call Dave Dusman at (716) 458-5610.

MCI JH-16-16-trk w/auto loc, new heads \$8,500; MCI JH-110 24-trk 1,850; Tascam model 15, 2-trk, \$4,000. Call John or Paul at (305) 989-3543. All equip. in exc. cond.

#### STUDER A-800

MK-I modified transformerless. Being sold by private studio, only 1,900 hours. In mint condition. \$42,500. (916) 265-8003.

AmeK 3500, 56-channel auto ready, AmeK 2500 48-channel auto ready, EMT 250 \$14,000, Q-Lock 310 b/o fully loaded, Scamp Rack b/o, Dolby XP rack \$10,000, Otari 24-trk MTR-90 MKII \$30,000, GSI \$5,000, Synclavier systems full blown towers, world class library—all extras—(818) 980-4840—Tom.

Tangent mixing console Model 3216A, 24 in, 16 out, w/VU meters, custom EQ, TT Patchbay, mother board split for special bussing, one owner—never moved from studio, excellent condition—\$7,000—(213) 373-4938.

3M79 24-trk w/16-trk heads, completely rebuilt, new motors, heads, guides, w/Lynx cable interface, many spares, absolutely in mint cond. Very reliable audiophile machine. \$17,000 or b/o. Jared—(818) 980-1017.

#### MCI PARTS & MACHINES

Now available MCI-16 upgrade kits w/heads, super deals on spare cards for all MCI machines 1971-1987. Lamps & all other parts. Randy Blevins (615) 361-8429 or 361-6768.

AmeK/Tac—Matchless 28x24, loaded, 4 months old \$18,950; Tascam MS-16, \$8K w/locator; MCI JH-24-ALIII, \$17,950; Otari MTR-12C (like new) \$5,995; Otari MK-III-2 \$2,300; Sony 5002, \$3,900—exc. cond.; Tascam model 15, 24 chn. \$3,900; Tascam 52 \$1,799; Kaypro II \$600 (C/PM); Otari MK-III-8, one year old, \$3,600. OPUS Equip. (312) 336-OPUS.

#### MCI 24-TRK—2-TRK HEADS IN STOCK

We stock tape heads ¼" thru 2" & spare parts for most recorders (800) 553-8712 or (800) 325-4243 CA, (818) 994-6602, Telex: 754239, Sprague Magnetics, Van Nuys, CA

Harrisons w/auto., MCI, Soundcraft & Sphere consoles avail., Reduced MCI 24-, 16- & 2-trk. Quantec room simulator. Two sets 24-channel dbx \$4,500 each, 900 series dbx frames. Randy Blevins (615) 631-8429 or 361-6768.

NEOTEK ELITE-66 in, 50 out, 5 mo. old, absolutely mint condition, largest built in U.S. \$89K new, must sacrifice at \$76K; includes warranty. (203) 467-9038.

SONY AVAILABLE now—MXP-3000 Recording Console, MXP-2000 Production Console, JH-24 recorder with autolocator, APR-5002 Analog Master recorder, APR-5003 Center track recorder. All new and in stock, many other lines available (313) 455-5557.

#### 3M M-79 TAPE HEADS

IN STOCK 16- & 24-TRACK 2" We stock tape heads ¼" thru 2" & spare parts for most recorders (800) 553-8712 or (800) 325-4243 CA, (818) 994-6602, Telex: 754239, Sprague Magnetics, Van Nuys, CA

## LEASING

Specialists in Audio Equipment

If you qualify, we are your Co-signer.

WE TAKE TRADE-INS!

PMI, Inc.  
567 N. Market St.  
Wooster, OH 44691  
(216) 262-1518

**aces** Sound Professionals

NOW YOU CAN HAVE AFFORDABILITY AND PROFESSIONAL QUALITY. ACES OF ENGLAND HAS A COMPLETE LINE OF PROFESSIONAL RECORDING EQUIPMENT.

MADE BY ACES OF ENGLAND

A 24 TRACK - 2 INCH RECORDER. 30 & 15 IPS 50% VARIABLE & REMOTE FOR \$19,800.00

A 32 CHANNEL INLINE CONSOLE. 5 AUX SENDS WITH BUILT IN PATCH BAY & STAND FOR \$13,750.00

FOR OUR COMPLETE CATALOG CALL OR WRITE 1216 238 9426 13453 HOLLO OVAL CLEVELAND, OHIO 44136

**POWER** Audio Supply

SYNCLAVIER 76 Key 32 Stereo Voices Computer terminal—Music printing 16 Separate outputs—Guitar Interf. Super floppy—\$60,000. STUDER Mark A-80 16-trk 2" 15 & 30 IPS-autolocator \$11,500—George (212) 598-4640.

80-8 w/DX8, Sound Workshop 1280B, Teac 2-trk, cassette, Sony ¼-trk, Marshall time modulator, Tapco EQ reverb, dbx 157 & 160, 9 mics, stands, cables, PB., misc. supplies, Rhodes 73. All in good to exc. cond. SACRIFICE at \$7,500 or b/o. (209) 568-2748—Tony.

#### ISOLATION WITHOUT DEGRADATION The Best Audio Transformer

- Wide bandwidth
- No overshoot or ringing
- Flat group delay
- Low hysteresis distortion

**jensen transformers** INCORPORATED

10735 Burbank Blvd. • North Hollywood, CA 91610  
(213) 876-0059  
Visitors by appointment only. Closed Fridays

#### SYNCLAVIER II

(8) voices w/terminal (build from here). \$10,500. AMPEX AG440-B 1" 8-trk rec., \$4,500. DALQUIST DQ-10 speakers \$700 a pair. Best offers. Call Audio Engineer Cleveland Inst. of Music—(216) 791-5165.

FOR SALE: Valley People TR804 powered rack w/(2) Gain Brain II, (2) Maxi Q and (1) Valley People Kepex 500 Noise Gate—\$600. Lexicon 224 Version V3.2 Reverb—\$2,500. Hafler DH-500 Stereo amp (255 watts per channel)—\$400. All equipment in excellent condition. Phone (216) 832-3903. Ask for Jeff.

#### FAIRLIGHT CMI II

\$11,500 (212) 481-6464

## Equipment Rental

*Design Fx Audio*

DIGITAL AUDIO RENTALS

Specializing in digital tape machines, reverbs and effects processors. Technical consultation included. (213) 838-6555  
Outside CA (800) 441-4415  
P.O. Box 491087  
Los Angeles, CA 90049

On-Call 24 Hours



1619 Broadway, N.Y., N.Y. 10019  
(212) 582-7360

#### The Best That Money Can Rent

- Digital Multitrack
- Time Code Equip
- PA Equip
- Wireless Mikes
- Outboard Equip
- Mixing Consoles
- Walkie Talkies
- Video Playback

STAGE FRIGHT is cost-effective RENTALS for CHICAGO LAND. KURZWEIL 250 EXPANDER and MIDI BOARD, expander has sound blocks A.B.C.D., also the E-MU SP-12 turbo drum machine, the new DX7-II/DF, Matrix-6, and K-3. MAC-INTOSH sound libraries for Kurzweil, SP-12 and DX7. Matrix 6 and K-3 libraries coming soon. Stage Fright Inc., PO Box 237, Dolton IL, 60419 (312) 849-3735.

AUDIO AFFECTS  
AMERICA'S MOST  
ADVANCED STUDIO  
EQUIP. FOR HIRE  
(213) 871-1104 (818) 980-4006

DIGITAL DOMAIN  
Sony 3324—\$750 per day, Focusrite EQ (6)—\$200 per day, Dolby SR (24)—\$225 per day, Sony 3202—\$225 per day, Fairlight Voicetracker—\$75 a day, Free cartage within 25 ml. of NYC (914) 638-6978.

## Equipment Wanted

Wanted: McIntosh, Marantz, Altec, JBL, Tannoy, Dynaco, Levinson, Western Electric, Audio Research, Citation, Telefunken, RCA, Quad, Rogers, Thorens, EMT, Fairchild, Langevin, E-V, Dalquist speakers, amplifiers, tubes, tuners, etc. (713) 728-4343, Maury, 11122 Atwell, Houston, TX 77096.

WANTED!! your equipment—A.M.S., Lexicon, Publison, dbx, Yamaha, Eventide, Roland. Let us make it work for your \$\$\$\$. Call DAR—Discount Audio Rental, Today (213) 851-2261.

WANTED TO PURCHASE  
USED FAIRLIGHT SERIES III CMI  
w/ or w/o travel cases.  
(612) 944-8528—Ken Bateman

## Instruction

BE A RECORDING ENGINEER!  
New classes quarterly.  
INSTITUTE OF AUDIO/VIDEO  
ENGINEERING  
1831 Hyperion, Dept. E  
HOLLYWOOD, CA 90027  
(213) 666-3003

**Build Your Own Pro Monitors**  
32-page, five-part manual discloses design criteria utilized by major manufacturers of pro monitoring systems. Blueprints included! \$20.00 complete to: Brix Enterprises Inc., 2419 Richmond Road, Staten Island, NY 10306.

EDUCATIONAL VIDEOS  
2/6 12 hour sound mixing/recording courses: \$39, \$119, \$239; 2 hour MIDI course \$39; Add \$5 shipping/handling for each course. Visa/MC/check. For brochure: RECORDING ASSOCIATION, 5821 SE POWELL, PORTLAND, OR 97206, (503) 777-4621.



ELEC.  
BASSISTS!!  
Study With The

"World's Most Recorded  
Bassist in History!"™

• CAROL KAYE •

VHS VIDEO - 2 1/4 Hr. with Manual

SPECIAL \$59.95 (\$75 Value)

Quality Video - Quality Education featuring Rock, Funk, Pop, Jazz, Motown, Techniques, Inventing, How To Groove, In Depth Easy Theory - Triads, Scales, Cycles, in-V7-I. Some Studio Stories, Some Jazz Guitar For Ear Players and Readers

Beginning Amateurs to Top Professionals  
Over 30 years Teaching Experience (almost 40 years Professional Playing)

Learn from the Legendary No. 1 L.A. Studio Bassist (Mission Impossible, MASH, Kojak, Bill Cosby, Quincy Jones, Supremes, Mancini, Michel LeGrand, 4 Tops, Ray Charles, Monkees, Johnny Mathis, Beach Boys "Good Vibrations", "Feelin' Alright", "Memories", "Little Green Apples", "Wichita Lineman", etc.) From the Bassist who set the standards, to the Bassist who wants it all!

You'll love this interesting, information-loaded VIDEO - "The Best"

\$59.95 - \$3.00 Shipping - CO res add 7% tax  
Surrey, no COD's

Bass Video  
Camelot-Gwyn  
3124 S Parker Rd., J.C. 101  
Aurora, CO 80014

## UNIVERSITY OF SOUTHERN CALIFORNIA RECORDING ARTS WORKSHOP

### GRADUATE CERTIFICATE PROGRAM

USC is currently accepting applications for fall 1987 semester for a one-year intensive Recording Arts Program for 20 select individuals who hold a Bachelor's Degree. All courses are taught in a state-of-the-art 24-trk studio. A certificate of completion will be awarded by the USC College of Continuing Education. For information write or call:

USC  
Recording Arts Workshop  
MUS 102A  
Los Angeles, CA 90089-0851  
(213) 743-2627

INSTITUTE OF COMMUNICATION ARTS. Commercial Music Performance, Audio Engineering/Prod., Video Prod./Sound Reinforcement, Music & Entertainment Bus., Communications, Electronic Music, Music Theory & Arrang. 2 Yr. Prog./PT. Studies. 12-12840 Bathgate Way, Richmond, B.C. Canada (604) 278-0232.

The new summer 1987 *Mix* Bookshelf Catalog is now available! Write or call now for your free copy of the most comprehensive selection of books, tape courses, music software, SFX libraries, databases and more.

MIX BOOKSHELF  
2608 Ninth Street  
Berkeley, CA 94710  
CALL TOLL FREE: (800) 233-9604  
In California: (800) 641-3349

## Maintenance Services & Repair

TECHNICAL SERVICE  
Soundcraft/Trident/Neve/etc.  
Consoles/Multi-Trax/Amps/FX/etc.  
Hard Copy Test Results  
TLM Electronics Inc.  
343 Manville Road  
Pleasantville, NY 10570  
(914) 769-6423

RCA MICROPHONES — Repair service on all models. Complete sound and cosmetic restoration. 35 yrs. experience with company. ENAK Microphone Repair, 420 Carew Avenue, Pitman, NJ 08071. (609) 589-6186.

## Music Products/ Software

### THE ULTIMATE DRUM AND PERCUSSION SAMPLE LIBRARY

IS NOW

AVAILABLE IN 15 BIT DIGITAL

1000+ STUDIO QUALITY SAMPLES  
PCM BETA 1 2" FORMAT (PCM F-1, 701ES, 501ES, ETC.)  
COST: \$1500

ALSO AVAILABLE: A 250 SAMPLE VERSION FOR THE  
LHIN 9000, SP-12, PROPHET 2000, & AKAI S-900 (\$8250)

CURRENT USERS INCLUDE: GIORGIO MORODER, TOM SHOW,  
MICHAEL JACKSON, BERNIE TAUPIN & MICHAEL SEMBE LLO

SEND \$5 FOR EACH SPECIFIC CASSETTE DEMO & INFO

studiodigitalsamples

18653 VENTURA BLVD., SUITE 560A, TARZANA, CA 91356

ROLAND DEP-5 PROGRAMS  
50 exciting programs for the DEP-5. Ideal for professional or home studio. Expand your processing palette. \$10.95 for data sheets and detailed notes. Sardonis Sounds, 15983 Woodland, Dearborn, MI 48120

## Recording Services

Hamilton Brosious Associates

### STUDIO EQUIPMENT APPRAISALS

If you need a professional appraisal of audio/video equipment for insurance purposes, estate settlements, loan collateral evaluation or any other purpose, you are invited to call us.

Nationwide Service

(203) 359-3506

SNB

### Digital Transfers and Editing from:

- Sony DASH, F1, 1630
- CD Master Prep.
- Lacquer cutting  
and MUCH MORE...

disques SNB mastering

Itee  
8400 Cote de Liesse, Ville  
Saint-Laurent, Que. H4T1G7  
Tel.: (514) 342-8511

## MAKE YOUR SONG AS GREAT AS IT SHOULD BE GET YOUR 24-TRACK SONG RE-MIXED BY A PRO

I will re-mix your song to bring out the quality only a pro with many years of experience can. Full complement of outboard equipment. INC, AMS, Lexicon, Publison. All work done in major LA studio completely automated. **The magic's in the music, so don't let your music be trapped in a poor mix.** Send master & demo cassette along with \$800 to Dr. Robert Sound, 7095 Hollywood Blvd., Box 406, LA, CA 90028 (213) 969-8369. Include complete return address and phone #.

## Records & Tapes

Disc Mastering and Record Production LPs, EPs, 45s—Plating, Labels, Pressing, Jackets.  
**DIGITAL NOW AVAILABLE!**  
**THE CUTTING EDGE**  
Box 217M  
Ferndale, NY 12734  
(914) 292-5965

### REAL TIME

Best Quality Cassettes using Nakamichi decks only. Custom loaded Agfa or BASF Chrome. Label and insert printing, shrinkwrap, blank tapes.  
**SUPERB QUALITY  
AT LOW PRICES**  
Uni-Sette, Inc. 1854 Fulton Ave., Sacramento, CA 95825. (916) 485-9534.

### FACTORY DIRECT PRICES ON 3M TAPE & AMPLEX TAPE

Discounts available.  
**We can & have saved you money!** Call us—you'll like us. We're in the business, just like you. STUDIOWORKS is also a supplier of pro recording equipment. (800) 438-5921 & (704) 375-1053.

Super Low Prices on Agfa, BASF, Ampex and Mag Media, Bulk Cassettes and Accessories. Real-time and High Speed Duplication. Call or write for prices and brochure. TRAXX RECORDING PRODUCTS, 24 Crest Way KC, New Fairfield, CT 06812, (203) 746-3561.

### PROFESSIONAL RECORDING SUPPLIES

We are a major wholesale Distributor of Ampex, Agfa & 3M reel to reel mastering tape (1/4" to 2"). We also stock broadcast video tape, assorted reels and boxes, splicing/leader tape, and pre-packaged cassettes. We load bulk cassettes in custom lengths using a variety of tape brands. Please call or write for our FREE catalog.

### Advance Recording Products

7190 Clairemont Mesa Blvd.,  
San Diego, CA 92111  
(619) 277-2540  
Inside CA: (800) 858-1061  
Outside CA: (800) 854-1061





# ADVERTISERS INDEX

PAGE	ADVERTISER	PAGE	ADVERTISER	PAGE	ADVERTISER
180	A & R Record & Tape Manufacturing	117	Eastern Acoustic Works (EAW)	3	Rupert Neve, Inc.
130	Akai/IMC	176	Electro Voice	28	New England Digital (NED)
135	AKG Acoustics	104	Electrospace	70	Northeast Community College
60	Alesis	70	Electronic Systems Laboratories (ESL)	104	Opus Recording & Equipment
211	Allen & Heath Brenell	132	E-mu Systems	73	Orban Associates
56	Alpha Audio	123	Ensoniq	7, 53	Otari Corporation
27	Amek Consoles	157	Europadisk	103	Peabody Conservatory
159	American Audio Systems	149	Eva-Tone Soundsheets	118	Penn Fabrications
109	American Image Productions	74, 75	Fairlight Instruments	165	Polyline Corporation
13	Ampex Corporation	200	Filament Pro Audio	157	Pristine Systems
47	ANT Telecommunications	126	Firstcom	158	Professional Audio Services
162	Apex Machine Company	97	Five Towns College	146	QCA Record Pressing
191	Aphex Systems	121	FM TubeCraft	20	QSC Audio Products
54	API Audio Products	138	Forat Electronics	195	Rainbo Records
140	Applied Creative Technology	41	Fostex Corporation	128	Rane Corporation
17	Applied Research and Technology (ART)	190	Four Designs	80	RCA Test Tapes
142	Sam Ash Music	45	Full Compass Systems	84	Recording Academy
163	Associated Production Music	96	Full Sail Recording	92	Recording Workshop
146	ATM Audio	134	Fullersound	156	Resolution
43	Audio Media Research (AMR)	81	Gold Line	144	Rhythm City Music
31	Audio-Technica US	171	Hardy Company	193	Rocktron Corporation
32	Audix	57	Hill Audio	33, 34	RolandCorp U.S.
190	Auteri Associates	152	Home Recording Rights & Coalition	35 & 36	
85	Kenneth A. Bacon Associates	91	Hutchinson Area Vocational Technical Institute	22	Ross/IMC
91	Bertech Organization	119	Institute of Audio Research	66, 67	Royal Recorders
100, 101	Beyer Dynamic	87	Institute of Audio-Video Engineering	151	Howard W. Sams and Co.
26	Biamp Systems	55	Intersonics, Inc.	46	Sanken
39	Bryston	172	JRF Magnetic Sciences	29	Schoeps
163	Burlington Audio/Video Tapes	65	Kahler/APM	25	Shure Brothers
137	Carvin Corporation	63	Keystone Printed Specialists	19	Solid State Logic (SSL)
185	CAS Productions	145	Kurzweil Music Systems	149	Sound Master Recording
78	Cassette Works	197	LD Systems	212	Soundcraft Electronics
79	Center Video Industries	148	Leo's Audio & Music Technologies	185	Sprague Magnetics
127	Cetec Vega	105	Lexicon, Inc.	139	The Stocking Screen
44	Cipher Digital, Inc.	150	Littlite/CAE	144	Stoughton Printing
109	Clarity	89	Los Angeles Recording Workshop	2, 124	Studer Revox
194	Computer Music Supply (CMS)	202	LT Sound	32	Studio Consultants
111	J.L. Cooper Electronics	98	Manny's Music	200	Studio Southwest
106	Crown International	23	Martin Audio	183	Tannoy
& 107		155	Micro Point	51	TASCAM
147	C-T Audio Marketing	55	Microsystems	170	TC Electronic
71	D & R Electronica	156	Midcom, Inc.	68, 113	Telex Communications
15	dbx, Inc.	143	Milab	196	Thoroughbred Music
52	DDA/Klark-Teknik	10, 11	Mitsubishi Pro Audio	99	Trebas Institute
78	Digital Music Center (DMC)	95	Mix Annual Directory	76	Trident
169, 171	Digital Services	181	Mix Bookshelf	54	The United Group
& 173		80	Music Business Institute	112	Valhala
161	Dimension	142	Musically Intelligent Devices	115	Valley International
30	Diskmakers, Inc.	139	National Sound & Video Engineering	148	Vertigo Recording Services
82	DOD Electronics	9	NEOTEK Corporation	141	Video Expo
56	Bill Dykes & Associates			165	West & Company
172	EAR Pro Audio			18	Westlake Audio
				161	Wireworks Corporation
				202	World Records
				49	Yamaha International



# EXHIBIT

**D**esigned for the Working Professional!  
The Sigma Series offers you the Maximum Flexibility, in layout and design features that reflect the evolution of Sigma Engineering.

Built to the Highest Standards, to which AHB has established its reputation on... for over 14 years.

## Performance

Sigma will satisfy your Current and Future needs in 16, 24 and 32 track recording as well as MIDI First Generation Recording and Sound Reinforcement Applications.

For more detailed information on the New AHB Sigma Console, Contact your Authorized AHB Dealer Today.

## ALLEN & HEATH BRENELL

U.S.A.

**Allen & Heath Brenell (USA) Ltd.**

Five Connair Road

Orange, CT 06477 / (203) 795-3594

U.K.

**Allen & Heath Brenell Ltd.**

69 Ship St. Brighton, BN1 1AE England

Tel. (0273) 24928 / Telex 878235

CANADA:

**GerrAudio/Toronto**

(416) 361-1667



# AHB SIGMA SERIES

This is the mixing console that will cause a revolution in 24 track studios.

The world's first Dual Mode mixing console.

With the advanced features and performance of a desk you'd expect to cost a great deal more than it actually does, it's a remarkable achievement. Take Dual Mode.

When you record with the TS12, its in-line monitoring means you create a control room mix on the main faders.

In mixdown this becomes the basis for your master mix. Saving time and helping you keep a train of thought as to how the final mix will sound.

Unlike other in-line desks, though, the TS12 also allows true stereo subgrouping on long-throw group faders.

In this mode the routing matrix offers either six stereo groups or four extra auxiliary sends – totalling ten sends – plus four stereo groups.

No other console in the world provides such versatility.

The TS12 is an open-ended investment, with optional disc-based SMPTE automation for faders, mutes, EQ in/out and auxiliary on/off. Again, at the price it's unique.

And fittingly, audio performance is superb.

Recent Soundcraft advances in summing amp technology, and in grounding and decoupling systems, make the TS12 one of the cleanest and quietest consoles ever.

The mic amplifiers, a critical factor in console quality, create less than 0.01% distortion at 10kHz at 70dB of gain. (Easily exceeding 16-bit digital specifications.)

Standard features are impressive, to say the least. Six auxiliary sends, seven stereo line inputs or effects returns, a 'musician friendly' headphone mix, an extensive 19" metal frame patchbay – and the option to create a massive total of 102 inputs.

Quite a line-up.

Attention to detail is equally stringent with modular PCBs, no dual concentrics and a clear, logical layout that belies the sophistication inside.

But the most remarkable feature of the new TS12 is without doubt the price.

We suggest you call us today to find out just how remarkable.

## ALL THE FEATURES YOU'D EXPECT IN A \$50,000 CONSOLE, EXCEPT ONE. THE PRICE.



Soundcraft  
TS12