

AUGUST 1985  
U.S. \$3.00  
CANADA \$4.00

THE RECORDING INDUSTRY MAGAZINE

# Mix

Interview: Neil Young

**Studio Design Issue**  
**Listings: Designers/Suppliers**  
**Orchestral Recording**  
**Control Room Acoustics**

067682 MXAUG  
JBL INCORPORA  
MARK R GANDER  
850C BALBOA B  
NORTHRIDGE

**Thomas Dolby**  
**Prince's Stage Sound**  
**Ray Charles**  
**Paul Horn**

## Studer Audio: Advanced Recording Systems

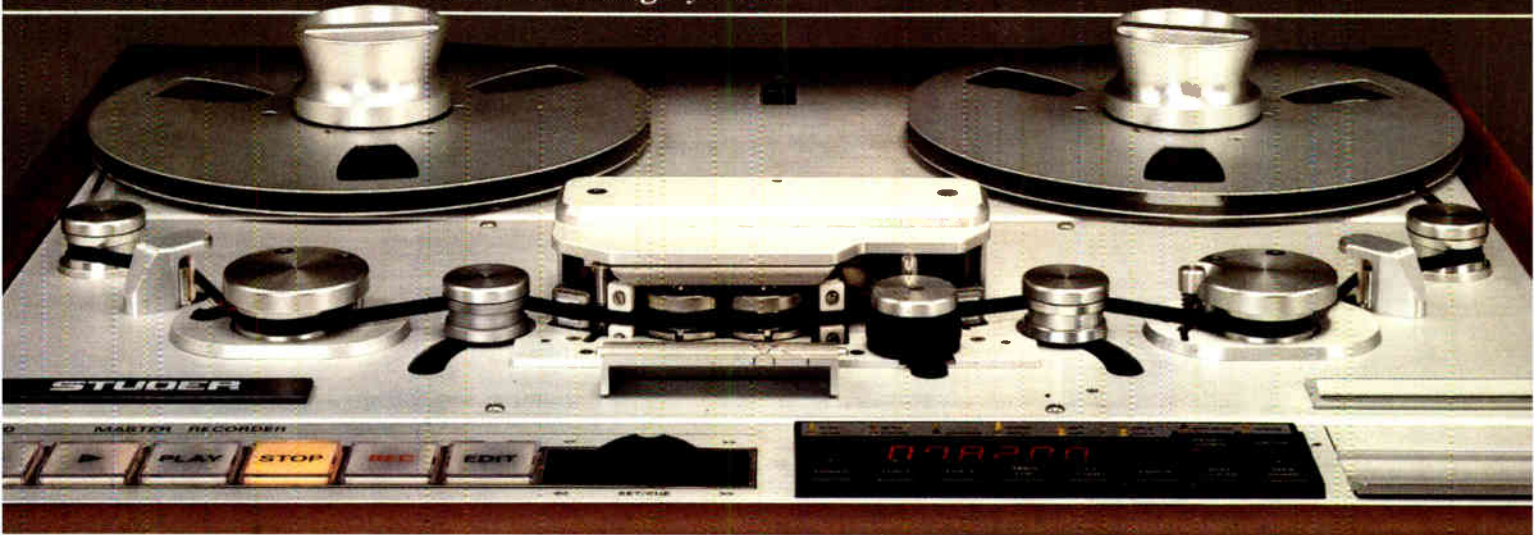

# The hardware is typically Studer. The software is simply astounding.

The transport mechanics in our new A820 Analog Master Recorder are solid, stable, and precision-crafted in the Swiss tradition. That's all typically Studer. What's new is an ingenious network of software-controlled operating systems.

Future Perfect. The A820 is designed to meet the demands of tomorrow's computer-controlled audio production facilities. Multiple on-board microprocessors control all operating sub-systems, including capstan drive, spooling motors, and audio parameter settings. Most operating features are user programmable, allowing you to tailor an A820 to your exact needs in a matter of minutes. If your needs change, you simply re-program your features. Also, virtually every operating feature of the A820 may be accessed and controlled through an optional RS232/RS422 serial data port.

Gentle on the Wind. The A820 handles your valuable tapes with kid gloves. The DC capstan motor starts, following a defined ramp, only after the pinch roller is engaged. A closed

loop servo system monitors tape tension and reel inertia to provide optimum acceleration and braking. Both tape tension and tape winding speeds are user programmable.

The Wheel Thing. The A820's dual thumbwheel shuttle/edit control makes tape-cut editing a breeze. One wheel fast winds tape in either direction at increasing speeds while the other precisely positions tape for the edit.

Also Noteworthy. The A820 incorporates Studer's new generation of phase compensated audio electronics, available with either transformer or active balanced inputs and outputs. In sound quality, the A820 takes a quantum leap ahead of recorders made just a few years ago. Options for the A820 include a center-track SMPTE time code channel and test generator.

The Payback. The "hardware" in the Studer A820 is made to give you dependable service for years to come. That's the Studer tradition. Plus, with its advanced software, the A820 also does more different jobs,

gets more jobs done in less time, and produces sonically superior results. That's the bottom line in any upgrading program.

For more information on the new A820 Analog Master Recorder, please contact: Studer Revox America, 1425 Elm Hill Pike, Nashville, TN 37210; (615) 254-5651.

**STUDER** REVOX



Circle #001 on Reader Service Card

World Radio History

## DEPARTMENTS

- 5 CURRENT
- 6 INDUSTRY NOTES
- 8 SESSIONS
- 10 STUDIO NEWS
- 74 PREVIEW
- 166 CLASSIFIEDS
- 170 AD INDEX

## AUDIO

- 14 AUDIO APPLICATIONS: SPIKES & SURGES by Ken Pohlmann
- 20 TRC STUDIOS' "STEALTH" TECHNOLOGY by John McCarty
- 26 CONTROL ROOM MONITORING SYSTEMS by Bill Morrison
- 42 ELECTRONIC ACOUSTICAL MODIFICATION by William Johnston
- 50 ORCHESTRAL RECORDING TECHNIQUES by Ron Streicher
- 78 FIELD TEST: AUDIO-TECHNICA AT-853 MICROPHONE by William Johnston
- 83 SOUND ON STAGE: PRINCE ON TOUR by George Petersen
- 100 IN SYNC: WIRING COMPLEX COMPUTER SETUPS by Bruce Nazarian
- 128 AUDIO DEALERS' FORUM by George Petersen

## MUSIC

- 58 THOMAS DOLBY'S ELABORATE COLLABORATIONS by Iain Blair
- 67 LUNCHING WITH BONZAI: PAUL HORN by Mr. Bonzai
- 94 NEIL YOUNG GOES BACK TO THE COUNTRY by Rose Clayton
- 104 PRODUCER'S DESK: GREG LADANYI by Robyn Flans
- 108 M.I. UPDATE by Craig Anderton
- 112 MUSIC NOTES
  - New Beatles Album
  - Gregg Rolie
  - Quantum Leap
  - Ray Charles
- 121 PLAYBACK: JON BUTCHER AXIS by David Goggin

## VIDEO

- 122 VIDEO NEWS by Mia Amato

## LISTINGS

- 136 STUDIO DESIGNERS & SUPPLIERS

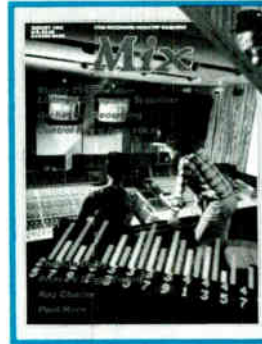

**Cover:** Studio 2 control room at Abbey Road Studios in London features a Solid State Logic mixing console. **Photo by:** John Price  
**Corner photo:** Neil Young by Rose Clayton

One of the most talked about tours of recent years was surely Prince's mammoth "Purple Rain" trek across America. Volumes have been written about those concerts and the surrounding hoopla, but for the first time anywhere, *Mix's* George Petersen examines the audio side of that tour through detailed discussions with two of Prince's engineers, David Hewitt and David Tickle. Petersen probes the tour's state-of-the-art sound system and looks into the remote recording Prince did on the road for his latest LP. That article appears on page 83.



The special focus of this issue is **studio design** and so we offer a number of articles related to that area. In a special forum, **audio retailers** talk about equipment trends, what's hot and what's not (page 128). William Johnston talks about "Electronic Acoustical Modification" (page 42) and John McCarty takes a detailed look at Indiana's TRC Studios to see how one studio has incorporated some of the latest technological advances made by the government into its design (page 20). Ken Pohlmann discusses those maddening **spikes and surges** in his "Audio Applications" column (page 14), and of course, we have detailed **Listings of Studio Designers and Suppliers** (page 136).

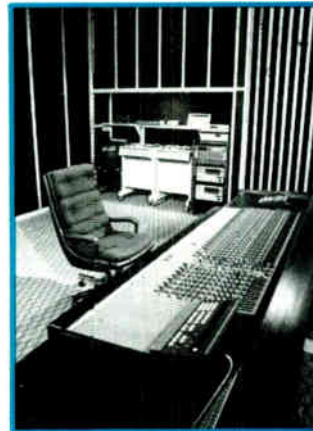

*Mix Magazine* is published at 2608 Ninth St., Berkeley, CA 94710 and is ©1985, by Mix Publications, Inc. This is Volume Nine, Number Eight, August, 1985. *Mix* (ISSN 0164-9957) is published monthly. Subscriptions are available for \$24.00 per year. Single or back issue price is \$4.00. Subscriptions outside U.S.A. are \$36.00. Please address all correspondence and changes of address to *Mix Magazine*, 2608 Ninth St., Berkeley, CA 94710. (415) 843-7901. Second Class postage paid at Berkeley, CA and additional mailing offices. *Mix Magazine* is distributed in recording studios, pro-audio stores, music stores and other related businesses. If you have a recording or music related business and would like to distribute *Mix*, please give us a call. Display advertising rates, specs and closing dates are available upon request. This publication may not be reproduced or quoted in whole or in part by mimeograph or any other printed means, without written permission of the publishers.

# OUR NEW BABY

Announcing the arrival of the MTR-90's little brother; Otari's one inch, 16 channel MX-70. A multitrack mastering recorder that lets you do virtually anything you want to do in audio, affordably.

The MX-70, specifically designed for multitrack recording, derives its features from our experience with MTR-90 customers and their applications. For example, the "70's" microprocessor controlled constant tension transport is ideal for use with SMPTE time code-based video editing systems, machine controllers, and synchronizers. Its "3-way" design (1 inch 16 track; 1 inch 8 track, and 1/2 inch 8 track) allows conversion right in the studio, so if need be, each session could be done on a different format. And as your needs change, this machine will stay with you all the way up to 16 tracks—you won't be left behind as your business grows.



The new MX-70 for Recording Studio, Audio Post Production, and Broadcast Production. You can see why we're so proud of our new baby. We know you will be too. From Otari: The Technology You Can Trust. Otari Corporation/recording, 2 Davis Drive, Belmont, CA 94002, 415/592-8311, Telex: 910-376-4890.

**OTARI**®



© Otari 1984

Circle #002 on Reader Service Card

# CURRENT

## NARAS Trustees Meet

Mike Greene, former president of the Atlanta chapter of the National Academy of Recording Arts and Sciences, as well as co-founder of the Video Music Channel and executive producer of Atlanta's Crawford Communications, has been elected NARAS National President at the recent trustee's meeting in Tucson, AZ. Other new officers include Eddie Lambert as first vice president and Marilyn Baker as secretary/treasurer.

In other business the trustees approved a referendum that would permit membership for artists, directors and line producers of music videos and added new Grammy categories for best new classical artist and best polka recording. A five-year contract with executive producer Pierre Cossette for the Grammy Awards telecast was also approved, and plans for other TV programs were discussed, including one built around the Academy's lifetime achievement award.

In his duties as president, Greene plans "to investigate, as soon as possible, a potential for expansion of the Academy in the United Kingdom, Japan and other international markets."

## SPARS Plans Database

The 3M Corporation has provided a grant to the Society of Professional Recording Studios to establish a studio industry market statistical database. SPARS will survey manufacturers and a wide variety of production studios to determine what data will be usable, valuable and obtainable. A questionnaire will be developed from this input and sent to over 5,000 audio and video production facilities. The data obtained from the questionnaire will be published in an annual slated for release in February of 1986.

SPARS plans also call for installing the studio listing portion of the database as a service on the IMC computer network. SPARS executive director, Gary Helmers, stated, "There are a large number of touring artists and other entertainment business professionals utilizing the network; the online database will enable them to locate quickly the studio with the services and

equipment they need, while on the road in any market."

One of the primary purposes of the database, according to Helmers, will be to provide recording operations with the market information they need for structuring financing, planning expansion and developing business plans.

## Compusonics Demonstrates Long Distance Digital Recording

The Denver, Colorado-based Compusonics Corporation has announced the successful long distance demonstration of their patented, high fidelity digital audio recording system for music. The "Telerecording" demonstration was conducted at the AT&T Bell Laboratories in Holmdel, New Jersey. Using AT&T's Accunet Switched 56 service, which permits voice, data and video information to be transmitted at 56 kilobits per second over AT&T digital switched network facilities, Compusonics digitally transmitted music over a 100-mile circuit, to and from New York City.

In the test, Compusonics first digitally recorded a Glenn Miller Orchestra song on a 5¼" floppy disk. The

song was then transmitted over the Accunet Switched 56 line and re-recorded on a second 5¼" floppy disk.

## Sony Intros New DASH Recorders

Sony Corporation has announced plans to market new two-track digital audio stationary head recorders in the fourth quarter of 1985. The PCM-3202 Twin DASH two-track recorder, running at 15 ips, and the 7.5 ips PCM-3102 will feature both electronic and mechanical editing. The latter machine, with three hours of record/play time, is designed specifically for applications such as tape duplication and broadcast, where extended play time is required.

The move was prompted by recent recommendations by both SPARS and the APRS for features and conveniences seen important by the organizations' member studios. Sony plans to alert prospective clients to the inconsistencies between the formats, encouraging the buyer to decide which machine is most appropriate for the needs. A switchable DASH two-track with enhanced editing capabilities is also planned for a summer 1986 release by Sony.



*Sony PCM-3102 DASH digital two track recorder.*

# INDUSTRY NOTES

*The Plant Studios*, in Sausalito, CA has launched *Plant Services*, a 24-studio maintenance service for preventative work as well as emergency service. The operation is headed up by **Dr. Richie Moore** and will serve private as well as public studios within a 40-mile radius of Sausalito. For more information, call (415) 332-6100. . . **Wolff Associates**, of Springfield, VA, has purchased the *API* product line from Southlake Technologies, Inc. (Datatronix, Inc.) and plans to add new products including retrofits for the older consoles to the "new" API line. They can be reached at (703) 689-0448. . . **Flanners Pro Audio** will be hosting the *Midwest Music Expo*, a conference for musicians, record companies, sound reinforcement and pro audio specialists, September 20-22 at the Hotel Continental in Chicago. For more information, call (414) 785-9166. . . **Artisan Sound Recorders**, the Hollywood music recording and mastering facility of *Kendun Recorders*-Burbank, has been purchased by the *LaTorre* family of El Paso, Texas. **William Rogers** has been appointed general manager and **Greg Fulginiti**, director of mastering for the new company. . . **Jack Hunt**, formerly with *Mobile Fidelity Sound Labs*, has rejoined *Alshire International* in Burbank, CA as mastering supervisor. . . The former *Audio Video Resources* in San Francisco is offering a \$300 reward to anyone who comes up with the best name for their reorganized facility. Call (415) 781-2603 for details. . . The non-profit *Interactive Video Association* has been

formed as a forum for individuals and organizations to communicate on the industry's developments. They can be reached at P.O. Box 1333, South Bend, IN 46624. . . **Camille Perillat** has joined the magnetic tape division of *Ampex Corp.* as associate administrator, marketing communications. . . The Queen's Award for Export, Britain's highest industrial honor, has been awarded to both *Soundcraft Electronics* and *Advanced Music Systems*. . . **The Real World Technologies Group, Inc.** has moved to larger quarters at 130 McCormick Ave., Suite 109, Costa Mesa, CA 92626. . . **Test Instruments, Inc.** has been formed to service operations with a wide variety of testing and measurement devices. They can be reached at P.O. Box 458, Mantua, OH 44255, (800) 241-1773. . . **Shape Inc.** has been granted a patent for a new design audio cassette designed to improve tape azimuth, height, tilt, tangency and contact variables. . . **Jeff Evans** has been chosen VP of systems products for *Audio Intervisual Design*, the L.A.-based professional audio dealer and systems developers. . . **Terry O'Kelly**, after more than a year as a product manager for *BASF Flexible Media*, has rejoined the company's audio/video department to oversee sales of professional products. . . **Crown International, Inc.** has appointed **Patti Smith** to the position of purchasing agent. . . **Jim Holt** has been named director of marketing for *Electro-Voice, Inc.'s* music, professional, pro sound reinforcement and commercial business sectors. . . New York-

based *I Contact* is matching up live sound engineers with summer tours. Call (212) 935-2962 for information. . . **Broadcast Marketing Associates**, the San Jose-based distributor of audio and video equipment has opened a branch office at 131 Townsend Street in San Francisco, CA 94107, (415) 543-3191. . . **Re-cortec, Inc.** has announced the appointment of **Mathew S. Ceterski** as vice president of marketing. . . **EECO Inc.** has announced the appointment of **Jim Peacher** as western regional sales manager for its video products division. . . **Digital Entertainment Corp.** has appointed **Cary Fischer** to the position of regional manager for the Hollywood sales and support office. . . **SLM Electronics**, manufacturers of *Crate* amplifiers and *Audio Centron* sound reinforcement gear, has hired **Stefen Paun** into their R&D department. . . **Jonathan Wisniewski**, former lab manager for JRF Magnetic Sciences, and **Christopher Rappolt** have formed *AMP Services*, a precision head reconditioning facility located at 6270 Wauconda Way West, Lake Worth, FL 33463, (305) 964-5414. . . **Ann Schwarz** has been appointed director of advertising and merchandising for *MCA Home Video*, following a seven-year stint with *Pacific Arts Video Records*. . . **Jonathan P. Kendall** has joined equipment vendor *Audiovisual Washington* as director of the presentation systems group. . . San Francisco's *Realtime Video Productions* has announced that **Giff Cummings** has been named director of sales.

## M I X M A G A Z I N E S T A F F

PUBLISHER/EDITOR  
David M. Schwartz

PUBLISHER/GENERAL MANAGER  
Penny Riker Jacob

ASSOCIATE PUBLISHER/ADVERTISING DIRECTOR  
Hillel Resner

MANAGING EDITOR  
Blair Jackson

ASSISTANT EDITOR  
George Petersen

ASSOCIATE EDITOR  
Ken Pohlmann  
MUSIC EDITOR  
David Gans

EDITOR AT LARGE  
Mr. Bonzai

FILM/VIDEO EDITOR  
Lou CasaBianca

CONTRIBUTING EDITORS  
Iain Blair Larry Oppenheimer  
Bruce Pilato Elizabeth Rollins  
Tony Thomas Neal Weinstock  
EDITORIAL ASSISTANT  
Linda Johnson

ASSISTANT ADVERTISING DIRECTOR  
Jeffrey Turner

ADVERTISING REPRESENTATIVES:  
SOUTHERN CALIFORNIA/SOUTHWEST  
Cecilia Hernandez  
NORTHWEST/NORTH CENTRAL  
Harton Firmin

DIRECTORIES/CLASSIFIED MANAGER  
Lauri Newman

ART DIRECTOR  
Tim Gleason

ASSISTANT ART DIRECTOR  
Bonnie Blair Ofshe

DESIGN & PRODUCTION  
Dave Marrs Patsy Messerer

TYPESETTING  
Linda Dierking Lynn McCormick

PRODUCTION MANAGER  
Anne Letsch

CIRCULATION MANAGER  
Mary Holland  
CIRCULATION ASSISTANT  
Allison Hershey

ACCOUNTING DEPARTMENT  
Mark Elsberg Mark Gunther  
Linda Simpson Cathy Boyum

TRAFFIC MANAGER  
Neil McKamey

BOOK DEPARTMENT  
Craig Wingate Caryl Sherman

OFFICE MANAGER  
Rachel McBeth

OFFICE ASSISTANTS  
Athena Craig Ron Ward

National Editorial, Advertising and Business Offices: 2608 Ninth Street, Berkeley, CA 94710. Telephone: (415) 843-7901  
Southern California Advertising Office: 4000 MacArthur Blvd., Suite 3000, Newport Beach, CA 92660. Telephone: (714) 851-1706

# DOLBY® NOISE REDUCTION FOR THE 1980'S



SP multi-track unit



360 single-track units



CN 234 for  
Sony BVH 2000



CN 221B for  
Sony BVH  
1000/1100



CN 226 for  
Ampex  
VPR-2

Dolby noise reduction is keeping pace with today's demand for high-quality sound — everywhere. With the introduction of such products as plug-in modules for VTRs and the SP multi-track unit, it is easier than ever before to protect *all* your irreplaceable audio tracks from hiss, hum, and print-through. From broadcasting to music recording, from video sweetening to motion picture dubbing, Dolby A-type NR reliably continues to fulfill its original promise: effective noise reduction combined with complete signal integrity.

Dolby Laboratories Inc., 731 Sansome St., San Francisco, CA 94111.  
Telephone 415-392-0300, Telex 3:409, 340 Clapham Road, London SW9,  
Telephone 01-720-1111, Telex 915109. "Dolby" and the double D symbol  
are trademarks of Dolby Laboratories Licensing Corp. 583-5050

 **Dolby®**

# SESSIONS

## NORTH CENTRAL

Heartland recording artist *Prodigal* has begun laying tracks for their third LP, *Just Like Real Life* in Cincinnati at *Fifth Floor Studios* with *Gary Platt* producing and engineering... *Hanf Recording Studios* of Toledo, the oldest and largest audio recording studio in the Toledo area, has changed its name to *Audio-Com, Inc.* effective immediately... At *Sweetwater Recording Studio* in Fort Wayne, IN, singer/songwriter *John Lay* was in working on some of his original songs with engineer *Chet Chambers* at the board... *Solid Sound, Inc.* of Ann Arbor, MI, has completed an industrial film soundtrack for *Hiram Walker*, featuring impressionist/comedian *Fred Travalena*. *Rob Martens* engineered... *Knightclub* has just released their first album, recorded at *Sunset Recording* in Lagrange, IL. The engineer for the project was *Mark Maclean*... *Jor/Dan Studios* in Wheaton, IL, hosted *Saturday Night Live* personalities *Al Franken* and *Tom Davis* with the band *Badmouth* recording tracks for the soon-to-be-released Columbia picture, *Datenaught*. Producer for the session was *Jerry Garcia* of Grateful Dead fame... Producer *Kraig Wall* put the finishing touches on midwest rock and roll artist *Tommy Eglin's* latest efforts "Your Money Can't Buy My Love" and "Two Hearts," at *Sound Ideas Productions Studio* in Sioux City, IA...

## SO. CALIFORNIA

At *Preferred Sound* in Woodland Hills, *Laura Branigan* was in with producer *Gary Usher* and engineer *David Devore* working on background vocals for Branigan's next LP... RCA artist *Kenny Rogers* tracked at *Sunset Sound* in Hollywood for his upcoming LP. Rogers and *George Martin* produced with *Terry Christian* engineering, *Stephen Shelton* assisting... Since opening a few months ago, *Master Control* in Burbank has had *Don Henley* in with *The Textones* for their new A&M/Gold Mountain LP with *Jimmy Iovine* producing, *Joe Chiccarelli* at the desk with *Steve Hug* assisting... At *Group IV Recording* in Hollywood, composer *Alan Silvestri* mixed the feature film *Back to the Future* with engineer *Dennis Sands*, assisted by *Andy D'Addario*, and *Bones Howe* for Amblin Productions... *Kommunity F.K.* was in at *Skip Saylor Recording* in L.A. mixing an album with producer *Jules Chaikin* for Auspex Music. *Skip Saylor* was behind the board... At *Crystal Studios* in Hollywood was

Weather Report's *Wayne Shorter* recording his solo album. *Howard Siegel* was engineering and *Jim McMahon* assisting... *Weddington Studios* in North Hollywood recently had Warner Bros. artist *Jack Wagner* in working on the studio's 32-track digital Mitsubishi, with producers *Cliff Magness* and *Glen Ballard*, and engineer *Francis Buckley, Jr.*... At *Image Recording* in Hollywood *Pat Glasser* produced *Night Ranger's* third album for Camel/MCA; *John Van Nest* at the board, assisted by *Steve Krause*... *Mikey Davis* of Talon Productions manned the controls at *Baby O Recorders* in the Berwin Entertainment Complex for the group *Burn*, formerly *Hellion*, with *Dana Strum* producing...

## SOUTHEAST

At *Treasure Isle Recording Studio*, Nashville, *Shane Keister* completed the film score for *Dr. Otto and the Riddle of the Gloom Beam*, a feature for Guerilla Productions. *Richard Schirmer* engineered, assisted by *Tom Harding*... *Glen Campbell* cut tracks for his new album, with *Jim Cotton* and *Joe Scaife* engineering, *Harold Shedd* producing at the *Music Mill* in Nashville... *Stevie & the Hotheads* recently recorded their first 45 for Sweaty Records at *Morrisound Studios*, Tampa, FL. *Chet Bennett* of CBS Records produced the sessions with *Rick Miller* engineering... *Wally Cleaver's Recording Studio* in Fredericksburg, VA continues work on *Gary Herrewig's* latest project, and *Gene Ryder* is laying tracks for his LP. *Peter Bonta* is engineering on both of these sessions... Arista Recording artists *Krokus* did pre-production for their next album with *Jack Holder* and *Don Smith* behind the console at Memphis' *Sounds Unreal*... Mixing tracks for his album at North Miami's *International Sound* was *Phillip Michael Thomas* (Tubbs of *Miami Vice*) with *Geoffrey Chong* at the board... On hand at *Florida Sound* in Clearwater were *The Sunairs*, a local group shopping for a label deal. The session was engineered by *Chuck Cavanaugh*, chief engineer at the studio... At the *Soundshop* in Nashville were *Ronnie Mcdowell* and *Buddy Killen* producing "One Big Family," to aid the World Hunger Fund. Also a video was done in connection with the record... *Hidden Meaning Studios* in Warner Robins, GA had *Doc Holiday* in mixing down some tracks. *David Norman* produced and engineered... Recent clients at Ft. Lauderdale's *New River Studios* included Nempereor Records artists *The Romantics* in overdubbing and mixing their new album. Co-producing and engineer-

ing duties were shared by *Pete Solley* and *Gordon Fordyce*, assisted by New River's *Ted Stein*. Also, *Bob Seger* was in overdubbing his next LP. *David Cole* engineered, assisted by *Ted Stein*... *Commercial Music Productions, Inc.*, a Columbia, SC-based production company, finished production of a music image package for WTVM-TV in Columbus, GA, at *GEM Recordings* in Columbia... At the *Creative Workshop* in Nashville, *The Judds* completed their new R.C.A. album with *Brent Maher* producing... Mastering engineer *Randy Kling* of *Disc Mastering Inc.*, Nashville, has been busy on an album project featuring Number One hits by country stars like *Dolly Parton*, *Waylon Jennings*, *Elvis Presley*, *Razzy Bailey*, *Alabama*, *Earl Thomas Conley*, and *Charley Pride*, among others... At *Woodland Sound Studios* in Nashville, producer *Kelso Herston* was in and out working on jingles for Sears, Ford Motor Company, Lowenbrau Beer, Bojangles, and Wisc. Power & Gas Company. Engineering was *Travis Turk*...

## SOUTHWEST

*Planet Dallas Studios & Publishing Companies* have been open since January 1985 and have been working with Texas-based bands and writers, among them, *The Escorts* and *The Tribe*. Recently in from Los Angeles working with *The Tribe* was engineer/producer *Henry Lewy*, known for his work with Neil Young, Joni Mitchell and others... *The English Band* called *Rivendell Recorders* (Pasadena, TX) their home for a month recently. *Joe English* and *George Cocchini*, together with *G. Brian Tankersley*, produced the tracks for the band's new LP... Voted by the Texas Music Association the top sound engineer for 1985, *Phil York* engineered *Robert Lee Kolb & Local Heroes'* first album at *Crystal Clear Studios* in Dallas... At *Dallas Sound Lab*, producer *Bob Farrar* recorded film scores for General Dynamics and M Corporation on 24-track digital with *Rusty Smith* of the Dallas Sound Lab engineering... Recent activity at *Goodnight Dallas* included producer *Randy Wills* in session cutting overdub Kurzwel tracks for an upcoming album by *Elizabeth Seales*, and a video album for *Joe Atkinson*. Engineering was by *Ruben Ayala*... Sessions at *Lone Star Recording* in Austin took on a European flavor as *Bad Sign*, a rock group from Finland, recorded and mixed their album, *Travelin' Bone* with producer *Vince McGarrey* and engineer *Jay Hudson*... Dallas' *Castle Re-*

—PAGE 164





*What drives successful people?*

An age old question that can now be answered in literal terms; the people are Showco, the answer is Crown.

Consider the major tour. Each move a major task. Truckload after truckload of sound and lighting equipment must be put up and torn down, more often than not, overnight. In most cases the awesome responsibility for a successful technical performance rests squarely on the shoulders of Showco.

A tour company, with a client list that reads like Billboard's Top 100, Showco has been at the forefront of this highly specialized field for years. Their reputation stems from a finely tuned marriage of technology and sweat. We are proud of the many years we have been involved in Showco's efforts and our new Micro-

Tech™ 1000 power amplifier dramatically illustrates the value of this relationship.

Innovative Crown technology shaped by advice from Showco has produced a more powerful, lighter and smaller amplifier ideal for the touring professional. Higher power, less weight and less rack space translate into critically needed efficiency on the road.

Currently on tour with the largest system ever designed for indoor arenas, Showco once again relies on the power and dependability of the Crown product. 134 Crown PSA-2s and 28 new Micro-Tech 1000s supply the power -- in excess of 200,000 watts to drive over 16 tons of loudspeakers.

The performance of the new MT-1000 further strengthens the dependability of Crown amplifiers. The only reason Showco has had to touch their new amps is to move them. And move they have, 78 shows in 52 cities without a failure of any kind. Not surprising for a Crown product but unheard of in any product fresh from the assembly line. Months of Showco's heavy duty field testing has established the MT-1000's reliability even before it hit the market.

At your next concert take a look beyond the performers; chances are you will find Showco and the driving force of Crown.

Crown International, Inc., 1718 West Mishawaka Road, Elkhart, Indiana 46517. (219) 294-8000



**crown®**

Circle #003 on Reader Service Card

World Radio History

# STUDIO NEWS

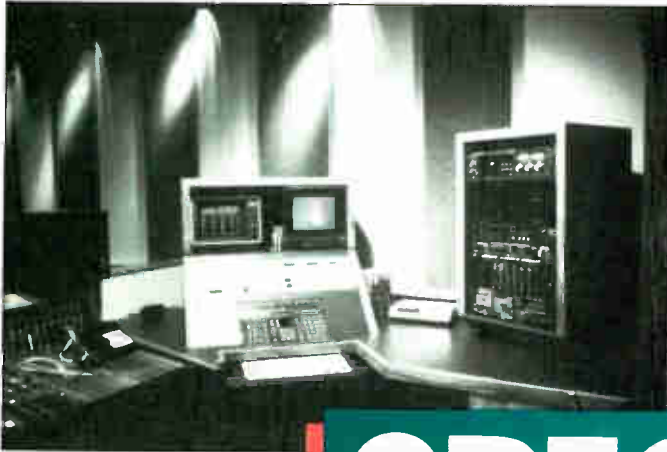

Audio sweetening room for Atari, Inc. corporate facility designed by Randy Sparks of RLS Acoustics of San Francisco. The audio equipment was supplied and installed by Sound Genesis of S.F.



Celebration Recording in New York City recently installed the new Westlake BBSM-12 monitoring system (with spring-loaded shock mounts), and powered by two Hafler PH 500s. Design and installation of the new system was by Al Fierstein of Acoustilog, NYC. The original room design was by Maurice Wasserman.

## SPECIAL EDITION

### A Sampling of New Rooms for '85



(Left) New Age Sight & Sound is Atlanta's first digital multi-track studio, and features the Southeast's first Sony PCM 3324 recorder as well as a Sound Workshop 50 input console. The facility was designed by Jerry Milam, who recommended the studio install RPG diffusers on the back wall of the main control room. New Age has only been open since spring.



Abba's Polar Studios in Stockholm, Sweden took delivery of the first Calrec UA8000 48-channel console, to go along with the studio's 3M digital recording system.



Cougar Run is a new 24-track studio built in a 25-year-old estate overlooking beautiful Lake Tahoe (Incline Village, Nevada). Owner Jody Everett Peterson selected Carl Yanchar and Lakeside Associates to design the facility, which is equipped with a Neve 8108 with NECAM I, a Studer A800 III and such perks as a heated pool, hot tub and, of course, access to Tahoe. The picture above shows the studio just before completion.



Omega Studios has a new location in Rockville, Maryland, just 15 minutes from Washington D.C. Featuring four studios equipped with a wide variety of top gear (Studer and MCI recorders, an API board with a Neve console expected early next year), Omega's primary acoustical designer was John Gardner. Upon completion, Omega's rooms will be able to handle everything from huge orchestras to video sweetening sessions.



(Left) Showcase Audio/Video Systems' installation at JBS Recording Studio in Atlanta has a number of unique features. The studio is built in an old movie theater, so it has a high ceiling, wood floors and naturally good acoustics. The spacious control room is equipped with an Amek console and two interfaced 16-track Otari MX-70s.



Studio B at Triad Studios (Redmond, Washington) features an LEDE control room along with an acoustically open studio of more traditional design but with flexible acoustics. Control room and studio (outfitted with all the latest state-of-the-art equipment) are suspended on a concrete "floating" floor. Studio B was designed by Tom Hall and Larry Nefzger.

(Right) Located in Alsip, Illinois, ARS Recording Studio (formerly Timbre Recording) has had its control room completely redesigned and rebuilt by owner and chief engineer Gary Cobb, with consultation by Doug Jones of Electro Acoustics Systems. The "new" control room utilizes an LEDE design aided by Sonex and RPG Systems QRD diffusors. The room is equipped with a Trident Series 70 console.



# YOUR WORLD



© 1997 3M Co. "Your World" is a registered trademark of 3M. Photographed at Soundworks Digital Audio/Video Studios, Ltd., NYC.



For you, it's the sixth session of the day. For them, it's the biggest session of the year. So you push yourself and your board one more time. To find the perfect mix between four singers, 14 musicians, and at least as many opinions. To get all the music you heard on to the one thing they'll keep. The tape.

We know that the tape is the one constant you have to be able to count on. So we make mastering tapes of truly world-class quality. Like Scotch 226, a mix of Scotch virtuosity and the versatility to meet your many mastering needs—music, voices, effects. And Scotch 250—with the greatest dynamic range and lowest noise of any tape, it is simply the best music mastering tape in the world.

Both offer a clearer, cleaner sound than any other tape. Getting you closer to your original source. Plus, they're both backed by our own engineers a call away. They are just two of the tapes that make us... number one in the world of the pro.

# OUR TAPE

MASTERS OF CLARITY.

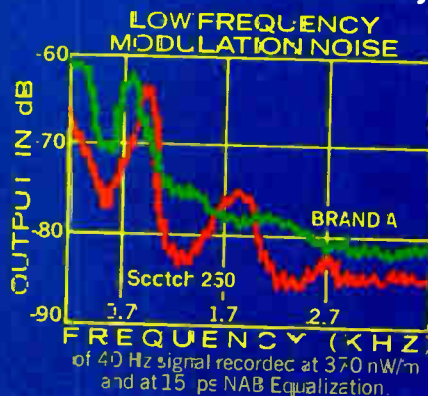

# Scotch®

AUDIO & VIDEO TAPES

NUMBER ONE IN THE WORLD OF THE PRO



# AUDIO-APPLICATIONS

by Ken Pohlmann

You're talking to a guy who rides large displacement motorcycles too fast for complete control. Moreover, I'm totally uninsured. That's right—anti-social, and irresponsible, too. Insurance? Does Allstate issue policies for Russian roulette players?

On the other hand, I'm a lot more careful when it comes to electronic equipment. I've witnessed three micro-computers, two printers, and a stereo system expire at the hands of sudden, cruel fate. Even if I haven't reconciled my own mortality, I have reconciled (and paid for) theirs. Now all of my gear

has line spike and surge protection, with hash filters thrown in, too. The point is that digital electronic equipment is vulnerable to both annoying and catastrophic interference from power line problems. And the danger is from both without and within; black-outs and brown-outs are beyond your control, but your own equipment radiates interference which can cause problems. As studios become increasingly filled with computers, digital recorders, and digital synthesizers, your liability is multiplied. When designing a new studio, build in line protection; in existing studios, add it on.

Partly, it's a question of probability.

between electrically different objects; it might measure a million amperes, and several million volts, providing instantaneous power of a trillion watts. A direct hit isn't required for damage; a strike anywhere in a local utility network can cause a spike up to 5,000 volts, lasting 100 microseconds, to head right up your power cord. The result can be catastrophic or insidious; for example, components may become marginal, to fail later, intermittently.

The other odds which must be considered are non-lightning induced, man-made fluctuations in line voltage. Spikes can also occur through switching off of inductive loads; when a transformer or motor coil is de-energized, the collapsing magnetic field sends a voltage spike back through the line of perhaps 3,000 volts or more. This spike in the circuit could affect other circuits as well; wiring capacitance can couple transients from one wire to another, or from a wire to ground. Thus vacuum cleaners and similar appliances are potentially lethal to sensitive digital equipment. Having equipment problems? It might be the guy next door keeping his rugs clean.

Other man-made line variations proliferate. Aside from black-outs, and brown-outs (5% to 15% voltage reduction), surges above nominal line voltage, and sags below it can occur. Surges and sags are long duration (compared to transients) problems stemming from load fluctuations in the network; their magnitude depends on the

## SPIKES, SURGES SAGS AND HASH

For example, lightning strikes can occur anywhere, but they tend to favor certain unlucky areas. Figure 1 shows the relative frequency of lightning strikes in the U.S. There is no truth to the rumor that South Florida became a 100% area only after I moved here a few years ago. Lightning is a discharge



# These three consoles have a lot in common.

## However, one costs much less.

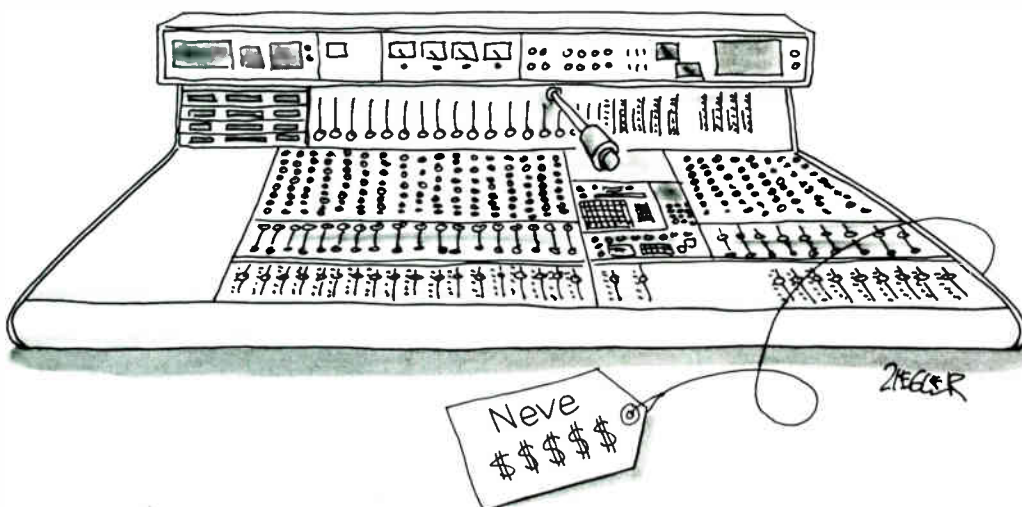
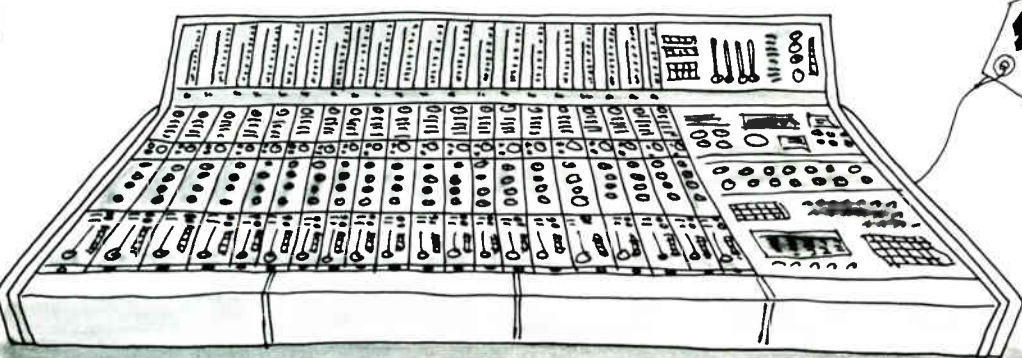
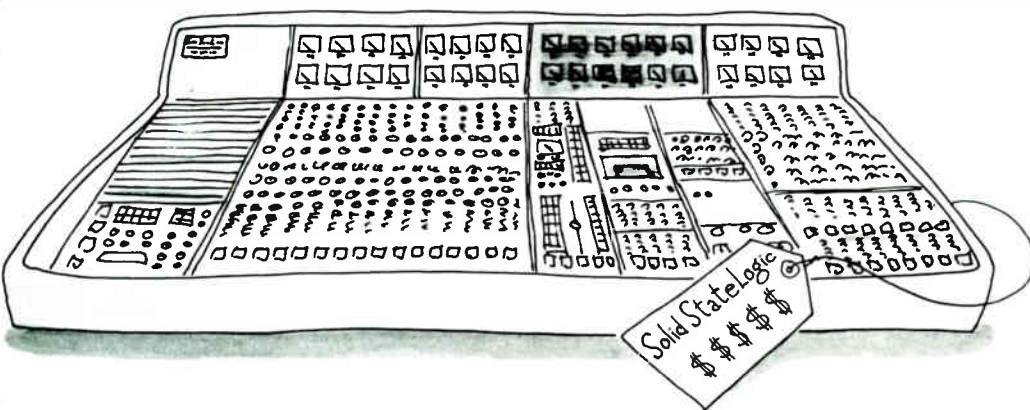

Of the many console manufacturers active today, only three companies had the same inclination years ago to design their consoles around the precision and flexibility of digital control. All three have proven track records backed up by numerous commercial successes. All three are known for their continuing commitment and investment in the R&D and updating of their digitally-controlled console systems.

More importantly, all three are universally recognized for a higher standard of practical functionality and sonic purity achieved through unique approaches to circuitry and signal flow.

Sound Workshop has built its reputation with straightforward, logical and "sensible" designs for the kind of performance that enhances the creative process.

As computer technology invades our industry, many other manufacturers are beginning to incorporate digital control into their products. However, only three companies have years of experience in this area and are today issuing second and third generation systems.

If your studio requires the kind of performance and function that these three companies are known for, but your budget can't stretch to six figures, Sound Workshop is the sensible choice.

The Sound Workshop Series 34B with the new Arms II console computer.

 **sound workshop**  
It makes sense.

AVAILABLE FROM:

**sound genesis®**

BEFORE YOU MAKE A SOUND, LISTEN TO US.

2001 BRYANT STREET, SAN FRANCISCO, CA 94110  
415 285-8900 • 213 622-0212 • TWX 910 372-7393

WorldCircle #004 on Reader Service Card

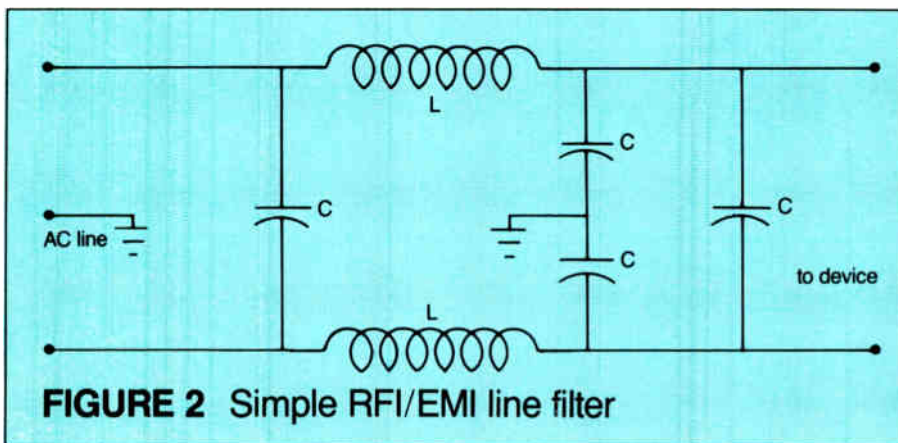

size of the load. The starting current of a motor, a refrigerator or air conditioner for example, can cause a sag, manifested by a momentary dimming of lights. A sag might measure as a 20% reduction in line voltage, lasting hundreds of milliseconds. Surges typically are caused by a sudden decrease in utility demand; an overvoltage exists until the system can compensate. Both sags and surges might occur as a result of a lightning strike as the system tries to cope. The further away you are from a power plant or substation, the greater the chance of fluctuation.

Thanks to modern technology, our part of the solar system is increasingly noisy; our electrical equipment and broadcasting systems radiate made-for-TV movies and other junk out into space. Unfortunately, our own equipment is as receptive to this hash as passing spacecraft. The following are hash sources: motors, small electrical appliances, police or CB radios, commercial broadcasts, corroded light sockets and cords, fluorescent lights, SCR or triac dimmers, welders, diathermy machines, X-ray machines, photocopying machines, DC switching power supplies, internal combustion engines, any digital electronic equipment. We may classify the noise as RFI (radio frequency interference), EMI (electro-magnetic interference), or EMP (electro-magnetic pulse). Whatever its incarnation, it may be understood as high frequency interference with frequency greater than 10 kHz and it may be broadcast from the source, or carried directly through power lines. While direct damage seldom occurs as a result of hash or line interference, it can disrupt the operation of digital equipment.

As I've mentioned, digital equipment itself is a prime course for electrical interference, FCC requirements notwithstanding. With system clock frequencies of 1 to 10 MHz, and the resulting harmonics, broadband interference up to 54 MHz (channel 2) or beyond can be anticipated. Digital

gates open and close at high speed—a rate equal to radio frequency interference; that confusion between normal digital signals and generated noise can cause equipment errors internally, and in surrounding equipment.

A simple AM radio can be used for EMI testing; tune it to the loudest noise, and wander around looking for sources. Not only will digital equipment radiate noise, but connecting cables are culprits as well. A simple computer/printer cable can be an efficient electro-magnetic broadcasting system. Furthermore, an AC cord can radiate noise (especially if it's long, and ungrounded). The complexity of the problem is apparent when it is considered that the hash can radiate from the source, couple from line to line, and be disseminated directly through connecting cabling. Not only is digital equipment a prime culprit, it is also more susceptible to noise than ordinary appliances. Electric typewriters, fans, and lights are virtually immune but your \$10,000 keyboard is highly vulnerable.

What kinds of problems can occur? Anything from flakiness to annihilation. Integrated circuits are thoroughly checked before leaving the fabrication plant, but a certain percentage must appear at the low end of the reliability scale. A marginal chip may fail when subjected to the stress of power line problems. Aging due to normal wear and tear is accelerated by overvoltage conditions caused by surges and spikes. More severe overvoltages damage power supply components as well as chips. If there is no filter, or some low impedance path to ground, it will use the device as its sink. A rectifier diode might fail while running only a fraction of its rated current, voltage regulator integrated circuits and transistors will blow while they weren't even running warm—all thanks to power surges or spikes.

Even a powered-down device can be critically damaged; the surge may arc across the power switch, applying

high voltage to the device. A lightning strike may cause a common-mode voltage surge in which both power lines are raised in a high potential relative to earth. The high voltage may cause arcing across conductors and ground destroying anything which happens to be between a conductor and ground. And, of course, even non-damaging interference takes its toll in terms of lost programs and data.

Now that we've outlined the problems, what can be done? Let's go through the list again, looking for prevention and protection. Lightning is potent stuff, but some simple measures can go a long way. Lightning rods are designed to provide an attraction point and current shunt. The rod itself is a sharp-pointed copper shaft connected by a copper cable to copper-plated steel rod buried in the ground. When mounted at the highest point on a structure, the rod offers a zone of protection around it; larger structures require multiple rods. Because of the extreme voltages present in a lightning strike, flashover can carry high voltage to conductors a foot away. Furthermore, induced surges can spring up in any nearby conductors; further protection is required in addition to lightning rods.

For increased protection against lightning strikes, or any kind of power surges, transient suppression is required. Lightning arrestors such as zeners, thyristors, or varistors should be placed across the AC line, and between AC lines and ground. A high-power zener network can be located across power supply secondaries, or between rectified outputs and ground. A heavy-duty solution to consistent problems is the installation of a constant-voltage transformer; the effect of both surges and sags can be minimized. Isolation transformers provide an ideal way to protect equipment from power fluctuation.

Low-pass filters are effective against both transient and noise problems; 60 Hz is passed whereas high frequencies are attenuated; this is accomplished by a high series input impedance, and low shunt impedance to ground. A parallel capacitor or series coil is the simplest example; for example, veteran TTL builders are well familiar with the 0.01 microfarad capacitor between the power busses and ground to suppress switching transients. More typically in protection devices, L, T or Pi sections are employed; although the filter should be installed at the point where the line enters the equipment's casing, it is usually inserted at the power receptacle. An example of a RFI/EMI filter is shown in Figure 2.

Hash filters can be installed in the device under attack; however, a more enlightened approach counter-attacks by eliminating hash at the source. Any



# M P S

In this confusing new world of music software someone has finally created a computer program that is so powerful that it allows musicians to forget about learning computers and get back to what they like doing best—music. Only now with more control and creative potential than ever before. Behind this program is the same company responsible for some of the music industry's greatest achievements. The company, of course, is Roland. And the product is called MPS. It stands for the Music Processing System. What if a musician could harness the same computer power to create music that writers use in word processing? That's exactly what MPS does. It gives you the creative freedom to develop, edit and shape your ideas into a complete piece of music, all under computer control, totally at your direction. Working together with Roland's MPU-401 intelligent interface, any IBM PC (or compatible) computer and your MIDI instruments, MPS takes you every step of the way from first inspiration to a beautifully realized printed score. The MPS system's power is unleashed in its three operating

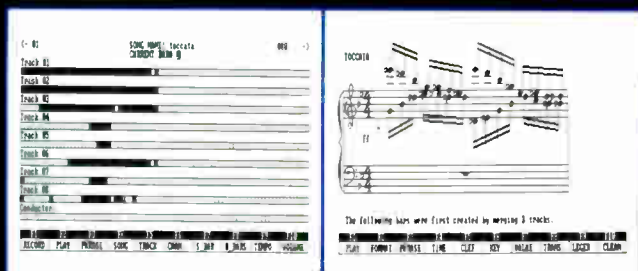

modes: Song, Score and Print. All modes are totally interactive, so that any change made in one is automatically made in the others. In the Song Mode, you assemble musical phrases into complete compositions. Use any MIDI instrument as an input device. Once phrases are entered, they can be altered, edited, combined and recombined at will. MPS Software gives you eight tracks to fill with music. Each track can be assigned to any of 16 MIDI channels and used to drive any MIDI instrument. Merge tracks or phrases as needed and reassign MIDI channels to check out how a passage sounds on different instruments. A clear, concise on-screen display keeps you up to date on track status on a measure-to-measure basis. The process continues as you move on to the Score Mode. Here, the music you've created becomes a graphic score, which can be further polished and perfected. You define keys, clefs and time signatures, transpose octaves, assign accidentals and rests...even change the direction of note flags and stems for a highly legible, musically correct score. There are three different areas on the staff to spell out song lyrics, verbal cues and instructions—everything you want to put into words. When you've finished perfecting your score, you're ready for the MPS Print Mode. Everything you've put into your on-screen score can be transformed into an attractive hardcopy printout via the MPS Hi-Resolution Print Mode. As always with MPS software, you're in control. "Cut and paste" your score to meet your own specific needs. You can print out single parts for individual players or a complete score representing your entire composition. Print copies on your computer's standard printer with or without song lyrics or in any quantity you desire. Break into the future of electronic music production—harness the power of Music Processing with the MPS—the Roland of Music Software. For more information contact: RolandCorp US, 7200 Dominion Circle, Los Angeles, CA 90040 (213) 685-5141. Hardware Required: IBM-PC or full compatible (256K minimum, up to 640K), 2 disk drives recommended, IBM color graphics card and CRT monitor, Roland MIF-IPC interface card, Roland MPU-401 MIDI Processing Unit, Any MIDI-equipped Instrument(s), Optional dot matrix graphics printer (IBM compatible).

**Song Mode: Arrange Phase**     **Score Mode: Arrange Phase**

As always with MPS software, you're in control. "Cut and paste" your score to meet your own specific needs. You can print out single parts for individual players or a complete score representing your entire composition. Print copies on your computer's standard printer with or without song lyrics or in any quantity you desire. Break into the future of electronic music production—harness the power of Music Processing with the MPS—the Roland of Music Software. For more information contact: RolandCorp US, 7200 Dominion Circle, Los Angeles, CA 90040 (213) 685-5141. Hardware Required: IBM-PC or full compatible (256K minimum, up to 640K), 2 disk drives recommended, IBM color graphics card and CRT monitor, Roland MIF-IPC interface card, Roland MPU-401 MIDI Processing Unit, Any MIDI-equipped Instrument(s), Optional dot matrix graphics printer (IBM compatible).



Roland Music Software Series

**MPS**  
Music Processing System  
Version No. 1.0



**Roland Music Software**

Circle #005 on Reader Service Card

Trademarks: IBM and PC, IBM Corp; Roland and MPS, Roland Corp.

World Radio History

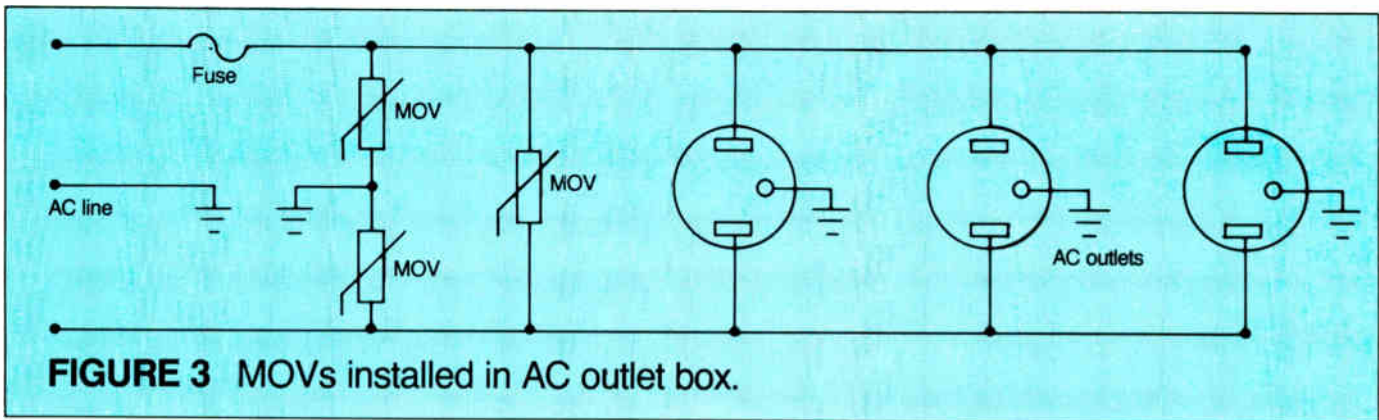

**FIGURE 3** MOVs installed in AC outlet box.

defective wiring should be replaced, filters should be placed on noisy tools or equipment, all covers and shields should be securely fastened, and grounding rules should be scrupulously followed to minimize interference. A summary of RFI/EMI protection includes the following: Enclose sources and receivers within a shield, filter all incoming and outgoing leads, use shielded coax cable for high frequencies, and twisted leads for lower frequencies, use single-point grounding, eliminate ground loops, keep signal sensitive leads short.

In addition to filters, crowbar circuits and voltage clampers are used to sup-

press transients. Crowbars use a thyristor or spark gap to divert transients; it is critical to insure that the protection device can operate quickly enough to catch spikes; for example, SCRs and triacs are often too slow. Metal oxide varistors (MOV) are voltage clamping devices; they operate similar to a back-biased zener diode. Below the threshold voltage, it is an open circuit; above the threshold it conducts and thus absorbs the transient, dissipating it as heat. An MOV can respond to a transient in a few nanoseconds, with peak current capacities up to 50,000 amperes with a wide variety of operating voltages.

For the buck, the MOV is perhaps the most effective insurance you can buy. It guards against high energy power line transients and can be installed in existing power strips. For example, the General Electric V130LA10A MOV will clamp to 340 volts at 50 amperes in 35 nanoseconds; it's available from Radio Shack (part number 276-570) for a few bucks. Three of them should neatly fit inside a power strip; wired between the hot, neutral, and ground wires as shown in Figure 3. Of course, an MOV does not guard against hash; a separate line filter must be employed as well, as described above.

When specing power protection devices, you must determine how many output watts your application requires. Add up the ampere ratings of the equipment to be protected on a line and multiply by the voltage (120) and throw in some headroom; the resulting figure is an approximation of the wattage required to operate the devices, and the rating required of the protection device. A good protection device should offer the following: fast response to repeated voltage spikes, and high frequency filter for incoming and outgoing noise.

Line protection: You can pay a little for it now. Or you can pay a lot for it later. Fortunately, catastrophes only happen to other people. Now, time for a motorcycle ride. It's a hot day; I don't think I'll bother with a helmet. ■

**References**

Ciarcia, "Keep Power-Line Pollution Out of Your Computer," *BYTE*, December, 1983.  
 Ciarcia, "Electromagnetic Interference," *BYTE*, January, 1983.  
 Hahn and Martzoff, "Surge Voltages in Residential Power Circuits," *IEEE Transactions on Power Apparatus and Systems*, vol. 89, no. 6.  
 McCain, "Spikes: Pesky Voltage Transients and How to Minimize Their Effects," *BYTE*, November, 1977.  
 Wiles and Stewart, "What Happens When the Lights Go Out?" *Popular Computing*, August, 1982.

## They know why...

■ "We can work around lights on the studio floor with far less concern about noise."  
 W. E. (Bill) Thompson  
 KPRC TV, Houston, TX

■ "The quietest cable we have ever used."  
 Jim Bartel, Engineer  
 Victor Duncan, Inc.  
 Film & Video Equip. Dist.

■ "The flexible, smooth surface eliminated our kinking and twisting problems."  
 Jim Van Waay, Pres.  
 V. J. Electronics  
 Sound Contractor

### CANARE MICROPHONE CABLES are becoming the professional's first choice.

- Unique "Star-Quad" 4 conductor configuration plus high shield density reduce hum and noise to less than 1/10 that of the leading 2 conductor microphone cable.
- Excellent frequency response preserved due to low capacitance provided by dielectric qualities of Polyethylene insulation.
- Tough, flexible jacket available in 10 colors for easy identification.

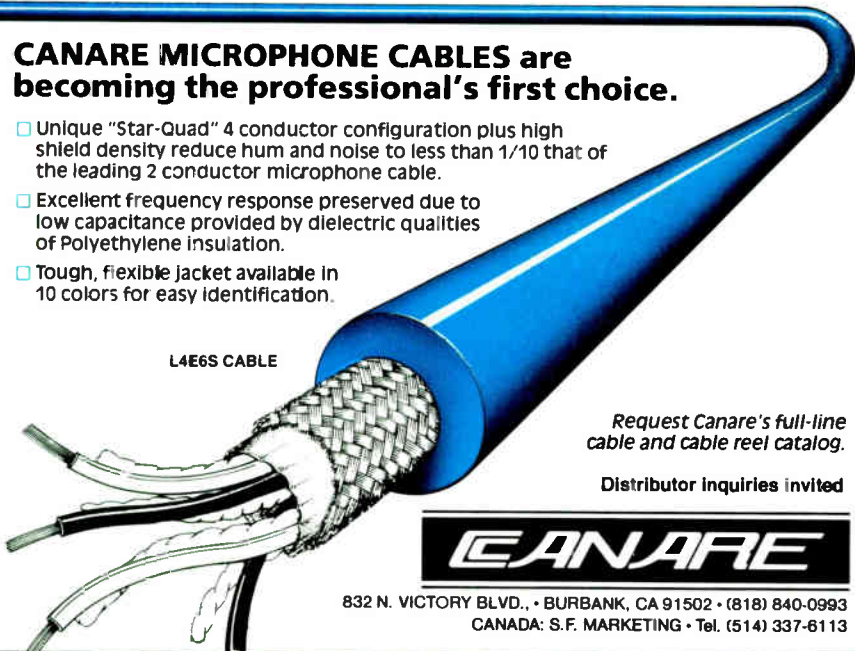

Request Canare's full-line cable and cable reel catalog.

Distributor inquiries invited

CANARE

832 N. VICTORY BLVD., • BURBANK, CA 91502 • (818) 840-0993  
 CANADA: S.F. MARKETING • Tel. (514) 337-6113

Circle #006 on Reader Service Card



# If you're reaching for Gold or Platinum, first reach for **AGFA PEM 469**

Because there's never been a mastering tape like it. Agfa PEM 469 captures your sound perfectly in its complete dynamic range. It's everything you've always wanted. Reach...and you'll succeed...with Agfa PEM 469. The only thing standard is the bias.

**AGFA  
AUDIO**

AGFA-GEVAERT  275 NORTH STREET, TETERBORO, N.J. 07608 (201) 288-4100

Circle #007 on Reader Service Card



PHOTO: MCGUIRE STUDIO

**Rear view of Studio A control room with D'Antonio quadratic residue diffusers.**

involved in each of TRC's upgrades and expansions since 1973, Schatzlein naturally conferred with Milam regarding his plans. "Jerry's part of the 'family' here," says Schatzlein. "We just wouldn't consider a major move or equipment acquisition without involving him."

**Mortuary Site Rejected**

Initial plans were to relocate both 24-track rooms in a downtown building that had housed a mortuary. A local developer planned to restore the building and lease it to TRC. At Schatzlein's request, Milam asked Berger to check out the acoustic feasibility of the place.

"It was a beautiful old building," Berger says, "with stained glass windows and ornate cornice work." But the acoustic problems were formidable. The building fronted on a busy street, so additional windows of heavy laminated glass would have been needed to cover the stained glass. Isolation from low frequency noise would also have been a problem, says Berger, "because the structure is rather flimsy by studio standards." A plan to pour a resiliently-mounted concrete slab over the wooden floor at ground level was nixed by structural engineers since supports in the basement were inadequate.

"It would have cost \$100,000 just to bring the building up to the level of a new shell, from the acoustic standpoint," says Schatzlein, so that site was abandoned. During a visit to Indianapolis, however, Berger happened to look at space adjacent to TRC's Studio B and told Schatzlein he thought that would be quite appropriate for the new Studio A. Studio B is located in a business/industrial park of concrete block buildings with 20-foot warehouse ceilings.

"Our clients like 'B', so the prospect of not having to move or change it much was appealing," says Schatzlein. The firm was able to get space adjoining Studio B for a total of 8,000 sq. ft. at ground level, on a nine-year lease. This allowed 6,000 sq. ft. for the two 24-track rooms, with the remaining space divided into two stories and occupied by the two smaller studios, corporate offices, and support facilities.

**Selecting Design Concepts**

With the site selected, Milam and Berger went to work on the plans for the new Studio A. "They really had to convince me on LEDE," says Schatzlein. "I've tended to believe the bad things I've heard about those rooms, and I just didn't want one." Berger insisted that properly-designed LEDE control rooms best achieve the objectives which define the optimum music mixing environment. According to Berger, those objectives are:

1) Control of short reflections into the mixing environment, so they do not interfere with the direct sound. This, he says, provides "even power distribution over a wide frequency bandwidth throughout the listening area."

2) Creation of "appropriate" ambience, to facilitate subjective judgments ("the room can't be anechoic"). This amount of "liveliness" allows proper judgments regarding microphone placement during recording and the addition of electronic reverberation during remix.

3) Insure that the room's ambience is diffuse as well as optimally delayed in time after the direct sound. This provides assurance that the ambient energy in the control room will not "overpower or degrade the program material."

4) Minimize hard "slap" reflections, so that the room is inert and "free from unnatural resonances and low frequency buildup."

"LEDE was originally perceived as a panacea for the correction of all control room ills," says Berger. "So it became a political issue, with almost everyone taking a firm stand either 'for' or 'against.' But practically everybody is building rooms now that incorporate at least some of the same concepts, whether they're calling them 'LEDE' or not." ("LEDE" and "Live End/Dead End" are trademarks of Synergetic-Audio-Concepts, San Juan Capistrano, CA).

The talk didn't convince Schatzlein.

He flew to Dallas to evaluate Dallas Sound Labs, a studio designed by Joiner-Pelton-Rose using LEDE criteria, and came away impressed. "The 'sweet spot' was really big," he says. "The producer was getting the same flat response and stereo perspective as the engineer." But he remained concerned about the uncertainty of controlling back-wall reflections in this type of room.

**Quadratic Diffusers Make the Difference**

Milam and Berger convinced Schatzlein of their ability to take LEDE technology a step further in the TRC room by installing quadratic residue diffusers (QRDs), made by Peter D'Antonio's RPG Industries, in appropriate locations on the live rear wall. "I just wasn't sure about LEDE until quadratics," says Milam. "It sometimes seemed to be a hit-or-miss proposition, depending upon a hodge-podge of polycylindrical diffusers and angled panels on the back wall. With quadratics we're into a new wave of design. It's like coming out of the voodoo and into reality."

QRDs scatter an incident broad spectrum of audio frequency waves in a hemispherical pattern, just as the undersurface of the "Stealth" bomber will diffuse radar waves rather than sending reflections back to the source.

Milam says it's taken time to gain the confidence to employ QRDs to full benefit in LEDE rooms. The diffuser arrays are expensive (TRC has 14 at up to \$900 each), so nobody wants to install more than are needed. "Studio design requires a balance of budget, client acceptance, and acoustical science," says Berger. "People have used these diffusers sparingly in the past to a good advantage, but the configuration at TRC seems optimal for the present state of the art."

**Selecting a Builder**

Having settled on design concepts, Schatzlein went in search of a builder. After evaluating a dozen contractors, TRC hired Stephco Construction of Indianapolis, headed by Chuck Ballard. "This is the fourth time we've built or completely rebuilt a multitrack room," Schatzlein says, "and we've used a different builder each time. I know what these guys try to do. The minute you glance away they start cutting corners on the acoustic specs, because they just can't believe things really need to be done to those kinds of tolerances. But Chuck is different." A musician himself, Ballard showed a real concern for acoustic considerations as well as aesthetics and musician comfort in the TRC rooms. He's now working as a consultant on several major studio construction projects around the country.

# Focus On Excellence



Introducing the MR-1 Discrete Head Professional Cassette Deck—  
From Nakamichi—the company that created the cassette revolution!

The MR-1—a *professional* deck with front and rear  
balanced inputs, unbalanced inputs, balanced and unbalanced outputs,  
linear-scale peak-reading meters, independent  
Tape and EQ selection, Dolby-B and -C NR, provision for external NR,  
remote control, EIA rack mount and more!

The MR-1—with an Asymmetrical Dual-Capstan Direct-Drive Transport with  
less than 0.027% flutter, an exclusive pressure-pad lifter that eliminates  
scrape flutter and modulation noise, and a Motor-Driven-Cam operating  
system that ensures gentle tape handling, automatic slack takeup,  
and long-term reliability.

The MR-1—with the legendary Nakamichi Discrete 3-Head recording system  
for 20—20,000 Hz  $\pm$  3 dB response, absolute azimuth accuracy,  
and incredible headroom.

The MR-1 Discrete Head Professional Cassette Deck—  
From Nakamichi—the company whose profession is recording!



Nakamichi U.S.A. Corporation 19701 South Vermont Ave., Torrance, CA 90502 (213) 538-8150

\*Dolby NR manufactured under license from Dolby Laboratories Licensing Corporation  
The word "DOLBY" is a trademark of Dolby Laboratories Licensing Corporation

Circle #009 on Reader Service Card



PHOTO: MCGUIRE STUDIO

**Studio A employs Lombard Diffusers mounted in standard suspended ceiling grids.**

The live part of the room is dominated by the QRDs, while the front (dead) part makes innovative use of absorptive panels created for this project by Working Walls (Cleveland, OH). The panels are six inches thick and covered with fabric of TRC's burgundy and grey colors. They contain various absorptive materials in layers as specified by Berger, and fasten to the control room walls with Velcro. The attachment design allowed for prefabrication of the panels in the Working Walls plant, and will allow for easy replacement in the event of future damage or wear.

### Studio A

Flexibility was important in the design of Studio A, since TRC's clients include everything from rock bands to symphony orchestras. Schatzlein wanted a room that was more "live" than the old Studio A, or even than Studio B, to facilitate recording of strings. Yet provisions had to be made for cutting "tight" rhythm section tracks.

The result is a room that is large (roughly 35 x 43 x 14 ft.), and which has both a large drum booth and an iso-booth. The drum booth has its own independently-isolated concrete floor overlaid with hardwood. An oversized window (1/2" sound-rated laminated glass in each wall) provides an excellent sight line into the main room, and an overhead acoustic diffuser system smoothes the booth's decay times. The vocal booth has direct sight lines into the control room and a sliding glass door into the studio. An adjacent piano alcove for the nine-foot Baldwin concert grand features a proprietary overhead acoustical trap.

The main room offers a variety of "live" and "dead" areas, as determined by wall and floor treatment, massive flip panels on one wall, and overhead diffusers. The diffusers, manufactured by Lombardo Diffusor Corporation, mount in standard suspended ceiling grids. The traditional studio cloth walls have been replaced with prefabricated panels made by Working Walls. A unique "step-down" HVAC return and proprietary air diffusers insure that air handling system noise is undetectable even during digital recording of strings.

"Hard" floor surfaces are achieved with Norament synthetic, imported from Germany. In addition to superior acoustic properties, the Norament is extremely durable, as proven by its performance in Amsterdam's Schiphol Airport.

Studio lighting is provided by a theatrical lighting system with eight

### Milam and Berger on "Isolation"

Were there any special isolation problems at TRC? "The outside environment is pretty quiet right now, although we had to keep in mind that somebody could put a machine shop in next door or the airport approach patterns could change to our detriment," Berger says. "But compared to the other location under consideration, this was far superior." The major concerns about isolation were within the TRC complex, which includes four studios and control rooms.

Milam and Berger agree that there is a lot of confusion regarding the rating of walls for sound transmission. "Sound Transmission Class" (STC) is the most commonly-cited measurement, but is not necessarily the best way to rate studio walls, according to Berger. STC is weighted toward the mid-range frequencies, and would be better named "Speech Transmission Class," he says. The criteria were originally developed to measure effectiveness of office walls, and have limited applicability to recording studios. "Low frequency noise control is more important in recording studios," Berger explains. "The lower the problem frequency is, the more expensive the noise control."

Berger's firm is a major consultant on noise exposure to airports, land developers, the Department of Defense, and others. That experience helps them in predicting environmental problems for studios as well as in planning for isolation between rooms in a studio complex. Berger felt that there should be a minimum transmission loss of 72 dB between the inside and outside of a

control room for the TRC project. His lab predicted 74 dB of isolation for Control A at TRC, and tests on the room following its completion have confirmed that figure.

There are some popular misconceptions about isolation, according to Milam and Berger. "In all the magazines you see a block wall with gyp (sheet rock) on either side," says Berger. "That's worse than one block wall and one gyp wall, according to reproducible test data that have been out for 25 years." TRC's Control A front wall is composed of a grout-filled block wall and a sheet rock wall, separated by an air space. Windows are 1/2" sound-rated laminated glass (in each wall). Control monitors, the independent HVAC systems, and the entire studio ceiling are suspended on resilient isolators.

### Control A

TRC's Control A is built according to LEDE criteria, and measures roughly 20 x 22 x 14 ft. (see floor plan). The floor is lightweight concrete, poured on resilient isolators resting on the building's main slab. Walls are grout-filled concrete block (inside), and sheet rock (outside). The outside walls rise from floor to roof deck, and are sealed airtight to the roof around the bar joists. A dedicated high-volume low-velocity HVAC system rests on resilient isolators on the roof and serves this room only. Acoustically-treated ductwork is used, releasing fresh air in a forward direction from high in the back of the room and collecting air from low in the back above the tape machines.

circuits on each of two scenes. A solid state lighting control panel is located behind the mixing desk.

### Designed for Digital

Schatzlein insisted that the rooms be acoustically and electronically quiet enough for eventual installation of digital recording equipment, though he doesn't feel Indianapolis is ready to pay for digital recording right now. The entire A.C. electrical system is wired to hospital-grade grounding codes, with Studio and Control A on their own isolation transformer. Audio cables run in chases along the base of the studio walls, to minimize the number of wall penetrations. Ninety-six mike lines come from various input panels in the studio, drum booth, and isobooth to punchblocks in a shielded cabinet in a loft above the control room, and are routed from there to the console.

### Equipping the Room

The old Studio A had a Harrison 3232, while Studio B uses an MCI JH-528. Schatzlein and his engineers agonized over a replacement for the Harrison. "The 'digital control of analog audio' consoles are an expensive interim step on the way to completely digital boards," says Schatzlein. "When we go digital we'll go all the way." TRC clients and engineers liked the Harrison, and were reluctant to part with it. "A lot of the newer boards, at least in the \$200,000 range, aren't built as well as the 3232," says Andy Symons, TRC chief engineer. The board's Allison automation had proved reliable. And the TRC staff points out that the best-selling LP of all time, Michael Jackson's *Thriller*, was recorded on a 3232.

After much deliberation, TRC embarked on an ambitious plan to re-fit the Harrison board. "Our goal was to bring it up to today's specs without losing its character as a vintage Harrison," says Symons. That involved replacing every capacitor and every pot in the board, and fitting new Allison ECG-202 VCAs. The new VCAs made other circuit changes possible, to increase headroom and transparency while decreasing noise and distortion. The patchbay was overhauled, and the wooden parts of the board refinished in grey laminate to match the burgundy/grey color scheme in the new control room. "We even re-upholstered the armrests," says Symons, who reports that he and TRC maintenance engineer Kevin Van Wyk spent hundreds of hours and several thousands of dollars in parts for overhauling the board.

TRC selected JBL 4435 monitors, and Berger specified bi-amplification. Berger is insistent on critical placement of the monitors (see July 1984 *Mix* article), and has measured differences

of up to 28 dB in frequency-dependent power responses of popular monitors "depending upon where you mount them." Surveyor's sighting equipment was used to position TRC's monitors to within tolerances of one millimeter. The speakers are mounted in specially-designed steel frames suspended on resilient isolators for mechanical isolation from the studio construction, but acoustically coupled to the control room walls with barium-loaded vinyl.

An exhaustive 72-hour series of tests conducted prior to opening the room demonstrated the expected flat frequency response over a wide range of listening positions within the control room. The White 4001 equalizers in the monitor chain are used only when

producers want to duplicate a familiar but non-linear curve from another room. Furthermore, the uniformity of frequency-related decay times makes the room very "honest" in its portrayal of echo and other effects.

Schatzlein says TRC clients are "ecstatic" about the room. "We've got ourselves a hit," he reports. Clients are particularly enthusiastic, he says, about the stereo perception in the control room. "Stereo placement is very accurate from a wide range of listening positions, yet you are not conscious of the speakers as discrete sources of sound. The music comes at you from the entire front wall of the control room, with each track placed just where you panned it." ■

## MILAM AUDIO

1470 VALLE VISTA BLVD., PEKIN, ILLINOIS  
(309) 346-3161

Mr. Gary Schatzlein  
TRC Studios  
Indianapolis, Indiana

Dear Gary,

I am pleased to hear that your new rooms are being so well received by everyone. I have heard a number of your recent productions aired in major markets and the sound is outstanding.

It is always gratifying for me to be part of a project like TRC when a successful plan comes together. With Russ Berger's design and Chuck Ballard's craftsmanship we could hardly go wrong.

As always, it was a pleasure to work with you and Michael, and all of the very professional TRC staff.

Your comments regarding the new MCI/Sony digital compatible analog and digital products are appreciated. I will keep you informed as it all becomes available.

Sincerely,



Jerry Milam

Circle #010 on Reader Service Card

# CONTROL ROOM MONITORING SYSTEMS

The philosophy, as well as the implementation, of Control Room (CR) monitor design has been a controversial subject. As the acoustical aspects of control room design and monitoring have been subjected to the sincere opinions, theories, and styles of engineers and designers, various approaches to CR monitor design have been developed. Up to this point, CR monitor designs can be found which have various levels of tonal coloration, transient reproduction accuracy, imaging coherency, linearity, and distortion.

The current market demands for higher musical and production quality, made possible through digital as well as advanced analog recording techniques, require significant advancements and unifying approaches to control room and CR monitor design. Higher levels of accuracy within all acoustical aspects of the control room monitoring system (the CR monitor and room design) are necessary if the engineer/producer is to be fully equipped to produce to the quality levels allowed and required by advanced digital recording technologies.

## APPROACHES TO HIGHER ACCURACY

by Bill Morrison

The control room monitoring system is a critical, yet fundamental tool required to reveal the sonic truth. The listener must hear in exacting detail and resolution the musical outputs from microphones, the musical effects produced by signal processors, the sonic results of mixing, and the sonic truth of what is ultimately being recorded. If the control room monitoring system is not accurate in its dynamic, tonal, phase, imaging, or transient re-

production, the engineer/producer is in the position of basing technical and creative decisions upon "garbage" information. The potential result is the introduction of production mistakes, musical inaccuracies, and a less than optimum end product.

The accuracy of a CR monitoring system can be simply defined in terms of a comparison between the input electrical signal to the monitoring system (the musical signal which is to be recorded) and the acoustical output as measured at the listening position. If the monitoring system is accurate, the monitoring system will reproduce an exact acoustical analog of the input electrical signal at the listening position. This level of accuracy can be described as waveform accuracy. From a scientific standpoint, accuracy at the waveform level requires that the monitoring system, over the musical dynamic and frequency spectrum, be linear (distortion and compression free), have a uniform steady-state frequency response (tonal accuracy), and have a linear phase response (transient and imaging accuracy).

**Figure 1: Acoustical reflections from the console have an effect upon the monitoring accuracy of nearfield loudspeakers.**

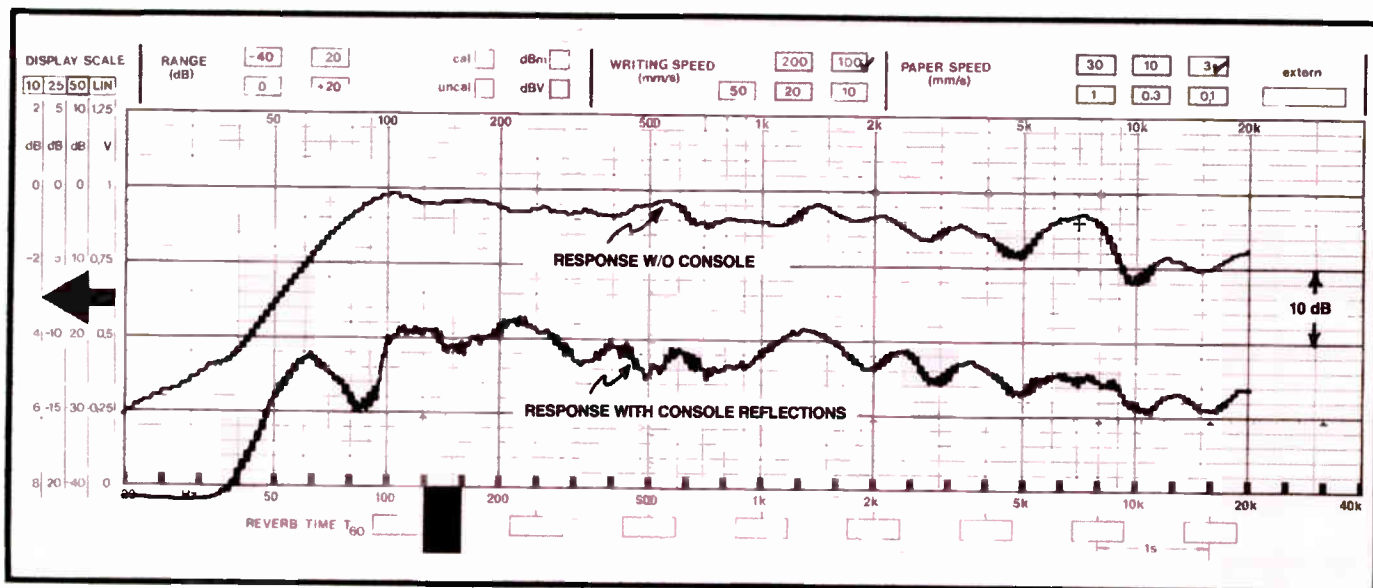



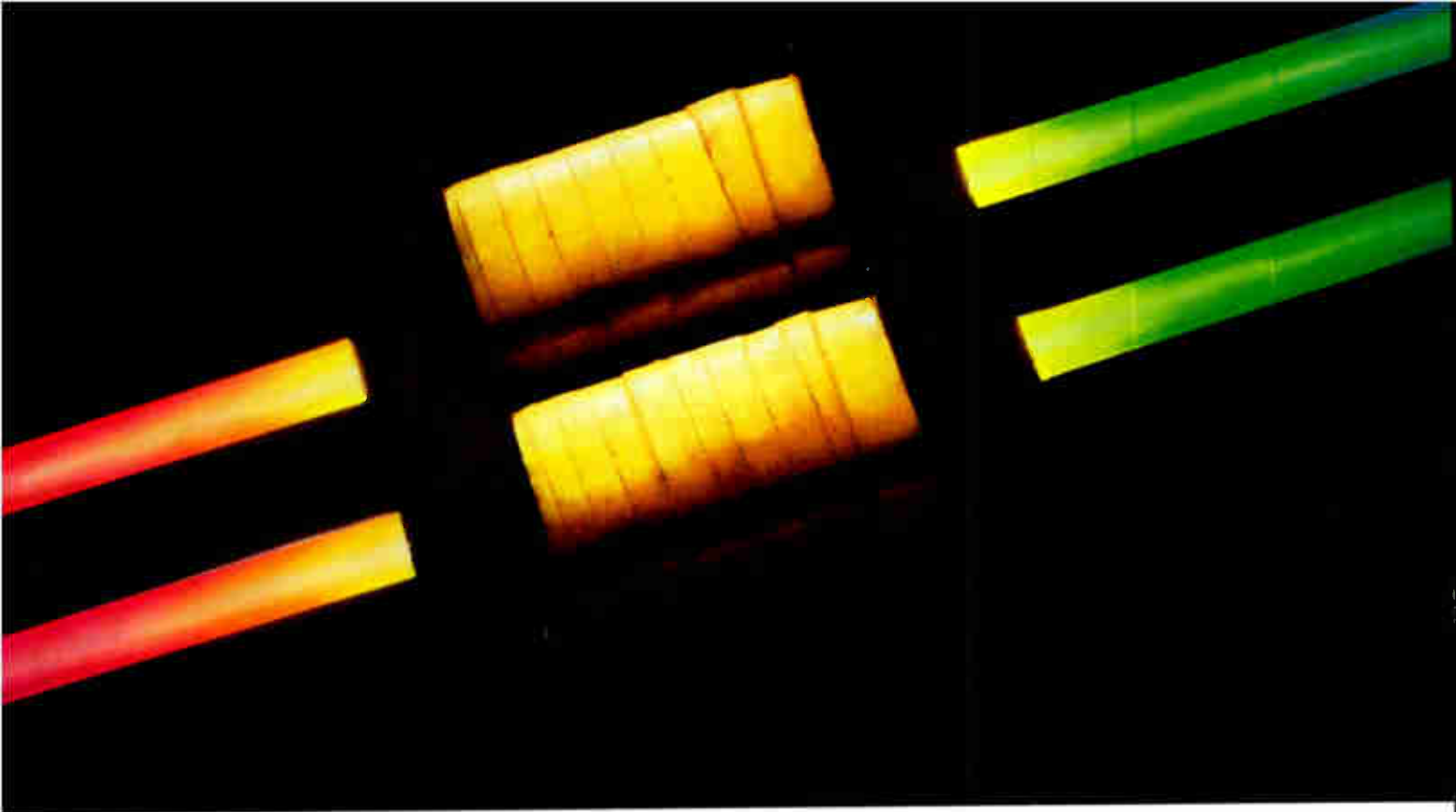

*Our painstaking vacuum and coil-winding technology increases efficiency and eliminates acoustical "buzz"*

## OUR SCIENTISTS HAD TO OPERATE IN A VACUUM TO GIVE YOU A NEW QUALITY OF SOUND.

The quality of any sound system begins at its source. Precision in the power supply is vital to capturing and maintaining the fullness and subtlety of amplified sound. The need for that exactness is why we insist on operating in a vacuum rather than depending on outside sources.

A vacuum tank, to be precise. An environment in which our transformer is created with an air expulsion process. Where air pockets are purged from multi-layers of the transformer's high grade core laminations, and the core made airtight with a special impregnating sealant.

This process gives us impeccable control of transformer function and quality. Which gives you the assurance of the most efficient transfer of power possible, and an end to the acoustical "buzz" that so often fights sound purity.

To a lot of manufacturers the lowly transformer is far down on the list of priorities. For us, every element in the sound system relies on the exacting performance of every other element, and must be painstakingly attended to.

Whether you're driving your studio monitors in a demanding final mix, or powering a massive sound reinforcement array, you'll find our technology giving outstanding clarity to your work in products from our new Model 6230 and 6260 amplifiers to our broad line of signal processing equipment. To find out which system is designed to meet your needs, contact your authorized JBL/UREI professional products dealer today.



JBL Incorporated,  
8500 Balboa Boulevard,  
P.O. Box 2200,  
Northridge, CA 91329  
U.S.A.



UREI  
ELECTRONIC  
PRODUCTS

JBL harman international JBL INCORPORATED 1984

Circle #011 on Reader Service Card

CR monitoring accuracy is objectively testable through properly configured listening tests as well as through instrumentation-based tests. These tests, in order to be valid, must allow a comparison between the electrical input signal to the monitor system and the resulting acoustical output. Such tests are described in Appendix A. Be advised that ordinary listening tests or 1/3 octave analysis techniques are grossly inadequate to evaluate the accuracy of CR monitor systems. That a CR monitoring system "sounds great" or that it "sounds like the live performance" or that it produces a "flat" 1/3 octave real time analyzer display does not necessarily indicate monitoring accuracy.

Assuming that accuracy at the waveform level can be approached within the design of a CR monitor, we must then insure that the control room's acoustical environment does not significantly perturb the CR monitor's direct radiation to the listening position. This requires, within the design of the control room, uniform radiation loading, control of reflections, control of diffrac-

*That a CR  
monitoring  
system "sounds  
great" does  
not necessarily  
indicate  
monitoring  
accuracy.*

tion effects, properly engineered absorption characteristics, and highly damped room eigenmodes. Unfortunately, traditional control room and CR monitor designs do not meet or address these accuracy requirements. The traditional and typical control room has been designed more for pseudo acoustical and dramatic cosmetic reasons than for the purpose of allowing the CR monitors to present an accurate acoustical signal to the listener. As a result, most control rooms exhibit detrimental resonances, reflections, and diffraction effects. These acoustical problems, combined with inherent flaws in traditional CR monitor design, result in significant monitoring inaccuracies.

The traditional and predominant wall-mounted CR monitor system in use today is basically a refined version of a theater loudspeaker system designed in the 1940s. The traditional monitor system incorporates 15-inch drivers in a fourth order vented enclosure with a crossover transition (active or passive) at 400Hz (or above) to a midrange compression horn and high frequency tweeter. Examples of this

**Figure 2: Free field monitors which meet high accuracy requirements allow the advantages of nearfield monitoring with the SPL and bandwidth capabilities of large monitor systems (shown with acoustical shielding removed).**

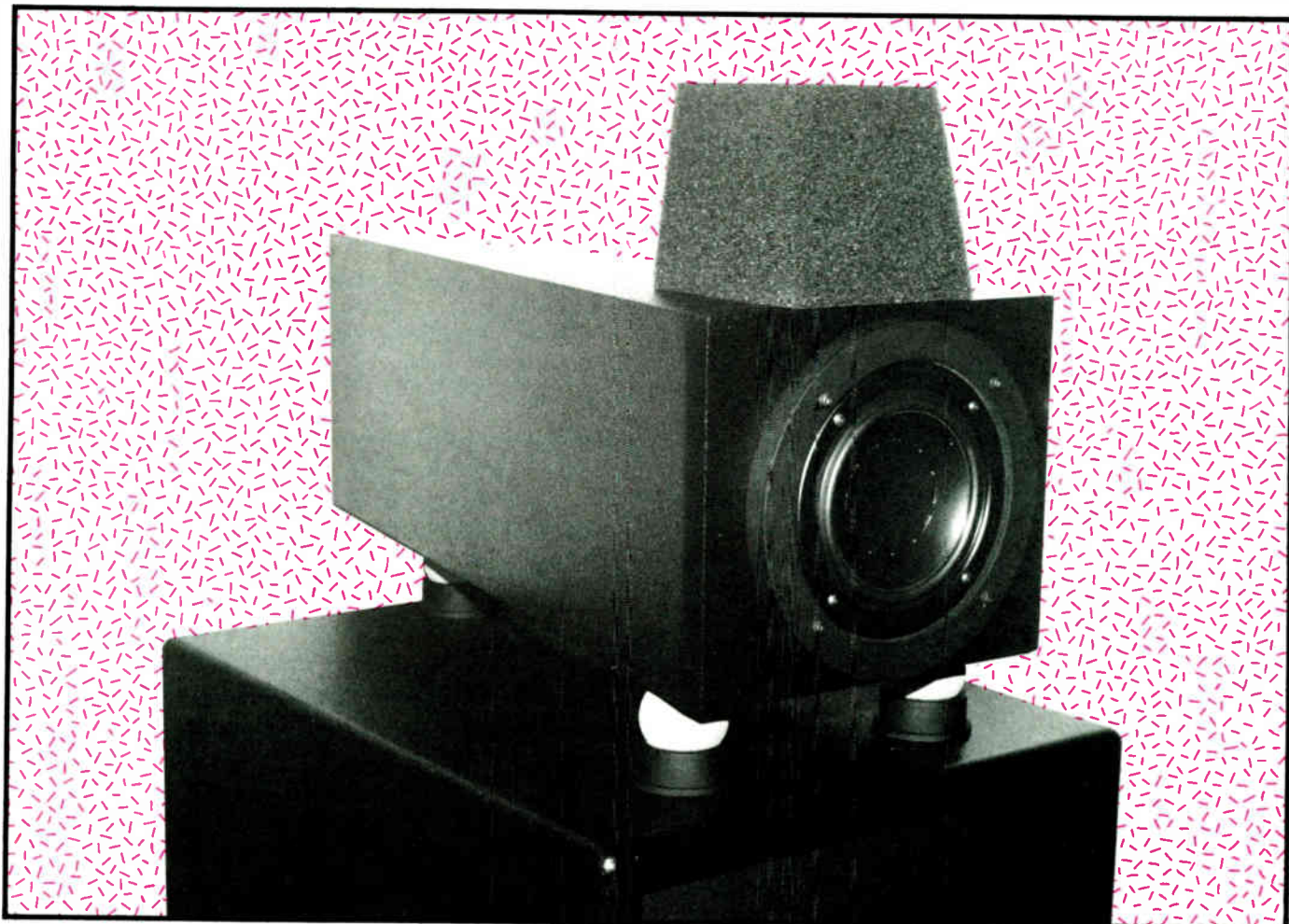



# QUIET CONFIDENCE.

The design of sound studios shouldn't be left to chance. Intuition alone will only get you so far. It's not enough for a studio to "feel good," it must also "feel right." But how do you arrive at a facility that feels right?

Teleimage, Inc. in Dallas recently was confronted with this dilemma. The construction of their new studios in Las Colinas was the realization of a ten-year dream. They were seeking the perfect balance of audio and video quality to offer to their wide range of clients. Though they were willing to try some new ideas to expand the state of the art, they were also seeking the predictability which is so necessary in the recording industry. It was their goal to enjoy the current evolution of multi-track sound studios with one of the most advanced video facilities in the country.

There was one obvious concern. When you are investing the kind of money it takes to develop a studio of

this caliber, there is no room for error. You need the confidence that the design and construction is done right the first time. Joiner Pelton Rose, Inc., consultants in acoustics, blended sound scientific principles with a keen sense of practical application to render a design which was totally compatible with Teleimage's unique philosophy. Their 25 years of experience in environmental noise control, architectural acoustics, video systems, electro-acoustics, vibration isolation, and facilitization provided Teleimage with the quiet confidence which they were seeking.

You can have this same level of confidence on your next project. Simply call 1-214-392-7800 and ask for Russ Berger.



Circle #012 on Reader Service Card

**JOINER  
PELTON  
ROSE INC.**

*Silent Partners in Sound*  
4125 Centurion Way  
Dallas, Texas 75244

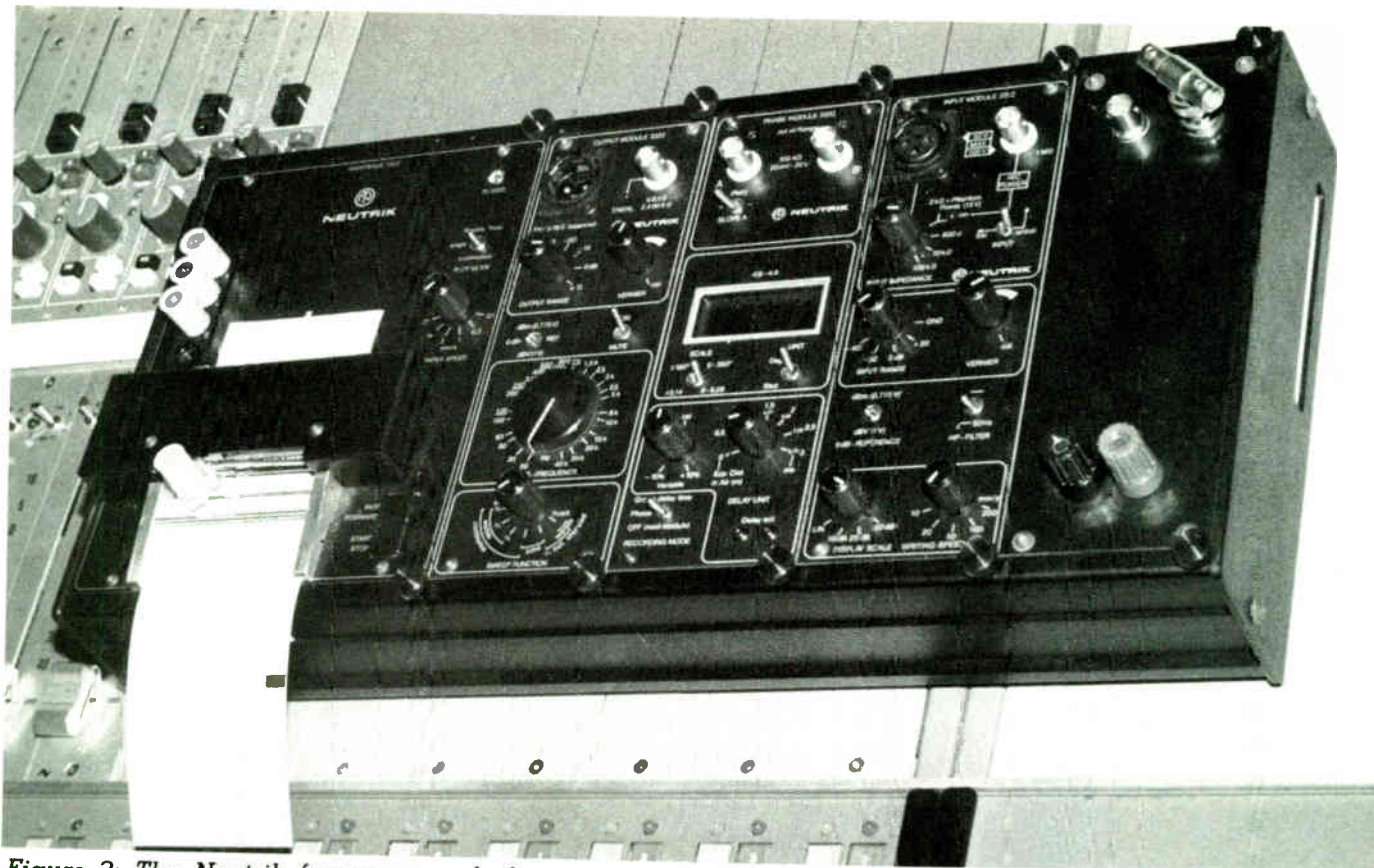

Figure 3: The Neutrik frequency and phase response instrument allows aspects of monitoring accuracy to be analyzed and documented.



**AUDIO • VIDEO RECORDING STUDIOS**  
**251 W 30th St., NYC 594-7554**

**New Music Masters** John Cole - Kid Creole and the Coconuts - David Sigeron - **Serious Funk and R&B Stars** Chaka Khan - Manhattan - Kool and the Gang - **Rap and Beat Artists** Whodini - Jean Michel Basquiat - **Techno Disco Acts** Jocelyn Brown - Mike Theodore - Victor Willis - **Jazz Greats** Peter Erskine - Michael Brecker - Gato Barbieri - Barry Finnerty - Mike Manieri - **Exercise** Jane Fonda "Prime Time" - **National Commercials** Nabisco - Car 45 - plus the ever: **Hard-Rockin'** Ramones have all found the technology, experience and attention to personal style they needed to get the job done at a reasonable price.

PLANET operates two recording studios with up to 48 track capability (64 for mix). It is owned by gold record producers and Grammy award winning engineers.

**Recording Consoles** include a computerized MCI 500 Series and a Trident Series 80 with 40 input modules.

**Tape Machines** are Studer 24 track and MCI 24 track. **Mix Machines** are Studer A80 and Ampex ATR both set for 1/2" mixdown.

A partial list of **Outboard Equipment** includes Lexicon 224X Digital Reverb, EMT Stereo Plate, Valley People Dynamics and DRX Gates, DBX 165 & 160, Urei 1776 Limiters, Marshall Time Modulators, Pan Scan, Lexicon PCM 42's Eventide Harmonizers, Chorus, Flanging and Phasing Effects and much more.

Any additional **Exotic Units** such as AMS Delay, Reverbs and Emulators are available with reasonable notice.

**Synthesizers** (Midi equipped) include Yamaha DX7 Digital, OBB, Moogs. **Drum Machines** include Linn and DMX with DSX Sequencer and Dr. Click.

**Monitor Systems** in both studios are Urei 813's Time Aligned, Ha'tler and Crown powered.

**Recording Areas** are both live and dead end in design, featuring an incredible live drum environment.

**PLANET SOUND IS PROUD TO HAVE WORKED WITH**  
**CHAKA KHAN ON HER NEW HIT LP - I FEEL FOR YOU.**

Circle #013 on Reader Service Card

type of monitor system are currently being produced and marketed by numerous manufacturers and "name" designers.

Inaccuracies inherent in the design approach of the traditional CR monitor are exemplified by the use of fourth order vented bass enclosures, by the use of compression horn systems, by poor electrical and acoustical crossover characteristics, by inherent driver inaccuracies, and by noncoherent acoustical time arrivals from drivers.

The use of fourth order vented alignments for bass reproduction results in non-optimum phase characteristics and transient response ringing. The resulting inaccuracies are poor bass definition, a dominant bass coloration, and bass transient "overhang." Other inaccuracies found in the traditional CR monitor result from the use of compression horns. High Q internal resonances within the compression driver and throat areas of the horn produce transient ringing and frequency response anomalies which are inaccurate, offensive, and fatiguing. In addition, high sound pressure levels produced within the horn throat force air into nonlinear behavior.

The traditional CR monitor system's crossover from low frequency drivers to midrange drivers at 400 Hz or above is at a much higher frequency than optimum. This high crossover frequen-

Eventide SP2016

Dollars  
\$6,895



## NOW IT COSTS MUCH LESS. AND IT DOES EVEN MORE.

**Great News!** Increased production of Eventide's SP2016 now makes it possible for you to get the best sounding, most versatile effects processor/reverb for thousands less. You get the densest, most natural-sounding reverb programs available at any price (just ask anyone who's used an SP). And you get our Generation II software package, with more great effects than any competitive unit. At its new low \$6895 (U.S. list) price, we think you'll find the SP2016 irresistible. Call Eventide at (201) 641-1200 and we'll set up a demo for you.

**More Great News!** Eventide's newest SP2016 Generation II software release includes the hot Reverse and Non-Linear Reverb sounds (just like that British unit—except Eventide gives you TWO independent channels and some additional parameters). Ditto for our stereo Gated Reverb program. Our optional Automatic Fanner program has lots of nifty tricks. And wait 'til you hear our exclusive 18-Band Channel Vocoder program option. By all means, check out all the latest SP2016 software soon. You'll see... We can do everything the others do, but they can't do what we do!

Circle #147 on Reader Service Card

**EVENTIDE, Inc.** • ONE ALSAN WAY • LITTLE FEN World Radio History • LY 07643 • 201-641-1200 • TWX-710-991-8715

flexibility!

**Littlite**<sup>®</sup>

Gooseneck Lamps & Accessories

mixing consoles, amps,  
turntables, effects racks,  
multi-tracks, synthesizers,  
music stands, drum machines,  
keyboards, orchestras,  
d.j. consoles



**Littlite/CAE, Inc.**  
P.O. Box 430  
Hamburg, MI 48139  
313/231-9373

Circle #015 on Reader Service Card

## Your Recordings Can Only Sound as Good as the Cables Used to Record Them



**Introducing Prolink™ High Performance Studio Cables by Monster Cable®**

Many people in the recording business used to think that cables were just cables. And in fact, many of us still do.

**A Sound of their Own.** Many engineers have found that the opposite is true. They are discovering that ordinary cables have "a sound of their own" and distort music recording and reproduction in ways that we were never even aware of. Critical areas such as clarity, depth of bass response, quickness

of transients, and the "naturalness" and "presence" of voices and instruments, are all lost through conventional cables.

**A Monster New Technology in Cable Design.** Monster Cable has shown music listeners worldwide that the sound of their playback systems could be significantly improved simply by changing their cables to the Monster. Now you can obtain an improvement in the sound of both recording and playback that will sur-

prise the most critical and skeptical of engineers, simply by switching from your current connecting cables to Prolink by Monster Cable.

**Come Hear the Monster.** We invite you to hear our entire line of microphone, speaker, and studio hookup cables. Put them through your most critical listening and durability testing. You'll discover just how good your recordings can really sound.

*Prolink™*

**MONSTER CABLE®**

For your free brochure please call or write Paul Stubblebine, Professional Products Division Manager.

Monster Cable® Products, Inc.  
101 Townsend, San Francisco CA 94107  
415 777-1355 Telex: 470584 MCSYU1

Circle #016 on Reader Service Card

cy requires the low frequency drivers, which must produce high cone excursions for low frequency reproduction, to also reproduce a significant portion of the voice range. The result of low frequency cone excursions and simultaneous midrange reproduction from the same cone is the production of bass induced intermodulation and doppler distortion. In addition to these forms of midrange distortion, the operation of the bass drivers above their piston band results in irregular amplitude and phase characteristics where cone body breakup and cone suspension resonances occur.

Crossover networks (active or passive) which are employed in traditional CR monitors are usually 12 dB/octave and are not phase accurate through the crossover region. This, combined with mechanical driver misalignments, results in poor phase and time domain performance for the system. The consequences are inaccurate left-to-right sound stage imaging, inaccurate front-to-back depth imaging, and inaccurate reproduction of complex transient waveforms which have Fourier spectral components spanning the crossover region.

Attempts to salvage the traditional CR monitor design have included substituting various manufacturer's drivers, using various amplifiers, trying different cable systems, using wood horn designs, trying various horn flare geometries, attempting driver time alignments, using 1/3 and 1/6 octave first arrival equalizations (or worse—room equalizations), and various crossover designs. The results of these attempts to achieve higher accuracy from the traditional CR monitor system may produce some levels of improvements, but when analyzed with high resolution acoustical instrumentation and valid, objective listening tests, the futility of these attempts is revealed. These "band aid" type of improvements simply do not address the inherent inaccuracies of traditional CR monitor design approaches.

Many engineers, in addition to using the traditional wall-mounted CR monitoring system, are using, to some degree, nearfield monitors. The use of nearfield monitors varies from their use as analytical mixing tools to their use as typical "cheapo" speakers.

Nearfield monitors do minimize the effects of poor control room design and allow the listener to essentially receive the direct radiation (except for console reflection and diffraction effects) from the monitor; however, the use of nearfield monitors typically results in some monitoring inaccuracies. The crossover frequency from bass to midrange or treble drivers is usually as high or higher than the traditional wall-mounted CR monitor. The result is the introduction of bass intermodulation distortion

# AMEK On-Line At JBS

Foresight. When it's time to upgrade your studio, being able to anticipate the needs of your clients is the most critical aspect of choosing the right system. That's why JBS Studio chose Showcase Audio/Video Systems, the southeast's emerging leader in pro-audio and video.

Working with JBS and the engineers at Amek, Otari, and BTX, Showcase interfaced dual 16 track Otari MX-70s, the Amek Angela, and the BTX Shadow.

The result: The first fully synched Otari MX-70 16/32 track system in the nation. Depending upon their clients, JBS now offers 8, 16, or 32 track with full lock-up to video. And those clients enjoy the sonic superiority of the Angela's famous "English" sound... leading edge technology, at rates they can *afford*.

So whether you're upgrading or building a studio from the foundation, contact Kevin Witt or Lewis Frisch at 1-800-241-9738 (Ga.: 1-800-532-2523). Showcase. The foresight to put you on the leading edge.

**AMEK**  
**OTARI**

**SHOWCASE**  
AUDIO/VIDEO SYSTEMS



# IF YOU'RE IN THE STUDIO...

**I**f you're in the studio, whether as an engineer, producer, artist, tech or manager, you know there are some things you can't do without—things like good clients, the best tape, efficient maintenance and organization...



PHOTO: COURTESY RUSSIAN HILL RECORDING

There's something else you should never be without if you're in the studio, and that's MIX! Because MIX is the publication that is most dedicated to keeping recording professionals informed about their industry. MIX keeps you up to date on the latest equipment and production techniques. It tells you what other studios, engineers and producers are doing. And MIX listings are the most complete guide available *anywhere* to studios and other production facilities...



PHOTO: PHIL BRAY

If you're a recording professional, *you're in the MIX!* If you're not a subscriber, don't delay: use the coupon in this issue to subscribe to MIX today. Because in the studio, there are a few things you should never be without...

## ...YOU'RE IN THE MIX



to midrange reproduction. Drivers are typically operated beyond their piston band with crossover transitions having serious frequency and phase response anomalies. Most nearfield monitors have a limited and inaccurate low frequency reproduction capability. Low power handling in the design of most nearfield monitors (both thermal and cone excursion limitations) results in a limited dynamic range as well as dynamic compression (a form of non-linear behavior—see Appendix A). The results are monitoring characteristics, tonal and distortion related, which vary with the average and peak SPL level of the program material's spectral content.

The positioning of nearfield monitors upon the console results in a transition from nearly full-space to half-space radiation for frequencies with wavelengths that are less than one half of the smallest front baffle dimension. Unless compensation is introduced, the spectral output from the monitor is disproportionately greater (+3 dB) as the nearfield operates into a half space. Reflection and diffraction effects from the console create additional monitoring inaccuracies. Figure 1 demonstrates the effect of the console upon the measured frequency response of a Fostex RM780, one of the better console-mounted loudspeakers.

New approaches to CR monitor design which address the inherent flaws of traditional wall-mounted CR monitors as well as nearfield monitors and which are incorporated in the design of our firm's custom CR monitors include the following: Low frequency reproduction is handled either by QB-3 vented alignments or by aperiodic (non-ringing) acoustic suspension, transmission line, or servo-controlled designs. The QB-3 vented alignment results in improved transient reproduction accuracy, bass definition, and bass detail as compared to the fourth order designs used in traditional CR monitors. Even higher levels of transient response accuracy are achievable through *properly designed* aperiodic sealed systems, transmission line designs, and servo-controlled low frequency systems.

Advanced crossover designs are incorporated which provide high slope (18 dB or greater), 80-120 Hz, phase accurate transitions from low frequency drivers to midrange drivers. This insures that low frequency drivers are not operated above their piston band and that bass cone excursions do not introduce intermodulation and doppler distortion to the midrange of the audio spectrum. Crossover transitions to all drivers within the system are handled similarly to insure that all drivers are operating within their piston band and within a range in which they are accu-

rate and distortion free. In general, proper crossover-to-driver matching, coherent driver time arrivals, and phase accurate crossover transitions are employed and are necessary for the design of accurate CR monitor systems.

High power handling cone and dome-direct radiators are incorporated within high accuracy CR monitor designs instead of compression horn drivers. Recent advances in cone materials and voice coil power handling in direct radiator drivers allows compression horn drivers to be eliminated from CR monitor design (forever). The direct radiators (cone and dome types) do require higher power to produce horn-equivalent SPL levels; however, the significant reductions in coloration, harshness, distortion, and listener fatigue, when compared to horn drivers, are well worth the price of higher powered amplifiers.

The development of new driver technologies may provide even higher levels of CR monitoring accuracy. Our firm is now investigating ribbon drivers, electrostatically-driven membranes, and electrostatically-driven ionized plasmas. Such driver technologies may provide additional advancements in the accuracy of CR monitors; however, objective listening tests and

scientific acoustical measurements of linearity, amplitude, and phase response must be used to evaluate the merits of these technologies.

These new approaches to more accurate CR monitor design, as well as our own proprietary design advances, have been designed, installed, and performance certified as wall-mounted monitoring systems in several recording studios and mastering labs. Unfortunately, such installations into previously designed control rooms can be costly as it is usually necessary to custom construct and design the CR monitor for optimum performance. In many cases, major design modifications or acoustical treatments to the control room are necessary.

A less costly approach incorporates the same design refinements which are incorporated in our custom wall-mounted CR monitors into a "free field" design. The free field design approach can be described as an advanced nearfield design with acoustical shielding to minimize room and console effects. When properly designed, such a system is capable of high accuracy monitoring without requiring major modifications to the control room. An example of a free field CR monitor (designed for Warner Brothers) is shown in Figure 2.

—PAGE 38

# THIS CALLS FOR A CELEBRATION!

The technical advantage you need and the comfortable creative atmosphere you want. Two 24-track studios in the heart of Manhattan. Sal Ciampini, Studio Manager



## CELEBRATION RECORDING INC.

2 WEST 45TH STREET NEW YORK, NEW YORK 10036 (212) 575-9095

A division of MZH&F, Inc.

Circle #018 on Reader Service Card

# RCA Test Tapes



*A Sound Measure*

- Cassettes
- Open Reel up to 1"
- Custom Formats

For a catalogue of standard test tapes or further information contact:

**RCA TEST TAPES**  
DEPT M  
6550 E. 30th St.  
Indianapolis, IN 46219  
(317) 542-6427

Circle #020 on Reader Service Card

**CSE Audio**  
Leads you in the right direction.

**OTARI**  
MTR90

**AMEK**  
Angela

**CSE**

**APHEX**  
**orban**

**ADAMS•SMITH**

**TANNOY**  
& more

(716) 227-7763  
Rochester, N.Y.

Circle #021 on Reader Service Card

—FROM PAGE 35

This specific system is tri-amplified and incorporates a ribbon tweeter, a polypropylene midrange driver in a lead-lined transmission line enclosure, and a transmission line subwoofer system. This "free field" design is capable of 132 dB SPL output, has a frequency response from 25 Hz to 65 kHz, and is phase accurate to within 5 degrees.

The benefits of high accuracy monitoring systems for use in the recording, mixing, and production of music certainly justifies the efforts required. For existing facilities, the accuracy of the CR monitoring system or systems should be evaluated and documented through the series of tests described below.

This usually requires the services of an acoustical consultant equipped with the required high resolution acoustical instrumentation and a knowledge of valid acoustical measurement techniques. If such tests reveal serious inaccuracies within the CR monitoring system, or if it is known in advance of any testing that such inaccuracies exist, a high accuracy wall-mounted or a free field monitor system should be considered. In either case, the installation of a high accuracy monitoring system is a critical necessity if the highest potential for production and recording quality is to be achieved.

### Accuracy Tests for CR Monitoring Systems

The following listening and instrumentation-based tests are designed to assess the accuracy of CR monitoring systems by comparing an input signal to the CR monitoring system with the resulting acoustical output. These tests, in order to be valid, must incorporate highly accurate electronics and an accurate microphone. Electronic instrumentation designed for acoustical measurements with accuracy traceable to the National Bureau of Standards is manufactured by Bruel & Kjaer of Denmark. Crown, Neutrik, IQS, and other companies also manufacture accurate test equipment which can be used for these tests. The Neutrik 3300 is shown in Figure 3. The only microphone which I can recommend for CR monitor testing is the Bruel & Kjaer 4133 1/2-inch air condenser microphone. This instrumentation microphone has the required amplitude and phase response accuracy necessary for CR monitoring tests.

### The Objective Listening Test

The objective listening test allows an observer to make an audible comparison between a musical input signal to the CR monitor and the CR monitor's acoustical output. For this test a switching arrangement is set up which allows

the tester to listen to the input signal at the CR monitor and then switch to listen to the CR monitor's output—as picked up by the Bruel & Kjaer 4133 microphone. Audible differences between the input and the output of the CR monitoring system represent inaccuracies introduced by the CR monitoring system. This test should be performed by using a wide range of musical program materials and SPL levels. Note that the absolute accuracy of the headphones is not a critical requirement for this test to be valid; however, the higher the quality of headphones, the better the resolution for detecting CR monitoring inaccuracies.

### Amplitude or Frequency Response

A basic measurement used to help evaluate the tonal accuracy of CR monitoring systems is a high resolution chart recording of the system's steady-state amplitude or frequency response. In this test, the CR monitor is driven by a constant amplitude sine wave generator which sweeps logarithmically from 10 Hz to 20 kHz. Through the use of an air condenser microphone, a measurement amplifier, and a chart recorder, the amplitude of the acoustical output from the CR monitoring system versus the driven frequency is plotted on a chart. If the CR monitoring system is perfectly accurate, the amplitude of the acoustical output from the monitor system will, just as is the input to the CR monitor, be a constant amplitude over the audio frequency spectrum.

A variation of this test is the swept warble response. In reflective environments, phase interactions between the direct signal from the CR monitors and reflected signals from the room produce narrow band cancellations and reinforcements in the measured steady-state frequency response. To minimize the effects of these narrow band phase interactions, the swept sine wave can be frequency modulated or "warbled". The resulting chart recording, depending upon the amplitude and rate of the frequency warble, is much smoother than the actual steady-state frequency response measurement.

Other techniques for measuring the frequency response of CR monitoring systems include FFT (Fast Fourier Transform) and TDS (Time Delay Spectrometer) methods. FFT techniques typically use impulse signals as the test signal to the CR monitor. The CR monitor's time domain impulse response, as picked up by a microphone and digitally stored, is then, through FFT computer calculations, spectrally analyzed. By analyzing specific time windows of the CR monitor system's impulse response, first arrival, room reflections, and other time-related phenomena may be analyzed.

TDS frequency response measurement techniques allow the same type

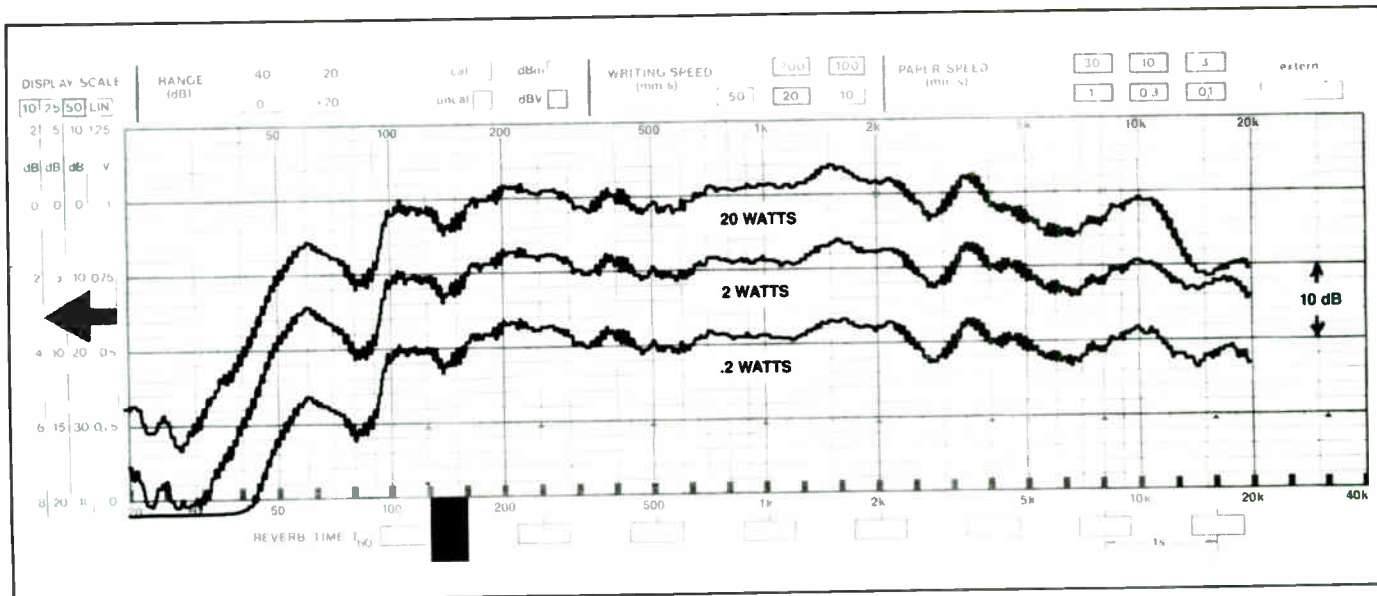

Figure 4: As input levels become higher, monitor systems exhibit compression, resulting in nonlinear behavior.

of frequency response measurements which FFT measurement techniques allow. TDS measurements use swept sine waves as the input signal and perform an analysis of the CR monitor system's acoustical output through the use of a frequency displaced (with respect to the input swept sine signal) swept filter. In both TDS and FFT measurement techniques, care must be taken to understand and use time windows of

analysis which yield valid and meaningful results and to understand the trade-offs in resolution between spectral accuracy and the time windows employed.

The frequency response test, as a basic test method, is capable of revealing great information about the CR monitor's inherent performance as well as determining the effects of the control room upon the monitoring

accuracy. Frequency response plots of the left and right CR monitoring systems should be plotted upon a single chart along with a plot of the acoustical summation of the left and right CR monitoring systems. This allows a comparison of the left-to-right stereo matching as well as revealing left-to-right crossover/driver/room phasing problems. A comparison between on-axis chart recordings of the CR monitor's

# AUDIO AFFECTS

—LA.'s LARGEST FULL SERVICE RENTAL COMPANY—

**(213) 871-1104 (818) 980-4006 (800) 252-2010**

**NEW!!!**

AMS Keyboard Interface for DMX 15-80S ■ Yamaha Rev I ■ Publison 90  
 Dyno-My-Chorus ■ Cyclosonic Panner FSI ■ Drawmer Tube Compressor  
 Massenberg EQ & Limiter ■ ADR Panscan ■ Otari MTR20

AMS • Mitsubishi 2 & 32 track • Otari 4 & 24 track • Q-Lock  
 3/4" video • Yamaha • Synclavier II • EMT • Lexicon • Publison • Quantec  
 Simmons SDS7 • Master Beat • SRC • MXI • Linn 9000 • Emulator II • Drawmer  
 DBX • Dynamite • Tube Mics • Kepex II

**...and LOTS MORE!**

**Call THOM or DERRA today!**

Circle #022 on Reader Service Card

nearfield frequency response and the frequency response as measured at various on-axis positions in the control room (including the listening position) allows room effects to be analyzed. Multi-colored frequency response plots of each driver's response through its respective crossover network combined with a plot of the CR monitor system's frequency response allows crossover transitions to be analyzed.

### Phase Response

The phase response of the CR monitoring system is a measurement of the time delay, expressed in phase angles of the input signal, between the electrical input signal to the CR monitoring system and the acoustical output from the CR monitoring system. The phase

response is measured through the use of swept sine waves or through computer calculations upon the impulse response of the system. The first arrival phase response from the CR monitoring system should be linear such that the first derivative of phase with respect to frequency (called group delay) is zero. Plots of phase response or of group delay reveal time domain-related inaccuracies in crossover design, inaccurate physical alignments of drivers, and phase effects from room reflections. Phase accuracy in a monitoring system is required in order for the Fourier components of musical transients to be accurately reproduced. Accurate phase response is also critical to stereo imaging accuracy as it is the proper time relationships between acoustical

signals which allows the human hearing mechanism to coherently position sounds.

### Linearity

The linearity of a CR monitoring system is a measure of how proportional the CR monitoring system's response is with respect to input signals. Disproportionate or nonlinear behavior from the system results in distortion products. The actual characteristics and mechanisms of the monitor's nonlinearities determine the severity and type of distortion products which are produced. A measurement of the distortion generated by a CR monitor in reproducing a test signal can be accomplished by measuring the residual spectral output from the monitor which is not a part of the input spectrum. This residual output can be expressed as a percent of the input signal's amplitude and plotted as a function of frequency and of driven amplitude level.

Distortion measurements such as intermodulation, transient, difference frequency, out-of-band noise, etc. represent distortion products generated by the monitor's attempt to reproduce complex, music-like test signals. Such tests are important in determining the refinements to CR monitor design which should be addressed. Once a distortion product can be identified and measured, design refinements can usually be incorporated to minimize the distortion.

Dynamic compression is a form of nonlinear behavior which is characterized by less-than-proportional acoustical output from the CR monitor as the input amplitude is increased. This phenomenon can be observed by plotting a series of response curves which represent increases in the power input. As the input power increases, the acoustical output should track the input increases. As input levels become higher, monitor systems will exhibit compression—a restriction in the ability of the system to linearly respond to increased power inputs. This is usually caused by the heating of voice coils or by driver excursion limitations. The result is a change in the shape of the response curve. Figure 4 shows an example of compression in a nearfield monitor. Note that at a 20 watt input level the tweeter's output above 10 kHz is reduced. ■

Bill Morrison is the president of Acoustical Physics Laboratories—a design and engineering firm located in Doraville, Georgia. He holds a Master's Degree in Physics from the Georgia Institute of Technology and specializes in the design, installation, and performance certification of control rooms and control room monitoring systems.

# THE SPOILERS

**OTARI** - Soundcraft - e.a.r.



**SPOIL YOUR CLIENTS WITHOUT SPOILING YOUR BUDGET WITH OTARI'S NEW MX70 16 TRACK AND SOUNDCRAFT'S SERIES 600 RECORDING CONSOLE. STATE OF THE ART PERFORMANCE, RELIABILITY, AND SERVICE AT A PRICE YOU WON'T BELIEVE.**

- EQUIPMENT SALES
- SERVICE
- SYSTEM DESIGN . . .



PROFESSIONAL AUDIO  
2641 East McDowell  
Phoenix, Arizona 85008  
(602) 267-0600

Circle #023 on Reader Service Card

# THE RIGHT STUFF!

Lenco's New 600 System Audio Distribution Components Put All The Right Stuff Together... Any Way You Want It!

Lenco's new 600 System audio components bring a new standard of performance to the field of audio/video distribution equipment. But that's not the only reason why you'll want to specify the Lenco 600 System for your next purchase.

**UNMATCHED VERSATILITY**  
Mix Lenco Audio and Video Distribution Equipment to suit your needs. Virtually all Lenco distribution components fit the 600 System Main Frame. And you can mix audio/video in almost any combination in the unique 9 cell frame. You're not limited to a 50/50 maximum video-to-audio mix. Engineers will also appreciate our innovative frame and module design which ensures ease of installation and maintenance.

**ENGINEERED FOR PERFORMANCE**  
Lenco 600 System components are built to the toughest standards in the industry, and engineered to assure unmatched performance with specifications such as:

- S/N 105 dBv
- Common Mode Rejection 70 dB

- Intermodulation Distortion < .004%
  - Total Harmonic Distortion < .006%
- up to 24 dBm
- Finally, our design engineers have taken extreme caution using grounding and shielding to minimize crosstalk.

**SUSTAINED SUPPORT SERVICE**  
If you should experience a problem with any Lenco component, we can supply a loan replacement from our factory... Fast, usually within 24 hours. It's just one more reason why when you need "the right stuff" for your audio or video operation, your first choice should be **The Professional's Choice... Lenco.**

For complete technical information on Lenco's New 600 System Components and the full line of quality Lenco distribution equipment, Call Toll-free: 1-800-325-8494.

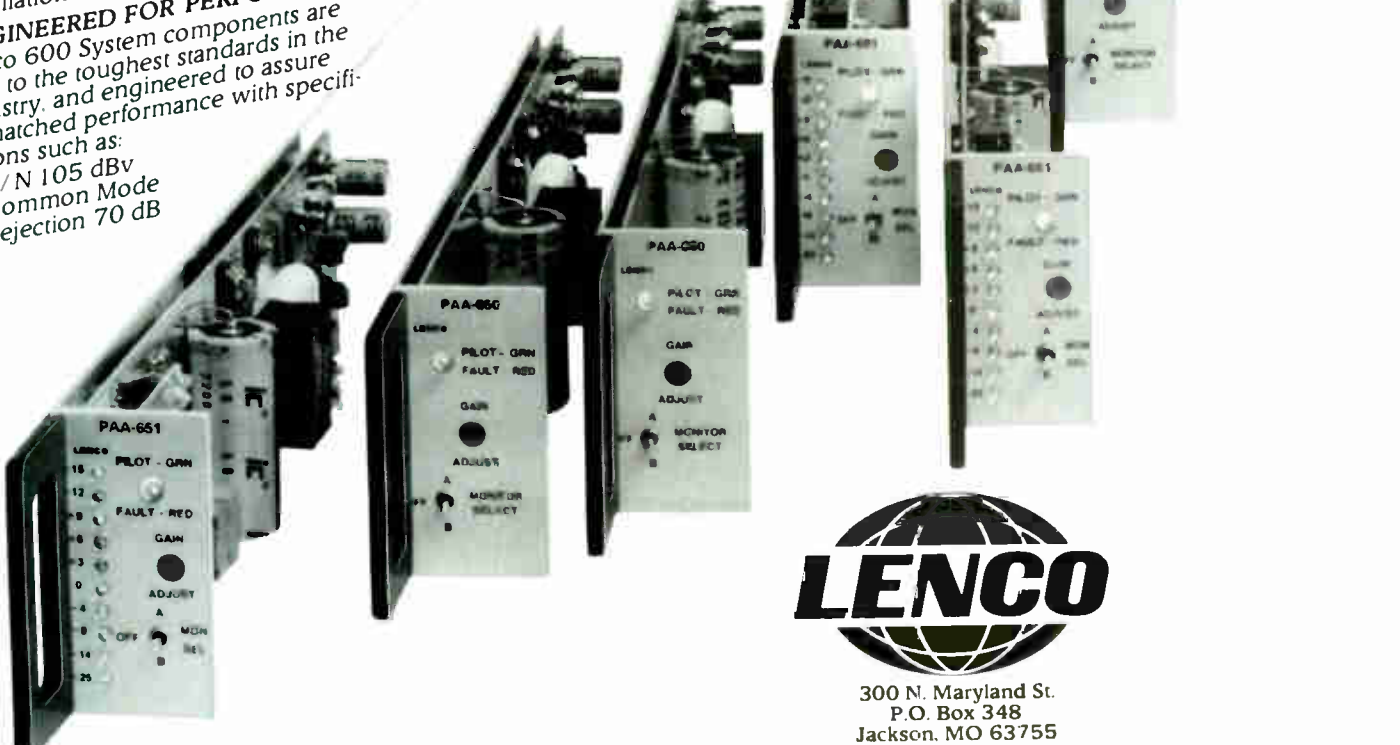
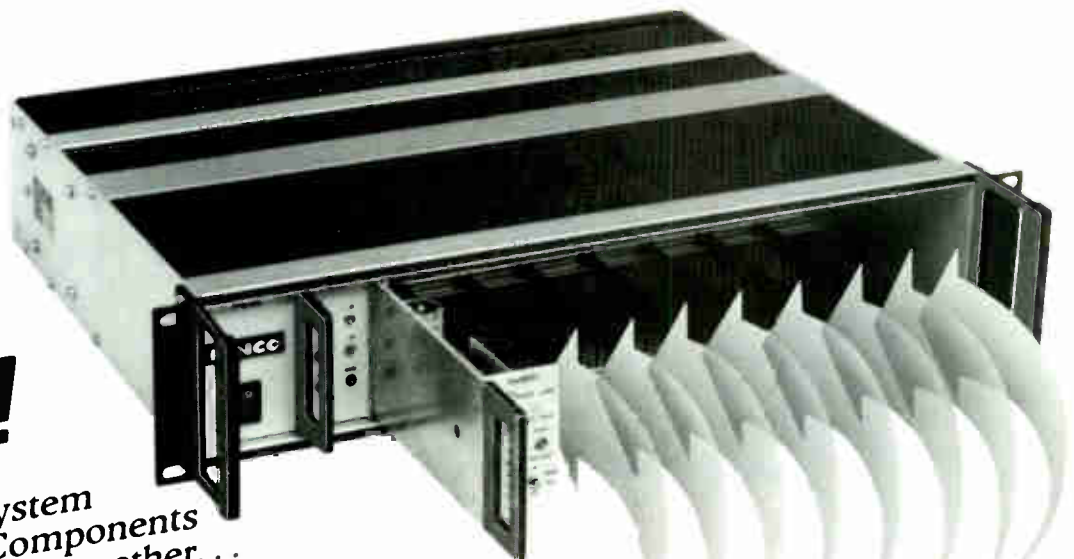

300 N. Maryland St.  
P.O. Box 348  
Jackson, MO 63755  
1-314-243-3147  
TWX-910-760-1382

# ELECTRONIC ACOUSTICAL MODIFICATION

## *Is there a future in the studio?*

by William Johnston

In these days of rising building costs and a demand for flexibility, studios everywhere are searching for a solution to the age-old constraints of acoustics. Gone are the days of the nearly anechoic studio, completely devoid of reflections and reverberation; likewise the days of completely live rooms are numbered. Furthermore, most small and medium-sized studios cannot afford to build two separate recording rooms, each featuring a contrasting acoustical medium. The cost is just too high for materials, the real estate and labor. Thus, many studios try to straddle the fence by creating a single room which has a live end and a dead end. This, when combined with variable absorbers, can change the acoustics of a room to a moderate degree. Yet this method can be expensive and inefficient.

So, how can a studio create the ability to record a commercial jingle in the

afternoon, and the Budapest String Quartet at night? The answer may lie in the area of electroacoustics, a relatively new science, which has been used to modify the acoustics in concert halls since 1964. It has been used to correct existing facilities which were deficient, and to create multi-purpose halls capable of everything from speech/lecture acoustics to liturgical music.

Psychoacoustic research by German physicist Manfred Schroeder has shown that when not told of an electronic modification, people's conception of a concert hall's acoustics changed consistently for the better after the system's implementation. In the original installation of Assisted Resonance at Royal Festival Hall in London, no one was told of the electronic enhancement. Meanwhile, both critics and musicians began commenting on the improved sound of the hall. At a recent installation at the Hult Center for the Performing Arts in Eugene, Oregon, the man-

agers have avoided the performers' fear of the system by not telling them about it. What you don't know can't hurt you, right?

Yet, according to acoustical consultant Chris Jaffe, an expert in electroacoustics, "Electronic acoustics is not a panacea. It is not a substitute for natural acoustics, allowing the architect to ignore the physical requirements of good acoustics. [Electronic acoustics] is just one of the many tools we have at our disposal. Why not use it where appropriate?" And, the modern recording studio, with its ever-increasing need for flexibility and the high standards demanded by the digital revolution, seems to be an obvious candidate for this electronic assistance. These systems could be made available to existing studios who desire the option of increased reverberation and stronger wall reflections, or to new studios designed with the system from the ground up.

### ELECTRONIC ACOUSTICAL MODIFICATION DEFINED

There are two discrete, yet interacting systems which can be used to enhance the apparent size, reflections, and reverberation of an environment. If we rummage through our old Acoustics 101 notes we will remember that reverberation can be represented as a series of strong initial reflections, followed by a series of diffuse reflections which decay exponentially (figure 1). Thus, in order to recreate the apparent reverberation in a room, we must simulate the early reflections in one system (A), and the diffuse reverberation in another (B). The interaction of the two should closely approximate the natural phenomenon, as shown in figure 1.

The first implemented system, called Assisted Resonance (AR) by designer P.H. Parkin of the Building Research Station, centered only on the diffuse reflections (B). Parkin's design utilized a normally undesired audio property: acoustical feedback. Parkin used a series of controlled feedback loops con-

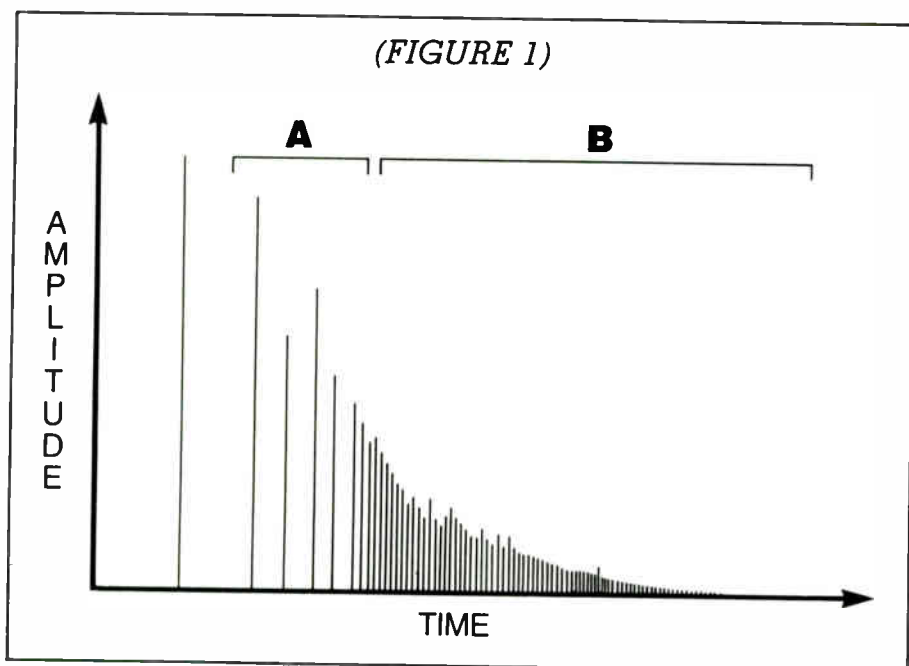

# ANNOUNCING THE FIRST BROAD-BANDWIDTH WIDE-ANGLE ACOUSTICAL DIFFUSOR—THE RPG™



Chicago Recording Company—Chicago, IL

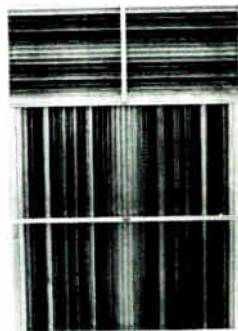

QRD® Cluster



TRC Studios—Indianapolis, IN

The RPG is a new modular diffusive surface treatment which uniformly distributes a broad bandwidth of acoustical energy in a room, without absorption. The RPG can easily, effectively and economically enhance the acoustics of any critical listening or performing environment.

The RPG consists of a series of wells of equal width, but different depths, separated by thin dividers. Well depths are based on quadratic-residue sequences. The spatial and temporal diffusion provided by the RPG minimizes frequency coloration by eliminating flutter echo, resonances, intense specular reflections and slap echos.

In addition, the RPG provides a unique dense reflection pattern which:

- Increases the apparent size of small rooms and the clarity and intelligibility of large rooms
- Allows accurate evaluation of signal processing and reverberation in post-production
- Increases the psychoacoustical spatial impression associated with early lateral sound
- Enhances the binaural perception of spatial textures and stereo images
- Provides ensemble reflections for performing musicians
- Affords a neutral ambiance

- |                       |                           |                           |
|-----------------------|---------------------------|---------------------------|
| • ACOUSTICAL CEILINGS | • DISC MASTERING          | • RADIO PRODUCTION        |
| • AUDIO-FOR-VIDEO     | • EDITING SUITES          | • RECORDING STUDIOS       |
| • AUDITORIUMS         | • EXHIBIT DEMO ROOMS      | • RECORDING CONTROL ROOMS |
| • CHURCHES            | • FILM MIX                | • REHEARSAL SPACES        |
| • CONCERT HALLS       | • MOBILE STUDIOS          | • STEREO TV PRODUCTION    |
| • CONFERENCE ROOMS    | • ORCHESTRAL/CHOIR SHELLS | • THEATERS                |

The RPG is a new architectural design component which was formerly unavailable. We invite you to investigate how this innovative technology can improve the acoustics of your next project. Join the growing number of RPG diffuser users, a few of which are listed below.

**Acorn Sound Recorders—  
Oak Ridge Boys**  
Hendersonville, TN

**Mastermix**  
Nashville, TN

**Mastersound Astoria**  
Astoria, NY

**Medallion Film Labs**  
Toronto, Canada

**NBC**  
Burbank, CA; Brooklyn, NY

**NFL Films**  
Mt. Laurel, NJ

**New Age Sight & Sound**  
Atlanta, GA

**Otis Conner  
Productions**  
Dallas, TX

**Polygram**  
New York, NY

**RCA**  
New York, NY

**Sigma Sound**  
New York, NY

**Jimmy Swaggart  
Ministries**  
Baton Rouge, LA

**Streterville Studios**  
Chicago, IL

**Tele-Image**  
Las Colinas, TX

**WFMT Radio**  
Chicago, IL

All QRD® 2' x 4' modular models are now in stock

For more information write or call:

**RPG DIFFUSOR SYSTEMS © 1985**  
12003 Wimbledon Street  
Largo, Maryland 20772  
**301-249-5647**

Canadian Representative: Gerr Electro-Acoustics, Ltd.

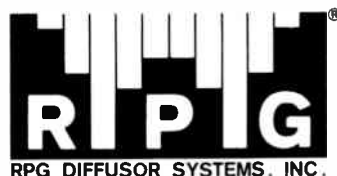

Patent Pending

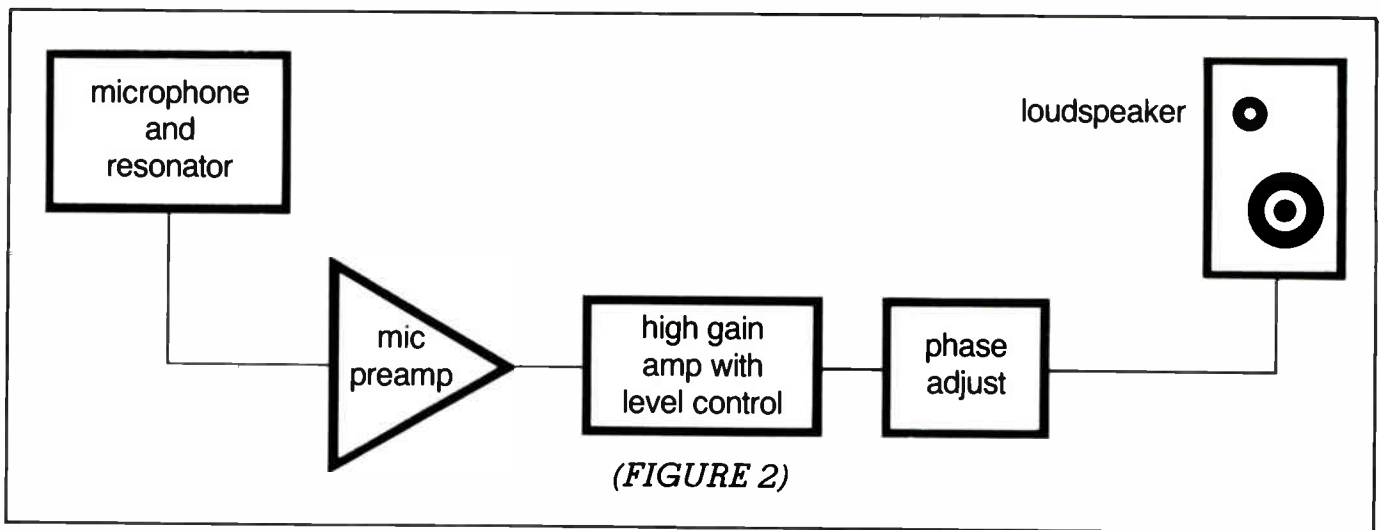

sisting each of a microphone, a mechanical equalizer, an amplifier, and a loudspeaker spaced throughout the lower audio band. By tuning each feedback "howl" to a specific frequency, Parkin was able to significantly increase the decay time in the hall. This is shown in figure 2.

The second, more recent system, developed by Chris Jaffe, is known as the Electronic Reflected Energy System (ERES), which is a long name for a fairly simple, yet effective idea: To create artificial reflections from a wall through

the use of digital delay lines, and to change the apparent absorption coefficient of the wall by the use of equalization. Thus, by adjustment of the level, length, and color of the equalization, the apparent distance between a wall and a listener can be changed, as well as the apparent composition of the wall surface.

Therefore, Assisted Resonance can give a room greater warmth and volume, while the ERES system can make a room seem narrower and more intimate. A contradiction? Actually, the

early reflection and the even decay of sound is characteristic of the best concert halls built, and is important to clarity, articulation and warmth in the recorded medium. A closer look at these two systems will help underscore their utility, and the limitations of acoustical enhancement.

**DETAILS OF THE ASSISTED RESONANCE SYSTEM**

Assisted Resonance attempts to modify the acoustics of the space, rather than modify the sound delivered to the

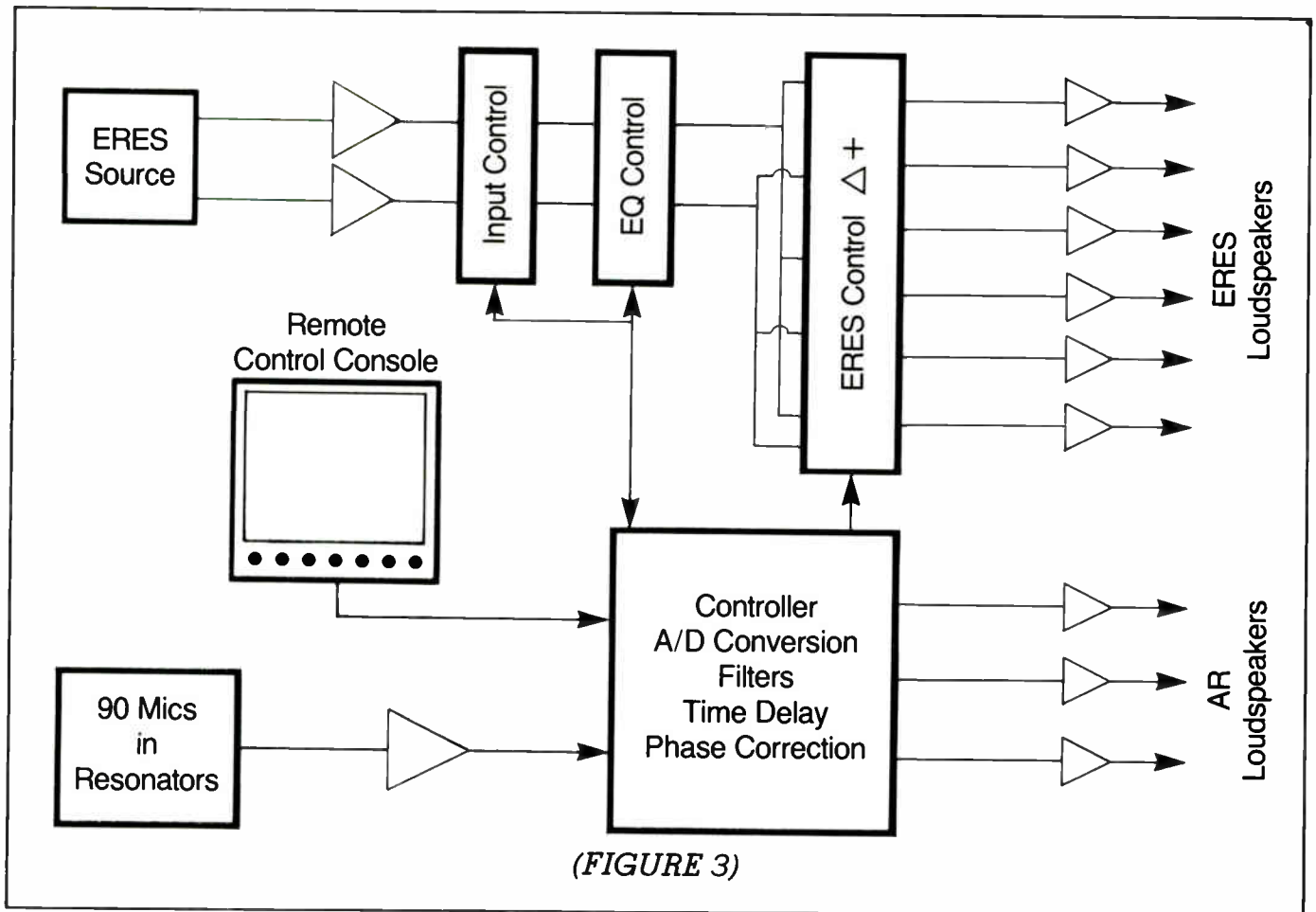



**martin rents AMS**  
**martin rents Aphex**  
**martin rents Calrec**  
**martin rents dbx**  
**martin rents Dolby**  
**martin rents Eventide**  
**martin rents Lexicon**  
**martin rents Neumann**  
**martin rents Otari**  
**martin rents Quantec**  
**martin rents the best**

Whether you need mic stands or a multi-track tape machine, a vintage tube mic or the latest, greatest digital reverb, Martin Audio now rents a full selection of the most-wanted pro audio equipment.

And Martin Rentals has much more to offer than just the best equipment. Martin's applications experts can help you choose and make use of the right equipment for the job. Our renowned technical services staff makes sure that you get the right cables and that every item works every time you rent it. But perhaps above all, Martin's commitment to you is to make each and every rental the best it can be.

So, next time you need to rent, don't just rent equipment...

**rent martin.**

423 West 55th Street/New York NY 10019/(212) 541-5900/Telex 971846

**martin rentals**

a division of martin audio video corp

# McVee productions

## Connecticut's Leading Independent Production Center

- Hitachi and Ikegam Cameras
- 1" Ampex VPR 80 s Slomo & Still Frame
- 1" VPR 20 Portable Type C VTR
- 45" x 48" Studio with Full Lighting
- Full 1" and 1/2" Computerized Editing
- Duplication 1" 1/2" and 3/4"
- Quantel DPE 5000 sp Digital Effects
- Music Videos
- Full Broadcast Quality Commercials
- Scriptwriting
- Illustration
- Art Services
- Slide Productions
- Rentals

**McVEE PRODUCTIONS**  
will take your production from concept to post production perfection without taking your budget for a ride.

McVee Productions  
P.O. Box 8575  
140 Bradley St.  
New Haven, CT. 06531  
**(203) 776-4800**

(A Division of M.C.V.P. Inc.)

Circle #027 on Reader Service Card

# MOGAMI®

## SUPER FLEX

2 TO 48  
PAIRS  
INDIVIDUAL  
SHIELDED

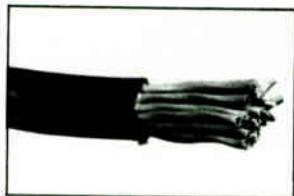

(Shown) MOGAMI NEGLEC 2698  
Hi-Definition 48-Pair  
Multi-Conductor Cable.



Write for free catalog

MOGAMI Product Division

**MARSHALL ELECTRONICS, INC.**

P.O. Box 2027  
Culver City, CA 90230  
(213) 390-6608

Circle #028 on Reader Service Card

space. The feedback of each loop in the system is adjusted so it occurs at the frequency at which the in-phase loop gain is at a maximum. Thus, any increase in the system's gain will increase that frequency's reverberation. Furthermore, by adjusting the system to be perfectly in-phase, any phase drift in the system will merely result in a decrease in gain, rather than a drift toward uncontrolled feedback by approaching the loop gain maximum.

The reverberation of each individual channel can be increased by the factor "R" where,

$$R = \frac{\text{assisted reverberation time}}{\text{natural reverberation time}}$$

Then, the loop will operate at approximately  $20 \text{ LOG}(R / R-1)$  below uncontrolled feedback. Therefore, for small increases in the reverberation time, the system will operate well below feedback, while large increases require one to operate closer to uncontrolled feedback. For instance, if the reverb time is to be doubled, ( $R = 2$ ), the channel could be operated at a safe 6dB below feedback. If, however,  $R = 3$ , a more dangerous level of 3.5dB below feedback is achieved.

Yet, as the loop gain is increased, the Q of the loop increases as well causing the frequency characteristics of the whole system to have a comb-like response. This would cause the number of channels required to increase tremendously, and costs would rise tremendously as well.

In the original Royal Festival Hall application, each of the channel microphones were unfiltered. It was felt that by placing the microphone at the pressure maxima of the particular frequency, it would ensure that each channel would deal only with its own wavelength. Yet, by the time six or seven channels had been installed in this manner, they all combined to feedback at a frequency of their own choosing. The interference between the channels was lessened by the use of Helmholtz and simple tube resonators. Ideally, the resonators respond to a 4% bandwidth, with a Q of 25.

The original channel spacing at the Royal Festival Hall was about 2-3 Hertz. This was based on studies by Shroeder and Kuttruff who showed that the transmission response between any two points in a given space has peaks which may be expected to occur at an interval of:

$$f = \frac{3.91}{\text{reverberation time}} \text{ Hertz}$$

Yet, in subsequent tests and installations, the channel spacing has been developed along an equal percentage

interval rather than an equal frequency interval due to the exponential response of the ear. This results in a cost-saving reduction of the numbers of channels required, and adequately covers the necessary audio band. In practice, a spacing of about 2% beginning at 40 Hertz, moving to a 4-5% spacing at 1800 Hertz is used. In all cases, Assisted Resonance above 2,000 Hertz is unnecessary. The lowest bands from 40-250 Hertz contribute the most to the sensation of resonance, while the higher frequencies are less important due to the increasing effects of the molecular absorption of air.

The large number of channels needed (usually around 75 channels), obviously makes the equipment somewhat expensive. Yet, each channel can be simple and of low cost and power. The response of neither the amplifier nor the loudspeaker need be very flat, since each channel deals with a small frequency area. In practice, an amplifier with a 4% frequency spacing was never asked to deliver more than 15 watts, yet a 50 watt amplifier has been used for a safety margin and distortion's sake. In the Royal Festival Hall, a 20 watt amplifier was sufficient. The exact amount of wattage needed for any application must be calculated by the chosen microphone's output, the speaker efficiency, the frequency mode maximum in phase level, and the amount of reverberation desired. In a studio application, a 20-35 watt amplifier should be enough power since the space is significantly smaller than a concert hall. The primary requirements of the amplifier are that it exhibits high gain stability and phase stability over time.

Incorporated into every amplifier is a low noise pre-amp, a high gain op-amp, a phase adjustment from 0-180 degrees, and a series of resistor values which is selectable for the desired amount of gain.

The loudspeakers' main criterion is a high efficiency in the frequency area that it must drive. Since good frequency response and low distortion are not as important, the speaker selected may have an effective efficiency as much as ten times greater than an ordinary loudspeaker.

The final placement of the assisted resonance system must be as far from the audience, performers and recording microphones as possible. The AR system microphones must be located well past the direct to reverberant critical distance, in the far field where the direct sound has the least effect on the channel input.

Therefore, the logical placement is near the ceiling. While all the energy will be driven from above, this is not noticeable. No doubt this is partly due

to the Haas effect, but another factor must be considered. Since each microphone is driving an actual room mode, the energy arriving at the listener may be coming from an entirely different direction. This is aided by the omnidirectional nature of low frequencies.

The exact adjustment of the microphone placement can be quite tricky. One of the main problems is a room's inability to recreate the same room modes over time. This, coupled with the interaction between the channels, demands that the system be adjusted over the period of several weeks.

By maintaining these parameters, and by spacing each mutually connected loudspeaker and microphone as far from each other as possible, the corresponding resonant mode will be ensured of reaching out into the general volume of the room. The placement of adjacent channels (with respect to frequency) far from each other will also help create an even distribution across the room and minimize channel interference.

### ERES EXPLAINED

The design of ERES is less involved. It is necessary to pick up the direct, balanced sound of the source with a microphone. In a concert hall, this is usually located up in the orchestral shell, about 20 feet above the stage. The object here is to catch a typical direct wave, and then process the sound digitally. The sound may now be delayed, amplified, and equalized. These signals are then fed to loudspeakers mounted on each wall from which a reflection is desired. Assuming the wall's actual absorption is fairly dead, ERES can time the release of the "wall" reflection. In addition to this echo, ERES can delay the lowest frequencies for a slightly separate release. This is an important attribute of the best concert halls, and is essential in post-1800 classical music to convey the warmth and depth of the music.

Obviously, in the studio, one would not be limited to using only one microphone source to capture the sound. A series of hanging microphones throughout the room could be used, or any signal could be routed from the audio console to the delay networks, giving the engineer full control of the source, equalization, and level of reflection desired.

If the reflections take much longer than 25-30 milliseconds, the Haas law of localization will be defeated. Experiments have shown that even if the reflected sound is louder than the initial direct sound, but the time difference is less than 30 milliseconds, the source localization will be preserved. The height of the loudspeaker is not as

important as its horizontal dimension. Since the human ear is not able to precisely localize the height of a sound source when it is less than 45 degrees above horizontal, the speakers can be placed fairly high on the wall, well out of the path of travel. Thus, assuming the time of the reflection is correct, there should be no problem with fixation or localization of any loudspeaker. They should act as a "natural" wall reflection, which we normally ignore psychoacoustically. Therefore, the engineer would have control over which walls in the studio were "live" and which were "dead."

### CONCLUSIONS

Figure 3 is a block diagram of a complete artificial resonance system, integrated with the ERES system that is installed at the Hult Center in Eugene, Oregon. This system is available from AIRO Limited and any need of a hall or room becomes simply a matter of initial tuning and software.

In the studio, these systems could add a new degree of versatility. The

—PAGE 170

# CONSTANT-Q GRAPHICS: THEY ARE BETTER

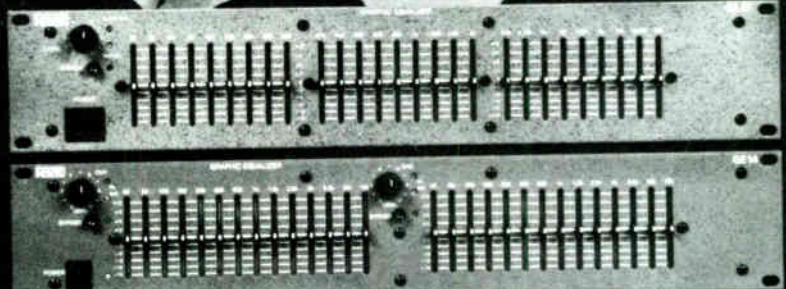

## GE 27 1/3-OCTAVE and GE 14 DUAL 2/3-OCTAVE STATE VARIABLE GRAPHIC EQUALIZERS

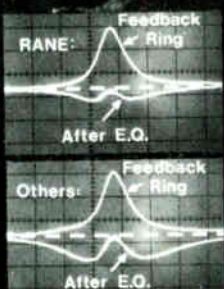

**RANE:** Feedback Ring  
After E.Q.

**Others:** Feedback Ring  
After E.Q.

Constant bandwidth ("Q") filter performance is a quantum improvement over conventional designs where bandwidth seriously degrades at moderate slider settings. These analyzer photos clearly show how Rane's State Variable equalizers can remove feedback tones with considerably less attenuation of surrounding sound quality. Constant-Q filters also have significantly less interaction, which maintains

graphic precision and reduces the need to re-adjust adjacent sliders every time you make a single EQ change.

And yet better technology isn't necessarily expensive: either model costs only \$499 suggested list price. You'll hear the difference —and that's what counts.



6510 216th SW,  
Mountlake Terrace, WA 98043  
(206) 774-7309

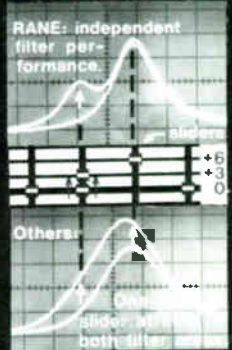

**RANE:** independent filter performance

**Others:** ...



Circle #029 on Reader Service Card

# BEYER RIBBON MICROPHONES AND



**THE DYNAMIC DECISION**

# THE DIGITAL RECORDING PROCESS

## *Digital technology holds forth the promise of theoretical perfection in the art of recording.*

The intrinsic accuracy of the digital system means any recorded "event" can be captured in its totality, exactly as it happened.

Naturally, the ultimate success of digital hinges on the integrity of the engineer and the recording process. But it also depends on the correct choice and placement of microphones, quite possibly the most critical element in the recording chain. This can make the difference between recording any generic instrument and a particular instrument played by a specific musician at a certain point in time.

The exactitude of digital recording presents the recordist with a new set of problems, however. The sonic potential of total accuracy throughout the extended frequency range results in a faithful, almost unforgiving, recording with no "masks" or the noise caused by normal analog deterioration. As digital recording evolves, it places more exacting demands on microphones.

**Ribbon microphones are a natural match for digital because they are sensitive and definitively accurate.** The warm, natural sound characteristic of a ribbon mic acts as the ideal "humanizing" element to enhance the technically perfect sound of digital.

Beyer ribbon mics become an even more logical component of digital recording due to an exceptional transient response capable of capturing all of the nuances and dynamic shifts that distinguish a particular performance without the self-generated noise and strident sound generally

attributed to condenser mics.

**Beyer is committed to the concept of ribbon microphones.** We manufacture a full range of ribbon mics for every vocal and musical instrument application.

The Beyer M 260 typifies the smoothness and accuracy of a ribbon and can be used in stereo pairs for a "live" ambient recording situation to record brass and stringed instruments with what musicians listening to a playback of their performance have termed "frightening" accuracy.

Because of its essential double-ribbon element design, the Beyer M 160 has the frequency response and sensitive, transparent sound characteristic of ribbons. This allows it to faithfully capture the sound of stringed instruments and piano, both of which have traditionally presented a challenge to the engineer bent on accurate reproduction. Axis markers on the mic indicate the direction of maximum and minimum pickup. This allows the M 160 to be used as a focused "camera lens" vis a vis the source for maximum control over the sound field and noise rejection.

Epitomizing the warm, detailed sound of ribbon mics, the Beyer M 500 can enhance a vocal performance and capture the fast transients of "plucked" stringed instruments and embouchure brass. Its diminutive, durable ribbon element can also withstand extremely high sound pressure levels.

The Beyer M 130's bi-directional pattern enables the engineer to derive maximum ambience along with clean, uncolored noise suppression. Two M 130s correctly positioned in relationship to each other and the source can be used as part of the



The range of Beyer ribbon microphones.  
From left to right: M 500, M 160, M 260, M 130

Mid-Side miking technique. The outputs from the array can be separated and "phase-combined" via a matrix of transformers to enable the most honest spatial and perceptual stereo imaging — sound the way we hear it with both ears in relationship to the source.

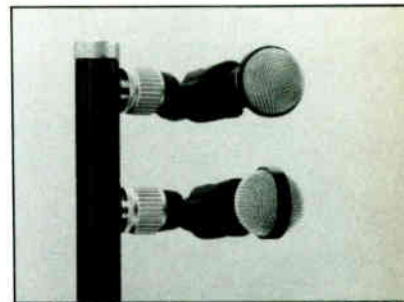

**Given the high price of critical hardware used in digital recording, the relative price of microphones is nominal.** Realizing that microphones are the critical sound "source point," no professional can allow himself the luxury of superficial judgements in this area. Especially when one considers the value of ongoing experimentation with miking techniques. For this reason, we invite you to acquaint yourselves with the possibilities of employing Beyer ribbon technology to enhance the acknowledged "perfection" of digital recording technology.

Beyer Dynamic, Inc.,  
5-05 Burns Avenue, Hicksville,  
New York 11801

**beyerdynamic** 

Circle #030 on Reader Service Card

# CLASSICAL M·U·S·I·C

## RECORDING • TECHNIQUES

by Ron Streicher

### Introduction:

#### The Philosophy of Recording

When planning a recording session, the producer and engineer immediately encounter the primary dilemma confronting the recording process: Is the recording intended to be a "creative" product or a "recreative" one? In the former case, the whole gamut of available technology is open without necessarily any concern for a "realistic sonic perspective." The final product, after all, will be a new creation—emanating from the imaginations of the artists (and producers/engineers) involved.

With the recording of a symphony orchestra, or any "acoustical music" ensemble, however, the process is more constrained: the performance still may be a "new" creation—one that has not previously existed in the "real world"—or it may be of a more traditional nature. The decision is crucial, for nothing relating to the recording project can proceed until it has been made.

The basic difference between a "creative" recording and a "recreative" one is that the former brings something new to the listener—something which need have no reference to any previous musical experience. The latter, however, must draw upon the traditions of several centuries which dictate that certain sonic "conventions" must be preserved. It is this—the "recreative recording"—which is most appropriate for the genre we usually refer to as "classical" music.

Having said that, however, I do not mean to rule out the use of advanced technology to accomplish such recordings. On the contrary, a good "recreative classical" recording places perhaps the highest demand on our technical resources, for what music

  
Recreative  
classical  
recording  
places  
perhaps the  
highest  
demand on  
our technical  
resources.

has more dynamic or spectral range than a full symphony orchestra? What music is more subtle than a string trio or wind quintet? What sound is more natural than the unaccompanied human voice?

Furthermore, the "recreative" recording process does not forbid the use of special miking techniques to "enhance" an otherwise sonically uninteresting or deficient recording environment. The discrete use of secondary

microphones is fully compatible with the primary stereo pair(s) described later. (The operative word in the previous sentence is "discrete.")

The oft-used term (all too frequently in the pejorative sense) "purist recording" means only that the sound which results should be as free from the artifacts of the recording process as is possible. Modern technological advances in the recording art and science have thus given us marvelous tools with which to accomplish this goal. No, it is not the technology which determines the results of our art—it is our application of that technology.

#### The Scope of the Recording:

Enough said of the philosophy of recording. The topic at hand is *how* to go about making a recording of "classical" music. Once you've decided that yours is to be a "recreative" recording, the next detail to consider is where and how the performance is to be recorded. The scale of the music is the first element in the process: what are the performing forces required? Is the recording to be of a live performance (i.e. with an audience) or is it a special session? Are the musicians accomplished performers—and are they operating under an AF of M contract? What are all the arrangements which need to be made? These are some of the pragmatic issues you must consider before pulling the first microphone from the locker. (For more information concerning pre-production planning, refer to my article "Location Recording Practices: A Tutorial" in the June, 1985 issue of *Mix*.)

As to the specifics of the recording itself, the first aspect to consider is the scale of the recording: if it is of a large ensemble such as a full symphony orchestra, the final sound should reflect

# Before you choose speaker components, listen to Tom Hidley.

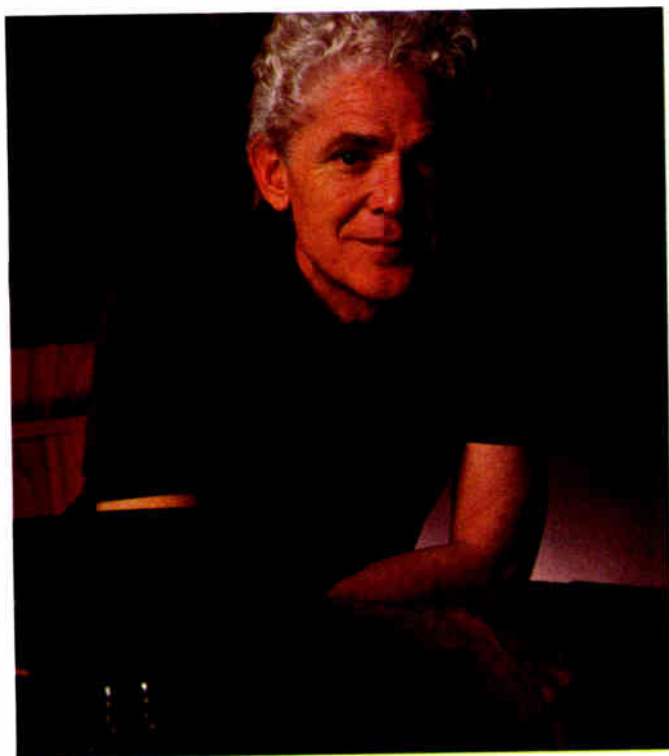

It's a good bet that of all the people reading this ad, 10 out of 10 know the name Tom Hidley.

One engineer we spoke with called him "the best engineer in the world." Another described him, a bit more colorfully, as "pretty damn hot."

But most of you know him as perhaps the foremost studio designer in the world today.

The reason we bring this up is that the speaker components Tom prefers for his clients are the ones we make.

TAD.

---

*"I WILL USE ONLY TAD, UNLESS A CLIENT DEMANDS OTHERWISE."*

---

In fact, he does more than prefer them. Insists Tom, "I will use only TAD, unless a client demands otherwise."

We, of course, are delighted that Tom feels so strongly. But it should also be of more

than passing interest to you, since you want the speaker components you use to be the best.

And on the subject of "best," Tom has some very definite opinions about TAD. "They are the most state-of-the-art, consistent quality products today. Nothing touches their performance, honesty, stability and transient response."

---

*"NOTHING TOUCHES THEIR PERFORMANCE, HONESTY, STABILITY AND TRANSIENT RESPONSE."*

---

There are some sound technological reasons for such enthusiasm. For example, we use only pure beryllium diaphragms in our compression drivers for high speed sound propagation and exceptional efficiency. We also assemble every component by hand, with tolerances as close as a millionth of an inch. And we use exhaustive and esoteric evaluation techniques — such as the Doppler laser and anechoic chamber — every step of the way, from original design right through to manufacturing.

---

*"TAD MAKES THE BEST SOUNDING COMPONENTS I'VE EVER HEARD."*

---

But for Tom, that's all frosting on the cake. "At the end of the day," he says, "it's what comes out of that speaker that determines success or failure. No matter what it measures, it all comes down to what it sounds like. TAD makes the best sounding components I've ever heard."

If you're in the market for professional speaker components, for yourself or a client, we hope you'll seriously consider what Tom Hidley has to say about TAD.

And thanks for listening.

**TAD** Technical Audio Devices

Professional Products Division of Pioneer Electronics (USA) Inc.,  
5000 Airport Plaza Dr., Long Beach, CA 90815. (213) 420-5700.

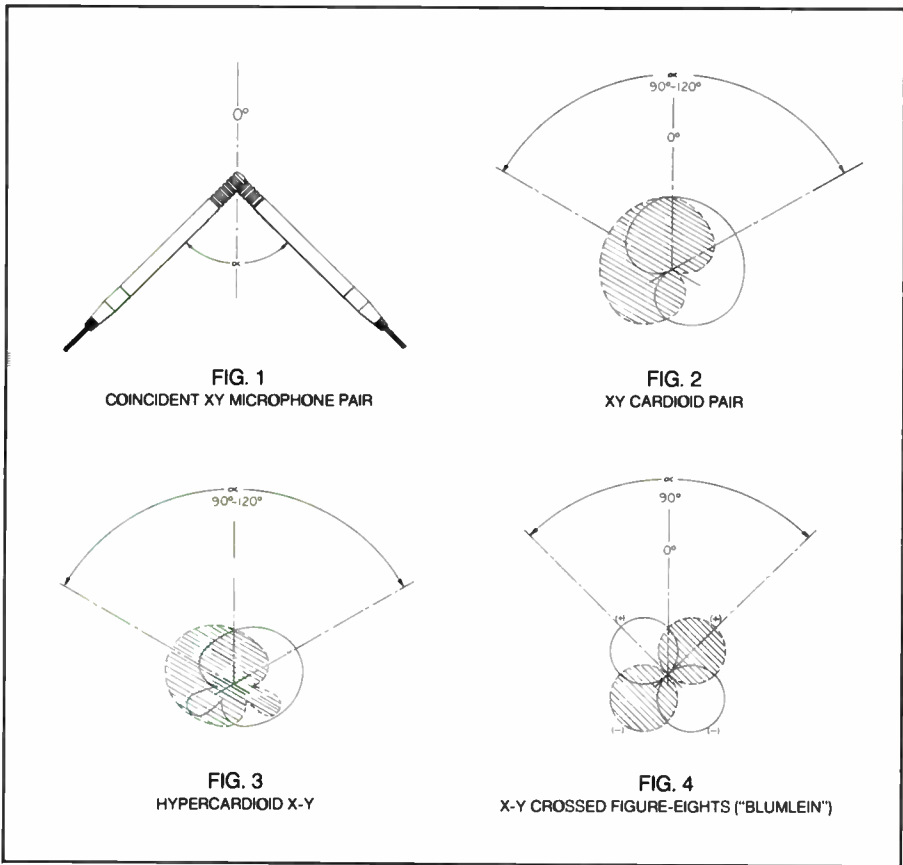

that perspective in both size and power. Similarly, but on the other side of the issue, a small ensemble, such as a string trio or solo instrument, should also sound in the proper perspective. (A solo piano, for instance, does not stretch from one end of the room to the other, and therefore should not span the full width between the two loudspeakers of the listener's living room. With a large pipe organ, on the other hand, it is quite proper to present a "broader" image to the listener.) Proper microphone technique is the key to these sonic determinations, and it is in this realm that I will spend much of the rest of this article.

**Microphone Techniques:**

The basic method of making a stereo recording of a "live musical experience" is to take two microphones, place them in front of the performer(s) and connect them to the two tracks of a stereo recorder. In this modern age of multitrack recording, this may seem simplistic, but it is a method that has served well for decades, and is often overlooked by today's overzealous engineer. There are, of course, many types of mikes to use for that basic pair, and many ways to place them. (There is also a valid argument to be made for multi-

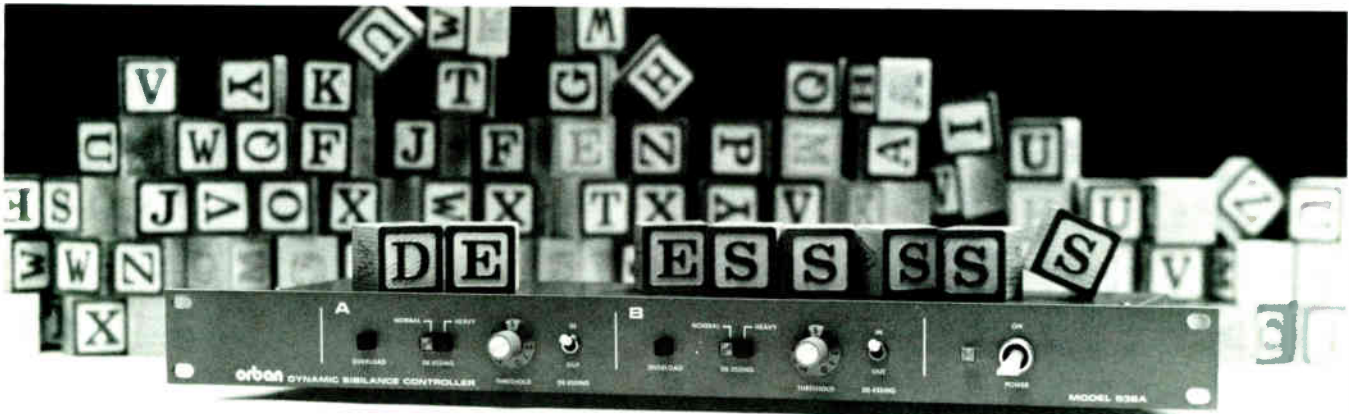

# The ABC's of de-essing.

You know they're out there—those nasty "S" sounds that stymie the pursuit for quality in your vocal productions. That's why we've perfected our 536A Dynamic Sibilance Controller which subtly and effectively controls harsh "S" sounds while you mind your P's and Q's.

The 536A is a single purpose, two-channel de-esser which allows your vocal tracks to have the presence and sparkle you demand without the abrasive, distracting sibilance which can be an unexpected by-product. The 536A also allows for constant de-essing regardless of changes in input levels.

Listen and discover why some of the world's greatest producers and engineers rely on the Orban 536A De-Esser to give them a bright, up-front vocal sound, without excessive sibilance.

**orban** Orban Associates Inc. 645 Bryant St.  
San Francisco, CA 94107 (415) 957-1067  
Telex: 17-1480

Circle #032 on Reader Service Card



mike/multitrack methods, and I will cover these later.)

### Coincident Configurations:

As the term implies, coincident microphone configurations employ two microphones which are placed in close proximity to one another, usually one directly above the other. [Figure 1] With this arrangement, there is minimal time/phase differential between the two mikes for sounds arriving along the horizontal plane. Directional information is thus determined solely by the differences in sound pressure level between the two microphones; this is also referred to as "intensity stereo," since directional cues rely only on the intensity of the sound at the mikes. Spaced microphones rely on both intensity and time of arrival (or phase) to provide directional cues. (These techniques will be covered later.) The two microphones used for these configurations should be matched, and may be of any directional pattern or operational type.

The most common coincident pair is configured with cardioid microphones, with an included angle between 90° and 120°. [Figure 2] In this way, there is a good forward pickup, with a range of "spread" from fairly narrow to wide—depending on the angle used. This is a very natural sounding perspective, and is quite useful in noisy environments.

The general rule for placing this configuration is to begin at a height just above the head of the tallest performer, and five to ten feet downstage (i.e. in front) of the closest performer. I must stress here that this position (and any such initial suggestion given in the remainder of this article) represents only the *starting* point for placing the microphones. The optimum location for the mikes must be determined by carefully listening to them as you move them about—in all directions—until you find the "one right spot" where everything sounds properly balanced. Remember, with only two microphones the performers must balance their performance among themselves. You can only distort that balance with improper mike placement; you cannot improve it.

The included angle between the mikes should be determined by aiming their principal axes of pickup at a point just inside the outer extremes of the performing group. Thus, the closer the mike to the performers, the wider the angle; the farther away, the narrower the angle must be.

A comment is needed here about room acoustics, for the art of proper mike placement is only partly involved with the proper pickup of the performers. It is also dependent on the proper *avoidance* of unwanted sounds: air conditioning, audience noise, exces-

# it's about time...



We at A.M.S. work hard to maintain your competitive edge by continually updating our systems. Take for instance the New Keyboard Interface for the DMX 15-80S. A CV and G input to this new unit can control either of the unit's two pitch changers in real-time, or even allow the playing of samples using the Loop Editing System (LES). Each pitch changer may now be altered over its two octave range by independent rotating pots. Also, a new program called Chorus provides variable speed and depth control of random pitch change variations.

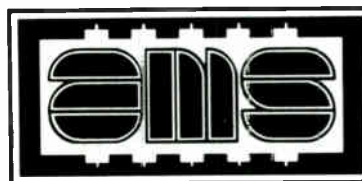

England

Advanced Music Systems

Tel: (0282) 57011 Telex: 63108 AMS G

U.S.A.

Harris Sound (Los Angeles)

For Nationwide Sales, Rental or Service Tel: (213) 469-3500

sive reverberation, etc. Obviously, the farther the mikes are from the performers, the more "extraneous" sound they will "hear"; the closer they are, the more "direct" sound they will receive from the performers. This balance between "direct" and "ambient" sound is the essence of a pleasing, articulate, and natural sounding recording of a "live" ensemble. When in doubt, it is always safer to make a recording which is somewhat "dry," since reverberation can be added (artificially) later; an overly reverberant recording, however, is forever.

There is, of course, another way to accomplish a "closer" sound, and that is by using a microphone with a "tighter" polar pattern, such as a hypercardioid. [Figure 3] As you can see, there is a narrower region of pickup in front of the mikes, so they will tend to have a bit more "reach" than cardioid mikes. Thus, they can be placed somewhat farther from the performers, and maintain the same sense of presence as cardioids. This is useful in situations where the mikes must—for whatever reason—be located at some distance from the musicians.

Hypercardioids are also somewhat more "dead" to the sides (around 120° - 135° off the primary axis) so that they are

often very useful when dealing with noises coming in from these directions. Note, however, that these mikes have a small lobe to the rear, so that they tend to pick up a bit more of the space directly behind them than do cardioids.

Another common microphone used in coincident pairs is the bi-directional (or figure-eight) microphone. This mike is often overlooked by today's engineers, but it is a very useful tool. (In fact, this was the polar pattern specified by Alan Blumlein in his historic patent of 1931, wherein he developed techniques for stereo recording, film production, and disk cutting—some 20 years before they came into general use!) [2] When configured as a "Blumlein pair," [Figure 4] crossed bi-directional mikes produce what is sometimes credited as the "most natural" of all stereo perspectives, affording both an excellent sense of presence to the performance and a spacious feeling of the environment unequaled by any other miking technique. [3]

However, this same sense of spaciousness can get you into trouble if the environment is too live, or has an unpleasant character. Notice that the rear lobes of bi-directional mikes have the same sensitivity as those in front; thus, their pickup to the rear is just as prominent. This means that these mikes

can be placed closer to the performers, to maximize presence, yet provide an excellent sense of the space in which the performance is taking place. Caution: herein lurks potential danger—these rear lobes have reversed polarity and channel orientation relative to the front, and thus severe imaging problems can result if they are not placed carefully. Keep in mind the rules for "direct-to-reverberant" sound, and listen carefully before rolling tape! And one final caveat: beware of narrow halls or strong reflections directly from the sides, as these enter the stereo pair *out-of-polarity* and can cause drastic sonic degradations.

One more intensity stereo configuration remains to be discussed. This is the M/S (or Mid/Side) technique created by using a forward-facing directional microphone (the M mike) together with a bi-directional microphone (the S mike), oriented laterally (90°). [Figure 5] The outputs of these two mikes are then put through a sum-and-difference matrix to produce conventional left and right signals. (From the figure, Left = M+S, and Right = M-S.) There are numerous advantages to this technique, the most significant being the absolute monaural compatibility it affords; this is of primary importance when the recording is for

# The New <sup>and improved</sup> Truck In Town!



## REELS on WHEELS®

The only *other* mobile studio in North America with the Studer A800 MK III.

- Harrison MR-4-36 with automation
- Otari MTR-10, MCI JH-110B
- Sony PCM F1 Digital Processor
- Lexicon 224, Ursa Major, Eventide, EXR
- UREI, dBX, Spectra Sonics, Valley People, Pultec, Drawmer
- Neumann, AKG, Sennheiser, Shure, E.V., PZM
- Color and Black and White Video Monitoring, with Sony 3/4" A2300
- 250 foot Snake with Iso-transformer Splitter
- Unique recording environments available



Call for information on our reasonable rates.



36 Hillandale Avenue, North White Plains, N.Y. 10603

914 949-0672 • 212 876-1445

Circle #034 on Reader Service Card

broadcast, and should always be an important consideration for any recording. [4]

#### Near-Coincident Techniques:

Similar to those discussed above, these techniques also employ two directional microphones, placed in close proximity to one another. The difference here is that they are configured side-by-side, are angled outward from each other, and have a small spacing between them, usually seven to twelve inches. The two most common of these configurations are known as ORTF and NOS, named for their French and Dutch broadcasting origins respectively. [Figures 6 and 7] Like coincident configurations, these rely heavily on intensity differences for their directional cues, but as the mikes are separated in space, they also possess phase (time) differences, which provide these pickups with an "airiness" not afforded by intensity stereo.

As with their coincident counterparts, the recommended initial placement is generally slightly in front of and above the performers, with the angle of the two mikes including the arc of the sound stage. Again, experiment with placement, to find the "right spot." These techniques are often the "safest" to use when recording in a new environment, or if a sound check is not possible: if placed in any reasonable location, they will likely give a very pleasing result.

#### Spaced Microphones:

Developed during the pioneering days of stereo by the engineers at Bell Laboratories, this is another of the primary miking techniques. Originally configured with two omnidirectional mikes [Figure 8] this technique is frequently augmented with a third, center omni mike to reduce the "hole-in-the-middle" and improve the center-stage imaging inherent in the two-mike pickup.

The difference in time of arrival (phase) of the soundwave as it reaches the separate microphones plays a critical role in determining directional cues, and is often of greater importance than the intensity of the soundwave. It is also this differential in the arrival times which creates one of the major problems inherent with spaced mikes: for frequencies whose half-wavelengths equal integral multiples of the distance between the mikes, phase anomalies can occur, resulting in cancellations, or "comb-filtering" within the overall spectral response. Also, due to the incoherence of the phase of the soundwaves as they are recorded by the mikes (and later reproduced by the loudspeakers) there results an ambiguity of the imaging within the stereo soundstage.

Omnidirectional mikes, of course, pick up equally in all directions and, thus, spaced omnis will need to be

# *still* You can take up to 12 months to pay for your Telex duplicator and start saving money immediately



For as little as \$271.13 a month  
and 10% down you can own  
a basic 6120 system,  
without interest or finance charge.



Shown here are just  
a few of the many configurations  
available with the 6120 system. You can even  
build a system with as many as  
23 cassette slaves and five  
reel slaves or  
more!



## Build a system—build a payment plan.

For a limited time, participating Telex dealers are extending these very special financing terms to qualified buyers. That's right, choose the system that fits your duplicating needs and begin making or saving money immediately. Write or call Telex today and we'll send you system prices, technical specs, the name of a participating dealer and a chart that lets you determine production capability. See for yourself how quickly a 6120 system can pay for itself — while you take up to 12 months to pay for the system! And, remember no interest—no finance charges.

Call Toll Free  
**800-828-6107**  
or in Minnesota call (612) 887-5531.

# TELEX®

TELEX COMMUNICATIONS, INC.

9600 Aldrich Ave. So. Minneapolis, MN 55420 U.S.A.

placed carefully with respect to the "direct-to-ambient" sound ratio. Generally, they need to be somewhat close to the performers, and this also dictates that they be placed quite high above them, in order to maintain an equality of the distance from the mikes to both front and rear extremes of the ensemble.

The use of cardioid mikes allows for a somewhat more distant placement from the performers, while hypercardioids allow for even greater distance. This can be useful if the mikes must be kept "out of the shot" in televised recordings. These directional patterns are also beneficial when ambience or audience noises must be minimized.

### Multi-Miking:

Multi-microphone techniques have developed into a genre all their own in recent years. It is not uncommon today for more microphones than performers to be present at a recording session. Although there is a certain validity to this method for "rock" music, where the recording process itself is as much (or more) a part of the music as is the contribution of the musicians, this is not the case with most "classical" music. (Here, the traditional nomenclature tends to become inadequate: the term "classical" no longer applies to such composers as Subotnick, Reich, or Xenakis, for example.)

I leave the decision of multi-miking to the requisites of the individual situation. If the music or the performance is such that basic stereo miking techniques are not adequate to the task, then of course multi-miking is mandated.

Keep in mind, therefore, that what you do as the balancing engineer has just as much—if not more—to do with what the listener will hear as anything the performers do onstage. This means that you have now become a part of the performance itself, and you should have an intimate knowledge of the music being played. The ability to read a score is, in my opinion, not merely helpful in this instance—it is absolutely necessary.

### Recording Considerations:

In the following sections, I will offer some general guidelines (based on my own experience) for making "classical" music recordings of various ensembles. There is no magic in these recommendations; they are just things that have worked and continue to be reliable. Use them as you will, and feel free to experiment.

#### 1. Different Ensembles: Size, Perspective, Balance:

As stated earlier, the recorded perspective of a "classical" music ensemble (or any "acoustical" music ensemble, be it folk, jazz, or whatever) should bear a specific relation to the size of the original

performance. Thus, for chamber music or solo performers, a single coincident pair is usually the only miking needed; placed properly to maintain an even balance of the ensemble—and the proper direct-to-reverberant sound ratio—this technique will produce an accurate and pleasing result. If additional ambience is desired, a second "ambience pair" can be discretely added into the mix. (Don't overlook the application of a "Blumlein pair" as the main mike pair, placed so as to accomplish both tasks.)

A full symphony orchestra can also be properly miked with a single pair, given proper musical balance and good

acoustics. More often than not, however, additional mikes will be needed to achieve a good recorded balance. Frequently a "sweetener" pair will be needed over the woodwinds to add "a little presence" since this section is generally far upstage. Likewise, additional microphones might be necessary to "tighten" the percussion, or to "bring out" the orchestral keyboard instruments (piano, celeste, xylophone, etc.). In a concert hall with "flabby" bass, a mike on the principal contrabass will often add just what's needed to bring that entire section into focus.

Add a chorus and/or soloists, and some additional mikes might be needed to provide the clarity or balance lacking in the "real" recording environment.

If all this begins to sound like "multi-miking" techniques... it is. Once you get beyond the original stereo pair, any added mikes (no matter how few) must be kept in the proper perspective: they must not be allowed to contribute more to the total recording balance than is appropriate to the natural acoustical balance. If they exceed this, the final result will be a distortion of what the composer and/or conductor intended.

#### 2. Superimposing Stereo Pairs:

One of my favorite methods of adding "sweetener" mikes is by superimposing stereo pairs. By this, I mean that I will start with a primary stereo pickup and then add another (usually coincident) stereo pair to the mix. These mikes should not increase the level of their subject, but should be brought in "just enough" to add only the desired presence.

This technique is particularly pleasing when used for a soloist, as it places him firmly in the stereo space, without the "cardboard cutout" feeling so often conveyed by a single, panpotted microphone. (Be sure to balance the solo mike pair so that the position of the soloist does not "wander" within the overall stereo image as these mikes are brought into the mix, or as the performer changes dynamics.)

#### 3. Session -vs- Concert: Placement of Performers:

Given the situation of recording a live concert, there is little the recording engineer can do to rebalance the ensemble to "suit" the recording. The live audience is—in these circumstances—the primary audience; the recording is secondary. Placement of performers on the stage is generally determined by the conductor, based upon visual as well as aural considerations. If there is a rehearsal, however, the opportunity does exist to correct for certain balance problems onstage. Discuss the specific situation with the conductor and see if a

—PAGE 124

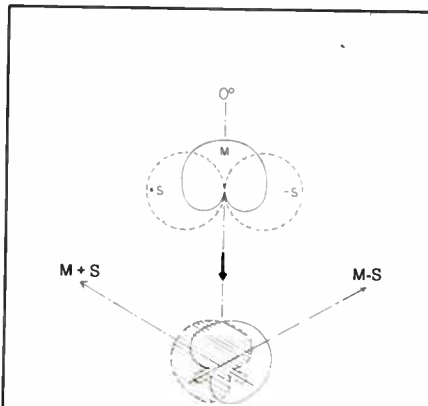

FIG. 5  
M-S CONVERSION TO X-Y

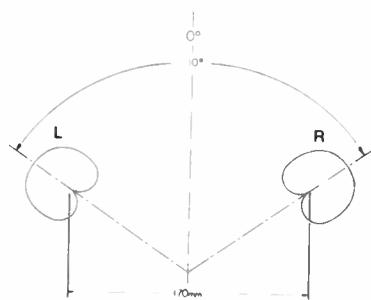

FIG. 6  
O.R.T.F. CONFIGURATION

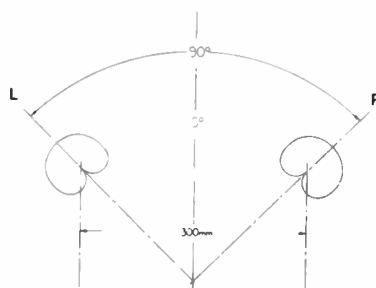

FIG. 7  
N.O.S. CONFIGURATION

# NOW THAT DIGITAL IS HERE, A RECORDING STUDIO DOES NEED A PIANO THIS GOOD.

Times have changed.

Digital technology produces recordings of magnificent clarity, full dynamic range, and virtually zero distortion. The piano, to capitalize on this technology, must deliver exemplary tone, timbre, and presence.

Steinway® is the logical choice.

Its expense, however, has tempted some studio owners to consider buying a lesser piano. A fact that many musicians accept with reluctance. When performers sit down at a Steinway piano, they know they are playing the best.

Having a Steinway speaks for the overall integrity of your studio. It also attracts return business. And now it's easier than ever to have one.

## LEASE A STEINWAY \$350/mo.

Steinway & Sons is now leasing new Steinway grands directly to recording studios. A model B leases for \$350.00 per month. This leasing includes an attractive option to buy at the end of the term.

For full details, contact Mr. Ed Bezursik at Steinway & Sons, Steinway Place, Long Island City, NY 11108. Or call him at: (718) 721-2600.

Be sure to visit the Steinway Suite at this year's Audio Engineering Society (A.E.S.) Show, New York Hilton Hotel, October 13-16.

STEINWAY & SONS 



In use at the recording studio: Kampo Cultural Center, New York.

Circle #036 on Reader Service Card

On location during the shooting of the "Field Work" video



thomas dolby's

# ELABORATE COLLABORATION

by Iain Blair

**TAKE 1:** Thomas Dolby, sporting an enormous fright-wig and looking for all the world like a Mad Professor, races around the Grammy stage in front of Stevie Wonder, Herbie Hancock, and Howard Jones.

**TAKE 2:** Wearing a plain cloth cap, and quietly sipping tea in his rented house high up in the Hollywood Hills, Thomas Dolby explains just how thrilled he is to be co-producing Joni Mitchell's new album.

Dolby and the likes of Wonder and Hancock surrounded by banks of the latest electronic equipment? OK, but Dolby and Joni Mitchell? Too far fetched?

But then Dolby is nothing if not eclectic, and it's far from easy to put this synthesizer *wunderkind* in any musical niche (which is just how he likes it.) After all, this is the guy who played synthesizer on such diverse projects as Malcolm McLaren's *Duck Rock*, *Foreigner 4* and Joan Armatrading's *Walk Under Ladders*, as well as blinding a lot of people with his own science.

• • •  
*How did you hook up with Joni Mitchell? It would seem to be an unlikely collaboration.*

Yeah, although in fact, I've always been a big fan of hers, since I was 14 or 15. I knew all her piano parts, and I'd go and see her every time she played Britain. And then I covered her song "Jungle Line" back in '79. It's funny, 'cause around the same time, all those bands like Adam & the Ants and Bow Wow Wow were getting into all the Burundi rhythms and beats, and she'd already done it back in '72, using real Burundi drummers and a few synthesizers over the top of her "jazz-beat" lyrics. So, to me, because she's so totally out of touch with the current music scene, Joni's often lucidly ahead of her time, although to most people she's considered as more in the great folk tradition.

Anyhow, while I personally regard her as an innovator, I also felt that over the last couple of albums she'd slightly lost that edge, and that maybe she could use a few suggestions regarding new instrumentation and sounds, etc. In fact, I'd made the suggestion about a year ago by proxy, but never heard anything back. Then this engineer friend of mine who worked on my last album called up and said she was interested in using a lot of Fairlight and keyboards on her new album, and would I like to get involved. So naturally I said yes, especially as I thought it'd be an interesting combination.

*What sort of working methods did you employ in the studio?*

# THE MIXING LINK



Space-age technology has joined the musician in the studio and the producer in the studio... everything from digital covers to 16-bit sampling. Sure, you'd love to have an easy way to put it all together.

Enter TOA's D-4... the first electronic music mixer. The D-4 is a 4-input stereo rack system... expandable to 16-in. designed to handle the varying voltages and complex timbres produced by state-of-the-art gear. For live performance... the D-4 delivers balanced XLR mic inputs, stereo and mono mixing, and ground lifting.

For recording applications... the D-4 accepts a vast range of source levels, and provides 48-volt phantom power and MIDI-THRU patching. For post-production work... there's plenty of accessory patch points, selectable pre or post... a direct output for every input, and headphone cue monitoring.

The TOA D-4... the evolution continues.

For complete technical information or write: TOA Electronics, Inc., Professional Music and Entertainment  
600 Carlsbad Avenue, South San Francisco, California 94060 (415) 585-2538  
World Radio History, 755 1st St., San Francisco, CA 94102 (415) 398-3511 ©1985 TOA Electronics, Inc.



It was a matter of adapting to her style at the same time as introducing her to my ways of recording. For instance, in the past, she's usually recorded piano or guitar and voice first, and then sweetened it by using different instruments to layer and build up the track. But I tried to encourage her to do away with her traditional type of accompaniment altogether, and just bring it down to the raw elements of the sequencers, drum programs and percussive sounds, and then build up from there.

*Did you approach her vocals in any special way?*

Well, I found out that there are really a lot of very interesting phonetic noises she can make with her voice that she's never tried using much before, and one of the beauties of the Fairlight sampling technique was that we could put them to use. So when she heard a melody line, instead of bringing in a sax or a guitar to play it, we'd sample her own voice and use that instead. The result gives the album an incredibly intimate feel, because although there are a lot of electronics in there and all the drums are synthesized, it also has this very organic feel as the human voice elements are making up a lot of the textures.

*You co-produced the album?*

Yes, along with Larry Klein, her husband, and engineer Mike Shipley. As it turned out, I did a variety of things, from arranging songs, to programming synthesizers and finding sounds for her. Other times, I'd leave the studio altogether, as she likes to put down her vocals on her own. Working with her was a great experience, though, and pretty different to what I'm used to. As a musician she's totally intuitive in that she doesn't read music, or speak any musical language or have a musical vocabulary that most people would understand. But she can come up with ideas, both vocally and instrumentally, that, although they defy any logic, are absolutely wonderful. And I think she's rightfully protective of that quality—she doesn't really want to "join the club" as far as music is concerned, but just to go with what works for her. The thing is, most musicians, even if they don't read or communicate in traditional accepted terms, at least have a common language. But Joni talks more like a painter, in terms of colors and textures. She'd say something like, "This string part we're putting down is a little bit nylon sounding to me—I was really hoping for a more 'crinoline' sound." Or "I think we need a browner kind of sound for this particular section,

something a bit more murky down there, perhaps with little flashes of crystal light on top..." And that's how she communicated her ideas and feelings. Initially, I found it slightly uncomfortable, but gradually I also started to do things in a visual way...it was very stimulating.

*Were you surprised that you worked so well together?*

Not really, because I think one of my best talents is being able to collaborate with lots of different people. I find that I can usually zoom in on their taste, their own ways of listening to things, and then add my own ideas. I think the last thing she actually wanted was to work with someone who was completely fluent in all the hi-tech electronic hardware and techniques, and just let them come in and take over, so to speak. It still had to basically come from her, so very often I'd just program a certain sound for her, and she'd come over and play around with it for awhile, and a few hours later, she'd have changed it completely and put down a whole new part.

At the other end of the spectrum, I went back to just being a player on some things. She's used to working with the likes of Jaco Pastorius and Wayne Shorter, so she's very into spontaneous musicianship. So overall, my jobs were varied. Some were purely academic, just programming the various machines, while others would be completely intuitive—she'd say, "Try something on this, but if it doesn't happen after a couple of takes, forget it." So it was extremely varied and demanding work for me.

*Did you write anything together?*

There was no need, as Joni already had tons of songs—in fact, the trouble is she kept writing new ones which superseded the ones we've already recorded! But when I recorded her "Jungle Line," I also recorded a song I wrote called "Urban Tribal" which was very influenced by her and which kind of complements "Jungle Line" lyrically. She heard it, loved it, and now she wants to put it on the album as well, so I've suggested doing it as a duet. If we get it done in time and there's room, it'll be there. If not, it'll probably land up on my next solo album.

*When's her album due out?*

Sometime later this year I think. The great thing about working with Joni is that she doesn't have a whole lot of record company or management pressure on her to deliver "product." No one talks to her about radio play, or album promotion or synchronizing tours, etc., which is very refreshing. And to me, her talents are so intangible that they wouldn't be enhanced by all

For more than ten years, the highly skilled (and mildly crazed) group of audio, synthesizer and computer specialists at Bananas At Large have been providing the extra support that makes our customers, our friends.

Become a member of Bananas' extended family. Send us one dollar and we'll send you ten issues of *Bananas News*—the inside scoop on equipment as it hits the market, plus special sales and industry gossip. Don't hesitate...



**Get serious, Go bananas**

Bananas At Large 802/804 Fourth Street, San Rafael, CA 94901 415/457-7600

Circle #037 on Reader Service Card



the usual rubbish of deadlines, etc.

*You also recently collaborated with funkmeister' George Clinton?*

Yeah, I did that album just before I started working with Joni, and it was quite an experience!

*How did that come about?*

We met each other one night at a video show, and it turned out we were both fans of each other's music. You see, as a kid, I traveled a hell of a lot—my father is an archaeologist—and the best radio stations in Europe were the American Forces stations, so I started listening to a lot of the soul/funk/R&B tracks they played, and that's how I got so interested in the lineage from James Brown, through Sly & the Family Stone, to George Clinton and Parliament, etc. Anyway, we hit it off, and started working on all these crazy tracks together. I suppose I played David Niven to his Richard Pryor!

*How was he to work with in the studio?*

Great—but totally mad and crazy. Again, like Joni, he's a hard person to communicate with in orthodox musical terms, but his face lights up when you play something he likes, and it gives you such a charge that it really helps bring out the best in you. We actually went fishing a lot of the time—George is really into it, as well as UFOs. He has all these totally bizarre stories about aliens landing on his car. I actually went and played a gig with him after we finished the album. It was a James Brown Testimonial in Washington, D.C., and there was a huge crowd—about 20,000—far more than I'd ever played to, and only about seven white people! I ended up performing a version of "Sex Machine" in my very best Oxford accent, and there was James Brown himself watching from the side of the stage! It was pretty amazing, and I loved working with him.

*You obviously enjoy working in totally different areas of music.*

You're right. There's no one single style. It's more the oddballs in each category! For instance, I recorded that Dan Hicks song, "I Scare Myself," on *The Flat Earth*, 'cause I really like him, although I'm not generally a big jazz or swing western fan.

*Who are you listening to at the moment?*

Well, I like a few out of the current crop of British bands, such as New Order and Everything But The Girl, and I still like Siouxsie & The Banshees. There aren't too many American bands that interest me, although I've always quite liked Talking Heads. But then I

—PAGE 64

# RECORD PLANT TRUCK FOR SALE

RECORDING STUDIOS

## Mobile Unit #1

This truck was recently returned to us from its 3½ year "remote" with Stevie Wonder. We built a replacement truck while Stevie recorded "Secret Life of Plants", "Hotter Than July" and "Original Musiquarium", so now it must go. This legendary truck is priced for immediate sale.



**REDUCED \$40,000!**

1978 GMC 6500 chassis  
ABC aluminum box  
Waltco lift gate  
Full A/C and heating  
240v single-phase power  
90 amp system  
A/C and technical power  
on separate breaker  
panels  
L: 29'2" (add 5' for  
lift gate)  
H: 11'9"  
W: 8'4"

API 32 x 24 Automated Console with Allison 65K  
2-JBL 4333 Monitors with White 4000 EQ  
2-Phase Linear 700 Power Amps  
1-Crown 150 Amp  
1-Soundcraftsman RA 5502 Amp  
1-Yamaha P2100 Amp  
1-Panasonic Video Monitor  
1-Sony B & W Video Camera with Case and Tripod  
1-RTS Intercom System with Power Supply, Biscuit  
1 belt pak  
2-150' A.C. Cables/Extra Road Cases & Misc. Equip.

Truck available with equipment, or to your specifications.  
**For Information Call (213) 653-0240**

Circle #038 on Reader Service Card

# AKAI

**MG 1212  
12 Channel Mixer  
12 Track Recorder  
\$6995.00**

**Write:**  
Akai Professional Products  
P.O. Box 2344  
Fort Worth, TX 76113

.....Please Send Technical Information on The AKAI MG 1212.....

Name \_\_\_\_\_  
Address \_\_\_\_\_  
City \_\_\_\_\_ State \_\_\_\_\_ Zip \_\_\_\_\_

Dept. A-4

Circle #039 on Reader Service Card



**Tri-Amp System C24-2000 DIRECT \$5469 List \$9695**

The new tri-amp C24-2000 Concert system produces a wall-of-sound that's earth shaking! Components include; the new 24 ch MX2422 pro stereo console, 2 dual 15" 2000M folded horn sub-woofers, 2 1220M mid-range enclosures, 2 R540H Carvin/Renkus-Heinz radial horns, 2 DCA800, 1 DCA300 power amps (1900 watts rms), and 1 XC1000 electronic cross-over. Also, our ultimate **SC24-2000 Super Concert** tri-amp system features twice the speaker components and sound coverage. **DIRECT \$7699**

**System S16-1330 DIRECT \$2579 List \$4995**

Carvin's popular 16 ch S16-1330 System delivers clarity and power for the most discriminating audiophiles. It's crystal clear highs from Electro-Voice drivers and deep bass punch from horn loaded Carvin HE15 woofers, exceeds equivalent systems. Components include; the new MX1622P stereo powered mixer with 400 watts rms, 2 1330M woofers, 2 R540E radial horns and cables.

# Carvin Sound Systems.

**Sound System S12-980**

**System S12-980 DIRECT \$1979 List \$3895**

Our best compact 12 ch sound system, S12-980, features the same speaker components as used in our large S16-1330 system. Tremendous volume levels are obtainable with a sound that's second to none. Components include; the MX1222P stereo powered mixer with 400 watts rms, 2 980M speaker enclosures, and cables.

The 980M speaker enclosure features the Carvin high energy HE15 woofer and Electro-Voice DH1202 radial horn compression driver. **DIRECT \$369 List \$695. Add \$50 ea.** for the optional 980E model with the Electro-Voice woofer.



**Sound System S8-960**

**System S8-960 DIRECT \$1449 List \$2695**

One of our best performance values is the 8 ch S8-960 system featuring the 960M enclosures. The 960's offer Carvin's high energy HE15 woofer in a tuned port enclosure for smooth, deep bass output. Carvin's HE490 compression horn delivers superb highs. Components include; the MX1222P stereo powered mixer with 400 watts rms, 2 960M enclosures, and cables.

The 960M speaker enclosure has a high power capacity of 150 watts, 300 watts peak. An exceptional value at **\$269 ea. DIRECT List \$495. Add \$50 ea.** for the optional 960E model with the Electro-Voice woofer.

**Pro Monitors**



Carvin's Pro monitors are incredibly powerful, projecting a clear full-range sound to your ears when everything around you seems deafening. The 12" 750M model sells **DIRECT \$179 List \$295**. The 15" 790M model sells **DIRECT \$219 List \$395**. Optional Electro-Voice woofers, add \$50.

**DCA800 Power Amp**



The stereo DCA800 amp clearly demonstrates uncompromising performance. Its' 800 watts rms (bridged) output drives speakers from sub-audible sounds to explosive levels without distortion. Pro features include balanced inputs and fail-safe protection. **DIRECT \$549 List \$1005**

Join the Pro's who use Carvin mixers or P.A. systems

- Tony Brock (Rod Stewart)
- Brad Gillis (Night Ranger)
- Danny Gottlieb (John McLaughlin)
- T Lavitz (The Dregs)
- Peter McLan (prod. Men at Work)
- Missing Persons
- Oingo Boingo
- Earl Slick
- Steve Vai
- Frank Zappa

**MX2422**  
**\$1999** List \$3995



**Professional MX22 console features**

- 8 Models from 6 to 24 channels
- Stereo powered models w 300w & 400w rms
- Professional XLR balanced inputs and outputs
- Ch "patching" for recording and effects
- Mic/Line switch • +48V for condenser mics
- 11 step gain control w/peak LED indicators
- 3 Band ch equalization with Sweep Mid-EQ
- 2 Monitor sends (pre) • 1 Effects send (post)
- Effects return w/Level & Pan
- Channel Solo system w/LED indicators
- Talk-back system (except 6 & 8 ch models)
- Monaural output for PA • Stereo headphones
- Dual graphic EQ's w/patch jacks
- Hammond reverb w/foldback to monitors & 2 track
- Professional VU meters
- 2 track mix-down for recording
- Hand rest • Oak sides • Channel markers
- Super quiet, -128 dBv input noise
- Frequency response 20 to 20,000 Hz
- +4 dB or -10 dB operating levels
- 20 dB headroom at all stages
- THD better than .05% • 1 Year Warranty

# Performance Guaranteed!



**MX1622 mixer only**  
**\$399** List \$2795  
**MX1622P w 400w rms**  
**\$1599** List \$3195



**MX1222 mixer only**  
**\$1099** List \$2195  
**MX1222P w 400w rms**  
**\$1299** List \$2595



**MX622P w 400w rms**  
**\$949** List \$1795  
**MX622P w 300w rms**  
**\$799** List \$1495 (not shown)

Carvin's MX22 series mixers offer real performance values. Use of the finest components and professional designs are just some of the features you've grown to expect from Carvin. All computer grade circuit cards are fully modular for easy maintenance. Carvin's Power-Track dynamic range extender gives tremendous distortion-free output exceeding volume levels of conventional 600 watt rms amps. Carvin has over 50 sound system packages starting at \$799! Ask about Carvin's Pro CM67 and CM68 mics priced Direct at \$99.

Why are Carvin products so reasonable? It's because Carvin sells DIRECT. Retail store commissions are not included in the DIRECT price. All Carvin products are "Performance Guaranteed" or your money back after trying for 10 days. All items are stocked for immediate shipment. Send for your FREE 84 page color catalog. To rush 1st class mail, enclose \$1, send \$5 for foreign. Master Card and Visa accepted.

Circle #040 on Reader Service Card

**For more information call**  
**TOLL-FREE**  
**800-854-2235**  
**Calif. 800-542-6070**

## CARVIN

Dept. MX67, 1155 Industrial Ave.  
 Escondido, CA 92025

World Radio History

### Free Catalog

FREE CARVIN CATALOG

Free Catalog     \$1 for Rush 1st Class Mail

Name \_\_\_\_\_

Address \_\_\_\_\_

City \_\_\_\_\_

State \_\_\_\_\_ Zip \_\_\_\_\_ MX67

feel they've gone off the boil a bit over their last few albums. Basically, I have varied tastes. I love the new Peter Gabriel album, although he doesn't even sing on it, and I've always loved Eno. Like me, his strength is as a collaborator—he's a man after my own heart—and his best work has been with other artists like Bowie, Devo and Talking Heads. Personally, I don't have a lot of time for his solo "ambient" experimental stuff.

*So you see yourself as largely a collaborator?*

I think so, yes. I always viewed my solo albums as something I return to every couple of years, after all the joint projects in the meantime which have hopefully opened up all sorts of new avenues and ideas. For instance, I just completed this big video project with a Japanese artist called Torushi Sakamoto.

*How did that come about?*

When I finished touring last year, I ended up in Japan, and went to visit him. I'd already met him. His wife sang on an early record of mine, and he asked me to write and direct a video for this new single he had called "Field-work." Then, a few weeks later, he called me in London and asked me to do an English vocal on the track, so we agreed to meet in New York and work on the project together. As it turned out, we both checked into the same hotel under assumed names, and then couldn't find each other! Anyway, when we did eventually get together, we both realized that we had a very strong cinematic idea to the song which couldn't just be conveyed through the lyrics, so in the end it grew into this eight-minute film epic.

*What's the storyline?*

Sakamoto plays the part of a Japanese soldier found on a Pacific island in the early '50s by some American Marines, and he doesn't know that the war's over. That's a true story, but what happens next is all imagination. He's taken to New York and interrogated, and then allowed to go back. But he decides he'd rather stay in New York and live off his CIA pension. We then cut to the present day, where I play one of these survivalists—a guy who can live off the land for months at a time, just eating roots, etc!—and I become totally obsessed with the old soldier, because he's actually lived like that for years on the island. So, I start stalking him and watching him, and eavesdropping on his conversations, etc. I won't reveal what happens, but you can see there's quite a bit of dialogue, and the actual song doesn't begin until about half-way through.



PHOTO: RICHARD HAUGHTON

We ended up shooting it all in L.A. because we both were in town working on other projects, and a lot of the downtown section looks just like New York anyway. We also eventually rewrote the music around the vocal and lyrics, and as I was then in London and he was in Tokyo, the easiest way to do it was to send our Fairlight discs back and forwards, so that we could each adapt our own parts after listening to what the other person was doing. Using the E-mail system is even quicker. I just plug a little Radio Shack computer into my phone. I mixed the song after he'd sent me the track sheet in the E-mail, and after I'd written the concept for the video on my word processor, I then sent it back to him on the same system. It's really quite amazing. None of this would have been possible a few years ago, and soon it'll be possible to link a Fairlight to the phone and transmit directly like that through a modem.

*You seem pretty busy with all these different projects. What's happening with your solo career?*

I'm just about to start work on my new album, which I'll be recording at my own studio in London, the one I've been building. It's a dedicated studio which I won't rent out, and I'm really looking forward to getting in it. The problem is that I've got so much equipment now, it's a real pain tearing it down and setting it up all the time, so it was the logical next step to put it all in one place.

*What sort of equipment are you using?*

A Soundtracs computer-automated console for a start. I really need computer automation because I like to run everything live—even when I'm making records, I'll record the vocals but everything else will go down live in the mix. So the Fairlight will be running live, and all the sequencers and drum machines, etc., and the only thing coming off the tape will be the vocals. And in order to write that way and produce it, you need very sophisticated and comprehensive mixing facilities. You literally just don't have enough fingers to punch in all the channels and effects, etc. for different parts of a song. And the Soundtracs board is basically the most affordable computerized mixing desk there is, although there are more and more of them coming on the market now.

*What about synthesizers and keyboards?*

The Fairlight CMI system is my main workhorse, and that gets used all the time. For sounds that require a longer sampling time, I use an AMS unit which is essentially an echo unit, but you can also use it to sample at a very high quality, up to about 21 seconds, and you can also play it with a keyboard. I've got a bunch of different keyboards, especially a lot of Roland gear which is what I started out with. I recorded the whole of the *Blinded By Science* album using a full-voice Roland synthesizer which has been superseded about five times now, but I think the sounds still hold up pretty well.

*And drums?*

I tend to experiment a lot and use a lot of different combinations. For instance, I'll take the toms off an Oberheim DMX, and the snare off something else, and just mix it all until I like it. The last thing I want is to get drums that sound just like everybody else's.

*Have your studio techniques changed much over the past few years?*

I find I'm tending to MIDI a lot of stuff together now. In the past, my technique for sounds was always to layer them. I'd find a sound I particularly liked, and then find another compatible tone on a different keyboard. The great advantage of MIDI is obviously that if you sit down in front of the mixer with this one keyboard, you can be controlling all the guts of all these different keyboards at the same time, and by using the mixing desk switch them in and out and blend them to get the right sounds.

I'm also using a lot of PPG equipment now. They're this quirky German company who've somehow never managed to hook up with anyone who

can speak reasonably good English—and consequently, their manuals look like a thesis by some Hamburg University student! So it's pretty hard to get on with, but that's also what I like about it. It's the only keyboard that I've never really learned properly—all the others I know inside out, and exactly how to get any sound I hear in my imagination. But with the PPG equipment, you can twiddle one knob by mistake and the sound is radically altered. It's all very frustrating, but it also allows you to chance on things you never would if you were completely in control.

*You've got quite a reputation as being a tech-head. Is that how you see yourself?*

I suppose so, although I certainly don't like the idea of being categorized as a "whiz-kid synthesizer genius." I mean, I think the guitar has now become a kind of folk instrument of this generation, in that it's not particularly important whether someone's playing one or not. Whereas, if you happen to use electronics, you're very often pigeon-holed as "an electronics buff," and I think that scares a lot of people away from what I do.

*If you don't like to be labeled as a*

*synthesizer player, how do you see yourself?*

Good question! I think that the recording studio is really my main instrument, and no studio today is complete without all the electronic keyboards and synthesizers and sampling devices, etc. And they all pretty much do the same things now, and there's technically very little difference between them. Like I was saying, you can use an echo unit to sample sounds, for instance. So I don't think it'll be long before all this sort of equipment is automatically built into the mixing consoles so that you can assign it any way you want.

*What sort of direction is your new album heading in?*

It'll definitely be a lot more fun. The first album was obviously propelled by the success of "She Blinded Me With Science," and I think a lot of people bought it as a novelty record, only to then find my other sides on the rest of the album—the more intense, melodic, atmospheric flavors. And then my second album, *The Flat Earth*, was as atmospheric as I could get. Every song was in its own little pocket, with its own concept. Having got all that off my chest, I feel a lot more extroverted about this new album. I'd like it to be

comical, and have some of the humor I hopefully get in my videos, without compromising the musicianship.

*Any more tour plans after last year's success?*

Not for awhile, I don't think. I toured for over seven months last year, with a very complex live show which took three months alone just to put together and rehearse. I loved doing it, but it takes a lot of time out of other projects, and when I got back home eventually, I actually felt very out of touch with the whole music scene and what was going on, which depressed me. So I'm unlikely to try anything like that again! Next time, it'll be a lot looser, with a bunch of musicians I can just leave to their own devices, and let them develop more as a band without worrying so much about the visuals and synchronizing video clips, etc. What it comes down to is that although I enjoy touring and playing live, it's still a temporary thing for me—it's not top priority. Tours are largely forgotten after you've done them, and I always feel people are more likely to remember the girl they pulled that night than the particular arrangement you played! Whereas on the other hand, records last for years. ■

# AFFORDABLE HIGH POWER!

## THE ALL-NEW PR1800



**600 WATTS p/c MOSFET performance...continuous average sine wave @ 4 ohms, 20Hz to 20kHz.**

**900 WATTS p/c @ 2 ohms.**

**1800 WATTS p/c BRIDGED.**

**PHASE CONTROL REGULATION...** allows Safe Operation even at 1 ohm.

**MODULAR Design for easy Field Serviceability.**

**ROADABLE 14 gauge steel chassis in a space-saving 5¼" rack space**

**TWIN FORCED AIR cooling system.**

Whether you're touring the **WORLD**, or the **NEIGHBORHOOD**, the Incomparable PR1800 is the **ONLY AMP** you may ever need!

*Soundcraftsmen*



2200 So. Ritchey, Santa Ana, CA

CANADA: E. S. Gould, Montreal H4T 1E5

*You're Invited*

The Staff of Professional Audio Services and Supply Company request your presence at our new facility. Formerly a world renowned recording complex, it now features our expanded product line and our acoustically designed demonstration room.

Whether you're buying a whole studio or buying piece by piece, Professional Audio Services will give you master quality recording systems at a competitive price.

.....  
Please R.S.V.P. for more information on all of your audio needs.



Our New Location  
**619 South Glenwood Place**  
**Burbank, CA 91506 (818) 843-6320**

- ACES
- AGFA
- AKG
- Allen & Heath
- AMEK
- Aphex
- Audioarts
- BGW
- dbx
- Electro-Voice
- JBL
- Klark-Teknik
- Lexicon
- Micmix
- Orban
- Otari
- Ramsa
- Scotch
- Sennheiser
- Shure
- Smpl Systems
- Tannoy
- Ursa-Major
- Valley People
- Zetka
- and
- many other
- fine products

Circle #041 on Reader Service Card

# BLOWIN' IN THE WIND

# PAUL HORN

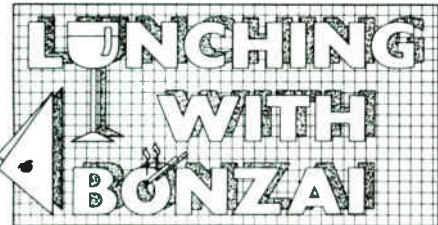

by Mr. Bonzai

Paul Horn takes his flute to Russia and mesmerizes audiences that haven't heard a jazz combo since 1927. He crosses the great walls into China and performs in schools, in temples and in the streets. He records in spiritual/acoustical monuments like the Great Pyramid and the Taj Mahal. He even plays for whales—and perhaps more importantly, they play for him.

His music is free and easy going, unselfconscious, yet internally disciplined. Paul Horn is a composed mixture of new age bohemian, hardcore jazzman and wandering beachcomber. Way back in the Chicago of the '50s he met a Zen priest who liked jazz. The priest appreciated his music and told Paul he was going to create a little enlightenment for him. This spiritual glimpse led to studies in Transcendental Meditation, trips to India, becoming a TM instructor at the request of Maharishi Mahesh Yogi, and a radical change in Paul's musical career.

To love life, or to love a person, there must be romance. The Chinese Book of Changes, the I Ching, says that the difference between seduction and courtship is perseverance. After all these years, Paul Horn is still courting the world through his music.

**Bonzai:** Where did you get your training and education?

**Horn:** My mother, Frances Sper, was a professional pianist. She made records in the '20s and had her own radio show in New York City. She played piano and sang and got married in '29. When I was born she stopped playing professionally, but the influence was there and she continued to sing and play around the house. We moved to Washington, D.C. when I was four and I started playing the piano. I took up the clarinet when I was 11 and started playing along with Benny Goodman and Artie Shaw records. Next, I took up the saxo-



phone and after high school I went to conservatory at Oberlin College in Ohio. I majored in clarinet but started playing the flute then. After Oberlin, I went to the Manhattan School of Music for my Master's Degree. I got a good classical background, but jazz was always my love. I played in bands and combos all through college. What I wanted to do in life was to play jazz.

**Bonzai:** What was your first significant gig or recording?

**Horn:** My first record date was early in 1956 for RCA with the Sauter-Finegan Band. I was with that band in New York for about six months. They were on their last legs by then and I happened to meet Chico Hamilton. He was very well known in those days with a new type of group. The music was called chamber jazz—cello, guitar, bass, drums and a woodwind player doubling on all the instruments I played. The band's reed player, Buddy Colette, was doing a lot of studio work and couldn't be on the road. I wanted to travel and it worked out well. That brought me to Los Angeles in October of '56 and I stayed with the band for two years. We made three or four records and I started to become known as an individual, because it was a small group, unlike the big bands. The flute

was just starting to come into its own as a solo jazz instrument and I guess I was one of the first to start doing records on my own. Chico's was one of the first groups to feature the flute as a special instrument and it got popular very quickly. I got in on the ground floor.

**Bonzai:** How did you make the transition from jazz appeal to reaching such large audiences?

**Horn:** The growth of audiences for solo flute led to the emergence of another career for me, but it happened very spontaneously. I did the solo flute album in the Taj Mahal in '68. It came out in '69 and became a big underground thing. It was different than anything that had been out there before—just solo flute and nothing else, and there were wonderful acoustics in the Taj Mahal, great echo and acoustics. A note could hang in the air for 28 seconds. It started a whole new trip for me.

**Bonzai:** How did you end up in India?

**Horn:** I was over in India doing my own spiritual pilgrimage and spending time with Maharishi Mahesh Yogi.

**Bonzai:** Did you spend any time with The Beatles?

**Horn:** Yes, when I went back for the second time in '68. That's when I did

the Taj Mahal album and The Beatles were there at the Maharishi's ashram. I got to know them quite well, and played music and hung out with them and all of that. They were incredibly popular throughout the world—even the people in a small Himalayan town knew about The Beatles. What I admired so much about them was their sincerity in studying with the Maharishi, especially George Harrison, who was probably the most spiritually oriented. He had spent time in Bombay studying with Ravi Shankar. Patti Harrison, George's wife at the time, had met the Maharishi and was responsible for bringing The Beatles to him.

We all ate in the same little dining area at the ashram, and we would all sit around in the evening listening to Maharishi talk. The Beatles were only part of a group of maybe 70-80 people and weren't given any special consideration. They enjoyed that. There was a certain awe associated with them, but after awhile people got over that, and it was just "Hello, Paul; Hello, John." I also respected the fact that they were really into their music. Even with all the fame and attention, they enjoyed getting together every day for the music—especially John and Paul. The Maharishi had set aside a little hut right at the edge of the Ganges as the music room.

## Proven Success

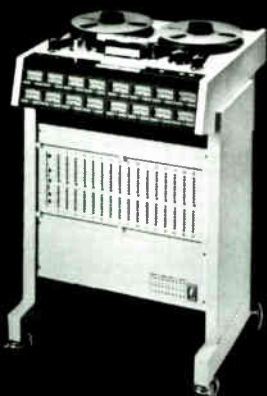

### OTARI MX-70 1" 16 Track Recorder

MX-70 features a microprocessor-controlled constant-tension transport, a full-function remote controller, exceptional audio electronics, and connectors for interfacing to any SMPTE/EBU time code based editing system, controller, or synchronizer.

**RETAIL PRICE \$14,950.00**



### AMEK/TAC SCORPION

- 2 Chassis Sizes: 16 x 8 x 2 and 24 x 16 x 2
- Fully Modular Construction
- 12 - 32 Inputs
- 4 Band EQ, Swept Mids, high/low shelving
- 8 and 16 Tape Monitors/Effects Returns
- 8 and 16 Buss Outputs/Subgroups
- 4 EFX/Cue Sends
- 4 EFX Send Masters with AFL
- Transformerless Mic Preamps
- 48 Volt Phantom Power each Channel
- Direct Outs on all Inputs

**RETAIL PRICE FROM \$6,495.00**



Our New Location  
**619 South Glenwood Place**  
**Burbank, CA 91506**  
**(818) 843-6320**



It was a very creative time for them and a lot of songs were written.

**Bonzai:** Did you play music with them?  
**Horn:** Yes, quite a bit, with George especially. We would play a lot of flute and sitar things. Donovan was over there at that time, too, and as a result of meeting him I did two tours with him in '69 and '71.

**Bonzai:** How did the Taj Mahal album come out?  
**Horn:** It didn't start as a planned album. I was in India for my second trip as producer of a film project about Maharishi. The film was never completed, but one of our locations was the Taj Mahal. I had been there before and remembered the really beautiful sounds. I had my flute and hoped to make a tape for friends back home. It was never conceived as an album, but we had some fine recording equipment and it came out quite well. So, it was a nice accident.

**Bonzai:** Exotic recording locales have become your trademark...  
**Horn:** It shows you what accidents can happen in life—how things unplanned can somehow be the most dramatic events of your life. Many people think that was the first album I did. Actually it was my fourteenth album. The ones before were basically straight ahead, traditional jazz albums, but this opened up a whole new area of exploration for me.

**Bonzai:** Acoustically speaking, what do you consider when you're looking for new places to record in?  
**Horn:** I'm cautious about that because I don't want it to be gimmicky. I also wonder how many solo flute albums I can do without it becoming boring. It has to be very selective—it was eight years before I did another one, in the Great Pyramid. It's a very special place and I thought there would be some interesting acoustics, and also a special ambience. It's not just a sound I'm looking for, although that's certainly part of it. There is a quality of the sound from the structure, the echoes and reverberations. There is also a spirit and a mystery of a building that becomes part of the music.

**Bonzai:** Have you read *A Search in Secret Egypt* by Dr. Paul Brunton? He was there in the '20s shortly after the inner chambers were first opened.  
**Horn:** Yes—he had some very frightening experiences in the King's Chamber, but nothing like that happened to me.  
**Bonzai:** Did you feel an affect on your playing?  
**Horn:** Yes. When I play I really get absorbed in the music; I get my ego out of the way. If I am aware of myself on a stage or in a recording studio, I can't

really get into the music. You get self-conscious or you get nervous, and something gets between you and the music. What I do is get out of my own way, so to speak. I get absorbed in the music, so that I'm lost. I'm almost in a trance, but I'm still aware. I want the music to come through me in a very open, clear way, as if I am a channel. I am the primary instrument and my flute is the second instrument. I just try to be open to the creative flow and these buildings become part of that.  
The Great Pyramid is a remarkably mysterious place, probably the most mysterious place on Earth. They don't know when it was built, how it was built, or why it was built. It becomes part of

the music if I can be open and not think about my feelings while I'm playing. Afterwards, I can say, "Well, how did that feel at the time?" It's certainly different than recording in a studio in Hollywood, but that also has its own feelings. So, yeah, the building becomes part of the music—somehow there's a little magic in there that wouldn't be there if I had done it somewhere else.

**Bonzai:** What room were you in?  
**Horn:** There are two main chambers in the Great Pyramid: the King's Chamber and the Queen's Chamber. I was in the King's Chamber, which is dead center in the middle of millions of tons of stone. There's a lot of energy and a lot of

# THE SENNHEISER OF WIRELESS MICROPHONES.



Only a Sennheiser sounds like a Sennheiser. That's why Sennheiser condensers and dynamics are industry standards. Superior response, directional characteristics, overload resistance, pop suppression, lower handling noise—you know the reasons.

Now, you can have Sennheiser performance in a wireless performer's microphone. Like all Sennheisers, it's technologically in a class by itself. With unique circuitry that includes a DC-to-DC converter for longer, more consistent performance from standard AAA batteries. So you change

batteries less often, while your audience enjoys cleaner, crisper, dropout-free performance.

We could tell you a lot more about the Sennheiser of wireless microphones. Like double-wall construction that eliminates mechanical noise. And recessed controls, to prevent mistakes.

But perhaps the most important advantage Sennheiser wireless mics have over every other on the market, is that they're the only ones that start with a Sennheiser microphone.

Discover the difference at your Sennheiser dealer, or contact us for more information.

 **SENNHEISER®**  
Sennheiser Electronic Corporation (N.Y.)  
48 West 38th Street • New York, NY 10018 • (212) 944-9440  
Manufacturing Plant: D-3002 Wedemark West Germany  
© 1985, Sennheiser Electronic Corporation (N.Y.)

Circle #043 on Reader Service Card

*Paul Horn*



PHOTO: MR BONZAI

power, and there's a lot of silence, especially at night when you're alone.

**Bonzai:** Did you record at night and did you have an engineer?

**Horn:** Yes, I was with David Greene, a wonderful recording engineer from Toronto. He's a friend of mine who had worked on other albums in the past. We got special permission to be alone in the Pyramid—just the two of us.

**Bonzai:** Were there any spirits walking in and out?

**Horn:** Well, we had our own personal experiences. I felt presences, if you want to put it like that. They were rather friendly and comforting. It seems that the Pyramid is like a mirror—if reflects each person differently. We spent a week in there during the days before the recording, getting familiar with the chambers. We didn't even know if we were going to get permission to record, but finally we found someone who could get us in there alone at night. I watched people come through and some would be quiet and wanted to sit and meditate. Others would start crying; some would say "Hallelujah, praise the Lord" and others would say, "Is this all there is to it?" People had their own reactions.

**Bonzai:** Let's touch on some other exotic locations—the China album is especially interesting with the sounds of the streets, the sessions in the temple, the strange instruments...

**Horn:** We recorded two solo flute tracks in the Temple of Heaven in Peking, now called Beijing, right outside of the Forbidden City. The temple is about 300 years old and was used by the emperor for special harvest prayers. It's circular and all wooden and

has its own special vibe and ambience. It had its own sound, but they wouldn't let me record at night when it was empty. I had to go there at 7:30 in the morning when no one was around and the temperature was about 20 degrees. It was so freezing that it's a wonder anything happened, but you have to transcend the discomfort and forget about it. We didn't have enough material for a complete solo flute album, so when I got back to Canada, where I live in British Columbia, I met a Chinese musician and professor named David Liang. He plays a number of obscure Chinese instruments so we collaborated. It's both East and West, in a Chinese way.

**Bonzai:** Has your academic training helped in playing ethnic instruments?

**Horn:** I play mostly traditional flutes—different sizes: alto, bass, piccolo. I haven't gotten into wooden flutes too much, but on the China album I play a Chinese flute. The basic Chinese flute is a simple piece of bamboo with six holes. Amazing things can be done with it, but it takes real mastery. I don't profess to be a master.

**Bonzai:** Glancing at your subconscious, who are your big musical influences?

**Horn:** I always loved the Impression-

**WOULD YOU LIKE A SAMPLER™ FOR LESS THAN \$1,000.00? (SO WOULD 348,000 OTHER SYNTHESIZER PLAYERS!)**



Now the S-612 SAMPLER™ by AKAI enables thousands of synthesizer owners the freedom of sampling technology without mortgaging their wife and kids! AKAI has introduced and is delivering a 12-bit, 32K Band width, 6-voice SAMPLER™ for \$995.00. Remember ... nothing is sacred with an AKAI

612 SAMPLER™. Sample a ... voice, a train, a bell or any analog or digital signal ... and then 8 seconds later be playing it on **any** MIDI keyboard.

Call or write for all the AKAI SAMPLER™ facts and see it at your local dealer.

**AKAI**

**AKAI PROFESSIONAL PRODUCTS**  
P.O. Box 2344 Fort Worth, TX 76113  
(817) 336-5114

**IN CANADA: AKAI AUDIO-VIDEO CANADA**  
121 Watline  
Mississauga, Ontario, Canada L4Z1P2  
(416) 890-2300

Circle #045 on Reader Service Card

ists. Ravel is probably my all time favorite composer. Debussy, Scriabin, Eric Satie—that's a period I like. I also like early Stravinsky very much, and Bach and Bartok, some of Schoenberg. I'm a Romanticist; I like pretty melodies, pretty sounds, pretty harmonies. As far as jazz is concerned, Charlie Parker is my all time hero. And Miles Davis is way up there—especially early Miles. John Coltrane is a big influence, too.

**Bonzai:** Can you draw parallels between music and the visual arts?

**Horn:** No, not really—I'm not that familiar with the art world. I like early Picasso, where he says a lot with a few lines. I like R.C. Gorman, a Navaho Indian, whose work reminds me of Japanese Haiku. There is lots of space, and one line can conjure up so much form. I can relate that to music. Miles taught me that many years ago. I used to hang out with him in the early '60s. He was a big influence, not only because he was a hero of mine before that, but because I had the privilege of knowing him and being one of his intimate friends. I was very inspired and formed my own band, and wrote a lot of music in those years because of him. He was always talking about space and pointing out to me how young musicians often play so many notes. Like most people, I was impressed with technique, but then Miles would say, "So what?", his favorite expression. I began to focus on what he was doing and realized he didn't have great technique. He wasn't the technician Dizzy Gillespie or Clifford Brown were. But Miles stood out as an amazing talent and had the ability to wait and not play—to pick the right note at the right time and place in the right space. There aren't many people who can do that. It takes a lot more control and maturity to do that than to play a lot of fast notes.

George Shearing said that the true test of a musician's musicianship is being able to play a ballad. Some of the hardest classical pieces to play are the slow movements in a sonata or a symphony. You can fake your way through some of the fast stuff, but you can't fake your way through the slow. Everything is exposed and there you are standing naked. You can't hide behind anything. The tone is there for everyone to hear—your phrasing, your breath control, your intonation. The control and the patience is what shows up in the maturity of the musician.

**Bonzai:** What was it like playing for whales?

**Horn:** I live in Victoria, B.C., where they have been experimenting to see if communication can take place between whales and music. I've found that there is acknowledgement and reactions, a definite communication through music.

They would make sounds back to me when I played which were different each time. They pay attention and they are obviously interested in the music. They dance—there are little movements and playfulness in the water. Once a whale died and its mate was nearing death because of the loss. They claim that my flute playing brought the whale out of its depression.

What we really need to do is to relate to each other. We've got a long way to go. Music is definitely a universal language. I played 18 concerts in Russia in '83 with a straight ahead jazz quartet. My son Robin was the drummer on the tour along with David Friesen on bass and John Stowell on guitar. A lot of communication took place. People love the spirit of jazz. We played to three or four thousand people a night and I bet 95 percent of them were totally unfamiliar with jazz. But they connected with the spirit, the improvisation, the emotion, the feelings. There was a lot of warmth and communication with a supposedly dire enemy. What governments perpetuate among people—the power trips—have nothing to do with people. We buy into it, and many times don't have a real choice. It's important to be aware that people are the same all over the world. There may be religious, cultural, philosophical and racial barriers, but they are transcended when you get up and play some music, or dance, or put on a magic show, or get involved in sports. People can communicate right away. The Russians are afraid to die just as much as we are. They are afraid of war, they are happy, they're sad, they laugh, they cry...

**Bonzai:** When you were in China, did you just wander?

**Horn:** Yes, I just went out and started playing—a pretty far out experience. I had never done it before, but now I know what a street musician feels like. It's harder than playing for a large concert audience. I also played in schools for little children, in colleges for older audiences, and at festivals.

**Bonzai:** What types of music did you play?

**Horn:** Just solo flute. Maybe I'd play some blues riffs, or just drift off and play free stuff like in the Taj Mahal, or maybe a tune like "Summertime." The people were very patient when I played the moody, meditative music, but what they really liked were funk things and blues—that had energy and rhythm to it. They started clapping their hands right away. The old concept of monasteries and temples does not reflect the China of today. China today is survival—a billion people trying to stay alive. They are "outside" not "inside." With all the teeming activity, they seem very

## Put Together RCF & EAW And What Have You Got?

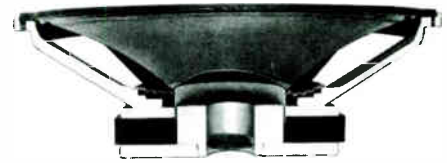

## You've Got The Drivers That Put You In The Driver's Seat!

RCF is Europe's largest manufacturer of drivers.

EAW is the U.S. manufacturer of loudspeaker systems that win prizes:

Prizes not only from organizations like Nippon Onkyoka Kyokai, which named the EAW-based Unicus System "the best performing high-level sound system in the world."

But also, the even more important prize of recognition from listeners with an ear for good, clean, natural sound.

Here are some reasons for that quality:

- 1) The rigid, heavy-duty aluminum alloy frame, cast to especially tight tolerances.
- 2) The oversized 100mm (4-inch) high-temperature voice coil.
- 3) The European advanced cone and suspension design, with exceptional excursion capacity.
- 4) The massive, high coercivity ferrite magnetic structure that achieves superior flux characteristics.
- 5) And the copper shorting-ring — uniquely RCF/EAW, too — that just about eliminates third-order distortion.

And there's much more:

Component parts, for example, that are designed precisely for each driver's exact function and best performance — not designed to interchange with other units, to save money.

There's the testing: Each driver, without exception, is tested individually for centering and response linearity.

On top of that, samples of each day's production run are tested, full power, over their entire operating range for 100 hours.

And especially, there's the precision hand assembly by craftsmen who give more of themselves to the things they do than others may think worth while.

But reading isn't believing. Hearing is believing. Listen to the EAW/RCF Laboratory Series:

You'll get the message.



59 Fountain Street/ Box 111  
Framingham, Massachusetts 07101  
(617) 620-1478

"Hearing is Believing!"

Circle #046 on Reader Service Card

calm and centered in themselves. They don't have much but they seem basically fulfilled. It's a communal society and they are very family-oriented—very different from Russia. They smile and laugh a lot and it's contagious. We have a thousand times more material success in the West, but it was there that I found myself laughing and smiling more than ever. It made me wonder.

**Bonzai:** Who is the most amazing artist you've worked with?

**Horn:** Duke Ellington. I did a recording with his band in the early '60s. Johnny Hodges was sick and I was called to take his place. The album was called *Suite Thursday*—an amazing experience. It took me awhile to appreciate Duke. It's easy to appreciate Count

Basie—a down home, groovin' blues band you can feel right away. With Duke, it's strange and beautiful and different. A genius musician that will go down in history as an incredible composer of American music.

When I played in his band it didn't sound like it did when I was outside listening. The voicing was so different. Sitting in the sax section, it was very difficult to relate to what was going on around me, and to play in tune, because he didn't voice things like regular sax sections. He might voice the first saxophone and the first trumpet together, and the second tenor and second trombone and third trumpet. All of these clusters were happening in a way I wasn't used to. When you're out front and hearing the whole thing it all

fits, but when you're sitting in the band it's strange.

Also, those guys had been playing together for so many years that they never needed to look at the written music. Musicians that play together for so long have a certain empathy and understanding. You can't put it down in notes. You could put five great superstar musicians in a band and it might sound terrible, but with Duke's band there was a certain undefinable connection. It's like when two people live together for awhile. They get to know each other so much that it's beyond what both of them are. The "x" factor starts working; there's a communication which is almost mystical. That was happening in Duke's band.

He was like a magnet. There are people out there in the world looking for someone that they can be with who will give them the opportunity to be part of something truly great. Duke was a leader. His band was drawn to him because he provided the space and the opportunity.

**Bonzai:** What are your plans for future location recording?

**Horn:** I'm planning some videos of my travels to different places, like the Arctic. I've been up there for a few concerts and I would like people to see as well as hear different cultures through music. Home video is going to open up a lot of opportunities that I would like to explore.

**Bonzai:** Do you have any words for aspiring musicians?

**Horn:** Much of the unhappiness in the world is caused because people don't do what they want to in life. Most people don't even know what they want to do. I think that if you're a musician, then number one, you're very fortunate in knowing what you want to do. My encouragement would be to go for your dreams. Give it a shot. There are no guarantees, but you shouldn't be sucked into a need for security, something to fall back on. Someone who studies medicine doesn't have something to fall back on if he can't become a doctor. It's crazy to put up barriers because you might not make a million dollars. Just do it, and if somewhere along the line life shows you that you shouldn't really be in music, well, you haven't lost anything. It's not a question of having failed. Life is just telling you "dead end—turn right." If that takes you into selling real estate, then be a happy real estate salesman. You can say, well, I gave music a try and had a good time—but if you don't give it a try, until the day you die, you will wonder what would have happened. That will plague you. So, just go for your dreams and don't let the record companies tell you what to do. ■

## "PART OF THE OVERALL DIMENSION OF MY COMPACT DISC PROJECTS HAS BEEN THE RESULT OF THE AN-2"

*Tom Jung, President  
Producer/Engineer  
Digital Music Products, Inc.*

"Recently, I did a project, Music for Christmas by Keith Foley, with 9 synthesizers all MIDI-interfaced together and fed into the console. The AN-2 really opened up the sound and spread it out . . . it sounded three dimensional and very interesting. Anybody

that has a synthesizer rack should have an AN-2.

I have also used the AN-2 on a lot of guitars—makes them sound great! It's as useful as reverb itself!"

For the name of your local dealer call Studio Technologies, Inc. at 312/676-9177.



**STUDIO  
TECHNOLOGIES  
INC.**

7250 NORTH CICERO AVENUE • LINCOLNWOOD, ILLINOIS 60646

Circle #047 on Reader Service Card

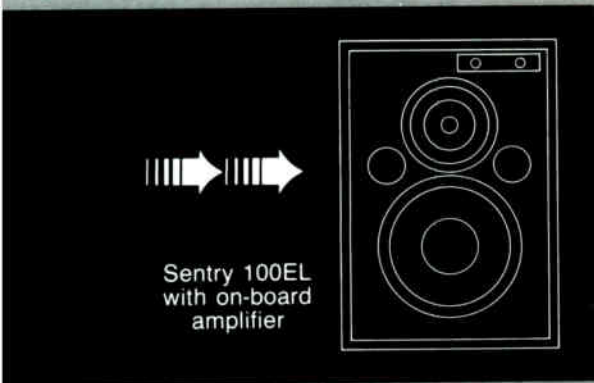
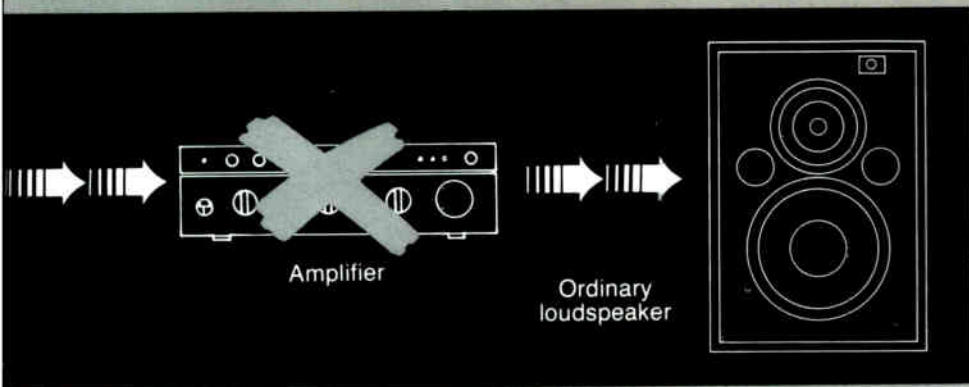

## Finally, a Monitor System with the Power to Make Things Easy

Imagine a monitor speaker that provides its own power. Fits in tight spaces. Simplifies setup. And reproduces sound with test-equipment accuracy.

If you can imagine all that, you've just pictured the **Sentry 100EL powered monitor system** from Electro-Voice. Designed and created for your monitoring convenience, the 100EL combines the superb audio reproduction of the Sentry 100A with an integral, 50-watt amplifier.

With speaker and amplifier in one compact, rack-mountable package, this monitor system solves problems like limited rack space, equipment transport on remotes or cramped spaces in video editing booths.

Also, by requiring less hardware—fewer cables and connectors—the 100EL keeps setup simple

and reduces potential interconnect problems. And there's no possibility of power loss caused by resistance from a lengthy speaker cable.

The on-board amplifier in the 100EL makes it ideal for single-channel monitoring. Why buy one speaker and an extra amplifier channel, when the Sentry 100EL does the job all by itself? And because amplifier power is perfectly matched to the speaker system, there's no chance of damage from inadvertent signal overload.

But convenience and trouble-free operation are only part of the package. Like all Sentry designs, the 100EL offers uncompromised accuracy. So you can be certain of quality sound.

The Sentry 100EL - with the power to make your job easier. For more information, write to: Marketing Department, Electro-Voice, Inc., 600 Cecil Street, Buchanan, MI 49107.



**Ev** Electro-Voice®  
SOUND IN ACTION™

# P R E V I E W

## Sound-Text Acoustical Wall Treatment

Alpha Audio Acoustics, Richmond, VA, has become the exclusive distributor of Sound-Text for the professional audio industry. Sound-Text is an attractive fabric wall-treatment which has a 20% noise reduction coefficient, yet is only 3/16-inch thick. A light-duty sound absorber, Sound-Text reduces clatter and high-end reflections, and can be used in conjunction with Alpha Audio Acoustics Sonex, which has a 95% noise reduction coefficient.

Sound-Text has a Class A fire rating, and comes in 14 colors with two ribbed patterns to match any decor. The fabric comes in 54-inch wide bolts and can be applied with standard wallpaper adhesive.

Circle #049 on Reader Service Card.

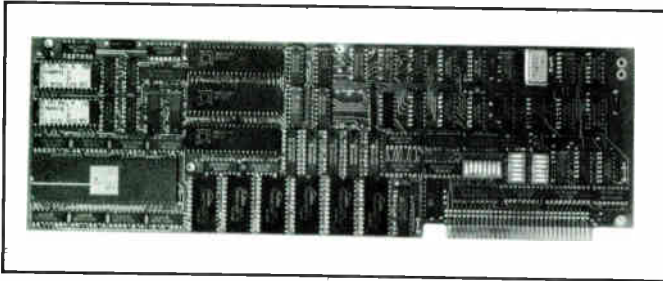

## Ariel FFT Peripheral for IBM

Ariel Corporation of New York City has introduced their PC FFT, a single card Fast Fourier Transform processing card that plugs into the IBM PC, XT, AT or compatible computers. An FFT is performed by the execution of a single program line in BASIC, Pascal, and other languages. Disk-based, assembly-language driver routines make the host/peripheral interface transparent to the user. Standard (PROM resident) algorithms include forward/inverse FFT, Hamming window, and power spectral density.

Operating on 16-bit integer data, the PC FFT will transform arrays of up to 2048 complex points in less than 20ms. A compact, highly efficient, pipe-lined architecture allows all the hardware to fit within a single expansion slot in the host computer, and the peripheral's low power consumption permits two or more processors to be installed for greater versatility. The Ariel PC FFT is priced at \$1,850.

Circle #050 on Reader Service Card

## Mogami Catalog Available

A General Wire & Cable catalog from Mogami Products includes a new series of ultra-miniature multi-conductor cables, superflexible computer cables, and a series of high-conductivity cables with oxygen-free copper conductors developed through Mogami's Neglex research program. Also featured are: standard co-axial cables, foil shielded cables, plenum cables, and retractile cords, as well as speaker/microphone cables and connectors.

A free copy of the catalog is available from Marshall Electronics, Inc., Mogami Products Division, Department WC, P.O. Box 2027, Culver City, CA 90230.

Circle #051 on Reader Service Card

## Jensen High-Performance Output Transformers

Jensen Transformers (North Hollywood, CA) has developed a new high performance 1:1 output transformer (Model JE-11-BM) which approaches a "straight piece of wire" in transparency, according to the manufacturer. A special 80% nickel alloy core significantly lowers hysteresis distortion and allows use with source impedances from zero to 1,000 ohms. HF performance is also excellent. The JE-11-BM is priced at \$61.60 in single quantities.

Circle #052 on Reader Service Card



## Wireworks TE-3 Cable Tester

The Wireworks TE-3 is a lightweight, pocket-sized tester which detects and identifies shorts, open circuits and out-of-phase wiring conditions in cables with XLR or 1/4-inch connectors. The unit is 1 1/2-inches smaller than its TE-2 predecessor and an internal nine-volt battery provides the power to test an average of 1,000 cables. The TE-3 is priced at \$99.

Circle #053 on Reader Service Card



## D & R Electronics' Series 2000 Boards

The Series 2000 range of in-line mixing consoles from D & R Electronics (Amsterdam, The Netherlands) are scaled-down, non-modular versions of the company's Series 4000 boards. The 2000s feature four-band equalization and FSS (floating subgroup system), which allows the creation of a subgroup wherever necessary without patching. The series

is available in 10, 20 and 30 channel models, and includes an external power supply.

Circle #055 on Reader Service Card

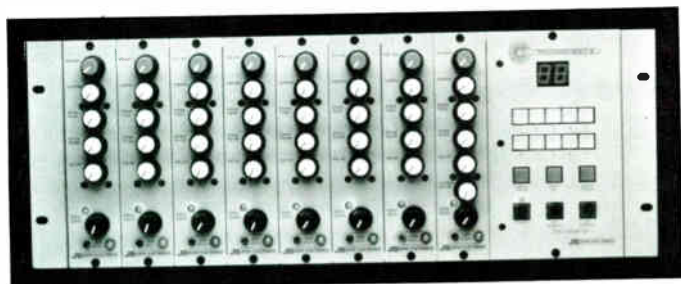

## Cooper Sound Chest II

Europa Technology, of Venice, CA, is now distributing the J.L. Cooper Sound Chest II, a programmable MIDI drum computer consisting of individual voice modules under the control of a computer module. Triggered by drum pads, MIDI note on commands, and tape sources, the voice modules contain a basic drum sound and space for an additional sound chip set of the user's choice. Each voice module boasts extensive programming capabilities, including volume, tuning, dynamic tuning, dynamic filter, and decay rate. The Sound Chest II's MIDI features include send/receive program changes, MIDI channel select, individual note assignment, send/receive dynamic pad hit data, and MIDI enable/disable.

The rack-mountable Sound Chest II is available as a basic system with five voice modules and a computer module for a suggested retail price of \$2,995. Extra voice modules are priced from \$350 for a module without sound chips, to \$450 for a module with the Crash chip set.

Circle #056 on Reader Service Card



## "Mini-Loc" Recorder Controller

The SV-1000 "Mini-Loc" from Sound and Vision (Los Angeles, CA) is a digital tape counter that interfaces with a recorder's transport and record functions, enabling the programming of memory punch-in/out, or play/rewind points with repeatable precision. Features include an accurate digital tape counter, full transport, user preset play/rewind tape loops, auto record punch-in/out, return to zero, punch-out foot switch jack, LED function indicators and variable fast forward/rewind shuttle speeds. The SV-1000 interfaces with Tascam, Otari and Fostex recorders and is priced at \$275.

Circle #057 on Reader Service Card

## Agfa PEM 297 D Digital Tape

Agfa PEM 297 D, a new highly dependable digital audio mastering tape, has been introduced by the Magnetic Tape Division of Agfa-Gevaert, Inc., Teterboro, New Jersey. The 1/4" tape comes on 4,600 foot, 10 1/2" reels. The new material features fewer dropouts which lowers the need for error correction and reduces the possibility of program loss.

Circle #058 on Reader Service Card

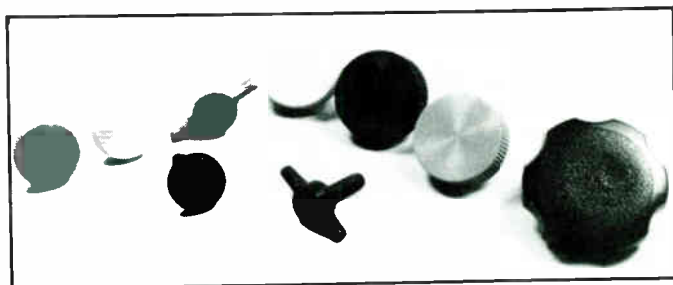

## Replacement Boom Lockscrews

Black Audio Devices, of Glendale, CA, has introduced a solution to the frustrating problem of replacing lost or stripped microphone boom lockscrews. Since factory replacements can be hard to find, the Black Audio Devices line provides an alternative to retiring a boom from service, or finding a bolt and using pliers. These lockscrews grip securely on the boom shaft, so even heavy mikes won't slip, and are available to fit AKG-type booms in four styles and three colors, and Atlas-type booms in two styles and colors.

Circle #059 on Reader Service Card

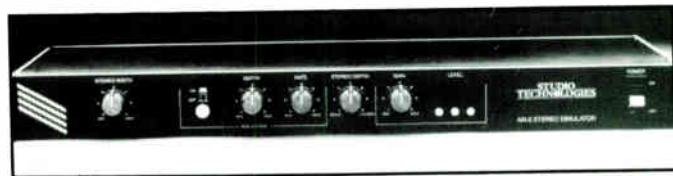

## AN-2 Stereo Simulator

Studio Technologies, Inc., (Lincolnwood, IL) has introduced the AN-2 Stereo Simulator, a versatile processor designed to create a wide range of effects, including convincing stereo from any mono source. The resultant stereo signal is completely mono-compatible. In addition, the unit has a proprietary circuit to randomize the non-recursive filtering process, thus avoiding the harshness that can result from stereo simulation via delay lines.

Input and outputs are electronically balanced (selectable to -10 or +4 dBm) and manufacturer specifications indicate a dynamic range of 90dB and a 20 to 15k Hz ( $\pm$  2dB) frequency response.

Circle #060 on Reader Service Card

## Mitsubishi X-850 Digital Recorder

Digital Entertainment Corporation, a subsidiary of Mitsubishi Electric Sales America, has unveiled the new model X-850 32-track digital audio recorder with cut and splice facility. The new machine is fully compatible and electronically identical to the X-800 recorder, except for a new cosmetic appearance and the inclusion of the cut and splicing ability. The U.S. list price for the new model will remain at \$170,000, and the first machine was slated for delivery to Lion Share Studios in Los Angeles last month.

Circle #061 on Reader Service Card

## Omni Craft GTX Gates

Designed to fit into the two most common rack systems, the GTX(d) and GTX(K) modular noise gates from Omni Craft offer low noise and distortion through the company's proven optical control system. In addition to selectable gate and duck functions, the units also provide switches for inserting a high or low pass filter (or both) into the signal chain, substantially reducing the chance of accidental triggering. Some of the GTX series' other features include balanced inputs; adjustable range, release, and threshold controls; and simplified "traffic light" LED operating status indicators. The GTX units are list priced at \$275.



## Valley People Model 440 Processor

The Model 440 from Valley People, Inc., of Nashville, TN, is a single channel device offering the convenience of a peak limiter, a high quality compressor/expander package, and a dynamic sibilance processor, each controlling a common VCA. Sophisticated intercoupling of the unit's control circuitry allows the device to simultaneously operate in all of the processing areas. The compressor section features continuously variable threshold, attack time, ratio, and release time, as well as an interactive expander control which reduces residual noises which otherwise would have been pumped up by the process. The limiter section exhibits very fast attack characteristics (stated as typically under one microsecond/dB), continuously variable threshold, a fixed 60:1 ratio, and adjustable release time. According to the manufacturer, the dynamic sibilance (de-esser) processor can be effectively used on mixed program material, since it does not alter the tonal or spectral content while removing sibilants.

The Valley People Model 440 is priced at \$599, and electrically balanced input/outputs are standard, as are barrier strip connectors.

Circle #065 on Reader Service Card

## Recording Studio Management System

Pristine Systems, Inc., a Hollywood, California-based software publisher, have completed their automated micro-computer business system for the small to medium-size recording studio. The Recording Studio Management System includes studio bookings, work orders, billing, accounts receivable and payable, tape library management and financial reporting. The software package is completely integrated and available for use on any IBM compatible micro-computer. Turnkey systems are priced from \$7,000 to \$13,500, and customer modifications are available.

Circle #063 on Reader Service Card



## Audiopro AX-3 Crossover

The Audiopro AX-3 professional electronic crossover, distributed by Yorkville Sound, Scarborough, Ontario, Canada, is a single rack-space unit featuring 24 dB/octave rolloffs, zero phase shift at all crossover frequencies and rotary frequency controls which regulate digital tuning circuitry accurate to within one-sixth of an octave. The AX-3 also includes balanced and unbalanced inputs/outputs; push-button two-way to three-way conversion; a 10Hz/40Hz low cut selector; input level control with a two-color activity/clip LED; low, mid and high-frequency output level controls each with two-color activity/clip LEDs and output mute pushbuttons.

Circle #066 on Reader Service Card

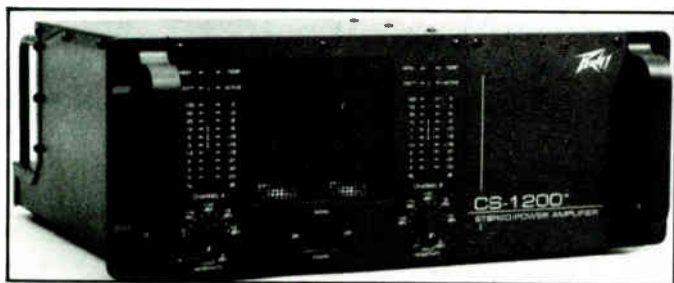

## Peavey CS-1200 Amplifier

The CS-1200 is the latest entry in Peavey's line of CS-series power amplifiers. The unit features large, continuous-duty power transformers of a new semitoroidal type; Peavey's patented DDT™ compression circuitry; and the new "back porch" accessory plug-in patch panel for adding balanced input transformers, crossovers and special function modules. This seven-inch high rack mount amplifier weighs 70 pounds and is rated at 600 watts RMS continuous per channel into four ohms, and 1200 watts per channel (RMS continuous) into an eight ohm mono bridged load. The CS-1200 has a list price of \$1,199.50.

Circle #064 on Reader Service Card

## Klark-Teknik DN780 Software Update

Klark-Teknik, Electronics, of Farmingdale, NY, have introduced Version 1.5, a new software program which expands the versatility of their DN780 digital reverberator/processor. Newly added features include three gated decay programs, a memory lockout option, and a remote slider update. The gated decay programs include non-linear decay, reverse decay, and "Alive," a unique vocal program. The memory lockout feature allows the user to protect the settings on one or more memory locations, and the slider update permits the assignment of any program function to any fader on the remote control. All DN780 software updates are free from the manufacturer for a period of 18 months after purchase.

Circle #067 on Reader Service Card



## A Commitment to Sonic Accuracy

by:

**Acoustical Physics Laboratories**

principal acoustician:

**Bill Morrison, MS Physics  
Georgia Institute of Technology**

- High Resolution Monitor Systems
- Control Room and Studio Designs

for: Recording Studios

Mixing/Mastering Labs

Edit/Sweetening Rooms

Soundstages

Monitoring accuracy is a fundamental tool required to fully realize the technical and creative potential of digital recording technologies. Toward this end, Acoustical Physics Laboratories offers advanced monitor systems and control room designs. Performance certification, through the use of Bruel & Kjaer analogue and FFT instrumentation, is provided for all monitor systems and acoustical designs.

Custom monitors incorporate cone, dome, and ribbon drivers in active systems designed for accurate time and frequency domain performance. The result is unrivaled detail resolution, transient clarity, imaging coherency, and tonal accuracy. Monitors are available in wall mounted and free field configurations.

Control rooms are designed to minimally interact with the fundamental accuracy of the monitor system. Designs incorporate proper radiation loading, dampened room eigenmodes, diffraction controls, and dispersion controls. Studio designs feature adjustable reverberation times, variable early to late reverberation ratios, and high isolation neoprene/spring floating room construction.

For More Information:

**ACOUSTICAL PHYSICS LABORATORIES**  
3877 Foxford Drive, Doraville, Georgia 30340  
404-934-9217

Circle #068 on Reader Service Card

## Audio-Technica AT853 Microphone

by William Johnston

When I was first confronted with the prospect of reviewing this microphone, I admit I had my reservations. I mean, aren't microphones supposed to be housed in large containers appearing to once have held vacuum tubes? And all engineers know that a microphone's performance is supposed to increase in a direct ratio to its weight, right? Besides, lavaliers have traditionally been known as the bastard child of the microphone family, lost somewhere between shotguns and the telephone.

Well, I was in for more than a few surprises with the AT853. First and foremost, this is not exactly a lavalier per se. The microphone was originally designed for use in sound reinforcement applications, professional recording studios, and for television work. Although it features an extremely low profile, don't be fooled (as I originally was) into assuming that its sound is a function of size. Throughout the years, lavalier microphones have been called on to perform in situations somewhat beyond their capacity. They have been stuffed into instrument "f" holes, taped to guitars, suspended over orchestras, and used anywhere where the sight of a microphone would be a sin, such as stage, TV and film applications. Yet, often these microphones were only intended to be draped around the neck of Dan Rather for limited range speech pickup, and don't live up to musical expectations. The AT853, however, is designed first as a good sound transducer, and secondly as a small microphone. Through careful design, Audio-Technica has been able to create a tiny, yet excellent multi-purpose microphone.

### Microphone Design

The AT853 is an electret condenser with a cardioid polar pattern. Audio-Technica increased both the frequency response and the transient response of the microphone over its predecessors through the use of a new, lower mass diaphragm. Moving the electret charge off the diaphragm and on to the fixed back plate allowed Audio-Technica to

lower the diaphragm mass by one-third, yielding a four micron-thick gold vaporized diaphragm. Furthermore, the new design helps to reduce distortion and alleviate the need for a high voltage power supply demanded by some early condenser configurations.

The AT853 is powered via the AT 8505 power module which is supplied with the microphone. This module allows the user to switch between a battery source in the module, or an external phantom power source. The battery required is an N.E.D.A. type 910 ("N") 1.5 volt, which will give approximately 2000 hours of intermittent use, using an alkaline or mercury-type battery. Although these batteries are readily available, you may not find them at your corner 7-Eleven at 2 A.M. Yet, since the current demands of the capsule are extremely low, the replacement period of the battery will be quite long.

When employing an external phantom power supply, a typical 9-52 volt supply is required. The use of such a supply will automatically bypass the battery in the power module. This is accomplished by a diode in the module circuitry allowing the battery to be

isolated for longer life during phantom power usage. The AT853 can also be powered without the use of the 8505 power module. A simple power source will suffice. This, however, will bypass the main advantage of the 8505 module: Since the AT853 is a cardioid, it exhibits proximity effect, and, since lavaliers are more often than not asked to do close miking (i.e. dropping down the bell of a saxophone), the 8505 is supplied with a low end cut to minimize the increased bass response.

In general, the overall frequency response of the AT853 is quite good. The microphone is relatively flat on axis between 60 Hz and 15 kHz ( $\pm 3$  dB). Below 60 Hz, there is a gradual roll-off, and above 15 kHz there is a fairly quick roll-off. The signal to noise ratio, however, is listed as "greater than 47 dB" at 1 kHz @ 10 dynes/cm/s<sup>2</sup>. While this microphone is obviously not intended for the next digital recording of Pavarotti, it is well suited to a wide variety of other applications.

The AT853 is able to take a maximum input level of 130 dB SPL (1 kHz @ 1% THD) which basically means that it will take a jet engine to overload the



**IF IT'S WORTH DOING,  
IT'S WORTH DOING RIGHT!**

Flanner's Pro-Audio has been doing it right for the past 8 years with knowledgeable sales people and factory trained technicians. With a parent company over 90 years in the audio business, Flanner's Pro-Audio assures you accurate, dependable information and support of the products we sell. Doesn't it make sense to deal with a totally professional audio dealer for all your audio needs? Flanner's sells and services over 120 professional manufacturers.

**FLANNER'S  
PRO-AUDIO, INC.**  
Serving The Recording & Broadcast Industries

CHICAGO

MILWAUKEE

**MMX**

MIDWEST MUSIC EXPO

SPONSORED  
BY FLANNER'S  
PRO-AUDIO

HOTEL CONTINENTAL  
CHICAGO, ILLINOIS

**SEPT. 20-22**

Flanner's Pro-Audio in conjunction with KBA Enterprises present the Midwest Music Expo, September 20-22, 1985. The MMX will be held at the Hotel Continental in Chicago, Illinois. This will be a three day expo of professional manufacturers, seminars and special events. For more information call Flanner's Pro-Audio or KBA Enterprises at (312) 279-8323.

**SALES & INFORMATION  
(414) 785-9166**

**ORDER DESK (800) 558-0880**

**COMING SOON**

**NEW!**  
**SONY**  
Professional Audio Products  
**APR-5000**  
**Analog Audio  
Recorder Series**



The new Sony APR-5000 is a recorder/reproducer capable of operation in all production and broadcast environments, designed for superlative audio performance and optimum ease of set up, operation, and service. The APR-5000 is available in many configurations with optional center-track time code capability.

**CALL FOR COMPLETE  
DETAILS AND PRICING**



**NEW  
K-240M**

**SPECIAL  
\$65**



**NEW**

**TASCAM**  
TEAC Professional Division

**MS-16**

*16-Track Recorder/Reproducer*

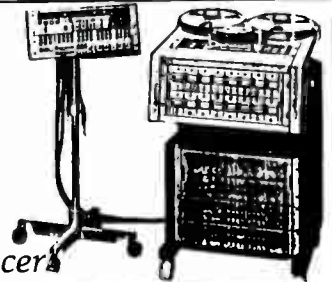

**SENNHEISER**  
The name for perfect sound

**SPECIAL  
ONLY \$196**



MD-421U

2323C Bluemound Rd, Waukesha, WI 53186

microphone. A-T takes the trouble to include three standard sensitivity ratings in its specifications. The sensitivity rating is -50 dB (0 dB = 1 mW 10 dynes.cm/s<sup>2</sup>), the E.I.A. rating is -144.5 dB, and the open circuit sensitivity rating is 0.40 mV (-68 dB ref. 1 volt @ 10 dynes.cm/s<sup>2</sup>).

### Accessories

The AT853 comes equipped with a number of accessories. As if to get the point across that this is not a typical lavalier, no tie-clips or neck straps are included. The accessories that are included are meant to complement the microphone's intended applications, and were developed to give the microphone a low profile in situations where a larger microphone would be inadequate. These simple accessories help to increase the overall flexibility of the microphone.

First of all, the AT853 is permanently connected to a 25-foot cable which is then plugged into the 8505 power module via a three pin (TA3) type jack. Thus, the larger 8505 can be isolated away from the actual microphone setup. The power module then accepts a typical female XLR connector. The power module also comes with two

mounts, for attaching the module to a fixed object. The remaining accessories include a desk stand/microphone stand adapter, a windscreen, and an adjustable wire hanger for overhead applications.

### Evaluation

As Audio-Technica considers this an all-purpose microphone, I tested it in a variety of situations and it did well in all phases of this test.

To begin with, I used a pair of the microphones in an ORTF stereo mixing configuration and recorded a 20-piece chamber string orchestra. I considered this application to be the least likely use of the microphone, and really did not expect it to perform too well. Furthermore, perhaps to stack the deck in my favor, I used two Neumann U-87s for comparison. To my surprise, the AT853 sounded fairly smooth, except in the low end, to which I added some equalization. The Neumanns, of course, are hard to beat, and overall had a much warmer sound. The imaging of the two pairs, however, was fairly comparable. The biggest difference was in the noise floor. In such a critical application, the noise floor of the AT853 was clearly audible.

I then tested the microphone in several applications to which I felt it was more suited. I used the microphone on several live recording jazz concerts, in which sound reinforcement was utilized as well. The microphones worked well for both the recording and reinforcement of brass, exhibiting no undue feedback or discoloration of the sound. Considering the fair job that microphones did on the sound quality of the strings, I would recommend these microphones for any string, brass, woodwind or vocal section pickup. I also used (abused?) the microphones on kick drum and snare with fine results. In these close miking situations, I was glad that I had the low end cut option on the 8505, to minimize proximity. Also, in these multi-microphone, reinforcement situations, the noise floor is not as critical, and therefore posed no problems.

The only real problems that I had with the microphone was that I seemed to want more accessories. I guess that if they give you a few toys, you always want more. A tie clip or neck strap wouldn't have hurt, even if it seems to cheapen the image. Also, the power module mounts have no way to connect to a microphone stand directly, so the power module spent a lot of time on the floor, which is not ideal. As with many lavaliers, the cable is permanently affixed to the microphone. Personally, I would prefer about 10 feet of attached cable (rather than 25 feet) with a TA3 connector to a 15-foot extension. This would obviously mean another connector, but it would give more flexibility to the setup. Besides, 25 feet of thin cable can get very tangled very easily. The wire hanger, however, worked well and kept the microphone accurately pointed when hung. This is important for those who wish to set a microphone once, and leave it permanently hung (as in a church choir). Outdoors though, the light weight of the microphone and hanger could become a problem in high winds.

Overall, I would have to admit that I went from being skeptical about the microphone (before I heard it) to pleasantly impressed (after actually listening to it). As a lavalier, it is fantastic. And, viewing it purely as a microphone without regard to its size, it is quite good, a very flexible microphone. So I guess that finally we have a good, solid lavalier that we can tape onto trumpets, hang on a harp, drop over an orchestra, and abuse as we always have with lavaliers. But now, it can even sound good.

The AT853 has a suggested retail price of \$175.00 For more information contact Audio-Technica, U.S., Inc., 1221 Commercial Drive, Stow, Ohio 44224. ■

## Optimize — don't compromise:

If you demand optimum performance from  
your tape recording equipment . . .  
you need our services!

JRF maintains a complete lab facility insuring precision relapping and optical alignment of all magnetic recording heads and assemblies. Worn unservicable heads can be restored to original performance specifications. 24-hour and special weekend service available.

- Broadcasting
  - Mastering
    - Recording Studios
    - Tape Duplicating

New and reconditioned replacement heads from mono to 24-track . . . Many in stock.

For repair or replacement, we're at your service!

Call or write.

**JRF/Magnetic Sciences, Inc.**

101 LANDING ROAD, LANDING, NJ 07850 • 201/398-7426

Circle #070 on Reader Service Card



# TESTED. PROVEN.

The Carver PM-1.5 Magnetic Field Power Amp—For performance, reliability and sound.

**On the Road** Since the professional debut in 1983 of the Carver PM-1.5 Low Feedback High Headroom Magnetic Field Power Amplifier, the sonic excellence and reliability of this 21-lb., 450 watts per channel\* powerhouse has been tested—and proven—on some of the biggest and toughest tours ever to go on the road. 108 Carver PM-1.5's were used by Clair Brothers on the Bruce Springsteen tour, and 180 PM-1.5's on the Michael Jackson "Victory" tour. In both cases the result was purely awesome power.

"Our new Carver amp racks pack twice the number of channels in about the same truck volume as the conventional racks they replace. In addition the average power per channel has increased while the average weight per channel has decreased. In the low end, for example, we now have 1,200 watts per cabinet where 650 watts were previously available. They take less room on the truck, they weigh less and our systems have more headroom than before. The Carver amplifier has allowed us to take a significant step in improving our sound systems." **CLAIR BROTHERS**

And not only a sound industry giant like Clair Brothers tours with Carver.

"We have toured Carvers with the following artists: Softcell, Paul Young, Johnny Mathis, Donna Summers, Howard Jones, Pointer Sisters, Psychedelic Furs, Lee Greenwood, General Public, George Thorogood. This is exclusive of our numerous one-nighters. The consensus of the performers is that the equipment sounds great. They have been amazed by the sound of the amps as well as their size and weight. As for reliability, out of 50 amps we had only one fail in the past year of touring. This is by far the best record we've had with any manufacturer of amplifiers. Sonically, the extra headroom is readily apparent. We, at Manticore unanimously agree that the PM-1.5 is incredible and is the only amp we intend to buy."

*Tom Whisner (owner) MANTICORE*

**In the Laboratory** The Carver PM-1.5 was rigorously tested by Len Feldman for MODERN RECORDING (February 1985). His laboratory test results also prove that the PM-1.5 really delivers. The following quotes from the Lab Report are reprinted with permission of MODERN RECORDING & MUSIC:—

"The first thing we noticed when we began to work with the Carver PM-1.5 was the ease with which the amplifier delivered almost limitless power to speaker loads which we had previously considered to be difficult to drive to loud levels. This is the sort of amplifier that just refuses to quit."

"The amplifier delivered a clean 480 watts per channel into 8-ohm loads with both channels driven for its rated harmonic distortion level of 0.5%. Even at the frequency extreme of 20 Hz, power output for rated THD was 470 watts as against 450 claimed by Carver. Furthermore, at rated power output, distortion decreased to an insignificant 0.015% at mid-frequencies and 0.007% at 20 Hz. When connected to 4-ohm loads, the PM-1.5 delivered 750 watts per channel for rated THD of 0.05%—far more than the 600 watts claimed by Carver. Clearly, when it comes to specs for a professional amplifier, Carver has taken a very conservative approach... All (manufacturer's claims) equaled or exceeded published specifications—usually by a wide margin."

"Carver has managed to deliver a tremendous amount of power in a small lightweight package at a very reasonable cost..."

"For the professional audio engineer or technician who has to move a lot of gear around much of the time and who expects total reliability and circuit protection, come what may, the Carver PM-1.5 represents, in our view, a real winning product. We will probably see it used increasingly by professionals in every area of sound reinforcement."

Now—don't you think you owe it to yourself to hurry over to your local Carver Pro Sound Dealer and *test your own PM-1.5?* Whether you run a megawatt sound company, a struggling bar band, or a recording studio gearing up for digital, the Carver PM-1.5 will pay you. In increased portability and reduced freight costs. In freedom from expensive blown drivers. In sheer sonic excellence.

**\*Power:** 8 ohms, 450 watts/chan. 20 Hz-20 kHz both channels driven with less than 0.5% THD. 4 ohms, 600 watts/chan. rms 20 Hz-20 kHz both channels driven with less than 0.5% THD. 16 ohms, 300 watts/chan. 20 Hz-20 kHz both channels driven with less than 0.5% THD. 2 ohms, 525 watts/chan. at clipping, 1 kHz, with less than 0.5% THD. Note: 2-ohm specification for information purposes only. Operation at 2 ohms is permissible but not recommended. **IM Distortion:** Less than 0.1% SMPTE. **Frequency Response:** -3 dB at 3 Hz, -3 dB at 80 kHz. **Damping:** 200 at 1 kHz. **Gain:** 26 dB. **Noise:** Better than 115 dB below 450W A-weighted. **Input:** Balanced to ground, XLR or phone. **Impedance:** 15k-ohm each leg, balanced to ground. **Bridging:** 1200W into 8 ohms, 1000W into 16 ohms, accessed through rear-panel recessed switch. **Dimensions:** 19 in. wide, 3½ in. high, 10½/16 in. deep. Weight: 21 lbs.



## CARVER

POWERFUL

MUSICAL

ACCURATE

For more information write to CARVER CORPORATION, 19210 33rd Avenue West, P.O. Box 1237, Lynnwood, WA 98046

Circle #071 on Reader Service Card



KLIPSCH KSM-1\* PICTURED ABOVE

# KLIPSCH® Presents A Whole New Slant On Stage Monitoring

No longer will a musician have to strain to hear his performance over the sound of the P.A. stack.

At least not when he's using the new KLIPSCH KSM® or its big brother, the KLIPSCH KSM-1®.

Both these slant monitors have exceptionally hot midrange sensitivity and a response curve that allows them to cut-through any P.A. stack and to virtually eliminate bass masking – that annoying loss of detail that occurs in music mixes with heavy bass information.

Both have a multiangle cabinet configuration that gives you tremendous versatility in placement for shallow or deep stage.

Simply stated, these new KLIPSCH monitors let you hear yourself perform. Clearly.



Introducing the new KLIPSCH KSM (left) and KSM-1 slant monitors.

## Hear For Yourself

For a hot demonstration of the new KLIPSCH KSM and KSM-1 slant monitors, look in the Yellow Pages for your nearest KLIPSCH Professional Products dealer. He'll have the products and the pamphlets to help you make the best decision.

Compare these new monitors to any others of any price and you'll see what

a great value KLIPSCH offers.

Get with the new slant on monitors. With KLIPSCH.

## Which Is For You?

The real difference between these new monitors is in the bottom end. The KSM-1 has a larger (15") woofer and gives you a little deeper bandwidth making it ideal for monitoring kick drums, keyboards, and other instruments requiring extended bass response. In most applications, however, the low-end of the KSM is more than adequate.

 **klipsch®**

**A Legend In Sound.™**

P.O. Box 688 • Hope, Arkansas 71801

Circle #072 on Reader Service Card

# SOUND ON STAGE



PHOTO: LEWIS LEE

by George Petersen

Prince's Purple Rain tour, certainly one of the most talked about live sound events of the past year, brought together a number of elements which clearly set it apart from the usual mega-concert series. Aside from the mammoth quadraphonic sound system put together by tour specialists Showco of Dallas Texas (featured on the cover of the June *Mix* and said to be the largest sound system of its type ever assembled for an indoor tour), a half-dozen of the hottest remote recording trucks in the nation were constantly kept busy by His Royal Badness' frenetic working schedule.

The recordings on the road included: tracking and mixing album cuts for two different LPs—"The Ladder" from *Around the World in a Day* and "4 the Tears in Your Eyes" from *We Are the World*; mixing, assemblage and editing

## ON THE ROAD WITH

# PRINCE

---

## A CONVERSATION WITH ENGINEER DAVID TICKLE

---

for *Around the World in a Day* and the forthcoming Sheila Escovedo release; backing instrumental tracks for Sheila E.'s appearance on the American Music Awards; a 17-minute live mini-video of "I Would Die for You" and "Baby, I'm a Star" for MTV; tape-delayed live video broadcasts for South American distribution (aired live to Europe and Australia); numerous soundchecks that became demo sessions; and an as-yet-unreleased audio/video documentation of the final show, held at the Orange Bowl in Miami on Easter Sunday. As anyone from a roadie to a featured headliner can attest, a major national tour can be an exhausting, difficult experience, but when combined with this kind of rigorous recording schedule and the pressures of completing a new album release, one can only begin to imagine the hard work and contributions of everyone involved with pulling off this totally first-class event.

Certainly one of the key figures on the tour was engineer David Tickle, who handled most of the live sound mixing, as well as a number of broadcast and recording dates. Tickle, who began his career by working with various British bands at the age of 16, found himself running Ringo Starr's studio at the superstar's Tittenhurst Park estate a year later. While there, he also learned the craft of producing, by working with notables such as Terry Melcher who did a project there at the time. Tickle then got a job with producer Mike Chapman and came to the States, engineering on records like Blondie's *Parallel Lines* and *Eat to the Beat*, The Knack's *Get the Knack*, Nick Gilder's "Hot Child in the City," and Exile's "Kiss You All Over." "It really was a very good year," comments Tickle.

He then left, to try his hand as an independent producer, scoring big with his debut, the highly successful *True Colours* LP by the Split Enz. Tickle has since produced for The Swingers (a popular Australian band formed by one of the original Split Enz members), Ellen Shipley, Vapors, and Red Rider. His most recent project (cut at Tittenhurst Park) is an album by Larry Galen, which had just been released in Canada at press time.

We talked to tour survivor David Tickle, who commented on his approach to live mixing, his live sound experiences with Peter Gabriel and Prince, and some of his insights on what it was like to be on the road with the Purple Rain tour.

**Mix:** How did you get started doing live shows?

**Tickle:** I went on the [Peter] Gabriel tour last year, which was the first real tour I'd ever done. Peter wanted somebody to "take the studio on the road," so I did Europe and the States with him, mixing live sound. We had 24 Solid State Logic gates, which normally you'd only find in the studio, specially built into racks, and we used them on the drumkits. It was pretty tricky to set up, especially with gated reverb and things like that going on, but the tour was really great fun, because the musicians were so good. I got along with those guys so well that I ended up wanting to do an album with them.

**Mix:** How did you become involved with Prince?

**Tickle:** Prince had been to the Gabriel show in Los Angeles and he heard the mixes I did there, and felt that was the sound he wanted live—a thick sound that was very controlled, and very clean: very articulated, like the album was. So they figured since I had done the Gabriel shows and used Showco,

## DAVID HEWITT: ROAD RANGER

A self-described lifelong "road ranger" with a background in auto racing, David Hewitt is a widely respected engineer with expertise earned by thousands of miles and countless gigs over 17 years of remote recording. His experience also includes a 12 year stint with the Record Plant, working with clients ranging from internationally renowned orchestras to major rock tours (such as The Stones '81 and

Record Plant New York Remote Division. We had gone out to Minneapolis on several occasions to record live shows for him—in fact, some of the tracks we recorded with him at the First Avenue Club were eventually used in the *Purple Rain* movie. He's a very inventive artist in that way—he'll use material from all over the place for different purposes. He's just amazing; you can never figure out all the possibilities this guy can come up with.

For example, Prince would sometimes soundcheck for a couple of



PHOTO: DAVID HEWITT

*Mixing Prince's appearance at the American Music Awards in the L.A. Record Plant #2 truck are David Tickle (left, at console) and recording consultant David Hewitt.*

The Who '82) and nationally televised award shows. In 1984, Hewitt left to focus full-time on his company (Remote Recording Services), which has been providing consultation and technical production services for the past seven years. At press time, Hewitt, who had just completed working on a Hall & Oates video shoot at the Apollo Theatre in Harlem, was involved in supplying a Sony 3324 digital multitrack for the production of a film with Laurie Anderson.

With a busy schedule of summer touring projects slated, Hewitt graciously took a few rare, non-hectic moments to comment about coordinating the multifaceted recording services the Prince tour required.

**Mix:** How did you become involved with the tour?

**Hewitt:** It came about primarily because I had done shows with Prince before, when I was running the

hours, but that consisted of working on new songs, and if we were there, we rolled tape on the soundcheck. If he got something that clicked, and he liked it, he would come back to it, do some overdubs and work it into a song. He always had something happening like that. There was never an empty moment. Like Mozart in *Amadeus*, who always had the tune complete in his mind, Prince would always have songs pre-composed, and teaching it to the band was all that stood in the way of recording it.

The determining factor in bringing me in on this tour is that he's totally spontaneous—although things like the satellite distribution had to be set up way in advance—but on the other shows, he'd say "OK, *this* is what we want to do," and I'd literally have to jump from that point, grab the available facilities, outboard packages, and crew,

—PAGE 86



# CHRISTINE McVIE ON FOSTEX

*Christine is a singer, songwriter and, of course, a member of Fleetwood Mac.*



“Fostex is wonderful for experimenting with ideas quickly, and under my own roof.”

*Christine McVie*



“As a singer/songwriter, I hadn’t previously known a lot about recording techniques and studio technology. So my newfound relationship with my Fostex B-16 will teach me a most important dimension of a musician’s career — engineering.

“Not that I’m becoming a studio engineer. Fostex is relatively simple to use; for me, having this equipment at home enables me to produce really superior demos. The sound quality is comparable to many 24-track studios.

“If I record something I’m really satisfied with, I then have the option of transferring tracks to a 24-track machine, and continuing.



**Fostex®**  
PERSONAL MULTITRACK

FOSTEX CORPORATION OF AMERICA  
15431 Blackburn Ave., Norwalk, CA 90650  
(213) 921-1112

—FROM PAGE 84, HEWITT

and get them there on time, when he wanted them. It's that kind of specialty that led me to get involved with the tour, because we had done that a number of times before, and we've got the knowledge of the trucks and crews available nationally.

We were originally called in by Prince's management to work on the album that's out now [*Around the World in a Day*]. They had a deadline to meet, they were putting this tour together, and had disassembled the studio he had in his house. So I was contracted to get a truck out to where they were setting up for the tour rehearsals. They did extensive pre-production for the tour at the St. Paul Civic Center, which he leased for a couple of weeks. It was a valid way of testing the P.A. and the production. I hired Mobile Audio [of Rome, GA] to come up and we started cutting tracks, primarily on one tune ["The Ladder"] for about three to four days. Mainly it was like studio work—we just cut tracks while the band was on stage, and then

he'd come out to the truck and do a little overdubbing and mixing.

Prince has his own style, and he does a lot of the mixing himself. So Tickle empirically knew what would need EQ, and what didn't, and in what directions they wanted to go. Prince's concept was that it was the *work* that was important, and you had to find a way to make it happen. They were all very sharp and knew what they were hearing. It's his style that's more important than technology.

**Mix:** What specific tour dates were being recorded?

**Hewitt:** The next time they called us, we brought the same truck [Mobile Audio] to Washington, D.C., where they actually started doing overdubs in the booth—it's a 45-foot trailer with an overdub booth. We did a video utilizing the in-house video capability of the Capital Centre, which was all live-to-tape. I engineered that particular one, because Tickle was handling P.A. on that date.

We came back to St. Paul for the

—PAGE 88

and it was great, they'd use Showco. Although when he saw us, we were using a house system, not the Showco system. So he started to track me down and caught up with me. I was working in the studio with Genesis in England at the time.

Showco's a very good company, they really try hard and they've got a good product, but we had a few battles at first, 'cause I'm not a live engineer; it isn't my career. I really enjoy working in sound in whatever environment it's in, and mixing is mixing. Their attitude at first was that live sound is really different than studio, but it isn't—it's just *sound*. It's a bigger room, and you deal with that, but it's still sound. Once I got the credibility with them technically—and not just artistically—it helped everything.

**Mix:** If you mix a live show in stereo, doesn't that mean that half the seats are bad?

**Tickle:** No, because the Prince tour was a 360-degree show and our front fill—the main front P.A. which captures about 60 percent of the whole audience—was totally stereo. Once you're about 30 feet from the P.A., you can hear both sides and it sounds big. Plus you're getting the source directly off-stage from the ground support front fill in mono, so the further back you get, the more apparent it [the stereo image] becomes, and the bigger the picture. The side baskets and back fill were all mono, so if you sat on one extreme side, it would be in mono, but for 60 percent of the audience, there was a complete stereo picture.

Then we had a quadrasonic array at the back, which I used as a special effect. I would bring certain sounds in, such as guitar or echo, and pan them around. The whole idea was to make the whole audience feel like a real part of the show, as opposed to everything being at one end of the hall. Roy [Bennett], the lighting designer, had all these Telescans and would scan around the audience when I did certain effects, to make the audience part of the stage. I also had extra subwoofers on a send where I could feed into them and really make the auditorium rumble. It was quite amazing.

**Mix:** Who made the microphone selections for the tour?

**Tickle:** Prince chose the microphones. Because of the way he uses them, he wanted a specific microphone weight and we were able to put any capsule in them. The vocal mikes were Sennheisers. Cubby, Prince's sound engineer on stage, who got an excellent sound happening on the monitor system, was in charge of maintaining the mikes, and making sure we had the best cap-

# Your unique systems source.

Ready for some innovative ideas in systems concepts and equipment? ESL specializes in bringing you exclusive products of European design that are totally cost effective. Our international background gives us access to unique support structures for the studio recording industry, and our technical expertise backs them up.

For more information on ESL and our product lines, please check the appropriate boxes, or give us a call today. ESL...the company with a world of experience behind it.

- Barth Electronic
- Eela Audio

- Giese Electronic
- Haase Electronic

**ESL**  
Electronic Systems Laboratories, Inc.

110 S.W. 21st Terrace B107, Ft. Lauderdale, FL USA 33312  
Telephone (305) 791-1501/Telex (WU) 753027 ESL FTL UD

Circle #074 on Reader Service Card



**Spacious,  
Sparkling,  
Expansive,  
Effervescent,  
and yes,  
Beautiful.**

The new XT digital reverb from Alesis. With features usually found only in units bearing sky-high price tags. Like 14Khz frequency response. And extended delay options like Pre-Delay and Slap-Back. Wide range decay time control. Diffusion, Damping, and filters. With the XT you can fatten drums, fill in dry strings or simply set vocals back into the deepest, smoothest acoustic cushion imaginable. All in full stereo.

The XT mixes reverb into a signal directly from the front panel or connects to any board with echo sends.

Digital reverb technology finally comes down to Earth. See the Alesis model XT at better music stores and studio supply centers everywhere.

Made in USA, suggested retail price \$795.

**ALESIS**

Alesis Corporation, P.O. Box 3908, Los Angeles, California, 90078 Telex 855310.

Circle # 146 on Reader Service Card

World Radio History

SOUND SYSTEM

# BUZZ

ITS TOO BAD YOU  
CANT ALWAYS KEEP IT CLEAN

BUT NOW  
ITS ONLY TEMPORARY  
INTERFERENCE WITH  
A  
**MODEL PS-1**



In addition to reducing RFI the PS 1 can also protect your sound reinforcement equipment from:

- HIGH VOLTAGE TRANSIENTS
- UNEXPECTED POWER UP TRANSIENTS
- IMPROPER LINE POLARITY



**linear & digital  
systems, inc.**

46 marco lane  
centerville, oh.45459

Circle #075 on Reader Service Card

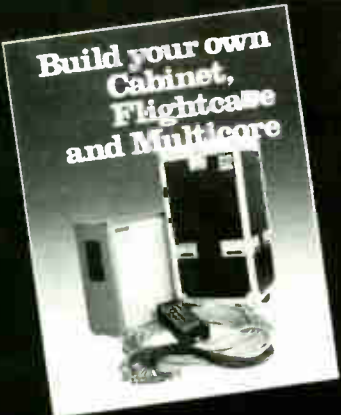

**Build your own  
Cabinet,  
Flightcase  
and Multicores**

We have the necessary top quality hardware:  
Corners, handles, catches, aluminum, extrusions, cables, connectors, vinyl and speakers.  
Write for free 60 page brochure and price-list.  
Please send 2 \$ for postage.

**fcc**  
FCC Fittings  
Hawthorne, NJ 07506  
Postbox 356 d  
Phone: 201 423 4405

Circle #076 on Reader Service Card

sules in them, because they did get dropped and do break. Microphone selections were basically between Cubby and myself. I chose Crown PZMs for drum overheads—they have a certain sound I really like: they sound great

without having to EQ them. The snare was a Shure SM57; guitar and bass guitar, Sennheiser 421s. The bass was also direct.

Between Cubby and myself, we used an awful lot of DIs. Most of the

—FROM PAGE 86, HEWITT

Christmas stint in his home town. We set up and waited, but he chose not to work until Christmas Eve. We had to break the truck down and take it out to his house to do some work on Christmas Eve, which gives you some idea of that man's absolutely incredible work schedule.

Next we went to The Omni in Atlanta [January 7-8] with Mobile Audio to do another TV shoot with both Prince and Sheila E. I'm not sure that had a final destination, but with all of these things, we were doing a variety of production work—working on the album [*Around the World in a Day*], working on Sheila E.'s album, and doing various video tracks and live bits.

From Atlanta, we went on to Houston [January 10-17] and hired Le Mobile [North Hollywood, CA] for about a ten-day stint at The Summit, and they did various bits of production work and cut another track or two. There was a lot of editing and what not going on for both albums. It was relatively serene—we sat there for ten days while Prince ran in and out doing his work.

I sent Mobile Audio to Memphis on January 26 to record backing tracks for Sheila E.'s performance at the American Music Awards. We flew everything out to Los Angeles to do the show, which set up on the next day and took place on the 28th. For that particular gig, we rented the Record Plant L.A. #2 truck, and set that up strictly for Prince. He was about the only live act playing on that set, which got a little crazy because as you can imagine, those awards shows are banged out—most are done with tape playback/live vocals or totally tracked, but Prince refused to do that. He wanted a live performance, with that kind of pressure. It was a very high pressure situation, but even with all the usual dilemmas that go on in those kind of award shows, it did come off very, very well.

From there, we went back on the road, this time with my former mount—the Record Plant [NYC] "Black Truck"—to New Orleans [January 31-February 1] and did a TV shoot at the Superdome, a videotape of both Prince and Sheila E. This is also where he did ["4 the

Tears in Your Eyes"] the cut for the *We Are The World* album.

We flew out for the Grammy Award rehearsal on February 25th, with the ceremony on the next day. Once again that was the [LA] Record Plant #2 truck which was just for Prince. I think the album was out of the way at that point.

The next recording date was the satellite audio and video bounce to Europe, Australia, and the live tape eventually went out delayed to South America. It was from the Carrier Dome in Syracuse, NY, and we used the Record Plant [NYC] "Black Truck." This was a very large scale live-to-air show, the kind that makes every hair stand up and take notice, but it came off almost flawlessly.

We took the "Black Truck" down to Miami for the last show, [also being videotaped] at the Orange Bowl on Easter Sunday [April 7, 1985]. I had to mix in the truck, because Tickle was handling the P.A. chores. He was doing everything—the live mix, running back to the truck, and then running off to some local studio—they were just like the "Whirling Dervish Brothers."

**Mix:** Isn't it hard to record and mix in so many different trucks during a tour and still have things sound consistent?

**Hewitt:** It is difficult, and what we usually did was to standardize on the smaller JBL monitors—4311s, and on some occasions, 4412s, 4413s—as well as Auratones. Each situation was slightly different—with different consoles and so on, but Tickle had done many shows with the band and really had them down. It's one of his fortes: he does studio work, P.A. work, remote work, and having done that sort of work myself for quite a few years, it does become quite a bit easier when you're on the road and you *have* to do it. There is no time for excuses, and you don't have three hours to dicker around with the EQ on the kick drum. The time's not there—you have to jump in, rough it out, and then get on to the next subject. Consequently, you get pretty good at finding the sound quickly, and Tickle nailed it down pretty quick.

—G.P.

# Who Uses Soundtracs?

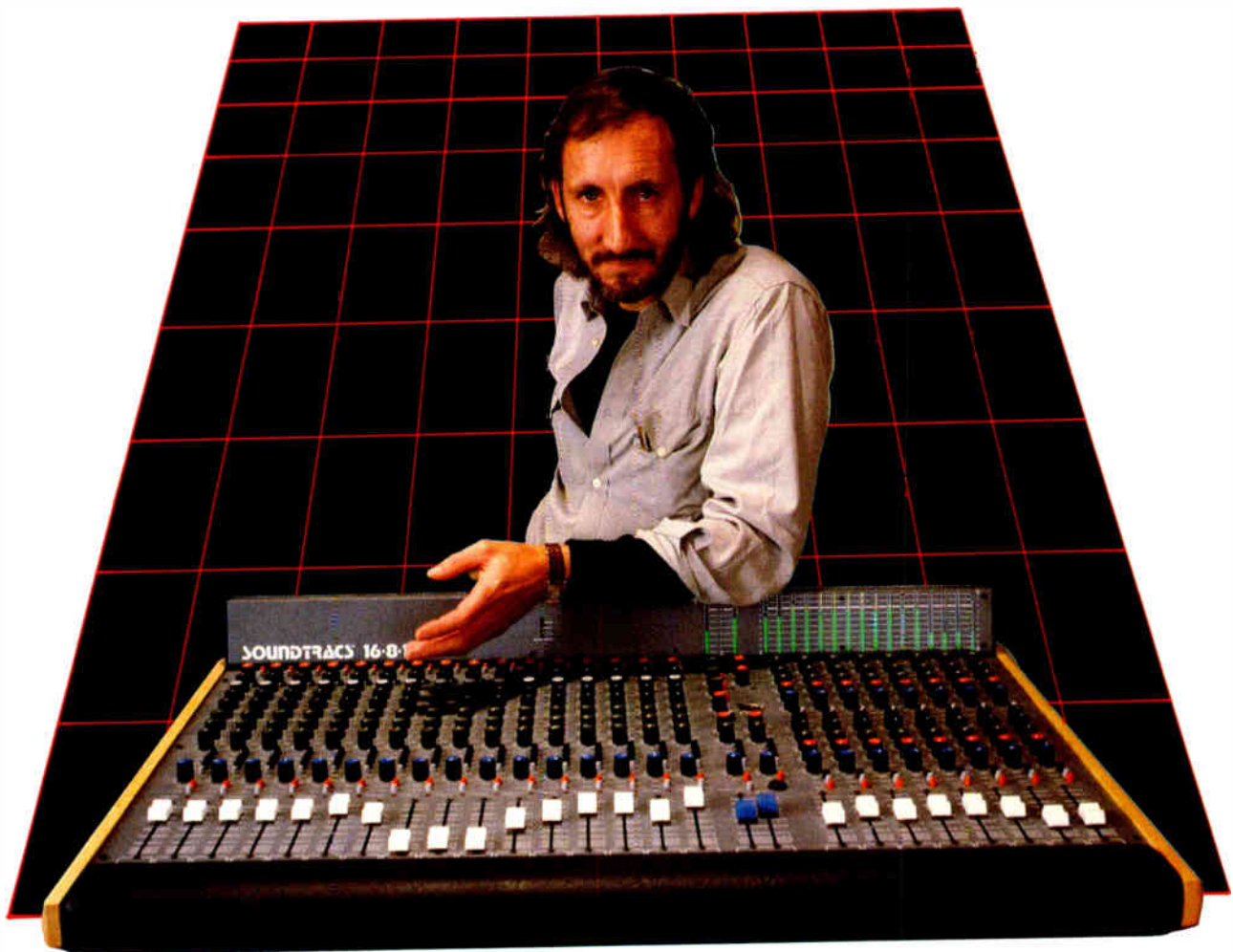

## Pete Townshend that's who!

When Pete Townshend wanted to purchase a mixer for home use he obviously had the choice of every mixer available in the U.K. Pete was looking for flexibility such as 16 extra inputs on re-mix, transparent equalisation, high resolution control of the effects returns with equalisation and compatibility with  $-10\text{dbv}$  or  $+4\text{dbm}$  tape machines (he's got quite a few!).

Pete took his time, asked around and kept being referred back to the Soundtracs 8-16 series. After one day's evaluation Pete's decision was made — the Soundtracs 16-8-16.

— “the only mixer in the 16 track market designed with the musician in mind — either you people at Soundtracs are musicians or you've talked to a lot of people. I'd recommend this mixer to anyone — and tell them that I paid full retail price for the 16-8-16 I bought!”

Pete Townshend  
November 7th 1984



affordable quality

Dealer list and brochure for professional products from: Soundtracs Inc. 125 Simpson Street, N.W., Atlanta, GA 30313 (404) 223-6093  
Dealer list and brochure for music industry from: MCI Music Inc. 745 One Hundred and Ninth Street, Arlington, Texas, 76011. Tel: (817) 469 1600  
In Canada: Omni Media Corporation Ltd 9653 Côte de Liesse, Dorval, Québec H9P 1A3 (514) 636 9971



Circle #077 on Reader Service Card

drum kit was DIs, because we had a real drum kit triggering a LinnDrum or whatever. The drum triggers were pretty much custom and were put together by [engineer] Susan Rogers, who works for Prince.

**Mix:** I understand that the soundchecks were run almost like rehearsals...

**Tickle:** That's right. Soundchecks weren't really sound "checks"—mostly him rehearsing different things, or just jamming, or sometimes recording. Quite often, we'd have a truck outside and I'd go out to the truck and we'd roll tape during a rehearsal. Very often we'd track in an afternoon and finish it up that night.

**Mix:** Did you ever go through "traditional" soundchecks?

**Tickle:** About five times during the tour, we had regular, traditional soundchecks where you'd go through every individual thing, stop everybody, and then see how it balances. Basically that wasn't comfortable for anybody. They're all musicians, and would want to get up there and play. I did it like we were in the studio where you solo everything. They just kept on playing while the monitors were happening.

**Mix:** Was that method faster?

**Tickle:** Not so much faster, but probably more accurate in terms of really hearing songs going on. You could

walk around the room and hear different songs, and hear different mixes with different dynamics, so it was more realistic. Focusing the speakers around the arena and doing time alignment on the speakers was actually the major part of the soundcheck.

**Mix:** Were there any halls in particular that stood out as being significantly better than others?

**Tickle:** It's difficult to say, because it depends on the performance of the band. We were in some halls that were really bad, but the shows were good. There weren't any halls that were really, really bad. With all the horror stories you hear about these big halls, you have to say "OK, it's a big hall"—and then listen to the sound of the room and shorten or lengthen the echoes on the drum kit or whatever and use the room as part of the sound.

So if it was very echo-ey, I'd cut my echoes short and percussive; and if it was a pretty dry room, I'd increase the reverb decay time to fill in for the hall.

## Showco System for Purple Rain Tour

**House Console:** 32 input Harrison HM-5 with HM-5 (16 channel) expander for a total of 48 inputs.

**Monitor Console:** 32 input Harrison SM-5 with 16 input expander.

**Amplification:** 230,000 watts in 47 amp racks containing 168 Crown PSA-2s and 28 Crown Micro-Tech 1000s.

**Speakers:** 20 pair Showco ASX four-way systems in main array; 4 pair ASX for backfill; 8 pair ASX for quadraphonic array; 12 ASX LO subwoofers; 16 pair Showco model SS for monitoring and front fill; 10 biamplified floor monitors (single 15"); MF 6 biamplified (dual 12") floor monitors; 4 biamplified (dual 15") floor monitors.

**Outboard Gear:** Quantec Room Simulator; (3) AMS RMX 16 digital reverbs; (3) AMS DMX 15-80S digital delays; (2) Lexicon PCM42 digital delays; Roland SRE-555 chorus/echo; (2) ADR Vocal Stressers; (2) dbx 900 card racks; (3) Valley People Dyna-Mites; (2) UREI 1178 limiters; (4) dbx 160 limiters; Ivovonics RTA; (16) channels of Klark-Teknik graphic equalization; (2) Tascam cassette decks; Sony Compact Disc player.

**PRODUCTIVITY.**  
*Imagine if Mozart were alive today how technology might maximize his creative genius. The production process has always maintained the same goals: shaping creative ideas into a finished product. Today's technology not only allows you to be more creative, but more efficient in your productions through the use of automation, synchronization and computer sequencing and editing. And at remarkably affordable costs.*

*Whether your needs are for creative music, professional recording, broadcast, production or post-production, Leo's Audio and Music Technologies is uniquely suited to supply your equipment needs. Leo's incomparable selection, systems interfacing, product training and professional services (including maintenance & customization) are just what you need to maximize your genius.*

**leo's audio and music technologies**  
*Anticipating the needs of musicians and audio professionals since 1956.*

5447 TELEGRAPH AVENUE • OAKLAND • CA 94609 • (415) 652-1553

Circle #078 on Reader Service Card

# DigiTech



Digitech RDS 1900—\$299.95  
15 KHZ to approx. 2 sec.

Digitech RDS 3600—\$399.95  
15 KHZ to approx. 2 sec.  
8 KHZ to approx. 4 sec.  
4 KHZ to over 7 sec.

Digitech RDS 900—\$259.95  
8 KHZ to approx. 1 sec.



Digitech PDS 1000 — 7 KHZ to 1 sec. — \$199.95  
Foot switching for off/on and repeat — hold functions  
Also available: Digitech PDS 2000 — 7 KHZ to 2 sec. — \$269.95  
Foot switching for off/on and repeat — hold functions

DOD Electronics is proud to introduce a new series of products that represent the finest in state-of-the-art digital technology. Best of all, our new DigiTech line gives you the ultimate in digital delay systems at completely affordable prices. DigiTech. We invite comparison.

**DigiTech**

® registered trademark of DOD Electronics Corporation

5639 South Riley Lane  
Salt Lake City, Utah 84107  
Telephone (801) 263-8400

Circle #079 on Reader Service Card



Waylon Jennings &amp; Neil Young

# NEIL YOUNG

## ARE YOU READY FOR THE COUNTRY (AGAIN)?

by Rose Clayton

Neil Young's music has always been enigmatic. It is, for example, often catalogued in most record stores under the style "MISC"—usually between The Who or Yes and Frank Zappa. Young, himself, is even at a loss as to how to describe his art.

"I have to be in the unclassified sec-

tion right off the top," Young admits, "but what I have tried to do is follow my instincts. What I feel like doing with music is what I've done. More and more lately I've come to enjoy the music I'm doing with my friends here in Nashville. It keeps coming back into my life over and over—one of the few things that has repeated—country music."

Young's involvement with country goes back some 20 years to the time he was a driving force in Buffalo Springfield, one of the bands generally credited with breaking ground for country rock. His work with Crosby, Stills, Nash & Young featured several countrified classics ("Country Girl," "Helpless," etc.) and throughout his long and intensely varied solo career, he has made continual forays into country on albums such as *Harvest* (which contained "Heart of Gold"), *Comes A Time*, *Hawks & Doves* and others. For his 1984 live shows he assembled a band that included both pedal steel guitar and a country fiddler, and he even played a number of dates with Johnny Paycheck opening and joining Young for a song or two. Making predictions about Neil Young's career is always a hazardous proposition since he continually confounds even his closest friends with his chameleon-like musical metamorphoses; he does, however,

seem content with his current infatuation with country because he believes these songs are truly coming from his heart.

"My good music comes from my heart and my mediocre music comes from my mind," says Young. Does he know the difference when he hears it? "Pretty much," he says. "It's just being able to deal with the fact that I have this song that's inferior because it's not real. Sometimes you try to record them anyway, but they're the ones you keep pounding away at and never get."

The best songs, his "good music," come easily he says. "Music is a funny thing. You can't ever say what is going to make music happen. Music is magic. No one can nail it down. I've made some of my best music when I was totally unhappy."

Young's latest project for Geffen (at this time still unnamed) appears to be from his more cheerful side.

"We're just having a great time," Young smiles. "We're just playing it straight because the songs are all songs that I really believe in. They mean something to me and to my family and to the musicians."

"We all play it live together and I was singing while they were playing," Young continues. "It was all happening at once. I feel real lucky to be able to



# THE MOST SOPHISTICATED COMPOSITIONAL TOOL EVER CREATED IS BASED ON A VERY SIMPLE CONCEPT.

In the race to merge the computer into the musician's art, most companies overlook a major point. Music is a creative profession with its own language, its own pace, and especially its own style.

As we set about to develop the LINN 9000, integrating the ultimate in digital drums with the most "musician-friendly" MIDI keyboard recorder, we realized that operation

had to be virtually effortless. Quite simply, we let the musician in us win over the temptation to push computer technology to the ragged edge.

The result: the most sophisticated compositional tool ever created. The LINN 9000.

The 9000's 18 digital drum and percussion sounds are unquestionably the best. Alternate sounds from our library can be loaded in from cassette or the optional 3.5" disk drive, or sample your own sounds using the optional audio sampling card. The 9000 captures all the spontaneity of your performance through front panel pressure sensitive pads, remote electronic drum pads or other sources plugged into dynamic-sensitive trigger inputs. The "Repeat" button lets you create drum rolls with a single touch. You can easily program high-hat decay for every single note using the front panel slider or an external foot pedal.

The beauty of the LINN 9000 32 track/16 channel MIDI keyboard recorder is its ability to capture every expression and nuance of your performance. Simply. Quickly.

This is possible because you control the process the same way you operate a multi-track tape machine. Punch-in and out, auto-locate, fast forward and rewind, insert a part, copy another, merge them all... always in perfect sync. Concentrate on your art while the LINN 9000

memorizes the subtleties of your performance.

The LINN 9000. No more struggling with boxes spread all over your studio, patching and re-patching or tangled cables. Best of all, you don't have to be a computer wizard. The LINN 9000 speaks your language, the language of music.

To get your LINN 9000 brochure send \$1.00 to the address listed below. Or better yet, head down to your local authorized Linn dealer and try it for yourself.

## Linn 9000

Linn Electronics, Inc.  
18720 Oxnard Street, Tarzana, CA 91356  
(818) 708-8131 Telex #298949 LINN UR





PHOTO: RON DELANY

play with the people I'm playing with, and I'm real thankful that I was able to get the kind of sound that I was able to get here."

While Castle Recording, where the sessions took place, is one of Nashville's premier state-of-the-art studios, Young chose to cut his album with as little overdubbing as possible using as many as 33 players on a session at one time.

"A lot of records, even country records, that you hear today, are just machines playing away being directed by brilliant producers and being programmed by genius engineers, and it's coming from the mind," says Young. "They are saying, 'This will create a sound that will make everybody feel sad.' It's different than singing from your heart with everybody playing at once and feeling the song. It's a different approach. It's a human approach without the use of machines. I think machines are great. I love them. But right now they just don't fit with me." (You may recall that just three years ago Young put out a mainly electronic album, *Trans*.)

Young chose the same basic outline when he recorded *Comes A Time* in Nashville in '77 and has many of those same musicians playing on his new album. Why did he return?

"There is no place in the world like this," Young says enthusiastically. "This is Music City. There is no other Music City. Everywhere you go there's music.

There's music around the corner and in each building. People in restaurants are musicians, songwriters, publishers. They are everywhere. The whole town revolves around music. Some of the greatest musicians in the world live here. We had over two million dollars worth of violins in the room while we were playing—four Stradivariuses. Then we had some of the finest Martin guitars and one of Hank Williams' old guitars that I was using.

"There's just a feeling of heritage and quality of history that everyone is aware of here," says Young. "It really is the heart and soul of country music."

Though Young's admiration for Nashville apparently knows no bounds, he does not expect the country music establishment to accept him with open arms.

"They have no real reason to," he says. "What I am doing to them could just be construed as another phase I'm going through in my life. There are people in this town who are working with young struggling country artists. They are country through and through. They love country and they've never done anything else. Those are the people who deserve the support of this town and this music industry here in Nashville.

"If I sell records and do well in country music, it will only be on the merit of my music," Young says. "It won't be anything else that will help. No amount of famous people singing with me or any-

thing will ever make it important if the music isn't real and is not from the heart. That's what I think we've got here."

The "famous people" Young alludes to are none other than Waylon Jennings and Willie Nelson.

"Waylon and I met on the road a little over a year ago," Young recalls. "We just hit it off from the very beginning. We started working together. After one show I went to his bus and knocked on the door and said, 'Waylon, I want to sing with you.' I had been practicing 'Mammas Don't Let Your Babies Grow Up To Be Cowboys,' so I sang the part for him. I had it all down and everything—of course I had been practicing it in the wrong key—and when we got out on stage, it was in a totally different key, and I was the *worst*. I was just very funny. Everybody was laughing. I went out there and made a real fool of myself.

"But, then I got my part down and we realized what a good blend we have," he continues, now serious. "It's a real musical blend. I like singing with Waylon a lot. I called him and said, 'I'm coming to town. Are you going to be around to come down and see what you can do?' He just came down and he's putting in what he feels like putting in. It seems to be the right thing, and we're having a great time."

In addition to Waylon's duet, Young sings with Willie on "Real Cowboy," which also features Lynn Anderson. The track for that song was cut in Nashville and the tape shipped to Willie's Perdenales Studio in Austin where he and Young did vocal overdubbing.

"I don't know if there's a trend towards country or what it is," Young says. "I do know that when I was deciding to record in Nashville and telling my record company in Los Angeles that I'm going to do that no matter what and I hope you can get behind it 'cause this is me,' at the same time a lot of people were coming to Los Angeles from Nashville to record. I felt like I was the only one on the road going the other way. It felt great to me," Young smiles. "I'd rather be by myself going in a different direction. There's more room for me to do what I want when it's like that.

"I don't know what the trends in music are going to be," Young continues. "I hope my music is popular—that people like this record—but more important than that I can go to sleep at night knowing that I've done a great record and go home on the airplane and see my family and feel real good and just forget about it and think about the next one."

And what about Young's record label that filed a suit against him last year for what they called "musically uncharacteristic material"? Is it going to support Young country?

*Just The Right Mix*

# 601R™/701R™/R6M™ RACK MOUNT MIXERS

Peavey introduces the R Series, a professional line of Rack Mount Mixers capable of providing the musician and sound technician with performance levels that most console-type mixers costing twice the price cannot achieve.

No longer does the industry standard of 19" dictate what you get in terms of features and price. The 601R, 701R and R6M offer

versatility and choice... whether it be monaural or stereo configuration, 3 or 4 band equalization, balanced inputs, RIAA capability, outfront mixing, monitor mixing, specialized mixing such as keyboards, drums, etc. and even four track recording.

For the complete run down, write for our new Monitor magazine or contact your nearest authorized Peavey Dealer.

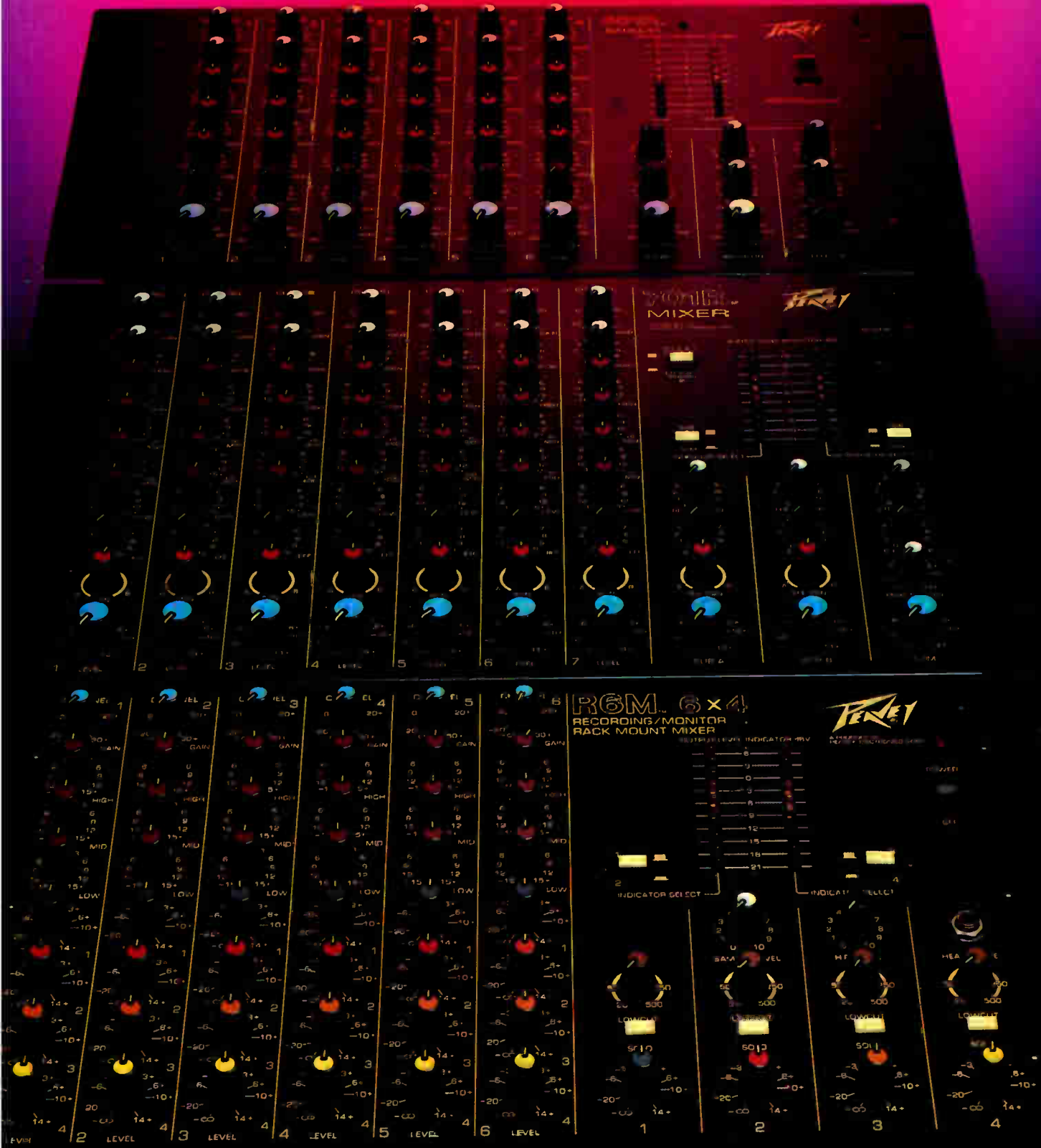

# Designed For Results!



If results are your bottom line in mixers, then we invite you to put our SR Series through its paces. Only then do we feel you will be convinced that AHB offers the features you have been looking for, at a price you can afford.

### **Stateside Savvy**

One reason is because the SR Series Mixers were designed here in the "States" by our own R and D department, allowing us to incorporate features from customer input, into its Development . . . and Producing a Mixer for the Perfectionist in all of us.

### **The Results**

Features such as 4 aux sends, 4 band E.Q., long throw faders, multi-source peak indicators on input channels and primary mix buses, stereo

and mono outputs, and external power supply with 48 volt phantom power are all provided as standard on all SR models.

### **Pro Performance**

For 4-Track Recording and more demanding Sound Reinforcement situations, 16 and 24 input models are available with 4 submaster/group outputs as well as the addition of channel mute and E.Q. bypass switching on all input channels.

### **The Bottom Line**

For more detailed information on the AHB SR SERIES of mixers, Call or Write Today. Give yourself "The Edge" with the Mixer That Achieves Recognition . . . Through Your Results!

# AHB

Mixing **ART** With **SCIENCE**

**Allen & Heath Brenell (USA) Ltd.**

Five Connair Road  
Orange, Ct. 06477 / (203)795-3594

**Allen & Heath Brenell Ltd.**

69 Ship Street, Brighton, BN1 1AE England  
Telephone: (0273) 24928/ Telex 878235

Canadian Distributor: Heint Electronics Inc. / 1-416-727-1951

Circle #082 on Reader Service Card

"I think they will be very supportive of this album," answers Young. "For one thing, the whole lawsuit really made no sense. It was more a flashing of tempers on some level, more of an emotional outrage on a corporate level that they had to sue me for something—so they sued me for that.

"I had made two off-the-wall records in a row [*Trans* and *Everybody's Rockin'*]," Young explains. "So, okay, 'We got to get his attention somehow and bring him back to earth.' I'm sure that's what they were trying to tell me.

"They never really meant for me to leave the label or for them to get all my money or anything like that," continues Young. "They were just trying to manipulate me. For my own good they thought they could save me from some disaster course they thought I was on. But I just kept on going. I paid for my own sessions, and I went out on the road and played all the country dates and talked to the stations everywhere I went. I worked with Waylon and got to know more and more people and just became happier and happier with what I was doing.

"Pretty soon everybody just gave up and just called up and said, 'We're sorry and everything's OK, and let's just keep going,'" Young concludes. "They pay me a lot of money to make records and from the beginning I said, 'I'm going to make whatever kind of record I want to make because I can't go to sleep at night if I don't make the records I want to make.' They said they would pay me a lot of money to do that; so they paid me a lot of money, and I did that, and they panicked."

Young is gambling that his fans will support his new country project.

"I think they'll like it. It's a Neil Young album. That's what I really think it is. It's no more or less than that. It's just music and I love country music and this music sounds country. I can't say my rock 'n' roll audience is not going to like it, 'cause I think it's great music, and I think my audience knows great music when it hears it. They don't care whether it's rock 'n' roll, country, or folk—as long as it's *real* music."

It may take a while to measure the reaction of Young's fans to his brand of country music, but the response of the country musicians to Young was immediate and most complimentary.

"Neil's just great," says Waylon breaking into a big smile. "I think it is really good for country music to have Neil come here to record. I think sometimes we get in a rut where we just keep doing the same thing over and over. Neil's one-of-a-kind. He comes up with the most creative things and I think, 'Where did he get that?' It's so inspiring to me that I tell him he makes me want to go home and try and write something."

"There are some songs on the album that are pretty far out," adds Ben Keith, Young's pedal steel player and co-producer. "Most of them are pretty straightforward though—about love, life, and the pursuit of happiness. He got real excited the night he got here and wrote a song for him and Waylon to do the next day—'Where is the Highway Tonight.'"

"There is one song that goes back to the way the old Neil Young writes," says Keith. "Neil didn't know what to name it, and after they cut it Waylon said, 'Why don't you name that thing the 'Misfits,' that sounds like a good one to me.'"

"Musically it (the LP) is more like a group thing," Keith explains. "Neil plays a lot of guitar on it; it's just not as much as he used to do on his rock 'n' roll things which called for it. Also, one reason he wanted to play in Nashville is because he has such respect for the musicians here. He wanted to cut the album live so we could get energy from each other.

"It's getting so sterilized," Keith continues. "You just go in and cut the basic track and sometimes you don't even know who you've cut with. You never see who's playing bass or guitar because people come in on different days."

"I think it was the first time I have ever been on a record that I have seen the string players stay around and listen to the playbacks," says drummer Carl Himmel. "That's pretty heavy right there. There are several of them who have never played with a band. They have always done overdubbing. One of them commented, 'Look, the bass player is right in here with us.'"

Having a 33-piece live tracking session must have been a challenge for the staff, yet all the musicians remarked that Young's album was probably one of the smoothest they had ever worked.

"Technically it was difficult," says Keith Odle, second engineer. "Gene Eichelberger is the only engineer that I know of in Nashville who could have handled that much going on live. The idea was to get as much as we could during the track and work it out later knowing Neil didn't want to overdub. We used the Solid State console to the maximum.

"Another thing—we had a large number of singers doing background live," says Odle. "It's much harder to work that way than when you overdub and can concentrate on individual performance. But everybody involved was a real pro and they made it happen."

The session was unique, according to Odle, because it used the state-of-the-art version of the Sony dual 24-tracks locked together to be a 48-track operation. Those were pre-DASH format digital machines upgraded to DASH standards. ■

**FREE  
20 PAGE BOOK**

the essential planning and price guide for all your custom record and tape needs

**45's, EP's,  
ALBUMS,  
CrO<sub>2</sub> CASSETTES**

**CALL NOW TOLL FREE**

**1-800  
263-7798**  
(Continental U.S. Only)

Ultra gloss board jackets/virgin vinyl/inhouse graphics/  
VMS 80 lathe  
**3 WEEK PREPAID  
AIR DELIVERY**



**WORLD RECORDS**

Baseline Road West  
BOWMANVILLE, ONTARIO  
L1C 3Z3

Circle #083 on Reader Service Card

**The Affordable**

**Digital Real Time  
Third-Octave  
Spectrum Analyzer**

- Full 30 Bands • Six Memories • Quartz Controlled "Switched Capacitive Filtering" to eliminate drift • Ruggedized for: Road Use • Microprocessor Controlled • Built-in Pink Noise Source • "Flat," "A," or "User Defined" Weighted Curves may be employed
- ROM User Curves Available.



**MODEL 30**

**Affordable at just \$1895.00**

**GOLD LINE**

Box 115mx • West Redding, CT 06896

**(203) 938-2588**

**SEND FOR COMPLETE LITERATURE:**

NAME \_\_\_\_\_  
COMPANY \_\_\_\_\_  
STREET \_\_\_\_\_  
CITY \_\_\_\_\_  
STATE \_\_\_\_\_ ZIP \_\_\_\_\_

Circle #084 on Reader Service Card

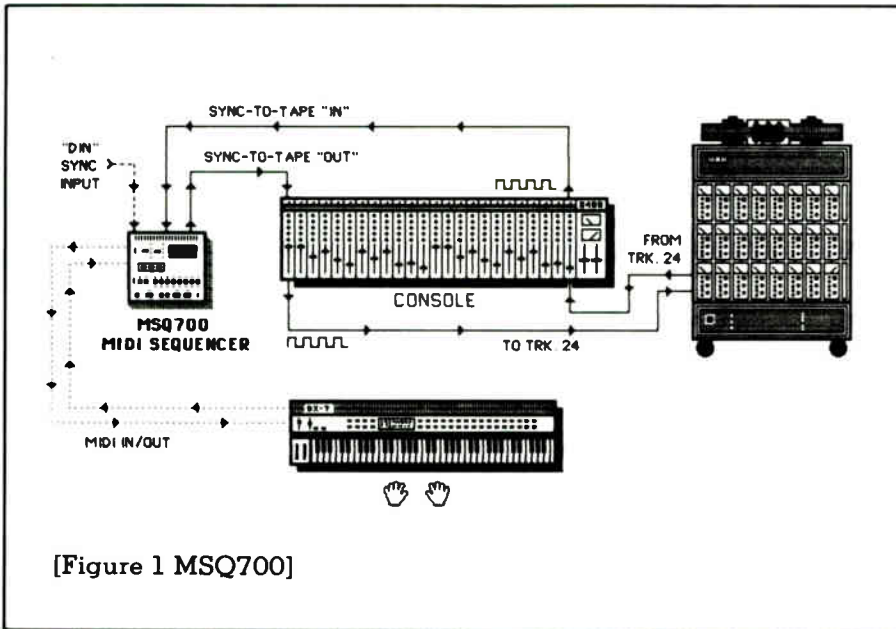

[Figure 1 MSQ700]

"slave units." This "hierarchy" allows the computers to clearly understand which unit is giving commands, and which units obey them. In some cases, it is possible for the function of a unit to alternate; it may be the master for one overdub, and slave for another one. This almost always requires a change in wiring, or at least a change of settings so that the related devices understand which unit is now commanding.

Let's look at a typical computerized setup and how this hierarchy allows clock synchronization to occur.

Figure 1 shows a sequencer. In this case, a Roland MSQ700 MIDI sequencer. This sequencer can get its clock signal from any of several different sources, internal metronome, external sync, MIDI clock, or sync-to-tape code (FSK). Since it is the only device we are using at this time, it assumes the role of master in this configuration. To use this unit properly, you would first record its tape sync signal, set to the proper tempo. To overdub, send the sync signal back to the unit, selecting the tape sync input for the clock. When the MSQ "hears" the beginning of its sync tone from the multitrack tape, it automatically starts playing, "locking" itself to the tempo of the sync track.

That's fine for just one MSQ 700, but how about something a bit more complex?

Figure 2 shows such a setup; an MSQ700 and a Roland Rhythm Composer (TR808). In this case, you must make a choice: which unit will be the *master*, and which will be the *slave*? If you have already been recording with the MSQ 700's sync-to-tape code, it may be easier to retain the MSQ700 as the master unit. In this case, the setup will be like Figure 2A, with the MSQ 700 as master, feeding its DIN sync output (the 5-pin DIN connector), over to the TR808's DIN sync input. Since the MSQ700 will generate both a clock and a start/stop signal for the TR808, it will control it completely, and in perfect sync. (Remember to switch the TR808 sync connection to input, however, or the 808 will ignore the incoming sync signals!) In the case of the TR808, since it does not have provisions for sync-to-tape, this is probably the only way you could get these two devices to work together. If, however, your drum machine is like the TR909, and has provision for sync-to-tape, and sync in and out, you may elect to choose either unit

## Wiring Complex Computer Setups

Knowing *what* to connect is as important as knowing *how* to connect it.

by Bruce Nazarian



Last month, we discussed the basics of how to use computers in recording. Understanding how to connect the various devices is as important as understanding how to run them. Inevitably, it comes down to wiring—whether you are using MIDI sequencers or drum machines, knowing how to connect them together can help you accomplish the desired recording goal.

Knowing *what* to connect is as important as knowing *how* to connect it. The element that provides the common thread running between all computerized sequencers and drum machines is the *clock signal*. Equally important is understanding the "chain-of-command," so to speak, that is involved in almost every situation involving more than one computerized device, sequencer, etc., there must be a "master unit," to which all other devices are

# LET GAND MUSIC AND TASCAM PUT YOU IN SYNC WITH A CREATIVE RECORDING PACKAGE!

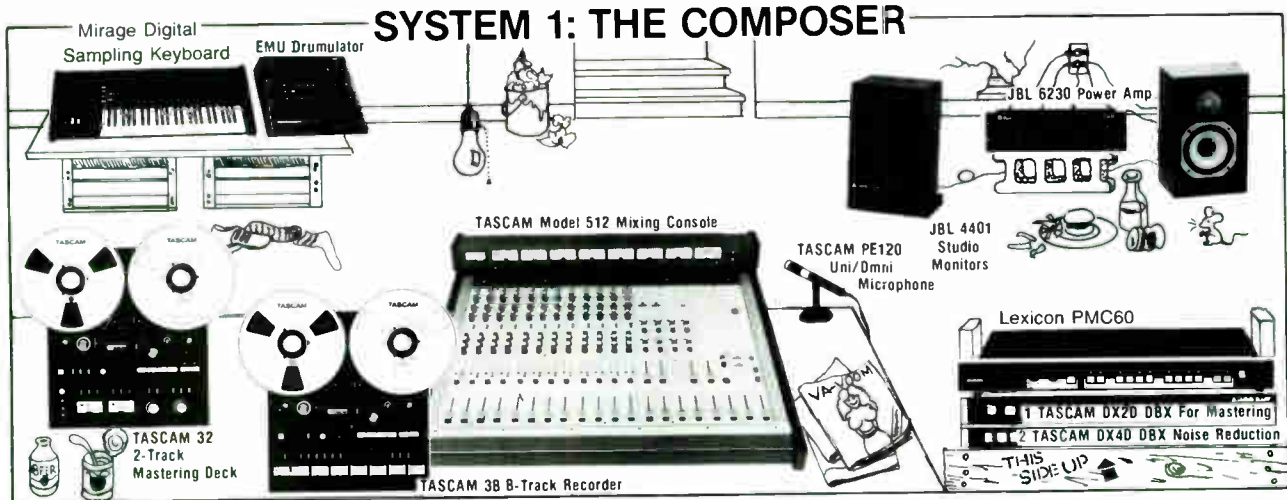

## The perfect musical scratch pad gets your tunes on tape!

Our huge stock of moderately priced recording gear, keyboards, and drum machines give you a selection not found at any other store. This enables our expert sales staff to design a system especially for your budget.

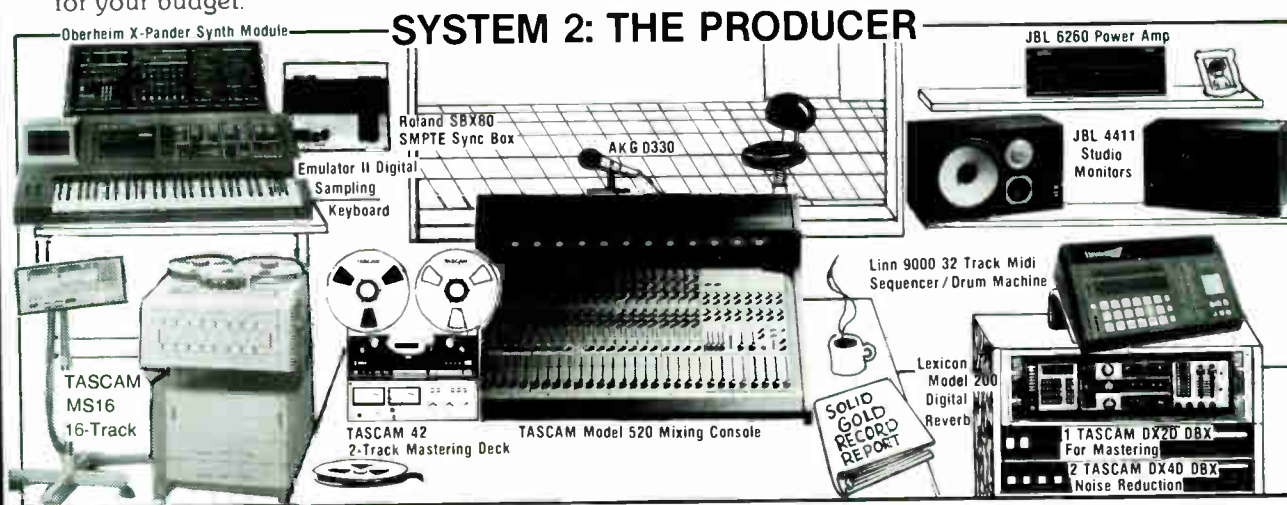

## A full-blown production studio for film soundtracks and video scoring.

Visit the Gand "PLAYROOM" to see Chicago's most incredible selection of hi-tech toys: Fairlight CMI and Video Synth, Quantec & Lexicon Digital Reverbs, Kurzweil, Emulator II, PPG, Linn 9000, Dr. Click, SMPL Lock, Tascam 48 and new MS16 16-track pumped into UREI 813B monitors! You've hit the big time and you need our experts to design your ultimate electronic production studio. Chicago's top producers have!

### Chicagoland's TASCAM Headquarters

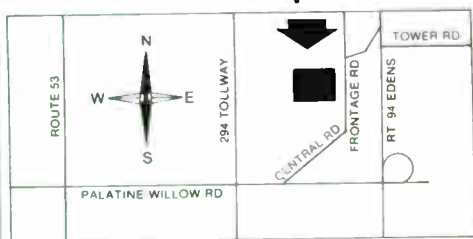

# Gand



# music & sound

780 Frontage Rd. Northfield, IL. 60093

Store Hours M-F 12:00-8:00 Sat. 11:00-6:00 **312-446-G-A-N-D**

Circle #087 on Reader Service Card

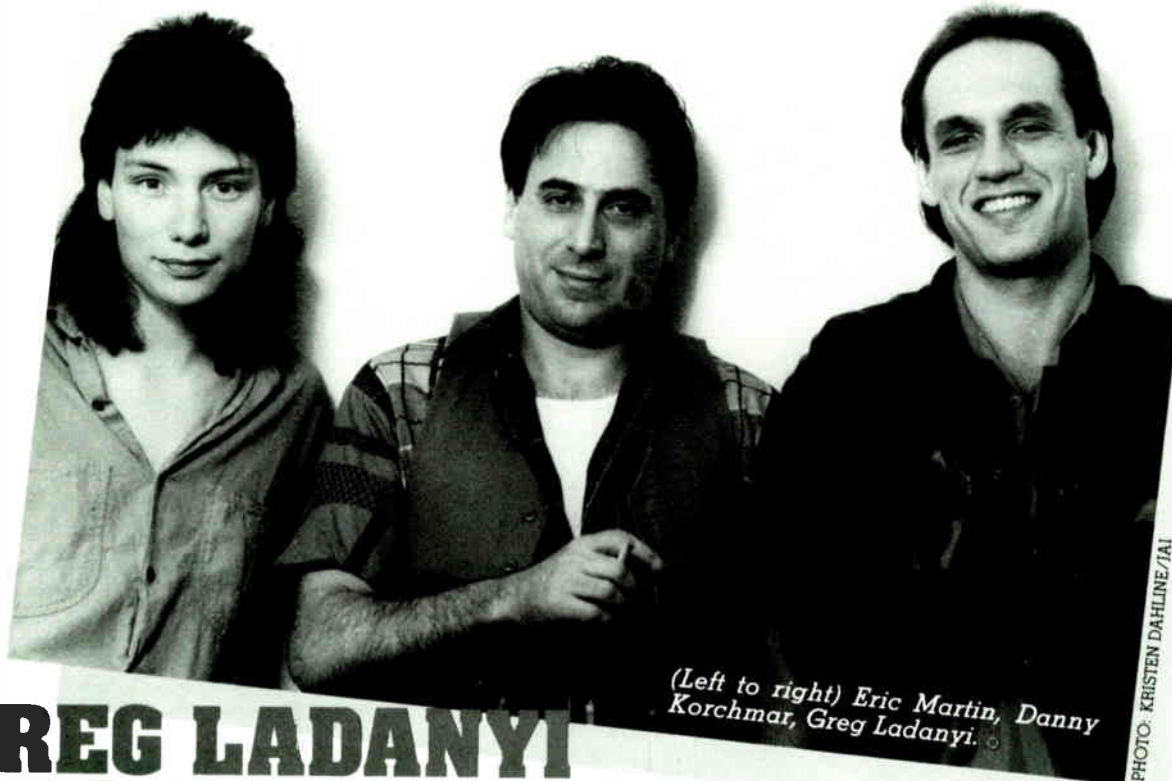

(Left to right) Eric Martin, Danny Korchmar, Greg Ladanyi.

PHOTO: KRISTEN DAHLIN/JAI

## GREG LADANYI ENTERS A NEW PHASE

by Robyn Flans

Greg Ladanyi is moving into a new phase of his career. After dealing with a roster of established artists, he's enjoying the process of helping to develop the careers of lesser knowns.

Ladanyi and co-producer Danny Korchmar had free reign in creating a new direction for San Francisco Bay Area-based singer Eric Martin. Up to now, Martin, who is managed by the Journey organization, Nightmare, and whose last album was produced by Journey producer Kevin Elson, has understandably taken on characteristics of that sibling band. Upon hearing Martin's demo tape, however, Ladanyi instantly knew that had been the wrong approach.

"The soul I heard in this kid's voice..." Ladanyi trails off. "I knew it had to be an R&B record, and the only guy I know I can do that with is Kootch [Korchmar]. Eric's whole style of singing now has changed. He's not trying to be a big power singer, he's singing with that R&B soul. He's like a white

black kid. We took a song that was demoed up in San Francisco called 'Eyes of the World' and created the feel in that song, instead of it being a big power rock 'n' roll song. When we went to the solo, we used the Roland 707 guitar synthesizer, which played a melody solo, instead of someone wailing a guitar solo. Then this was where it was up to Eric as a singer to convince you that he is serious and real. The way the record was made, there was nothing to hide behind. He had to be who he is, and hopefully, giving him the room to do that, in what I did in terms of making the record, enhanced and created his own style."

If Ladanyi has an approach to production, it is to do just that: enhance an artist's style, by passively asserting his own style.

"It is developed around what the artists' style is supposed to be, because, after all, I'm not the artist. 'What does this song mean to you? How do you want this song to feel? How am I going to get this to that level?' It's impossible for me to do that if I forget to ask those

kinds of questions."

Ladanyi didn't know what kinds of questions to ask when he engineered his very first effort, a Captain Beefheart record. He had started in the business at 17, managing bands and booking them into local nightclubs. A couple of years later, he and a partner set up shop at Stronghold, a small rehearsal studio with a 4-track. The 4-track graduated to 8-, then 16-, and finally a 24-track studio. He was still booking bands, now around the country, when he began tinkering in the studio.

The Beefheart record, however, was a less than pleasurable experience. "My partner was supposed to do it and something happened where I ended up doing it. I was always the guy who had the air of 'I can cop anything,' because that's what I learned from playing the manager's games and getting people to believe in me very quickly. That was an account that we couldn't afford to lose because it was paying our bills. I'd be in the studio, messing around, getting the basic things down, but it was, 'I gotta go get a coffee,' and



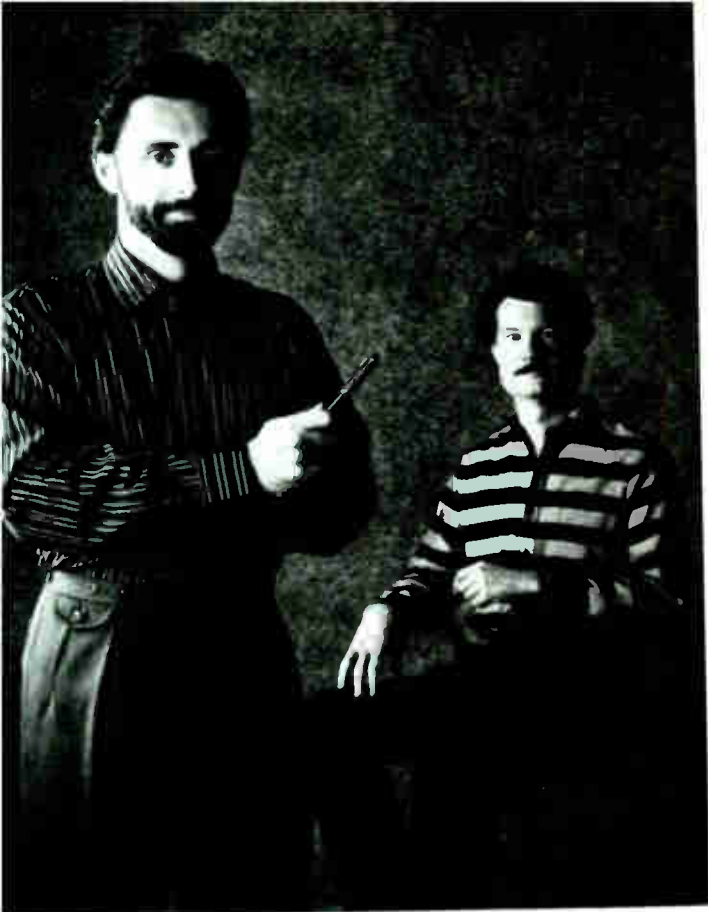

“We’re Committed  
To Building A  
Quality Product  
That Really  
Works...”

“We’re Committed  
To Being  
Number One.”

Patrick Quilter  
Vice President/Engineering,  
QSC Audio.

Barry Andrews  
President,  
QSC Audio.

Commitment runs deep at QSC. We’re dedicated to continually improving our products and our company. For us, building a better product and backing it up with top-notch customer support is the key to success. It’s as simple as that. The QSC linear output circuit is one outcome

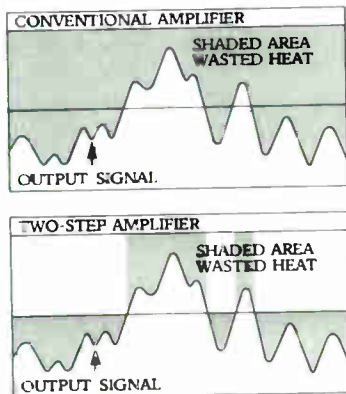

of our commitment to design excellence. Its three-stage signal path optimizes the sonic advantages of traditional push-pull amplifier circuits. By combining a multiple level DC power supply with conventional power transformers and rectifiers, we’ve improved on previous efforts at increasing heat efficiency—anticipating the benefits of “Class D” and “smart power supply” amplifiers, without relying on unproven technology. This has enabled us to build a power amp that is more

compact and reliable, and which delivers unmatched audio performance. The diligent research that went into our Series Three paid extra dividends in the development of our economical Series One amplifiers. Both series feature our patented Output Averaging™ short circuit protection, dual isolated power supplies, calibrated gain controls, premium components throughout, and complete rear panel connection facilities that include balanced XLR and 1/4” jacks, octal sockets for active and passive input modules and a full selection of output connectors. Our dedication to design excellence goes hand-in-hand with our commitment to providing full-service support on all our products. When you put it all together, QSC amplifiers reflect the commitment to leadership, service and design innovation that has guided us since we were established in 1968. For more information contact: QSC Audio Products, 1926 Placentia Avenue, Costa Mesa, CA 92627, (714) 645-2540.

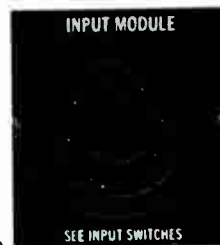

**QSC** Quality Service Commitment

Circle #088 on Reader Service Card



—*PRODUCER'S DESK* continued

I'd go call my partner. 'Real quick, how do I do this?'"

By 22, Ladanyi had become frustrated with the way their business was going and left to assist Dave Hassinger and Val Garay at the Sound Factory.

"After I was done working, I would literally sit in the studio from midnight until 4:00 or 5:00, just mixing tapes we had been working on. I did that for a good five or six months. I developed a sense of feel for balance and mixing while understanding what makes an artist try to do what he's trying to do."

It definitely paid off. It wasn't long afterwards that Ladanyi was asked to mix Jackson Browne's landmark album, *The Pretender*. That was followed by engineering *Running on Empty*, then co-producing *Hold On, Hold Out* and *Lawyers in Love*.

"I would say my role as co-producer with him was organizing the troops, trying to be there for Jackson for an objective opinion and really trying to develop a sound with him. None of his past records really came on sonically very much. And Jackson really came through with me, where he taught me a lot of

things about music, songwriting and words—why they're important and have meaning and substance. In turn, I gave him ways to figure out how to use echo, Harmonizers, delays and different things. It was an exchange of concepts that really meshed well together.

"The approach with Jackson on *The Pretender*, was to make a really solid foundation on the rhythmic end, where it had to have some feeling of liveness in it, almost like it was live, but be studio. You can do that through placement in the mix, where you might put a piano, for instance. Instead of the piano being in stereo, you might put it left center or right center, put the guitar on the right and just move things around until you find the right slot where you sit there and emotionally feel the vibe from the song. That's the method in which I go about trying to create a pocket for the singer/songwriter, so he can sing his song."

The other songwriter with whom Ladanyi is most identified is Don Henley; he worked on both of Henley's solo albums. With someone like Henley, it's easy for Ladanyi to put the focus on the song, which, to him, is the most crucial element of production.

"When I go to mix, the song is my emphasis. Some of the songs you have to mix aren't brilliant lyrically, but if you try to mess with a song that has real substance, number one, the artist will tell you, and number two, you're going to feel it. That's been my main concentration. I know I can do anything I want to do with technology, but that's not the point. Don, Danny and I went into the studio to do the dance mix of 'All She Wants To Do Is Dance' and it was hopeless. We turned it over to this guy named John Luwongo. He took the song, completely cut it apart and put things in other places. I felt, 'God, I don't want anything to do with that.' He was in the studio for 30 hours making this eight minute disco dance tune. It's good for the discos, but it's not something I really want to be doing. At that point, you're really taking apart a song and the song is no longer a big factor. That's not fun for me."

What is exciting now to Ladanyi is this new phase of his career. In addition to Eric Martin, Ladanyi is co-producing (along with David Paich and Steve Porcaro) a new A&M signed act, Logic.

"These two records are important to me because you can work with the great guys, but what deems you great? What makes you so special in the eyes of the world? Don Henley is Don Henley and Jackson Browne is Jackson Browne. Fortunately, I think I've been able to enhance their thing, but now it's time for me to give somebody else a chance." ■

# multimix

16:2:1 12:4:2:1 16:4:2:1

## All from one 19" rack mount console

- 3 band Equalisation
- 2 auxiliary sends
- 90mm smooth action faders
- Mic and Line inputs
- Subgroup direct outputs
- RIAA equalised inputs
- Peak LED on inputs
- 12 way LED displays on masters
- Phantom power on every input
- 5532 Op-amps throughout

Hill Audio, Inc.  
231 Marquis Court  
Lilburn, GA 30247 USA  
(404) 923-3193  
TLX 293827 HLAD

Headwater Industries  
635 Caron Avenue  
Windsor, Ontario N9E 5B8, Canada  
(519) 256-2454

Hill Audio, Ltd.  
Hollingbourne House  
Hollingbourne, Kent ME17 1QJ, England  
(062 780) 555  
TLX 966641 HILL



Circle #089 on Reader Service Card

Custom Design

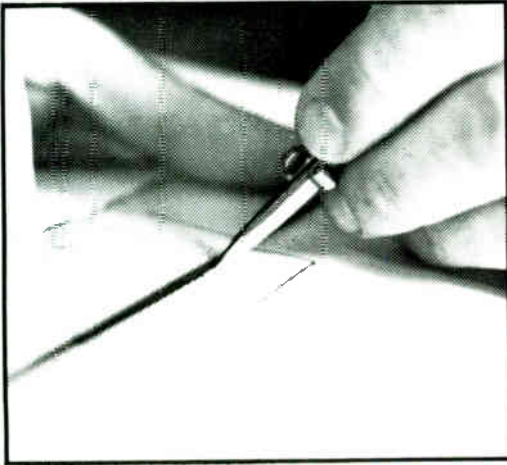

Installation

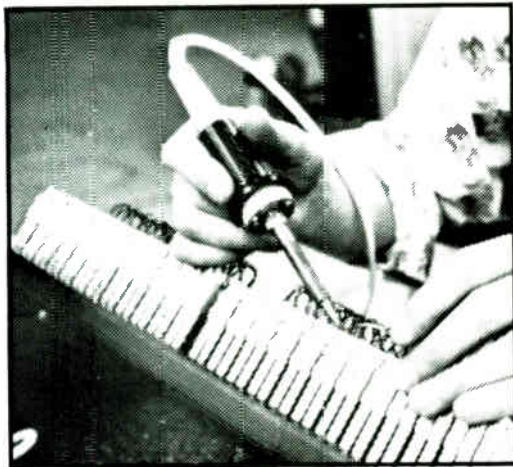

Maintenance



# THERE'S MORE TO A GOOD STUDIO THAN GOOD EQUIPMENT...

**Smooth operation** is necessary for your studio's success, but difficult without careful planning. **AVC's** experience in every facet of Recording/Audio/Video Production Studio design and installation will ensure smooth operation. We draw from an equipment line of over 200 professional brands including:

 Harrison

**OTARI**<sup>®</sup>

**Fostex**<sup>®</sup>  
MULTITRACK DIVISION

**lexicon**

**TASCAM**  
TEAC Production Products

**Soundcraft**

Whether its a patch cord or a complete studio installation, call **AVC** in Minneapolis or Elmhurst/Chicago for the best support to complement your systems needs.

**AVC**  
**SYSTEMS**  
**INCORPORATED**

# AVC

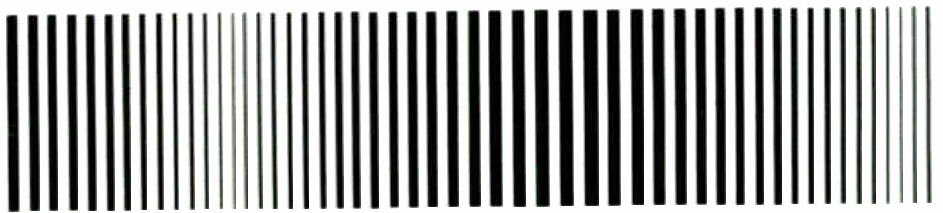

2709 East 25th Street • Minneapolis, Mn. 55406 • (612) 729-8305

747 Church Road, Suite A6 • Elmhurst, IL. 60126 • (312) 279-6580



ART has unveiled new software programs for both their O1A model and the lesser-priced DR2 (above).

## New Products, New Ideas

by Craig Anderton

**T**he search for an inexpensive guitar-to-MIDI converter continues. At the Winter 1985 NAMM show, Cherry Lane was showing a device called the Pitchrider (manufactured by the Canadian company IVL). This \$500 device tracks a monophonic sound source (voice, flute, etc.) and provides MIDI information for note on, note off, pitch, and level. I called the company about the suitability

of this device for single-note guitar playing; they said that it *can* work, but requires extremely clean playing so that only one string is vibrating at a time. Not to worry, though—they're working on a hex version for a guitar that is targeted to sell for under \$1000. Although you will need to use their add-on hex pickup and a multi-conductor cable, the pickup is quite small and mounts unobtrusively towards the bridge of the guitar. Planned introduction for the guitar-to-MIDI converter is at the Summer NAMM show (one month from the date of writing this column), and you can bet I'll be one of

the first people in line to check it out.

Yamaha will be among the many other companies introducing new products at NAMM. In the under \$1000 category (probably much less; pricing is not yet set), look for the TX7, a keyboardless DX7 packaged in a cute little wedge, and the QX7, a similarly packaged and priced two-track MIDI sequencer that's a "little brother" of the QX1 eight-track MIDI sequencer. Also expect the DX21, an "entry-level" FM synthesizer that's part of the DX7 family; and on the high-end front, Yamaha will unveil the DX5. This is basically two DX7s in a single package, but is still easily transportable (it's considerably smaller than their top-of-the-line DX1). In the rumors category, I've heard of a \$6,000 sampling keyboard à la Kurzweil and a guitar synthesizer; we'll see.

FM technology keyboards aren't the only items becoming more affordable... if you like Steinberger instruments more than their price, Hohner has received an exclusive license to use the Steinberger body shape and tuning system in their affordable Hohner Professional Series. The guitar will be available with a tremolo tailpiece designed specifically for the instrument. Both the guitar and bass are manufactured from solid maple, feature neck-through-body construction, and include two high impedance humbucking pickups.

ART has been enhancing their reverb software. The model DR2 digital reverb was originally specified as having three different room types but currently includes a total of nine unique rooms. Their flagship reverb, the O1A, is now up to software revision 2.4. This latest revision provides seven banks of seven presets for a total of 49 different room presets. Also, the smoothness and character of each room has been improved. Overall, with these improvements, the O1A is one of the more cost-effective digital reverbs going.

With a price drop from \$10,000 to \$7,995, the Quantec Room Simulator has become somewhat more affordable. (Incidentally, there's a JL Cooper-designed Quantec to MIDI adapter available for \$395.) Europa Technology also distributes the MDB Window Recorder, a 16-bit rack mount sampling device that samples up to six seconds of very high quality sound. The MDB responds to MIDI, CV/gate, and drum pad triggers. In other sampling news, I hear that Moog is working on a sampling keyboard.

# It's like holding an isolation booth in your hand!

Compared to older microphone designs, the ATM63 is far better at rejecting sounds from the sides and rear. Even with a stage full of monitors and amplifier stacks. And as you get farther from unwanted sound, the ATM63 advantage sharply increases when compared to the others.

Only the vocal comes through loud and clear, making both monitor and house mixes cleaner and far more controllable. With the punch and clarity that is the very definition of a great vocal microphone.

But the ATM63 works

for more than vocals. Around a drum kit, for instance, the ATM63 provides outstanding bleed-through rejection to greatly reduce troublesome phase cancellation. Both musicians and engineers have more freedom...and more control.

If your "old reliable" microphones have reached their limit, reach for the new ATM63 from Audio-Technica. It's a far better sound value...for just a little more.

Learn all the facts from your nearby Audio-Technica sound specialist today.



# ATM63



**audio-technica.**

Audio-Technica US, Inc.  
1221 Commerce Dr., Stow, OH 44224  
(216) 686-2600

Circle #091 on Reader Service Card

World Radio History

**GRD**  
**AMERICA'S MOST EXPERIENCED REAL TIME DUPLICATOR**  
 The world's largest state-of-the-art cassette duplication facility continues to give you incredible sonic excellence. GRD was first to introduce Real-Time cassette duplication at a reasonable cost, and elevated the cassette to audioophile quality. This year GRD has taken the next step into the future with Digital Duplicating, AGFA's super-extended normal bias 612 tape and high bias 627 tape. GRD will faithfully reproduce your most demanding programs without compromise... in Real-time at unreal prices.

HIGH QUALITY PRINTING  
 AND ASSEMBLY  
 CUSTOM LOADED BLANK  
 AGFA CASSETTES, CHROME, 612

(602) 252-0077  
 P.O. BOX 13054  
 PHX., AZ 85002

THE RECORDERS Quartz lock, Auto Bias, 30-20,000 Hz, 0.25% w/r.m.s., Dolby B - more than 67 dB S/N ratio

Circle #092 on Reader Service Card

# MIDI HARDWARE! MIDI SOFTWARE! SOUND SAMPLING!

Decillionix has new sound sampling and MIDI products for your Apple II computer. Our DX-1 sound sampling system let's you record and playback any sound musically under computer control. Use our MIDI products to tie the DX-1 to your MIDI keyboard. Call or write for our free brochures today.

**Decillionix**  
 Dept. M3, P.O. Box 70985  
 Sunnyvale, CA 94086 (408) 732-7758

Circle #093 on Reader Service Card

# ... Digital... ... Delay... ... Handbook. The... ... Digital... ... Delay.. Handbook.... The

Fresh off the presses, the author's Digital Delay Handbook is a user friendly guide to getting the most from a DDL.

JL Cooper's "Expression Plus" includes eight VCAs which may be set to a preset level or controlled by MIDI controllers Pedal 1, Pedal 2, or Breath Controller. The EP responds to MIDI program change data; therefore, by running various instruments through the VCAs, you can have different preset levels for different songs or sections of songs. Also new from JLC: a 16 in/20 out MIDI switching box (designed with the QX-1 in mind) for \$1395, and a MIDI clock-to-standard click converter for \$195.

Mirage owners who want to get more out of their instrument will be interested in *Transoniq Hacker*, a newsletter based on the Mirage and featuring disk reviews, software applications, reviews of peripheral equipment, a free classified section for the disk-swappers in the crowd, and so on. \$15 brings you 12 issues. For more information, write TH at 5047 SW 26th Drive, Portland, OR 97201 or phone (503) 245-4763. If you'd like a sample issue, mention "MI Update" and they'll send you one for free.

And now for some self-promotion (hey — if I don't do it, who will?). My latest book, *The Digital Delay Handbook*, is available from the *Mix* bookshelf. It includes 69 unique delay line applications and is intended for those who want to get the most from these ubiquitous signal processors. (Incidentally, there are a couple of glitches in the first printing; on page 119 the reference to Fig. 9-4 should be to Fig. 9-3, and Fig. 9-4 should be on page 128.)

As this column is being written, in three weeks I'll be leaving for the summer NAMM show... so we'll have plenty to check out next issue. See you then.

—Craig Anderton

# 40,000 ears. 40,000 eyes. One spectacle.



Steve Gilbard / Concert Sound Engineer  
Tasco Sound Ltd.  
Credits: Madonna

At every concert Tasco does, why do 20,000 screaming fans experience the same sound and light spectacle? Steve Gilbard. He strips sound and light down to the basics, then puts it back together again in just the right measure. No matter whose sound. No matter what sight. No matter where. That's Gilbard's talent, and the innovative use of technology.

Nikko Audio has been making substantive contributions to technology for 50 years. We were first with MOS FETs, first with circuit breaker protection. And now, for the first time, Nikko's LABO Series of commercial audio components. Like all Nikko components, they're built to last.

As a primary manufacturer with demanding double QC aerospace tolerances, it's no wonder Nikko Audio offers a fully transferable, unconditional 3 year warranty.

Nikko Audio and Steve Gilbard. Stretching the power of technology to every seat in the house... and beyond.

**NIKKO AUDIO**  
*The power of technology.*

5830 South Triangle Drive, Commerce, CA 90040

Nikko Audio systems and components are available exclusively through Authorized Nikko Audio Dealers.

Circle #094 on Reader Service Card





## Gregg Rolie's Solo Return

by Hillel Resner

Gregg Rolie is looking, feeling and sounding good. After a little over four years of "semi-retirement," the former lead singer and co-founder of Journey and Santana will hit the stores this month with a new solo album, tailored to the musical tastes of the '80s.

Begun a year-and-a-half ago, the project finally coalesced in May of this year, when Rolie recorded the album's final three cuts with red-hot producer/engineer Bill Schnee. Rolie, Schnee and keyboardist/arranger Peter Wolf (Commodores, Starship) closeted themselves in Schnee's North Hollywood studio for three weeks and recorded the last three of the album's ten songs. At least two of the cuts—the uptempo rocker "Young Love" and the slower, slightly hypnotic "I Want to Go Back" (recorded previously by Billy Satellite) sound destined for lots of airplay on contemporary rock stations. Multiple layers of Synclavier, Yamaha DX7 and other synthesizers, stacked on a pro-

pulsive foundation of electronic drums, provide solid melodic and rhythmic support for Rolie's vocals—which sound stronger and more self-assured than they ever have. This may have been due in part, the singer thinks, to the relatively relaxed approach of recording with a three-man team.

"It was just Bill Schnee, Peter Wolf and me in a control room, surrounded by keyboards and equipment," Rolie says. "I learned a lot that I didn't know before. Being on your own is a real different ballgame when you're used to bouncing things off a band. Since I was 19 or 20 years old I've always been in a group. When you've got a few people it can be easier, and at the same time it can be hard to know what to do. I had never done that before."

Fortunately, according to Rolie, the participants were pretty much in accord about which way to go with the material, which made for a free-flowing project.

"I bet 90 percent of everybody's ideas are on there," Rolie said. "We were very much in agreement all the time, which made it slick. I consider Peter Wolf my 'band' at this point, because he did the drums, the synthesizers, the arrangements. And Bill Schnee made it very easy to record. I didn't feel any pressure, and therefore my vocals came out very relaxed, and yet real strong. We did very few takes."

The album's other seven tracks, recorded in 1984 with producer Kevin Beamish, provide something of a contrast, in terms of both musical approach and working methods. Rolie recorded for about two months with a large group of musicians, including bassist Dave Margen, drummer Mark Craney, and a platoon of guitarists that included Carlos Santana, Neal Schon, Craig Chaquico and Mark Ross.

"There's a lot of guitar on the other cuts," Rolie says. "It's real guitar-strong, and unfortunately, guitar nowadays doesn't seem the way to go as much as it is synthesizer. I love guitar, I grew up with that sound, but you have to be current."

As a result, Rolie's record company (CBS) brought him together with Schnee, who in turn introduced him to Peter Wolf. The result was the three new tracks, which together with the original seven provide a pleasing blend of sounds that should appeal to both longtime Rolie fans and the new wave of radio programmers.

The studio-oriented approach to the making of the album also fits into Rolie's career game plan:

"I've built image through a band," he says, "but what I'm trying to do now is build an image through a record. It's basically to set me up as a singer and player, but more a singer. I've never really had a focal point put on me. Hardly anybody knew that I sang 'Black Magic Woman' with Santana. People find that out and they say, 'That was you?'"

"The best part is the record company's behind it and everybody's in agreement. Now it's up to people, and whether they like it. I think we've got a real good shot at it." ■

## A "New" Beatles Album

by Rip Rense

Once upon a time back in the 1960s, a lot of people used to wait for new music by The Beatles the way kids used to wait for Christmas. The group's singles used to reach number one routinely through advance orders.

It's time to start waiting again.

For the first time since The Beatles broke up in 1970, their old record company has not only admitted having enough leftover songs for at least one new album, but is enthusiastically seeking to release them. The long and winding and often apocryphal saga of the band's unreleased music has finally taken an official turn for the turntable in 1985.

But before you start singing "It Won't Be Long"...

"We have put a suggestion to the relevant individuals and their representatives which has not met with their full approval at this time," said EMI Records general manager of public relations Brian Southall, reached in London. "And we're back to the drawing board. With their input, hopefully we'll see what we can come up with."

The "suggestion" Southall spoke of was a 13-song LP provisionally entitled *Sessions* (plus a single containing one song not on the album.) The "relevant individuals" who did not grant "full approval" to the project are Paul McCartney, George Harrison, Ringo Starr, and Yoko Ono (who represents John Lennon's estate.)



Sources said, incidentally, that the most "relevant" in this issue is McCartney, who happens to be EMI's most valuable client.

Fourteen new songs. At least...

Here's the scoop:

For years, EMI has admitted to owning a "few odd tracks" the band never issued—either for artistic reasons or merely because there were a few tunes too many for a given album. EMI has always poo-pooed the idea of releasing these tracks, brushing them off as historical curiosities and not up to the standard The Beatles held themselves to. Among these few numbers, the company grudgingly acknowledged over the years, were Mitch Murray's "How Do You Do It?" and Johnny Preston's "Leave My Kitten Alone."

For reasons never entirely clarified by EMI—possibly just a response to recurrent waves of Beatlemania—the company's "Beatles Committee" elected to release "How..." and "Kitten" as a single in 1980. Those plans were scrapped after the murder of Lennon for fear of exploiting the tragedy. Then, about a year later, there began another strange and poignant post-script to the Beatles' remarkable story.

"Some work was done," said Southall, "by a gentleman who has since passed away which indicated that there were a number of tracks—alternate versions, etc., in the studios in our possession."

The gentleman was a young Abbey Road Studios engineer named John Barrett. Barrett, fighting a losing battle with cancer, found himself unable to carry out his regular schedule while receiving treatments for the disease. EMI generously suggested an assignment that allowed him more flexible working hours. The assignment was to listen to the approximately 90 tapes left behind by The Beatles—nine years' worth—and catalog their contents. It became a labor of love.

"He spent a long time going through tapes and logs and various other things and discovered a number of... alternative takes that differed fairly significantly from the final released versions," said Southall.

Barrett also discovered at least one finished track that has never even been rumored to exist—not by the most fanatic collectors or highest EMI leaks—a Beatles version of the old Lloyd Price song, "Mailman Blues."

Barrett died before the work was finished. About a year's worth remains, and is being listened to now by other Abbey Road Studio officials. But the painstaking research by the late engineer woke up EMI to an amazing fact—one that collectors of Beatle bootleg LPs have maintained for years—



that there was enough recorded material in the form of finished songs to complete at least one more Beatles album.

"Yes, prior to that we had never believed there was sufficient material," said Southall. "It became apparent that there were a lot more versions of songs than probably we were even aware of."

EMI set to work. Under the guidance of Southall and the Beatles Committee, plans for an album were drawn up. Potential tracks were polished up and readied for release by longtime Beatles engineer Geoff Emerick. Several possible packages were considered before the LP known as *Sessions* was chosen. Seldom-seen photos of the group were retrieved from EMI archives, and a release date was set for November of 1984. That date was bumped, according to sources at Capitol Records, to make way for the release of McCartney's *Give My Regards to Broad Street* soundtrack. The new date, January '85, was cancelled after the project was rejected by the remaining Beatles and Lennon's estate.

But all is not lost.

"There are some discussions to take place over the possible content of the album," Southall said. "Hopefully, we will be able to come up with an album between us that will keep everybody happy, and can keep the fans happy, who have basically been looking for this product for a long time."

What? Discussions? The remaining Beatles, especially McCartney, have never endorsed the idea of releasing the group's leftovers. Yet a spokesman for McCartney reached in London confirmed that, indeed, "discussions are taking place" about the possible release of some kind of new Beatles LP. (Harrison and Starr could not be reached for comment. Elliot Mintz, spokesman for Yoko Ono, confirmed that Ono had rejected the pack-

age "along with the others," but added he was unaware of further discussion at this point.)

Speculation is that the LP was rejected because it would not "play" like a Beatles album; that it wasn't up to snuff by Beatles standards. Indeed, the tracks—as they were listed on official "label copy" shipped by EMI to Capitol in Los Angeles—seemed to comprise more of a "leftovers" or "rarities" package than a carefully paced Beatles album. And here, courtesy of a source who obtained a copy of the list, are the titles:

The LP opened with what must have been EMI's idea of a joke, a Beatles version of Badfinger's "Come and Get It" (written by McCartney.) Then: "Leave My Kitten Alone," Harrison's "Not Guilty" (first recorded for *The White Album* in 1968, later re-recorded for the 1980 *George Harrison* LP), a different version of "I'm Looking Through You" from the *Rubber Soul* LP, and "What's the New Mary Jane" (the widely-bootlegged session with Lennon, Yoko Ono, and Harrison allegedly intended to deflate the deifying of The Beatles.) Side two: the much-bootlegged "How Do You Do It?" (rejected over George Martin's recommendation for The Beatles' second single in favor of "Please Please Me"), "Besame Mucho" (recording date uncertain), "One After 909" (an early version dating from March 5, 1963), "If You've Got Troubles" (a Lennon-McCartney number from 1965 featuring Ringo singing), "That Means A Lot" (a Lennon-McCartney tune later released by P.J. Proby), a quiet acoustic rendition of "While My Guitar Gently Weeps" (from 1968, with an extra verse), "Mailman Blues" from 1969, and a snippet of an original Christmas song used in the band's 1967 fan club Christmas message entitled "Christmastime is Here Again."

The collection is uneven. (The following information is based on listening to bootlegs of varying quality, and collectors' observations.) "Come and Get It" and "Christmastime" are interesting only as curiosities. "Kitten" is an all-out rocker, however, arguably better than a lot of tracks the band did release. (Illegal tapes of it surfaced on radio stations in New York, Houston, and Los Angeles.) "Not Guilty" is rumored to include Eric Clapton (Clapton and possibly Mick Jagger could be on one or two of the tracks, according to Southall, who added that even EMI doesn't know for sure.) "Mary Jane" is possibly the most bizarre and daffy track ever to bear the group's signature (and that includes "You Know My Name, Look Up the Number"). "How Do You Do It?" has a small, unexciting charm.

—PAGE 115

**studio consultants, inc.**

321 West 44th St., NY, NY 10036 (212) 586-7376

**A wide range of equipment and services for professional audio facilities and broadcasters**

We represent and sell the products of a small number of quality-conscious manufacturers, design systems and studios, and provide extensive technical support both before and after sales.

- **Bryston** – Superb, reliable power amplifiers from 50W/channel stereo to 800W bridged mono, with balanced inputs, modular channel electronics, and dual independent power supplies. Professional preamps also.
  - **White** – Equalizers and crossovers, active and passive, including third and sixth octave room EQ.
  - **Westlake** – High-quality monitor speakers, large and small.
  - **Fostex** – Phase-coherent coaxial reference monitor speakers.
  - **Audio Digital** – Digital delay and effects, including the TC-3 Pre-Delay.
  - **Ursa Major** – Digital reverb and signal processing, including the new MSP-126, which synthesizes a rich, convincing stereo image with excellent mono compatibility and **no coloration**. Seven other delay-based effects programs as well.
  - **Audio Kinetics** – Versatile, intelligent Q-LOCK audio/video synchronizer systems.
- and other fine products.

Circle #095 on Reader Service Card



**VERTIGO BURNISHER AND VERTIGO INJECTOR RESTORE ORIGINAL PERFORMANCE TO YOUR PATCH BAYS**

**VERTIGO 1/4" TRS AND TT BURNISHERS:**  
Each eliminates noise in main contacts under normal patching situations.

**VERTIGO 1/4" TRS AND TT INJECTORS:**  
Each injects cleaning solvent to eliminate intermittents in breaking contacts (normals) when patch cord has been removed.

**ONLY \$29.95 EA.** Please write for additional information and order form today.

**VERTIGO RECORDING SERVICES**

12115 Magnolia Blvd. #116  
North Hollywood, CA 91607

Circle #096 on Reader Service Card

**MIX WORDS**

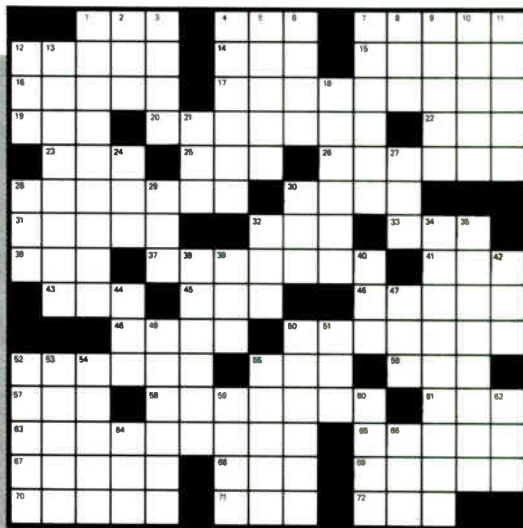

**"HARPING ON SAX AND VIOLINS"**

©1985 Armand E. St. Martin

**ACROSS**

1. Simon Le \_\_\_\_\_
3. Seafarer
7. Type of reverb
12. Film music
14. "Able was I \_\_\_\_\_"
15. Hourly
16. Branches
17. Large valve horn
19. Emissary (abbr.)
20. Three-stringed fretless Japanese lute
22. I was, to Nero
23. Musical measure
25. Place for iniquity
26. Members of the viol family
28. Sang Jingle Bells
30. Island or terrier
31. Nostalgic hit
32. Paris season
33. "\_\_\_\_\_ baue ganz auf deine Starke," (Mozart aria)
36. "\_\_\_\_\_ Goo Barabajagal," (Donovan tune)
37. Instrument whose name is Hawaiian for "ilea"
41. Western Hemisphere org.
43. L-P connection
45. "...he floats like a butterfly, and stings like a bee"
46. Founder of the Persian Empire
48. Irish
50. Lays a slab
52. Brought up
55. Ethiopian title
56. Producer \_\_\_\_\_ Fraboni
57. "Small \_\_\_\_\_" Bob Marley
58. Predecessor of the bassoon
61. Gold Bug author
63. Early members of the harpsichord family
65. Beer garden vessel
67. U.S. born British writer
68. Type of "bug"
69. Lend-\_\_\_\_\_ (FDR)
70. Oozes
71. Dandy
72. Unclose, to the poet

**DOWN**

1. Large valve horn
2. Sphere
3. Loch \_\_\_\_\_
4. Thrived
5. Left in \_\_\_\_\_ (demolished)
6. Salesmen
7. Fake
8. Chaney
9. Tempest spirit
10. Bullish prefix
11. St. \_\_\_\_\_ Fire (Michael Franks tune)
12. Patty Hearst captors
13. Hungarian orchestral instrument of the psaltery family
18. Inventor of the modern German bassoon
21. King Sunny \_\_\_\_\_
24. French king
27. Luau wear
28. Part of a gear
29. Rumanian monetary unit equal to approx. one U.S. cent
30. Jeanne d'Arc, e.g.
32. Yalie
34. Early name for the cornet
35. French oboe
38. Writer-director Larry of "The Big Chill" and "Silverado"
39. Rubber tree
40. Anti-radar acronym
42. Draft org.
44. Above, to Burns
47. "\_\_\_\_\_ Blues," Beatles tune
49. Equips again
50. Condiment
51. Id \_\_\_\_\_
52. Good press from the critics
53. "Kiss You All Over" band
54. John Denver LP
55. Scandinavian chieftain, first duke of Normandy
59. Large hook on a pole
60. Norway city
62. Compass pt.
64. Republican org.
66. Sam Snead starting point

—FROM PAGE 113

"One After 909" is a more sinewy and punchy rocker than the novelty-like version of 1969. "If You've Got Troubles" sounds like it's about half-way finished. "That Means A Lot" is pure 1965 *Help* or *Rubber Soul* Beatles, with a "Ticket to Ride" beat, lovely melody and lush harmony vocals. "Guitar" is perhaps more affecting in this small (solo?) setting, and includes the extra verse: "I look from the wings / At the play you are staging / While my guitar gently weeps / As I am sitting here doing nothing but aging / Still my guitar gently weeps..." No information was available about "Mailman Blues," other than it probably is on par with "Let It Be" sessions quality.

The single was to have been "Kitten" backed with an alternate version of "Obla-di, Obla-da," according to sources at Capitol.

Southall would only confirm that these are some of the tracks considered for release, and would identify no others in EMI's possession. However, several more of the EMI tracks were excerpted for the public during a tour of Abbey Road Studios in 1983. They include three very different versions of "Strawberry Fields Forever" (including the two that were patched together for the final release), "Lady Madonna," with a different vocal, and an earlier version of "She's a Woman." Also known to be among the EMI tracks, according to sources at EMI and Abbey Road Studios, are different renditions of "Penny Lane," and alternate versions of songs from the *Let It Be* sessions.

What might eventually be released is anybody's guess. Southall even said that EMI would welcome contributions from avid collectors, and from the remaining Beatles themselves (Harrison, for example, has said he owns the "best" recording of "Revolution"—acoustic, with Ringo on maracas.) Further, Southall expressed interest in reports that a well-known collector from Burbank, California owns acetates of two 1966 Beatles tracks entitled "Granny Smith" and "Mark One."

For the record, so to speak, there are new indications that other long-rumored material actually does exist. A new Beatles bootleg album includes a near studio-quality version of "Shout," McCartney singing a solo acoustic version of the song he gave to Mary Hopkin, "Goodbye," and—most importantly—a track labelled "Cat's Walk." Collectors believe "Cat's Walk" to be an early instrumental (probably with Pete Best drumming) from a legendary audition tape that supposedly includes titles like "I Lost My Little Girl" and "Thinking of Linking." "Cat's Walk" was given by Lennon and McCartney

CASSETTE  
DUPLICATION

# Now there's a No.1

Finally a cassette duplicator that delivers the ultimate in technical fidelity and high quality packaging to give you a truly competitive product. A staff of professional audio engineers, graphic designers and marketing personnel bring a long-awaited leadership to the industry. If you require the best — *No. 1 is the one.*

Write: AAPEX, 350 East Todd Road, Suite A, Santa Rosa, CA 95407. Or call 707-585-1132.

**AAPEX™**  
WE UNDERSTAND SOUND

© 1985 AAPEX INC.

Circle #097 on Reader Service Card

# BRYSTON



## Bryston's 2B-LP

Bryston has been known and respected for years as the manufacturer of a line of amplifiers which combine the transparency and near-perfect musical accuracy of the finest audiophile equipment, with the ruggedness, reliability and useful features of the best professional gear. Thus, Bryston amplifiers (and preamplifiers) can be considered a statement of purpose to represent the best of both worlds — musical accuracy and professional reliability to the absolute best of our more than 20 years' experience in the manufacture of high-quality electronics.

The 2B-LP is the newest model in Bryston's line, and delivers 50 watts of continuous power per channel from a package designed to save space in such applications as broadcast monitor, mobile sound trucks, headphone feed, cue, and any installation where quality must not be limited by size constraints. As with all Bryston amplifiers, heatsinking is substantial, eliminating the requirement for forced-air cooling in the great majority of installations. This is backed up by very high peak current capability (24 amperes per channel) and low distortion without limiting, regardless of type and phase angle of load. In short, the 2B-LP is more than the functional equivalent of our original 2B in spite of the fact that it occupies only half the volume, and will fit into a single 1.75" rack-space.

The usefulness of the 2B-LP is extended by a long list of standard features, including: Balanced inputs; female XLR input jacks; dual level-controls; isolated headphone jack; and individual two-colour pilot-light/clipping indicator LEDs for each channel. In addition, the channels may be withdrawn from the front of the amplifier while it is in the rack, vastly facilitating any requirement for field-service, including fuse-replacement.

Of course, in keeping with Bryston's tradition of providing for special requirements, the 2B-LP can be modified or adapted to your wishes on reasonably short notice, and at nominal cost.

Best of all, however, the 2B-LP is a Bryston. Thus the sonic quality is unsurpassed. The difference is immediately obvious, even to the uninitiated.

Other amplifiers in Bryston's line include the model 3B, at 100 watts per channel, and the model 4B, at 200 watts per channel. All ratings continuous power at 8 ohms at less than .01% IM or THD.

IN THE UNITED STATES

BRISTOLVERMONT  
RFD#4, Berlin, Montpelier, Vermont 05602

IN CANADA

BRISTOLMARKETING LTD  
57 Westmore Dr., Rexdale, Ontario, Canada M9V 3Y6

Circle #098 on Reader Service Card

to the Chris Barber Band, which recorded a version in 1967.

Rumors of other material abound. Among the tunes most likely to exist—possibly in the vaults of what is left of Apple Corps. Ltd. in London—are “Shake, Rattle and Roll,” “Blue Suede Shoes,” and a remake of “Love Me Do,” all reported by The Beatles official publication in 1969 to have been finished for an oldies album.

Whatever does become available for an EMI album will not have to face two important obstacles: 1) Payment—the group members and Lennon’s estate will be paid according to their old contracts 2) Lawsuits—Southall said there are no indications that there will be any legal objection to the release

of more music by the remaining Beatles or Lennon’s estate.

So Southall remained optimistic—despite the setback, and so does someone with a good deal of expertise on the subject: Elliot Mintz. Mintz, who has done considerable research into leftover Beatles material, grew convinced long ago—after discussions with Lennon—that more songs will surface.

“Regardless of what EMI has done in its research, I must say that based on the work I’ve done, I don’t think anybody could possibly make a statement that there isn’t sufficient material for another album. Or that there aren’t undiscovered songs or pieces of music. John and Paul got together in front of a microphone the way you and I make

telephone calls, and there were reference track tapes running through all of those Beatles sessions.”

Mintz made a prediction:

“I know there are a lot of people who have a tremendous desire to hear more stuff, and that is a real concern,” he said. “I think the possibility of that happening in the future is probably good. I don’t think it’s curtains because this project can’t be released. I think there is considerably more stuff to come, but when it does, it should be the kind of stuff that would maintain the standard they all had established so long ago.”

## Ray Charles’ Country Supersessions

by Rose Clayton

“I had this dream—this vision of what I wanted to do before I leave this earth, but I never thought, even in the most minute way, that I’d get to do it,” says Ray Charles, one of music’s most eclectic virtuosos.

“When I signed with CBS, I mentioned it to Rick Blackburn as something I’d like to do in the future,” Charles continues. “Well, he says, ‘What would you think if I speak to some of those people for you?’”

The rest is history. Blackburn, vice president/general manager of CBS, Nashville, pieced together Charles’ dream of recording with some of his all-time favorite country singers. They named the album *Friendship* and it went on to hit number one on *Billboard’s* country LP charts.

For those who have not heard the record, it features Charles dueting with George Jones, Merle Haggard, Johnny Cash, Ricky Skaggs, Hank Williams, Jr., the Oak Ridge Boys, Janie Fricke, B.J. Thomas, Mickey Gilley, and naturally, Willie Nelson.

“Seven Spanish Angels,” the Charles-Nelson song was a number one country single and a popular music video. Gilley’s duet, “It Ain’t Gonna Worry My Mind” was released in early June as the fourth single from the album. Earlier 45s were Jones and Charles singing “We Didn’t See a Thing,” featuring Chet Atkins, and “Rock and Roll Shoes” with B.J. Thomas.

Rumors that he was committing “musical suicide” when he recorded *Modern Sounds of Country and Western Music* some 20 years ago were quickly dispelled when Charles’ cover of Hank Williams’ “I Can’t Stop Loving You” became a number one hit and

## Computer Support

mimetics™

**T**oday’s MIDI instruments are typically limited in their ability to store large quantities of voice information inexpensively, or provide easy visual access to that information. Mimetics has created a solution to this dilemma by developing software which allows your personal computer to extend the limited facilities of your MIDI instrument.

Mimetic’s DATA series of software is designed for high speed storage and retrieval of voice information, while providing visual access to voice and function parameters through easy-to-use self-prompting screens.

**DATA 6:** For Sequential Circuits SixTrak

**DATA 7:** For the Yamaha DX-7

**DATA 11:** For the Yamaha RX-11 Drum Machine

**DATA ODX:** For the Oberheim DX Drum Machine

**PERFORMANCE 7:** For the Yamaha DX-7 in live performance or the studio.

	DATA 6	DATA 7	DATA 11	DATA ODX	PERFORMANCE 7
Apple w/Passport	X	X	X	X	X
Apple w/MPU-401		X			X
C64 w/Passport		X	X		X
C64 w/SeqCirc		X	X		X
IBM w/MPU-401		X			X
Price each	\$75.00	\$125.00	\$75.00	\$90.00	\$125.00

MetaMIDI interface card now available (completely Passport compatible) Apple & C64 \$95.00

**Send Your Order and Payment to:**  
**Visa and MasterCard accepted**

mimetics

...the professional software source!!

P.O. Box 60238 Sta. A, Palo Alto, CA. 94306 (408) 741-0117

Circle #099 on Reader Service Card

DEALER INQUIRIES WELCOMED!

Yamaha, Passport, IBM, Oberheim, Sequential Circuits, Roland MPU-401, Apple II, Commodore 64 are trademarks of their respective companies

stuck at the top of the charts for more than four months.

"I feel that my thing towards music is to record good music," Charles says. "I think Duke Ellington's music will be around 200-300 years. Why? Because it's good. I think this album is good. I feel as long as people can appreciate good music as we know it, it will be around forever."

The reason Charles is so optimistic about *Friendship* is that he thinks it has something for everyone.

"We have a good diversity of styles," Charles explains. "Take Ricky Skaggs. How bluegrass can you get? I love him! On the other hand you say, 'What about George Jones?' There he is, 'Mr. Country,' or Johnny Cash, who if he opens his mouth you know who he is; or Merle Haggard, who I think is *the* country balladeer. You know how smooth he is.

"And Willie Nelson," Charles continues. "There's a man who is outstanding, truly, and yet as we worked together there was no ego thing—no, 'I'm Mr. Big.' As a matter of fact, all these people I'm telling you about said, 'You tell me what you want. Show us how you want it done and we'll do it.' I think you can't get better than that. I got respect from everyone."

PHOTO: RON KEITH

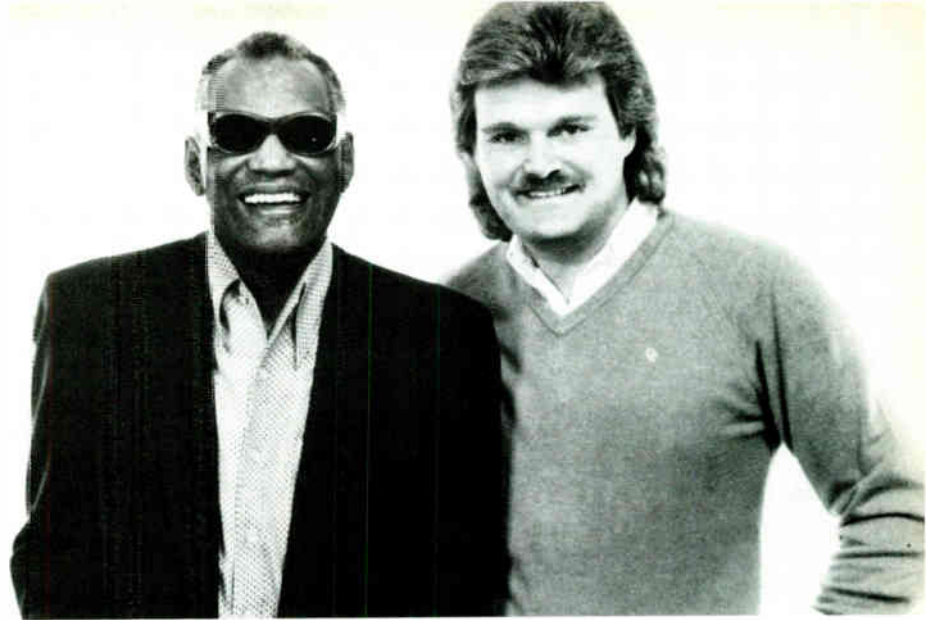

Ray Charles with Ricky Skaggs

It was more than respect, however. *Friendship* was a meeting of the mutual admiration society.

"Getting to work with Ray Charles was a dream come true for me," says Ricky Skaggs. "Now if I can work with George Jones, I can die and go to heaven because I will have done everything I want to do.

"Ray's just so full of music all the time," Skaggs adds. "If he's not playing something on the piano, he's singing it; if he's not singing it, he's thinking it and wishing he was playing it.

"But," Skaggs warns, "he's very precise. If something is not right he will let you know. He loves feel and groove and he doesn't like to be pushed him-

## The Aphex Aural Exciter.™ The Best Way to Improve Your Sound System.

By now you've probably invested in flangers, reverbs, delays, and other accessories for special effects. But, there's still something missing in your sound. The excitement of an Aphex Type B Aural Exciter.

The Type B generates the same psycho-acoustic excitement pros have used for years for that *extra punch*. The Type B restores natural brightness, presence and detail. Your live sounds fill the room with-

out all the problems of high frequency EQ. Even multitrack tapes made on narrow format machines sound like they were made on expensive studio recorders! All for less than \$500.

Hear the difference an Aural Exciter can make at your dealer today. Or, write us for the name of your nearest dealer and a demonstration record that's fun and informative. "Trouble at Madame Dong's."



**Aphex Systems Limited**  
13340 Saticoy St., N. Hollywood, California 91605  
(818) 765-2212 TWX: 910-321-5762

Aural Exciter is a trademark of Aphex Systems Ltd. © 1985 Aphex Systems Ltd.

Circle #100 on Reader Service Card

self. He likes to be the pusher. He's a leader."

Joe Bonsall of the Oak Ridge Boys says: "When we were asked if we wanted to be a part of the album we said, 'Yeah, to sing with Ray Charles? Set up the mikes we're coming.' It was a real thrill being led by Ray Charles—having him tell us how to sing our parts."

With Charles surrounding himself with so many country music heavies, one might wonder if he has found a permanent home, or if a *Friendship II* album might bring him together with top artists from other genres.

Just how deep is Charles' commitment to country music?

"The only commitment I have is to play whatever music I play to the best of my ability," Charles responds. "I have to say that I am a person that when I do whatever kind of music—jazz, blues, light opera, which I do—I give it everything I've got."

Charles says he is satisfied with *Friendship* because it represents a unified commitment.

"Everybody who was on the album was so in tune with me," says Charles. "I mean that sincerely. I'm not trying to feed you something plastic. We're in a profession where I know what you do and you know what I do and we cannot bullshit each other."

"It was the most unbelievable thing I've ever done. Everybody bent over backwards to give me what I wanted. That means—what they were telling me is—'Hey, we want your album to be the best it can possibly be.' I think that is the greatest tribute an artist can receive." ■

## Quantum Leap Ganging Up With Synthesizers

by David Goggin

Quantum Leap is a daring combination of talent and technology. Conceived and conducted by Ed Freeman, veteran L.A. musician/composer, the group's first project is entitled "The War on Attitude." A far cry from Freeman's past pop successes, such as producer of Don McLean's "American Pie," Quantum Leap breaks new ground both musically and technologically.

With L.A. Record Plant president Chris Stone as executive producer for the project, Freeman had access to a cornucopia of high-tech recording tools. To create the ultimate synthesizer sound, Freeman composed a complex collection of highly rhythmic avant-garde instrumentals and then joined forces with the cream of L.A.'s pro-

grammers, players and synth designers.

The music is hard to categorize. Unlike the familiar "theme and variation" style of composition, Quantum Leap takes a musical idea, progresses, distorts, twists and never returns to home base. The lush, alien musical landscapes conjure up images of bio-rhythmic cellular activity, subtle waves of movement beneath turbulent surfaces, new music echoing from nightclubs and temples on a distant planet.

At times, as many as 28 synthesizers, 9 programmers and 6 recording engineers were simultaneously employed to create the sounds of Quantum Leap. Miles of cable linked the Oberheims, Yamahas, Prophets, Korgs, Jupiters, Kurzweils, 360 Systems and Serge modular configurations together in a temporary mad scientist's lab at the massive Studio M scoring stage on Hollywood's Paramount movie lot. Conceived as a performance/recording project, Quantum Leap was also designed as a showcase for Chris Stone's studio leap into video and film scoring.

As Chris wandered among the cables, banks of synthesizers and team of programmers, there was silence in the studio. A Sony digital multitrack waited patiently as musicians programmed musical data under Freeman's direction. "This isn't a recording studio—it's

# Computers



Presents



The

## Voice Librarian Series™

Software to load and save libraries of sounds for MIDI synthesizers

### Computers:

Apple™  
IBM™

### Synthesizers:

Yamaha DX™  
Roland Juno 106™  
Roland JX-8P™  
Casio CZ Series™  
Oberheim OB-8™

Available Now for \$49.95

The Voice Librarian Series™ ©1985 Computers and Music. All rights reserved.

- Send or receive presets and banks of presets.
- Store/Load presets and banks to/from disk.
- Name each preset and bank of presets.
- Move presets from one bank to another.
- Listen to sounds without overwriting Internals.
- Printout the names of all your presets and banks.
- Save MONEY.

Computers & Music

1989 Junipero Serra Boulevard • Daly City, California 94014 • (415) 994-2909

Circle #101 on Reader Service Card

**Ed Freeman conducts Quantum Leap at Record Plant Studio "M."**

a spaceship," quipped Stone.

"This album is an exploration and a celebration of future music," added Freeman. "Most composers are unfamiliar with recording technology and merely use the studio to capture what they have written. After 20 years in the studio, I decided to break down our barriers between composition and recording technique."

In particular, Freeman has applied his knowledge of orchestral music to synthesizers, driving them to the limits of cascaded interface. This is no collection of "bleeps" and "bloops." In some passages, scores of synthesizers have been combined and overdubbed to formulate music with the richness of a Stradivarius—yet with the bizarre quality of sounds we have never heard before.

Most of the music was written on a DSX sequencer. In a typical recording set-up, two or more interlocked DSXs were used to drive two or three Oberheim Xpanders, which convert the CV (control voltage) and gate pulses from the sequencer to MIDI information, which in turn was used to drive additional slave units. Often, 20 or more tracks of synthesizers were recorded, bounced down to two tracks, and the entire process repeated for different parts. To augment the synth sound, guitars, drums, percussion and a 20-voice choir were recorded live with real humans.

The synth team included Anne Graham, who designed the first MIDI interface for the Oberheim OB-8 and was on the design team for the Matrix-12 and the Oberheim Xpander, the pivotal instrument in the Quantum Leap assemblage. Joining Anne were Drew Neumann (freelance programmer for Fairlight Instruments), Eric Rasmussen, Blake Lewin (virtuoso on the Chapman "Stick"), Jim Mandell, Mark Mann and Susan Seamans (composer with L.A.'s Mark Taper Forum).

"The compositional challenge of Quantum Leap," says Susan Seamans, "was to mathematically interlock the sequences into a high-density wall of sound that could be washed with ever-changing subtleties of tone color."

Freeman sees Quantum Leap as an experiment with far-reaching consequences. In film scoring, the improvised, computer-assisted nature of the music greatly shortens studio time. As a performance group, Quantum Leap is suited for collaboration with dance groups or even symphony orchestras. Some musicians might read sheet music while others would sit at computer terminals. Interfaced with computer



PHOTO: ALLAN S. ADLER

## Puzzled by Audio/Video/MIDI Sync Lock? It's SMPL™

**Y**esterday it took lots of money and hassle to implement a truly contemporary Audio for Video Studio.

**Y**ou needed a box to lock a Video transport to the Audio. And boxes to autolocate the Audio and Video transports. And a box to lock and locate the "virtual" MIDI tracks. And more boxes to convert the sync your sequencer likes to the kind your drum set favors.

**A**nd an Engineering Degree to tie it all together and work it, and a very friendly banker to help pay for it.

**B**ut, today, Sync Tech's SMPL System performs all of these functions and MORE. In one easy to use, low cost package you get a complete Audio editing, Video lock-up, Instrument syncing system that includes:

- Two machine (Audio or Video) Sync Lock
- 10 point autolocator for both transports.
- MIDI Sync/Autolocate
- 24, 48, 96 Tick/Beat instrument sync
- Automatic Punch In/Out
- DF, NDF, 25 F/S, 24 F/S SMPTE Time Code Generator
- 8 programmable EVENT gates
- Transport remote controls

**B**est of all, the SMPL System is for real — no "gotchas". Works with equipment from every major manufacturer from inexpensive Portable Studios to 2" transports, even consumer quality VCRs.

**F**or more information and the name of the nearest dealer who can SMPLify your life, call or write:

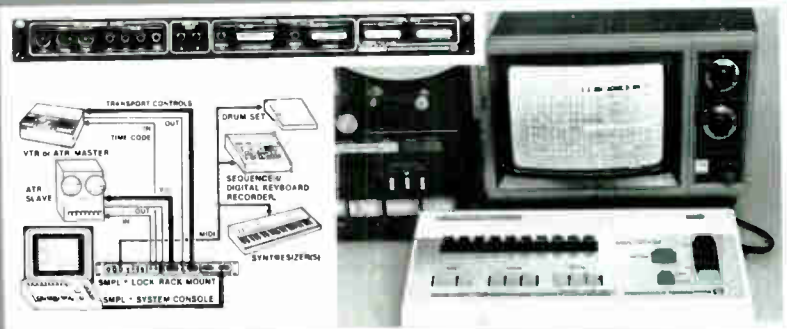

**SYNCHRONOUS TECHNOLOGIES**

P.O. Box 14467 • 1020 W. Wilshire Blvd. • Okla. City, OK 73113 • (405) 842-0680

Circle #102 on Reader Service Card

graphics systems and video projectors, Quantum Leap could generate fresh visuals at each performance. On the commercial level, the concept group is appropriate for TV and radio ads, theme park soundtracks, and other multi-media applications.

"I use the studio as a compositional tool," says Freeman. "The future of music for records, films and video lies in the healthy collaboration between the human mind and computer intelligence."

**PRODUCT NEWS:**

**E-mu's Emulator II**

Like its predecessor, the Emulator II from E-mu Systems allows the user to digitally record any sound and play it back from its five octave keyboard. The II uses a new data encoding technique that results in increased frequency response with decreased digital distortion. A full 17 seconds of sampling time and up to a megabyte of storage is standard, as is a velocity sensing keyboard with programmable dynamic sensitivity.



The extensive modification of any sampled sound is enabled by the inclusion of filters, VCAs, envelope generators, and independent delayed LFOs for each of its eight channels. Any number of voices (limited only by available memory) can be assigned to the keyboard at one time, either with its own keyboard range, or stacked with other assigned voices. A unique "digital splicing" function allows the attack portion of one sound to be spliced to the sustain or decay portion

of another.

The Emulator II's track oriented sequencer includes editing and overdubbing capabilities, as well as programmable rhythm correction. Other features include RS-232 and MIDI interfacing; an integral SMPTE reader/generator; and a software-based design for future updates. The Emulator II is priced at \$7,995, and an optional second disk drive is \$650.

Circle #103 on Reader Service Card

**PULSAR LABORATORIES, INC. NOW AVAILABLE A MONTHLY LEASING PROGRAM**

- \*100% Financing
- \*No Collateral Required

- \*100% Tax Write Off
- \*Investment Tax Credit

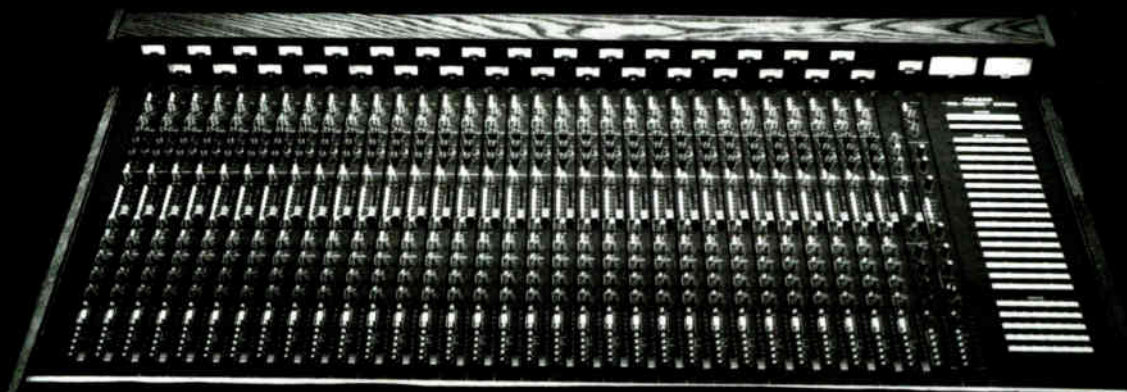

**"ON TRACK" I/O recording consoles**

24 channel @ \$475 a month  
32 channel @ \$600 a month

**SERIES 80 front consoles**

32x8 @ \$250 a month  
24x8 @ \$215 a month

**M8 monitor consoles**

32x8 @ \$250 a month  
32x16 @ \$515 a month

\*Call for additional pricing and information 216-784-8022\*

Circle #104 on Reader Service Card



## The Jon Butcher Axis Looks for the Magic

by David Goggin

*Along the Axis* is the third album from Boston heavyweight Jon Butcher, and the first to effectively explore the artist's amazing range. Butcher is a figurehead of the new generation of guitarists who actually grew up with the instrument. An accomplished virtuoso at 30, he has been playing—no, "living"—guitar since he was seven.

The new album blasts from the doors of the Pasha Music House, an interesting phenomenon in modern pop music. Pasha is a self-contained organization headed by Spencer Proffer, the president of the Pasha/CBS label, owner of the active Hollywood studio, producer, and a lawyer well-versed in the intricacies of entertainment law. Proffer was booted into the Heavy Metal Producer's Hall of Fame in the past few years with the multi-platinum Quiet Riot, but has turned out a steady stream of successes with such diverse acts as The Little River Band, Eddie Money, Billy Thorpe, W.A.S.P., and film scores with groups such as the Beach Boys, Heart and Cheap Trick. With Proffer at the helm, Pasha Music has a distinctive cohesiveness and unified vision.

For the Butcher project, Proffer handed over the engineering responsibility to Hanspeter Huber, who has been sharpening his skills at Pasha for the past three years. The key to the strength of this record is the triumvirate of Butcher, Proffer and Huber combining artistry, a longrange vision and technology in the appropriate places.

Jon Butcher is the pivot man in the four-man "Axis," providing the words, music and athletic musicianship. "Jon personifies the essence of fusion music in its truest sense," says Proffer. "He makes rock and roll with hypnotic rhythms, passionate vocals and intense atmospheres—the power of rock at its finest."

On "Stop," the album opens with an acappella vocal intro. One track of straight vocals is combined with six tracks heavily altered with backwards echo created by flipping the tape over, then doctored with pre-echo and whiz-



zing post-effects. When the Axis kicks in, it does so with a vengeance. "It's a total image cut," says Proffer, "meant to rivet the listener with Jon's personality—virtuosity with tasteful stylizations."

Butcher, a recent transplant to L.A., first gained national attention when Peter Wolf picked him out of the Boston clubs and hired his group to open for a J. Geil's Band tour. Critical acclaim and healthy chart action led to mass exposure on MTV and a big push from Capitol for the new album. As an aggressive guitarist, he performs and records with an arsenal of instruments custom-modified by himself, including two Stratocasters rebuilt from parts and a new Kramer.

"Kramer makes a production guitar that is brilliant—basic and free of gimmicks. The neck is unfinished in the back, the fingerboard is flat [not arched]

and the fret work is perfect—no filing necessary," Butcher says. "I did replace the pick-up to give it less distortion, but it's truly a guitar for the serious player. I have to continually redefine my playing and the Kramer was perfect for the fierce sounds—it brought some magic out of me."

On the title track, Butcher uses the Ebow, a device recently made popular with Big Country. "It electromagnetically aggravates the strings," Butcher explains. "You hold it in your right hand over the pick-up and use your left hand as the dictator. It makes a backwards guitar sound, but it's really different from the usual effects generators. It's nothing other than what you make of it, and relies on your imagination to make it happen."

*Along the Axis* is a guitar tour de force, but the imaginative playing is subservient to the overall sound of the album. There is a broad range of textures, from the melodic "Sounds of Your Voice" with it's Princely groove-oriented style to "Only the Fox," a driving and dancing number impeccably tailored for high-class club action. On "2 Hearts Running" he joins with Bowie vocal alumnus, Ava Cherry, whose album Butcher will sing and play on, as well as co-produce with Proffer for Pasha. The album closes with "The Ritual," a breathtaking instrumental odyssey with a surprising dash of the Orient and enough stereo fly-by to unbalance your system and rebalance your equilibrium.

At a time when album re-mixes for nightclubs and offshoot markets can create studio headaches, Huber engineered with great forethought. "On the drums especially, Hans infused a sound to grasp the AOR, CHR, and dance markets," Proffer says. "He focused on what we really needed for our target demographics and gave the record an easy future—we may not need any special re-mixes. Hans was passionate in his engineering, from pre-production to final master."

"This was the best recording experience I've ever had," reflects Butcher. "Spencer is one of the few producers who still sees records as an artistic medium. He's open-minded and ambitious, and Hans will be my engineer forever, if he will have me. I will try anything in the studio and he stayed with me step for step. He knows all the tricks, but the important thing is that he was sympathetic to my conceptions. Limitless imagination is the best effect in the recording studio." ■

# VIDEO NEWS



Ken Beckman's new dance video, produced in stereo on Betacam, is the video artist's second collaboration with pianist "Blue" Gene Tyranny. Tyranny's original jazz score for the piece was edited with location sounds of Tim Buckley's choreography, which includes something rarely heard in a music video—the sound of the dancers' feet. The program was funded by the NEA and will be released to home video after its PBS debut.

## AES Looks at Audio-for-Video

by Mia Amato

Live End/Dead End design for studio control rooms was the topic of a recent meeting of the New York AES, where a panel of studio designers and acoustic researchers offered their views on its application to audio-for-video mixing rooms.

"One of the things we strive for is a wider listening area," said **Kent Duncan** of Sierra Audio Acoustics. "For television work, it's important that all the people in the room—which usually means the producer, the director, the client—have to be able to hear good sound, not just the engineer."

**Peter D'Antonio**, of RPG Diffusor Systems, discussed his favored type of surface for control rooms, panels of narrow wells with rigid dividers. "Incidental sound is spread equally over a 180 degree angle and over a broad frequency range," he claimed. D'Antonio also favors "splayed front surfaces" to the fore of the console to control

sound reflections in the room. That design and the new surface material have been used in the design of an audio-for-video room at **TeleImage** in Dallas.

**Doug Jones**, a psychoacoustic researcher from Northwestern University's computer music studio, used a video graphics display to demonstrate how placement of a monitor can affect frequency perceptions. "TV sound is moving not so much to stereo but to 3-D sound effects, such as Ambisonics and Holophonics," he said. "I believe it will be imperative when mixing stereo for TV that we control early reflections so these 3-D images can be heard."

**Chips Davis**, designer of the first LEDE control room offered that Live End/Dead End considerations can provide the ideal "neutral" environment for sound mixing, while studio design troubleshooter **Alan Fierstein** of Acoustilog bent a few spines in the room with some blistering remarks on "certified" LEDE rooms. "Don't be misled by fancy test equipment and cryptic initials," he

warned the audience. "Take care not to let your brains and ears be fooled by hype."

All the panelists agreed that more diffusion can improve the mixing room or sweetening suite. Offered D'Antonio: "If you simply took an acoustic panel out of the ceiling and added a diffusor, you would increase the feeling of spaciousness and enhance the stereo in the room."

### IN THE STUDIOS...

Synclavier expert **Charles Hammer** has taken up residence at New York's **Sync Sound**, where he is available for music composing and sound effects work. Recent video projects at Sync Sound included a voice-over session with **Billy Joel** and **Christie Brinkley** which forms a kind of running narration on Joel's soon-to-be-released compilation video album. The studio also handled sweetening for **Bob Dylan's** clip, "Tight Connections," as well as for **Prime Cuts**, a jazz compilation tape for the home market, digitally mastered, featuring **Herbie Hancock** and **Miles Davis**.

**Primalux Video** (New York) has added Betacam format editing and now offers half-inch component recording with Ikegami cameras. Burbank's **Rock Solid Productions** completed a behind-the-scenes documentary for **Kenny Loggins** on the making of his elaborate clip for the "Vox Humana" single.

In Dallas, **Video Post & Transfer** has installed the Montage Picture Processor; first job on the system was a five-minute video biography of artist Frederick Remington for the Amon Carter Museum of Fort Worth. **Positive Video** (Orinda, CA) has opened doors on **Positive Audio**, two 24-track video mixing rooms "designed specifically for audio for video" in its San Carlos stage facility. **Videofonics** (Raleigh, NC) now offers the sophisticated Bosch FGS-4000 three-dimensional computer graphics system.

**Video people...**it's musical chairs for directors in New York now that both Picture Music International and MGMMO have closed their Manhattan offices. Director **Jack Cole** and Producer **Paul Flattery**, along with PMI VP **Bob Hart**, return to LA under the name **Split Screen Productions**. **Millaney, Grant, Mulcahey**, and **Mallet** are now best reached through their London office; **Overview**, the "O" of MGMMO, continues to rep directors

# Sometimes Success Depends On The Company You Mix With.

## CRAWFORD POST PRODUCTION INC.

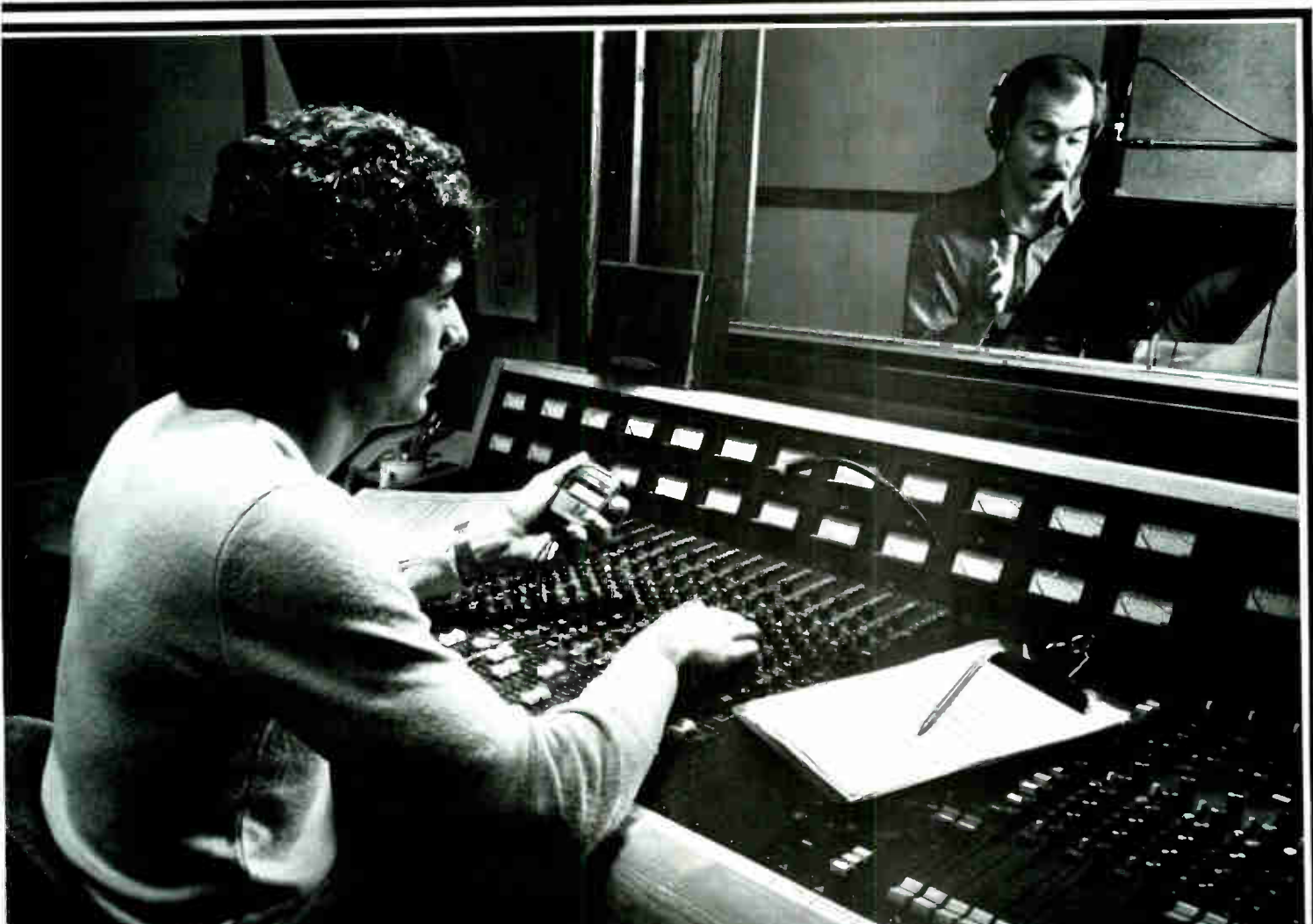

There is a reason why our audio post studios are considered to be two of the best in the country.

It's more than our state-of-the-art equipment, the large array of outboard gear, or our complete music and sound effects libraries.

It's even more than our original

music recording and radio spot production services. Or even that we can compose your music, or mix and layback to picture.

It's the talent and experience of our people that reflects the success of our company. A success you'll share in on your next audio post project.



**CRAWFORD**  
POST PRODUCTION INC.

We're the company that remembers that our success depends on your success.

Contact Bob Judson or Jerry Johnson at 404/876-7149.

Circle #105 on Reader Service Card

Howie Deutsch, John Diaz, Collin Cheevers and Julia Hayward.

### PCs FOR POST-PRODUCTION

We thought *Terrance Forgette* was pretty clever when he showed us how he rigged up his TRS-80 portable computer with a Sony BVH-1500 time code reader to automatically log edit points on video footage. Forgette is a news editor with CBS News' Los Angeles Bureau. "When tapes come back from the field, all I have to do is touch the space bar on the computer's keyboard and it will automatically store the frame numbers of all the good takes as I review the tape," he explained. "It saves a lot of time in the edit room later on, and sometimes I can log an entire reel while I'm rewinding it."

Now *Virtual Image Inc.* is making available a portable computer software program called *Scriptease* which can generate an edit list and serve as a time code reader in the studio or in the field. Abby Levine and Barry Minnerly are selling the program on a one-inch computer chip that can be plugged right into the back of Radio Shack's TRS-80 Model 100 portable computer.

"Most people still log tapes by watching a 3/4-inch window dub of the footage, constantly having to look up at the picture and then down to a piece of paper to write down the time code number of the frames for each scene," Levine said. "Now all you have to do is push a button as you're viewing, and the program will automatically store the time code number for the frame at the exact moment." Levine added that the computerized time code reader can be used "with any time code source" and that time code numbers need not be "burned in" on the videotape footage.

The computer keyboard can also be used to store notes on each edit point, such as "NG" or slate and scene numbers. One application to music video production would be using the portable computer in the field to make notes during live shoots; at the end of the day the program would print out a complete list of all scenes shot, with notes. "The Model 100 can store about 20 pages of script notes," Levine said. "We were recently doing some work with CTW and the continuity person on the shoot kept a week's worth of notes in the computer."

**Video Music Seminar:** The Rock-america Video Music Seminar runs August 4-6 at the Roosevelt Hotel in New York City. Sessions include day-long hands-on hardware workshops, seminars on cable TV, corporate underwriting, club video and black music videos. For more information, call (212) 475-5791. ■

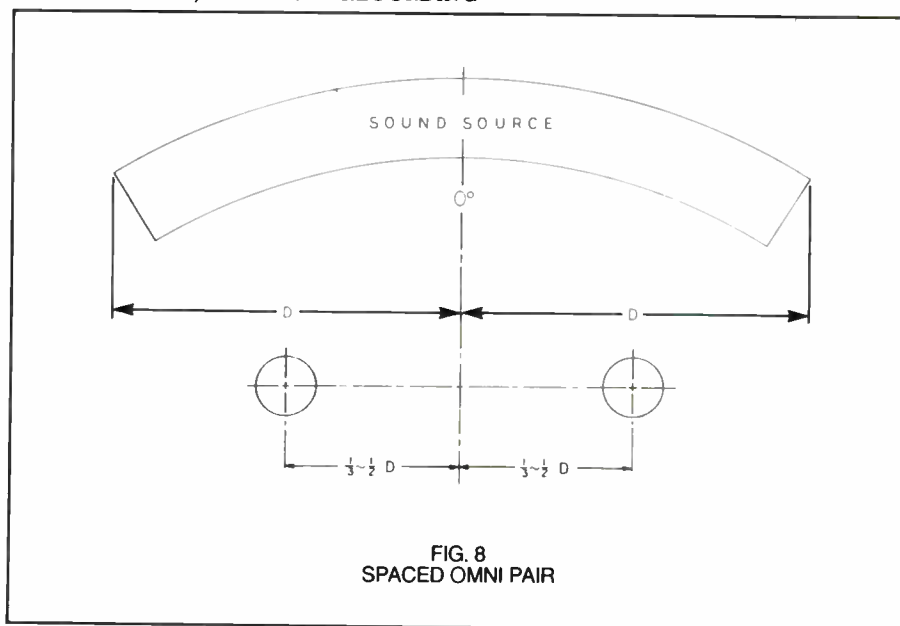

FIG. 8  
SPACED OMNI PAIR

solution can be worked out; I have found that this will usually improve the audience's enjoyment of the performance, as well as produce a better recording. If this is not possible, the use of additional microphones is called for.

During a recording session, all the rules can change. However (there's that word again) be very careful in rearranging a musical ensemble which is accustomed to a particular configuration. A string quartet, for example, always seats itself in a certain order; try to change it, and the performance will suffer.

---

## Miking is the most crucial aspect of the recording process, and the only way to learn is to try various procedures.

---

The same is true for a full symphony orchestra. There are some liberties which can be taken with placement of the instruments or sections, but keep in mind one primary fact: *the musicians must be able to hear one another.*

Conventional studio techniques (isolation gobos and headphone cue feeds) generally won't work here, since most "classical" musicians can't or won't play with headphones. It is best to discuss these situations with the conductor or orchestra manager well before the session; this will avoid costly (with regard to both time and morale) delays when the musicians arrive.

Placement of a chorus and/or soloist should be similarly treated. With these

differing ensemble forces, it is frequently beneficial to arrange the chorus facing the orchestra. This not only lets each group hear the other, but also provides some "free isolation" when directional mikes are employed. The soloist should always be near the conductor (in the "normal concert position") so that the musical communication between the two artists is not impeded. The musical balance between the two is primarily the conductor's responsibility, but careful use of a solo "sweetener" can add the needed "lift" required for the recording.

### 4. Two-Track -vs- Multitrack:

If more than two mikes are used, there are, obviously, two ways to record them: direct-to-two-track (i.e. a "live" mix) or logged onto a multitrack, for later remix. The former is, to my taste, more fun; the latter, more safe. If multi-miking, I frequently will do both: record a live stereo mix, and "cover myself" with a multitrack backup...just in case. There is little else to say about this, except that if the stereo mix works—and it will, if the miking is properly done—the job is finished. With a multitrack recording, remixing is always necessary, and this usually will take far more time than the original recording.

### 5. Visual Considerations:

When the recording is to be made at a concert with an audience—or if television is involved—the visual aspect of the miking must also be considered. (This, obviously, is not a problem with a session recording.) Usually, the main visual objection will be to the principal stereo pair since, properly placed, this is "front and center" in the picture, and is difficult for cameras (or audiences) to avoid seeing. Audiences are generally quite forgiving, and will not "take notice" of the mikes; they are (or should be) engrossed

in the performance taking place in front of them, and their eyes naturally wander all over the stage.

Television cameras (and their associated lighting and artistic directors) are more often sources of contention. *Diplomacy is the only solution to this problem.* Try to "negotiate" a position for the mikes which will serve your needs for proper sonic perspective, but still be "as unobtrusive as possible" to the cameras. Today, most directors are enlightened to quality sound, and will not object unless the mike(s) directly obstruct the faces of the performers.

Occasionally you may come up against a more obstinate attitude: "I don't want to see any mikes in the shot... ever!" When this happens, you could respond with the following: "Do you want to hear the music, or is this program 'M-O-S'?" ("M-O-S"—a film term meaning silent picture, without sound)... *Diplomacy*... Better to try something else, when possible.

Since this will be a broadcast recording, the M/S miking technique, using a (hyper)cardioid pattern for the M signal, is most appropriate; this can be accomplished with a single stereo microphone (I prefer the AKG C-422) suspended high enough above the ensemble to remain out of a tight camera shot, yet close enough to produce a reasonable pickup. Alternatively coincident or near-coincident hypercardioids can be suspended somewhat higher above the ensemble. (The Schoeps MK-41 capsule suspended by a KC-5 "Colette" cable is an excellent choice for this technique).

Finally, the multi-mike technique, with several small, unobtrusive mikes "buried" within (or above) the ensemble, may be the only way to save the recording. If this is the case, make the best of a bad situation, but remember about balancing a multi-microphone pickup.

#### 6. Additional Broadcast Considerations:

Whether for radio or television broadcast, additional mikes will be necessary for hall ambience and audience response. My suggestion here is to use a "Blumlein pair" spaced directly behind the main pickup (at an appropriate distance for the venue) and kept very low in the mix during the performance, so that the time delay between the primary pickup and this one does not introduce unwanted phasing or echoes into the recording. Bring it up for audience applause, etc.

Another technique I have found to be satisfactory is two spaced bi-directional mikes, aimed so that their "dead plane" is aimed directly at the performance stage; thus, their active pickup is solely of the hall ambience and/or audience. Again, do not use too much of these mikes during the performance, as time delay problems can still result.

#### Some Concluding Thoughts:

There is a great deal more which can be said about all of these techniques, but space does not permit here. (Several good texts are available which discuss these—and other—techniques in great detail; some of these are listed in the references at the end of this article.) What must be remembered from all of this, is that miking is the most crucial aspect of the recording process, and the only way to learn is to try various procedures. Put out mikes and listen to them; move them around, and listen again. And again. And again... ■

*Since 1977 Ron Streicher has been audio consultant to the Mann Music Center summer concert series of the Philadelphia Orchestra. Prior to that he was chief engineer for the Los Angeles Philharmonic Orchestra's radio broadcasts for KPFK-FM. Mr. Streicher served as vice-chairman for the 78th AES Convention this past May, and chaired the Microphone Technology session of AES the previous year.*

#### RECOMMENDED REFERENCES:

**Microphones—An Anthology**, published by the Audio Engineering Society, New York, 1979.

**Music, Physics, and Engineering**, by Harry Olson, 2nd Edition, published by Dover Publications, New York, 1967.

**The Technique of the Sound Studio**, by Alec Nisbett, published by Hastings House, New York, 1974.

**Sound Recording**, by John Eargle, published by Van Nostrand Reinhold Company, New York, 1976.

**The Microphone Handbook**, by John Eargle, published by Elar Publications, New York.

"Early Hi-Fi and Stereo Recordings at Bell Laboratories (1931-32)" by Arthur C. Keller, published in the Journal of the Audio Engineering Society, April, 1981, pp. 274-280.

1. This and subsequent diagrams are taken from "Basic Stereo Microphone Perspectives: A Review," presented with co-author Wes Dooley to the 2nd AES International Conference in May, 1984, and published in the Journal of the Audio Engineering Society, Vol. 33, No. 7/8; 1985 July/August.

2. British Patent Specification no. 394, 325, by Alan Dower Blumlein, December 14, 1931.

3. Refer to the paper "Stereo Microphone Techniques: Are the Purists Wrong?" by Stanley P. Lipshitz, presented to the 78th Convention of the AES, May, 1985, preprint no. 2261 (D-5).

4. For a detailed discussion of the M/S technique, refer to "M/S Stereo: A Powerful Technique for Working in Stereo," an article which I co-authored with Wes Dooley, published in the Journal of the Audio Engineering Society, Vol. 30, No. 10; October, 1982, pp. 707-718.



**In New York City professionals look to Sam Ash**

**SALES AND RENTALS  
RECORDING, SOUND AND VIDEO  
ELECTRONIC KEYBOARDS • MUSICAL INSTRUMENTS  
OUR PROFESSIONALS UNDERSTAND YOUR NEEDS  
YOU'LL LIKE OUR SERVICE AND PRICES**

**Sam Ash MUSIC STORES**

**SIX CONVENIENT LOCATIONS**

160 WEST 48 ST. NY, NY 10036 (212) 245-4778	124 FULTON AVE. HEMPSTEAD, NY 11550 (516) 485-2151	E-50 ROUTE 4 PARAMUS, NJ 07652 (201) 843-0119
178 MAMARONECK AVE. WHITE PLAINS, NY 10601 (914) 949-8448	113-25 QUEENS BLVD. FOREST HILLS, NY 11375 (718) 793-7983	447 ROUTE 110 HUNTINGTON STA. 11746 (516) 421-9333

**MAIL ORDER DEPT 1-800-645-3518 (NYS 800-632-2322)**

Circle #106 on Reader Service Card



Giant Sound Studio is a brand new facility in the heart of midtown Manhattan that offers state-of-the-art gear in a beautiful new space. Owned by Chris Snow, the studio offers a Trident 80B console, MTR-90, -10, and -12 recorders, Dolby SP racks and the latest outboard gear. Giant was designed by the staff in conjunction with Jaffe Acoustics of Norwalk, CT.



Crawford Post Production in Atlanta is one of the most technically advanced audio-video facilities in the Southeast, boasting two fully equipped audio studios, (one with a Neve console and Studer recorders) and everything necessary for film and video post-production work.



Studio Consultants, Inc. of NYC has done acoustic consultation and design for numerous facilities, including San Juan, Puerto Rico's Ochoa Recording Studios, whose Studio D is pictured here. The studio has an API 3232 custom console and Ampex tape machines. The main room is quite live, with slatted surfaces used for absorption and diffusion. The Ochoa project is Studio Consultants' largest installation to date.



Pearl Sound, in the Detroit suburb of Canton, MI, features a Sierra design with a fully trapped ceiling and Sierra/Hidley monitors with TAD components. The studio has all Studer recorders and a custom Neotek console. The main studio has a solid oak floor built on floating concrete, and curved oak walls.

(Left) The trend towards larger control rooms equipped with multiple keyboard set-ups is in evidence at Kajem Studios in Gladwyne, PA (near Philadelphia). Kajem is also the only studio in the area equipped with an SSL board. The recorders are Studer and Tascam. The studio was built in the original Derringer gun factory.



New York City's Unique Recording now has an SSL 4000E console with Total Recall to go along with its MTR-90 24-track recorder, BTX Softouch and cornucopia of out-board gear and musical instruments. The studio was outfitted by Martin Audio, Audiotechniques, Manny's and Sam Ash; design was by Bobby and Joanne Nathan, co-owners of the studio.



Under the direction of co-owner Paul Wickliffe, NYC's Skyline Studios now boasts an SSL 4000E console to go along with its complement of tape machines that includes Studer A80 multi-track 1/2-inch and 1/4-inch mastering machines. Installation of the SSL made a few changes in the control room necessary, including the construction of a sound and environmentally isolated computer room.



## SONEX CONTROLS SOUND.

With its patented anechoic foam wedge, SONEX absorbs and diffuses unwanted sound in your studio. And it can effectively replace traditional acoustic materials at a fraction of the cost. SONEX blends with almost any pro audio decor and looks clean, sharp, professional. Check into this attractive alternative for sound control. Call or write us for all the facts and prices.

SONEX is manufactured by Illbruck and distributed exclusively to the pro sound industry by Alpha Audio.

**Alpha Audio**<sup>®</sup>

2049 West Broad Street  
Richmond, Virginia 23220 (804) 358-3852

Acoustic Products for the Audio Industry

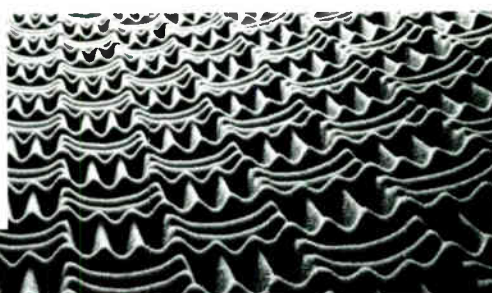

Circle #108 on Reader Service Card

# Need a reliable employee?

**Mix Classifieds** are the place to advertise for management, sales and technical personnel. They all read **Mix**, the audio industry's largest, most widely-distributed magazine!

To place a **Mix Classified** ad, call Lauri Newman at **(415) 843-7901**. Deadline: 10th of month, two months prior to publication.

THE RECORDING INDUSTRY MAGAZINE

**Mix**

# New Directions in Audio:

## Dealers Speak Out

Along with the continual advancements in product technology over the past decade, audio dealers have also been changing with the times. While a brisk amount of sales activity still remains in simple sound reinforcement and recording systems, many customer queries today involve the complex interfacing of keyboards, MIDI peripherals, video, computers, automation, and multiformatted audio in both the analog and digital domains. Manufacturer brochures, trade shows, and industry periodicals can do much to steer the bewildered consumer in the right direction, but in truth, a dealer's recommendation is probably the single most influential factor in affecting an equipment purchase. Establishing a rapport with a knowledgeable dealer you can trust is an important step in a relationship that can grow along with a studio's needs.

—PAGE 130



### Professional Audio Services & Supply: A Store in a Studio

A lot of audio and MI dealers offer listening rooms and studio mock-ups to afford customers the opportunity of checking out equipment in a "real life" situation. A few retailers have even added working studios to their businesses, but Professional Audio Services & Supply, a dealer in Burbank, CA, recently took a different route, by relocating their entire operation into one of the studio sites that had been vacated by nearby Kendun Recorders.

PASS owner Bob Hacken ex-

plained how the move came about: "We had been actively looking for a facility for the past year or so, and my realtor told me about this 'funny building' that had strange walls and weird-shaped rooms which would serve well for office space. He thought it had been used for video work. We went over, and as we pulled up, I realized it was Kendun. We immediately went for it because it was perfect. It just needed a good cleaning and some exterior paint."

Currently, PASS utilizes the former

quad disk mastering room for equipment demonstrations, while the facility's main control room and two studios are leased to Take One Recording Studios, a long-time PASS client. Hacken notes that the arrangement has worked out well for all concerned: "We've transformed the quad room—while keeping all the acoustics intact—and faced the equipment on two halves of the room, utilizing the two stereo imaging areas. The front left/right is for high end equipment and the rear left/right section for the mid- to low-end equipment. But it's *not* a studio—it's strictly a tool where the prospective buyer can evaluate the equipment in a proper acoustic environment, which is very rare."

According to Hacken, customer impressions of the facility have been quite favorable so far. "It's incredible—they're totally impressed. Clients feel this is exactly what they need and spend a lot of time making a proper evaluation, bringing in their own tapes if they wish, because we have every format that's available. It's not like walking into a music store where you've got guitars jamming and drums bashing away in the background and the noise spills over. Here the equipment is in a room unto itself—you close the airlock doors and it's just you and the salesperson. It's a very nice environment."



# AFTER 12 YEARS, OUR CONCEPT'S COME OF AGE SO YOUR CONCEPTS CAN COME TO LIFE.

The TRC Mid-America Recording Center—brand new studios representing the state-of-the-art in modern recording technology.

Two 24-track computer-assisted studios. One 8-track production studio. A complete edit suite. Video post scoring (SMPTE capable). And engineers with the ears and experience to get you maximum results with minimum hassle.

We've been working and growing for 12 years to realize this dream. Today, we have the people, the equipment and the environment to make your concepts come to life.

**trc** Studios

TRC Mid-America Recording Center  
5761 Park Plaza Court  
Indianapolis, Indiana 46220

**For more information, call Gary Schatzlein, 317-845-1980**

# MCI

## REPLACEMENT HEADS

## RECORDER PARTS

## REFURBISHMENT

## BASE PLATE REPAIRS

### 800-553-8712

### 800-325-4243 N CA

## SPRAGUE MAGNETICS INC.

### IN STOCK IMMEDIATE SHIPMENT

### 818-994-6602

15759 STRATHERN STREET  
VAN NUYS, CA 91406  
TELEX: 754239

Circle #110 on Reader Service Card

### **Spectrum Magnetics is your Company for Audio Cassette duplication and Packaging!**

As an Artist-Musician, you strive for the finest and most accurate reproduction of your musical material. At Spectrum Magnetics, we understand that desire . . . and we have made it our goal.

We have the people and the machines to realize that goal with your Audio Cassettes. Our bin-loop duplication process will give you what you want because our people know how, and we use quality components. Direct-to-cassette labeling, Norelco style boxes and shrink wrapping provide you with a complete, professional package. Insert (J card) printing is done by one of the premier printers in the trade.

For the ultimate in cassette reproduction, Spectrum Magnetics can duplicate your material on BASF Chrome tape (High bias, Normal or Chrome equalization) at a slight additional charge.

Our products are top quality, our delivery is fast and our prices are competitive. Call us today for a free demonstration cassette.

**Call us today TOLL FREE and find out more. 800-441-9374, then dial 1652. (in Pennsylvania call 215-363-6300)**



**Spectrum Magnetics, Inc.**  
Marsh Creek Corp. Center  
Lionville, PA 19353

Circle #111 on Reader Service Card

—FROM PAGE 128, DEALERS

With their constant contact with dozens of manufacturers, and after years of listening to customers' input and requirements, audio dealers are in a unique position to give a meaningful evaluation of current trends in the industry. We talked to a number of audio dealers around the country, eliciting their insight about client expectations, changes underfoot in the marketplace, and a few predictions of what may be to come in five years. It may be interesting to look back at this forum a half-decade from now, just to see how well they all fared.

*Mix: Have you noticed a change in your customer base over the past five years?*

**John Loeper, Flanners Pro Audio, Waukesha, WI:** "I've noticed more of a change in customer attitude than in the customer base. A lot of people are looking for less service and lower prices and unfortunately that puts a service-oriented dealer such as ourselves in a precarious position. Having to go head to head against some of the 'box sellers' in the country becomes extremely difficult. For me to substantiate having top notch technicians and service people on staff, and to support sales efforts with knowledgeable people becomes difficult.

"With products becoming more sophisticated and requiring more technical support, the [box sellers'] customer is going to feel it when a product goes down and they have to wait for the manufacturer to service it. Coming from a studio background, I can say that downtime can really cost you money. If you're down for a day, you've lost a day's income. To compete with a box house and still offer expert service is suicidal!"

**Bob Todrank, Valley Audio, Nashville:** "We now do a lot of equipment sales and facility design for the broadcast and video post market, especially from the high technology side. We're heavily into synchronizer sales and digital control of products rather than turntables and cart machines. We're also doing some commercial sound, again from a higher technology side than small PAs. Our market has expanded, but we're still strong in the recording studio area: it's our bread and butter."

**Henry Root, Hy James—The Audio Professionals, Farmington Hills, MI:** "The television people are much more interested in audio than they were three or five years ago. We're seeing more of the home studio-type places, an area that was strictly MI gear five years ago. We're also seeing a lot more people from the MI market, mostly out of sheer desperation: they can't get the

information they need out of MI stores, so they come to us."

*Mix: How has the pro audio market been affected by the popularity of home studios?*

**Courtney Spencer, Martin Audio, New York City:** "From our point of view, the home studio today is best described as a private use or artist studio. A couple of years ago, home studios were more in the vein of someone building a studio and also trying to rent it out for 15 bucks an hour. Fueled by advancements in synthesis and sampling keyboards, the need for acoustic space is not the issue it used to be. For us this has been a very large growth area, and you can almost plot this increase as a nearly-coincident trend with the rise of sophisticated synthesizers, particularly those which are economically accessible. Many of these studios are full 24-track, with an artist or producer as a typical owner and at any given time, we have four or five of these types of studios in the works."

**David Angress, Sound Genesis, San Francisco:** "A lot of artists are adding multitrack facilities to their homes so they can do creative work before going in and spending big dollars in the studio. For years we've also been putting in systems for bands who live in different areas: they would each have a four- or eight-track studio and would send tapes back and forth. In the late '70s, we put together a system for the Doobie Brothers, where each one got an Otari eight-track and a console and could send tapes around. It's not a larger part of our business than it used to be, but it continues to be a significant part."

**Bob Ulius, Leo's Audio and Music Technologies, Oakland, CA:** "We're a strong supplier to home studios as well as strictly professional studios—if anything the home market has increased our business. I would say that the larger studios are diversifying—they can't support their large overhead because of this trend to put together smaller, privately-owned studios that are perhaps more productive. Today, more and more people are creating their own software in their own location and amortizing the cost of the equipment rather than studio time. We've been on the forefront of working with musicians on the smaller studios, since we sell not only professional recording equipment, but also specialize in keyboards, which are becoming more and more a staple piece of gear in a recording studio, as are computers and software."

**Todrank:** "In Nashville, we're definitely seeing more people building home studios, and a lot of them tend to be people who are associated with, or

—PAGE 132



*The Music Source*

## Space Allocation in a Modern Recording Studio

by Jim Wolfe

For fifteen years the Music Source has been recording rock bands and commercials in Seattle. For the past several years we have been acquiring a fairly vast array of synthesizers, drum machines, sequencers, etc. (As a keyboard player and studio owner, I love those toys!) It has always seemed to me that the best place for all that stuff is in the control room, not

just for engineer/players like myself, but since the sound is best in front of the monitors, why put the synthesist out in the studio with headphones?

So little by little our wall space started to get eaten up with keyboard racks. The acquisition of our Kurzweil 250 last October was the last straw: there was room for either the instrument or the player—not both.

It was definitely time for us to remodel or move, and since I own the building that houses the studio it was to our advantage to start knocking out walls. The question was how to divide up the 1200 square feet of available space.

Our basic shell was a rectangle approximately 28 by 44 by 15 feet high. We decided to allocate almost one half of the total square footage to a control room large enough to house all our keyboard racks plus the Kurzweil and leave room for a few new toys.

When I first laid out this sketch it looked like a reasonable compromise. Our studio wasn't huge, but we don't usually have more than five or six people playing at once, and often many of them are in the control room either going direct or with the amps in the studio.

Seeing it on paper was one thing,

the actual reality of a control room that large was another. When the plasterboard was going up I couldn't tell if I'd made a mistake or not, but now that it's done and operational I realize what a smart move it was.

We now have the largest control room in the Northwest. There's room for as many clients, account execs, producers, writers, musicians, engineers, roadies or groupies in that control room that any album or jingle date could ever require. It's big and airy and all of our clients love it.

So far we haven't needed any more space in the recording room than we have, and if there are occasions where that room is too small, it's more than compensated for by the daily joys of walking into that big control room.

So the point is this: the classical approach to studio space allocation has been—little control room, big studio. I think that for '80s music production this is no longer the correct balance. Direct-Inject is the name of the game, so let's devote the square footage to its best use—bigger control rooms. We did, and there are no regrets.

*Jim Wolfe is the president, Music Source, Inc.*

*LaSalle stocks over 250 product lines, giving you the widest choice.*

*LaSalle's prices are the lowest, offering you the best values. Their product*

*knowledge and service are expert, supporting you both before and after your purchase.*

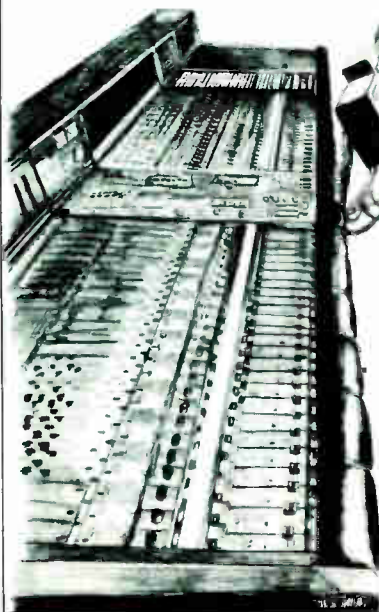

### **Call:**

*inside MA (617) 924-7767  
Nationwide (800) 533-3388*

### **or Visit:**

*75 North Beacon Street  
Watertown, MA 02172*

*1116 Boylston Street  
Boston, MA 02115*

*22 LaSalle Road  
West Hartford, CT 06107*

# **LaSalle**

**Professional Audio & Musical Instruments**

Circle #112 on Reader Service Card

**KABA**  
**REAL TIME**  
 AND DOUBLE SPEED  
**4-TRACK**  
**CASSETTE**  
**DUPLICATION SYSTEM**

Produces true audiophile quality cassettes from any master-cassette, digital, reel-to-reel — at a fraction of the system cost of a 64 X bin system of equal production capacity.

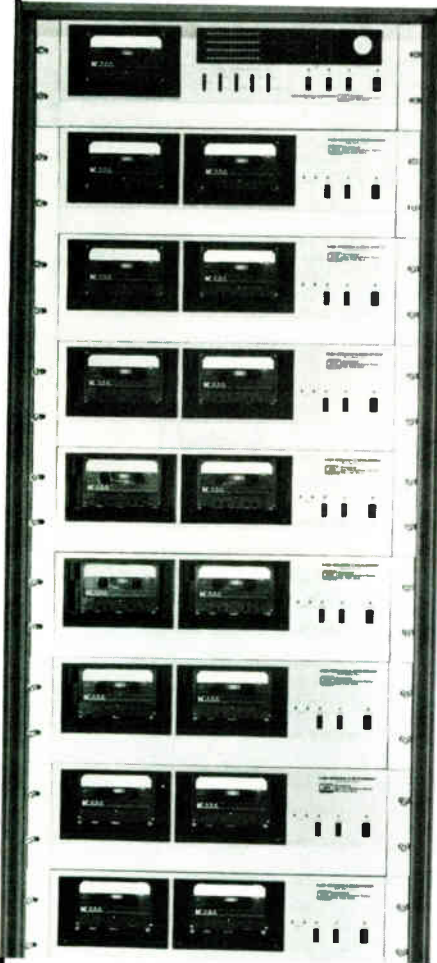

Call or write for details



AN AFFILIATE OF  
**KENNETH A. BACON ASSOC.**  
 24 Commercial Blvd., Suite E  
 Novato, CA 94947, USA  
 415-883-5041  
 800-231-TAPE

Circle #115 on Reader Service Card

—FROM PAGE 132, DEALERS

the PCM60, has been an excellent seller —in fact, so good that it takes a while to get them. The Eventide Clockworks SP 2016 is another digital processor which has been doing very well."

**Spencer:** "Digital is the key word, especially in reverb, where sales are almost all digital now—the sales of plates and so forth have pretty much dried up. Obviously, when you deal with dynamics —compression, limiting, and so forth—it's still analog, but digital is what the market is looking for in signal processing. Four years ago, it was almost impossible to sell a \$10,000 digital processor, and now we can't get enough of them."

**Mix: What are the customers' attitudes about digital recording?**

**Loeper:** "There's a tremendous amount of interest in digital audio. I think the price is inhibitive, but most people are asking for information about where it's going, what's happening price-wise, and what's available. Some manufacturers have shown product, but haven't delivered any: Sony comes to mind with their digital two track, which won't be available until fall. This hurts the marketplace to a certain extent, because there was a lot of excitement when it was first introduced, and that has started to diminish over a period of time. I still think that digital multitrack and two track—as far as being an item that's going to sell on a wide basis—is still some time away, at least in the Midwest."

**Root:** "Most customers are looking the other way in this marketplace. We've sold a few of the dbx 700 units, but at this time there are no other digital recorders (in this area) other than the inexpensive PCM units. We're not in L.A. or New York—the market here is nowhere near as healthy."

**Todrank:** "Nashville tends to be a follower, rather than a leader market. We tend to be pretty conservative in purchasing here, and wait to see what the two coasts do, so digital recorders are still pretty slow here. We don't try to convince our customers not to buy digital, although we do counsel them to be quite careful in their considerations. Most of the people are waiting for trends, to see if any one of the particular machines becomes a favorite, or if prices come down a little. The people here are also figuring that we have one more round of analog left before it's all digital, and we have seen a significant increase in MTR-90 (Otari) sales in the past eight to 10 months. People here would like to see an established digital standard, although I don't have much hope for that happening."

**Angress:** "Customers are looking at digital recorders as very interesting devices which they will end up buying

once they become cost-effective and some of the things in the marketplace have settled down. A lot of customers are using the Sony PCM-F1-type units and the Nakamichi DMP-100, but activity on multitracks at this point is limited to the extreme high end of the market. Frankly, I still think digital recorders have a way to go—in terms of the way they operate and the way they're built—to be able to give customers the same advantage per dollar that you get from a good analog deck now."

**Spencer:** "Digital today is considerably stronger than it was a year ago—there's a lot more potential to be realized, but that may be a function of prices coming down somewhat. It's also a function of better understanding of the technology. People still harbor suspicions as to the permanence of the various standards, and a majority of the studios are playing the waiting game. There's a bit of uncertainty as to how long any standard in place today will remain, and where prices will be a year from now. The nature of the studio business is such that if digital is not a necessity, that studio owner will wait, given the presumption that prices will be lower and the question of what machine to buy will become clearer. But I think that's changing rather quickly, and by the end of the year a lot more will be able to be said about these trends, after the Sony and Studer DASH two tracks become available."

**Ulius:** "We're right in the middle ground of the changeover. I, for one, feel like I've bought my last LP: I'll buy nothing but CDs from now on. The digital recording process is gaining much more acceptance as the process becomes more economical. Sony has one machine (DASH two track) under \$20,000 which we should have shortly. The major studios across the country have already caught on, as evidenced by the popularity of the Sony 3324 and Mitsubishi machines out there, and the next level of studios are about to catch on. We're about two years away from it filtering down to a large percentage, say 70 to 80 percent of the marketplace. Obviously it's the wave of the future."

**Mix: What kind of gear will we be seeing in five years?**

**Root:** "We're going to be seeing a whole lot more digital recording, and somehow we're going to see a price break. CompuSonics, even though it's not cheap right now, has one particular two-track machine storing on floppies and selling for \$2700. I also find the AMS AudioFile unit to be very exciting—it's an amazing tool for a small production company. The technology is there: it's just a matter of marketing."

**Angress:** "In terms of signal process-

ing, everything will be digital. While microphones and loudspeakers will continue to advance, I don't see their basic technology changing. Mixing consoles are going to have more digital control over analog circuitry, but purely digital mixing consoles are going to remain extremely expensive and limited for a long time. The key there is digital control, which allows you to do a lot of things and manipulate signals while keeping the audio in the analog domain. Certainly there will be a lot more digital recorders, which will continue to improve and come down in price, although I don't know whether five years from now is the point when the mass market will start buying digital and shunning analog.

"There are going to be some really neat effects editing systems coming out. You're familiar with SoundDroid, but SoundDroid is a quarter-million-dollar device before you add a bunch of options to it. It certainly is not addressing the mass market. It's also using a lot of storage devices and a lot of hard disks, as the hard disk can operate faster and hold more data. As people come up with hipper ways of addressing it and doing editing, that type of system is going to exist at a much lower cost. You'll have to give up certain features it has, like length of recording time and some of the ways you can manipulate it to come up with a system that costs much less, but it won't take long."

**Loeper:** "Digital is here and here to stay. Everybody recognizes that, and the kind of gear people will be looking for in five years is the kind that can interface keyboards with the special effects devices that musicians use to create their sounds. Equipment will have to be compatible with MIDI interfaces, and most of the gear out in five years will be computer controlled. The days of manual operation are numbered—people will sit down at a computer terminal and run their studio and record that way. The technology is there now, and if the manufacturers can sell it at a competitive price that people can pay, then it will happen sooner."

"As a whole, studios have not addressed the capabilities of MIDI yet, and a lot of the manufacturers that make the recording equipment haven't either. They're starting to, with the samplers that are out now, but they have to address the issue even further. This is where a lot of the marketplace will go. I also see the control room of the future being nothing more than an extension of the actual studio, with a multiple of keyboard pieces and processors filling up the control room. One of the things in a threatened state is the microphone, especially with the increasing numbers of projects being done direct."

**Ulius:** "In five years we're going to be putting down audio and video in the same medium, be that tape-based, erasable laserdiscs, or whatever. We're already just beginning to see people building pieces towards that direction and it's not that far away. Just as five years ago people said we'd now start to see digital, in five years we'll start to see audio and video being totally married, inseparable. It may even arrive in less than five years—we have MTV and Friday Night Videos now, and we're a couple of years away from having 40 available channels by satellite or whatever, that are music-based. This will increase the demand for software and for knowledge. The market is clamoring for equipment that makes it easier and more affordable to do audio and video at the same time."

**Todrank:** "One thing that will be emerging is other forms of digital recording. We'll see new storage mediums which will bring the price down. In the console end, we'll see much more in the assignable techniques, like the Harrison Series 10 and the Calrec assignable console. Console sizes in the next five years will have to come down, because control room acoustics are getting better every day, and the console is still the most significant detriment to control room acoustics. Most of my major customers are looking forward to smaller consoles with more facilities, and the only way to do that is with some sort of assignable control-type console."

**Spencer:** "Equipment in five years will integrate sound creation, manipulation and storage into one system, which is the sort of technology that Synclavier or SoundDroid embodies. Storage will obviously be a random access system—whether disk, optical systems or hard knows what—you'll be able to get from point A to point B in a matter of milliseconds. Editing and all other functions will be automated and integrated into a single control system."

"The recording of instructions to synthesizers or samplers as opposed to recording the actual audio waveform, is a trend that offers a lot of power, and that power will be significantly enhanced over the next five years. I would also expect signal processing to become a part of that integrated system, with perhaps certain items being available through external signal groups, all under software control. We'll see a similar situation to what's happened in video, where the owners of Mirage processors often have software writers on staff, creating their own programs to go with the library of effects that come with the unit. I think we may be seeing more of that in audio, where studios differentiate themselves via the software they develop."

## TAPE SYNCHRONIZERS!

SYSTEM 2600  
"Building Blocks"

from  to 

### PLAY-SPEED SYNCHRONIZING

- lock ATRs together
- lock ATRs to video sync
- lock ATRs to projectors
- lay back audio to video



### CHASE SYNCHRONIZING

- sweeten audio-for-video
- add ATRs to video editing systems
- synchronize to automated mixers
- slave VCRs for digital audio



### REMOTE TRANSPORT CONTROL

- ours, yours or theirs\*
  - our modular remote (to 500') control panels
  - your computer, terminal or keyboard
  - their\* edit controllers or mixers
- \* CMX, Solid State Logic, Calaway, others



### FULL-FUNCTION AUDIO-FOR-VIDEO EDITING CONTROL SYSTEMS

- cueing, trimming, looping, displaying, jogging, rehearsing, recording, audio event editing, and lots more



FOR DETAILS ABOUT  
SYSTEM 2600 BUILDING BLOCKS,  
CALL, WRITE OR WIRE:

## ADAMS•SMITH



34 Tower Street  
Hudson, MA 07149 USA  
Tel.: 617-562-3801  
NYC.: 516-352-2341  
TWX: 710-347-0096

Circle #116 on Reader Service Card



1669 E. 13th St., Brooklyn, NY 11229  
(718) 645-3886

Mail Order:  
124 Fulton Ave., Hempstead, NY  
(800) 645-3518, (800) 632-2322

**AST SOUND**  
*SES, EI*  
250 W. Broadway, New York, NY 10013  
(212) 226-7781  
Contact: Michael Kramer

**A/T SCHARFF RENTALS**  
*SES, EI*  
1619 Broadway, New York, NY 10019  
(212) 582-7360  
Contact: Peter Scharff, Josh Weisberg

**ATLAS SOUND**  
*SES*  
10 Pomeroy Rd., Parsippany, NJ 07054  
(201) 887-7800  
Contact: David A. Chambers

**AUDIO ARTISTRY**  
*AC*  
P.O. Box 56, Kensington, MD 20895  
(301) 493-8323  
Contact: Farrel M. Becker

**AUDIOFORCE**  
*SES, Rental Only*  
147 W. 24th St., New York, NY 10011  
(212) 741-0919, (800) 847-4123  
Contact: Sid Zimet

**AUDIO INTERFACE**  
*EI*  
38 Woodcrest Rd., Whippany, NJ 07981  
(201) 884-1542  
Contact: Jim Stephen

**AUDIO INTERNATIONAL**  
*SD, SES, EI*  
424 Grant Ave., Scotch Plains, NJ 07076  
(201) 322-4466  
Contact: Warren C. Slaten

**AUDIOTECHNIQUES, INC.**  
*SES, EI*  
1619 Broadway, 4th floor, New York, NY 10019  
(800) 223-2486, (212) 586-5989  
Contact: Gene Perry  
**Services offered, credits, specialization:** Representing Sierra Audio in the Northeast for design & construction. Digital audio specialists representing: Sony Digital, Harmonia Mundi, CompuSonics, Publison etc. Analog products include: A&D Calrec, Sony, Trident, Lexicon, Studer, Hafler, Keith Monks, Otari, Tascam, etc.

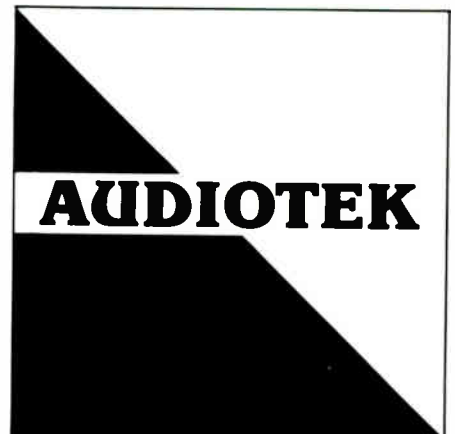

**AUDIOTEK**  
Hollis, NY

**AUDIOTEK**  
*SD, AC, SES, EI*  
182-35 Jamaica Ave., Hollis, NY 11423  
(718) 526-1456  
Contact: Herb Horton, Charli Pumell

**LEGEND:** SD: Studio Designer; AC: Acoustical Consulting; SES: Studio Equipment Supply; EI: Equipment Installation/Maintenance/Serviceing

## NORTHEAST

**ACES (USA)**  
*SD, AC, SES, EI*  
244 Lyell Ave., Rochester, NY 14608  
(716) 458-5613  
Contact: Mr. Boyd McCoy

**ACOUSTIC DESIGN/CONSTRUCTION**  
*SD, AC*  
P.O. Box 646, Naples, ME 04055  
(207) 693-6499  
Contact: John Julien

**Services offered, credits, specialization:** Serving the communications industry of the east coast, central U.S., & Canada; audio/video facilities (new construction); club/studio upgrading; initial site evaluations (at a fee).



**ACOUSTIC SPACES**  
DESIGNER/BUILDER

**ACOUSTIC SPACES**  
Woodstock, NY

**ACOUSTIC SPACES**  
P.O. Box 884, Woodstock, NY 12498  
(914) 331-1726

Contact: David Vercelletto  
**Services offered, credits, specialization:** Acoustic Spaces is a design and construction firm specializing in all aspects of facility and room fabrication for the production industry. A highly-skilled staff headed by David and Steven

Vercelletto deliver innovative design, while maintaining a high degree of cost-effectiveness in both construction and renovation.

Credits: Steven has worked extensively in solar construction and acoustical renovations for the past seven years. His skills also include production art and drafting, and he is draftsman for KDP Engineering. David has serviced, designed, and installed systems and circuitry for the recording and telecom industries for six years.

Specializations: 1) High efficiency plant design and construction; 2) Electronic system and circuitry design and installation including video, computer, communications and most other related areas; 3) Advanced Environmental control systems including the latest in solar architecture; 4) Efficiency engineering and computerization of existing facilities for higher through-put; 5) On staff personnel in all fields.

**ACOUSTILOG, INC.**  
*SD, AC, SES, EI*  
19 Mercer St., New York, NY 10013  
(212) 925-1365  
Contact: A. Fierstein

**ADR STUDIOS INC.**  
*SD, AC*  
325 West End Ave., New York, NY 10023  
(212) 486-0856  
Contact: Stuart Allyn

**ANDREWS AUDIO CONSULTANTS**  
*SD, AC, SES*  
347 West 39th St., New York, NY 10018  
(212) 736-9570  
Contact: David M. Andrews

**SAM ASH MUSIC STORES**  
160 N. 48th St., New York, NY 10036  
(212) 719-2299

113-25 Queens Blvd., Forest Hills, NY 11375  
(718) 793-7983

124 Fulton Ave., Hempstead, NY 11550  
(516) 485-2151

447 Rte. 110, Huntington Station, NY 11747  
(516) 421-9333

E. So. Rte. #4, Paramus, NJ 07652  
(201) 843-0119

178 Mamaroneck Ave., West Plains, NY 10601  
(914) 949-8448

# Digital recording gets its own microphone. At Camera Mart.

The VIP-50 by Milab, the prestigious Swedish manufacturer of professional microphones, is the first microphone fully able to cope with the stringent demands of digital recording.

It is transformerless for 48 volt systems and features freedom from phase, harmonic and overload distortion, a noise level approaching the theoretical limit of modern circuit design, and a sonic purity previously unavailable at any price.

The VIP-50 sets new standards of excellence that will be hard to match for years to come.

It's new, and, as you'd expect, it's available right now from Camera Mart.

***The more you know about audio,  
the more you can rely on Camera Mart.***

**The Camera Mart, Inc.**

456 West 55th Street, New York 10019 • (212) 757-6977

Telex: 275619/FAX (212) 582-2498

305 Vine St., Liverpool, NY 13088 • (315) 457-3703

**Sales • Service • Rental**

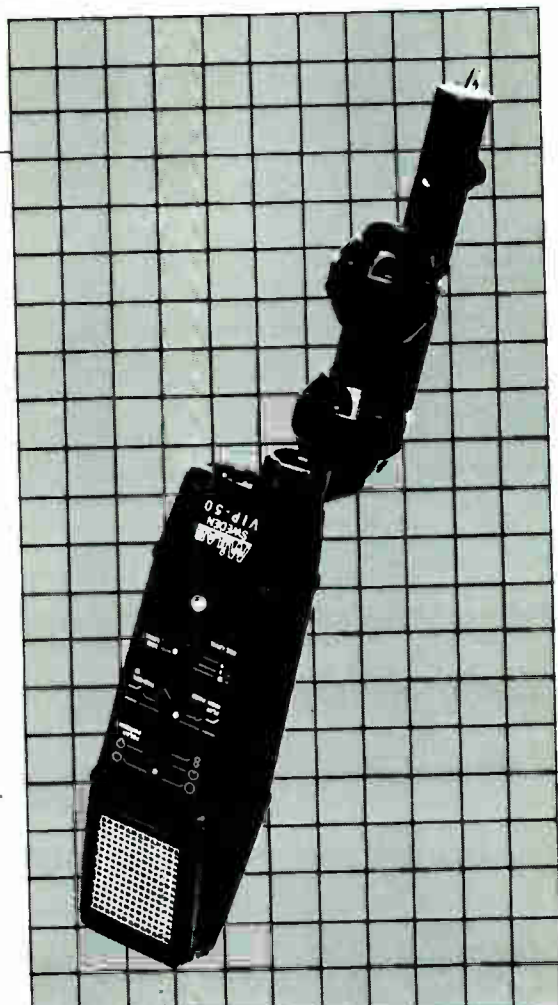

**MILAB VIP-50 Professional  
Microphone**

Services offered, credits, specialization: Audiotek is a full-service company providing everything from A to Z with regard to studio consultation, studio design, installation, modification, custom manufacturing, as well as equipment installation for all broadcast transmission equipment, etc. Services also include 24-hour supply and sales of all pro audio, video, and broadcast equipment available on the market, including full maintenance and service of this equipment. Audiotek has been in business 16 years providing expert consultation and conscientious servicing of all your needs, with full financing available for all projects. We provide anything and everything your heart desires with no limitations in completing your project.

**AURA SONIC LTD.**  
SD, SES, EI  
140-02 Poplar Ave., Flushing, NY 11355  
(718) 886-6500  
Contact: Steven Remote

**AUTERI ASSOCIATES**  
9 Heneary Dr., Miller Place, NY 11764  
(516) 331-5022  
Contact: Bob Auteri

**BAYSTATE SOUND & RECORDING**  
SES, EI  
320 Plumtree Rd., Springfield, MA 01118  
(413) 783-5084  
Contact: William P. Arnold

**BENCHMARK ASSOCIATES**  
SD, AC  
425 East 63rd St., New York, NY 10021  
(212) 688-6262  
Contact: Vin Gizzi  
Services offered, credits, specialization: Architectural and Acoustic Design for the recording industry. Complete planning and project design; room acoustic design—compu-



ter-assisted optimization of room geometry and proportions, diffuser and absorber design, monitor alignment, specifications for isolation systems and all construction materials; certified LEDE design; preparation of all construction drawings and specifications—architectural, acoustic and mechanical; interior design and furnishings. Technical Facilities Design: conceptual planning; electro-acoustic systems design and engineering; video systems design and engineering. Consulting Services: acoustic testing and measurement— isolation, reverberation time, TEF, analysis and solution of noise problems—air conditioning systems, noise control; computer-assisted room acoustics design. Typical Projects: recording studios and control rooms; digital audio facilities; audio for video facilities; video production stages and control rooms; video editing facilities; radio and television studios.

## NORTHEAST

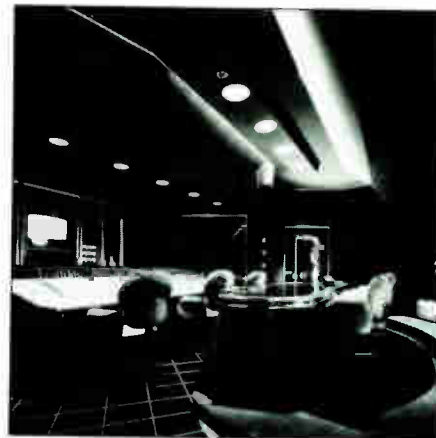

**BENCHMARK ASSOCIATES**  
New York, NY

**BRIGHTON LITES INC.**  
SD, AC, SES, EI  
315 Mt. Read Blvd., P.O. Box 24799  
Rochester, NY 14624  
(716) 436-8475

Services offered, credits, specialization: Acoustic Services: analysis, evaluation, design (control room, studio, theatre), noise control. Sales: audio, video, lighting, sync systems, tape machines. Rentals: all equipment we sell is offered for rental—technicians and engineers available. Installation: anything from equipment installation to complete construction of a finished facility. Custom Fabrication: custom products and interfaces. Training: classes offered to facilities needing specialized instruction of personnel. Remotes: lighting, audio, video, special effects, recording, all offered with or without technicians/engineers.

**In A/B tests, this tiny condenser microphone equals any world-class professional microphone. Any size, any price.**

Compare the Isomax II to any other microphone. Even though it measures only  $\frac{5}{16}$ " x  $\frac{5}{8}$ " and costs just \$189.95,\* it equals any world-class microphone in signal purity.

And Isomax goes where other microphones cannot: Under guitar strings near the bridge, inside drums, inside pianos, clipped to horns and woodwinds, taped to amplifiers (up to 150 dB sound level!). Isomax opens up a whole new world of miking techniques—far too many to mention here. We've prepared information sheets on this subject which we will be happy to send to you free upon request. We'll also send an Isomax brochure with complete specifications.

Call or write today.

\* Pro net price for Omnidirectional, Cardioid, Hypercardioid, and Bidirectional models.



**COUNTRYMAN ASSOCIATES INC.**  
417 Stanford Ave., Redwood City, CA 94063 • (415) 364-9988  
Canadian Distributor: Gerr Audio, 363 Adelaide Street, Toronto, Ont. M5A 1N3



**BRIGHTON LITES INC.**

**BRIGHTON LITES INC.**  
Rochester, NY

**BRYCE AUDIO**  
SES  
115 W. 40th St., New York, NY 10018  
(212) 575-8600, (800) 223-1346  
Contact: Roger Nader

**BURLINGTON AUDIO TAPES**  
SES  
106 Mott St., Oceanside, NY 11572  
(516) 678-4414  
Contact: David Schwartz

**CARUSO MUSIC, INC.**  
AC, SES, EI  
20 Bank St., New London, CT 06320  
(203) 442-9600  
Contact: Larry or Richard Caruso

**C&C AUDIO-VIDEO**  
SD, AC  
RD #1 Box 581A, Glassboro, NJ 08028  
(609) 881-7645  
Contact: Edward Candelora, Jr.



**COAST COMMUNICATIONS, INC.**  
 AC, EI  
 Suite 32 Independence Mall, Wilmington, DE 19803  
 (302) 654-2713  
 Contact: Mitchell Hill, Dennis Melton

**CONNECTRONICS CORP.**  
 SES  
 652 Glenbrook Rd., Stamford, CT 06906  
 (203) 324-2889  
 Contact: Richard Chilvers

**CRAMER AUDIO-VIDEO**  
 SES, EI  
 120 Hampton Ave., Needham Heights, MA 02194  
 (617) 449-2100  
 Contact: Bill Ford

**CRYSTAL CLEAR AUDIO — M.Y.SOUND**  
 SES, EI  
 100 Wompatuck Rd., Hingham, MA 02043  
 (617) M-Y-S-O-U-N-D  
 Contact: Bounard Sage

**CSE AUDIO**  
 SD, AC, SES, EI  
 173 Old Well Rd., Rochester, NY 14626  
 (716) 227-7763  
 Contact: Craig Fennessy

**DANBURY ELECTRONIC MUSIC CENTER**  
 SES  
 84 Federal Rd., Danbury, CT 06810  
 (203) 792-5542  
 Contact: Gary Schwartz

**EAST COAST SOUND**  
 SD, AC, SES, EI  
 SD, AC, SES, EI  
 40 Main St., Danbury, CT 06810  
 (203) 748-2799  
 Contact: Ed Roman

**EPA AUDIO**  
 EI  
 844 Park Ave., Hoboken, NJ 07030  
 (201) 795-3339  
 Contact: Mr. Eddy

**PETER GEORGE ASSOCIATES INC.**  
 SD, AC  
 34 West 17th St., New York, NY 10011  
 (212) 243-8600  
 Contact: Jay Panzer

**GRC INC.**  
 EI  
 1137 Fillmore St., Baltimore, MD 21218  
 (301) 889-4228  
 Contact: R. Friedman

**"HANKSOUND" STEVE A HANKS**  
 SD, AC, SES, EI  
 1218 Woodside Rd., Brunswick, ME 04011  
 (207) 725-5155  
 Contact: Mr. Steve A. Hanks

**HARVEY PROFESSIONAL AUDIO/VIDEO**  
 SD, AC, SES, EI  
 25 W. 45th St., New York, NY 10036  
 (212) 921-5920  
 Contact: Peter Hoagland

**HOT HOUSE PRODUCTIONS**  
 SD, AC, SES, EI  
 Rd. 1 Box 362A, Highland, NY 12528  
 (914) 691-6077, 11AM-6PM  
 Contact: Richard Rose  
**Services offered, credits, specialization:** We are a small organization specializing in close personal client relations. Our product line is characterized by equipment we have found to be the most functional, cost-effective and reliable. In addition to the broad range of products offered, we provide system design, installation and maintenance for the pro & semi-pro recording studio, disco, sound reinforcement, electronic musician, and home audiophile. Our recording studio/demonstration facility is available for equipment evaluation by appointment only.  
 Akai, AKG, Alesis, Aphex, Astatic, Banner, BBE, BES, Beyer,

—CONTINUED ON PAGE 140

**If you are using these products,  
 you MUST talk to us.**



**El Mar Plastics, Inc.**

821 E. Artesia Blvd., Carson, CA 90746

Phone: (213)327-3180

Telex: 215295

Circle #129 on Reader Service Card

**Now, Controlling Room Acoustics  
 Is As Easy as 1,2,3.**

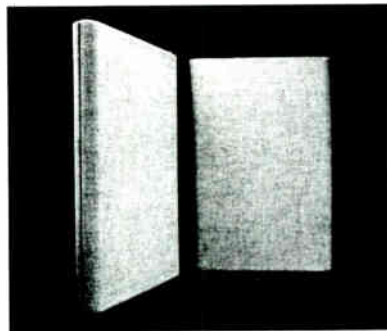

**Introducing Soundex™  
 Acoustic Control Panels  
 from Monster Cable®**

**Engineered for  
 controlling sound.**

Soundex Acoustic Control Panels are a simple, attractive way to control unwanted room resonances and reverberation. Made from a special high density fiberglass mixture, Soundex is designed to attenuate sounds linearly . . . without creating peaks and dips in the frequency response or changes in phase that can "color" the sound. And Soundex is effective,

providing over 20 db of broadband sound attenuation. Each panel frame is sturdily constructed from a rigid plastic extrusion that is lightweight, sturdy, and will not warp. Covered in durable, fire retardant, designer fabrics, Soundex is easy on the eyes as well as the ears.

Available in 3 easy to use configurations:

- Soundex 1 Wall Panels
- Soundex 2 Free Standing Isolation Panels
- Soundex 3 Hanging Panels

Use one or all in combination for maximum flexibility in placement and effective-

ness. Concert hall, recording studio, or hotel lobby, Soundex works hard to control sound while being attractive and reasonably priced. Specify Soundex for your next job, its performance and good looks will surprise you and your client.

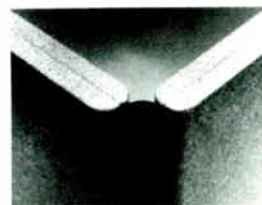

**SOUND EX™**

Write or call us for prices and technical specifications.

Monster Cable® Products, Inc.  
 101 Townsend, San Francisco, CA 94107  
 415 777-1355 Telex: 470584 MCSYUI

Circle #130 on Reader Service Card

**WHO'S YOUR  
DIGITAL MAN...**

NOTHING BUT DIGITAL

DO YOU HAVE  
HIS BEEPER #?

32-TRACK DIGITAL  
STUDIO \$95.00 HOUR

**Digital by  
Dickinson**  
(201) 429-8996

Circle #118 on Reader Service Card

## VICTOR'S PRO AUDIO

New Jersey's  
Pro Audio Center

ADA	Lexicon
AKG	Micmix
Ampex	Otari
Aphex	Ramsa
Ashly	Sennheiser
ART-MXR	Shure
Audio-Technica	Soundcraft
Countryman	Studer-Revox
Crown	Studiomaster
DBX	Symetrix
DeltaLab	Teac/Tascam
Eventide	TOA
Fostex	USAudio Gatex
JBL	Valley People

plus many more

**Victor's Pro Audio**  
235 Franklin Ave.  
Ridgewood, NJ 07450  
(201) 652-5802

**COMPLETE SHOWROOM**

Circle #119 on Reader Service Card



**LEGEND:** SD: Studio Designer; AC: Acoustical Consulting; SES: Studio Equipment Supply; EI: Equipment Installation/Maintenance/Service

## NORTHEAST

—CONTINUED FROM PAGE 139

Brooke-Siren, Carver, Celestion, Crown, dbx, DeltaLab, Digitech, DNR, EAW, Emilar, EXR, Fane, Fostex, Fried, Gallien-Krueger, Goldline, Grado, GT Electronics, Harbinger, Hartley, Hill, HME, JBL, Klark-Teknik, Lexicon, LofTech, Magnepan, Marshall Electronics, Milab, NAD, Nakamichi, Onkyo, Orban, Otari, Phoenix Systems, Rane, Revox, Rocktron, SCS, Sennheiser, Shure, Soundcraft, Soundtracs, Sundholm, Swinlek, Symetrix, Synchronous Technologies, Tandberg, Tannoy, UREI, Ursa Major, and a full line of magnetic tape, cables and accessories.



**HOT HOUSE PRODUCTIONS**  
Highland, NY

**INNER EAR RECORDING**  
SD, SES  
118-17 97th Ave., Queens, NY 11419  
(718) 849-5725  
Contact: Steve Vavagiakis

**DANNY KAPILIAN**  
AC, SES  
G.P.O. Box 802, New York, NY 10116  
(718) 802-0268

**KDP ENGINEERING**  
SD, EI  
P.O. Box 383, Bearsville, NY 12409  
(914) 338-8958  
Contact: David Vercelletto

**LAKE SYSTEMS CORP.**  
SES, EI  
55 Chapel St., Newton, MA 02160  
(617) 244-6881  
Contact: Steve Blake, Luke Furr, Tom Cook  
Services offered, credits, specialization: Lake stocks over 100 lines of pro audio and video equipment. Top studio designers, consultants, and architects consistently specify Lake Systems for system design, equipment requirements, and their knowledgeable time efficient installation and service team. Lake has been in business for over 30 years, and

can handle any size job, from a small production studio or nightclub, to fully blown multitrack recording studios, TV and radio stations, casinos and stadiums. We are in the forefront of the digital audio movement, and leaders in interactive video technology. We are committed to our clients.

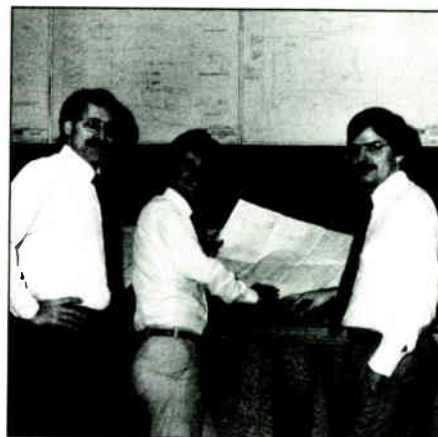

**LAKE SYSTEMS CORP.**  
Newton, MA

**LANDY ASSOCIATES, INC.**  
SES, EI  
1890 E. Marlton Pike, Cherry Hill, NJ 08003  
(609) 424-4660  
Contact: Jim Landy, Dave Newborg  
also:

1605 Trapelo Rd., Waltham, MA 02154  
(617) 890-6325  
Contact: Brad Reed, Mike Landy  
Services offered, credits, specialization: Systems design and installation of Auditoriums, Quantum, Neotek, Tweed and Ramsa audio consoles; AKG, Crown, Electro-Voice, Sennheiser, Shure and Telex microphones; Ampex, Otari and Studer tape machines; JBL speakers, Crown, dbx, Datalek, Orban, Thomson-CSF, RTS Systems, Telex Intercom, Clear-Com, etc.

**LA SALLE**  
SD, AC, SES, EI  
75 N. Beacon St., Watertown, MA 02172  
(617) 924-7767, (800) 533-3388

22 La Salle Rd., W. Hartford, CT 06107  
(203) 236-5401, (800) 533-3388

**MAGNA-TECH ELECTRONIC CO. INC.**  
SES  
630 Ninth Ave., New York, NY 10036  
(212) 586-7240  
Contact: R. Eberenz

**MANNY'S MUSIC**  
SES  
156 W. 48th St., New York, NY 10036  
(212) 819-0576  
Contact: Stuart Manny, Ian Manny, Doug Cook

**MARTIN AUDIO/VIDEO CORP.**  
SES  
423 W. 55th St., New York, NY 10019  
(212) 541-5900

**MCG AUDIO CONSULTING & TEF™ ANALYSIS**  
AC  
88 Myrtle Ave., Edgewater, NJ 07020  
(201) 224-4937  
Contact: Mary C. Gruszka

**L. MATTHEW MILLER ASSOC. LTD.**  
SD, SES, EI  
48 W. 21st St., New York, NY 10011  
(212) 741-8011  
Contact: Bernard Palmer, VP Sales

**MUSICCO-PRODUCTIONS**  
SD, EI  
c/o 7294 Michael Rd., Orchard Park, NY 14127  
(716) 675-7052  
Contact: David Musial

# **MANNY'S PROFESSIONAL AUDIO DIVISION**

NEW YORK CITY'S LARGEST MUSIC DEALER HAS EXPANDED TO INCLUDE A FULLY OPERATIONAL PRO AUDIO DIVISION. COMPLETE WITH DEMONSTRATION FACILITIES AND OUR SPECIALIZED SALES STAFF, WE CAN ASSIST YOU IN SELECTING ANYTHING FROM MICROPHONES TO A COMPLETE MULTI-TRACK RECORDING STUDIO. WE SHIP WORLDWIDE. WE'RE JUST A PHONE CALL AWAY.

**MANNY'S MUSIC  
156 WEST 48<sup>th</sup> STREET  
NYC, NY 10036  
212 819-0576**

Circle #120 on Reader Service Card

## TOY SPECIALISTS

*SES, Rentals Only*  
254 W. 54th St., New York, NY 10019  
(212) 333-2206, (800) 847-4123

Contact: Rita Laone, Bill Tesser

**Services offered, credits, specialization:** The Toy Specialists is a rental company specializing in all the latest musical instruments, such as the Linn 9000, Emulator II, Simmons SDS-7, TX-816, and the DX7; the most up-to-date synchronizing equipment, such as the SRC, SBX-80, various Dr. Clicks; not to mention some of the classics, such as the LinnDrum, Prophet-5, OBX-a, OB-8, MiniMoog and of course, assorted toys, such as DMX, DSX, MSQ-700, SDS-5, MX-1 Trigger and the list goes on.

The Toy Specialists also provide technical assistance to all their clients, in addition to expert programming and pre-production.

Some of the Toy Specialists' most recent projects have included Julian Lennon, Foreigner, Yoko Ono, Mick Jagger, KISS, Carly Simon and many others.

## VICTOR'S PRO AUDIO

*SD, SES, EI*  
235 Franklin Ave., Ridgewood, NJ 07450  
(201) 652-5802

Contact: James Hovey

**Services offered, credits, specialization:** Victor's is NJ's most comprehensive music store for the recording professional. Our pro-audio & keyboard departments offer a full line of the gear you need with every salesperson a specialist in his field. Your most technical problem is no problem because we personally use every piece we sell including Otari, Neumann, Lexicon, UREI, JBL, dbx, Valley People, Tascam, Fostex, AKG, Crown, Sennheiser, Toa, Klark-Teknik, U.S. Audio, Urse Major, Aphex, Roland, Voyetra, Sequential, etc... Standard services include custom wiring, calibration, and in-house repairs. In our newly completed pro-audio showroom, you can get your hands on the controls of every piece of gear we sell, or just sit back and listen to our extensive library of test tapes. Not sure how that gear will sound in your environment, or equipment broken? Established customers are always entitled to our unique loner policy. Victor's hates down-time as much as you do! Call (201) 652-5802.



**LEGEND:** SD: Studio Designer; AC: Acoustical Consulting; SES: Studio Equipment Supply; EI: Equipment Installation/Maintenance/Serviceing

## NORTHEAST

### WEST WIRES RECORDING

*SD, EI*  
1716 Elm St., Allentown, PA 18104  
(215) 435-1924

Contact: Wayne A. Becker

### WESTEC AUDIO/VIDEO

*SD, AC, SES, EI*  
1841 Broadway Suite 1203, New York, NY 10023  
(212) 586-1662

Contact: Mr. David Bellino

**Services offered, credits, specialization:** Proudly serving the broadcast and postproduction industries for over 15 years, Westec Audio/Video provides the industry with the utmost professionalism in sales, service and consultation. Sales engineering can provide state-of-the-art equipment, in-depth design and consultation with creative financing to fulfill any requirements. A comprehensive service center

provides the client with prompt, attentive service to the industry. A factory trained service center is available for most wireless microphones and two-way radio systems in addition to servicing most audio equipment. Our Emmy award-winning engineering staff provides the industry with the most extensive sound effects library in the area. Custom sound effects are our main areas of expertise in addition to mix-minus work. Our technical staff combines their experience and knowledge of audio for video production, synchronization, intercom systems and wireless communications to meet our client's needs today, and their expectations tomorrow.

## SOUTHEAST

### ACE MUSIC CENTER, INC.

*SD, AC, SES, EI*  
13630 W. Dixie Highway, N. Miami, FL 33161  
(305) 891-6201

Contact: Neil Richards

### ALPHA AUDIO

*SD, AC, SES, EI*  
P.O. Box 6306, Pensacola, FL 32503  
(804) 358-3852

Contact: Eric Johnson

### ALPHA AUDIO

*AC, SES, EI*  
2049 W. Broad St., Richmond, VA 23220  
(804) 358-3852

Contact: Eric Johnson

### AUDIO, LIGHT & MUSICAL

*SES*  
3301 N. Military Hwy., Norfolk, VA 23518  
(804) 853-2424

Contact: Jim McDonald

### AUDIO SYSTEMS

*SES, EI*  
205 22nd Ave. North, Nashville, TN 37203  
(615) 320-1600

Contact: Jack Tenzel

### BAE INC. (BLEVINS AUDIO EXCHANGE)

*SES, EI*  
1717 Elm Hill Pike, Suite B-9, Nashville, TN 37210  
(615) 361-8429

Contact: Randy Blevins

### CATES MUSIC CENTER

*SES, EI*  
305 W. Walnut St., Johnson City, TN 37601  
(615) 928-8821

Contact: Norma N. Cates

### DIGITAL ASSOCIATES' AUDIO RENTAL

P.O. Box 422, Spring Hill, TN 37174  
(615) 256-4487

Contact: Rick Horton, Mike Poston

### EDUCATIONAL ELECTRONICS CORPORATION

*EI*  
216 Oak Ave., P.O. Box 23217, Harahan, LA 70123  
(504) 737-4545

Contact: Donald I. Geier

### ELECTRIC MOUNTAIN SOUND, INC.

*AC, EI*  
2021 12th St., Sarasota, FL 33577  
(813) 366-2622

Contact: Terry F. Donato

### ELECTRONIC SYSTEMS LABORATORIES INC.

*SES*  
110 S.W. 21st Terrace, B-107, Ft. Lauderdale, FL 33312  
(305) 791-1501

Contact: Lutz H. Meyer

### GORDON LIGHT & SOUND

*AC, SES, EI*  
922 Poinsett Hwy., Greenville, SC 29609  
(803) 242-5140

Contact: James Floyd

# Don't lose your head

**Recondition It The Professional Way**  
AMP Services Will Make Your Worn Magnetic Recording Heads Perform Like New Again!  
Just Compare Our Quality, Service and Prices To Anyone!

Featuring:

- Optical Alignments
- New Replacement Heads Available
- Ultrasonic Cleaning Of Flutter Filters
- Free Written Evaluations
- 24 Hour Service
- All Work Guaranteed

**AUDIO MAGNETIC PROFESSIONAL SERVICES INC.**

**10% OFF**  
COST OF RECONDITIONING DURING AUGUST



(305) 964-5414 • 6270 Wauconda Way West • Lake Worth, FL 33463

Circle #122 on Reader Service Card

**GRAY COMMUNICATIONS CONSULTANTS, INC.**  
*SD, AC, SES, EI*  
404 Sands Dr., Albany, GA 31705  
P.O. Box 3229, Albany, GA 31708  
(912) 883-2121  
Contact: Perley E. Eppley, Sr.

2254 Northwest Parkway, Suite C, Marietta, GA 30067  
(404) 956-7725  
Contact: Richard Schmidt

209 Oxmoor Cir., Suite 708, Birmingham, AL 35209  
(205) 942-2824  
Contact: Jim Robinson

2866 Dauphin St., Suite A, Mobile, AL 36606  
(205) 476-2051  
Contact: Richard Brown

5401 Southern Comfort Blvd., Tampa, FL 33614  
P.O. Box 24336, 33623  
(813) 885-1411  
Contact: Fran Fehr

1031 NW 91st Terrace, Gainesville, FL 32601  
(904) 378-2896  
Contact: Jerome Hoffman

1605 S. Bumby Ave., Orlando, FL 32806  
(305) 896-7414  
Contact: Jean Stervinou

1657 NW 79th Ave., Miami, FL 33126  
P.O. Box 523297, 33152  
(305) 591-3637  
Contact: Russ Thom

5441 Pepsi St., New Orleans, LA 70123  
(504) 733-7265  
Contact: Kenny Shewmake

1838 Elm Hill Pike, Apcom Place, Suite 101  
Nashville, TN 37210  
(615) 883-9175  
Contact: George McCrary

100 Greenbrier Dr., Knoxville, TN 37919  
(615) 523-3107  
Contact: Tom Owens

5105 McClanahan Dr., Suite J-1, N. Little Rock, AR 72115  
(501) 758-3234  
Contact: Harold Cole

**INTERFACE AUDIO**  
*SD, AC, SES, EI*  
3378 Regalwood Dr., Atlanta, GA 30340  
(404) 938-3041  
Contact: Ridge Nye

**Services offered, credits, specialization:** Offering sales, installation, and complete technical support for the recording industry. Lines include Studer, Harrison, AMS Digital Reverbs. Client references: New Age Sight & Sound (Atlanta's first totally digital studio), Crawford Post Productions, Studio One, RKM Studios, Webb 4 Recording, Musicworkshop, Jayen Films, Lake Bradford Studios/Tallahassee, Fame Recording/Muscle Shoals.

**LONG COMMUNICATIONS**  
*SD, AC, SES, EI*  
961 Burke St., Winston-Salem, NC 27101  
(919) 725-2306  
Contact: L.E. Hancock

**MASTER AUDIO INC.**  
*SES, EI*  
1227 Spring St. N.W., Atlanta, GA 30309  
(404) 876-1644  
Contact: Bob Richardson

**NATIONAL AUDIO TECHNOLOGY & ELECTRONICS CO. (NATECO)**  
*SD, AC, SES, EI*  
P.O. Box 1327, Holly Hill, FL 32017  
(904) 255-2240  
Contact: Nate Mudge

**OMNI TECHNOLOGY**  
*SD, AC, SES, EI*  
110 South West 21st Terrace, B-107, Ft. Lauderdale, FL 33312  
(305) 583-0626  
Contact: Gregg Lamping

**PARAGON MUSIC CENTER**  
*SD, AC, SES, EI*  
2139 W. Hillsborough Ave., Tampa, FL 33603  
(813) 876-3459  
Contact: Dick Rumore

**PHASE AUDIO**  
*SD, AC, SES, EI*  
1545 Monroe, Memphis, TN 38104  
(901) 726-1900  
Contact: Murphy Odom, Chip Benson

**PRECISION SOUND DESIGN, INC.**  
*EI*  
2817 Tremont Ave., Savannah, GA 31405  
(912) 236-4406  
Contact: Ferman Tyler

**PROFESSIONAL SOUND SERVICES**  
*SES, EI*  
12227 N.E. 113 Ct., N. Miami, FL 33161  
(305) 891-2206  
Contact: Mark Weber

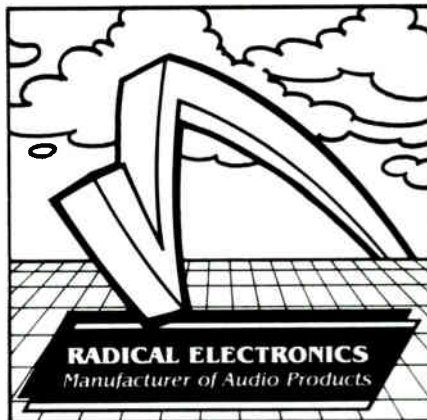

**RADICAL ELECTRONICS**  
Falls Church, VA

**RADICAL ELECTRONICS**  
*SES*  
2872 Hartland Rd., Falls Church, VA 22043  
(703) 573-6948  
Contact: David Eltroth

**RECORDING AUDIO MUSICAL**  
*SD, AC, SES, EI*  
410 Elm Ave. S.W., Roanoke, VA 24016  
(703) 343-1102  
Contact: Howard Beasley, Harold Thompson

**RECORDING STUDIO EQUIPMENT COMPANY**  
*SD, AC, SES, EI*  
P.O. Drawer P, N. Miami Beach, FL 33160  
(305) 945-9774  
Contact: Seth Snyder

**RELIABLE MUSIC**  
*SD, AC, SES, EI*  
1001 S. Independence Blvd., Charlotte, NC 28202  
(704) 375-8662  
Contact: John Saviano, David Bustle

**S.C.M.S.**  
*SD, AC, SES, EI*  
10201 Rodney Blvd., Pineville, NC 28134  
(704) 889-4508, (800) 438-6040 sales  
Contact: Cal Walker  
**Services offered, credits, specialization:** S.C.M.S. specializes in turn-key production facilities and broadcast studio packages. We are authorized dealers for most major lines of recording and broadcast equipment and have on-call one of the foremost acoustic consultants in the U.S. Our experience comes from years (20) in the broadcast and production fields, and also current hands-on work in our own commercial production facility. Check out our ad in this issue, and give us a call.

**TOM SEMMES ASSOC.**  
*SES, EI*  
1035 Draughon Ave., Nashville, TN 37204  
(615) 292-8130  
Contact: Tom Semmes

Attention:

## North Central U.S. and Canadian Studios

The annual listings for your region will be published in the November issue of **Mix**. If you have not yet received a questionnaire, and wish to be listed, call Lauri Newman at:

**(415) 843-7901.**

# SCMS

STUDIO CONSTRUCTION,  
DESIGN & EQUIPMENT

REPRESENTING:

AKG	ORBAN
APHEX	OTARI
ATLAS	PROTON VIDEO
AUDIOTECHNICA	RTS
AURATONE	SENNHEISER
BEYER	SESCOM
CROWN	SHURE
DAVID HAFLER	SONY MICS
DBX	STUDER REVOX
ECHOPLATE	SWITCHCRAFT
EDCOR	SYMETRIX
E-V	TENTEL
EVENTIDE	3-M TAPE
JBL	TASCAM 40 & 50
LOFT	UREI
MICMIX	VALLEY PEOPLE
NORTRONICS	VIKING CASES
	XEDITEDITALL
	AND MANY MORE

**SONY**  
PROFESSIONAL AUDIO

**CHARGE IT!**



(704) 889-4508  
(in N.C.)

**(800) 438-6040**

Circle #123 on Reader Service Card

## Thoroughbred Music

Studio Supplies at  
Competitive Prices

AKG	MXR
Aphex	Oberheim
Audio-	Otari
Technica	PPG
Countryman	QSC
Crest	Ramsa
Crown	Rane
dbx	Roland
DeltaLab	Scotch
Electro-Voice	Sennheiser
Emulator	Sequential
Fostex	Circuits
Hill	Simmons
JBL	Soundcraft
Klark-Teknik	Symetrix
Lexicon	Technics
Linn	Turbosound
	UREI

2204 E. Hillsborough Avenue  
Tampa, Florida 33610

**813-237-5597**

Florida's Music Supermarket

VISA

American  
Express

MasterCard

Circle #124 on Reader Service Card



LEGEND: SD: Studio Designer; AC: Acoustical  
Consulting; SES: Studio Equipment Supply; EI:  
Equipment Installation/Maintenance/Serviceing

## SOUTHEAST

### SHOWCASE AUDIO-VIDEO SYSTEMS SES

2323 Cheshire Bridge Rd. NE, Atlanta, GA 30324  
(404) 325-7676, (800) 241-9738

Contact: Lewis Frisch, Kevin Witt

Services offered, credits, specialization: Showcase is the South's fastest growing pro audio/video sales, service and installation company. We offer solutions with a combination of quality equipment, personal service and after-the-sale support. From a mike cable to a complete audio/video post-production facility—Showcase will handle all your needs in a fully professional manner. Our clientele is a "Who's Who" of recording studios, postproduction, and broadcast users throughout the Southeast.

Featured authorized equipment lines include Otari, Otari MTR, the full line of Amek mixing consoles, Hafler, Crest, Cipher Digital (BTX), Neumann, Yamaha, EAW, Fostex, dbx, Aphex, Shure, Soundcraft, Nakamichi, Valley People, and many others. Our video department features JVC, Panasonic, Fairlight, and more.

We maintain large inventories for quick delivery, offer design and installation services, and back all our sales with prompt, professional maintenance services. Visit our demonstration rooms including 1/2" and 3/4" video editing suite, audio sweetening and control room, and realtime duplication studio.

SMITH & ASSOCIATES, INC.  
Consulting Sound & Video Engineers  
SD, AC, SES, EI

214 Doverwood Rd., Fern Park, FL 32730  
(305) 331-6380

Contact: Mr. Hillary (Mel) Smith

SOUND & COMMUNICATIONS, INC.  
SD, AC, SES, EI

5466 N. State St., Jackson, MS 39206

SOUND TRAX, INC.  
SES, EI

1626 Glenwood Ave., Raleigh, NC 27608  
(919) 832-9953

Contact: Don Stone

SPECTRUM SOUND, INC.

SD, AC, SES, EI  
429 Space Park North, Goodlettsville, TN 37072  
(615) 859-4381

Contact: Ken Porter

STEREO SALES AND AUDIO REPAIR SERVICE

SD, AC, SES, EI  
637 W. Tennessee St., Tallahassee, FL 32301  
(904) 224-2635

Contact: W.T. Menasco, AES member

STUDIO SUPPLY CO., INC.

SD, AC, SES, EI  
1717 Elmhill Pike Suite B-9, Nashville, TN 37210  
(615) 366-1890

Contact: John Alderson

SYNERGETIC SERVICES, INC.

SD, AC, EI  
15201 S. River Dr., Miami, FL 33169  
(305) 947-7372

Contact: Ross or Eileen Alexander

# Technical Audio Systems

TECHNICAL AUDIO SYSTEMS  
Atlanta, GA

### TECHNICAL AUDIO SYSTEMS

SD, AC, SES, EI

4301 Pleasantdale Rd. Suite E, Atlanta, GA 30340  
(404) 447-9211

Contact: Ron Montgomery, Bruce Schneider, Steve Starnes  
Services offered, credits, specialization: Recording studio equipment, broadcast audio equipment, ENG/EFP equipment, noise control, design/consultation, most major lines, leasing available, production experienced staff.

### THOROUGHbred MUSIC INC.

2204 E. Hillsborough, Tampa, FL 33610  
(813) 238-7085

Contact: Fred Grunewald, Bill Gillespie

3160 Bee Ridge Rd., Sarasota, FL 33579

(813) 921-5714

Contact: Nick Ferlicchi

### TRACKSIDE ENGINEERING

SD, SES, EI

2652-C S. Cobb Dr., Smyrna (Atlanta), GA 30080  
(404) 436-3024

Contact: Les Duncan

### TW RICH

EI

P.O. Box 6252, L. Worth, FL 33461  
(305) 439-4592 after 5:00

Contact: Thomas D. Rich

### 21ST CENTURY SOUND, INC.

DBA HOT SESSIONS RECORDING

SD

3851 62nd Ave. N. Suite "I", Pinellas Park, FL 33565  
(813) 522-1642, 527-3538

Contact: Paul or Mike

*studio supply company*

Acoustic Design:  
Willie Nelson \* Mickey Gilley  
United Sound — Detroit

Larry Butler  
Scene 3 (Audio Post)

Jakarta, Indonesia

1717 Elm Hill Pike, B-9 \* Nashville, TN 37210  
(615) 366-1890

STUDIO SUPPLY CO., INC.  
Nashville, TN



# INTEGRITY RELIABILITY SUPPORT.

The Hy James modus operandi.  
It's on all our price tags  
But it doesn't cost a penny more.

Serving the Great Lakes and beyond  
with the ultimate in professional audio and  
audio post production equipment and consultation.

---

## **HY JAMES**

*the audio professionals*

24166 Haggerty Road  
Farmington Hills, MI 48024  
(313) 471-0027 994-0934 - Ann Arbor

Circle #125 on Reader Service Card

—CONTINUED FROM PAGE 149

**Services offered, credits, specialization:** Consultation, specification, budget, design, custom work, installation. Consultation, specification, budget: Full Compass Systems, Ltd. offers expert help in the specification of equipment for any production facility to fit any budget. Design control room layout for best human engineering. Design studio layout for best efficiency and co-existence with video production. Custom work: Full Compass Systems, Ltd. will modify existing equipment or create equipment that may not exist. Installation: expert wiring of patch fields and system interface. Full Compass Systems, Ltd. offers rebateable against purchase consultation. Attention to budget and appropriateness are first criteria.

**GHL AUDIO ENGINEERING**  
SD, AC  
P.O. Box 273, Hilliard, OH 43026  
(614) 876-1057  
Contact: Gary Hedden

**Services offered, credits, specialization:** Due to active participation in current music production, GHL is particularly qualified to develop a design which is sensitive to a client's unique preferences and needs. GHL does not retail any equipment nor does GHL subscribe to any rigid approaches to acoustic design or control room geometry. Credits include several artist's personal rooms, Hedden West, the Diskworks, The Malt Shop, Bison Recording, Full Sail's, Dream Machine



**LEGEND:** SD: Studio Designer; AC: Acoustical Consulting; SES: Studio Equipment Supply; EI: Equipment Installation/Maintenance/Serviceing

## NORTH CENTRAL

# At Last, a 200 Watt Coax!

Everyone knows the benefit of a well designed coaxial loudspeaker... a single-point sound source. Until now, the most popular coaxials presented severe power limitations... had to have "trick" crossovers... and needed time compensation. Gauss technology has changed all that.

The new Gauss 3588 is the first computer designed coaxial. But, we know computers can't hear, so we used a panel of "golden ears" at the fall AES to help determine the final sound of the loudspeaker. This combination of computer design and great ears gives you a coax with the sound *and* the power you want!

With a conservative power rating of 200 watts RMS, this new Gauss coaxial has been tested to 750 watts delivering clean sound... and can "coast" along at control room levels still delivering great sound. Metric sensitivity is 95dB for the low frequency and 109dB HF.

Because of our proprietary design parameters, both drivers are virtually in the same acoustic plane, eliminating the

need for costly time compensation networks. For bi-amp operation, you can use any standard professional quality crossover.

The unique *cosh* horn was designed using Gauss's exclusive Computer Aided Time Spectrometry (CATS™) program. This design provides an extremely stable image... reduced second harmonic distortion... and virtually no midrange shadowing.

For additional information on the new Gauss coaxial loudspeaker, call or write Cetec Gauss, 9130 Glenoaks Blvd., Sun Valley, CA 91352, (818) 875-1900. Or better yet, hear it at a selected sound specialist soon.

Sound Ideas for  
Tomorrow... Today!  
**gauss**  
by Cetec

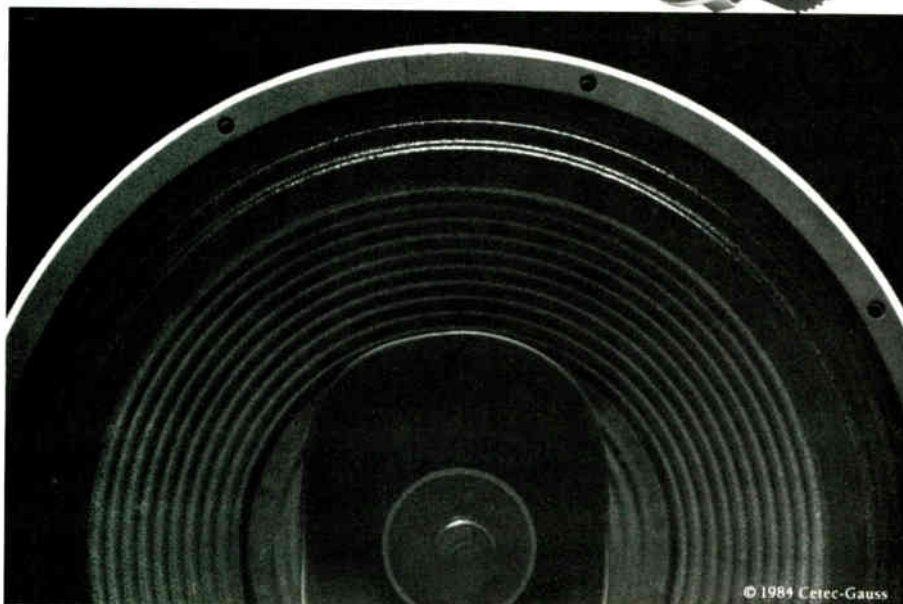

© 1984 Cetec-Gauss

Circle #131 on Reader Service Card

and the GHL Remote Audio facility. Special services include custom manufactured interfacing, electronics and complete audio truck construction.

**HENRY'S MUSIC**  
SES  
P.O. Box 3589, Greenbay, WI 54303  
(414) 494-1876  
Contact: Henry Czachor

**HOOD INDUSTRIES**  
EI  
5700 Superior, Cleveland, OH 44103  
(216) 431-4663  
Contact: Jack Boessneck



**HY JAMES**  
*The Audio Professionals*

HY JAMES  
Farmington Hills, MI

**HY JAMES - The Audio Professionals**  
SES, EI  
24166 Haggerty, Farmington Hills, MI 48024  
(313) 471-0027  
Contact: Henry Root, Tom Greenberg

**Services offered, credits, specialization:** Tape Recorders from Otari, Tascam and Revox. Mixers from NEOTEK, Soundcraft, Amek, Ramsa, Sony and more. Neumann, AKG, Foster, Crown, Bruel & Kjaer, Beyer, Sennheiser, Shure and E.V microphones. Signal Processing by AMS, Klark-Teknik, Orban, Lexicon, Aphex, Ursa Major, DeltaLabs, Loft, Symetrix, Audio Design/Recording, dbx, Eventide, and Omnicraft. We have over 100 companies so that we can provide what best meets your requirements. From a Tascam MiniStudio to an Otari MTR-90 synchronized to a 1" VTR, it's available with professional consultation you can rely on from Hy James. Call and talk with Tom or Henry about SMPTE Time Code Synchronizing.

**ICB AUDIO CO.**  
SD, AC, SES, EI  
1349 E. McMillan, Cincinnati, OH 45206  
(513) 281-5535  
Contact: Ian C. Budd

**IRC**  
**AUDIO**

IRC AUDIO INC.  
Indianapolis, IN



**IRC AUDIO INC.**  
SD, AC, SES, EI  
8112 Castleway Ct. West, Indianapolis, IN 46250  
(317) 849-6887

Contact: Kevin Meeks, David Wright  
**Services offered, credits, specialization:** IRC Audio talks Tascam. The complete Tascam line, Series 20, 30, 40, 50 & MS16 is in stock and on display in our demo control room. We specialize in complete turn-key studio packages for recording, audio for video, broadcast, corporate A/V and mobile recording, from 2 to 16 tracks using Tascam tape machines and mixing consoles. Other support equipment from: JBL, UREI, dbx, Valley People, Crown, Carver, Tannoy, Ramco, Lexicon, AKG, Beyer, Symetrix, Klark-Teknik, E-V, Yamaha, EAW, Amek, TAC, TAD, DeltaLab, Ursa Major, Shure and many more. We also offer custom designed sound reinforcement systems for any application.

**KHS SOUND COMPANY**  
SD, AC  
P.O. Box 126, Park Forest, IL 60466  
By written appointment only  
Contact: Klaus H. Seliger, Pres

**MIDWEST SOUND AND LIGHTING**  
SD, AC, SES, EI  
308 S. 72nd St., Omaha, NE 68114  
(402) 399-8028  
Contact: Pete Franks, John Knuth

**MILAM AUDIO**  
SD, AC, SES, EI  
1470 Valle Vista Blvd., Pekin, IL 61554  
(309) 346-3161

**MONTREUX MUSIC INC.**  
SES, EI  
3648 Rochester Rd., Troy MI 48084  
(313) 689-6644, 689-6645  
Contact: Bob Crane

**MUSIC CASTLE, INC.**  
SES, EI  
1418 N. Woodward, Royal Oak, MI 48067  
(313) 543-5070  
Contact: Tim Flaharty

**MUSICMANS RECORDING STUDIO**  
SD  
1844 S. Smithville Rd., Dayton, OH 45420  
(513) 256-8731  
Contact: Perry Scott  
*NOTE: Studio will open late June or July, 1985*

**NEW LIFE SOUND**  
SES, EI  
717 S. Main St., No. Canton, OH 44720  
(216) 499-9906  
Contact: Ronald J. Bartlebaugh

**O.P. PRODUCTIONS**  
SD, AC  
131 Callan, Evanston, IL 60202  
(312) 869-4793  
Contact: Orville Pibbs

**PI AUDIO**  
SES  
2121 Brookpark Rd., Cleveland, OH 44134  
(216) 741-1400  
Contact: David Yost, Craig Zacharyasz  
**Services offered, credits, specialization:** Specialization in studio/pro-audio equipment supply and repair. Fully stocked operational showroom of Otari, Tascam, Foxtex, Soundcraft, Amek, Ramco, JBL, UREI, Lexicon, Eventide, Ursa Major, Valley People, Symetrix, Aphex, Scotch, dbx, LinnDrum, Kurzweil, E-mu, and more. Service dept. in-house. Warranty repair on most brands. Hours: 11-8 Mon.-Thurs., 11-6 Fri., 11-5 Sat.



PI AUDIO  
Cleveland, OH

**POGO RECORDS RECORDING STUDIO**  
SD, AC  
35-37 Taylor St., Champaign, IL 61820  
(217) 351-8155  
Contact: Mark Rubel

**PRO AUDIO AUCTION**  
SES  
823 Monroe Ave., River Forest, IL 60305  
(312) 366-1090  
Contact: Tom Riordan, Tom Gena  
**Services offered, credits, specialization:** At Pro Audio Auction, we buy as much equipment as we sell. Your valuable used gear will bring top dollar as either trade-in, or on consignment sale, because we have clients in need of good working equipment at affordable prices. And since we serve as brokers for both new and used recording equipment, you can use your present equipment as instant cash down on

—CONTINUED ON PAGE 152

## USED RECORDING EQUIPMENT FOR SALE

### MICROPHONES

AKG: C61, C28, C29, C12A, C12, C24, D12, D15, D202. Neumann: KM54, KM254, KM53, KM253, KM56, KM64, U67, U47, M49, M50, U48, SM23, SM2, SM69. Telefunken: M260, M154, Elam 251. RCA: BK5 A, BK5 B, 44BX, 77B. Schoeps: CM51V, CM61. Sennheiser MKH 405. Sony: C500, ECM377, C37A. Pearl 8CK. Beyer M101. Altec tube mic. Shure SM53. B & O ribbon mic.

### RECORDING CONSOLES

Aengus wired for 16x8x16 has 8x8x8 in place, 2 phono inputs with map EQ • MCI 542 with 28 I/O modules • API 20 input 8 groups, 16 monitor 550 EQ • Trident Series 80 6 years old • Trident Series 80 B as new • API, Neve, etc. ...Call for details.

### TAPE RECORDERS

24 tracks: Otari MTR-90 MK 2 24 track; MCI 24 track JH-114 with auto locator. 16 tracks: Ampex MM1100 \$9,000, with remote/autolocate; JH114-16 1979 w/autolocate III. Other: Scully 280-8 w/4trk & 2 trk heads. Studer A80 8 track, 3M M64 4 track, 3M M64 2 track. Cassette decks: Technics RS 45, Hitachi D7500.

### OUTBOARD GEAR

DeltaLab DL-1 digital delay • Eventide 1745M digital delay • Eventide Instant Phaser • AKG BX-10 reverb • UREI 1109 cards • Orban de-esser • RCA BA6A limiter • EMT stereo plate reverbs • Roland SPH323 stereo phaser • MXR digital delay • UREI Little Dipper • Lexicon 122S DDL.

### RACK MOUNT EQUALIZERS

Furman PQ-6 parametric • UREI 545 parametric • Pultec HLF-3 hi/lo filter • Altec graphic • Furman parametric • U.A. 550 hi/lo filter • White 3400 1/3 octave graphic.

### RACK MOUNT LIMITERS

Decca tube limiter • Electrodyne compressor limiter • Pye limiters • Altec tube limiter.

### EQUALIZER MODULES

Melcore GME • API 550 • Map EQ • Altec 9061A • Orange County sweep EQ • B & B EQF-1.

### LIMITER MODULES

Allison Gain Brain 1 • Orange County comp/limiter • API 525C • API 525A.

### AMPLIFIERS

McIntosh MI-75 • McIntosh MC-75 • McIntosh MC-30 • McIntosh MC-40 • Crown IC-150 preamp • Crown D-60 • Langevin AM-16 • Marantz 240 • Crown SA 30-30.

### CONSOLE COMPONENTS

Neve 1058 input module • API 515Q assign module • API 512 input module • API 325 line amp cards • API 312-5 line amp cards • API 575 oscillator.

### MISCELLANEOUS

Pultec MH-4 mixer • Stephens VSO as is.

**Dan Alexander Audio**  
Box 9830  
Berkeley, CA 94709  
415/527-1411



## PRO AUDIO AUCTION

PRO AUDIO AUCTION  
River Forest, IL

virtually any acquisition that you plan to make. Call us to list your equipment, free of charge, with over 4,000 studios. You may also be interested in our "hands-on" demonstrations of new products, our one year trade up policy, and a new service directed toward future owners of Neve and SSL recording consoles. Call today. You'll be surprised how much more your used equipment is worth at Pro Audio Auction.

**PYRAMID AUDIO, INC.**  
SD, AC, SES, EI  
450 W. Taft Dr., So. Holland, IL 60473  
(312) 339-8014  
Contact: Rob Vukelich

**SELLER SOUND STUDIO**  
5014 Peekskill Dr., Sterling Heights, MI 48078  
(313) 758-7620  
Contact: Gary Spaniola



LEGEND: SD: Studio Designer; AC: Acoustical Consulting; SES: Studio Equipment Supply; EI: Equipment Installation/Maintenance/Serviceing

## NORTH CENTRAL

**SOUND COM CORPORATION**  
SD, SES, EI  
227 Depot St., Berea, OH 44017  
(216) 234-2604  
Contact: Jim Rivard

**SOUND ENGINEERING & DESIGN**  
SD, AC, SES, EI  
1934 S. Stewart, Springfield, MO 65804  
(417) 883-6373  
Contact: Steven E. Smith

**STAGE FRIGHT INC.**  
SES  
661 S. Eton Rd., Birmingham, MI 48008  
(313) 642-9880  
Contact: Tim Magee, Bill Tar

**STEPHCO CONSTRUCTION, INC.**  
EI  
8450 Moller Rd. Unit C, Indianapolis, IN 46268  
(317) 872-0113  
Contact: Chuck Ballard

**SUNSET STUDIO**  
SES, EI  
117 W. 8th, Hays, KS 67601  
(913) 625-9634  
Contact: Mark Meckel

**TALDEK SOUND INDUSTRIES**  
SD, AC, EI  
530 Arlington Rd., Newton Falls, OH 44444  
(216) 872-5719  
Contact: Mike Talanca, Joe Hudek

**THOMPSON ELECTRONICS COMPANY**  
AC, SES, EI  
3522 W. Harmon Highway, Peoria, IL 61604  
(309) 637-2277  
Contact: Bill Harlan

**TKO PRODUCTIONS**  
SES, EI  
117 N.E. Trilein, Ankeny, IA 50021  
(515) 964-7155  
Contact: Joe R. Denton

**TRIAD PRODUCTIONS**  
SD, AC, SES, EI  
1910 Ingersoll Ave., Des Moines, IA 50309  
(515) 243-2125  
Contact: Richard F. Trump

**BOB WHITE ASSOCIATES**  
SES  
P.O. Box 39104, Solon, OH 44139  
(216) 248-1317  
Contact: Bob White

**WISE MUSIC**  
SES, EI  
11740 West Florissant, Florissant, MO 63033  
(314) 839-1900  
Contact: John Wise, Jim Kay

## SOUTHWEST

**ASSOCIATED PRODUCTIONS OF TEXAS**  
SD, AC, SES, EI  
218 College St., San Antonio, TX 78205  
(512) 227-3400, (713) 780-7227  
Box 22801, Houston, TX 77227  
Contact: H. W. Lam, D. L. Roberson

**DEAN BAILEY**  
SD, EI  
12869 Montfort Dr. #250, Dallas, TX 75230  
(214) 386-7783  
Contact: Dean Bailey

**BRASSWIND RECORDING STUDIO, LTD.**  
SD, AC, SES, EI  
2551 Texas Ave., Shiloh Place, Suite F  
College Station, TX 77840  
(409) 693-5514  
Contact: David O. Cooper

**COMMERCIAL ENTERTAINMENT SERVICES**  
EI  
1051 Dalton Ln., Austin, TX 78742  
(512) 385-3493  
Contact: Spencer Kendall

**CROSSROADS AUDIO, INC.**  
SES  
2623 Myrtle Springs Ave., Dallas, TX 75220  
(214) 358-2623  
Contact: Chuck Conrad

**YOU DESIRE/L.D. SYSTEMS DESIGNS  
YOU REQUIRE/L.D. SYSTEMS PROVIDES**

Our showroom has recently been enlarged to accommodate a constantly increasing range of pro-audio and lighting products. Our sales staff, designers and technical support people are field and factory-trained professionals. L.D. Systems will design, construct and install the best system for your needs, studio to stage.

**YOU EXPECT/L.D. SYSTEMS SURPASSES**



audio and lighting sales, service and rentals

Adams-Smith  
Agfa  
AKQ  
Amek  
Ampex  
Ashly  
Audio-Technica  
Community  
Crest  
Crown  
dtx  
DeTaleh  
Electrovoice  
Eventide  
EXR  
HME  
Interface  
Ivis  
JBL  
Klark-Teknik  
Lexicon  
Micmix  
MXR  
Orban  
Otari  
QSC  
Ramsa  
Scotch  
Shure  
Soundcraft  
Teac  
TurboSquad  
Urei  
Ureia

**D.J.'s PRO AUDIO**  
*SD, AC, SES, EI*  
 2440 E. McDowell Road, Phoenix, AZ 85008  
 (602) 275-0654  
 Contact: J.R. Guess

**D.M. ELECTRONICS, LTD.**  
*AC, EI*  
 929 "G" Ave., Douglas, AZ 85607  
 (602) 364-3451  
 Contact: Luis Nector Margaillan



*E.A.R. PROFESSIONAL AUDIO*  
 Phoenix, AZ

**E.A.R. PROFESSIONAL AUDIO**  
 2641 E. McDowell, Phoenix, AZ 85008  
 (602) 267-0600  
 Contact: John Gibson, Ed Vogt  
**Services offered, credits, specialization:** E.A.R. Professional Audio specializes in the sales and service of new and used recording, broadcast, and audio for video equipment. Support services include installation, maintenance, and systems design for any professional production facility from automated 48-track studio to artist's home demo studio. An experienced and knowledgeable sales staff along with the finest selection of equipment lines to choose from has made E.A.R. Professional Audio one of the major studio supply companies in the country.

**HARDIN ELECTRONICS**  
*SES*  
 5635 E. Rosedale, Fort Worth, TX 76112  
 (817) 429-9761  
 Contact: Larry Bell, Sales Mgr.; Curtis Nichols, Inside Sales



*JOINER-PELTON-ROSE, INC.*  
 Dallas, TX

**JOINER-PELTON-ROSE, INC.**  
 Consultants in Acoustics  
*SD, AC*  
 4125 Centurion Way, Dallas, TX 75244  
 (214) 392-7800  
 Contact: David Joiner, Russ Berger  
**Services offered, credits, specialization:** Founded in 1954, J.P.R. is one of the largest acoustical consulting firms in

the country. We are a company of engineers, architects, and scientists who deal exclusively in acoustics. Our recording studio design team is comprised of people who relate to the recording industry and have experience collectively as recording engineers, session musicians, and studio owners and managers. Studio designs are tailored to meet our client's needs and market goals. We have a wide range of instruments used in the design and testing of acoustic, vibration and electro-acoustic systems, including RTA, wave analyzers, chart and level recorders, FFT, computers and full TEF™ measurement system. Recording studio and control room design, architectural noise control, room acoustics, acoustic performance verification and testing, electro-acoustics, environmental acoustics, industrial noise control, CAD.

**L.D. SYSTEMS**  
*SES, EI*  
 467 W. 38th St., Houston, TX 77018  
 (713) 695-9400  
 Contact: Bruce Coffman

**Services offered, credits, specialization:** Full line equipment and services offered. Professional products include Otari MTR-10/90II, AMEK, Tascam, Adams-Smith and others. Complete and functional showroom facility for all products as well as on location demonstration if desired. Total service support for all products represented. Design and consulting services are available.



*METEX INTERNATIONAL INC.*  
 Laredo, TX

**METEX INTERNATIONAL INC.**  
*AC, SES, EI*  
 1217 Lincoln St., Laredo, TX 78040  
 (512) 722-3941  
 Contact: Edward Foster, Gen. Mgr.  
**Services offered, credits, specialization:** Product lines: Crown International, JBL Pro, Cabaret, DeltaLab, Ashly Audio, Altec, Electro-Voice, Lansing, MXR/ART Pro, Shure Products, TOA, Panasonic, Ramsa, dbx Pro, TEAC, Tascam. Consultation, PA sound reinforcement, installations, retail establishment.

**MIDCOM, INC.**  
*SD, SES, EI*  
 Three Dallas Communications Complex, Suite 108  
 6311 N. O'Connor Rd., LB 50, Irving, TX 75039  
 (214) 869-2144  
 Contact: Mike Simpson, Richard Avery, Jeff Jones  
**Services offered, credits, specialization:** Midcom, Inc. exists in three divisions. First, Midcom provides sales, engineering and service for the finest lines of audio available including Otari, MTR Series, Soundcraft, Neve, Lexicon & Audiotronics. In fact, because of our reputation in customer service, Neve has selected Midcom as their only distributor in the U.S. outside of East and West coast district sales offices. Midcom also maintains a large rental inventory to service any requirement. Our stock includes wireless microphones, two-way "walkie-talkies," eng mixers, Lexicon PCM 60, 200 & 224XL, RTS, Clear-Com and RTA's. The third division of Midcom incorporates our 48-track audio remote truck. This mobile facility is available for production, postproduction, and remote recording throughout the Southwest.

**PRODUCTION CONSULTANTS**  
*AC, EI*  
 642-A W. Rhapsody, San Antonio, TX 78230  
 (512) 340-9591  
 Contact: Mr. Bob Herrick

The graphic for Polyline Corp. features a collection of audio equipment including a reel-to-reel tape machine, a cassette tape, a CD, and a vinyl record. The text 'Polyline Corp.' is written in a large, bold, stylized font. Below it, the text 'REELS & BOXES FOR AUDIO AND VIDEO TAPE' is written in a bold, sans-serif font. Further down, it says 'PROFESSIONAL QUALITY ALL SIZES' and 'Shipped from Stock (312) 297-0955'. The address '1233 Rand Road Des Plaines, IL 60016' is listed at the bottom.

Circle #134 on Reader Service Card

## SAVE BY BUILDING OUR RACK MOUNT STUDIO EQUIPMENT

**QUADRAFUZZ** — four separate frequency bands of distortion are mixed for the smoothest fuzz you've ever heard. no. 6720 ..... \$39.88

**HYPERFLANGE/CHORUS** — the cleanest, widest range, most versatile flanger anywhere at any price. no. 6750 ..... \$149.95

**VOCODER** — unmatched performance in a versatile, low cost rack package. no. 6710 ..... \$99.95

**HOT SPRINGS** — user's agree, short of studio plate systems, you won't find a better reverb at any price. no. 6740 ..... \$59.95

**ADD \$3 SHIPPING  
 FOR EACH KIT ORDERED**

Innovative, cost effective designs by Craig Anderton in easy to assemble kits from:

**RAA Electronics, Inc.**  
 Direct mail orders and inquiries to: Dept. 11x  
 1020 W. Wilshire, Oklahoma City, OK 73116 - (405) 843-9626  
 Ask for your free catalog.

**CHARGE TO VISA OR MC TOLL-FREE**  
 1-800-654-8657 9AM to 5PM CST MON-FRI

Circle #135 on Reader Service Card

SOUND AND INTERCOM SYSTEMS, INC.  
3146 W. Clarendon, Phoenix, AZ 85017-4512  
(602) 279-0551  
Contact: Tom Levno

## SOUTHWEST PRO AUDIO

SOUTHWEST PRO AUDIO, INC.  
Austin and Dallas, TX

SOUTHWEST PRO AUDIO, INC.  
SD, AC, SES, EI  
1500 Summit St., Austin, TX 78741  
(512) 443-4567

Contact: Greg Klingensmith  
3341 Towerwood #205, Dallas, TX 75234  
(214) 243-4477

Contact: Dennis Lowe

Services offered, credits, specialization: MCI/Sony sales, service and parts support. Over 50 lines of other professional audio equipment. Complete audio systems design, installation and service. Southwest Pro Audio is a Sierra Hidley studio design representative for Texas.

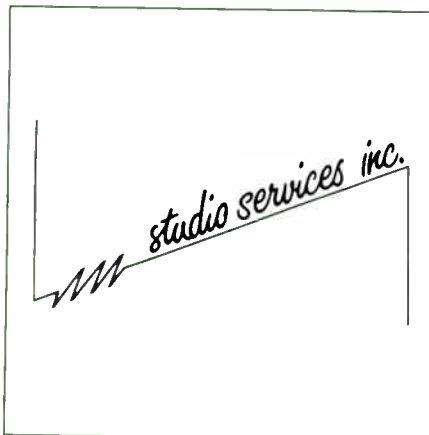

STUDIO SERVICES, INC.  
Dallas, TX

STUDIO SERVICES, INC.  
SES, EI  
P.O. Box 2338, Dallas, TX 75221-2338  
(214) 828-4075

Contact: Ron Lagerlof

Services offered, credits, specialization: We are a full-service professional audio organization staffed by top-flight recording engineers, studio managers and equipment designers, offering state-of-the-art pro audio equipment, technical service, systems installation and custom special products. Through our parent company, Studio Supply, Nashville, we offer studio designs by Tom Irby, whose most recent Texas accomplishments include Willie Nelson's studio near Austin and Mickey Gilley's club and studio in Pasadena. Studio Services manager, Ron Lagerlof, has installed studios for Dallas Sound Lab, Studio Centre, Omega Audio, TM Productions, Sunrise Studios and Sierra Audio. Our product line includes, but is not limited to: AMS, Audio & Design/Calrec, Haller, Harrison, Sanken, Sony, Soundtracs, Ursa Major, and US Audio. SSI is dedicated to serving, and servicing, the Texas, Oklahoma and Louisiana area and are interested in each customer from microphones to mixer to multitrack to monitors, analog to digital, radio or records, and audio for video.



LEGEND: SD: Studio Designer; AC: Acoustical Consulting; SES: Studio Equipment Supply; EI: Equipment Installation/Maintenance/Service

## SOUTHWEST

TEXSOUND  
AC, SES, EI  
26219 Cypresswood, Spring, TX 77373  
(713) 442-8000, ext. 397  
Contact: John S. Jones, Operations Dir.

VICTOR DUNCAN, INC.  
SES, EI  
6305 N. O'Connor Rd., Irving, TX 75039  
(214) 869-0200  
Contact: Richard M. Smith

## SO. CALIFORNIA

A-1 AUDIO  
SES, EI  
6322 De Long Pre Ave., Hollywood, CA 90028  
(213) 465-1101  
Contact: Al Siniscal

AUDIBLE SYSTEMS  
SES, EI  
1631 Maria St., Burbank, CA 91504  
(818) 843-2121  
Contact: Richard L. Castleberry

AUDIO CONSULTANT COORDINATION  
SD, AC  
P.O. Box 865, Venice, CA 90291  
(213) 306-6736  
Contact: Claude Venet  
Services offered, credits, specialization: ACC offers design consulting and engineering services in the following disciplines: electronics, sound system engineering (fixed and touring); acoustics, electro and architectural (for any communication); and architecture for recording studios, theaters, auditoria & all performing spaces. In every case, we provide a full set of plans, calculations, specifications, supervision and technical training of personnel on three continents and in four languages. Representation in Rio de Janeiro & Paris.

AUDIO INDUSTRIES CORPORATION  
SD, AC, SES, EI  
1419 N. LaBrea Ave., Hollywood, CA 90028  
(213) 851-4111  
Contact: Matt Robertson, Ike Benoun

AUDIO INTERVISUAL DESIGN  
SES  
8474 W. Third Ave., Los Angeles, CA 90048  
(213) 653-0240  
Contact: Candice Moore, Jim Pace

AUDIO M  
EI  
17671 Loyola Circle, Irvine, CA 92714  
(714) 733-0284  
Contact: Mike Tuuri

AURA SYSTEMS INC.  
SD, SES, EI  
2215 Anniversary Lane, Newport Beach, CA 92660  
(714) 642-4349  
Contact: Tim Shepard

BBN LABS  
SD  
21120 Vanowen St., Canoga Park, CA 91303  
(818) 347-8360  
Contact: Rolly Brook, Ron McKay  
Services offered, credits, specialization: We offer design services for recording studios and control rooms, radio and television studios, scoring stages, Foley stages, film and video postproduction facilities including acoustics, noise control, space planning, and electronic systems. We will provide acoustic and electronic testing and evaluation of existing and new facilities including reverberation time, sound distribution, time-delay spectrometry, sound isolation, NVAC noise, electronic noise and distortion. We offer independent laboratory evaluation and certification of acoustic and electronic performance of equipment. Recent projects include: remodeling of Scoring Stage and Control Room for Walt Disney Productions, Burbank; Studios for KOIN-TV, Portland; Audio-visual Studios for National Geographic Society, Washington; Dallas Communications Complex, Irving, Texas. BBN is the world's largest acoustical firm with offices and laboratories in Los Angeles and Boston.

BERTECH ORGANIZATION  
AC, SES, EI  
6804 Foothill Blvd., Tujunga, CA 91042  
(818) 352-3181  
Contact: Lee Berman

BROADCAST EQUIPMENT RENTAL CO. (BERC)  
SES  
4545 Chermak, Burbank, CA 91505  
(818) 841-3000  
Contact: Jim Green



CENTRO CORPORATION  
San Diego, CA

CENTRO CORPORATION  
SD, AC  
9516 Chesapeake Dr., San Diego, CA 92123  
(619) 560-1578  
Contact: Darrell Wenhardt

Services offered, credits, specialization: Complete project responsibility for production, postproduction, broadcast and mobile facilities. We specialize in video and audio based facilities and mobile units for the educational, industrial, and broadcast users.

JEFF COOPER ARCHITECTS, A.I.A.  
SD, AC  
4766 Park Granada, Suite 106, Calabasas, CA 91302  
(818) 887-9100

Services offered, credits, specialization: Architects for the entertainment industry. Specializing in: recording studios, film studios, video studios, theaters. Clients include: Steven Spielberg, George Lucas, Mann Theatre Corporation, Walt Disney Studios, Warner/Hollywood Studios, MCA, others. Services: Architectural Design, Acoustic Consulting,

—CONTINUED ON PAGE 156

# That British sound

▶ ACES TR-2: 1/2", 1/4" 2 track

\$4,950.00

■ ACES TR-4: 1/2" 4 track \$6,950.00

## 24 TRACK TAPE MACHINE FEATURES:

- +4dBm IN/OUT ■ 15/30ips
- Full-function 9 cue position remote-autolocator ■ stand
- 50% range vari-speed

◀ ACES TR-24: 2" 24 track

Recorder/Reproducer

\$19,950.00

■ 2" 16trk., pre-wired 24 trk

\$14,950.00



▶ ACES ML24:

I/O console, 32 in x 24 buss,  
Integrated wired patch bay

\$17,025.00

■ ACES SM16: Split console,  
32 in x 16 buss \$15,665.00



## BOTH CONSOLES FEATURE: Fully modular construction

- Audiofad long-throw conductive plastic faders ■ 5 Aux sends ■ 5 band switchable EQ ■ Input LED PPM's ■ Stand
- +48v phantom power ■ LED display (optional) ■ Two year parts warranty ■ Other frame sizes available ■ Many options available

Circle #136 on Reader Service Card

—CONTINUED FROM PAGE 154

Engineering, Interior Design, Construction, Management. The new 1984 edition of Building A Recording Studio by Jeff Cooper is available in this office.



**JEFF COOPER ARCHITECTS**  
A.I.A.  
ARCHITECTURE  
ACOUSTICS ENGINEERING

*JEFF COOPER ARCHITECTS, A.I.A.  
Calabasas, CA*

**DYNO KEYBOARDS/DYTRONICS**  
SES  
P.O. Box 1007, Burbank, CA 91507  
(818) 845-7864

Contact: Chuck Monte

Services offered, credits, specialization: Keyboard sound reinforcement and effects rack design for multi-keyboards/multi-effect players and programmers. Specializing in MIDI routing and programming for synthesizers. Famous for Dyno My Piano modifications for the Rhodes, Wurlitzer and Yamaha electric grand pianos. CS-5 Tr Stereo Chorus/Splitter w/6 waveforms and 5 speeds occurring simultaneously. FS-1 Cyclosonic Panner featuring two in, stereo or quad out



**LEGEND:** SD: Studio Designer; AC: Acoustical Consulting; SES: Studio Equipment Supply; EI: Equipment Installation/Maintenance/Serviceing

## SO. CALIFORNIA

w/6 panning modes, 24 "round" modes, 3 trigger modes, waveform and two intensity and speed controls. Dyno Keyboards "Signature Series" modified Rhodes with MIDI.

**F. ALTON EVEREST**  
Registered Consulting Engineer (Acoustics)  
SD, AC  
6275 S. Roundhill Dr., Whittier, CA 90601  
(213) 698-8831  
Contact: F. Alton Everest

**FARRELL AUDIO**  
SD, AC, SES, EI  
229 N. First St., Burbank, CA 91502  
(818) 846-3024  
Contact: Dave Farrell, Brent Cemper



*FILAMENT PRO AUDIO  
San Dimas, CA*

**FILAMENT PRO AUDIO**  
SD, SES  
143 E. Arrow Hwy., San Dimas, CA 91773  
(213) 339-0081, (714) 592-2848  
Contact: Frank Offenstein, Albert Lyon

**GOLDEN GOOSE RECORDING**  
SD, AC, EI  
2074 Pomona Ave., Costa Mesa, CA 92627  
(714) 548-3694  
Contact: Dennis Rose

**ALAN GORDON ENTERPRISES, INC.**  
SES  
1430 No. Cahuenga Blvd., Hollywood, CA 90028  
(213) 466-3561  
Contact: Tad Malone, audio division

## FROM TAPE TO A COMPLETE STUDIO, WHATEVER YOUR NEEDS, WE HAVE IT



## FILAMENT PRO AUDIO

143 E. ARROWHIGHWAY  
SANDIMAS, CALIF. 91773  
714-592-2848 818-337-3915

SEND US YOUR DREAMS WE'LL MAKE THEM REALITY

Circle #137 on Reader Service Card

**HARRIS SOUND**  
*SES, EI*  
 6640 Sunset Blvd. Suite 110, Hollywood, CA 90028  
 (213) 469-3500, (800) 233-1580 outside CA  
 Contact: Harry Harris

**HOLLYWOOD VAULTS, Film & Tape Storage**  
*EI*  
 742 N. Seward St., Hollywood, CA 90038  
 (213) 461-6464  
 Contact: David Wexler

**HUGHES SOUND ENGINEERING**  
*SES, EI*  
 3533 Old Conejo Rd., Newbury Park, CA 91320  
 (805) 499-7744  
 Contact: William Hughes, Cy Holmes, Jim Bass

**LAKESIDE ASSOCIATES, INC.**  
*SD, AC, SES, EI*  
 27939 Chillana, Mission Viejo, CA 92692  
 (714) 855-3171  
 Contact: Carl J. Yancher

**LANE AUDIO & RECORDS**  
*SD, SES*  
 Box 29171, Los Angeles, CA 90068  
 (213) 469-8007  
 Contact: Michael R. Lane

**L.A. SOUND CO.**  
*SES*  
 12547 Sherman Way Unit F, N. Hollywood, CA 91605  
 (818) 765-6900, (213) 245-6900  
 Contact: Richard Rakle

**MARCOM**  
*SES, EI*  
 P.O. Box 828, Hollywood, CA 90078  
 (818) 703-0381  
 Contact: Douglas B. Howland

**MARTINSOUND, INC.**  
*SES*  
 1151 W. Valley Blvd., Alhambra, CA 91803-2493  
 (213) 283-2625, (818) 281-3555  
 Contact: Annette Martinson, Studio Mgr.

**MOGAMI WIRE & CABLE**  
*SES*  
 P.O. Box 2027, Culver City, CA 90230  
 (213) 390-6608  
 Contact: Lenard Marshall

**NEW WORLD**  
*SD, AC, SES, EI*  
 4877 Mercury St., San Diego, CA 92111  
 (619) 569-1944  
 Contact: Jim Scott



**PERCEPTION INC.**  
 Los Angeles, CA

**PERCEPTION INC.**  
*SD, AC*  
 P.O. Box 39536, Los Angeles, CA 90039  
 (213) 938-5126  
 Contact: G.L. Augspurger

**Services offered, credits, specialization:** This consulting group is headed by well-known acoustician and studio design expert, George L. Augspurger. His wide experience with commercially successful TV, film and recording studios covers every major record label as well as the most prestigious independent studios. Projects currently underway include four major recording complexes, a number of studio remodeling designs, acoustical consultation for auditoriums and film sound stages, two TV sweetening room designs, and acoustical corrections in three existing studios. Perception Inc. provides professional consulting and design services to architects, builders and studio owners; it has no association with any contractor or equipment supplier. In addition to studio design services and acoustical consultation, the company provides extensive acoustics testing capabilities. Mr. Augspurger is a member of the Audio Engineering Society, Acoustical Society of America, U.S. Institute for Theatre Technology, American Theatre Association and National Council of Acoustical Consultants.

**THE PERCUSSIVE PROJECT**  
*SD, AC, SES, EI*  
 3670 Grand View Blvd., Los Angeles, CA 90066  
 (213) 391-4370  
 Contact: Mark Wenner

**PLATINUM by KENNEDY SOUND**  
*SES*  
 P.O. Box 818, Midway City, CA 92655  
 (714) 842-2239  
 Contact: David Kennedy



**PROFESSIONAL AUDIO SERVICES & SUPPLY CO.**  
 Burbank, CA

**PROFESSIONAL AUDIO SERVICES & SUPPLY CO.**  
*SD, AC, SES, EI*  
 4628 W. Magnolia Blvd., Burbank, CA 91505  
 (818) 843-6320  
 Contact: Bob Hacken

**RSC/RECORDING SERVICES COMPANY**  
*SES, Rentals Only*  
 2414 W. Olive Ave., Burbank, CA 91506  
 (818) 843-6800  
 Contact: Sandra Wilson

**SMITH, FAUSE & ASSOCIATES, INC.**  
*AC*  
 5601 W. Slauson Ave. Suite 201, Culver City, CA 90230  
 (213) 568-8555  
 Contact: Kenneth R. Fause

**SOUND ADVICE**  
*SES*  
 7611 Slater, Suite N, Huntington Beach, CA 92647  
 (714) 842-2213  
 Contact: Hugh Healy

**THE SOUND SOLUTION**  
*SES, EI*  
 1211 Fourth St., Santa Monica, CA 90401  
 (213) 393-5332  
 Contact: David Epstein, Rod Clark

**IF YOU'RE NOT  
 USING IT -- SELL IT !  
 THE  
 BERTECH ORGANIZATION**

**YOUR NATIONAL  
 CLEARINGHOUSE  
 FOR FINE USED  
 AUDIO & VIDEO**

Our mailers reach thousands of professionals every month. We'll list your used equipment free of charge—or help you find that rare item you've been looking for.

**THE  
 BERTECH ORGANIZATION**

Distributors, brokers and custom fabricators of quality audio and video equipment.

**6804 FOOTHILL BLVD.  
 TUJUNGA, CA 91042  
 (818) 352-3181**

**THINK BERTECH FIRST !**

Circle #138 on Reader Service Card

**MOVING?**

**FOR UNINTERRUPTED SERVICE  
 MAIL TO:**

**MIX PUBLICATIONS  
 2608 NINTH STREET  
 BERKELEY, CA 94706**

(PLEASE ATTACH OLD ADDRESS LABEL HERE)

(PLEASE PRINT NEW ADDRESS BELOW)

NAME \_\_\_\_\_  
 COMPANY \_\_\_\_\_  
 ADDRESS \_\_\_\_\_  
 CITY \_\_\_\_\_ STATE \_\_\_\_\_ ZIP \_\_\_\_\_

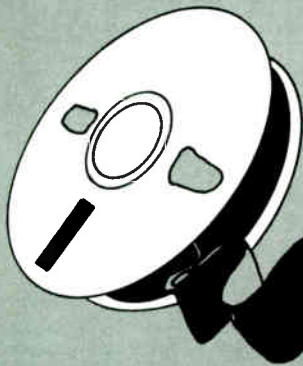

When the tape runs out,  
call United Tape Company

Manufacturers of BASF Custom-Length  
Chrome Cassettes

Authorized Distributor of:

**AMPEX** Blank Recording Tape

**BASF** Calibration Cassettes

**CAPITOL** Audiopak Carts

**TEAC** Accessories

**SONY** Accessories



10746 Magnolia  
North Hollywood, CA ☐ (818) 980-6700

Call for our free 40-page catalog

Circle #140 on Reader Service Card

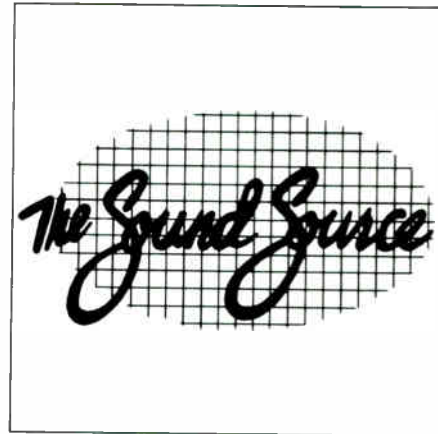

**SOUND SOURCE, INC.**  
Hollywood, CA

**SOUND SOURCE, INC.**

*SES*

P.O. Box 1495, Hollywood, CA 90028

(213) 876-2400

Contact: Rob, John, Lena, Bob

**Services offered, credits, specialization:** The Sound Source is a full-service audio & synthesizers rental company. We feature AMS, Massenburg, Quantec, Lexicon, Eventide, EMT, Publison, API, Roland, Valley People, dbx, Drawmer, Sontec, ADR, Lang, Pultec, Aphex & Klark-Teknik. In our synthesizer department you'll find E-mu, Yamaha, PPG, Oberheim, Roland, Linn, Simmons, & Garfield Electronics. We also rent the Mitsubishi X-80. The Sound Source offers free local delivery, 24 hours a day, and no tax is added.

**STUDIO AMERICA, INC.**

*SD, AC, SES, EI*

50 N. Mentor, Pasadena, CA 91106

(818) 440-9919

Contact: Joe Pollard



**STUDIOBUILDERS**  
Burbank, CA

**STUDIOBUILDERS**

*SD, AC, SES, EI*

919 N. Victory Blvd., Burbank, CA 91502

(818) 842-9526

Contact: Barry Brenner

**STUDIO INSTRUMENT RENTALS/PRO AUDIO**

*SES*

6048 Sunset Blvd., Hollywood, CA 90028

(213) 466-3417

Contact: Tom Estby

826 Folsom St., San Francisco, CA 97105

(415) 495-3200

Contact: Tim Scott

310 W. 52nd St., New York, NY 10019

(212) 975-0920

Contact: Bo Holtz

310 5th Ave. So., Nashville, TN 60150

(615) 255-4500

**EVERYTHING UNDER THE SUN**

**NEW WORLD**

**NEW WORLD AUDIO**  
4877 Mercury Street  
San Diego, CA 92111

Over  
**100**  
lines

**Professional Audio Sales**  
1-800-854-2005  
except California (619) 569-1944

Circle #141 on Reader Service Card



**STUDIO MAINTENANCE**  
*SD, AC, SES, EI*  
21414 1/2 Ventura Blvd., Woodland Hills, CA 91364  
(213) 877-3311  
Contact: David Michaels

**WATERLAND DESIGN LTD.**  
*SD, AC*  
1979 Whitley Ave., Los Angeles, CA 90028  
(213) 876-9438  
Contact: Vincent A. van Haaf

**HOWARD WEISS ENGINEERING**  
*SD*  
8255 Beverly Blvd., Los Angeles, CA 90048  
(213) 658-5990  
Contact: Howard Weiss

**WESTLAKE AUDIO INC.**  
*SD, AC, SES, EI*  
7265 Santa Monica Blvd., Los Angeles, CA 90046  
(213) 851-9800  
Contact: Christopher Carey

**RICK WISE SOUND**  
*AC, EI*  
4209 LaSalle Ave., Culver City, CA 90230  
(213) 838-7642  
Contact: Rick Wise

**WIZARDZ SOUND AND LIGHTING SYSTEMS**  
*SES, EI*  
620 W. Santa Anita St., San Gabriel, CA 91776  
(818) 284-2124  
Contact: Mark Cruz

## NORTHWEST

**AMERICAL SYSTEMS INC.**  
*SES, EI*  
30982 Huntwood Ave., Suite 204, Hayward, CA 94544  
(415) 471-7451  
Contact: Richard Kehoe

**ARCHMEDIA**  
*SD, SES*  
1169 Howard St., San Francisco, CA 94103  
(415) 626-0500  
Contact: L.A. Paul

**ARTISTS' ENGINEERING**  
*SD, EI*  
14444 Skyline Bl., Woodside, CA 94062  
(415) 851-0388  
Contact: Harry Sitam  
Services offered, credits, specialization: A full range of technical services for recording studios and related production facilities, (except acoustical or computer work). Both shop and field services are available by appointment. Owner/Operator was employed at Wally Heider's San Francisco maintenance department 1970-76; provides technical services for Neil Young's studio 1971-present; established Artists' Engineering in 1976 to provide service for various Northern California studios; factory trained at 3M and Ampex.  
Specialization: 1) Installation and modification of recording systems. 2) Custom design and fabrication of sub-systems and interface assemblies for recording systems. 3) Tape recorder service; experienced on most brands and models; facilities for complete overhaul.

**ASSISTANTS IN DESIGN SERVICES (AIDS)**  
*SD, EI*  
2101 Bryant St., San Francisco, CA 94110  
(415) 282-4433  
Contact: Edward Tom, Tony Bartolomucci

**AUDISSEY**  
*SD, SES, EI*  
1020 Auahi St. #6, Honolulu, HI 96814  
(808) 521-6791  
Contact: Rick Parlee, Boyd Collings



An Affiliate of  
**KENNETH A. BACON ASSOCIATES**  
Developers of the world's most  
cost effective audiophile quality  
cassette duplication system.

**KENNETH A. BACON ASSOCIATES**  
Novato, CA

**KENNETH A. BACON ASSOCIATES**  
*SES*  
24 Commercial Blvd., Suite E, Novato, CA 94947  
(415) 883-5041, Toll Free (800) 231-TAPE  
Contact: Kenneth A. Bacon  
Services offered, credits, specialization: New dedicated 4-track Real Time (and 2x) cassette duplication system; all equipment, supplies and services for cassette production and packaging; AGFA mastering and cassette tapes; AKG microphones; Garner degaussers; labelers for pin-feed and standard cassette labels; MLR calibration tapes; Nortronics recorder maintenance products; Marantz pro decks; Otari tape decks and hi-speed duplicators; TTL loaders; mixers, timers, rewinders, turntables, speakers, amplifiers, equalizers, c-zeros, vinyl binders, Norelco boxes, poly boxes, EDP and standard cassette and box labels, box liners, graphics, complete production and packaging services—Everything for the cassette user and producer.

**BANANAS AT LARGE**  
*SES, EI*  
802 4th St., San Rafael, CA 94901  
(415) 457-7600  
Contact: J.D. Sharp, John Sugnet  
Services offered, credits, specialization: Full line of professional audio sales and service. Large selection of microphones and signal processing gear. Consoles by: Soundcraft, Neolek, Dynamix, Allen & Heath, and Amek. Bananas at Large offers consultation for studio design, complete studio packages at competitive prices, with a decade of professional audio experience.

**B.A.S.E. (Bay Area Studio Engineering)**  
*SD, AC, EI*  
54 Ney St., San Francisco, CA 94112  
(415) 469-0136  
Contact: Michael Gore

**BROWNELL SOUND**  
*SD, AC, SES, EI*  
3601 S.E. Concord, Milwaukie, OR 97222  
(503) 659-0394  
Contact: Kurt Bevers

**RICK CHAISSE SERVICES**  
*SD, AC*  
19 Locke Wy., Scotts Valley, CA 95066  
(408) 438-2331  
Contact: Rick Chaisse

**JAMES K.C. CHANG, P.E.—dba J.C. ELECTRONICS**  
*SD, AC, SES, EI*  
2344 Kam Hwy., Honolulu, HI 96819  
(808) 841-5526  
Contact: James K.C. Chang

**CHIPS DAVIS LEDE DESIGNS, INC.**  
*SD, AC*  
3364 Clandara, Las Vegas, NV 89121  
(702) 731-1917  
Contact: Chips Davis  
9 Sierra Circle, San Rafael, CA 94901  
(415) 457-1070  
Contact: Jerry Jacob  
Services offered, credits, specialization: Chips Davis designed and built the first LEDE control room in 1978 in Las Vegas, Nevada. Since then, Davis has defined and set the standards for LEDE and LEDE Type monitoring environ-

**Knowledge  
Commitment  
Experience**

**Chips Davis**  
**LEDE™ Designs, Inc.**

LEDE™ SYNAUDCON

**CHIPS DAVIS LEDE DESIGNS, INC.**  
Las Vegas, NV and San Rafael, CA

ments. Davis' research and continued commitment to the scientific principles involved have made him the acknowledged expert in the field. Among Chips Davis designed facilities you might wish to visit are: Tres Virgos Studios, San Rafael, CA; Crescendo Audio Productions, San Juan, P.R.; Radio-TV Caracas, Caracas, Venezuela; Audio Archives, Syracuse University, Syracuse, NY; McClear Mastering and Sounds Interchange, Toronto, Ontario, Canada; MBC Center, Winnipeg, Ontario, Canada; NBC PPS 1, CRs 2 and 4 Burbank, Brooklyn 2, Brooklyn, NY; (Bill Cosby Show) Universal City Studios, Burbank, CA; Grammie's House, Reno, Nevada; Starstudio, Hamburg, W. Germany. Services offered: design, consultation, seminars and training, TDS™ measurements, electronic and product design consultation, marketing and management services as well as on-site supervision and turnkey services.

**FRED FOXX MUSIC CO.**  
*SD, AC, SES, EI*  
5 Elkwood Dr., So. San Francisco, CA 94080  
(415) 994-5908  
Contact: Fred Nesbitt, V.A. Nesbitt

**HORIZON SOUND**  
*SD, AC, EI*  
P.O. Box 4310, Vista Grande Station  
Daly City, CA 94016  
(415) 239-6913  
Contact: Ron Armstrong

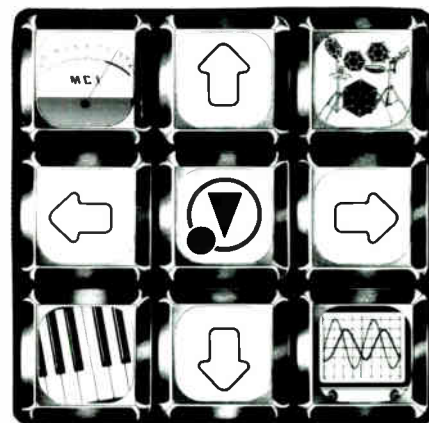

**LEO'S AUDIO AND MUSIC TECHNOLOGIES**  
Oakland, CA

**LEO'S AUDIO AND MUSIC TECHNOLOGIES**  
*SD, AC, SES, EI*  
5447 Telegraph Ave., Oakland, CA 94609  
(415) 652-1553  
Contact: Bob Ulius, gen. mgr.  
Services offered, credits, specialization: Sales, service, and installation of Sony/MCI Professional Audio Equipment and virtually every major brand of professional recording, broadcast, and sound reinforcement equipment. Extensive inventory of keyboards, synthesizers, computers, and software for studio and stage use including the new and highly innovative Kurzweil 250. Leo's maintains four showrooms including a working 24-track control room and is uniquely able to demonstrate the complete product lines of

—CONTINUED ON PAGE 160

- ✓ highest quality
- ✓ yet affordable
- ✓ experienced staff
- ✓ constant user evaluation
- ✓ classic designs
- ✓ latest audio advances
- ✓ road-ready

presenting

# WOODWORK

audio enclosures

call for dealers in your area

913 South Chapman Street • P. O. Box 5485  
Greensboro, N. C. 27403 • (919) 292-2486

Circle #142 on Reader Service Card

Are you ready for digital? stereo t.v.?

## rls ACOUSTICS

### DESIGN SERVICES

LEDE Type, or Traditional, Recording Studios  
Audio Sweetening Rooms • Video Production Suites  
Broadcast/Radio Facilities  
Film Soundstages • Small Theatres  
- Full Studio Construction -

### RECENT CLIENTS

Robert Berke Sound • Intel Corporation  
San Francisco Production Group

Designing studios  
for the Digital Age...

**(415) 541-0818**



LEGEND: SD: Studio Designer; AC: Acoustical Consulting; SES: Studio Equipment Supply; EI: Equipment Installation/Maintenance/Serviceing

## NORTHWEST

—CONTINUED FROM PAGE 159

over 120 manufacturers. Our sales staff is particularly attuned to the marriage of multitrack audio, computers, and keyboards. Factory trained service available on most major lines.

### LISTEN UP AUDIO/VIDEO

SES, EI  
999 S. Logan St., Denver, CO 80220  
(303) 778-0949  
Contact: Bill Rollin

### E.M. LONG ASSOCIATES

AC  
4107 Oakmore Rd., Oakland, CA 94602  
(415) 531-8725  
Contact: Edward M. Long

### MATRIX SOUND SERVICE

AC, EI  
134 Alta Vista Way, Daly City, CA 94014  
(415) 587-1240  
Contact: Jo Bajza

### NEVADA SOUND & COMMUNICATIONS

AC, SES, EI  
60 Glen Carran Circle, Sparks, NV 89431  
(702) 331-5555  
Contact: Walter H. Wellman

### PAOLETTI/LEWITZ/ASSOC INC.

SD, AC  
40 Gold St., San Francisco, CA 94133  
(415) 391-7610  
Contact: Dennis Paoletti, AIA

### PERFORMANCE AUDIO

SES, EI  
2538 S. Main St., Salt Lake City, UT 84115  
(801) 466-3196  
Contact: Kevin Lewis, Klay Anderson

### PROFESSIONAL PIANO SERVICE/DAVID TRASOFF

SES, EI  
P.O. Box 2053, 5596 Old Stage Rd., Boulder, CO 80306  
(303) 440-3703  
Contact: David Trasoff

Services offered, credits, specialization: Professional Piano Service offers expertise to the recording studio, producer and musician in all areas relating to the piano and its use in the studio and concert environment. Services include: achieving the best performance from a studio's present piano to provide the sound and touch a pianist or producer requires, analyzing a studio's instrument needs and providing the service or consultation necessary to meet those needs, precision tuning and voicing for the demanding artist, and the design and realization of unusual or altered tunings increasingly heard in progressive music. Clients have included numerous recording studios in the San Francisco Bay area and Denver, Colorado, among them The Record Plant, 1750 Arch St., Grateful Dead Studios, Applewood, Colorado Sound and Avalanche Studio. Special tunings were created for Jordan de la Sierra's "Gymnosphere/Song of the Rose" and the soundtrack for "Apocalypse Now/River Music."

# If it's worth doing, it's worth doing right.



## We did it right.

It's no surprise that when the key engineers of our PZM® microphone technology set their sights on combining the benefits of the boundary effect with unidirectionality, the fruits of their efforts would be nothing less than superior.

After all, Crown has been leading the way in boundary technology longer than anyone in the industry. And, like the PZM project, our commitment to developing the "premiere" unidirectional, surface-mounted microphone rings true.

Introducing the PCC™-160 Phase Coherent Cardioid™ from Crown.

Designed for easy mounting on a boundary surface, the PCC-160 utilizes a subminiature supercardioid mic capsule to create a directional pattern which improves gain-before-feedback, reduces unwanted room noise and rejects sounds from the rear.

For stage reinforcement, podiums, news desks, or for hiding in sets, the PCC-160 offers superior performance.

And because the microphone is mounted on a boundary, direct and reflected sounds arrive at the diaphragm in-phase. The result...wide, smooth frequency response free of tonal coloration or unnatural sound which can occur with conventional microphones.

Self-contained electronics eliminate the need for a sometimes awkward in-line preamp box. The PCC-160 can be powered directly from the console or other remote power source. Or if battery power is convenient, a battery supply unit can be inserted anywhere in the mike line...right up to the console or mixer.

For maximum flexibility, the

PCC-160 features an exclusive three-way "bass tilt" switch which allows you to tailor, up or down, the low-end response for special applications or unusual boundary sizes.

Due to its low profile and "go away gray" finish, the PCC-160 microphone becomes nearly invisible in use, making it ideal for the stage, newsroom or lectern top.

But beneath its cloak of dark gray, the PCC-160 is protected by a heavy-gauge, all-steel body, tough enough to stand up to even the most severe abuse.

The PCC-160. A microphone meeting the needs of today's sound professional with today's most advanced technology.

We did it right.

Call or write for more information and complete specifications.



Crown International, 1718 W. Mishawaka Rd., Elkhart, IN 46517 (219) 294-8000

Circle #014 on Reader Service Card  
World Radio History

**RAIN RECORDING & PRO AUDIO**

*SD, AC, SES, EI*  
 Box 297, Mt. View, HI 96771  
 (808) 968-6346  
 Contact: Ken or Ean

**RHEMA SOUND**

*SES, EI*  
 97-719 Kam. Hwy #204, Pearl City, HI 96782  
 (808) 456-4827  
 Contact: Vincent Ching

**DENNIS RICE STUDIO SERVICES**

*SD, AC, EI*  
 1907 Ardith Dr., Pleasant Hill, CA 94523  
 (415) 689-6718

Contact: Dennis Rice

**Services offered, credits, specialization:** Acoustic consultation and design for your new audio complex or expansion of your existing studio. Computer assisted evaluation to insure an acoustically sound room environment, while maintaining a pleasing aesthetic quality. Complete design-from site analysis to finished blueprints.

A full range of technical support services offered for your recording studio or production facility. Installation, modification, and maintenance of all pro audio equipment. Custom electronic design and fabrication to suit your special needs. We want to make it all easy for you.

**RLS ACOUSTICS**

*SD, AC*  
 650 Fifth St. Suite 301, San Francisco, CA 94107  
 (415) 541-0818

Contact: Randy Sparks

**Services offered, credits, specialization:** At RLS Acoustics our goal is to help build your studio. We work directly with our clients to assist in the realization of their project. Reinforcing your ideas with solid acoustic principles, and innovative design concepts, we can build a strong foundation for your successful venture.

All our clients receive the benefit of our computer assisted design process. RLS Acoustics has developed proprietary computer software to assist our consultants in designing

acoustically accurate studios. The increased efficiency which the computer brings to our design process allows RLS Acoustics to keep project design costs down.

Services offered: recording studio design (LEDE type, traditional, or our unique Media design), broadcast and video postproduction studio design, soundstage design, small theater design, studio construction, interior design, general acoustic analysis and consulting, and design related mechanical, electrical, and structural engineering.

Clients include: Atari, Inc.; Robert Berke Sound, San Francisco, CA; Intel Corporation; Live Oak Studio, Berkeley, CA; New Life Broadcasting, Quincy, CA; Pacific Telephone; The Sound Service, San Francisco, CA; Snazelle Films, San Francisco, CA; Theatre on the Square, San Francisco, CA; Theatre of the Recording Arts, Seattle, WA.

**CHARLES M. SALTER, ASSOC. INC.**

*SD, AC*  
 930 Montgomery St., San Francisco, CA 94133  
 (415) 397-0442

Contact: Dave Schwind, Tom Schindler

**DONALD SETARO**

*EI*  
 P.O. Box 6002, Modesto, CA 95355-0002  
 (209) 576-8632

Contact: Donald Setaro

**TERRY A. SETTER, ACOUSTICAL CONSULTANT**

*AC*  
 3138 Overhulse #151, Olympia, WA 98502  
 (206) 866-6000

Contact: T.A. Setter

**SHYNE SOUND**

*SD, AC, EI*  
 36D Woodland, San Rafael, CA 94901  
 (415) 459-2833

Contact: Leroy Shyne

sound  
genesis®

**SOUND GENESIS**  
 San Francisco, CA

**SOUND GENESIS**

*SD, AC, SES, EI*  
 2001 Bryant St., San Francisco, CA 94110  
 (415) 285-8900

Contact: David Angress

**Services offered, credits, specialization:**

- \* System Design
- \* System Installation
- \* Expert Equipment Repair
- \* Synchronization of Audio and Video Systems
- \* Exclusive No. California Distributor for: Otari MTR Tape Recorders, Audiotronics, Harrison, Sound Workshop consoles, Cipher Digital and Time Line Synchronizing and audio editing systems, JBL Bi-Radial studio monitors.

# SHOWCASE AUDIO PLAIN AND SIMPLE

After 18 Years in the Pro Audio Field  
 WE KNOW WHAT YOU NEED.  
 WE HAVE WHAT YOU WANT.  
 and nobody can beat our  
 PRICE, SELECTION, and SERVICE.  
 We ship **worldwide**.



## Showcase Audio • A Division of Guitar Showcase

Call us TOLL-FREE  
 1-800-248-4827  
 or inside California  
 1-800-348-4827



American  
Express

Or write to us for a  
**FREE Pro-Sound Catalog**  
 3090 S. Bascom Avenue  
 San Jose, CA 95124



**THE SOUND STAGE**  
Fresno, CA

**THE SOUND STAGE**

*SES, EI*  
1615 N. Blackstone (at McKinley), Fresno, CA 93703  
(209) 233-6531

Contact: Rocky Giannetta, Gary Manker  
**Services offered, credits, specialization:** The Sound Stage is a retail outlet that provides and services an extensive line of products in the professional audio, recording and musical instrument fields. We can provide inside and outside servicing and consultation for professional audio/ recording applications. The Sound Stage also staffs personnel who are both educated in and have many years of practical experience in multitrack recording and live sound reinforcement.

The Sound Stage offers competitive prices on products from manufacturers such as: Ampex, AKG, Aphex, AB, Auratone, Ashly, Audio-Technica, BES, Beyer, Biamp, BGN, Carver, Countryman, Crown, Cetec Vega, DeltaLab, DOP, E-V, EXR, Hafler, JBL, Lexicon, Nady, Renkus Heinz, Samson, Sennheiser, Shure, Studiomaster, Ramso, Rane, Sunn, TOA, MICMIX, Tascam and many more lines of products in keyboards, strings, instruments, drums and instrmt amplification.

The Sound Stage also offers rentals, leases, financing and other "creative" options for purchasing or use of equipment. The Sound Stage is the most extensively stocked supplier of professional audio products in Central California. Call us for all your audio and musical needs.

**STAROUND AUDIO INC.**

*SD, AC, SES, EI*  
2679 Oddie Blvd., Reno, NV 89512  
(702) 331-1010  
Contact: Scott Bergstrom

**SUMMIT AUDIO INC.**

*SES*  
P.O. Box 1678, 131 W. Main St., Los Gatos, CA 95030  
(408) 395-2448  
Contact: Mike Papp

**SUN VALLEY AUDIO/ICC**

*SD, AC, SES, EI*  
P.O. Box 285, Sun Valley, ID 83353  
(208) 726-3476  
Contact: Lance Parker

**TRAX AUDIO**

*SD, AC, SES, EI*  
841 S. 500 West, Bountiful, UT 84010  
(801) 298-3280  
Contact: Jeff Ostler

**WILSON, IHRIG & ASSOCIATES**

*AC*  
5776 Broadway, Oakland, CA 94618  
(415) 658-6719

Contact: George Paul Wilson, President  
**Services offered, credits, specialization:** Based on nearly twenty years experience in the acoustical design of all types of recording and performance facilities and in the measurement, evaluation, prediction and control of noise and vibration, Wilson, Ihrig & Associates, Inc. (WIA) has earned a reputation as one of the nation's leading acoustical consulting firms. By virtue of the technical expertise developed by our professional staff, we are eminently qualified to provide consulting services on a wide range of acoustical projects. In addition, our precision noise and vibration measuring equipment and extensive laboratory facilities provide us with the capability of performing detailed acoustical analyses when

required to solve complex problems. Whether your project requires innovation, state-of-the-art engineering and architectural solutions, or simple answers to more routine noise and vibration problems. WIA can provide you with the appropriate level of assistance and design you need.

**OUTSIDE U.S.**

**ACUSTICA-CONSULTORIA DE PROJETOS**

*SD*  
Rua Joao Moura 428, Sao Paulo, Brazil 05412  
(011) 852-9017, 282-0767  
Contact: Eng. Eduardo Cszasznik

**GERR ELECTRO ACOUSTICS LTD.**

*SD, AC, SES, EI*  
363 Adelaide St. E., Toronto, Ontario, Canada M5A 1N3  
(416) 868-0528; Telex: 065-24385  
Contact: Gerry Eschweiler, General Sales Mgr.

**GROUP ONE ACOUSTICS INC.**

*SD, AC*  
4 Buddell Terrace, Toronto, Ontario, Canada M6S 1B4  
(416) 762-5452

Contact: Terry Medwedek  
**Services offered, credits, specialization:** Group One's Terry Medwedek specializes in the acoustics of recording studio's, film, video and entertainment facilities. Professional consultation and design services are provided to architects, contractors and studio owners. His projects range from broadcast production rooms to multi studio facilities and include a wide variety of designs. He works directly with the client, to combine their requirements with innovative, functional designs. In control rooms there is no commitment to one particular design, but from experience, preference is to provide an acoustic design appropriate to a given situation. Current projects include three new studio facilities, acoustic updates in several control rooms and a theatre. Clients include: Mars Studio in Toronto, Elora Sound, Comfort Sound, Ian Thomas, CILQ Radio, Music Room Productions,

Ocean Sound, Vancouver and Phase One Studio's in Toronto.

**MANTA ELECTRONICS GROUP**

*AC, SES, EI*  
204 King St. E., Toronto, Ontario, Canada M5A 1J7  
(416) 868-0513  
Contact: Mr. Ron Lynch

**NEIL MUNCY ASSOCIATES, LTD.**

*SD, AC*  
109 Fieldwood Dr.  
Scarborough, Ontario, Canada M1V 3G3  
(416) 298-3964  
Contact: Neil A. Muncy

**SOUND CONTROL**

*SES, EI*  
10 Donegall Park Ave., Belfast, N. Ireland BT15 4ET  
+44232-772491, 771555  
Contact: John Connolly

**STATE OF THE ART ELECTRONIK INC.**

*SD, AC*  
1165 Parisien St., Ottawa, Ontario, Canada K1B 4W4  
(613) 744-1003

Contact: Dr. Claude Fortier  
**Services offered, credits, specialization:** State of the Art Electronik specializes in the acoustic design of control rooms and studios, room acoustics, acoustic performance testing and verification, music facility design, as well as video edit suite and postproduction facility design. We also manufacture a range of patented acoustic align studio monitors and associated electronic crossovers that can be custom designed or adapted to obtain the maximum acoustic performance from your space. By integrating studio design with our Acoustic Align Monitors we can achieve a state of the art analytical monitoring environment. We have a wide array of acoustic (Bruel & Kjaer) and electronic test and measurement equipment and the expertise to use it. Recent clients: TeleImage, Dallas; MasterMix, Nashville; Starmusikproduktion, Hamburg; KPL Corp, New York; Sounds Interchange, Toronto; Solar Audio, Halifax; Marc Productions, Ottawa.

**990**  
**Discrete**  
**Op-Amp**

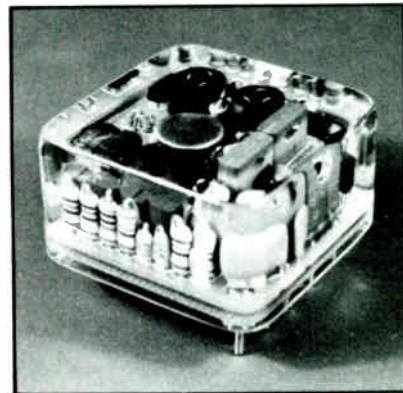

**Electronic Design by Deane Jensen**  
**Packaging & Production Design by John Hardy**

- **Fast:** 18V/ $\mu$ S @ 150 Ohms, 16V/ $\mu$ S @ 75 Ohms
- **Quiet:** -133.7 dBv E.I.N. (20—20kHz, shorted input, unweighted)
- **Powerful:** +24 dBv @ 75 Ohms (Ref: 0dBv = .775 V)

**AND IT SOUNDS GREAT !**

**THESE USERS AGREE:**

Sunset Sound, JVC Cutting center, Mobile Fidelity, K-Disc Mastering, Sony (Digital Audio Div.), Capitol Records, Inc., WFMT Chicago, Jensen Transformers, Bonneville Productions, DeMedio Engineering, ABC-TV, 20th Century Fox, Armin Steiner, and many more !

**THE HARDY CO.    Box AA631, Evanston, IL 60204    (312) 864-8060**

Circle #144 on Reader Service Card

—FROM PAGE 8, SESSIONS

*cording/Channel One Productions* has started work on a compilation LP featuring Metroplex area underground pop and rock talent. The album, to be titled *Town Without Basements*, will showcase upbeat original songs, according to *Drew Townson*, the record's producer...

## NORTHWEST

Fresh off the recent Chicago tour, multi-talented Bill Champlin settled in *Starlight Studio* in Richmond, CA to contribute vocals to former Sons bandmate *Terry Haggerty's* solo album. The guitarist and producer Norman Kerner are shooting for a late summer release to coincide with the live debut of Terry's new acid-funk quintet...*Russian Hill Recording* in San Francisco contributed to the soundtracks of three feature films that were screened at this year's Cannes Film Festival: *Dim Sum*, Wayne Wang's new independent film scored by Oscar winner (Amadeus) *Todd Boekelheide* at Russian Hill, *Mishima* (Lucasfilm) which did their Foley work at RHR with sound designer *Leslie Shatz* and *Latino*, directed by *Haskell Wexler*, which did their dialogue work at RHR in association with Sprocket Systems of Lucasfilm... At *Mushroom Studios* in Vancouver, *Dave Ogilvie* engineered and produced an album for *54/40*, a band the subject of US major and independent label interest... At *Prairie Sun Recording* in Cotati, CA, East Bay heavy metallers, *Possessed*, were in working on their debut LP on Combat Records with *Randy Burns* producing and engineering, and *Steve Buck* assisting... At *Montage Recording Studio*, Newark, CA, recent sessions include a new ballad for *Dean Keith's* forthcoming EP engineered by *Randy Spendlove* with *Louise Singleton* assisting... Post-production work at *Studio C* in San Francisco included *David & Janaki Rathod*, fresh from Bombay with the first-ever MTV filmed in India for *Translator* and 415 Records... At *Triad Studios* in Redmond, WA, *Queensryche* was in for a demo project with *Tom Hall* on the board... Recent sessions at *Heavenly Recording* in Sacramento included San Francisco's *Monkey Rhythm*, with *John Baccigaluppi* producing and engineering, and *The Convertables*, with *Brent Bourgeois*, *Craig Liviach*, and *John Baccigaluppi* engineering and producing...

## NORTHEAST

Activities at *Rawlston Recording* in Brooklyn, NY included the *Fat Boys* album, produced by *Kurtis Blow*, for *Autra Records*. *Kurtis* also did overdubs for his fifth album for Mercury/Polydor Records, *Akili Walker* engineering, *Bob Brockman* assisting... Recording at *Planet Zero Studios* were *Irma Estel La Guerre*, co-star with *Yul Brynner* in the

*King and I*; engineer for the sessions was *James Cannings* assisted by *Steve Rosenthal* and *Fitz*... Mixing their second LP at *Pyramid Sound Studios* in Ithaca, NY were *Crazed Management* recording artists *Anthrax*. *Alex Perialas* engineered with *Peter Bombar* assisting and *Carl Canedy* producing... *Edwin Birdsong* was in *Power Play Studios* producing his new single "Get it Right." *Marly Marl* mixed the record and *Stevie Wonder* played some keys on it. *Patrick Adams* engineered... *Isley, Jasper Isley* (formerly of the *Isley Brothers*) were in at *Eastern Artists Recording Studio* in East Orange, NJ recording their next album for CBS Records. *Dave Dachinger* engineered... Singer *Mara Friedman* was in NYC's *Quadrasonic Sound Studios* doing tracks for the re-make of "Ball of Confusion," originally done by the *Temptations*. It was produced by *Kenny Beck* and engineered by *Tom Gonzalez*... At *Classic Sound*, NYC, *Ben Rubin* produced the *Ray Brown All-Stars*. *Jim Anderson* engineered, assisted by *M. Denise McGrath*... *Tim Moore* was in *Tiki Studios* (Glen Cove, NY) mixing for his new LP for Elektra Records. *Rob Freeman* (Go-Go's) produced with *Danny Caccavo* engineering. *Robbie Dupree* ("Steal Away") was in doing some background vocals for the project... *Walter Duda*, pianist and vocalist, completed a demo recording at *A&R Recording* in New York City for George Butler of CBS Records. He also recorded additional original compositions at *Carriage House Recording Studios* in Stamford, Connecticut. *Larry Franke* engineered the session at A&R, and at the Carriage House he was helped by *Jeff Jones*... At *Golden Apple Media* of Mamaroneck, NY, *Tim Scott* has been laying tracks with his new band, *Wild Mojave* in preparation for their debut album on Warner Bros. *Peter Denenberg* was at the board... Jazz guitarist *Kevin Eubanks* recorded a new album for GRP records with engineer *Paul Wickliffe* and assistant *Mario Rodriguez*; and *Dizzy Gillespie* cut tracks for a new album on GRP produced by *Larry Rosen*. *Joe Jorgenson* was at the console, with *Scott Ansell* assisting... The *Diamond 2 Crew* cut their fresh 12-inch "We're Getting Too Old" for A.S.D. Records with producers *Hernandez & Allecca* at *Reel Platinum Studios* in Lodi, NJ... The *Works* finished recording their debut single at *Pyramid Sound Studios*, Ithaca, NY. *Alex Perialas* and *Peter Bombar* engineered and co-produced the project... At *39th Street Music* in NYC, *Ashford & Simpson* were in doing several demos for an upcoming movie starring *Mikhail Baryshnikov* and *Gregory Hines*. *Tim Cox* engineered... Recent happenings at *Shakedown Sound* included *Brass Construction* in the studio laying down tracks and mixing for their forthcoming album on EMI. Producing was *Randy Muller*, with *Andy Wallace* engineering... *Secret Sound Studio* in NYC had *Grandmaster Flash* recording a single for Elektra Records with *Tom Gartland* engineering and *Bob Brockman* assisting... At *Boogie Hotel* in Port Jefferson, NY, *John Waite* recorded his forthcoming album for EMI Records. The proj-

ect was co-produced by *Stephan Galfas* and *Waite*, and *Stephan* shared engineering duties with *Chris Isca*... At *Inner Ear Recording* in Queens, NY, singer/bassist *Bob Guida* and pianist/singer *Michael Greene* recorded and edited their new album on *Global Village Records*. *Steve Vavagiakis* engineered... Recent mastering projects at *The Cutting Edge* in Ferndale, NY included a 45 for *Louis Dicks & The World's Greatest Gospel Singers* and an LP for *Roach-Egg Invasion*... At *All Star Sound Studio*, Bloomfield, NJ, *Southside Johnny & the Jukes* cut tracks for an upcoming LP with *Jay Vicari* engineering, *Southside Johnny* producing, *Brian Bannon* assisting... Elektra Recording artist and former leader of the band *Suicide* *Allen Vega* finished his newest album at *Broccoli Rabe Studios* in Fairfield, NJ. The album was engineered by *Kennon Keating* (who also played guitar) and assisted by *Marc Lennard*... *Rob Freeman* was in NYC's *D&D Recording* working on *Tim Moore's* upcoming release on Elektra Records, with *Danny Caccavo* engineering... *Joey Lynn Turner*, former lead singer of *Rainbow* recorded his debut album for Elektra Records at *Bearsville Studios*. Veteran producer *Roy Thomas Baker* handled production chores, and the project was engineered by *Ian Taylor* with assistant engineer, *Ken Lonas*... At *Celestial Sounds* in NYC, *Allan George* and *Fred McFarland* produced tracks for *Evelyn King's* upcoming LP for RCA. *Hugo Dwyer* was at the board with *Larry Decarmine* assisting... *Allan St. Jons* (Billy Squier Band) and *Scarlet Rivera* (Bob Dylan) completed work on a feature-length movie soundtrack, *Las Vegas Weekend* which they co-wrote and produced at *Michael Levine's Studio* in NYC. Engineering were *Michael Levine* and *Barnaby Bristol*... Ongoing projects at *Normandy Sound* in Warren, RI included singer *John Cafferty* doing an interview with *Joe Interrante* for RKO Radio with engineer *Bob Winsor* and producer *Maurice Starr* working on new material with engineer *Phil Greene*... *Jeff Rust* of *Jasir Recording* (Boston, MA) recently produced demos for *Tom Whaley*, a Berklee College of Music trombonist, which helped Tom to win an "Outstanding Performance Award" in the Jazz Instrumentalist Soloists category of *downbeat* magazine's 1985, Eighth Annual Student Music Awards... Actor *Jackie Gleason* recently produced his own Dixieland compositions for the CBS-TV movie *Izzy and Moe*, in which he stars with former *Honeymooners* sidekick *Art Carney*, in *Media-Sound's Studio A*; *Michael Golub* engineered, seconded by *Tim Hatfield*...

Get into the Mix! Send your press releases to: Sessions/Studio News, Mix Magazine, 2608 Ninth Street, Berkeley, CA 94710. Photographs are also welcome and will be used as space permits.



# CLASSIFIEDS

## Acoustic Consulting

### ACOUSTIC SPACES DESIGNER/BUILDER

All aspects of recording studio and video facility design and construction, residential and commercial soundproofing and renovations. PO Box 884 Woodstock, NY 12498 914-331-1726

## Employment Offered

### ELECTRONIC TECHNICIAN

Cassette tape manufacturing plant is in need of an experienced, electronic technician to troubleshoot & maintain high speed duplicating equipment. Must have good background in electronics & understanding of electronic theory. Send resume to: ELECTROSOUND L.A., 9545 San Fernando Rd., Sun Valley, CA 91352.

## Employment Wanted

**1985 GRAMMY NOMINATED ENGINEER** Available for quality project. Can furnish certain accessories such as SSL Total Recall, Sony multi-track digital and/or dual Studer analog, AMS 1580S, Lexicon 224XL etc. Bill Mueller (301) 628-6862. Serious inquiries only.

## Equipment For Sale

FOR SALE: MCI 528B highly modified. Tres Virgos Studios (415) 459-2888.

Scully 280 2 trk, Russ Lang cabinet 7 1/2/15, good condition; Scully 280 2 trk, Scully cabinet, 15/30, good condition; Scully 280 4 trk w/3 trk head assembly/sync, good condition; 3M M64 2 trk, 7 1/2/15, good condition; 3M M64 2 trk mastering machine 7 1/2/15, good condition; 3M M79 4 trk, w/2 trk head assembly, mint condition; MCI 24 trk JH114 w/AL II excellent condition; Eventide H910 Harmonizer, excellent condition; JH45 Autolock w/2 MCI interface boxes, mint condition; U67 Neumann tube mike, excellent condition; M249 Neumann tube mike, mint condition w/power supply. Ardent Recording Inc. (901) 725-0855. Contact Pat Scholes or John Hampton.

### TRIDENT TSM

40 in, 24 out, 32 monitor, fitted 32-

24-24. Parametric 4 band EQ, 6 sends, 4 returns, customized patch bay. Extensive modification, matching outboard rack \$55,000. (416) 291-9553.

### LOW OVERHEAD MEANS

LOWEST PRICES. We carry most major lines of pro audio & recording equipment. **Get your best price, then call me.** 3M Tape and accessories at factory prices.

### S.C.M.S.

East U.S. Toll Free:  
**(800) 438-6040**  
West & N.C.: (704) 889-4509

Sam Ash Music Store Mail Order Service. Deal with the professionals. N.Y.C.'s largest inventory and best prices on musical instruments, sound and recording gear. 1-800-645-3518. N.Y. State 1-800-632-2322.

### SYNTHESIZER BLOWOUT!

Tired of impersonal service? You think you're getting your best deal? Try Starsound Audio for free! 1-800-354-7252. Fluid synthesis spoken here. Studio mixer, \$1,500; Tascam Model 10 \$500. Most major lines in stock. Call for free studio gear hot sheet. Crown, T.E.F. analysis available IN YOUR STUDIO or here. David, Tom, Scott or Bob.

### VINTAGE MIKES

Call Bill Bradley  
(312) 751-1216

DANBURY ELECTRONIC MUSIC CENTER, 84 Federal Road, Danbury, CT, 06810, (203) 792-2794. New England's oldest and most experienced Tascam dealer. All professional recording equip. and supplies from stock plus widest selection of electronic keyboards including Yamaha DX-PF.

USED/DEMO EQUIPMENT SALE Tascam 8516B w/locator, 80-8 x/DX8, Ecoplate II, Otari MKIII 2 tr w/locator, Otari OCF duplicator, Neumann U64s, Nagra IV-S. Also SOUND CRAFT, LEXICON, OTARI, NEOTEK, TRIDENT, UREI, ORBAN, EVENTIDE.

E.A.R. PROFESSIONAL AUDIO  
(602) 267-0600

### API CONSOLES

WOLFF ASSOCIATES is an authorized dealer for all API products. We buy/sell new/used API modules, parts, consoles. Repair/refurbish modules and consoles ON LOCATION. WOLFF ASSOCIATES, 1378 Northgate Sq., Reston, VA 22090 U.S.A. (703) 689-0448.

1 pair JBL 4333 studio monitors,

\$900, excellent shape. Call Charlie (904) 576-4741.

## Reliable Music

### The Finest in Professional Audio With Service to Back It Up!

Crown, JBL, Tascam/TEAC, Yamaha, Biamp, Technics, Orban, Gauss, Eventide, dbx, UREI, Neumann, AKG, Sennheiser, Beyer, Sony, Shure, Otari, MICMIX, MXR, RTS, Revox, Cetec-Vega, E-V, Omnicraft, Symatrix, Sescom, Urso Major, Whirlwind, Audio-technica, Ramsa, Lexicon.



(704) 375-8662  
1001 S. Independence Blvd.  
Charlotte, N.C. 28202

**FRANKFORD/WAYNE DISC MASTERING EQUIPMENT SALE** We're Overstocked! with Lathes, Stereo Cutterheads — Complete Disk Mastering Systems...Cheap!!!! Frankford/Wayne Mastering Labs. 134 N. 12th St., Philadelphia, PA 19107, (215) 561-1794.

MCI JH-114 24/16-trk tape machine, Studer A80 2-trk 1/2"/1/4" tape machine, Ampex 440C 1/4". Accessories included. Pkg. \$25,000. Contact Robyn (212) 226-4278.

Looking for Eventide SP-2016 or H949? Space Station Banner RTA, ADR Scanner. Need AKG, BGW, dbx, E/V, Neumann, Orban, Sennheiser, Shure, Technics, UREI or White products? Call UAR for the best quote: (512) 690-8888, 8535 Fairhaven, San Antonio, TX 78229.

### NEW API PRODUCTS

Modules—Equalizers—Parts Factory Warranty! Immediate delivery at CLOSEOUT PRICES! For further information call:

RAATA AUDIO SYSTEMS, INC.  
1446 N. Cherokee Ave.,  
Hollywood, California 90028  
(213) 469-9593 Telex 910-321-4465

IF YOU'RE NOT USING IT —SELL IT!

Your national clearinghouse for used audio and video! Call for free copy of our latest listings, or to list your used gear free.

The Bertech Organization  
(818) 352-3181  
THINK BERTECH FIRST!

### MICROPHONES

Vintage, used, new. Call John O'Connor, (213) 473-9004.

Tascam 90-16 16-track recorder w/full remote, dbx & auto loc. Excel-

lent condition. Will include alignment tapes, \$7,800. Call Kurt at (215) 642-2346.

NEOTEK SERIES III: 28x24 with 16 busses, 6 echo returns custom "pre-return" submaster fader, extra patch bay, producer's desk, leg set, patch cords, spare parts, exc. cond. White 32-band EQ's \$550 ea. 312-864-4460.

### SIGMA SOUND STUDIOS GREAT EQUIPMENT BUYS:

24, 2-trk recorders, console automation, synchronizers, hi speed dupe equip plus lots of audio processing gear.

Call or Write:

212 N. 12th St., Phila., PA 19107  
(215) 561-3660

Ameck 2500 console 36 input, 24 plus 6 out, near mint condition; full parametric EQ continuously variable w/3 dB detents; extra patch points; 6 aux sends and returns; automation ready; 10 grouping busses; XLR snakes available. (213) 462-0000.

**Excess Stock** — Audio manufacturer liquidating unused wire, connectors, transformers, components, heatshrink tubing, hardware, multi-cable, roadcases and many Kelsey mixing consoles at wholesale prices. Call Craig for a complete listing (201) 423-1300.

MCI 2-trk JH110 + Remote Control US \$3,600.00

UREI 813 Monitors + UREI 6500 Power Amp US \$4,200.00  
AKG BX20 Reverb US \$1,800.00  
Roland Compu Editor Automation For 16 tracks US \$4,200.00  
Eventide FL201 Flanger US \$500.00  
ADR Sweep EQ US \$250.00 — (902) 423-0233

**New Used & Demo Soundcraft**, Neotek, Otari, Akai, Klark-Teknik, dbx, EV, Crest & Urso Major. Best prices on the best gear. MCI JH-16 24 track w/AL3 \$18,500. Auditronics 501 18x 16-26 channel mainframe \$4,800. Like new Otari MX 7800 w/remote \$5,900. EMT 140S Tube \$4,000. UREI 6500 new \$1,499. ADR Scamp system. Call **Pyramid Audio Inc** (312) 339-8014.  
**Call Us Last!**

STEREO CASS. DUPLICATOR TELEX 300. Makes 9 copies. Cassette & 1/4 Trk R-R masters, rewind mod. 3 blue telex cab. adj. bias & record EQ. New heads. 10K when new! Asking \$4,500. (703) 521-1871. Arlington, VA.

GERALD LEWIS RECORDING

MCI 16-trk tape mach (auto-loc III) \$18,000, Neotek Series 1E record-



ing console \$9,500, Studer Revox 1/2 trk \$1,500, Lexicon 200 digital reverb \$3,500, Master-Room XL 305 reverb \$1,000, JBL 4411 studio monitors \$900, full selection of mikes from Neumann, Sony, Shure & Audio-Tech. Equip is 2 years old. Sound Factory Recording Studio (216) 289-1000, Dan.

**STUDIO LIQUIDATION!** Tangent 3216 16x16 Console \$5,800. AKG C414EB \$495. Otari MX 5050 B with Console \$975. Over 50 Effects and Microphones — Top Names — Best Prices. Call for details: (918) 252-9581 days, (918) 252-1798 eves. Ask for Jim.

**NEUMANN LATHE**

Scully Preview Tape M., Ampex 2-tr. AG440, Neve Patch Bays, Steinway Model B Grand Piano. Call Glenn (615) 227-5027.

**Recording Studio Software** Commodore, Apple, Macintosh. INVOICE PROGRAM, CASSETTE LABELING PROGRAM, & MISC. UTILITIES (tracksheets, work orders, inventory, etc.). norm. \$199.00 each! now only \$99.00 each! Specify computer & printer. SWEETWATER STUDIO SOFTWARE, 2350 Getz Rd., Ft. Wayne, IN 46804, (219) 432-8176.

**LIKE NEW EQUIPMENT SALE**

SOUNDCRAFT 400B 32x4x2 w/Star case, \$8,000; AB 1200 A, 2/\$1,200; GAUSS Dual 10" 3184 mid-bass horn, 4/\$650; GAUSS dual 18" 4883A bass horn, 2/\$850; GAUSS dual 18" MT bass horn, 2/\$400; JBL dual 15" MT scoop, 2/\$250; GENIE Super Tower, 24' w/outriggers & safety brake 4/\$1,300; POWERTRON custom dimmer packs in birch rack w/Camlock & Pyle-National multipin connectors, 18 channels at 8K each, complete w/Star case; custom dual row 10' alum. light racks w/wheels, 2; custom dual row 4' alum. light racks, 2; complete w/4-way boxes & Pyle National connectors; custom 50', 60', 100', 100', 10/20 S.O. cables w/Pyle-National multi-pin connectors; 600 amp SQUARE D disconnect w/Camlock and cables; Par 64's w/1000 watt lamp, 30/\$65; Total light system package \$25,000. Call Harold (504) 863-2815.

Equipment Sale in Stock: Crown DT-1000, Akai MG-1212, Orban 414A, dbx 160x, Neumann U-87Z, Tannoy, EV Sentry 100A, Sanken, Sennheiser ME-88/K3U, Sony digital audio tape. We make your Dolby "M" into a "MH," \$100 per channel. Super sale on 24-trk MCI. John or Linda (615) 366-1890 Studio Supply, Nashville, TN.

Roland Rack Mount Digital Delays SDE1000-\$349; SDE2000-\$595; Boss DE200-\$239; TR707-Digital drums \$429; Juno 106 synth-\$785; Boss SCC700 effects controller (no case) \$299; Korg Digital drums or perc.-\$229. Great prices on all our

product lines including Shure, Rocktron, Gibson, Pearl, Washburn, G & L, etc. U-CREST MUSIC CENTER (716) 684-5143.

SCULLY 100 2" 16-track recorder. New heads, spare sets of 2" 16-track & 1" 8-track heads. Meter bridge, digital readout, very good condition. Includes console, manuals, updates, all documentation. Used on Hendrix's "Cry of Love" gold album. \$8,500. (617) 372-4236.

KURZWEIL, AKAI & AUDIO-TECH-NICA. Best prices on the new Kurzweil 250 & Akai MG1212. Complete studio packages available. New & used, buy and sell. SOUND ADVICE (205) 252-2632.

Automated Processes Console 16x4 x2 w/24 mainframe, custom built w/550 EQs, 515B input modules, 2-525 limiters, 575 oscillator, 475 faders, in place solo, 23 meters. \$10,500, (2) Neumann 267, (3) E-V RE20, (2) UREI 527, (2) UREI 813 monitors, Harmonizer, EXR Exciter, (2) API 525 limiters, (2) Kepex, (2) Gain Brains, (2) JBL 4320 monitors, 73 key Fender Rhodes. (205) 595-8497.

Sound Workshop Series 30; ARMS automation with Super-Group. Full 336 pt. TT patch bay. 28 Main Frame, 251/Os. IMMACULATE CONDITION! Must sell. \$14K. Contact: Michael Creamer at (305) 298-3917.

16-Track Tascam 85-16 w/dbx \$7,000 Speck 800-C 16x8 console w/patch bay, 3 band sweep EQ 16 channel monitor, DeltaLab DL-2 stereo digital delay and reverb \$750, MXR rack-2 compressors, (1) phaser, (1) flanger \$350, MICMIX XL-305 stereo reverb \$700 Shure SM81s \$400 pr. (305) 772-0864 Mike.

MCI 528B console, excellent condition 28 input 8 echo returns. VU meters, JH50 automation, includes custom producers desk \$37,500. MCI JH24 recorder Auto-Locator III, transformerless in great condition, \$18,200. (214) 241-5182. Attention: Ruben.

Trident Series 80B 30/24/24 w/EQ monitoring, 2 months old \$37,950. Also Trident Series 80 32/24/24 \$24,950 — (813) 238-3900.

API console 20x16, 3M M56, M79, Scully mastering 2 track, wide selection of Neumann tube mikes including KM54, U47, U67 & other vintage Neumann mikes, AKG tube mikes 414 UREI limiter compressors, Allison Gain Brains & Kepex, Lexicon, Prime Time, McIntosh 2300 amplifiers, AKG BX20 reverb, Sony PCM-10 digital 2 track and much much much more. Please call Don (415) 285-8911.

Sound Workshop 1280B 12 in 8 out w/8 channel monitoring, Studio Talkback, playback super EQ, phantom powering, like new \$1,500. (213) 328-8208 or (213) 375-1312.

Lexicon 224, recently updated to

current software. Excellent condition, first \$5,500 takes: Soundtrek, (816) 931-8735 Grant.

MCI JH-542B Console with 28 i/o modules, automated plasma meters, Sacrifice \$25,000 or b/o. Call Bobby (212) 921-1711.

NEVE BCM 10/2 console with fl./case \$6,500. SOUNDCRAFT SCM 381 16-track on 2 in. with remote and multicable \$8,000. Prices include transportation. Write Colin Martin: 2 Fairview Ave., Whitehead, N. Ireland BT38 9NU, call N. Ireland 09603 72487.

SOUNDCRAFT SER. 1600 mixing console, 1 1/2 years old, 24-inputs, 8 busses, 24-outputs, producer-patch-bay, stand, etc. Lists for \$21,000.00 plus, now only \$12,950.00. OTARI 5050-III-8, 8-channel recorder, never used, 2 months old, \$3,995.00. Call (312) 872-1665.

**Equipment Rental**

NEW YORK NASHVILLE



"The Audio Rental People"  
DIGITAL RECOARDERS • EFFECTS SYNTHESIZERS • WIRELESS MICS AUDIO FOR VIDEO • TIME CODE 1619 Broadway NY (212) 582-7360

**Instruction**

BE A RECORDING ENGINEER!  
New classes quarterly.  
INSTITUTE OF AUDIO/VIDEO ENGINEERING  
1831 Hyperion, Dept. E  
HOLLYWOOD, CA 90027  
(213) 666-3003

**LEARN FROM THE PROFESSIONALS  
ELECTRIC BASS**

By Carol Kaye:  
How to Play the Elec. Bass ..... \$4.95  
Elec. Bass Lines #1 ..... 3.95  
Elec. Bass Lines #2 ..... 3.95  
Personally Yours ..... 4.95  
Elec. Bass Cassette Course ..... 35.00  
Elec. Bass Lines #3 ..... 3.95  
Elec. Bass Lines #4 ..... 4.95  
Elec. Bass Lines #5 ..... 3.95  
Elec. Bass Lines #6 ..... 3.95  
How to Play Elec.  
Bass Chords ..... 4.95  
and:  
Easy Elec. Bass  
(Carroll/Kaye) ..... 4.95

**And Much More!**

Please write for a free catalog.  
Foreign postage: \$2.00 1st book, \$1.00 ea. additional. \$1.50 for cassette. \$8.50 C.K. Bass Cassette Course - \$13.50 to Australia, N.Z. & Asia.

Sorry, no CODs. Colorado add 6% tax. Good store discounts.

**GWYN PUBLISHING CO.**  
177 Webster St., #272  
Monterey, CA 93940  
GOOD MUSIC MAKES  
A HAPPY WORLD

**SCHOOL OF AUDIO ENGINEERING**

The world's largest training school. A full practical (HANDS-ON) one-year diploma-level course in our own studios, unrestricted amount of studio time, the School of Audio Engineering operates 21 fully set-up schools and studios, ranging from 8 track to 24 track. Details contact SAE, 97 St. John St., E.C.I. London 01-6082420 or 420 Elizabeth St., Sydney Australia 02-6997931, for location of all our schools.

**IN TEXAS: RECORDING ENGINEER TRAINING.** Introductory to Professional. Send for brochure today. Phil York, Multi-Track Recording Class of Texas, Exchange Park, Box 45744, Dallas, TX 75245. (214) 438-8248.

**Digital Sampling Demo**

Lucid demonstration of changes in sampling parameters. Recording and accompanying report explain the effects of changing sampling rate and bit resolution.

Send: \$15.00 for Sampling Demo Cassette and Report.

To: Sounds Digital  
PO Box 4660  
Stamford, CT 06907

**Instruments For Sale**

Bill's Music has thousands of hard to find new & used musical instruments and accessories in stock. We ship anywhere! Call or write! Bill's Music Warehouse, PO Box 3157, Baltimore, MD 21228 (301)788-8900.

**Maintenance Services & Repair**

**STUDIO SERVICES**  
Affordable electronic repairs for video and audio studios. Steve Kadar Audio Engineering Services (415) 641-4343.

**New York Technical Support, Ltd.  
IS SERVICE**



"We are factory trained by Studer, Otari, MCI, Ampex, 3M, Neve, Trident, and Scully. Our work is guaranteed."

**CALL GREG HANKS 914-776-2112**

1440 Midland Ave., Suite 10  
Bronxville, NY 10708

**AMPEX**  
Parts — Tape — Recorders  
Northwestern Ind.  
1-800-547-2252

## Recording Services



Private Secure Storage  
Vaults for Audio & Video  
Tape, All Media Materials  
and Business Records.

Temperature & Humidity  
Controlled Space. 24 Hour  
Self-Service Access.

742 N. Seward Street  
Hollywood, CA 90038

**(213) 461-6464**

## Records & Tapes

DISC MASTERING — Cut from  
your tapes at low cost — Plating,  
Pressing, Labels & Jackets —  
LPs, EPs & 45s. Write for free  
information:

### THE CUTTING EDGE

Box 217 M  
Ferndale, NY 12734  
(914) 292-5965

### REAL-TIME

Cassette Duplication C45 as low  
as 98¢. 4-color printing, foil labels,  
shrink wrap. Send for complete

price list & services inc. bulk price  
on AGFA & chrome tape. CAT,  
3005 W. Glendale Ave., Phx, AZ  
85021 (602) 246-4976.

### PROFESSIONAL RECORDING SUPPLIES

We are a major distributor of Am-  
pex, Agfa & 3M bulk & reel mas-  
ter tape from 1/4" to 2". We also  
stock empty reels, boxes, video  
cassettes, Norelco boxes & other  
recording supplies. We manufac-  
ture custom length bulk cas-  
settes using top quality tapes.  
Cassette duplication service  
available. Please call or write for  
our FREE catalog.

### Advance Recording Products

7190 Clairmont Mesa Blvd.,  
San Diego, CA 92111  
In Calif.: (800) 858-1061  
CA Phone No: (619) 277-2540  
Outside Calif.: (800) 854-1061

REAL-TIME CASSETTE DUPLI-  
CATION Superb quality from  
your Analog or Digital masters.  
VIDEO CASSETTE DUPLI-  
CATION Stereo VHS HiFi, or U-  
Matic. Competitive rates. (303)  
751-2268 Mirror Image.

ROCK BOTTOM PRICES  
AGFA, AMPEX, 3M-SCOTCH  
AUDIO & VIDEO TAPE, 1/4"-2".  
Custom Agfa cassettes. Reels,  
boxes, leaders, splicing tapes,  
metal reels & speciality items.  
Catalog upon request.  
BURLINGTON AUDIO TAPES  
106 Mott St., Oceanside  
NY 11572 1-800-331-3191  
in N.Y. (516) 678-4414



FOR THOSE WHO CAN HEAR  
THE DIFFERENCE

AUDIOPHILE CASSETTE  
DUPLICATION & PACKAGING

Eastern Standard  
Productions, Inc.  
26 Baxter Street  
Buffalo NY 14207 (716) 876-1454

### REAL-TIME

Best Quality Cassettes using Naka-  
michi LX-5 decks only. Custom load-  
ed Agfa or BASF Chrome. Label  
and insert printing, shrinkwrap, blank  
tapes, Competitive pricing.

YOU NEVER HEARD IT BETTER  
Uni-Sette, Inc. 5125 Marconi Ave.,  
Carmichael, CA 95608. (916) 485-  
9534.

FACTORY DIRECT  
PRICES ON 3M TAPE  
We can save you money.

We ship from stock.  
Small quantity orders O.K.  
**STUDIOWORKS**  
(800) 438-5921

CUSTOM LENGTH CASSETTES,  
highest quality CrO<sub>2</sub> Tape C-10—  
85¢, C-20—\$1.00, C-30—\$1.15, C-  
40—\$1.25, C-46—\$1.35, C-50—  
\$1.40, C-60—\$1.45. Send cert.  
check or MO to: IER 118-17 97 Ave.  
Queens, NY 11419 or call (718) 849-

5725. NY state residents add 8 1/4%  
tax. All shipments UPS—C.O.D.  
100% GUARANTEED.

### CASSETTE PRODUCTIONS, INC.

35 years state-of-the-art tape dupli-  
cating. Real-time or high-speed.  
Full service, fast delivery, any quanti-  
ty. Call JULIUS KONINS, (201) 666-  
3300, 109 Prospect Pl. Dept. M, Hills-  
dale, NJ 07642.

## Diskmakers

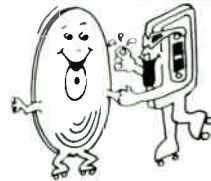

RECORD PRESSING  
CASSETTE DUPLICATION  
SEND FOR OUR PRICE LIST  
**CALL TOLL FREE**  
1-800-468-9353  
925 N. 3rd St., Phila., PA 19123

## Studios For Sale

CHICAGO RECORDING STUDIO  
Completely equipped 24x8 profes-  
sional recording and mastering  
studio. Prewired for 24x24. In-  
cludes 2 bdrm apt, 2 offices, base-  
ment & 1 1/2 baths. Extensive list of  
state-of-the-art equip. Sheldon F.  
Good & Co., 11 N. Wacker, Chi-  
cago, IL 60606 (312) 346-1500.

### BUSINESS OPPORTUNITY

Sacramento, CA, established clien-  
tele, excellent reputation, premium  
location and facility, 2400 sq. ft.,  
comfortable environment, w/office  
space and room for growth, reason-  
able lease, well equipped 16-track  
facility, \$60,000. (916) 424-8772.

House With Recording Studio for  
sale West LA Area — Canyon view  
setting near Malibu beaches. Archi-  
tect designed redwood with decks,  
hot tub, tile, 3 bedroom, 220 sq. foot  
control room, 280 sq. foot studio with  
air cond. & elec. per Westlake Audio  
specs. \$279,000. Call Bernie (213)  
455-3635.

Outstanding opportunity in central  
Manhattan. Top 16-track studio, fully  
equipped. Also includes grand piano,  
synthesizers, percussion, amplifiers,  
etc. Established business. Write or  
call Noise New York, 257 W. 34th  
St., NY, NY 10001, (212) 947-0048.

### RECORDING STUDIO FOR SALE OR LEASE

2200 sq. ft. recording facility in New  
York City. Office, tape library, two  
control rooms, two studios, fully air  
conditioned. Excellent village loca-  
tion. Perfect for personal or small  
recording/production/publishing com-  
pany. (212) 260-5226.

## How to Place a Mix Classified

Please print or type in CAPITAL LETTERS and lower case. There are 8 lines to the inch and approximately 24 CAPITAL letters per line or 32 lower case letters. \$60 per inch — 1" minimum. Additional lines \$10 per line. **Bold type** \$10 per line. Black border or gray screen \$10 extra. Logos or display advertising up to 4" will be charged at \$75/inch. Multiple insertion rates available — Call for information. **Payment by check, money order or charge must accompany ad. DEADLINE is the 10th of the month, 1 1/2 months prior to publication.**

### Categories Available (Check one.)

- |   |   |   |
|---|---|---|
| <input type="checkbox"/> Business Opportunities | <input type="checkbox"/> Equipment Wanted     | <input type="checkbox"/> Rehearsal Space          |
| <input type="checkbox"/> Employment Offered     | <input type="checkbox"/> Instruction          | <input type="checkbox"/> Session Player Available |
| <input type="checkbox"/> Employment Wanted      | <input type="checkbox"/> Maintenance Services | <input type="checkbox"/> Studios for Sale         |
| <input type="checkbox"/> Equipment for Sale     | <input type="checkbox"/> Records & Tapes      | <input type="checkbox"/> Miscellaneous            |
| <input type="checkbox"/> Equipment Rentals      | <input type="checkbox"/> Recording Services   |   |

Name \_\_\_\_\_

Address \_\_\_\_\_

Phone \_\_\_\_\_

I am paying by (Check one.):  VISA  MASTERCARD

Card #: \_\_\_\_\_ Expiration Date \_\_\_\_\_

Signature: \_\_\_\_\_

Check or Money Order #: \_\_\_\_\_ Amount Enclosed: \$ \_\_\_\_\_

### Mail to:

Mix Classified, 2608 Ninth Street, Berkeley, CA 94710  
(415) 843-7901

# TEC

TECHNICAL EXCELLENCE AND CREATIVITY

## AWARDS

If you've been reading **Mix Magazine** in 1985, you've almost certainly heard about the TEC Awards. Established by the publishers of **Mix**, this first-of-its-kind awards program will honor outstanding achievement in the professional recording and sound production industries. Encompassing three general categories (Technical, Creative, and Institutional Achievement) the TEC Awards will give audio and music professionals the opportunity to recognize the accomplishments of their peers.

On May 31st, balloting closed for the First Annual TEC Awards. Several thousand **Mix** readers took part in the voting, assuring that the awards will represent a true cross-section of our many-faceted industry. The sealed ballots have been turned over to a firm of certified public accountants, to be tabulated just prior to the TEC Awards celebration on October 14th.

---

### JOIN US IN HONORING EXCELLENCE!

---

On Monday night, October 14th, during the AES Convention, a gala celebration will be held at New York City's Puck Building. Beginning at 7:00 p.m., the TEC nominees and other members of the industry will gather to enjoy an evening of dining, entertainment, and—most importantly—the presentation of the TEC Awards. A specially printed TEC Program Guide, including profiles and photographs of all 130 nominees, will be handed out to each guest. If you or members of your company would like to attend the TEC Awards celebration, or you would like to reserve advertising space in the Program Guide, call or write today to: **TEC Awards, 2608 Ninth Street, Berkeley, CA 94710, (415) 843-7901.**

---

*All proceeds of ticket sales for the 1985 TEC Awards celebration will be divided among: The Deafness Research Foundation (for research into the causes and cure of hearing impairment); the Audio Engineering Society (for creation of an educational scholarship); and the winner of the Recording School of the Year Award (to fund a scholarship for a deserving student).*

---

# ADVERTISERS INDEX

PAGE	ADVERTISER	PAGE	ADVERTISER	PAGE	ADVERTISER
115	Apex	86	Electronic Systems Laboratories (ESL)	153	Polyline Corporation
87	Alesis	31	Eventide	66, 68	Professional Audio Services & Supply
77	Acoustical Physics Laboratories	88	FCC Fittings	155	& Supply
135	Adams-Smith	156	Filament Pro Audio	120	Pulsar Laboratories
53	Advanced Music Systems (AMS)	79	Flanner's Pro Audio	105	QSC Audio Products
19	Agfa Audio	148	FM Acoustics	47	Rane Corporation
61, 70	Akai/IMC	85	Fostex Corporation	38	RCA Test Tapes
93	AKG Acoustics	149	Full Compass Systems	61	Record Plant
151	Dan Alexander Audio	103	Gand Music & Sound	54	Reels on Wheels
98	Allen & Heath Brenell	99	Goldline	160	RLS Acoustics
127	Alpha Audio	110	GRD	102	Rocktron
144	AMP Services	162	Guitar Showcase	17	RolandCorp US
171	Ampex	163	Hardy Company	101	Ross/IMC
117	Aphex Systems	106	Hill Audio	43	RPG Diffusor Systems
125	Sam Ash Music	147	Hy James Audio	146	SCMS Pro Audio
39	Audio Affects	27	JBL, Inc.	69	Sennheiser
132	Audio Engineering Associates	29	Joiner Pelton Rose	33	Showcase Audio/Video Systems
36, 37	Audio Kinetics	80	JRF Magnetic Sciences	15	Sound Genesis
109	Audio-Technica	82	Klipsch & Associates	92	Sound Image
107	AVC Systems	131	LaSalle Music	139	Soundex
134	Kenneth A. Bacon Associates	152	LD Systems	172	Soundcraft Electronics
60	Bananas at Large	41	Lenco Electronics	65	Soundcraftsmen
157	Bertech	90	Leo's Audio & Music Technologies	89	Soundtracs
48, 49	Beyer Dynamic	88	Linear & Digital Systems	130	Spectrum Magnetics
142	Bryce Audio	95	Linn Electronics	130	Sprague Magnetics
115	Brystonvermont	32	Littlite/CAE	57	Steinway and Sons
137	Camera Mart	132	Magnifax International	2	Studer Revox
18	Canare Cable	141	Manny's Music	114	Studio Consultants
81	Carver Corporation	46	Marshall Electronics	72	Studio Technologies
62, 63	Carvin	45	Martin Audio	119	Synchronous Technologies
35	Celebration Recording	46	McVee Productions	133	Tannoy
150	Cetec Gauss	25	Milam Audio	21	Tascam
118	Computers & Music	116	Mimetics	51	Technical Audio Devices (TAD)
138	Countryman Associates	32	Monster Cable	55	Telex Communications
123	Crawford Postproduction	23	Nakamichi	146	Thoroughbred Music
9, 161	Crown International	158	New World Audio	12, 13	3M Corporation
38	CSE Audio	111	Nikko Audio	59	TOA Electronics
110	Decillionix	102	Omni Craft	129	TRC Studios
140	Digital by Dickinson	52	Orban Associates	158	United Tape Company
91	DOD Electronics	4	Otari Corporation	114	Vertigo Recording Services
7	Dolby Laboratories	153	PAIA Electronics	140	Victor's Pro Audio
40	EAR Pro Audio	97	Peavey Electronics	149	Wise Music
71	Eastern Acoustic Works	30	Planet Sound	160	Woodworx
139	El Mar Plastics			99	World Records
73	Electro-Voice, Inc.				

## —FROM PAGE 47, MODIFICATION

engineer would now have enormous control over the acoustical parameters of the room. At the present time, a recording session may need to take place in several different studio locations, merely to meet the acoustical requirements. The recording of such traditional instruments as strings and woodwinds is not suited to a rock and roll studio. With these systems in place, however, one studio and one room could conceivably cover each acoustical requirement.

Another factor to be considered is musician comfort. Acoustical instruments need a room's resonance and reflections to sound correct to the musician. And, playing an acoustical instrument without these aural cues can be frustrating, and cause poor musicianship. Therefore, a proper room tuning not only benefits the recording

medium, but enhances the musician's ability to perform in the studio.

The systems could also be useful in film and video studios to recreate the environment being portrayed. This would save on postproduction costs, where external processing is used to simulate the medium, and would perhaps create a more realistic atmosphere.

The studio would also have in place a very interesting special effects tool. The studio itself could be used as a processing chamber for reverb and delay effects in mixdown. And since there is no limitation in the sends to the ERES system, myriad unconceived effects would be available. This could include the use of specialized binaural effects which are difficult to create with conventional studio equipment.

There are some disadvantages to these systems, however. The studio would have to be of medium size, with

fairly high ceilings as previously discussed. Implementation in a small studio would be difficult, as feedback in the resonant loops and proximity to the ERES loudspeakers would increase. Thus, this system is not a cure-all. Yet, in the right applications, these systems would be powerful tools for multi-dimensional studios.

Since this system has never been used in a studio, the first application will be costly. And of course, with anything new, there will be some unexpected problems. The science, however, is ready. In time, if many studios were to successfully implement this system, the cost and problems would diminish, and the possibilities would multiply. Someone, somewhere, must now take the risk of the initial installation. It should be to their advantage, in the long run, over previous acoustical remedies. ■



# THE LEGEND CONTINUES

*When you're in the studio, tape that's good enough is not enough. Which is why for ten years Ampex has continued pushing the potential of recorded sound. Through a decade of increased fidelity and reliability, Grand Master™ 456 remains an audio tape obsessed with performance. Which is why more top albums are recorded on Ampex tape than any other tape in the world. For Grand Master 456, the beat goes on.*

**AMPEX**

Ampex Corporation, Magnetic Tape Division, 401 Broadway, Redwood City, CA 94063 415/367-3809

Ampex Corporation • One of The Signal Companies

## AND THE BEAT GOES ON

# The 2" multi-track for those with a 1 track mind. Value.

When selecting a multi-track, it's easy to get thrown off track. Why pay for technology, for technology's sake? It contributes most where you want it the least. Cost. But for professionals who value their music as much as their money, there's

stan motor delivers variable speeds in excess of 45 ips with heavy duty performance. And in video applications, external frequency or voltage controllers easily interface with the Mark III.

## Versatile Value.

The headblock is a precision milled, flat wired, self contained unit which simply plugs into place. Therefore, upgrading from 16 to 24 track recording can be accomplished without disturbing any head alignments, saving expensive time.

configuration allowing timely and hassle-free maintenance. We've also added new audio channels with low frequency record and replay trim, adjustable phase compensation and available sync head transformer.

These features, coupled with our optional full function nine memory autolocator, makes the Mark III the ultimate in appropriate tape technology.

Soundcraft's 760 Mark III Series. It's everything the 2" professional needs to get back on the right track. At a price that really attracts attention. Under \$18,000\*

\*Suggested retail SCM 762-16B. Other models up to \$24,950.

*Appropriate Technology*

# Soundcraft

**Soundcraft Electronics**  
1517 20th Street, Santa Monica, CA 90404  
(213) 453-4591 Telex: 664-923  
In Metropolitan N.Y. call (212) 315-0877

**Soundcraft Electronics Canada, Inc.**  
1444 Hymus Blvd., Dorval, Quebec, H9P 1J6  
(514) 685-1610 Telex: 05-822582

**Soundcraft Electronics Limited**  
5-8 Great Sutton Street, London, EC1VOBX,  
England Telephone: 01-251-3631 Telex: 21198

one recorder that's second to none. The new Mark III Series from Soundcraft.

## Heavy Duty Value.

A newly developed German cap-

## Extra Value For Nothing Extra.

Another valuable feature is its durable construction and modular

World Radio History

