

MIX

PROFESSIONAL AUDIO AND MUSIC PR

LIVE SOUND

ON TOUR WITH

STEVIE NICKS

BJÖRK

JOSS STONE

THE DECEMBERISTS

REGINA SPEKTOR

new handheld mics

FOX in the club

INSIDE TRACK

Mixing guitar

NATIVE PROCESSING

Making out multicore

#BXNKXJB *****CAR-RT LOT**C-000

#MX3306571# SAMP RGS

|||||

MARK GANDER S018

JBL 00166

8500 BALBOA BLVD

NORTHRIDGE CA 91329-0003

Dolby® Media Encoder

Now You Have a Choice

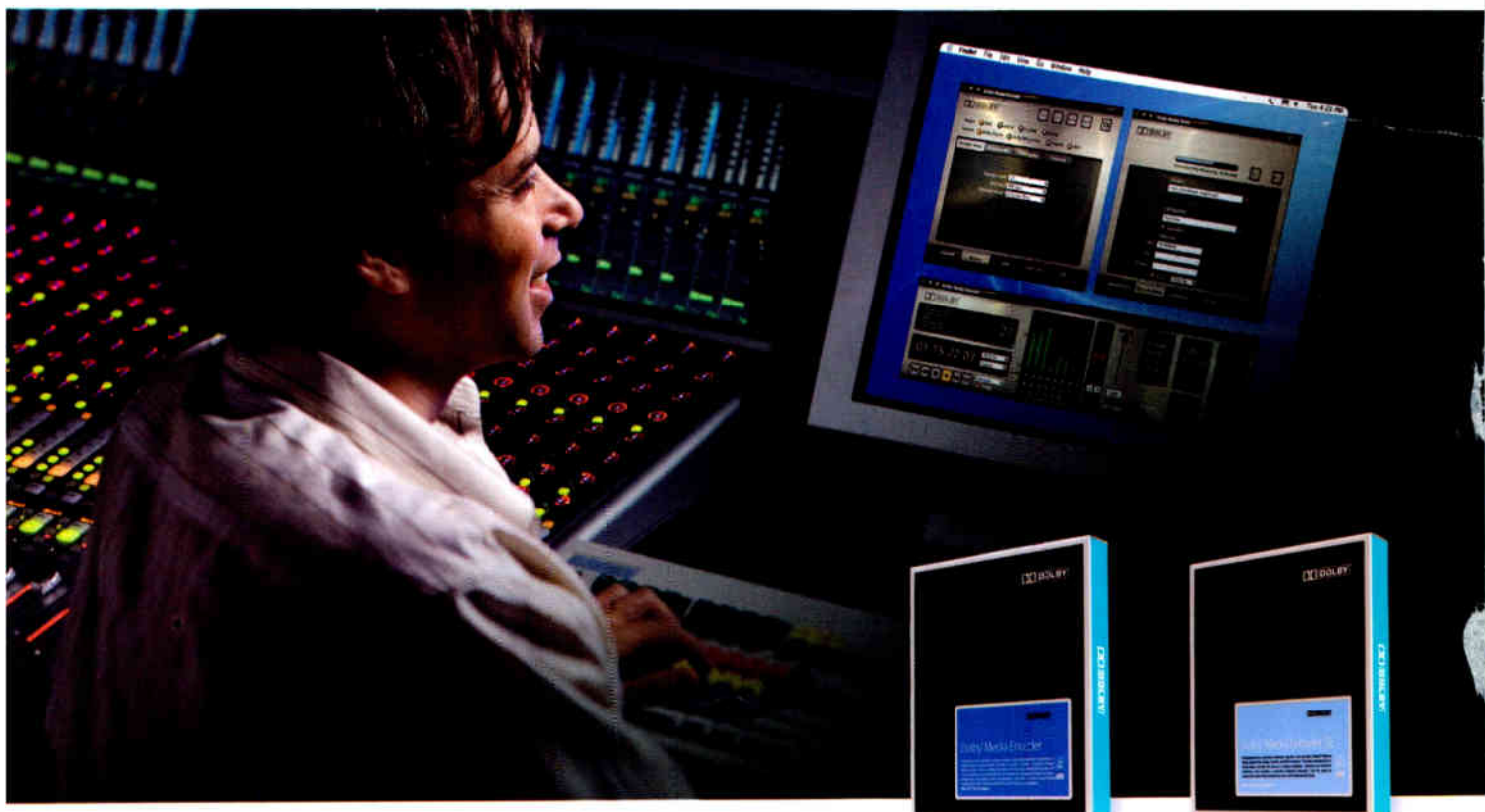

Dolby® Media Producer is the definitive professional software suite for mastering the audio files for all DVD and HD disc formats. Now there are two versions. **Dolby Media Encoder** includes three Dolby Media Clients that allow multiple operators to set up and submit jobs locally or over a network to a centralized facility server. **Dolby Media Encoder SE** is the cost-effective choice for use on a single computer. Both versions support all Dolby technologies for packaged media formats.

Choose the one that's right for you. Dolby Media Encoder and Dolby Media Encoder SE are now shipping. Contact your Dolby dealer for a demo and more details on all Dolby Media Producer products.

 **DOLBY**[®]
www.dolby.com

Features

Dolby Media Encoder
 Ideal for multiroom facilities

Dolby Media Encoder SE
 Cost savings for individual users

Features	Dolby Media Encoder Ideal for multiroom facilities	Dolby Media Encoder SE Cost savings for individual users
Supports encoding of Dolby Digital, Dolby Digital Plus, Dolby TrueHD, and MLP Lossless™ technologies	■	■
Compatible with Mac OS® X, version 10.4.2 or later	■	■
Includes integral preview decoder	■	■
Works with Dolby Media Decoder and Media Tools products	■	■
Allows queuing of multiple jobs for encoding	■	■
Optimized for use in multiroom facilities by multiple operators	■	
Designed for use on a single computer		■
Additional Media Encoder Clients available	■	
Allows encoding multiple codec types simultaneously on multiprocessor computers	■	
Permits browser access from any computer for administrative control of server jobs	■	

Dolby and the double-D symbol are registered trademarks of Dolby Laboratories. MLP Lossless is a trademark of Dolby Laboratories. Mac OS is a registered trademark of Apple Inc. © 2007 Dolby Laboratories, Inc. All rights reserved. S07/17782/17839

For recording, mixing, mastering, post-production, broadcast, and live sound.

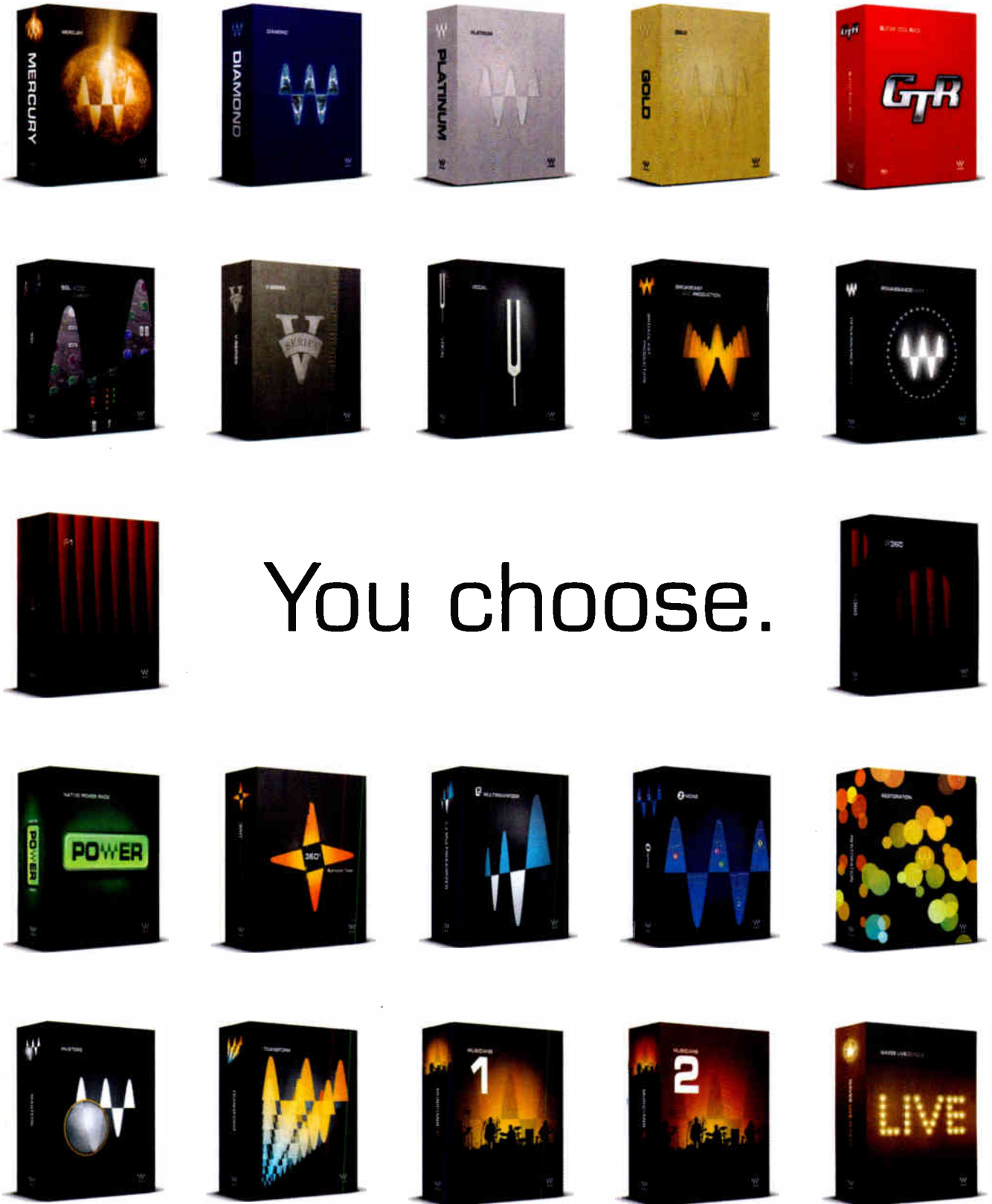

ROYER

Nineteen-time Grammy Award Winning Engineer

Al Schmitt

Photograph by Clark Schmitt

"When it comes to a ribbon mic,
there's nothing like a **Royer.**"

- Al Schmitt

(Engineer: Diana Krall, Natalie Cole, Ray Charles,
Chris Botti, Barbra Streisand, Steely Dan)



R-121
Ribbon Mic



R-122V
Variable
Type Ribbon Mic



SF-24

SF-24 Active
Stereo Ribbon Mic

Royer Ribbons - Hears Like Your Ears
Handcrafted in Burbank, CA • www.royerlabs.com • 818.847.0121

World Radio History

SON OF H8000



The Eventide H7600 Ultra-Harmonizer® Reviews are in...

*"...simply stunning, refined, glowing and always useful." **George Shilling, Resolution***

*"Apart from the dual-engine H8000FW, the H7600 is by far the best-sounding and most versatile professional multi-effects unit now available." **Barry Rudolph, Mix***

*"If I had the choice of just one processor unit to have with me in the studio, at this point, the Eventide H7600 would have to be that choice." **Simon Tillbrook, Audio Media***

*"...do yourself a favor and find your inspiration with a great outboard processor like the H7600....it will long outlast your next several digital workstations." **Adam Kagan, Tape OP***

Eventide®

For more information call (201) 641-1200, email audio@eventide.com or visit www.eventide.com
Eventide and Harmonizer are registered trademarks of Eventide Inc. ©2007 Eventide Inc.

World Radio History

INTRODUCING

S5 FUSION

Designed for HDTV Surround Sound Audio Post

The perfect fusion of...
System 5 Control Surface, DSP Channels
and EuCon control of multiple DAWs



euphonix.com

©2007 Euphonix, Inc. All Rights Reserved

220 Portage Avenue | Palo Alto, CA 94306 | p 650.855.0400 | f 650.855.0410

World Radio History

RND

Dynam-Izer™ Get Those Levels Under Control

Includes RTAS, VST, AU for Mac OSX & RTAS, VST for Windows® Why always apply the same compression to all audio levels? This plug-in lets you break your audio levels up into zones so you can control them exactly how you want.

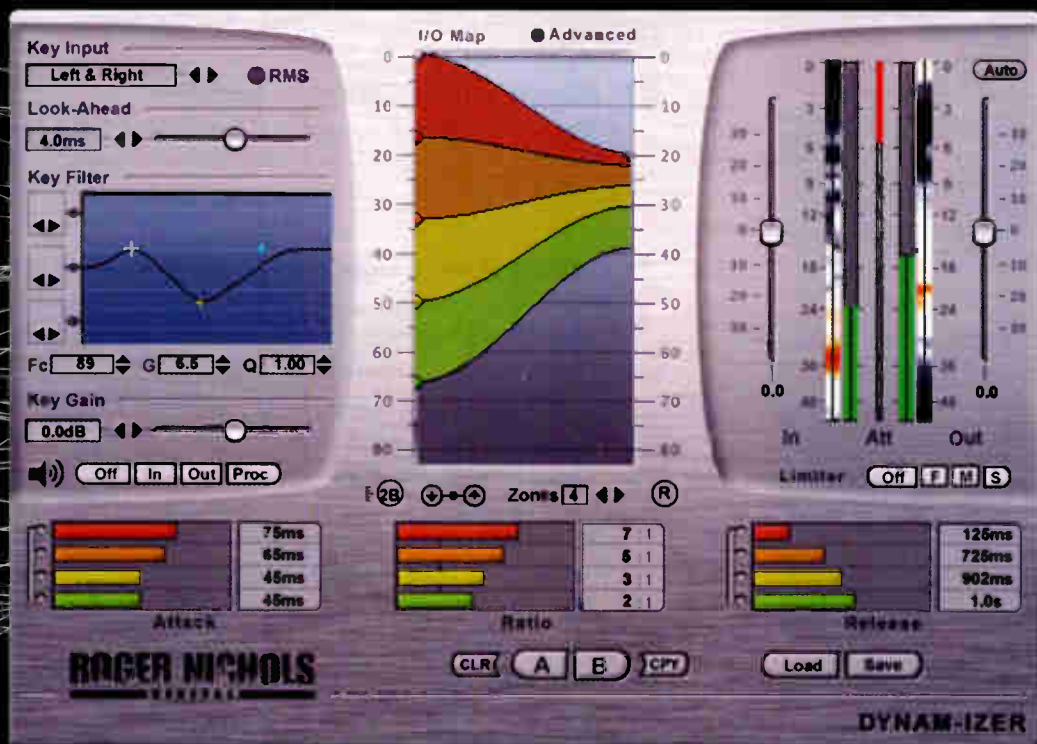

The revelation in digital processing!

ROGER NICHOLS
DIGITAL

www.RogerNicholsDigital.com 727.230-1603

RND™, DETAILER™, DYNAM-IZER™, FREQUAL-IZER™ and UNIQUEL-IZER™ are trademarks of Roger Nichols Digital, Inc. All other trademarks and registered trademarks remain the property of their respective owners. Design ©2006 RND

MIX

PROFESSIONAL AUDIO AND MUSIC PRODUCTION
 JULY 2007, VOLUME 31, NUMBER 7

features

22 The Inside Track: Mixing Guitars

A finely placed guitar track is key to a successful mix—whether it is the driving force on a song or strumming quietly in the background. *Mix* technical editor Kevin Becka continues this bimonthly mixing feature by focusing on the axe.

28 New Handheld Microphones

They get screamed at, whispered to, swung around, spit on...but a handheld microphone can be a vocalist's—and engineer's—best friend. Find out about the latest models.

36 Native Processing: Ready for Prime-Time?

Multicore processing is here, and it's poised to be a true challenger for hardware-based systems. But what about those hot-button issues: latency, CPU load, and everyone's favorite, compatibility? In a souped-up recording session, we put a quad-core SONAR DAW through the paces.

44 The Unfamiliar P.A.

While you may be in the midst of a summer-long shed tour, it's never too early to start thinking about the fall and upcoming club dates. *Mix* sound reinforcement editor Steve La Cerra offers tips to ensure that your "P.A. *du jour*" is on par, and that nothing is left off the rider.

52 Mix L.A. Open

Everyone scored at *Mix's* annual golf tournament, as all of the event's proceeds benefit hearing health and awareness charities.

56 TEC Awards Nominees

At this year's Technical Excellence & Creativity Awards in New York City, television sound mixer Ed Greene will be inducted into the TEC Hall of Fame. Find out the rest of this year's nominees in the Technical and Creative Achievement categories—which you can vote on for the first time online!



PAGE 22



PAGE 28

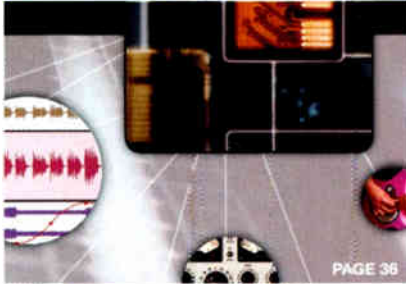

PAGE 36



PAGE

On the Cover: Out in support of her latest, *Introducing Joss Stone*, the soulful vocalist and 11-piece band are hitting numerous-sized venues—from clubs to arenas. Clair Showco is providing FOH/monitor/stage gear; racks and stacks are venue-provided. **Photo:** Steve Jennings.



Check Out Mix Online! <http://www.mixonline.com>

(Volume 31, Number 7) is ©2007 by Penton Media Inc., 9800 Metcalf Ave., Overland Park, KS 66212. *Mix* (ISSN 0164-9957) is published monthly. One-year (13 issues) subscription is \$35. Canada is \$40. All other international is \$50. POSTMASTER: Send address changes to *Mix*, PO Box 15605, North Hollywood, CA 91615. Periodicals Postage Paid at Shawnee Mission, KS and at additional mailing offices. This publication may not be reproduced or quoted in whole or in part by printed or electronic means without written permission of the publishers. Printed in the USA. Canadian GST #129597951; Canada Post Publications Mail Agreement #40597023. Canada return address: Bleuchip International, P.O. Box 25542, London, ON N6C 6B2.

VERSATILITY THROUGH ACCURACY

Musical accuracy, incredible detail and nearly unlimited dynamic range capability make the DPA 4011-TL THE cardioid for micing virtually any instrument.

Adding nothing to the sound, our uncompromising approach to microphone design has made DPA microphones the choice of discriminating professionals for both live and recorded sound for years. The new TL versions increase the resolution and detail of these legendary models.

Not only will the 4011-TL be the most musically accurate cardioid microphone you own, it will also be the most versatile.

Find out more at www.dpamicrophones.com or call us at 866-DPA-MICS



DPA 4011-TL

The microphones for sound professionals with uncompromising demands for musical accuracy

DPA 
MICROPHONES

contents

sections

SOUND FOR PICTURE

- 60 Greg Russell and Kevin O'Connell**
by Blair Jackson

LIVE MIX

- 72 Live Mix News**
76 All Access: The Decemberists
by Steve Jennings



PAGE 78

- 78 Tour Profile: Björk** by David Weiss
82 Tour Profile: Joss Stone
by Sarah Jones
84 Tour Profile: Stevie Nicks and Chris Isaak by Candace Horgan
88 New Sound Reinforcement Products

RECORDING NOTES

- 116 Michael Brecker** by Blair Jackson
117 Avril Lavigne by Heather Johnson



PAGE 117

- 118 Classic Tracks: The Ventures' "Walk, Don't Run"** by Gary Eskow

COAST TO COAST

- 122 L.A. Grapevine** by Bud Scoppa
122 Nashville Skyline by Rick Clark
123 N.Y. Metro Report by David Weiss
124 Sessions & Studio News
by Barbara Schultz

technology

- 94 Tools of the Trade**
98 Field Test: Lectrosonics Venue Hybrid Wireless Receiver



PAGE 98

- 102 Field Test: Focusrite Saffire Pro 26 I/O Interface**
106 Field Test: Klein + Hummel 0 100 D Active Studio Monitors



PAGE 106

- 108 Field Test: Mojave MA-100 Tube Microphone**
110 Field Test: zplane vielklang Auto-Harmonization Plug-In
112 Auditions
 - Audix VX5 Handheld Vocal Mic
 - TC Electronic Konnekt 24D FireWire Interface
 - Future Sonics Atrio Personal Monitors**144 Power Tools: Roland VS-2480**
by Eric Mauriello

columns

- 58 Project Studio: Maurice Gainen Productions** by Matt Gallagher

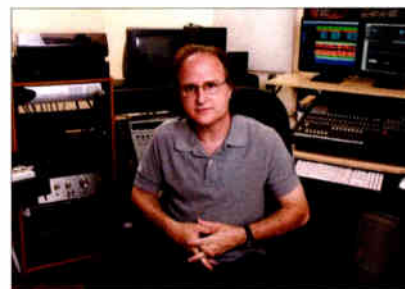

PAGE 58

- 68 AudioNext: Vortex Surround Technology** by Alex Brandon

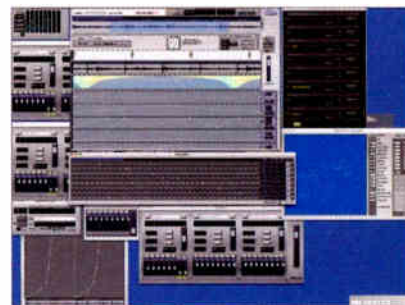

PAGE 68

- 90 Tech's Files: Summer D.I.Y. Fun** by Eddie Ciletti

departments

- 10 From the Editor**
14 Feedback
16 Current
129 Mix Marketplace
135 Classifieds

Digidesign Reference Monitor Series— Nothing but the Truth



Digidesign revolutionized the music and post-production industries with Pro Tools[™], empowering audio professionals to create the best-sounding audio possible. To further ensure this audio integrity, Digidesign now looks to redefine the near-field monitoring experience with the introduction of the Digidesign Reference Monitor Series (RMS), co-developed with world-leading professional monitor manufacturer, PMC.

Using PMC's groundbreaking Advanced Transmission Line (ATL[™]) technology, the RM1 and RM2 professional near-field monitors deliver pristine, high-resolution clarity and accurate low-frequency response to provide the most honest representation of your audio mix. You can now hear the excitement and life of your recordings in their truest, purest form. To facilitate this, onboard DSP manages a variety of tasks, including the complex digital crossover, which employs sophisticated filter designs resulting in extremely low distortion and superb phase response over a wide listening window. And if you want to hear how your mix translates to a ported speaker, simply engage Bass Port Emulation mode to have the monitors emulate the tonal characteristics of a ported bass reflex speaker, allowing for easier mix compensation decisions.

Learn more about the Digidesign Reference Monitor Series at digidesign.com/rms or experience next-generation near-field monitoring for yourself at your local Digidesign dealer today.

ENGINEERED WITH
PMC



MIX[®]

GROUP EDITORIAL DIRECTOR Tom Kenny tkenny@mixonline.com
EXECUTIVE EDITOR George Petersen gpetersen@mixonline.com
EDITOR Sarah Jones sjones@mixonline.com
SENIOR EDITOR Blair Jackson blair@blairjackson.com
TECHNICAL EDITOR Kevin Becka kbecka@earthlink.net
GROUP MANAGING EDITOR Sarah Benzuly sbenzuly@mixonline.com
ASSISTANT EDITORS Barbara Schultz bschultz@mixonline.com
 Matt Gallagher mgallagher@mixonline.com
LOS ANGELES EDITOR Bud Scappo bs7777@aol.com
NEW YORK EDITOR David Weiss david@dwords.com
NASHVILLE EDITOR Rick Clark rmluge@mac.com
FILM SOUND EDITOR Larry Blake smelltone@aol.com
SOUND REINFORCEMENT EDITOR Steve La Cera
CONSULTING EDITOR Paul D. Lehman lehman@pan.com
CONTRIBUTING EDITORS Michael Cooper Heather Johnson
 Eddie Gletti Gary Eskow Barry Rudolph

SENIOR ART DIRECTOR Dmitry Panich dmitry.panich@penton.com
ART DIRECTOR Kay Marshall kay.marshall@penton.com
ASSOCIATE ART DIRECTOR Elizabeth Heaven
PHOTOGRAPHY Steve Jennings
INFORMATIONAL GRAPHICS Chuck Dahmer

EXECUTIVE VICE PRESIDENT Darrell Denny darrell.denny@penton.com
VICE PRESIDENT John Chalon john.chalon@penton.com
ASSOCIATE PUBLISHER Erika Lopez erika.lopez@penton.com

DIRECTOR OF AUDIENCE AND BUSINESS DEVELOPMENT
 Dave Reik dave.reik@penton.com
DIRECTOR OF INTERACTIVE AND LIVE MEDIA
 Joanne Zala joanne.zala@penton.com
ONLINE AUDIENCE DEVELOPMENT MANAGER Tami Needham
tami.needham@penton.com

NORTHEAST ADVERTISING DIRECTOR Michele Kanatous
michele.kanatous@penton.com
NORTHWEST ADVERTISING MANAGER Greg Sutton
greg.sutton@penton.com
SOUTHWESTERN ADVERTISING MANAGER Albert Margolis
albert.margolis@penton.com
SOUTHEAST/EUROPE ADVERTISING MANAGER Jeff Donnerwerth
jeff.donnerwerth@penton.com

CLASSIFIEDS/MARKETPLACE ADVERTISING DIRECTOR
 Robin Boyce-Trubitt robin.boyce@penton.com
CLASSIFIEDS/SPECIALTY SALES MANAGER
 Kevin Blackford kevin.blackford@penton.com

MARKETING DIRECTOR Kirby Asplund kirby.asplund@penton.com
SALES & MARKETING COORDINATOR Clarina Roydmanov
clarina.roydmanov@penton.com
SALES & EVENTS COORDINATOR Jennifer Smith
jennifer.smith@penton.com

DIRECTOR, SPECIAL PROJECTS Hillel Resner hillel.resner@penton.com

VICE PRESIDENT, PRODUCTION Lisa Parks lisa.parks@penton.com
SR PRODUCTION DIRECTOR Curt Pordes curt.pordes@penton.com
PRODUCTION MANAGER Liz Turner liz.turner@penton.com
CLASSIFIED PRODUCTION COORDINATOR Jamie Coe
jamie.coe@penton.com

VICE PRESIDENT, AUDIENCE MARKETING Jerry Okabe jerry.okabe@penton.com

OFFICE MANAGER Lara Duchnick lara.duchnick@penton.com

COPYRIGHT 2007
 Penton Media Inc.
 ALL RIGHTS RESERVED.

FOUNDED IN 1977 BY DAVID SCHWARTZ AND PENNY RIKER

Live Sound—New Style

It's often been said that live sound is slow to change—one of the most conservative industries around. This is partly true in the sense that SR pros are often reticent to take new, untested gear out in the field for the sake of technology. When a performer's onstage and the audience is in the house, there are no second chances.

Yet live sound technologies have changed radically during the past two decades or so. These days, it's a rare instance to not find a laptop at front of house, whether for wireless frequency coordination, running acoustical measurement/analysis programs or simply storing digital console presets for quick setups. On the manufacturing side, CAD-driven design tools have brought significant improvements, leading to the development of new enclosure concepts, and better horns and drivers.

Meanwhile, DSP control has become firmly ingrained into even the most basic routines and procedures of system design/production. Single boxes providing cross-overs, delays, EQ and driver/system overload protection are now standard, replacing racks of gear and putting fingertip control in the operator's hands, whether from a front panel, laptop or Wi-Fi tablet. There's something very cool (and certainly convenient) about doing system tweaks while sitting in the back row or off to the side under a balcony.

Fiber-optic snakes offer signal distribution in a lightweight, easily transportable rig, while the old issues of ground loops and "who gets the first split" become passé. As an added benefit, remotely controllable stage boxes provide clean signals that are easily carried over longer runs—unlike the horrors and low-fi results of sending a mic-level signal over a 200-foot copper snake.

In terms of live sound, these really are the good old days. Amps are smaller, lighter and more reliable. Wireless rigs offer dependability and a sound that rivals hard-wired mics, while today's handheld mics put near-studio quality and condenser performance into bodies that are almost indestructible. At the house or monitor position, modern consoles easily outperform their predecessors from just a few years back, with digital boards offering the versatility of onboard processing and/or plug-ins. As in-ear monitoring becomes the norm, stage volumes can be substantially reduced.

Now that all of the tools are in place, we finally have the key to the puzzle. Once such factors as band volume, venue irregularities and system/driver imperfections are removed from the equation, engineers are actually in charge of the mix—where it belongs. And that is the true benefit of technology.

In other news, we ushered in some big changes here at *Mix*. Tom Kenny moves from editor/editorial director to take the helm as the group editorial director for *Mix*, *Electronic Musician* and *Remix*. Sarah Jones steps up as *Mix*'s new editor, and Sarah Benzuly is now the group managing editor for all three magazines. The reason behind it is to offer better ways of presenting the information you need on a daily, weekly and monthly basis—in print and online. We have some exciting things planned in the months to come. Stay tuned.

George Petersen
 Executive Editor

Sweetwater®

Music Instruments & Pro Audio

A Better Way To Buy Gear



➤ **GREAT PRICES & THE BEST VALUE!**

Sweetwater's great prices and unparalleled customer service lead the industry.

➤ **HUGE SELECTION OF THE LATEST GEAR!**

Our massive 40,000-square-foot warehouse is brimming with the gear you want.

➤ **FRIENDLY, KNOWLEDGEABLE SALES!**

Our Sales Engineers are well-trained and know the gear inside and out.

➤ **FREE 24/7 ONLINE TECH SUPPORT!**

The best technical minds in the business are at your disposal around the clock.

Sweetwater®

Music Instruments & Pro Audio



sweetwater.com



Call today and experience the sweetwater difference!

1-800-222-4700

World Radio History

Hear no hum!

Look for InGenius inputs in your pro audio gear

InGenius[®]

Balanced Line Receiver ICs

THAT Corporation

Analog ICs for Pro Audio™

www.thatcorp.com/mix2.html e-mail: mix2@thatcorp.com

WWW.MIXONLINE.COM

Penton Media

Chief Executive Officer John French john.french@penton.com

Chief Financial Officer/Executive Vice President Eric Lundberg
eric.lundberg@penton.com

Sr. Vice President, Administration Eric Jacobson eric.jacobson@penton.com

Vice President, Human Resources Kurt Nelson kurt.nelson@penton.com

Chief Operating Officer Andrea Persily andrea.persily@penton.com

Chief Technology Officer Cindi Reding cindi.reding@penton.com

Vice President, General Counsel Robert Feinberg robert.feinberg@penton.com

Vice President, New Media Group Prescott Shibles prescott.shibles@penton.com

Vice President, Corporate Controller Steve Martin steve.martin@penton.com

SUBSCRIBER CUSTOMER SERVICE: To subscribe, change your address or check on your current account status, go to www.mixonline.com and click on "Customer Service" for fastest service. Or, e-mail mix@espcamp.com, call toll-free 866/860-7087 or 818/487-2020, or write to P.O. Box 16886, N. Hollywood, CA 91606.

BACK ISSUES: Back issues are available for \$10 each by calling 800/532-8190 or 815/734-1216.

POSTMASTER: Send address changes to *Mix* magazine, P.O. Box 638, Mt. Morris, IL 61054.

PHOTOCOPIES: Authorization to photocopy articles for internal corporate, personal or instructional use may be obtained from the Copyright Clearance Center (CCC) at 978/750-8400. Obtain further information at copyright.com.

REPRINTS: Contact FasteReprints to purchase quality custom reprints or e-reprints of articles appearing in this publication at 866/436-8366 (219/879-8366 outside the U.S. and Canada). Instant reprints and permissions may be purchased directly from our Website; look for the RSCopyright tag appended to the end of each article.

ARCHIVES AND MICROFORM: This magazine is available for research and retrieval of selected archived articles from leading electronic databases and online search services, including Factiva, LexisNexis and ProQuest. For microform availability, contact National Archive Publishing Company at 800/521-0600 or 734/761-4700, or search the Serials in Microform listings at napubco.com.

PRIVACY POLICY: Your privacy is a priority to us. For a detailed policy statement about privacy and information dissemination practices related to Penton Media Inc. products, please visit our Website at www.penton.com.

LIST RENTAL: Marie Briganti marie.briganti@walterkarl.info.usa

MAILING LISTS: Penton Media Inc. makes portions of our magazine subscriber lists available to carefully selected companies that offer products and services directly related to the industries we cover. Subscribers who do not wish to receive such mailings should contact the Penton Media Inc. subscriber services at 800/532-8190 or 740/382-3322.

CORPORATE OFFICE: Penton Media Inc., 249 West 17th St., New York, NY, www.penton.com.

NATIONAL EDITORIAL, ADVERTISING AND BUSINESS OFFICES: 6400 Hollis St., Suite 12, Emeryville, CA 94608; 510/653-3307; fax 510/653-5142; Website: www.mixonline.com. **PHOTOCOPY RIGHTS:** Authorization to photocopy items for internal or personal use of specific clients is granted by Penton Media Inc., provided that the base fee of U.S. \$2.25 per copy, plus U.S. \$00.00 per page is paid directly to Copyright Clearance Center, 222 Rosewood Drive, Danvers, MA 01923. The fee code for users of this Transactional Reporting Service is ISSN 0164-9957/2000 \$2.25 + \$00.00. For those organizations that have been granted a photocopying license by CCC, a separate system of payment has been arranged. Before photocopying items for educational classroom use, please contact CCC at 978/750-8400.

Simply Stated

Joe Satriani Guitar Amp Mic Pack



Need we say more?

To learn more about
the Joe Satriani
Guitar Amp Mic Pack
visit us at www.cadmics.com

Visit us at NAMM booth
#518

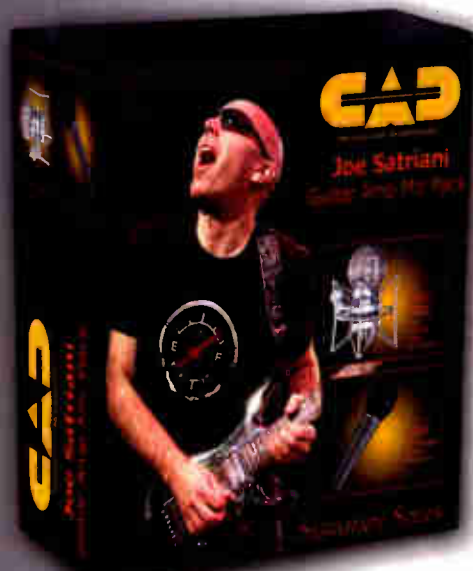

Joe Satriani Guitar Amp Mic Pack
Contains: Trion 7000 & D189



FRANK FILIPETTI

Five-time GRAMMY® Award-winning engineer,
producer whose credits include projects with:

10,000 Maniacs
Barbra Streisand
Billy Joel
Carly Simon
Courtney Love
Elton John
Frank Zappa
James Taylor
John Waite
Kiss
Korn
Luciano Pavarotti
Luther Vandross
Mariah Carey
Ray Charles
Rod Stewart



"When working in a recording environment, I've found it critical to 1. create an atmosphere that people find comfortable and 2. make sure the listening environment, especially your speakers, are as good as you can get - so you don't second-guess what you're hearing. When I first used the LSR6300s, I just loved what I was hearing and I've been using them ever since. They're smooth across the entire spectrum. I don't hear the speaker - just the music. Working in a range of rooms in LA, London, and here in Manhattan, the ability to tune the LSRs to the room is extremely useful. I'm really stoked about the new LSR4300 series especially the 6-inch model. The 4300s, with automated Room Mode Correction, go one step further. I put the supplied calibration mic in the center of the room, push a button and the speaker does all the work. It not only does it, it does it well and it does it right! The technology's amazing - I'm blown away by it. I take my LSRs wherever I go."

Hear why award-winning engineer, producer, Frank Filipetti is blown away by the
LSR series studio monitors. Visit JBLPRO.com/LSR



LSR4300

S E R I E S



H A Harman International Company

World Radio History

Letters to Mix

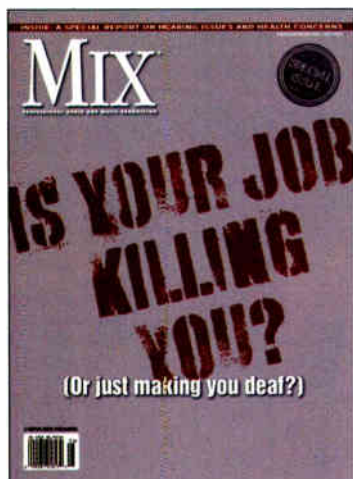

IT'S ABOUT TIME

God bless you and your staff for the article on hearing loss. I used to love to record, getting the sound just right, then I got the 'T' [tinnitus]. That was two years ago, and it's still hard to deal with today. Since then, I've sold all of my recording gear, which was very painful to get rid of. I just hope more people will get the information you provided in other media ways.

Daniel Thomas

LEARNING TOO LATE

I played in some pretty loud bands and did not use hearing protection. I actually bought a pair of Etymotic Research musician's earplugs with a 15dB attenuation and didn't wear them; they made me feel like I was playing in another room. Looking back, I feel bad. I wear two hearing aids now. By the way, good hearing aids are very expensive. I have a *major* hearing deficit between 1 and 6 kHz. I have to ask people to say things over because I might not understand it the first time. Also, because of this, my hearing is inaccurate. Forget mixing. I don't trust my ears (with great reason).

What would I have done differently? On concert days, I should have worn the plugs starting mid-afternoon so that I would have become adjusted to the different dB level and would not have freaked out onstage when the music started and removed the plugs. Once your hearing is gone, it's never coming back.

Anonymous

MUSIC THERAPY

I was really glad to see your article on audio therapy ("Insider Audio," May 2007). I am an

audio engineer on the product-development team for Advanced Brain Technologies. The company's primary product, The Listening Program (TLP), was designed for home use under direction of a certified professional, and the flexibility gained has huge implications.

I was a little disappointed that the AIT practitioners "don't talk much about the technology." We want people to understand exactly what TLP is doing and why it works. ABT set up a Website just for this purpose (www.thelisteningprogram.com). I've found that even we audio professionals underestimate the impact that sound has on the brain and body. Occupational therapists, neurologists and other health professionals are really at the front lines of realizing the dramatic impact that controlled frequency can have on an individual.

This is a field that needs more research and attention given by our industry. Good for you for devoting an entire issue to audio-related health—both ours and those whom our industry can rightly take responsibility for!

Greg Lawrence

Lawrence Lockhart Studios

Advanced Brain Technologies

WHEN HEARING DAMAGE HURTS

I work for Hosa Technology, but in my "former life," I was a keyboard player/saxophonist in a loud dance band. For four hours a night, five or six nights a week, my unprotected ears withstood the onslaught of the drummer's ride and crash cymbals (which were set up pretty much exactly at my ear height), as well as our guitarist's Strat/Twin combination, which were always "dimed," not to mention my own 15-and-horn-amplified synth setup.

Now, at age 57, I have developed a severe hearing condition called "recruitment," in which certain audio frequencies sound painfully loud to me. Certain voices "cut through me," and I have to ask the speaker to talk more quietly, especially if there is any other sound happening at the same time. Something as seemingly innocuous as the sound of a person opening a plastic bag of chips can force me to plug my ears. Restaurants with lots of "live" surfaces are particularly brutal. The sound of plates and silverware clinking, the murmur of many voices, the background music system all combine into a monolithic roar in my ears.

If I had worn foam earplugs during all of those years of abuse onstage, I could have

prevented this condition that severely reduces my current quality of life. Now, the only relief is to avoid those sounds and situations that exacerbate my symptoms. And yet many of those situations, like eating out at a restaurant, are things that used to give me great pleasure. To you guys in your 20s who insist upon monitoring *loud* and who frequent the clubs, and whose car stereo systems' decibel levels rival those of live venues, and whose iPods are plugged directly into the ear canal for hours a day, I say this: You must protect yourselves. You wouldn't repeatedly jam your thumbs in your eyes, would you? How important to you is your hearing and your future quality of life? Get smart now or pay the price.

Lee Watkins

Hosa Technology, VP/general manager

IT'S JUST TOO LOUD

I'm writing about the earplug poll [at mixonline.com]; it is quite revealing. If two-thirds of musician/sound techs who love music and live for audio have to wear earplugs at concerts, is this not a huge wake-up call that concert volumes have gotten severely out of hand?

A little time [of listening at] over 100 dB, our ears begin to auto-compress and shut down. If we're at a concert where SPLs are over 110 dB, we cannot "hear everything," as the poll suggests. Our ears are already in self-protection mode, though not equally across the frequency spectrum. Pro studio mixers who want to hear everything mix at low to mid-volumes, and rarely above 85 dB. Much above 100 dB for very long, and we may lose some hearing permanently in a part of the frequency range. I understand that some concerts will run up to and even over 115 dB! I can only assume that those running sound and those in attendance have already damaged the sensitivity in their ears and are by now already suffering from at least partial deafness.

I would hope the concert industry wakes up. No way should an engineer mix with earplugs: His sense of balance is impaired. Also, it is a dead giveaway that he's simply running things too loud and people closer to the speakers are getting their ears damaged. Let's bring the music back to listenable levels.

Craig Allen

Send Feedback to *Mix*
mixeditorial@mixonline.com



You know what your music looks like.
Now find out what it sounds like.

The powerful new EXO studio monitoring system from Blue Sky delivers true, full range sound, so you'll hear every detail of your music.

Thanks to a desktop remote hub, you can plug in your computer, your mp3 player and your mixer, all at the same time – and all without having to crawl around under your desk.

It's affordable, accurate audio monitoring that sits on – and under – your desk.

So when you're ready to hear what your music sounds like, you're ready for EXO. Find out more at www.abluesky.com and ask your local dealer for a demo today.



EXO

All the Monitoring You Need



www.abluesky.com

blue sky

JOHN MORGAN EARGLE, 1931-2007



John Morgan Eargle, an author, educator, engineer and product developer whose writings influenced a generation of audio students, passed away in late May. He was 76.

Born in Tulsa, Okla., he pursued degrees in music and electrical engineering from the Eastman School of Music (B.M.), University of Michigan (M.M.), University of Texas (B.S.E.E.) and Cooper Union (M.E.).

Eargle joined JBL as a consultant in 1976, and soon after moved to a full-time position as VP of product development. In the early 1980s, he returned to a consulting role

as senior director, product development and application, the position he held for the rest of his life.

Eargle participated in product-development activities for the professional and consumer JBL divisions, for Harman Becker on branded car sound systems and for other Harman divisions. He championed the concept of flat power response in sound reinforcement applications, and conceived of the application of the Bi-Radial® constant-coverage horns to both studio monitors and cinema systems. In 2002, Eargle and other JBL engineers received a Scientific and Engineering Award from AMPAS for the concept, design and engineering of the modern constant-directivity, direct radiator-style motion picture loudspeaker systems.

He had just completed the book *The JBL Story: 60 Years of Audio Innovation* and had previously co-authored *JBL Audio Engineering for Sound Reinforcement*, which are among 10 books on audio, loudspeakers, microphones and recording that he authored. He taught at the Aspen Audio Recording Institute for more than 20 years and was a member of its corporate board.

In recording, he was a member of NARAS, and had engineered and/or produced more than 275 albums, including releases from Grammy-winners Joe Williams and Ruth Brown; Eargle took home a Grammy himself in 2001 for Best Engineered Album, Classical, for *Dvorák: Requiem, Op. 89; Sym. No. 9, Op. 95 From the New World*.

He was a member of the National Academy of Recording Arts and Sciences, the Academy of Motion Picture Arts and Sciences and of the Society of Motion Picture and Television Engineers; a senior member of the Institute of Electrical and Electronic Engineers; a Fellow of the Acoustical Society of America and reviewer of electro-acoustical patents for the *ASA Journal*; and a Fellow, honorary member and past-president of the Audio Engineering Society. Eargle also served as a member of the AES Journal Review Board and was awarded the AES Bronze Medal.

"John Eargle and I both joined JBL in 1976, and John was continually associated with JBL for the last 31 years," says Mark Gander, JBL Professional VP marketing. "His broad academic and practical background, his technical

and applications knowledge, his leadership talents and political acumen, and his erudite writing and presentation skills all made essential contributions to myriad JBL projects and products. He was truly a modern renaissance man, whether behind the keyboard of his piano, behind the mixing console at a recording session, behind the analyzer with the transducer engineers, behind the lectern giving a presentation or sitting in the listening position in cinema, studio, car or home. He was a colleague and a friend, and will be missed by many."

"John was one of a kind," adds Leslie Ann Jones of Skywalker Sound. "So accomplished, so humble, such a great recording engineer, so happy doing

The industry lost a giant with the passing of John Eargle, but we at JBL and Harman International lost a beloved and revered member of our family. John Eargle cannot be replaced, but his life, his vision and his many contributions to our industry can and will be memorialized in concrete ways by our company.

—Dr. Sidney Harman, Harman International Industries' founder/
executive chairman

what he loved, always equally as interested in other's recent works, always a gentleman. There's not much more one can say except our community has lost a great one. I'll miss him."

John Eargle is survived by brother Robert Gray Eargle, sister Pauline Tension Eargle Dahlgren, nephew John Paul Eargle and five additional nieces and nephews.

Industry colleagues have established a remembrance Website at www.johnmeargle.com; plans are under way for a memorial convocation for friends and associates to be held in the near future. In addition, a scholarship fund has been established in Eargle's name under the auspices of the Audio Engineering Society's Educational Foundation. The John M. Eargle Memorial Scholarship will be given to a deserving student who combines the attributes of engineering capability and musical interests in the tradition of John Eargle. The scholarship is being established with an initial donation from JBL/Harman International Industries, Incorporated. Contributions should be made by check to the AES Educational Foundation with instructions to credit the Eargle Fund. They should be mailed to: AES Educational Foundation, Robert Sherwood, Treasurer, One Wolf's Lane, Pelham, NY, 10803. All contributions will be acknowledged. ■

TEC AWARDS UPDATE



ED GREENE TO JOIN HALL OF FAME

Acclaimed production sound mixer Ed Greene will join an elite group of individuals as he is inducted into the TEC Hall of Fame at the 23rd Annual Technical Excellence & Creativity Awards, Saturday, October 6, 2007, at the New York Marriott Marquis. For a complete list of this year's nominees, go to page 56.

Greene has mixed some of the most highly regarded music, variety and award shows, and has won 19 Emmys, with a total of 47 nominations. He has taken home nine TEC Awards and has been nominated 14 times (including this year). Greene has also received a Cinema Audio Society Award (four nominations) and was honored by the organization this year as a 2007 C.A.S. Career Achievement Award honoree. He has worked on such shows as *The Academy Awards*, *The Emmy Awards*, *Kennedy City Honors*, *Will & Grace*, *So You Think You Can Dance*, *The West Wing* and the *AFI Tribute to George Lucas*, among many others.

For tickets or information about the TEC Awards, contact Karen Dunn at 925/939-6149 or Karen@tecawards.org, or visit www.mixfoundation.org.

TEC VOTING GOES ONLINE

For the first time, voting for the 23rd Annual TEC Awards will be conducted via an online ballot. *Mix* subscribers will be able to access the ballot using a personal passcode beginning August 1 to vote in 25 categories of Technical and Creative Achievement. Voting instructions will be included in the "TEC Awards Voters Guide" in the August issue of *Mix*, as well as at www.mixonline.com and www.mixfoundation.org. If you are not a *Mix* subscriber, sign up today!

ON THE MOVE

Who: Ralf Tschannun, AKG VP of sales
Main Responsibilities: develop and execute the sales strategy to strongly grow the AKG business.

Previous Lives

- 2006-2007, Avaya Inc. director of sales
- 1998-2006, Cisco Systems sales manager
- 1988-1998, IBM in various positions in Austria, Russia and other Eastern European countries

If I could do any other profession it would be...a race car driver!

If I could ask one question to my favorite recording artist, it would be: Why did you pass away so early, Freddie?

Currently in my CD changer (or iPod): Adam Green's *Friends of Mine*, The Dresden Dolls' *Yes Virginia*.

When I'm not in the office, you can find me... doing sporty activities like free-climbing, kite-surfing, mountain biking, skiing, golfing, wake-boarding, playing tennis, squash or football.



NOTES FROM THE NET

ALBUM CREATION VIA ONLINE COLLABORATIONS

StudioTraxx.com provides a free e-commerce platform that allows artists/bands to purchase and book time with musicians, engineers, producers and other professionals for online studio collaborations. Through the site, users create "Musician for Hire" accounts that include a profile/resume, samples of work, availability and hourly/project rates. Likewise, bands, songwriters, managers and individual artists can create "Artist" accounts whereby they can assemble a music project and then find and book time with musicians. All work is exchanged as digital files through the site.

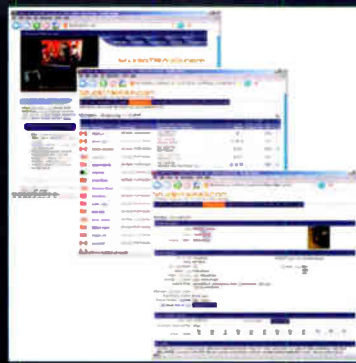

INDUSTRY EVENT NEW MUSIC WEST



On May 6, Canadian Recording Services and the Warehouse Studio (Bryan Adams' facility) sponsored a producer/engineer workshop for music conference New Music West. Of the many participants, shown is Randy Staub presenting a master mixer workshop in Studio 1, where he focused on an engineer's mix role and showed off some of his tricks. Other presenters included Mike Fraser, Dave Ogilvie, Chris Potter and Jeff Dawson.

AND THE WINNER IS...

Keith Denmon is the winner of our "Got a Pocket Full of Quarters...and a Lighter" arcade game trivia question (March 2007). The winning answer was chosen in a random drawing from correct submissions. The arcade game was called *Journey* and was released in 1983 to coincide with the tour supporting the band's release of the *Frontiers* album. Denmon wins a three-disc *Journey* box set—congratulations!



Mix also congratulates all those who submitted the correct answer: Mitchell W. Barratt, the Romano Brothers, Anthony Caruso, Pete Chu, James Creer, Jon Cyphers, Steve Foldvari, John Hennessey, Timothy B. Hewitt, Sammy James, Ken Landers, Sam Larkin, Less Lincoln, Brian Madison, Jeff Sansone, Kevin Schilder, Robert J. Shook, Elisa Silva, Chris Webb and Sam Wetsel.

MEDIATECH GROWS

The MediaTech Institute (www.mediatechinstitute.com), housed at the Dallas Sound Lab, expanded its Las Colinas facilities to make room for its new digital film and video arts studios. The studios will shoot for the commercial film industry, but the institute also includes programs designed to teach students how to make movies using high-definition video. The \$500,000, 7,500-square-foot facility includes an insert stage with three studio cameras and a control room, edit rooms with two Avid DS/Symphony Nitris systems and a post-production lab. Most of the studio equipment was purchased from Houston's KPRC.



CREATING MUSIC EXPO



Intel, Cakewalk and Microsoft hosted a listening panel at the ASCAP Expo: I Create Music (April 19-21, 2007), focusing on what it takes to make a well-produced and engineered demo. Titled "Audio Production & Engineering Listening Panel," the Intel/Cakewalk-sponsored panel featured Grammy Award-winning producers and engineers who critiqued actual demos and gave tips on how to make the best-possible production. From left: moderator Carl Jacobson (Cakewalk marketing director) and panelists Allen Sides (Ocean Way Studio), Nathaniel Kunzel (Studio Without Walls), Terry Howard (engineer/producer), Michael Boddicker (composer/producer) and Benjamin Wright (producer/engineer/songwriter).

COMPOSER HAVEN

Composers Cody Westheimer and Julia Newmann have opened their own recording/mixing facility, New West Studios (L.A., www.newweststudios.com), which offers two control rooms, a shared live recording/instrument room and a screening room. Westheimer (*The Runner*, *Innerstate*, *Little People Big World*) works out of Studio C (JBL LSR4300 5.1 monitoring system, Auralex custom acoustic treatments), while Newmann (*Giving for Giving*, *Freedom Park*) can be found in Studio J (JBL LSR4300s).



INDUSTRY NEWS

Quentin Howard, chief executive of Digital One and president of the WorldDMB Forum, has joined APT's (Belfast, Ireland) board of directors in a non-executive capacity...New York City-based MusicBox hired Aaron Davis as VP, licensing...New business unit manager for Beyerdynamic's (Farmingdale, NY) pro audio division is Paul Froula...New face at Aviom (West Chester, PA) is Michael J. McGinn, VP, sales and marketing...Networking and storage solutions provider Small Tree Communications (Oakdale, MN) appointed Jeffrey D. Bipes to director of marketing and sales...Digigram (Grenoble, France) new hires: Eric L. Richardson, director of strategic marketing, and James Ohana, solutions integration manager...Responsible for a territory comprising Texas, Oklahoma, Arkansas, Mississippi and Louisiana is Terrence Becht, district



Quentin Howard

sales manager for Harris Corp.'s (Cincinnati) Radio Broadcast Systems business unit...Sennheiser (Old Lyme, CN) welcomed Robby Scharf to its fold as Western region market development manager, pro and MI products...Joe Fustolo is EAW's (Whitinsville, MA) new manager of the company's application support group...Gepco (Des Plaines, IL) promoted Todd Harrington to Midwest regional manager; the company also added a New York branch in Chestnut Ridge, N.Y....Distribution deals: Bosch Communications Systems (Burnsville, MN) announced that Erikson Pro will no longer distribute its Dynacord line in Canada; Dolby Labs' (San Francisco) Live Sound group added these distributors: Vari Internacional SA de CV (Mexico City), Sotex Audio E Luz Ltda. (Brazil), Media Business Solutions (Warsaw), R.K. International Pte. Ltd. (New Delhi) and Samat Show Technics Ltd. (Republic of Kazakhstan); Brauner Microphones' (Rees, Germany) new North American distributor is Network Pro Marketing (Corona, CA), which is also handling Vovox Sound Conductors (Switzerland) in North America.



3 NEW SOUNDS FOR
**EVERY SONG. EVERY STAGE.
EVERY VOICE.**

**ATM710
FOR STUNNING
FIDELITY.**

The ATM710 cardioid condenser delivers exacting detail and highest-fidelity vocal reproduction. Ideal for stages with controlled volume. **Tailored for studio-quality live performance.**

**ATM610
FOR BLARING
STAGES.**

The ATM610 hypercardioid dynamic microphone offers focused pickup, reduced feedback and minimal stage spill. **It cuts through the mix when vocals really need to stand out.**

**ATM410
FOR ULTIMATE
FEEDBACK
SUPPRESSION.**

The ATM410 cardioid dynamic delivers smooth, natural reproduction in the face of hot stage monitors. **The perfect all-purpose lead/backup vocal mic.**

ARTIST SERIES™
THE NEXT GENERATION IS HERE.

For detailed information on the all-new Artist Series, visit www.audio-technica.com.

 **audio-technica**
always listening

World Radio History

LISTEN...PLAY

READ...WATCH...LISTEN...PLAY

Go beyond the printed page and log on to www.mixonline.com to get extra photos, text and sounds on these select articles—plus much more online:



READ: "Tour Profile:" Bright Eyes

Only online can you read about the current Bright Eyes tour and peruse the photo gallery.



READ: "Inside Track: Mixing Guitars"

Get more information on properly bringing these crucial instruments into your next hit track.

LISTEN: "Recording Notes"

Check out audio clips from Avril Lavigne, Michael Brecker and The Ventures' "Walk Don't Run."

PLAY: MixGuides Live

Mix adds to its series of MixGuides with MixGuides Live, which includes new products, tour information, tips and techniques from the touring engineers and much more!



CURRENT

SONY INTEGRATES

Sony Pictures Studios (Culver City, Calif.) has installed two new Digidesign ICON integrated consoles into its Stage 7—the first dubbing room to move entirely into the Pro Tools realm with a new large-format, dual-operator ICON D-Control™ worksurface. Independent sound designer Steve Ticknor recently mixed the new Sony Pictures feature *Premonition* on the ICON, as well as 3-D animated feature *Surf's Up*.



Sony Pictures' senior VP of engineering Mork Koffman (left) with Steve Ticknor

MARSH EXPANDS

Stephen Marsh (www.StephenMarshMastering.com) has opened a new mastering boutique at Radio Recorders complex in Hollywood. Joining Marsh is assistant/mastering engineer Stephanie Villa. First-week sessions included Cesar Rosas and Los Lobos mastering a new live album titled *One Time, One Night* and an iTunes Originals digital album for Elvis Costello.

PHOTO: WYOMING TELFORD



The new room centers on a custom analog mastering console built with Steve Firlotte of Inward Connections and features processing from Inward, EAR, GML, Maselec, Weiss and Waves. Other gear include modified Apogee conversion, Sound Blade and Pro Tools hardware feeding Bryston powered PMC mains.

CORRECTIONS

In the March "Track Sheet" portion of "Coast to Coast," the item about Neveragain should have mentioned co-producer Bill Cutler, as well as bandmember Paul MacLachlan.

In the June issue, our "Class of 2007" feature contained the wrong name for the designer of Pilot Recording Studios (New York City). The facility was redesigned by owner Will Schillinger's Wilbur Systems Ltd., with original acoustic design by Frank Comentale. The extensive work undertaken by Schillinger and co. comprised acoustical upgrades to increase isolation, including installing an RPG diffusion system; complete rewiring; and installing a Neve VR60 console and a massive amount of outboard gear. For more about Pilot Recording, visit www.pilotrecording.com.

Mix regrets the errors.



Pilot Recording



Make an Investment in Your **Voice.**



KSM9

H A N D H E L D
C O N D E N S E R
M I C R O P H O N E

Live Performance Mastery. Engineered to exacting standards, KSM9 unites the best of studio and stage. With its dual diaphragm design and switchable polar patterns, KSM9 reveals nuance and subtlety in a microphone optimized for the most demanding live environments.

The choice for the world's most accomplished vocal performances.

www.shure.com

© 2007 Shure Incorporated



World Radio History

SHURE[®]

LEGENDARY
PERFORMANCE™

Mixing guitar

MAKING SIX-STRINGS SING

BY KEVIN BECKA

MIX CONTINUES ITS SERIES “THE INSIDE TRACK,” A BIMONTHLY FEATURE IN WHICH TECHNICAL EDITOR KEVIN BECKA EXPLORES THE CRAFT OF MIXING IN-DEPTH. EACH INSTALLMENT TACKLES A DIFFERENT INSTRUMENT, FROM DRUMS TO GUITAR TO PIANO TO VOCALS. WHETHER YOU’RE A STUDIO VETERAN OR JUST GETTING STARTED, YOU’LL FIND SOMETHING HERE TO HELP TAKE YOUR TRACK TO THE NEXT LEVEL.

The words “signature” and “guitar” go hand in hand. Along with a well-conceived and -played part, a well-crafted mix draws the listener in and sells the tune, whether it’s country, R&B, pop, metal or jazz. To guarantee a good mix, you have to take into account the interplay between the guitars and the rest of the track. Is the guitar a lead track carrying the melody? Is it more of a rhythm part in a supporting role? Or is it intermittent, random ear candy, weaving its way in and out as the tune progresses? The first steps on the road to a great mix involve analyzing your resources and formulating a good plan.

First, talk to the artist and creative team about direction. Getting the creative team involved early in the process can keep the mix on track from the beginning and your clients happy in the end. Of course, the style of music and the instrument itself will determine how you will treat your tracks. For instance, you wouldn’t process an acoustic bluegrass track in the same way you would layered metal guitars.

In this feature, we’ll talk about using panning, effects and EQ to add dimension and shape tone. We’ll also talk about how a song’s tempo can change your processing decisions, how to use compression (or not) and how tube amps can be a delicious addition to your mix, even after you record. As you read this feature, it’s important to remember that a little goes along way—build your mix incrementally and with taste.

TRADING SPACES

A guitar can be a pushy space-hogging customer, especially when you have many of them eating up areas occupied by vocals, background vocals, keys and other vital mix players. Guitars can even fight with *each other*

for bandwidth. A busy mix can comprise a strumming stereo acoustic, a classical guitar doing fills, phasey guitar fills that come in and out in key spots, and one or more distorted guitars with random “wire choir” fills. This is an extreme example, but the point is, if you have more than one guitar in your mix and you’re trying to make each one heard, then simply tweaking the tracks with EQ and panning is not enough.

To give your guitar tracks extra “spatial” definition in the mix, bring in time-based effects such as ambience and delays. One way to add dimension is to use delays to increase the presence of your parts across the stereo soundstage. Start by hard-panning dueling mono guitars on either side of the stereo field and then double them across the opposite side using a delay. This incremental mixing step adds ambience without overpowering other mix elements. It takes up far less overall stereo space than sending each one to a stereo reverb, which would quickly eat up valuable mix space by creating too wide an image.

Because you’re trying to add just a bit of the illusion of space, set your feedback parameter to zero and add between 40 and 80 milliseconds of delay time. Play with the panning of the delays and guitars until you’re satisfied with the total stereo image. The guitars should be loud enough to be heard, without stepping on the toes of other important elements such as vocals and keyboards. Keep in mind that if a player was recorded with effects, you may have to complement those during the mix. For instance, if the delays aren’t as big as you’d like, then you may have to add more. Don’t overdo it by adding more frosting than cake, though; sometimes *feeling* a part, rather than hearing it, means it stands out enough.



Mixing guitar

What if you have four overlapping stereo guitars? If the mix has a lot of stereo information, then you can make one or two key tracks stand out by adding a slight doubling effect, which makes these tracks louder by creating the illusion of two parts. Use a harmonizing processor that allows fine pitch and delay adjustments, and bring up the pitch on the left side by 4 or 5 cents (1/100th of a semitone) and the right side down by a similar amount. Then play with the delay setting on each side, adding 8 to 12 ms until you can feel the image jump out a bit without really hearing the delay as a double. Subtlety is the name of the game here: The more your mix sounds open and free of clogging effects early on, the more room you have for other subtle effects later on in the process.

VERB VIBE

Using reverb is the best way to create ambience. When set up properly, it draws the listener into a bigger "space" that's pleasing to the ear. Keep in mind that if you have numerous, multi-layered parts, applying a plate reverb or concert hall setting on everything will only dull the image because all the parts are painted with the same sonic brush. Variety is the spice of ambient life!

To keep supporting parts from overpowering your lead track, treat them with a shorter room with less than one second of decay or slap delays, thus keeping the listener's attention on what counts: the lead actor. When it comes to your star guitar, go for a longer plate reverb set to 1.5 to 2.5 seconds to draw the listener in and create a unique ambience for the part. In this case, using a reverb with a pre-delay setting will make your guitar track more prominent in the mix because the drier signal appears closer to the listener. The pre-delay setting adjusts the time between the initial dry attack and when the reverb starts. Note that the faster the song, the less pre-delay you can get away with because it will have the effect of tripping over itself. But on a slower tempo and especially on a sparsely played part, there is plenty of room for more pre-delay. On a ballad, start at 120 ms or so and trim it back if the delay is too long. On a faster tempo, start at 80 ms and take it down or up by using your ear to discern if the part has a lot of repeated notes that are getting confusing.

The reverb's room-size adjustment—in milliseconds, meters or feet—is just one way of adjusting the apparent size of your

space. If the part is sparse (with long rests in between notes), then increase your room size and use the reverb's return to lower the volume of the effect in the mix. This way, the reverb decay will span over the open spots (rests) and be present without overpowering.

THE ULTIMATE PLUG-IN?

In the past 40 years, no matter who has been the rock guitar *dieu du jour*, making guitars sound big and unique has been the consistent goal of tracking and mix engineers. A critical step in creating an effective guitar-heavy mix is recognizing that guitars are moving air—the instrument is going through an amp and not some kind of freeze-dried emulator or "amp in a box." With all due respect to emulators (they do have their place, as you'll see), there's nothing like the nuance and individuality you can get out of a completely tweaked tube guitar amp going through a speaker. (That's

not to say that a solid-state amp is bad, but let's just say a tube amp is true whipped cream, as opposed to Cool Whip.)

If you're on a budget, you can introduce this kind of power and personality *after* your record by reamplifying. This is a great way to maximize your budget and studio time by getting the parts right at home, and then mixing your tracks in a studio, where you can blaze till dawn and not wake the neighbors. During tracking, use an emulator as your guide track while recording a clean DI feed to another track for reamplifying. Then, when you mix, you can add flavor by using amps from Krank, Mesa Boogie, Fender, Marshall, Bogner, Engel, Framus and Brunetti to move some serious air and take you well beyond what an emulator can provide.

For maximum use of your time, use a splitter such as the Little Labs Redeye or the Smart Research Smart Guitar DI to get your signal out to more than one amp at a time.

TROUBLESHOOTER

DEATH TO SQUEAKY

One of the most annoying problems you'll encounter when mixing acoustic guitars is the squeaking of strings as a player's hand draws up and down the neck between chords. It can ruin the focus of the song and become something you can't get rid of—the audio equivalent of gum on your shoe. There are some solutions to this problem. For starters, try ducking the squeaks with automated fader moves. Make a manual move as the track plays with the fader's automation mode in Write. If you're working in a DAW, then use a physical fader to make your moves; a mouse makes it difficult to react quickly and return the fader to the proper position. If you're mixing with a mouse, call up the volume graph on your waveform and draw in your volume dips where the squeaks are happening.

Automating an EQ plug-in is another powerful option when trying to eradicate random squeaks. First, loop playback on a problematic section and find the frequency of the annoying squeak by boosting a band set at a narrow Q (try a setting of 10 to 15) until the squeaky offender is more apparent. Then automate the gain on the offending frequency so you can quickly pull it out when the squeak occurs. Let's say that you first write the gain at zero



Zeroing in on an annoying squeak using the Waves Q4 EQ

for an entire song; when you put the fader in Touch-Write mode and let go of the fader, it will snap back after your move, ensuring a smooth transition back to your original volume. This EQ method is a bit less intrusive than the method mentioned above because you're not ducking the entire track to get rid of the squeak, just a part of the spectrum that offends. If string noise is still too intrusive, then try adjusting the Q setting until you're removing only the squeak and not so much of the surrounding spectral info.

If none of these options work, then zoom down to the sample level and draw out the squeak with the pencil tool. Remember that this is destructive editing, so don't paint yourself into a corner. As always, when making permanent audio decisions, having a duplicate copy of your session is good insurance.

—Kevin Becka

20 cakewalk

Est. 1987

When you are ready to take the next step, we'll be there

Cakewalk is a company founded and run by musicians with the mission to help you succeed.

We believe the best way to do that is to provide innovative, creative tools that make a real difference in your music production experience. So when you're ready to take the next step, you can focus on what matters most, your music...and we'll take care of the rest.



We're happy to announce that in 2007, Cakewalk's 20th anniversary, the entire SONAR line, Cakewalk Instruments, and Project5 now support Windows Vista. So when you're ready for Vista...we'll be there. Visit www.cakewalk.com/Vista to learn everything you need to know about music creation on this emerging operating system.

20 Years of Innovation

- 2007 1st DAWs with native Windows Vista support
- 2006 AudioSnap, Active Controller Technology introduced. 1st to support VST 2.4
- 2005 1st DAW with end-to-end 64-bit audio. Windows x64 support. BitBridge introduced to run 32-bit VSTs on x64. Cakewalk Instruments launched
- 2004 SurroundBridge introduced for using stereo FX in surround
- 2003 1st DAW with advanced multi-processor support. Universal Busing Architecture introduced
- 2002 MIDI Groove Clips introduced. 1st DAW to support both ASIO & WDM
- 2001 SONAR introduced. 1st DAW to combine MIDI & audio. ACO-style looping, & virtual instruments
- 1999 WavePipe technology for low latency audio streaming
- 1998 1st DAW with synchronized host-based playback of MIDI, audio, & video. MIDI FX introduced
- 1997 1st native DAW for Windows NT. 1st with real-time DirectFX. StudioWare introduced
- 1995 Cakewalk Pro Audio. 1st native 32-bit MIDI & digital audio workstation for Windows 95
- 1993 Real-time MIDI editing introduced
- 1991 Cakewalk Professional for Windows. 1st sequencer for Windows 3.1. CAL (Cakewalk Application Language)
- 1987 Cakewalk for DOS introduced. 256 tracks

If you're a tweaker, then experiment with different tubes to change your tone. (Check out the Tube Store at www.thetubestore.com for a full description and list of tubes.) Also, be sure that your tube amp is properly biased for maximum tube life and performance. Lastly, when reamplifying, use a variety of mics on the cabinet for flavor. (See "Adding Flavor in the Tracking Room" sidebar to the right.)

TIME TO TONE UP

Having the guitars properly EQ'd can make a dull track vibrant. Never make EQ decisions with the track isolated—this is like groping in the dark. Have the guitar in the mix at a level you feel is comfortable to see how it's competing with the other mix elements. For big, speedy and distorted parts that sustain throughout a track and eat up a lot of mix room, get a more powerful, punchy and present guitar sound by removing some high end (7 to 8 kHz and above) so the midrange and lows are more prominent. Because a guitar shares this crucial bandwidth with so many competing elements, removing some of this information makes space for the other tracks to shine through.

As a general rule, guitar "punch" is at 100 to 200 Hz, whereas bite or more cutting tone is between 3 and 5 kHz, and the sheen or "air" is from 10 to 15 kHz. These frequencies work well for acoustic and electric guitars. On an up-front finger-picked acoustic guitar track, only limited presence boost can be achieved through panning and levels. To make the track cut through, experiment with the frequency ranges mentioned above.

For instance, some producers like to have the acoustic guitar track married

BEFORE YOU MIX

ADDING FLAVOR IN THE TRACKING ROOM

From the start, your audio project has to be recorded and conceived with the end product in mind. It's an old cliché, but expecting someone to "fix it in the mix" is simply being lazy. When tracking guitars, err on the side of giving the next engineer in the chain more than they need. This means using a few different mics to capture the tracked sound by employing more than one mic and taking advantage of your natural surroundings.

For instance, when recording a guitar amp, don't just box the amp in a corner, but place it in a space where you can take advantage of your room's acoustics. Your space may involve two rooms or a hallway if you're recording at home, or opening an iso booth and putting up a mic in the "big room" if you're at a proper recording studio.

When choosing your transducers, put up an array of mic choices. Options may include a close mic or two, a mic placed about five feet back and another 10 to 12 feet back. Add even more color by using an omni mic in the room to pick up more ambience. When mixing, the engineer

can take or leave the extra info to add some extra zip to the final product. Don't be afraid to add a DI on a dedicated track to give the mix engineer the option of reamplifying or just adding some bite and twang to the overall sound.

Using mics with different frequency and transient responses will bring a variety of sonic characteristics that will make the mix more interesting. Think of it as adding different colors to a painting: You wouldn't paint a tree with just blue paint and a roller because you get more nuance by using varied brush strokes and colors. For instance, a moving-coil dynamic (such as the venerable Shure SM57) coupled with a ribbon (such as a Royer R-121 or AEA R84) can add a variety of colors to your recording. The dynamic imparts midrange grit while the ribbon's lazy transient response can round out the edges, creating an interesting aural cocktail. Keep in mind that placing the paired mics is critical to achieving a phase-aligned outcome, so be sure to measure the distance of your mics exactly to the inch.

—Kevin Becka

with the hi-hat; if so, add that 10 to 15kHz sheen until the parts meld together. Also, be sure not to remove too much low end in a boomy track—this can suck the life out of the instrument. To maintain clarity, remove 2 to 3 dB of midrange around 300 to 500 Hz by using a notch filter with a narrow Q. (Try a setting of 10 to 15.)

There are no hard and fast Q numbers to go by here; use your ears as the final arbiters of what works. Another useful tool is a mild highpass filter. Start at 50 Hz at 12 dB or less per octave. Start moving up in Hz value and listen to the way it affects the guitar's presence in the

mix. Watch out, though: This technique can sometimes make the guitar sound thin because you're removing frequencies that are in the same range where desirable instrument traits reside. The trick is to spend as much time as you need and combine a few different techniques to get the job done.

If your boominess problem is spotty, one solution could be to automate a band of EQ that you only use when the boom is more pronounced. Find the offending range of frequencies by raising the gain on a single band of EQ, once again using a narrow Q. Once you've isolated the problem area, write the gain at zero for the entire song. This way, when you put the fader in Touch mode to remove the band at problem points, the fader will jump back to your zero level.

BEING A FADER JOCKEY

A mix is like a living, breathing thing, and boosting various elements through automated fader moves draws the listener's attention to important moments as they occur. When a hook or a particularly catchy lick comes up, even if it only happens once, bring up the volume to keep the mix interesting. The inverse—dropping some parts—can have the effect of making other tracks louder. For instance, just because you have 15 guitar tracks playing throughout an entire song doesn't mean that they all have

POWER TIP

A SIDE OF COMPRESSION, PLEASE

Here's a great tip that's mainly for electric guitar, but you might want to try it on acoustic guitar, as well. To keep a signal sounding full in the mix without feeling overcompressed, use a compressor on a duplicate of the track. This trick is as simple as multing the signal to another channel if you're in the analog world, or copying the track to a second channel in your DAW and instantiating a compressor plug-in on the duplicate. Knowing the effect you're going for is important here. Is fullness your goal? If so, use a 4:1 ratio and set the balance between the compressed and uncompressed guitars so that the uncompressed guitar is more prominent. Think of it as a wet/dry mix like a reverb where the original "dry" signal is predominant.

Bring up the apparent loudness of the track in the mix by combining more of the compressed signal with the original.

If you want a flatly compressed (crushed) sound, then go for an 8:1 ratio or higher on the compressor and make it more prominent by bringing up this track higher than the original in the mix. On an acoustic guitar, if you need to tame an especially dynamic part, try a compressor that has some warmth to it, such as the Empirical Labs Fatso, Universal Audio LA-2A or the Retro Sta-Level. That way, if a note sticks out because it was picked too hard, the compressor will rein that in and add some pleasing harmonic distortion, as well as soften the attack and release transients.

—Kevin Becka

to be present in the mix all of the time. Try building your mix by omitting some key parts until the song changes to the bridge or chorus. Or remove an element altogether in the second verse to make the melody more prominent, and then bring back even more layers on the next "B" section.

Keep in mind that reverb and time-based effects can also be dynamic. Ride the sends or returns to bring out more or take back reverb and effects that can accentuate a section of the song. Riding these elements gives the mix a fresh and dynamic feel that keeps the listener interested from beginning to end.

Before you put the track to bed, it's always a good idea to hear your mix on other systems to see if the decisions you've made translate well. Use your car system, a

Using reverb is the best way to create ambience. When set up properly, it draws the listener into a bigger "space" that's pleasing to the ear. But keep in mind that if you have numerous, multilayered parts, variety is the spice of ambient life!

boom box or even an iPod to evaluate the balance and overall dynamic consistency of the mix, as well as to listen for that squeak or bad edit you simply didn't hear on your system. Headphones can also give you a perspective that you don't get from speakers because the transducers are right on your ears and the mix is unaffected by the room.

Mixing guitars is like being a tour director: You point out a song's high points to the listener by drawing attention to its ingredients through tone, fader moves, effects and compression. By using the tools and techniques mentioned, you're on your way to solving even the most difficult and busiest of sonic puzzles. ■

Mix technical editor Kevin Becka thanks Jeff Balding, Will Solares and Dave Zebertayev for their help with this feature.

Raise Your Wireless Standards

Today's PA system requirements demand superior sound to accompany advanced lighting and staging techniques. Trust Lectrosonics and their **Venue Modular Receiver** to deliver the sound, with rock solid RF performance.

The Venue UHF system operates with Digital Hybrid Wireless™ transmitters, and a variety of analog transmitters. The receiver uses a host assembly that includes:

- Six channels in a single rack space
- Built-in antenna multicoupler
- Computer interface included with USB and RS-232 ports
- Compandorless Digital Hybrid Wireless™ technology



For more information, call Location Sound Corp., an authorized Lectrosonics dealer: (818) 980-9891 or outside CA at (800) 228-4429



LOCATION SOUND CORP

SERVING THE PROFESSIONAL AUDIO INDUSTRY FOR OVER 25 YEARS.

www.locationsound.com

SALES • RENTAL • SERVICE

Location Sound is a supplier of professional audio and communications solutions for film, video, broadcast, business, institutional and recording applications.

Experience THE WORLD'S LOWEST PRICES!

EVERY MAJOR BRAND IN STOCK!

Recording Equipment • Sound Systems • Keyboards • Synthesizers
Samplers • Guitars • Amps • Drums • Software • Accessories



West L.A. Music's Don Griffin with George Duke



West L.A. Music's Mark Spiwak with Frank Sinatra Jr.



Edgar Winter with West L.A. Music's Mark Spiwak



West L.A. Music's Mark Spiwak with Warren Zevon



West L.A. Music's Rodney George with Sinbad



Earth, Wind, & Fire's Philip Bailey with West L.A.'s Noel Gould

Shop Where the Pros Shop • Call Us Today!

West L.A. Music

West Los Angeles (310) 477-1945 • Universal City (323) 845-1145
Fax (310) 477-2476 • sales@westlamusic.com

We will beat any price from any authorized stocking dealer anywhere in the United States.



Front and Center

THE LATEST IN HANDHELD VOCAL MICS

By Robert Hanson

One of the most crucial aspects of nearly any live performance is the lead singer. Seeking musical perfection, other bandmembers spend thousands on their keyboard/drum/guitar/bass rigs. Yet there's a certain irony that—far too often—vocalists will grab whatever is handed to them before they hit the stage. And even with all eyes on the singer in the spotlight, the need for matching a performer's vocal timbre and style to just the right mic that complements that particular voice is essential. The time and money spent in mic selection to improve a vocalist's sonic signature is an investment that should at least be as important as picking hi-hat cymbals for the tour.

Fortunately, there isn't a live sound engineer on the planet who hasn't spent countless hours auditioning every vocal mic available in search of that perfect blend of response, sensitivity, pattern control and resistance to feedback. Today's latest handheld vocal mics not only offer studio-quality response and superior rejection, but also, in some cases, provide quality rivaling their studio recording siblings. If you're in the market for a nearly indestructible, road warrior-grade dynamic or a high-end condenser for the ultimate in diva-quality response, there has never been a better time to go shopping. All mics featured in this article have debuted in the past 18 months.

You know what they say about Allen Sides' legendary Ocean Way Monitor Systems...



Ocean Way's Record One (Studio A)



Ocean Way Hollywood (Studio D)



Ocean Way Nashville (Studio A)

Well, now you know. The amazing monitors enjoyed by the world's most respected mixers are now available, custom designed specifically for your studio by Allen Sides, exclusively through GC Pro. Want to put some Ocean Way in *your* room? Contact your local GC Pro Account Manager for more information or to schedule a private demo.



"The Ocean Way Monitor Systems are the best speakers in LIFE!!!"

- **Bruce Swedien**

"I can't think of any large monitoring system I'd rather have in Skywalker Scoring Stage than Allen's Ocean Way Monitors."

- **Leslie Ann Jones**

"Ocean Way Recording's accurate and expansive monitoring systems are equally impressive in every room."

- **Jack Joseph Puig**

"The monitors Allen built for my private studio, which we used to mix the last Foo Fighters album, let me hear my music the way I want, very loud and very clear."

- **Dave Grohl**

"Allen and I share a passion for accurate, high definition speakers that have the ability to sound big and impressive for artists when it's required. The OWR monitor system squarely hits that mark."

- **George Massenburg**

GC Pro has expert Account Managers in nearly every territory of the USA... contact us today!

 **800-935-MYGC**

 **www.gcpro.com**



GC PRO

www.gcpro.com

© 2007 Guitar Center, Inc. All rights reserved.
All images and trademarks are property of their respective holders.

Recently, AKG (www.ake.com) added three new vocal handhelds to its line of performance mics. The D5 (\$160) dynamic features the company's patented Laminate Varimotion diaphragm, neodymium-iron-boron magnet and a supercardioid pattern for excellent bleed and feedback rejection. The mic has a stated frequency response of 70 to 20k Hz. A double shock-mount minimizes handling noise.

The C5 (\$299) is a hard-wired cardioid condenser featuring a 24-carat, gold-plated transducer. The mic is designed to help vocals cut through dense mixes, and fea-

axis rejection. The 381 is a low-impedance, handheld dynamic that is built around a high-energy, neodymium magnet; a double-dome diaphragm; and an aluminum-alloy voice coil. The mic also features an internal double shock-mount to minimize plosives and excessive handling noise, a rugged heat-treated grille and the company's new "leather feel" grip for easier handling.

Audio-Technica's (www.audio-technica.com) new AT2010 (\$169) delivers the essential components of the company's AT2020 studio condenser in a road-worthy,

bass roll-off filter and a ported steel-mesh screen. The VX-5 can handle SPLs as high as 144 dB and is capable of rejecting up to 20 dB of ambient noise. According to the company, the mic is intended for use on everything from lead vocals and acoustic instruments to guitars cabinets and drum overheads.

German manufacturer Beyerdynamic (www.beyerdynamic.com) has added two new products to its collection of live vocal mics: the Opus 89 (\$299) and TG-X 48 (\$124). The 89 is a hypercardioid dynamic that uses a neodymium magnet. It also boasts an internal pop filter and is



The AKG C5 features the company's Presence Boost adapter.



Audio-Technica phantom-powered AT2010

handheld design. Featuring the same 16mm low-mass diaphragm as its studio sibling, the phantom-powered 2010 boasts a flat frequency response of 40 to 20k Hz and a dynamic range of 133 dB. It can handle SPLs as high as 136 dB. The 2010 is intended for lead vocals, and the fixed-cardioid pattern provides excellent side and rear rejection.

Rounding out Audix's (www.audixusa.com) line of mics is the new VX-5 (\$299). Designed for a wide array of live and studio applications, the VX-5 is a supercardioid condenser. The mic features a 14mm gold-vapor diaphragm, a -10dB pad, a



Beyerdynamic Opus 89 hypercardioid dynamic

designed to fight handling noise. The budget-oriented 48 brings together a number of elements from the company's higher-end products. Featuring an internal pop screen, hypercardioid polar pattern and a soft lacquer finish, the ruggedly designed 48 is intended to deliver years of worry-free performance.

Nashville-based Equation Audio (www.equationaudio.com) expands its Dominion Series of live performance mics with the DS-V10 and DS-V9. The DS-V10 has a supercardioid dynamic capsule with a high-output neodymium magnet structure. The \$179 (retail) mic features a 40 to 17.5k Hz response, 140dB SPL handling and a hardened steel grille over a multistage plosive/pop filter. The electret condenser DS-V9 model features max SPL handling of 129 dB, a multipoint internal shock-mount for its mid-diameter, graded cardioid capsule, a low-noise head amplifier and a 30 to 18k Hz



Audix VX-5

tures AKG's Presence Boost adapter, which adds a 5dB boost from 4 to 8 kHz. The C5 boasts a frequency response of 65 to 20k Hz, handles SPLs as high as 140 dB and includes a double shock-mount to minimize handling noise.

For female vocalists, AKG offers the new Elle C (price TBA). Similar to the C5, the Elle C features a tailored frequency response of 60 to 20k Hz and a slim, low-profile design. It also comes with the company's Presence Boost adapter pre-installed. The mic is available in white and silver finishes.

The latest additions to the Apex (www.apex.com) line include the Apex115 (\$159), a hypercardioid handheld condenser, and the Apex381 (\$109) dynamic. The phantom-powered 115 features an electret condenser design. The mic boasts a stated frequency response of 70 to 18k Hz and a signal-to-noise ratio of 65 dB. The 115's low-frequency roll-off is designed to minimize proximity effect. Internal dampening ensures minimal handling noise, and the hypercardioid design delivers maximum off-



Equation Audio DS-V10 with supercardioid capsule

response. List is \$199.

The PR 20 (\$179) from Heil (www.heilsound.com) is an all-around live dynamic with an emphasis on lead vocals and snare drums. This mic features a frequency response of 50 to 18k Hz (with a 3dB bump at 4.5 kHz) and 30 dB of off-axis rejection. It is built around a special magnet structure and 1 $\frac{1}{2}$ -inch aluminum low-mass voice coil. The dynamic element is built into a shock-mounting system that delivers low handling noise. The PR 20 is also designed to deliver minimized proximity effect and the ability to handle extreme SPLs. The standard-edition PR 20 features



The Heil PR 20 is aimed at miking lead vocal/snare.

a matte-black finish and heavy steel construction. More fastidious users can opt for the Pink Pearl 20, Red Pearl 20 or White Pearl 20 (each \$210), which all offer the same components as the PR 20 but in pink, red or white finishes. All feature a fixed-cardioid pattern and include three

SONIC MAXIMIZER



What's in a name?
Depth. Detail. Definition. Clarity.
Get more with the push of a button.

UBE

bbsound.com

5381 Production Drive • Huntington Beach, CA 92649 • 714-897-6766

WE ASKED!

MPATHX

SMARTRACK™

MPATHX™
WE CONNECT

MPATHX.COM

(316)262-8788

If you're looking for coloration from an Aurora Converter

During July 2007, get up to \$500 in Free Cables with a new Aurora and an AES16 or LT-HD. See your authorized USA or Canada retailer for details.



This is the only way you're going to get it.

When we designed the Aurora 16 and Aurora 8 AD/DA converters, we had a simple goal. Converters with clear, pristine, open sound and no coloration or artifacts. We wanted you to be able to get the identical audio out of Aurora converters that you put into them. From what we have heard from you and the major magazines, that's what we have accomplished.

Aurora includes no compression, no limiting, no equalization. No coloration. Why?

First, if you want or need coloration, you already have that handled. You have carefully selected your signal processing, which you can add to the signal chain at any point you like, or leave it out altogether.

Second, how would we know what processing would fit your needs and your tastes? We could nail it for our tastes and for a few of our friends, and completely miss what you want.

Third, we wanted to build the best possible AD/DA converter – period, not a converter/signal processor/preamp/exciter. Adding these functions would add the price of Aurora, for features you may not want or need.

Instead we packed in features such as our exclusive SynchroLock™ word clock, LSlot expansion port for optional interfaces, and exclusive remote control options into a single rack space format. And, most importantly, world-class audio quality that rivals converters costing many times the price.

Aurora 8 and Aurora 16 from Lynx Studio Technology. We'll handle the conversion and leave the coloring up to you.



Lynx
STUDIO
TECHNOLOGY

www.lynxstudio.com/aurora1

Front and Center

microphone screens (of varying colors) and a foam windscreen.

The Heil Handi Mic Pro Plus (\$110) checks in at a diminutive four inches, yet is anything but short in the features department. Featuring a cardioid pattern, this dynamic boasts a frequency response of 50 to 18k Hz (with a 3dB bump at 4.5 kHz) and 30 dB of off-axis rejection. Its small footprint makes it useful for close-miking drums and cabinets, in addition to use on lead vocals. The mic ships with a wall-mount, a 3/8-inch mic clip and a foam windscreen.

Although not strictly a vocal mic, Nady's (www.nady.com) VHM-7 (\$149.95) is the perfect solution for harmonic play-



Nady's VHM-7 lets the user adjust volume level.

ers or vocalists who desire a secondary mic channel with a gritty, overdriven tone. This cardioid dynamic features an innovation volume control that allows users to adjust the level with virtually no risk of feedback. And for additional flexibility, the VHM-7 can be plugged into an amp or a standard vocal channel. Engineered by Bushman Music Works and distributed by Nady, the VHM-7 features a retro-chrome finish.

Similar to the original KK 104/105 S, the cardioid/supercardioid KK 105 HD from Neumann (www.neumannusa.com) brings together the KK 105 capsule with Sennheiser's SKM 5000 N wireless technology. The mic borrows heavily from the venerable KMS Series of wired mics and features the same low-handling noise, excellent rejection and tonal characteristics. The stated frequency response is 80 to 20k Hz. And like the KK 105 S, the HD includes a nylon pouch designed to carry the capsule, transmitter, batteries and other necessary accessories. Also available from Neumann is the new KMS 104 (\$849)

BBE[®] MAX-X3

BBE Sonic Maximizer and
3-way Crossover...
Two processors, one great unit.

BBE
5381 Production Drive • Huntington Beach, CA 92649 • 714-897-6766

bbesound.com

YOU ANSWERED!

MPATHX
SMARTRACK™

MPATHX™
WE CONNECT

MPATHX.COM

(316)262-8788



Neumann's cardioid KSM 104

condenser, which is a cardioid version of the KSM 105 and features an internal, elastic shock-mount design.

Blurring the line between studio and stage, the SE Electronics (www.seelectronics.com) H1 (\$299) delivers the attributes of both a true studio condenser and a road-worthy handheld. Featuring a handcrafted gold diaphragm, an internal shock-mount and a five-layer wind/pop screen, the H1 is designed to handle it all. A specially tailored response minimizes proximity effect, and the mic can handle SPLs as high as 145 dB for



SE Electronics' H1 is geared for studio and live use.

PORTABLE AUDIO MIXING



Rolls makes a variety of battery powered mixers to accommodate most any portable audio application. From live remote radio broadcasts to professional video recording, a Rolls mixer will fit the need.

The **MX56c MiniMix A/V** mixes a microphone with two stereo line inputs and a single mono line input. Individual line level and mic level outputs are provided.

The **MX34 LiveMix** features two mic inputs, switchable phantom power, pan controls, and phone outputs designed to connect directly to most video cameras - or any line input.

The **MX54s ProMix Plus** and **MX124 ProMix IV** each feature XLR mic inputs, switchable phantom power and low-cut filters, pan controls, phone outputs, and transformer-balanced XLR outputs. The MX54s has three mic inputs, the MX124 has four.

For complete info on these and all Rolls products, check out our website: www.rolls.com.

All Rolls mixers are manufactured in the U.S.A.

We've got something for the job.

ROLLS

5968 South 350 West
Salt Lake City, UT 84107
(801) 263-9053 - FAX (801) 263-9068
www.rolls.com

even the loudest live sound applications.

Engineers using the Sennheiser (www.sennheiser-usa.com) 5000 Series of wireless mics now have another capsule at their



Sennheiser's MD 5235 is based on the 935 mic.

disposal. The new MD 5235 (price TBA) is a cardioid dynamic based on the 935 vocal mic and is designed for vocal applications on very loud stages. The capsule's enhanced rejection characteristics and punchy response make it especially suited to rock and pop acts that use a lot of guitar and monitor cabinets. Available in black or silver finishes, the MD 5235 is the ninth available capsule for the 5000 Series and is compatible with the SKM 5000, SKM 5000 N and SKM 5200.

Another offering that delivers studio-grade condenser technology in a handheld design is the KSM9 (\$850) from Shure (www.shure.com). The mic features a dual-diaphragm design (3/4-inch, gold-layered Mylar) for higher gain before feedback, switchable cardioid or supercardioid patterns, and minimized proximity effect. Stated frequency response is 50 to 20k Hz, and the KSM9 can handle SPLs as high as 153 dB. Adding to the mic's smooth response is its Class-A, transformerless preamp circuitry. And to minimize handling noise, the KSM9



The Shure KSM9 features a dual-diaphragm design.

features a proprietary two-stage internal shock-mount.

Violet's (www.violetaudio.com) Pearl (\$669) and Grand Pearl (\$749) are medium- and large-diaphragm cardioid condensers, respectively, that include copious internal shock-mounting, making them suitable for handheld vocal applications and a wide range of live and studio miking duties. The Pearl features a 17mm, gold-sputtered Mylar capsule; a multilayer



Violet Pearl medium-diaphragm cardioid condenser

brass-mesh grille; Class-A, fully discrete, transformerless electronics; and two internal shock-mounts. The Grand Pearl ups the ante with a 26mm diaphragm. Both mics have a stated frequency response of 20 to 20k Hz. The Pearl can handle SPLs as high as 140 dB, and the Grand Pearl tops out as 136 dB. ■

Robert Hanson is a former editor at Mix and Remix. When he's not watching the sun come up in San Francisco and wondering where all of his cash went, he works for the Internet and manages to sit down in his studio, at least once a week, and contemplate Depeche Mode.

LOSSLESS COMPRESSION



MaxCom actually reveals sonic details lost with ordinary compressors.

BBE

bbesound.com

5381 Production Drive • Huntington Beach, CA 92649 • 714-897-6766

COME & GET IT!

- ▶ Kills Wall-Warts
- ▶ 9 DC & 7 AC Outlets
- ▶ Computer Controlled
- ▶ Sequence All AC/DC Outlets
- ▶ 7000 Joules
- ▶ Reduce Noise, Heat & Waste
- ▶ Firmware & Software Upgrades



SmARTRACK™



MPATHX™
▶ WE CONNECT

MPATHX.COM

(316)262-8788



PUSHING THE LIMITS OF

Native Processing

CAN MULTICORE MACHINES RIVAL HARDWARE-BASED DAWS?

By Tony Nunes

Computers effortlessly handle most of the the basic demands in our lives without breaking a sweat. Yet when it comes to DSP-intensive audio apps, native systems haven't been able to compete with the power and speed of hardware-based DAWS. But CPUs have reached whole new levels of performance with such new processors as AMD's Barcelona quad-core and Intel's Core 2 quad processors. In fact, at press time, Apple announced a monster Mac Pro with twin quad-core Intel Xeons. With these advancements, most native DAWS fitted with a few gigs of RAM and a dedicated audio drive should be able to perform quite well during sessions with high sample rates, hefty plug-in loads and high track counts.

Before native systems can be accepted as real-world contenders in the studio, they must perform as well as hardware-based systems. Tracking sessions need to flow. If a system fails in the middle of a perfect take, it's frustrating to both engineer and artist. If rebooting is necessary, it breaks a session's stride. Latency problems can destroy the entire feel of a performance. Another issue is compatibility: Are third-party products and developers truly ready for prime-time? In search of some answers, we put a multicore native system to the test.

THE CENTER OF ATTENTION

Our work flow revolved around a PCAudioLabs machine running Windows XP Professional with Service

Pack 2 installed. Everything within the four-rackspace case was acoustically treated for a hushed environment. Two dual-core AMD Opteron 280 processors operating at 2.42 GHz and a front-side bus running at 1,000 MHz powered the heart of the computer. The AMD machine was fitted with a generous 3 GB of DDR400 RAM, and storage included an 80GB SATA drive housing the OS and a 300GB SATA data (audio) drive configured in a RAID 0 fashion for speed and throughput.

To me, record production at 44.1/48 kHz is passé; at higher sample rates of 88.2 kHz and above, there is a definite sonic improvement. So for the session and to push the system twice as hard, I required high sample rates and A/D conversion for 16 analog inputs and D/A for six analog outs, which included the feed for the control room monitor mix and four outputs to feed the cue mixes. My first choice was Mytek Digital's 8x192 AD/DA with the optional FireWire interface. Unfortunately, its drivers for the FireWire platform were still under development, but Mytek would strive to have them ready in time for the sessions.

I also planned on using two MOTU 828mkIIIs for other sessions, but my initial tests exposed some clocking errors within the FireWire setup. I couldn't daisy-chain two units together without experiencing digital snats due to clocking problems. As a remedy, I tried running the two 828mkIIIs from two independent FireWire ports but experienced the same issues. Research led me to a concern about the Windows XP Service



Pack 2 installation causing a substantial performance decrease within the FireWire bus. I needed Service Pack 2 installed for other applications on my computer, so I tried installing the update but still experienced the same issues. Because MOTU units clock their devices through the FireWire bus, I believe that the FireWire instability was due to controller chip-set compatibility. Checking Windows' Device Manager revealed that my computer was using Texas Instruments and VIA chip sets. A phone call to MOTU and a time crunch led me to use one of its PCI-424 cards with a MOTU 24I/O audio interface. This setup would more than suffice with 24 simultaneous analog inputs and outputs, including support up to 96 kHz.

With the session date closing in, Mytek acknowledged that its FireWire drivers were not perfected. As a fan of Mytek converters, I still intended to use the company's 8x192 as my AD/DA but would have to use a different interface. Mytek supplied me with an excellent



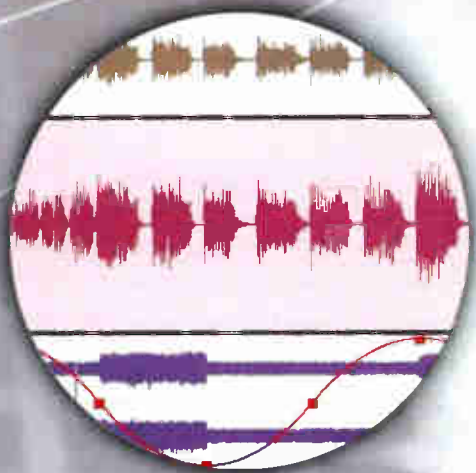
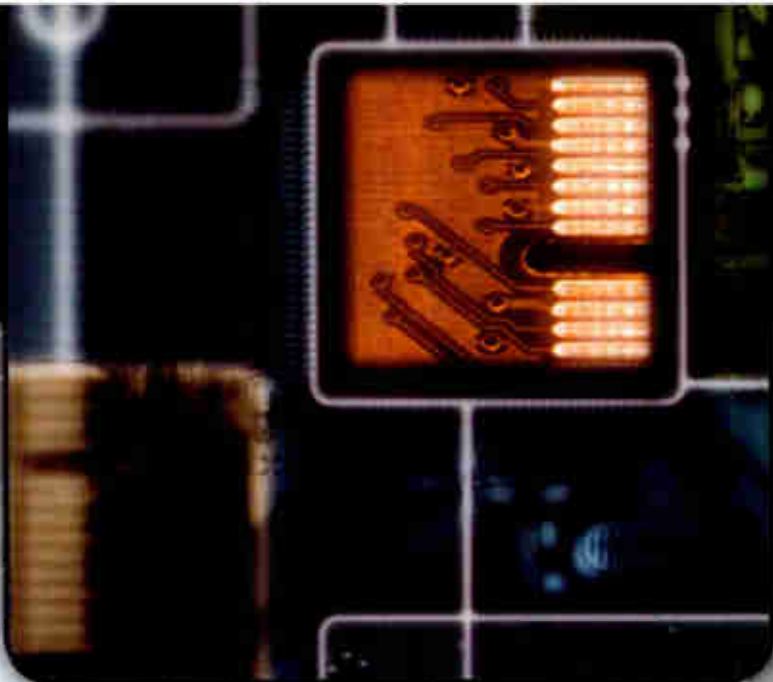

RME HDSP AES-32 PCI card providing 16 AES/EBU I/Os with support for up to 192 kHz at full channel count. AES/EBU connections were via two 25-pin D-Sub connectors accompanied by BNC connections for word clock I/O. MIDI connections were available through a supplied breakout cable. The updated setup now included two Mytek 8x192s as my AD/DA and the RME HDSP AES-32 as the audio interface.

I needed a proven Windows DAW that would work with any interface. After reviewing Cakewalk's SONAR 6 Producer Edition for *Mix's* April 2007 issue and being thoroughly impressed by it, I selected it for the tests. SONAR features a 64-bit double-precision, floating-point engine, multicore processor integration, ACT (Active Controller Technology, dynamic re-mapping of MIDI controls), AudioSnap audio quantizing and surround support. It's worth mentioning that I ran the Version 6.2 update, which made SONAR the first DAW to natively support Windows Vista.

Along with SONAR's abundant plug-ins, we added Audio Ease's Altiverb V. 6 convolution reverb. Altiverb 6 includes a quality sample library of real spaces, including everything from cars to cathedrals. It supports sample rates up to 384 kHz and is compatible with plug-in formats including RTAS, VST, Audio Units, MAS and AudioSuite. The plug-in roster also included the PSP VintageWarmer 2, which uses 64-bit floating precision and supports sample rates up to 192 kHz. SONAR's Lexicon Pantheon Reverb and the VC-64 Vintage Channel—which essentially is the Kjaerhus Golden Channel re-skinned and optimized for SONAR's 64-bit processing engine, including a gate, a de-esser and dual stages of compression and EQ—were also in use.

DOING THE BUFFER DANCE

The session was tracked in the Conservatory of Recording Arts and Sciences' Studio D; an SSL AWS 900+ was in for a short visit, and I welcomed it as the front end for mic inputs. The signal flow included the SSL providing the mic pre's directly to the Mytek converters, which then connected digitally to the RME PCI card via AES/EBU for busing into SONAR. Output was simply through the RME card back to the Mytek

SESSION SETUP

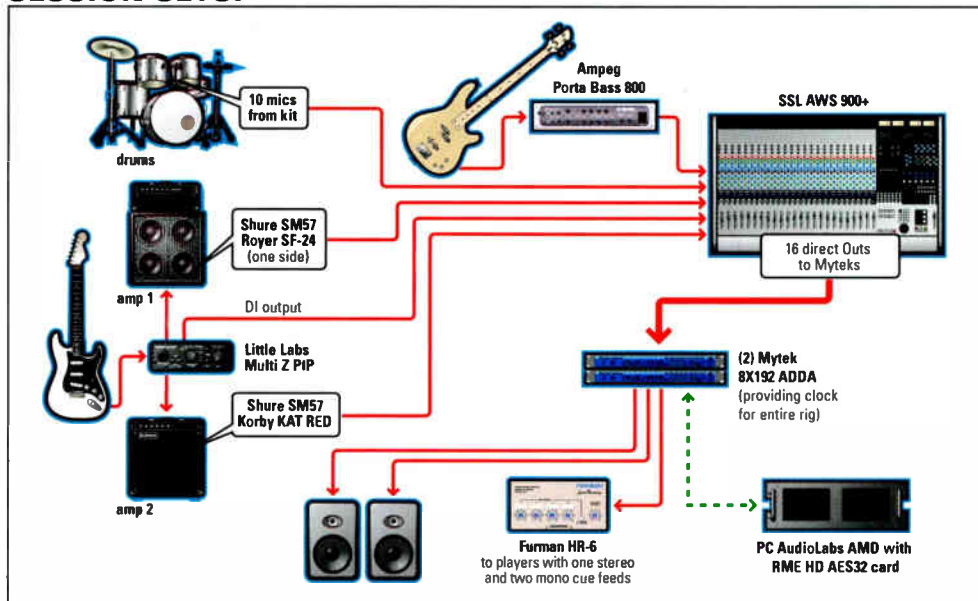

The studio configuration centered around a PC AudioLabs custom rackmount AMD-powered computer (bottom right).

units for D/A conversion directly into the room's M&K monitoring and cue system. The Mytek 8x192 AD/DA served as the master clock for the room, connecting to the RME HDSP AES-32 via a BNC connection. I began by launching a preconfigured 24-bit/88.2kHz session template, which included all of the input/output routing. Building a cue mix and adjusting levels within SONAR was a breeze.

As my goal was to keep latency to a minimum and access to 16 inputs, I wanted to use all of them simultaneously to test the system. I started off with a buffer set to 128 samples, and the musicians reassured me that the latency at 128 (equivalent to 3 ms) was not noticeable. I recorded 16 tracks while feeding monitors and cues for four minutes without any issues. The meters within SONAR reflected a 24-percent CPU usage and disk usage at 5 percent. (Granted, no plug-ins were inserted.) Playback confirmed the absence of digital oddities and the take sounded superb. The SSL, Mytek converters and SONAR were a great sonic combination: The top end was excellent, and the drums sounded better than I had ever heard them sound in that room.

For the next take, I tried my luck with lowering the buffer to 64 samples while tracking at 88.2 kHz. Instantly, I experienced monitoring quirks with digital pops and glitches. To say the least, the musicians didn't appreciate hearing this in their cans, so I went to plan B: I increased the buffer to 128 samples and started adding plug-ins. I set up an aux track and loaded an instance

of Altiverb 6 with its EMT 140 plate emulation. After doing so, the snatting returned. Increasing the buffer to 256 samples solved the problem and I was able to record another smooth, glitch-free take.

For the last take, I retained the 256 buffer setting and, along with the Altiverb, I added an instance of the PSP VintageWarmer2 over the kick. Interestingly, I didn't experience any snatting, but the drummer did notice an increased latency issue on his kick. I convinced the band to attempt the take and the system recorded the entire tune, but the added latency put a dent in their vibe. This was the first time the session had to be compromised. The workaround in this situation would be to use less-intensive plug-ins during tracking and save the more demanding ones for mixdown. Alternatively, I could have used a full plug-in complement while tracking at a lower sampling rate, but I was adamant about the prerequisites.

At the end of the day, I met my goals and the session yielded great sonic results. I did encounter a latency issue with plug-ins but countered it by increasing the buffer size. Even with the RME interface set to 256 samples (equivalent to 6 ms of delay, according to its ASIO control panel), the musicians weren't bothered with latency.

I recalled the same 24-bit/88.2kHz session on a later date to experiment with plug-in count. With the same I/O routing and a buffer setting of 128, I could record eight instances of SONAR's VC-64 Vintage Channel, but then the system couldn't handle an instance of either Altiverb 6 or



Nelly Furtado

Magic in the Air

50 Years of Sennheiser Wireless Microphones

There's nothing more exciting than the magic of an electrifying performance—and nothing harder to capture. 50 years ago, Sennheiser's engineers designed their first bulletproof wireless systems to grab that magic and transmit it with flawless fidelity. Today, top artists like Nelly Furtado insist on Sennheiser wireless for the freedom to deliver their magic. Whether it's microphone or monitor systems for broadcast, theater or stage, Sennheiser sets standards for wireless quality and sound. www.sennheiserusa.com

Lexicon's Pantheon Reverb. I had the same experience with the PSP VintageWarmer2 as I did during the tracking date. As soon as I loaded it over a live guitar track, I experienced noticeable latency. With the buffer set at 256, I could record with a load of 34 instances of VC-64s, an instance of Altiverb 6 and an instance of the Pantheon Reverb before the system gave up. With a buffer at 256, a channel strip plug-in across all tracks and two reverbs, these results would more than suffice during the typical recording sessions I'm involved with.

I was curious to find out how a different interface would change the recording experience. For a later tracking session, I used the MOTU PCI-424 system and the same computer running SONAR V. 6.2. The PCI-424 system comprised a PCIe card and a MOTU 24I/O interface connected with a proprietary AudioWire cable, which resembles a heavy-duty FireWire cable. Each PCI-424 card can accept up to four MOTU interfaces. Once the drivers were installed, SONAR instantly recognized the MOTU system, and within 10 minutes I was on my way. I worked with a 24-track transfer from an analog tape. The SONAR session

was already heavily edited and had volume automation written across most tracks. This new session simply required acoustic guitar overdubs including two inputs, 16 outputs feeding a custom 16x2 summing system and two more outputs for a cue mix—all at 24-bit/96kHz audio.

The MOTU system includes MOTU's direct-monitoring CueMix software, yet to push the CPU, I ran the cue mix completely through SONAR using an Altiverb spring reverb and SONAR's VC-64 across the two guitar tracks for a polished sound in the cans. This test would simply display how the system would react with choppy edits and written automation, all at low-latency buffer settings. For the session's first attempt, I set the buffer to 64 samples; at this setting, the session wouldn't play back, let alone record. Increasing the buffer to 128 provided clear playback, yet some drop-outs occurred during recording. Bumping up the buffer to 256 samples solved the issue and yielded a successful 4-minute recording. I copied all of the previous track parameters to another two tracks and the second overdub was as successful, with the CPU meter peaking at 50 percent and the

disk occasionally peaking at 40 percent. This particular system worked and sounded great. With a buffer of 256 samples and the plug-ins across the guitar tracks, there were no latency concerns and the cue mixes sounded great in the cans.

PUSHING THE CPU LIMIT

With the recording sessions successfully completed, I wanted to see how far I could push the system's plug-in count. Within the same 24-bit/96kHz SONAR session fully edited and automated, and the MOTU buffer at 256, I played back the take with the addition of SONAR's Vintage Channel VC-64 across all 28 tracks, two Waves Q10 Paraphrastic EQs and seven Altiverb plug-ins before the system finally choked. Reverbs are notorious CPU hogs, so as a stress test I was curious to see how many I could get away with.

Bumping up the buffer to 512 allowed a total of 13 Altiverb plug-ins and finally, with the buffer at 1,024 samples, I had a ridiculous 47 Altiverb plugs in addition to the 28 VC-64s and the two Waves Q10s. I can't think of a situation in which I would need 47 reverbs, but it's nice to know that the system is capable of handling it. Under typi-

IF GROOVE TUBES MICROPHONES ARE PRO AUDIO'S BEST KEPT SECRET, OUR SECRET KEEPERS AREN'T DOING A VERY GOOD JOB.

HARDTOP CONVERTIBLE GT30 GT40 GT50 GT60 GT57 GT67 MD1B FET MD1B TUBE VELO 8

GREG LADANYI:
"I turn to GT mics every day in the studio."

MICHAEL WAGENER
"GT mics have become an essential part of my setup."

NEWMAN SCORING STAGE
GT tube and FET microphones in use every day for orchestral scoring sessions.

Don't miss out on the secret mic of the world's best engineers and studios!
GT microphones are available at the best pro audio dealers around the world.

www.groovetubes.com **Hear the Difference™**

A **Symphony** that fills the dance floor.



"...the Symphony System rocks and is rock solid... I now have the sonic quality Apogee is known for, mixed with seamless integration on my Mac Pro/Logic rig."



Vincent di Pasquale

Producer, Artist, Remixer

"Most simply put, the Symphony System rocks and is rock solid! With most big projects, I prefer mixing 'out of the box' through an analog console. Being a Logic user, **my new Symphony System is hands down the best sounding I/O option with plenty of expandability for larger track counts.** The other big bonus is the Big Ben clock, the C777, built right into the AD-16X. The timing precision is so solid, and with the simple user interface, I easily know all is running smoothly. I now have the sonic quality Apogee is known for, mixed with seamless integration on my Mac Pro/Logic rig. Life in the studio is good!"

Recent projects:

Nelly Furtado, Justin Timberlake
Mariah Carey, Missy Elliott, Nadia Ali



The **Symphony** System:

Apogee X-Series & Rosetta Series Converters,
Apple's Mac Pro & Logic Pro

See Vincent's system and more Symphony users at:
www.apogeedigital.com



cal circumstances, results like this simply indicate that there is plenty of headroom in this system to continue with higher track counts and more plug-ins.

I've used this rig on quite a few mixing sessions since the original test and it has never let me down. As an example, a mix at 24-bit/88.2kHz with a buffer setting of 1,024 samples executed 52 audio tracks and two instrument tracks (Session Drummer 2) with a ridiculous 58 plug-ins (10 were reverbs), and the CPU meter never broke the 50-percent mark.

NATIVE: THE SUM OF ITS PARTS

Having tested a native Windows DAW in the studio, I found that the resulting sessions still required balancing configuration and performance, but considering the heavy demands we placed on the system, the outcome actually exceeded my expectations. The RME/Mytek configuration with an 88.2kHz sampling rate sounded excellent, and latency was either nonexistent or minimal. I did hit a bump with some plug-ins, but this can be remedied with less intensive selections. The MOTU PCI-424

with the 24I/O provided good performance and fidelity. Low buffer settings and inefficient drivers can cause tracking headaches riddled with snatting and audio dropouts, but in my tests at 88.2 to 96kHz sampling rates, 256 samples proved to be a happy buffer for both the musicians and the different systems.

Other than the two configurations I used, there are many FireWire interface options from which to choose that are jam-packed with mic preamps, analog and digital I/O, MIDI I/O and sync capabilities. A few popular choices are Digidesign's Digi003 Rack Factory Bundle (32 tracks at 24-bit/96kHz and an attractive plug-in bundle), PreSonus' FireStudio (an 18x18 24-bit/96kHz interface), RME's Fireface 800 (capable of 192kHz rates), the M-Audio FireWire 1814 is (an inexpensive entry) and Focusrite Saffire Pro 26 i/o (also capable of up to 192kHz rates).

However, a native DAW system is definitely the sum of its parts. Any weak link—a slow CPU, inadequate RAM or poor interface drivers—may leave you experiencing latency problems and recording oddities. Viable alternatives include direct monitoring software, increased buffer settings or limiting CPU-intensive applications during tracking. If you intend to use an older computer, there is still hope: A more costly alternative may be upgrading the CPU/motherboard and/or a simple investment in additional RAM.

Considering that the machine I used during testing was nearly two years old, today's machines are pretty promising. Quick visits to Dell and Apple's Websites confirm that dual-core and quad-core processors are the norm. Furthermore, the recent combination of 64-bit chips and Vista's 64-bit architecture provides DAWs with more dynamic headroom during taxing applications and improves the scenario for mixing "in the box."

The inevitable rise in sampling rates will continue to increase the fidelity of digital audio. Lack of processing power for plug-ins and virtual instruments is almost a thing of the past. Ambitious DAW manufacturers and interface companies offer platforms for launching host-based systems to exciting new performance levels. With processing punch on the upswing and price/performance ratios at an all-time high, the future outlook for native systems is bright, indeed. ■

Tony Nunes is an audio engineer, teacher and new daddy to Luc.

KORG

INSPIRED TO CREATE. CREATED TO INSPIRE.



MR-1



Shown with included CM-2M microphone.

"What a capture medium! One listen, and you'll know exactly what I mean: It's truly a new day for those who record with digital audio."

—Craig Anderton, EQ

Superior fidelity. Unsurpassed versatility. MR-1: The ultimate portable recorder.

The 1-bit MR-1 mobile recorder is the highest fidelity handheld recorder in the industry. Its stunning audio quality leaves no audible footprints on your recordings. With an included condenser mic and 20 GB internal hard drive, the MR-1 is perfect for location recording. Flexible recording options allow you to also record to WAV, AIFF and MP3 formats, then convert to any other format with the included AudioGate™ software.

Unequaled location recording now. Unaltered recordings forever.

Visit www.korg.com/mr1 for demos and info.

Also available: the new 1-bit MR-1000 mobile recorder.

©2007 Korg USA, 316 S. Service Road, Melville, NY 11747 • (631) 390-8737 • www.korg.com

It's showtime.

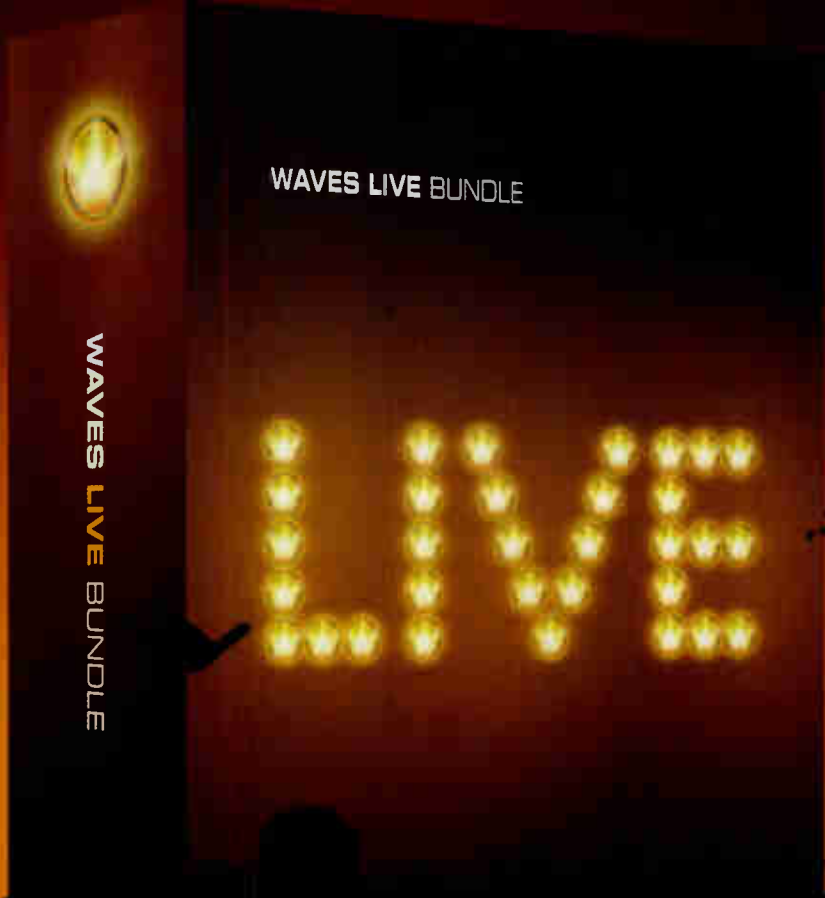

Waves Live Bundle

27 processors custom-engineered and optimized for Digidesign Venue Series **D-Show Consoles**.
Finally, studio quality sound – live.

www.waves.com



The Unfamiliar P.A.



ARM YOURSELF

FOR CLUB TOURING

By Steve La Cerra

the scariest P.A. is the one you've never met before. Traveling with production is a very comfortable place: You always know what type of gear you'll be using, you know it will be set up correctly and you learn to adapt to any operational quirks you'll discover. When you bring the same system into different venues, it quickly becomes apparent what the P.A. contributes to the sound vs. what the venue contributes.

However, when fall rolls around, many bands return to smaller venues such as clubs and theaters. Smaller venues usually mean less revenue, which translates into "it's too expensive for us to carry production so we'll use promoter-provided gear." Mixing on someone else's P.A. is a completely different animal from carrying your own. Here are some ideas to help you make the adjustment and maintain some level of sanity.

Introducing The New C 5 & D 5



New **C 5** and **D 5** live sound microphones deliver a unique combination of the best performance and durability establishing new standards for live performance microphones.

The **C 5/D 5** Series features an attractive and robust new industrial design with the highest quality and durability standards, along with excellent sound and unmatched feedback resistance for professional singers and musicians.

- dent-resistant spring steel wire mesh grille
- unmatched feedback resistance
- attractive and robust new industrial design
- 24-carat gold-sputtered housing
- Laminate Varimotion™ diaphragm technology
- gold-plated XLR output connectors
- rugged zinc alloy die-cast housing
- shock absorber minimizes handling noise
- highest quality and durability standards

"Our goal was to create vocal microphones that would set new standards for performance and reliability in the live sound microphone market," stated Stefan Gubi, President of AKG Acoustics GmbH.

"Through unique features and new technologies such as our Laminate Varimotion diaphragm, AKG's new **C 5** and **D 5** microphones deliver unmatched performance, providing musicians with superb sound quality and outstanding durability."

www.akg.com

A Harman International Company



GETTING TO KNOW YOU

When advancing a show, start by speaking with the proper person. Club management may lose your latest P.A. rider, input list and stage plot, and then go into their files and pull paperwork that someone sent to them via courier pigeon in 1975. Speak to the house engineer and e-mail or fax your info directly to that person. Tread carefully if you're told, "I won't be here but Bob will, and he's mixed everyone from the Moses tour to Britney." I find it difficult to advance with someone who won't be at the venue on show day because miscommunication inevitably leads to a finger-pointing match over what was promised.

Get a list of gear (often posted on the venue's Website) and venue capacity. Every once in a while, I shudder at what I think will be a lack of power or speaker coverage, only to breathe a sigh of relief when I learn that the room only holds 500 people. Always ask where the mix position is located. I remember one place in New Jersey where I was expected to mix front of house from the side of the room, *behind* the P.A., where monitor land would normally be located. Sorry, I didn't do that for bar bands

in Brooklyn, and I'm certainly not going to do it with Blue Öyster Cult. That's why they call it *front of house*. If the venue rents P.A., you might have a say regarding location of the mix position, but that's a sticky situation because the venue is usually reluctant to give up seats. Ask the house engineer if there are any quirks to the mix position, especially when it's located in a balcony or booth. You might learn that you are mixing within a bass trap. Part of your soundcheck should include walking the room to evaluate the coverage. You may not be able to solve all coverage issues, but if there are front-fills, then you can adjust their aim to make the folks down front happy.

Unfortunately, any advance must include some silly questions. One of my favorites addresses the number of compressors and gates available at the house console. Many smaller venues use multi-dynamic processors such as the dbx 1066 2-channel gate/compressor or PreSonus ACP88, which provides eight channels of gating/compression. This approach is different from eight channels of gate and eight channels of compression because you don't have the ability to separate the gate from

the compressor and patch them to different channels. Some folks will count the ACP88 as eight gates and eight comps, which it is not. (Note: I'm not picking on PreSonus; I'm picking on people who don't know how to count). You need to know ahead of time whether the requisite number of processors will be available so you can request additional gear or bring it along with you. A note on carrying your own processing rack: You'll need two sets of wiring harnesses: one with "insert"-style cables (TRS-to-dual-TS breakout) and another with "normal" TS (or TRS) cables for consoles that use separate jacks for insert send and return. Other dumb but necessary questions include: How many channels on the desk have mic inputs? How many actually work? What is the number of snake channels from stage to FOH? If you don't ask, don't be surprised by the reality you encounter.

WHAT YOU NEED TO PACK

If you can't have all of your toys, all of the time, then you may be able to travel with key elements. Traveling with the lead singer's mic and a "money channel" can cut down on wasted time and energy. Ditto for

BERLINER MICROPHONES
Capturing the Sound Of the Future!

"The art of recording drums has evolved quite a bit over the years. Nevertheless, getting great drum sounds in the studio remains a daunting task. Since I started using the Berliner mics, that task has become so much easier. With only the CM 33's on overheads and the DK1 on kick my kit sounds killer every time."

~Steve Stephens, LA Session Drummer, Composer & Producer. (Janet Jackson, Stanley Clarke, George Duke)

WWW.BERLINERUSA.COM

DISTRIBUTED BY VINTAGE SONICS GROUP, INC. • WWW.VINTAGESONICS.COM • 1-888-MIC-THIS (642-8447) • 208-545-0446 (FAX) • ©2007 BERLINER USA, INC.

“THE BEST CUE SYSTEM IN TOWN”

After winning nine Grammy Awards® as the driving force behind Asleep at the Wheel, as well as producing for artists like Willie Nelson, Ray Benson knows a little bit about what works in the studio.

From his home base at Bismieux Studios in Austin, Texas, the “King of Western Swing” has been enjoying the use of what his studio manager called “the best cue system in town” – **THE AVIOM PRO16™ SERIES.**

The Aviom system is intuitive, easy to use, and fully scalable, so it adapts easily to any size session – from a solo artist to a six-piece rock band to a full orchestra.

**TAKE IT PERSONAL WITH AVIOM AND HAVE
THE BEST CUE SYSTEM IN YOUR TOWN.**

“The Aviom system has been the most productive addition to our studio since headphones! It not only provides the players complete control of their mix, it frees up the engineer and producer to concentrate on recording instead of tweakin’ mixes for the musicians.”

“As a guitar player and a singer, I can control not only the volume, but the many different elements of the session. Having that kind of control, at the touch of a button, allows me to concentrate on my performance and creativity to a level unattainable before.”

**RAY
BENSON**

Bandleader, Guitarist, and Producer



**PRO
16
SERIES**

For more information visit www.Aviom.com/Studio

AVIOM

The Unfamiliar P.A.

your effects, particularly if you use a lot of specific delays or verbs for specific songs. This can ease a lot of stress when you have to “grab it and growl” and don’t have time for programming. (Armed with the appropriate memory card, you can program a device such as the Yamaha SPX-990 at home, store programs on the card and take it with you.)

Speaking of programming, you’ll need to become familiar with a variety of effects units. On a daily basis, you can expect to see any of the following: TC Elec-

tronic M•One and D•Two, Yamaha SPX-990/900/90, Roland SDE-1000/3000/330, Lexicon PCM70/80/81/90/91, and Eventide H3000 and Eclipse. Learning how to quickly program these devices is a mandatory skill. Some of the less-common effects devices you’ll encounter include Lexicon Model 300, TC Electronic M5000/M3000/M2000 and Klark Teknik DN780. Download the manuals and make it your business to learn them, or at least maintain a library of PDF manuals on your laptop. One of the joys—or horrors, depending on your

perspective—of P.A. *du jour* is that you get to use different gear all of the time, so you sharpen your tech chops really quickly. If new consoles scare you, then attend a demo or workshop for desks such as the Digidesign VENUE, DiGiCo D5 or Yamaha PM5D—and don’t forget that software is available to help you preconfigure these desks, so you can load in scenes when you arrive.

USE YOUR EARS

A CD with familiar music and/or test tones can help reveal technical issues in an unfamiliar P.A. Listen to the system for left/right consistency, overall volume capability, coverage, phase relationships between driver and cabinets, and unwanted noises such as rattling grille work or blown drivers. Get into a routine of using signals that help you understand the nature of a P.A. You may not be able to run spectrum analysis, but playing third-octave tones can help identify nonlinearities so you can adjust accordingly. Though I’m not shy about adjusting the output levels of a crossover or drive processor, check with the house engineer before you modify a crossover frequency setting. Sometimes these adjustments are best left alone or left for someone who knows the system more intimately.

I DON'T WANT TO SHARE

Dealing with opening acts becomes a big issue at small venues. Carrying your own mics is a wonderful thing because, as my friend Bruce Swedien once pointed out, “you know where they’ve been.” Nothing compounds an unfamiliar P.A. system more than unfamiliar mics, and having your own means that opening acts need not share, which facilitates changeover between acts. Often, there are not enough channels on the monitor and/or house desks to avoid sharing between bands. If possible, set aside any extra channels for the opener’s drums because that’s where engineers apply different EQ and gain settings.

Sharing channels on a monitor desk is another story. In my book, that story starts and ends with “no.” It’s simply too time-consuming to change monitor settings from act to act unless the monitor console is programmable. If you don’t have the ability to program a scene, then you’ll need to split the channels between opening and headlining acts. Concessions must be made on both parts, so have an idea ahead of time about which channels you can nix from monitors. Likely candidates include the snare bottom, overheads



VINTAGE

You know the sound—warm and crisp with incredible presence. About 60 years ago, Neumann figured out how to get that sound. Back then, it took a tube. Today, Neumann’s done it with some hot new technology. And yes, it sounds amazing. Now, grab a couple and go make some hits. We’ll toss in the shockmounts.

TLM 49 Condenser Mic

NEUMANN.USA
DISTRIBUTION FOR THE AMERICAS

MODERN

How do you make one of Neumann’s all-time most popular microphones better? Our KM 180 Series microphones are now available in digital versions. With analog to digital conversion right next to the capsule, you won’t believe the dynamic range and sonic detail that’s been hiding in your sources.

KMD Digital Mics

NeumannUSA, Tel (860) 434-9190 • www.neumannusa.com
Latin America: Tel 52-55-5638-1020 • Canada: Tel (514) 426-3013

Solid State Logic

S O U N D | | V I S I O N



Alpha VHD Pre. The Four-Channel Mic Pre with attitude.

Transform your DAW audio interface with four SSL analogue mic preamps

Ultra-clean, high-grade mic preamps with line and instrument level switching

Four independent Variable Harmonic Drive (VHD) circuits

VHD - A time machine of overdrive characteristics

100% analogue signal path

Based on the VHD circuit from our acclaimed Duality console, the Alpha VHD Pre adds four SSL mic preamps to any line level DAW audio interface, transforming it into a high quality, multi-channel analogue recording system.

The four high-grade, ultra-clean mic preamps are combined with independent Variable Harmonic Drive circuits that use 100% analogue signal paths to generate rich harmonic overdrive - adding SSL analogue attitude to your digital recordings.



www.solid-state-logic.com

Solid State Logic
S O U N D | | V I S I O N

The Unfamiliar P.A.

and bass mic (assuming there's a DI), plus "second" channels on a multi-miked instrument. (For example, if there are two mics on the kick drum, then you don't really need both of them in the monitors.) Other omissions will be determined by the band. At the top of your list, insist on having a working talkback mic from FOH to stage. After the changeover is complete, you'll want to check every line, and you can't accomplish this if you can't speak with your crew through the monitors.

MIXING TECHNIQUES

Now that you've piled into a smaller venue, how does your mixing approach change? For one thing, you'll have to make adjustments to deal with the stage sound. In large venues, stage volume is insignificant when compared to the house mix. Once you get into smaller rooms, you may need to adopt the philosophy that the P.A. is "highlighting" the stage sound. When dealing with raging guitar amps in a small room, a major concern may be getting vocals louder than the band. This takes control out of your hands and into the band's. You may need to ask your musicians to take the stage level

down—particularly wedges, which will now contribute to your *house* mix.

You can use brute force to create a mix that overpowers the band's stage volume, but this really isn't much fun, nor is it healthy for your ears. In rooms with relatively low ceilings, the need for cymbal mics decreases radically, sometimes to the point where you can use one overhead mic or eliminate them completely. As the drums (and the entire backline) are now pushed closer to the vocal mics, leakage becomes a major issue. A Plexiglas baffle in front of the kit can clean up the vocal mics to an amazing degree (if your drummer is willing). It's possible to unintentionally put effects on the drums via leakage into the vocal mic(s), so either baby-sit the lead vocal channel or gate it so that it's off when not in use.

Ditto for bandmembers who have multiple "stations," such as a guitar player who doubles on keys and has more than one vocal mic. In some situations, you may need to move the mic position of a player relative to his/her amp. If a guitar amp is blaring in *your* face, aiming the amp slightly cross-stage instead of directly at the

audience can make a major improvement in your ability to mix.

Smaller rooms also mean vocal mics are more prone to feedback. Applying a highpass filter on a vocal mic not only helps reduce leakage from the bass amp, but it also reduces the possibility of low-end feedback between that mic and the house P.A. While you're at it, try reversing the polarity (phase) of the vocal mics while listening for leakage; sometimes flipping the polarity can diminish the effects of backline leakage.

An important aspect of mixing in any venue is respecting the house gear. The house engineer knows what the venue's gear can do and how much it can be pushed into the red. It's the house engineer's responsibility to monitor your use of the equipment and protect the owner's investment. If he/she thinks you're pushing the system too hard and asks you to pull back, you have to respect that—especially if you want to come back next year. ■

In addition to being Mix's sound reinforcement editor, Steve La Cerra is the front-of-house engineer for Blue Öyster Cult.

●●●●ARGOSY:TRANSFORMATION:●●●●ARGOSY:TRANSFORMATION:●●●●ARGOSY:TRANSFORMATION:●●●●ARGOSY:TRANSFORMATION:●●●●ARGOSY:TRANSFORMATION

Studio Furniture:
▶ Custom-fit consoles
Workstations
Equipment racks
Accessories

The finest facilities in the world rely on Argosy studio furnishings...

so can you.



©2007 Argosy Console, Inc.



www.argosyconsole.com ●●●●ARGOSY

Go online to request the new 2007-2008 product guide

SO TRUE

VXT MONITORS FROM KRK

You need to trust that the music you hear in the studio will be true to your artistic vision. Above all things KRK engineers understand this, and take great care to create products that can be trusted and relied upon. The new VXT monitors embody the attention to detail and design expertise you would expect from KRK. Key elements such as a cutting-edge enclosure, optimal airflow with low port turbulence, and high-quality components, enable VXT monitors to deliver a very real and true sound that is in a class of it's own.



12th Annual Mix L.A. Open

ALL PHOTOS: PAUL LEETER PHOTOGRAPHY
EXCEPT WHERE NOTED

The 12th Annual Mix L.A. Open was a rousing success as approximately 120 of the best and brightest in the audio industry played 18 holes in perfect weather at the Malibu Country Club. Winner of the contest was Team Ed Cherney (Chuck Cherney, Kenny Gradney, Paul Barrere and honorary chairman Ed Cherney) with a score of 55. The Village Recorder team also shot a 55 for second place. Third-place honors went to the Bose team. Other awards include Ryan Andrews in the Longest Drive Contest. Closest to the Pin to Marc Bertrand and Longest Putt to Kenny Gradney.



Honorary chairman Ed Cherney and Mix magazine associate publisher Erika Lopez get down to business during the awards ceremony.



Longest Putt Sponsor, Mix magazine, was represented by Mix magazine southwest advertising manager Albert Margolis, Manley Audio's EveAnna Manley, Mix's vice president Jon Chalon and Universal Audio's Erica McDaniel.



Scott Weber, representing Team Digidesign, participates in the Putting Contest.



Members of first-place-winning Team Ed Cherney (L-R: Ed Cherney, Kenny Gradney, Paul Barrere and Chuck Cherney), with Pin-Up Golf's Jennifer Pennington.

Special thanks for the support of sponsors Absolute Music, Acme Audio, Audio Technica, Design FX Audio, Full Sail, Harman Pro/JBL Professional, The Pass Studios, Record Plant, The P&E Wing, Sembelser Electronic Corp., Shure, Sound Design Corporation and Yamaha Corporation



Intelligent I/O - Integrated F/X



Not Just Another Audio Interface

Konnekt 24D is a groundbreaking audio interface that integrates TC's world famous effects in a state-of-the-art design. Developed for recording and performing musicians seeking the highest possible sound quality, Konnekt 24D ensures that your analog recordings make it to the hard disk in perfect shape.

konnekt 24D

Expected features

- ▶ 14/14 I/O: 2 mic/inst/line, 2 line inputs and 4 line outputs, 8 ADAT and 2 S/PDIF (optical and coaxial)
- ▶ Full feature stand alone mode
- ▶ Link up to 4 units to get more inputs, outputs and effects channels
- ▶ DICEII digital interface chip with JET™ Jitter Elimination Technology
- ▶ FireWire bus powered
- ▶ Low latency drivers: WDM, ASIO and CoreAudio (Including Intel Macs)
- ▶ 24-bit/192kHz sampling rate
- ▶ Sample accurate MIDI
- ▶ Bundled with Cubase LE

Unexpected features

- ▶ Built-in real-time DSP effects; Fabrik R reverb and Fabrik C channel strip based on MINT™
- ▶ IMPACT™ mic preamps
- ▶ True Hi-Z guitar inputs
- ▶ Front panel light ring control of internal mixer parameters
- ▶ Intuitive control panel with automatic input detection
- ▶ Analog volume control for perfect integration with powered speakers
- ▶ Dual headphone outputs, one with auto speaker muting
- ▶ Assimilator Konnekt native fingerprint EQ included
- ▶ 3 DSP programs for total recall of internal routing, mixer and effects settings
- ▶ TC NEAR™ 1394 FireWire based network for full feature direct monitoring – even between units



FABRIK R
INTEGRATED

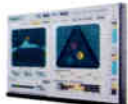

FABRIK C
INTEGRATED



ASSIMILATOR
KONNEKT
INCLUDED



konnekt 8
ALSO AVAILABLE

t.c. electronic
ULTIMATE SOUND MACHINES

TC ELECTRONIC A/S DENMARK ▶ ☎ +45 8742 7000
TC ELECTRONIC INC USA ▶ ☎ (818) 665 4900 ▶ MAIL: INFO@TC ELECTRONIC.COM
WWW.TCELECTRONIC.COM

12th Annual Mix L.A. Open



Pin-Up Golf's Jennifer Pennington holds out cards for golfer Benny Mardones.



Sound Design Corp.'s Paul Sandweiss (right) checks out the silent auction.



PHOTO: KYLE KEENE

The Producers & Engineers Wing (Golf Cart sponsors) are represented by (L-R) mixer/engineer Jimmy Mitchell, Remote Recording owner Karen Brinton, producer CJ Vanston, P&E Wing executive director Maureen Dronney and mixer/engineer Jim Scott.



Johnny Hagan (right) of Absolute Music, sponsor of Closest to the Pin, presents winner Marc Bertrand with his prize.



Third-place team honors go to, from left, Bose's Rob Grubb, Jeaf Wyrick and Bryan Bradley from Guitar Center, and Blue Sky's Chris Fichera.



Team Yamaha (Golf Ball sponsors) members, from left: Val Garay, Paul Furtkamp, John Conard and Mike Mierau



PHOTO: KAREN DUNN

Keeping things lively at the Clubhouse are (L-R) Record Plant president Rose Mann Cherney, Capitol Studios studio manager Paula Salvatore, P&E Wing executive director Maureen Dronney and Mix magazine associate publisher Erika Lopez.



Second-place team from The Village, from left: Kyle Weba, Chris Rossassen, Charles Bidwell, Cort McCown



JBL Professional's Lou Wilhelm (far left) joined Longest Drive sponsor Audio-Technica team members (L-R) Larry Martin from Tour Supply, and Audio-Technica's Jeff Simcox and Glenn Roop.

MANLEY



TNT

"TUBE" channel from our award-winning SLAMP®

Ultra-fresh, feature-laden, solid-state "COOL" channel. New from Hutch's lab!

Choice. Flexibility. More options for you. Better sound for all.



GET A PAIR!



The Langevin baby brother of the famous Manley Massive Passive!

Tone-shaping capabilities of giant, wind-blowingly gargantuan proportions!

Hand-built in the USA, as always!



MANLEY'S LATEST  NOMINEES!

Langevin

MANLEY
LABORATORIES, INC.

13880 Magnolia Ave. emanley@manleylabs.com
Chino, California 91710 Tel: +1 (909) 627-4256
www.manleylabs.com Fax: +1 (909) 628-2482



THE 23RD ANNUAL TECHNICAL EXCELLENCE & CREATIVITY AWARDS NOMINATIONS

Listed below are the nominees for the 23rd Annual TEC Awards as selected by the members of the 2007 TEC Awards Nominating Panel. A special TEC Awards Voter's Guide will appear in the August issue of *Mix*, and for the first time, qualified subscribers will also be able to vote online.

OUTSTANDING TECHNICAL ACHIEVEMENT

Ancillary Equipment

Apogee Electronics Symphony
Audio-Technica ATH-M50 Headphones
Dolby Media Producer
EAW Smaart Version 6
PreSonus FaderPort
Ultrasonie Edition9 Headphones

Digital Converter Technology

Apogee Electronics Ensemble
Digidesign Mbox 2 Pro
Focusrite Saffire PRO 26 i/o
Lynx Aurora With LT-HD Card
PreSonus FireStudio
TC Electronic Konnekt 24D

Mic Preamplifier Technology

AEA The Ribbon Pre
Manley TNT
Neve 8801
PreSonus DigiMax FS
SSL XLogic Alpha Channel
Universal Audio Solo Series 110/610

Microphone Technology/Sound Reinforcement

AKG D5
Audio-Technica ATM250DE
Audix VX 5
Equation Audio DS-V10
Neumann KMS 104
Shure KSM9

Microphone Technology/Recording

Audio-Technica ATM450
Blue Microphones Woodpecker
DPA SMK4061
Neumann KM D Digital Mics
Royer Labs R-122V
Telefunken USA R-F-T AK47

Wireless Technology

Audio-Technica 1800 Series Dual Channel
beyerdynamic Opus 900
Lectrosonics SMQ Transmitter
Mipro ACT-81/82
Sennheiser NET1
Zaxcom TRX990 Transmitter/Recorder

Sound Reinforcement

Loudspeaker Technology

Electro-Voice Phoenix Series
JBL Professional VP Series
Meyer Sound M'elodie
Nexo GEO D Series
QSC ILA Line Array
Turbosound Aspect TA-500

Studio Monitor Technology

ADAM Audio A7
Blue Sky Big Blue
Dynaudio Acoustics BM 6A MkII
Genelec 8200/7200
Pelonis Signature Series PSS110P
Tannoy Precision 8 iDP

Musical Instrument Technology

Access Music Virus TI Polar
Arturia Prophet V
Cakewalk Rapture
IK Multimedia Ampeg SVX
Moog Little Phatty
WaveMachine Labs Drumagog 4

Signal Processing Technology/Hardware

API 5500 Dual Equalizer
Dolby Lake Processor
Eventide H7600
Focusrite Liquid Mix
Langevin Mini Massive EQ
Neve 8803 Dual Equalizer

Signal Processing Technology/Software

CEDAR Audio CEDAR Tools 3.2
Celemony Melodyne 3 Studio
McDSP ML4000 Mastering Limiter
Roger Nichols Digital Dynam-izer
Universal Audio Neve Classic Console Bundle
Waves V Series

Workstation Technology

Ableton Live 6
BIAS Peak Pro 5.2
Cakewalk SONAR 6 Producer Edition
Digidesign 003
MOTU Digital Performer 5
Steinberg Cubase 4

Recording Devices

Edirol R-4 Pro
HHB FlashMic
Korg MR-1000
Marantz CDR310
Sony MZ-M200
Tascam DV-RA1000HD

Sound Reinforcement Console Technology

DiGiCo D5T12
Digidesign D-Show Profile
Mackie Onyx 32.4
Midas XL8
Soundcraft Vi6
Yamaha PM1DV2

Small Format Console Technology

M-Audio NRV10
SSL XLogic Xrack Summing System
Tascam DM-4800
Toft Audio ATB Series
Trident Audio Series 8T-8
Yamaha LS9

Large Format Console Technology

Calrec Bluefin Technology
Fairlight DREAM II With Crystal Core Engine
Oram GP40 Custom
SSL Duality
Studer Vista 5

Note: A new category—Interactive Entertainment Sound Production—has been added in the category of Outstanding Creative Achievement. Also, a complete list of all Creative nominees for each project can be found at www.mixfoundation.org.

OUTSTANDING CREATIVE ACHIEVEMENT

Tour Sound Production

Dixie Chicks, Clair Showco
Eric Clapton, Concert Sound
John Mayer, Clair Showco
James Taylor, Clair Showco
The Who, Audio Analysts

Remote Production/Recording or Broadcast

49th Annual Grammy Awards, CBS
79th Annual Academy Awards, ABC
2006 American Music Awards, ABC
40th Annual Country Music Awards, ABC
Super Bowl XLI, CBS

Television Sound Production

24, Fox
American Idol, Fox
Heroes, NBC
Lost, ABC
The Sopranos, HBO

Film Sound Production

Blood Diamond, Warner Bros. Pictures
The Departed, Warner Bros. Pictures
Dreamgirls, DreamWorks
Pan's Labyrinth, Warner Bros. Pictures
Pirates of the Caribbean: Dead Man's Chest,
Walt Disney

Studio Design Project

Great Divide Studios, Aspen, CO
Levels Audio, Hollywood
Record Plant/SSL 1, Hollywood
Sony Computer Entertainment America, San Diego, CA
Talking House Studios, San Francisco

Interactive Entertainment Sound Production

Call of Duty 3, Activision
Gears of War, Microsoft Game Studios
God of War II, SCEA
Tom Clancy's Ghost Recon Advanced Warfighter 2,
Ubisoft
Tomb Raider: Legend, Eidos Interactive

Surround Sound Production

A Valid Path, Alan Parsons (DualDisc)
Barenaked Ladies Are Me, Barenaked Ladies (DVD-A)
Live at 1988 Montreux, Carlos Santana & Wayne
Shorter (DVD)
Love, Beatles (DVD-A)
Score XDX—20th Anniversary World Tour Live With
Octavarium Orchestra, Dream Theater (DVD)

Record Production/Single or Track

"Chasing Cars," Eyes Open, Snow Patrol
"Crazy," St. Elsewhere, Gnarlz Barkley
"Not Ready to Make Nice," Taking the Long Way,
The Dixie Chicks
"Waiting on the World to Change," Continuum,
John Mayer
"What Hurts the Most," Me and My Gang, Rascal Flatts

Record Production/Album

All the Road Running, Mark Knopfler & Emmylou Harris
Continuum, John Mayer
FutureSex/LoveSounds, Justin Timberlake
Stadium Arcadium, Red Hot Chili Peppers
Taking the Long Way, The Dixie Chicks

The 23rd Annual TEC Awards will be held Saturday, October 6, 2007, at the New York Marriott Marquis. For more information, contact Karen Dunn at 925/939-6149 or karen@mixfoundation.org.

DREAMERS WANTED.

SCHOOL OF RECORDING ARTS

800.226.7625

3300 University Boulevard • Winter Park, FL 32792

FULL SAIL
Real World Education

Financial aid available to those who qualify • Career development assistance • Accredited School, ACCSCT

DEGREES IN: COMPUTER ANIMATION > DIGITAL ARTS & DESIGN > ENTERTAINMENT BUSINESS > FILM > GAME DEVELOPMENT > RECORDING ARTS > SHOW PRODUCTION & TOURING

ONE OF THE FIVE BEST
MUSIC PROGRAMS
IN THE COUNTRY

- Rolling Stone Magazine

fullsail.com

World Radio History

© 2006 Full Sail Inc. All rights reserved.

Maurice Gainen Productions

Mastering Starbucks Offerings Complements Label Work

It's safe to say that most coffee drinkers are familiar with Starbucks' ever-expanding catalog of *Hear Music* CDs. Many of these releases are thematic compilations of diverse tracks that require a highly skilled mastering touch. Since 2003, musician/engineer/producer Maurice Gainen (www.mauricegainen.com) has put his skill set to use on more than 60 of these offerings in his private studio in Los Angeles' Silver Lake district. Gainen's Starbucks credits include *Remember: John Lennon* and *The Age of Aretha* from the Opus Collection, and Artist's Choice Series CDs including those from Norah Jones, Sheryl Crow and Joni Mitchell. But Starbucks is only one loyal client.

Gainen also produces, records, mixes and masters album releases for indie and major labels in a wide variety of genres. His clientele ranges from L.A.-based artists and bands to projects for Disney, Clear Channel, Virgin Entertainment Group and Hallmark. Gainen has also produced two solo albums—*Jazz World Colors* (2004) and *Jazz Flute Jams* (2006)—and is currently working on a third. "I tell people the best thing about my engineering is my saxophone playing because I approach it from a musical angle," Gainen says. "The gear is just an extension of my musicianship."

A graduate of the Berklee College of Music, Gainen took an interest in the recording process as a session musician in the late '70s. "I was always curious about what the engineers were doing," he remembers. "I would ask questions, and I learned a lot through working as an arranger and a producer."

In 1988, he moved his gear into a 16x16-foot storage space with a concrete floor within a six-unit apartment building that he owns with his father. "The building is up on a hill and it's on a wide street that doesn't have any through traffic," Gainen notes. "All the walls and ceiling were insulated and have double drywall and Celotex. The window has a custom soundproof cover." In 1996, Gainen took over an adjacent 175-square-foot room with wood floors for use as a control room. "I installed a split-system heating and AC for near-silent temperature control. The rooms are separated by a wall, and the control room is about two-and-a-half feet lower than the live room." To compensate, Gainen installed a video camera in the live room for visual contact.

Gainen's control room houses a dual-core 2.5GHz Mac G5 running Apple's Logic Pro Version 7.2 and a Pro Tools HD3 system with a Digidesign 192 I/O audio interface. "Logic works great with Pro Tools hardware as

PHOTOS NORM ZELLER



Maurice Gainen in his control room. Inset: Gainen displays 34 of the more than 60 CD compilations that he has mastered for Starbucks.

the front end, and I can use the TDM stuff in Logic, too," Gainen says. He relies on plug-ins from

Waves, Logic and Bomb Factory, among others: Apple Loops libraries; Spectrasonics soft synths; and Tascam's GigaPiano. A Yamaha P-60 88-key weighted keyboard serves as a MIDI controller. A MOTU MIDI Timepiece A/V routes MIDI data, and an Avalon Design VT737SP is critical to his recording chain. He works with four sets of monitors: Genelec 1030A speakers and a 7060A active subwoofer, Tannoy Reveal 6.5-inch near-field monitors, Alesis Monitor One speakers and JBL Control Micro monitors.

Microphones include a Neumann U87; AKG C-414, D-12 and C-1000S; Shure SM57s; and MXL condensers. "The room mics are important," he says. "I do track entire bands at once. If I have acoustic bass and drums in the same room, I have a fold-up Futon that I put around the bass. Last week, I recorded tabla and sitar and did the same. If it's a rock band, I take the bass direct and put the guitar amp in the storage area. I usually have vocalists in the live room, except if they're tracking with the band—then they would be in the control room with me."

Gainen uses a Logic control surface for mix automation and masters in Logic with Waves' Platinum TDM and Restoration bundle plug-ins. "I'm monitoring through my [Yamaha] 02R, and with one button I can easily switch from listening to the mastered version to the unmastered version to an example track in the Logic file," he says. "Once I started mastering, I started mixing differently. It's just a question of throwing all the songs into one file and taking a look at them as a whole. It's all very inter-related. I'm relying on my ears, but I'm also relying on the client's." ■

Matt Gallagher is an assistant editor at Mix.

MIPRO

ACT-81 / ACT-82 True Digital Wireless Microphone Systems

The Ultimate Wireless Technology from MIPRO



- 24-bit audio quality and digital RF transmission
- Proprietary 128-bit encryption guarantees secure audio transmission
- DigitnamicPlus™ technology eliminates compander noise and accurately restores original sound quality
- Digital technology delivers no saturation or distortion at higher frequencies under high SPL input conditions
- Built-in selectable microphone modeling equalization faithfully reproduces the industry's most popular microphone capsules
- Digital design provides increased resistance to interference and offers better sound quality than analog systems
- Featuring the industry's first full color VFD display with controls are intuitive and easily accessible allowing for quick and easy system set-up via a single rotary switch
- PC-controllable software allows simultaneous monitoring and control of multiple, large-scale systems
- High energy rechargeable battery design allows extended 8-10 continuous hours per charge



Avlex

Exclusive US Distributor for MIPRO
www.avlex.com Toll Free 877.447.9216

Transforming Blockbuster Sound

Kevin O'Connell and Greg Russell Know When It's Loud Enough

By Blair Jackson

When it comes to mixing sound for blockbusters, the indisputable kings of Hollywood are Kevin O'Connell and Greg Russell. Their track record is staggering: Since the duo first worked together in the late '80s, they have received 11 Oscar nominations for

among many others. When we spoke in late May, they were hard at work on the final mix of Michael Bay's latest popcorn extravaganza, *Transformers*, in their usual lair: the Cary Grant Theatre on the Sony lot in L.A.

O'Connell was born in Long Island, N.Y., but raised in L.A., where his parents were sort of in show business:

His father worked as an accountant for numerous television shows, including *Batman*, *Daniel Boone* and *Voyage to the Bottom of the Sea*; his mother got a job at 20th Century Fox as a secretary in the sound department. Growing up, O'Connell had only one career goal, however: to be a fireman. At 19, he passed the test to be an L.A. County firefighter and landed a job battling brush fires. But with the persistent encouragement

of his mother, who frankly did not like seeing her son come home charred and dirty, he abruptly switched career paths. His attempt at becoming a film projectionist didn't pan out, but he landed a job as an apprentice in the sound department at the Samuel Goldwyn Studios, cleaning film and working as a machine room operator and recording technician for the mixers there, including Bill Varney and Gregg Landaker. By 1981, sound department head Don Rogers had elevated O'Connell to the mix chair. His first film was Steve Martin's *Dead Men Don't Wear Plaid*.

"That was the scariest moment of my life," he recalls, "because I'd never sat and mixed in front of clients before, and though I only had 10 or 12 tracks in those days, it was a non-automated console, and I didn't really have any idea what I was doing. I asked Bill Varney what to do, and he said, 'Put all the faders at 10,' so I did that, we hit 'go' and it was horrifying! The movie starts out with a lightning bolt and rain and a car driving in the mud, and it was all way too loud. No one could hear any of the music or the dialog! It was awful. I was perspiring so heavily I went into the bathroom and wadded up pa-

per towels and stuck them under my armpits. Eventually, of course, I figured out what I needed to do, and I learned so much from the people around me—Gregg Landaker was always gracious and helped me a lot in my early years as an effects mixer—but I have to say that nervousness lasted for several years before I settled into a comfortable groove."

After working as an effects mixer for a number of years, often with Don Mitchell as his mixing partner, he branched out to dialog mixing. In the early '90s, "I went to work for Skywalker South in Santa Monica [Calif.] and my partner at the time, Rick Kline, was a music mixer, so since I'd been a sound effects mixer first, I did dialog and sound effects. I mixed several films that way, but after a while it seemed like too much work. You're literally working from the first day of the mix to the last day of the foreign—100 percent of the time you are at the console, so it just became too much. That's when I got into mixing music and dialog and working with someone who could mix effects." After working with a variety of other re-recording mixers, from Mitchell to Kline to Steve Maslow, O'Connell settled into his fruitful—but always non-exclusive—relationship with Russell in the mid-'90s.

Russell was also exposed to the entertainment world at a young age: His father, Sheldon Russell, was the lead alto saxophonist on *The Merv Griffin Show* (first in New York, then, beginning in 1970, in L.A.) and an in-demand session reeds player who worked on numerous albums by everyone from Frank Sinatra to Barbra Streisand. Russell sometimes got to sit on the *Griffin Show* bandstand between his father and sax great Plas Johnson (of "Pink Panther Theme" fame), "and I always gravitated toward the musicians," he says. "At the same time, I was always interested in what the engineer was doing; I liked studios." By his mid-teens, Russell had learned how to set up a band in a studio, put slap delays and reverbs on vocals, and the rudiments of live sound engineering.

At 18, he took a job as a runner at TTG Recording in Hollywood, which specialized in recording music scores for television. "They did all the Spelling-Goldberg shows—*Charlie's Angels*, *The Love Boat*, *Hart to Hart*,"



Kevin O'Connell, director Michael Bay and Greg Russell

a range of projects including *Black Rain*, *Armageddon*, *The Musk of Zorro*, *Pearl Harbor*, *Spider-Man 1* and *2* and, most recently, *Apocalypto*. O'Connell, meanwhile, has eight other nominations, from the quiet of *Terms of Endearment* to the power of *Top Gun* and *Twister*. Any way you look at it, that's a very impressive list, not just because the collective grosses of those films could probably subsidize a handful of Third World nations for a decade, but for the incredible variety of projects—everything from effects-filled spectacles to historical dramas to comic-book fantasies.

And it just scratches the surface of the amazing careers in film sound the two have enjoyed, both together and separately, and the wide variety of films they tackle. Many would no doubt be surprised to learn that within the same time period they were completing high-profile sound jobs like the three *Spider-Man* films, *Terminator 3*, *Men in Black II* and *Apocalypto*, they also worked on the comedies *RV*, *Guess Who*, *Bewitched* and *Talladega Nights*; the crowd-pleasing adventures *National Treasure* and *The Da Vinci Code*; and the sports movie *Glory Road*.

he recalls. "After about six months, I was given the opportunity to run mag—the 35mm recorder—and that was my first real job. From there, I became Ami Hadami's second engineer on these television shows and eventually the engineer recording the music."

In 1981, he moved over to another studio that specialized in scoring and jingle work—Evergreen Recording in Burbank—then in 1983 migrated to a small post-production facility called B&B Sound,

where he branched into dialog recording for animated shows. On the side, however, Russell and Jeff Haboush had partnered to become a mixing team, working on a wide variety of mostly lower-budget films (the original *Hairspray*, *Pumpkinhead*, "lots of slasher films," Russell says with a chuckle) and some TV (such as the hit series *Moonlighting*). "I was doing both music and effects; Jeff did the dialog and some effects, too. We did 55 features together from 1983 to 1988. They were small so you could do them in three or four days. We worked day and night together: TV by day and small feature films at night. It was crazy."

In 1988, Russell received a fateful call from Warner Hollywood's Don Rogers offering him a job. "Getting a call from him was like getting a call from the president of the club," Russell says, "and going to work there was amazing because the studios were filled with all these people I'd looked up to, like Bob Litt, Elliot Tyson, Don Mitchell, Rick Kline, Gregg Landaker, Steve Maslow and, of course, Kevin O'Connell, who was still an effects mixer. It was almost like a ball player working in the minor leagues getting that call to come up to the majors and play with the big boys.

"I was thrilled and honored to be given the opportunity. I was able to really absorb and be a sponge and learn a lot." In his early days at Warner Hollywood, Russell primarily mixed music, but by 1991 had



O'Connell and Russell mixed Michael Bay's Transformers at the Cary Grant Theater.

moved back to effects, "which I found I'd really missed. It's such a creative job. I love those spaceships going over your head," he says with a laugh.

I mention that it's somewhat ironic that O'Connell started out as an effects mixer and moved into music and dialog, whereas Russell had been mixing music and moved back to effects. "I think that's one reason we work so well together," Russell offers. "When he started working as a music mixer, he had someone on the stage who had 75 films under his belt as a music guy. And even though I had however many effects shows I'd done, I had a guy who spent many years and was a really excellent effects mixer in Kevin. So it's really served both of us well. We can give each other suggestions and figure out together what can we do to make something sound great."

It was in the mid- to late '90s that Hollywood started to really take notice of the Russell O'Connell mixing team, thanks to a string of *really loud* action movies, including *Con Air*, *The Rock* and *Armageddon*, the latter two directed by Bay. Although these garnered the duo Oscar nominations, these films were also criticized in some circles for contributing to the trend toward deafening volume in film mixing. Today, both acknowledge that things did get out of hand there for a while, but they've worked hard to pull in the reins. It's no coincidence, they say, that the shift

occurred with the widespread introduction of digital technology on the stage.

"Anybody who is given a new toy is going to push it to its limits," O'Connell notes. "As soon as we got into the digital era and the fact that most films were going out not stereo optical anymore but in 6-track, it opened up the door for that stuff to happen."

"*The Rock* was big," Russell says. "*Armageddon* was even bigger, and too big. In the case of *Armageddon*, we were definitely asked to make things bigger and louder. I'll give you an example: In our shuttle take-off sequence, Michael [Bay] came in, and said, 'Guys, it's wimpy.' And by no means was it wimpy, but he was looking for more snap out of the metal, more power. So you go where you need to go to get the thumbs up from the director. That's not to say we don't take responsibility for that particular film. But we were also mixing around the clock, completely exhausted, and from ear fatigue you're not listening to things as well as you could be if you were fresh. We did that entire movie from start to finish in five weeks and two days and that was unheard of.

"But in that same year, we mixed *The Mask of Zorro*, which I thought was very tasty," Russell continues, "with great dynamics and detail and definition, and we were nominated for that, as well, along with *Armageddon*. So it wasn't that every-

thing suddenly became too loud."

"*The Mask of Zorro* was a gas," O'Connell agrees. "It was more organic sound, and for me maybe it was even more exciting to work on than a film like *Armageddon* because there's more subtlety. In *Armageddon*, you've got a rocket ship going by that's on fire that's then going to explode into an asteroid, which then blows into pieces and starts tearing apart another planet, then another space shuttle comes by..." [Laughs]

And you're thinking, "Where's my dialog?"

"Not just that," O'Connell continues, "the filmmakers put so much on the screen at one time and I think they don't always realize that, yes, it looks cool, but when you try to hear it *all*, it becomes a bit of a mess. So what I've been trying to do in the latter stages of my career is figure out what on the screen do we *need* to listen to? What can we get rid of and how can we make it all better? That comes with experience.

"One reason movies are too loud is sometimes they're presented to the director too loud the first time they see it. The director says, 'I like it, but I can't hear the dialog,' so they raise the dialog, and then the music guy says, 'Well, now I don't hear the

music,' so they raise the music. It's rare that once they hear the jets and the explosions loud that they pull them back; it generally works the other way, to keep turning it up. So that's something Greg and I work at—to present it to the director at a reasonable level that gives us some room to work with."

But that doesn't always get them off the hook. As Russell explains, "Sometimes we're still asked to go really loud. On *Terminator 3* with Jonathan Mostow, he wanted *huge*, and his statement when we tried to talk to him about dynamic range—not playing everything up at '10'—was, 'I want the audience, at the end of the movie, to be *exhausted*.' And I said, 'Well, I think we're going to accomplish that! Sometimes you have to do things to make a director happy, but there are things within a mixer's control to say, 'We're where we need to be.'"

These days, of course, everything arrives on the mixing stage in Pro Tools sessions:



Both O'Connell and Russell received nominations for their work on *The Mask of Zorro*.

dialog, FX, Foley, music. "Certainly, it's a lot easier than when we had things coming in all sorts of different [formats]," O'Connell comments. "Pro Tools has got its little ticks and glitches and whatever, but just like anything else, when you have a technological change you work your way through it. There are major advantages to it, obviously. I can reach up and move tracks and edit tracks and I volume-graph tracks. There's a lot I still don't know about, but I'm learning. At this point,

the legend continues...

Available in 16, 24, & 32 Channels
Starting at \$3,999



Toft Audio Designs
ATB Series
Classic Analogue Console
www.toftaudio.com

The Art of Analog



Universal Audio: Making Music Sound Better Since 1957

1945: Milton T. "Bill" Putnam establishes Universal Recording in Chicago, installing a prototype "610" console.

1947: The first million-selling record, "Peg O' My Heart" by The Harmonicats appears on Bill's Vitacoustic ("Living Sound") Label in 1947.

1948 - 56: Bill engineers and/or produces Bing Crosby, Frank Sinatra, Nat King Cole and countless others, pioneering innovations including the control room, vocal booth, console, sends /returns, echo, artificial reverberation... even stereo recording and half-speed mastering.

1957: Bill Sr. founds United Recording, and later United Western Studios on Sunset Boulevard in Hollywood which are now the world famous Ocean Way and Cello.

1957: Bill founds Universal Audio who's legendary products such as the 1176LN, LA-2A and LA-3A became synonymous with sound quality and hit records.

1983: Bill retires and sells UA (now UREI) to Harman International. His original products become prized collectors items for almost two decades.

1999: Universal Audio brand is revived by Bill's sons "Bill Jr." and Jim Putnam who continue their father's legacy with hand-assembled re-issues based on Bill Sr.'s drawings, vintage components, and design secrets from his personal diaries.

2000: Bill is awarded a posthumous Technical Achievement Grammy as the "Father of Modern Recording".

Today: UA continues the Putnam legacy of "making music sound better" with its world class hardware and software, designed with passion in Santa Cruz, California under its company motto "Analog Ears, Digital Minds".

Become part of this unique and illustrious recording heritage. Live, hear and experience the UA difference today. Visit us on the web at www.uaudio.com or just subscribe to our free informative online 'zine, the UA WebZine: www.uaudio.com/subscribe

Universal Audio, Inc. www.uaudio.com
 Santa Cruz, California info@uaudio.com
 "Analog Ears, Digital Minds" 866-UAD-1176



©2007 Universal Audio, Inc. All rights reserved. All trademarks property of their respective holders

World Radio History

NEW! DC Remote Preamplifier

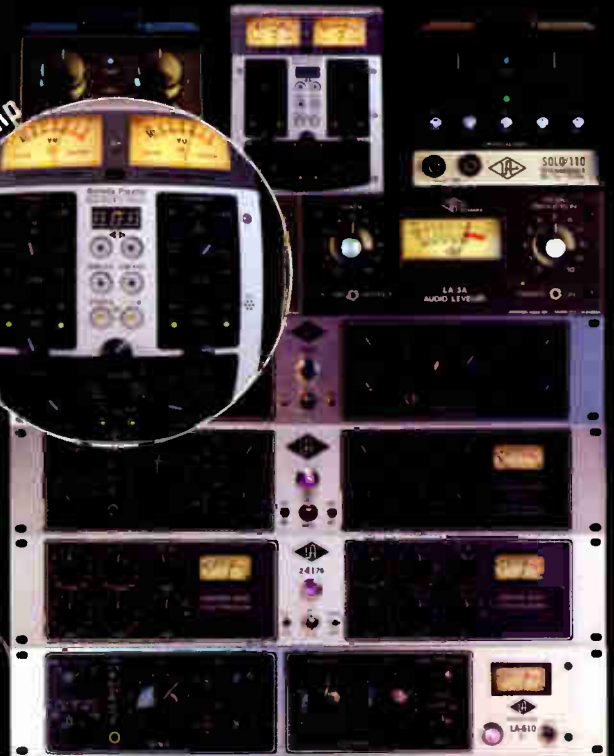

NEW! 2-LA-2



UNIVERSAL AUDIO
LA-2 Leveling Amplifier



I believe Pro Tools is great for recording and playing back on, and I believe the Harrison [MPC] board I work on gives me the best mixing surface on the planet, so I have the best of both worlds."

Adds Russell, "Pro Tools has made it so much easier for everyone to present their material, and it's given all of us much more flexibility when it comes to making changes. Editorially speaking, now that everything is living in Pro Tools, if they have picture conforms and edits to be made, it's not like they have 25 drives that have the audio media on them and individually edit each one. They

can put them in a 'super-session,' which is how we do things now, and they can make a conform and give it back to us in the speed of light, compared to the way it used to be. And because there's more flexibility, you find yourself experimenting more now than before, which I think is a good thing in the creative process."

Ultimately, it is that tremendous creativity, coupled with the variety inherent in working on different projects under different directors with different editors and supervisors, that makes being a re-recording mixer's life so rewarding. Jumping from *The Pursuit of*

Happyness to *Spider-Man 3* to *Transformers* is like entering three completely different worlds. "It's what makes this job fantastic!" Russell enthuses. "It's absolutely extraordinary. It's like telling a painter, 'Here's a palette of colors to play with and create with. Now, here's a completely different set of colors to create something very different.' That's what every film is like. A film like *Apocalypto* was completely organic, nothing high-tech industrial—it was just nature at its best, from all the rock elements and bamboo and weeds and gravel. Fire elements. Thunder. It was all the elements of the earth vs. the opposite of what we're doing now with *Transformers*, which is the highest-tech movie you can possibly imagine. It's literally 180 degrees, and the idea that we can be a part of all these various genres of film makes it very special."

Back on the stage at the Cary Grant Theatre as Memorial Day approaches, though, there is light at the end of the tunnel. "We've mixed the entire film, and it went really well," O'Connell says. "We only took about 12 days to mix the movie, with Michael Bay coming in and looking at playbacks and making a few comments. Then we screened the movie for him and he was really excited about it. Actually we *all* were, because when you're working on a movie in sections, sometimes you forget a bit about the overall picture, but we're all happy with the way it came out."

Russell adds, "Now we're going back through it and there are new music cues that have been revised that Michael had notes on that we're putting into the movie. We're doing final effects notes, final dialog notes and basically going through and dotting every 'i' and crossing every 't.'"

"Michael's been really great on this film," O'Connell says. "Over the years he's really become a proponent of how much sound helps his movies because they're so visual effects-oriented. He's matured into a fantastic filmmaker."

"But really, everyone who worked on this film has done a good job. We had yet another new sound editorial team, with [supervisors] Ethan Van der Ryn and Mike Hopkins [the Oscar-winning team behind *The Lord of the Rings* trilogy and *King Kong*], and the film is really a collaboration between the dialog editors, the sound editors, the music editors and the mixers to where the playing field is completely leveled. Everyone is working toward the same goal; there's no ego. Everyone's doing what's right for the picture. I've never felt the sort of camaraderie that I have with this group of people; it's amazing."

Blair Jackson is senior editor of Mix.

**Independence is
Mainstream**

Next Open House:
Saturday, Jul 21 '07
10:45 a.m.

The music industry is evolving.
Independent artists have more control than ever.
Musicians Institute will put the advantage in your hands.

Musicians Institute
School of Contemporary Music and Recording
Performance - Recording - Music Business - Guitar Craft - Film Production
1655 McCadden Place, Hollywood, CA 90028
1-800-ALL-PLAY (USA/Canada), 323-462-1384 (Int'l) admissions@mi.edu www.mi.edu

MI
MUSICIANS INSTITUTE
30TH ANNIVERSARY
1977-2007

YOU ASKED FOR AN ALTERNATIVE

We Delivered...

The 21st Century Media Platform



**DREAM II
PRODUCT FAMILY**

DREAM II powered by CC-I Go on - put your head above the crowd

If you are fed up with continuously upgrading your system to achieve the results you need, then move over to Fairlight because we've invented and delivered the alternative. CC-I delivers the step change in audio performance that you have been waiting for. With more channels, lower latency and guaranteed processing on every channel, CC-I out performs an entire stack of DSP cards. One CC-I card delivers more power than eight HD Accel™ cards. Utilizing 21st Century FPGA technology, CC-I puts the power back in your hands freeing you from the limiting factors of "those" ubiquitous DSP and uninspired host based systems. Be better, and be more than ready for emerging standards including three dimensional audio, DXD audio formats and more. In short, CC-I has arrived in the world of multi-media creation delivering more power and more performance – and there's no going back!

THE BREAKTHROUGH YOU'VE BEEN WAITING FOR...

What can be achieved with just
ONE PCIe CC-I card ?

- **230 Super Hi Resolution Audio Channels**
- **8 fully parametric bands of EQ on EVERY channel**
- **3 Stages of Dynamics on EVERY channel**
- **Less than 0.5mS latency with full processing**
- **Lightning fast tactile response**
- **72 User definable mix busses from Mono to 7.1**
- **64 channel audio bridge for 3rd Party plug-ins**
- **Up to 212 physical I/Os per CC-I card, Analog, Digital or MADI**
- **Integrated 192 track disk recorder**
- **Integrated Video track in SD or HD format**

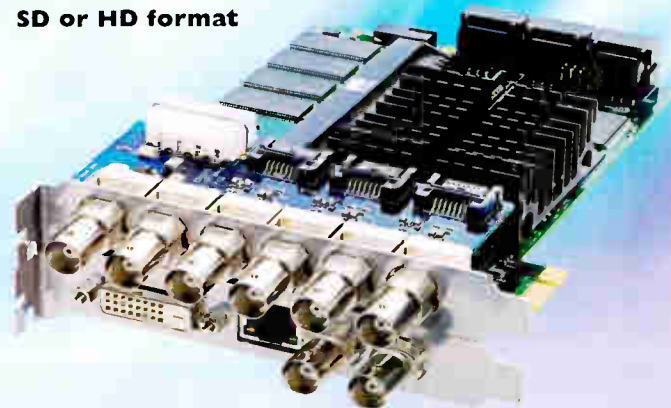

FAIRLIGHT

World Radio History

www.fairlightau.com

helios



Helios Type 69 4 Channel Lunchbox

Exact replica of the venerable pre/eq modules used on classic recordings by Led Zeppelin, the Beatles, the Stones, the Who....these modules are the sound of classic British rock and roll.

A Designs



A Designs EM-PEQ 500 Series Mic Pre

The essence of the classic Pultec EQP-1A in a compact 500 series format allows smooth frequency attenuation and boost with a vintage vibe. Wonderfully smooth and musical.



Prism Orpheus Firewire Interface

All-in-one firewire interface solution for your DAW. Includes 8 ch. AD/DA, 4 mic preamps, and "Over-killer" limiters on every channel, along with a host of other cutting edge features. Uncompromised sonics from the makers of the world's finest converters.

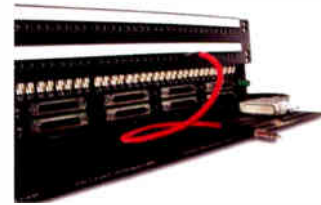

Mini/TT Audio Patchbay to DB25/D-Sub

Professional quality 2x48 audio patchbay terminated to DB25's. Pinned out to allow direct connection to ProTools and other popular pro-audio gear. Quick-Switches on rear of unit to allow reconfigurable normals & grounds. A professional bay built to last.



- *Holds 8 Modules
- *XLR & D-Sub I/O
- *Powers a Vrack too!
- *D-Sub Links



The New Tonelux Portable Rack

"NAME THE RACK CONTEST"

Go to GearSlutz.com and name the new TONELUX Portable rack and WIN the FIRST RACK, 2) MP1A Mic Pres and 2) EQ4P EQ's!



Royer Labs R-122v

The world's first vacuum tube ribbon microphone, its amazing depth and reach in the midrange frequencies will add dimension to any source it encounters.

vintagekingaudio. we've got it all.

studio standards | vintage classics | cutting edge digital | custom racking | recording consoles

888.653.1184 or 248.591.9276 | info@vintageking.com

World Radio History



Korby Kat Red & Kat Blue Tube Mics

The Red is silky and dark with a dreamy high end shimmer. The Blue's luscious Neumann inspired midrange and airy top-end make it an outstanding performer in a wide range of applications. Arrange your demo with Vintage King today!



Neve 8816 Summing Mixer

Add classic Neve tone to your DAW. Sterile digital mixes come out sounding warm and co-hesive with punch and excitement. Classic analog transformer-based with digital recall for Mac or PC.



Shadow Hills Mastering Compressor

Each channel has two compressors in series; a mastering grade electro optical compressor, followed by a discrete Class-A compressor/limiter. Both feed switchable output transformers of Nickel, Iron, or Steel for a vast array of tonal colors!



VT-4 'Class A' Vacuum Tube LC EQ

Anyone who's heard one knows; smooth and sweet, subtle or strong. The LC-style passive equalization circuitry is based on the classic designs that are still the best-sounding way to achieve high-quality tonal control.



Rupert Neve Designs 5088 Mixer

The 5088 is a fully discrete analogue mixer, designed by the master himself. As your studio grows, your 5088 can also grow with the addition of more input channels.



Barefoot Sound MicroMain27

A groundbreaking new monitor that lets you hear what's really happening in your mixes from top to bottom. Nearfields, mains, and mastering speakers all in one! Read reviews at GearSlutz.com.



Plunging Into the Vortex

New Directions in Surround Playback

Surround sound. If you're into next-gen audio, then you need to get hip to multichannel audio. Forty percent of game consoles are hooked to surround systems, the decade-long trend in home theater. It's here, it's now, and a couple of academics are looking to change the way we work with it.

Peter Otto, director of music technology at the University of California, San Diego, and Terry Maedche, formerly of the aerospace industry and a man with a passion for sound, are working on a surround sound system that operates independently of the number of channels you have. Maedche is taking his business acumen (he's the CEO) and combining it with Otto's hands-on tech savvy, and the result is Immersive Media Research, a company devoted to the "art" of surround. With MR's first suite of tools, surround instructions can be applied to any set of speakers and the system figures out the proper panning and attenuation for you. It is delivery platform-agnostic, so to speak, and it's being developed at UCSD. It's called Vortex.

How does Vortex Surround differ from other surround applications, such as using a Dolby Digital or DTS encoder within Pro Tools or Nuendo?

Otto: Vortex differs significantly from Dolby Digital and DTS workstation-based software tools. These great products are oriented around the final stages of converting finished surround content to deliverable formats—including cinema and new HD formats for DVD/Blu-ray release. The DTS and Dolby tools you would use in final mastering of content—automated down-mixing tools; confidence monitoring; and compression choices, including bit rate, dialog normalizing, final channel ordering and some import/export choices—this is indispensable functionality, to be sure. We don't attempt to support all of the dozens of compression varieties and do not offer sophisticated mastering tools. Vortex Surround is a content-creation tool used prior to the mastering phase. We are interested in the delivery end, but in real-time spatial audio rendering in game engines rather than mastering and compression decoding.

Vortex Surround is all about improving surround mix workflow. The original concept was mostly concerned with creating better spatial imaging and simulations, but

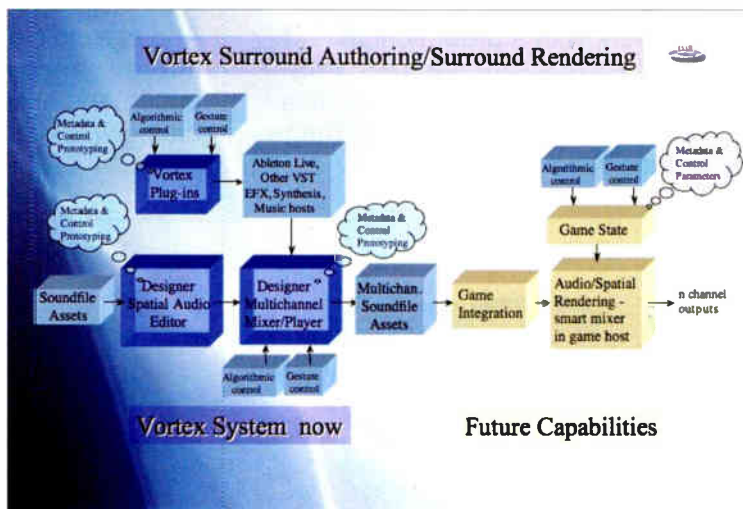

The Vortex system allows sound designers to create in a multichannel environment, then pass the audio along in an improved surround workflow.

once the DSP work was done and composers and sound designers started using the DSP, we realized how many steps are involved in the surround production chain: file management, layering surround files, session configuration, channel ordering, test routines, bass management, ease of playback and monitoring, etc. These are all issues that were barriers to creativity and productivity for surround or 3-D audio.

Can Vortex operate as a plug-in to standard DAW apps?

Otto: Yes! We are in beta now with a powerful VST plug-in that combines many features of our Mixer and Designer products. The first version integrates seamlessly with Ableton Live and other workstations. Other surround-processing variants, plug-in formats and some crazy plug-in controls like flocking, physics, gestural controls, etc., will be forthcoming this year, as well.

Vortex Encoder appears to bypass Dolby Digital but supports DTS export. Will AC-3, Dolby Digital Plus and Dolby TrueHD be supported in the future as an export format?

Otto: We embraced DTS in the pre-HD days because we preferred the fidelity and scalability, and we were very hopeful for the DVD-A format and wanted to support it. But in the future, we will not focus on compression encoding, which is done very well with other products. We will concentrate on our strong suits: content creation, imaging, control, DAW and authoring host integration [plug-ins], and spatial audio rendering, which is different from encoding/decoding of the various compression flavors.

How would one go about supporting a field bigger than 7.1 in a game that is, say, PC only? One would use a mul-

M-AUDIO

The new vintage.

SPUTNIK

Hand-Assembled Condenser Tube Microphone



"Until recently, my trumpet recording setup was a Royer ribbon mic with a Neumann U67—that was until I heard the Sputnik. Everything I've recorded for my new album has been on the Sputnik and the Royer, side by side. *It's the best trumpet sound I've ever had*—smooth and transparent, with just the right amount of coloring. It stands beautifully against some of the best mics in my collection... very well done."

—Mark Isham, composer

"The M-Audio Sputnik is *my new favorite microphone*. Anyone searching for a high-quality tube microphone can begin and end their search with Sputnik... it's destined to join that select group of 'go-to' mics... it really does have that 'magic.' "

—Pro Audio Review

"The Sputnik is a microphone that you can trust to deliver a beautiful, transparent take on every session. After all, that's what really matters."

—Rexxix



Hand-Assembled Condenser Tube Microphone
with optional carry case included

vintage tube design

> Unveiled classic transparent sound

3-micron evaporated-gold Mylar diaphragm

> extremely sensitive

selectable cardioid, figure-8, and omni polar patterns

> total studio flexibility

low-current/high-voltage 6205M vacuum tube

> linear behavior with graceful overload characteristics

hand-assembled limited production run

> boutique quality



▶ GET M-POWERED

www.m-audio.com

World Radio History

ticchannel Ogg or WAV file, but what would the game's playback system require?

Otto: The file format is not such a problem—you could use mono AIFF or WAV files as long as you keep them sample-synchronous, just as a DAW does. You could also use multiple compressed streams. So you would need a playback engine that could deal with lots of channels. We've done 10.2, 16.8.2 and above.

And then you need a multichannel interface that gives you as many channels of output as you need. If you wanted to use multiple compressed streams, you'd have to mount more than one soundcard or interface to pass encoded streams to A/V receivers for decoding and conversion. On a Mac, you can mount multiple "aggregate" interfaces; I've seen something similar on PCs.

When will the Designer and Mixer be available for Windows XP/Vista?

Otto: We are moving everything to Universal Binary now so we should have XP/Vista by the end of summer. The surround mixer plug-in will be released for both platforms from the get-go, so that's exciting.

How much will the tools cost and when will they be available for purchase?

Maedche: The three-product suite—Vortex Designer, Mixer and Encoder—have been

on the market since 2005, and have been adopted by a number of educational programs, sound designers and avant-garde composers. The pricing of the suite for the education market is \$599, and we've just introduced individual student licenses for \$149 when their respective institution buys a license. The introductory price of the Vortex Surround VST is \$99.

What reaction have you had thus far from game developers and film studios?

Otto: Superpositive reaction from the Sony PlayStation 3 [PS3] guys we've shown to. Very much encouragement from everyone we've demo'ed for in the game community. Incidentally, my Project Bar-B-Q work group [the game audio think tank] is very much onboard with this idea of tightly integrating audio authoring with run-time rendering for consistency on the game platforms.

What I think the game folks like is that our goal is to provide a scalable, superior-sounding spatial DSP and easy-to-use interface, so that an IMR audio engine that runs as a plug-in on audio content-creation workstations will run exactly the same on our or someone else's real-time game authoring tools and, in turn, will run the same on a cell-processor game engine. So when you design a sound to move in a particular path at

a particular speed—or following a particular set of rules—from 80 meters to 20 meters, left-front to right-rear, it will sound exactly the same in the sound designer's Pro Tools rig, in our Designer application, in a middleware authoring plug-in and in the PS3 at home.

Beyond Vortex, do you see any radical design changes to the way surround sound is produced?

Otto: Consumers have not yet heard what is possible in the best labs and studios, but the cell processor, though now completely underutilized, will likely turn out to be the best audio engine. The kind of processing that is needed to do really great immersive, 3-D audio is now becoming available, and given great tools we'll have the potential to make audio a pure virtual-reality experience.

I look forward to being able to convolve the acoustics of a concert space into a super-high-definition, surround sound theater using high-speed networking, acoustical capturing and enhancement systems. Audience-based gaming in digital cinemas with elaborate real-time spatial audio interactivity is fun to imagine, and probably not as far away as you might think. ■

Alexander Brandon is the audio director at Obsidian Entertainment (Santa Ana, Calif.).

From console to desktop...

Oxford
Plugins

From strength to strength...



Using many of the same algorithms as the original Sony OXF-R3 digital mixing console. The acclaimed range of plug-ins from Sonnox has been carefully developed with a no-compromise approach, to be THE very best in audio signal processing, where sonic quality means everything.

The acclaimed Sonnox range including the OXF-R3 EQ, Dynamics, Inflator, Transient Modulator, Reverb and Limiter plug-ins have become today's standard tools of choice for the quality conscious audio professional.

To find out why, download your Pro Tools, Native or Powercore demo versions today.

Sonnox Plugins - formerly Sony Oxford Plugins

Sonnox

www.sonnoxplugins.com

Can the advanced technology of Neutrik's XX series connectors reverse your receding hairline?



Possibly. You see, a growing amount of research suggests that job related stress can cause hair loss. And that's where we can help.

While our X series connectors are the industry standard, our next generation XX series is even more durable, easier, and quicker to assemble. When you specify XX, you eliminate the worry that can weaken follicles.

NC3FXX-B

How does XX help? We start deep inside the shaft. Notice the ingenious "cage" type female contact. It creates multiple contact



points that boost conductivity and reduce stress on the male pin. Now check out the aptly named "solder cup." It keeps the solder away from the contact, for faster, easier assembly. You can feel yourself relaxing. Your shower drain seems less clogged.



Is there a patented formula? Well, the XX does have a new ground contact that enhances conductivity between the chassis and cable connector. And a unique latch design that improves security, ease, and speed. You feel increasingly mellow. The mirror is now your friend.

But will it work every time? Relax.

Our chuck type strain relief has higher traction teeth, for increased retention force. And our unique guide flaps make alignment and insertion completely hassle free. You now have more hair than you did in high school, and with a reunion coming up at that.

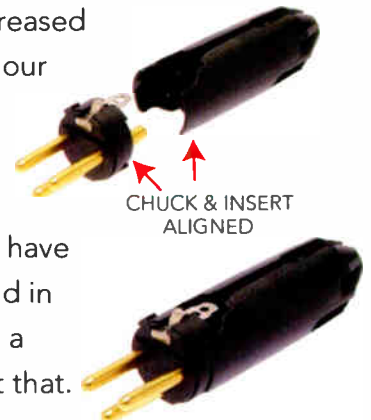

The moral of this story? If you want a new head of hair you need a new connector.

The XX series from Neutrik.



www.neutrikusa.com

Regina Spektor



Photos and Text by Steve Jennings

Regina Spektor's solo tour (before heading out with her band this fall) kept the audience enthralled with her vocal and piano-playing prowess. *Mix* checked in with front-of-house engineer Greg Duffin about his clean and vibrant mix—no easy feat when you're not carrying production. (At the San Francisco Warfield show, Duffin mixed on a Yamaha PM3000 using the venue's V-DOSC system.)

"I prefer analog over digital, purely for sonic differences," he says of the board. "If we were touring with a more elaborate setup—a small orchestra, brass and percussion—I'd probably use a digital [board] for the ease of recall. This is a solo tour, so there's not a lot of inputs going on—eight total.

"Regina's show is very dynamic so I try to let as much of that range come through for the audience," he continues. "Regina is a classically trained pianist and is used to playing with the lid open, so this adds some issues, especially when touring with a full band. Also, with the piano facing the

audience, I get a lot of crowd noise back into the mics, so I'm trying to find the fullest-sounding mics with the best rejection. So far, the winner is the Schoeps CMXY 4V. The other main ingredient in Regina's piano sound is a Helpinstill Model 120 lpickup. It carries a good portion of the sound of the show and is great for the monitors because it won't feed back." Spektor sings through a Shure SM58.

"My approach to mixing comes from my studio background: Make sure there's room for everything and then play the room for volume. With Regina, I mix as loud as the rooms dictate. Her show is meant to be a high-fidelity ordeal, so I try to make the mix as clean and cohesive as possible."



Front-of-house engineer Greg Duffin

FixIt

Monitor and FOH engineer Raphael "Raf" Alkins has more than 25 years' experience under his belt, with credits including The Grammys, Billboard Awards, MTV Video Music Awards, Jon Secada, Roberta Flack, Kenny G, Juanes, Hilary Duff and countless others. He is currently out with Ricky Martin.



PHOTO: STEVE JENNINGS

When mixing IEMs, many new and upcoming mixers tend to just turn things up loud in the ears mix, which can burn the musician and the artist, and, in the end, destroys the FOH mix. Set the artist lead vocal to a normal level with a nice, smooth compression that makes him/her stay on the mic and keep the band mix full and tight, making them work and not hold back. Turn the lead vocal mic down to -10 or -15 dB. As the SPL is reduced in between songs, the limiter in the IEM pack opens up and the lead vocal, which is now the only thing in the mix, is now really loud, which will result in the artist holding back or getting off-mic, which can cause feedback.

inside

- 72 **Live Mix News: Tours, Events, Installations**
- 76 **All Access: The Decemberists**
- 78 **Tour Profile: Björk**
- 82 **Tour Profile: Joss Stone**
- 84 **Tour Profile: Stevie Nicks**
- 88 **New Sound Reinforcement Products**

News



Production Resource Group has named Mickey Curbishley senior VP of its concert touring group. He will work out of PRG's offices in Greenford, UK, and Los Angeles.

For Guillemots' recent UK tour, **Concert Sound** supplied six XTA DP226s using AudioCore via a WISER wireless network, which took care of system control for the Adamson Y-10/Spektrix line array P.A....After completing a sold-out run at the Pasadena Playhouse (Pasadena, CA), *Sister Act: The Musical* is now playing to audiences at The Alliance Theatre in Atlanta, where FOH engineer Pierre Dupree is manning a Midas XL8 deployed by **Sound Associates Inc.**, whose Carl Casella, Wallace Flores and Dominic Sack completed sound design for the show...**St. Pete Times Forum** (Tampa) recently installed a turnkey L-Acoustics system comprising 66 dV-DOSCs, 12 dV-SUBs, eight SB218s and four ARCS boxes, all powered by LA48a amplifiers...**On-Stage Rentals** (Duarte, CA) purchased a new loudspeaker system comprising items from D.A.S. Audio's Aero and Compact lines... Sound rental company **LMG Inc.** is gearing up for Avril Lavigne's upcoming tour by purchasing two DiGiCo D5 consoles, which will be manned by Jim Yakabuski (FOH) and Matt Peskie (monitors)...Prepping for the current summer touring season, **Nitelites** added **Martin Audio** LE1500 floor monitors to its inventory...**Lab.gruppen** announced its "Certified Pre-Owned" program, whereby pre-owned amps will be listed on the company's Website by the current owners and interested buyers can register to view these offerings. All units will be condition-rated and age-identified, as well as under warranty for three years from date of purchase.

AMP'D UP

And ready to go. The Tn Series of amplifiers from Yamaha have the power needed to drive your speakers the distance. With a 2 Ohm UL approved rating, these amps are set to get to work using a NEXO system or any other line array. With Yamaha's own EEEEngine technology, power consumption is reduced by up to 50%. Additional features include removable handles, easy air-filter maintenance and robust construction. Network control capability wraps up the package and superior sound quality ships it out the door.



*Yamaha's Tn Series Amplifiers.
Sound Intensified.*

When you need help, time zones shouldn't matter. Yamaha provides coast-to-coast 24/7 technical support. With dedicated staff and regional service centers, assistance is around the corner. If we can't fix it over the phone, we'll put a part or a person on the next plane out. It's that simple.



Yamaha Commercial Audio Systems, Inc. • P. O. Box 6600, Buena Park, CA 90620-6600
©2007 Yamaha Commercial Audio Systems, Inc.



On the Road

Katie Melua

Singer/songwriter Katie Melua is currently out on a summer European festival tour (including a performance at Live Earth in Hamburg) in support of *Piece by Piece*. *Mix* spoke with front-of-house engineer Bill Fertig, who recently wrapped up a world tour with Steely Dan.

How much gear is the tour carrying?

I have chosen a Meyer MILO system with M3D cardioid subs, M'elodie side hangs, MID and UPJ near-fills, and MJF-212 wedges. Meyer speakers are unlike all others and offer the most time-coherent and detailed sound available. Listen and measure for yourself. You can see and hear the proof of this.

What kind of board are you using?

We have a DiGiCo D5 at FOH and D1 for monitors. I have an ADK MAD1 recorder that runs real-time plug-ins.

What about mics?

Like my sound system choice, I consider my mic selection very carefully. During rehearsals, I will record while the band rehearses and work on mixes and evaluate mic selections in the evening on a pair of Meyer HD-1s.

I choose mics for high detail and use more cardioid condenser mics that have much less proximity effect than the typical default hypercardioid mic choice. The difference is very evident. The vocal mics are Audix VX-10s. I have Royer 121s on guitars, Royer 122s on saxes, Neumann TLM 193s on trumpet and trombone, Shure KMS 44s in omni also on guitars, AKG 414s in figure-8 on cymbals and my favorite mic—an Audix SCX-1H—on hi-hat, ride, snare top and bottom. There are also DPA 4011s and Audix D6s on kick. DIs are Radial, Avalon and Ampeg tube on bass.

Where can we find you when you're not on the road?

I am at home making sure my three children know they have an involved dad.

Now Playing

Skillet

FOH Engineer/Board: Jason Plahutnik/Yamaha PM5D
 Monitor Engineer/Board: Sean Geyer/Yamaha PM5D
 P.A./Amps: Electro-Voice X-Line
 Monitors: Westone in-ears
 Microphones: Shure SM91, Beta 52, SM57, Beta 56, SM81, SM98; Sennheiser e 604, e 609, 421

Rush

Sound Company: Clair Bros.
 FOH Engineer/Board: Brad Madix/Digidesign Profile
 Monitor Engineer/Board: Brent Carpenter/Digidesign Profile
 P.A./Amps: Clair Bros. i4 with i4b flown bass/Showco Prism subs (Crown power)
 Monitors: six Martin "clamshell" subs (Crown power), Sennheiser EW300 G2 transmitter/receivers, Ultimate Ears UE-7 Pro
 Outboard Gear: Lake Clair i0
 Microphones: Audio-Technica AE3000/AT897/4050/6100/5400/23he/AE5100/AE2500/4060, Neumann KM184, Shure Beta 98
 Additional Crew: system tech Jo Ravitch, stage audio tech Anson Moore

John Butler Trio

FOH Engineer/Board: Colin Ellis/venue-supplied
 Monitor Engineer/Board: Rafael Lazarro/venue-supplied
 P.A./Amps: venue-provided
 Monitors: Ultimate Ears UE7, Sennheiser EW300 G2



Microphones: Beyer M88, Sennheiser 901/e 604/e 609, RØDE S1/NT5, Shure SM57/SM98
 Additional Crew: production manager Steph Popoff, tour manager Julian Cribb, drum tech Cliff Wesley

House of Blues Opens in Dallas

The sound system for the new Dallas House of Blues features Electro-Voice XLC DVX line arrays, Electro-Voice P and CP Series amplifiers, Midas mixing consoles and Klark Teknik Square One signal processing.

The Dallas House of Blues features two main hangs of eight XLC DVX per side, each split in the middle with two XLC118 subs. System designer Harry Witz (former db Sound president and now general manager at Clair Showco, Chicago) says splitting the top four and bottom four XLC DVX enclosures with two subs effectively makes each hang operate as two individual arrays. Individual processing for upstairs and downstairs coverage eliminates the need for upstairs delays, and the sub-split configuration helps minimize main system slapback from the front of the balcony back onto the stage. Three custom-designed Quad 18 subwoofers located under the stage feature new Electro-Voice DVX 18-inch drivers.



The Blues Brothers performing at HOB Dallas in mid-May



THE NEXT GENERATION OF POWERED LOUDSPEAKERS

**Standard Ethernet Networking
Digital Audio Distribution
User Accessible DSP In Every Loudspeaker
Remote Control & Supervision**

RHAON
EQUIPPED

RENKUS-HEINZ

Renkus-Heinz, Inc. 19201 Cook Street, Foothill Ranch, CA 92610-3501, USA • Phone: 949 588 9997, Fax: 949 588 9514
www.renkus-heinz.com



THE DECEMBERISTS



ndie faves The Decemberists have culled a loyal following, adding more radio play and sold-out concerts with the release of their third album, *The Crane Wife*. The five-piece—Colin Meloy, vocals/guitar; Chris Funk, electric/acoustic/pedal-steel guitars; Jenny Conlee, keyboards; Nate Query, bass; and John Moen, drums—recently held court at San Francisco's Warfield Theater for two nights.

Front-of-house engineer Rich Hipp mans a Midas H3000, preferring to use an analog board. "The digital consoles have their place and do a fine job—they just take a little more getting used to," he says. "It's hard to just jump behind one and feel like you're getting the most out of it." Hipp runs 38 inputs from the stage, four stereo effect returns and two playback inputs. "Typically, we send seven outputs from the console, depending on how the P.A. is zoned and managed, a main L/R, fill L/R or two mono fills, a sub aux and L/R record."

Hipp is carrying a few choice pieces of outboard, including two Yamaha SPX-2000s, and a TC Electronic D-Two and M3000 for effects; handling dynamics are BSS Audio 402/504/404, dbx 160As, Empirical Labs EL8 Distressors, Aphex 651 Expressor, a Manley Stereo Variable Mu and an XTA GQ600.

The tour's control system is provided by Eighth Day Sound (Highland Heights, Ohio), relying on the venue's racks and stacks for P.A. At the Warfield show, Ultrasound provided a JBL VerTec system with Meyer fills; Lab.Gruppen powered the system with XTA DP226 crossover/drive alignment and BSS SoundWeb.

"I have been with the band for about three years," Hipp says. "It's a very complex and dynamic mix. There are some unusual acoustic instruments, like the hurdy-gurdy, pump organ and bouzouki, along with the cello, violin, banjo, six- and 12-string acoustic guitars, accordion, standup bass and glockenspiels, with your usual electric guitars, B3, electric keyboard, synths, drums, plus six vocal mics thrown in on top."





Colin Meloy sings through an Audix VX10-LO



Bassist Nate Query plays a Lakland 4-string electric bass, an upright bass and a cello. In his amp rack, he uses two Aguilar AG 500 bass heads: one for the electric and the other powers the upright and the cello. Query also uses two Aguilar bass cabinets: a 4x10 and a 2x12. For switching sounds and instruments, he had Bradshaw build a custom mixer with a pedal switch. His rig is miked with an Audix D4, and he sings through an Audix OM-5. The electric bass direct signal comes from the direct out on his Aguilar head, and the standup bass direct signal comes from a Radial J48 DI.



Keyboardist Jenny Conlee's setup comprises, above from left, an EMS suitcase pump organ, Petosa Futura accordion, Hammond B3 with 122 Leslie, Yamaha CP33 keyboard, Moog Little Phatty synth and a marching band concert glockenspiel. Her vocals are miked with an Audix CM-6.



According to guitar/backline tech Rick Sanger (right), guitarist Chris Funk (above) uses three different amps: a Dr. Z Amplification Blonde combo, a Fuchs Black Jack 21 head with a Dr. Z 1x12 cab and a Peavey Nashville combo for his pedal steel. Mics on the amps include two Audix CX-112s (clean) and a D3 (dirty), and he sings through an Audix OM-6.

Funk's pedal board is running a Bass pedal tuner, Line 6 DL4 delay and MM4 modulation, Boss CS3 compressor sustainer pedal, Klon Centaur overdrive, Fuzz Face and an AC Booster distortion.



Marcel Caccac (left) with system engineer Justin Quade

Monitor engineer Marcel Caccac is also on a Midas H3000 with much of the same rack gear as FOH, including dbx, Drawmer and BSS Audio dynamics, and effects from Yamaha and Lexicon. He has two ambient mic channels and a compressed return of Meloy's vocal, with a Distressor on an aux. "I also use a dbx 160SL on an aux for all of Colin's instruments that is hard-patched to the external direct input of John's mix. This signal is limited for John for consistency."

Everyone is on Sennheiser EW300-IEMG2 with Sensaphonic Pro-Phonic 2X-S molds. "I am running five stereo mixes for the band and a stereo aux for Rick, guitar tech with and spare stereo mix."

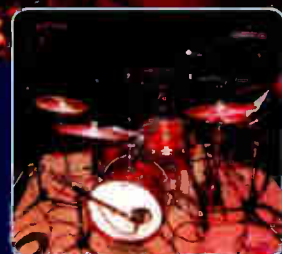

John Moen's drum kit (below) is miked with Electro-Voice N/D868 (kick); Audix i5 (snare top), SCX-one (snare bottom, hi-hat), D4 (rack tam, floor tam) and two CX-112s (overheads); his vocals are miked with a Shure Beta 57.

Björk

PRIMAL SINGER BLENDS ART AND ONSTAGE ELECTRONICS

By David Weiss

Björk's tour in support of her new album, *Volta*, is a highly advanced achievement of sound and vision immersion that leaves the packed house of jaded New Yorkers at the Radio City Music Hall exhilarated by night's end. He wasn't onstage and most of the audience never even looked at him, but watching Björk's front-of-house soundman, Kevin Pruce, at work is an exciting performance within the performance.

Pruce's intensity as he works the snapshots on his Digidesign D-Show Profile console is borne out of his experience supporting Björk for nearly two decades. "I've worked with Björk since *The Sugarcubes*," Pruce recalls. "After that long of a time, you build up a relationship. She's not standard, and she's never been standard, so you have to think outside the box, which is what I like about it. It's quite a challenge."

Björk, her highly eclectic band and crew are out on a year-plus tour of one month on, one month off, which will see Pruce, monitor engineer Bob Lopez and Jordan Zur of live sound supplier Eighth Day Sound deal with new surprises every night. The constant stream of guest stars appearing for one or two nights only at the behest of Björk's artistic whimsy would be enough to keep any FOH/monitor tandem busy; add in her core group for the *Volta* tour, and things get incredibly interesting.

"Everything is about the sound for her. It's very important that the sound is right and interpreted correctly," explains



Front-of-house engineer Kevin Pruce at the Digidesign D-Show Profile

ALL PHOTOS: PAUL SAWIANO

www.yamahaca.com



POWER TRIP.

Eliminate your power struggle and get on your high horse. Control your DAW with Yamaha's DM1000 and DM2000 digital mixers. With the freedom to play with faders, knobs and buttons, and the ability to pan surround, the authenticity is all yours. Compatible with Nuendo, ProTools, Logic and more, the DM series is ready to take command. As your hands direct the console, enhance your DAW's DSP with onboard EQ's, dynamic processors and extra effects.

Yamaha's DM Series of Mixers. Control. Yourself.



When you need help, time zones shouldn't matter. Yamaha provides coast-to-coast 24/7 technical support. With dedicated staff and regional service centers, assistance is around the corner. If we can't fix it over the phone, we'll put a part or a person on the next plane out. It's that simple.

Yamaha Commercial Audio Systems, Inc. • P.O. Box 6600, Buena Park, CA 90620-6600

©2007 Yamaha Commercial Audio Systems, Inc.

DM2000VCM

 **YAMAHA**

commercial audio

Pruce. "It's not a straight-ahead band. There are about 62 inputs: There is a drum kit and then there's weird and wonderful things like a 10-piece Icelandic girl brass section that also sings and a concert pianist playing various harpsichord, celeste, organ and piano sounds, plus three gadget/techno people pushing buttons and running sequencers, and we also have a reactable [tabletop synth]. Tonight, we also have a pipa, which is a Chinese lute. Ultimately, it's all about marrying the electronics with the natural acoustic instruments."

At Radio City Music Hall and other premier venues where the tour will stop, the system that gets flown is a J Series line array from d&b audiotechnik. "I've used a lot of their systems over the years," Pruce says. "Line arrays are pretty much the same. They each have their own little quirks and differences, but d&b boxes just seem to sound good when you turn them on. It has a passive mid-high and active low with a clever amplifier on it, and it's the sound that I'm looking for."

Flanking the stage in two arrays are 12 d&b J8 loudspeakers, a three-way design housing 2x12-inch LF drivers, one horn-loaded 10-inch MF driver and two 1.4-inch exit HF compression drivers with 3-inch voice-coils mounted to a dedicated wave-shaping device. Farther down on the array are a pair of d&b J12 three-way loudspeakers. "The J12s are a slightly wider-dispersion box put on the bottom as more of a downfill," Pruce says. "We round things off with six of the J-SUB subwoofers per side. I'd been running cardioid subs before with the d&b B2, but this time they took the technology and put it in the box, which helps a lot in eliminating horrible rumbling sub-frequencies onstage."

"The d&b Q1 and Q10 passive two-way loudspeakers are fill-in boxes: The people who are seated above the orchestra pit are behind the P.A., so we put those fills in for the people in front," he continues. "Our computer at FOH is running [SIA] Smaart and ROPE, a d&b system control, which is linked via Ethernet to the amplifiers for muting individual amps, volume changes and the like. It's very useful for setup and troubleshooting."

A VOICE TO BE RECKONED WITH

Experienced live, Björk's voice is truly astounding. On recordings, her voice may come across as gorgeously beautiful, fragile and hauntingly expressive; in concert, her vocals take on a strongly primal, as-old-as-Earth quality. "Björk's voice is brilliant," Pruce confirms. "It's a stunning

thing, and there's nobody like her. Her microphone is a standard wireless [Shure] SM58. She's a little bit sibilant, and over the years it's proven to be the best mic for her. She's got great mic technique, a lot of level. The only issue is to not make the voice too loud. She likes it to sit in the track, so it's not voice and hand but the two together. We don't effect it too much; I add some distortion on some songs and a little reverb. Outdoors, you have to add a little more reverb or it sounds a bit strange."

Each member of Björk's all-female brass band sings and plays a horn, adding 20 mics to Pruce's track count in one fell swoop. "The vocal mics there are Shure SM58s, as well," he says. "The brass mics are clip-on Sennheiser e908Bs. They're very good, light and don't upset the balance of the trumpets. With the clip-on mics, at least if the players are moving, I don't have to worry about them being off-mic."

Miking the drums and drummer Chris Corsano is a pretty standard affair, although being ready to mix them later on during the show is anything but. Pruce applies Shure Beta 91 and Beta 52A mics to the kick and Beta 57A on the snares. An AKG 451 covers the hi-hat, while AKG 414s handle the overheads. "The drums are a bit of a challenge because a lot of his stuff is quiet and fiddly," says Pruce. "He is not playing straight time in the normal way, but adding sounds and noises, using metal and various other toys laid on the drums. That's a challenge to pick up in the mix. You also have to be careful so that when he comes back in and plays straight or hits a cymbal, it doesn't rip your head off!

"That's knowing the song, and the beauty of having a digital console so that you can program it from song to song. I have a snapshot for each track with the plug-ins assigned and all the fader moves. You couldn't do a show like this without a digital console in this day and age; it's so complex."

Pruce's first run with the new Profile console earns a thumbs-up from the seasoned engineer, as the board doubles as the FOH engine and the link to Pro Tools for full archiving of each show. "We record everything, and then the following afternoon I can play back the previous



Monitor engineer Bob Lopez

show as a soundcheck tool without the band being there. It all comes back into the same channels, and if I find something that's not right, I can restore it as a snapshot in the desk and it's fixed."

A MONITOR ENGINEER AND EDUCATOR

Behind the Yamaha PM5D console in the monitor position, Bob Lopez is the

first to admit he's completely jaded after too many years on the job, but that doesn't stop him from being on full alert during soundcheck and the show. "Variety is the way to sum it up: There's a huge amount of variety show to show," he says. "Every time she comes out, it's a different band. Tonight, there's two additional artists here [Antony Hegarty and Min Xiao-Fen], and one of them has got a pipa—you can't just slap a mic on it or it'll get scratched. Things like that keep you on your feet."

While the 14 d&b M2 stage monitors take good care of Björk and many of her friends onstage, with the brass section on their first tour, Lopez found he also had to play the role of educator to allow use of Shure E5 sound-isolation earphones there. "I prefer in-ears because of stage levels; it gives everyone what they want to hear at a good level without having to turn the SPL up," he explains. "But they didn't know what in-ear monitors were. Letting them know they could all have separate mixes each was all first-day stuff, but once we got over that, it's been plain sailing. Björk wasn't happy with the idea because she firmly believes that it takes away spontaneity, so we had to have quite a few discussions, try it and show her that's not the case."

The 17-song set's dynamic sonic experience is paired with a thrilling laser show helmed by Paul Normandale of Lite Alternative Design. The buzz of the concertgoers filing reluctantly out of Radio City Music Hall was palpable. "I want to make Björk happy, and I want the audience to experience what she wants," says Pruce. "She always seems to be at the front of music, pushing things along, which I always find refreshing. And she's not doing it for commercial reasons; she's not out to make conventional albums that will sell millions. It's about trying to get an idea out there." ■

David Weiss is Mix's New York editor.



Find the right music content every time.
Fast, easy, and 100% royalty-free.

When you need music and audio content, you want to cut through the clutter and locate unique materials that won't blow your budget. The Sony® Sound Series™ catalog contains over 125 royalty-free content libraries—from single instrument files and song construction kits to exclusive sound effects and our groundbreaking Artist Integrated™ series of fully synchronized libraries. Our sounds are expertly organized so you can find what you need—fast. Our legendary pitch-shifting and time-stretching metadata has made ACIDized™ loops an industry standard that is supported by most music creation applications. Sony Sound Series loops can be imported into any program that supports the .wav file format.

To audition and purchase Sony Sound Series loops or locate a dealer near you go to www.sony.com/loops.



Joss Stone

SOULFUL DIVA HITS HER STRIDE

By Sarah Jones

Joss Stone is touring in support of her third album, *Introducing Joss Stone*, which she has described as finally communicating “who I am as an artist.” And like the album, the tour has been an exercise in versatility, touching down everywhere from the House of Blues and other mid-size club venues to arenas and sheds. *Mix* caught the stop at the Warfield Auditorium in San Francisco, where the soulful songstress demonstrated a musical sensibility beyond her years—with the pipes to match.

Although the tour has been relying on local speaker stacks and racks, Clair Showco is providing all front-of-house, monitor and stage gear. Monitor engineer Larry “Filet” Mignogna spec’d out the equipment, using the gear list from the previous tour as a point of departure and building in options for experimentation. “I pretty much went into it blind,” he says. “So I spec’d a lot of things—just to be versatile—and it’s a good thing because things have changed a lot in terms of inputs, instrumentation; bandmembers have changed, some are on in-ears, some aren’t.”

Most of the musicians are wearing personal monitors, but the technology was a tough sell for some who were new to touring. “They’re not for everybody,” Mignogna concedes, although there were certainly converts. “The horn players are James Brown’s players, and even though they’re old touring guys, I got them on in-ears and they love it.”

Stone, however, settled on wearing only one IEM. Mignogna supplements her single-ear mix with wedges and sidefills for a seamless effect. “I just try to make a blend of both so you can’t tell where the sound is

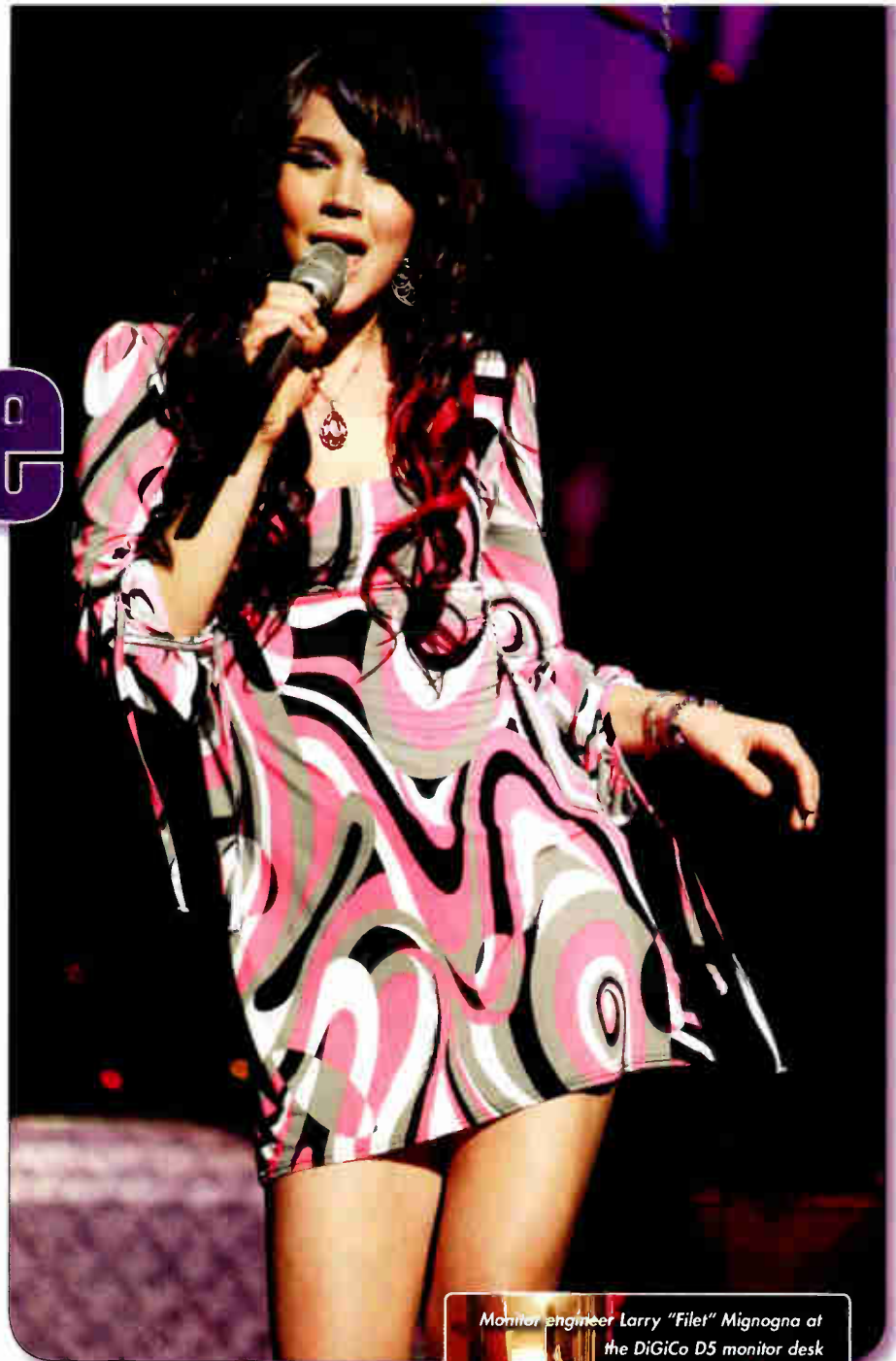

coming from; it’s just there around you.”

Stone sings into a Sennheiser SKM 5200 and is fed a simple mix; the vocals are treated with a BSS 901 compressor only. “Most of my compression is in my finger,” he says with a laugh, adding that frequency-dependent compression is key to getting her voice to cut through her mix. “She’ll go from a whisper to a full scream in one second. I use the BSS because the tonal quality is different when she’s singing soft and singing loud.” The rest of the band mixes are also straightforward—just basic reverb with short settings.

Mignogna mixes on a DiGiCo D1, and with 11 musicians onstage, he’s maxed out his 32 outs. One of the biggest challenges on this tour is determining how much P.A. the musicians are hearing over a different system each



Monitor engineer Larry “Filet” Mignogna at the DiGiCo D5 monitor desk

night. “I pretty much have to make a whole new mix for the sides and wedges.”

The first U.S. leg wrapped up in Florida before heading out to Europe for monster festivals Glastonbury, Live Earth and the Concert for Diana at the new Wembley Stadium in London, returning Stateside in August. ■

Sarah Jones is the editor of Mix.

ICON: Redefining the Art of Professional Mixing

ICON EMPOWERED STUDIOS

"The ICON system's flexibility and ease of use let people work in a way that they can't with any other console."

- Jeff Greenberg, CEO, The Village Recorder

When it comes to recording, editing, and mixing audio for music and video post production, nothing gives you more hands-on, creative control over Pro Tools™ than the Digidesign ICON integrated console environment. And when it comes to state-of-the-art facilities, legendary music-recording powerhouse The Village Recorder has worked with many of the biggest icons in the industry, including Johnny Cash, Aretha Franklin, and Eric Clapton.

Recently, the studio installed a 32-fader ICON D-Control™ worksurface into its newly built Studio F 5.1 digital room to enable engineers to achieve more creative and efficient workflows while getting the most out of ProTools.

To learn more about ICON and why over 1,900 consoles (and counting) are in use around the world, visit digidesign.com/icon or your local Digidesign dealer.



Find out how ICON empowers other studios around the world at digidesign.com/iconstudios.

 digidesign

Stevie Nicks

By Candace Horgan

It is, as front-of-house engineer Dave Morgan says, "One of the most unique instruments: Everybody knows it's Stevie Nicks singing as soon as you hear the first note of a song." The longtime Fleetwood Mac vocalist walks onstage at Denver's Red Rocks Amphitheater, does a few twirls and launches into "Stand Back." She's currently on tour with Chris Isaak, hitting large venues across the country to promote her new anthology, *Crystal Visions*. The set includes some of her best solo pieces, classic Fleetwood Mac songs and a few surprises, including a roaring cover of Led Zeppelin's "Rock and Roll."

Nicks is supported onstage by guitarists Waddy Wachtel and Carlos Rios, keyboardists Cornell Thigpen and Ricky Petersen, drummer Jimmy Paxson, percussionist Lenny Castro, and backing vocalists Lori Nicks, Jana Anderson and Sharon Celani. These musicians continually provide a tight foundation for Nicks' trademark style. The job of translating that sound falls on Morgan and monitor engineer Brian Hendry.

Morgan, who grew up in Boston playing hockey and now lives in California, was watching the first game of the Stanley Cup finals when *Mix* visited the tour. "I'm not too interested in talking about engineering with the Stanley Cup finals on, so you'll have to steer me," he says with a laugh. Morgan was in a chipper mood throughout the evening, as the Anaheim Ducks won the first game over the Ottawa Senators.

Both Morgan and Hendry are tour veterans, but this is their first time out with Nicks. Hendry has crisscrossed the world with such acts as Deep Purple, the Rolling Stones and Led Zeppelin in Europe. He came to the States in '76 with Thin Lizzy, then jumped into an Aerosmith tour and later began a 14-year run with Tom Petty & The Heartbreakers. During last year's Petty tour,

KEEPING A VOCALIST'S SIGNATURE STYLE IN THE POCKET

Nicks was a guest vocalist for 27 shows, and she liked Hendry's approach to mixing. Morgan first did a one-off with Nicks in December 2005, and has been mixing her shows since February.

DIGITAL IS KEY

Both engineers are using a Digidesign D-Show VENU.

"I started using the Digi in February with James Taylor," says Morgan. "With his One Man Band tour, I was using the smaller version, the Profile, and I was really thrilled with the available features and the audio quality. The results obtained with the Digidesign desk led me to specify it for this tour, and I've had nothing but wonderful success translating this show from the stage to the audience.

"Using the TDM plug-ins is the entire game," Morgan continues. "You can configure your board to be whatever you want it to be. If you want it to have a classic tube sound,

you can use a lot of classic tube plug-ins. If you want it to have a fat, Class-A sound, you can do that, too. You go through the libraries of plug-ins on the [Digidesign] Website and then ask your sound company to include those on the menu on the console. You can just pop them in during rehearsal and see if they work. If they don't, you just go to the library and start all over again. It really gives you a whole new level of creativity."

Adds Hendry, "The studio plug-ins I'm using are awesome. Having the Pro Tools rig with me, I can use that for playback and



Front-of-house engineer Dave Morgan: "I would much rather look at a venue, look at the variables myself, make the decisions and array the P.A."

Imagine a Line Array You Can Use Everywhere



Introducing VRX928LA The First Personal Line Array

Perfect for large-scale concert sound, JBL's industry leading VERTEC® line arrays can be more than you need for smaller rooms. Meeting the need for VERTEC quality in a smaller, more portable format, JBL designed the VRX900 Series including the VRX928LA and VRX932LA Constant Curvature Line Arrays. Perfect for sound rental companies, installers and discerning musicians looking for the ultimate, flexible, no-compromise sound system. At just 28 lb's, the VRX928LA is extremely portable for any size gig. Using VERTEC transducer technology and JBL's unique Constant Curvature waveguide, the VRX delivers extraordinary power, flexibility, and coherent coverage, making it the perfect line array for the rooms you actually play.

Hear the VRX900 Series at
your Authorized JBL Professional
Dealer or learn more at
jblpro.com



VRX900
S E R I E S





For more information about jump starting your career call 1-877-27 AUDIO or go to www.sae.edu

Professional Audio Education Since 1976.
Industry Standard Equipment.
International Recognition.
Individual Studio Time.

OPEN HOUSE

August 4th: Atlanta, Los Angeles, Miami, Nashville

August 5th: New York City

Current U.S. Locations:

NEW YORK 212.944.9121

ATLANTA 404.526.9366

LOS ANGELES 323.466.6323

MIAMI 305.944.7494

NASHVILLE 615.244.5848

Plus a further 40 locations around the world!



Apple MacBook, MIDI Controller, Pro Tools, Logic & Peak INCLUDED in Diploma Program!

Global Education Partner of Middlesex University London

you can set all your dynamics and mixes." The plug-ins loaded up on his desk include a Phoenix Crane Song Luster on Nicks, a Digidesign proprietary Smack! digital tube compressor and a Reverb One. "There's a lot of 'verb for her; it sounds really big," he explains.

Morgan uses a few more tricks: "I use a pair of LA-2As on piano and Fairchild 670 stereo tube compressors on all the synthesizer inputs to warm them up. I use 1176s and three different TC Electronic 6000 reverbs: One's on the drums, one's on the acoustic guitars and the other is on the keyboards. I use both ReVibe and Reverb One. With the proper quantity of processing power, you have an almost infinite amount of choice, and it's not limited to what your sound company has on the shelves at the time."

Morgan is flying a Clair Bros. i3 three-way line array for Nicks, which he tunes by ear for the venue. Because the cabinets are relatively light—about 100 pounds each—the sound crew has no trouble adjusting angles by hand. At Red Rocks, with its steep seating, Morgan and Clair crew chief Andy Sottile make an initial determination on angles when they get to the venue, fly one side, observe the array, make a few adjustments to the other side and then reincorporate those changes into the first side. "It's not like you have to sit there with



Monitor engineer Brian Hendry: "When you work with music that you care about and like, you put more into it."

a spreadsheet and accept somebody else's word about what coverage is going to be," Morgan says. "I would much rather look at a venue, look at the variables myself, make the decisions and array the P.A."

INSIDE STAGE-LEFT

Most of the band uses in-ear monitors, though Wachtel and Castro use Clair CBA 12AM wedges. "We've got Plexiglas around all the percussion and drums," says Hendry. "To make it work for in-ears, I've got ambient mics to get the audience and the P.A. to make it sound natural and not closed in."

In terms of a mixing style, Hendry says that he follows the album as a guide. "It's her on top, vocals layered down, everything in there, and when there's a solo I bring it up, whether it's keys or guitar, on top of that and then bring it back down," Hendry explains. The backing vocalists get a similar mix. "One of them is usually on top of the other and layered down with the other two and Stevie, so they're hearing their part marginally ahead of the other females." Wachtel and Rios both get Nicks and a lot of percussion, while Ortiz, Peterson and Castro get a solid rhythm mix.

Hendry and Morgan both feel lucky to be part of this tour. Says Hendry, "When you work with music that you care about and like, you put more into it. When you love the music, you can get it so that [an audience member] can shut his eyes and sing like he's in the shower. When you know it's all going on and you're in the pocket, you find yourself appreciating it more."

Adds Morgan, "This is a labor of love for me. Many old friends are in this band, and I'm having the time of my life. Everybody brings their wonderful flavor. What these guys do is make me look really good. I would be hard-pressed to ask for a much better job." ■

Candace Morgan is a Denver-based writer.

ALL MIKED UP

Stevie Nicks likes to sing into a Sennheiser 935 dynamic microphone, as do all the backing vocalists. Says Morgan, "With most everyone on in-ears, the amount of off-axis stuff that comes in with a dynamic is significantly less than with a condenser, and it tends to give you better separation in the ear mixes and you also have a lot less random high-end leakage."

Rios uses a Line 6, so he goes direct to the P.A. Wachtel uses a Mesa cabinet and a Marshall cabinet; Morgan puts a Shure KSM 27 on each cabinet. On Peterson's B3, Morgan puts two Audio-Technica AT4047s on the high rotor and an MD421 on the bottom.

The drum setup is fairly standard: Shure Beta 91 and Beta 52 in the kick, Shure SM57 on the top of the snare, a Beyer M201 underneath snare, a Neumann KM184 on the hi-hat, Shure SM98s on the toms, another KM184 underneath the ride cymbal and Shure KSM44s on overheads.

PORTABLE ACOUSTICS



The Reflexion Filter

Patent Pending

"If anything, sE underhypes the RF. Even in an acoustically treated room, you can get additional isolation."
- Craig Anderton, EQ

NEW MK II EDITIONS

Z5600a II

GEMINI II



Our award winning Z5600A and Gemini mics have been enhanced with more features and superior specs while retaining their highly acclaimed sound. Upgrades include 10dB pads, hi-pass filters, sure-lock shock mounts and new, sleek power supplies with even better performance.



www.sonicus.net
usa@sonicus.net
617.623.5581

Summer D.I.Y. Fun

Let the Sun Shine on Your Guitar Amp

In July, nothing beats the radiant glow of vacuum tubes and that “high-tension” reminder to discharge the power supply before poking around! This month, I’ve got three skill levels’ worth of guitar amp tweaks—just right for your summer-fun experimentation.

BUZZ BE GONE

An urban customer from a famous heavy metal band called about a troublesome guitar amp buzz. Someone suggested a Faraday Shield, a method of “screening” a room to make it interference-proof. Considering that the studio was already up and running, this is an impractical, costly after-the-fact “solution.”

It’s good to be reminded that noise is all around us, but more often than not the gear is the problem. I suggested trying a clip-on ferrite clam from Radio Shack or TDK (Fig. 1). These are the blobs you’ve seen hidden under shrink tubing on all types of computer-related cables—video, USB, FireWire, etc.

The noise that sounds like a power-related buzz is often the video-sync portion from a local TV station. It’s 59.95 Hz, and if you listen closely (which is “easy” at metal levels), you’ll notice a slow “phasing” sound as the vertical sync “comb filters” against the 60Hz power line hum. For guitar cables, place the clam just before



Figure 1: Ferrite clams go around the guitar cable just before the plug at the amplifier input.

the plug at the input (destination) end. This simple contraption creates a choke—essentially, an inductive high-frequency (RF/TVI) noise filter. The result? A joyous 80-percent reduction in that nasty RFI, followed by the question, “Now, how do I get rid of the rest?”

The noise mostly plagues amps with *plastic* input jacks? My Marshall and Vox amps have them, but the Fenders don’t. Keep in mind that tube amp wiring was once point-to-point. “Plastic” jacks were introduced about the same time as PCB construction; they’re stuffed and soldered directly to the PCB, saving that costly “human-intervention factor.” When metal jacks make the metal-to-metal chassis connection, the chassis acts like a noise “firewall.”

Not all plastic jacks are equal. Some have metal threads or an extra metal tab that makes the chassis connection when mounted, but many older models do not. Another solution is to connect a 0.1µF capacitor between the point of entry (the input jack ground at the circuit board) and the chassis. I had the studio tech replace the plastic jack with an all-metal one, and the remaining noise disappeared.

BRING ON THE MICS

Most condenser or dynamic mics have a rising top end that may not be complemen-

Biased Opinions

The subject of replacing output tubes always generates questions about tube bias. At minimum, bias sets the safe operating current, but it also affects the tube’s sensitivity and overload characteristic; when driven hard, it affects its tone. There are several ways to measure the bias current, the easiest being a third-party adapter that goes between the tube and the amp. Inside is a resistor in series with the cathode, plus a voltmeter test point.

A customer wanted to experiment with a range of output tubes, so I installed an adjustable bias circuit and cathode resistors. The figure above shows the power amp schematic. The cathodes—pin #8 on 6L6s and many other octal-socket output tubes—are normally tied to ground. I chose to insert a pair of 22-ohm resistors (just left of the 220k-ohm grid resistors), higher than the standard value because I also wanted to drive a pair of LEDs for a visual indication of current, especially when the amp was overdriven.

The 6L6 data sheet specs the plate current between 55- and 79 mA, depending on the plate voltage (and other factors). If you apply Ohm’s Law to solve for the voltage drop across the resistors, where $E=I \times R$ with 22-ohm resistors, then the drop for that current range will fall between 1.21 volts to 1.73V. No matter whether you buy the adapter or try this mod, getting the bias right will help the power tubes last longer and be more sonically consistent.

—Eddie Ciletti

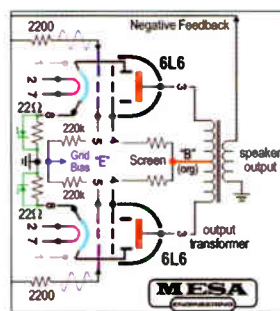

make some noise

get a degree

Explore a career in one of the most exciting industries in the world. Ex'pression College offers:

- Bachelor's degrees in just over 2.5 years
- Digidesign certified training for Pro Tools
- Small classes taught by industry professionals

Stop dreaming it—start living it.



ex'pression
COLLEGE FOR DIGITAL ARTS

Bachelor's degree programs:

- Sound Arts
- Animation & Visual Effects
- Game Art and Design
- Motion Graphic Design



tary to some types of gritty guitar overdrive. Ribbon mics tend to be more complementary, but they are not the most cost-effective solution for those on a budget. However, one student suggested the Cascade Fat-head, which at \$159 is a must-have, but that review will have to wait.

Another student came to rehearsal with a Peavey 210 Studio Chorus, an affordable, lightweight "stereo" guitar amp with one dry and one chorus/delay channel.

ues needed to cover a frequency range between 1.8 and 4 kHz, and then found the nearest standard inductor at www.mcminone.com (part number 50-3019), a "choke" in the form of a 0.5-milliHenry (mH) air-core bobbin inductor. (See Fig. 2.)

There's a handy online crossover calculator at www.the12volt.com/caraudio/crosscalc.asp#cc, a car audio Website. After some ciphering, I determined the roll-off would begin around 2.5 kHz, so that 5 kHz would be down 6 dB. You'd think this was too low, but it was very effective and made the mic choice much less critical.

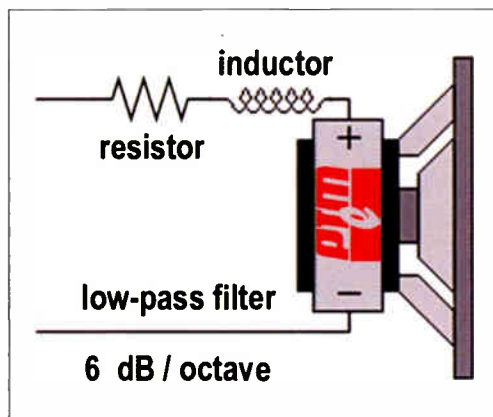

Figure 2: A series inductor (coil) creates a passive 6dB/octave lowpass filter typical of simple crossover networks. When combined with a non-typical series resistor, the woofer's free-air resonance can contribute to the low end.

IT'S A TUBULAR WORLD

All woofers have a natural low-frequency (free-air) resonance. You can prove this by placing a naked woofer next to your ear and tapping it, using a clip lead to alternately short the terminals (or not). You will be amazed to hear the difference that a simple, passive test like this can make.

The relationship between speaker impedance and amplifier output impedance is called Damping Factor (DF). For a solid-state amp, it is typically a number of 80 or higher, and it essentially acts like a magnetic brake or shock-absorber. The better sonic analogy is how Q (bandwidth) affects an equalizer's resonance. An amp with a high DF effectively lowers the Q (widens the bandwidth).

Back in the all-tube '50s, amplifier DF was lower and less consistent, the latter being partially due to varying amounts of negative feedback. (More feedback raises the DF.) Even then, there were complaints that better amps and speakers were not as "warm" as the previous technology, so a damping-factor adjustment was one of the solutions.

Inserting a series resistor purposefully lowers the damping factor and can be combined with the previous treble-taming step as shown in Fig. 2. I chose 4 ohms after experimenting with lower resistor values. This reduced the power dissipated by the speaker by a little more than half (3.5 dB), an acceptable loss in this application because there's ample reserve. Total cost of the choke and the resistor is less than \$10 per channel. It's still not a tube amp, but it's no longer painful. ■

(I found service documentation at www.schematicconnection.com.) Typical of older solid-state amps, this one has no sonic air bag between clean and fuzz. The low end is dry and lifeless, and the top end cannot be miked.

At our first rehearsal, we made do with a Shure SM58 placed five feet away to let the air attenuate the treble and bring some ambience to the mix. Another time, we took advantage of the rear (dark/rejection) side of a pre-silver Sennheiser e609 placed directly in front of the speaker.

THE FILTER FACTOR

Guitar amp purists have their speaker faves for good reason: They can drastically affect the amp tone. Some are bright while others are warm and mellow. This next pair of mods will tame any harsh-sounding guitar amp simply by applying readily available crossover components. You'll find a table of typical values at www.ptme.com/et/audio/reference/crossovers_passive/component_values.htm.

Do you see where I'm going with this? Not much fidelity is needed from a "full-range" 10-inch woofer, so I installed a passive 6dB/octave filter—half of a two-way crossover network. I made note of the val-

Eddie posts items of interest at www.tangible-technology.com. If you'd like to see more of this mod, just bug him.

WHAT DOES YOUR FUTURE SOUND LIKE?

THE CENTER FOR DIGITAL IMAGING ARTS AT BOSTON UNIVERSITY RECORDING ARTS PROGRAM
 Using the latest technology and working with other CDIA students, you'll gain real-life experience in audio for new media, film, television and games. **APPLY NOW.**

 CALL 800.808.CDIA (2342)
 VISIT WWW.CDIABU.COM

NEED MORE MIX



News Online Extras Blogs, Videos & Podcasts Mix Line *and more*

GET YOUR MIX FIX AT MIXONLINE.COM



The analog console for the digital world: Solid State Logic AWS 900+

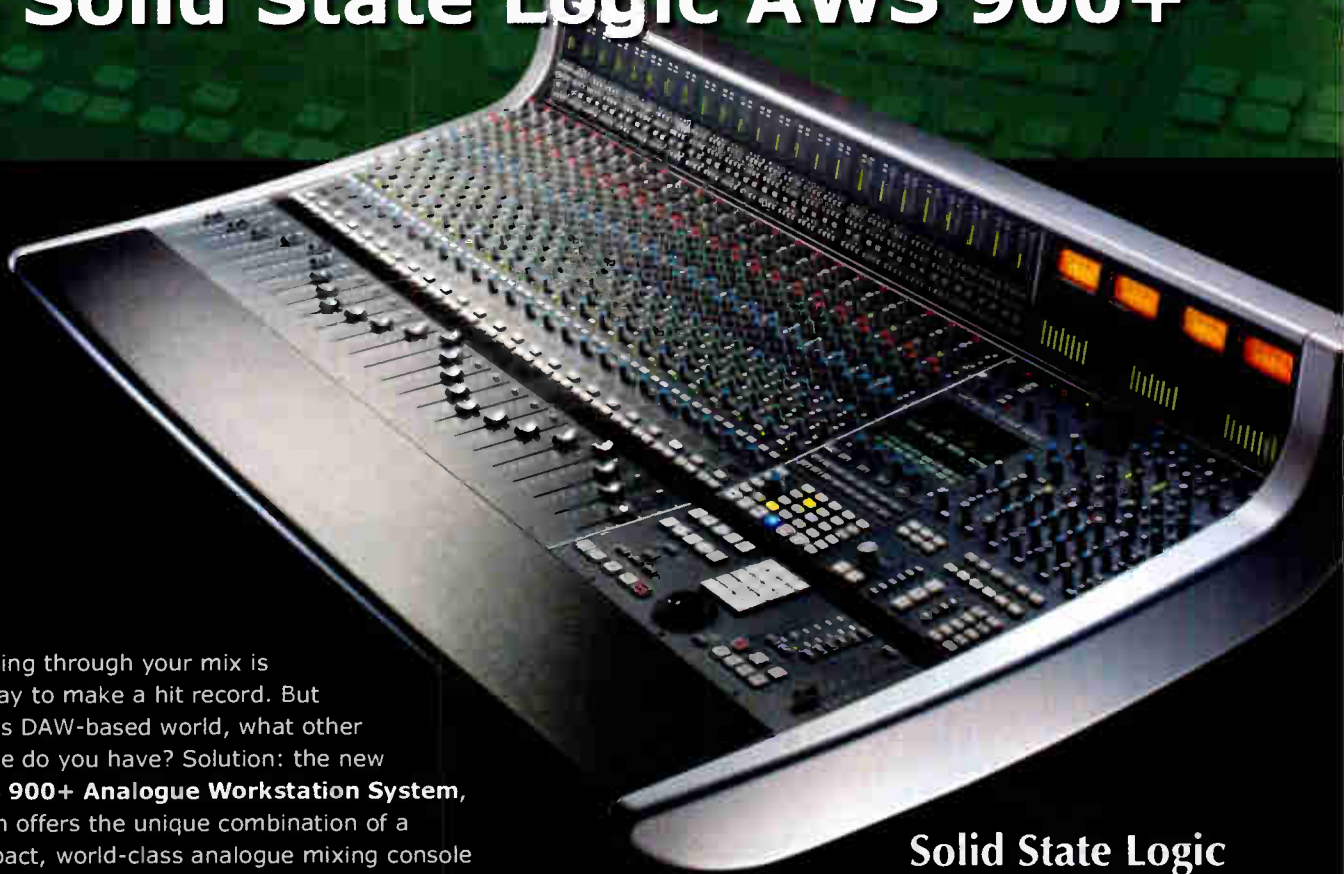

Mousing through your mix is no way to make a hit record. But in this DAW-based world, what other choice do you have? Solution: the new **AWS 900+ Analogue Workstation System**, which offers the unique combination of a compact, world-class analogue mixing console and a comprehensive DAW controller. Every inch a 'real SSL', the AWS 900+ is the answer for producing exceptional results in today's digital environment.

Solid State Logic
AWS 900+
Analogue Workstation System

Make It Happen With GC Pro!

It's pretty simple: GC Pro offers the very best pro audio products, at the excellent pricing you'd expect from the world's largest pro audio dealer. Then, we add world-class service through local GC Pro Account Managers who deliver the expertise and extraordinary service you deserve.

From rare/vintage gear to the most sophisticated audio technology, we are your one-stop solution. Contact us today for a personalized consultation.

Music • Post • Live Sound • Lighting



GC Pro has expert
Account Managers
in nearly every
territory of the
USA... contact
us today!

 **800-935-MYGC**

 **www.gcpro.com**



GC PRO

www.gcpro.com

© 2006 Guitar Center, Inc. All rights reserved.
All images and trademarks are property of their respective holders.

Tools of the Trade

CORSAIR FLASH SURVIVOR

If you thought that Flash drives were wimpy, think again. The Corsair USB 2 Flash Survivor (www.corsair.com) is water-resistant to 650 feet/20 atmospheres, encased in CNC-milled aluminum and uses rubber-molded collar shielding for shock-proofing. It comes in two versions: the 4GB Survivor (\$59) for regular use and the GT (8 GB, \$129), which transfers data 5x faster than the smaller model. Both come preloaded with

a security application using 256-bit AES encryption, allowing the user to create a hidden, password-protected partition on the drive to secure the data should the Survivor be stolen or compromised.

EDIROL M-10DX DIGITAL MIXER

Meant to be more portable and affordable than its big brother, the M-16DX, the M-10DX (\$499) 10-channel digital mixer



from Ediol (www.ediol.com) features a 24-bit/96kHz processing engine (the same engine featured on the M-16DX), backlit LCD, built-in COSM effects, and dedicated channel controls for 3-band EQ, pan, aux, select and level. The unit also offers two phantom-powered mic preamps, 10 line inputs and headphone output, and it includes Room Acoustic Control software for room compensation.



SFX BACKWARDS MACHINE

The Backwards Machine (\$35) from SFX Machine (www.sfxmachine.com) reverses and overlaps snippets of the incoming audio to produce an ongoing backward effect. Other features include the Reverser, which switches audio backward or forward without clicks or glitches; Time, which controls the delay time or the length of each audio snippet; Feedback Depth, and separate Wet Mix and Dry Mix controls.

IK MULTIMEDIA AMPLITUBE JIMI HENDRIX

It's back to the '60s you go with this simulation plug-in (\$249) that evokes guitar legend Jimi Hendrix' rig. Based on IK Multimedia's (www.amplitude.com/ Hendrix) AmpliTube 2 and made with Authentic Hendrix, LLC, the plug-in re-creates Hendrix's complete guitar amp and effects setup. In addition, it offers more than 20 new amp models,

including the Vox Wah V846, Maestro FuzzTone, Univox Uni-Vibe, several Roger Mayer fuzz stomp pedals, the Marshall 1959 JTM100 Super Lead and more. Modules include a tuner, stomp effects, amp heads, cabinet/mics and rack effects. The SpeedTrainer audio player allows the player to slow those lightning fast licks down for easy ripping.

SE ELECTRONICS GM10

The new GM10 (\$599) mic from SE Electronics (www.seelectronics.com) is designed to capture guitar through an innovative design: A clamp holds the mic capsule while the preamp is located at the end of the extension arm, allowing it to be placed precisely, close to the guitar. To keep nasty vibrations from getting into the signal path, the capsule has a built-in shockmount. The mic

and assembly ship together in a black-aluminum flight case.

STUDER ETHERSOUND INTERFACE

Studer (www.studer.ch) and Digigram have jointly developed an EtherSound interface card for Studer consoles. Designed to fit into the Studer D21m I/O system rack for use with the Studer OnAir 3000 and Vista Series and routing systems, the card offers 128 channels of audio (64 input/64 outputs) to be connected to the D21m via a single Cat-5 connection. A second Cat-5 connection permits daisy-chaining or redundant ring setups, allowing for the network to remain uninterrupted should a cable be broken. Boasting low latency, inputs and outputs



can be patched internally within the console on the OnAir 3000's I/O screens; Digigram's control software can be used to route signals between different EtherSound-enabled devices over a standard Ethernet network.

ARDOUR 2

Just when you thought you knew every DAW on the market, Ardour (www.ardour.org) 2 arrives with the ability to transform any computer running Linux or OS X into a tool to record, edit and mix multitrack audio. The upgrade features more accessible menus via an improved GUI, instant accelerator key rebinding direct from menu, destructive recording, undo/redo across program startup/shutdown, redesigned support for VST plugs, and support for Frontier Designs' TranzPort and Mackie Control protocol devices. The best part is that this product is free for download from Ardour's Website, and it is an open-source application without copy protection so that anyone with programming skills can participate in the

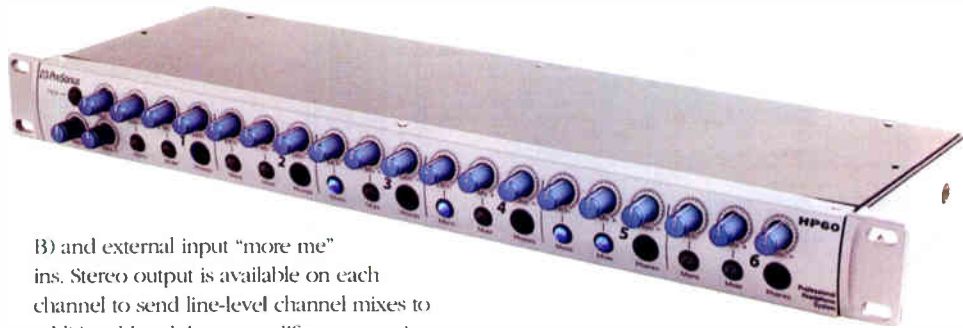

B) and external input "more me" ins. Stereo output is available on each channel to send line-level channel mixes to additional headphone amplifiers or monitor systems. Channel controls offer headphone level, mix between inputs A and B, external input volume, mute and mono. Talkback is via external XLR microphone.

RME HDSPE 9632 CARD

The RME (www.rme-audio.com) HDSPE 9632 is a newly engineered PCI-Express card operating at up to 192 kHz and featuring two channels of balanced analog I/O, a 96kHz-capable ADAT I/O (SMUX), SPDIF I/O, MIDI I/O and a separate headphone output with its own D/A converters and volume control. Optional analog expansion boards offer four balanced ins or outs. The unit ships with unbalanced RCA/phono breakout; optional breakout cables are available for balanced XLR I/Os and AES/EBU. The HDSPE 9632 offers RME's TCO (Time Code Option) module

inputs. Up to eight LSR4326P (\$1,199 each) or LSR4328P (\$1,699 each) monitors can be configured (with 6-inch and 8-inch woofers, respectively), along with two LSR4312SP subwoofers (\$1,100 each). The speakers feature the next-generation automated version of JBL's RMC (Room Mode Correction) technology, in which each speaker (plus the new LSR4312SP subwoofer) has a built-in analyzer that measures and automatically compensates for low-frequency problems caused by the room's standing waves and boundaries. The user connects a supplied calibration microphone to the speaker, presses a button and then views correlations on a computer using the LSR4300 Control Center Software. The app also includes a monitor

control section, and solo and mute, and can be controlled wirelessly.

HEIL SOUND HANDI MIC PRO PLUS

New from the company that's chosen large-diaphragm dynamic mics as its niche, Heil Sound's (www.heilsound.com) new Handi

Mic Pro Plus (\$110) is said to be the world's smallest, large-diaphragm dynamic available. In addition, the off-axis ports create a linear cardioid pattern, making it ideal for live situations. Similar in performance to the company's PR20, the handheld Pro Plus offers the ability to take high SPLs, and because of its small size has the ability to fit into tight spots such as in broadcast applications.

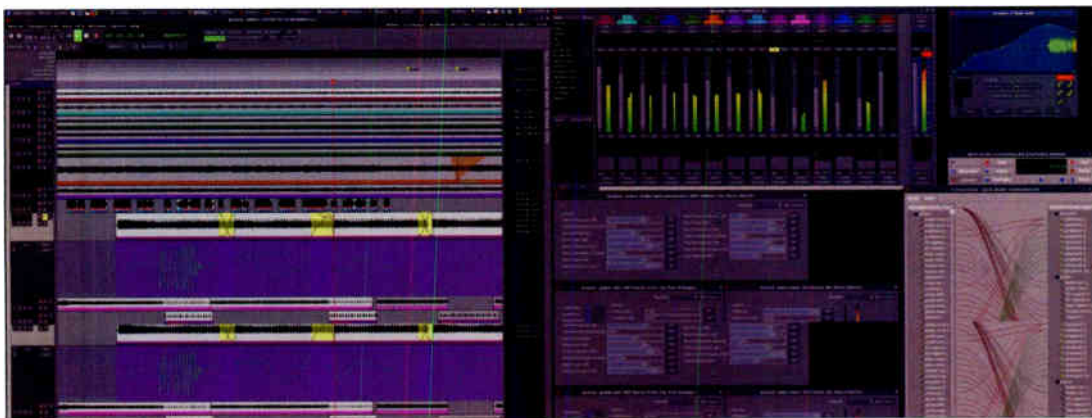

development of Ardour, adding features and fixing bugs, and then passing updates along the pipeline for other users.

PRESONUS HP60

Stepping into the distributed cue mix arena, PreSonus (www.presonus.com) has released the HP60 (\$399) headphone amplifier system. The unit features six headphone amps outputting two stereo main inputs (A and

and features RME's TotalMix, SyncCheck and SteadyClock. The card supports Windows XP, Vista and Vista 64; Apple Power PC; and Mac Universal (Intel).

JBL LSR4300 SERIES

JBL Professional (www.jblpro.com) has introduced two 5.1 surround systems that feature 24-bit, 96kHz AES/EBU and S/PDIF digital inputs, along with analog

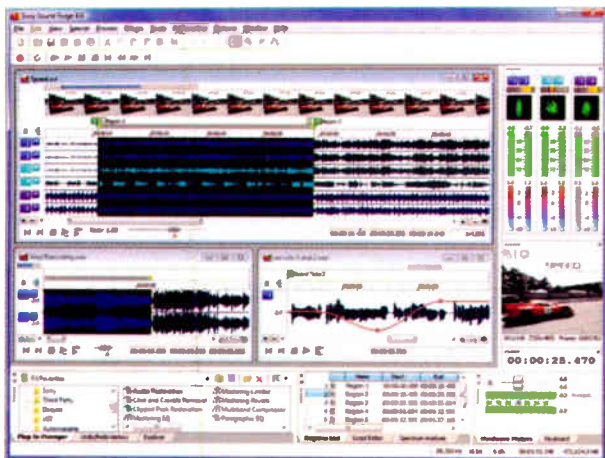

SONY SOUND FORGE 9

This major upgrade to Sony's (www.sonycreativesoftware.com) Sound Forge application introduces a range of new features, including multichannel audio support, drag-and-drop editing between channels, wet/dry mix and crossfade options. New tools for audio analysis include phase scopes, mono compatibility meters and multichannel-capable spectrum analysis. Other features include channel and hardware meters, multichannel Windows Media format support, and Dolby Digital AC-3 export. Windows XP and Vista are supported. The upgrade includes additional software: CD Architect 5, Noise Reduction 2 and four mastering plug-ins comprising a reverb, multiband compressor, IRC limiter and loudness maximizer, and a parametric equalizer. Price: \$399.95.

MUSICXPC C5, C5X

Those producing in tight spaces will appreciate the small footprint of MusicXPC's (www.musicxpc.com) Windows-based

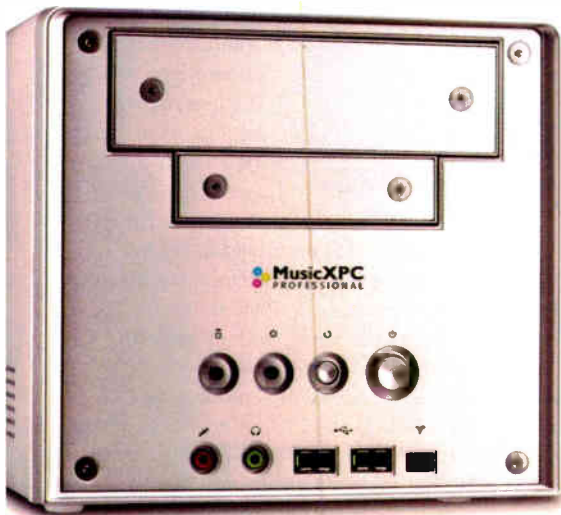

media production computers. The Professional C5 (\$1,449) and Professional C5x (\$1,749) offer Heat-pipe technology, which moves heat away from the CPU without the use of fans. A backup/restore system allows quick recovery from catastrophic failure, a drive crash or even a re-formatting. The C5 features a 2.13GHz Intel Core 2 Duo processor, 1 GB of RAM and an 18x dual-layer DVD±RW drive. The C5x uses a 2.4GHz Core 2 Duo processor with 2GB RAM and a 256MB DDR2 PCI-E x16 dual-channel graphics card. Both use two separate 7,200 rpm hard drives, providing a total of 570 GB of storage, and carry ports for FireWire, USB 2, PCI and Gigabit LAN.

BREMMERS AUDIO DESIGN MULTITRACKSTUDIO

The Bremmers Audio MultitrackStudio (www.multitrackstudio.com; Pro, \$69, Pro Plus, \$119) features unlimited tracks, MIDI recording and comprehensive editing/mixing with VST and DX plug-in support. The Pro Plus offers all this plus operation at up to 192 kHz for more powerful mixer routing and automation. In addition, the app includes a Level History display, EQ Spectrum display, VariSpeed, Guitar Amp simulator, reverb and instrument plug-ins. Windows Vista or Windows 98 is supported.

Older versions can be upgraded for \$23 (Professional) or \$39 (Pro Plus).

TONELUX TXC, MP1A

The TXC (\$949) compressor from Tonelux (www.tonelux.com) allows parallel mixing of the dry and compressed signal and the ability to control the mix of feedback and feed-forward compression effects for custom compression knees. The unit also offers an Over-Ratio control, where the gain reduction is greater than the gain of the signal going into it for negative compression effects

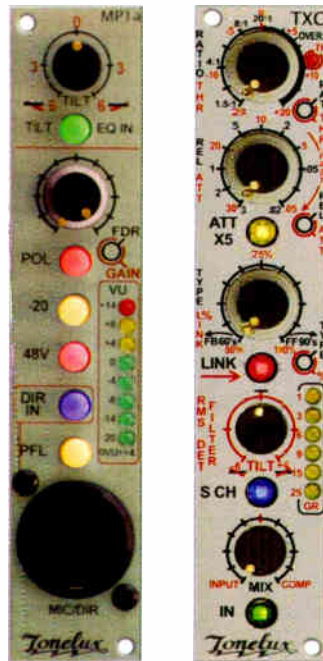

and for restoring transients to signals with minimal dynamic range. The Tilt control increases high frequency and decreases low energy into the sidechain, eliminating pumping due to a more uniform distribution of energy across the spectrum. It also features a 6-LED gain-reduction meter and can be linked to another unit. The MP1a mic preamp (\$749) offers a transformer-coupled input and output, plus an instru-



ment input on the front. There is also a -20dB pad, polarity switch, dual-knob input gain and output fader. In addition, there's an 8-segment LED with peak indication that can be switched to monitor input or output level. The rear panel XLR is milled to the front panel, as well as a D-Sub on the rear of the host V-Rack. The insert return input of the V-Rack is a resistor-isolated mic level input that can be used when the MP1 is in a live recording situation and there is no splitter. ■



PRODUCTION

THE PROFESSIONAL'S SOURCE



real world solutions from industry professionals!

www.bhproaudio.com



800-947-5508 | 420 Ninth Ave, New York 10001 | We Ship Worldwide



Lectrosonics Venue Hybrid Wireless Receiver

Digital System With Low Noise, High RF Rejection

Today's pro wireless audio systems face tremendous demands. Along with "traditional" interference sources—such as radio and television—increased RF traffic from consumer wireless technologies is becoming problematic. (See April 2007, "The Sky is Falling" for more on this timely issue.) Lectrosonics' Venue Hybrid Wireless modular receiver system is designed to combat interfering technologies with multiple independent, configurable diversity receivers, all housed in a \$1,495 VR rack chassis. Complementing the VR are Lectrosonics' transmitters, including the LM/IM beltpack (\$685), SM Series miniature transmitter (\$1,710) and the VMS handheld transmitter (\$1,860).

HOW IT WORKS

Lectrosonics' Digital Hybrid Wireless technology is a multistage process employing proprietary software, whereby analog audio is converted into digital information. Digital audio is encoded *back* into an analog signal, which can be broadcast via FM. The information transmitted is encoded, yielding an inherently low noise floor without the need for companding. As the transmission itself is analog, efficiency and transmission range are increased. The technology also enables VR and SM transmitters to be backward-compatible with Lectrosonics' 100, 200 and IFB wireless systems, as well as with certain Shure and Sennheiser wireless products.

The Venue chassis has six small bays, each holding a discrete \$395 receiver module. Modules are user-installable and factory-tuned to frequency "blocks," facilitating system expansion without creating conflicting frequencies. The VR frame can tune across two blocks, and transmitters can broadcast within one block. Nine blocks are available in the UHF band. The VR rear panel provides a balanced XLR audio out for each receiver, as well as two antenna I/Os and a threaded jack for the line-lump power supply. I was happy to see a locking collar for the DC plug, but it is possible to manipulate the DC plug so that the receiver loses power, although this never occurred during my road tests.



PACKED ON THE TRUCK

Initial setup of the VR was easy, as the unit provides two methods of locating open frequencies. The first is by selecting a receiver and a tuning group, and then scrolling through the tuning group's eight preset frequencies while watching that receiver's signal strength on the front panel LCD. No signal means that the channel is clear. I found the second method, using the VR's Scan function, much more engaging. By selecting Scan, the VR analyzes the local RF spectrum and displays busy frequencies as black spikes on the LCD. The graph is displayed while you move the cursor along the graph to find a blank area. As you scroll, the display indicates the frequency, and the receiver automatically tunes to that frequency. You can increase the display's resolution by zooming in. This function was very effective, easy to use and just plain cool. Set a transmitter to the same frequency and you're off and running.

The VR receiver modules are configurable for three types of diversity operation. SmartDiversity™ uses antenna phase for best signal reception with one module. OptiBlend™ ratio diversity uses two receivers (1/2, 3/4 or 5/6) set to the same frequency with one transmitter. When you select ratio diversity on one receiver, the other is automatically set to the same channel. Either receiver's XLR output produces the same audio signal, and the two receivers' audio outs are internally mixed so the

signal-to-noise ratio increases by 3 dB. We used this mode most of the time and it delivered clear, dropout-free performance. A third mode, Frequency Diversity, uses two transmitters and two receivers that are set to different frequencies. Audio output from both receivers is delivered to both XLR outputs in the pair, with the idea being that you would connect the outs to two channels on a mixing desk and raise both faders. If one receiver failed, the other would still deliver audio. In this mode, I found it possible to produce an audible thump by turning off one transmitter.

SOFTWARE AND EXTRAS

Using the included VRpanel software, diversity, frequency and mode settings can be stored/recalled via PC (there is no Mac OS support at present) for instantly resetting the unit for different applications or locations. For system setup/monitoring, VRpanel displays critical information (i.e., broadcast frequency, RF strength and transmitter battery status) for each receiver. This made it easy to check performance during a show, without being tied to the unit's front panel.

Along with the VR and three transmitters, Lectrosonics sent a few goodies, including some deceptively simple-looking ¼-inch straight and right-angle instrument cables. These cables (as well as the lav and headset mics) connect to the SM and LM/IM beltpacks using a TA-type connector. (One minor gripe: When the connector

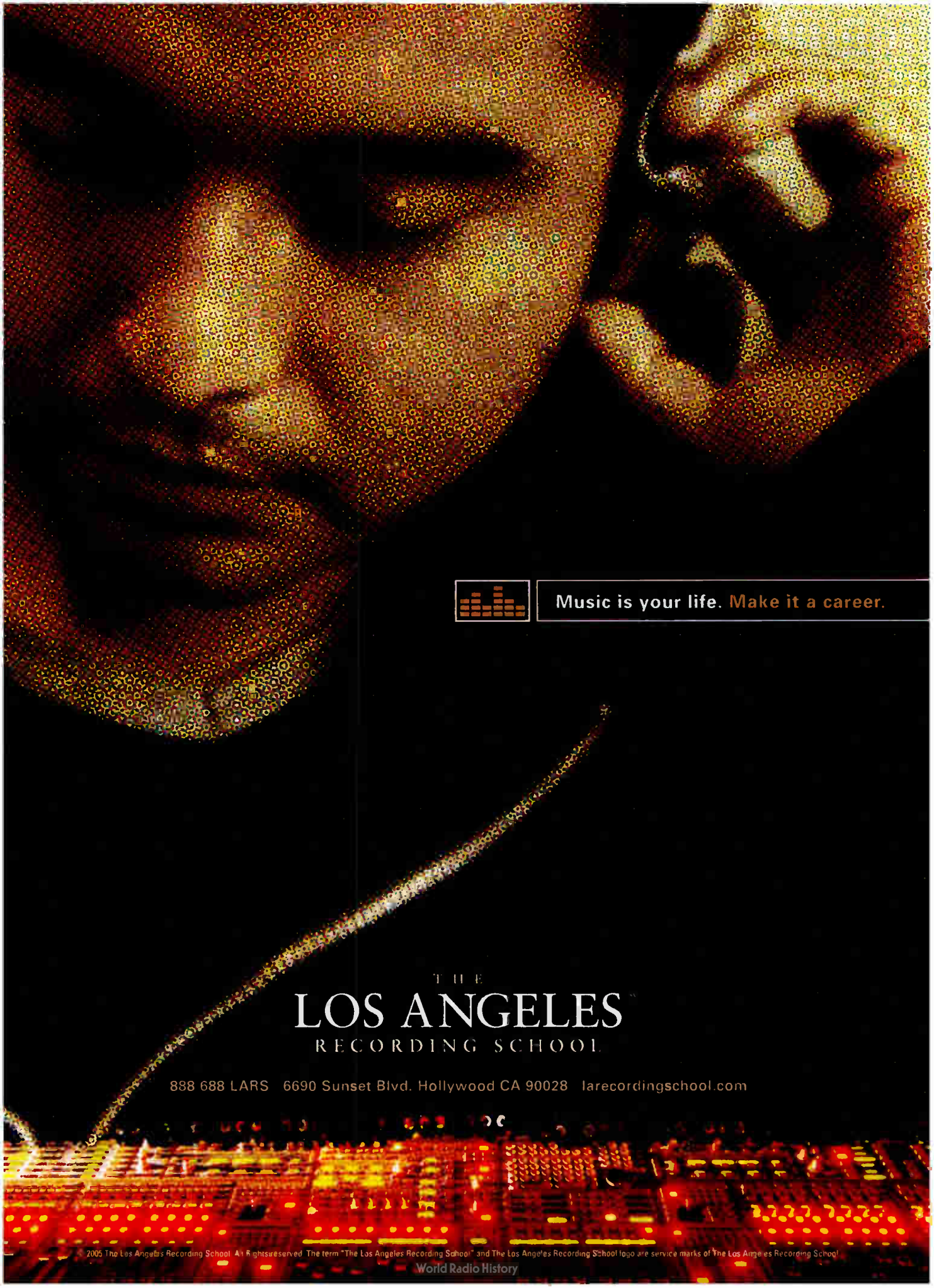

Music is your life. **Make it a career.**

THE
LOS ANGELES
RECORDING SCHOOL

888 688 LARS 6690 Sunset Blvd. Hollywood CA 90028 larecordingschool.com

Bad Drum Sound?

Replace It.



Is your drum sound driving you nuts? Relax - Drumagog will make those old, stale drums sound like a million bucks! It works by automatically replacing what's on your audio drum tracks with samples of new drums. The industry choice for over 5 years, Drumagog is available for both PC and Mac, in VST, RTAS, and Audio Units plug-in formats. See why producers Chuck Ainlay, Brian Tankersley, and Greg Ladanyi use Drumagog in their projects every day.

877-318-WAVE
www.drumagog.com

WAVEMACHINE LABS

Become An Audio Insider



*Digital Magazine Delivery
Special Merchandise Discounts
Exclusive Content, Videos & Podcasts
Downloadable Samples, Loops & Beats
Searchable Product Guides, Directories & More*

Details coming soon.....

is plugged in, the LM/IM beltpack's audio level control is difficult to access.) Opening up the ¼-inch ends of the instrument cables reveals a miniature circuit board worthy of "007" status: a built-in active DI with a J-FET front end. This is why guitar and bass sounded so great through the VR: The instrument pickups are properly loaded so there's no high-frequency loss. You have to tweak the audio output level to get the gain structure "right" with a guitar or bass rig, but once that's done, the results are outstanding. Digital Hybrid mode exhibited no compression or transmission artifacts, nor any attenuation of high frequencies—often encountered with other wireless systems. The electret lav mic was quiet by wired standards, and you could even hear ambient background noise through the transmission process.

Other options include an adjustable antenna (\$79) with built-in gauges that clearly show the distance to which they should be extended for specific frequency ranges—excellent! The battery compartments are very secure, so you don't need to worry about intermittent operation from slightly undersized batteries. An optional SM transmitter remote control emits a modem-like chirp that can raise/lower the audio level, change the transmitter frequency or put the transmitter to sleep, allowing you to change settings without disturbing an actor's or news anchor's dress. It took a few tries and some experimenting with the volume level, distance and angle of the remote from the mic before the transmitter received the remote command, but this is great a option for theater use.

DID IT STAND UP TO THE TEST?

Bells and whistles aside, the true test of a wireless rig is RF performance. Here, the Lectrosonics VR is a champ. I used the VR system in a variety of locations including midtown Manhattan (an RF nightmare) with fantastic results. RF performance was impeccable with no dropouts or noise. The VRpanel software even provides a walk-test recorder that stores RF response data as you walk around a room to expose possible dead spots before a show. Used on guitar or bass, the LM/IM transmitter sounds as close to a wire as I have ever heard, and the battery life is excellent—the SM transmitter runs almost four hours on a single AA. (The LM ran almost seven hours on a 9-volt.) The Lectrosonics VR might seem a bit pricey, but it's worth every cent.

Lectrosonics, 505/892-4501, www.lectrosonics.com. ■



Microphones



Timbre! The new Woodpecker active ribbon microphone.

www.bluemic.com

World Radio History

Focusrite Saffire Pro 26 i/o Interface

Upgraded With FireWire, Software Control, Enhanced Routing

The Focusrite Saffire 2-channel desktop I/O unit that was released in 2006 set the stage for a larger version with more muscle. It didn't take the company long to create one, and the new Saffire Pro ably picks up where the original unit leaves off.

The Saffire Pro 26 i/o FireWire 400 device is based around a 24-bit/192kHz engine capable of handling 26 channels of inputs and outputs simultaneously. It features eight converters and eight preamps with a pedigree that traces back to Focusrite's Green Series preamps. The Pro 26 i/o interacts with its computer host using the same intuitive software control in the original Saffire. It also includes plug-in technology borrowed from the company's Liquid Channel and Forte Suite TDM line, but curiously drops the integrated hardware-side DSP found in the original Saffire in favor of using the computer's native processing to handle effects.

START YOUR ENGINES

The interface works with all ASIO- or Core Audio-compatible platforms (but not Pro Tools), including my dual-core 3.2GHz Pentium 4 with Steinberg Nuendo 3 as host under Windows XP SP2 and 1.8GHz single-core Mac G5 running Logic Pro Version 7.2 under OS 10.4.9. Focusrite recommends that you run Saffire on its own FireWire bus or card—something I also learned while testing Liquid Mix. Installation was easy on both test systems. With the latest drivers installed and the SaffireControl Pro application running, the interface plugged in and “booted up” immediately.

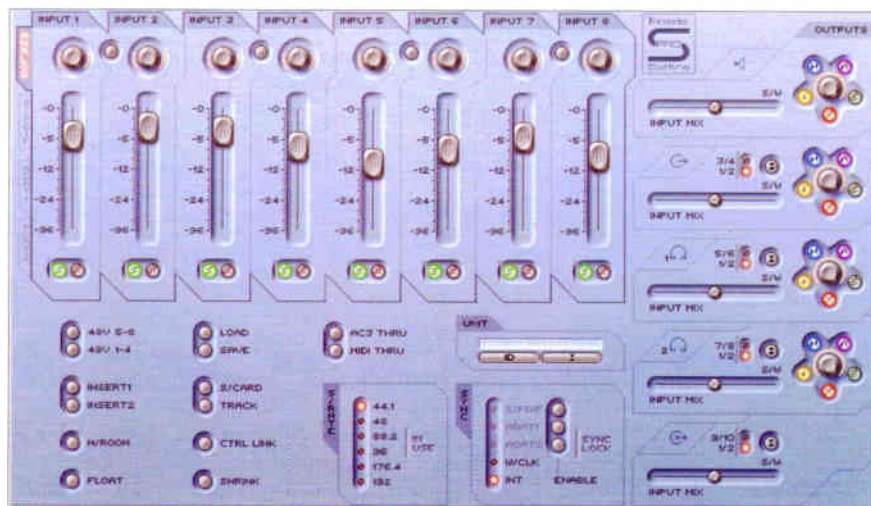

SaffireControl Pro software GUI showing mixer with panning, solo and mute, and monitoring options

Channel 1 also offers a phase-invert switch. Inputs 5 and 6 may also act as unbalanced inserts on channels 1 and 2, respectively. Phantom power with on/off LEDs can be flipped in banks of four. A master monitoring level control—with dim and mute switch, plus dual 1/4-inch headphone out jacks with level controls for separate headphone mixes—round out the connectivity up front.

The back has eight XLR inputs (subordinate to the instrument/line inputs on the front), eight balanced 1/4-inch line-level outputs (configurable for surround), two sets of SMUX ADAT I/Os, and co-ax S/PDIF I/O. Also present are MIDI I/O, BNC word clock I/O, dual FireWire 400 ports and a professional-grade screw-in connector for the line-lump power supply. The Pro 26 i/o can be bus-powered using the included 6-pin FireWire cable, so the external power

the SaffireControl Pro software is an elegant and highly advanced mix surface that sits between the hardware and your DAW. All settings and controls that are not physically present on the hardware can be accessed here. It also provides comprehensive custom mix and monitoring solutions, in addition to the preset Tracking or Playback modes.

Mixer features include input-level faders, pan knobs, solo/mute and stereo-link switches for each available channel in a given input mode; output mix controls; and a crossfader that allows you to set the balance of the input mix and the tracks playing back from the sequencer. The outputs can be muted and solo'ed, dimmed by 18 dB in software or padded by 18 dB post-DAC at the interface—a handy tool for calibrating Saffire Pro to extra-hot monitor speakers. A software switch allows the



A PACKED RACK

The 1U front panel, with detachable rack ears for desktop use, sports an anodized finish in an attractive high-tech shade of blue. Channels 1 and 2, nicknamed “super-channels,” each feature an instrument switch for accepting input from guitar, bass, etc., as well as lo-Z buttons for impedance matching. Chan-

supply is only necessary with computers that have nonpowered 4-pin FireWire connections or cannot supply enough power on their own (such as laptops).

WINDOW TO ITS SOUL

More than the mere “audio setup” panel that you typically get with other interfaces,

Monitor dial on the hardware to act as a tactile control over the output level.

There are global controls for setting the sample rate and sync source, and an AC3 thru switch allows the S/PDIF Out to transmit an AC3 or DTS signal directly from DVD-playing software to a home surround setup. I appreciated that I could set the control panel

Best Drum Microphones.

MIPA
2007

- | | |
|---|--|
| <p>USA</p> <ul style="list-style-type: none"> Interstate All Star Technoparticle Drumscene Musikalnyj Zhurnal Hot Music Stage Audio Music & Technology Archetype Produção Profissional London Music Trade Canadian Musician Professional Sound Musikus Musikerin Soundcheck Bytat Sound! Battour Guitarist Keyboard Recording Guitar & Bass Espresso audiobach.net Production Partner Schweizer Sound & Recording Sticks drums & percussion AV Pro Drum! schaltpop AAA Archetype Citizene Computer Music B Project Studio Drum Club Il Giornale della Musica Intellina Inblond Music File Magazine Percussion! RecPlayer Sound & Site Strumenti Musicali Soundcheck Musikpraktika Musikwelt Batarda i Studio Storystro Top Drummer Top Master | <p>Produção Audio</p> <p>Produção Profissional</p> <p>Audio Producer</p> <p>Filarmônica</p> <p>Interradio</p> <p>Musican.OuKa</p> <p>Show Master</p> <p>Music Maker</p> <p>Acordes</p> <p>Computer Music</p> <p>Future Music</p> <p>Guitars Electrica</p> <p>Guitarista</p> <p>Music Magazine</p> <p>Production Audio</p> <p>Production Professional</p> <p>Musikermagazin</p> <p>Stierlist</p> <p>Interface</p> <p>Music Maker</p> <p>dr Music news</p> <p>Illegalebrant</p> <p>Anuncia</p> <p>Paloue</p> <p>Audio Media</p> <p>Computer Music</p> <p>Drummer</p> <p>Future Music</p> <p>Guitar and Bass</p> <p>Guitarist</p> <p>Live Sound</p> <p>MS Pro</p> <p>Resolution</p> <p>Rhytha</p> <p>Total Guitar</p> <p>Acoustic Guitar</p> <p>Bass Player</p> <p>Beats&Drum</p> <p>crum!</p> <p>Electronic Musician</p> <p>ES</p> <p>*retu</p> <p>Guitar Player</p> <p>Guitar world</p> <p>Harmony Central</p> <p>Keyboard</p> <p>Kit</p> <p>Modern Drummer</p> <p>Music Player Network</p> <p>Musikstar.com</p> <p>Pro Audio Review</p> <p>Recording</p> <p>Sticks</p> <p>Sound and Communications</p> <p>The Music Trades</p> <p>Loquat</p> |
|---|--|

Drum Microphone
AUDIX DP-7 DRUM
MICROPHONE PACK



107 magazines representing 25 countries voted AUDIX the winner of the 2007 Musikmesse International Press Award for "Best Drum Mic". Audix would like to thank all the members of MIPA for this recognition.



For more information go to www.audixusa.com or call 1-800-966-8261
Audix Corporation, PO Box 4010, Wilsonville, OR 97070. ©Audix Corp 2007. All rights reserved. Audix and the Audix logo are trademarks of Audix Corporation.

World Radio History

to whatever level of complexity was required for a session, and that I could shrink or expand its window. I also liked that it has no annoying drop-down menus.

FLEXING STUDIO MUSCLE

My unit hummed along smoothly without any pops, crackles, drop-outs or lost FireWire signal. Granted, it was almost always the sole sync device during my tests, but was well-behaved when I slaved it to another clock source. What's especially nice for mixing in smaller rooms is that by engaging the 18dB analog pad, you can work at quieter levels without sacrificing bit-depth at the DAW master fader.

Latency is practically a non-issue, as the unit offers a low-latency hardware monitor that is controlled in software. The actual latency figures (which manifest themselves while playing virtual instruments, for example) vary depending on the power of your computer, available RAM and the DAW buffer size you set. With Nuendo's buffer set to 256 samples, and 2 GB of system RAM, input latency was 6 ms at 48 kHz, and output closer to 10 ms. Being a Tascam GigaStudio user, I missed not having GSIF driver support.

One thing I noticed when reconfigur-

ing my Logic Pro environment for Saffire's connections was that SaffireControl Pro hardwires its I/O names to specific channel numbers. For example, if you only wish to use the ADAT facilities, you cannot reconfigure these as channels 1 through 16; the analog channels, even if disabled, are always channels 1 through 8. Though renaming the tracks within your DAW and saving a session/setup template should clear any practical confusion, you'll need to spend some time reconfiguring I/O settings in existing projects. A far-greater annoyance is making any switching changes (such as turning ADAT banks on/off or changing sample rates); this causes several seconds of delay while physical relays click over in the hardware unit. And this is a cumulative effect—several changes can put your session on hold for 10 seconds or more.

The Saffire Pro's VST/Audio Units plug-in suite is the same as in the original Saffire, including EQ, compression, amp simulation and reverb. Though simple, they are top-notch in quality, exhibiting no sonic difference from the likes of d2/d3 and Forte Suite plug-ins when I compared similar settings. One feature that I discovered at the very end of the manual is that Saffire Pro can be

used in stand-alone mode for use in recording or mixing without a computer.

PRECIOUS GEM

I'm thoroughly impressed with what Focusrite has accomplished here. For the power user, it provides the most I/O connectivity, and to my ears, the best-sounding preamps and converters of any device in its class. The ultra-low-latency 192kHz HD audio sounds brilliant and, when paired with the straightforward control software, can be used to create highly flexible custom monitor mix and talk-back schemes that rival those in large-console facilities. The fact that the unit can work in stand-alone mode as a high-quality converter is such a juicy extra that you could purchase one simply for the sound of the Focusrite inputs and exploit any unused ADAT/SMUX ports in your studio. The Saffire Pro 26i/o is also an ideal solution for live sound recordists and mobile users who demand quality sound without the bulk. Price: \$999.

Focusrite, dist. by American Music and Sound, 866 FOCUSRITE, www.focusrite.com, www.americanmusicandsound.com. ■

Jason Scott Alexander is a producer/mixer/remixer in Ottawa, Ontario.



THERE'S A NEW SHERIFF IN TOWN

The most wanted microphones - Heil Sound.



The first breakthrough in dynamic microphone technology in over 25-years, Heil has the old "standards" shaking in their boots. Assembled in America, the HEIL PR Series uses a unique combination of large diaphragm dynamic elements with a proprietary neodymium motor, to deliver unequalled performance over a wide variety of applications. Join the ever-growing Heil posse, and see what all the commotion is about.

Heil Sound Ltd.

www.heilsound.com | info@heilsound.com

618.257.3000



3 TEC AWARD NOMINATIONS!



vote early and often!



- 1 FIRESTUDIO™**
26x26 firewire recording interface system
:: 8 XMAX preamps
:: 16 ch. ADAT input/output
:: recording and production software included

*"... an uncompromising, clean and expensive sound that is truly impressive, especially for this price range."
– Mix Magazine*

*"After tests between the much pricier 96 I/O, Apogee's acclaimed Big Ben C777 chip and the (PreSonus) JetPLL technology, I feel confident that the DigiMax FS' (same as FireStudio) clocking abilities compare favorably."
– Mix Magazine*



- 2 DIGIMAX FS**
8 ch. mic preamp with ADAT input/output +
:: 8 class A XMAX preamplifiers
:: 96k operation, ADAT input and output
:: direct outputs and inserts on each channel

*"Whatever PreSonus did with the converters, they got it right. I preferred the sound of the PreSonus DACs over those in my Pro Tools HD 192 IO—and it wasn't just a minor difference."
– Tape Op Magazine*



- 3 FADERPORT™**
USB automation and transport controller +
:: write single and group volume, pan and mute automation
:: high-quality Alps fader for fast, smooth and accurate automation
:: complete transport control (play, rewind, record, set markers, etc)

*"The FaderPort is good about letting you stay in 'right brain' mode, and it takes minutes — not hours — to get comfortable enough to fly around the buttons."
– EQ Magazine*

*"In its bomb-proof metal housing, the FaderPort looks and feels very professional. I love mine!"
– TapeOp Magazine*

+ Add this product to expand/upgrade your existing computer recording system including Digidesign, M-Audio, RME, Mackie, Tascam, etc

PreSonus, Faderport™ & FireStudio™ are trademarks of PreSonus Audio Electronics Inc. All other company names are property of their respective owners including Digidesign, M-Audio, RME, Mackie, and Tascam.

www.presonus.com
225.216.7887

World Radio History

PreSonus

Klein + Hummel 0 110 D Studio Monitor

Portable, Bi-Amped Close-Fields With Flexible I/O, Room Correction

Klein + Hummel's 0 110 D active monitors are a next-generation digital successor to the company's 0 110 analog model. The new monitors sport analog inputs and AES/EBU and S/PDIF inputs with 24-bit digital conversion (32 to 96 kHz). The 5.5-inch woofer and 1-inch, titanium fabric-dome tweeter are bi-amped and magnetically shielded, and each are driven by their own 50-watt power amps, with a crossover point at 2.5 kHz with 24dB per octave slope. Frequency response is rated at approximately 58 to 20k Hz.

The 0 110 Ds are available in a variety of colors (enamel anthracite gray, white or custom colors) and have a deceptively small footprint (170x267x190 mm), but still pack a punch, even when used on a workstation desktop or in a video production suite.

PICK YOUR FORMAT

The unit has a built-in, dual-purpose, switchable XLR input jack for analog or digital operation, so getting signal into the 0 110 Ds comes down to whatever you require. Input sensitivity on the analog side is +6 dBu (1.55V), and an input attenuator trim pot allows for continuous control from 0 to 24 dB in both analog and digital modes.

The XLR and BNC connectors are wired in parallel across a transformer, which allows external termination and a variety of stereo connection schemes, including AES/EBU via one BNC cable, AES/EBU via two XLR cables, S/PDIF (or AES-3id) with two T-connectors and so on.

For equalization, a pair of four-position rotary switches allow you to adjust bass and midrange frequencies to compensate for room response. Silk-screened setup suggestions let you quickly dial in your preferences. Bass settings are optimized for speaker placements that include freestanding, near a wall, flat against the wall and corner settings; the midrange settings are optimized for freestanding, tabletop, meter bridge or soffit-type situations.

OUT AND ABOUT

My tests with the 0 110 Ds were varied and, at times, punishing. First, I took them out

on location for an off-Broadway vocal recording session with male and female soloists and piano accompaniment. I was immediately taken with the monitors' larger-than-expected sound, as well as their wide and useful sweet spot.

Working in a small room just off the concert hall, the composer/arranger and I had a clear idea of where we were going with the vocal levels and placement, which I won't usually attempt on location. The redesigned waveguide and drivers did a stand-up job of widening the sweet spot and translating well, no matter where I had them.

In use as field/remote speakers, I had little time to agonize over their placement. I just set them up and went for it, hoping for the best. The 0 110 Ds' stereo imaging was always clear and detailed, and there were no nasty surprises when I checked the mixes back in the studio.

I didn't need to play with the EQ settings very much. However, in most of my sessions, the monitors were far enough away from any walls or corners, usually in a free field, up on pedestals for a direct line of sight (and listening position) on the remotes. Because of this, I noticed that the compensation trim pots have enough range to handle excessive bass buildup or harsh, bright surfaces.

Another test involved tracking a variety of string players in small clusters for a videogame soundtrack. While the session itself was tricky, the monitors' playback was robust and detailed, accurately reproducing lots of low-end synths and drums, which allowed the composer to hear the full-range music bed we were synching to in the session. The 0 110 Ds were just what we needed, keeping the



composer happy each time he returned to the playback booth for reality checks and decision-making.

THE D, PLEASE

The 0 110 Ds offer a lot of features and pack a lot of punch for their size. Their sound is smooth, wide and open. I found their portability and twin inputs to be very handy. I used them as monitors for video and audio sweetening, as rear surround speakers in the studio and on the road whenever I had a soundtrack or tracking session. On the aesthetic side, the white-colored versions blended in with the new iMac in my studio. This very flexible, attractive package may be just what you're looking for in a great-sounding, portable active monitor. Prices: gray, \$1,495 each; all other colors, \$1,795 each.

Klein + Hummel, dist. by Sennheiser, 860/434-9190, www.klein-hummel.com, www.sennheiserusa.com. ■

Joe Hannigan runs Weston Sound & Video in Delaware.

All 4 YOU

Sometimes great musical ideas just turn up in your head. And it's these spontaneous moments of creativity and emotion that you want to capture quickly. Cubase 4 makes it easier than ever before to get your ideas onto your hard disk. For example, the new Track Presets system lets you call up exactly the right sound for any instrument or voice almost instantly. Open a track, select the preset – including EQ and effect settings – and that's it. This is just one of the ways in which Cubase 4 keeps your head free for what's most important: your music.



CUBASE 4

Breakthrough technology. More creativity. All 4 you.

 **steinberg**
Creativity First

www.steinberg.net
World Radio History

Mojave MA-100 Tube Microphone

Flexible Condenser With Swappable Capsules

Mojave Audio, which produces a line of condenser mics from David Royer, has released its second effort. A little brother to the large-diaphragm MA-200, the MA-100 features two interchangeable, 3-micron capsules (cardioid and omni), Jensen transformer and a military-grade JAN 5840 vacuum tube. It ships in a handsome aluminum case with power supply, cable, IEC power cable and clip. The power supply can be set for either 115 volts or 230V via an external switch. Each MA-100 microphone, power supply and cable set is burned-in for 24 hours and then sent out for sale.

PERCUSSION PLUS

I first heard a pair of MA-100s used as a spaced pair of drum overheads about 1.5 feet off the top of the cymbals using the cardioid capsules. Cymbal detail was very good with no washy artifacts when hit hard. The toms and kick offered good, punchy low end and nice stick definition and beater strike. On another session with another drummer, the pair was hung over the kit in an X/Y array—again with the cardioid capsules—with comparable results. The top end provided by the pair had plenty of extended high-end detail without being in the least bit harsh; the toms and snare were well-positioned and quite up-front. All transients were slightly rounded, making for a good blend with the snare's Shure Beta 98 direct mic, which brought more mids to the mix.

I then swung the pair over to a set of timbales placed in a spaced pair about four feet off the top of the drums. I turned off the power supply and carefully switched out the capsules to the omni pair. I had a problem with a loud hum in one of the mics, making it unusable. Unfortunately, I didn't have time to troubleshoot this during the session, so I decided to punt and go mono with a single omni. It sounded great and was able to handle the sharp transients of the drum, yet maintained room presence. On a later session, when switching out the capsules, they operated perfectly.

The pair worked great as room mics with the omni capsules, reproducing the room sound very well and blending with the rest of the kit. The mics were set as

a spaced pair 10 feet from the floor and 15 feet back from the front of the kit. This drummer had a large rock 'n' roll kit with cymbals the size of manhole covers. I used a pair of MA-200s as overheads about three feet from the tops of the cymbals. The combo of 100 and 200 worked very well together, providing an accurate stereo image and rendering transients that were easy on the ears. The cymbals have sounded strident in the past when recorded with less-forgiving non-tube condensers, but they sat well with the kit and were never overpowering.

I should mention that the clip that ships with the mic is very poor. The metal threaded ring that fastens it to the stand easily comes out of the rubberized clip and doesn't inspire confidence. I also had an intermittent problem with one of the power supplies after it had operated perfectly at first. The on/off switch, which should be lit when on, would only light up when the switch was in the middle of its throw, leaving me in the dark as to whether there was power getting to the mic at all. The next day, this problem went away.

GUITAR AND ORGAN

In another session, the pair was used on either side of a wooden Leslie speaker to record a Hammond C3 organ. It brought out the honk of the horn nicely and offered plenty of balanced bottom, despite being placed at the top of the cabinet. It needed no help in the mix with EQ or compression to decisively cut through other guitars, a drum kit and an acoustic piano.

Placed about nine inches from and cen-

tered just above the sound-hole on an acoustic guitar, a single MA-100 was just the ticket. It provided plenty of pick definition, tamed the normally overbearing mid-range that this guitar exhibits and wasn't boomy in the least. If anything, it needed a bit of dressing up for the mix with some 100 Hz added, but that's because the recording would support it, not because the MA-100 was lacking.

PROBLEM-SOLVER

In spite of the intermittent ghosts that visited twice during my time with the mics and the poorly designed clip, the MA-100s operated flawlessly. The great thing about this mic is that its forgiving transient response and silky top end seem to fix a variety of problems I've had in the studio with certain instruments when using condensers with a faster transient response.

I'm reluctant to say they're inaccurate because that sounds negative; I'd describe it better as a mic with an altered personality that is flattering to certain instruments with brash qualities. It tamed an oft-encountered acoustic guitar that has an overbearing upper-midrange and balanced a big rock drum kit with large cymbals that likes to tear your face off. In these situations, and in others when recording instruments with better aural

behavior, the mics operated like journey-men transducers, delivering a well-defined stereo image, frequency range and transient response. Having a mic this versatile come with two capsules for less than \$1k (\$795) is a steal. Mojave's second outing is a must-hear.

Mojave Audio, 818/847-0222, www.mojaveaudio.com. ■



Apogee, Apple & Sweetwater

An Amazing Ensemble



The promise of a fully native pro audio production system realized...

With the legendary sonic quality of Apogee's audio interfaces combined with the power of Logic Audio and the computer audio expertise of Sweetwater, there is nothing standing between your Mac and sonic perfection.

Apogee Ensemble - The first digitally controlled pro audio interface built specifically for the Mac.

Apogee worked closely with Apple to deliver uncompromising performance and seamless integration with Logic Pro via Logic's Apogee Control Panel. With Ensemble, everything from mic pre and output gain to sample and bit rate selection are controllable from the Mac.

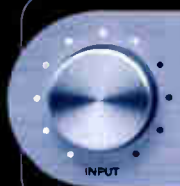

- 8 channels of premium 24-bit 192K AD/DA conversion
- 8 channels of ADAT I/O
- 2 channels of SPDIF I/O
- 4 digitally controlled 75db mic preamps
- 4 Hi-Z instrument inputs
- 2 individual assignable headphone outputs
- Core Audio compliant FireWire 400 I/O
- Apogee exclusive "Soft Limit" and "UV22HR" technologies

Apple Logic Pro 7 - Everything you need for creative audio production

Logic Pro 7



Once your audio reaches your Mac, you need a powerful, flexible application to turn your musical vision into reality. That's where Logic Pro comes in. With more than 30 software instruments, over 70 effects and distributed audio processing, Logic Pro is the choice of

musicians, engineers and producers the world over.

Sweetwater - putting it all together for you

At Sweetwater, we've been helping our customers use Macintosh computers to make music since the 80's.

We've designed, installed, configured and tested more Mac audio systems than any other retailer, period. Give us a call and let us help you realize the promise of a professional native pro audio production system today.

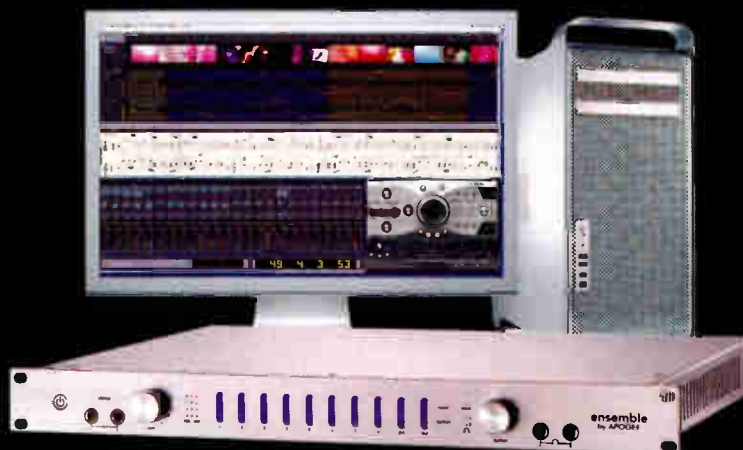

 Authorized Reseller

Sweetwater
Music Instruments & Pro Audio

(800) 222-4700
www.sweetwater.com/ensemble

Apogee
SOUND AMAZING

zplane vielklang Auto-Harmonization Plug-In

Generating Multiple Voices From a Mono File

For smaller studios and jingle producers on tight deadlines, getting a herd of backup vocalists together for a session can be a hassle. New German software company zplane offers a shortcut: vielklang. When a monophonic audio file such as a vocal or trumpet line is dragged and dropped into this program, it produces an intelligent (and editable) four-voice harmonization.

The process works in three steps. First, the program analyzes the pitches of the notes in the file and attempts to guess the key signature and scale being used. With clean audio, I found that it did a good job at getting the notes, but sometimes analyzed, for instance, a G-major melody as E-minor. Second, it uses the rules of classical voice-leading to produce four diatonic harmony lines, one of which will mostly comprise the original input (but possibly with a few pitches changed by a half-step to match the harmonic analysis). The program then uses formant-based pitch-shifting to generate new audio voices from the original melody, transposing each note up or down as needed.

TWEAKING YOUR PARTS

Of the three harmonization modes, either Intelligent or Parallel may give you a good starting point, after which you can switch to Edit mode and drag a few of the notes up or down in the piano roll. Instead, remain in Intelligent mode and choose a different root for any chord. At present, vielklang only knows about major, minor and diminished 7th chords. The extended voicings often used in pop music have to be created by hand, as do blues scales and secondary dominants.

In Intelligent mode, you can tell the program to use wider or closer voicings, and specify whether the original melody should be the top, second, third or bottom voice in the four-part harmonization. In Parallel mode, you can choose the interval relation that each voice will have to the original input. The results will be diatonic, but altered voicings can be created after switching to Edit mode.

When you get something you like, save it as a snapshot, which can contain different harmonizations and different regions isolated out of a longer sound file. Each snapshot can be assigned to its own MIDI trigger key.

for playback. You could use this feature to create three different background vocal arrangements based on the same lead vocal line, and then trigger a different arrangement in every chorus. Because vielklang is instantiated as an instrument and not an effect, it can receive MIDI note input.

Each of the four voices can be sent to a separate DAW mixer channel, or you can pan and attenuate them in vielklang and use its stereo mix output. The formants of each voice can be adjusted up or down for a more natural vocal blend, and each voice can be delayed to enhance the impression that you're hearing an ensemble.

I'M HEARING VOICES

I tried vielklang with my own vocal, a cello track and a solo trumpet part played by the Arturia Brass soft synth. I felt that vielklang produced a fairly natural pop ensemble sound with the vocal (in spite of my bad singing). With the trumpet, the results were a bit stiff and artificial because the small variations and liveliness produced by a real brass section were missing. The cello "quartet" had a somewhat unnatural silvery tone, probably produced by phasing in the HF range.

Needless to say, the better the source material, the better the results. When I tested vielklang with a vocal track I had sung myself (rather expressively), it altered the pitches of some of my notes by a half-step in attempting to make harmonic sense of them. As a result, quite a lot of manual editing was required to produce the harmony I wanted. If the source track has an out-of-tune note, then tightening vielklang's tuning parameter for the voices can steer them into concert pitch. If the vibrato in the source track is too wide, then you can tighten up the pitch-drift parameter to tame it in the synthesized voices. However, it's advisable to start with a track that's sung in tune.

A couple of notable features are missing, such as the ability to change the length, loudness or start time of individual notes. In

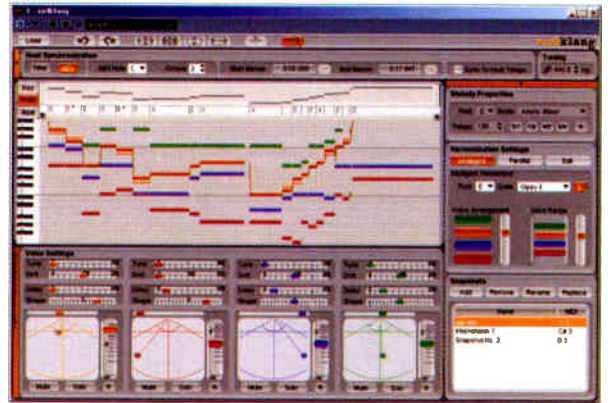

vielklang's note editing (upper left), harmonization options (upper right) and voice output settings (bottom)

my tests, this gave vielklang a "marching in lockstep" sound, but the loudness and timbre of each voice can be automated.

When I tried importing a solo trumpet track, vielklang identified two notes that were a half-step apart and connected legato as a single note. Currently, the program has no way to split notes apart, so my options for harmonizing these two notes were adversely affected.

GOOD FRESHMAN EFFORT

I spotted a couple of minor bugs—not surprising in a Version 1 release. Double-click mouse messages in Cubase 4 (on a PC) were hijacked by vielklang whenever the latter's Edit window was open. At one point, the buttons in vielklang's Harmonization Settings area went dead and remained so even when I quit and restarted Cubase, but the manufacturer e-mailed me a bug-fix version (V. 1.01 is now available) in which this problem had been corrected.

On the positive side, the four voices can also be transmitted as MIDI notes, so you could generate harmonies in vielklang and then trigger other sound sources. Also, you can output the voices separately for processing and panning. It's a promising technology and well worth keeping an eye on. Price: \$249 (download only).

zplane, 49-308-540-9150, vielklang.zplane.de. ■

Jim Aikin writes regularly for Mix and Electronic Musician. Visit him online at www.musicworks.net.

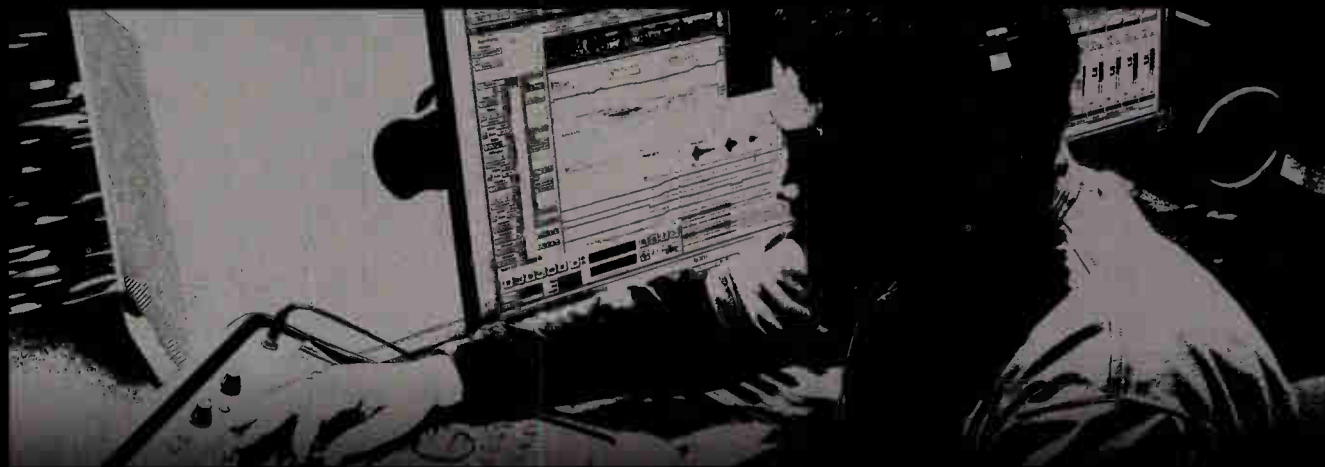

**DESKTOP
AUDIO**

THE PROFESSIONAL'S SOURCE



real world solutions from industry professionals!

www.bhproaudio.com



800-947-5508 | 420 Ninth Ave. New York 10001 | We Ship Worldwide



Snapshot Product Reviews

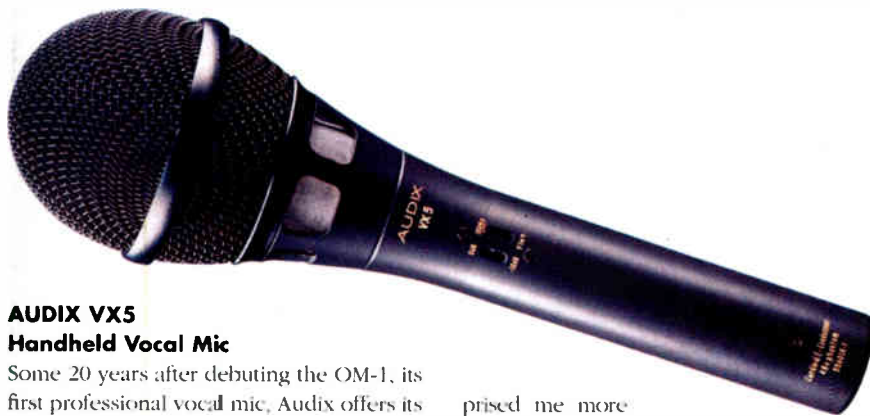

AUDIX VX5 Handheld Vocal Mic

Some 20 years after debuting the OM-1, its first professional vocal mic, Audix offers its latest entry, the VX5 handheld condenser. Retailing for \$299, the VX5 has recessed switches for bass roll-off (150 Hz) and a -10dB pad. The 14mm gold vapor-sputtered diaphragm on the electret condenser capsule helps provide a 40 to 16.5k Hz (± 3 dB) response.

The first thing you notice about the VX5 is its "feel"; the slim, tapered 8-ounce mic balances nicely in the hand. The black-satin body is capped by a rugged, three-stage pop filter (stainless-steel outer mesh, fine inner screen and fabric stretched over the capsule). These combine for effortless plosive and vocal pop handling.

The VX5's supercardioid pattern is somewhat tight, which could be a challenge for vocalists who bounce around a lot and have trouble staying on-mic. Yet even in such cases, the VX5's off-axis response remains consistent. The minimal rear lobing of its polar pattern helps maximize gain before feedback, while rejecting off-axis stage noise and keeping drum/guitar/etc. out of the vocal mic channel. The mic exhibits a fairly flat frequency response up to a rising top-end boost peaking around 9k. The result is clear and accurate, yet not spiky nor harsh, with a top end that's airy without being overly sibilant. At the other end, the VX5 exhibits a smooth proximity effect for a lush, close-in fullness, if desired. Whether the mic is used for male or female voices, any need for EQ is minimal and done to suit the performer rather than to correct for the microphone.

The mic has a 130dB SPL spec that extends to 140 dB with the -10dB pad kicked in. The VX5 doesn't distort, even when it's hit really hard by the loudest close-in singers. What sur-

prised me more was hearing the mic on acoustic 6- and 12-string guitars.

Handheld vocal mics are hardly my first choice in this application, but here the VX5 delivered natural, uncolored reproduction with a nice blend of low-end bottom, balanced mids and top-end zing, with tons of detail, especially with harmonics.

With the VX5, Audix offers a great-sounding mic that—like the OM5—will surely be a popular item on riders for years to come and be appreciated by artists, and house and monitor engineers alike.

Audix, 503/682-6933, www.audixusa.com.

TC ELECTRONIC KONNEKT 24D FireWire Recording Interface

TC Electronic's Konnekt 24D packs a lot into a compact desktop enclosure. This 14x14 (in/out) FireWire recording interface features two mic/DI/line inputs, two additional line inputs, ADAT Lightpipe and (96kHz) S/PDIF co-ax I/O, MIDI I/O, four analog line outputs, headphone amp, control room level control and onboard DSP. Under the hood,

the Konnekt is no slouch: The ADCs/DACs on the analog I/Os are 24-bit/192kHz, and the internal effects are the Fabrik R reverb and Fabrik C channel strip/compressor from the company's PowerCore platform. The DSP can be placed inline during recording, or show up as channels in your host application or used without a computer, like a standard outboard effects processor.

The unit can be powered from a FireWire bus or an included AC adapter. In addition to its low-latency drivers for Mac OS X, Intel-based Macs, Windows XP and all apps supporting WDM, ASIO and Core Audio drivers, the unit ships with TC NEAR™ (Network Expandable Audio Recording). This application provides intuitive control of all routing, setup, DSP and mix functions, and allows networked control of up to four Konnekt 24D units for more versatility.

The TC NEAR install disk includes the appropriate drivers and a copy of Cubase LE for those needing a recording application. After smooth sailing on an AMD Opteron PC and a lowly Power Mac G4, I experienced a variety of strange quirks using Konnekt 24D on an Intel Mac, but these were finally cured by a Version 1.20 update of TC NEAR that's downloadable from the company's Website. And according to TC, Konnekt 24D's Intel Mac performance is much improved by using a beta version of Apple's upcoming Mac OS 10.4.10.

On *any* FireWire audio system, data clog can result when a multichannel audio interface is being run on the same FireWire bus as an external hard disk. On desktop

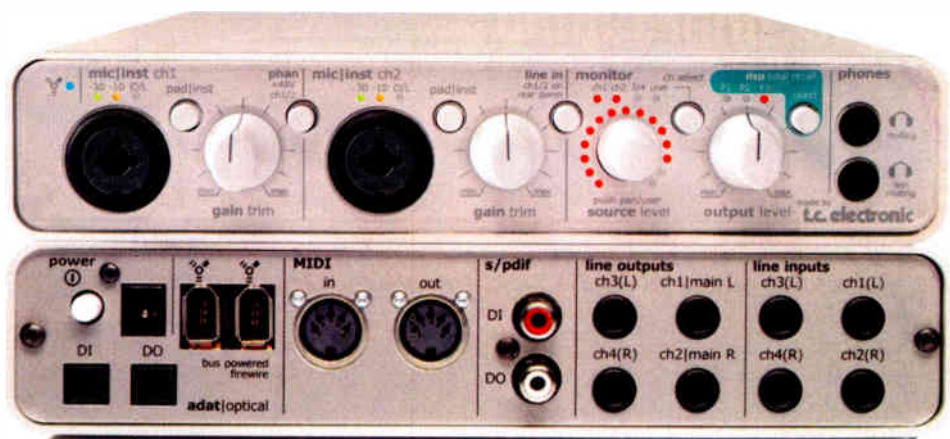

computers, an additional bus can be created using a PCI FireWire card to supplement the built-in bus. When using Konnekt 24D for remote recordings directly to a laptop, I simply stored the tracks to the internal HD and later copied them to an external disk before mixing/editing.

Aside from these few caveats, working with the Konnekt 24D was a pleasure. The mic preamps offer 62 dB of gain and—while they're hardly in the league with the Millennials in my studio—these were surprisingly good: clean and transparent with decent headroom. Other nice touches include the hi-Z instrument DI inputs, the rear panel's TRS balanced line I/Os and the two headphone jacks, one of which automatically mutes the control room feed when plugged in.

Eight of Konnekt 24D's 14 I/Os come from two Lightpipe ports. There's a lot of versatility here: each can operate as eight channels in ADAT 44/48kHz mode (or four SMUX channels at 96kHz) or be software-switched to provide S/PDIF Toslink optical I/O, in addition to the co-ax S/PDIF ports. Here, the little-used ADAT out on my 8-channel PreSonus DigiMax (which I normally use for tracking drums) was a perfect complement to the Konnekt 24D. Running Logic or Cubase, everything was plug-and-go.

One of Konnekt's 24D's strongest suits is its interface, which is designed to get you up and running as quickly as possible. Beyond the front panel's gain and output knobs is a multifunction source/level control (surrounded by an LED value ring), which ties into the software, offering a tactile control option for adjusting levels or panning. Another cool feature is Konnekt 24D's ability to save three TC NEAR setup/configurations as presets that can be recalled from the unit's front panel—even when you're not using a computer.

TC NEAR provides fast onscreen access to setup parameters (i.e., buffer size, clock source, sample rates), as well as the mix and routing screens. It's also the gateway to the Fabrik C and Fabrik R windows. Both use MINT™ (Meta Intuitive Navigation Technology), a remarkably simple means of tweaking effects by moving various parameter icons within a grid. This visually oriented approach is easy to master and gets results fast.

Anyone who's used PowerCore will be familiar with the excellent audio quality and flexibility of the onboard DSP. Fabrik C offers 4-band parametric/notch/peak/shelving EQ, a scalable de-esser, limiting and single/multiband compression. Fabrik R

features versatile live, hall, plate and club programs. The effects are not available at 176.4/192 kHz. Only one plug-in (Fabrik R or Fabrik C) can be accessed at 88.2/96 kHz, although both can be used simultaneously at 44.1/48 kHz.

TC Electronic's Konnekt 24D is a little box with a lot to offer, and with a list of \$625, it should appeal to novice and pro users alike.

TC Electronic, 818/665-4900, www.tc-electronic.com.

FUTURE SONICS ATRIO Personal Monitors

Expanding its line of in-ear monitors, Future Sonics is shipping the Atrio Series universal-fit personal monitors. Based on the company's latest MG5PRO™ driver technology, the \$199 Model m5 is designed for live performance applications and is supplied with several sizes of ComfortFit™ foam and EarFills™ silicon sleeves, with the ability to upgrade to custom-fit SofterWear™ sleeves at a later time. The addition of this affordable (\$199) custom-mold option makes the m5 an ideal choice for artists who are starting out with personal monitoring or upgrading from lower-quality earpieces and want to get their feet wet before making the full plunge into custom-molded earpieces.

You can try either the foam or silicon sleeves and choose whichever feels most comfortable. Both are replaceable and slide on easily over the stem of each m5 earpiece. Once the unit is in place, plug the

stereo 1/8-inch connector at the end of the 1-meter cable into your belt-pack receiver and you're ready to go. Depending on your own ear canal geometry, the sleeves provide up to -26 dB of attenuation from the outside world. The units do not have to be pushed very far in for an effective seal, and they are lightweight; with several choices in sleeve size/types, they are comfortable, as well.

The drivers have a 20 to 20k Hz response, but are not designed for a flat response; the Atrios provide a musical response, intended to offer a big sound at lower levels. Bass in particular seemed rich and full. I suspect this comes from an LF bump (sort of like the left side of the classic "smile" curve), but whatever it is, it works. Midrange sounds are easy for earpieces to reproduce, but Atrio's high-frequency response offers ample top end to hear details like reverb tails and decay—a tough call for a loudspeaker measuring less than 10mm.

Best of all, with a good seal and a good mix, you can listen at lower levels (even while drumming), forget the mechanics of the system and focus on your performance. With a sensitivity of 112 dB at 30 Hz/1 mW, the Atrio Series can get plenty loud, but this efficiency also means you don't have to drive your belt-pack's headphone amp into clipping to get enough level. Your ears will thank you.

Future Sonics, 215/826-8826, www.ear-monitors.com. ■

George Petersen is Mix's executive editor.



ROAD-READY

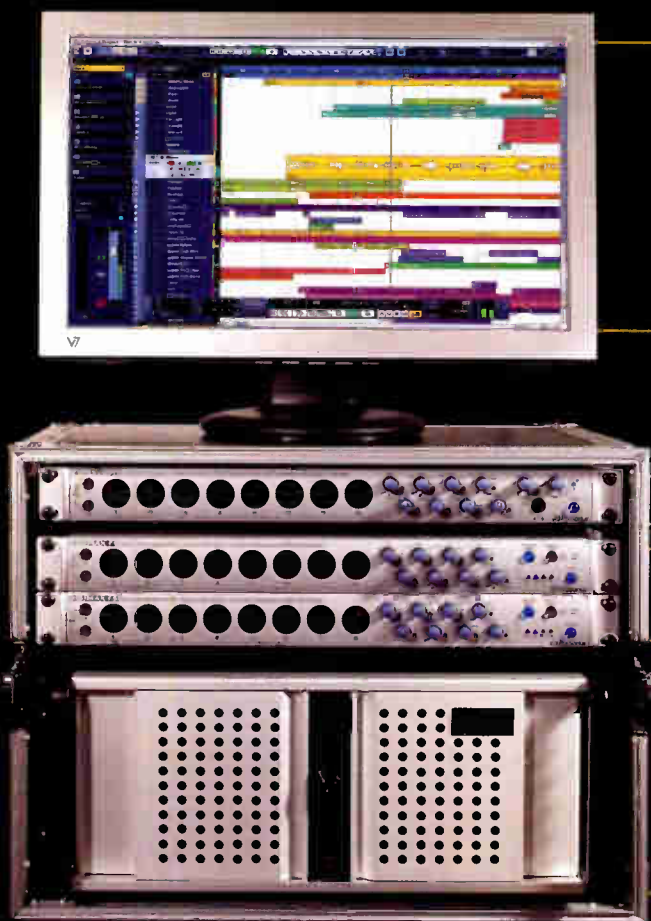

Steinberg

CUBASE 4

advanced music production system

- Record unlimited audio/MIDI tracks
- Complete host based mixing engine with EQ and dynamics
- 50 real time VST audio effect plug ins
- Integrate with PreSonus via Control Room feature for software controllable sub mixes

PreSonus

FIRESTUDIO

26x26 firewire recording system

- 8 XMAX class A microphone preamplifiers
- JetPLL jitter elimination technology
- DSP matrix routing mixer
- Word clock I/O, MIDI I/O, SPDIF I/O

PreSonus

DIGIMAX FS

8 channel preamp w/ lightpipe

(2 units shown for an additional 16 channels)

- 8 XMAX class A microphone preamplifiers
- 96k digital output via SMUX
- JetPLL jitter elimination technology
- Direct outputs, insert points, DAC inputs

Sweetwater

CREATION STATION

audio production pc

- Rock-solid rackmount configuration
- Every component hand-selected for audio production
- Audio-optimized Windows OS
- Glyph hard drives built for audio recording

FREE
MONITOR STATION REMOTE

BUY A FIRESTUDIO & CUBASE 4 FROM SWEETWATER
GET A FREE MSR (\$229.95 value)



Take control of your
FireStudio with the MSR.
Input and speaker switching,
surround control, talkback,
mute, dim, mono and more.

LIMITED TIME ONLY

 **PreSonus**

 **steinberg**

RECORDING



JARS OF CLAY PRODUCES LIVE CD DURING TOUR

When Jars of Clay hit the road to promote their current release *GOOD MONSTERS*, they wanted to record their shows in hopes of releasing a live recording after the tour. After recording the first few shows, they realized, not only was their Creation Station system rock solid, but that the recordings were so high quality they decided to release a live record, called *LIVE MONSTERS*, during the tour! How did they do it?

It starts with a recording system capable of dealing with the demands of a national tour. At the heart of the system is the **Sweetwater Creation Station** – designed and configured by the computer audio experts at Sweetwater specifically for audio production. Connect the **PreSonus FireStudio™** and two **DigiMax FS'** for 24 Class A microphone preamplifiers with Jet PLL synchronization technology enabling hours of rock-solid continuous multi-channel recording. Finally, add **Steinberg's Cubase 4** – the most advanced audio recording and production software with the ability to mix during recording, send sequencer and virtual instrument tracks in real time and more, for a fully integrated hardware and software recording rig that can handle anything thrown at it.

"Our recording rig is exactly what we need it to be: dependable, easy-to-use, and powerful," says Jars of Clay guitarist Matt Odmark. "It has become an integral part of our production and recording. The PreSonus preamps sound amazing, Cubase 4 is unbelievably creative and powerful and the Sweetwater Creation Station never skips a beat, literally. Thanks Sweetwater for the sweetest recording rig!"

Call Sweetwater today at 800-222-4700
or visit www.sweetwater.com

Check out video and photos of the recording at www.sweetwater.com/jarsofclay
Check out www.jarsofclay

Sweetwater

Music Instruments & Pro Audio

World Radio History



PHOTO: DARRYL PITT

At *Legacy*, L-R: Pat Metheny, Jack DeJohnette, John Patitucci, arranger/producer Gil Goldstein, Michael Brecker, Herbie Hancock

MICHAEL BRECKER

ENDING ON AN UP NOTE

By Blair Jackson

When saxophone great Michael Brecker died of leukemia at the age of 57 this past January, the music world lost one of its most versatile, prolific and influential players. The sheer scope of his career is staggering: He played on some 900 albums in nearly every musical style imaginable, from rock to funk to folk to Latin to jazz, with such "names" as John Lennon, Elton John, Frank Sinatra, Steely Dan, Joni Mitchell, Lou Reed, Pat Metheny, Funkadelic, Paul Simon, James Taylor, Chick Corea, Frank Zappa, McCoy Tyner, James Brown, Dave Brubeck and hundreds more.

The tenor sax giant played in a number of jazz and fusion groups, from Dreams to the Brecker Bros. (both with his trumpet-playing bro Randy) to Steps Ahead, toured with many more and somehow also found time to put out a dozen or so albums under his own name. He won 13 Grammys, the most recent for his 2003 CD, *Wide Angles*. He was loved, admired and respected by nearly every-

one who ever had any contact with him. No question about it—this is a huge loss, deeply felt.

But Brecker left us with one helluva "good-bye" album: *Pilgrimage*, recorded in August 2006 and

mixed just days after his death, features Brecker playing in a fantastic all-star jazz quintet featuring guitarist Metheny, bassist John Patitucci, drummer Jack DeJohnette and (depending on the track) pianists Herbie Hancock and Brad Mehldau. Not surprisingly, Brecker had long histories with all of these jazz titans, who bring imagination, exquisite taste and, when needed, real firepower to nine Brecker compositions that span a wide range of jazz moods, from quietly contemplative numbers to intricate and unpredictable mid-tempo pieces that feel like well-constructed puzzles, to blistering hop-inspired workouts. Far from seeming like the sad coda to a brilliant career, *Pilgrimage* feels like the statement of an artist at the peak of his powers. That Brecker could summon the strength to make an album this brilliant when he knew he was dying makes this an extraordinary story, but *Pilgrimage* would still be a masterpiece even if he was still with us, back in New York and L.A. studios, pushing toward his 1,000th album appearance.

It seems somehow appropriate that *Pilgrimage* was recorded and mixed by another jazz legend, Joe Ferla, whose own career spans nearly four decades in New York studios, working with a who's who of the jazz world (including all the players on the record, multiple times) and a number of pop artists (such as John Mayer, for whom he engineered much of the Grammy-winning *Continuum*).

"It was an amazing record to work on," Ferla says of *Pilgrimage*. "Obviously, they're all brilliant musicians and it was really an honor to be part of it. We're so lucky we even got to make the record, let alone

—CONTINUED ON PAGE 119

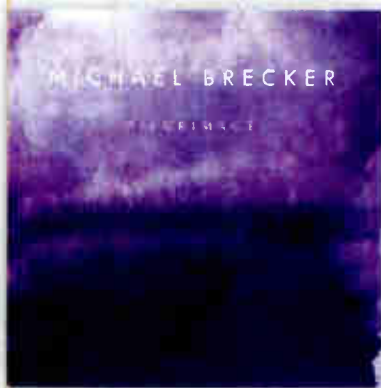

AVRIL LAVIGNE

"COMPLICATED" SINGER DEFEATS
POP PRINCESS LABEL

By Heather Johnson

Among the in-crowd of young, female pop singers that includes Britney Spears, Christina Aguilera, Jessica Simpson, and later, Jessica's sibling Ashlee Simpson, Avril Lavigne doesn't *totally* fit in, even though people consider her part of that clique. Her music, beginning with the hit single "Complicated" from her 2002 debut, *Let Go*, offers up precisely crafted pop much like the rest of the flock, but she works in more guitar riffs and sports a snarky attitude and baggy skater clothes that make the tweens with a rebellious streak think she's *bella cool*.

Her follow-up, *Under My Skin*, revealed a more pensive, brooding Lavigne, with songs that hinted at a young woman mulling over late-teenage dramas. Now at the ripe old age of 22, Lavigne has seemingly unloaded some of that emotional baggage, leaving her free to play around with some *seriously* catchy and *way* fun pop/punk-inspired fare. In honor of her fascination with power chords and light profanity (there's a dirty and clean version of this record), Lavigne comes forward with *The Best Damn Thing*, released this past spring on RCA; it's a lighthearted collection of mostly upbeat numbers with a few emotional ballads tossed in, oh, I dunno, for fun, I guess.

Lavigne reportedly hand-picked her producers and musical collaborators. On the production end, she turned to Butch Walker, with whom she had worked on *Under My Skin*, Rob Cavallo (Green Day, Goo Goo

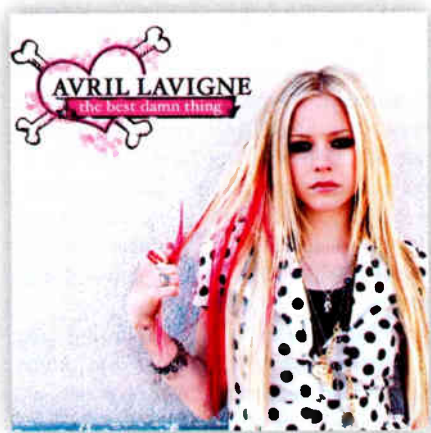

Dolls, My Chemical Romance) and Dr. Luke, best known for producing Kelly Clarkson's "Since U Been Gone," the influence of which can be heard on Lavigne's *Best Damn* debut single, "Girlfriend." The album also features six-string work from Lavigne's husband, Derek Whibley of Sum 41, and her longtime guitar player, Evan Taubenfeld, who also co-wrote several tracks.

Walker's name appears on three of the album's final cuts, including the title track, the ballad "When You're Gone" and the hard-driving so-long-evil-ex-boyfriend song, "Everything Back But You."

Lavigne and Walker collaborated democratically: Lavigne expressed both her lyrical and melodic ideas, then left Walker to his own devices to hash out a basic track. He played most of the instruments himself, working with Karl Egsieker, his engineer of more than six years and now his first-call partner on the West Coast. (They both relocated to L.A. from Atlanta in 2004.)

Working at Michael Bienhorn's Venice Beach studio, followed by stints at NRG Studios, Sunset Sound and Walker's studio, Egsieker recorded Walker's guitar, bass, keyboard and background vocal parts on the nearest available Pro Tools HD system. Phase One took place at Bienhorn's studio,

where renowned drummer Kenny Aronoff pounded out the initial drum tracks. "We laid down a basic guitar, bass and vocal melodies—some songs had words, some didn't—and we tracked drums to that," says Egsieker.

Egsieker miked Walker's guitars—which he plays through Bogner, Marshall and/or Fender amps—with a Royer R-122 and a Shure SM57 blended together in varying combinations, then used an Audio-Technica AT4047 either as a room mic or positioned up close to the instrument. Continuing the chain, he typically used Chandler TG2 mic pre's and an API 550 EQ, both from Walker's rig. Drums received treatment from API 512, 550 or 560s, depending on the song's requirements. He also pulled out Empirical Labs Distressors for drums, guitars, vocals—"just about everything," Egsieker says. On occasion, he used a Neve 1073 EQ or Universal Audio's 1176 on the guitars to create a slightly different effect.

With the basic song structure in Pro Tools, Walker further developed the songs—adding parts here, tweaking a line there—until he felt he had nearly completed a track. At that point, they called in another renowned drummer, Josh Freese, for a second round

—CONTINUED ON PAGE 120

THE VENTURES' "WALK DON'T RUN"

By Gary Eskow

Buckle up, because this month we're taking the Way-back Machine out for a real spin—all the way back to 1960. JFK became president that year, proclaiming, "The torch has been passed to a new generation of Americans, born in this century." Elvis Presley returned home from a two-year Army stint in Germany, and Cassius Clay (soon to become Muhammad Ali) captured a gold medal at the summer Olympics in Rome. The Civil Rights movement was heating up and exposing the great racial and cultural divide that was splitting America. Fifteen years after the end of World War II, America was enjoying unparalleled prosperity, and the West Coast in particular was growing fast and beginning to influence the culture more and more.

Against this backdrop, a pair of young guitar players from the Seattle area, Don Wilson and Bob Bogle, walked into Boles Studio one day with a drummer and recorded their version of a Johnny Smith instrumental they'd heard on a Chet Atkins album called *Hi-Fi in Focus*. "Walk Don't Run" became the song that launched The Ventures.

Bogle, who would relinquish first-chair duties to Nokie Edwards when Edwards joined the group several years later, played the melody line on "Walk Don't Run." "I played a lot of the leads at first," says Bogle, "and then moved over to the bass when Nokie joined the band. I never did try to copy anyone else's style because I wasn't that good! I had no choice but to develop my own style; Les Paul and Chet Atkins were *way* over my head. In fact, I hadn't been playing for long before we recorded 'Walk Don't Run!'"

Although they prefer to be labeled a rock band, both Bogle and Wilson acknowledge their contribution to the "surf-rock" genre, and still cover many surf hits (including "Wipeout" and "Pipeline") in their live shows. A shower of reverb, emanating from the spring units of the Fender amplifiers they favored, and a heavy emphasis on the vibrato bar marked their sound. "I loved the whammy bar!" Bogle enthuses. "Everything sounded better when you leaned on that, I thought—and still do! We use it on the majority of leads, even today."

Often overlooked is the precise intonation that is a characteristic of Ventures' records. This was no small feat in 1960, when the technology that players rely on today to leave the guitar in tune when the whammy bar is used had not been developed. "That's right," Bogle says. "We paid strict attention to tuning, and we knew that lots of records were released with poor guitar intonation."

Wilson played rhythm guitar on "Walk Don't Run" and has held that position in The Ventures ever since. A state champion wrestler in his high school days, Wilson brought an athletic approach to his instrument that helped define the group's sound. "When Bob and I first started, there were only the two of us," says Wilson. "Eventually, we got a drummer and bass player, but at that time we didn't know any! Bob



played full chords behind some of the notes in his leads, and I tried to make up for the lack of drums by playing very percussively. My approach to playing rhythm guitar was unique, I suppose, in that I really hit hard. I play lots of double rhythms that sound like drum rolls."

Speaking of rhythm and the cultural divide that existed at the time, it must be pointed out that an absence of *string* is a critical component of The Ventures' guitar sound. They articulate as precisely as the Philadelphia Orchestra would when playing a Mozart symphony: Eighth notes are always two equal divisions of the quarter. "No matter what we play, we 'Venturize' it," says Bogle. "It's certainly fair to say that our music is not R&B. Everything we do has an aggressive, driving sound, but it's not the kind of aggression you hear with rock groups that feature a distorted guitar."

The Ventures decided to record "Walk Don't Run" at Boles Studio, one of the most respected in the area. Wilson's mother, Josie, who passed away recently, was a pivotal force in the history of The Ventures. She financed "Walk Don't Run," helped market it and gave the group its name; originally, Bogle and Wilson had called themselves The Versatones.

"Joe Boles used a 2-track Ampex recorder," Wilson recalls. "He was a very good engineer who had recorded a couple of Number One hits—'Come Softly to Me' and 'Mr. Blue'—for The Fleetwoods. Joe always used a tape-based delay effect. When you're using a 2-track tape player without a board, there's a lot less going on in the recording process, but Joe had plenty of tricks up his sleeve. He'd even mike the pick sound when you were playing! We were so impressed with him that we recorded our first two LPs there."

"There weren't many decisions to be made in the mix; whatever effects Joe would put on the guitars and drums were added during the recording process," Wilson continues. "The bass and drums were on one track, the rhythm and lead on the other. We did have a lot of input on the sound of the record. In particular, I remember us asking for lots of reverb on the lead guitar." No one involved remembers what mics

might have been used on those sessions.

Despite that, the initial session remains vivid for Bogle. "At the time, I had recently purchased a Fender Jazzmaster guitar [the group's identity would in part be shaped by the Mosrite guitars they later came to play], which I played through a Fender Dual Showman amplifier. In those days, there were no punch-ins; you kept playing the entire song until you got it right. I seem to remember us laying down about a half-dozen takes of 'Walk Don't Run.'

"The mastering process sticks in my mind. The final mix was sent down to Hollywood to be mastered by an engineer named Bunny Robine at United Recorders. 'Walk Don't Run' was mixed in stereo, but it also had to be mixed down to mono because there were very few stereo record players in 1960. Bunny's initial mix was too trebly for our taste and so he fixed it nicely for us."

I loved the whammy bar.
Everything sounded better
when you leaned on that,
I thought—and still do!
We use it on the majority
of leads, even today.

—Bob Bogle

After being picked up by Dolton Records, "Walk Don't Run" quickly climbed the charts and peaked in *Billboard's* Number 2 slot, behind Presley's "It's Now or Never." With a lineup that included Edwards and drummer Howie Johnson, the group turned out a number of albums in the early '60s and enjoyed a second round of commercial success with the song when they tracked "Walk Don't Run '64." In 1963, Johnson was injured in a car crash and Mel Taylor joined the group. Taylor remained the group's drummer until his death in 1996, at which time his son, Leon, assumed those duties.

Surf groups became déclassé during the cultural revolution that swept through America in the late 1960s, and The Ventures, who continued to record, found it hard to remain in the forefront. Until 1969, that is, when their cover of the theme to the popular television show *Hawaii Five-O* vaulted the group back into the limelight. It would be their last commercially successful record-

ing in the United States. In all, though, they put out 37 charting albums between 1960 and 1972, and landed 14 instrumentals on the *Billboard* Hot 100 singles chart.

Over the years, The Ventures have become one of the most popular recording groups in Japan, amassing, as of 2007, a total of 20 Number One recordings there. In addition to the players mentioned, guitarists Gerry McGee and Bob Spaulding have lent their talents to the group on a regular basis for more than two decades. To date, The Ventures have sold more than 110 million albums and enjoy the distinction of being the best-selling instrumental rock group in history. ■

MICHAEL BRECKER

FROM PAGE 116

have it come out so well. Michael had been sick for a couple of years. He was really weak and a lot of the time he was in the hospital. But there was a little window of opportunity, and I got a call from his manager a couple of weeks before we went into the studio—it was really short notice, and I was thankful that my schedule was open. Michael was feeling good, and so he and the group had a couple of rehearsals and then we got together at Legacy Studios—the old Right Track—and if you hadn't known that he was sick, you wouldn't have known it from those sessions because he did eight- to 10-hour days. He played so incredibly well—what's on the album is what he played—that we never went back and fixed anything. He got sick after that. We did have two days scheduled to let him go in and take another crack at solos if he wanted to, to see if he could top what he did live, but that never happened and he didn't need to come back in.

"This was really difficult, complicated music; it kicked everybody's asses," he continues. "Not one musician had an easy time with it. But everybody played brilliantly and rose to the occasion—for Michael, but also for each other because that's what a great group does. Michael was pretty tired at the end of each day, no doubt, but everything was always very upbeat."

Did Ferla suspect at the time he would never work with Brecker again? "I suppose in the back of my mind I thought there was a chance this could be Michael's last recording," he answers. "But he showed up in such good spirits and he looked so good, you'd think, 'This guy's not dying.' I think we all felt that way, and it's nothing that we ever talked about." Producers listed



Joe Ferla engineered Michael Brecker's *Pilgrimage*.

on the project include Brecker, Gil Goldstein (who produced *Wide Angles*), Metheny and the longtime bass player in the Pat Metheny Group, Steve Rodby, whom Ferla describes as "a real Pro Tools wiz."

The live tracking took place over three days in the big room, with Ferla recording direct to Pro Tools. "You can put a 90-piece orchestra in there," Ferla says, "so we weren't using that much of it. I had Michael in an isolation booth so we'd have the option to fix any mistakes he might have made—but he didn't! I also had Jack [DeJohnette] in a booth and Pat in a booth. But the piano and the bass were in the large room, with the bass baffled off."

As for mic choices, "On Michael I used a Neumann U67 and a Coles 4038; a blend of those. The 67 gets you that three-dimensional tube sound with the nice, beautiful air, and the Coles gives it more body; it's a warm-sounding mic. I had both mics right next to each other, as close as I could get them." Additionally, on a couple of tracks Brecker played an EWI [Electronic Wind Instrument], "which sounds a little synthetic to me at times," Ferla notes, "but we EQ'd it and [later] re-amped it to get a little analog warmth out of it to make it not quite so thin and bright."

"In the piano, I put a couple of Beyer MC 704s, and a [Neumann] U47 tube and a KM84. Brad [Mehlclau] picked a 9-foot Steinway and Herbie [Hancock] had a Fazioli. Pat has a DI and a microphone inside his guitar, and then we re-amped him in the mix with a Beyer M88. On drums, I used KM54s for cymbals, Beyer M88s on tom-toms and bass drum, and a KM184 on the snare." Ferla eschewed room mics because they made the piano and bass "too washy. If I'd had the drums in the room," he says, "I would've put a room mic up or if Michael had been in there with them." Preamps were Neve 1081s.

Shortly after the tracking sessions were completed, Brecker fell ill again, underwent more chemotherapy and, just a few months later, passed away. In the meantime, Rodby



Brecker and ca. discuss tracks that engineer Joe Ferla calls "difficult, complicated music. Not one musician had an easy time with it, but everybody played brilliantly."

edited the tracks in Pro Tools to everyone's satisfaction and then, as Ferla relates, "About a week-and-a-half after Michael died, we were in the Euphonix [System 5] room mixing the record. I have to say that was probably the most emotionally draining mix session I've ever done. Everyone tried to check their emotions at the door, but I couldn't really do that myself because I'm not that kind of engineer; I need to get emotionally involved in the music.

"The fact that he had just died made it very difficult to me. I probably knew Michael 25 or 30 years—a long time. And here was this brilliant music, and it sounded like he was in the room with us. Susan, his wife, came by every day. His kids came by probably every other day: Sam is 12 or 13, and his daughter, Jessica, is 17 or 18. And that added to the emotion of what was going on, too. But we're all really proud of it. We gave an extra 100 percent trying to second-guess what Michael would have liked if he'd been around for the mix. I guess I was playing a little mind game that Michael was there, that he heard what we were doing and liked it, tricking myself psychologically to not get too depressed about what really took place."

The mix itself was relatively straightforward, requiring little processing beyond some Lexicon 960 and 480 reverb for each player. "I don't have more than one player in a particular reverb," Ferla says. "Each was carefully fine-tuned to the particular instrument. I think those Lexicons are the smoothest and most natural-sounding of all the digital reverbs."

Months after the mix sessions, Ferla is still devastated by Brecker's death: "It's such a huge loss. Michael was one of the sweetest, most humble, gentlest men you would ever meet. He would play something in-

credible, then look at you and sort of shrug his shoulders, and say, 'Was that okay?' And your jaw is still dropped and you think, 'Okay? Are you f***ing kidding me?'" He says with a laugh, then turns serious again. "So talented, so talented. I'm just happy to have been able to work on this project. To be in this company was definitely a highlight of my career; a real privilege." ■

AVRIL LAVIGNE

FROM PAGE 117

of monster rhythms. When Walker had what he felt was a keeper, he put in the call to Lavigne. From there, Lavigne expressed her likes and dislikes, and she and Walker then worked together to fine-tune the arrangement and make sure the song moved in the direction Lavigne wanted.

Their mutual fondness for hook-laden melodies (as proven on her earlier releases, as well as Walker's power-pop-influenced solo work) makes them a good team, and their established relationship helped both parties feel more comfortable about expressing ideas. In Walker's case, that can mean brutal honesty as opposed to overly gushy compliments. "I'm not going to B.S. her," he says, noting that other producers may be inclined to spare the feelings (and boost the ego) of an artist who could bring them multi-Platinum royalties. The direct approach, in this case, helped Walker take this singer to an even higher level of achievement.

When the time came for Lavigne to step into the vocal booth, she sang primarily through an AKG C 12. Egsieker ran their mic of choice through an API 512 mic pre into a Distressor and an API 550 EQ. For moni-

toring purposes, he used the Fairchild 670 tube compressor on the back end. Walker also occasionally used the Waves SSL channel strip plug-in on the monitor side "to hype up the track a bit and get it sounding good in the headphones so Avril will react to it," says Egsieker.

For the final bits of overdubbing, the team migrated to Walker's former studio at Pulse Recording, the facility owned by producer Josh Abraham that occupies the former Sound Castle building in Los Angeles. They used Pulse's large live room to record drums for "When You're Gone," then retreated to Walker's personal space—which contains his Digidesign D-Control worksurface, Pro Tools HD system with Apogee converters and racks of classic outboard gear—for additional elements. Walker assumed the space at Pulse not long after moving to L.A., but after purchasing a house in Malibu that came with a built-in control room and iso booths, he moved his operation home.

While Walker took the one-man-band approach (sort of) with Lavigne, Rob Cavallo, who produced the emotional mid-tempo number "Innocence," employed a full band of A-list L.A. session musicians. Working mainly at Ocean Way Hollywood's Studio B, Cavallo aimed to create a track reminiscent of Alanis Morissette's moving "Uninvited," which he produced for the *City of Angels* soundtrack. That song, as well as the many albums he has produced for the Goo Goo Dolls, prompted Lavigne to seek out Cavallo for her new album. Considering she once covered Green Day's "Basket Case" and is occasionally compared to the band, one would assume Cavallo's long association with Green Day would have come into play. But that's not why she called him. "Uninvited" is one of her favorite songs, and she even played it at her wedding," Cavallo recalls. "She wanted a song with that same sort of epic intent. So based on the strength of that song, and particularly the Goo Goo Dolls' songs, we were brought together."

Lavigne had a very clear idea of what she wanted melodically, as well as a sheet of lyrics she had written with Taubenfeld. During her initial sessions with Cavallo, the two explored her ideas a bit further. "We played around on the piano and thought of different ways of recording the song," Cavallo explains. "We used the Goo Goo Dolls and Alanis as reference points, but by cutting the song the first time, we were able to learn about the song. And the song told us a lot about itself, so we were able to make subtle changes from there. It was a great process. Avril doesn't like to spend hours on a song; she likes to come in and make her com-

ments, and then let you work on it so that she can stay fresh. Then when you've actually gotten there, she knows it."

For the basic track, Cavallo's "dream team" of ace musicians included Abe Laboriel Jr. on drums, Paul Bushnell on bass, Tim Pierce and Greg Suran on guitar, and Cavallo and Jamie Muhoberac on piano and keyboards. David Campbell orchestrated the string arrangements. The band recorded the first pass together in Studio B's ample live room, while engineer Doug McKean manned Ocean Way's custom 48-input API. Keyboard and electric and acoustic guitar parts were then broken out and fine-tuned, followed by drum programming and strings. McKean, who recorded the sessions at 96k to the studio's Pro Tools HD system, notes that once the mood, tempo and key of the song were worked out, the musicians' high level of talent helped the tracking dates flow seamlessly.

With the first version of the song complete, Lavigne and Cavallo made necessary tweaks; in just two takes, they had her vision of the song nailed, and one highly inspired vocalist sang her parts like a pro. "She sings very fast, pretty much in the pocket, right off the bat," says Cavallo. "But that track has to

Avril doesn't like to spend hours on a song;
she likes to come in and make her comments, and then
let you work on it so that she can stay fresh.

Then when you've actually gotten there, she knows it.

—Rob Cavallo

be inspiring to her, so she works really hard to get the track together, and then, because she has such a strong vision of what she wants to do with that vocal, when she does it, it really comes together easily." To capture those nearly spot-on vocals, McKean used a pre-G Series Sony C-800 mic, which ran into a Neve 1073 to a Universal Audio 1176. He used the Telefunken Elam 251 on certain takes, but ultimately the C-800 vocal track made the final cut.

The album's final dozen songs were then delivered to Tom and Chris Lord-Alge, who took tracks from three disparate producers, recording in multiple studios with varying techniques and equipment, and mixed them into a cohesive collection that's primed and

ready for Top 40 radio. But unlike some of the other songs vying for top chart positions, the spunky cheerleader shout-outs, hand-claps and insanely catchy chorus on Lavigne's debut single, "Girlfriend," for example, reveal a bit of Lavigne's non-nonsense personality. And while her voice could very well be layered more times than her recently sliced wedding cake, the song maintains some semblance of authenticity that's hard to find in today's modern music. "She's very talented and very much responsible for the stuff that you're hearing," says Cavallo. "She has more to do with the record than I would imagine a lot of [solo] singers do. She ain't no pop princess—she's way more than that." ■



PUT YOURSELF IN THE MIX

Would you like to mix concert sound like Conservatory graduate Eddie Mapp for Evanescence, Staind, POD and Zakk Wyldé? What about winning a Grammy for Radiohead's 'Hail to the Thief' like Darrell Thorpe? Thousands of audio recording professionals have graduated from the Conservatory to work in a career that they had only once dreamed about. With your passion and our training you too could be working as a recording engineer, mixing sound for motion pictures and even touring with bands as their Front of House engineer. When it comes to audio... WE ARE THE EXPERTS. LET US HELP YOU GET IN THE MIX.



CONSERVATORY OF RECORDING ARTS & SCIENCES
2300 E. Broadway Rd. | Tempe, AZ 85282
1205 N. Fiesta Blvd. | Gilbert, AZ 85233
1-888-273-6412
www.audiorecordingschool.com/mix.html

L.A. GRAPEVINE

by Bud Scoppa

One of L.A.'s most respected producers, engineers and mixers—and one of the busiest—Jim Scott has built his rep off of crisp, live-off-the-floor sounds and attendant good vibes. Scott picked up his first Grammy in 1995 for engineering Tom Petty's *Wildflowers*, scoring two more for his work with Santana on *Supernatural* and the Foo Fighters' *One By One*. In February, he doubled his Grammy total, scoring a hat trick for his recording of the Dixie Chicks milestone *Taking the Long Way*. That album was the

PHOTO: DR. HOWARD MARSHALL



From left, *The King* and producer/engineer Jim Scott

most recent of dozens of projects Scott has done with Rick Rubin during the past two decades, from Petty and Johnny Cash to the Red Hot Chili Peppers and Slayer.

John Fogerty realized Scott had major-league chops as soon as they sat down to mix *The Long Road Home—In Concert* live DVD and CD, so when the Creedence auteur was ready to start work on his latest studio album, he tapped Scott as his go-to guy.

On a recent Monday, Scott joined Fogerty, drummer Kenny Aronoff, bass player David Santos and guitarist Hunter Perrin in Studio B at North Hollywood's NRG. During a week of rehearsals, the band had worked up five songs, hoping to nail at least three of them by the end of Friday. "I'm delighted and maybe amazed," says Fogerty. "We got five out of five, and they're all good. Jim really knows what he's doing, and he's also the nicest man.

Sonically, he'll get the instruments up and sounding really good pretty quickly, and that's not an accident."

"John is a musically aggressive guy," Scott points out. "He wants the drums to sound really powerful; that's why he sticks with Kenny Aronoff. What we went for was an in-your-face, honest rock 'n' roll drum sound that's loud and clear. John has a great guitar sound; he really takes time and care choosing his guitars and amps. As far as working the sessions, John's a strong leader, but if you're confident and have something intelligent to say, he'll listen. So if I had a thought or a favorite take, I'd tell him, instead of being a 'What do you think, John?' kind of guy. Everything we've done has been fun and quick."

Between now and the second set of Fogerty sessions at NRG, Scott will return to another work in progress—producing, engineering and recording an LP with Canadian alt country artist Kathleen Edwards—and mixing several projects, including tracks by country star Travis Tritt and Interscope buzz band the Midway State. All of this work is going down at PLYRZ Studios, Scott's personal workspace, a converted ware-

house located in his home base of Santa Clarita, 20 miles north of L.A. He is cagey about the name, saying only that it was inspired by a "kinda top-secret rock project" he's been working on. "But they're the guys I thanked at the Grammys," he says. Since opening the place in January 2006, Scott has been working there nonstop, producing bluegrass group King Wilkie and Finnish rock 'n' roll band The Latebirds, and mixing projects by artists including Dave Alvin, Los Lobos, Lavender Diamond, Marc Cohn and Minnie Driver, as well as Wilco's *Sky Blue Sky* and the band's covers of "Simple Twist of Fate" and "I'll Be Your Baby Tonight" for the upcoming Bob Dylan movie, *I'm Not There*.

The cornerstone of PLYRZ is a rare Neve 8048. The 32-input, 24-monitor, 16-bus board was built in 1976 for RCA Studios in New York City and acquired by Kitaro in

—CONTINUED ON PAGE 126

NASHVILLE SKYLINE

by Rick Clark

Since the mid-'90s, Jim DeMain has been the go-to mastering guy in Nashville for many artists and bands. His extensive credits include Michael McDonald, Tony Bennett, Jimmy Buffett, John Hiatt, Patty Loveless, Lambchop, Delbert McClinton, Billy Joe Shaver—the list goes on. Along with loving the results of his mastering touch, the one thing I've always heard from his clients is how much he truly cares about each job.

I never really got to hang with DeMain until last year, when I popped over to visit and see his facility, Yes Master (www.yesmasterstudios.com), which is located near the fairgrounds in South Central Nashville. Before I knew it, he and I were a couple of hours into some really deep conversations about audio, the state of music and of the industry, and the bands and artists who really inspired us over the years. I left that afternoon feeling like I had known him for a long time. Then, as fate would have it, I ended up using DeMain to master an XM radio project I was doing with Marty Stuart. It was seeing him in action that allowed me to understand why his thoughtful approach and great results inspire so much repeat business.

Yes Master's beginnings were in 1996 at DeMain's Sylvan Park home in an upstairs loft. His first paid projects were for Nashville-based producer Brad Jones for albums by Vince Bell and Tommy Womack. By the early 2000s, business was booming so much that it became clear that DeMain needed to build out a dedicated facility. So he found a nice commercial space and hired acoustic designer Carl Tatz to realize his vision for the facility, which opened in October 2004.

"We found this great under-the-radar place and gutted the biggest room we could find in it," recalls DeMain. "It's built into the side of a hill, so it's really nice and quiet in here, with high ceilings, and I built a really nice 'economy with dignity' control room from the ground up that sounds fantastic. The room is designed to be flat down to 23 Hz.

"As far as the equipment goes, I proba-

NEW YORK METRO

by David Weiss

bly use a lot of the same stuff everybody else does: high-quality A/D and D/A converters, Weiss EQ and compression, [gear by] Manley, Millennia, the Waves L2, et cetera," he continues. "Just like any carpenter is going to have a circular saw, a drill and nail guns—mostly all of the same tools."

DeMain also uses Steinberg's WaveLab 6. "It's really an excellent and intuitive platform," he says. "I use two computers. Sometimes I do everything in real time through all the outboard gear, sometimes I work 'in the box' and sometimes I'll do a combination of both. It really is all about the project. I usually spend the first hour or so just trying out several different signal paths. I'll try analog only, digital only, combinations to see what flatters the mixes the best. I can usually tell pretty quickly what will work. Sometimes just the combination and sequence of the gear can make a big difference before you start turning any knobs."

For his monitoring setup, DeMain relies on Lipinski 707s with Bryston amplification and M&K subs, all tuned by Carl Tatz. "One of my biggest assets is my monitor system," explains DeMain. "Every single client that has come here, even guys that are used to enormous studio playback systems, all comment on how great the monitors sound and how they can hear stuff that they never heard

—CONTINUED ON PAGE 128



Mastering engineer Jim DeMain in his Yes Master facility

Actors aren't the only ones whose dreams are ensnared in New York City's renowned theater scene. There's also a distinctive phalanx of audio enthusiasts—musicians, engineers or a combination of the two—who can't seem to help getting wrapped up in the opportunities that spring off the stage.

For Guy Messenger, founder of the royalty-free multimedia music library Soundscapers (www.soundscapers.org), the lure of Broadway and its off-off-offshoots was triply hard to resist. A multi-instrumentalist, engineer/producer and actor/voice-over artist, Messenger's inspiration to create Soundscapers arrived when he started to think hard about the unlicensed music he often heard in the smaller shows in which he's appeared.

"I was acting in what you call 'black box' theater productions—small plays," he explains. "I noticed directors were using a lot of classic tracks and not worrying about the royalties because artists aren't generally concerned about use in 50-seat theaters. But for when plays move up to the next level, I thought, 'Wouldn't it be great if they had a CD with 100 selections that emulated the artists, but were original and royalty-free?'"

Messenger became more and more focused on creating a library that would serve mid-level theaters and, armed with determination and a guerilla soldier's mentality, did just that. Interested only in world-class recording quality of real instruments—no canned beats or samples—for genres ranging from reggae to rock, jazz, Afrobeat and beyond, Messenger's search for a studio took him intriguingly far from his Brooklyn home base.

"I don't own a studio and I wasn't about to buy one," he says, "so I shopped with an openness to big ideas,



Guy Messenger's Soundscapers company provides royalty-free music for theatrical productions.

anywhere. I figured if I could get a good deal on a studio, then I wouldn't have to worry about the airfare to get there. I'm very glad that I found this place in Scotland: a studio called The Byre, which is a Scottish word for an old barn. What was important was finding a studio owner who cared, and Andrew Graeme called me in response to my query and took a long time talking to me. He said, 'Come over and stay with me.'"

Messenger jetted from JFK to the Scottish Highlands and found an idyllic setting for laying down as many tracks as possible in a seven-day lockout. Recording through an Amek Media 51 console to a RADAR 48-track system, he played guitar, drums, percussion, Hammond organ and more, as well as enlisting the help of select local musicians. "I layered tracks until I ran out of time," says Messenger. "Then I put it all on a LaCie portable hard drive, took it home and continued editing back in New York City."

Knowing that there was a multitude of expertly staffed but affordable Pro Tools rooms from which to choose in Brooklyn, Messenger selected Galuminum Foil for its comfort level and velocity of engineer Jeff Berner. "I liked how fast Jeff worked and

—CONTINUED ON PAGE 128

RANDY KOHRS' SLACK-KEY STUDIO TEARING IT UP ON BOTH SIDES OF THE GLASS

Randy Kohrs (www.myspace.com/slackkeystudio) has played guitar and other string instruments with many of Nashville's finest (including Dolly Parton, Randy Travis and Hank Thompson). He considers himself "first and foremost a session musician," and he began working with recording technology as a way to experiment, listen back and perfect his musicianship.

"I started with small recorders and having a studio in the house that I could practice in, and it just evolved," Kohrs explains. "I've had lots of help from some of the great engineers here in town. There's lots to learn from those guys, and I've been lucky enough to play on sessions where I could ask them questions."



Kohrs now uses his project room, Slack-key Studio, to record his own bluegrass band, Randy Kohrs & The Lites (get it?) and a number of other indie country acts, such as Larry Cordle & Lonesome Standard Time, Hank III and Jim Lauderdale. At press time, Kohrs and Lauderdale were busy tracking the follow-up to Lauderdale's Grammy-nominated *Bluegrass*. Kohrs co-produced *Bluegrass*, which he says was recorded mostly live at Bil Vorndick's studio. "On this next album,"

Kohrs says, "we've recorded upright bass, mandolin, guitar, banjo and Jim's scratch vocal going down, and I'm really taking my time with the dobro and fiddle parts. Also, this album has a different character from *Bluegrass*. We've got some vintage country kind of mirror-image licks—a lot like they would do with pedal steel and fiddle back in the '50s. We're really breaking them down, and there's all kinds of unison playing that branches off into harmonies—it's very creative, very enjoyable stuff." Also going onto Lauderdale's release will be a

duet with Patty Loveless and guest vocals by *American Idol* stand-out Melinda Doolittle.

Kohrs' studio comprises a 13x16-foot control room and a 500-square-foot tracking room, where he gets separation with the use of 12-inch-thick foam partitions. Kohrs tracks to Steinberg Nuendo 3, using Apogee 16X AD/DA converters. His outboard gear includes a collector's assortment of analog preamps from Universal Audio, Telefunken, Forsell Technologies and Ampex. "I have a stereo pair of vintage Ampex 601s that were modified by Natale Tomiano in New York City,"

Kohrs explains. "I met him when I was on tour with Dolly Parton, and we've been friends ever since. He makes these old pre's—basically guts them and does his mods on them, and when he gets done they're just incredible."

Kohrs also benefits from a number of endorsements, including microphone manufacturers RØDE, Royer, Shure and, most recently, Lauten Audio with its Horizon tube mic. His main monitors are Mackie 824 near-fields with matching sub.

Next up for Kohrs, once Lauderdale's project is in the can, will be four bonus tracks for a Dave Evans compilation and a follow-up to his own solo album, *Old Photograph*, which was released this past March on Rural Rhythm Records. "That album was done 50 percent with my touring band and 50 percent with session musicians. I just found out that it went up this week from Number 30 on the bluegrass chart to Number 20. So things are definitely looking up."

—Barbara Schultz



Musician/engineer Randy Kohrs (seated) is recording the follow-up to Jim Lauderdale's *Bluegrass* in his Slack-key Studio. Meanwhile, Kohrs' album, *Old Photograph*, is climbing the bluegrass chart.

BEHIND THE GLASS

PROFESSOR OF SOUL VILLAGE HOSTS CHERNEY, COLLABORATORS

Guitarist/producer Jerry Stucker submitted this photo taken during mixing sessions for a new CD by artist Professor RJ Ross and The University of Soul (former singer/keyboard player for Detroit-based soul band Brainstorm). Ed Cherney mixed the tracks on the Neve VR in The Village's (L.A.) Studio B.

From left in *The Village's* Studio B: producer/guitarist Jerry Stucker, drummer James Gadson, artist Professor RJ Ross and engineer Ed Cherney



AUSTIN SESSIONS

HUBBARD IN THE ZONE STELLAR "SNAKE FARM"



From left: Peter Rowan, Mike Morgan, Ray Wylie Hubbard, Pat Manske and Gurf Morlix

Roots artist Ray Wylie Hubbard's bluesy *Snake Farm* album, recorded in Mike Morgan's Zone Studios, features some big names by Americana standards. The disc was produced by the multitiered Gurf Morlix and includes mandolin work by Peter Rowan. Pat Manske engineered the project in Studio A.

ALAMO SESSIONS PARROT TRACKS GOES MOBILE



From left: musicians Mike Fowler, Greg Lowry, Poul Pearcy, Doug Taylor, K.R. Wood, Jim Price

George Coyne's Parrot Tracks studio has provided a combo of analog and digital recording services since 1980. Coyne recently took his gear to the historic Alamo in San Antonio, where Mike Fowler played the original fiddle of Davy Crockett. Coyne engineered the sessions and co-produced with Wood.

NORTHEAST

Neil Dorfsman mixed the Rolling Stones' upcoming live DVD release in Avatar Studios' (NYC) Studio G with producer Joshua Zeman and assistant Chad Lupo. Also in Studio G, the New Pornographers mixed their new album with engineer Phil Palazzolo and assistant Lupo. Producer Barry Eastmond was in Studio B recording tracks for Peabo Bryson with staff engineer Anthony Ruotolo and assistant Justin Gerrish... At Hobo Audio Company (NYC), engineer Chris Strangroom mixed radio and TV spots for Aetna and Grey Worldwide, and Joe Gauci mixed a documentary about the Iraq War called *Meeting Resistance*...Cure-esque rock band New London Fire was in Retromedia Sound Studios (Redbank, N.J.) tracking a follow-up to their 2006 album, *I Sing the Body Holographic*. The new album is being produced by Jack Ponti and engineered by Adam Vaccarelli, and will be released on Eyeball Records.

SOUTHEAST

Former Elvis Presley backing singers The Jordaires and drummer D.J. Fontana visited Merit Recording Studios (Nashville) to record new songs with producer Henry Golis. Tom Pick engineered...At Studio B Mastering (Charlotte, NC), engineer Dave Harris mastered new releases by artists GB Leighton, Derek Daisey and Jim Hurst. Hurst's project featured performances by bassist Viktor Krauss and "newgrass" mandolin player Sam Bush...Whitewater Recording Studios is celebrating the opening of new facilities in the Averbs Creek area of Asheville, N.C. The new, relocated studio was built from the ground up and features expanded duplication/packaging capabilities, as well as a range of audio and video recording/editing services. Visit the new studio online at www.whitewaterrecording.com.

MIDWEST

Producer Timbaland and his production team booked all three rooms at Maximedia Studios (Dallas, TX) to work on Missy Elliott's next release and, separately but simultaneously, with Zomba recording artist Samantha Jade. Also at Maximedia, Forever the Sickest Kids recorded with engineer Matt Aslanian, and chief engineer Hal Fitzgerald mixed producers Play-N-Skillz' remix of Hillary Duff song "With Love"...Maritime's new release for Flameshovel Records was tracked and mixed in Studio A at The Burst Collective (Milwaukee, WI). Stuart Sikes engineered and produced, assisted by Daniel Holter, Kyle White and Matt Smith...Fear City tracked and mixed their new CD with engineer Brad McGrath at Brick City Sound (Chicago)...At sound design/audio post studio Vagabond Audio (Chicago), engineer Drew Weir and producer Rise Sanders created



Keith Urban band guitarist Brad Rice

ROCKIN' AT 5 A.M.

Guitarist Brad Rice, who plays in Keith Urban's band, visited 5am studios (Austin) to lay down tracks for a new album by Austin's own Amy Cook. The sessions were produced by Jamie Myerson and engineered by Les Brooks.

the audio track for an Allstate TV commercial... The Recording Conservatory of Austin reports a number of sessions taking place for its Stinson Studios facilities and music production students: rock band NVANE with Zach Hillyard, punk rockers The Sweethearts with Joseph Radtke and Emersom Biggins Band with Rusty Kotzur.

NORTHWEST

Prairie Sun Recording Studio (Cotati, CA) hosted Paris-based artist Phoebe Kildeer, who mixed her new album in Studio A with engineer Oz Fritz. In Studio C, Howlin' Rain tracked their next release with engineer Tim Green...Engineers Don Budd and Steven Glaze have opened a new studio, Tone Freq Recording Studios, in downtown San Jose, Calif. The facility features Pro Tools HD3 and a large collection of modern and vintage pre's and mics, and will cater to local artists, as well as major and indie labels...The June issue featured Drew Youngs' Earthwire studio, but listed an old address. The studio is now located at 69 Green Street in San Francisco.

SOUTHWEST

Full Well Recording Studio (Phoenix) hosted tracking and mixing sessions for a new album by Spanish alt-rockers 21 Wattz. The release was produced and engineered by Mike Bolenbach, and was mastered by Roger Seibel at SAE Mastering (Phoenix). ■

Please send "Track Sheet" news to bschultz@mixonline.com.

1995. While Scott was working on the Dixie Chicks project at the Village in 2005, studio head Jeff Greenberg found out the 8048 was available. "I jumped on it, probably much to Jeff's chagrin," Scott says with a laugh. Two Neve BCM 10s and Pro Tools HD round out the power plant, and Scott makes constant use of an arsenal of vintage compressors, reverb units and tape recorders from dbx, Universal Audio, Altec, Scully and AKG.

When you walk in the back door of the studio, you suddenly find yourself in a big, high-ceilinged warehouse space that's so jam-packed with vintage instruments and gear—guitars, amps, keyboards, drum kits, road cases—that it could serve as a rock 'n' roll museum. "I finally have my entire life-long collection of gear in one place," he says. There's also a separate tracking room, a vocal booth, a kitchen, a bar and a huge lounge upstairs with 9-foot-high picture windows overlooking the surrounding mountains and valleys. The walls are bedecked with tapestries—he calls it "hippie-style" décor. "It's beautiful up here," Scott says, "and people love it. It's an alternate environment for people to chill out—it's bright, it's happy, it's different. People appreciate what went into how the place looks and feels. And the room

sounds awesome."

Sky Blue Sky, the highest-profile album Scott has mixed at PLYRZ thus far, is a return to Wilco's roots in late-'60s/early '70s music, following the envelope-pushing *Yankee Hotel Foxtrot* and *A Ghost Is Born*. After recording it live to tape in Wilco's Chicago rehearsal space, bandleader Jeff Tweedy gave the tapes to mainstay Jim O'Rourke, who had mixed both *Yankee* and *Ghost*, producing the latter, but Tweedy wasn't satisfied with the results. "Compared to the demos, [O'Rourke's mixes] just didn't feel quite the same or like the record we, as a band, had made," Tweedy explained in *Billboard*. So he turned once again to Scott, who had mixed several Wilco albums, most recently the live *Kicking Television*. A day after receiving it, Tweedy asked Scott to mix the entire album.

"I've done enough mixing for Jeff that I have learned where he wanted his vocal and where he wanted the band to be," Scott explains. "But on this record, I just couldn't help myself—I felt like I wanted to mix his vocals a little louder and clearer than ever. I thought, 'That's what this record is: It's about his words and his voice, and the music he wrote to support and accompany his vocals.' Jeff's just in the best place ever, and why not make a record that sounds great, too? There's nothin'

to hide. You get the songs and *feel* the songs; he sings so well and with so much emotion. And the album isn't all dolled up and fixed up like everything else—it's just real, and it's great. So I'm really happy for him."

As for the band as a whole, "After mixing the live album last year with the same lineup, I got the gist of what they were trying to do," says Scott, "and I wanted to hear everything. If you keep your eye on the most important parts of the music, the other parts will find their own balance and importance, especially with Wilco. There's not a lot of overdubs—they worked really hard to make their sound. Those weren't spontaneous jams; they were the result of rehearsal and decisions. And it still sounds fresh because they're totally performing. Wilco's just a crackin' band."

Said Tweedy in the *Billboard* interview: "The mixes we did with Jim Scott put you in this room a lot more than the [first] ones we did, which sounded much more like a 'record.' The room was gone."

When Scott works on a record, the room is always present, along with everything else that needs to be heard—pure and simple, loud and clear. He rocks. ■

Send your L.A. news to Bud Scoppa at bs7777@aol.com.



Master the universe.

Designed from the ground up for mastering and sound design professionals, these state-of-the-art plug-ins were originally available as part of Peak Pro XT™. Now the Master Perfection Suite™ is available for virtually every host application on Mac and Windows, offering more features and many interface improvements over other plug-ins in their class.

PitchCraft™ — Real-time pitch correction/transposition

Reveal™ — Seven-tool analysis suite

SuperFreq™ — 4-, 6-, 8-, and 10-band parabolic EQ

Repli-Q™ — Spectral matching with linear phase EQ

Sqweez™-3 & -5 — Linear phase multiband dynamics

GateEx™ — Professional Gate/Expander

Find out more at www.bias-inc.com



Master Perfection Suite™



CONSOLE SOUND. RACK PRICE.

If you're serious about audio, you're undoubtedly familiar with SSL. Their consoles are the heart of the most sought-after studios in the world, imparting a bit of sonic magic to everything that passes through their circuitry. But this magic carries a hefty price tag.

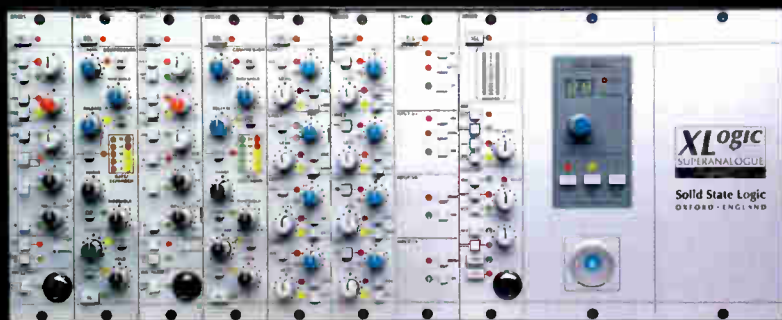

With the XLogic X-Rack Series, you can piece together your ideal combination of SSL modules — all of which come directly from a variety of SSL consoles. These modules are racked in a dedicated XLogic rack that provides Total Recall for your settings, providing the best of the analog and digital worlds. These X-Rack modules are DC-coupled, which means these modules will sound the same twenty years from now as they did the first time you plugged them in. These aren't emulations of the SSL sound — this is the real deal, SSL SuperAnalogue DC-coupled circuitry. Console sound at a rack price — SSL XLogic X-Rack.

Sweetwater Sales Engineers specialize in putting together custom recording systems and can put together a customized SSL X-Rack system that meets your needs. Call today and the experts at Sweetwater will configure the perfect SSL X-Rack system for you.

XLogic X-Rack Modules

Mic Amp Module

The perfect front end. SSL mic pre with 75dB of gain, variable impedance control, and high- and low-pass filters.

Channel EQ Module

One of the most revered EQs ever. SSL's twin-curve 4-band parametric EQ from the E and G series consoles.

Dynamics Module

Classic compression. Dynamics processing ripped straight from the XL 9000 K with compression, limiting, expansion, and gating.

Four Channel Input Module

Integrate outboard gear. Four line-level inputs with solo, volume, and pan with insert points for each input.

Eight Input Summing Module

Eight Stereo Inputs. Input synths, submixes, multi-channel feeds from audio interfaces, or any other stereo signal into the X-Rack.

Master Bus Module

The final link in the chain. Mix insert and sum points, mono compatibility check, and master metering with monitor outputs.

Solid State Logic
SOUND | VISION

800-222-4700
sweetwater.com

Sweetwater
Music Instruments & Pro Audio

in their mixes. When you think about it, for mastering it's the most important thing you can have. You can have all the latest bells and whistles in compressors and EQs, but if you can't hear what they're doing, then all that other stuff doesn't really matter. You're making final decisions on people's work that they have spent hours and hours working on up to this point. If you're not listening in a space where you don't know what you're hearing, that's in a way disrespectful.

"Everything is another tool you can use," he adds more generally about gear. "You just have to learn the best way to use each tool. You know, I'm not a guy that's like, 'It has to be all analog through a console!' Now, there's no argument that a good mix done through a console sounds phenomenal. The front-to-back depth and the height and width of a mix through a console is still pretty hard to beat in the box. But I have heard really good recording and mixing that was done all in the box. I think it really comes down to the people who are doing the recording using their ears. Sometimes I think that with all the computer monitors in front of us, maybe we're looking at the music a little more than we're listening to it."

Like all mastering engineers, DeMain is carefully watching the evolution of popular listening formats and wondering how it will affect his work both in the short term and over the long haul. "I try to never really get too comfortable with the state of things because they are always changing," he explains. "The basics will always apply: great songs, great performances, great recordings. But how they reach and interact with the end-user is always in motion. Take digital downloads, for example: Younger listeners are completely content to listen to MP3s. And most only download their favorite songs. So where does that leave the full-length CD as a format? I wonder what the future of making CDs will be—is that kind of full-length presentation going away? I don't know. I hope not, because I still enjoy listening to CDs."

"I am interested in exploring more multimedia work. With how affordable video editing has become, I think more and more artists are going to want to work that into what they have to offer. So it'll be about more than just audio content. I think there will always be a place for what a mastering engineer can bring to the table, where you take the mixes and you improve their quality. But how the results will be used will probably be totally different. So I guess my future plans would be just to keep my eyes open and see where it's all going." ■

Send Nashville news to nrburlur@mac.com.

that he understood what I wanted to do," he notes. "In addition to editing, I put new instrumentalists on to add things like saxophones and mandolin. There are so many musicians that are eager to work that you can trade services with them."

Finished audio tracks finally in hand after roughly a year, Messenger then traded guitar lessons for a Website design and was officially in business. Although the library is also being applied to TV, film and multimedia use, Messenger is most interested in proving to theater's sometimes-conservative decision-makers that his innovative collection is really a must-have.

"It might not be a million-dollar product, but there's a need for it," he says. "People are telling me that Soundscapers has made producing their play easier. I know I'm right—the challenge is convincing people of that."

While Messenger is spreading the gospel about his work, a downtown Manhattan studio has already gotten its message across. In fact, Yellow Sound Lab Studios (www.yellow-soundlab.com) was actually booked solid the second it opened for business.

Already living a dream as the drummer for hit Broadway musical *Avenue Q*, Michael Croiter's other big dream came true in 2005 when he found out that the Disney-produced children's show *Johnny and the Sprites* chose him to produce music for a full season. "I was actually working out of my 58th Street bedroom apartment at the time, using Pro Tools LE and a few mics, but suddenly I needed something world-class," he recalls. "It was November, and they said, 'We're starting next August,' so every second afterward that I wasn't on *Avenue Q*, I was on the hunt for the perfect studio. When I walked into this place, I said, 'This is it.'"

"This place" was a former beauty shop on one of the East Village's most beautiful blocks, 5th Street between 2nd and 3rd Avenues. Croiter turned to studio architect John Storyk of Walters-Storyk Design Group (WSDG) to help turn the low-ceilinged (7.5 feet), 850-square-foot basement into a top-tier facility, complete with a versatile live room with Yamaha C2 grand piano, iso booth, machine room and spacious upstairs client lounge. Down to only a six-month window for actual construction, the turnaround was almost frighteningly fast, as WSDG worked around the multiple structural constraints to make the surprisingly comfortable Yellow Sound Lab (named in honor of Croiter's friendly Labrador, Tyler) fully functional in time for the deadline.

In addition to the TV scoring gig that started it all, Croiter has enjoyed a very fast start courtesy of his thorough understanding

of the recording needs of the multiple top Broadway composers with whom he's connected. "What separates the Broadway composers from the rest is that they can write in any style for what's needed," he says. "For example, Gary Adler and Michael Patrick Walker, who do their demos here, wrote the off-Broadway hit *Altar Boyz*, which is a riff on *NSYNC that's about a Christian boy band. It's hilarious, and the music is better than any boy-band music out there, but they've also written very classical theater pieces. Theater composers can do everything—they're compositional chameleons. My philosophy is to record their rock pieces, for example, 100 percent as if it's a rock band. You have to truly mix and produce for the genre that they're in, instead of saying, 'This is for a musical.'"

According to Croiter, one of the biggest engineering challenges that comes with such versatility is manifested in vocal recordings. Working with his deep experience and a system, specified and integrated by Professional Audio Design that includes an Audient ACS-8024 console, Pro Tools HD, Apogee AD 16X/DA 16X converters, Dynaudio BM 15As and Aviom A16 personal mixers, Croiter is up to the task.

"Typically in rock, pop, jazz or most other situations, the vocal dynamic range is more predictable," he notes. "But with what theater writers are doing, you have to constantly stay on top, which could mean riding faders or a whole lot more. My signal path for tricky vocals is a Lawson L47 tube condenser microphone, which is basically an updated Neumann U47 that happens to have a dip around 4 kHz, exactly where my iso booth has a little high-end issue. From there I go through a Millennia Origin SIT-1 recording channel and straight into Pro Tools."

"I found if you go into the console after the preamp, it's too many gain stages and the sound gets compromised," he continues. "That's one thing I've learned: When you get a new studio with lots of new toys and more plug-ins than ever, you start loading things on to sessions just because you have it. Then you start taking things away and it gets better."

Between being centerstage at his own facility and shuttling off nightly to the orchestra pit of *Avenue Q*, Croiter has learned a few things about being a studio owner in New York City. "I've learned that there's more time and money involved to do it right, but it's been worth every second and dime," he says. "I'm working every day, all day, and I just thank God it's in the music business. If it weren't something I was enjoying, that would be a problem!" ■

Send New York news to david@dwvords.com.

MARKETPLACE

**Coleman
Audio**

(516) 334-7109
www.colemanaudio.com
coley@colemanaudio.com

Digital meters measure a number, peak meters a transient.
A VU meter is like seeing what you are hearing.
After chasing all those digits around, can you relate to the real world ?



SpectraPLUS 5.0

Real-Time Spectrum Analyzer

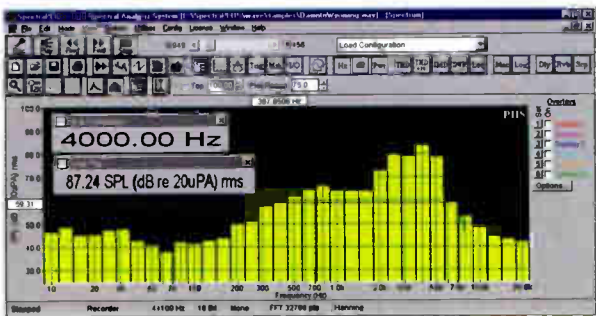

SpectraPLUS allows you to perform complex audio signal analysis using your sound card: SPL readings, THD, SNR, RT-60, Delay Finder, Narrowband FFT, 1/1 thru 1/96 Octave, Signal Generation and more.

Download a 30 day FREE trial!
www.spectraplus.com

PHS

Pioneer Hill Software 360 697-3472 voice
24460 Mason Rd 360 697-7717 fax
Poulsbo WA 98370 pioneer@spectraplus.com

CASCADE MICROPHONES

\$159.00



FAT HEAD RIBBON



www.AtlasProAudio.com
 US Toll Free 1.866.235.0953
 Open 'til Midnight EST - 7 days

Toft ATB32



pure analog large format console

Toft Audio ATB Console 16, 24, 32 channel



Great River



LaChapell Audio

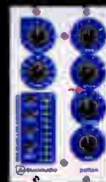

Buzz Audio



Telefunken USA



AEA



Wunder Audio

Over 80 brands of NEW gear!

Mics - Preamps - EQs - Compressors
 A/D Converters - PlugIns - Speakers

THE REVOLVER

The ultimate portable 500 series powered rack



A



B



C

THE REVOLVER

Made by and available exclusively at Atlas Pro Audio

The Revolver can hold two single width 500 series modules, or one double width module (C - shown with one Buzz Audio Elixir and one OSA MP1-L3) (B - Shown with one double width Buzz Essence Class A Opto compressor).

One Revolver is perfect for desktop usage (vertically - see B & C), or you may rackmount one, two, or three Revolvers using our custom 19" rack kits (A - shown above with 2 empty Revolvers racked horizontally).

The Revolver is 100% compatible with all modules made for the API(tm) 500 series. The Revolver is a self contained system, with oversized internal power supply for the utmost in portability, reliability & headroom.

XLR inputs and outputs are located on the rear of the unit. Removable IEC power cable. On/off switch. Heavy duty construction with ventilation.

Odds On
cd & dvd manufacturing

FACTORY DIRECT

CDs in Jewel Box \$599
Includes 1000 CDs in Jewel Box with Full Color 4 Panel Booklet and Tray Card, Full Color Offset CD Printing and Cello Wrap.

CDs in Printed Sleeve \$599
1000 CDs in Full Color Printed Sleeves with Shrink Wrap.

CDs in Digi-Pak \$1,199
Includes 1000 CDs in Full Color 4 Panel Digi Pak with Clear Tray and Shrink Wrap.

DVD-5 SPECIAL \$1,299
1000 Full Color DVDs in Amray Box with Full Color Entrapment and Cello wrap. DVD only add \$104

Radio Ready CD Mastering \$599
Level & Fade Correction, Equalization, Compression, Noise Removal, Track IDs & Re-sequencing with Digital Peak Limiting for the Hottest Playback Level up to 6 Hours of Time.

All CD/DVD Specials include Glass Mastering, Film outpacing and Offset Printing, No Extra or Hidden Charges.

Graphic Design SPECIAL \$299
4 Hours • Basic Layout
Typesetting • Ready to Print
Scanning • PDF Proof
Deluxe Designs Starting at Only \$699!

14 Sunset Way
Henderson, NV 89015
702-318-6001
TOLL-FREE 877-633-7661
OddsOnRecording.com

Order Today!

Odds On
cd & dvd manufacturing

ADL 600
HIGH VOLTAGE TUBE PREAMP

PreSonus

VU METER -6dB

TEC

+48V

POL INV

INPUT

"The ADL 600 has rapidly become a favorite. Unlike most tube pre's, it's very open, clear and natural."
Dennis Tousana, Absolute Audio

ANTHONY DEMARIA'S
ADL 600 FROM PRESONUS
HAND BUILT IN LOUISIANA

LIMITED STOCK OF OPEN BOX UNITS AT VERY SPECIAL PRICING!!!

PreSonus

this and much more available from your pro audio experts:

DEMO BOTH TODAY!

sound pure

BEST GEAR BEST PRICES BEST ADVICE

www.soundpure.com / sales@soundpure.com
call toll free now for great deals: 888.528.9703



CDs • DVDs • SHAFED DISCS • SPECIALTY PACKAGING • CASSETTES

NEED CDs? THE CHOICE IS
CRYSTALCLEAR
DISC AND TAPE

CHECK OUT OUR CURRENT SPECIALS!

1000 CDs • \$999 (COMPLETE RETAIL READY)
1000 PROMO CD PACK • \$599
1000 DVDs • \$1499 (COMPLETE RETAIL READY)

TRUSTED EXPERIENCE FOR OVER 35 YEARS!

WWW.CRYSTALCLEARCD.COM • 1-800-880-0073

IN-HOUSE CD • DVD • VINYL • CASSETTE

300 CD Package: \$775.00
1000 CD Package: \$1099.00

Includes: 1-color booklet & 1-color CD label from print-ready film, jewelbox, shrinkwrap
Includes: 4-color booklet & 2-color CD label from print-ready film, jewelbox, shrinkwrap

D.J. VINYL PROMO
100 12" VINYL \$799.00 Additional LP's: \$1.30 each
500 12" VINYL \$1,279.00 REORDER \$710.00
1000 12" VINYL \$1,889.00 REORDER \$1319.00

PACKAGES INCLUDE: WHITE JACKET w/ HOLE • MASTERING • FULL PROCESSING • TEST PRESSINGS • 2-COLOR LABELS (stock background) • SHRINKWRAP • QUICK TURN AROUND ASK FOR OUR FREE BROCHURE!

WE'VE MOVED!
to larger facilities in Canoga Park

RAINBO RECORDS MANUFACTURING CORPORATION
8960 Eton Ave., Canoga Park, CA 91304 • (818) 280-1100
fax: (818) 280-1101 • www.rainborecords.com • info@rainborecords.com

Peluso

THE PELUSO 2247 SE STEEL TUBE
"NOTHING SOUNDS LIKE A STEEL TUBE"
GORGEOUS SOUND, ENDLESS VALUE
HAND BUILT IN VIRGINIA

BLINDFOLDED



it's a \$3500 mic



But open your eyes
to **\$749.00** MSRP

The TS-2
Large Diaphragm
Tube microphone



The New Price
of
Great Sound

Chameleon Labs

Listen for yourself at www.chameleonlabs.com • 206.264.7602

potion

harmonic energizer



Introducing the newest addition to our API™ 500 Series module family - the Potion True Class A FET Compressor.

The Potion has been conceived with modern music styles in mind and possesses a somewhat aggressive character designed to add REAL analogue harmonic energy to your tracks.

You have been warned!

UK Call 207-231 9661
USA Call 866-235-0953
Canada Call 450-227-3818
www.buzzaudio.com

buzzaudio
the future of great recordings

Studio Suite 8

STUDIO MANAGEMENT SOFTWARE



Simplify your Office Manage your Studio Organize your Tech with **ONE** Product!

1.800.450.5740
International: 1.818.752.3900
www.studiosuite.com altermedia

JOSEPHSON ENGINEERING C42MP

"They have an excellent transient response, dimensionality and high-end clarity, making them great for stereo recording."

...

The C42s sound like they cost twice as much, and they will get plenty of use in my studio."

- Gino Robair
(Electronic Musician, Senior Editor)



JOSEPHSON

josephson.com

We see the forest and the trees.



CDs/DVDs MASTERING/EDITING GRAPHIC DESIGN MULTIMEDIA

PLAY-IT PRODUCTIONS

259 W. 30th Street, NY, NY 10001
TOLL FREE: 1-800-815-3444 or 212-695-6530
WWW.PLAY-ITPRODUCTIONS.NET

**The savings
are North,
check your
Compass**

**Top Quality Brands Award Winning Service
Maximum Discount Prices**

Northern Sound & Light[®]

www.northernsound.net

Toll Free: 1-866-796-6232

MIX BOOKS

The one-stop online shop featuring the latest books, directories, and cool stuff. Instant access to top titles in the biz such as *MIM Pro*, *Mix's Master Directory*, *EM's Personal Studio Buyer's Guide*, back issues, Thomson Guide publications and much more.



Online at mixbooks.com

1,000 CDs IN JEWEL BOXES
JUST **\$1,190**

PRICE
was \$1,290



All Disc Makers' packages are complete, with no hidden charges, and include our exclusive promotional tools, like free distribution, download sales on DigStation.com, a free UPC bar code, a review from TAXI, and much more. For more information or to get a free copy of our catalog, visit www.discmakers.com/mix or call 1-866-677-7912.

DISC MAKERS
CD AND DVD MANUFACTURING MADE EASY

Get your music into digital retail for free such as Apple's iTunes, MusicMatch, AOL MusicNet, Napster, Buy Music, EMusic, Listen.com, Audio Lunchbox, and many more.

1,000 Retail Ready CDs

\$950



10th Year Anniversary

We at Media Services look forward to providing you with outstanding service and quality. You can trust us to take your CD/DVD project to the next level. Call us today on pricing for all standard and custom packages. We also offer great deals on promotional products such as posters, t-shirts and postcards.

• Cricket Rumor Mill courtesy of Loose Thread Records.
www.cricketrumormill.com

Call today 888.891.9091 or visit www.mediaomaha.com

the leaders in cd & dvd manufacturing



CD & DVD Duplication
Lowest Prices
Fast Service

100 Full Color
RETAIL READY CDs
Just ~~\$240.00~~
**\$215.00

In 2
Business
Days!



100 Full Color
RETAIL READY DVDs
Just ~~\$399.00~~
**\$314.00

In 2
Business
Days!

**Mention MIX
and get \$25.00
off of your first
order! (Order must total
\$150.00 or more).

1-800-927-3472

Call or visit our web site for information on this
and other packages - Free sample packet available!

www.elsproductions.com



CD & DVD Replication

Full Retail Ready Packages
State of the Art A/V Facilities
Mastering • Editing • Authoring
Award-winning Art Department
The Best Customer Service

FREE T-Shirt from your album art with CD package
www.progressivecds.com

Toll Free: (800)421-8273

THERE'S A REASON WE'VE BEEN HERE 29 YEARS!

CLASSIFIEDS

MIX Classified Ads are the easiest and most economical means to reach a buyer for your product or service. The classified pages of MIX supply our readers with a valuable shopping marketplace. We suggest you buy wisely; mail-order consumers have rights, and sellers must comply with the Federal Trade Commission, as well as various state laws. MIX shall not be liable for the contents of advertisements. For complete information on prices and deadlines, call (800) 544-5530.

Acoustic Products

REALTRAPS®

High-Performance Acoustic Treatment
Rave Reviews From Top Pros



"After adding seven MondoTraps the bass response in my mastering room smoothed out measurably and audibly, and not a bass note is out of place. Plus, the sweet spot has grown!"
—Bob Katz, Digital Domain

Grammy Award-winning mastering engineer, and author of *Mastering Audio - the art and the science*.

Learn why REALTRAPS has fast become the most sought-after brand for treating pro recording studios and listening rooms. Please visit our web site for a wealth of product information, demo videos, and some of the clearest explanations of room acoustics you'll find anywhere.

Toll-Free: 866-732-5872

www.REALTRAPS.com

VocalBooth.com

Complete Your Dream

New 14 Carat Diamond Series



Modular Sound Reduction Systems
Broadcast, Voice Over, Drums,
Rehearsal, Audio Post Production,
Studio Control and More!

541-330-6045

www.vocalbooth.com
Information@vocalbooth.com

WhisperRoom INC.

SOUND ISOLATION ENCLOSURES

Celebrating over 16 years of
reducing sound to a Whisper!

Recording, Broadcasting, Practicing



MDL 102126S
(8.5'X10.5')

19 Sizes and 2 Levels of Isolation Available

New! SoundWare Deflection System
(Change parallel walls to non-parallel)
Immediate Shipping!

www.whisperroom.com

PH: 423-585-5827 FX: 423-585-5831

RPG AcousticTools

PROVEN, AFFORDABLE ROOM SOLUTIONS
FROM THE MUSIC INDUSTRY'S LEADING
ACOUSTICAL INNOVATOR.



www.rpginc.com/proaudio

BLACK BOX

VOCAL BOOTH



Vocal, Practice and Broadcast Booths

Seulx Acoustics

www.seulxacoustics.com



www.gkacoustics.com

Be Professional, Buy the Best!
Sound Isolation Booths
Soundproofing Products

Custom Projects & Free Advice Toll Free 1-888-833-1554 (or) 541-947-2602



Solar 2

Studio Construction

Custom Acoustical Devices

Creative Work Stations

Consultation and Design

www.Solar2.net (248)860-0503



AcousticsFirst
Toll Free 888-765-2900

Full product line for sound control and noise elimination.

Web: http://www.acousticsfirst.com

ACOUSTIC

Design Consulting Products

www.soundcontrolroom.com
toll free 866-788 1238

SILENT Source

58 Nonotuck St., Northampton, MA 01062
Info: (413) 584-7944 Fax: (413) 584-2377

ORDER: 800-583-7174

Acousticore Fabric Panels •
Sound Barrier • Isolation Mats •
Tube Traps • Silence Wallcovering •
WhisperWedge • ProFoam • Clearsonic
• Hushfoam • R.P.G. Diffusers •
Sonex • Sound Quilt • More
www.silentsource.com
info@silentsource.com

QUALITY • PRICED RIGHT • INTEGRITY

ACOUSTICAL SOLUTIONS INC.

Sound Control & Noise Reduction Products

Call (888) 529-9220 Free Catalog
www.acousticalsolutions.com

Cases/Covers

UNDER COVER

Custom Covers and Bags
Speaker Cabinets / Consoles
Anything!

www.undercovernyc.com
917 237 1535

Get your gear Under Cover!

Design & Installation



301-607-6607

"We specialize in audio, video, acoustic design and installation."

- Studios
- Live Venues
- Churches
- Government
- Theatres
- Museums

www.audiodesignsolutions.com

Employment

Sweetwater: The thrill of a "start-up," the security of established success!

Take your expertise in music technology, strong people skills, and desire to succeed, and apply them toward a rewarding career at Sweetwater!

"Start-up" Company Excitement!

- Brand-new 44-acre campus with private health club, coffee shops, restaurant-style dining, and additional amenities!
- Planned company events: family picnics, amusement park trips, holiday parties, and a whole lot more!
- Work side-by-side with other musicians and engineers in an amazingly creative environment!



"Established" Company Benefits!

- Amazing earning potential!
- 401(k) Plan & Profit-sharing Program
- Employee Accommodation Plan (purchase gear at cost!)
- Relocation assistance
- Group health & dental insurance
- Flexible Spending Account



See More Info Online!

Step inside the doors and get an in-depth look at Sweetwater.

Visit: www.sweetwater.com/careers

Call: **1-800-222-4700** Jeff McDonald x1052



SEARCH. RECRUIT. COLLABORATE. NOW.

Reel-Exchange is a professional business to business community that connects you with the industry's best film and video professionals - whether you're looking for freelance talent to handle a given project, a full-time employee with a specific skillset, or a collaborator for your next production. Seek out and view demo reels and profile information for freelancers, companies or collaborators based on geographic location, discipline, equipment/format, project credits, and more. They're here. Now.



Electronic Musician's weekly e-newsletter delivers the latest news direct to your inbox! Subscribe today at

www.emusician.com

Equipment For Sale

Brent Averill
ENTERPRISES

BAE 1272 repro

Single w/ps: \$1139 | Two-Channel w/ps: \$1859

BAE 1073 repro

Single w/ps: \$2550 | Two-Channel w/ps: \$4900

14300 Hortense Street • Sherman Oaks, CA 91423
(tel) 818-784-2046 • 818-784-0750 (fax)
www.BrentAverill.com

vintagekingaudio

Our product lines range from vintage classics and esoteric rarities to exciting new boutique gear, many of which are exclusively available from Vintage King. We offer a full warranty and a staff of experienced engineers and technicians, bringing you friendly and unparalleled service.



More high end, boutique audio manufacturers have given their exclusive trust to Vintage King than any other dealer. ...Shouldn't you?

VINTECH AUDIO
CLASS A MIC PREAMPS MADE WITH



NEVE™ 1272 COMPONENTS
www.vintech-audio.com
call toll free: 1-877-4-mic-pre



VT-2 Vacuum Tube Mic Preamp
www.dwfearn.com



D.W. FEARN

steve's

MUSIC STORE
Serving musicians since 1965

TORONTO (416) 593-8888
OTTAWA (613) 789-1131
MONTREAL (514) 878-2216
www.stevesmusic.com

Vintech



The Vintech X73i!

"I used five X73i's and one X81 to record all of Carlos Santana's guitar tracks for both the 'Shaman' and 'All that I am' albums." **Jim Gaines**
Engineer for Carlos Santana, Stevie Ray Vaughn



THE "X81 CLASS A"

1-877-4-MIC-PRE



The Vintech X73

"I use the X73 for recording Patti Scialfa and Bruce Springsteen in their home studio." **Toby Scott**, Engineer for Bruce Springsteen



The Model 473

www.vintech-audio.com

o d y s s e y
p r o s o u n d

The outlet for the finest new & pre-owned recording equipment anywhere.

www.odysseyprosound.com
1-800-249-1821
Phone: (978) 744-2001 Fax: (978) 744-7224

STEDMAN

Keep your headphones convenient and safe. Clamps to music stand or mic stand.

NEW!

888-629-5960
www.stedmancorp.com

Lifetime Warranty
Made In USA

Fat Pro
TECHNOLOGIES

The Future of Audio Technology is here!

FBPS- 1 (Mono) and FBPS-2 (Stereo)
BATTERY POWERED 48V PHANTOM POWER SUPPLY
Utilizes a high frequency switch-mode power supply which converts 18 vdc to a highly regulated output to drive microphones requiring 12 vdc to 48 vdc. **These are the only product on the market that will produce 48 volts with any microphone!** Low battery and battery on led's also included.

Toll Free: 877-454-4404 • www.FatPro.com

Sound Good? Absolutely not. Sound Real? **ABSOLUTELY**

HEAR BEHIND OF YOUR HEAD

PYRAMID SPEAKERS

www.pyramid271.com

JOSEPHSON ENGINEERING
C700A

Two-capsule condenser microphone
Variable pattern
For vocals, spot and far-field pickup.

josephson.com

buzzaudio
the future of great recordings

visit www.buzzaudio.com to begin...

Subscribe to Electronic Musician

www.emusician.com

VINTAGE EQUIPMENT: SSL9080J/72/surround, SSI4048G \$115k, SSL4056G \$60k, NeveVX96w/FF, Harrison5632w/Uptown, API 32x16 550b/560, EuphonixCS2/2000, STUDER A-820/827/800/80, OTARIMTR90H/MX80, SONY 3348/APR24/JH24, FocusriteISA Blue215micpre/eq, Lexicon200

We Buy Vintage Equipment

NEW EQUIPMENT: EMPIRICAL LABS, CRANESONG, MILLENNIA, VINTECH, DEMETER, GLYPH, DYNAUDIO, TC ELECTRICS, EVENTIDE, QUESTED, DRAWMMER, TELEFUNKEN, FM ACOUSITCS, DW FEARN, LEXICON, EAR, NEUMAN, PURPLE AUDIO, SONY, ANTHONY DEMARIA LABS, DAW-SALES & INSTALLATION, CUSTOM PATHCBAYS, STUDIO WIRING

HARBORSOUND

www.harborsound.com | Phone: 781.231.0095
email: guitar@gis.net

ENTERTAINMENT TECHNOLOGY

eClassifieds

Reach more than 1.1 Million web visitors!

The Entertainment eClassifieds are the user friendly, affordable way to connect buyers, sellers, job seeker and employers. Immediate response • Sell your gear to an interested market • Post items yourself, anytime with self-service tool • Include a photo, audio or video file • Power search capabilities

Find what you need, sell what you don't!
www.mixonline.com/eMarketplace

Furniture

Studio Furniture
800.315.0878 **FREE CATALOG**



ARGOSY®
argosyconsole.com

MIX

For the latest news and technology check out Mix at

www.mixonline.com

Professional Audio and Music Production

Instruction

BE A RECORDING ENGINEER
★ **TRAIN AT HOME**

Easy Home-Study practical training in Multi-track Recording. Join our successful working graduates or build your own studio. Career guidance! Diploma/Registered School.

FREE INFORMATION:
Audio Institute of America
814 46th Ave. Suite A.L. San Francisco, CA 94121
Or visit us at www.audioinstitute.com

Subscribe to

REMIX

www.remixmag.com

ARTI Audio Recording Technology Institute
ORLANDO, FLORIDA

- Extensive Hands-On Training
- Music, SFX Design, Audio Post
- Low Student/Teacher Ratio
- Placement Assistance
- Financing to Qualified Applicants
- Accredited by ACCSCT

FEATURING **THX pm3** MIX THEATER

888-543-ARTI • audiocareer.com

gear racks and more
Modular, stackable oak furniture

Factory direct since 1984
Per Madsen Design

Free brochure (mention Mix)
800-821-4883 www.rackittm.com

Learn the Art of Recording

www.mediatechinstitute.com

mediatech institute
1.866.498.1122

THE ORIGINAL

RACKMOUNT YOUR G5 • WWW.ISO-BOX.COM



ORDER TOLL-FREE: 888.580.9188

Sound Construction & Supply Inc.

OMNIRAX
STUDIO FURNITURE



CODA DB with Sidecars

OMNIRAX 800.332.3303 415.332.3302
FAX 415.332.2007

www.omnirax.com

Legal Services

AXIOS LAW GROUP
Inspired By You, Protected By Us®

Axios Law Group is an intellectual Property Law firm that caters to the needs of the audio industry. Let us help you with your legal matters including patent, copyright, trademark, and entertainment law.

www.axioslaw.com-audio@axioslaw.com

Mastering

MASTERING
MIXING & RECORDING
STUDIO VMR

708.267.2198 studiovmr.com

Professional Mixing and Mastering Services

Nathan Eldred

www.AtlasRecording.com
US Toll Free 1.866.235.0953

DRT Mastering
the Analog Specialist

You will have the fat, slammir major-label sound that sells discs. Or the work is free...

Custom gear. 1st-class results. Free broch
800-884-2676 www.drtmastering.com

MASTERING
Guaranteed to give you that "Big Label" sound.

Complete Album Deal!
\$475.

1-800-692-1210
www.musichousemastering.com

Stephen Marsh
MASTERING

Los Lobos • Beyoncé • Wolfmother

310.569.1688
www.stephenmarshmastering.com

THRESHOLD MASTERING
Electronic Music Specialist

STEPHANIE VILLA
mastering engineer

310.571.0500
www.thresholdsound.com

DON'T WAIT TO PLACE YOUR AD IN THE CLASSIFIED SECTION!

For details, contact the MIX Classified Department at (800) 544-5530.

Records Tapes CD Services

BARE BONES PRICES!
Odds On! No! Out Discounts!

Includes on-disc printing, full-color printed booklet, barcode and cello wrapping.

1000 CDs - \$1099

Odds On
cd & dvd manufacturing
www.OddsOnRecording.com

877-ODDS ON 1
6 3 3 7 5 6 1

For the best price in CD Replication
there is only one number you'll need!

1.888.891.9091

MEDIA WWW.MEDIAOMAHA.COM
services

CD & DVD Replication Duplication and much more!

Progressive Media & Music
www.progressivecds.com
Toll Free: (800) 421-8273

THERE'S A REASON WE'VE BEEN HERE 29 YEARS!

www.yourmusiconcd.com

100 BULK CDRS \$59
including cd-r and duplication

100 BASIC CDRS \$89
including cd-r, cd-rw and duplication

100 FULL COLOR CDR PACKAGE \$169

1000 FULL COLOR PACKAGE \$899

500 FULL COLOR PACKAGE Only \$699
LIMITED TIME "SPECIALS!"

100 BULK DVDRS - \$99
100 BASIC DVDRS - \$110
1000 FULL PACKAGE DVDRS - \$1199

POSTERS - \$0.65
BUSINESS CARDS - \$7
FLYERS - \$29

SNS DIGITAL ATLANTA 678-442-0933
INC. TOLL FREE 1-877-442-0933

NEED CDs? THE CHOICE IS CRYSTALCLEAR
DISC AND TAPE

CHECK OUT OUR CURRENT SPECIALS!

1000 CDs - \$999 (COMPLETE RETAIL READY) **1000 DVDs - \$1499** (COMPLETE RETAIL READY)
1000 PROMO CD PACK - \$599 **500 DVD's - \$999** (COMPLETE RETAIL READY)

WWW.CRYSTALCLEARCD.COM • 1-800-880-0073

Software

sweet studio?
get
Studio Suite 8
Studio Management Software
www.studiosuite.com
See our ad in MarketPlace

SpectraPLUS
version 5.0 now available! Free trial
www.spectraplus.com

ELS CD & DVD Duplication - Lowest Prices - Best Service

100 Full Color RETAIL READY CDS just \$249.00 in 2 Business Days!
**\$215.00

**Mention Mix Magazine and get \$25.00 off of your first order!

1-800-927-3472

Call or visit our web site for information on this and other packages - Free sample packet available!

www.elsproductions.com

MIXLINE www.mixonline.com

Sign up to receive the FREE Mix e-mail newsletter!



Don't miss out on eDeals!
Shop Now and Buy Anytime.

eDeals sends the best buys to your inbox so they're only a click away!
This bi-weekly e-newsletter brings you product updates and blowout deals on manufacturer overstock equipment, demo gear, discontinued products and more.

In addition, **eDeals** includes a services and employment section of interest to musicians and audio pros everywhere.

Subscribe today at: <http://www.mixonline.com/edeals>

Give Your MOTU Studio 8-core Performance

Your MOTU desktop studio performance just doubled again with the 8-core Mac Pro tower and a host of exciting new third-party virtual instruments, effects plug-ins and affordable, world-class studio hardware.

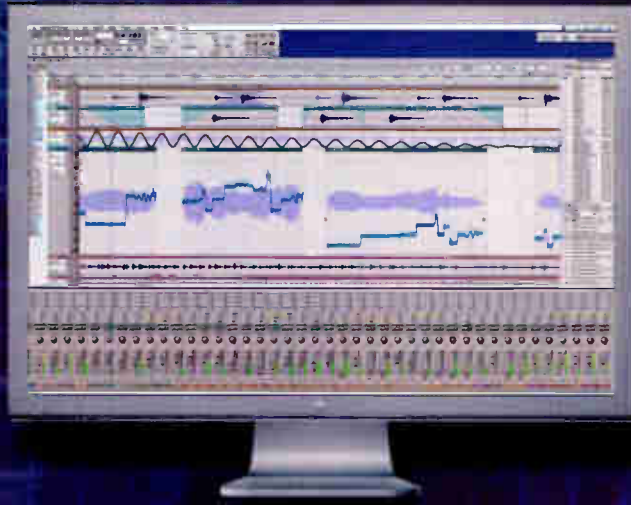

8-Core Intel Processing

The new 8-core **Apple Mac Pro** tower delivers the power of two Quad-Core Intel Xeon "Clovertown" processors running at 3.0GHz. That's eight 3 GHz processors performing as one, allowing you to run Digital Performer 5, a stunning array of virtual instruments and all the powerful plug-ins you need, all from the supreme convenience of a single computer desktop. Just a few years ago, a system with this much real-time audio processing power would have cost you many tens of thousands of dollars. Now you can own it with plenty left over to equip your MOTU studio with the latest and greatest virtual instruments, plug-ins and studio hardware.

Eight mic inputs via FireWire

The new **MOTU 8pre** delivers eight mic inputs in one rack space, complete with a five-segment level meter, phantom power switch, 20 dB pad switch and trim knob right on the front panel for each input. Now add two banks of ADAT optical digital I/O for eight more channels — even at 88.2 or 96 kHz. Top it off with main outputs and MIDI I/O, and you've got a FireWire audio Interface that turns your Mac into a complete studio that can record your entire band. Or, if you already own an optical-equipped MOTU FireWire, PCI or UltraFast USB2 audio interface, the 8pre is the perfect way to add 8 mic inputs directly to your MOTU interface CueMix DSP on-board mixing via 8-channel optical.



Waves native processing

Waves has long been synonymous with quality plug-ins, and the **Waves Platinum Bundle** contains a huge range of top-quality Waves processing for your DP5 studio. The Platinum Bundle now includes Waves **Tune LT**, **L3 Ultramaximizer**, and **IR-L Convolution Reverb** as well as all the plug-ins found in the **Waves Gold and Masters bundles**. Platinum brings extraordinary signal processing power to DP5, for tracking, mixing, mastering, and sound design. From dynamics processing, equalization, and reverb to pitch correction, spatial imaging, and beyond, Waves Platinum Bundle is a must-have for every MOTU studio.

The MOTU experts at Sweetwater can build the perfect DP5 8-core studio for you.

We'll help you select the right components, and we can even install, configure and test the entire system for you. Why shop anywhere else?



Jimi Hendrix Guitar Tones

IK Multimedia AmpliTube Jimi Hendrix™ is the first authentic software recreation of the complete Hendrix guitar amp and effects rig in a single product, offering all the rare vintage stompers, amps, cabinets and mics that contributed to make Hendrix's legendary sound. Based on IK's award-winning AmpliTube 2 and made in cooperation with Authentic Hendrix, the official family-owned company, AmpliTube Jimi Hendrix™ features 9 vintage stomp effects, 4 vintage amp models, 7 cabinets and 5 mics, putting a complete collection of extremely expensive and hard-to-find gear right at your fingertips, all carefully modeled with proprietary AmpliTube 2 DSM™ (Dynamic Saturation Modeling) technology and accurate craftsmanship from actual gear of the '60s. Get that classic Jimi Hendrix tone, plus the best vintage guitar effects and amp gear ever offered in software.



Mastering at its finest

Master Perfection Suite™— Six stunning new audio plug-ins at a breakthrough price.

Repli-Q provides unparalleled spectral matching for improving an improperly equalized track, mastering for different delivery formats, or applying the EQ of one mix or track to another.

Squeeze-3 and **Squeeze-5**, two powerful multi-band compressor/limiter/expander plug-ins, feature advanced new linear phase equalization filters. **PatchCraft** offers super natural pitch correction/transposition and manipulation with minimal artifacts. **Reveal** integrates seven analysis tools in a single plug-in — Oscilloscope, Peak & RMS Power History, Spectrogram, Pan Power, Spectral Analysis, Lissajous Phase Scope and Peak & RMS Level Meters. **SuperEQ** offers ultimate 4, 6, 8 and 10-band parametric EQ. **GateEx** provides high-quality gating and downward expansion. Available separately, or with Peak Pro XT, the Master Perfection Suite is an indispensable addition to your Digital Performer desktop studio.



Vintage EQ/Compression

The **Focusrite Liquid Mix** is another Focusrite first and a true one-of-a-kind. Based on the award-winning Liquid Technology, the Liquid Mix provides 32 channels of simultaneous DSP powered vintage and modern EQ and Compression plug-ins into your DP5 mix without affecting your host computer's CPU. 40 classic compressors and 20 timeless EQs are included. Each EQ and Compressor emulation is painstakingly created through a process called Dynamic Convolution which is a huge step beyond modeling. Through Dynamic Convolution, every frequency at every possible combination of settings is perfectly sampled. That means that you get the true sound and feel of a vintage or modern classic. Tens of thousands of dollars of gear is now right at your fingertips! Think how great your Digital Performer tracks will sound with the Liquid Mix.



Support 2.4 GHz AirTunes™ in a single download!

© COMPLETE 4



Komplete control

For DP5 users who want it all: Reaktor5, Kontakt2, Guitar Rig 2 software, Absynth4, Battery3, FM8, B4II, Akoustik Piano, Elektrik Piano, Vokator, Spektral Delay and Pro-53 in a unified interface with hands-on control — **Native Instruments KOMPLETE 4** and **KORE** put an infinite universe of sound at your fingertips. Every preset included in NI KOMPLETE 4, more than 8,500 in total, has been preconfigured and categorized in KORE with searchable musical attributes and hands-on controller assignments. This seamless integration of software and hardware turns Native Instrument's award winning synthesizers and samplers into tactile instruments. If you purchase today, you'll receive the KORE 2 software update FREE when it ships later this year!

www.sweetwater.com (800) 222-4700



Sweetwater

Music Instruments & Pro Audio

World Radio History

©2007 Sweetwater, Inc.

Give Your MOTU Studio 8-core Performance



Keystation Pro 88 features

- 88-key hammer-action, velocity-sensitive keyboard
- Powered via USB bus (cable included) or optional 9V power supply
- 24 MIDI-assignable rotary controllers
- 22 MIDI-assignable buttons
- 9 MIDI-assignable Alps faders
- MIDI-assignable pitch bend and modulation wheels

88 Weighted Hammer-Action Keys

Digital Performer 5 gives you unprecedented control over your MIDI and audio tracks. And what better way to take advantage of this hands-on control than the **M-Audio Keystation Pro 88**. Regardless of whether you're a seasoned pro or just ready to take your music to the next level, these hammer action keys are so expressive

that you just won't want to stop playing! The Pro 88 could easily become your sole keyboard in the studio or onstage. Yet the Keystation Pro 88 weighs only 47 lbs. — half of most weighted-action keyboards! And the Pro 88's extensive features make it the most comprehensive and competitive product of its kind!



Control room monitoring

The **PreSonus Central Station** is the missing link between your MOTU recording interface, studio monitors, input sources and the artist. Featuring 5 sets of stereo inputs (3 analog and 2 digital with 192kHz D/A conversion), the Central Station allows you to switch between 3 different sets of studio monitor outputs while maintaining a purely passive signal path. The main audio path uses no amplifier stages including op amps, active IC's or chips. This eliminates coloration, noise and distortion, enabling you to hear your mixes more clearly and minimize ear fatigue. In addition, the Central

Station features a complete studio communication solution with built-in condenser talkback microphone, MUTE, DIM, two separate headphone outputs plus a cue output to enhance the creative process. A fast-acting 30 segment LED is also supplied for flawless visual metering of levels both in dBu and dBfs mode. Communicate with the artist via talkback. Send a headphone mix to the artist while listening to the main mix in the control room and more. The Central Station brings all of your inputs and outputs together to work in harmony to enhance the creative music production process.



Lexicon effects processing

With the **Lexicon MX500** you can have, in a purely digital form, the rich Lexicon sound that has defined studio reverb for three decades, with the convenience of an automated plug-in right inside your Digital Performer studio environment. The new MX500 takes Lexicon's "Hardware Plug-in" feature to the next level by actually streaming dual stereo audio via FireWire. Like the MX200, MX300, and MX400, all parameters of every reverb, delay and dynamic effect can be controlled from a plug-in window in Digital Performer. The MX500 houses 17 classic Lexicon

reverbs, delays, and modulation effects plus dbx compression and de-essing. Front-panel control is easy, too, with a generous LCD display and big comfy knobs you can get your hands around. A wealth of routing options from quad mono to dual stereo are possible. You get 99 Factory programs and 99 user programs for Stereo mode, another 99 Factory and user programs for Dual-Stereo mode, and 25 Factory/25 user surround programs. Also included is Lexicon's intuitive **MX-Edit™** Editor/Librarian software, for convenient yet advanced programming.

Professional pad controller

The **Akai Professional MPD24** is the velocity sensitive pad controller for musicians and DJs working with sampled sounds. The MPC24 features 16 MPC-style velocity and pressure sensitive pads plus transport controls for interfacing with Digital Performer and your virtual instruments. You get Akai's exclusive feel: either MPC 16 Levels or Full Level features for ultimate pad control. Now add four selectable pad banks totaling 64 pads, six assignable faders and eight assignable and 360 degree knobs for transmitting MIDI Control Change data. Included editor/librarian software gives you complete, intuitive programming and control for DP5 all of your other software titles. The MPD24 provides unprecedented creative freedom for manipulating sampled material.



The MOTU experts at Sweetwater can build the perfect powerhouse DP5 8-core rig for you. We'll help you select the right components, and we can even install, configure and test the entire system for you. Why shop anywhere else?



New Mackie monitoring

The high-resolution **Mackie HR824mk2** active studio reference monitor sounds as smooth as it looks. The new Zero Edge Baffle™ minimizes diffraction for a crystal clear image of your Digital Performer mix, and controls sound waves for wide, even dispersion. The rear-firing, mass-loaded passive radiator ensures tight, detailed bass extension, down to 35Hz. And thanks to remarkably linear frequency response, you always get accurate mix translation. Acoustic Space, LF roll-off and HF controls let you tailor the sound to suit your MOTU studio space—and your taste. With all this and more, the HR824mk2 turns your Digital Performer desktop studio's sweet spot into a full-on sweet zone.

New hands-on control for DP5

The new **Mackie Control Universal Pro** control surface gives you ultimate hands-on control of your Digital Performer desktop studio. Nine motorized, touch-sensitive Penny + Giles faders, eight V-Pots and more than 50 master buttons let you tweak parameters to your heart's content. Unlike generic MIDI controllers, the MCU Pro employs a sophisticated communication protocol that delivers ultra-precise control, makes setup easy - no mapping required - and enables you to see your mix in action with real-time visual feedback via the huge backlit LCD and eight LED rings. Apply the custom overlay for Digital Performer for dedicated labeling of DP-specific functions. The MCU Pro is the ultimate way to mix in DP5!

The MOTU 8-core experts

When it comes to building your powerhouse 8-core MOTU recording system, nobody does it better than Sweetwater. Whether you're building a 200+ track powerhouse Digital Performer studio centered around the latest 8-core Mac Pro tower or a simple portable recording rig with an UltraLite and a new MacBook, Sweetwater can help you select the perfect components for your MOTU system, from the specific MOTU audio interface model, to control surfaces and hard drives, to plug-ins and studio monitors. Even better, we can install, configure, test and ship a turnkey system straight to your door — all you'll need to do is plug in the system and start making music.

Why shop anywhere else? **Call the experts at Sweetwater today!**



Sweetwater

Music Instruments & Pro Audio

www.sweetwater.com (800) 222-4700



Authorized Reseller

Roland VS-2480 Workstation

Clicking Around Can Save Time and Project Sanity

When I first ventured into the realm of recording and production, I began with the Roland VS-880EX, which I still use for live recordings. Eventually, I moved to the VS-1880 and later to the VS-2480, the unit I turn to first for projects ranging from band recordings to podcasts.

SUPERSIZE YOUR UNIT

To get the most out of your VS-2480, add a Song Vault (I archive projects to it rather than make CD backups, which can be time-consuming), Roland's MB-24 Meter Bridge and an external VGA monitor. Also invest in a mouse and keyboard—the wireless varieties are especially useful. Many VS-2480 functions can be performed using either the unit's control surface or mouse/keyboard equivalents. Most of my tips include mouse/keyboard commands, but you should learn several ways to perform your most common operations.

SAVE, SAVE, SAVE

You might think this goes without saying, but at one time or another, everyone has lost at least one "perfect take" because they forgot DAW recording's Golden Rule. There are three different ways to save your work on the VS-2480. Using the mouse, click Project Menu, click Store and then click Yes. Using the keyboard, press F9 (Project Menu), arrow down to Store, press Enter and then press Enter again to confirm. From the VS-2480 console: Press and hold Shift, press Store (the left transport button) and then press Enter to confirm.

ONE BAND, MANY SONGS

If you're working with a band that's recording many songs during a session using the same track setup, configure patchbay routings and name tracks, set up the first song, and *before* recording store it! Then open it again and copy the project. Make as many copies as you need, but remember to go back and change the project names; otherwise, all will come up with the same name until you do so. Using the mouse, click Project Menu, click Project List, mark the project you want to copy, click to page 2, click F1 Copy and then click F5 OK. If you

want to save to a different drive, then choose that with F4 Sel Drv before selecting F5 OK. If you had changed settings that you would like to keep in this project "template," then you can easily transfer those settings to a new project (without audio tracks) if you turn on the "Copy Utility Prm" settings when creating a new project from the File menu. The settings from the previous project will be imported automatically.

SAVING ROUTING

Sometimes, a project has many songs, and while the band's setup remains the same, not all tracking will be the same. Or perhaps the project will not all be done on the same day. In such cases, you should save a Routing Template. This is also a helpful feature when using the VS-2480 for live sound applications. Using the mouse, click EZ Routing Menu, click Routing View and make all your routing settings; click Routing View again and then click Save. Then choose a User Template: Click F1 Name to name your setting and then click OK. To recover a setting, use Routing View and Load.

MAKING TIME

The VS-2480 does have an internal metronome with a tempo map feature, but there are times that you may need an actual click track. First, make your metronome and tempo map settings. Then click Utility Menu; click Gen/Osc, click SW to On, click Source to Metro and click F6 Exit. Click Routing View in the Track Assign section to make the connection from Gen to the track you want to record to and then simply arm the track for recording.

UTILITY SECRETS

Like many other digital toys, pressing some odd combination of keys can yield useful results. For example, determining your VS-2480's software version (the most current version is 2.504) is easy: Power the unit down. Then press and hold Track 1's Channel Edit and Track Select buttons while



powering the unit up. The LCD will show its software version. Press Enter to complete startup of the unit. Another slick trick: Pressing the Shift and Utility buttons at the same time will shift the mouse functioning from the LCD readout to the VGA screen. The function will change each time you do this.

PAN-O-RAMA

The VS-2480's pan knobs normally change pan values in increments of 10. To make adjustments in single-digit increments, simply hold the Shift button down while using the pan knob. Speaking of pans, you can return any track or input fader to the default 0 dB and center panning by just pressing Clear and Ch Edit for any fader you want to restore.

GET BACK

Keyboard transport is possible on the VS-2480, yet there is no *simple* way to return to zero. However, you can get around this by using your locate points. First set a locate for zero and for any other spots in the project you'll want to access. Then, using the keyboard, press F12 (Utility Menu), arrow down to Locator, press Enter, use the arrows to get to the desired Locate point and press F4 Go To. ■

Eric Mauriello is a New York City-based composer/producer.

m201 2 channel microphone preamplifier



Presenting the m201-
the redesigned successor
to the venerable model 201
microphone preamplifier.

The m201 delivers unmatched
audio performance; with massive
headroom, ultra-wide bandwidth
and a distinctly musical character
to capture the essence of
the music being recorded.

Each channel has an input mode
switch which selects between
standard 48V input, ribbon mic
mode, front panel HI-Z inputs or
optional DPA high voltage (130V
or 190V) inputs. Included is our
newly designed M+S circuitry
with a front panel width control.

Plus, later in 2007 we will be
offering a state of the art 24-
bit/192 kHz A/D converter option.

Whatever the application, the
exceptional sonic performance
and powerful functionality of the
new m201 will help you make the
finest recordings of your career.



fully balanced, transformerless design • ribbon mic mode • M+S matrix with dedicated outputs and front panel width control • precision 24 position gold contact rotary switch gain controls • 130V DPA™ mic input option • 24-bit/192 kHz A/D converter option (later 2007) • no electrolytic capacitors in the signal path • sealed gold contact relays for all signal switching • five year warranty on parts and labor

GRACE
d e s i g n

Power • Detail • Grace
info@gracedesign.com • www.gracedesign.com • 1.800.443.7454

World Radio History

Studio



UltraLite Features

- 10 inputs / 14 outputs
- Compact: 8.5 x 7 inches
 - Bus-powered
 - 96kHz recording
- On-board CueMix DSP mixing
 - LCD programming
 - 2 mic inputs
- Individual 48V phantom power
 - 60dB pad/trim gain range
 - Stand-alone mixing
 - 6 TRS analog inputs
 - 10 TRS analog outputs
 - Separate main outs
 - Main volume knob
- Headphone volume knob
- S/PDIF digital I/O @ 96kHz
- Metering for all inputs & outputs
 - Sample-accurate MIDI
 - On-board SMPTE sync
 - Expandable
- 2 FireWire ports for daisy-chaining
- Mix & match with other interfaces
- Includes AudioDesk® software
- Across-the-board compatibility

Studio to go



UltraLite

Compact bus-powered 10x14 FireWire audio interface

The award-winning 828mkII FireWire audio interface turns your Mac or PC into a top-notch desktop studio. Born from the same innovative design, the award-winning bus-powered UltraLite lets you take your studio to go. And it's the only half-rack audio interface that offers stand-alone operation with programmable mixing

from its unique backlit front panel LCD, plus all the analog, digital and MIDI I/O that you need.



Winner
2007 Editors' Choice Award
Best Audio Interface
— Electronic Musician



Winner
2007 ACE Award
Best Audio Interface
— Future Music

MOTU
motu.com