

MIX

PROFESSIONAL AUDIO AND MUSIC PRODUCTION

GAME SOUND

- EA Does 'Lord of the Rings'
- Music for 'Myst,' 'M:12'
- Dolby surround sound
- Audiogang.org

BETTER, FASTER, CHEAPER, COOLER

Product Hits From Winter NAMM

NETWORKED STORAGE SYSTEMS

The 'New' Machine Room

BOWIE LIVE!

BONUS TRACK:

Bowie Classic

#BXNMDTC *****AUTO** SCH 5-DIGIT 91324
#91329GND850BL001# NOV 2006 MIXM 153



MARK GANDER
JBL
8500 BALBOA BLVD
NORTHRIDGE CA 91329-0002

GO
S0003

3>



0 09281 01817 9

Turn Up the Experience with Dolby Pro Logic II



DP563 Dolby Surround and Pro Logic II Encoder

Audiences love Dolby® Digital 5.1 discrete surround in digital entertainment such as DTV, DVDs, and video games. But what about surround sound for two-channel audio delivery?

Dolby Pro Logic® II offers the best matrix-surround experience for stereo-only television services, top-selling video games, or VHS tapes. With five full-range channels, improved steering logic for

greater channel separation, and an exceptionally stable sound field, Dolby Pro Logic II remains compatible with consumer decoders with Dolby Pro Logic, stereo, or mono outputs.

Encode your analog or digital two-channel productions in engrossing Dolby Pro Logic II matrix-surround, now available with the DP563 Dolby Surround and Pro Logic II Encoder.

www.dolby.com/professional



Your Monitor Mix...Your way...

The Aviom Personal Monitoring System

- 16 Audio Channels
- True Stereo Mixing
- Save 16 Mixes as Presets
- Instant Mix Recall
- Line/Headphone Output
- Unlimited System Expansion
- Easy

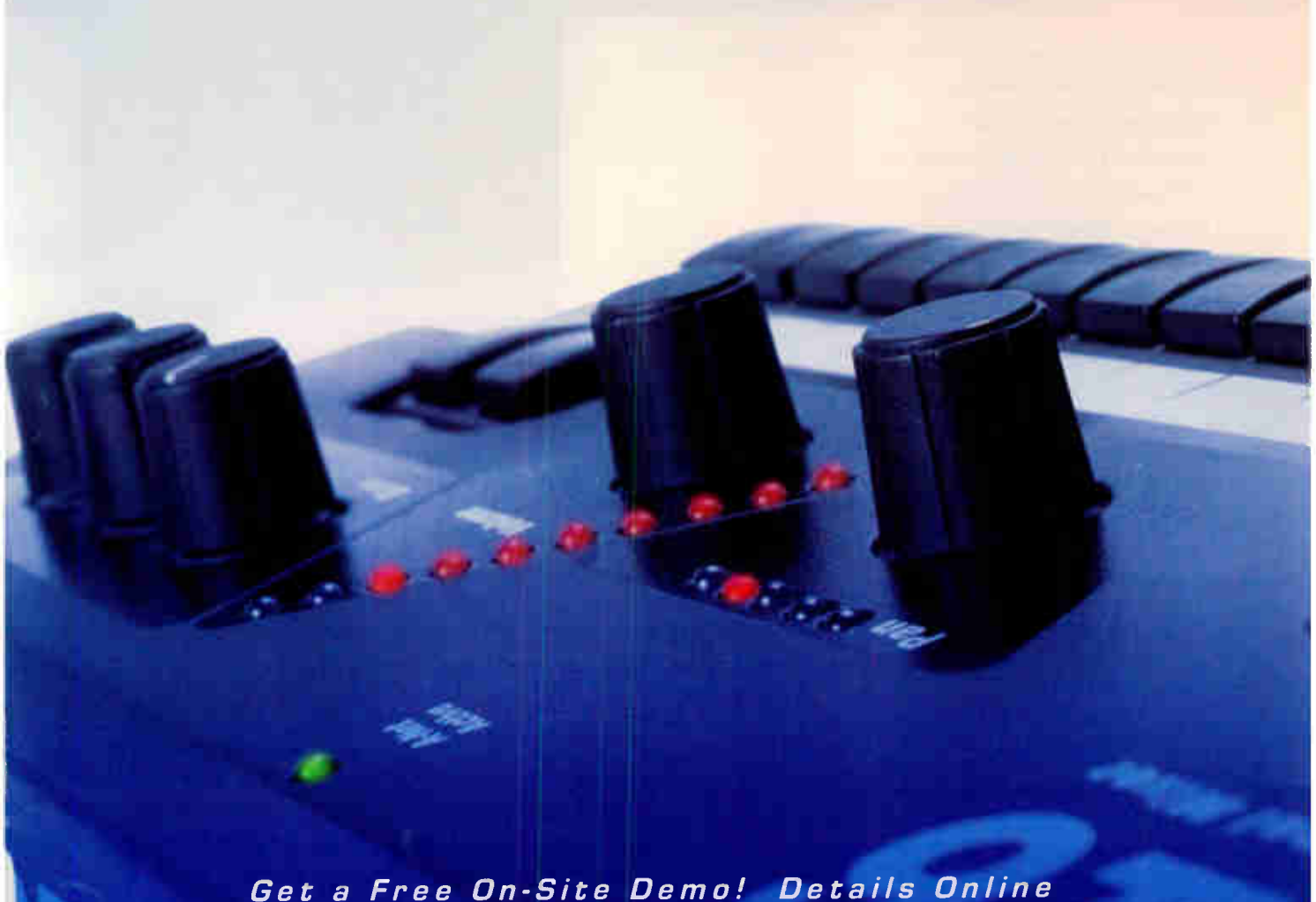

Get a Free On-Site Demo! Details Online

The Standard of Performance.

The most trusted professional digital audio editor moves forward with version 7. Incorporating new features and functions, nothing's more powerful or comprehensive.

Sound Forge® software is the established leader for 24-bit, non-destructive two-track digital audio editing and mastering. It's the best application available for audio recording, real-time editing and processing, and streaming media creation. Sound Forge software offers over 40 built-in effects and processes, saves to all popular audio formats, and includes the acclaimed Acoustic Mirror™, Wave Hammer®, and Spectrum Analysis tools. Over a decade ago, Sound Forge software revolutionized the audio industry through its effectiveness and ease-of-use. Now it further raises the standard of performance you require from a digital audio editor.

Sound Forge software advances with version 7.0. New features include:

- Automated time-based recording
- Audio threshold record triggering
- Clipped peak detection and marking
- Windows Media® 9 Series import and export
- Support for 24fps DV and other video formats

Sony Sound Forge 7.0 software maximizes its legacy to deliver a new level of technological sophistication.

Rely on it.

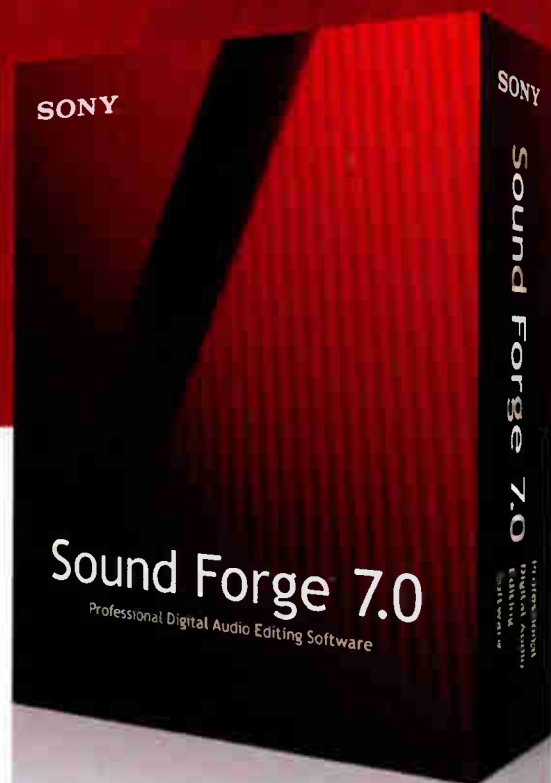

Available worldwide, or on the Web at: www.sony.com/mediasoftware



© 2003 Sony Pictures Digital Inc. All rights reserved. Sound Forge is a trademark or registered trademark of Sony Pictures Digital Inc. All other trademarks are the property of their respective owners.

World Radio History

SONY

GIGAPULSE™

The real-time convolving reverb plug-in that lets you sample actual acoustic spaces.

The **Acoustic Space** window displays sound source location or a dimensional drawing of the space.

Impulse Sets are organized by bank.

Save a **Preset** with your custom edits.

Use **Cascade** to combine two impulses and create a new reverb.

Sim Stereo turns a mono input into a stereo output.

Position your sound source in the **Placement Selection** grid to choose an impulse taken from an unlimited number of positions.

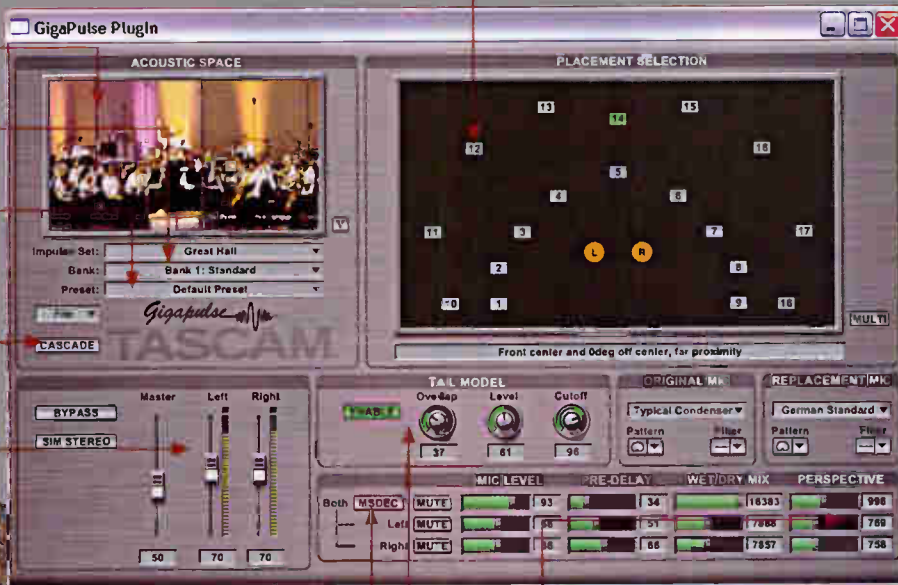

GigaPulse ships with a great collection of drum rooms, reverb plates, echo chambers, classic processor models and a set of modern and vintage mic models.

Integrated Mid/Side decoding. **Tail Model** lets you fine tune the decay of the reverb impulse for more efficient use of your CPU resources.

Change the **Perspective** to model the effect of moving a mic closer to the source, while maintaining imaging and proper phase alignment.

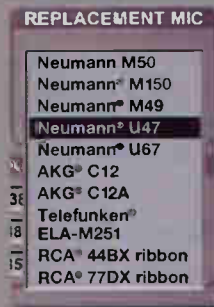

sampled rooms to GigaPulse format.

Our patent-pending, breakthrough technology also adds microphone modeling, selectable room position and tail model processing to the convolution engine for unparalleled fine-tuning of reverberation parameters.

But the real revolution is GigaPulse's reverb quality — so realistic that instruments, samples and vocals come to life.

Even if you thought you'd heard it all when it comes to reverb plug-ins, you haven't until you've experienced GigaPulse. Visit a TASCAM dealer for a demo today. ◀

TASCAM GIGAPULSE™

- ▶ Acoustic space modeling via exclusive convolving algorithms
- ▶ Perfect for capturing room characteristics during remote recordings
- ▶ Create new impulses from your own recordings
- ▶ 2D mic/source placement
- ▶ Apply mic modeling from a selection of vintage microphones to the environment or use it alone
- ▶ Impulse libraries will be available from TASCAM or download numerous freeware impulses from the internet



©2003 TASCAM All Rights Reserved. All specifications are subject to change without notice. Windows is a registered trademark of Microsoft. GigaPulse and GigaPulse are trademarks of TASCAM, TASCAM, Inc.

TASCAM
www.tascam.com



Adjustable Power Seat

Featuring unprecedented control over response at the mix position, JBL steps forward with the new LSR6300 Studio Monitors, the first complete solution to tackle problems in the room. Our exclusive RMC™ Room Mode Correction system, including a hand-held acoustic analyzer (shown above in your seat), accurately measures boundary-induced low frequency modes so you can adjust the speaker's 1/10th octave parametric equalizer and correct the problems in the room. Designed from the ground up, the LSR6300's deliver ultra-flat response (+1/-1.5 dB), an exceptionally wide sweet spot free of spatial anomalies and an incredibly accurate window on your mix. Shielded, mountable, and THX® pm3® approved, for stereo or multi-channel, music or post, the LSR6300's truly put you in the power seat.

See your JBL Dealer today for a demo of this extraordinary new monitoring system.

LSR6300 Studio Monitors – Mix Without Boundaries.

Learn more about the power of the LSR6300 Studio Monitors at www.jblpro.com/LSR



H A Harman International Company

SONAR3

PRODUCER EDITION

Inspiration > Speed > Precision

In today's fast-paced production world, it's not enough to have all the features at your fingertips. SONAR 3 offers a complete software-based production environment that expands your creativity with fast, intuitive controls that capture and excite your inspiration; and powerful, precision tools for true real-time editing. And SONAR 3 provides unparalleled customization, allowing you to fine-tune your studio to match your workflow. Take your music to new heights with SONAR 3 today.

Completely redesigned UI

Cutting edge mixing environment

Advanced MIDI routing & synth layering

Integrated per-channel EQ and assignable FX controls

Universal Bus Architecture

Smoother audio engine with gapless effects patching

ACID™ loop & MIDI Groove Clip support

DX, DXi, ReWire, VST, VSTi support

Integrate MIDI-compatible control surfaces

Import/export OMFI & Broadcast WAV

VSampler 3.0 DXi multi-format digital sampler

Ultrafunk Sonitus:fx audio effects suite

Lexicon Pantheon Reverb

ASIO & WDM compatibility

Multi-port MTC transmission

Confidence recording

Full plug-in delay compensation

\$719 MSRP

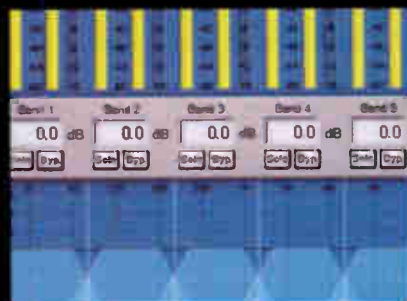

For more information: visit your local SONAR retailer
www.cakewalk.com | 888.CAKEWALK | 617.423.9004 (outside the U.S.)

World Radio History

MIX

PROFESSIONAL AUDIO AND MUSIC PRODUCTION

March 2004, VOLUME 28, NUMBER 4



PAGE 50

features

Video Game Design

As little as 10 years ago, sound and music for games were practically afterthoughts, usually handled by the same person, generated on MIDI synths and only occasionally using samplers and libraries for effects, and wedged into the game at the end. But my, how things have changed! Today, audio designers are working in studios rivaling today's top music facilities, working up sounds at high resolution for 44.1k playback in the home. With that in mind, *Mix* brings you this special section on the audio side of video games.

50 Audio at Electronic Arts:

Bringing "The Lord of the Rings" to the Game Console

58 Gods, Trolls and Minotaurs: Audio Design for Strategy Games

60 Surround Sound for Video Games

62 Music for Games: Scoring for the Smallest Screen

66 Song Licensing: A New Market for Bands

70 Pre-Compression: Audio Optimizing Tips

72 Jack Wall on Music for Games and www.audiogang.org

33 Oceans of Audio, Rivers of Bits

Storage Area Networks for Every Audio Application

Whether you're working in a home-based project studio, a four-room post facility or a multiroom Web hosting/post/music recording/Foley/voice-over studio, you need to access your audio quickly and efficiently. Audio is, after all, data—and lots of it. Enter the storage area network, where multiple users can simultaneously access the same tracks at any given time.

42 Product Hits From Winter NAIMM

Mix editors George Petersen, Sarah Jones and Kevin Becka bring back the hottest music and audio equipment hits from Winter NAIMM 2004.



PAGE 58



PAGE 42

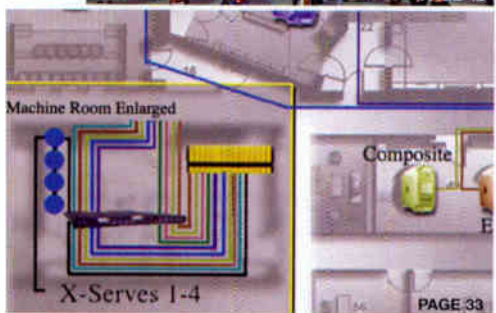

PAGE 33

On the Cover: Upstairs Productions, Oklahoma City, was designed by Francis Manzella and features a 72-channel Amek 9098i, ADAM S5A monitoring, iZ RADAR and 7-foot Stewart Grayhawk screen. For more, see page 22. **Photo:** George Roos. **Inset:** Steve Jennings.



Check Out Mix Online! <http://www.mixonline.com>

Mix (Volume 28, Number 4) is ©2004 by PRIMEDIA Business Magazines & Media, 9800 Metcalf Ave., Overland Park, KS 66212. Mix (ISSN 0164-9957) is published monthly except semimonthly in January. One-year (13 issues) subscription is \$52. Canada is \$60. All other international is \$110. POSTMASTER: Send address changes to Mix, P.O. Box 1939, Marion, OH 43306. Periodicals Postage Paid at Shawnee Mission, KS and at additional mailing offices. This publication may not be reproduced or quoted in whole or in part by printed or electronic means without written permission of the publishers. Printed in the USA. Canadian GST #129597951; Canada Post Publications Mail Agreement #40597023. Canada return address: DP Global Mail, 4960-2 Walker Rd., Windsor, ON N9A 6J5.

Absolute accuracy -whatever you play

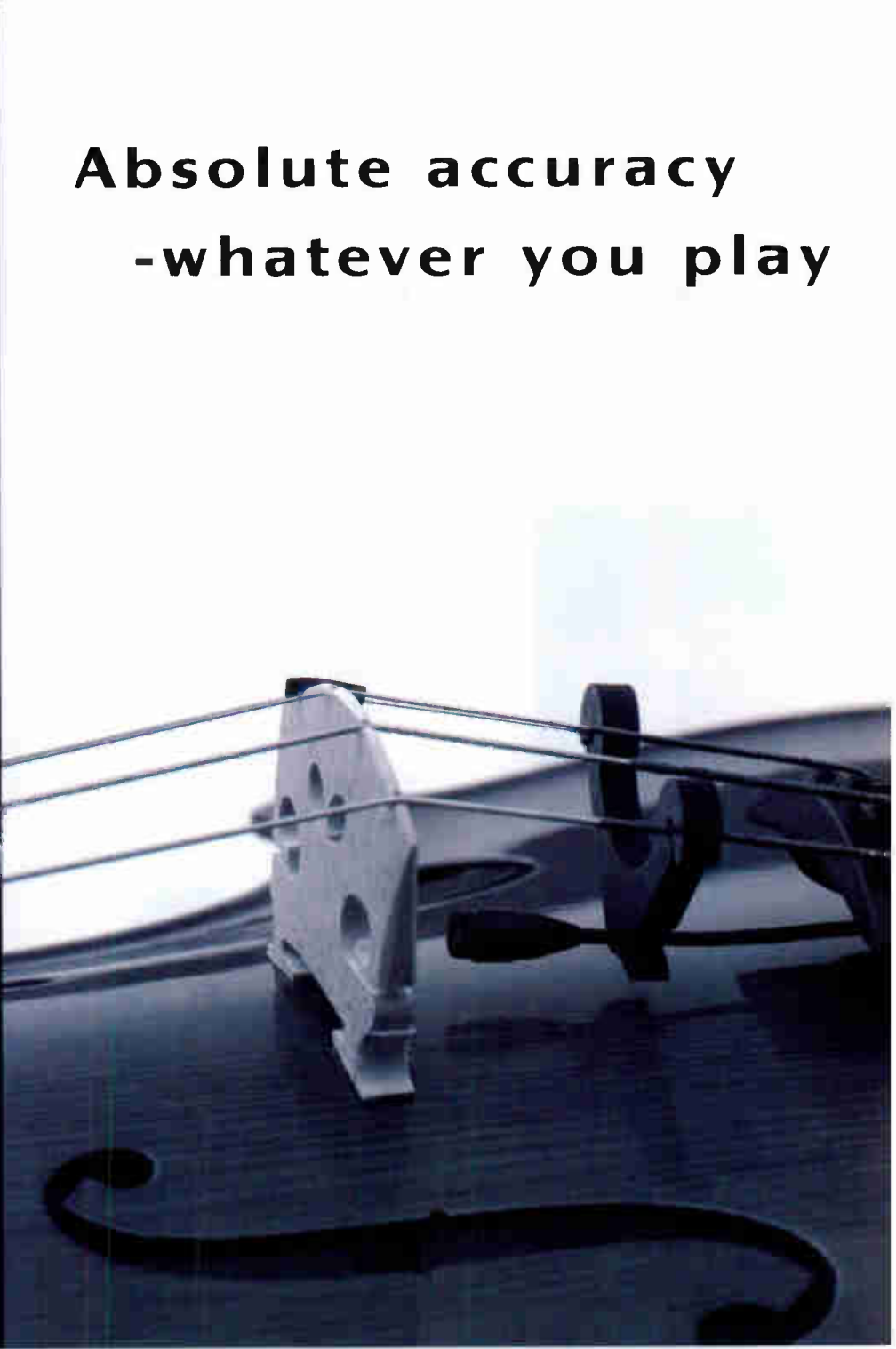

IMK 4061: DPA 4061 Miniature Microphone, XLR Adapter, Microphone holder for strings, Miniature windscreens, Self-adhesive miniature holder, Miniature magnet

The DPA 4061 miniature microphone is designed to mount directly onto virtually any acoustical instrument and produce a uniquely crisp, accurate and natural sound. The 4061's versatility is based on a combination of its extremely low noise floor, wide, flat frequency response and ability to handle sound pressure levels up to 144dB before clipping.

The IMK 4061 Microphone Kit contains the DPA 4061 microphone plus mounting accessories for drums, wind and string instruments. So, with the DPA 4061, you're guaranteed absolutely accurate sound whatever instrument you play.

For more information call 1.866.DPA.MICS or click to www.dpamicrophones.com
DPA Microphones, Inc. info-usa@dpamicrophones.com

World Radio History

DPA 
MICROPHONES

JUST ADD TALENT

sections

LIVE MIX

- 86 Live Mix News**
90 All Access: Mary Chapin Carpenter, Shawn Colvin, Patty Griffin, Dar Williams *by Heather Johnson*



PAGE 90

- 92 Tour Profile:** David Bowie *by Breean Lingle*
96 New Sound Reinforcement Products

RECORDING NOTES

- 128 Ryan Adams** *by Heather Johnson*
129 Miles Davis: Revisiting the Jack Johnson Sessions *by Paul Tingen*



PAGE 129

- 130 Classic Tracks:** David Bowie's "Five Years"/"Soul Love"/"Moonage Daydream" *by Rick Clark*
132 Cool Spins

COAST TO COAST

- 138 L.A. Grapevine** *by Maureen Drone*
138 Nashville Skyline *by Rick Clark*
139 N.Y. Metro Report *by David Weiss*
140 Sessions & Studio News *by Breean Lingle*

technology

- 102 Tools of the Trade**
106 Field Test: Waves Transform Plug-In Bundle
110 Field Test: Apogee Electronics Rosetta 800—Multichannel AD/DA Conversion, Soft Limiting



PAGE 110

- 112 Field Test:** Buzz Audio SOC 1.1 Stereo Optical Compressor
114 Field Test: Studio Projects B Series Studio Microphones
116 Field Test: QSC SRA2422 Studio Reference Amplifier



PAGE 120

- 118 Field Test:** iZotope Ozone 3 Plug-In
120 Field Test: Brauner Phantom C Condenser Microphone
122 Auditions
 - Sibelius Notation Software Version 3
 - IK Multimedia T-RackS
 - Dave Smith Electronics Evolver
 - DW Electrochemicals Stabilant 22**168 Power Tools:** Ableton Live Version 3 *by Barry Milroy*

Mix
ONLINE
EXTRAS

Visit www.mixonline.com for bonus materials on select stories in this issue.

columns

- 24 Fast Lane:** What a Tangled Web We Weave—When We Practice to Receive *by Stephen St.Croix*
28 Insider Audio: In a Silent Way—Why Is Everything So Darn Loud? *by Paul Lehrman*



PAGE 28

- 78 Mix Masters:** Bob Clearmountain *by Maureen Drone*
84 Project Studio: Johnny A. *by Barbara Schultz*
98 Bitstream: A Glossary of IT Terms for the Audio Pro *by Oliver Masciarotte*
124 Tech's Files: A Dangerous Science Fair Project—Bringing NASA Technology to Home-Brew Microphone Capsules *by Eddie Ciletti*

departments

- 10 From the Editor**
14 Feedback: Letters to *Mix*
16 Current
22 On the Cover: Upstairs Productions, Oklahoma City
148 Ad Index
150 Mix Marketplace
156 Classifieds

FOR OVER 30 YEARS LEXICON HAS BEEN IN WORLD-CLASS RECORDING STUDIOS

NOW YOUR HOME CAN BE ONE OF THEM

ΩMEGA
DESKTOP RECORDING STUDIO

Lexicon has taken a whole-system approach to desktop recording. Omega Studio is an integrated computer recording system that includes the Omega 8x4x2 USB I/O mixer, Pro Tracks Plus 32-track recording software and Pantheon world-class Lexicon reverb plug-in. Omega Studio contains all of the components necessary to transform your computer into a professional 24-bit recording studio.

Whether you're working on your first demo or your fifth gold record, Omega has the performance to produce your masterpiece.

Maybe you don't have the coin to record in the city of Westminster on Abbey Road, but that's no reason your music shouldn't sound like it.

Visit your local Lexicon dealer today and see what Omega can do for your studio.



Omega 8x4x2 USB I/O mixer

Differentiating itself from standard computer I/O boxes which are typically based on a patch-bay paradigm, the Omega 8x4x2 USB I/O mixer is based on a mixer paradigm and includes input, output and mixing functions that support a variety of tracking/monitoring applications while requiring no additional mixing hardware. The I/O mixer is packed with professional features such as ultra-transparent, high resolution A/D converters, extremely low-noise mic preamps with 48-volt phantom power and active balanced line level inputs. MIDI and S/PDIF ports allow connection to a variety of digital equipment.

Pro Tracks™ Plus PC Recording Software

Pro Tracks Plus is an easy-to-use, comprehensive 32-track recording suite that includes all the modules you'll need to track, edit, process, sequence and mix your masterpiece. Not only does it include intuitive non-linear editing, plug-in support, and acidized looping features, it contains a full featured MIDI sequencer with outstanding event editing and powerful automation features as well as soft synth support.

BIAS® Deck™ 3.5 SE Mac Recording Software

BIAS Deck 3.5 SE turns your Mac into a full-fledged recording studio. Easily record up to 64 tracks, with full CD quality and then edit your work instantly, while always being able to revert to your original recordings.

Pantheon™ Reverb Plug-in

From the name synonymous with "world's best reverb", Lexicon brings you Pantheon. With 35 factory presets, 6 reverb types and a simple yet powerful user interface, Pantheon is an indispensable tool for your recording studio.



lexicon^{PRO}

Lexicon Pro 8760 So. Sandy Parkway, Sandy, Utah 84070 • Tel: (801) 568-7567 | Fax: (801) 568-7662 • www.lexiconpro.com • www.protracksrecording.com

A Harman International Company

World Radio History



Not Just a Game!

Game audio? Why in the world is *Mix* covering game audio? To answer that, we pose our own question: Have you driven a game lately?

If you don't think the video game industry is booming, just ask any 14-year-old—or any 8-year-old. The \$12-billion-a-year game industry surpassed the revenues of Hollywood theatrical releases years ago, and it continues to zoom upward. Hardware prices (such as the new \$99 Nintendo GameCube) keep spiraling downward, but the big money is in software, and besides improved images, today's users want to feel the impact of high-quality surround sound.

Game production today is serious business, and a major part of that appeal is great audio. Galaxies removed from the blips and boings of Atari's 1972 *Pong* or the primitive "soundtracks" of early 1980s classics such as *Donkey Kong* or *Mario Bros.*, the cheesy 8-bit music and effects have been replaced by high-quality streaming audio (16-bit/44.1kHz) with real-time, hyper-realistic Foley thunks, screams, shots and explosions that are triggered from RAM, with near-zero latency.

Gamers themselves have been quick to notice the difference between good audio and bad. Debuting in 2000, the first PlayStation 2 units offered multiformat playback of CD-Audio, DVD-Video, CD-ROM-XA (the original PlayStation disk) and the then-new proprietary PS2 DVD game format. In contrast to the big sound of movies played on PlayStation 2 consoles, game audio seemed flat. And with an audio-savvy audience of users looking for bigger and better thrills, the race for hyperfidelity became a major movement.

Sound design for the little screen is no picnic. One constant obstacle is finding enough disk space, especially where having even 10 percent of the disk allotted to audio is a rare occurrence. Understanding the nuances of the release formats is a must. PlayStation 2 and GameCube consoles now come with the ability to play back Dolby Pro Logic II matrix-encoded material. Just a year old, Pro Logic II allows true 5.1 program material to be encoded onto 2-channel media that's compatible with mono, stereo, LCRS or 5.1 playback. Microsoft's Xbox format takes surround a step further by including a separate Dolby Digital AC-3 chip in the game console, thus keeping all surround processing off of the host processor for uncompromised playback.

Compared to other segments of the entertainment industry, video game production may still be fairly young, but this is an industry that's just now reaching maturity. And the world is definitely taking notice. Bands are fighting to get singles tied to new game releases, and these days, a song on a hot new game can translate to a lot of revenue for an upcoming or established act. Two years ago, some industry insiders formed G.A.N.G. (Game Audio Network Guild), an organization of production professionals interested in advancing the state of interactive audio. For more information, visit G.A.N.G. at www.audiogang.org. And serious game producers will be checking out this month's Game Developer's Conference (March 22 to 26, 2004, in San Jose, Calif.)—the place to be for those in the know.

George Petersen
Editorial Director

MIX[®]

A PRIMEDIA Publication

EDITORIAL DIRECTOR George Petersen gpetersen@primediabusiness.com
EDITOR Tom Kenny tkenny@primediabusiness.com
SENIOR EDITOR Blair Jackson blair@blairjackson.com
FEATURES EDITOR Sarah Jones sjones@primediabusiness.com
TECHNICAL EDITOR Kevin Becka kbecka@earthlink.net
ASSOCIATE EDITOR Sarah Benzuly sbenzuly@primediabusiness.com
EDITORIAL ASSISTANTS Breean Lingle blingle@primediabusiness.com
 Heather Johnson hjohnson@primediabusiness.com
LOS ANGELES EDITOR Maureen Droney MaureenDroney@aol.com
NEW YORK EDITOR David Weiss david@dwards.com
NASHVILLE EDITOR Rick Clark rmlurges@mac.com
SOUND REINFORCEMENT EDITOR Mark Frink mix@markfrink.com
FILM SOUND EDITOR Larry Blake swellstone@aol.com
TECHNICAL PROVOCATEUR Stephen St. Croix
CONSULTING EDITOR Paul Lehman lehman@pan.com
WEB EDITOR Dan Cross dcross@primediabusiness.com
NEW-TECHNOLOGIES EDITOR Philip De Lancia
CONTRIBUTING EDITORS Barbara Schultz Robert Hanson Michael Cooper
 Bob McCarthy Eddie Ciletti Oliver Masciaratte Gary Eskow Randy Albers

SENIOR ART DIRECTOR Dmitry Panich dpanich@primediabusiness.com
ART DIRECTOR Kay Marshall kmarshall@primediabusiness.com
ASSOCIATE ART DIRECTOR Elizabeth Heaven theaven@primediabusiness.com
PHOTOGRAPHY Steve Jennings
INFORMATIONAL GRAPHICS Chuck Dahmer

SENIOR VICE PRESIDENT Pete May pmay@primediabusiness.com
PUBLISHER Dave Keik dreik@primediabusiness.com
ASSOCIATE PUBLISHER Erika Lopez elopez@primediabusiness.com

EASTERN ADVERTISING DIRECTOR Michele Konatous mkonatous@primediabusiness.com
NORTHWEST/MIDWEST ADVERTISING MANAGER Greg Sutton gsutton@primediabusiness.com
SOUTHWEST ADVERTISING MANAGER Albert Margolis amargolis@primediabusiness.com
SALES ASSISTANT Anthony Gordon agordon@primediabusiness.com

CLASSIFIEDS/MARKETPLACE ADVERTISING DIRECTOR
 Robin Boyce-Trubitt rtrubitt@primediabusiness.com
WEST COAST CLASSIFIEDS SALES ASSOCIATE Kevin Blackford kblackford@primediabusiness.com
EAST COAST CLASSIFIEDS SALES ASSOCIATE Jason Smith jasmith@primediabusiness.com

MARKETING DIRECTOR Christen Pocock cpocock@primediabusiness.com
MARKETING MANAGER Angela Rehm arehm@primediabusiness.com
MARKETING TRADESHOW COORDINATOR Megan Koehn mkoehn@primediabusiness.com

DIRECTOR, SPECIAL PROJECTS Hillel Resner hresner@primediabusiness.com

GROUP PRODUCTION MANAGER Melissa Langstaff mlangstaff@primediabusiness.com
SENIOR ADVERTISING PRODUCTION COORDINATOR Liz Turner lturner@primediabusiness.com
CLASSIFIED PRODUCTION COORDINATOR Jennifer Kreebone-Laurie jkreebone@primediabusiness.com

SR. DIRECTOR AUDIENCE MARKETING Susi D. Cardill scardill@primediabusiness.com
GROUP AUDIENCE MARKETING DIRECTOR Phil Semler psemler@primediabusiness.com
AUDIENCE MARKETING MANAGERS Jef Linsan jlinsan@primediabusiness.com
 Craig Diamantine cdiamantine@primediabusiness.com

HUMAN RESOURCES MANAGER Julie Nave-Taylor jnave-taylor@primediabusiness.com
RECEPTIONIST/OFFICE COORDINATOR Lara Duchnick lduchnick@primediabusiness.com

COPYRIGHT 2004

PRIMEDIA Business Magazines & Media Inc.
ALL RIGHTS RESERVED.

FOUNDED IN 1977 BY DAVID SCHWARTZ AND PENNY RIKER



Professional sound for sound professionals.

TO SUCCEED TODAY, you don't need a digital audio gimmick. You need a digital audio platform featuring a range of highly scalable, interoperable systems. Systems

that function as stand alone units or as part of integrated networks. Open systems that incorporate a built-in software upgrade path that lowers your cost of ownership. Modular systems that allow you to build your network as you build your business.



Real creative professionals have realized our industry is being threatened by cheap, low-cost, low-performance cookie-cutter products offering the promise that anyone can be a sound professional.

We know better than that. So do you.

Our new DREAM Constellation large format mixing console, DREAM StationPlus integrated mixer/editor, DREAM Satellite platform and QDC engine operating software, and SoftMix PC-based mixing controller offer you the next generation of a sound business partnership that dates all the way back to the birth of the digital audio industry.



For 30 years Fairlight has helped customers build sound businesses by providing digital audio solutions that make sound business sense. That's why we continue to enjoy the support of more than 3500 customer partners.



www.fairlightau.com

FAIRLIGHT.AU PTY LTD CORPORATE HEADQUARTERS • AUSTRALIA • PH +61 2 9975 1777 • FAX +61 2 9975 1999 • INFO@FAIRLIGHTAU.COM

USA WEST COAST MEDIAGEAR • 626 792 8773 USA EAST COAST MEDIAGEAR • 631 265 4499

JAPAN FAIRLIGHT JAPAN • +81 3 5432 4151

FRANCE FAIRLIGHT FRANCE • + 331 4610 9292

UK TEKCARE • +44 1582 760004

World Radio History

Life is about choices...

U.S. EDITION MICROPHONE SETS

It's easier than ever to get the world-class precision built sound of Schoeps in your studio. U.S. Edition Sets combine our most popular amplifier body and capsule combinations with accessories in a custom case.

CHOOSE SCHOEPS



REDDING AUDIO
97 S. Main Street, #10
Newtown, CT 06470
(203) 270-1808

For a complete list of
U.S. Sets and dealer
locator, go to:
www.reddingaudio.com

SCHOEPS
Mikrofone
www.schoeps.de



WWW.MIXONLINE.COM

PRIMEDIA Business Magazines & Media

Chief Operating Officer Jack Condon jcondon@primediabusiness.com
Executive Vice President John French jfrench@primediabusiness.com

Sr. Vice President, Business Development Eric Jacobson ejacobson@primediabusiness.com

Vice President, Content Licensing & Development Andrew Elston aelston@primediabusiness.com

Vice President, Corporate Communications/Marketing Karen Garrison kgarrison@primediabusiness.com

Vice President, Human Resources Kurt Nelson knelson@primediabusiness.com

Sr. Vice President, Chief Information Officer Kris Paper kpaper@primediabusiness.com

Vice President, Technology Cindi Redding credding@primediabusiness.com

Primedia Business-to-Business Group

745 Fifth Ave., New York, NY 10151

Chief Executive Officer Martin Maleska martin.maleska@primedia.com

Primedia Inc.

President/CEO Kelly Conlin kelly.conlin@primedia.com

Chairman Dean Nelson dean.nelson@primedia.com

Vice Chairman & General Counsel Beverly Chell beverly.chell@primedia.com

SUBSCRIBER CUSTOMER SERVICE: To subscribe, change your address or check on your current account status, go to www.mixonline.com and click on "Customer Service" for fastest service. Or, e-mail mixm@kable.com, call toll-free 800/532-8190 or 740/383-3322, or write to PO Box 1939, Marion, OH 43306.

BACK ISSUES: Back issues are available for \$10 each by calling 800/532-8190 or 740/382-3322.

POSTMASTER: Send address changes to *Mix* magazine, P.O. Box 1939, Marion, OH 43306.

PHOTOCOPIES: Authorization to photocopy articles for internal corporate, personal or instructional use may be obtained from the Copyright Clearance Center (CCC) at 978/750-8400. Obtain further information at copyright.com.

REPRINTS: Contact Wright's Reprints to purchase quality custom reprints of articles appearing in this publication at 877/652-5295 (281/419-5725 outside the U.S. and Canada). Instant reprints and permissions may be purchased directly from our Website; look for the Copyright tag appended to the end of each article.

ARCHIVES AND MICROFORM: This magazine is available for research and retrieval of selected archived articles from leading electronic databases and online search services, including Factiva, LexisNexis and ProQuest. For microform availability, contact ProQuest at 800/521-0600 or 734/761-4700, or search the Service in Microform listings at proquest.com.

PRIVACY POLICY: Your privacy is a priority to us. For a detailed policy statement about privacy and information dissemination practices related to Primedia Business Magazines & Media products, please visit our Website at www.primediabusiness.com.

LIST RENTAL: Primedia@statistics.com

MAILING LISTS: PRIMEODIA Business makes portions of our magazine subscriber lists available to carefully selected companies that offer products and services directly related to the industries we cover. Subscribers who do not wish to receive such mailings should contact the PRIMEODIA Business subscriber services at 800/532-8190 or 740/382-3322.

CORPORATE OFFICE: PRIMEODIA Business Magazines & Media, 9800 Metcalf, Overland Park, KS 66212, 913/341-1300, primediabusiness.com

NATIONAL EDITORIAL, ADVERTISING AND BUSINESS OFFICES, 6400 Hollis St., Suite 12, Emeryville, CA 94608; 510/653-3307; fax 510/653-5142; Website: www.mixonline.com. **PHOTOCOPY RIGHTS:** Authorization to photocopy items for internal or personal use of specific clients is granted by PRIMEODIA Business Magazines and Media Inc., provided that the base fee of U.S. \$2.25 per copy, plus U.S. \$00.00 per page is paid directly to Copyright Clearance Center, 222 Rosewood Drive, Danvers, MA 01923. The fee code for users of this Transactional Reporting Service is ISSN 0164-9957/2000 \$2.25 + \$00.00. For those organizations that have been granted a photocopying license by CCC, a separate system of payment has been arranged. Before photocopying items for educational classroom use, please contact CCC at 978/750-8400.

Amphenol

CONSIDER...STYLE



M-Series Instrument Connectors

call toll free:

1.866.242.1704

local: **714.230.6231**

email: amphenol@penn-elcom.com

www.amphenol.com.au

penn-elcom
hardware and fastener solutions

Completely Amazing

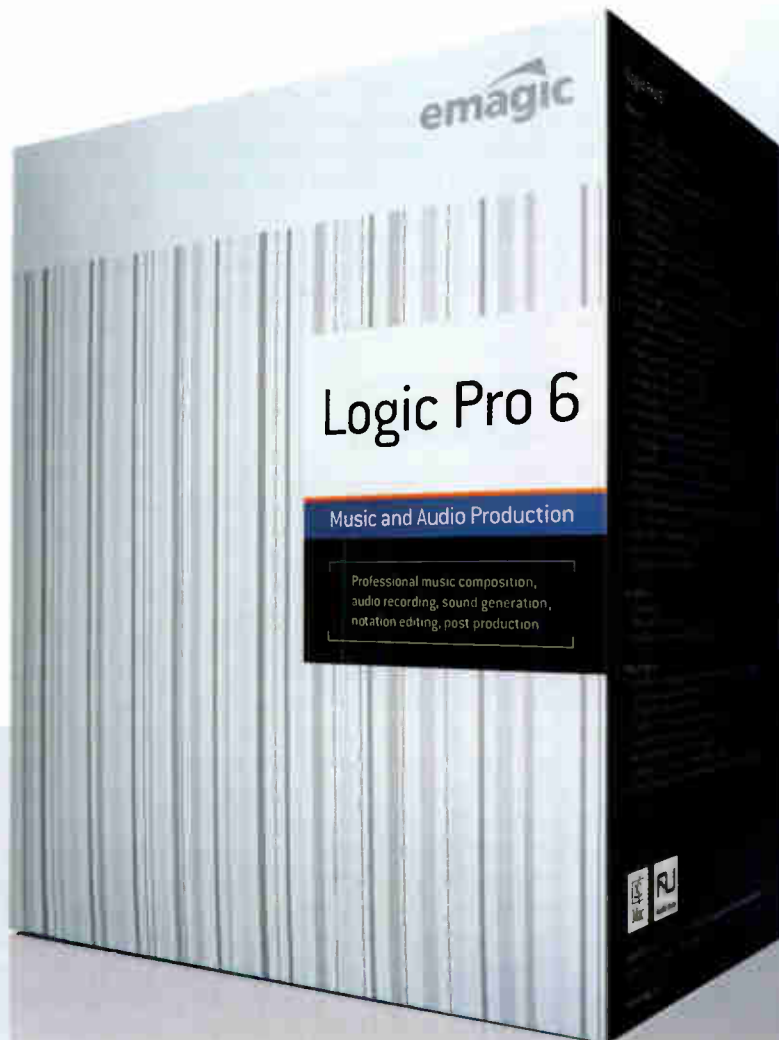

Introducing the new Logic Pro 6, the most flexible, most advanced and best equipped music production software for the Mac. At an impressively low price you get all the highly praised professional software instruments and plug-ins from Emagic. Also included is the renowned EXS24 mkII software sampler. Plus you'll get incredibly realistic sounding vintage instruments such as the EVP88 electric piano, EVB3 organ and EVD6 clavinet, and a range of software synthesizers that provide amazing options for creative sound design. Even the new convolution reverb – Space Designer – is included. While Logic Pro 6 includes an outstanding array of impressive capabilities and options, if you're just looking to get started, check out Logic Express 6, an even lower cost way to experience the key benefits of Logic. Either choice will be music to your ears.

Letters to Mix



PRODUCTION MASTERS

In the December 2003 issue, you published an article on the sound work involved with *Master and Commander: The Far Side of the World*. It was an interesting article, except for the fact that you only gave a cursory mention of the seven months spent recording original dialog and sound effects during production.

Your magazine did miss out on some very interesting recording and mixing facts for your readers. Even though only "49 percent" of the dialog recorded on location made the final mix, pains were taken to build an ADR stage at Fox Studios Rosarito so that dialog obscured by jet engines, fans and wave machines could be recorded immediately and substituted. Multi-track sound effects were recorded at sea aboard the frigate *Rose* under various sailing conditions, including storms. Hydraulic gimbals were engineered to quietly move a 225-ton set around on the head of a pin. Master music tracks were recorded at the fabled Capitol Records Studios in Hollywood for on-set playback in scenes involving Russell Crowe and Paul Bettany playing Boccherini, Buxtehude and Mozart. Finally, time was spent on the Galapagos Islands recording indigenous animals in their natural habitats.

The latter must have been a first for any major motion picture. There were some unique tricks and systems developed for this picture, but what really made the sound on *Master and Commander* work so magnificently is that we all worked together as a team under coach Peter Weir.

Arthur Rochester

THE BEATLES...ALMOST NAKED

I enjoyed reading "The Beatles' 'Let It Be...Naked'" in your January issue. Who in our business isn't fascinated with how those recordings were done? But it does strike me as odd that the premise behind the new mixes was [to retain] what the four of them (plus Preston) played or had intended to be presented, yet

what we hear now are edited pieces of "best takes." This practice is certainly not new to recording, but it is striking when such care [is taken] to present what they sounded like as a group, when, in fact, they did not sound that good without the comps.

This is much like the paradox of recording orchestra with state-of-the-art mic pre's and hallowed halls. Everyone's in time and tune, but few except those involved know the extent of editing that goes into producing a classical release. It's staggering.

While recording [requires] an awful lot of magic-making, one can't help but wonder if we in this business don't fool ourselves once or twice too often along the way.

Elliott James

Waterree Studio, Atlanta

1-800-GOT-HELP?

How about doing an article about the poor quality support that companies are giving for their software? When I buy a piece of hardware, if it didn't work, it went back to the store. Now with all of the new software, if you have a problem, it takes an act of God to get any help.

[Here are] two examples I am suffering through at this time. I purchased Nuendo 2.0 for my Mac G4. It played for a moment and then stopped and then played and then stopped. I tried for more than an hour to get through to Steinberg on the phone. Busy. Busy. I finally called the Canadian support number and got some help. The support tech walked me through a new download, but it still didn't solve another problem that I have.

Today, I purchased Audioease's Altiverb in the Netherlands. When I went to the Web page to answer the challenge/response question, there was no page! I tried over and over. I sent an e-mail. No response. I telephoned and got a voice message.

Someone needs to hold these companies responsible for customer support. These two programs I mentioned cost \$1,700 between the two.

I think that even though it is kind of "biting the hand that feeds you," these companies [are] accountable for the stuff they sell.

Ken Roberts

THE OPEN SOURCE TRAIN STAYS ON TRACK

I've always enjoyed the "Bitstream" column; I've found it extremely informative and helpful on many occasions at key moments.

I'd like to make a comment about your most recent *Mix* articles [November and December,

2003]. The column was about Open Source solutions. Thanks for driving this train in your discussions, by the way!

The comment I take a bit of exception to was something to the effect of "I have a friend who just gave up trying to get a Web server up and running on Linux and went to M\$/IIS because it was so much easier to setup."

I have to agree: Certainly, it is much easier to deal with GUIs and get an M\$/IIS box up and running. However, if the user isn't super-proactive about patch updates, They will be more likely to contribute to the propagation of new Web-related viruses, worms, etc.

This doesn't mean Apache is impenetrable, but as an Open Source product, it is tested for exploits. In accordance with your theme, you ought to have suggested to this person to:

1. Install Windows, get IIS running.
2. Install Apache on the Windoze box, get familiar with the configuration files, including restricting.
3. Install Linux on a test machine and follow the tutorials and its easy-to-follow GUI defaults for installing the OS.

There is so much documentation for Apache and Red Hat OS that one really has to spend a little time and will have Red Hat up and running, serving Web pages via Apache more efficiently and more securely than an M\$ implementation. (The box won't have to be rebooted when it gets into a state of funk, either!)

Of course, once the box is up and running, one needs to find out about how to harden the OS, the Web server and turn off all unnecessary applications. This is probably the most intimidating part, because Linux runs many programs with the default install that are particularly vulnerable and ought to be turned off. The server should only have apps listening that the user requires!

The main point I'm hoping to make is that you gotta keep driving this Open Source Train! Don't let someone who wants to run a simple Web server on Linux fail and revert back to M\$!

I can't yet get away from running Logic on Windows because I can't afford a Mac! I've [got] too much riding on my M\$ gravy train! I don't mind paying developers for a kick-ass app like Logic and plug-ins if I can run it on my own custom kernel!

Dominique

Send Feedback to *Mix*
mixeditorial@primediabusiness.com



When your
Equipment
absolutely **Has To Work**

Must-Have Wireless: Sennheiser 3000 & 5000 Series

In Real Life, there are no second takes. That's why you need Sennheiser 3000 and 5000 Series systems and components. Our benchmark products have garnered praise from every corner of the industry and an Academy Award® for our wireless technology. We've brought you such innovations as the Neumann KK105 vocal capsule and the SK5012 - the world's smallest professional bodypack. But more than that, Sennheiser gives you the best RF link and the most durable, dependable gear on the planet. When your life depends on reliable wireless, choose Sennheiser.



www.sennheiserusa.com

STEPHEN PAUL, 1951–2003

On December 22, 2003, the world of professional audio and microphone technology lost a great thinker, engineer, craftsman and artist. Born in New York City, Stephen Paul had suffered in recent years from an aggressive and fast-moving form of arthritis. Renowned for his restoration and "hotrodding" of classic tube microphones, Stephen played no small part in the current microphone Renaissance. His impeccable work earned him the respect of top scientists in the field of microphone technology, as well as top recording artists, engineers and producers who would settle

for nothing less than the Stephen Paul restorations and those remarkable gold-sputtered diaphragms less than a micron thick!

Stephen's search for the best microphones was the result of his early career as a singer/songwriter befriended by John Hammond Sr., Ahmet Ertegun and Gary Usher. Stephen once earned his living as a singing waiter, and as an engineer/producer and/or performer, he worked with artists such as Jefferson Airplane, Seals and Crofts, Ike Turner, Solomon Burke, Air Supply, Chicago, Toto and Al Jarreau. He also served as chief

tech at a number of top recording studios, and continued recording his own work throughout his life. His heart was in the music, and the technology was always designed to serve that cause. When I first met and interviewed him in 1987, I asked how he would like to be remembered in history. He simply replied, "As an artist who cared for his work and tried to achieve perfection."

Stephen Paul Audio celebrates its 20th anniversary in 2004, and the work that he pioneered is being faithfully continued by Stephen's

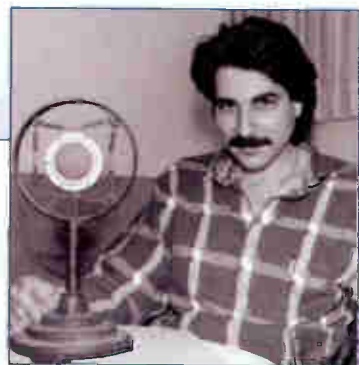

PHOTO: MR. BONZAI

longtime associate Tony Merrill. The long-awaited Stephen Paul original microphone, with the help of PMI Audio, is currently in the final manufacturing stages and will be commercially available later this year, a fitting memorial for the indelible character known as "Dr. Microphone."

—Mr. Bonzai

DIGIDESIGN ACQUIRES BOMB FACTORY DIGITAL'S ASSETS

Digidesign has acquired the assets of Bomb Factory Digital Inc., a manufacturer of real-time audio DSP effects for the Pro Tools platform. Terms of the deal were not disclosed. In the near future, Digidesign will announce its plans for deploying the Bomb Factory assets across the Pro Tools product line.

According to David Lebolt (pictured), Avid VP and Digidesign general manager, "By providing these classic processing plugins, as well as continuing to work closely with our thriving third-party community, we will offer our users tremendous variety and unrivaled



audio processing quality. Pro Tools customers will benefit from the continued availability and support of these high-quality plug-ins as our platform grows and evolves."

Bomb Factory co-founder and president Erik Gavriluk commented, "My partner, Dave Amels, and I are proud of the great digital audio processing products we've created for the Pro Tools community, and we're especially pleased that these products will now be even more closely linked with the world's pre-eminent provider of digital audio equipment to audio engineers everywhere, from high-end professionals to home studio buffs."

Visit www.digidesign.com for more information, including the complete list of the Bomb Factory plugins and their compatibility with Pro Tools systems.

SETTING UP AT THE SOUND SHOP



Sound Shop Studio (Nashville) recently held a tracking session for artist Robbie Chevront (Sony Records, pictured in the middle) with co-producers Don Cook (left) and Chris Waters (right), and engineer Mike Bradley (at the console); Cook and Bradley are also co-owners of Sound Shop. This date was the first outing for the recently purchased pair of Tannoy System 800As, plus a PS110B and PS350B subwoofer; a pair of Tannoy Reveal monitors are also on the meter bridge.

HEARING CONVERSATION GETS FINANCIAL BOOST

Mix magazine founder and Mix Foundation board member David Schwartz (left), TEC Awards executive director Karen Dunn (second from left) and Mix Foundation president Hillel Resner (right) presented a check for \$23,000 to Marilee Potthoff, marketing director of the House

Ear Institute. The money, representing half of the proceeds from the 19th Annual TEC Awards, will support the efforts of the Sound Partners hearing conservation program. The remaining proceeds from the TEC Awards will be distributed this month.



ROAD-TESTED AND APPROVED DPA Mikes NASCAR Racer for Video Game

The challenge for Electronic Arts' audio director Aubrey Hodges and *NASCAR Thunder 2005* video game sound designer Jesse James Allen was to mike the insides of the engine and driver Tommy King's cabin of EA's NASCAR racing machine—at high speed on the Walt Disney World Speedway (Orlando). They knew that



they would need miniature condenser microphones that could capture every sonic nuance of the engine and car under actual race conditions, as well as withstand the high SPLs and extremely high temperatures generated by the engine.

"We used DPA 4011s and DPA 4062s inside the engine and the cockpit and it worked out great," said Hodges. "We were really surprised how much headroom we had with the DPAs. The mics handled the sound pressure levels just fine, and we used some special techniques so that the wiring wouldn't get burned up:

wrapping the microphone cords in aluminum foil and mounting them with gaffer's tape around the engine to make sure the aluminum foil didn't come off.

"Once we miked the car, we had them do a test lap around the track to make sure the G-force on the microphones and equipment would be okay," Hodges continued. "Because of the speeds they were reaching, we were afraid that the DVD transport functionality might be affected, but it wasn't. We did two passes communicating with the driver via headset, and we got the engine



starting at 2,000 rpm and then in 500 rpm increments, going up to the limit of the car. They also did some really neat stuff like 'off throttle,' 'braking,' 'down-shifting'—anything you can imagine."

Recording was done to a Fostex PD6 digital recorder with two Fostex PD4 DAT recorders as backups.

ARDENT BRINGS EDUCATION INTO THE STUDIO

Ardent Studios and Visible School (both based in Memphis) have formed an educational initiative that creates the first recording and music business school to be hosted in a working studio facility.

"I have a long-standing personal commitment to the importance of education to the health and prosperity of the music recording industry and related media fields,"

commented John Fry, Ardent founder. As vice chairman of the Memphis and Shelby County Music Commission, Fry recently participated in a Memphis music community needs—assessment project, which led to the creation of a comprehensive strategic plan for the economic development of Memphis' music industry. "One of the top priorities that emerged in this process was the

importance of professional education. We consider our new initiative with Visible School a perfect fit with the commission's directives and a significant contribution to establish Memphis as one of the nation's most innovative and progressive independent music centers."

With a backbone of music recording courses, Fry and Ken Steorts, Visible School's founder, will also offer a focus on music business (through Ardent's record label and music publishing operations), film, video, Internet and multimedia production.

According to Steorts, "Ardent's facilities are second to none. Their staff brings real-world experience in producing amazing music that can't be manufactured overnight. By adding the curriculum development and teaching experience of our team, we are very excited about how this combination of resources will serve our current and future students from around the world."

For more information, visit www.ardentstudios.com or www.visible-school.com.

NASHVILLE "A TEAM" PERFORMS ON 'REGENERATION'

Chicago-based producer Neil J. Cacciottolo recently brought together Nashville-based musicians "Boots" Randolph (saxophone), Bob Moore (stand-up bass), guitarists Harold Bradley and Neil

Cacci, pianist Walt Cunningham and drummer "Buddy" Harman—also known as the "A Team"—for a session at Bradley's Barn (Nashville) to perform on *Regeneration*. The Jordannairens contributed background vocals on the album. Engineer Bob Bradley manned the Otari Concept 32-input console, which offers 64-channel automated mixdown. The 4,000-square-foot "old barn turned world-class recording studio" is owned by music industry executive Jerry Bradley.



Guitarist Harold Bradley



Pictured at Ardent Studios, from left, are John Fry, Ardent Studios founder; Aislynn Rappe; Ardent Records marketing coordinator and Visible School graduate; Ken Steorts, Visible School founder; Pete Eekhoff, bassist for JONAH33 (Ardent Records) and Visible School graduate; Jody Stephens, Ardent productions A&R director; and John Hampton, Ardent producer/engineer

TELEFUNKEN NORTH AMERICA MAKES NAMM DEBUT

Telefunken North America made its first appearance at Winter NAMM 2004. During the convention, Telefunken NA hosted a gala listening party at Ocean Way's Record One Recording Studios, where studio

owner/engineer Allen Sides manned the console for performances by Howard Fishman and his band. Fishman used the new Telefunken U47M for vocals and a pair of Telefunken Ela M 251s for guitar.



Pictured at the SSL console are (front row, L-R) John Neff, chief engineer of David Lynch's Asymmetrical Studios; Alan Venisofsky, Telefunken engineer/sales manager; and Allen Sides. Standing (L-R): Charles Bolois, Ross Hogarth, Doug Feiger, Telefunken CEO Toni Fishman, "Mack" Craig Allmendinger, Telefunken president, and Ian Gargner.



Performer Howard Fishman

HEI HONORS MIX FOUNDATION'S RESNER

The House Ear Institute has announced that it will be presenting Hillel Resner, president of the Mix Foundation for Excellence in Audio, its 2004 Sound Partners Lifetime Achievement Award for Recording Arts. The award honors Resner for his "significant contributions to the recording industry and his passionate commitment to the Sound Partners hearing conservation program over the years," and will be presented at the Institute's annual benefit gala on March 18, 2004, at the Beverly Hilton Hotel. For ticket information, call 213/989-7494.

WORKING IN THE BOONDOG



Pictured from left: mix engineer John Hill, Jack Douglas, owner/engineer Billy Branigan and assistant engineer Chanh Wang

Grammy Award-winning producer Jack Douglas is taking time off from producing Aerosmith's upcoming album and is now producing New York-based rock/pop/punk band Morningwood. Douglas tracked and mixed for the upcoming release at Boondog Recording Studios (New York City) with owner/engineer Billy Branigan, mix engineer John Hill and assistant engineer Chanh Wang.

JULIAN HIRSCH, 1922-2003



Julian Hirsch effectively invented the field of testing commercial audio products. For more than four-and-a-half decades, he wrote some 4,000 reviews and test reports for many magazines, most notably *HiFi/Stereo Review* (later just *Stereo Review* and now called *Sound & Vision*).

He was fanatical about accurate lab reports, but he didn't just measure stuff: He explained why he was making the measurements and what they meant to anyone who was going to be using the thing to listen to music. While he was a strict adherent to the scientific method, he also explored in his reviews more

subjective areas like construction quality and usability, the area that has since evolved into the fashionable academic subject known as "human factors." His monthly column, "Technical Talk," was a shining example to anyone considering technical writing as a career of how engineers should talk to non-engineers.

When Hirsch retired in 1998, his publisher established a scholarship in his name at his alma mater, the Cooper Union School of Engineering.

—Paul D. Lehrman

INDUSTRY NEWS

Former executive VP and COO at Klipsch Audio Technologies (Indianapolis) **Paul Jacobs** has been promoted to company president...**James R. Bonfiglio** joins **Furman Sound** (Petaluma, CA) as president/CEO...The new CFO at **Gibson Guitar Corp.** (Nashville) is **Anthony Crudele**...**Harry Poloner**, new VP of membership for **ASCAP** (New York City), will head up the organization's pop/rock membership activities on the East Coast...Jumping from **Masterdisk**, **Leon Zervos** joins **Sterling Sound** (New York City) as senior mastering engineer...You may have seen him at **M-Audio's** (Irwindale, CA) Winter NAMM booth: **Scott Wilkie** is the company's new lead clinician...A former sound crew member at London's Millennium Dome, **Martin Barbour** joins **BSS Audio** (Potters Bar, England) as systems engineer...**Chyron Corporation** (Melville, NY) has appointed **William Payne** as the new director of sales, Asia Pacific...Former gigs at Mackie Designs, EAW and Mark IV Pro Audio Group have led **Ivan C. Schwartz** to his new position: U.S. national sales manager for **DiGiCo USA** (Mt. Pleasant, SC)...**White Systems'** (Kenilworth, NJ) two new regional sales managers are **Richard Lanpheare** (Northeast) and **Daniel VanHooser** (Midwest)...Joining **Sennheiser Communications'** (Old Lyme, CN) inside sales staff is sales rep **Shannon Murphy**...**Steven Cullipher** joins **PRG's** (New Windsor, NY) systems integration team as a business development executive; he will be based out of the Orlando



Paul Jacobs



Anthony Crudele

office. Meanwhile, as part of PRG's restructuring, the company promoted **Bill Campbell**, general manager of lighting operation in Las Vegas; **Cathy Gilligan**, asset manager for Las Vegas office; **Erin Bymes**, national asset manager; and **David Patton**, national director of lighting operations...Musician/actor/radio producer **Steven Van Zandt** joined **SIRIUS** (New York City) Satellite Radio's programming staff as creative advisor...**Universal Audio** has assumed marketing and distribution for future versions of **LOUD Technologies'** (Santa Cruz, CA) UAD-1 DSP card and Powered Plug-Ins bundle. Other distribution news: **Front End Audio** is now distributing **Safe Sound Audio's** (West Yorkshire, UK) P1 audio processor in the U.S., Canada and Mexico; **Bag End** (Barrington, IL) loudspeaker systems will be distributed in Germany via **Heavenly Sound Systems** (Oberhausen, Germany); and serving Arizona, Southern California, Colorado, southern Nevada, New Mexico, Utah and Wyoming for **Inter-M Americas** (Chester, PA) is **Anew CT** (La Mesa, CA).

Clearly Superior...



Yorkville
unity™

Ever wonder why high efficiency professional PA systems never sound as clear and concise as a studio monitor? Well so did we... until now.

The new Unity™ Series U15 from Yorkville is a radical new loudspeaker design with ultra clear reproduction, extremely linear frequency response, and extremely low distortion. We combined a single compression driver with three sealed back midrange drivers on a patented Unity™ horn. This single point source assembly combines well with a high efficiency Neodymium woofer to redefine the boundaries of affordable professional PA.



The Unity™ Horn

Hear the U15 today
at your Yorkville dealer
or find out more on
the web at
www.yorkville.com/unity



Real Gear.
Real People.

Yorkville.com

United States • YORKVILLE SOUND INC. 4625 Wilmer Industrial Court, Rickerfing, Ontario L1W 2Y8 • Phone: 905-837-8481 • Fax: 905-839-5776
Canada • YORKVILLE SOUND INC. 4625 Wilmer Industrial Court, Rickerfing, Niagara Falls, NY 14305 • Phone: 716-297-2920 • Fax: 716-297-3689

NOTES FROM THE NET

Pricing War?

Phase 1: For a full 36 hours, MusicRebellion.com offered digital song files for a dime each, its version of demand-driven pricing technology. Like other music services, MusicRebellion has fixed costs that it must pay to labels and other rights holders, but hopes to promote the e-commerce idea of floating prices. Phase 2: The site's track prices now range from \$0.75 to \$0.95, depending on consumer demand, and each track is offered as a pay-per-download with more than 99 percent being burnable and transportable.

File-Swapping Declines



- People surveyed during March 12-19, 2003, and April 29-May 20, 2003
- People surveyed between November 18, 2003, to December 14, 2003

According to a recent report from Pew Internet & American Life, a fifth of survey respondents who continue to download or share files online said that they are doing so less often because of the recent suits filed by the RIAA. Of 1,358 Internet users surveyed between November 18, 2003, to December 14, 2003, the results showed that the percentage of music file downloaders has fallen to 14 percent from 29 percent surveyed during March 12-19, 2003, and April 29-May 20, 2003.

A LITTLE HELP FROM MY FRIENDS



Joe Cocker recently stepped into Capitol B (Hollywood) to work with Grammy-nominated producer CJ Vanston (A Mighty Wind soundtrack) and engineer Marc DeSisto to record an album full of songs that have influenced Cocker throughout his recording career. Pictured from left: bassist Lee Sklar, engineer Marc DeSisto, Joe Cocker, guitarist Dean Parks, producer/keyboardist CJ Vanston, guitarist Mike Landall and drummer Ray Brinker

FOR THE LOVE OF GUITARS



Kim Simmonds (right) of blues/rock band Savoy Brown recently stepped into Lakewood Audio Video Group (Jamesville, N.Y.) to mix and master the band's upcoming album, *You Should Have Been There*, and his solo acoustic album, *Stuck By Lightning*. Handling mixing and mastering duties was Ron DeRollo (left), engineer/owner of the facility. Recording was done to Alesis ML9600 MasterLink, Ampex and Studer 2-tracks and Pro Tools|HD3, then to a Sonic Solutions mastering workstation. Monitoring was via Dynaudio "Air 6" 5.1 surround, Genelec 1031As, UREI B138 time-aligned speakers, Yamaha NS10s and JBL 4421s. "The vocal chain I used while mixing the lead vocal was all analog: first into a Manley VoxBox for compression, de-essing and EQ, then into a Pultec EQP-1A for some 'air' and finally into either a UREI 1176 or Empirical Labs Distressor for final compression. I don't like to hit any one compressor too hard." Visit the studio online at www.lakewoodavgroup.com.

JOHN FREY, 1949-2003

Respected audio engineer and electronics expert John Frey died on December 27, 2003, after a year-long fight with cancer. Frey lived and worked in the Washington, D.C., area for most of his life, spending a good part of 30 years at Rodel Audio in Georgetown.

After a short stint in Vietnam (where he befriended pilots by fixing their radio equipment), Frey's interest in sound led him into professional audio. His strong theoretical understanding of electronics allowed him to create countless custom devices for recording and sound reinforcement. Frey was responsible for much of the design and installation at Rodel, which included a film mixing stage with interlocked mag dubbers, analog multitrack studios and digital audio workstations. During the 1970s, he also worked at legendary music stu-

dio Nimbus 9 in Toronto.

Frey's greatest skills were as a designer and troubleshooter of electronic equipment. His workshop included a vast collection of test equipment, tools, parts and technical manuals, as well as a professional machine shop for custom fabrication. His technical interests ranged from audio to industrial control, radio systems and ocean navigation. There were few things he could not design and even fewer that he could not fix. His high standards set the mark for quality regardless of application; no matter how big or small the job, he wanted it done right. Frey was one of a diminishing breed and will be greatly missed in the audio industry.

—Eric Wenocur, Lab Tech Systems



CORRECTION

In the January 2004 "L.A. Grapevine," James Stone at 5.1 Entertainment mixed the OutKast DVD.

Mix regrets this error.

Introducing Antares Filter

QUAD RHYTHMIC MULTIMODE FILTERS

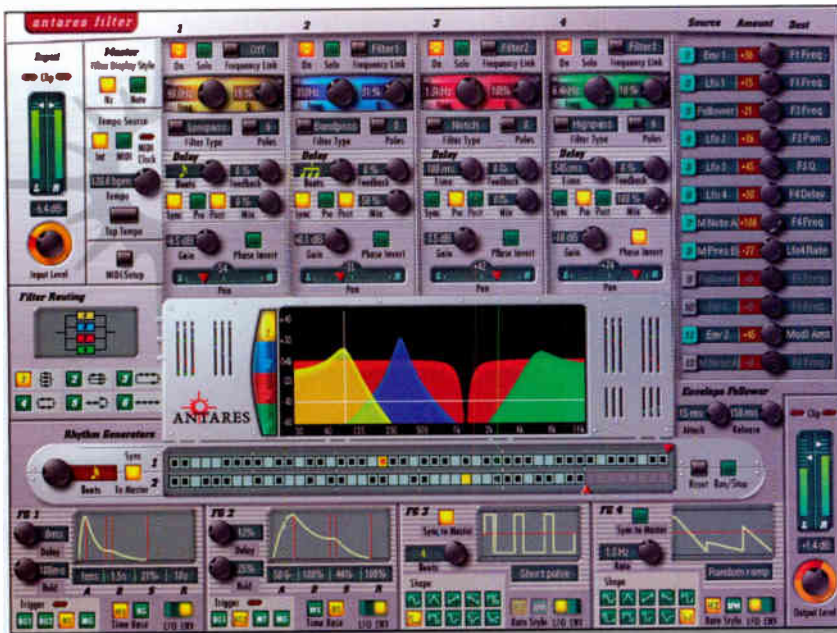

HERE'S WHAT YOU GET:

- >> Four warm, analog-sounding stereo multimode filters
- >> Lowpass, highpass, bandpass and notch modes
- >> Variable slope: 12dB/oct – 48dB/oct
- >> Four independent delay sections
- >> Multiple filter routing options
- >> Four Envelope Generators and four multi-shape LFOs
- >> Envelope Follower
- >> Two Rhythm Generators
- >> Powerful Modulation Matrix
- >> Extensive MIDI control
- >> Every time-based parameter syncable to internal master tempo or MIDI Clock
- >> Tracks (or entire mixes) that pulse with life and character

Think of it as the audio equivalent of a brilliant surgeon — who's a really good dancer.

Antares's new Filter plug-in gives you everything you need to shape your tracks with surgical precision or animate them with an almost limitless variety of tempo-synced rhythmic effects.



A DANCING SURGEON?

SONIC SURGERY

At the core of Filter are four stereo multimode filters that provide all the warmth and smoothness you'd expect from classic analog filters. With lowpass, highpass, bandpass and notch modes, variable cutoff slope, four independent delay sections, and a variety of filter routing options, you'll have the power to create dynamic filter effects that range from extremely subtle to just plain extreme.

CONTROL FREQ

Since filters sound the coolest when they're whizzing around, we've given Filter a modulation section that would make many a full-blown synthesizer jealous. Pretty much everything that matters can be modulated. Control sources include four multi-shape LFOs, four Envelope Generators with delay and hold times, two Rhythm Generators, an envelope follower and a slew of MIDI controllers. All routed through a Mod Matrix with more than enough patches to get yourself into serious trouble.

FEETS, GIT MOVIN'

To really get you dancing, Filter includes two drum-machine style Rhythm Generators for loop-based grooves or complex polyrhythms. And to make sure everybody stays in step, every time-based parameter—from tempos, to delay times to envelope rates—can be locked to Filter's internal master tempo or your host's MIDI clock.

Filter will be available for RTAS (Mac+PC), VST (Mac+PC), MAS and DirectX. Check it out at your local Antares dealer or drop by our web site to download a fully functional demo.

Then get out your scalpel and your tap shoes and prepare to have some serious fun.



WHERE THE FUTURE'S
STILL WHAT IT USED TO BE

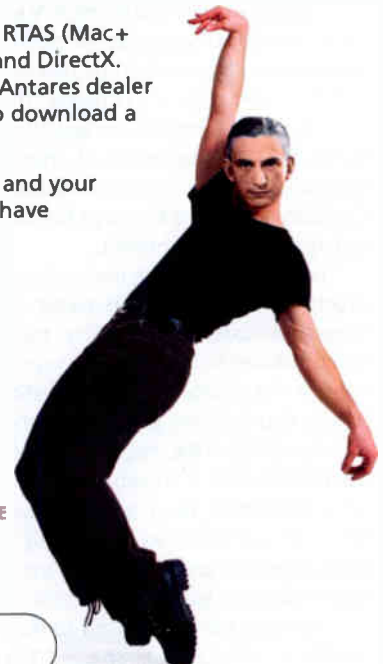

1.0 ANTARES AUDIO TECHNOLOGIES 231 Technology Circle, Scotts Valley, CA 95066 USA
voice: 831 461 7800 | info@antarestech.com | www.antarestech.com

©2003 Antares Audio Technologies. No fish were harmed in the design of this ad.
All Antares plug-ins are certified isinglass-free.

World Radio History

Upstairs Productions

By Blair Jackson

Ted Curtis was born and raised in Oklahoma City and has been part of the city's surprisingly vibrant music scene since his teens, when he played in various bands and then apprenticed as an engineer at one of the area's top recording studios, Media Sound. When the owner of that studio decided his heart was in broadcasting, he sold the studio to Curtis, who was just 19 at the time but the son of a well-heeled restaurant supply magnate. Curtis renamed the facility Studio 7, and at the 1981 AES show, went on a shopping spree to equip his studio with tons of quality gear.

During the decade Curtis ran Studio 7, it became the top recording room in town, but in 1990 he made an abrupt left turn: He sold the studio and went into the restaurant business, opening a Mexican place called Ted's Café Escondido. "I applied everything I learned in the record business about consistency and attention to detail to running the restaurant," he says. "It turned out to be a good match of skills. We've had the number one restaurant in Oklahoma City for the past seven years."

Curtis never left music entirely. He continued to play drums and run the audio for his church band, did occasional studio work, plus kept a lucrative sideline as a designer and installer of high-end home A/V systems. Then, a couple of years ago, he got the urge to own a studio again, so he had one built in the second story of his house. The aptly named Upstairs Productions was born. Curtis has hosted a succession of artists at the new studio, many from the contemporary Christian genre, and also kept his successful restaurant business thriving.

The studio took more than a year to construct, with top New York-based designer Francis Manzella spearheading the effort, which included raising the roof on certain sections of the studio, reinforcing load-bearing ceilings and installing plenty of isolation and soundproofing. In the end, Curtis had a good-sized studio with a superb 25x19x9 control room connected by a small hallway to a 34x16x11 live room, an only slightly smaller piano room and an iso booth. All rooms provide a high-res video feed to the control room.

"Ted gave me a free hand to do what I wanted with the acoustic spaces," Manzella



In the piano room: "concierge"
Kara Curtis, owner Ted Curtis
and guitarist Daniel Chrisman

comments. "I had this vision of four different acoustic environments, with one of them being a very live room, and I think they all turned out really well.

"Actually, one of the greatest challenges was how do you get a huge console up into the control room, which is a wraparound staircase from any doorway? What ended up happening is we built a set of double doors into the side of the control room wall out over the garage. So the doors just sort of lead to empty space, but they're perfect for equipment load-in and load-out. Overall, we had a great experience working with one of the guys 'in the trenches' out in America's heartland. Ted's making records, scoring movies and getting it done in Oklahoma City. You have to respect that."

The control room is based around a fully automated 72-channel Amek/Neve 9098i. "That was the first addition to this obsession," Curtis says with a laugh. "But I knew I was going to take a hybrid approach. So I've got the Pro Tools IHD and RADAR, but also an MCI JH-24 2-inch and a Mike Spitz ATR-102 1-inch analog. Digital was not a fix-all deal. It does what it does and it's great for editing and storage, but it isn't analog, and analog isn't digital, so why not do the hybrid approach? The important thing is that the chain be as pristine as possible."

Curtis also sings the praises of his ADAM S5A monitors, tuned by Bob Hodas. His control room is equipped with Genelec 1032As and a 7071 sub at the ready for 5.1 work. Additionally, there is large complement of

top-quality microphones (by Brauner, Neumann, AKG, Sony, Coles, Sennheiser, Soundfield, etc.) and outboard gear that includes GML and vintage favorites (LA-2A, LA-3A, 1176) and the latest cool boxes (Sony DRE-S 777, TC 6000).

Perhaps the most challenging aspect of building Upstairs Productions was designing the video interface that links each room of the complex with the control room. Rather than relying on various small monitors, the A/V-savvy Curtis put together a system based around the JVC DILA Project, or RGB Spectrum Quadview Plus and a 7-foot Stewart Grayhawk screen. "What it basically allows you to do is take multiple inputs and display them on the same screen in any configuration you choose—so you can put RADAR and/or Pro Tools up there, and next to that, you've got a couple of composite cameras, maybe have the console automation up there, whatever you want to see. Then I use an AMX touchscreen to be able to control all the presets and be able to select which cameras I want to use, et cetera." Each of the rooms has a small, unobtrusive Canon pan-tilt-zoom camera, "and so far the artists seem to just forget about them immediately," Curtis says. "You can zoom in on the big room and see how the drummer is hitting the snare drum in ways you couldn't unless you were in there standing next to him. You can also monitor the DAC levels in the machine room. It's really been great so far."

For more information, visit www.upstairsproductions.com.

SRS (●)

We've Got You SURROUNDED



Professional Surround Sound Encoding Software

Introducing SRS Labs' new line of professional software surround encoding tools: SRS Circle Surround® TDM Pro, and SRS Circle Surround VST Pro. Powerful, flexible, and easy to use, SRS Circle Surround is at the heart of both of these new plug-ins.

Visit us online today and check out why industry professionals are choosing SRS Circle Surround as their surround format of choice.

SRS (●)
Circle Surround

www.srslabs.com
800.243.2733

PRO TOOLS TDM
version 6.0

PC
version



World Radio History

What a Tangled Web We Weave

When We Practice to Receive

I thought this might be a good time to take a logical look at Reason, followed immediately by a reasonable look at Logic, Apfel's pro virtual studio offering. Of course, everybody and his drummer have already looked at some version of these apps, but not the way I will. I have a vision. A portable, imaginary vision. And I figured I would look at other apps, too, and some of the tiny new feature-packed portable USB keyboards—all in the interest of creating a snapshot of this collective journey from our humble beginnings as analog studio users to our lofty goal as Masters of the Digital Desktop for recording and mixing.

And I had two weeks left until drop-dead. For those of you who may not know, when a columnist is very, very late, far too late for an illustration and far too late to decide for himself how many words there will be, he finds himself staring directly at the abyss, sort of like when Jason and The Argonauts sail up to the edge of the world and the ocean is about to sweep them over the cliff into oblivion. This is the drop-dead date. And that is today.

NO, SIR, YOUR PACKAGE HAS NOT ARRIVED...

But nothing showed on time. Nothing. Endless calls and treks to the end of the driveway in knee-deep snow produced only a mild ringing in my left ear and wet shoes—but no gear. Several factors contributed to this. It is very difficult to reach anybody right after NAMM. I used up one week trying before I finally began to connect. Then one company jumped right on it and rushed a giant package out that very same day...UPS ground. From the other coast. One week. That's two weeks now, and that's too late. Another company said its stuff would ship that day, but it never showed. Many follow-up calls finally produced a logical reason—a new version is coming—so they thought they would wait and send me that. But they did not think to let me know this. Still another company's gear was DOA. Another needed a translator that was on vacation (I *think*).

So, in other words: My dog ate my homework. I get to use this once in 20 years, don't I?

But that's actually fine, because I wanted to talk first about our overall direction anyway. Specifically, what it takes to actually pull off this inevitable mutation from linear hardware to a *true* virtual studio.

Everyone seems to assume that all we need is fast enough computers, cool enough displays and some mysterious new 3-D user interface. Personally, I don't think so. Sure, we need all that stuff, and even though some of it, like the special spatial 3-D grab-your-loop-in-the-air-and-move-it display/interface combo, looks like a bit of a challenge, it *will* happen.

Hell, the gaming developers will get it going if no one else does. Ick, mixing your next album on a PS6...

But the mere existence of the components does not a system make, any more than the existence of words makes a sentence. No, somebody actually has to have the vision to put it all together, and surprisingly, I don't necessarily mean technically.

BUT BACK TO THE FUTURE

Let's go back and hit GarageBand one last time. Patience, there *is* a reason. This little app is, unto itself, nothing earth shattering. In fact everything it does is already being done better by some other app. And, yes, last month I said it was groundbreaking. But ground-

We need a modular but fully
integrated desktop suite
that can adapt to each user's needs
if the dream of a true
virtual studio is ever to be realized.

breaking is a hole or crack appearing in the earth, while earth shattering is the earth breaking into shards and killing all the dinosaurs, or guys who still record analog.

Not a single app in iLife is a new concept, GarageBand included. Something else makes iLife, the iTunes Music Store, the iPod and the Mac itself historically noteworthy.

What's it all about, Alpha? No, not even beta. These products, soft and hard, are the result of two components, two concepts: one foofoo, the other simple and simply brilliant.

OH, SIR, YOUR PACKAGE HAS ARRIVED...

Apple *packages*. Apple packages premium packages. No mere green eggs and ham, but Bluetooth and wireless LAN.

Apple stuff is visually, tactilely and intellectually beautiful. It is exciting to touch and use. It has slowly changed from a quirky high-performance Maserati to the powerful, elegant Mercedes SL55 of computers (and now MP3/AAC players).

And so much for the foofoo, except of course to note that it actually *works*.

On to the brilliant. Jobs designs great toys, but actu-

How can *every* **PRO AUDIO DEALER** guarantee the **lowest price?**

>> **THEY CAN'T — SINCE WE ALL SELL MUSIC GEAR AT THE SAME LOW PRICES, THAT "GUARANTEE" IS MEANINGLESS.**

We're going to let you in on a little secret — low price guarantees are generally either nothing but marketing hype or backed with so much fine print that you need a law degree to figure them out. It's no wonder; otherwise, you could literally pit one dealer against another until they were paying YOU to take a piece of gear off their hands!

The fact of the matter is that all the major music technology retailers, including Sweetwater, get the same great deals and charge the same low prices, so other companies will gladly agree to match a price that is within pennies of their normal price anyway.

So if there's no difference in price, why talk about it so much? Other retailers make such a big deal about price because that's all they have to offer. Sweetwater has become the leading music technology retailer because in addition to great prices, we offer much, much more.

- > An award winning, expert sales staff with more combined music technology experience than any retailer, period.
- > Millions of collars of music technology equipment, in stock and ready to ship to you!
- > The best tech support staff in the business, able to help integrate gear from hundreds of manufacturers.
- > A world-class service center, factory authorized to fix virtually everything we sell.
- > The web's largest music retail site, with the most comprehensive tech support database anywhere!

With 25 years in the industry, we've been reminded time and time again that musicians and audio professionals are looking for far more than just a good price. We've built a reputation for excellence based on a level of service and expertise that you simply can't find elsewhere.

Talk to one of our Sales Engineers today and discover why at Sweetwater —
a good price is only the beginning.

25th Sweetwater
music technology direct
Anniversary

FAX: (260) 432 1758 > 5335 Bass Road, Fort Wayne, IN 46808

(800) 222-4700 > www.sweetwater.com

ally *invents* little. So what the hell does he do that I think is so important that I keep giving him ink even though four out of five of you use notmacs?

INTEGRATE SCHEME OF LIFE...

He integrates. He integrates like no one ever before. He goes out into the world and tackles the unsolvable problems that everyone else pisses and moans about. And he solves them. Then he hooks up all his new friends and—wah-friggin'-la: iPod/iTunes Music Store, and maybe even better, iLife.

Again, nothing technically earth shattering, he just gets existing incompatible components to work together so well that the end result works as a single concept far exceeding the sum of its parts. And remember, these parts have been available to everyone else out there, but they just couldn't pull it together. In the case of the iTunes Music Store, everybody has been far too busy talking about how no major labels would ever sign up for such a thing considering how lethal the Internet is. Yawn.

But Steve did in fact meet and negotiate with these labels, and he *did* get the majors to sign up. The rest is already history, with

everybody from microsoft to Pep Boys offering me-too services now after the fact. Capitalism and greed are *sooo* cute together.

iLIKE iLIFE AND iBET iCAN TELL YOU WHY iAM NOT THE ONLY ONE (i'M SO SORRY)

The following have existed for years now: baby music-making apps, music organizer/browser/player apps, photo-management packages, digital video editors, DVD builders and even MP3 players, along with mail apps and calendars. Hundreds of varieties exist, with thousands of combinations of compatibilities and incompatibilities. So it has been, and so it would have always been it seems.

Apple bought a lot of apps and companies. Then they wrote a lot of code integrating them or their core technologies with each other and with Mac's OS X. And it *works*. The total is more than the components, and this total is included free with every Mac. You get a computer that does just about everything that any normal citizen interested in media would need. An all-inclusive virtual vacation in media paradise. All you pay for is the alcohol. When you learn how to use *any* of these apps, you know how to use all the oth-

ers. It's magic. Dangerous magic, actually.

Dangerous because with every additional integration (have you looked at GarageBand and then Logic?), more third-party developers (not counting, of course, the ones that are bought) are slapped in the face and may be walking away. This behavior is almost unique to Apple.

And magic because—and here is this month's point—this type of integration is probably the key to us, the non-ordinary citizens eventually getting our long-awaited virtual studios, our coveted desktop production stations. Bold, visionary integration skills can get the job done. Whining about how overwhelming the task is and how nobody will ever go along will not, and never has gotten *any* job done. Billy, can you hear me?

BUT I WANT CHOCOLATE, NOT VANILLA

No one application can be the answer for everyone. It can dominate, but it can't be what *everybody* actually wants. Look at how many deeply dissatisfied and angry Pro Tools users there are—but they are still users, locked into its *de facto* format be-

—CONTINUED ON PAGE 145

The z-Qualizer



(z-Qualizer, \$1200 MSRP)

World-class **On a**
digital **project-studio**
EQ **budget**

Z-Systems Audio Engineering
www.z-sys.com
z-sys@z-sys.com

Introducing the z-Qualizer by Z-Systems Audio Engineering. For nearly a decade, the world's top mastering engineers have relied on Z-Systems digital equalizers for their daily work. Whatever the job -- pop, metal, country, jazz, or classical -- our digital EQs are known for delivering the soul of the best analog processors with the precision that only digital can bring.

Now you, too, can have the same glorious-sounding digital EQ algorithms in a small, affordable package. Break the plug-in habit and hear what a world-class outboard EQ can do for your projects.

ZSYS.

To locate a Z-Systems dealer near you, contact TransAmerica Audio Group at 702.365.5155 or sales@transaudiogroup.com

EmulatorX

Desktop Sampling Systems

The Next Generation of Professional Sampling

Emulator® X is the culmination of over 30 years of sampler development; combining the pristine sound quality, powerful synthesis and legendary filters of E-MU's hardware samplers with the disk streaming, file management, and interface advantages of software. Emulator X is a true professional sampler from the ground up, providing you with breakthrough tools for automated sampling and preset creation unlike anything that has come before.

- **Automated sampling and preset creation**

Effortlessly sample external sources and turn existing audio files into playable presets in seconds with a single click of your mouse.

- **Unmatched synthesis engine**

Over 50 patented Z-Plane morphing filters, 35 patchcords per voice, multi-wave LFO's, conditional voice modulation, clock modulation and a host of other synthesis features deliver unmatched control over your sounds.

- **Hard disk streaming and RAM playback**

- **Standalone and VSTi operation**

- **Comprehensive sound format support**

Includes EOS, EIII, GigaSampler™, Akai, HALion™, EXS24, SoundFont™ 2.1, .WAV and many more. Ships with over 2GB of sounds including a stunning multi-layer piano, complete Proteus™ 2000 sound set and more.

- **Integrated waveform editor**

Easily edit your samples with a host of professional DSP tools.

- **Hardware-accelerated effects processor**

Over 20 plug-in effects (more than 500 presets).

- **24-bit/192kHz I/O**

Mastering-grade converters guarantees pristine sampling and playback of your audio.



*Estimated Street Price

©2004 E-MU is a registered trademark of E-MU Systems, Inc. in the US and other countries. All other brand names are the property of their respective owners.

www.emu.com
8 7 7 . 7 4 2 . 6 0 8 4



World Radio History

In a Silent Way

Why Is Everything So Darn Loud?

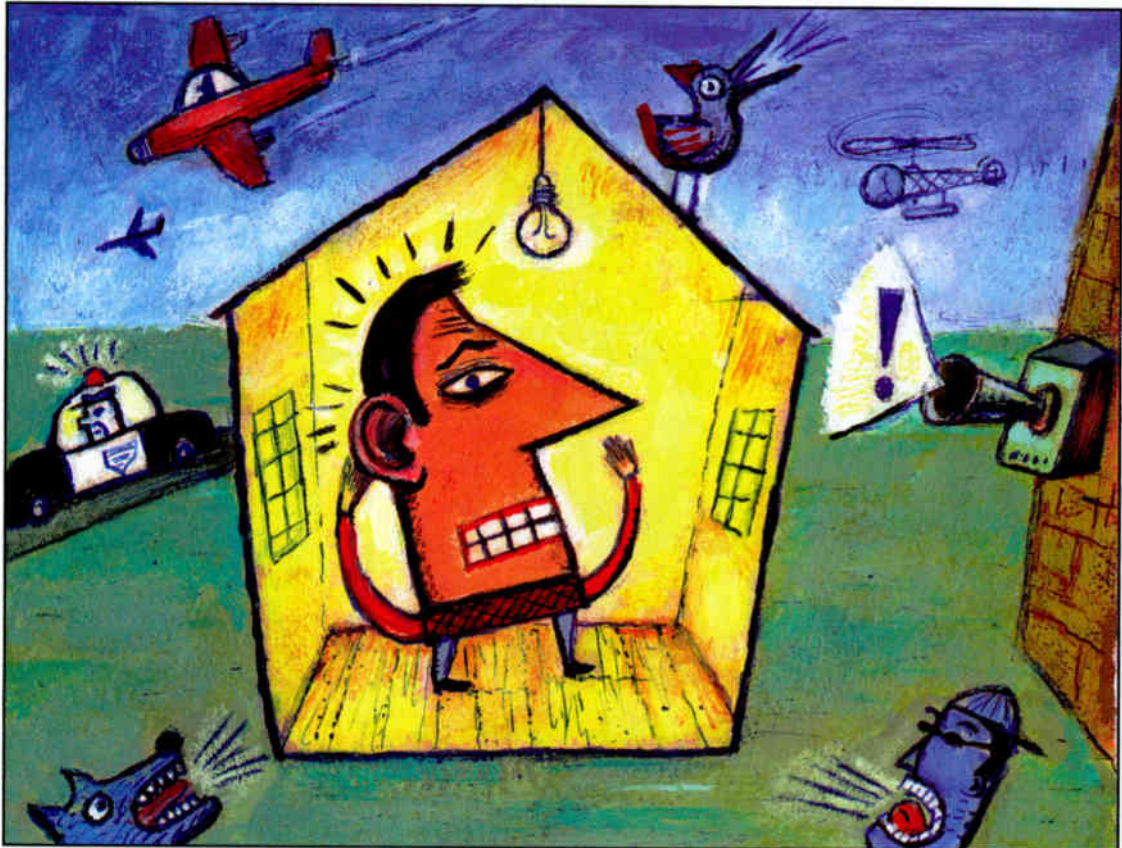

ILLUSTRATION: ANDREW SHACHAT

"Beautiful, isn't it?" Gomez said. She seemed to sense that he was uneasy.

"Yes, beautiful," he answered. But he didn't feel that way at all; something about this forest struck him as sinister. He turned round and round, trying to understand why he had the distinct feeling that something was wrong with what he was seeing. Something was missing or out of place. Finally, he said, "What's wrong?"

She laughed. "Oh, that," she said. "Listen."

I knew the movie version of *Timeline*, Michael Crichton's latest Cassandrian sci-fi tome to get the Hollywood treatment, was going to be a stinker when I saw the preview. It came on before *School of Rock*, and it was way, way louder than anything Jack Black could coax out of those precocious kids and his van full of amps. It featured stampeding horses, clashing armor, and various and sundry explosions, all of which had precious little to do with the 14th-century world that Crichton, in his usual convincing fashion, had constructed in his novel.

Chris stood silently for a moment, listening. There was the chirp of birds, the soft rustle of a faint breeze in the trees. But other than that...

"I don't hear anything."

"That's right," Gomez said. "It upsets some people when they first arrive. There's no ambient noise here: no radio or TV, no airplanes, no machinery, no passing cars. In the twentieth century, we're so accustomed to hearing sound all the time, the silence feels creepy."

And not only do we hear sound all of the time, but it's loud sound, and it's getting louder. The amount of noise that we put up with in our average existence is, when you think about it, pretty awful. So I thought I'd talk this month about noise, environmental and otherwise.

When was the last time you really heard silence? I mean outside of a well-built studio or when you didn't have heavy-duty headphones clamped on your skull. The neighborhood where I live is known as one of the quietest in the Boston suburbs. When a teenage driver honks his horn at night to announce his arrival at a friend's house, neighbors complain to the parents. People tend to

Sound At The Speed Of Light

Imagine a snake system capable of handling a major tour that's light enough to carry over your shoulder. One that gives you...

- limitless lossless splitting and routing options
- built-in phantom power on every channel
- 24bit/96kHz sampling, balanced/unbalanced analog and AES/EBU digital outputs on every channel
- no need for DI's – ever

Imagine a digital snake system as transparent and easy to use as any snake you've ever used – plug and play – that COSTS FAR LESS than other digital snake systems. One that lets you focus on your show – not the snake.

Introducing LightViper - the world's ONLY digital fiber-optic snake system with this unique combination of features. Its 32 x 8 fiber optic cable can run more than 1.25 miles with no loss and no ground loops, while standing up to tough military standards. Now, the only way you'll encounter that scenario is on a USO tour, but the point is, LightViper can handle ANYTHING that's thrown its way and still come out shining.



LightViper
FIBER OPTIC AUDIO SNAKE

MADE IN THE USA BY:

fiberplex inc. www.lightviper.com • 301.604.0100 • sales@lightviper.com



**ACOUSTICAL
SOLUTIONS
INC.**

- **ABSORBERS**
- **BARRIERS**
- **DIFFUSERS**



WoodTrends Wall & Ceiling Panels



Alphasorb & Soundsuede Wall Panels

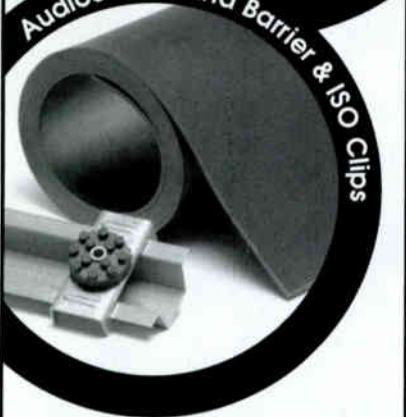

AudioSeal Sound Barrier & ISO Clips

Free Catalog
& Sample

800.782.5742

www.acousticalsolutions.com

NSCA BOOTH #2708

INSIDER AUDIO

not set their car alarms, because they know how annoying they can be when they go off. Stepping onto my front porch on a calm January weekend evening, when there are no insects spreading their aural blanket and birds aren't yet rolling out their mating calls, the world seems, at first blush, silent. But after a few seconds, I realize I can easily hear the traffic on the freeway over a mile away, the buzz of a transformer on a pole overhead, a distant police siren, someone on the next block starting their car and the endless procession of jets arcing up from Logan Airport, eight miles distant. It's noisy out here.

Inside my house, with the Anderson

Audiences are accustomed
to loud music in their
homes, in their cars,
at the movies and at
concerts.

double-paned windows shut tight against the cold and noise from outside, I can hear the furnace in the basement, the 60Hz hum from the light dimmers in the kitchen, the low rumble from the oil delivery truck down the street, the ticking of the security timer in the closet, and, of course, the fan and disk drive in my computer. It's noisy in here, too.

Few of us today really know what silence is, and since the beginning of the Industrial Revolution, the level of background noise has been constantly rising. Ironically, city streets may be one of the few environments where this trend has managed to reverse itself, at least a little: Recent efforts to improve traffic flow, make horn-honking a violation and tighten restrictions on car and truck exhaust noise have successfully reduced the ambient level in many urban cores. But as the streets may have become slightly less oppressive, many indoor environments are significantly more so. Who can walk into a modern office building or hotel lobby without feeling assaulted by the awful background music, the splashing from fake waterfalls and the walla from the coffee shop and bar amplified a hundredfold by the vaulted glass ceilings?

Even spaces that are supposedly designed for listening are becoming aurally unfriendly. My wife, a professional storyteller, performs for children in schools and libraries. When she first started, it was no problem to do a show for 100 children with-

out electronic assistance, but in newer buildings, she finds that she needs a sound system for groups of 50 or even fewer, unless she wants to come home with laryngitis. It's not that the kids are noisier—she's really good at getting them to be quiet—it's that she has to make herself heard over the ubiquitous "air exchange" systems: positive ventilation systems that seem to have been installed primarily to protect the builders from lawsuits resulting from "sick building syndrome." Teachers, librarians and even custodians are often powerless to shut them down, as they're on undefeatable timers. No doubt that representatives from the schools carefully considered lots of data when they spec'd these systems, like air volume and energy use, but unlike when you put in that ventilation system in your control room, no one at the school board thought to ask how loud it was going to be. That's too bad, because those systems deny the students the power and magic that come with direct, personal contact with a performer. Not to mention they throw away any effort or money spent on room acoustics.

There's a new trend in doctors' offices that you may have noticed. As medical practices get larger and more practitioners are crammed into smaller spaces, patient confidentiality is endangered because it's harder to keep those in adjacent treatment rooms from overhearing each other's complaints. So have office designers tried to acoustically isolate the rooms better? No, they buy doctors machines that generate white noise to cover up the conversations. They are effective unless the patient has a hearing problem, in which case the whole office can overhear the doctor shouting.

Theaters are getting louder, too, but not because of bad design. The days when someone like Rex Harrison, whose singing voice could hardly be called operatic, could be heard in *My Fair Lady* as clear as a bell in the back row of the balcony at the Mark Hellinger Theater are long gone. Harrison, or for that matter a vocal powerhouse like Bernadette Peters, can't keep up with the elevated sound levels that people expect to hear today, especially if they're going to make it through eight shows a week. Audiences are accustomed to loud music in their homes, in their cars, at the movies and at concerts, and so they expect to get the same impact from theater orchestras, which means that even the best singers need help to be heard.

It's not a good trade-off. I know I'm hopelessly old school, but I can't think of a single theatrical performance I've ever seen that used amplification and didn't suffer be-

—CONTINUED ON PAGE 146

Introducing Nuendo 2.0 - The professional solution

Nuendo 2.0 forms the core of a complete solution for today's audio professional. Nuendo's superior audio quality is combined with advanced mixing, routing, editing, and networking capabilities as well as professional components such as the new ID Controller, Time Base Synchronizer, 8 I/O 96k AD/DA Convertors, and DTS and Dolby Surround Encoding Plug-ins. A system so scalable - from laptop to installation - the choices are endless.

Nuendo 2.0:

- A new configurable mixer, toolbar, and transport control
- Multiple 12 channel busses for "stem" monitoring up to 10.2
- Multiple output configurations for multiple speaker set-ups
- Plug-in delay compensation throughout entire audio chain
- Flexible routing: any input to any output at any point
- Hyper-threading support for optimum performance
- Automation that moves with the audio data
- Support for Microsoft's WMA Pro (audio and video)
- Multiple time-lines and multiple VST directories
- VST System Link and TCP/IP networking
- Unlimited Rewire 2 channels
- Comprehensive MIDI functionality

Nuendo 2.0

The solution is clear. The choice is now yours.



Nuendo and Steinberg are registered trademarks of Steinberg Media Technologies GmbH. All other product and company names are TM or [®] of their respective holders. All specifications are subject to change without notice. © 2003 Steinberg Media Technologies GmbH. All rights reserved.



Don't get handcuffed by your SAN software



SANmpTM
Multi-Platform Management Software

Facilities around the world are realizing that their SAN must support multiple platforms. Will your storage network support your choice of operating systems? SANmp management software is the best choice no matter which platforms you use.

Each copy of SANmp includes a license for Mac OS 9, OS X, Windows 2000 and Windows XP at no additional charge. That means your entire facility can have true, shared centralized storage and archival - now and in the future.

- Supports Final Cut Pro[®], Avid[®], Nuendo[®], Pro Tools[®], and many others
- Supports Xserve RAID - all platforms
- Concurrent access to centralized storage
- Password protected storage
- No server or Ethernet connection required

www.sanmp.com



studio network solutions

www.studionetworksolutions.com
toll free 877.537.2094

OCEANS OF AUDIO,

RIVERS OF BITS

DIAGRAM COURTESY ANGEL MOUNTAIN STUDIOS

STORAGE AREA NETWORKS FOR EVERY AUDIO APPLICATION

BY RON FRANKLIN

It used to be that keeping track of audio or video projects meant pulling the appropriate tape reel out of the vault and cueing up the next session. But let's face it, in a digital age, audio is data. Tape vaults have been replaced by stacks of hard drives. These drives not only hold the raw digital bits that our workstations turn into audio and video, they also hold zillions of MIDI tracks, sampled sound collections, libraries of music or sound effects, and all of the metadata—the data about the data—such as log files, track sheets, databases, client billing records and much more.

When I first started working in Hollywood in the mid-1980s, hard drives came in denominations of 10 and 20 megabytes. If you could string several together (a risky proposition given the delicate nature of the early SCSI interface), then you could even get several whole songs (in stereo) on a single system! Fast forward to today when 24-bit, 48kHz audio is standard, alongside other bit-voracious rates such as 96 kHz, 192 kHz or even DSD. Now add high track counts for most projects and integrated digi-

tal video for post. Clearly, storage needs have become a major consideration in planning any kind of creative media environment, whether a home project studio or a multi-room facility.

With hard drives now ranging up to 250 GB in capacity, available storage on individual drives has certainly been keeping up with the demands of contemporary projects. But storage attached directly to a single workstation still belongs in the category of local attached storage. This means that other computers in a network can't really take full advantage of all that storage, even if they can "see" it over a local area network (LAN). To be really useful, each workstation has to be able to access shared media storage drives over a high-speed connection that can reliably deliver multiple tracks of data without choking.

The "gold standard" in speedy drive access for many years was SCSI (Small Computer Systems Interface), an interface that provided enough speed to handle the demands of multiple channels of real-time digital media. Unfortunately, with SCSI there are three or four points of potential failure: SCSI interface cards can fail, cables can fail, termination can be a problem, etc.

The types of data bus by which drives can be attached have now grown to include not only SCSI, but also FireWire (IEEE 1394), Serial ATA (a more efficient replacement for the parallel ATA used for IDE drives on most PCs), Fibre Channel, iSCSI (SCSI over Internet Protocol, a rapidly emerging technology) and even USB. All of them can deliver data, but some such as USB will not have the

OCEANS OF AUDIO, RIVERS OF BITS

speed you need to deliver high track counts of digital audio. For most audio applications, the choice comes down to SCSI, FireWire or Fibre Channel. There is also a choice to be made between using single drives or RAIDs. In network parlance, a collection of single drives is called JBOD, or Just a Bunch Of Disks. A RAID (Redundant Array of Independent Disks) can bring an extra amount of data security, as data is written redundantly to more than one drive, and any information lost due to failure of any single disk in the array can usually be recovered from the other disks.

And whichever technology one chooses for the drives and data bus, the two biggest problems plaguing local attached storage solutions are scalability and networkability.

Enter the storage area network (SAN). The primary purpose of a SAN is to provide a dedicated network to transfer data between computer systems and storage elements, and among storage elements. While local attached storage may provide a way for a few servers on a network to share a few hundred gigabytes of data over relatively modest connections (Ethernet) or via "sneaker net," the solution provided by a SAN can scale to allow for terabytes of information delivered reliably at high

speed to large numbers of stations.

The most common implementation of SANs today uses a high-speed serial I/O bus called Fibre Channel, which is capable of transferring data between ports at 100 MB/second or more. To be clear: You can use Fibre Channel drives as local attached storage, but you can also upgrade and integrate the FC drives into a SAN configuration when more workstations need to access that same storage.

There are networked data solutions for every application, whether it's as simple as hooking up two FireWire drives in your project studio or managing terabytes of data in a huge corporation. Here's a look at some of the more popular solutions currently available to digital music and post facilities.

DIGITAL AUDIO/VIDEO SPECIALISTS

Lucky for us audio people there are a number of companies that specialize in serving the unique needs of digital audio/video production. In many cases, the software solutions created by these specialty companies are designed to work seamlessly in the context of popular audio/video workstations.

One of the earliest companies in the professional digital media world to offer networking solutions for digital media data was Avid Technology. The company's Avid Unity MediaNetwork is designed specifically for sharing high-bandwidth digital media files between networked workstations. Unity's software takes advantage of Avid's file system architecture, allowing multiple users to access the same media files in a collaborative work group. The system includes a file server, the Avid Unity MEDIA-Switch, Avid Unity File manager

software and other software for system administration and performance monitoring. Configurations can be customized with storage and interface cards. According to Avid, the Unity system can handle more than 60 simultaneous real-time clients (200 simultaneous DV25 streams) with 200 48kHz audio tracks, all sharing the same media at the same time. The lower-cost Avid Unity LANShare EX is designed for small to mid-

size facilities as a cost-effective way to implement a SAN over Fibre Channel and Ethernet. For more information, see www.avid.com/products/unitymedianetwork.

Glyph Technologies (www.glyphtech.com) is familiar to many workstation users in the pro audio industry. The company had an early storage system called CodaSAN, and although a SAN solution is still available, Glyph has switched its main focus to providing "hot-swap" storage for the small to medium-sized operation. Glyph's line of hot-swap FireWire systems ranges from the Glyph GT 051 single-drive enclosure with an MSRP of \$499 to the Glyph GT 308, a three-space eight-bay enclosure that comes with the choice of two to six hot-swappable GT Key drives. Its SCSI/FireWire expansion bay offers the option of AIT backup, SCSI hot-swap receiving bay and DVD-R/RW and/or CD-R/RW. (Price varies depending on configuration.) Addressing concerns about the speed of FireWire compared to Fibre Channel, Glyph director of marketing Peter Glanville says, "The FireWire 400 bus offers 40 megabytes per second. In our experience, this easily handles the track counts most audio workstations use." Many of Glyph's products include its QuietMetal™ technology, which blocks the vibration of the hard drive and fan from reaching the enclosure by using a trilaminate construction.

Another longtime force in storage for digital media users is Rorke Data (www.rorke.com), a division of Bell Microproducts. Rorke products range from desktop storage and SCSI hot-swap systems to Fibre Channel SANs, incorporating the latest Serial ATA technology in the context of a SAN. Director of product development Pam Moeller says, "While we're selling a lot of Fibre Channel-based systems, we've also recently launched some new Serial ATA-based drives. These are lower-cost RAID systems that use the SATA drive technologies." Rorke has not pursued FireWire drive technology in any of its products, leaning instead toward the Fibre Channel and SATA technologies. Moeller notes that "we prefer the Fibre Channel connectivity and have tended toward this solution for bigger SAN facilities."

Rorke's Galaxy-i product line, targeted toward post-production, offers a choice of high-performance 2-gigabits-per-second Fibre Channel or SCSI-160 controller technology with high-capacity, cost-effective Serial ATA drive technology. Products include the Galaxy-16i Series with up to 4.8 terabytes in a single rack with single- or dual-controller and JBOD expansion capability available with either Fibre Channel or SCSI storage. The Galaxy-12LPi has similar

In Session With SAN: Metallica

The vast storage capabilities and extreme reliability of a Fibre Channel SAN can radically change the way a project can be approached so that it becomes a creative tool

in its own right. As an example, a Fibre Channel SAN proved a major factor in the creation of the latest album release of legendary heavy metal band Metallica. The band's digital audio engineer Mike Gillies describes what he believes to be "a first" in the recording process:

"For the *St. Anger* sessions, not one bandmember showed up to the studio with a single riff or lyric written," he states. "They would jam out for hours, sometimes for eight- to nine-hour sessions, and anytime anyone had an instrument in their hands, I recorded it. Then we went through and found the little bits that we liked, looped them and that's how the songs were written. This just isn't the way records are made, and there is no way this could be done before the Fibre Channel technology of the [SNS] A/V SAN."



software and other software for system administration and performance monitoring. Configurations can be customized with storage and interface cards. According to Avid, the Unity system can handle more than 60 simultaneous real-time clients (200 simultaneous DV25 streams) with 200 48kHz audio tracks, all sharing the same media at the same time. The lower-cost Avid Unity LANShare EX is designed for small to mid-

FW-1884

"TASCAM's FW-1884 is the answer for desktop musicians who like the Digi 002 design concept but don't want to switch to a new DAW."

ELECTRONIC MUSICIAN MAGAZINE NOVEMBER 2003



Assignable foot-switch jack for punch-ins or MIDI control

Eight analog outputs for L/R and 5.1 surround sound matrices.

Fourteen DAW shortcut buttons including Save, Revert, All Safe, Marker, Loop, Cut, Delete Copy, Paste, ALT/CMD, Undo, Shift and CTRL

Eight channel inserts.

Eight channel strips with 100mm, touch-sensitive motorized faders, Mute, Solo and Select buttons, Pan, trim and access to 4-band parametric EQ*. Rotary encoders can be assigned to 8 Auxes or Pan via keypad.

Optional FE-8 expander.

Add banks of eight channel strips with FE-8 expanders.

Separate Phones, Monitor and Solo (AFL/PFL) controls.

It's an 18-input-Firewire™ audio I/O box, a 4-in/4-out MIDI interface...and a motorized fader controller for popular DAW programs!

Co-developed with Frontier Design Group, the FW-1884 has everything you need to maximize workstation productivity in a single intuitive tool. For far less than the cost of a piecemeal approach.

Fire up the FW-1884 at a TASCAM dealer or visit our web site for more information.

Eight channels of ADAT® lightpipe I/O and stereo S/PDIF inputs & outputs.

Extra Firewire port so you can connect to external hard disks or daisy-chain to our FE-8 expander.

Word Clock in and out for accurate sync with computer systems.

Four MIDI inputs and four MIDI outputs for sound generation and timing.

Eight balanced 1/4" XLR analog Mic/Line inputs with studio-grade, high-headroom, low-noise mic preamps and switchable phantom power. XLR Input 8 is even switchable from Mic/Line to Guitar level.

Rotary jog/shuttle.

◻ ◻ No mouse-and-keyboard juggling: Dedicated transport buttons plus Nudge, cursor, In/Out/Set, Locate, function and Bank Switch keys.

24-bit A/Ds & D/A; 96kHz operation with applicable DAW software.

CO-DEVELOPED WITH FRONTIER DESIGN GROUP

Mapped controls for Digital Performer™, Nuendo®, Logic™, Sonar™ and Cubase®.

TASCAM



* via EQ feature set of compatible DAW software. ©2003 TASCAM All Rights Reserved. All features and specifications are subject to change without notice. Sonar is a trademark of Twelve Tone Systems. Nuendo and Cubase are registered trademarks of Steinberg Media Technologies AG. Digital Performer is a trademark of Mark of the Unicorn. Logic is a trademark of Emagic/Apule Computers.

CONTRACTOR
World Radio History

www.tascam.com

DJ AND PRODUCER

PERSONAL CREATIVITY

OCEANS OF AUDIO, RIVERS OF BITS

capabilities with capacity to 3.6 TB using a single controller with Fibre Channel or SCSI in a 2U rackspace server, while the Galaxy-8LPi provides up to 2.4 TB with the same specifications.

A key component of Rorke's line is ImageSAN file-level SAN-management software, which lets users share files without causing any corruption of the data traffic. "We have volume-level as well as file-level sharing products," says Moeller. "While our current implementation doesn't support cross-platform file sharing, this is in our development plans for the future of our Image SAN product."

Studio Network Solutions (www.studionetworksolutions.com) provides Fibre Channel SAN technology for post-production audio and video clients. According to CEO Gary Holladay, the industry is moving toward Fibre Channel and away from IDE, SCSI or FireWire as media drives due to concerns over reliability and capability (track count available from a drive). Holladay says, "People look into our solutions when they can no longer afford downtime or the instability of hot-swap. The new Pro Tools|HD Accel requires eight FireWire drives to operate to full track count right now. We can put together a four-seat system that guarantees

full track count on every workstation for less than \$20k."

Fibre Channel SAN improves the number of tracks that can be played simultaneously from a single drive. For example, the A/V SAN can deliver 128 tracks of 24-bit/48k audio from a single drive. Featuring up to 400 MB/s (200 MB/s per port) of throughput and concurrent access for multi-users, the unit also allows simultaneous data backup while using the drives.

Even an individual user with a single workstation can benefit: "Studio Network Solutions Fibredrive II starts at less than \$2,000 MSRP and offers everything that you need from a drive system," says Holladay. "It is the first step to a multi-user SAN because you already have purchased the FC card, cable and drive(s) and, like the A/V SAN, you can use this as part of a larger system as you grow."

SNS' SANmp cross-platform network software offers features such as auto-sync, database redundancy and hardware RAID support for Pro Tools and other DAWs, plus SANscan, which lets editors find sessions on the drive array without mounting the storage on the desktop.

With all of the recent improvements in the price/performance ratio, a multi-user SAN is now less expensive and adds considerably more value than buying local storage for each machine in a multi-workstation environment. Holladay points out the advantages that the SAN offers in this case: "You get the benefits of sharing the

drives in multiple rooms at the same time, eliminating 'sneaker net' and eliminating the need to move FireWire/SCSI drives all around the studio and having to spread the session data across multiple drives. You also get the benefit of simplified backup since all data is centralized.

Since the cost is more realistic these days, SAN is a pretty easy decision. In the past, when the drives were twice the cost of SCSI, you had to invest quite a bit in the whole system, but like anything else in the comput-

er realm, prices go down and you get more—as it should be."

BIG BUSINESS, BIG NETWORKS

Networked storage is big business, so it's not surprising that some very big companies have extensive solutions going well beyond typical audio/video needs. For users interested in putting together a robust, large-scale SAN, here are a few examples.

ADTX (www.adtx.com) is a Japanese company with a U.S. office in Irvine, Calif. The company's RAID systems include desktop and rackmount units using Fibre Channel or FireWire connectivity. The Array MasStore FC Series is a scalable Fibre Channel RAID solution available in configurations for small and medium installations, while the Array MasStore FCII is designed for larger data centers. The Array MasStor L Series incorporates Serial ATA RAID technology. The company also provides interface cards, including SCSI-to-IDE and FireWire-to-SCSI converters. The DV MasStor system allows direct, computerless recording and playback of high-quality digital video. ADTX is an investor in the U.S. company mSoft Inc., a supplier of sound library servers, and mSoft delivers its systems using ADTX RAIDs.

Advanced Digital Information Corporation (www.adic.com) makes tape library products; disk-based backup systems; software for backup, file sharing and archiving; and SAN appliances. Its SNC 5000 expands storage network functionality by linking devices that use different protocols, letting dissimilar operating systems share the same fabric, dynamically mapping diskless servers to disk volumes and providing access security.

Atto Technology Inc. (www.attotech.com) makes a wide variety of host adapter products for connecting storage and specialized software for controlling RAIDs and SANs. In addition to a variety of SCSI host adapters, notable products include the ATTO FibreBridge™ Fibre Channel-to-SCSI bridges and ATTO ExpressPCI 1- and 2-gigabit Fibre Channel host bus adapters. For SAN customers, the company offers ATTO AccelWare, its SAN volume-management software. For use with RAIDs, there is the ATTO ExpressRAID software and the ATTO ExpressStripe for Mac OS X.

EMC Corporation (www.emc.com/products) offers a full range of networked storage products and services. The company's Automated Network Storage system manages the storage and distribution of programming and advertising for Turner Broadcasting's 19 entertainment cable TV networks, including TNT, TBS, The Cartoon Network and Turner Classic Movies. Products include the Symmetrix DMX series of high-end SAN solutions and the

SAN In Post: Walter Murch and "Cold Mountain"

Another recent example of a Fibre Channel SAN providing solid support in a difficult creative environment was Oscar-winning picture and sound editor Walter Murch's use of a storage area network from Rorke Data during the editing of Anthony Minghella's Civil War film, *Cold Mountain*. (At press time, Murch was nominated for Best Film Editing for *Cold Mountain*.) The system included four Apple Final Cut Pro workstations running on a SAN loaded with 1.2 terabytes of storage set up near the film's shooting location in Bucharest, Romania. The workflow and scale for *Cold Mountain* were enormous, comprising 4,900 takes, 830 daily rolls, 225 video tapes and 190 sound rolls, all used for recording the film's 211 total scenes shot over 113 days. Having this vast amount of media data available to each of the workstations on the SAN contributed to the ease and flexibility with which the editorial team was able to work their creative magic.

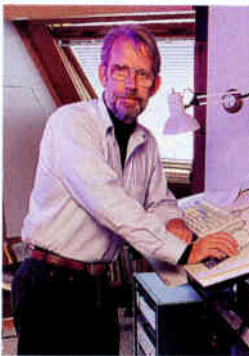

Analog Eye for the Digital Guy

So you have the computer, your favorite audio software, but you're still not getting "that" illusive sound. UA has the gear you really need to take your recordings to the next level. It's time to give your DAW a sonic makeover.

From the TEC award winning **6176 Channel Strip**, the EQ/PAR awarded **2192 Master Audio Interface** and the multi-honored **UAD-1 DSP Card** with classic modeled plugs, UA delivers the sonic results that Pros depend upon.

Whatever your DAW or budget, UA has a complete product line with the quality you're looking for from 44.1 all the way to 192k. Whether its stunning mic-pres, classic compression, pristine conversion or simply the best sounding plug-ins (TDM, VST, AU, MAS & DX), UA can supercharge your existing studio rig.

Hear the difference. Upgrade to UA.



UNIVERSAL AUDIO



(awards for UAD-1 and/or included plug-ins)

analog ears | digital minds



UAD-1 DSP Card & 20 Plug-Ins



2192 Master Audio Interface



6176 Channel Strip

All UA Products are Designed and Assembled with Care in the USA

330 Encinal, Santa Cruz, CA 95060-2101 • www.uaudio.com • toll-free: 866-UAD-1176 • voice: 831-466-3737 • fax: 831-466-3775

©2003 Universal Audio, Inc. All Rights Reserved. The Universal Audio Name, Logo, "2192" and "6176" are property of Universal Audio.

OCEANS OF AUDIO, RIVERS OF BITS

CLARiiON Series of entry-level networked storage systems.

Emulex Corporation (www.emulex.com) is the world's largest supplier and devel-

oper of storage networking host bus adapters. The company has a vast range of HBAs for Fibre Channel and also offers an iSCSI interface. The Emulex GN9000/SI host bus adapter is a high-performance iSCSI HBA featuring 64-bit PCI v2.2 and 1Gb/s data rate using industry-standard Gigabit



From SCSI to SAN: Angel Mountain Productions

The variety of audio and video mixing and editing suites at Angel Mountain Studios in Bethlehem, Pa. [see "On the Cover," September 2003], makes for a complex network of attached workstations. Simultaneous multiproject demands were taxing the facility's SCSI-based storage infrastructure, so they upgraded to a Studio Network Solutions SAN. Manager Carl James summarizes the studio's systems:

"We have five Pro Tools|HD3 rooms running on Apple G4s. The computers are rackmounted in machine rooms with the monitors connected at the mix location by Geffen extenders. There are also two Apple Final Cut Pro stations running uncompressed on Cinewave hardware installed on G4s and an Apple XServe in our central machine room."

Bringing these computers into the network requires installation of a PCI Fibre Channel card that connects to the SAN switch in the CMR. The SAN has a terabyte of storage dedicated to audio, divided among 72GB and 144GB Fibre Channel drives, and a 500GB Fibre Channel striped array

(RAID) for video.

"The XServe in the central machine room functions as the SAN administrator computer," James continues. "It also houses an Atto dual SCSI card that ties to a set of Jems Data SCSI hot-swap bays, and LTO, AIT, VXA and DDS tape drives for output and archival purposes. In addition, there is a 3-D animation G4, a compositing and DVD-authoring workstation G4 and a render farm of four Xserves—one of which has the seat on the SAN—that all interconnect with the two video workstations via a Gigabit Ethernet LAN."

Upgrading to a SAN has streamlined Angel Mountain's workflow. "A project can now migrate from one room to another with little effort and attention to asset management," says James. "Secondly, the speed of the Fibre Channel storage running over the SAN reduced the drive count per project: We can now run 128 tracks at 48k or 64 tracks at 96k from one drive, a reduction of four to one over our previous setup."



Toft Audio Designs

The Legend Continues...
MALCOLM TOFT (PROUDLY ENDORSING)



INTRODUCING
ATC-2 TWO CHANNEL MIC PRE / COMPRESSOR / EQUALIZER
AFC-2 DUAL CHANNEL EQ / MIC PRE

Ethernet networks.

Hewlett Packard offers a wide variety of SAN hardware components, including Fibre Channel switches, host bus adapters, and iSCSI routers and gateways. The HP StorageWorks SAN is its flagship SAN offering. HP also has a wide range of storage-management software and servers. To find out more, go to <http://www.hewlett-packard.com>.

IBM's (www.storage.ibm.com/ibmsan) SAN Integration Server is designed to help integrate IBM virtualization technology, Fibre Channel switches and RAID technologies into a preconfigured, comprehensive solution. The SAN Integration Server will initially be capable of scaling to more than 100 terabytes of storage capacity and connecting up to 42 hosts.

Network Appliance (www.netapp.com) offers enterprise storage systems and near-line storage solutions for backup and archiving applications. The company's Net-App® fabric-attached storage (FAS) systems are designed to be affordable, highly scalable and upgradable.

Nexsan (www.nexsan.com) is a technology company focused on providing ATA drive-based RAID and iSCSI storage solutions. The InfiniSAN ATAbay2 RAID array combines ATA disk drives with SCSI or FC connections, receiving the highest rating among storage products tested by Infoworld in 2003.

Omneon Media Server Systems (www.omneon.com) focuses on the broadcast and video industry. The company's Omneon Spectrum™ media server system incorporates an open architecture with a variety of components chosen from its MediaServer, MediaStore, MediaPort and software MediaTools product lines. Designed to make various formats of video files simultaneously available to multiple users, Omneon has partnered with several media companies to support its editing products, including Apple and Editware.

RAID Inc. (www.raidinc.com) acquired the assets of Jems Data in 2002, and the combined company now offers both direct attached storage and storage area network products. The Falcon Series uses Serial ATA drives, includes both U160 SCSI and 2GB Fibre Channel interfaces in 8, 12 and 16-bay configurations and can accommodate up to 4.8 TB of storage capacity in a compact 3U form factor.

Seachange International (www.schange.com) focuses on the broadcast market and is a major provider of servers and networks for television. Its products are well known as digital advertising spot-insertion systems.

Silicon Graphics' (www.sgi.com) SGI InfiniteStorage solutions are designed to

work flexibly to share data across file systems, including Windows, Unix, Macintosh, Irix, Linux, etc. The company's InfiniteStorage SAN 2000 is the entry-level system using the SGI® InfiniteStorage Shared Filesystem CXFS.

Xiotech Corporation (www.xitech.com) offers the Magnitude and Magnitude 3D line of SAN products. The company's patented technology is used to create fiber-distributed storage clusters that emphasize scalability and resilience. Major media customers include Warner Brothers Entertainment, which estimates that its storage system needs are growing at about 1 terabyte a quarter.

FINAL WORD

How do you know when a technology has really arrived? There are no hard and fast rules, but a good indication might be when it reaches such a level of maturity that it actively assists in the creative process, not bogging it down with needless complexity and maintenance problems. By that measure, it seems fair to say that the era of the storage area network has arrived.

MIX
ONLINE
EXTRAS

Ron Franklin is a principal with Atira Media LLC, a multimedia production company based in San Diego, Calif. (www.atiramedia.com). He can be reached at ron@ronfranklin.net.

MESA RECTIFIER® RECORDING PREAMPLIFIER

RECTIFY YOUR TRACKS...

In the world of recording things move fast. Session time speeds by, technology races faster than the sounds we craft, and the only thing that seems to slow are the learning curves. Wouldn't it be great to invest your precious green stash in something that won't be obsolete next month or need new software the day you bring it home. There's only one cure. Demand a horn-classic piece of old world, all-tube hardware that will stand the test of time.

The Rectifier® Recording Preamp is a bodacious hunk of pure old school magic that sounds huge and feels amazing to play. Six 12AX7's feed the dynamically active dedicated recording circuit to produce an inspiring vibe that will have you wanting to play for hours...direct through the board! So get down to your pro shop and check out a Recto® Pre. These guys were impressed and you will be too. Anchor your sound to gear that will be sticking around...and get on the fast track to timeless great tone.

"Channel 1 offers up classic sounds from the Beatles to the Bluebreakers, with all the punch and presence of a well mixed amp. In Channel 2's metal zone, the Rectifier serves up a low-end thump that I have yet to hear in a digital modeling unit."

Michael Ross
Horn Recording - Dec 2002

"For disciples of that elusive Recto sound, this is a serious tool that provides that tone (and a few others, as well) in a convenient recording package."

George Peterson
MIX Magazine - May 2003

"The Recto's value lies in its uncanny ability to reproduce the authentic timbres of a tube based guitar amp in a direct recording environment. If that's the sound you want, the Rectifier Recording Preamp delivers in spades."

Michael Cooper
Electronic Musician

MESA ENGINEERING

Get our 60 page full color catalog. Call us or send your name and address to the following address:

Mesa Boogie, 1317 Ross Street, Petaluma, CA 94954 707-778-6565 on the web at www.mesa-boogie.com

ONYX

PREMIUM ANALOG MIXERS
W/ PERKINS EQ® & FIREWIRE OPTION

All Onyx mixers have a built-in Talkback section with onboard mic.



Mackie's Onyx Development Team was comprised of veteran analog and digital engineers from the great Pacific Northwest (aka Woodinville, Wash). As a side note, this is the first time the elusive Viking Santa has been captured on film.



Engineering Director Chris Jubien puts an early Onyx prototype through its paces. Chris is from Canada, where he often tests audio gear in igloos.

Perkins

EQ

The Onyx 1220, 1620 and 1640 start with Mackie's new Onyx mic preamps, which meet or surpass any standalone mic preamp on the market in terms of pure fidelity and headroom (and yes, we have the specs to prove it). Next up is our completely new Perkins EQ circuitry, a "neo classic" 3- and 4-band design which gives you the sweet musicality of British EQ with greater filter control and minimum phase shift (plus a true hardware EQ bypass).



Two months to design a knob? Yep. Onyx knobs feature a more comfortable contoured shape with tapered top, smoother grip and a high-profile beak so you can almost mix blind.



In addition to balanced direct outputs on every channel via dual DB-25 connectors (a first for any small-format analog mixer), you can outfit each Onyx mixer with an optional FireWire I/O card, which lets you stream either 12 or 16 independent channels of 24-bit/96k audio, plus a stereo mix, directly to your Mac or PC. You can also monitor a stereo mix via FireWire from your computer, making our Onyx Series mixers superb audio interfaces to your digital world... or any other world you plan to rule.



**15 YEARS AGO,
MACKIE INTRODUCED
A WORKHORSE.**

**THIS YEAR,
WE UNLEASH OUR
NEW STALLIONS.**

ONYX

PREMIUM ANALOG MIXERS
W/ PERKINS EQ & FIREWIRE OPTION



☎ 800.258.6883 (Toll free within U.S.)
☎ 425.487.4333 (Outside U.S.)
✉ info@mackie.com

MACKIE.
www.mackie.com

BIGGER BETTER



PHOTO: MR. BONZAI

Product Hits Of Winter NAMM '04



• From January 15 to 18, 2004, as the East Coast was locked in one of the worst cold snaps in memory, some 74,000 music and audio industry pros made the annual pilgrimage to Winter NAMM in sunny Anaheim, Calif. With six-plus exhibition halls of musical instruments and sound technologies and a record 1,340 exhibitors, there was plenty to see. Here are a few of the hits.

There were enough plug-ins, synths, DAWs, live sound and pro audio debuts to fill a couple of AES shows, but NAMM would not be NAMM without gee-tars. **Fender** (www.fender.com) kicked off 2004 celebrating the Stratocaster's 50th birthday, unveiling several special models (retailing from \$1,599) that commemorate the anniversary of the most popular and influential electric guitar of all time. Ampmeister **Jim Marshall** (www.marshallamps.com) turns a still-young 80 and is honored in *Jim Marshall: The*

Father of Loud (www.backbeatbooks.com), a new 256-page biography by Rich Maloof. Meanwhile, Allen & Heath distributors North American Pro Audio announced the return of **Hagstrom** guitars—a fave of notables such as Frank Zappa, Elvis, The Beatles and Bryan Ferry—later this year. Stay tuned for more!

With the explosion of virtual synths, sometimes it's nice to get a little hands-on. **Korg** (www.korg.com) announced Triton Extreme, which features tube processing with an actual 12AU7 built in, a whopping 160 MB of ROM—including 1,334 programs, 50 drum kits and 1,280 combinations—audio CD-burning capability and USB connectivity. **Kurzweil** (www.kurzweilmusicsystems.com) debuted the 61-note VA1 analog modeling synth, featuring patented Power Shaped Oscillators that generate classic analog-style waveforms that can be smoothly "shaped" from one into another

CHEAPER COOLER!

By the Mix Staff



E-mu EXVoice Processor

without using crossfades.

Last year's underground favorite, **Open Labs** (www.opnlabs.com) has come of age. The company is now shipping its OpenSynth NEKO and NEKO 64 line of AMD Opteron processor-based keyboards, which host VSTi plug-ins and use standard micro-ATX motherboards and processors capable of running Microsoft Windows with standard PC hardware. The OpenStudio OMX 64 integrated 64-bit digital audio workstation is also shipping.

E-mu (www.emu.com) had a big crowd in its booth—maybe it was for the debut of the Emulator X and Emulator X Studio desktop sampling systems, which combine E-mu sampling technologies and hardware DSP with software features such as disk streaming and file management. Both systems feature an integrated waveform editor and powerful synth functions, with a 24-bit/192kHz audio interface with hardware-accelerated effects. (The Emulator X Studio comes with a sync daughter card.)

Apple (www.apple.com) is making inroads into the audio market, as evidenced by its GarageBand announcement at MacWorld a week prior to its first-ever presence at NAMM. At the Apple booth, we saw rebranded versions of the Logic line, which now comprises a full-featured Logic Pro (including Logic Platinum and 53 software instruments) and a more basic Logic Express designed for students and educators. We also previewed some hip new software instruments, including the Ultrabeat percussion synth and the Guitar Amp modeling plug-in. We were especially wowed by Sculpture, which simulates the behavioral char-

acteristics of a string or bar and lets users tweak and morph parameters such as material and environment. Sound designers, check it out.

At **BIAS** (www.bias-inc.com), we checked out Peak 4.1, which now includes Roxio Jam for Mac OS X, boosting Peak's CD-burning capability to allow full access to the Red Book spec to create pre-glass masters for mass commercial replication in OS X. Want more? Peak also adds a lite version of the SFX Machine multi-effects plug-in.

Cycling '74 (www.cycling74.com) announced Soundflower, a free system extension for Mac OS 10.2/10.3 that lets users route audio between CoreAudio apps. Although Soundflower is perfect for general routing tasks, it enables applications developed with Max/MSP to process audio originating from other programs—one can only imagine the possibilities. Cycling '74 also released Sustained Encounters, the first volume in the Cycles Series of audio source libraries from Ron MacLeod, who created the Poke in the Ear libraries.

Last year, we were floored by hearing

Vocaloid (www.vocaloid.com) at Musikmesse. Now, the voice-synthesis software that lets users generate authentic-sounding vocals on their PCs by simply typing in the lyrics and music notes of their compositions is distributed by East West Communications (www.soundsonline.com).

Minnetonka (www.minnetonkaaudio.com) broke the two-digit price barrier with Discwelder Bronze, a \$99 DVD-Audio authoring package. And **Digidesign** (www.digidesign.com) surprised us with its acquisition of the assets of Bomb Factory (see "Current," page 16).

PLUG-INS, PLUG-INS, PLUG-INS!

There are more cool apps than ever. **Universal Audio** (www.uaudio.com) showed a Fairchild 670 compressor for the UAD-1 card and a new UAD-1 Studio Pak Powered Plug-Ins bundle featuring 20 UA plugs, including the 1176LN/SE, LA-2A, Pultec EQP-1, RealVerb Pro and a lot more. **TC Electronic** (www.tcelectronic.com) is shipping the Virus virtual synth from Access, the TC Thirty classic Vox amp modeler and PowerCore Version 1.8, which features the Tubifex amp simulator.

Waves' (www.waves.com) IR-1 convolution reverb plug-in features impulse responses from some of the best rooms on the planet. The interface gives users a wide variety of

Roland Opens Platform

Roland (www.rolandus.com) V-Studio users are celebrating the biggest news of the show, the company's announcement that it has opened the platform to plug-in developers with the debut of the VS8F-3 Plug-In Effect Expansion Board. The board is compatible with the entire VS Series, from the new VS-2480DVD (shown), which lets users burn up to 4.7 GB of song data to a single DVD-R or DVD-RW disc, down to the 1680, giving thousands of Roland users the opportunity to upgrade their systems at any level.

Not only will Roland plug-ins be available, but Antares, IK Multimedia, George Massenburg Labs, Universal Audio, Cakewalk, McDSP, TC Electronic, Sound Toys and other developers are porting plug-ins over to the V-Studio platform; many of these plug-ins are already available. The VS8F-3 boasts 56-bit processing and sampling rates up to 96 kHz, depending on the V-Studio host. Each VS8F-3 can run two plug-ins; Roland includes five plug-ins with each board.



LIVE SOUND ROCKS NAMM

Long considered solely a "music store" market, NAMM has evolved into a premier showcase for pro products for live sound and touring. Here are some hits that caught our eye.

CONSOLES

Midas (www.midasconsoles.com) has finally entered the mid-market with Verona, an affordable analog 8-bus for front of house or monitors, with six models from 24 to 64 inputs, premium mic preamps, sweepable 4-band EQ, eight aux buses, 12x4 matrix, four mute groups, optional redundant PSU and more. **Altair Audio's** (www.altairaudio.com) Electra E-3 analog console has 32/40/48-input channels and features eight sub-groups, 16 auxes, eight VCAs with motorized faders, 8x16 matrix, LCR outputs and 4-band input EQ with parametric mids. Eight mute masters store 128 scenes, and digital parametric EQ and onboard dynamics complement the aux outs.

With 24 mic inputs for FOH/monitor work, the **Mackie** (www.mackie.com) TT24 Digital Mixer is a 56x45, 8-group, 24-bit, 96kHz-capable LCR design featuring 100mm touch-sensitive moving faders, onboard analog and digital I/O, digital recall, 4-band EQ, 12 aux sends, dynamics, effects, 11x8 matrix and two expansion slots. A 5-inch touchscreen, eight function buttons and 12 rotary encoders provide quick access to key live functions.

Hear Technologies (www.heartechnologies.com) Mix Back is an affordable (\$1,495) 16-in monitor mixer with 12 mono and two stereo outputs for live or studio cue use. The 11-rackspace unit can be cascaded for more inputs. An optional \$100 talkback remote instantly connects the engineer with any (or all) of the musicians.

Designed to optimize sound from inexperienced house-of-worship users, **Peavey's** (www.sanctuary-series.com) Sanctuary Series mixers offer onboard effects, auto feedback elimination and Automix™ to automatically switch from lapel to pulpit mics and mute unused inputs.

Distributed by ART, **Alto's** (www.altoproaudio.com) new Dragonfly Series powered 6 to 20-channel mixers have onboard digital amps. The 2x450-watts (into 4 ohms) PM16 is a svelte 18 pounds and retails at \$749. The **Soundcraft** (www.soundcraft.com) GigRac has two low-cost (\$430/\$650) powered mixers to make gigging easy with eight line/mic inputs (with 2-band EQ and phantom power), 7-band master EQ, internal digital effects, single or dual 300W amps and a road-ready case that also stores mics and cables.

MICS AND WIRELESS

Aussie mic company **RØDE** (www.rodemic.com) brings its studio sound to the stage with the S1, a high-performance handheld vocal mic with low-noise FET electronics, an internally shock-mounted true (externally biased) condenser capsule and five-year guarantee.



Midas Verona



Mackie TT24 digital mixer

Audio-Technica (www.audio-technica.com) updated its entry-level cardioid mic line with Midnight Blues higher-output designs and lower handling noise, including the MB1k and MB3k dynamic vocal models, the MB2k dynamic instrument mic and the MB4k (battery or phantom) condenser. Price: \$49 to \$129. **Wharfedale Pro** (www.wharfedalepro.com) enters the mic market with the DM 2.0, a tough, handheld dynamic featuring a non-dent,

spring-steel grille and shock-mounted cardioid capsule. They're sold in a three-pack priced comparably to a single competitive pro mic.

Sennheiser (www.sennheiserusa.com) announced Evolution Wireless G2, upgrading second-generation Evolution UHF wireless with new handhelds, smaller bodypacks, expanded receivers, 1,440 available channels, free channel search scan, rechargeable or battery operation, true diversity receivers and compatibility with earlier E Series models. **Shure's** (www.shure.com) new midline SLX UHF Series feature Audio Reference Companding technology, Auto Transmitter Setup with support of up to 20 systems in an area, a choice of 960 channels, and a variety of handhelds, bodypacks and receivers. Systems are priced from \$599.

LOUDSPEAKERS!

Eastern Acoustic Works' (www.eaw.com) industry-standard KF850s just got better. The new KF850zF (flyable) and KF850zR (road) versions include new internal components, such as Radial Phase Plugs, a neodymium Orbital Magnet Array HF driver, new HF horn and new dual 1,000W 18-inch woofers. **Cerwin-Vega** (www.cerwin-vega.com) showed Vision, a serious new flagship series including two three-way, bi-ampable trapezoidal enclosures with ATM-equipped fly points; two subs; a single-12 coaxial that doubles as a floor monitor; and flyable install speaker.

Community (www.loudspeakers.net) turned heads with its DnD12 (\$239) and DnD15 (\$259) speakers with 12- or 15-inch woofers and twin 1-inch PZT drivers on a 40°x90° horn that operates as upright (standing or pole-mount) mains or at two different angles for monitoring. **JBL Pro's** (www.jblpro.com) JRX115 and JRX112M (doubles as monitor) two-way speakers with 12- or 15-inch woofers have unique dual-angle pole sockets for vertical or -10° downward aiming. Also new are dual-15 JRX1215 and two (passive or powered) 18-inch sub boxes. Non-hardware installation versions, JRX112Mi and JRX115i, are also offered.

Integrating the functions of telephone, e-mail and Web interaction into a single online resource, **QSC's** (www.qscaudio.com) eBOX personalizes tech support with FAQs, submitted questions/answer archives, product content and messaging—all customized to each user's needs.



RØDE S1



TUBE VERSATILITY

**Announcing the redesigned
TPS II™ Tube Preamplifier
System and DPS II™ Digital
Preamplifier System from ART.**



V3™ Based on the success of our award-winning TPS and DPS preamp systems, the TPS II™ and DPS II™ feature our improved V3™ Technology (Variable Valve Voicing), which delivers a complete range of newly enhanced presets designed to compliment every microphone, musical instrument and direct signal you process. ART Engineers have improved key feature sets on these units that exceeds that of units costing much more.

Both the TPS II and DPS II also feature variable input impedance, LED input meters, automatic mic/instrument switching, OPL™ (Output Protection Limiting) and more tube warmth than their predecessors. These newly enhanced preamps can accept +20dB peaks while maintaining over 120dB dynamic range and incredibly low distortion. The DPS II includes a versatile insert loop on each channel which provides access for additional signal processing or direct access to our high quality A/D converter. Separate gain controls on analog and digital outputs allow you to optimize the unit for simultaneous applications. Digital outputs include S/PDIF, TOSLINK or ADAT (front panel selectable).

The A/D is front panel adjustable from 44.1 to 96K and syncs to ADAT or external word clock (32KHZ to 100KHZ). You can patch into any ADAT stream and select which pair (or all) of channels the DPS II transmits.

Out of the box, these preamps are ideal for any studio environment or live sound rig. Housed in a single rack space design, for musicians and engineers alike, there is a multitude of uses for the TPS II and DPS II. Use your TPS II or DPS II for any front end signal processing to smooth out your tones and control levels to your outboard devices. Now that's versatile!

Check one out at your local retailer today! For more info on these or any ART product, visit our website at www.artproaudio.com.

Celebrating Twenty Years of Audio.

A R T
APPLIED RESEARCH AND TECHNOLOGY

215 Tremont St., Rochester, NY 14608 • USA • 585.436.2720 tel • 585.436.3942 fax • info@artproaudio.com • www.artproaudio.com



Waves IR-1 convolution reverb

tweakable settings and promises to include numerous room updates in years to come.

We previewed the new Advanced Groove Engine from **Spectrasonics** (www.spectrasonics.net), a product of the new in-house development team. This technology will beef up plug-ins such as the upcoming Stylus RMX, which was previewed at the show.

SoundShuttle from **PowerFX** (www.powerfx.com) is a VST plug-in that lets users preview, audition and download loops directly within applications such as Cubase, Live and Fruity Loops. PowerFX also showed Miracle Beats, a combination sample CD/VST

instrument that slices drum loops and separates elements of the drum kit into individual tracks for separate control. More than 500 drum loops are included.

Sony (www.sonyplugins.com) added to its plug-in line with the Oxford TransMod for Pro Tools TDM (Mix, Accel), LE and PowerCore. The dynamic wonder-worker radically changes the dynamics of a track by sculpting transients and increasing or reducing ambience.

The two new **SRS** (www.srslabs.com) Circle Surround encoder/decoder TDM plug-ins support seven channels, operate at up to 96 kHz and are cross-platform (Mac and PC).

Eventide (www.eventide.com) was craning necks at the Digi booth with the H3000 Band Delays TDM plug-in, with eight tempo-based delays featuring programmable resonant filters and independent panning controls. Also at the Digi booth, **URS** (www.ursplugins.com) unveiled the SSL 4000e 4-band EQ emulator.

In addition to announcing Melodyne 2.5, **Celemony** (www.celemony.com) is teaming up with Ueberschall to develop sample-based VST instruments for Melodyne users.

It felt like Christmas at the **Ilio** (www.ilio.com) booth, with the company distributing more software packages than ever. **Applied Acoustic Systems** is the newest developer to join the fold, showing Tassman 3 and Lounge Lizard EP-2. We also checked out **Ultimate Sound Bank's** new Charlie classic organ module, Ultra Focus virtual synth and X-Treme FX sound design tool, plus **Synthology's** Ivory virtual piano and **Sonic Reality's** I-Drums kit library.

M-Audio (www.m-audio.com) made a splash with composer Jeff Rona's Liquid Cinema, a collection of loops and samples for soundtrack creation. The company also showed FireWire 18/14, an 18-in/14-out FireWire audio/MIDI interface with eight channels of ADAT Lightpipe I/O, 8x4 analog I/O and two channels of mic/instrument pre's; the Octane 8-channel Pre and A/D Converter with ADAT Lightpipe; and new Keystation USB MIDI controllers.

CONSOLES, INTERFACES AND SUCH

Mackie (www.mackie.com) unveiled a number of products, including the slick-looking Big

THE ONLY WIRELESS SYSTEM WITH A FUTURE.

Sabine 2.4 GHz Wireless

UHF: HERE TODAY, GONE TOMORROW
 You read all about it these days. Digital television is gobbling up UHF frequencies. Just when you need more wireless mics, government restrictions squeeze the UHF band tighter and tighter. Mics you buy today may well be useless tomorrow.

2.4 GHz: THE CLEAR ALTERNATIVE Here's the solution. Sabine's wireless operates in the globally approved, license-free 2.4 GHz band, beyond any interference from UHF or VHF (including all those wireless mics), as well as TV, emergency broadcast, or cell phones. And by international law, all devices sharing this band must be low-powered, so they won't interfere with anything outside their immediate vicinity.

SMART SPECTRUM: MORE SIMULTANEOUS SYSTEMS Smart Spectrum gives you the built-in agility to set up to 70 systems in one venue with clear channels always available. Now you can add as many channels as you need, and take your production into any city without fear of high-powered UHF interference.

SABINE: REDEFINING EXPECTATIONS Sabine's SWM7000 systems offer the sonic quality of the finest wired mics. And every system comes with a patented FBX Feedback Exterminator®, Compressor/Limiter, Adaptive De-Esser, 10 Parametric filters and exclusive Mic SuperModeling™. It even includes a built-in recharging system so you'll have money left over to invest in the future of wireless.

Call 800-611-4101 or email us at SWM6@sabine.com for a hands-on evaluation of the only wireless system guaranteed to be around for years to come.

SABINE®
www.Sabine.com/Eval6

PATENTED • MADE IN USA • © 2004



UA Fairchild Plug-In



Tascam US-2400 DAW controller

Knob, a desktop monitor switching and level control box with built-in talkback functions. Also at the show was a scaled-down, more affordable version of the dXb that the company showed at AES last October. **Yamaha** (www.yamaha.com/proaudio) introduced V. 2 software and five add-on effects packages for its 02R96 mixing console. Compatible for both Mac OS X and Windows 2000/XP platforms, the \$300 V. 2 upgrade includes more than 40 new features.

Tascam (www.tascam.com) revealed the US-2400, a 25-fader DAW controller for under \$2,000. The unit features 25 100mm moving faders, 24 assignable encoders, a full transport section and a joystick for surround panning. Also at the booth was GigaStudio

Hits You Might Have Missed

These products didn't grab all the headlines, but they could sure make your life easier.

Atlas Sound QR2: This adapter for your Atlas mic stands attaches between the 7/8-inch-lower tube and the cast-iron base and features a quick-release button allowing the stand to easily separate into two pieces for transport. Slick! www.atlassound.com

Atomic Reactor 112: Here's a \$699 single-12 tube guitar amp, with a twist: You insert a desktop modeling/DSP box (Pod, VAMP, etc.) into a docking adapter on top of the amp and you've got a killer tube amp for recording or stage with your fave tones preloaded. Awesome! www.atomicamps.com

Furman SB-1000 UPS: The single-rackspace SB-1000 uninterruptible power supply offers three minutes of power at a 5-amp draw or 32 minutes with a typical computer/monitor load—plenty of time to save important files or avoid crashes during brownouts/power failures. At \$699, insurance was never so affordable. www.furmansound.com



Latch Lake Music Microphone Jam Nuts™: These large-diameter rings replace those stupid, pinkie-ring-sized threaded nuts that secure mic clips/shock-mounts to mic stands. At \$4 each, these will change your life for the better, and while you're on the Latch Lake Music Website, check out the company's amazing mic'ing booms for serious users. Brilliant! www.latchlakemusic.com

Radial Engineering JPC Direct Box: This 2-channel DI is specifically designed for use with computer sound cards, consumer electronics, audio/visual post systems and electronic media. Smart! www.radialeng.com

GRACE

d e s i g n

HIGH FIDELITY

Built to a higher standard

Welcome to the inside of our model 801 microphone preamplifier. While few manufacturers would freely advertise the inner workings of their products, we are proud to show them off.

At Grace Design, we are seriously *passionate* about what we do. The near obsessive approach we take with our circuit designs, component selection, and manufacturing process is the means to one end—delivering the finest high fidelity audio products money can buy.

From our eye-popping model 101 single channel mic preamp, to our flagship model 801R remote controlled mic preamp system, or our new m904 and m906 reference monitoring systems, we build products to help you realize your highest level of excellence.

We invite you to contact your friendly Grace Design dealer for more information or to schedule a product demo. Once you do, you'll discover why our products are truly built to a higher standard.

Thanks to all of our friends for helping us celebrate ten years of audio excellence

For complete product information, please visit us at www.gracedesign.com or call 303.443.7454

Learn the Art of Recording



Powerful • Practical • Professional

- World-class (yet affordable) education in Recording Engineering & Music Production
- Full-time, two month experience to chart your career and change your life



Recording Workshop

www.recordingworkshop.com • info@recw.com

800-848-9900 • 740-663-1000 outside US

Founded 1971 • 455 Massieville Rd, Chillicothe, Ohio 45601 • Licensed by State Board of Career Colleges and Schools

DISCRETE DRUMS Series Three!! Rock Drums & Percussion



www.discretedrums.com

GREG MORROW - DRUMS
ERIC DARKEN - PERCUSSION

- multitrack drums AND percussion
- limitless 5.1 surround possibilities
- Compatibility with virtually all DAW's
- Roland V-Studio Edition
- GigaStudio Edition
- Yamaha AW machines
- Tascam SX1-LE
- Acidized 16 bit Stereo Wav Edition

Hits of Winter NAMM '04

3.0, a ground-up rewrite of the original application adds dozens of new features.

Allen & Heath's (www.allen-heath.com) Xone:92 is a killer 6-channel DJ club mixer with 4-band EQ, two LFOs, a tap-tempo feature, two independent filter systems and MIDI output for tweaking outboard effects, lighting, etc. Slammin'!

PreSonus (www.presonus.com) debuted Firepod, a 24-bit/96k recording studio, including eight microphone preamplifiers and Steinberg's Cubase SE 48-track, 24-bit/96k recording software. The cross-platform (Windows XP/Mac OS X) box is priced at less than



dbx 162SL compressor

\$700. **Edirol** (www.edirol.com) showed FA-101, a 10x10 FireWire audio interface capable of 24-bit/96kHz operation. The unit also offers stereo recording and playback at 24-bit/192 kHz.

GOING OUTBOARD!

NAMM had tons of hot new outboard toys, including some exotic entries. Complementing its ViPRE preamp, **Groove Tubes'** (www.groovetubes.com) Glory Comp is a \$2,999 all-tube compressor featuring built-in sidechain EQ and a "Glory" (second-harmonics boost) knob, with adjustment between Earth (no effect) and Heaven (full effect). The new 162SL from **dbx** (www.dbxpro.com) packs the punch and quality of its flagship 160SL Blue Series compressor, but in a more affordable package featuring Jensen output transformers, full-manual AutoVelocity and OverEasy modes, and a groovy purple chassis.

Most clever NAMM product name? The NY-2A from **Electro-Harmonix** (www.ehx.com), a \$2,999 2-channel tube compressor with a choice of three opto-coupler (slow incandescent, high-velocity clear LED or electroluminescent panel) light sources, Lundahl transformer I/O, and VU and EM80 "magic eye" output displays. At the other end of the price scale, **Phonic's** (www.phonic.com) \$250 T8200 TubeOptimizer is a stereo/dual-mono,



Groove Tubes Glory compressor



Dynaudio AIR 25

2-band (HF/LF) compressor with balanced I/Os, tube warmth controls and eight VU meters that show status.

The \$2,495 **Aphex** (www.aphexsys.com) Model 1100 MkII is an update of the discrete Class-A tube stereo preamp with MicLim limiting, 24-bit/192kHz AES and S/PDIF digital outs and an amazing -135dB EIN spec. **A Designs'** (www.adesignsaudio.com) Pultec-like



Electro-Harmonix NY-2A Tube compressor

EQ-1 mono tube equalizer features hand-wound output and Jensen input transformers, custom capacitors, EC99 tube and a custom spec transducer. **Demeter's** \$1,899 (www.demeteramps.com) VTMP-2c dual-channel tube mic preamp is a limited edition of the VTMP-2 released in 1985. **Nautilus Master Technology** (www.nautilusmaster.com) unveiled a number of new



Nautilus Commander

high-end products, including the Commander back-end summing bus. The unit features eight Class-A inputs, pan and mute, a stereo insert, aux input, stereo VU meters, left/right mute switches and a mono button.

Apogee's (www.apogeedigital.com) new AD-16X and DA-16X converters operate at up to 192kHz sampling rates and feature the same clocking technology found in Big Ben (reviewed in *Mix* December 2003), and optional Pro Tools|HD and FireWire expansion cards.

STUDIO ESSENTIALS

Dynaudio Acoustics (www.dynaudioacoustics.com) released the AIR 25, a three-way active near-field with two 10-inch woofers, a 5.5-inch midrange and a 1.1-inch soft-dome tweeter. The quad-amped unit offers 1,200 watts of power and retails for \$7,495. **KRK's** (www.krksys.com) Rokit RP-5 and RP-8 powered bi-amped monitors incorporate key design elements from the company's higher-end models and feature volume control, XLR, RCA and TRS inputs.

SE Electronics (www.seemics.com) showed several unique en-

tries: Gemini is a large-diaphragm cardioid studio condenser with dual-tube (12AU7 and 12AX7) electronics; and Ic15 has a superlarge 35mm (1.5-inch) cardioid capsule paired with tube electronics. Both mics include flight case, shock-mount and cables. For stage or studio, the I-5 from **Audix** (www.audixusa.com) is a \$179 retail, cardioid dynamic for high-SPL applications, such as close-miked snare or guitar cabs.

FIBER NATION

Light Viper from **Fiberplex** (www.lightviper.com) uses military-grade fiber optics to transport 40 line-level signals up to 1.25 miles without degradation from a stage box

with 32 inputs of phantom-powered mic/line amps. At the other end, a single-rackspace box has D-25 sub connectors breaking out to any analog configuration that the user needs.

The first CobraNet-based digital snake, **Whirlwind's** (www.whirlwindusa.com) E-Snake, sends/receives 24-bit audio over standard Cat-5 cable. Each E Snake Frame module handles eight to 32 channels with a capacity of hundreds of channels over a Gigabit Ethernet network. Control software remotely tweaks mic/line levels, pads and limiting.

MORE TO COME!

Too many toys, too little space! There were lots of other cool items at NAMM, and we'll include some of these in our regular new product sections in future issues. Meanwhile, Summer NAMM returns to Nashville July 23-25, 2004. See you there! ■

Mix correspondents contributing to this report included George Petersen, Sarah Jones, Kevin Becka, Maureen Droney, Michael Cooper, Nick Batzdorf, Barry Rudolph and Erik Hawkins.

ECHO

INDIGO ▶ io

FLAWLESS NOTEBOOK
INPUT AND OUTPUT



Windows and Mac OS X

www.echoaudio.com

AS LITTLE AS 10 YEARS AGO, sound and music for games were practically afterthoughts, usually handled by the same person, generated on MIDI synths and only occasionally using samplers and libraries for effects, and wedged into the game at the end, usually at 8-bit resolution. How things have changed! The video game industry has become a multi-billion-dollar worldwide phenomenon that now rivals (and often exceeds) the film and record industries when it comes to product volume, profitable companies and user loyalty. With millions to be made, the stakes have gotten higher and the pressure more intense to have the most amazing visuals and the best sound possible on every new game. Today, audio designers are working in studios rivaling today's top music facilities in 96 kHz to deliver 44.1k playback. We've gone from those 8-bit mono footsteps feebly rendered at 11 kHz to sound effects and music delivered in 5.1 CD-quality audio. With that in mind, *Mix* brings you this special section, a close look at the audio side of video games.

If you are a serious gamer or, like me, have children or teens in the house who fit that description, chances are you own a few games made by Electronic Arts (EA), the Redwood City, Calif.-based software company responsible (along with a number of top development partners) for some of the best-selling sports games (*Madden Football*, *NCAA College Football*, *FIFA Soccer*, *NBA Live*, *Tiger Woods PGA Tour*, etc.), simulation games (*SimCity* and the incredibly popular series, *The Sims*), war games (the *Battlefield* and *Medal of Honor* series) and games based on films or film characters, from James Bond to *Looney Tunes* to Harry Potter to the company's skyrocketing *The Lord of the Rings* franchise. My household spent a lot more on games this past year than on CDs, and EA took a big chunk of that money. With revenues of \$2.5 billion in 2003, a whopping 22 titles that sold more than a million copies each, and offices in Northern California, London, Tokyo, Austin, Orlando, Vancouver and Montreal that employ some 4,400 employees, EA is definitely the industry's top dog. On a rainy afternoon in early December, I visited EA's headquarters to tour its facilities and talk to some members of the audio staff, including the team responsible for the sound on the recent hit game, *The Lord of the Rings: The Return of the King*.

Bringing *The Lord of the Rings* to the Game Console

EA made it clear that it was committed to high-quality audio a decade ago when it hired former recording industry giant Murray Allen to be the company's director of audio production. (He has since moved up the ladder to become VP of post-production.) Allen helped equip the audio rooms in the company's former facility in nearby Foster City, as well as the lovely new multibuilding "campus" (as they call it) just south of San Francisco. Now, another studio veteran, Fred Jones, is EA's audio facilities director. Like his predecessor, Jones has his work cut out for him.

THE QUEST FOR HIGH-QUALITY SOUND

Though set in a somewhat anonymous business park, EA's sprawling headquarters is everything one would hope it might be. Aside from such amenities as a soccer field, full-court indoor basketball gym and a lovely restaurant/food court that serves a wide variety of nicely prepared foods, the campus boasts a number of specially equipped rooms where games can be played and/or tested, and cubicle after cubicle of state-of-the-art computers used for everything from animation to sound design and realization. In *The Lord of the Rings* wing of one of the nondescript high-rise buildings, artwork, models, fantasy game miniatures and props from the film can be found on the walls and on desks, and the rows of cubicles—quiet the day I visited because the game was finished and work hadn't quite begun on the *next* EA *LOTR* game—have "street" names pulled from Middle Earth locales. These people clearly dig their work.

Down in one of the two adjoining ground-floor studios—a THX-certified room equipped with a Pro Tools HD 3 system, a Pro Control (replacing the studio's former console, an SSL Avant) and two different models of Genelec speakers (1038s in front, 1032s as rear surrounds)—I sit down with Fred Jones, *LOTR* audio director Don

BY BLAIR JACKSON

Electronic Arts





Veca and lead sound designer Charlie Stockley to talk about how video game sound design is both similar and quite different from its feature-film counterpart. (The other lead sound designer, Paul Gorman, was not available that day.) And *The Lord of the Rings: The Return of the King* game is particularly apt, as it incorporates extensive footage and sound effects from Peter Jackson's films amidst the multiple levels of sophisticated third-person animated game play. In its first month of release alone, the game sold half-a-million copies, and it has been widely hailed as one of the best of 2003. With *Ringsmania* at an all-time high, the game almost couldn't lose, but its creators—who are also now co-perpetuators of an ongoing *LOTR* game franchise at EA—embrace the task of creating a mind-blowing game with the same determination and seriousness as Frodo's quest to reach Mount Doom. Most of the sound work was done on the designers' individual Pro Tools MIXPlus systems in small offices that are scattered throughout the complex, with the big high-end studio being used later in the process for intensive mixing and surround work.

IT'S LIKE THE MOVIES, BUT...

Whereas a video game can often have a development time of several years from conception to release, *The Return of the King's* gestation period was considerably shorter because of the annual release of each *LOTR* film. For marketing reasons, it was paramount to have the game come out shortly before the film itself, or roughly a year after *The Two Towers*, which is a completely different game. "A lot of people might think *The Return of the King* is a sequel to the last game the way the movie is, but to us it wasn't, because everything was in-house for this game, and we built it completely from scratch," Veca notes.

Veca has been with EA for 12 years. Originally a multi-instrumentalist who went to San Jose State for the university's music program, he found himself spending much of his free time in the college's recording studios programming electronic music, and eventually got his degree in computer science. He got a job at nearby Apple Computer, where he worked on early versions of Sound Manager, MIDI Manager and QuickTime, and then was hired by EA to do audio tools and ad libs programming and authoring.

Everyone agrees that it was the eventual widespread adoption of the CD-ROM format for video games that allowed for the rapid improvement of game audio. "It's still a *video* game, not an audio game," Veca says. "But audio has been slowly catching

combination of film elements and effects created specifically for the game.

"We have this cool starting place," Veca says. "We get to use the music, we get to use some of the sound effects, but we have to chop it up, fill in the holes and create



The key members of EA's audio team (L to R): Charles Stockley, Don Veca, Fred Jones and Paul Gorman

up, and now we're getting to the point where we're expected to sound like a movie. So if we're expected to sound like a movie, then we have to have the resources and the horsepower. Fortunately, we've had lots of support. Neil Young (executive producer of the game; no relation to the rock star) is one of the first executive producers I've encountered who really understands the value of video game audio and its importance in the overall game experience. We were the first THX-approved game. Why did he do that? Because he thought sound was a real priority."

On the simplest level, creating sound for video games these days is similar to working on a Hollywood film: It usually involves original effects creation, Foley, the integration of score and, in many cases, voice-over. For *The Return of the King*, the game's sound crew had the added advantage of having actual 5.1 audio from the film and music stems of Howard Shore's score delivered to them. But because the footage they used from the film in different sections of the game had to be completely re-edited to fit the game, so did the audio. And, typical of Hollywood films, the finished audio for the movie was not available at the time EA was working on the game. As a result, the soundtrack is a

brand-new stuff. But then the hardest part, the most important part, is making it play back correctly, implementing it correctly.

"The analogy one of the guys who works here has used is, you can give me a Stradivarius and it will sound like crap, but you can give Isaac Stern a student model and he's gonna rip it—it's gonna sound great! The point being, you can create the coolest samples and have the most pristine audio, but it's not going to be worth a damn unless it's in the game and implemented correctly." Veca says that for this game, he had the authority and tools that he needed to place the sounds in the game as intended. "It's a double-edged sword because, sure, we get the power and we get to make it sound way better than normal, but it's that much more work—implementing is a whole other job."

Games are, by definition, interactive, so just as the player controls the movements of the game's characters, the sound must reflect the action, too. A game like *The Return of the King* might have a dozen different levels for a player to navigate through, with each level presenting tasks that the player must complete to move on. There are, needless to say, many sound variables that need to be programmed into the game. This requires another level of technical expertise

AKG ACOUSTICS

WMS 4000 WIRELESS MICROPHONE SYSTEM



<< SONGBIRD
FREEBIRD >>



The WMS 4000 Wireless System. It's the only 1,200 channel wireless system that gives comparable range and frequency response as hardwired mics, making your performance soar. Have a nice flight.
akg.com • 615.620.3800



AS PASSIONATE AS YOU.

H A Harman International Company

far removed from the traditional sound designer's role.

"Usually, there are game programmers who write the code that lets you see everything and lets everything happen when it happens," Veca says. "Then there are programmers who write the authoring tools that let an implementer take these assets—our sounds and [film sound designer] Dave Farmer's sounds—put them into this game format, massage them, play them back and integrate them into the game. Those are the tools people. In this case, we [the sound team] were implementers for our own

audio. We took the raw assets, edited them and formatted them for the game so they're at the right sample rate or whatever. Then we take those assets and we plug them into the tools. We add triggers that will reference these assets and play them back correctly.

"Charlie [Stockley] was in charge of all RAM-based interactive sounds, including all the characters," Veca continues. "Every character that you see running around, he put the sound where it's supposed to go at exactly the right volume, using tools that our audio programmer gave us to give us full control. And the cool thing about our

audio programmer—Laurent Betbeder—is he's a sound designer and he understands what we need, so we can define how we want things. A lot of it is sequencing: We'll write a specification for the program that says, 'Okay, they want a footstep here. It's supposed to pick from these three samples, randomize it this much, et cetera.' So we give it a spec and tell when and where it goes in the game, and then, ultimately, we'll hit the Enter key and it'll grind away and

The Precious Vocals

The Return of the King audio director Don Veca on recording character voices for the game:

"I spent three weeks in New Zealand basically 'camped out,' waiting for the actors to be available between their movie work. I actually recorded them myself on a Mac laptop system, which worked out great. For the first *Lord of the Rings* game I worked on, *The Two Towers*, I wound up traveling to about five different studios around the world to record the actors, each with different recording studios and gear. Some of the studios and engineers were great, some were not so great. This caused consistency issues, which were very difficult to deal with when the dialog was implemented into the game. I overcame that this time by doing it all with my own portable rig. I used a hand-picked DPA 4035 headset mic for most of the recording, because most of what we recorded was loud yelling in a battle context and the 4035 is great for this [144dB SPL]. Also, many of the actors tend to 'act'—move around a lot—during their delivery. In fact, Andy Serkis [Gollum] actually did the entire four-hour recording session on his hands and knees, constantly jumping around all over the booth! The headset mic totally saved us there, but the headphones were soaked after the session!

"The actors themselves were pretty fun to work with, too, especially the Hobbits: Elijah Wood [Frodo], Billy Boyd [Pippin] and Dominic Monaghan [Merry], who are all avid gamers. As it turned out, I was expecting to have to miss my daughter's tenth birthday due to the three-week recording schedule, so the Hobbits and Andy each allowed me to record a special birthday 'audiograph' for her. Needless to say, she was thrilled. On top of the three weeks in New Zealand, I also had to fly to the UK for Gandalf; the rest were recorded in the U.S. Overall, it was a great experience."

The QTC1 has a More Affordable Little Brother!

Earthworks QTC1 is the most accurate recording microphone available. Its pristine sound quality and extraordinary realism make it a "must have" for many studios and world-class recordists.

Earthworks QTC30 is the new more affordable little brother. They share most of the same valuable qualities... Both are very hot & made of beautifully machined stainless. Both are truthful and quiet with incredible realism! The QTC30's cost/performance ratio reveals it to be a bargain of gigantic proportions. Find out how very affordable it is, and how real it sounds. Visit your local dealer to hear the QTC30, or contact Earthworks for the name of a dealer near you.

Earthworks Audio Products

Phone: 603-654-6427 (-6107 fax)
PO Box 517 Wilton NH 03085
www.EarthworksAudio.com

create a big hunk of data that includes the new information in the *whole* game." Veca explains that this trial-and-error process is getting faster with new technology. "In the old days, when I was a programmer, you could change some code, hit the Compile button and literally go to lunch and come back before it was finished. If you made one little mistake, you had to go through the whole thing again and wait another couple of hours. But now, like on the effects end, with Pro Tools, you do a crossfade, it isn't quite right, you do it again and it's simple. That improves the process dramatically."

"The sound design is probably 20 or 30 percent of the process, and the implementation is probably a good 70 percent of what we're doing," adds Stockley. "It's kind of like a pre-mix in a way. We're adjusting all these minute elements, like how far are we going to hear it if the character walks by that fire, and how does it change as you get closer to it or farther away? Ultimately, the player is the mixer, in a way, because we *don't* know how close the guy is going to walk to that fire. But we do know that the timbre is going to change along with the volume as the player walks closer or farther away."

The music, too, is spurred by specific events in the game. "There were six hours of music from the movie, and for this three-



minute scene, we might want a high-energy fight thing, or for a sneaky level something completely different. We'd have to scour this score, find this mood, maybe match a key, put it together and make a new piece out of it that you *then* could say, 'Now trigger this when you go into this area.' More often than not, it is not just one piece of Howard Shore's music. It might be a montage that stays within a particular vibe for a certain amount of time. Then you go into this other area and you find this other piece of music that's been edited.

"In the old days," he continues, "audio couldn't be streamed from disk. Anything you heard was from RAM and it was very limited. So you had these tiny little loops, and we used MIDI because it used even less RAM because you're triggering instruments. We did a lot of cool interactive things with that, but one day, somebody decided to

take some of that bandwidth that the rest of the gamers were using for their video streaming. Now, no one uses MIDI; it's almost exclusively streaming. Now, not only do we get a stereo music track at 44.1—still compressed, but pretty high-quality—we're also streaming ambience, so when you go into a battle, you don't just have the characters making sounds, you have an ambience track that somebody has created in a 5.1 studio. We even have one more stream that doubles as streamed sound effects and for VO." (For *The Return of the King* game, Veca went to New Zealand for three weeks to record the principal actors for game voice-overs—a rare privilege.)

RAM BUDGETS

Even with sound gaining importance in video game design, there are still major decisions—and concessions—to be made at every step of the audio process. "There are trade-offs all the time," Veca says. "There's a limited budget for RAM; Charlie's in charge of that. You've got all these characters to work with—where are we going to use a high-quality sound, where are you going to use the low-quality sound."

Stockley adds, "I'll look at footsteps or some low thunder rumble and I can either sample rate-convert them lower or higher or

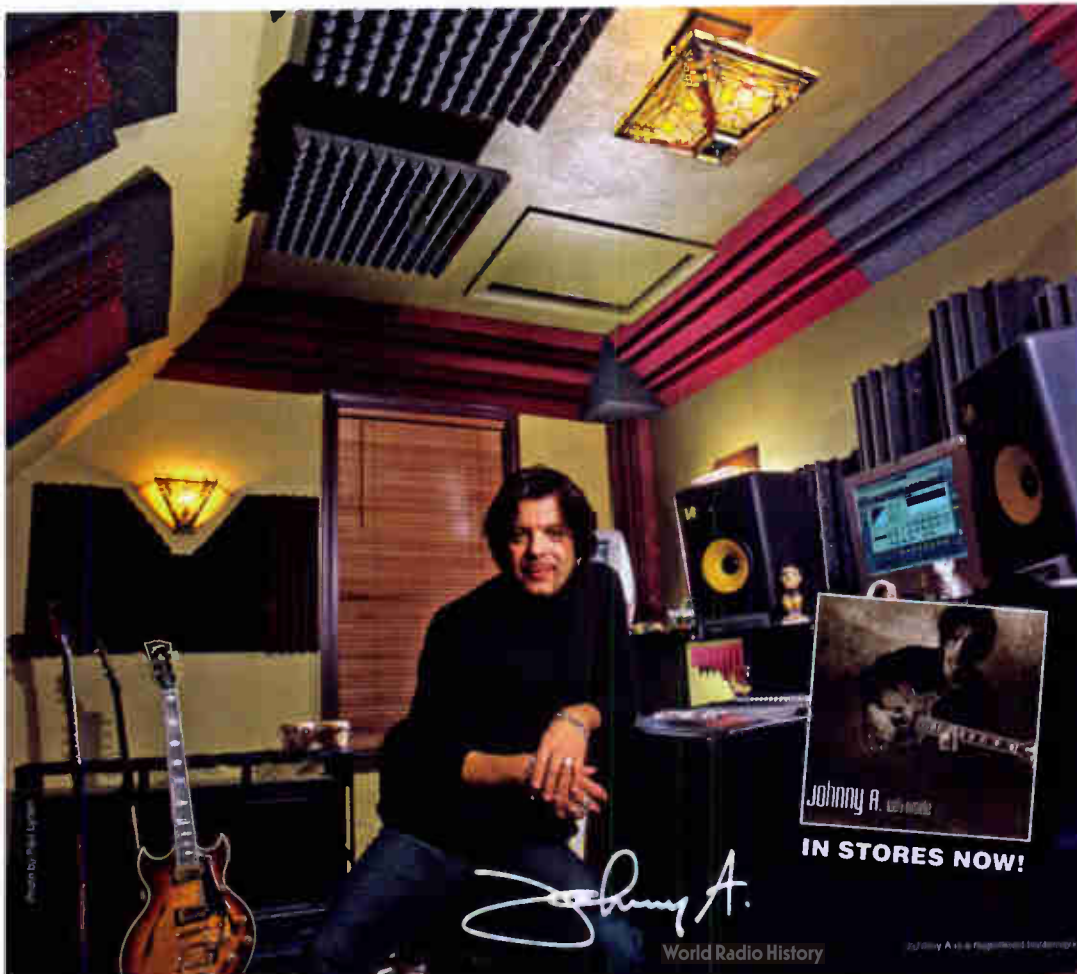

Favored Nations' recording artist **Johnny A.**, with help from **Auralex Acoustics**, turned an extra room of his house into his personal mix suite.

After spending multiple 10-hour days working on his NEW release, **'GET INSIDE'**, Johnny stated;

"I can sit in my room all day and not feel beat up, which to me is the key to stamina in the studio; not getting beat up by the environment."

Johnny A.

**Your Studio. Your Sound.
Your Choice.**

Total Sound Control™

Auralex
ACOUSTICS

www.auralex.com



IN STORES NOW!

Johnny A.

Audio at Electronic Arts

message sounds to fit in my RAM budget. The timbre of the sound and the length are what I focus on most. If I have breaking ice or glass or something, that's going to be a higher sample rate, and, obviously, I want to keep the highs and keep it sounding good. The big huge catapult launching with all the wood creaking and everything—I'll want that to be special. But then a footstep or a clothing Foley can be down-sampled because you're not going to hear it clearly anyway in a massive battle of 10,000 Orcs [the evil manufactured creatures in the *LOTR* trilogy].

"Then there were the siege towers. These

things are huge pieces of wood and metal and stone and everything else, and there's no way I could fit that kind of sound in my RAM budget—if we implemented it as a streamed sound effect, it would step over everything else and streams would be cut off everywhere—so I had to think of a way to make this thing sound huge. So I took little snippets of metal and things like that, lowered the pitch and pitched down some squeaks to become this groany, metallic sound, and then I sequenced maybe 20 or 30 of those sounds so it randomly creaked between metals and little pieces of woods.

Then underneath all that, I had a one- or two-second loop of a continuous rumble. I mixed all that together inside of a sequencer and came up with a big sound that didn't take up too much [space]."

WHICH BOX?

Another factor is the format of the game: Each has its own demands, peculiarities and limitations. These days, everything is geared toward surround, and because it is the most popular format, "We do our main development on the [Sony] PlayStation 2," Veca says. "But PlayStation doesn't play 5.1, it plays surround. So does [Nintendo] GameCube. You *can* get 5.1 from the PlayStation via a DTS software solution, and some of our EA games use a software solution for DTS, which is routed out of the digital/optical output. But it takes too much CPU horsepower for most games—another trade-off. [Microsoft] Xbox does 5.1, so we use 5.1 for our interactive sound effects. But to stream six discrete channels from disk on that box is just not feasible for the *LOTR* games.

"We have to do a lot of planning and say, 'If this works on this box, what about that box?' People are expecting this on this box, and this other box doesn't do it—what do you do? So there's a lot of pre-production work we have to go through to figure out how we're going to deal with this. Actually, we have fairly limited horsepower on the PlayStation. The audio hardware has been frankly lagging behind and, hopefully, the next generation will improve on that. But our biggest job is trying to fit all this cool stuff into this little tiny box and make it all sound good."

Because of the compressed schedule required to make *The Return of the King*, the audio department's production timetable was, Veca, admits, "brutal. I think in the summertime, there were quite a few 90-hour weeks." But no one seems to have any regrets. "We learn something new during every game and we get better at what we do each time out," he says. Adds Stockley, a veteran of such game titles as *Wing Commander IV* and *Nuclear Strike*, "I've been here six years and this game in particular is the best game I've been on. The team is amazing."

And they'll likely all be working together again this year on the next *The Lord of the Rings* game. Next up is a game centered on the battle for Middle Earth, and who knows what other adventures await eager game players? Whatever emerges from this EA team—just one of dozens working all over the world—you can count on the audio being more sophisticated and more prominent with each future release. ■

Blair Jackson is Mix's senior editor.

ROLLS INTRODUCES THREE NEW MIXERS



RM65b HexMix 6 x 4 Professional Audio Mixer

FEATURES: 6 Mic / Line Inputs

1/4" Line Inputs may be reconfigured as Inserts

Pre-fader Monitor Send, Post-fader Effects Send

Stereo Effects Return

1/4" TRS Balanced Outputs

MX122 MiniMix PRO

FEATURES:

4 Stereo 1/4" Inputs

1 XLR Microphone Input

Stereo 1/4" TRS Balanced Outputs

1/4" and 1/8" Headphone/Earphone Outputs



MX124 ProMix IV 4 Channel Stereo Mic Mixer

FEATURES:

4 XLR Inputs

2 Transformer isolated XLR Outs

Output Trim Controls

1/4" and 1/8" TRS Phone Outs

Individual Level and Pan Controls

Battery and AC operation



ROLLS

CORPORATION

5968 South 350 West
Salt Lake City, UT 84107
(801) 263-9053 - FAX (801) 263-9068
info@rolls.com - www.rolls.com

London to Los Angeles. Now.



Introducing DigiDelivery

Faster and less expensive than overnight delivery services.

More secure and reliable than FTP. Able to leap across planet Earth with a single click.

- Exchange any kind of file of virtually any size with anyone in the world
- Robust network appliance easily installs on your existing network, DSL, or cable modem
- 128-bit encryption for military-grade security from sender to recipient
- One-click secure downloads — Recipients don't need accounts, passwords, etc.
- No per-use or subscription fees
- All administration managed with standard Web browsers
- Automated reporting for billing clients



Visit www.digidesign.com/digidelivery for the full story on DigiDelivery.

World Radio History

Ensemble Studios on Gods, Trolls and Minotaurs

Audio Design for Strategy Games

Ensemble Studios in Dallas is one of the most successful publishers of what are known as real-time strategy games. These games have a completely different perspective than third-person character games, such as *The Lord of the Rings*, or first-person shooter games. The vantage point is higher and wider—you're looking down on the action from above—and the games usually involve a range of methodical tasks to advance in the game: constructing villages from scratch, figuring out ways to keep workers motivated, building armies, figuring out how to defend your city, etc. Ensemble, which was acquired by Microsoft in 2001, is responsible for such popular game series as *Age of Empires* and *Age of Mythology*. Though not requiring the same level of audio sophistication as third- or first-person games, the real-time genre still demands evocative sound and music.

"A number of years ago, while I was in college," notes Ensemble's music and sound director, Stephen Rippy, "I did half the music for *Age of Empires* out of my apartment. Back then, the music was done on a little general MIDI synth, and the big innovation for us at the time is we got an E-mu sampler; that opened up a lot of doors for us. Our first few games were done with a lot of MIDI stuff, and starting with *Age of Mythology*, we started incorporating more live instruments and even orchestra. Our latest *Age of Mythology* expansion—*The Titans*—has lots of guitars and percussion, and, in general, the music and effects are more sophisticated than they were in the past. I have a partner named Kevin McMullan who's responsible for creating about half the content with me, so it's basically a two-person job." In all, Ensemble employs about 80 people, mostly on the visual side.

STRATEGIZING A STRATEGY GAME

"The original *Age of Mythology* game had a couple-year-long development cycle," Rippy continues. "I'm present from the concept stage of it on through to the end. So when people are talking about, 'Wouldn't it be cool to have a game with minotaurs in it?' I start thinking about what a minotaur might sound like. From there, we'll see concept sketches and follow the visual side as it de-



Ensemble Studios' Kevin McMullan (left) and Stephen Rippy in real time.

velops. In terms of the musical direction, quite independent of the topic of the game, we knew we wanted to move more into live playing and actual audio recording. As the game was being ramped up, we put together a CD of things we liked—we had some tracks from *Passion* by Peter Gabriel on there and things like that—and it was sort of like a temp dub. We brought that to the designers and told them that this is sort of what we were shooting for and then started recording things.

"We always need to support what's going on visually, but that doesn't mean we can't be creative with the audio and the music, too. Like with *Age of Mythology*, we wound up coming up with a system where if you lose a large part of your army, it starts to play a different mix of the music track; it'll go half-time, it'll drop out half the instruments and become somber. It's pretty subtle, but it's cool if you notice it. Conversely, if you attack certain buildings, it plays a whole different track that's very exciting."

SMALL STUDIO, BIG SOUNDS

Much of the recording takes place in Rippy's own office, which is about 10x15 feet. "We can even do drums in here without driving everyone bananas," he says. "Kevin has a separate writing room." Most of the

original sound effects were recorded in the field using a portable DAT recorder. The in-studio music was recorded to Cakewalk, mixed to DAT and then put in the game as MP3 audio.

"The higher perspective [known as isometric] of real-time strategy games has its own requirements," Rippy says. "You have to fudge a lot of stuff. Given that you're that high up, you wouldn't hear a lot of swords clinking against things, but we put it in there anyway. Also, you're dealing with a couple of dozen little characters on the screen at once, so it's finding a balance between hearing general mayhem and being able to identify what you're selecting and, 'Is this thing responding to what I'm telling it to do?'"

"It gets more and more like working on a movie every year," he concludes. "Just the fact that we could go up to Seattle and record an orchestra [for *Titans*] was a dream come true for me and for Kevin. Beyond that, it's always fun coming up with sounds for the characters. We had a three-headed dog, which is Greek, and a Norse troll, so they had to get their own sounds. The troll is mostly me grunting. There's a lot of that: Me going into the studio and screaming, slowing it down and adding Waves plug-ins to it. We'll try just about anything to come up with something cool." ■

Convolution Reverb with Classic Controls

A breakthrough in parametric control
of convolution based sampling reverb



IR-1

is for any DAW user who needs superior reverbs and ambiances. IR1 is a sampling reverb which has flexible classic controls of the key reverb parameters. Unlike other sampling reverbs only IR-1 allows you to change all the traditional reverb parameters. IR-1 comes with an extensive library of over 60 carefully sampled impulse response files that recreate both the acoustics of real spaces and the sounds created by classic electronic devices, all with unmatched clarity and accuracy.

Extensive IR Library of over 60 spaces captured with unprecedented accuracy and sophistication

- o Concert Halls
- o Auditoriums
- o Theatres
- o Amphitheatres
- o Churches
- o Opera Houses
- o Recording Studios
- o Scoring Stages
- o Clubs
- o Halls
- o Rooms
- o Hallways
- o Stairwells
- o Car Interiors
- o Stadiums
- o Outdoors
- o Devices

Revolution of Control - The first sampling reverb that allows classic parameters to actually effect the convolution.

- o Reverb Time
- o Reverb Envelope (w/ unlimited editing breakpoints)
- o Room Size
- o Density
- o Room Modes (Resonance)
- o De-correlation
- o Damping
- o 4-band parabolic EQ
- o Independent ER/Tail/Direct gain and pre-delay

Spaces are captured at 96kHz/32bit floating point using unique mic setups at multiple locations

Supported on selected hosts via

HTDM (Mac) • RTAS • AudioSuite VST • DirectX (Win) • MAS (Mac) • Audio Units (Mac)



North & South America
306 W. Depot Ave, Suite 100
Knoxville, TN 37917
Tel: 1-865-909-9200
Fax: 1-865-909-9245

Rest of World
Azrieli Center 1, 21st floor
Tel-Aviv, 67011 Israel
Tel: +972-3-608-4000
Fax: +972-3-608-4056

powered by



14 DAYS DEMO AVAILABLE AT YOUR WAVES DEALER OR AT WWW.WAVES.COM

World Radio History

Immersed in Game Play

How Dolby Put 5.1-Channel Audio Into Xbox, PlayStation 2 and GameCube

Slashy game ads were all over TV this past holiday season, complete with photo-realistic graphics, huge explosions and 180 bpm music. The best of the spots even resembled Hollywood action-movie trailers, and it was no accident. Games have grown up. Games are big business.

Technology has moved so fast in the consumer electronics world that an entire generation knows nothing about Atari, Nintendo 64 or Sega Dreamcast, let alone *Pong*, *Asteroids* or *Pac-Man*. For the current generation of gamers, PlayStation 2 is already feeling outdated, even though its introduction four short years ago started the revolution in gaming—both for graphics and sound.

“PlayStation 2 was the first game console to be released with a built-in DVD player,” says Jack Buser, manager, game developer relations, at Dolby Laboratories. “A lot of gamers were playing DVDs for the first time on the same box they were playing games on. Consumers started to say, ‘Hey, if I fire up my home theater and these DVDs sound so good in Dolby Digital, what gives with my games? My Dolby Digital light isn’t even lighting up!’ It was a wake-up call for the entire industry.”

At the same time PlayStation consumers were calling Dolby with questions, Dolby met with Microsoft and began to discuss the feasibility of implementing true 5.1-channel Dolby Digital surround into its top-secret game console, Xbox. Having the luxury of designing a console for Dolby Digital from the ground up, the Xbox was able to deliver games with 5.1-channel audio on the day it launched.

“It was an entirely different problem we faced than when we originally developed Dolby Digital,” Buser explains. “For games, we realized we would have to do an encode essentially in real time, meaning that if the Dolby Digital encoder saw PCM from the game, it would have to turn the crank extremely fast and get a Dolby Digital bitstream out to the decoder fast enough so that the game player, when he pressed a button, could hear the sound happen at the exact same time. Latency was absolutely critical.”

It is also crucial that the audio never

touch the host processor, as there isn’t a publisher in the world who will allow audio to compromise graphics or game play. To that end, Xbox includes a separate DSP chip to handle the real-time encoding. The first big game to take advantage of 5.1 capability was *Halo*, which Dolby would use for demonstrations with developers to let the technology sell itself.

Meanwhile, Dolby started looking at the market leader, PlayStation 2, and began working on a 5.1 solution. Dolby Surround had been on games for years, but it didn’t allow for a sub or split surrounds. At the very least, the company knew that it needed to provide a stepping stone to Dolby Digital, so engineers worked up the backward-compatible Dolby Pro Logic II.

“If you want game developers to think about these issues, you have to give them a solution on the platform where they make the most money, meaning PlayStation 2,” Buser says candidly. “At the time, we had released Pro Logic II decoding into the consumer market, but we never really intended to have a new content program. We already had one! Dolby Surround. But then we knew that we needed to get the game experience as close to a true 5.1 environment as possible. Pro Logic II is not dissimilar to the original surround encoder, except it doesn’t band-limit the surrounds and you have stereo panning in the rear. Most importantly, it doesn’t touch the host processor.”

The first game to really take advantage of Pro Logic II was *Rogue Leader* for GameCube, developed by Factor Five in Marin County, Calif. It’s a *Star Wars* game that takes the extra step of providing a channel test by having a Tai fighter fly overhead and around the sound field. “GameCube is a very powerful console for audio,” Buser notes. “The chips they are using, the audio horsepower, the tools available to developers. But there’s no way to get digital audio out of the back, and that’s unfortunate. Still, it allows us to demonstrate that no matter whether you’re using analog or digital cable,



Dolby Laboratories’ Jack Buser

Pro Logic II would work, and it’s very cool.”

Because Xbox has the encoder built in, content creators simply place sounds in the game as they normally would, with whatever provided or third-party tool they desire. For PlayStation 2 and GameCube, Dolby provides developers with an interactive Pro Logic II encoder for effects or anything firing out of RAM. For the music and ambiances that stream off of the disc, many audio folks are using Minnetonka’s SurCode or Dolby’s DP563 to “pre-encode” those elements and mix into the game for a seamless experience.

“Pro Logic II streams will mix together just fine,” Buser says. “If you plug your PlayStation 2 or GameCube development system into the TV, you can hear the mix on the fly. A lot of game developers are still doing confidence monitoring on consumer equipment. The ultimate, of course, would be to get one of our DP564s, which allows you to do Pro Logic II monitoring, Dolby Digital, headphones...it’s a fantastic piece of gear for game development.”

And it’s a good time to be a game developer. ■

Tom Kenny is the editor of *Mix*.



THE ORIGINAL MAKES THE DIFFERENCE

Our 29 years of experience developing state-of-the-art interconnect products and a reputation for delivering original ideas to market, has made us the industry leader. Neutrik has always been committed to innovation to meet our customers' changing needs. Only the Neutrik logo and  guarantees you total quality. Choose Neutrik connectors. The original makes the difference.

Visit us at www.neutrikusa.com to see our full line of quality products.



NEUTRIK

CONNECTING THE WORLD

Neutrik USA, Inc. | 195 Lehigh Ave | Lakewood, NJ | 08701 | 732.901.9488 | info@neutrikusa.com
World Radio History

Music for Games

Scoring for the Smallest Screen

We've moved from MIDI to audio files, from 22kHz mono playback to 44.1 stereo, and from repetitive bursts of loops to full scoring and interactive transitions—in key. Files once sent to programmers on DAT are now delivered as sessions or .AIFF or .WAV files. We've even reached the point where songs are making their way into the gaming experience, breaking new artists and resuscitating older, genre-based stars (see "Licensing," page 66).

Any way you look at it, music has upped the profile of sound in the game experience. While it's easy, and not always accurate, to say that creation of score for video games rivals that of a feature film, the two mediums do share the demands that a composer must work in grand themes and short snippets. Here we profile two musicians-turned-composers—one a guitar slinger, one a keyboardist and trumpeter—and find out how they entered the world of video games.

BOB DASPIT

Guitar Ace Turned Game Composer
By Bryan Reesman

After beginning his musical career as a Sunset Strip glam-rocker, composer and musician Bob Daspit has evolved during the course of 17 years to become a session player for film scores, a record producer and video game composer, becoming known for soundtracks to such games as *Spy Hunter*, *Terminator: Dawn of Fate* and the new *Mission: Impossible—Operation Surma*.

In the mid-'80s, Daspit fronted an L.A. hair band, and his six-string playing scorched such clubs as The Roxy and Whisky A-Go-Go. After the group broke up, he went on to UCLA and graduated in 1990 with a B.S. in Philosophy. Soon after, on the recommendation of Eric Persing (now head of Spectrasonics), he was hired by Roland R&D. "This was when the S-770 was coming out," he recalls, "so I was brought in to work on their sample libraries. I was with them for the next five years." He recalls working with an SE 20 when Macs were smaller. He also remembers how long it took to loop a sample.

Musicians who knew sampling were in high demand with film composers at the time, and Daspit landed a gig with renowned Hollywood composer Hans Zimmer. It would last for a decade, and he would occasionally do session work as a guitarist, keyboardist or sampler for most of the prominent Los Angeles-based film composers. His first movie was *Toys*, to which he contributed guitar work. He has since performed on more than 65 movie soundtracks.

While session work on films kept him busy, it did not offer much in the way of career advancement. When an old business associate hooked Daspit up with a gig scoring the *Duck Dodgers* video game (Paradigm Entertainment, for the original Playstation), it was a welcome and refreshing challenge.

"I not only had to write the music, but I had to create the sound set for it," Daspit recalls. "They used to hire a bunch of different people: One guy would do the music, another guy would encode the sound set and another guy would integrate that into the game. They liked me because I could do the sound set [and the music]. I had to take a full orchestra and cram it down to [approximately] 2 MB. Then the score was played back via MIDI. As far as interactivity, there was a lot more control over what could be done, but the sound was horrible. It's amazing how far things have come since then. The way that games are scored now, it's basically just with audio. You do a full piece of music as you would for a film and they just place it in there. That's it. There's not a lot of control. That's the trade off, but I wouldn't go back. It just sounds better this way."

Since scoring *Duck Dodgers*, Daspit has gone on to do several more games



Bob Daspit can't seem to put down his guitar.

for Paradigm, which is now part of Atari. All three of Daspit's recent forays are for titles linked to famous franchises: *Spy Hunter*, which incorporates Henry Mancini's famous "Peter Gunn Theme"; *Terminator: Dawn of Fate*; and the new *Mission: Impossible—Operation Surma*, with its instantly recognizable theme.

"*Mission: Impossible* was great because I really love that theme," Daspit acknowledges. "It's pretty involved and I can sink my teeth into it. You've probably heard the Limp Bizkit version and the U2 version and Danny Elfman's version. I listened to all the versions, and I've got the original. Those guys had all kinds of resources, and I'm trying to do it on a laptop, so I try to do little rhythmic tricks or use the melody in a different way to do something fresh with it." Listening to the composer's work on *M:I—OS*, it is obvious he tried many different approaches, from ambient atmospheres to heavy metal mayhem.

After years in Tinseltown, Daspit and his wife relocated to Northern California, where he constructed a home studio by converting half of his garage to a 10x13-foot control room with an adjoining 4x6-foot vocal booth. It's a modest setup used to maximum effect, and thanks to the Internet, he can work where he wants.

"Right now, I have a three-computer setup," explains Daspit. "I have a Pro Tools setup, which I mainly use on my record projects or if I need to record live instruments for video games. I have a PC, which is pretty much dedicated for Ableton Live and I use it as a loop machine. Then my main rig is my Titanium G4 running Logic. That's really where I do the bulk of my work for the video games. It's kind of nice, because I can pull it in or out of the studio. I can work on it literally anywhere."

Daspit runs his Pro Tools | Mix 3 system on a G4/867 running OS 9.2.2. His hardware interfaces include an ADAT Bridge and an 888|24. He runs his Ableton Live rig on an HP Pentium 4 1.8GHz PC running Windows XP Home with

RME Digiface. His Logic rig is on a Titanium G4/1 GHz running both OS 10.2.6 and OS 10.3, with a MOTU 896 audio interface clocked via a Rosendahl Nanosync. The 896 and Digiface feed the Pro Tools rig via Lightpipe to the ADAT Bridge. His mic preamps, compressors, the 888|24 and headphone feed all appear on a TT patchbay.

"When composing for video games, I almost exclusively use just the Logic rig, usually just the laptop 'untethered' from the rest of the setup," Daspit remarks. He uses Logic Audio Platinum 6 as his sequencer, and his plug-ins are Emagic's EXS-24, and Stylus, Atmosphere and Trilogy from Spectrasonics. "In fact, I scored all of *Mission: Impossible* with just these four plug-ins."

Although he uses samplers and sample playback to create the majority of his scores, Daspit does not use many synthesizers. In fact, he currently doesn't own any synths. "I used to have racks and racks of gear back when I was with Roland," he remarks. "I had all the products I worked on, from the JD-800 all the way through the JV-1080. Because I'm a guitar player too, I wanted to make a conscious effort to keep my scores as acoustic as possible. So I try to stick to using samplers and sample playback plug-ins, and anything else that I do I'll go to a studio or I'll record something here and get human beings to play on top."

The composer records his guitars in his home studio. He has a good selection of amps—including various Fenders and a Dr. Z Route 66 that he really likes—and his vocal booth is just big enough to place a cabinet. He also owns a fair collection of guitars, including Les Pauls, Stratocasters and Telecasters, although he says he's playing a lot of acoustic these days.

He observes that his best vocal mic is the Neumann M148, but he tends to favor the Brauner VM-1. He also owns RØDE NT2s, Neumann KM194s and Shure 57s, and he loves the Royer Labs SF-12 stereo ribbon mic: "That thing is



Music for Games

just amazing," he declares. "I haven't heard it sound bad on anything." Additionally, he owns Manley mic preamps, a Vox Box and a Variable-MU compressor.

Daspit mixes in Pro Tools with a HUI controller, while he has Logic Control for his Logic rig. "Oftentimes, I don't even have to take it to Pro Tools," he says. "I'll just listen straight out of Logic. I have a MOTU 896 audio interface. A lot of times, I'll just be monitoring two channels out of my laptop, and that'll be the finished product.

"One interesting thing that I do is to use the same D/A converters for all of my gear," Daspit reveals. "The Digiface, MOTU and 888 analog outputs all sound vastly different, so I feed a pair of Lucid D/A 9624s digitally from each of the three audio interfaces and only listen to the analog outputs of the Lucid converters. That way, my D/A conversion is consistent, and I can really tell what I'm listening to from rig to rig."

In spite of all this technology at his fingertips, Daspit will continue to reduce the size of his digital arsenal. He says it feels great to own less stuff. "Before the next video game, I'll probably sell as much of this



stuff as I can and probably get a G5 and call it a day," he divulges. "I don't even think I'll be using the Pro Tools rig as much for the next game. I've just heard good things about people being able to record audio into the G5 with pretty low latency, and that's finally starting to come together."

Beyond video games, another new avenue opened up for Daspit when he was asked to engineer and mix Sammy Hagar's solo release, *Ten 13*, in 2000. He landed the gig after being recommended by Hagar's son (with whom he had written and recorded music previously) and providing a sample mix of one of the songs. Since then, Daspit produced, engineered and mixed Hagar's *Not 4 Sale* and produced and mixed his concert release *Live—Hallelujah*. Additionally, he mixed and mastered *Songs of Alan Broadbent* by jazz artist Ron Berman.

TIM LARKIN

Out of the *Myst* Comes *Uru*
By Blair Jackson

One of the most ambitious and admired fantasy game franchises is the *Myst* series, created by brothers Rand and Robyn Miller for their company Cyan, originally in conjunction with Marin County's Broderbund Software, now published by UbiSoft. The *Myst* games combine a slowly unfolding mythic tale set in all sorts of fantastic visual environments/worlds, with a variety of mysterious goings-on and clues and puzzles for the game player to solve to move through the story. The *Myst* games have sold in the millions and continue to enchant young and old players. The latest entry is called *Uru: Ages Beyond Myst*, which is a single-player adventure that can also be played online with others, a feature increasingly common in the video game universe.

Because the worlds in the *Myst* series are so unusual and impressionistic, music has always been an important part of the games' feel. The man behind the music and some of the audio for *Uru* is Tim Larkin, who cut his chops as a keyboardist and trumpeter in various San Francisco Bay Area bands and orchestras before landing a job as composer/sound designer at Broderbund a

INTRODUCING
SERIES II
THE NEXT GENERATION
IN POWER TECHNOLOGY

FURMAN 30th ANNIVERSARY
Purifying your power since 1974

- Series Mode Protection
- Maintenance Free Surge Protection
- No Ground Contamination
- Linear Filtering Technology
- Ultra-Wide Bandwidth Noise Reduction
- LED Lights for Front Rack Illumination
- Rear BNC Connection for Gooseneck Lamp

SERIES MODE PROTECTION
LINEAR FILTER TECHNOLOGY

ON
OFF

LIGHTS DIMMER

PROTECTION OK
EXTREME VOLTAGE

FROM THE LEADER IN POWER CONDITIONING

1997 S. McDowell Blvd. Petaluma, CA 94954 • Phone 707.763.1010 • Fax 707.763.1310 • www.FurmanSound.com

decade ago. He started out doing audio and music for such kids' games as *Carmen San Diego* and *Playroom/Treehouse*, but soon signed on to help work on *Riven*, and eventually moved to the Northwest to work full-time at Cyan's headquarters in Mead, Wash., outside of Seattle.

According to Larkin, it took about four years to complete *Uru*. "But that's because we were building an engine at the same time we were building this game. The engine is the platform on which the game runs: You have to put the sound somewhere; you have to put in the animation and the art. Ours was developed in-house and has its own needs built into it. We did an engine redesign about halfway through, which means we had to re-implement the audio and redesign how it worked within the engine itself."

As for the music, which besides being in the game, is also on a recently released CD. "We wanted to come up with something that was as unique as the game," Larkin says. "We didn't want to do your typical game score, whether it be orchestral or something you hear that doesn't stand out. So I was very diligent in finding instruments and combinations of instruments that were unique and sounds that were rare. When the game starts out, the setting is in a New Mexico desert, so we begin with this Southwest guitar kind of feel—sort of Native American mixed with dobro. But it takes so many twists and turns from there and you get taken to these other worlds, which we dealt with one at a time and treated differently. We had live musicians come in with guitars and Armenian flute and percussion."

Larkin's recording setup includes "Pro Tools|Mix Plus, Macintosh G4, Digital Performer for sequencing and MIDI software. I have tons of plug-ins and also lots of Roland gear—two 1080s, one 5080—plus two Kurzweil samplers and Gigastudio, JB 990 and software samplers. I'm using Kontakt, Atmosphere and a lot of sample libraries. The studio here is probably 12 by 20, and then I also have an 8-by-10 booth. We also have tons of outboard gear. I have a setup at home, as well."

In composing music for *Uru*, Larkin says, "I tried to break it up so you're not hearing the same piece of music over and over in these different areas. The 'ages' in *Uru* are relatively large, and as a result, there's a lot more opportunity to have musical variety. And the other thing is you don't have to have music everywhere. Sometimes it's nice to just have an ambience—some subtle wind blowing and birds and crickets, or whatever there might be. There are other cases where an abstract ambience actually crosses over to music. There's an age called Teledahn, which is like a giant mushroom age, essentially—



Tim Larkin in the midst of a composing session

there are 100-foot-tall mushrooms—and within that age there are probably five different pieces of music. Some of them are pretty melodic, underscoring the feel of the

space. But there are two or three of them that are bordering on abstract ambience, but still have musical elements to them. Then there are other ages where the music is more rhythmic and active.

"With a level-based game, you have to keep things changing and interesting, and as the levels intensify, the music has to reflect that. You have a template that's based on the game play, and you always have to keep that in mind. It's nice to do music that works apart from the game—as a lot of this does—but as the composer, you always have to remember that the music is part of this larger thing: the game. That's the fun and the challenge." ■

Neumann Invents the Microphone

For the Umpteenth Time...



Solution-D
Neumann goes Digital

Introducing Solution-D: Neumann's Digital Microphone System

For more than 75 years, Neumann has been THE key innovator in the world of microphones: The first commercial condenser microphone. The first multi-pattern microphone. Phantom power. Remote pattern control. The first stereo microphone. Neumann stands alone with its peerless combination of technology and matchless sound quality.

Today, Neumann continues to lead with the development of the Solution-D Digital Microphone System. The first to adopt the AES 42-2001 standard for the digital microphone interface. The first to provide dynamic range in excess of 130 dB. The first to use Neumann's proprietary A/D conversion process. And of course the first to have the *Neumann sound*.



Solution-D is featured on the John Pizzarelli Trio's new Telarc release "Live At Birdland"

The Choice of Those Who Can Hear The Difference

NeumannUSA



Tel: 860.434.5220 • FAX: 860.434.3148
www.neumannusa.com
Canada: Tel: 514-426-3013. Fax: 514-426-3953
Mexico: Tel: (525) 639-0956. Fax: (525) 639-9482

A Wide-Open Market for Songs

Licensing Tracks From Established Artists and Up-and-Comers

One fairly recent development in game audio is the steady increase in the licensing of songs by both established and up-and-coming rock and hip hop artists, usually not at the exclusion of a conventional music score, but in addition to. *NBA Live* has wall-to-wall hip hop: Snoop Dogg contributed three new songs to *True Crime: Streets of L.A.*; Peter Gabriel has a song on the soundtrack of *Uru: Ages of Myst*; *Grand Theft Auto: Vice City* is loaded with "classic" and more modern rock tunes; gamers can mix their own version of a P.O.D. song on *Amplitude*, and the list goes on and gets longer every day.

It's a good marriage: The games get some hip cache, and the artists and their record companies potentially reach millions of listeners and pocket some serious change. In some cases, DVD soundtracks from the games have been sold separately and done very well; in other games, there might be a separate music CD included in the package. It's definitely been pushing up the expense to make games, but it's been good for a record industry that's still very much on the ropes.

"With the advent of PlayStation and console games actually appearing on a CD [ROM], you finally had enough storage capacity to have real music on the game created by real composers," comments Chuck Doud, music director of Sony Computer Entertainment America. "The turning point in the industry was probably *Wipeout*, which came from our London studios. That was the game that pretty much set the standard for including licensed music in video games. It was primarily electronica, which perfectly matched the feel of the game."

Formerly based in Boston but now working in Sony's Foster City, Calif., game production facility, Doud used to write music for games himself—including a number of PlayStation titles—before moving into his current executive capacity. "Now I spend half my time working with the record industry to secure artists for our games, and the other half of my job is finding composers or producers to create original content for our games, essentially like a movie score. Increasingly, the line between those two roles is starting to blur.



"Three years ago, when we first started licensing a lot of music, there was this great fear among the composers that we were going to be taking work away from them," Doud continues, "but in fact, the way things have fleshed out now, there's actually *more* work. There are more games, more music, and it's all being used more creatively within the game. Also, we're more likely now to have multiple people working on the music—we might have someone working on the score and other people taking the multitracks and adapting them to the game. All that, in addition to licensed content. Right now is a good time to be doing music for video games."

When it comes to licensing, Doud and his counterparts throughout the gaming community have found the record labels—and most artists—to be extremely receptive to fitting tracks into video games. "While we like to put a few 'name' bands on each of our titles that incorporate licensed tracks, our focus is really on identifying emerging artists that have a good chance of blowing up in the near future. When done right, video games are a good place to showcase emerging artists and mid-tier bands, or established artists who want to reach a different demographic. It's almost like it's becoming the next MTV. People are hearing about bands and being exposed to them for the first time through video games.

"A lot of times, we end up hearing songs before the record labels do," Doud adds with a laugh. "Typically, we start working on

a soundtrack from eight months to a year before a game is released, so we're out there talking to [artist] management and looking to coordinate games with their own album releases to maximize promotional opportunities. In addition, as long as the production quality is on par with something we would get from the major labels, we also always save a few slots for artists who don't have the support of a record label but whose music we feel fits the game play and delivers something new to the player that, chances are, they would not have otherwise been exposed to."

The fees for licensing tracks vary wildly, just as they do in feature films. A David Bowie track is probably going to cost a lot more than a Papa Roach track, to name two artists whose songs Doud has licensed. Newly commissioned tracks will usually cost more than licensed ones. Increasingly, too, game producers are asking for, and receiving, multitrack tapes of both licensed and original music that they can massage or even remix to better fit songs into the games. As Doud notes, "If we have a song that's actually going *into* a racing game instead of just appearing over the credits, we might need to make some adjustments to the mix because it has to compete with the sound of the engines. We want to make sure the mix comes through, so it might not be the same mix you hear on the radio."

Custom mixes and exclusive content—that's the direction licensed music is headed in the world of video games. ■



Full Sail's Suite 4 is one of over 60 studios, production suites, and computer labs located on campus.

**WE'VE GOT THE GEAR.
BRING YOUR PASSION.**



school of

- ▶ Recording Arts
- ▶ Show Production & Touring



If you're passionate about pursuing a career in the recording industry, **Full Sail** is the place to start.

To find out why:

800.226.7625
fullsail.com

YOU CAN GET THERE FROM > **HERE**

3300 University Boulevard • Winter Park, FL 32792

Financial aid available to those who qualify • Job placement assistance • Accredited College, ACCSCT

© 2003 Full Sail, Inc. All rights reserved. The terms "Full Sail," "You Can Get There From Here," "Full Sail School of Recording Arts and Entertainment," and the Full Sail logo are either registered service marks or service marks of Full Sail, Inc.

World Radio History

Herrera Productions

Spotlight on Sound Effects

Raymond Herrera probably didn't think his percussive skills would lead to a second career in the video game industry. But three years ago, when his drumming for industrial band Fear Factory led to work providing music for games such as *Test Drive Cross-Town* (Atari), *Gran Turismo 4* (Sony) and *Dead to Rights 2—Hell to Pay* (Namco), he founded the aptly named Herrera Productions.

"It's very exciting to be working in the video game market, because I've been into video games since the 2600 came out when I was 10," Herrera says. "I started Herrera Productions because a lot of projects started popping up that didn't want heavy music like Fear Factory. If they wanted something heavy and fast, we could still do Fear Factory. If they want something different, I do it through my production company."

GETTING INTO SOUND EFFECTS

Starting the company enabled Herrera to move into sound effects and voice-overs. Steve Tushar, one of Herrera's first hires, is one of three sound designers in the sound effects department. Tushar, who came into the video game market from the film industry, says that his continued work in film has helped his game work. Indeed, Tushar has collected sounds from Foley artists who have performed effects work on some of his film projects. "Sometimes I'll use my connections in the film industry to get sound for my video game work," Tushar says. "I've done that once in awhile to get some sound effects from Foley artists, like sword-dropping sounds or wooden shields falling on concrete. It's good when you can get some original sounds rather than library stuff. That's some of the best stuff I have."

Both Foley sounds and Tushar's effects library have been collected into about 400 GB of hard drives. His main audio editing tool is Steinberg's Nuendo. "It makes every other program seem like a toy," he says, "especially when you're dealing with audio and doing editing and crossfades and inside-out fades. You can slip audio while keeping crossfades intact without having to throw them out like in other systems. If you're doing one-second loops and you've got all these fades, you can actually shift the audio

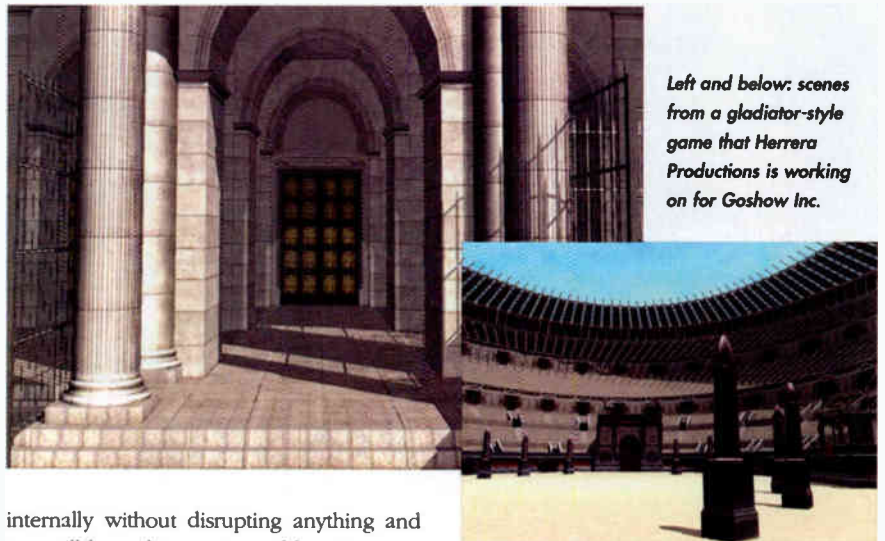

Left and below: scenes from a gladiator-style game that Herrera Productions is working on for Gashow Inc.

internally without disrupting anything and you still have the one-second loop."

In addition to Nuendo, programs such as Steinberg's WaveLab and plug-ins from Native Instruments get the call. Tushar adds few effects, relying mostly on pitch bending and pitch shifting. "Sometimes, I'll put a really short reverb on something to make it sound more stereo. Other than that, you don't use many more plug-ins, because you need to make things ultra-short. Maybe I'll use a Doppler [effect] plug-in for certain things, but for video games, it's pretty basic. It's all about finding the right sounds, laying them together, cleaning it up and bouncing them down, and hoping it matches what they've got."

Tushar says creating short sound effects is one of his biggest challenges. "On a gladiator game, they asked us for a wooden cart that was rolling. They wanted a one- or two-second loop, and it's hard to get it to loop without it sounding stupid and not hearing repetition over and over that's really annoying. So, a lot of times I'll try to find some kind of rhythmic thing that has bumps in it that actually will make sense."

Tushar delivers sounds to the programmers via e-mail. He explains, "I'll take the .AIFF files and zip them up to under 5MB attachments, which you can get quite a bit of sound in, considering most of them are under a second anyway, and e-mail them."

WE'VE COME A LONG WAY

Before the advent of such gaming consoles as Microsoft Xbox and Sony PlayStation 2,

audio professionals had to deal with some fairly strict compression rates. Rather than the 11- or 22kHz rates they faced then, composers and sound designers are free to work up to 44.1 kHz. "We don't really need to compress too much and [programmers] handle the compression a lot on their end of things," Tushar says. "We just deliver .AIFF or .WAV files for the most part and they compress it down. The good thing now with all the PC games is that they can actually have almost an unlimited sound per level, but they pretty much allocate how much they want to use to load up. It's not like the old days of the PS1 and the Nintendo when you really had to squash things."

"You used to have to make sure everything sounded good at 8-bit or lower sample rates," Tushar continues. "I used to monitor my sound effects with a lowpass filter on the output of my program, just to hear what it's going to sound like muffled because it might be playing only at 22 kHz or 11 kHz. You had to make sure the sound stuck out at lower sample rates, and then you'd have to bounce it down to whatever they wanted. Sometimes they'd want delivery at 11 or 22kHz, but now we can do everything at 44.1 for the modern game systems. I'm so happy now that I can work in full bandwidth. These are good days." ■

David John Farinella is a San Francisco-based writer.

Sounds good enough to eat.

Today's Special



If you're looking for delicious sound, meet the Bluebird, Blue Microphone's new Class A discreet condenser mic. Combining the best characteristics of our award-winning designs in a single package, the Bluebird is uniquely versatile, with applications ranging from vocals to electric and acoustic guitars, drums, percussion, piano, horns, strings, and any other application where crystal-clear sound quality and detail is of the utmost concern. It's truly a microphone of exceptional quality, cutting-edge design and superior craftsmanship for even the pickiest of audio gourmets.



The Bluebird comes with the Bluebird Accessory Pak - BirdCage Pop Filter, BirdNest Shockmount and Blueberry Cable.

Stereo Tuna Salad	\$1.25
Preamp Pot Pie (Giles' Favourite)	\$1.75
Veal à la Virella	\$1.90

"The Bluebird Cafe serves up some of the best audio vittles in the whole tri-state area. Whenever I'm traveling through, I always stop in and sing its praises"

- Simon Gooddle, EarCandy Review

We refuse the right to... service... use address all inquiries to John Given, barrister... level. No... service.

WEST ROUTE 28... 156 • RAFTER, IL

The Bluebird Cafe

Try these lastly

PLATINUM COMBOS!



Our chef has outdone himself with these special combos featuring three best-selling Focusrite Platinum Series entrees along with the scrumptious new Bluebird Mic and accessories. Not only are these special creations aurally satisfying, but the savings are even more delectable. Bon appétit!

Combo NUMBER 1 VOICEMASTER PRO PAK

A tasty combo featuring the award-winning VM Pro. Vocalists desiring a sonic upgrade with lots of features will appreciate this entree. The 24/96 digital output card has been added to cleanse your sound palette.



- Focusrite VoiceMaster Pro Channel Strip w/ Class A Mic Pre, Latency-free Monitoring, Vintage Harmonics, Compressor, Voice Optimized EQ, Tube Sound and more
- Bluebird Mic w/BirdNest & BirdCage (Pop/Shock) & Blueberry Cable
- Focusrite 24-bit/96 kHz A-D Card

SRP: \$1985 - SPECIAL BUNDLE PRICE: \$1299



Combo NUMBER 2 TWINTRAK PRO PAK

An equally delectable dish for the digital DAW-user who desires to get rid of a traditional mixing desk and gain improved tracks with latency-free monitoring. We've doubled the feature-set for tantalizing sonic results.

- Focusrite TwinTrak Pro Channel Strip featuring Dual Class A Mic Pres and Instrument Level Inputs, unique "Scoop" EQs, Dual/Mono Compressor, Stereo Latency-free Monitoring, and available 24-bit/96 kHz A-D (additional cost)
- Bluebird Mic w/BirdNest & BirdCage (Pop/Shock) & Blueberry Cable

SRP: \$1685 - SPECIAL BUNDLE PRICE: \$1099

Combo NUMBER 3 TRAKMASTER PAK

Our most value-oriented dish with mouth-watering features and a great price to match. Don't let the low price fool you, this flavorful combo packs a lot on its plate!



- Focusrite TrakMaster Channel Strip featuring Class A Mic Pre and Instrument Level Input, Voice/Instrument EQ, Opto-compressor, available 24-bit/96 kHz A-D (additional cost)
- Bluebird Mic w/BirdNest & BirdCage (Pop/Shock) & Blueberry Cable

SRP: \$1385 - SPECIAL BUNDLE PRICE: \$899

DANCING & MUSIC NIGHTLY WITH MODEL CITIZENS

For the location of a participating dealer, call toll-free 1-866-FOCUSRITE or find out more online at: www.focusrite.com • www.bluemic.com • www.digidesign.com



Microphones
World Radio History



North American Distributor
www.digidesign.com



Tips for Game Sound Designers

Ten Ideas to Streamline Audio Delivery

So you're a pro at post or an expert at mixing music CDs. Designing audio for games, however, is a whole different ballgame. You're creating sound for an interactive environment with serious space limitations. Optimize your audio—and your workflow—with these 10 tips.

1) **Learn everything about the target platform:** The delivery platform(s) for your game will have a profound impact on your approach to designing the audio. PCs, Sony PlayStation 2, Microsoft Xbox and Nintendo GameCube all have different audio capabilities in terms of sound RAM, DSP power and number of output channels. The Xbox is currently the most powerful console, audio-wise, with Dolby Digital 5.1, a healthy amount of RAM and a built-in hard drive. The market leader, PlayStation 2, is the most challenging current-generation console to develop for, with a paltry 2 MB of audio RAM.

2) **Touch up with a 2-track editor:** It can be tempting to bounce finished files out of Pro Tools or Nuendo and ship them directly to the client. Editing each file in a 2-track editor such as Sonic Foundry's Sound Forge, Steinberg's WaveLab or HairerSoft's Amadeus II before shipping is critical. You should trim the tops and tails as tight as you can. It is also the best way to create loops, adjust final amplitude and apply any last-minute processing.

3) **Naming convention is critical:** Computers are stupid. If you misspell a file name, use an uppercase letter where a lowercase letter is expected or inadvertently add a space to the end, the program will not find the file, and your sound will not play. Moreover, games often have hundreds of individual files in a single directory, so devising a cogent, agreed-upon naming convention is critical. Example: FS_sneaker_mud_walk_01.wav.

4) **Create a RAM budget:** Before you start, determine exactly how much RAM you have to work with, and then create a spreadsheet to calculate the expected sizes of your files. Though tedious, this exercise will help you determine the number, duration and sampling rate of files you can fit in memory at any one time. These variables are all inter-related. You want a wide variety of sounds to minimize repetition with sufficient durations to sound smooth and natural, while

maintaining the highest sample rate possible. A budget will help you compromise between these conflicting demands.

5) **Roll your own:** Every game sound designer owns the same off-the-shelf sound effects libraries. You hear the same effects show up in game after game, so make yours different. Strive for as much custom field recording and Foley as is feasible. A day away from the computer grabbing door slams, footsteps and servo motors from the real world will liven up your project and is loads of fun.

6) **Spice up backgrounds:** Backgrounds are crucial for immersive game experiences. The player is often in the same area for long periods of time, so short, repetitive ambiences will be noticed. I try to implement one- or two-minute stereo ambient loops that stream off the hard drive or CD-ROM. These are then spiced up with a half-dozen or so stingers that are short RAM-resident files. They should play back at random, with varied volume, pan position and pitch shift.

7) **Shoot for the highest sampling rate:** In the game world, RAM-resident files almost never have the luxury of a 44.1kHz sampling rate. Twenty-two kHz is a far more common rate, with 11 kHz and even 8 kHz not unheard of. Try to maximize the sampling rate whenever possible, particularly for sounds rich in upper harmonics. Game consoles can usually process files with different sample rates simultaneously, so I might choose 18 kHz for dialog, 11 kHz for distant explosions and background sounds, and 22 kHz for primary weapon fire or other high-priority sounds. Sounds that stream continuously from a hard drive or CD-ROM, such as music or ambiences, usually have a higher sampling rate.

8) **Don't make everything a brick:** There is the temptation to audio-compress the living daylights out of every file, making them the biggest, loudest explosions or gunshots possible. These "crew cut" waveforms may sound loud and punchy, but they can be problematic. You can't tell ahead of time what the final player experience is going to be. A heavy-duty fire fight could trigger a dozen of these sounds simultaneously, overloading the DACs or forcing the audio programmer to set a low default-level threshold to protect against such an eventuality. Hearing such compressed sounds over and over

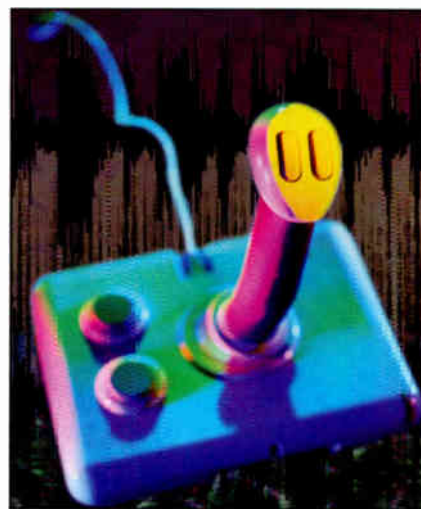

during a long game session leads to ear fatigue and a diminished playing experience.

9) **Design smooth workflow:** All too often, audio is an afterthought in games, with files delivered at the last minute, while the programmers are exhausted and up to their elbows in other bugs. You can improve the situation by designing a good workflow with the game producer. When within your control, try to begin your deliveries as early in the process as possible. Determine exactly when and to whom you will be delivering your files. Make them your friend and set up regular communication via phone and e-mail. I tend to deliver one set of files per week, with a detailed e-mail listing the file names, along with notes to their usage.

10) **Delivering the files is only half the battle:** Creating the world's greatest sound effect doesn't mean much if it doesn't play back in the game. It is the sound designer's responsibility to make sure that the sounds are playing back as they should within the game. Communicate your thoughts to the other members of your team clearly and regularly. Get regular builds of the game in progress and allocate time to hear how it sounds. Fix as many glaring problems along the way as you can through replacing files, requesting level adjustments and suggesting improvements. Work with the programmers to tweak levels, pans and distance curves. Do a final tweak pass at the end of development to polish your game to a high shine.



Nick Peck is a sound supervisor at LucasArts in San Rafael, Calif.

“I Switched”

Who: “Prince Charles” Alexander

Occupation: Music producer, mixer, multi-instrumentalist

Honors: RIAA multi-platinum award-winner; Governor, Grammy Committee Board of Governors

Clients: Mary J. Blige, Jennifer Lopez, Faith Evans, Puff Daddy, Alicia Keys, Notorious B.I.G., Destiny’s Child, and many more

Current Projects: Aretha Franklin, Thalia, Angie Stone, Will Downing, Stephanie Mills

Why He Switched to Studio Precision 8 Bi-amplified

Direct Field Monitors: “When I’m in the studio, I need the artists to be excited about what they’re hearing. I can’t expect them to imagine the bass frequencies and high end snap that my old monitors simply didn’t reproduce. So I switched to the Studio Precision 8. It gives me smooth, full-range reproduction that sounds great and has plenty of low end thump—essential for hip-hop and r&b production. And they’re ‘real world’ too. So I know that when a client plays my Studio Precision mix at home or in their car, they’re going to hear just what they heard in the studio.”

**Studio
Precision™**
Now Hear Everything

PO. Box #180 • Santa Barbara, CA 93103-0180 • Voice: (805) 964-7777 • Fax: (805) 964-7771 • Email: info@event1.com • Web: www.event1.com

World Radio History

EVENT
ELECTRONICS

www.audiogang.org

Everything Audio for Everyone in Games

If you've been involved in games for any length of time, then you know about the Fatman, aka George Sanger. He's a myth, a legend, a very real proponent—through print and the Internet—of better audio for games. A while back, he began hosting an annual gathering at his home in Texas, inviting the leading designers, manufacturers and developers for a game sound think tank posing under the guise of a barbecue.

At the 2001 gathering, another well-known name in games, Tommy Tallarico, made the bold proposal to form an organization, a guild, as it turns out, to promote, educate, provide resources and whatnot for the industry. He received overwhelming response and set up a summit for early 2002 at Dolby Labs in San Francisco to make it all official. Six weeks later, the Game Audio Network Guild was officially launched.

Today, the nonprofit G.A.N.G. has more than 500 members from all areas of game production, and the charter has expanded to include an annual awards show, along with forums and support for the burgeoning markets in wireless, Internet and other forms of interactive audio.

To find out a bit more about this very active organization and about content creation for games, *Mix* sat down with G.A.N.G. co-founder Jack Wall, a longtime composer, engineer and producer and one of the prime movers in the interactive music industry. Wall took a brief time away from his current gig producing music for the *Myst* Series, which this time around involves Peter Gabriel.

Has the Website become the center of G.A.N.G. operations?

I would say it's the hub, because we have message boards for the members, and the information on those is vast. When people join, they always tell me the message boards alone are worth the price of admission. The connections they are making...

I came into this industry in 1996, and I felt like every time I did another contract with a developer or game publisher, I had to start over, I'd have to re-educate these people about how audio is produced in other media and how it should now be done in this one. I thought, "Let's do this one time. Let's provide amazing resources that are free to any-



Jack Wall, left, conducting Seattle's Northwest Sinfonia for the game *Wrath Unleashed*

body in the business who wants to look at them. Let's start this conversation at all the conventions and have the Game Audio Network Guild be the entity, sort of a brand that people look to to get advice."

We also felt that we had to start recognizing individuals who are making great sounds and music for games. We did our first annual G.A.N.G. Awards last March at the Game Developers Conference, and we had about 600 people there. Individuals got recognized and people know who they are now. We have this amazing system online, where people can go up and listen to samples from all the nominees and decide who they like best, right then and there, and vote. *Most of our readers work in film, TV or music. What's different about preparing music, linear pieces of music, for an interactive medium?*

Let's use the film analogy. When you spot a film, you sit with your director, look at the film and you decide where music goes. In video games, you usually don't have a game to look at when the composer gets hired, so they give you what's called a design document. The design document outlines how the game is played—what the levels are and what they entail—like scenes in a movie. Sometimes, they even hand you a music de-

sign document, which will go in-depth specifically about music. Normally, a music design is what you'd get once the "spotting" process is over. It's nice to get that before you even begin adding your thoughts because that means they're thinking about music during the game design process. In either case, I would then propose to the producer and designer where I think music should go.

Then you have to decide how it gets played in the game. There are a number of tools out there; for the Xbox, there's a tool called XACT [X-box Audio Creation Tool].

That's a proprietary authoring tool?

Yes. Microsoft makes it especially for the Xbox, and you need a special de-bug unit [used for development] so that Xbox plugs right into your computer and into your television. You can then play sounds directly through the Xbox into your TV. And you can take music that you've created and do things like put markers in a particular digital file, like cue points, and you can tell the XACT tool, when it hits the next marker, that you're going to go to this file. Let's say you're in this massive battle sequence. You've got this full orchestral pounding, brass-heavy score—it's just going crazy. Suddenly, the battle is over. Right when it's over, the Xbox creation tool gets a command from the software that says "End." So as soon as it gets to the next marker, it crossfades into another file that's basi-

cally the ending of that piece.

So are you composing within the parameters of these marker setups?

I'll give you an example: I'm writing about 90 minutes of music for this one game. We've already gone through that whole music design—we've got a piece for this level, a piece for that level and three pieces for this level. One is really, really scary, one is the same theme that's not so scary and one's kind of a happier version. So I produce all that music, and it's got a beginning, a middle and an end. Then I go through an editing phase, where I edit it all up and put it in the Xbox tool and I'll start playing with it while I'm watching the game. I'll say, "Is this working?" No. "Is this working?" No. "Is this working?" Yes! I like that. Okay, *tweak* it, it's done.

Is there a tool like that for every platform?

There's one called "Screen" for PlayStation 2, and for PC games, there's the MILES sound system, but that doesn't really give the composer any tools for implementation. Sometimes you'll do a multiplatform title—like I just did a multiplatform title called *Wrath Unleashed*—where all I did was make notes for the guy who was implementing. It was all programming, and I'm working with a programmer at that point. So the ideal situation is to take all that out of the programmer's

hands and just hand him a set of commands.

Do these tools take into consideration RAM budgets?

Very few games have music that plays from RAM. Most of it is streamed off the disc. Even ambiences are usually streamed. But I'm doing another title for the PlayStation 2 that's all MIDI music. All the sounds that get triggered have to fit into a snug 800 KB of RAM—lots of *tweaking* there.

Can you produce music in full resolution, then?

Usually at 44.1/16-bit stereo. That's what I give them, and they normally have to compress that. Like the PlayStation 2 creates a proprietary format called a VAG, and there's all kinds of compression on it. It's a little lossy, but fairly clean. The Xbox also does IMA compression, and that can be pretty nasty, too. You can hear it; it sounds a little grainy. But new versions of the consoles are coming out, and they'll incorporate more MP3-like file types in their playback.

Do you do any premastering to compensate for compression?

I do, but I don't know that everyone does. When I did *Wrath Unleashed*, I had all this orchestral music, and I threw it in the game and I listened back to it, and it wasn't popping. So I threw up some really cheap PC

speakers, messed with it a little bit to get it to pop out, and it began to feel pretty good mixed with the sound effects and dialog.

Is there anything someone getting into this medium should know?

Join G.A.N.G.! The best thing that someone can do is play a lot of games, and understand how music is used in the best games. But I'm being serious when I say join G.A.N.G., because there are so many resources for new people coming into the business. Our basic goal is to try to answer all the questions ahead of time, because we keep getting asked the same questions: How do I get a gig? How do I get into this industry? Who are the players? Who do I talk to if I want to get a gig? All that information is all over the Website for members. You just go in there and hunt around. We're also about to launch our Phase III of the Website, which will incorporate the Game Audio Database, our most comprehensive resource for finding anyone who's ever done a game. That part of the site will be open to the public, not just members. We want to truly embrace and provide great resources not only for the people who create audio, but also all the producers, designers and game executives out there who are starting to take audio for games very seriously.

MIX
ONLINE
EXTRAS

AKG ACOUSTICS



<< NOISE POLLUTION

NOISE SOLUTION >>



The K 271 Studio and K 171 Studio Headphones. These innovative closed-back headphones offer tons of ambient noise suppression and our new Varimotion XXL transducers deliver the most detailed sound for pro studio use. Filter out the noise, hear the music. akg.com • 615.620.3800



H A Harmon International Company

AS PASSIONATE AS YOU.

E-MU® Digital Audio Systems

Professional PC Audio at an Unbelievable Price

E-MU's Digital Audio Systems deliver everything you need to produce audio on your PC with professional results – 24-bit/192kHz converters, (the same A/D converters used in Digidesign's flagship ProTools® HD 192 I/O interface), hardware-accelerated effects and mixing, and seamless compatibility with your favorite PC audio and sequencing software for less than \$500. These Digital Audio Systems stand toe-to-toe with the most advanced and expensive audio systems in the world, and will change your expectations of desktop recording forever.



- Complete analog, digital and MIDI I/O, plus sync and FireWire® interfaces
- TFPPro™ Mic/Line/Hi-Z preamps – plug your microphones, keyboards and guitar straight into your system (no mixer needed)



- E-DSP hardware-accelerated effects with over 500 presets
- Zero latency hardware mixing and monitoring



- Works with your favorite audio/sequencer software (ASIO 2.0, WDM and DirectSound® drivers included)
- Audio recording, editing, mixing and effects software package included

MASTERSHIP GRADE
24-bit/192kHz
120dB SNR – measured
A/D & D/A Converters

Works with
Windows
**2000
& XP**

E-MU**1820M**

Mastering Grade Digital Audio Interface

**1820M** \$499.99***I/O Configuration:**

- Two TFPPro[™] Mic/Line/Hi-Z preamps (w/48V phantom power)
- Six 1/4" Balanced Inputs
- Eight 1/4" Balanced Outputs
- Turntable Input (w/ground lug and hardware RIAA preamp)
- 24-bit/192kHz ADAT In/Out (switchable to S/PDIF)
- 24-bit/96kHz coaxial S/PDIF In/Out (switchable to AES/EBU)
- 24-bit/96kHz optical S/PDIF Out (switchable to AES/EBU)
- Two sets of MIDI In/Out
- Four stereo 1/8" Speaker Outputs (configurable from stereo to 7.1)
- Stereo Headphone Output
- FireWire[™] Interface

Sync Configuration:

- Word Clock In/Out
- SMPTE In/Out
- MTC Out

E-MU**1820**

Digital Audio System with Half Rack Space & Internal 40 Watt Driver

Professional Audio Performance at an Unbeatable Price!

**1820** \$399.99***I/O Configuration:**

- Two TFPPro[™] Mic/Line/Hi-Z preamps (w/48V phantom power)
- Six 1/4" Balanced Inputs
- Eight 1/4" Balanced Outputs
- Turntable Input (w/ground lug and hardware RIAA preamp)
- 24-bit/192kHz ADAT In/Out (switchable to S/PDIF)
- 24-bit/96kHz coaxial S/PDIF In/Out (switchable to AES/EBU)
- 24-bit/96kHz optical S/PDIF Out (switchable to AES/EBU)
- Two sets of MIDI In/Out
- Four stereo 1/8" Speaker Outputs (configurable from stereo to 7.1)
- Stereo Headphone Output
- FireWire[™] Interface

E-MU**1212M**

Mastering grade Audio

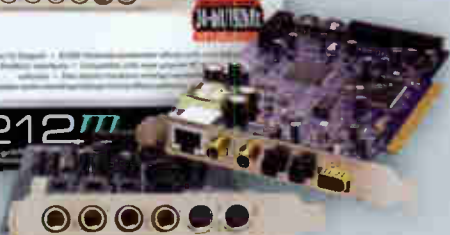
**1212M** \$189.99***I/O Configuration:**

- Two 1/4" Balanced Inputs
- Two 1/4" Balanced Outputs
- 24-bit/192kHz ADAT In/Out (switchable to S/PDIF)
- 24-bit/96kHz S/PDIF In/Out (switchable to AES/EBU)
- MIDI In/Out
- FireWire[™] Interface

*estimated street price

CREATIVE
PROFESSIONALwww.emu.com
877.742.6084
World Radio History**E-MU**

Complete Analog, Digital and MIDI I/O, Plus Sync and FireWire® Interfaces

AudioDock Front

Two premium TFPro Mic Preamps with Neutrik Connectors, 48V Phantom Power and 40dB of Input Gain control



MIDI, Sample Rate and Sync Source Indicators

MIDI In/Out 1 Optical S/PDIF Output Stereo Headphone Output

AudioDock Back

Six balanced 1/4" Analog Inputs (24-bit/192kHz)



Stereo Turntable Input with RIAA Preamp and Ground

4 Stereo 1/8" Speaker Outputs (configurable from stereo to 7.1)

EDI Connector to E-MU 1010 PCI Card (no external power required)

Eight balanced 1/4" Analog Outputs (24-bit/192kHz)

MIDI In/Out 2

E-MU 1010 PCI Card

Sync Daughter Card

E-MU I/O Daughter Card

EDI Connector to E-MU AudioDock M

Coaxial S/PDIF In and Out

ADAT In and Out (192kHz compatible) - switchable to optical S/PDIF

FireWire® Port for Video Capture, connecting peripheral devices and/or additional hard drives



Word Clock Sync In and Out

SMPTE Sync In and Out

MTC Out



Two balanced 1/4" Analog Inputs (24-bit/192kHz)

Two balanced 1/4" Analog Outputs (24-bit/192kHz)

MIDI In/Out



Hardware-accelerated Effects, Mixing and Monitoring

E-MU PatchMix DSP

Toolbar

Quick access to your most-used functions (e.g. Show/Hide, Session and effects management, etc.)

Viewer Window (3 Modes)

- Effects Editor lets you view all effects parameters for quick editing
- Input/Output Patchbays give you an instant overview of your I/O configurations at a glance

Audio Source

A Patchstrip can be fed by any external analog or digital input, as well as internal host sources from your audio application via ASIO™ or DirectSound®

Insert Chain

The Insert Chain allows you to easily route a channel of audio to any effects plug-in, physical output, or virtual output (ASIO) in any order (i.e. monitor your recording with effects but record dry). You can also send and return audio to/from your outboard gear like a traditional insert

Aux Sends

The two Aux Sends let you patch your audio to Busses for effects processing or submixing before hitting your audio recorder (perfect for headphone cuemixes)

Effects Palette (over 500 Effects Presets)

Puts all your E-DSP effects plug-ins at your fingertips, letting you effortlessly drag-and-drop effects onto Patchstrip Inserts and Aux/Main Busses, as well as create and organize new effects presets and configurations – you can even chain multiple effects plug-ins and save them together to create specialized effects (e.g. vocal channel, guitar recording channel)

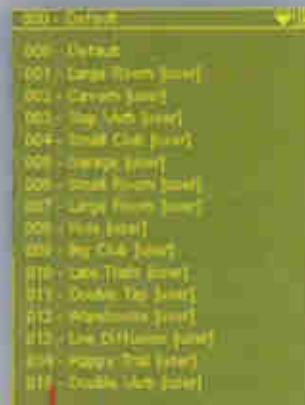

Effects Presets

Save your favorite effects parameter settings as presets within the effects plug-in

Main & Auxiliary Busses

Offer you the same flexibility as the Insert Chain above to route your Aux Busses and Main Bus to effects plug-ins, physical outputs and virtual outputs (ASIO)

Sync

Choose from Internal Clock, External ADAT, or External S/PDIF sync to synchronize your entire digital studio

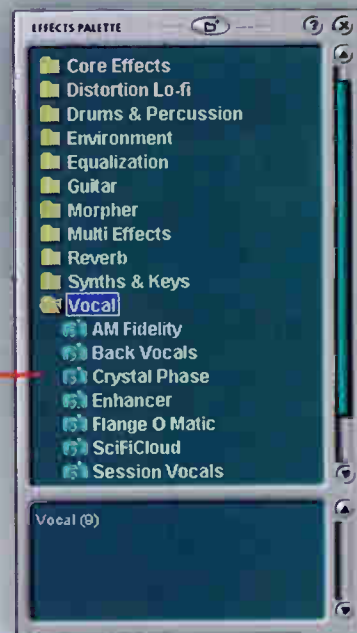

Bob Clearmountain

At the Top, But in the Trenches

In person, Bob Clearmountain looks much too youthful to have been engineering for more than 25 years. One of the first superstar engineers, Clearmountain's fame was key to elevating the role of mixer from obscurity to center stage, and his work, a seemingly effortless combination of technique and feel, inspired and influenced a generation of engineers.

In the 1980s, New York's Power Station Studios (now Avatar Studios) was Mecca for the recording industry. A phenomenon that spawned hit after hit, Power Station records featured unique and innovative sounds, many of them spearheaded by "Bad Bob." His lengthy discography extends from that era through to the present and is nothing short of awe-inspiring. Overflowing with classics, it includes Chic's "Good Times," Sister Sledge's "We Are Family," Bruce Springsteen's *Born in the USA* and "Streets of Philadelphia," Roxy Music's *Avalon*, Crowded House's *Woodface*, the Rolling Stones' *Tattoo You* and "Miss You," and Bryan Adams' Number One worldwide smash, "(Everything I Do) I Do It for You," from the *Robin Hood* soundtrack. More recently, it also includes hits by Shawn Colvin, Five For Fighting, Bon Jovi, Shelby Lynne, Ricky Martin and *American Idols* Clay Aiken and Kelly Clarkson. And that's just a few of the tunes on the BC roster—the list goes on and on.

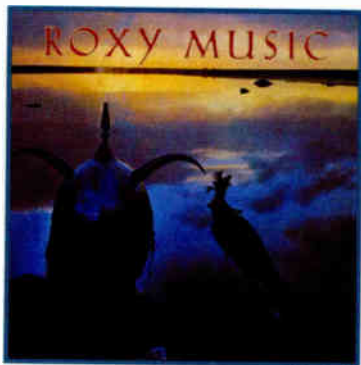

A lot of people in the music business who achieve great success get pretty full of themselves. Not so with the 10-time TEC Award-winning Clearmountain. Three things you always hear about BC are that he's lightning-fast, has a wickedly iconoclastic sense of humor and he's a *really* nice guy. That nice guy part is borne out of the long-term friendships he's maintained with many of the artists he works with.

Ten years ago, he built a studio in his Los Angeles home, which was designed by Brett Thoeny of Boto Design. And although he can still be prevailed upon to travel for work, you'll usually find him ensconced in front of his hot-rodded SSL 4000 G+ (with E Series EQ) console. When I visited him there, he was in the middle of mixes for a new Lisa Loeb album. He took a break and, accompanied by two dogs and a cat, relaxed for a bit as we delved into some questions about his career, his philosophy and his techniques.

How did you know that you wanted to be an engineer?
Growing up in Connecticut, I was a bass player. I was



PHOTO: MAUREEN DRONEY

also always the guy in the band with the tape recorder recording rehearsals and gigs. And I remember listening to Hendrix records, hearing the panning and flanging, and thinking, "Somebody's responsible for this; it's not just Jimi! Maybe that's what I should be doing." Ironically, Eddie Kramer, who actually *is* that guy, came over the other day and cooked us dinner!

And your first engineering job?

The last band I was in, after high school, had a lead singer who knew an engineer at Mediasound in New York. We went in with him one weekend to record some demos. It was a cheesy studio at the time, but for me—first time ever in a recording studio—it was, "Whoa! This is cool. I could just stay here!"

That band split up—I think because the lead singer's girlfriend was sleeping with the guitar player. Every one of my bands had broken up because of some stupid reason like that, and I finally started thinking, "This is never going to happen. I can't be depending on these idiots for my career." So I started hanging around Mediasound, telling them they should hire me. I actually moved to New York one summer and went there twice a week. Finally, they told me to come back in September because a guy was quitting.

I figured I was hired as a runner. I got there, went out on a couple of deliveries and when I came back after the second one, the studio manager said, "Are you that Clearmountain guy? Where have you been? You're not a runner! You were hired to be an assistant! Get down to Studio A." I walked into Studio A and it was a Duke Ellington session—my first day on the job! I was the "second" assistant following the assistant around, learning the ropes.

At the time, Mediasound did mostly jingles, music for *Sesame Street*, things like that during the day. At night, they did R&B: Ben E. King, the early Sister Sledge records and a bunch of disco stuff. A few months in, I did a night session for Kool & The Gang. The engineer was a jingle



Paragon Studios. Designed by Russ Berger Design Group. rbdg.com.
Custom monitoring and equipment provided by Pro Audio Design.

We're always in tune with your needs.

Pro Audio Design provides complete turnkey integrated solutions for recording professionals, large or small. We offer over 100 brands of new, used and vintage gear. All backed by experienced engineers, producers and technicians who consult with you before designing

and installing a system that perfectly meets your needs. No matter the size of the studio you have in mind, talk first to the people who take the time to listen and understand. Pro Audio Design. Visit us online or call 877-223-8858. You'll find we're music to your ears.



ALWAYS A SOUND DECISION

guy—records were just a waste of time for him—so he gave me the session. They came back six months later and Tony Bongiovi, who was supposed to be the engineer, was sick, so I got to work with them again. That time, out of the songs we cut, they had a Number 6 and a Number 40: “Funky Stuff” and “Hollywood Swinging.”

In '77, you helped start Power Station, working with Nile Rodgers and Chic. Actually, they were Power Station clients before the studio was even ready to use. The first few sessions we did were downtown at Electric Lady. When they did come in, there was plywood where the control room window was to be and a little iso booth off to the side where we did vocals. They were broke then—they hadn't made it yet—but we had so much fun. They were incredibly brilliant, and Nile is one of the funniest guys I've ever come across. I still miss those days.

I remember after recording the basic track for “Good Times,” saying to [the late] Bernard Edwards, “How the hell did you come up with that amazing bass line?” He said, “What? You like that?” I said, “Like that? That's one of the coolest bass lines I've ever heard!” Those guys were so humble. *Were you always naturally speedy or was it the jingle training?* I got used to doing things quickly. With jingles, you'd have a rhythm section and a percussion section come in and you'd have to be ready to go within 10 minutes. As soon as they'd read through the chart a couple of times, it was, “Okay, let's do a take.”

Immediately after, the horn section would come in—for 20 minutes! Then the string section, the backing vocals and you'd mix. In three hours, it was finished. At the end of the day, you'd have done two or three jingles. Then you'd go home and have a really big drink!

But I don't consciously try to mix quickly. When I get inspired during a mix, it tends to go fast. It becomes, “Oh, I know what to do here. I know what to do with this or that.” Before you know it, you have it together. It takes longer if you're not inspired and you belabor it.

Maybe that explains why your mixes have so much feel. Because you get excited and work fast, you keep the excitement of the rough mixes while still getting a more polished sound.

That's probably a good description. I do it kind of rough. Unfortunately, I make mis-

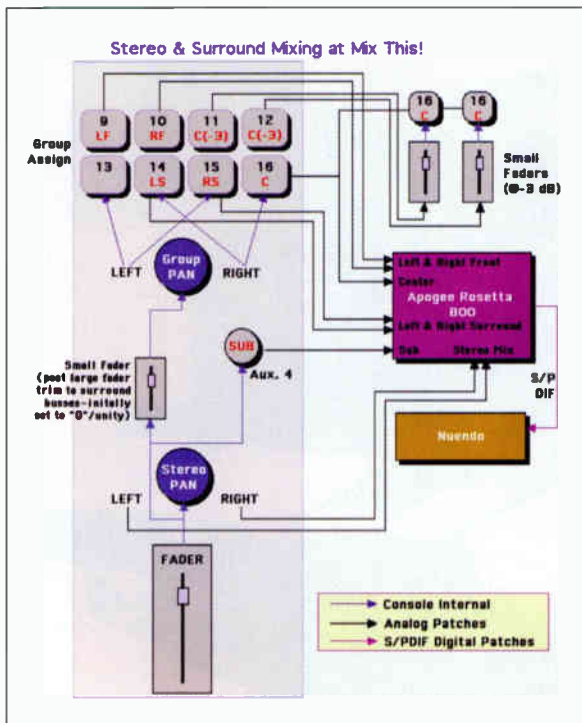

Clearmountain uses this audio chain when mixing at his home studio.

takes that way! [Laughs] I can't be bothered with soloing each channel all the way through. That's too boring. I'll just push the faders up and, as things hit me, I'll reach for them. I listen to it as an overall picture. Whatever sticks out as not fitting, I'll work on to make better. Usually, I do eventually catch the mistakes as well.

What were your musical influences?

Growing up in Connecticut, I had this rock affinity. I also always liked Motown and the Philly R&B stuff I heard on the radio. So my rock and R&B sensibilities got mixed together. Working at Mediasound in the '70s, I learned about the importance of bass, drums and feel in the rhythm track, and I applied the things I learned about R&B to making rock records.

Do you think you have a “sound”?

No, I don't think I personally have a sound. The sound of a record, to me, should come from the artist. I want to know what they're thinking about and where they want to go with the song. I try to make my sound their sound. Also, there's a certain clarity I try to go for. Although sometimes, of course, it's the opposite. If it's a noisy grunge record, it shouldn't be clear. Hopefully, what I do is just make things enjoyable to listen to.

Your mixes have an element of production in them, in that you find the strong point of the artist or the song and bring that out.

I'm glad to hear you say that because that's what I try to do. I hope I'm successful. I did produce something like 30 albums.

But you don't produce much anymore.

I do for some artists that I feel strongly about, but not that much. Mainly, I think, because I'm not very vocal. I'm also not much of a psychologist. Producers have to be able to get people to do certain things, and I'm not that good at giving direction. For me, it's not about getting people to do stuff, it's about getting the sound to do things.

Do you try a lot of new gear?

I usually have to be shown, or convinced, before I'll try something. Occasionally, a piece of gear comes along that fills a certain need that I have. An example is the BSS dynamic equalizer. I always wanted a box that would compress or limit certain frequencies, so when a frequency gets harsh, it will be sensitive to just that. Finally, BSS came up with it and it's brilliant: a 4-band equalizer that doesn't do anything until that frequency hits a threshold that you set. It was exactly what I'd been wanting.

But that's rare. Otherwise, I stick to things like the old Pultec EQs because they're fantastic-sounding. I don't have a lot of exotic gear; just Yamaha reverbs, Distressors, 1178s, a lot of Apogee converters...

Well, yeah! [Ed. note: Clearmountain's wife, Betty Bennett, owns Apogee Electronics.]

People are always telling me I should try this or that, but basically, I have what I need. Playing around with some new piece of gear tends to be more of a distraction and a time-waster than anything else. Most of the new stuff is just variations on what we already have; how many variations of a compressor do you really need?

I see you still have a lot of LA-3s with the Bob Clearmountain mod, right?

No, the Ed Evans mod. I would never take credit for what he came up with. But yeah, it made them usable. It doesn't change the sound; it just makes them quieter. For some reason, maybe for radio, only a very small percentage of the available gain was actually being used and the signal was way down into the noise floor. The mod is a pad that forces you to turn the input level up two or three times over what it would be normally without affecting the threshold.

What do you use them on?

They're very transparent for a vocal. Unless you really hit them hard, you can hardly tell that there's compression. It evens everything out in a very usable way that's complimentary to most voices. I like that it doesn't sound like there's a piece of gear on the vo-

cal. I go back and forth between them and the [UREI] 1178s, which are just two 1176s. The 1178s really pump. They have a sound, and that can be good, too, especially on modern music.

Why do you prefer the 1178s to 1176s?

Because I can fit two channels in my rack in the space where I could fit one 1176!

The only disadvantage is that the attack and release times are the same for both channels; you can't separate them. But typically, I'll have a snare and a bass drum in one, and I'll put two vocals or two guitars in another. I'll put in similar items, not a vocal and a snare drum. Or I'll use them in stereo with the Stereo Link switch, which is also a nice little feature for compressing drums.

Do you use the Pultecs a lot on vocals?

Almost never. Mostly on drums, guitars or piano.

Okay, I've been subtly trying to find out how you get that cool, raspy edge on vocals. It's not the LA-3, which you like because it's transparent. It's not the Pultec, which you don't use on vocals...

I dunno. The only EQ I really use are the SSLs. And I don't use much. It's more dipping than boosting. It's probably more about making room in the mix so the

voice sounds closer to the listener.

I assume songs come to you on Pro Tools.

Do you provide guidelines to people for what you want them to send?

I don't, but it's true that we often have to do quite a bit of cleanup on what we get. I have the tracks transferred to the Sony 3348HR, which is what I work off of. My assistant, Kevin Harp, goes through and fixes all the bad edits, puts in crossfades where they left them out, et cetera. Once he's got it sounding decent, he'll transfer it to the 3348 and I'll start mixing while he continues to work. If, once in a while, I need to replace a bass drum or something, he can be doing that on headphones while I continue to mix.

For vocal tuning—which, of course, we never do [Laughs], but if for some reason we were to ever do it—I don't, er, I mean I wouldn't use Auto-Tune. I don't like the mechanical way it sounds and it's often not accurate. When it has to track the existing tuning of a vocal, it sometimes picks up harmonics, which can actually put the vocal out of tune. We'll make a clone of the vocal track on the 3348, and I punch in any re-tuning through the Eventide DSP 4000 Ultraharmonizer. I go in and out of the Eventide through its AES ports, so there's

no audio compromise. It only takes me 20 to 30 minutes to tune a vocal. I do it by ear, because not everything *should* be in tune. I don't like to depend on a machine to tell me what sounds right.

What do you mix to?

[Steinberg's] Nuendo, because it sounds good, it's good for editing and I'm always mixing eight tracks: stereo and surround. I mix through Apogeess, which, every time they come out with a new box, changes. They just keep getting better. At the moment, it's a Rosetta 800, which is unbelievable.

You used to be a surround skeptic. It sounds like you've become a convert.

I think it's still a novelty. Don't get me wrong, I love it. Mixing and listening in surround is so much fun. But very few people—except engineers—even know what it is. Most people think it's just for movies. I was in a record store two days ago and I asked where the DVD-Audio/SACD section was. The clerks just looked at each other. They thought they had one, but they weren't sure where it was.

It's frustrating. And most people who buy surround systems don't know how to set them up. I've heard all these stories, like people lining all the speakers up in a row in

90v-series

look

feel

love

console enclosures

Control 24
ProControl
DMX R-100
DM2000
O2R.96
D88, DXB, 8.Bus
and more . . .

workstations

Universal
Keyboard

studio furniture
world-wide express delivery

rack enclosures

Solid Hardwoods
High-pressure Laminate
Custom Finishes

ARGOSY®

front. Then you've got manufacturers making silly little satellite speakers with a sub-woofer—it's like, "Hello, what about the midrange?" You spend all this time getting the midrange right, and they sell these lame, crunchy-sounding systems that deaf critics rave about, which actually sound horrendous. Also, they tend to add a bunch of DSP crap to their systems that can't possibly help the sound. If there was supposed to be more reverb on the mix, it would already be there! Too bad the hi-fi manufacturers seem to be so clueless; they just want to be able to list as many features as possible to sell their crap

to brain-dead consumers! But don't get me started. I just do the best surround mixes I can and have a good time while I'm doing them. The rest of the world can take 'em or leave 'em. Too bad they don't know what they're missing!

You generally do both stereo and surround mixes at the same time?

While I'm doing the stereo mix, I'll assign things to the surround buses, which are actually a group of the SSL's multitrack buses. I don't do a lot of fancy panning. When I'm done with stereo, I'll go through the surround a couple of times to make sure everything

sounds balanced. Because I have a console mod that gives me extra aux sends, I don't need the small faders for sends. I use the small fader as a post-fader send to the surround buses, kind of a static trim between the stereo mix and the surround. So the surround, to start off with, has exactly the same mix, same EQ and level rides. When I want to pan something, if I have extra faders, I'll just usually mult the track to a few of them to do it. Of course, it's different if I'm actually doing a dedicated surround mix, like with Roxy Music's *Avalon*, which Rhett Davies and I remixed last year. And which you should definitely get. I'm really pleased with it.

For your studio monitors, I see KRK E8s with a subwoofer, Yamaha NS-10M Studios and what are those little Apple speakers?

My favorite speakers. Unfortunately, Apple stopped making them years ago. They're much better than Auratones; they're not all midrange-y, and they have a nice, punchy bottom end.

What other gear of yours are you really fond of lately?

The Yamaha D5000 is the best digital delay ever made, which nobody seems to know about. It's really easy to work, and it does so much stuff. It's got six delays and panning. I think Yamaha emulated the Roland SDE3000, which is fantastic, because it's got everything right in front of you, and improved it. The D5000 sounds a little better and it does more.

I see an Ursa Major Space Station. Do you use that a lot?

I do, but I also use the new version designed by Chris Moore quite a bit. It has the same sounds but it's cleaner. The old one is better for really grungy, dirty sounds. I think of it as the "basement guitar sound." It sounds like a rock club. The new one is nice for vocals.

What other reverb and effects do you use?

I've got two little live echo chambers that I built out of what was originally a wine cellar. Its walls are half concrete-block foundation and half drywall with epoxy paint. We put a second layer of wall and a second ceiling above it because we're right under the kitchen and the dishwasher. I use it all the time. They're identical and both mono, so I use them left and right in stereo. Currently, the mics are AKG 460s and the speakers are Mackie HR824s that Greg Mackie gave me when he came over for dinner one evening. But, I occasionally change the components for different characters. Because the rooms have two parallel walls, they get a little boomy, but I filter the bottom out and they work fine. They're bright and short, kind of like the old '60s Motown reverb.

"Maximum Control"

InnovaSON has years of experience in digital live sound with hundreds of consoles in use every day around the world. Our new Sy80 control surface has been specifically designed for live mixing, providing the fastest most direct performance control without the need for multiple channel strips, hundreds of pots and switches, or layers.

Just what you need, when you need it...
...immediately



- 48 buses
- 80 Inputs, 80 faders
- no layers needed
- cost effective - exceptional return on investment
- superb performance to weight ratio, only 94kg
- acclaimed audio quality
- durable and reliable
- global support

**"the band loves it, our monitor engineer loves it,
our production accountant loves it"**

Neil McDonald - Tour Manager, Stereophonics

**innova
SON**

Distributed in the USA Exclusively by Sennheiser Electronic Corp.
One Enterprise Drive, Old Lyme, CT 06371 • Tel: 860-434-9190

But the most important piece of gear in the studio is, of course, the Funk Logic Valvecaster 960, with its proprietary "Teleknob Preampulator" circuitry. I use it on just about everything—very transparent. [For more information, visit the Funk Logic Website at www.funklogic.com.]

Your success has brought you work with many great artists.

Well, yeah, I get to work with Bruce Springsteen, who I've learned a lot from, and the Stones, but a lot of unknown artists are great, too.

What did you learn from Springsteen?

He has a very clear vision of getting his point across, and he taught me that the song and its central character are always the most important. Everything in the mix needs to complement that. Most of Bruce's songs are about someone's tribulations or joys of life. The connection between the character—as portrayed by the singer—and the listener can never be broken. Everything needs to add to the connection and not take away from it. From a mixing standpoint, that means you have to connect with the song first before you even start.

How do you do that?

Usually, it's by listening to the vocal. I'll put up a rough and listen to the vocal, then go through and solo things to see what the contribution of each instrument or vocal is. It's kind of like a play or a movie: Each instrument is a character. The main character is the lead vocal, the main subcharacters are the backing vocals and it goes on from there. In

some songs, say some pop tunes or a dance record where the lyric isn't really about anything, it can be other things. If it's a dance record, then it's the groove that's got to come through and nothing else can get in the way of that.

Do you relate to your mixes visually?

I tend to, which is why if you listen to my mixes, you won't find a lot of stereo instruments. A lot of guitar players will record their guitar with a nice stereo effect. I'll usually make it mono and put it on one side so it's like, "This is the guitar player here, that is the keyboard player over there."

You've been pretty much an idol to many engineers. How do you feel about that?

The best thing about being recognized is that I can walk into just about any recording studio on the planet and they know who I am. That's nice, because I really feel at home in recording studios. People go, "Come on in, check out our room!" Whereas, I remember years ago trying to get into the Sausalito Record Plant and they wouldn't let me in. "I just want a little tour; can't I see your rooms?" "Go away!"

Other than that, I was never interested in being famous. For one thing, back when I was in bands, I had terrible stage fright! The thought of people recognizing me walking down the street always freaked me out. I've always been most comfortable working behind the scenes. Honestly? I wouldn't trade places with some big rock star for all the money in the world.

Selected Discography

P = producer; E = engineer; M = mixer

Bryan Adams: *Cuts Like a Knife* (P/M, 1983), *Reckless* (P/M, 1984), *Into the Fire* (P/M, 1987)

Clay Aiken: "This Is the Night" (M, 2003), "Invisible" (M, 2003)

Jonatha Brooke: *Steady Pull* (P/M, 2001)

Shawn Colvin: "Sunny Came Home" (M, 1996)

INXS: *Kick* (M, 1987)

Five for Fighting: "Superman" (M, 2000)

Aimee Mann: *Whatever* (M, 1993)

Paul McCartney: *Tripping the Live Fantastic* (P/M, 1990)

The Pretenders: *Get Close* (P/M, 1986)

Rolling Stones: "Miss You" (M, 1978), *Tattoo You* (M, 1981)



Roxy Music: *Avalon* (M, 1982), *Avalon 5.1 Surround SACD* (M, 2003)

Simple Minds: *Once Upon a Time* (P/M, 1985)

Bruce Springsteen: *Born in the USA* (M, 1984), *Tunnel of Love* (M, 1987), "Streets of Philadelphia" (M, 1993)

Various Artists: *The Concert for New York* (P/M, 2001)

Believe Your Ears!

Winner 1992

- SOFT/FIRM CANALS
- CUSTOM COLORS
- MG4™ TECHNOLOGY DRIVERS
- PROVEN RELIABILITY & FINEST QUALITY

Ear Monitors® Brand Custom Fit Miniature Speaker Enclosures

2002 NOMINEE

- PRICED UNDER \$200
- CUSTOM SLEEVES AVAILABLE
- GREAT AS AN UPGRADE
- MP3, DVD, LAPTOP COMPATIBLE

Future Sonics Ears™ Universal Fit Miniature Speaker Enclosures

DARE TO COMPARE!

Just listen for yourself in your own side-by-side test and if you are not happier with the sonic performance of our Future Sonics Ears™ (EM3) over any other professional universal fit "in-the-ear" (ITE) product, we'll take them back.*

FUTURE SONICS INCORPORATED

HEAR WHAT YOU'VE BEEN MISSING!™

TOLL FREE: (877) FSI - EARS
www.futuresonics.com
info@futuresonics.com

* Offer subject to change without notice. Any returns must be within twenty (20) days and subject to a 15% restocking fee. Subject to the sole discretion of Future Sonics Incorporated. Contact us for details on this special offer.
 *Ear Monitors™, the Ear Monitors® brand and all associated logos and images are worldwide registered trademarks of Future Sonics Incorporated. ©2003 All rights reserved worldwide.

Guitar Wizard Johnny A.

Great Expectations, Great Results

A home studio can be a blessing and a curse for a workaholic. Guitar virtuoso Johnny A.'s newish project room allows him to write and record on his own schedule, which typically begins at the crack of dawn and continues on and off into the night. "Every recording situation has its pros and cons," Johnny A. says. "The pros about doing recordings at home are that you can catch magic moments because you're in a totally relaxed state. The cons are that you have this stuff at your disposal all the time and you can get into a routine where you feel you're never finished."

However, Johnny A. doesn't seem to suffer from that endlessly-getting-sounds disease. He is as disciplined as he is talented, and has just released his second instrumental album, *Get Inside*, on Steve Vai's Favored Nations Entertainment label. Vai discovered Johnny A. when his previous album, *Sometime Tuesday Morning*, which Johnny A. self-released, became a surprise success in the Northeast. "The first album was conceived in a relaxed atmosphere, in that I did not have a record deal at the time," he explains. "I never thought I would get a record deal with what I was doing, and it was more like I had the opportunity to record and I wanted to celebrate my influences and not make any musical or audio compromises."

"One thing led to another, and it became this regional thing that was very successful and very grass roots, selling close to 9,000 or 10,000 copies," he continues. "And then it got picked up by Steve Vai and went international. In the back of your mind, you hope to be successful at anything you do, but I had no delusions of grandeur thinking that I would put this out and it would be the next *Classical Gas*, Mason Williams' million-selling instrumental record." In fact, the album and Johnny A.'s playing have been so widely admired that Gibson released a Johnny A. signature guitar, which received drooling raves in the December 2003 issue of *Guitar Player* magazine.

The success of *Sometime Tuesday Morning* allowed Johnny A. to acoustically improve his recording room, which is in the 10x15-foot attic space of the two-flat building that he owns. The studio began as a writing room, outfitted with a Roland VS-2480 workstation and KRK V8 monitors, but when he wanted to take the room to the next level, he contacted Auralex Acoustics for materials and design advice.

"I called them and they ended up being fans," Johnny A. recalls. "I guess the radio station where they are [WTTN in Indianapolis] played my music a lot, and we struck up a great friendship and they offered to design the room. They flew Rusty Sulzmann out here, and they did the whole studio—the bass traps, the DST panels, the wedges, sunburst columns—and it just sounds great. They also did a great job with all the mitered cuts that go



Auralex Acoustics panels, wedges and bass traps dominate Johnny A.'s attic studio.

into the dormered ceiling line and slanted wall line. The room is beautiful and comfortable."

Johnny A. recorded demos of all the new songs at home and then went to Boston Skyline studio to self-produce the drums, bass and guitar recordings, which were engineered by Dave Lefkowitz. Johnny A. recorded direct from his amplifier (a Marshall 6100 head) through a vintage Neve 1058 mic pre—which he scored from his old friend Fletcher of Mercenary Audio—and then straight into the back of the Studer A827 2-inch machine in the studio's "A" room. Then, all of the tracks were transferred to a Pro Tools | HD system; horns and Hammond organ parts were recorded directly to Pro Tools. He brought an identical Pro Tools system home, where he and engineer Bob Catalano edited and created premixes of the basic tracks and then recorded some percussion overdubs. Phil Greene and Johnny A. did the final mix in Pro Tools, making use of the SSL 4000E (with G computer) to a Studer A80 RC at Unique Recording in New York City. Johnny A. was also on hand for the final mastering by Scott Hull at Hit Factory Mastering.

Promotional touring has just begun for *Get Inside*, but Johnny A. is already excited about a third album. "What I probably will decide to do is go into a really great studio and record the drums and immediately transfer them to whatever the digital greatness of the day is—lease or buy one of those rigs—and then do my guitars and everything else at home."

"As far as audio goes," he continues, "I'm a self-taught mixer and producer. I'm not a technician; it's all feel. I have a high expectation of things I like to listen to, and I put that same critical thinking into my own music."

For more on Johnny A., visit www.johnnya.com. ■

Barbara Schultz is a Mix contributing editor.



Emmy® and multiple Grammy®-winning mixer-engineer-producer **David Reitzas** has had his hands (and ears!) on recordings by the biggest names in Pop, Latin, and R&B. All these and more have benefited from his experience: Barbra Streisand, Madonna, Whitney Houston, Celine Dion, Natalie Cole, Cher, Frank Sinatra, Luis, and Ricky Martin.

Grammy-winning producer-composer **Walter Afanasieff** started his career as keyboardist for Jean-Luc Ponty and has co-written some of Mariah Carey's biggest hits. His production credits include Carey, Celine Dion, Savage Garden, Luther Vandross, Kenny G., Destiny's Child, Ricky Martin, Josh Groban, and Barbra Streisand.

When it's time to select mics for their Grammy-winning work, Walter and David know they can count on the sonic excellence of the 40 Series. "It is remarkable how versatile the 4060 microphones are for my recording sessions," says David. "Vocals, drums, guitars, piano, strings, percussion... you name it, these mics hold up!" He continues, "Recently on a visit to Japan, I had the great pleasure to tour the company headquarters and meet the people behind A-T mics. A group so dedicated to advancing the design and quality of sound recording devices. Truly an amazing company creating classic microphones."

Take the advice of these music industry superstars and try 40 Series mics on your next session. Who knows? You might just be making musical history – like they have.

Special thanks to Chalice Studios, Los Angeles, CA



(40) SERIES

 **audio-technica**

Audio-Technica U.S., Inc. | 1221 Commerce Drive, Stow, OH 44224 | 330.686.2600 | Fax: 330.686.0719 | E-mail: pro@atus.com | www.audio-technica.com

World Radio History

Hilary Duff



Photos and Text by Steve Jennings

When *Mix* first spoke with Tom Fletcher, front-of-house engineer for young pop sensation Hilary Duff, he was just out with her for warmup dates. Now out in full swing with full production, we spoke again and he gave us the low-down on her road gear.

"Of course, the Midas XL4 console has to be my favorite piece of gear; we use it at both FOH and monitors. The entire Clair Bros. P.A. system is an amazing piece. Our system consists of 16 Clair 14s, which is a curvilinear array as opposed to a line array. We also have eight T2 double-18 subs. These were originally designed by MD Systems, and in the past year have been modified and are now running off the Clair iO system.

"All mics are Audio-Technica. Hilary's is a wireless version of the [Artist Elite] AE6100: the ATW-T341 from the 3000 Series. I'm fortunate to

be part of a strong team. James [Pugsley] McDurmet is an extremely talented stage and in-ear mixer—one of the best in the industry. The other audio crewmembers that make this all a success are system engineer Arepad Sayko, stage tech Dwayne Diaz, and newest member, Bob Reinkin.

"This could be a whole other article in itself, but for the most part, I'm a big fan of TC Electronic for reverbs, delays, chorusing and many other things. I also use dbx compressors and Drawmer gates. I keep it pretty simple as with most anything to do with audio, but the key to good sound is the source. And we have an excellent source: The band and Hilary are kickin'."



FOH engineer Tom Fletcher

FixIt

Monty Lee Wilkes

After two decades of FOH mixing for everybody from The replacements to Prince and Nirvana to Julio Iglesias, Monty Lee Wilkes has seen it all. At press time, he was rehearsing for Britney Spears' new tour, which starts this month.

"A well-known living legend once advised: 'Listen. Listen to what's coming out of your speaker.' I listen to events in the room during the course of the day. When I enter the building, I grab some coffee, go to where I'll be mixing—and elsewhere—and I listen! What room effects do the forklifts cause when they drive by? What does it sound like when lighting guys are banging truss? All of these give you an indication of what the room will sound like or what you may be trying to correct when you excite it with thousands of watts of your 'art.' Regardless of what wondrous tools you have, at the end of the day, you must take the room on *its* terms—not yours!"



inside

- 86 **Live Mix News: Tours, Events, Installations**
- 90 **All Access: Mary Chapin Carpenter/ Shawn Colvin/Patty Griffin/Dar Williams Tour**
- 92 **Tour Profile: David Bowie**
- 96 **New Sound Reinforcement Products**

News

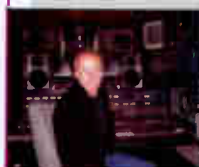

Guy Charbonneau in Le Mobile's remote studio truck

Guy Charbonneau, owner of *Le Mobile* (Vista, CA), announced the "My Place or Yours" pricing package. For a flat-fee per project, users can book the *Le Mobile* remote studio at any location, track and have the ability to mix in stereo and 5.1 surround...

The Church of Latter-Day Saints (Salt Lake City) installed a new system that comprises three **Lake Contour** digital loudspeaker processors (main left/right, center/underbalcony and effects, respectively), an **L-Acoustics dV-DOSC** loudspeaker system and **Yamaha PM1D** digital console...

2004 Syn-Aud-Con seminar schedule offers start dates ranging from February 16, 2004, to June 7, 2004, and includes a new class in **Architectural Acoustics**. For more information, go to www.synaudcon/sempage.htm... **The Air Force Museum's** (at Wright-Patterson Air Force Base in Dayton, Ohio) massive size created special requirements for installing a new sound reinforcement system, which comprises **JBL VerTec** speaker systems driven by **Crown MA-5002** and **MA-2402** amps, and fed



JBL's line array flown at the Air Force Museum

by a **Yamaha PM1D** console—all provided by **Washington Professional Systems** (Wheaton, MA)... Broadway productions of *La Bohème* and *Fiddler on the Roof* are using **Cadac J-Type** live production consoles... After a string of sold-out stateside shows, **Duran Duran** is touring abroad in New Zealand and Australia. Both FOH and monitor engineers are using **DiGiCo D5 Live** consoles provided by Cleveland-based **Eighth Day Sound**.

32x8 with 10 aux sends, four mute groups and 4-band double-swept mid EQ for \$4999*.



One of the new HP-EIGHT™ Series from Crest®.

(Grief counseling is available for our British and Japanese competitors.)



- ⊗ 24, 32, 40, 48 or 56 mono input channel versions, each surprisingly low-priced
- ⊗ 5 Stereo Line Input channels with EQ, assignment, and Aux sends
- ⊗ 8 analog subgroups
- ⊗ Left, Right, and Mono outputs
- ⊗ Individual 48-volt phantom power, mic/line and polarity reverse on mono input channels
- ⊗ 10 Aux sends on each mono input channel lets the console be used as a monitor mixer
- ⊗ "Fader Flip" function on Aux outputs swaps Aux masters for group channels on 100mm faders
- ⊗ 100mm high-quality faders on mono inputs, groups and left, right, and mono outputs
- ⊗ 4-band equalizers with two swept mid frequencies and fixed frequency HP filter on each mono channel
- ⊗ 4-channel scene mute system
- ⊗ 2-channel matrix system
- ⊗ Full talkback and monitor systems
- ⊗ Internal universal power supply with provision for external, redundant supply
- ⊗ Made in the U.S. by the same folks who brought you the Century Series, X-Rack Series, X-Series and V12 consoles
- ⊗ Five-Year Warranty



We packed in all that legendary Crest V12 and Century console sound quality, but eliminated considerable cost with advanced manufacturing techniques.



The result is the new Crest HP-EIGHT™ Series, the best live sound console values we have ever offered.

Available in 24, 32, 40, 48 and 56-channel frames. Designed and built in scenic Fair Lawn, New Jersey by



seasoned console experts. Backed with Crest's exceptional 5-Year Warranty. Don't even *think* about

buying a new live console until you've downloaded HP-EIGHT information at www.crestaudio.com.



FAIR LAWN, NEW JERSEY, USA

CREST AUDIO

www.crestaudio.com • tollfree 1.866.812.7378



On the Road

Rick Camp/Beyoncé Knowles

Rick Camp is one of those guys who never rests. This studio and live engineer has worked with the likes of Earth, Wind & Fire, Madonna, Erykah Badu, Burt Bacharach and Destiny's Child. Recently, he's done solo tours with DC's Kelly Rowland and Beyoncé Knowles. During a brief couple of weeks off the road, Camp was working in his Reel Tyme Recording facility in Southern California mixing the upcoming DVD release of Knowles' live show at London's Wembley Arena.

What's in Beyoncé's vocal chain?

I have an Avalon 737 preamp/EQ/compressor patched into the inserts on an ATI Paragon II console with a Lexicon 480L for reverb—all fed by a custom Sennheiser wireless with an e935 cardioid capsule.

Do you have a "must have" piece of gear on the road?

There are two things that really work for me. One is the Avalon 737, and the other is the Clair iO, which lets me voice the system with a wireless tablet from anywhere in the room.

Were there any challenges in working with Beyoncé?

Not at all. This girl is amazing—she can run across a 60-foot stage singing and never miss a note.

Do you have any favorite venues?

The Yokohama Arena in Japan sounds just like a studio—absolutely amazing. They don't all sound like that, so I sure remember the ones that do.

What do you like to do when you're not working?

It doesn't happen very often, but sometimes it's nice to just sit back and stare at some TV or see a movie on a real screen rather than just watching one on my computer in the tour bus.

Now Playing

Blake Shelton

Sound Company: Sound Image (Escondido, Calif.)
FOH Engineer/Console: Dirk Durhan/Midas XL4
Monitor Engineer/Console: Earl Neal/DiGiCo D5
P.A./Amps: JBL VerTec 360° arena array/QSC 6.0, 9.0 Powerlights

Monitors: Sennheiser Evolution 300 Series wireless in-ears, Clair 12AMs

Outboard Gear: TC Electronic 1128, M3000; ADL tube compressors; Drawmer DS201, DL241; Yamaha SPX-990; Eventide H3000; dbx 160SL

Mics: Sennheiser e865, Evolution 602, 604, e609, e855

Bette Midler

Sound Company: Clair Bros. (Lititz, Pa.)
FOH Engineer/Console: J.D. Brill/2 Midas Heritage H3000

Monitor Engineer/Console: Glenn Collette/
2 Midas Heritage H3000

P.A./Amps: 44 CBA I-4 "curved array" speaker cabinets, 28 CBA I-4 "sub lows" (11 Clair iO for processing)/QSC, Crown

Monitors: CBA 12am monitor wedges, R-4 sidefills; Shure PSM 700 IEMs

Outboard Gear: Lexicon 480L, PCM91s; Eventide H3500; Yamaha SPX990s; TC Electronic 2290; Focusrite ISA 430s; BSS DPR-404s; Aphex 622s; dbx 160As
Mics: Shure UA87, Beta 91, Beta 98s, Beta 56s, KSM 32s, SM81s, Beta 58s



PHOTO TODD KAPLAN

Aladdin Casino Gambles With Audio Upgrade

After the Aladdin Resort & Casino's original structure was imploded in 1998, the Aladdin Theatre was left standing and underwent a \$25 million renovation. The result is a virtual indoor amphitheater with no obstructions and one of the widest proscenium openings. Capable of handling large-scale artists, Broadway and orchestra shows, the new theater recently took delivery of a Yamaha DM1000 (in the Sinbad Lounge) and three DM2000s (one in the Center-Stage Showroom and two in the Aladdin Theatre for the Performing Arts) consoles, and the largest permanently installed L-Acoustics V-DOSC P.A. system in the country—82 cabinets.

Gary Kehm (director of operations for entertainment at the casino), Craig

Thomesen (technical director stage manager/lead sound/front-of-house mixer) and Tony Alamia (audio systems engineer/monitor engineer) assisted Al Siniscal, president and sound designer at A-1 Entertainment Services (Las Vegas) with the install. The P.A. was installed by head V-DOSC technician Bernie Broderick and assisted by Forrest Rowles.



SHAPING THE INVISIBLE



NEW AIR 25

With four times 300 w amps the AIR 25 delivers unprecedented clarity combined with massive power.



WORKING WITH AIR

The development of great art and breathtaking music has the same two things in common: Craftsmanship and originality. The essence of the AIR Series is just that, and today our speaker technology and monitor solutions stand as the apex of the industry. With the unique software and networking possibilities inherent in the AIR Series, we can proudly say that you won't find a more versatile monitor solution anywhere else. Listen to the sound of craftsmanship and originality....

What shapes the invisible...

- ◀ 192 kHz support via dual wire
- ◀ Networking in-between all AIR components
- ◀ Central and remote control of system and parameters
- ◀ Acoustic placement compensation
- ◀ Preset storage and recall, and programmable reference levels
- ◀ Integrated parametric EQs and delay in each monitor
- ◀ Advanced Bass Management
- ◀ Supporting 2.1, 5.1, 6.1 and 5.3 setups

Check out all the features at our website!



Don't take our word for it, trust your ears.

Call now to arrange a demo in your facility!

Leonardo da Vinci was among the first to use science to enhance his art. Being a musician, he also applied his genius to define the phenomenon of sound: "Figurazione dell'invisibile - Shaping the invisible."

dynaudioacoustics
IF IT'S THERE - YOU'LL KNOW IT

TC ELECTRONIC A/S DENMARK ☎ +45 8742 7000 [MAIL] INFO@TCELECTRONIC.COM
TC ELECTRONIC INC USA ☎ (805) 373 1828 [MAIL] INFOUS@TCELECTRONIC.COM
WWW.DYNAUDIOACOUSTICS.COM

World Radio History



Mary Chapin Carpenter

Shawn Colvin

Mary Chapin Carpenter introduced the concept of a "guitar pull," a song-sharing tradition in acoustic country and folk circles, to an appreciative audience when she kicked off an intimate evening with cohorts Shawn Colvin, Patty Griffin and Dar Williams at San

Francisco's sold-out Warfield Auditorium. (These photos were taken the previous night at the Luther Burbank Center, Santa Rosa, Calif.)

In-between stories about shoes (they all stare at them when they're not playing) and memories of their

first Bay Area performances, the four artists "pulled" from their respective catalogs and added covers such as Johnny Cash's "I Still Miss Someone," sung by Carpenter, and Tom Waits' "Heart of Saturday Night," sung by Colvin.



FOH engineer Jon "Rasta" Schimke

Front-of-house engineer Jon "Rasta" Schimke, an 11-year veteran of San Diego's Sound Image, mixed on a Midas XL4 console for the Warfield date, supplied by Bay Area-based Sound on Stage. Schimke uses only nine inputs for the "unplugged" performance: four for vocals and five for guitars.

Sound on Stage also provided the P.A., which includes 20 L-Acoustics V-DOSC cabinets (10 flown and 10 on the deck), 11 L-Acoustics SB218 subs and four of Sound on Stage's proprietary Power Physics 222 speakers. "I don't even use the subs," Schimke admits. "This show is so low volume that we can hit the balconies with just a deck stack and boxes." Crown Macro 5000 IS-8 amps, three XTA DP226 loudspeaker-management systems and three XTA GQ600 dual/stereo gates completed the system.



Patty Griffin



Dar Williams

Monitor engineer Gregory Hancock



Sound Image provided the monitor rig, which included a Midas Venice 32 console, QSC Powerlight amps, BSS digital crossovers, and processing from Klark Teknik DN360 EQs, Yamaha PRO R3 and SPX990 reverbs, and dbx 160 compressors. All four women used Sound Image G2 wedges. "I haven't worked on a wedge I like better," says monitor engineer Gregory Hancock, also with Sound Image.

Carpenter, Colvin, Griffin and Williams each sang through Shure SM58s. Carpenter, a Shure endorsee, uses a Shure UA Series wireless mic for her guitar, while the remaining six-strings ran

through Fishman and Countryman DIs. Despite the sparse set-up, Schimke has to stay on his toes when mixing four artists who speak and harmonize spontaneously. "Sometimes it seemed like they're having a contest as to who can talk the quietest," he says. "It's hard to get the vocals real loud when they're talking between songs. I can't turn all of them up wide open all the time, so I have to chase them as they're talking. And a couple of them will talk way off the mic and not even make an attempt to get near it. But once they start playing, it's a piece of cake."

DAVID BOWIE

Revitalizing Art Rock Onstage

By Breean Lingle

From the moment David Bowie's band entered the stage, walking along a high catwalk and silhouetted against a dramatic, projected backdrop of the Milky Way (Bowie appearing suddenly below them, wrapped and abstracted by white beams of light), it's evident that his Reality tour is a rock show of grand proportion.

On this January night at the HP Pavilion (San Jose, Calif.), midway through a nine-month world tour, the set list reads like a *Best of* album. The music and Bowie's enthusiasm are infectious, and the audience spends much of the two-and-a-half-hour concert on its feet dancing. A showcase for Bowie's enduring, haunting vocal sound and the versatility of his bandmembers, the show segues from hard-hitting guitar and drum-powered songs to piano and electronica-influenced tracks such as "Fame," "The Man Who Sold the World" and "Under Pressure" to songs off of his latest CD, *Reality*, including "Bring Me the Disco King," "The Loneliest Guy" and "Days."

PHOTO: STEVE JENNINGS

MEET THE CREW

Front-of-house engineer Pete Keppler and monitor engineer Michael Prowda head up the audio crew, with systems provided by Firehouse Productions (Milan, N.Y.) and Adlib Audio (Liverpool, England). While regularly selling out arenas, the show occasionally dipped into 1,500-seaters, which meant that the system had to be scalable and the mixers needed to stay on their toes.

As a studio engineer in New York City, Keppler—a music enthusiast, part-time musician and iPod convert—previously toured with such singer/songwriters as Steve Earle, Aimee Mann and Suzanne Vega. He first worked as an assistant engineer in the recording studio and for one-off events with Bowie in 2000, and was asked to join full time for this year's tour. Keppler uses a Yamaha PM1D digital console, which he calls a “good-sounding, relatively bullet-proof desk.”

“It's totally active mixing, and for each song, the instruments change quite a bit,” he says. “I can change the compression and EQ; I don't have to scramble in-between songs, I just hit a new preset. We had a lot of production rehearsals last summer, and I was really able to hear each song and solo inputs to hear how things were fitting together and make a lot of base preset structures. I've been improving on it ever since.”

There are seven musicians onstage—Bowie (vocals/guitar), Sterling Campbell (drums), guitarists Gerry Leonard and Earl Slick, Mike Garson (piano/keyboard), Gail Ann Dorsey (vocals/guitar) and Catherine Russell (keyboard backing vocals)—who, combined, require 53 inputs to FOH. Keppler handles FOH setup each day of the show, saying with a laugh, “It's just a preference of mine to be the one who connects everything because if anything has gone wrong, I don't have to blame anyone else. It's like a pilot knowing his plane.”

VOCALS ON TOP

Working with a dynamic vocalist such as Bowie, who not only has one of the most distinctive voices in the business, but also a masterful mic technique and a preference to control his own vocal effects, it's almost expected that his vocals would sit atop the mix. Keppler tempers this assumption, saying, “David's voice sits on top, but this is not a Vegas-style show. The band is every bit as present as they need to be in the mix.”

Bowie sings into a Shure Beta 58A, switching to a Shure wireless unit (comprising a U4D receiver matched with a U24D transmitter) when walking around the elevated sections of the stage during the show. The vocal chain starts with the Focusrite Red mic pre, from which both Keppler and monitor engineer Prowda take a line-level feed. Keppler uses two of the 24 onboard graphic EQs from the PM1D to compensate for the wired-to-wireless transitions. In addition to using the PM1D's onboard effects, Keppler relies on a couple of TC 3000s on vocals and select instruments and a BSS 901 dynamic EQ. All of Bowie's vocal mics go through a Summit DCL200, and a touch of reverb is added to vocals and the piano when necessary.



PHOTO: BRYAN OLSON

After experimenting with other P.A. systems on past tours, Keppler decided on a JBL VerTec line array, claiming that “it's the best rock 'n' roll P.A. out there. It really carries the high frequencies further than other systems I've used.” A maximum of 14 cabinets and subs are flown per side. Keppler takes the time to walk the house and check every zone in every venue for the most even coverage, making use of a PRAM wireless tablet that was introduced to him by his system tech, Tony Szabo. “I go into the deepest seats in the venue—up in the back row—tune the system from there and get it sounding good. Concert tickets are expensive these days. People come to hear a show as much as to see it. It doesn't matter where people are sitting. I want them to get the best sound they can.”

HALLO, MONITOR MAN

While Prowda has been a fixture on Bowie's tours for almost a decade now, he worked extensively—and just wrapped production—with the Blue Man Group before Bowie's current tour took to the road. A recent convert to the Yamaha PM1D, Prowda manages about 30 mixes during the show, a range that comprises six stereo musician mixes, 14 stems sent to Campbell's Mackie 1402 VLZ Pro, various tech mixes and a Bowie vocal send that feeds his vocal effects system. With 11 drum inputs and a variety of vocal, guitar and keyboard direct ins, Prowda relies on the scene capability of the PM1D, saying, “Every song is a scene and I have some 50-odd scenes.”

The Reality tour seems to be an atmosphere that encourages musicians to experiment with and take control of their own sound: Prowda has Campbell customizing his own mix. “He's got a 14-channel mix-

Front-of-house engineer Pete Keppler (left) and monitor engineer Michael Prowda taking in the view at L.A.'s Shrine Auditorium



PHOTO: STEVE JENNINGS

er," Prowda says. "I'm creating mix stems off of the PM1D, which includes kick, snare, hat, bass guitar, a stereo drum mix-minus, DB vocal, a stereo band mix-minus, stereo tracks and click. Once my levels to the Mackie are set, he creates his own blend. It's been working great." Campbell also gets extra punch on his drum throne through two Aura transducers. Prowda reports that there is another drum system onstage that uses a Firehouse F15 wedge on top of an L-Acoustics DV sub powered by L-Acoustics amps.

As for Bowie's mix, Prowda explains

that, "What sounds good to me works well for him. There's no second-guessing. I make it sound like I think a house mix should sound with a blend of everything." Bowie, meanwhile, puts his focus into his vocal performance, using a proprietary vocal effects system onstage that comprises a Digitech Vocalist and a Moog moogerfooger.

"These are doubler and distortion effects that go to monitors and front of house," Prowda explains. "David has two volume pedals onstage where he mixes his own distortion and doubling and sets his volume

level. He's hearing the balance in his head and wants it to sound similarly in the house." In addition to onboard effects, which Prowda varies from song to song, he uses a dual-channel Focusrite 8 preamp and one his favorite tools—a Summit TLA100—on Bowie's voice.

The entire band is on in-ear monitors: Sennheiser Evolution Series EW300s with Westone Elite Series ES2 soft molds, which Prowda likes because, "These systems provide the best audio quality and stereo imaging of anything I've heard to date," adding that the frequency agility of the Sennheisers have become essential in today's marketplace. Prowda also employs a rack of eight Aphex Dominator 2s, processing that he "can't live without," using it to "drive as much signal as possible into the radios."

When it comes to miking the performers and their instruments, Prowda selects the right mic for the job, anything from "Shure KSM32s and Audio-Technica A-T 4050s on the guitars and overheads, Shure Beta 56s and 91s on snare and kick, to Sennheiser E 604s and 602s on tom and kick. I've got this mic that I love on hi-hat: an A-T 4041." Backup vocals are heard through Shure Beta 58As and 87Cs.

Keppler credits his crew—Tony Szabo, Greg Lopez, Bob Lewis and John Drane—for their "expertise and ability to put up the P.A. up in such a wide variety of venues, and making it all work flawlessly." Keppler also notes the generosity of tour vendor owners Bryan Olson (Firehouse) and Andy Dockerty (Adlib Audio), and thanks Prowda for doing an amazing job mixing in-ears for Bowie and the band. "If David Bowie and the band weren't able to hear themselves as well as they do, it wouldn't matter how well I mixed the show. It all starts from the stage. If the band can groove with each other, we'll have a good show." Prowda, in turn, can't give enough kudos to his supporting crew who he laughingly refers to as a "dysfunctional extended family," which includes his assistant, Tristan Johnson, Andrew Burns (guitar tech), Tom Calcaterra (guitar tech), Peter Danilowicz (keys and vocals effects tech), John Walsh (drum tech), Jeff Ousley (bass tech) and Dave MacMullan (computer tech). Despite any new challenges and demands that Keppler, Prowda and crew have to overcome during Bowie's tour, the reaction in the stands at tonight's show makes it evident that, *Real-*

MIX **ONLINE** EXTRAS

Breean Lingle is a Mix editorial assistant.



- Proven reliability
- Clean transparent sound
- Continuous RMS rated
- Large power capacitors for low-end power*
- Distortion-free optoisolator limiters

* see kick drum tests @ dcm.carvin.com

CARVIN.com
800.854.2235
 TO ORDER or for CATALOG & SPECS
Proudly Made in San Diego, CA

"Power, Reliability, and VOLUME - that's what this rack of DCM's is about." -Rich Bartle B.I.G. Productions
 Clients include: Ricky Martin, Christina Aguilera, Sony Pictures, Woodstock '99, Epic Records, Capitol Records, Virgin Records, Warner Bros Records...

With the New AES16, the Biggest Part of Your Digital Audio System May Be the Smallest



You have invested a lot of time, money and commitment into your digital audio system, with the best in digital mixers, converters, digital audio workstations, software and recorders. All you need now is the final piece to tie the entire system together - the AES16™ from Lynx Studio Technology.

Working in single-wire mode, the AES16 offers 16 channels of 24-bit AES/EBU I/O at 192 kHz using Windows or Macintosh computers. You can also use dual wire devices for eight I/O channels. The AES16's software controls its internal sixteen-channel mixer, routing your signals just about anyway you can think of with virtually no latency.

In addition to being the ultimate digital audio router, the AES16 features a new Lynx technology SynchroLock™. Basically "jitter control on steroids", SynchroLock provides extreme jitter tolerance at all inputs. By coupling statistical analysis with low-noise clock generation techniques, SynchroLock extracts a very clean clock with 3000:1 jitter attenuation from AES signals affected by long cable lengths and other noise sources. The clock output of SynchroLock can also be used as a very accurate word clock source for other studio devices.



Need more than 16 channels? No problem. Up to four AES16 cards can be installed in a single computer, for a total of 64

inputs and 64 outputs. You can also add 16 channels of ADAT Lightpipe I/O with the optional LS-ADAT LStream card that attaches to the AES16.

The AES16 was developed with your facility in mind. The AES16-XLR model with two six-foot cables and professional XLR connectors may be the best option for you. For added convenience, we offer optional twelve-foot cables with D-sub connectors for Apogee, Benchmark, Yamaha, Mackie and other top digital audio brands. Plus the AES16's PCI interface is designed for either 5V or 3.3V signaling, making it totally compatible with the new Macintosh G5 models.

Please visit our website at www.lynxstudio.com to learn more about how the AES16 lets your computer become the control center of your digital audio system.

Now that's big news in a small package.

Lynx
STUDIO TECHNOLOGY

www.lynxstudio.com

Studio shown is Soundwork's Studio, North Hollywood, California ©2014 Lynx Studio Technology, Inc.

World Radio History

AES16

New Sound Reinforcement Products



ALLEN & HEATH PA SERIES STEREO LIVE MIXING CONSOLES

Debuted at NAMM, Allen & Heath's (www.allen-heath.com) PA Series of stereo live sound mixing consoles include the PA12 (eight mono inputs), PA20 (16 mono inputs) and PA28 (24 mono inputs) mixers, the unpowered siblings of the company's PA-CP (Constant Power) models. Features include a new padless preamp, onboard digital FX, parametric output EQ, 4-band channel EQ (with sweep HM band), individual phantom power switches, mutes and PFLs (with LEDs), four aux sends and two extra stereo input channels. Also standard are pre/post-fader analog and digital (S/PDIF) recording outputs, 12-segment LED meters and XLR lamp socket.

LAKE CONTOUR UPDATES

Contour Controller Version 2 software—available as a functional 30-day demo on Lake Contour's expanded Website (www.contour.lake.com) with full integration of Lake's SmaartLive™ Controller Version 5 software—is now shipping. SmaartLive Controller software supports bidirectional communication between Contour Controller and SIA SmaartLive. This allows spectrum, spectrograph and transfer function measurements to be displayed within the Contour's EQ and XOVER Overlay pages while passing control data from the controller back to SmaartLive. Communication can occur on the same host computer or across Ethernet connecting two PCs. Other Contour Controller enhancements include user selection of the input signal to each Contour module, block diagram and Toolbar Context navigation for quickly moving within the app, and a choice of milliseconds/feet/meters on the Delay page. Also, stereo AES/EBU digital I/O supports 24-bit resolution from 44.1k to 96 kHz, allowing Lake Contour to be used as an EQ, delay and dynamics channel insert processor.



KLARK TEKNIK DN100 DIRECT BOX

Klark Teknik (www.klarkteknik.com) debuts the all-new DN100 direct box. The active, transformer-balanced unit has two parallel TRS 1/4-inch and female XLR input jacks, a male XLR output, and runs on 48VDC phantom power. Standard are -20dB pad and ground lift switches, a fitted silicone-rubber outer sleeve to absorb shocks and a Kensington lock facility that works with a standard computer security cable to prevent unscheduled disappearances.



ROCK N ROLLER MULTI-CARTS

Now distributed exclusively by Dana B. Goods (www.rocknrollercart.com), Rock N Roller Multi-Carts are available in five models to suit the needs of musicians and live sound pros. The patented Multi-Carts transform into eight configurations to safely and easily move up to 500 pounds of gear. The latest models are lighter, stronger and fold smaller than earlier designs, and now feature black/yellow textured paint and patent-pending wheels and casters that improve shock absorption and reduce caster noise.

ATI AV8 SERIES

ATI (Audio Technologies Inc., www.ataudio.com) has released the AV8 Series, a new product line of Cat-5/6 twisted-pair transmitters and receivers for composite or S-Video and stereo audio (balanced or unbalanced). These are the first products to be delivered in ATI's compact XFORM size—a 1/2-rackwidth package, with 1RU and 0.5RU-high variations. The AV8 can transmit video and audio signals up to 1,000 feet over twisted-pair UTP cable such as Cat-5/5e/6. UTP cable is a fraction of the size of coaxial cable, and much lighter, more flexible, easier to terminate and less expensive.

PHONIC ROADGEAR 160/260

For truly portable sound reinforcement, Phonic America (www.phonic.com) offers a complete self-contained system featuring two full-range speakers, mixer, dynamic microphone and all the cables you'll need to get connected. RoadGear 160 features 160 watts of power with a 4-channel mixer, plus a stereo input for keyboards, CD players or other stereo sources. RoadGear 260 offers 260 watts, a 6-channel mixer, two stereo channels and ships with two dynamic microphones. Prices: 160, \$699.99; 260, \$849.99.

MAKING YOUR LIFE EASIER



GC PRO

WWW.GC PRO.COM

- + MUSIC PRODUCTION
- + POST PRODUCTION
- + BROADCAST
- + PROJECT STUDIOS
- + MOBILE RECORDING
- + EDUCATION FACILITIES

GC Pro was created to offer you solutions to your daily challenges. We recognize that rapidly changing technology, frequent upgrades, and budgetary constraints can make your life difficult.

We've assembled a network of seasoned industry professionals to assist you in making informed buying decisions. Your GC Pro account manager will research solutions for your technical problems, demonstrate equipment at your facility, and help you with easy account-based purchasing.

GC Pro leverages Guitar Center's bulk buying power, huge inventory and national reach to quickly deliver the right gear to your doorstep at very competitive prices.

Visit us online today to find your local GC Pro account manager for direct access to the broadest range of new and vintage gear available!

**EXPERTISE. EXCELLENT PRICES. EXTRAORDINARY SERVICE.
ALL IN ONE PLACE!**

GUITAR CENTER
PROFESSIONAL

Your life is about to get easier!

World Radio History

Pedant In a Big Box: Part 1

A Glossary of IT Terms for the Audio Professional

Just before the end of the year, I received an e-mail from my editor that read, "We have a feature on network storage systems that we're trying to figure out, [so] what we'd like from you, your mission if you agree to accept it, is a glossary of common storage and network terms. An IT glossary for the uninitiated pro audio folks. Whaddya think? A whole column of pedants in a box." So began this month's "Bitstream," a bass-ackward version of my usual offering. [Note that italicized words are terms that will be defined in the glossary, some in upcoming parts.—Eds.]

Granted, I could never compete with the many excellent IT glossaries out there on the Web, but I've tried to gather the most common *TLAs*, techie phrases and geek-speak for your edification. For those who need a bit of a mental housecleaning, this month will either sweep away some cobwebs or increase your *BBF* by several orders of magnitude!

1394: See *IEEE 1394*.

802.11: See *IEEE 802.nx*.

AAC (ADVANCED AUDIO CODEC): an, um, advanced version of the widely used MP3 *perceptual sub-band/transform codec* with additional tools to reduce the encoded data rate while simultaneously reducing encoding artifacts. It is formally known as MPEG-2 AAC.

AAF (ADVANCED AUTHORING FORMAT): an ad hoc standard promoted by a coalition of vendors, chiefly Avid and Microsoft, along with developers and end-users. AAF is a *wrapper* file format.

ABSTRACTION LAYER: virtual programming buffers or software insulators that reside between the inner details of some individual resource and any external entity that may want to use that resource.

AC-3 (AUDIO CODED [VERSION] 3): Known to consumers as Dolby Digital, AC-3 is Dolby Laboratories' third generation of *perceptual sub-band/transform codec*. AC-3 is one of the mandated audio formats for both DVD-Video and ATSC Digital TV.

AIT (ADVANCED INTELLIGENT TAPE): a proprietary, mid-level, 8mm, helical-scan data tape standard from Sony that pioneered the feature of embedded memory in the cartridge.

AP (ACCESS POINT): An access point is a specially configured node on a wireless network that *bridges* the *WLAN* and a wired *LAN*.

API (APPLICATION PROGRAMMING INTERFACE): In the world of software, APIs are structured *abstraction layers* be-

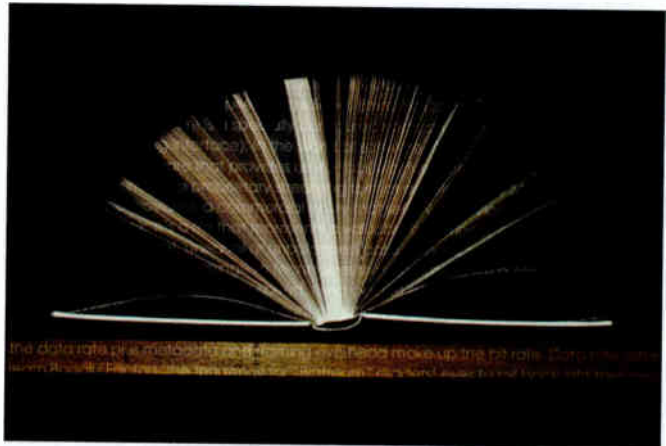

tween the gory details of an individual *application*, *operating system* or *hardware* item and the world outside that *software* or hardware.

APPLICATION: *executable* software that provides useful tool(s) or function(s). In ye olden days, applications were called "programs."

ASF (ACTIVE STREAMING FORMAT): a proprietary *streaming* format developed by Microsoft that provides streaming media services for the *Windows Media* framework.

ASP (APPLICATION SERVICE PROVIDER): a commercial entity that sells *Web services*.

ASSET: To a *rich media* geek, it's a file that represents a valuable commodity or could be useful at some time in the future. Digital video or audio files are both considered assets.

ASYMMETRICAL: refers to different, unequal or unbalanced data services, such as ADSL's send/receive data rate.

ASYNCHRONOUS: refers, among other things, to techniques that do not require a common clock between communicating devices. Because *IT streams* and files are self-clocking, timing signals are derived from *framing bits* within the data stream.

ATM (ASYNCHRONOUS TRANSFER MODE): a high-speed, fixed-packet data transport standard that interoperates with the switched circuit *telephony* network. Although providing valuable *QoS* features, ATM is being supplanted by less-expensive, IP-based standards that better interoperate with *LANs* and *MANs*.

AVAILABILITY: as used by *IT* professionals, the amount of *uptime*. A product, system or service with three nines or better uptime is referred to as "high availability."

BASEBAND: the lowest scale or simplest rate at which messaging occurs in a communications system.

BIT RATE: The data rate plus *metadata* and framing overhead make up the bit rate. Data rate refers to the "raw"

THINK YOUR PASSIVE MONITORS STILL PERFORM TO SPEC?



THE KRK ST SERIES

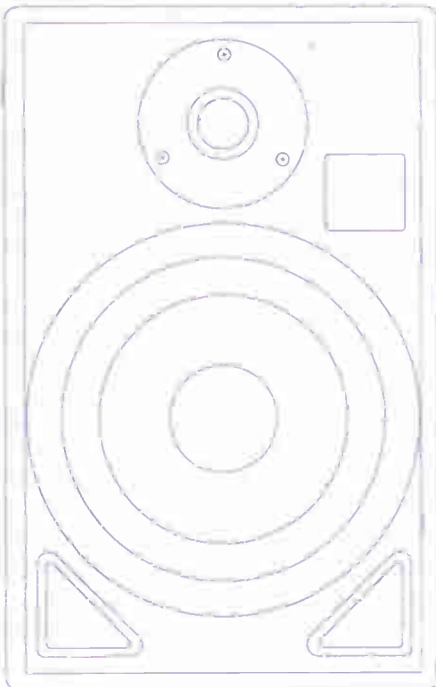

THINK AGAIN.

Years of professional use will take its toll on even the most durable transducer. Many of the most popular monitors over the last ten years are no longer in production and in some cases, it's impossible to get replacement parts. The fact is, your old standard is running out of gas. With the new KRK ST Series you'll be able to keep your amplifier investment and make a significant upgrade to your monitoring system.

The KRK ST Series is an all-new design that incorporates the latest in driver and crossover technology. The net result is a passive monitor that delivers the precision that professionals demand at an affordable price. The KRK ST Series — the new standard in passive near-field monitors.

KRK Systems, LLC • 555 E. Easy St., Simi Valley, CA 93065
Phone: 805.584.5244 • Fax: 805.584-5233 • www.krksys.com • email: info@krksys.com



Relive the Magic.

There's a reason why the classic microphones have endured for over 50 years. It's what happens when you put one on the mic stand and plug it in. And that's all you have to do. The classic microphones have a built-in character that makes things easy, so easy that it feels like magic.



There are two ways you can relive that magic. If you have a small fortune and can find a classic mic that works--that's one way.

The other way is with a Lawson microphone like the L47MP or the new L251--both large diaphragm condenser microphones that we hand-craft in the USA with all the look, feel, and sound of a true classic. Magic included.

Experience the magic for yourself with our ten-day, no risk trial.



LAWSON, INC.

2739 Larmont Avenue
Nashville, TN 37204 USA
Phone 615-269-5542
FAX 615-269-5745

Visit us at

www.LawsonMicrophones.com to see how others are reliving the magic!

BITSTREAM

or baseband data rate over time at which some *file* or *stream* is being delivered.

BBF (BITSTREAM BOGGLE FACTOR): the tendency for "Bitstream" readers' eyes to roll back into their heads as the dense geek-speak causes the reader to fall into a deep sleep.

BRIDGE TO BRIDGE: a device, either hardware or software, that "bridges" or connects two networks of the same type or *protocol*.

CARRIER CLASS: a marketing term used to denote a ruggedly constructed, full-featured product suitable for high-availability uses, as in, "This equipment is carrier class, buddy!"

CLEC (COMPETITIVE LOCAL EXCHANGE CARRIER): the commercial entities created to compete with the *ILECs* when the Baby Bells were broken up. Covad and OneEighty Networks are two examples of CLECs.

CODEC (ENCODER/DECODER): a broad class of signal processing that first transforms a signal from the original storage method into another to improve the distribution in some way. After distribution, the signal, or in our case data, is transformed back into some semblance of the original. DTV, POTS and MP3 are all household examples of codecs.

CODING, CODING METHOD: This refers to transforming or changing the characteristics of a signal to make it more suitable for some intended application, usually for transmission from one location to another or for storage onto some medium that is different than the original medium. Coding can improve fidelity, optimize carrier bandwidth, increase *essence* carriage, improve security or provide *error detection* and correction.

COFDM (CODED ORTHOGONAL FREQUENCY DIVISION MULTIPLEXING): the modulation method chosen for U.S. domestic *DAB* service, some versions of *ADSL* and *DTV* services in Europe and Australia. COFDM is used to encode or impose digital audio data onto an analog carrier signal.

CO-LOCATION: This refers to renting a designated space where a company's servers are situated, along with other companies in the same physical location. All machines share common HVAC and power. For physical security, each company usually has a lockable wire cage for its equipment.

DAB (DIGITAL AUDIO BROADCAST): the TLA for wireless digital radio services, also known as *IBOC/DAB*. DAB is terrestrial radio in that it's local or location-based, as opposed to national digital satellite

"radio." *IBOC*, or in-band on-channel, means that *DAB* shoehorns a digital stream into the existing AM and FM analog services, maintaining backward compatibility. *DAB* employs *lossy codecs* to reduce the transmitted *data rate*.

DAM (DIGITAL ASSET MANAGEMENT): a catch-all phrase that describes the process of *managing* digital "assets," files whose essence is deemed valuable by an organization. *DAM* usually refers to audio, motion and still-image files in particular.

DATA: Data is fundamentally any information of interest, but these days, the word data implies a binary (base 2 arithmetic), machine-readable representation of information.

DATA CENTER: a physical structure, usually a stand-alone building, that is designed to house a multiplicity of computers. Data centers can be private, serving a single company or, more commonly, a public "utility" serving a variety of companies.

DATA RATE: Often conflated with *bit rate*, data rate refers to the actual throughput or aggregate rate over time at which the *essence* is being delivered.

DDS (DIGITAL DATA STORAGE): DDS is a proprietary, entry-level performance, 8mm data tape standard originally based on the *DAT*, or digital audio tape format. DDS is close to the end of the product life cycle and is being supplanted by more modern formats such as *VXA*.

DIRECTORY SERVICES: On a *LAN* or *WAN*, directory services provide an abstraction layer, identifying *network* assets including users, resources and the various *policies* assigned to each. The result is that resources and users are accessible without possessing the details about a particular resource or *node*. Directory services also abstract network *topologies* and *protocols*.

DISTRIBUTED: For an *IT* nerd, distributed means decentralized rather than concentrated in one *node*, physical location or *server*.

DLT (DIGITAL LINEAR TAPE): a proprietary, mid-level, linear data tape standard originally developed by Matsushita.

To be continued next month... ■

Omas almost bit off more than he could chew when he took on this month's assignment. He couldn't have completed this installment without the influence of Jean Luc Picard, er, Patrick Stewart's "engage"-ing spoken word recording of Charles Dickens' A Christmas Carol.

Tools of the Trade



CAD e100²

The first of five new Series 2 condenser mics, the e100² from CAD (www.cadmics.com) features an internal power reservoir system that supplies significantly more than the current available from phantom powering. The new supercardioid studio mic boasts an extended frequency response of 10 Hz to 18 kHz, 132 dB of dynamic range, less than 0.15% THD, 148dB SPL handling (with pad in) and transformerless balanced output circuits.

DAKING MIC-PRE IV

The latest offering from Geoffrey Daking (dist. by www.transaudioelite.com) features four Class-A preamps in a single rackspace. The unit handles mic or line inputs via four rear TRS/XLR Neutrik Combo jacks; the front has four line inputs (+10 to -50) or 1/4-inch instrument inputs. Each input offers continuously variable gain control, a 20-segment LED level meter with +24dB peak indicator, switchable +48-volt phantom power, switchable input polarity and a 20dB pad. Price: \$2,895.



UNIVERSAL AUDIO FAIRCHILD 670

Universal Audio (www.uaudio.com) announces the UA Fairchild 670 compressor for the UAD-1 DSP card. UA designed the

\$149 plug-in using component modeling techniques to capture the sonic signature and behavior of Allen Sides' favorite

Fairchild at L.A.'s Ocean Way Studios, combined with a separate aux panel adding original rear-access controls, common mods and unique digital-only additions. Existing UAD-1 users can experience the UA Fairchild 670 phenomenon via a 14-day fully functional demo that is part of the Version 3.4 UAD-1 software release.

SOUNDTOYS SOUNDBLENDER VS

SoundToys (www.soundtoys.com) has released a new \$199 version of the SoundBlender multi-effects plug-in, specifically designed for the Roland V-Studio platform. The plug-in features dozens of individual time, pitch, filter and modulation-based effects, a newly designed interface and a host of new presets.



ADS 1394B FIREWIRE PRODUCTS

Feel the need for speed? ADS (www.ads-tech.com) offers three new affordable FireWire 800 products allowing Mac and PC users to step up to the fastest peripheral bus available. The \$99 Pyro 1394b

able storage device that can be used with almost any IDE hard drive, ATA-100 drive, CD, DVD or DVD-RAM drive.



ULTRASONIC HFI-650

Ultrasonics headphones (dist. by Ears Audio, www.earsaudio.com) from Germany claim

to offer depth, dimension and detail at lower, safer, less-fatiguing sound pressure levels, with up to 98% reduction in electromagnetic field emissions. The Ultrasonics 650s are foldable, offer a frequency response of 10 Hz to 25 kHz and are available with a coiled or straight 9-foot cable. Impedance is 75 ohms with sensitivity at 94 dB. Retail: \$249.

CONTOUR DESIGN KEY COMPOSER

Key Composer from Contour Design (www.contourdesign.com), a new tool meant to be used with ShuttlePRO v2 (\$129.95), lets Mac audio/video application users access multiple keystroke combinations with one touch, either all at once or

step-by-step. Version 2.5 of the Mac driver for the ShuttlePRO v2 is available via free download from the company's Website; a Windows version is also available.

TASCAM IF-FW/DM

Using a FireWire connection, the under-\$500 IF-FW/DM interface card from Tascam (www.tascam.com) ports 24 channels of I/O from a DAW to Tascam's DM-24 digital mixer (16-channel input and output when used at 88.1 kHz or 96 kHz). The unit adds eight inputs and eight outputs when used with the Tascam SX-1 or SX-1LE (up to two cards can be installed); offers MIDI I/O; supports ASIO, MME, WDM and Apple CoreAudio; and is compatible with Mac OS X and Windows XP.

URS S SERIES CLASSIC CONSOLE MIX EQ

The newest plug-in release from URS (www.ursplugins.com) is a digital emulation of Solid State Logic's SL4000e console equalizer. The plug-in closely models the original, but adds new features including numeric display windows to show gain, frequency and Q settings in real time, in/out switching on all four bands of EQ



and filters, input/output metering with gain clip indicators, total reset automation and full 192k support. Mac OS X 10.3.1 Panther is currently supported, as well as the MBox, Digi 001, Digi 002, MIX, HD and HD Accel systems. Prices: \$649.99 (TDM, RTAS and Audiosuite, Mac 9 and OS X) and \$399.99 (native RTAS and Audiosuite, Mac 9 and OS X). Owners of the URS Classic Console EQ TDM and Native Bundles can add the URS S series for \$599.99 and \$349.99, respectively.

SYNTHOGY IVORY

The Ivory virtual instrument from Synthogy (dist. by www.ilio.com), features more than



3,500 samples designed to faithfully recreate every nuance of the grand piano. All 88 keys were individually sampled at up to eight dynamic levels in the finest studios and concert halls in the world, producing more than 20 GB of samples. Sampled pianos include the German Steinway D 9-foot concert grand, Yamaha C7 and Bösendorfer 290 Imperial Grand. Ivory is available for AudioUnits, VST and RTAS for PC and Mac OS X. Price: \$349.

AVIOM EUROBLOCK MODULES

Aviom (www.aviom.com) has released Euroblock versions of its AN-16/i input and AN-16/o output modules, which, when used together, create a powerful digital audio snake capable of transferring high-quality 24-bit audio digitally over inexpensive, industry-standard Category-5 cables. The new releases are fully

compatible with their TRS-equipped counterparts and the AN-16SB System Bridge. TRS and Euro-block variations can be mixed/matched as needed when creating/installing a system. Each product has 16 Euroblock connectors on the rear panel, simplifying wiring and installation. The wire is simply inserted into slots on the connector and tightened in place with a screwdriver: no soldering is necessary. Each unit comes with everything needed to install the product. Price: \$999/each.

NAUTILUS NEMO DCM-8

Part of a group of new products from mastering engineer John Vestman, the two-rackspace Nemo DCM-8 from Nautilus (www.nautilusmastertechnology.com) features balanced and unbalanced (RCA) stereo bus inputs, two stereo bus thru outputs to recorders, a balanced source-select output, stereo bus pad, RCA input pad, optional remote and dim logic-in for external talkback control. Electronic design is from Steve Firlotte (Inward Connections) using the SPA690 discrete amp block electronics of John Hall, renowned designer of early Langevin products. We saw the boxes at NAMM and the fit, finish and feel are top-notch. Price: TBA.

PMC CB6 CENTER CHANNEL

Designed for use with the OB1 mains and TLE1 active subwoofer, the CB6 three-way center-channel speaker from PMC (www.pmccloudspeaker.com) combines a custom 170mm bass driver, 75mm acoustically isolated soft-dome mid and silk 27mm dome tweeter. The 31-element, 24dB/octave Linkwitz-Riley crossover uses matched Solen capacitors. The complex cabinet structure forms a labyrinth that is damped throughout its length to increase air density by up to 30%, effectively improving driver control, lowering distortion and producing a full octave more bass than that of an identical driver in a ported cabinet design.





PRESONUS CENTRAL STATION

Aimed at those seeking a quality monitor path for a DAW, the Presonus (www.presonus.com) Central Station offers affordable (under \$500) routing of up to five stereo inputs and outputs (two digital and three analog). The unit does not use amplifier stages, op amps, active ICs or chips, thus eliminating coloration, noise and distortion. In a further effort to keep the sound pristine, the unit is equipped with 28 sealed silver relays, offering a minimalist signal path and keeping audio from passing through extraneous electronics.

APOGEE X-SERIES CONVERTERS

Apogee Electronics (www.apogeedigital.com) unveils its AD-16X and DA-16X converters. The new units feature sampling rates up to 192 kHz, option cards to connect both units directly to Pro

Tools|HD and FireWire devices, and the same C777 clocking technology found in its Big Ben master clock. The units also include the familiar "SoftLimit" and "UV22HR" options and a redesigned power supply scheme. Prices: AD and DA 16X, \$3,495/each; HD and FireWire option cards are \$595/each.

WIZOO SONAR 3 BOOK

Wizoo announces the release of *Sonar 3: Mixing & Mastering*, an easy-to-read and practical book by Craig Anderton to help readers improve their arranging, mixing

and mastering skills using the powerful features in Sonar 3. The book also includes a CD-ROM containing audio examples and more to enhance the learning experience. The \$50 book is available directly from Wizoo (www.wizoo.com) or music book retailers.



Upgrades and Updates

IK Multimedia (www.ikmultimedia.com) is now offering its hot **Amplitube plug-in for AudioUnits and VST in OS X**. This brings the total number of platforms supported to 11 (HTDM, RTAS, VST, DXi and AU in Windows, Mac OS 9 and OS X). The price is \$399; free and low-cost upgrades are available from the Website for existing owners...**The Professional Audio Sourcebook from B&H is now available** in Volume II. The 790-page compendium was designed to assist musicians, engineers and producers find the right equipment. For more info, visit www.bhphotovideo.com...**Cycling '74 Pluggo 3.1**, a new version of its native audio processing plug-in software, is now **compatible with Mac OS X**



and adds AudioUnits to the list of supported plug-in formats. The introduction of AudioUnits to existing VST and RTAS support allows Pluggo to work with Emagic Logic Audio, MOTU DP4, and Apple Final Cut Pro and Soundtrack. Pluggo 3.1 is free to V. 3 users, \$99 as an upgrade from V. 2 and \$199 new...In an effort to be more focused on professional audio and video products, plus24 has announced that the production of most **Music and More products has been discontinued**. The existing stock of MAM products can be purchased direct from plus24 at a 50% discount. To order, call 800/330-7753 or visit www.plus24.net...**Front End Audio** (www.frontendaudio.com) will **distribute the Safe Sound Audio P1 audio processor** in North America and Mexico. The P1 is a high-quality mic preamp/instrument DI/line-level expander/compressor/limiter/mixer/headphone amp in a half-rackspace...**Native Instruments' Kompakt sampler** now fully supports OS X, including AudioUnits, RTAS, VST and stand-alone operation with CoreMIDI and CoreAudio. Registered users can get a free update at www.ni-kompakt.com...For a limited time, **TC Electronic** is offering a special bundle that includes **PowerCore PCI** and the

Sony Oxford Inflater plug-in for \$1,495. The Sony Oxford Inflater—traditionally an optional plug-in for PowerCore—provides an increase in the apparent loudness of almost any audio material without obvious loss of quality or audible reduction of dynamic range. Visit www.tcelectronic.com...**MOTU** (www.motu.com) has ported **MachFive for the Windows platform** and is also offering Windows RTAS and Windows HTDM versions. This means that both Pro Tools LE and Pro Tools|HD users can fully incorporate MachFive into their PC-based Pro Tools systems. MOTU is also adding several new features to Digital Performer, including a consolidated Preferences window, enhanced MIDI arpeggiator and a Beat Detection Engine that examines the transients in a waveform and applies artificial intelligence to determine beat locations and the overall tempo...**Tascam** announces **Mac OS X 10.3 Panther compatibility** for all of its USB and FireWire computer recording products. For downloads and more info, visit www.tascam.com...**Metric Halo** has released **OS X support for ChannelStrip TDM and RTAS**. Registered users can upgrade by contacting Metric Halo or their local dealer. The price is \$149 from www.mhlab.com. ■

Passion for Perfection

Radial - The World's Finest Direct Boxes



"Radial DI's are smooth and clean. My sound is my bass, my amp and my Radial DI!"
- **Chuck Rainey**
(Miles Davis, Steely Dan, Quincy Jones)



"Radial DI's don't change the colour of my bass. They retain the characteristic of the instrument."
- **Alain Caron** (Mike Stern, Gino Vanelli)



"The bass comes through extremely clear, very quiet, and with a smooth transparent low end. I use my Radial DI for everything."
- **Tony Levin** (Peter Gabriel, King Crimson, Pink Floyd)



"The JDV was the hands-down winner."
- **MIX**



"... completely transparent. An excellent DI box that will keep working even after the bands' van drives over it."
- **EQ magazine**



"Radial gives you the natural sound you only get with a very high quality box!"
- **Jimmy Haslip** (John Scofield, Robben Ford, Donald Fagan)



"My Radial DI is crystal clear and easily configures to the most elaborate set-ups; I love it and use it every day!"
- **Billy Sheehan** (Sieve Van, Mr Big, voted 3 times Guitar Player 'best rock bass player')

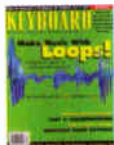

"No matter what type of signal I put through them, the Radial DI's sounded round and natural. ... Radial Engineering has done a superb job with these DI's."
- **Keyboard magazine**



"... I can say without hesitation that you won't find anything out there offering better performance or more durability for the money."
- **Electronic Musician**



"The JDI is a vision of purity, the platonic ideal of DI's."
- **Recording**



"The Radial DI gave me a special sound that was natural, with a fine presence... The engineer said 'What is that? I've got to get one!'"
- **Will Lee** (Letterman, Show, Billy Joel)

"... the bottom end was thunderous and tight. The top exhibited an openness I have yet to hear with any other DI. It literally sounded like I put new strings on the bass."
- **Professional Sound**



"My bass sounded better than I had ever heard it sound. It came to life, natural, pure and plenty of level."
- **Mark Egan** (Pat Metheny, Sting)

"The Radial design team understands the needs of engineers... and knows how to make a product to meet them."
- **Pro Audio Review**



"...DI's should add nothing and take nothing away... The Radial has proven its worth; I bought a couple!"
- **Audio Media magazine**



"...dramatically better sound, more defined attack, richer bottom, almost 'holophonic'... it seemed to step out of the speakers."
- **Khalid Glover** (Markus Miller, Herbie Hancock)

"Top tone, best built, most innovative... The Radial JDV can handle any situation."
- **Bass Player magazine**



The difference between good musicians and great artists is the passion that they bring to the music. The world's top bass players don't just lay down a track, they inspire the performance and take it to a higher level. This same passion for perfection is the very foundation that sets Radial Direct Boxes apart. Our passion to get things right is evident in every product that we build.

Radial JDI Passive Direct Box

With its low noise, exceptional signal handling, and virtually zero phase deviation, the Radial JDI has become the industry standard passive direct box. Radial uses Jensen audio transformers, acknowledged as the world's best, to ensure smooth, distortion-free performance. The JDI can handle huge levels effortlessly, and ground hum and buzz are tamed plug and play easy; In short, the JDI is the engineer's dream DI. Also available in stereo and multi-channel configurations. List \$200



Radial J48 Active Direct Box

Developed specifically for use with the limited current from 48V phantom power, the Radial J48 is capable of exceptional level handling and dynamics without choking. The internal rail voltage is stepped up using an internal switching supply that allows input levels to 9-volts before distortion. Smooth, natural sound, with extra 'reach', the Radial J48 is perfect for live and studio use where a wide dynamic range is required and the convenience of phantom power is preferred. List \$200.



Radial JDV Mark-3 Super DI

The JDV breaks all the rules by turning the DI box into a signal distribution central hub. Dual inputs for two instruments, direct out for the main amp, dual auxiliary outputs for a stereo rig or effects, and there's even a tuner out. Finally, the musician can work inside his own creative zone while the engineer gets pristine, unaffected sound. And sound you will get! The JDV features our proprietary Class-A 'feed-forward' design with a huge internal 30-volt rail voltage for unprecedented performance. As engineer Khalid Glover (Marcus Miller - Herbie Hancock) stated: "Until I plugged in the JDV, I never realized how much impact a DI could have. Compared to other DIs, the Radial JDV is almost holophonic". List \$450.



www.radialeng.com

RadialTM
True to the Music

Waves Transform Plug-In Bundle

New Tools for Morphing Pitch and Shifting Time

We've always thought of Waves as a manufacturer of solid, straightforward studio tools, but recently, the company has branched out with some really creative sound-shapers. The aptly named Waves Transform bundle offers four all-new plug-ins for innovative audio processing through pitch and time alteration. The package includes SoundShifter, a pitch/time expander/compressor; TransX, which changes the temporal expiry of percussive sounds' attack portion; Doubler, which is a multitap delay with pitch modulation that maintains the original length of sounds even with radical detuning; and Morphoder, a full-featured vocoder with eight-voice synthesizer and formant correction.

MY RIG

I installed and tested the Transform bundle on two different computer DAWs: Pro Tools|HD 3 running on a Mac equipped with 10.2.8 and OS 9.2; and a PC VST 2.0/DirectX host running XP Pro and Nuendo 2.1. My testing was mostly confined to the Mac OS X TDM rig at 48 or 96 kHz. Under Nuendo, not all of the VST and DirectX versions are fully functional. Variable I/O is required for parametric SoundShifter and graphic SoundShifter to work offline, and VST/DirectX does not (at this time) support sidechain, causing Morphoder's operation to be limited to mono only by using one track of a stereo pair as modulator and the other as carrier.

Transform runs under Waveshell 4.0 but will not coexist with earlier versions of Waveshell, so earlier Waves plug-ins must be upgraded. Check this before installing in Mac OS 9, because 4.0 will install over 3.0, causing your 3.x plug-ins to not show up. However, OS X Waveshell 3.5, which I used for all of my Waves Renaissance plugs, ran fine alongside Waveshell 4.0.x. Both the Mac and PC installations went fine, including the new Waveshells and the iLok dongle Mac extension. PC users can download an iLok driver at www.ilok.com; Nuendo 2.1 required a newer Waveshell version from www.waves.com.

DOUBLE YOUR FUN

The Doubler plug-in comes in mono and stereo versions with either two or four outputs called voices. I used it both as an insert

plug-in and, to save DSP, as a send and return effect similar to a reverb. As an insert, you can keep the track's original timing or "align" it to the inherent latency of the plug-in. With align on, you can set any of the voices' delay time to 0 ms; otherwise, the minimum delay is 7 ms with the Range set to 80 Hz or 24 ms when set to 20 Hz. Range sets the detuning range of the voice outputs. Shifting lower-frequency instruments such as a bass guitar requires higher latencies.

Doubler offers many adjustable parameters that make the effect sound more like an actual double- or quadruple-tracked vocal or guitar. By slightly detuning the different voices by a few cents (up to ± 100 cents) and panning them left and right, you can go anywhere from a wide "harmonizer" multivoice effect to a very tight monaural double track. Using Doubler to process background vocal tracks makes them sound like more people are singing—if you don't play this effect too loud—and I think is this processor's best effect. I preferred the tighter settings: 1 to 3 cents up and down, less than 5 ms of delay and panned narrowly. I used the Align mode and slid the original track earlier to compensate for latency. Maintaining the source audio's original length is most noticeable with wide detuning—there is no hang over, which is especially good for the octave-down mode. The octave's quality is not designed to be a featured voice, but sounds best when used as a shadow. I used two octave-down voices panned left and right with 0ms delay on a standard-tuned metal guitar track, making it sound like a drop tuning.

ATTACK!

TransX reshapes the attack transient of any percussive sound by detecting the rise time of a sound's waveform and then boosting or reducing its level for that moment. I found TransX to be excellent for snares, kicks, drum mixes, loops and bass guitar tracks. I also used it to reduce the amount of snare drum "hit" in

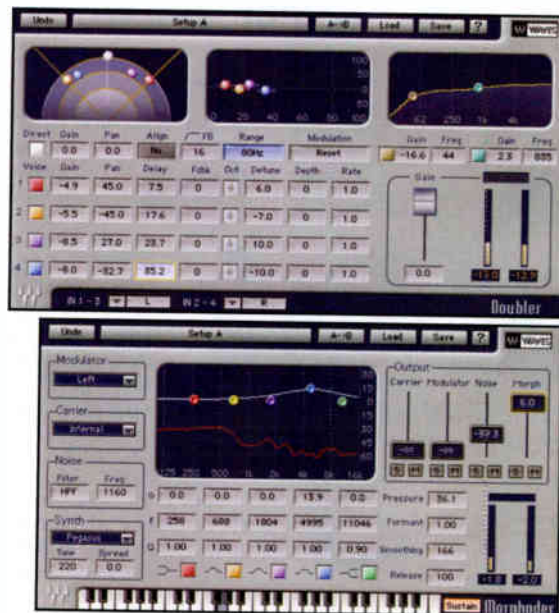

Waves Transform's Doubler plug-in (above) and Morphoder (below)

my room mics, letting the closer mics on the snare predominate the overall drum mix: mighty, big and roomy-sounding drums, but also very present.

TransX comes in Wideband and Multi-Band versions. Wideband uses less DSP and works remarkably 80% of the time by detecting the attacks of the total program. Wideband successfully fixed up a final mix by pulling up the snare drum's attack; this could be a mastering engineer's newest secret weapon. Multiband, with its Waves C4 crossover design, splits the sound into four adjustable bands. I could then modify any drum's whole spectral makeup, perhaps adding more punch in the lower frequencies or removing low-end wallop without making the drum thin-sounding. This plug-in works wonders on any loop.

The controls are simple to use, and there is a good group of factory preset "training wheels" to get you started. The four main parameters are Duration (to set the length of the attacks); Sensitivity, which sets the plug-in's level threshold; Range, for setting the amount of gain change; and Release (to adjust the time it takes the gain change to return to the original level).

ORDER 24/7 FROM OUR SECURE WEB SITE

All the best Pro Audio gear. From people who speak your language.

BSW specializes in pro audio. In fact, most of us here live, breathe and sleep this stuff. Our sales reps average over a decade of real-world experience in the recording or broadcast studio, on both sides of the mic. When you call BSW, you'll get someone who speaks your language. So for everything from finding a decent preamp to outfitting an entire production room, you can rely on us for expert, friendly advice.

And since we sell to the recording and broadcast industries in huge quantities, we're also experts at lining up the best pro audio gear at the lowest prices. We'll help you find what you need and get it to you for less. Go online or call for your **FREE catalog** today and find out why we're the audio source more and more

people are turning to for great gear, low prices and expert service!



Get your free 168-page catalog!

www.bswusa.com • 1.800.426.5780

ORDER 24/7 FROM OUR FAST-LOADING WEB SITE • CALL US 6AM-6PM PACIFIC TIME



NEW
WAVES • TRANSFORM Bundle • Native or TDM • Four powerful audio processing plug-ins transform your sound • **SoundShifter** accurately shifts time and pitch while preserving punch and transients • **Morphoder** creates vocoder-type effects • **Doubler** provides superior "Double-Tracking" effects • **TransX** allows you to shape the transients on your tracks and restore life

CALL FOR PRICE
TDM \$1,200.00 list
NATIVE \$1,800.00 list



NEW
TAPCO by MACKIE • S5 • affordable bi-amplified monitors • flat response for accurate mixes • 5.25" woofers • balanced XLR and 1/4" TRS inputs • RCA inputs

349
\$495.00 list



SOUND DEVICES • USBPRE1.5 • USB computer audio interface • 24-bit sound • bus-powered • S/PDIF I/O • two XLR mic inputs • 1/4" line inputs • 1/4" instrument input with excellent noise performance • RCA inputs

549
\$495.00 list



SENNHEISER • ME66/K6COMBO • short shotgun mic with power module • switchable bass roll-off • balanced XLR output • highly directional pick-up great for capturing quiet sounds in noisy settings • 40 Hz-20 kHz response

429
\$449.00 list



OSC • RMX5050 • 1050 watts/channel power amp • independent user-defeatable clip limiters reduce distortion • selectable low-frequency filters • balanced XLR and 1/4" TRS and barrier strip inputs • Speakon and binding post outputs

1,499
\$2,549.00 list



AKG • C2000BPKG • medium-diaphragm cardioid condenser mic • On-Stage boom mic stand • ProCo 25 ft. mic cable • all for the price of the mic alone!

199
\$299.00 list

BSW Exclusive Mic Package



AVION • PERSONAL MONITOR SYSTEM • no more bad monitor or headphone mixes! • extremely affordable system delivers 16 channels of audio to an unlimited number of daisy-chainable, completely controllable personal mixers via common Cat-5 computer cable • **A16T** transmitter has 16 1/4" line-level inputs • **A16** personal mixers can be daisy-chained up to 500 ft. apart • save 16 mix presets • volume and pan for each of 16 channels

389 669
\$429.00 list \$629.00 list

NEW



World's Best Source for Pro Audio Products

MORPHING VOCODER

Morphoder is a full-featured stereo vocoder—a cross between a processor and a musical instrument—and by far my favorite of the bundle. I found so many good ways to use this plug-in: subtly mixed back to create a dynamically changing guitar double track, or right up front for eerie, otherworldly a cappella vocals during a dance breakdown section. When Morphoder is instantiated on a keyboard or guitar track, that track becomes the carrier—the musical component—to be modulated by another track. The default carrier is the included eight-voice synth with an onscreen, four-octave keyboard and 10 factory sounds ready to go. To play this synth, click on the keys that you want—you can use automation to build chords, etc.—but, unfortunately, there is no way to route your MIDI controller, like a synth plug-in. Waves plans to make this available soon via a MIDI upgrade through the Waves Update Plan (see sidebar).

The modulating track is routed to the key input, like a key source for a noise gate. Sending on a bus, I could mix and match different modulation sources from across my mix. Morphoder uses a fully adjustable 5-band dynamic filter to track the modulator's frequency constituency and instantaneous level, and then conforms or "morphs" the carrier's spectral content and dynamic shape to it. I found that getting good vocoder sounds was easier and much faster than using hardware units. Many subprocesses—some little-known engineer/producer "tricks" to good vocoder sound—are either automatic or provided within Morphoder.

For example, in addition to more advanced filter control—frequency, shape, Q and level—there is pressure, a way to confine the dynamics of the modulator signal for better Morph intelligibility. Higher pressure settings were especially necessary when using a vocal track as modulator. The Formant Ratio control shifts the frequency contour of the modulator up or down before application to the carrier. Shifting up or down increases brightness and clarity by better matching the carrier and modulator's timbres.

Morphoder has a 4-channel output mixer that allows you to adjust the level of the carrier, modulator, morphed signal and noise. Noise, when used with a vocal modulator, traces the envelope of the vocal with wideband noise. Mixing in a little enhances intelligibility; using a lot brings out the Ghost In the Machine.

SOUNDShIFTER

SoundShifter has three main components: SoundShifter Pitch, a real-time pitch changer that is good for statically correcting pitch; Graphic SoundShifter, for graphically "drawing" dynamic pitch and/or time changes on a graph; and Parametric SoundShifter to change pitch and/or time of any music track or finished mix.



SoundShifter (above) and TransX plug-ins are part of the Waves Transform bundle.

Parametric SoundShifter is a powerful "meat and potatoes" DSP with two main controls: Time Ratio and Pitch Ratio. Both time and pitch can be shifted up and down to become twice as fast or slow or an octave up or down from the original. In TDM hosts, I found that it was easy to use this plug-in, with offline processing time approximating real time. Sound quality is excellent, and there are absolutely no problems using this plug-in for moderate up or down changes. I had no pitch glitching,

clicks or timing bumps, even with big changes of over three semitones or at 15 bpm. This feature alone could pay for the Transform bundle in one session.

Designed to be familiar and immediately useful in all facets of the post-production industry, parametric SoundShifter relates a selection's time length in six ways: time, tempo, bars/beats, samples, SMPTE and feet/frames. Windows show the original source time and the destination time, or where you'd like the music selected to end. Nomenclature for pitch is in familiar semitones/cents, musical intervals (minor 2nd, major 3rd, etc.), and a pitch center referenced to the A = 440 Hz standard.

After selecting a region of music and opening parametric SoundShifter, any of these ways of defining a track's pitch or length can be used to modify its pitch and/or time. You can also strap the time and pitch functions together via the Link button.

SoundShifter Pitch is a real-time pitch corrector that maintains the music's original length. It uses the same interface as the Pitch section of parametric SoundShifter and introduces a fixed latency that can be dealt with in Pro Tools. Graphic SoundShifter is the graphical version in which, after a selected region is displayed, you can put break points across the waveform where you want changes in pitch or time. Whether for an occasional tuning or timing fix or extensive vocal tuning and correction, both these plug-ins worked and sounded great.

I'M TRANSFORMED

The Transform Bundle is a creatively stimulating collection of technological marvels with pitch and time transformational abilities that are not easily obtained by existing software or hardware. As a serious utility, I especially liked SoundShifter with its easy-to-use GUI for simple control of complicated, simultaneous processes. For fun, I liked Morphoder because of the way it adds its signature to musical performances. The group is part of the Waves Diamond Bundle or can be bought separately. The TDM version, which includes native versions (VST, MAS, DirectX, etc.), sells for \$1,800; the native-only version is \$1,200.

Waves, 865/546-6115, www.waves.com.

Barry Rudolph is an L.A.-based recording engineer. Visit his Website at www.barryrudolph.com.

Check Your Platform

Transform comes in versions for TDM, AudioSuite, RTAS, VST, MAS, Audio Units, DirectX, and for both Mac and PC platforms. To find out if your system meets the bundle's requirements, download the compatibility report at www.waves.com/html/prods/transform/Transform_compatibility.pdf.

All four plug-ins feature full automation and run up to 48 kHz and 24-bit, but check www.waves.com/3_5_hd.htm for platforms and plug-in hosts that support higher sample rates. Transform is part of Waves' V. 4 product line and available with the new Waves Update Plan (WUP), giving you access to version updates for a full year on all of the products registered in your account.

dbx Just Sounds Better!

1 dbx—the only choice when your sound matters

2 Flexible expander/gate works over a 70 dB range.

3 Sidechain Monitor selection connects the sidechain return signal to the 1066's output. This allows monitoring of any signal that is inserted into the sidechain loop to assist in setup.

4 Sidechain Enable allows for quick A/B selection of the sound with or without sidechain processing. No re-patching required

5 dbx's exclusive OverEasy® allows for faster attack times and higher compression ratios while still maintaining the natural characteristics of the sound.

6 The Contour switch is extremely useful in keeping low frequencies from "muffling" or "punching" holes in your sound.

7 Independently set attack and release times or use auto mode to get that classic dbx sound.

8 Monitor either input or output signals.

9 12-segment gain reduction meter allows precision monitoring of compression.

10 Our patented switches are designed to be easily seen in the light or the dark

11 Link both channels with True RMS Power Summing. The proper way to achieve stereo compression.

12 Over/Under LED's let you know at a glance if you're expanding or gating.

13 dbx's patented 3-segment precision LED OverEasy® indicator helps you precisely dial in just the right amount of compression.

14 Vary the Ratio to select anywhere from gentle down-ward expansion to gating.

15 Detented controls and soft-touch knobs assure precision adjustments.

16 Patented peak-reading meter allows easy setting of optimum input and output levels.

17 Adjusts from mild compression to $\infty : 1$ limiting.

18 Add make-up gain or match levels over a 40 dB range.

19 Patented PeakStopPlus™ circuit intelligently tames signal peaks.

20 Heavy-duty steel chassis will take years of road use and abuse.

21 Internal power supply with easily replaceable power cord.

22 Easily accessible fuse—you'll probably never need to find out how easy.

23 Connect the unit hassle free using either unbalanced or balanced 1/4" TRS or balanced XLR connectors.

24 Ensure signal path integrity with gold plated locking Neutrik® XLR connectors.

25 Add processing to detector path (using the sidechain) for frequency-conscious compression/gating, special effects.

26 Servo-balanced outputs drive up to +22dBu

27 Separate sidechain send and return jacks—no special "insert Y-cables" required.

28 Convert semi-pro -10dBV signals to the dbx 1066's professional +4dBu internal level.

29 Precision balanced inputs reject hum and noise in tough audio environments.

dbx compressors have been the standard in signal processing for over thirty years. After all, our processors are in daily use all around the world with major touring companies, world class recording studios, radio and television broadcast facilities and anywhere else that audio professionals ply their trade.

Why do the best ears in the business time and time again turn to dbx for their processing needs? Maybe it's because we invented the modern day compressor. Perhaps it's because we have over 30 patents to our credit. It could be that our technology like OverEasy and PeakStopPlus won't be found in any other compressor. However, we think it's because dbx just sounds better.

It's no wonder that countless gold and platinum albums have used

dbx processing and that eight out of the top ten U.S. tours use dbx each night because their sound is too valuable to trust to anyone else. But don't take our word for it, head on down to your local dealer today and hear for yourself why dbx just sounds better.

dbx's industry standards: 1066XL and 2866XL



dbx

PROFESSIONAL PRODUCTS

The Professional's Choice In Signal Processing

For more information contact us at: (801) 568-7660 Fax (801) 568-7662 • www.dbxpro.com • 8760 S. Sandy Parkway, Sandy, UT 84070 USA

A Harman International Company

World Radio History

Apogee Electronics Rosetta 800

Eight Channels of Conversion with Dynamics Processing

The Rosetta 800 (\$2,995), Apogee's newest 24-bit multichannel converter, offers eight channels of A/D and D/A conversion, flexible sync capabilities and Apogee's proprietary UV22HR wordlength reduction and Soft Limit dynamics processing. Although the 800 bears the Rosetta name, the new unit uses different converter and clock circuitry than the original 2-channel Rosetta 96 A/D. The Rosetta 800 shares many analog design improvements from Apogee's high-end SE (Special-Edition) converters and functions (including D/A conversion and the ability to sync to external clock) that are not found in the original Rosetta.

er to analog outs—are possible with flexible routing. For the first multichannel stream, you can route analog ins simultaneously with digital ins of any *one* supported format in channel pairs to corresponding channels of digital outs. (All digital outs are active; the 800 automatically handles format conversions.) The second multichannel stream accommodates analog and digital sources (one digital format at a time) routed to like-numbered channels of *analog* outs in channel pairs.

Apogee's UV22HR processing can be applied globally to all digital output signals to reduce word length from 24-bit to 16-bit. Soft Limit processing (proprietary analog domain dynamics processing) can also be applied

audible. Performing the same A/B test with a flamenco-style nylon-string guitar track, the original track had slightly more depth than that processed by the Rosetta 800's AD/DA. These tests confirmed the uncanny accuracy of the 800's converters.

More tests involved recording a capoeira acoustic guitar using a spaced pair of DPA 4011 condensers with a Millennia HV-3D preamp, and on an electric bass guitar using a Millennia TD-1 Twin Direct Recording Channel. With each box synched to its own internal clocks, comparing the A/Ds in the Rosetta 800 to my Rosetta 96, I found that the 96 sounded a bit fuller in the lower mids, more understated in the lower highs, and ex-



A ROSETTA BY ANY OTHER NAME

Three D-sub connectors provide eight channels of balanced (+4dBu) analog and eight channels of AES/EBU I/O (supporting both single- and double-wide formats). Optional XLR breakouts are available. Two pairs of Toslink connectors provide eight channels of ADAT- or S/MUX-format ins and outs.

A rear option card slot accommodates Apogee's X-Series Expansion cards (\$595/each). The X-DigiMix card provides direct interface to Pro Tools TDM PCI cards. X-HD and X-FireWire cards should be available next month. Word clock I/O (on BNCs) and a detachable IEC AC cord round out the rear panel. The word clock input is non-terminated; users should fit a terminated T connector on this input when slaving Rosetta 800 to external word clock.

The 800 can sync to internal crystal, external word, single/double-wide AES/EBU, ADAT Lightpipe (including S/MUX) or option card clock signals. The unit supports up to 96 kHz, but a \$3,995/base 192kHz version is offered. Rosetta 800 can operate at any sampling frequency that's a multiple of where its word clock input is locked. It can also output word clock at a rate multiple of which its converters are operating.

Two simultaneous 8-channel audio streams—one routed to digital outs, the oth-

globally to all analog inputs or disabled. Soft Limit can't be activated independently for each channel. That said, the processing sounds incredibly transparent. Apogee's Soft Limit is easily my favorite analog limiter.

All eight channels have signal presence and "over" LEDs, although power users will bemoan the lack of external calibration trims. Only three fixed calibration levels are possible. The default is +4 dBu = -16 dBFS. Internal jumpers provide two alternatives: One calibrates +4dBu levels to -20 dBFS, and the other produces -13 dBFS for semi-pro -10dBV levels. This limits the choices for analog input sensitivity, but still offers headroom. Very quiet sources required at least 65 dB of external preamp gain for the 800 to achieve 0dBFS peak readings. Apogee plans to offer a retrofit calibration pot card that would fit over jumpers; however, accessing the card's trims will still require popping the top panel.

IN SESSION

For one test, I sent a kick drum track—previously recorded in Digital Performer—on a round trip through the Rosetta 800's D/A and A/D circuitry. The Rosetta 800 reduced—by a *hair*—the lower midrange frequencies in the processed track; otherwise, the track copy was indistinguishable from the original. The difference was so subtle that it was almost in-

hibited a slightly wider stereo image and a tad more depth. The 800's (A/D and D/A) dynamic range spec is 114 dBA, although the depth that I heard suggested a more impressive number. The 96's A/Ds sounded a little more fluid and analog-like on acoustic guitar than those in the 800, perhaps due to the 96's slightly greater depth and fuller low mids. On electric bass, the 800's A/Ds made the track sound present, clear and tightly focused, while the 96 produced a more soft and pillow-y sound; the two yielded a very similar bottom end.

Up next were recorded acoustic guitar tracks. When I synched the Rosetta 800 to Apogee's Big Ben Master Digital Clock, the tracks had a sweeter, more fluid high end, a slightly wider stereo image and a noticeably enhanced depth compared to those recorded with the 800 synched to its own internal clock. The combination of these two boxes sounded downright incredible.

The Rosetta 800 sounds outstanding and offers useful features and functions beyond AD/DA conversion. Every bit worthy of the Apogee name, the Rosetta 800 is a winner.

Apogee Electronics, 310/915-1000, www.apogeedigital.com.

Michael Cooper is the owner of Michael Cooper Recording, located in beautiful Sisters, Ore.

NEED PRO AUDIO GEAR?

THEN YOU SHOULD SPEAK TO THE PROS.

What is a real Pro, you ask?

Here at Full Compass we offer the most knowledgeable sales professionals in the audio world. Many of us have been serving our customers for 15 or 20 years, and they keep coming back. Why? Because of what a real Pro offers: loyalty and long term service. We build relationships.

You and Full Compass, where the Pros are.

Call us at 800-356-5844 and talk to a real professional, 8am to 8pm Central Time Monday through Friday or 10am to 4pm Saturday. We will give you the attention you need... and deserve.

Call us – you'll want to stay on the phone for decades.



Call us today
& talk to a real pro!
1-800-356-5844



WHERE THE PROS ARE.

www.fullcompass.com

Buzz Audio SOC 1.1 Stereo Optical Compressor

Expansive Style and Sound for Nearly Any Application

Leave it to the Kiwis to come up with a more reliable and clean-sounding version of the tried-and-true opto-compressor. Retailing at \$2,200, the SOC 1.1 from New Zealand's Buzz Audio is a stereo opto-compressor that expands on this familiar and popular dynamic controller's style and sound.

The SOC is housed in a two-rackspace black cabinet with large, easy-to-grab control knobs. Two large Sifam VU meters are backlit by a row of yellow LEDs highlighting the arc of the VU scale. A look inside reveals good construction with many field-replaceable circuit boards interconnected with ribbon cables or hand-wired looms. All of the op amps and line drivers in the signal path are DC-coupled Analog Devices OP275 chips with high-quality coupling capacitors. The opto gain-change element is Buzz Audio's and uses a Hewlett Packard Quad LED light block and four specially selected, light-dependent resistor elements.

ON THE FRONT PANEL

The SOC's front panel has identical controls for channels A and B. When compressing a stereo pair, you'll have to separately adjust both channels and then engage the Separate/Link A/B switch. I found both channels to match exactly: You can set the knobs the same and get equal results, a sign of careful design and quality components. When the two channels are linked together, audio sent to the sidechains is a composite of the A/B channel signal, but not a L+R sum. Assuming equal settings on both channels, with 6 dB of gain reduction on channel A, channel B will reduce 3 dB with no input signal present.

The Drive (threshold) control sets the amount of gain reduction. The Output level control goes up to +15 dB of makeup gain. There is no way to lower the output level when driving -10dBV semi-pro inputs.

Ratio allows users to select from 2:1/5:1/10:1/20:1 settings. The manual points out that the SOC is a soft-knee compressor, where the selected ratios of either 2:1 or 5:1 are reached only after 10 dB of gain reduction. The higher ratio settings are achieved sooner, with slightly less than 10 dB for 10:1 and 5 dB for 20:1.

The Release knob is labeled 1, 2, 4, 8 and



16 for 100, 200, 400, 800 and 1,600 ms, respectively. Release time is defined as the time it takes the compressor to recover or return to 0 dB of gain reduction from an initial reduction of 20 dB. In Auto mode, the SOC releases from fast transients quickly, but also releases more slowly for sustain or continuous signals such as entire mixes or sustaining sounds. Auto-Release is still fairly fast, and I noticed that switching to this mode lowers the amount of indicated gain reduction as measured by the VU meter.

The Attack switch is a simple, 3-position toggle for Slow at 70 ms, Fast at 1 ms and Auto for program-dependent attack timing. You could think of Auto as a medium-fast position; the manual calls this the Classic Sound setting when used with low ratios. The two 3-position meter toggle switches change the meters to input, output and gain reduction. The hard-wired bypass design bypasses audio only around the compressor section, leaving it to continue operating with all controls and metering active. Live sound mixers will like this feature as they can "fly by instruments" beforehand and then engage the compressor between songs.

AT THE SESSION

I used the SOC for typical compression chores and then compared it to other compressors in my rack. Both Auto Attack and Release modes are well-designed, getting solid results on drum overheads and room mics at moderate gain reductions. Auto was useful, unlike other compressors where I'm not exactly sure what is going on in Automatic mode.

With an Avalon AD2044 set approximately the same, the SOC was more forward-sounding with not as much top and bottom. My best vintage 1176LN Rev D sounded thin and boxy, and a Summit TLA-100 sounded tubey and round, but duller and with less accuracy and positive dynamics control than

the SOC. An old dbx 160 exhibited a transistorized, "in your face" quality, but was much thinner and smaller-sounding than either the SOC or the other compressors.

On snare drum tracks and overheads, the SOC was the best in the rack. Even if you like an extreme clamp on drum tracks, the SOC does it cleanly with less distortion and compressor artifacts. I found it warmer than the 1176LN and, although the Summit seemed to make the snare track sound more present, the SOC didn't dull as much.

Acoustic guitars, electric bass and upright bass sounded modern through the SOC. Compared to the Avalon, I found it just as clean and noise-free, with upright bass sounding better in the SOC because I could set a longer release time. The 1176LN and dbx were not great on these instruments. The Summit sounded good, but it didn't offer tight enough control (with its fixed ratio) at only 3 to 5 dB of gain reduction.

Vocal recording and optos have a long history together, and strict dynamic control of a rangy vocalist usually required big squashes, with the vocal sometimes sounding more like the compressor than the singer. With the SOC, you get the whole vibe, sound and action of a good opto but with faster attack times for less overshoot of occasional vocal peaks. The SOC changed the singer's sound very little, even under gain reductions of up to 10 dB (VU) during big chorus sections. I used either 2:1 or 5:1 ratios, Fast or Auto attack, 400- or 800ms release time and about 2 to 7 dB (VU) of compression.

With more control, and quieter and cleaner sound even at extreme settings, the SOC 1.1 is a fine choice for a neutral-sounding, general-purpose compressor. I liked its simple and accurate operation, reliable performance and modern sound.

Buzz Audio, 64/4/385-2478, www.buzzaudio.com.

"CLARITY!..."

Howard Burke, Front of House, Little Feat

"We were in rehearsal for the start of Bonnie's tour when the OM-5 was first introduced. We tried it and haven't looked back since. The mic is a lot like Bonnie - classy, consistent, and rock solid every time."

Paul Middleton,
Front of House, Bonnie Raitt

"From side rejection to gain before feedback to overall transparency, the OM-5 is consistently a winner. If I run the show, it's my first choice. If I'm the system engineer, it's my first recommendation."

George Rondinelli,
Soundcraft Audio - Dubuque, IA

"The OM-5 is the only mic that you can roll the High Pass to 120, turn it on and let it rip. Rock solid and built like a hammer. Keep them coming!"

Eugene Gira, Mulcahy,
Lead Audio Engineer,
Michigan Sun Casino

"These carried OM-5's with me since 1985 as a great 'get out of jail free' card for almost any vocal application. They're handier than a Leatherstocking out, oh yeah, they get LOUD!"

Adrian Cunningham,
Front of House, Altus

"The warm low end, crisp highs, and clarity of the OM-5 complements any vocal blend. I'm pleased to see that they're showing up on lots of stage riders."

Rance Caldwell,
Monitor Engineer,
Crosby, Stills, and Nash

"The OM-5 enables me to be heard no matter what else is going on. Whether I am conveying my message with a deafening roar, or the slightest of whispers, the Audix OM-5 gives every dynamic of my voice a crystal clear, powerful sound that is unmistakably AUDIX!"

Morgan Lander,
lead vocalist, Kittie

"I was able to simply swap the front line of vocal mics and replace them with OM-5's to get a smoother, warmer sound at a higher gain with no feedback."

Mark Frisk, Live Sound Editor,
Mix Magazine



"WITH 3 STAGES RUNNING SIMULTANEOUSLY 7 NIGHTS A WEEK, IT'S COMMON FOR US TO HAVE 15 OR MORE SEPARATE ACTS IN A SINGLE NIGHT. WHEN THE SMOKE CLEARS, IT'S THE OM-5 YOU SEE ON THE MIC STANDS. THE OM-5'S INDESTRUCTIBLE CASING IS ESSENTIAL, GIVEN THE UNENDING WEAR AND TEAR WE PUT OUR GEAR THROUGH. AND THE WIDE DYNAMIC RANGE IS PERFECT FOR THE VARIETY OF VOCALISTS WE HAND IT TO."

BRUCE DUFF

PRODUCTION MANAGER, KNITTING FACTORY HOLLYWOOD

"I wouldn't be comfortable using anything but OM-5's for the Downes' vocals. Their clarity, warmth, rejection and reliability are second to none... OM should stand for Oh My!"

Bruce Wheeler,
Front of House - The Downes

"Alaina really helped pave the way for a new generation of female vocalists, and her OM-5 has been there right from the beginning. If you love good sound, you'll love Audix mics."

Roger Ulrich, Manager,
Alaina Moraisville

"Audix mics are simply the best whether you're on a small stage or concert venue. I know that when I use my OM-5, the mic is going to sound perfect."

Jay Ferraro, Lead Vocalist,
Hypnotic

"Just with SOC's IDIA instrumentation, OM-5's help keep the vocals in front of the mix. They're reliable, consistent and unconditionally regardless of what PA system we're using."

Steve 'Mooney' La Torre, Front of House, Blue Oyster Cult

"In addition to being a terrific sounding vocal mic, the OM-5 has been my magic bullet when performance feedback is an issue. It gives me a usable signal when other mics are unusable."

Clay Martinson, Drummer,
Seattle, WA

"I have been using the OM-5 for about 10 years and continue to receive lots of compliments on my vocal sound. They give me a true, uncolored sound to work with as opposed to other mics that have a built in issue that sometimes works, but most of the time doesn't."

Paul Heger

Front of House, American Hi-Fi

"Our club has low ceilings and a loud band is very loud on our stage. The tight pick-up pattern of the OM-5 allows me to put the vocals out front in the mix without dressing in scaring guitars and cymbal wash."

John R. Dierstrom,

Head Sound Engineer,
Middle East Nightclub, Boston, MA

"...keeps the stage noise out, and the vocals in."

Tricia Ellsworth, Front of House, Dub Station

AUDIX
PERFORMANCE IS EVERYTHING

FOR A DEALER NEAR YOU CALL: 800-966-8261

TEL: 503-682-6933 FAX: 503-682-7114 www.audixusa.com

Audix Corporation, PO Box 4010, Wilsonville, OR 97070

In Canada, C-Tec, Tel 604-942-1001, Fax 604-942-1010

©Audix Corp 2003. All rights reserved. Audix and the Audix logo are trademarks of Audix Corporation.

Studio Projects B Series Mics

Low-Cost, Large-Diaphragm Studio Microphones

During the past few years, there has been an explosion of almost unbelievably low-priced Chinese condenser mics that look like prized German beauties. But while they look similar, not all of these mics are created equal. Some are shoulder-shruggingly okay, and some are pretty good. However, Studio Projects' B Series, a new line of mics that look like little U47s, range from only \$100 to \$350 list and sound better than pretty good.

STRIPPED DOWN TO THE FACTS

The B Series comprises three large-diaphragm (1-inch) models: the cardioid-only B1; the multipattern, dual-capsule B3; and the cardioid-only TB1, which uses a tube and comes with a separate dual-voltage (115-volt or 230V) power supply. Although the B1 and TB1 do not have controls, the B3's 3-position switch lets you choose either a highpass filter or a -10dB pad.

While the build quality of these mics is adequate, they do vibrate a little when you tap their bodies, as the manufacturer readily admits, but they certainly don't rattle or feel rickety. Studio Projects recommends using a shock-mount to combat the vibration, and the custom-fitted one provided holds the mics snugly in position. This shock-mount is an improvement over those generic ones with the rubber band in the middle or the nylon cord that quickly loses its elasticity.

The B1 and B3 come in plastic zipper bags, and the TB1 comes in a foam-lined briefcase that holds the mic, power supply and cables, but not the shock-mount. All three models come with a foam windscreens.

THE TEST DRIVE

I ran these mics through a Millennia Media STT-1 channel strip using its solid-state setting with the transformer switched out. This makes the preamp about as neutral as you can get; impedance considerations aside, what you hear is the mic and not the preamp.

You do hear a noticeable quality improvement as you go up the B Series line. However, even the B1 sounds quite a bit better than the Shanghai U87-alike I compared these mics to, and it sells for the same price.

The exception is that the Shanghai mic sounded better than any of the Bs on male

voice-over, but that's almost certainly due to off-axis reflections picked up by the Bs' wider pickup patterns. (This includes the B3 in cardioid mode.) The wide cardioid does make them more sensitive to what's going on off-axis, so be mindful of things like nearby walls when you're positioning them. A strategically placed Auralex Max Wall, which is a couple of sideways 2x4-foot foam sheets impaled on a mic stand, can really help.

The B's performance with what's in front of the mic is surprisingly good. Some side-by-side male vocal recordings through the TB1 and a \$2,000 RØDE Classic II—an undeniably great mic—were a real eye-opener. The RØDE definitely sounded bigger (and in fact, it is bigger!) and is more midrange-forward, but I couldn't say that the TB1 sounded worse in this application—just different.

Normally, you can identify inexpensive mics right away by their steely high end, but the TB1's high end is smooth and open, toe-to-toe with the RØDE—very impressive. While the solid-state mics (B1 and B3) aren't quite as nice overall, they do share the same sound quality.

The TB1 has a noticeable amount of the typical "tube" sound, a buttery effect that you hear on the transients and not very different from tape compression. That isn't always what tubes do, but in this case, it's reasonably descriptive. The effect is quite obvious on shaker, a broadband instrument that behaves almost like pink noise with transients, and can really point out what a mic does to the sound.

Studio Projects bills all three models as general-purpose recording mics, which is fair, as they have some character and a slightly recessed midrange, but the sound isn't colored enough to relegate the Bs to specialty mic status. The Bs work on a lot of instruments that many users wouldn't think of recording with a large-diaphragm mic. For example, I wouldn't normally mike a solo cello with a large-diaphragm mic, but the B1 didn't bring out the resonances to excess. That's not to say that it would be my first choice, but it does work. The TB1's recessed midrange sounded good on alto recorder. It also sound okay on acoustic guitar, although it's certainly not rare to use a large-diaphragm condenser in that application.



The B Series mics also did well on instruments that are normally captured with a large-diaphragm mic., such as close up on an upright piano. The proximity helped bring out some of the low end on a small piano that's pretty weak at the bottom.

Two B3s or a B1 and a B3 would make a very nice budget M-S miking setup. The B3s' 14dBA noise rating (12dBA for the B1) proves that they're quiet enough to use some distance from the source, which would also make them good choices as room mics.

Even though the TB1 is noisier than the other two (18 dBA), its tube circuitry gives it a rounder sound that makes it very appealing. The B1 and B3 specs list a 132dB SPL handling ability (128 dB for the TB1), so you're not likely to blow these mics out in front of a guitar amp. Their output is hot enough to allow the preamps they're feeding to operate at a comfortable, quiet range.

THUS

It's pretty scary that mics this inexpensive can sound this good. By all rights, the \$100 B1 shouldn't even be usable, and the \$200 B3 shouldn't be a dual-capsule model with switchable patterns. But if you have to choose one of the three to get excited about, it's the TB1, a \$350 tube mic that stands up to world-class mics that cost more than five times as much.

Studio Projects, dist. by PMI Audio Group, 877/563-6335, www.pmiaudio.com.

Nick Batzdorf is a composer, audio and music toy buff, and writer.

Mistral 2500

Analog Power Amplifier, 700 WATT (x2) @ 4 Ohms



ALTO's new Mistral Power Amplifier line comes in 900, 1500, 2500 (shown here), 4000 and 6000 watt configurations. The Mistral line of innovative power amp designs provide clean power and high stability all in two space chassis'. ALTO's Mistral line features a low noise air flow system which directs air flow from rear to front providing maximum efficiency and temperature control. These amps include two channels, each with its own

independent protection system (IPS) and power supply. The Mistral IPS avoids any open circuit, short or overheating while the protection system provides an automatic restart function. All outputs are equipped with standard balanced power connectors and a high quality transformers. Dollar for dollar, the Mistral Line offers reliable amplification at a great price.

Dragonfly PM-16

16-Channel Digitally Powered Mixing Console

The new Dragonfly Series of powered mixing consoles come in 6, 8, 12, 16 (shown here) and 20-channel board configurations, each ideal for a variety of live performance situations. With ALTO's digital amplifier technology, the Dragonfly Series, offers high power mixing and a dynamic sound. Extremely high efficiency means the amplifier is so compact that the console is no larger and barely any heavier than an

equivalent passive console. The PM-16 in its sleek, portable design weighs in at a mere 18 lbs. Equipped with many useful features, the PM-16 is digitally powered up to 900 watts of on board (both channels in 4ohms). When you need a powerful mixer on the go, go DRAGONFLY!



For Music with Passion.

L Series/S Series Mixing Consoles

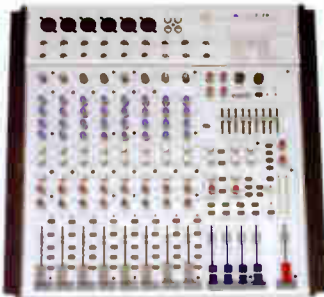

The "L" Series offers a range of quality, portable mixing consoles with a built-in 24-bit digital effects processor, 3 EQ bands on each input channel, and a 9-band stereo graphic equalizer for overall frequency correction. Offered in 12 (shown here) and 16-channel boards these mixers are ideal for live sound work but equally at home in your project studio.

The "S" Series are feature packed, versatile and compact mixing consoles for a variety of applications. Offered in 6, 8 (shown here) 12 and 16-channel boards, all "S" Series consoles feature ultra-low noise, discrete mic preamps with +48V phantom power, and deliver extremely high headroom offering extra dynamic range. Perfect for any location mixing or fixed install requirements.



CLE 8.0

8-Channel Compressor/Limiter/Peak-Limiter/Gate



The CLE line of pro compressors come in 2, 4 and 8-channel (shown here) configurations and have grown extremely popular. These interactive compressors have a robust feature

set and are designed to control signal levels for many applications. Each deliver clean, distortion free compression, brick wall limiting and are unequaled in value.

Get to know ALTO. Visit our website at: www.altoproaudio.com



ALTO® Distributed Exclusively in the US by: ART, Applied Research & Technology • 215 Tremont St., Rochester, NY 14608 • USA • 585.436.2720 tel • www.artproaudio.com
Distributed Exclusively in Canada by: Yorkville Sound • 550 Granite Court, Pickering Ontario Canada. L1W 3Y8 • 905.837.8481 tel • www.yorkville.com

World Radio History

QSC Audio SRA2422 Studio Reference Amplifier

A Clean, Quiet and Powerful Contender for Recording

QSC Audio has established itself as a leading manufacturer of amplifiers for live sound reinforcement. In conjunction with breakthroughs in amplifier technology, such as its patented PowerWave switching power supply, which drastically reduces the weight of high-powered amplifiers, QSC also developed QSCControl, a networking technology for remote amplifier management, and RAVE (Routing Audio Via Ethernet) digital audio networking.

Most recently, QSC turned its attention toward developing a line of high-powered amplifiers for critical use in studio and home theater applications. The result is the new Studio Reference Amplifier series that comprises three models: the SRA1222, the SRA2422 (reviewed here) and the SRA3622. Power outputs are rated at 200, 425 and 725 watts per channel, respectively (both channels driven into 8 ohms across the audio band @ 0.03% THD). For those who require more power, all SRA amps may be bridged for mono operation, resulting in a threefold increase over the rated stereo output.

SOLID, VERSATILE DESIGN

SRA amplifiers were designed with a variety of installation scenarios in mind. Rear panel DIP switches are provided (per channel) to configure the amps for stereo, parallel or bridged mono operation, and to turn the low-frequency filter on/off, select 20Hz or 50Hz roll-off and turn the clip limiter on/off. According to the well-written user's manual, the limiter kicks in only when clipping occurs, quickly reducing gain to remove the possibility of damage to the speakers. Rear panel input uses locking XLRs (pin 2 hot) and RCA connectors—unusual for a QSC amp, but this facilitates use in home theater applications. Speaker output is available on Speakon connectors and touch-proof binding posts that accept bare wire, spade lugs and dual-banana plugs. To facilitate bi-amplification, output from channel 2 is available on pin 2+/- of channel 1's Speakon jack. With amps as powerful as these, it's comforting to see that all of the outputs are safe from prodding fingers.

The only obvious control on the SRA2422's beautiful aluminum front panel is



The Studio Reference Amplifier Series features the SRA1222, SRA2422 and SRA3622.

an on/off switch. A small security cover hides the gain controls, enabling the gain pots to be locked out from unwanted tweak-ers. The gain controls will come in handy for anyone using small monitors or in need of adjusting speaker levels in a multichannel system. QSC includes rack ears, a hex wrench to remove the security cover and a 12-volt cable for use with the remote turn-on function.

IN THE STUDIO

I put the SRA2422 to work in my studio with a Yamaha 02R Version 2, Westlake Lc8.0 monitors and Monster Cable Z3 reference cables. (The SRA2422 took the place of a Bryston 3B amp.) Initially, I was concerned with the fact that the SRA2422 uses a fan for cooling, but in practice, the fan never became audible because it's a variable-speed unit producing only the amount of airflow necessary to keep the amplifier cool.

It takes about eight seconds for the SRA2422 to go through the soft-start sequence—a welcome feature for anyone who has blown a circuit breaker while turning on a high-powered amp. When switched on, the green power indicator illuminates dimly and then brightly while the red clip LEDs light. When the SRA2422 is ready, the red LEDs extinguish. Audio is muted until the amp has stabilized, so you'll hear no pops or thumps during power up. The SRA2422's green signal LEDs indicate the presence of audio.

With no input connected, the SRA2422 was virtually dead quiet. With my ear next to one of the Westlake monitor's tweeter, I could barely hear the slightest hiss and absolutely no hum, so it was easily established that the SRA2422 has a very low noise floor.

Even with the 02R connected and its volume cranked up, there was still virtually no noise. In addition to the SRA2422's high S/N ratio, its other obvious strength is the seemingly limitless power reserves. When playing hard rock or dance tracks at volumes that were way too loud to be comfortable for extended listening, the SRA2422 cruised along without an audible gasp or a flicker of the clip LEDs. In fact, I never saw the clip LEDs illuminate. With this kind of reserve, the SRA2422 will have no trouble running mid-field or large main-type monitors cleanly to high listening levels. Both the high- and low-frequency extremes were uncolored and extended, though I preferred running the amp with the low-frequency filter bypassed. In the 50Hz position, kick drums and synth bass were thinned a bit, while in the 20Hz position, the difference was barely noticeable. No doubt the filter will be useful for powering monitors with limited low-frequency capabilities, such as the Yamaha NS10M or the Tannoy Reveal.

The QSC SRA2422 does what a reference power amplifier is supposed to do: make the audio signal louder and get out of the way. Along with its technical strengths, the SRA2422 looks good and stays cool without intrusive fan noise. Combined with its low noise floor and ample power reserves, the SRA2422 should be on the audition list for anyone requiring a top-notch power amplifier.

QSC Audio, 714/754-6175, www.qscaudio.com. ■

Steve LaCerra, a veteran pro audio journalist, is based out of New York City.

It's not easy being the best ...

Times and technologies change, but some things remain the same. Since opening our doors in 1924, it has been our goal to keep musicians on the cutting edge of music technology - from analog to digital and beyond. The **Sam Ash Professional Audio Group** was created with the special needs of studio and live sound professionals in mind and is the only pro supplier backed by over **79** years of experience. We pride ourselves on offering an unbeatable selection of the latest gear backed by unmatched expert service and the guaranteed lowest prices in the industry. Visit our totally new website online at www.samashpro.com. If you are in the New York City area, stop by our newly renovated showroom. Call (212) 586-1100 for an appointment.

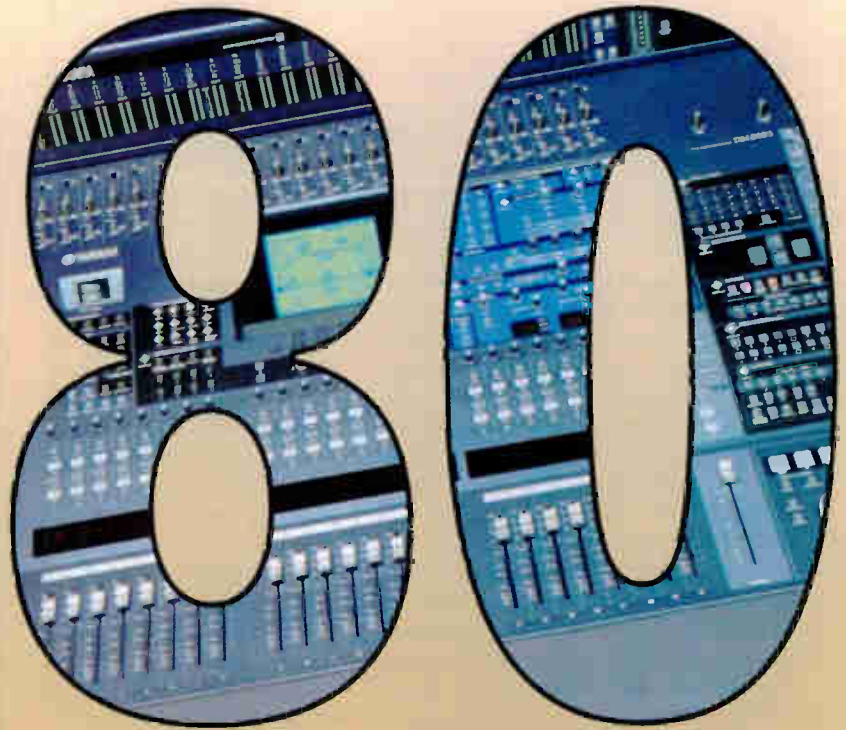

... but we've been doing it for 80 years!

SELECTION

The nation's largest selection of name-brand recording, live sound, DJ and computer solutions!

SUPPORT

Professional Service.
Professional Training.

PRICE

The Guaranteed Lowest Price backed by our 30-Day Satisfaction Policy!



162 West 48th Street • New York, NY 10036 • (212) 586-1100 • www.samashpro.com

iZotope Ozone 3 Plug-In

Mastering Tool Receives Major Improvements

The polymaths at iZotope, the company that came up with the innovative Spectron and Trash plug-ins, have significantly redesigned the manufacturer's popular Ozone 2 analog-modeled mastering suite and christened it Ozone 3. With more than 30 improvements, Ozone 3 is a DirectX-based stereo mastering plug-in that comprises six separate processors running within a common control panel interface. While it is an amazingly deep and comprehensive mastering "finishing tool," with internal 64-bit precision and the ability to run up to 192kHz sample rates, Ozone 3 also makes an excellent individual stereo track processor. CPU load is not light, but in a 2.8GHz Nuendo P4 PC, I was able to run a session with 60-plus tracks, many plug-ins and reverbs and still have enough steam left for four of six (possible) Ozone 3 processors on the stereo master fader. Even my poky 800MHz Celeron PC running Cubase SX 2.0 did fine with up to five of them running on a finished stereo mix. Ozone 3 supports Cakewalk's Sonar Record Automation option; you can automate Ozone from within Sonar by moving an Ozone control. Ozone 3 will be available for both VST and Pro Tools systems soon.

CALLING ALL PROCESSORS

The six processors in Ozone 3 are parametric equalizer, multiband dynamics, multiband harmonic exciter, multiband stereo imaging, loudness maximizer and mastering reverb. The sequence of these processes can be shuffled in any order and it's easy to bypass any of them with a mouse click. Master control panel features affecting all six processors include ganged (or not) stereo input and output faders with peak reading meters; global bypass (bypassing any individual processor relinquishes CPU power); and a drop-down menu of handy factory presets and your own stored concoctions.

Like Ozone 2, most work begins around the paragraphic equalizer where, besides switching between a modeled analog or digital phase linear EQ, you have up to eight different overlapping frequency points or nodes to affect. Being a sonic surgeon, I love this tool because it allows me to have this much control over frequency, level, Q

and the "shape" of each node. Combining a high-shelf, high-passband, peaking, low-shelf and lowpass filter types produces a resultant EQ curve that is unique and usually unobtainable. To this end, there is improved resolution of the graphical display with choices of 1x, 2x, 3x or 6x magnifications. The colorful graphical display instantaneously shows both the spectral content of your music and the algebraic sum of all the filters. You may take a spectrum "snapshot" of any moment of program, store it and use that EQ curve again over any other music program or track. "Matching" allows you to further modify this rendered curve manually by mouse-clicking and redrawing it.

Ozone 3's loudness maximizer has a new gain reduction meter to show the amount of limiting. Also, a new Intelligent mode is available, along with Ozone 2's stalwart analog-modeled soft or brickwall limiter settings. The intelligent maximizer is said to sound more neutral and transparent, which I verified in my test on track mixes. However, the other limiter modes sound better on individual tracks.

WAIT, THERE'S MORE

All of the multiband processors now have both analog and digital linear phase crossovers. Additionally, you can specify the Q or bandwidth for each of the crossovers. Multiband dynamics have both a peak compressor/limiter/expander and RMS compressor/limiter/expander. I like multiband dynamics for stereo pair processing like backing vocals or huge keyboards that I needed to scale back dynamically. The very serviceable mastering reverb now has a pre-delay parameter, and you can select between Ozone 2's plate and a new modeled room reverb. Ozone 3 also introduces the MBIT+ dither algorithm that reduces quantization distortion with mini-



Ozone 3 processors include parametric EQ, multiband dynamics, multiband harmonic exciter, multiband stereo imaging, loudness maximizer and mastering reverb.

mal perceived noise for a very smooth, quiet and almost analog sound. The multiband harmonic exciter now has three algorithm choices—retro, tube and tape saturation—across all four bands.

WRAPPING IT UP

Everyone from mastering engineers to master recordists will find Ozone 3 to be the engine that allows them to translate their wildest processing dreams into reality. I found the learning curve and interface easy to use and the results superb. iZotope Ozone 3 sells for \$199 as a download or \$229 for the CD-ROM; you can upgrade from Ozone 2 for \$49 via download or \$79 with a disc.

iZotope, www.izotope.com. ■

Barry Rudolph (www.barryrudolph.com) is an L.A.-based recording engineer.

MAXIMUM SECURITY



HHB Professional Recording Media: The safest place for your valuable recordings

Beware of recording media designed for general data storage. Only HHB Professional Recording Media is specifically designed and tested to deliver consistently low block error rates, superior archival security and widespread recorder/player compatibility in pro-audio applications. Take CD-R for instance. Most discs are developed for use in high-speed data writers and can cause problems in stand-alone audio CD recorders and duplicators. HHB CD-R discs, however, are optimized for use in 1X - 24X writers, so audio professionals get perfect recordings and copies, every time.

With an advanced dye formulation and brilliant white, inkjet printable surfaces, HHB DVD-R discs deliver similarly dependable, high-capacity recording, while HHB DVD-RAM discs are precision manufactured for 100,000 erase/record cycles. And with a range that also encompasses MiniDisc, MO, DAT, ADAT and DTRS, you can be safe in the knowledge that there's a high-performance, audio-optimized HHB disc or tape for every popular professional recording format. So if you need maximum security for your valuable recordings, ask your dealer for HHB Professional Recording Media.



For further information, visit www.hhbusa.com

Exclusively distributed in the USA and Latin America by:
Sennheiser Electronic Corporation T: 860 434 9190 E: HHB-Sales@sennheiserusa.com
 In Canada: **HHB Communications Canada Ltd** T: 416 867 9000 E: sales@hhbcanada.com
 In other territories: **HHB Communications Ltd** T: +44 (0)20 8962 5000 E: sales@hhb.co.uk



Brauner Phantom C Condenser Microphone

A FET Vocal Mic That Offers Depth for Miles

Brauner has a reputation for building ultratransparent tube mics with very low self-noise and high sensitivity. Recently, the Germany-based manufacturer shifted direction with its first solid-state mic, the Phantom C (\$1,750 list) cardioid condenser.

Despite its moderate price (relative to that of other Brauner mics), it's obvious that no expense was spared in the construction of the Phantom C. Its cylindrical brass body (the same used in the Brauner Velvet and Velvet Voice microphones) weighs a hefty 19.4 ounces. Inside the head grille is a 1-inch-diameter, 6-micron-thick diaphragm. Included with the mic are a sturdy shock-mount and foam-lined aluminum carrying case. The mic and its accessories convey outstanding build quality.

The only corners cut are in the mic's feature set. The Phantom C is cardioid-only and lacks any sort of pad or low-cut filter. Considering the mic's robust 28mv/Pa sensitivity, the omission of a pad can be problematic when miking loud instruments with a padless preamp. But the mic's high output, hushed 9dBA self-noise and stout 142dB maximum SPL (for 0.3% THD) ratings guarantee a stellar dynamic range and barely existent noise floor at the mic's output. The Phantom C's response is stated to be 20 to 22k Hz with no \pm tolerances given. Current draw is specified to be a hefty 4 ma.

The Phantom C's intricate shock-mount is more than just a standard-issue gizmo. A pair of semicircular aluminum rings—stabilized by three vertical struts—is suspended by beefy elastic bands inside a pair of larger, similarly constructed rings. The mount can rotate both vertically and horizontally through almost 180 degrees of arc. A clever ratcheting mechanism on the mount's stand adapter locks the mount in place.

PHANTOM C IN SESSION

Recording male lead vocals, I compared the Phantom C to my Neumann U87A using my Millennia HV-3D 8-channel preamp and Apogee Rosetta 96 A/D in the recording chain. The Phantom C delivered far more nuance and depth than the U87A, lending a striking sense of realism to the track. While the high end was also more articulate on the

track recorded with the Phantom C, it nevertheless sounded natural and unhyped. Both mics reproduced roughly the same amount of bottom end overall, but the Phantom C's bass response was smoother, exhibiting less of a hump in the upper bass. I won't give away my U87A anytime soon—it's an outstanding mic with a unique character that flatters in many applications—but I was floored by how much depth and nuance the less-expensive Phantom C reproduced.

Results were equally impressive on female vocals miked at seven inches from the Phantom C and recorded through the Millennia HV-3D/8 and Rosetta 96. The mic delivered enough bottom to round out the singer's timbre, and highs were detailed without sounding sibilant. The Phantom C lent beautiful midrange resolution without sounding "hard" or glaring. Once again, the depth of the recording was outstanding.

Next up was a seven-piece Latin band. I used the Phantom C to record timbales, which were mounted above the floor tom in a trap set. (The drummer played the timbales and traps simultaneously.) I placed the Phantom C behind and above the drummer's right shoulder, 2½ feet above the timbales and angled 45 degrees downward to face them. The sound was spectacular, needing only moderate boost in the top octave to make the timbales cut through a dense arrangement. I missed having a mic pad for this application, however, as I used the Phantom C with the Millennia HV-3D/8, which has no pads and produces a minimum of 8dB gain, and a MOTU HD192 I/O box, which has no calibration trims. With this setup, I couldn't avoid hitting 0 dBFS on some peaks in Digital Performer. The track sounded fine, though, as there was no audible capsule or other distortion.

On another session, I used the Phantom C to record a cajón, a large wooden cube with a circular cutout that is played with a technique similar to how congas are played, except the musician sits on the box. Although the spectral balance was excellent, the Phantom C didn't have the lightning-fast transient response I was looking for. My small-diaphragm DPA



4011 was a better choice. The Phantom C was also not the best choice to record acoustic guitar arpeggios, as the mic reproduced a bit too much bottom end and was not quite fast enough to capture the intricate detail that I was after. Considering the mic is tuned for recording vocals, this was no surprise.

WRAPPING IT UP

The Phantom C is an outstanding vocal mic offering excellent results in some instrumental applications. Of all the subjective qualities a mic might bring to a recording, depth is the most elusive. Brauner provided the Phantom C's sonic signature with a sense of realism usually only heard in far more expensive microphones. The Phantom C sounds transparent yet big, articulate yet smooth. Add high sensitivity, low noise, wide dynamic range and affordable pricing to the mix, and the Phantom C is a winner.

Brauner, dist. by Transamerica Audio Group, 702/365-5155, www.transaudiogroup.com.

THE SOURCE FOR SOFTWARE



- The Ultimate Information Source for Pro Audio Software
- B&H Audio Professionals Choose the Newest Products & Technology
- Over 700 Pages of New Computer Audio Hardware/Software, Standalone Software/Plug-Ins, MIDI, Samples, DJ, Cables, Studio Furniture

THE PROFESSIONAL AUDIO SOURCEBOOK

Volume 1 (Hardware) Volume 2 (Software)

420 Ninth Ave., New York, NY 10001

800 875-6951

800 947 7888

www.bhphoto

STEINBERG
CUBASE SL • CUBASE SX *continued*

Mixer Channels

Hardware Control Surface Support

STEINBERG
CUBASE SL • CUBASE SX *continued*

VST Software Effects Processors

Included VST Effects Processors

- Auto Filter
- Compressor
- Delay
- Distortion
- EQ
- Filter
- Limiter
- Mixer
- Reverb
- Tremolo
- Wah

VST (VST) Instruments

- All Steinberg VST instruments are included in the Steinberg VST software.
- All Steinberg VST instruments are included in the Steinberg VST software.
- All Steinberg VST instruments are included in the Steinberg VST software.

Included VST Instruments

ActiveX Support

COMPUTER AUDIO

COMPUTER AUDIO

BH ONE HOUR FREE PARKING
AT 349 1st Street, each purchase of \$50 or more

BH ORDER BY MAIL: 300 5th AVE • NYC, NY 10001 • TEL: (212) 512-2200 • FAX: (212) 512-2201
1-800-875-6951 • www.bhphotovideo.com **BH**



The Source for Professionals

800-947-5508 • www.bhphotovideo.com

Snapshot Product Reviews



IK MULTIMEDIA T-RACKS Mastering Plug-In

IK Multimedia now has a plug-in version of its stand-alone T-RackS mastering software. HTDM, RTAS, VST, DX, AU and MAS plug-in formats are supported across Mac OS 9, OS X and Windows 95/98/ME/NT/XP platforms. T-RackS is actually a bundle of four individual mastering tools and the whole "rack" of all four in a mastering suite. The four processors are a 6-band parametric equalizer, a "tube-based" modeled stereo compressor, 3-band stereo limiter and my favorite—an adjustable soft-clipping output stage.

Those familiar with the original stand-alone T-RackS will recognize some significant improvements in the plug-in version. The equalizer now offers full 20-20k Hz range with a sweepable midrange; there is now a sidechain highpass filter in the compressor module; individual limiter band controls and adjustable crossover points for more precise multiband limiting; and a calibrated limiter and clipper output guarantees that your mix will never go over -0.05 dBfs.

I installed T-RackS VST version on a PC (XP) running Steinberg's WaveLab 4.0 and the HTDM/RTAS version on a Mac running Pro Tools | HD (OS 9.2.2). I also installed the plugs on another XP PC running both Cubase SX and Nuendo 2.0.1. IK Multimedia allows you three additional authorizations on different

machines from joining its online users group.

All versions of the modules and suite plug-ins work well, although running all four in the suite uses a good amount of CPU resources in VST. I found the compressors very warm and smooth for mixes and individual tracks. However, on separate tracks, I'd have to crank them a lot to get any action. The soft-clipping stage is my pick for getting a saturated sound on mixes or separate instrument tracks. I also liked the Chaining feature, where you can easily "re-order" the chain of three of the four processors.

The multiband limiter is for stressing certain frequencies over others or reducing certain frequency peaks of individual instrument tracks—it works as advertised. The "tube" compressor module is probably best suited to vocals and drums, and the enhanced parametric is great for any vocal, track or mix. The sidechain filter is great for mixes where heavy kick drum and bass can cause excessive pumping. You can use more compression with the filter set to around 150 Hz and have less of these artifacts.

I found that the VST plug-ins do not report their latency to the host's plug-in delay compensator. Latency compensation is an inherent feature (over Pro Tools) when mixing inside of Nuendo or Cubase SX. This flaw would preclude me from using these plug-ins on phase-dependent tracks, like drum kits or any other multimiked acoustic instruments. I also found instantiating the mono versions of T-RackS crashed these programs, although in Pro Tools, this didn't happen. Tech support assures me that they are aware of these bugs and are working on them, with a fix due out by the time you read this.

Apart from these quirks, the plug-ins sound great and make a worthwhile addition to any multitrack DAW. T-RackS plug-ins sell for \$399 MSRP.

IK Multimedia, 954/749-3016, www.ikmultimedia.com.

—Barry Rudolph

DAVE SMITH INSTRUMENTS EVOLVER SYNTHESIZER

Dave Smith's name ought to be a household word. Here's a guy who's made a huge impact on our lives—his many innovations include designing the Sequential Circuits Prophet-5, laying the foundation for MIDI and developing Seer Systems' Reality, the first successful virtual synth. With chops like that, he could have gone on to bigger things, but instead he went smaller. Housed in a compact, 6x11-inch desktop chassis, his latest creation is Evolver, a monophonic synth that blends FM synthesis with four oscillators: two analog and two digital. So for a paltry \$499 retail, you get an analog/digital synth, 16x4 sequencer and full stereo audio processing.

Under the small hood, Evolver is a powerhouse. Digital oscillators emulate the dense wavetables of Sequential's Prophet



VS. Each channel has a VCA and a resonant analog lowpass filter (2/4 pole switchable). There are four LFOs, three ADSR envelope generators and an analog-style step sequencer that syncs to MIDI clock. Sounds can be triggered via the internal sequencer from an external sound source (mono or stereo), using the 1/4-inch line inputs/outputs or from a MIDI keyboard, using Evolver as a MIDI sound module.

Despite the Spartan top panel, Evolver's eight-knob interface gives the control of a massive analog synth without the size (or cost) of 100-plus pots. This approach uses a Shift button and eight row select buttons to give quick access to any parameter. It takes a few minutes to get used to it, but once you're there, it's fast and intuitive. The company al-

so offers a \$49 Evolver Editor for PC users; a Mac version is coming. This lets users see all parameters at a glance, as well as other goodies such as random program generation.

Evolver is powerful and deep. You can dive right in and start creating amazing sounds simply by stepping through its 512 (four banks of 128) programs. But the fun really accelerates if you have some knowledge of synth basics (ADSR, filters, oscillators, etc.). I routed a thin, wimpy Farfisa organ to the audio inputs, and within a minute, I had a phat monster bass! Acoustic drums can be transformed into huge, thick techno rhythms. Electric guitar can go directions you'd never imagined, and vocals—well, you'll just have to try it to believe it. The onboard sequencer can build everything from complex compositions to simple loops.

The best thing about Evolver is that it offers so much for so little. It does have a few drawbacks: a wall wart power supply, no single output volume knob and no headphone out, (although the output could drive phones if you had a dual ¼-inch-to-TRS jack adapter). Besides its awesome musical synthesis and compositional capabilities, game developers and sound designers are gonna love this one. If you want more, Dave Smith Instruments just debuted the Poly Evolver, which is the \$1,395 rackmount polyphonic version, slated for delivery next month.

Dave Smith Instruments, 707/963-7006, www.davesmithinstruments.com.

—George Petersen

SIBELIUS 3.0 NOTATION SOFTWARE

With all of the complex music-making capabilities available from software, it's easy to forget another basic reason why computers entered the mainstream in the first place: to make life easier. Sibelius, founded in 1993 by twin brothers/composers/programmers Ben and Jonathan Finn, has never lost sight of that objective. And its composing software, Sibelius 3.0, takes a traditionally time-consuming process and makes it much faster, more efficient and more creative.

Priced at \$599, or \$199 for an upgrade, Sibelius 3 is a deceptively simple yet deep program offering a complete toolkit for composers, songwriters, arrangers, teachers and students. Designed to streamline the task of writing, playing, printing and publishing music, Sibelius uses a flexible, intuitive user interface that's meant to take the pain out of creating charts, whether they're for solo piano or a full orchestra.

Sibelius' designers have paid careful attention to customer needs, adding features

that will be welcomed by advanced and beginning users. Most notable is the addition of Native Instruments' Kontakt Player Silver, providing a range of high-quality instrument samples, including brass, woodwind, strings, percussion, voices and a Bösendorfer piano. An upgrade to Kontakt Player Gold is also available. Sibelius 3.0 also sports an improved look and feel via its freshened interface, which has a new Smoothness setting that enhances display clarity, and offers zooming and navigation. Additions include a Focus on Staves feature to help navigate/edit specific score sections when writing for large ensembles and Shadow Notes, which displays where a note will appear before it's input.

Installation and setup of the Mac/Win-



compatible Sibelius disc was routine on my machine, which runs Windows XP on a 2.26GHz Pentium using 1 GB of RAM. Once installed, I ran the helpful Quick Tour, which appears at the front of the well-written manual. While the Sibelius interface is extremely intuitive and its basic functions can be quickly mastered, some more complex commands and procedures—such as creating an entire orchestral arrangement from a single instrument—need to be learned step-by-step before they can be pulled off correctly.

The program makes it easy to establish an onscreen template for creating a score, which it delivers with uncomplicated dialogs and a host of options for appealing looks. When inputting a score, Sibelius offers a flexible approach that lets users enter notes via mouse, QWERTY keyboard or MIDI keyboard. This last method of real-time input uses what Sibelius calls Flexi-time: Play the notes—and voila!—they show up on the staff. Not only is it highly accurate, but the program is also intelligent enough to track your tempo as you speed up or slow down against the click and then reflect it on playback.

Thanks to Sibelius' easy-to-navigate user interface, designers were able to pack it with a tremendous amount of functionality, as evidenced by the whopping 589-page manu-

al. This makes for a sizable list of shortcuts and commands that must be mastered to make the fullest use of the program. But as composers of all skill levels will find, such depth means that the only true limit of Sibelius 3.0 is your own knowledge of music theory. Whether you're just keeping track of your own ideas for reference, charting for a jazz band or scoring for a symphony, Sibelius makes short work of a hard task.

Sibelius, 925/280-0600, www.sibelius.com.

—David Weiss

STABILANT 22 CONTACT ENHANCER

Years ago, I tried Tweek, a conductivity enhancer for the consumer audio market. It was effective, but was sold in tiny bottles—enough to treat a home hi-fi system—making it pricey for the pro user who deals with hundreds (or thousands) of plugs, jacks, connectors and switches. However, the same formula—but in a concentrated industrial form—is available as Stabilant 22. When used in thin films between contacts, this nonconductive, amorphous-semiconductive polyoxyethylene-polyoxypropylene block polymer acts under the influence of the electrical field and switches to a conductive state.

Among other sizes, Stabilant 22 is available in \$28.95 5ml and (\$56.75) 10ml concentrate kits. Each is mixed 4:1 with 99% isopropanol or pure ethanol that you supply to fill a larger container (included with the kits) to the right dilution. The alcohol is not an active ingredient but evaporates, spreading the active ingredients evenly over the contact surface.

A small amount does the trick: One tiny bottle can treat hundreds of connections. Stabilant 22 is not a cleaner or lubricant (although it does do a bit of each), but does an exceptional job at improving conductivity. On various surfaces—ranging from internal Molex connectors in my MCI JH-110 2-track, to a noisy guitar pickup switch on XLR cables linking outboard preamps to my Pro Tools rig, the difference was audible and noticeable. The most dramatic improvement was on phono cartridge connections and interchangeable mic capsule interconnects, two areas of superlow voltage exchange. In both cases, the result was almost like a veil being lifted from the listening chain, with lower distortion and improved signal to noise. I'm hooked!

Stabilant 22, dist. by Posthorn Recordings, 212/242-3737, www.posthorn.com.

—George Petersen ■

A Dangerous Science Fair Project

Bringing NASA Technology to Home-Brew Microphone Capsules

Condenser microphones are the topic this month and I have a great story about them with a funny ending. But first, *mes amis*, I must tease you with the usual geek diversions, so hang in, okay? I attempted to repair a condenser mic capsule using a generic material that is most likely available at your local science museum and, certainly, on the Net. I don't have much self-control, but let's see if you can do me one better and read the whole story—no peeking!

THE AGING PROCESS

A pair of AKG CK-1 cardioid capsules came in for evaluation, the type used on the 451/452 Series preamp bodies. One capsule was dead, and the other noisy. Outwardly, condenser microphone mechanics are relatively simple (like any capacitor), with a pair of conductors separated by a nonconductor. That is, of course, until it becomes desirable to expect identical performance from each capsule. Parameters such as frequency response, noise and output level rely on consistent diaphragm tensioning, low-noise components (active and passive), high-quality insulators and long-life materials, including adhesives. That's the nature of it. Noise in condenser microphones can be elusive. More than the typical spurious emissions from tubes and transistors, the capsule itself can be a noise source.

D.I.Y. CAP

For a better appreciation of how delicate, yet resilient, these little critters are, let's mentally roll our own capacitor, then shrink it down to "microphonic" size. Take two sheets of aluminum foil sandwiched around two sheets of paper insulators, wrap around the center connecting wire, add a wire to the outer foil and then encapsulate with shrink tubing (or dip in wax if you're feeling old-fashioned). I actually did this just for fun (see Figs. 1a/1b), creating a 0.0028-micro-Farad cap in the process.

KEY THREE

For a condenser mic, the principle components are the diaphragm, air and backplate. With the CK-1, there is an insulating ring around the perimeter of the backplate. The diaphragm's base material is a thin plastic sheet—a nonconductor—with a molecularly thin coating of a conductor, such as gold, aluminum or nickel, on one side. Total thickness is typically between 3 and 6 microns, thin enough to see through to the backplate, which is a metal part with "holes" that act as either air cavities or vents, as needed. In the rear of the CK-1 is a vent capped with a cinkered bronze plug used to restrict airflow. AKG used a similar material as a windscreen/pop filter on some of its earlier handheld mics.



Fig. 1a: (above) raw materials for D.I.Y. capacitor

Fig. 1b: the assembled and tested capacitor



The capsule has a measurable capacitance; for the CK-1, it's about 30 pico-Farads (pF). A DC polarizing voltage is applied to the capsule so that changes in sound pressure vary the capacitance and, in turn, the DC voltage. This tiny signal is fed to an ultrahigh-impedance voltage amplifier before exiting the XLR and making the journey through some length of cable. The impedance issues are not just electronic, but also mechanical and acoustic, which contribute to sonic character and directional characteristics. After achieving precision in the manufacturing process, it's relatively simple to maintain repeatable control over each facet.

Of the vulnerabilities, human breath and other forms of high humidity will eventually deposit a layer of organic funk on the diaphragm, plus there is a possibility of puncture wounds by vocalists who have a propensity for projectiles. That makes a pop filter, if not two, *de rigueur*. For some capsule designs, the funk can grow over areas where there is no plating and the resulting conductivity may produce intermittent noise. Even worse: A particularly "wet" plosive can short out the capsule.

STUDIOPHILE

The experts speak

"I choose the tools that best help me convert my ideas and imagination into music. That's why I'm using M-Audio's new Studiophile BX8 reference monitors. They sound absolutely brilliant—even after an exhausting 18-hour writing day. And what I hear in my studio comes across exactly as I intended, wherever my mixes go."

Jeff Rona (film composer, "Traffic," "Black Hawk Down")

"I'm surprised and excited by the tonality of the BX8s. Unlike most speakers I've checked out, they have a nice open middle quality to them—along with the bonus of a smooth low end and not-too-shiny top. I added M-Audio's subwoofer and was really impressed with what it contributed to the mix."

David Kahne (Grammy-winning producer, Paul McCartney, Sugar Ray)

"I have to go between analog and digital all the time and the BX5s have become my workhorse."

Terry Howard (Grammy-nominated engineer/producer, Ray Charles)

"Little package, big presentation. I wouldn't work a session without them."

Steven Barkan (Grammy-nominated engineer/producer, BT, Mariah Carey, George Benson)

"Music broadcasts differently on different networks. So this week, the final test of the music created and mixed on M-Audio monitors was listening to it on air. "Will & Grace" (NBC), "Good Morning Miami" (NBC), "Reba" (WB) and "Less Than Perfect" (ABC) all sounded great."

Jonathan Wolff (TV composer, "Seinfeld," "Will & Grace")

Studiophile BX8 | BX5 | SBX | LX4



Where do you want to take your music?

M-AUDIO

www.m-audio.com

THE EXPERIMENT

Of the two CK-1 capsules, the dead one was disassembled, revealing a diaphragm that had separated at the edge either from age or, more likely, during a previous disassembly/cleaning attempt. I normally send capsules out for repair and had no intention of making a career change, but a recent trip to the science museum with my kids yielded a space blanket that seemed like it might serve as a crude diaphragm material. I had to see just how far my science fair exercise would go.



Fig. 2: a well-worn piece of space blanket material of the type used to replace the diaphragm on the CK-1 capsule. Note that the gold side is conductive, and the silver side is not.

The first step was to determine which side of the film was conductive. In Fig. 2, note that the space blanket has a gold and a silver side. The gold side was conductive, so it would go on the outside. Five-minute epoxy was chosen as the glue. Now, all I had to do was suspend the film in such a way to eliminate wrinkles and minimize tension; the backplate assembly would create tension by its own weight.

A solder-wick spool was used to suspend the material, Scotch tape secured the edges and glue was applied to the outer rim of the capsule (a band of white plastic insulating material that, by my guess, is most likely Teflon). After allowing sufficient time for the adhesive to cure, the space blanket material was trimmed and the capsule reinserted into its housing and screwed into the head amp. When it worked right off the bat, I was completely blown away. That it compared quite favorably to the reference capsule in terms of output and spectral response added to my amazement. Figure 3 depicts a normal CK-1 capsule side-by-side with the mutant space blanket version.

This fascinating detour increased my appreciation for microphone design and

manufacture. I dove back into a short book, simply entitled *Microphones* by Dr. Gerhart Boré, which was published by Georg Neumann GmbH in 1973 and reprinted in 1989. The book details all types of microphones, including the types of tensioning and dampening employed in various designs to achieve what we ultimately take for granted: a usable microphone. To say that I got more out of this book the second time around after some hands-on experience is an understatement that reinforces what this column is about: encouraging the scientist within.

As challenging as it was to work with space blanket material that, by my estimate, was somewhere between 10 and 20 microns thick (0.001 inches = 1 mil = 25 microns), I can only imagine the challenge of working with 3-micron material. Of course, having the proper tools and instruments would make the process easier. One can never have enough tools—a micrometer is only \$150.

In closing, I would like to thank David Josephson at www.josephson.com for recommending Boré's book to me several years ago. Also, while this article provided a fun excuse for some home-brew experimentation, neither myself nor the publishers of *Mix* magazine accept any responsibility for



Fig. 3: on the left, an AKG CK-1 capsule "exposed," and on the right, the D.I.Y. diaphragm using a piece of space blanket material that is available at your local science museum's gift shop. The diaphragm connects to ground via the case, and the backplate connects to the amplifier, which supplies a polarizing voltage via the gold-plated spring and contact point.

the action of readers who destroy irreplaceable vintage or modern condenser microphones in their attempts to duplicate the space blanket diaphragm-replacement procedure described herein. ■

Visit Eddie Ciletti at www.tangible-technology.com for more fun!

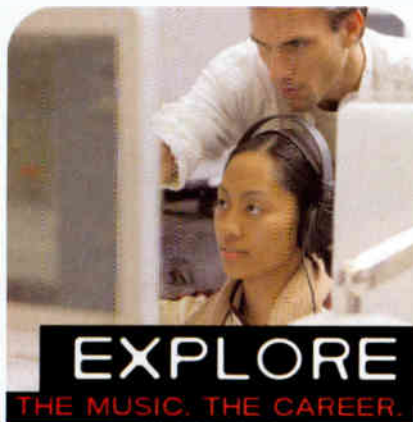

EXPLORE
THE MUSIC. THE CAREER.



> DIGITAL AUDIO
RECORDING > MIDI
MUSIC PRODUCTION
> MIXING > AUDIO
POSTPRODUCTION



Institute of Audio Research



800.544.2501

audioschool.com

64 University Place, New York City 10003

Licensed by NYS Education Department. High School diploma or GED required. Financial Aid if eligible.



REMIX

REMIX HOTEL MIAMI 2004

WMC MIAMI 2004 MARCH 7-9 RITZ PLAZA SOUTH BEACH

Remix magazine and our technology partners present three days of FREE master classes, workshops and clinics on music production and performance for electronic- and urban-music producers, engineers, musicians and DJs during the Winter Music Conference. Check in and check out the Remix Hotel at the Ritz Plaza South Beach.

Space is limited, so visit www.remixhotel.com today and register early.

Three days of poolside sunset sessions brought to you by XM Satellite Radio.

REMIX



digidesign



emagic



KORG

MACKIE

M-AUDIO



NATIVE INSTRUMENTS

PRO DJ

RANE

Roland



STANTON



Vestax



YAMAHA

RYAN ADAMS

TAKES 23 DAYS
TO ROCK N ROLL

By Heather Johnson

Various self-help books suggest that one has to hit "rock bottom" before one can reform. Alt-country artist Ryan Adams didn't crash and burn, per se, but he did experience noticeable symptoms of burnout and frustration after turning in the melancholic *Love Is Hell* (Lost Highway), released first as a pair of EPs and later as a double 10-inch vinyl. Nothing that a little Black Flag couldn't cure, though.

To recover from his malaise, the 29-year-old songwriter spent a few months underground—literally—at a tiny rehearsal space under the East Village bar Hi-Fi, where he jammed and listened to punk rock with drummer/bar owner Johnny T. Yerington. Revitalized and creatively recharged, Adams resurfaced with the beginnings of *Rock N Roll*, an upbeat, free-spirited, guitar-soaked *rawk* album that not only marks a stylistic U-turn for the Jacksonville, N.C., native, but also follows the philosophy that some of the most memorable rock 'n' roll albums are the ones recorded on the fly, with no time (or budget) for second-guessing or endless editing.

No more than two weeks after Adams asked producer James Barber to oversee his new album, the two joined engineer Jamie Candiloro at New York's Stratosphere Sound and recorded and mixed 19 songs in 23 days. "If we were going to release this record in 2003, we couldn't screw around," says Barber, producer of Courtney Love's new album. "We had to go in every day and be incredibly focused."

Barber used Led Zeppelin's classic *IV* album as a model for what they wanted to accomplish in the studio. "It's full of mistakes in its perfection," he explains, "and also records like the Dream Syndicate's *The Days of Wine and Roses*; they were made for like \$800 in two days, and they hold up over time because they're about emotion, performance, knowing what songs to record and knowing what mistakes will make things better."

Once Adams emerged with his new set of basement demos, he and Barber rearranged, added bridges and even co-wrote a few new songs for the

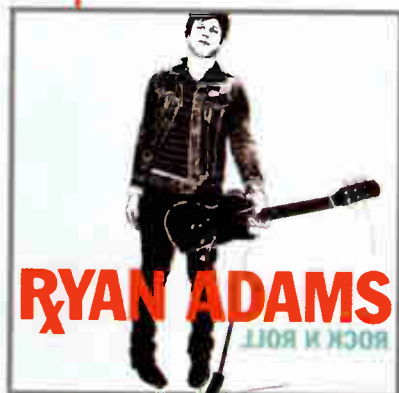

record. "It was easy in some ways, because he's so proficient as a player and a singer," Barber says. "And to think that he's not even 30 yet—to think that only now is he entering his most creative and productive phase."

Barber also encouraged the prolific artist to incorporate the alternative and punk music he'd grown up with into his music rather than limit himself to penning more of the rootsy, melancholic fare that helped him become a poster boy for 21st-century alt-country. "Ryan had always made records with guys who were great players, but they were usually a lot older than he was," explains Barber. "He never made a record that sounded like his own generation. And I was like, 'Ryan, why don't we make a record based on these records that you love?' We talked a lot about Black Flag and The Smiths, but we also talked about '80s bands like R.E.M. and the Gun Club, bands that—when he was 13 and 14 years old and was a little punk rock skateboard kid—really changed his life."

Indeed, *Rock N Roll* melds together late-'70s, early-'80s punk and new wave with contemporary pop and rock into one swaggering hybrid. Adams channels Bono on the debut single, "So Alive," mimics The Strokes on "This Is It," and breaks out thick, fist-pumping, T. Rex-like guitar riffs on songs such as "1974" and "Note to Self: Don't Die." However derivative, the album has put Adams in front of entirely new audiences. "Ryan does depressed as well as anybody, but we wanted to make something that was really life-affirming and celebratory," says Bar-

—CONTINUED ON PAGE 132

MILES DAVIS

REVISITING THE REVOLUTIONARY JACK JOHNSON SESSIONS

By Paul Tingen

In December 1969, Miles Davis boasted, "I could put together the greatest rock 'n' roll band you ever heard." It must have sounded rather presumptuous, because the jazz trumpeter had only begun to flirt with electric instruments and rock influences at the very end of 1967. And if there were two things beyond dispute in the confused and turbulent '60s, it was that jazzers couldn't rock and rockers couldn't play jazz. Moreover, *Bitches Brew*, Davis' seminal blend of rock and jazz, and the first entirely successful attempt at fusing the two musical directions, was recorded only a few months earlier and had not been released yet.

Davis attempted to prove his rock 'n' roll point during a series of intense sessions in the first half of 1970. Some of the results were released as the soundtrack to a documentary movie by director William Cayton about Jack Johnson, who had become the first African-American heavyweight boxing champion in 1908. The soundtrack, titled *A Tribute to Jack Johnson*, fell largely on deaf ears when it was released in 1971, despite featuring jazz luminaries such as John McLaughlin, Herbie Hancock and Billy Cobham, and arguably the strongest trumpet playing of Davis' entire career. The album,

Mastering engineer Mark Wilder

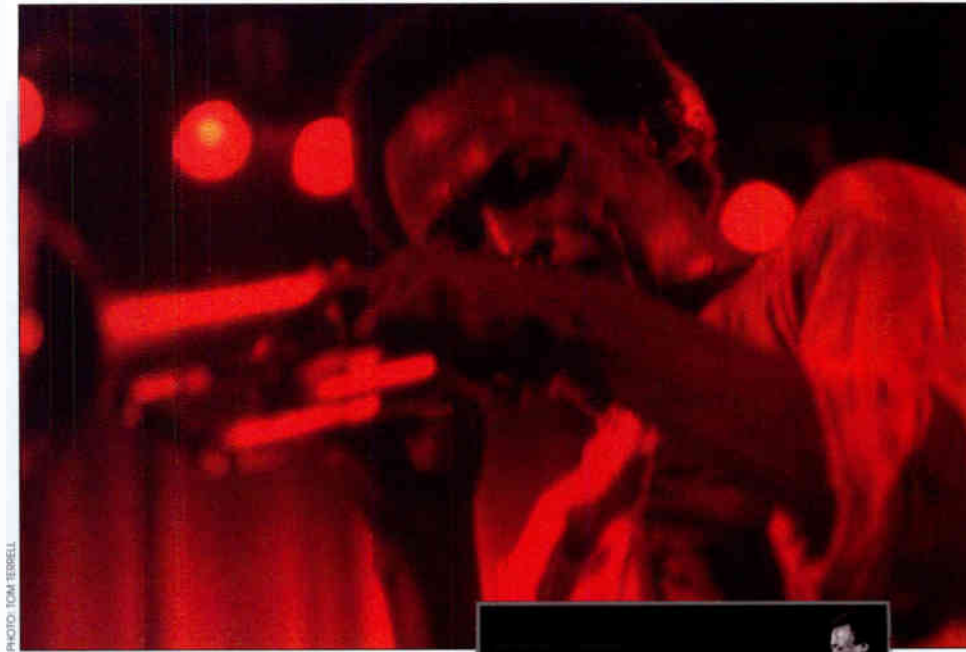

PHOTO: TOM STREBEL

which is laced with churning funk and rock rhythms that had never been blended quite this way before, never attained the iconic status of *Bitches Brew* or Davis' ambient jazz-rock epic of the same era, *In a Silent Way*.

Yet over time, the reputation of Davis' *A Tribute to Jack Johnson* has grown considerably, and its standing was further enhanced late last year when Columbia/Legacy released seven hours of music from those early 1970 sessions on a 6-CD boxed set called *The Complete Jack Johnson Sessions*. The set is the latest in a line of much-lauded and Grammy-laden Davis boxes, which includes such important master



works as *The Complete Miles Davis With John Coltrane, 1955-1961* (six CDs); *The Complete Live at the Plugged Nickel* (eight CDs); *Miles Davis & Gil Evans* (six CDs); *The Complete Columbia Studio Recordings of the Miles Davis Quintet, 1965-1968* (six CDs); *The Complete Bitches Brew Sessions, 1969-1970* (four CDs); and *The Complete In a Silent Sessions, 1968-1969* (three CDs).

Conceptually, these boxed sets are the brainchildren of reissue producers Bob Belden and Michael Cuscuna, while the main technical man behind them is mastering engineer Mark Wilder of Sony Music Studios in New York. Wilder has worked for Sony since the late 1980s, switched exclusively to mastering in the mid-1990s, but has been "happy to come out of engineering retirement" to work on the Davis boxed sets.

Wilder reveals that for the boxed sets that cover music from the 1950s and 1960s, most of the 2-track mixdown masters had deteriorated to such a degree that the decision was made to remix all material from the original multitrack masters. "For the Miles and Gil boxed set, I was dealing with a half-

—CONTINUED ON PAGE 134

DAVID BOWIE'S "FIVE YEARS" / "SOUL LOVE" / "MOONAGE DAYDREAM"

By Rick Clark

Much has been written about the importance of David Bowie's album *Ziggy Stardust & The Spiders From Mars*. His fantastical creation of a futuristic, androgynous rock star named Ziggy and the album's utterly unique-sounding songs influenced the look and music of many artists after its 1972 release—from Queen, Suede and Mott the Hoople to Lou Reed, The Cars and Elton John. Not only did *Ziggy Stardust* establish Bowie as a major talent, it also cemented Ken Scott's reputation as an important producer with a unique sonic and artistic vision in the rock world.

A few years prior to making *Ziggy Stardust*, producer/engineer Gus Dudgeon had invited Scott to leave Abbey Road and work at nearby Trident Studios in London, one of the hottest new facilities in the world at the time. It was there that Scott's working relationship with Bowie started, during the making of the artist's Tony Visconti-produced *Man of Words/Man of Music* album. (That album was later released in the U.S. as *Space Oddity* and featured the hit by the same name.) At the time, Dudgeon's own production career was just beginning, too.

"David was working with Tony on the album, but Tony hated the song 'Space Oddity,'" Scott says, "so David used Gus for that one song and Barry [Sheffield] engineered it. I ended up doing all the other songs on the *Space Oddity* album."

The album that preceded *Ziggy Stardust* was *Hunky Dory*, which eventually featured the artist's first real stateside hit, "Changes." It was Bowie's debut on the RCA label and his first production with Scott. It is hard to only address *Ziggy Stardust* without some mention of *Hunky Dory*, as both albums were recorded back-to-back within a several month period. "We recorded *Ziggy* before *Hunky Dory* was released," says Scott. "*Ziggy* was recorded a month after *Hunky Dory*. I think it was while we were recording *Ziggy* that they actually signed the deal with RCA."

Ziggy Stardust was recorded over a two-week period during November 1971 at Trident, which was located in the Soho area of London. In this era, Trident was home to many high-visibility projects for artists such as The Beatles, T. Rex, Elton John and others. The *Ziggy* sessions would usually run from two in the afternoon to just past midnight, Mondays through Saturdays.

There are a number of songs off of *Ziggy Stardust* that warrant "Classic Track" treatment, including the pile-driver rock of "Suffragette City," "Starman" (the album's single) or the dramatic sweep of the title track. Nevertheless, *Ziggy's* opening triptych of "Five Years," "Soul Love" and "Moonage Daydream" is one of the greatest opening sequences ever committed to vinyl. The three songs, seamlessly linked to-

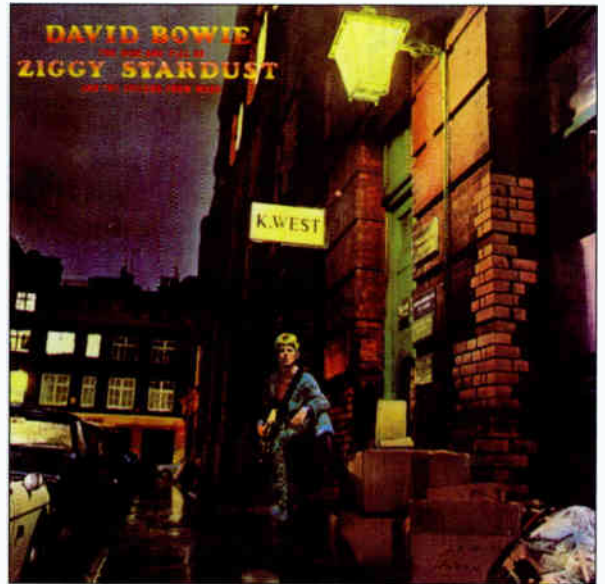

gether, are not only some of Bowie's best work, but they provide the emotional thrust for what has become one of rock's truly epic releases.

"Five Years," the apocalyptic lead track, draws the listener into the album's drama with the gradual fade-in of a spare drum pattern that sets the stage for *Ziggy's* environment, desperate people in a doomed world. Bowie's voice goes from numb intonations to wailing (at anyone who would listen) that time is running out. The song fades out in the same manner that it began, with a lone drum track. Suddenly, a hi-hat kicks in a couple of beats and a sensual percussion groove sets up the next tune, "Soul Love." The transitions between "Five Years," "Soul Love" and the following track, "Moonage Daydream," make these three songs work almost as a singular piece. Much of this has to do with Scott's sequencing and sense of timing between the tracks.

"I was brought up working at Abbey Road, and one of the first things you did there as a second engineer, when you weren't on sessions, was something called banding," says Scott. "When American albums came into the studio, they were just straight copies of the album, and you had to put white leader tape that was exactly five seconds long in between each track. They were the rules, until The Beatles came along. Having done the five seconds between every track, I realized as I was doing *Ziggy* that this didn't feel right. So I thought, 'F*** the rules; if I can get it to continue when I'm tapping my foot from one number, and I can tap it on the first beat of the next track and continue, that's the way it's going to be.' I was very careful about doing that." The idea for the fade-in on the opening track came from Bowie. "David wanted it coming from nothing and going to nothing," says Scott.

"The tracks were recorded on a Trident A Range—the very first one—and upstairs in the mix room we mixed on the Sound Techniques board. The monitor speakers at that time were Lockwood cabinets with Tannoys in them.

"It was so basic," he continues. "There weren't even pan pots on each channel on the console. I always had it set up so you could switch the signal to go left, center or right. I

Cool Spins

The Mix Staff Members Pick Their Current Favorites



Bruce Springsteen & The E Street Band: *Live In Barcelona* (Columbia Music Video)

When this remarkable DVD came out last fall, it didn't get much attention, probably because Bruce Springsteen's previous DVD release, *Live In New York City*, got so much ink. (That disc captured the E Street Band's 2001 reunion tour.) But *Live In Barcelona* is actually a much stronger set in my view: It's the E Street Band another year down the line from *New York City* and playing with even more passion and conviction (if that's possible). The reason is simple: The program is dominated by nine songs from Springsteen's extraordinary meditation of 9/11 and its aftermath, *The Rising*. Those songs are so full of life and spirit here, it's impossible not to be swept up in their grandeur and occasional sadness and desolation. Beyond all that great new material, though, is a fine collection of "hits" (several of which are also on *New York City*) and a handful of less predictable choices, including "Night," "She's the One," and exquisite solo piano renditions of "Spirit In the Night" and one of my all-time favorite songs, "Incident on 57th Street." The sound is occasionally a tad cluttered, but that's nothing new for this band—there's whole lot of mojo goin' on. But the performances couldn't be better and I must say, that Barcelona crowd really knows how to get down! A remarkable musical journey, from the edge of town into the fire and beyond. (As a bonus, there's also a documentary about the tour tagged on to the end of disc two.) Bruuuuuuuue!

Director: Chris Hilson. Recorded by Brendan O'Brien. Mixed by O'Brien and Nick Didia. Recorded at Palau Sant Jordi (Barcelona). Mixed at Southern Tracks (Atlanta), Silent Sound Studios (Atlanta) and Larrabee West (West Hollywood). Audio mastering: Bob Ludwig/Gateway.

—Blair Jackson

Beulah: *Yoko* (Velocette)

Beulah frontman Miles Kurosky disregarded the group's pretty indie pop formula on the group's fourth album, opting for more emotional weight, fewer trumpets and less sunshine. With the aid of producer/engineer Roger Moutenot (Yo La Tengo, Sleater-Kinney), the San Francisco band created an expansive album more languid in mood, but filled with Beulah's trademark solid melodies, fuzzed-out guitar and vintage keyboard parts.

Kurosky, who reportedly ended a relationship while writing the album's 10 songs (some co-written with keyboardist Pat Noel), speaks to his ex on the easygoing "A Man Like Me." She answers on "Landslide Baby," a song that references, however



slightly, the Beach Boys-influenced "ba-ba" melodies that Kurosky seemingly intended to avoid. The woeful "You're Only King Once" features lush strings and, yes, those pesky horns, all nestled behind verses for disenchanted, heartbroken souls. "Me and Jesus Don't Talk Anymore" offers up a bit of sunshine, but it's followed by the gray skies of "Fooled With the Wrong Guy."

Beulah's latest does explore the darker side of their layered, melodic pop, but it's far

—CONTINUED ON PAGE 137

then had two of the pan pots set for half left and half right, and the third one was just in case I wanted to move anything around."

Much of the effect of movement across the stereo spread was created by pulling up the reverb on the sides. "I think what you're hearing is more the spreading, because the reverb comes up much louder," Scott says. "So that would tend to pull it to the sides more. When I pulled the guitar up and the reverb down, then it would come more center."

Scott says that the reverbs he employed were "very simple because there was so little to use back then. We had two plates and a bunch of Studer tape machines, so it would all have been done by changing the times on two plates and various tape machines for the delays."

Bowie's vocal mic was a Neumann U67 run through a Trident mic pre and compressed through an LA-2A. "We would have UREI compressors over the overall mix. With *Ziggy*, the drums certainly weren't limited or compressed, except being limited a bit on the overall mix. There would have been some initial limiting or compression applied on the bass, keyboards, vocal and sometimes the guitars," says Scott.

Listening to Bowie's impassioned singing (especially on songs such as "Five Years" and "Rock and Roll Suicide"), it's amazing to consider that, as Scott says, "All of David's vocals were first takes. 'Okay, David, it's time to do a vocal.' 'Oh, all right,' he'd say, and down he would go."

Actually, for "Five Years," Bowie's vocal was done in two takes for two sections. Scott used different settings to capture the first half, which was sung very quietly. The second half required different adjustments to compensate for Bowie's dramatic singing.

Bowie's ability to knock off great single-take vocals still impresses *Spiders From Mars* drummer Woody Woodmansey, who says, "They were first takes! And then he would go, 'Okay, I'll double it.' I'd worked with other singers before, and I'd never met any singers who could sing the same thing again so you couldn't tell they were double-tracking it. David would do it, and you'd go, 'Shit, are both the voices up, Ken?' 'Yeah.' I can't hear 'em!' I could only hear one. Ken would say, 'They're both up, look at the faders!' It was wild."

While Bowie is unquestionably the star of the proceedings, it is lead guitarist Mick Ronson who is the unsung hero of *Ziggy* (and *Hunky Dory*), with his razor-sharp, lyrical guitar work and rich string arrangements. (Ronson passed away in Nashville on April 30, 1993.) Even though some know

Ronson as Bowie's guitarist, few know that his string arrangements were not only a powerful factor on Bowie's album, but also on a number of other artists' releases, ranging from Pure Prairie League's *Bustin' Out* to Lou Reed's *Transformer*, including "Walk on the Wild Side."

"Rono was amazing," says Scott. "One of the best things about those projects was that he was inside Dave's brain. He knew what David wanted without David ever having to say it."

Listen to the concise, yet powerful string arrangements on "Five Years" or the textural free-flights at the end of "Moonage Daydream" (not to mention *Ziggy's* closer, "Rock and Roll Suicide"), and it is surprising to learn that much of the arranging work was often knocked out right before the sessions. "[Ronno] was always late with his arrangements," Scott says with a laugh. "We would discuss what the arrangements were going to be and that would all be taken care of. But he wouldn't actually finish the arrangement until the session date. He would be working on them the night before and probably fall asleep, or something like that. The next morning, he'd make a beeline for the bathroom at Trident and finish up there. We'd all be sort of standing there, hanging around 15 minutes into the session, and then he'd come out and say, 'I got them finished. Here they are.' It worked every time."

One of *Ziggy's* other sonic trademarks was Woodmansey's hard-driving, economical drum parts and Scott's dry, tight drum sounds. "Woody didn't much like the drum sound on *Hunky Dory*," Scott recalls. "He thought it was too dead. That same sound on *Ziggy* wouldn't have worked because *Ziggy* is edgier and it is a bit livelier. The change in sound is probably a combination of Woody and myself—just less dampening and me changing it slightly upstairs. We wanted it more rock 'n' roll. Woody said he thought the drum sounds on *Hunky Dory* sounded like corn flakes, cereal packets [boxes]. So the first day of recording for *Ziggy*, I sent the tea boy at the studio out to get as many different sizes of Kellogg's Corn Flakes that he could find. And then I had the roadie set up the drum kit out of purely different-size Kellogg Corn Flakes packets. So that's what confronted Woody when he walked in, and he just fell out of the floor laughing. I wish I had a camera and taken a picture of that fake drum kit made of corn flake packets."

Woodmansey remembers working with Scott to arrive at *Ziggy's* unique drum sound: "Ken would sometimes get me tuning a tom-tom for an hour, so that when it

came up through the desk, it was right. On some tracks, he would have the snare tuned so flat and dead that it was like hitting a potato chip bag. It was just soggy and the sound in the drum booth was horrible. But what Ken was able to do with it when he brought it up through the desk, you thought, 'That sounds like a really neat sound!' And we hadn't really experimented on that side of things until then."

Scott also deliberately downplayed the cymbal work in Woodmansey's playing. In general, Scott preferred a more minimal style of playing. "We all got into streamlining what we played, so that what you

[Ken Scott] gave it a different slant, really, and made it so it kept its own thing, but put it into a new sound. It still rocks, but it's sort of been space-aged, you know—it's been streamlined.

—Woody Woodmansey

played meant something," Woodmansey comments, "getting it all down to the feel, not superfluous things going on. I also think David really did the same on the song side of it.

"We all lived in the same house, so David would be basically writing. He had a piano in one room and he'd play guitar in another room, and he'd just go, 'Woody, come in and listen. I just finished this one,' and he'd play a song."

When it came time to record the material in the studio, there was little done in the way of pre-production. "Nobody had worked that much of an arrangement out, so a lot of the time, when we went for a take, you were sort of riding on a knife's edge, because we had a thing where you never went more than three takes," Woodmansey says. "If you were on the third take, you knew that that was it, this was your last shot, because you knew you weren't gonna get a fourth. That was really how the album was done.

"I guess there was still a difference between us playing live and sounding like we sounded on *Ziggy*. Ken Scott was one of the

master technicians at the time for getting quality sound that still allowed a recording to breathe as a track. So he gave it a different slant, really, and made it so it kept its own thing, but put it into a new sound. It still rocks, but it's sort of been space-aged, you know—it's been streamlined. There really was [no one] around at the time that was particularly doing that, and I think Ken contributed to it more than anything. What he did on the sound was just incredible."

Of all the great songs on *Ziggy Stardust & The Spiders From Mars*, Scott, Woodmansey and bassist Trevor Bolder have all pointed to "Moonage Daydream" as a personal favorite off of the album.

"I've loved most of the albums that I have done over the years and, obviously, *Ziggy* is one of my favorites," says Scott. "It absolutely astounds me that here we are talking about it 30 years after the event."

Rick Clark would like to thank Ken Scott and Woody Woodmansey for their generous input on this story.



RYAN ADAMS

FROM PAGE 128

ber. "Something that people in both small southern towns and big cities can blast in their car and get this sense of release and freedom."

The majority of the album—with the exception of a few basic tracks recorded at Globe Studios—was tracked and mixed in Stratosphere's Studio A, home to a 32-bus Neve 8068 console with GML Automation, Studer A827 24-track and a Genelec monitor system. "To me, it's one of the best-sounding control rooms anywhere," Barber emphasizes. "We mixed in the same room because we knew how little time we had; we were making decisions as we recorded. By the time it came to mix, we were doing two-and-a-half songs a day."

Pro Tools HD, used sparingly, helped Barber and Candiloro work efficiently without losing the album's inherent messiness. "We had our HD rig running at all times," Barber says. "Even though we were recording and mixing on 2-inch, everything went into Pro Tools. It was absolutely an integral part of the process.

"The whole experience of having to make decisions in the moment and move on was interesting," he adds. "Adding Pro Tools to the mix gives you infinite options. You can take a lot more time to make a record, but when you're just using Pro

Tools as your razor blade for editing, it speeds things up even more. So we were able to work really quickly and then go back and revisit things."

Certainly not a polished record, but not a primitive 8-track home job either, *Rock N Roll* features a retro Juno synthesizer and classic guitar tones recorded with analog gear, but maintains a clarity on par with today's modern rock heavyweights. "I wanted a record that's going to sound good next to Staind and next to *Led Zeppelin IV* at the same time," says Barber, former VP of A&R for Geffen Records. "I think making something the same way The Beatles did is a lot of fun, but it's more archaeology than record-making. The bands that Ryan's competing with out there use a lot of modern technology, so you can't make something that sounds *exactly* like what Andy Johns was doing in 1975, even though what Andy Johns did in '75 informs every single minute of every piece of work I do in the studio."

Barber admits to a few sampled drums on the record, but assures, "Every drum



PHOTO: JAMES BARBER

Adams lights up at Stratosphere Sound.

sound was made in the room, on the drums, by the drummer. We had a strict rule: We wanted to make a record that truly reflects what went on at Stratosphere."

Very few people, however, were privy to what went on at the Chelsea district facility, which is owned by alt-rock musician/producers James Iha (Smashing Pumpkins), Adam Schlesinger (Ivy, Fountains of Wayne) and Andy Chase (Ivy). In fact, the only mu-

sicians present were Adams—who plays all guitars and most of the bass and keyboard parts—Johnny T. and guest players such as Green Day frontman Billie Joe Armstrong, ex-Hole bassist Melissa Auf Der Maur and actress Parker Posey, who contributes backing vocals to "Note to Self: Don't Die."

Candiloro used Neumann U47s on all vocals, including Posey's surprisingly strong set of pipes. A UREI 1176 reissue provided necessary compression for Adams' dynamic lead. For guitars, Candiloro "always settles" on two Shure SM57s, positioned on the amp "right where the cone and paper meet." For bass, the L.A.-based engineer miked an Ampeg B15 cabinet with a Sennheiser 421. Drums were miked with a combination of an AKG D112 (kick), an SM57 (snare), AKG 414s (toms), Neumann KM84s (overheads) and various Coles ribbon mics. "They suck a bunch of great stuff out of the drum kit," he says of the Coles. "I also had a [Shure] 58 going through a Distressor loose in the room. That was featured on some tracks just as a gnarly rock sound."

"If a person can't hear the difference these cables make, they probably shouldn't be in this business"

John Fishbach

Why are seasoned pros like John Fishbach singing the praises of Zaolla's solid silver conductors? Silver is simply the best signal conductor on the planet, exhibiting a full 7% less resistance to signal flow than oxygen-free copper does. And our continuously-cast conductors are the purest form of silver used in pro audio today: 99.9997% Pure Solid Silver! (See inset, below-right.)

John's opinion on Zaolla cables is backed up by the weight of all the precious metal in his collection of million-selling records. Try Zaolla Silverline cables for yourself, and hear what John Fishbach is talking about!

Also, did you know that Zaolla cables can reduce latency in digital systems? Oxygen free copper can cause "rounding" of high-frequency square waves, increasing jitter but our technology (ultra-pure silver) improves clocking, so your ones and zeros (and your audio) come through tight and clean.



OFC at 200X Tiny metal crystals in "oxygen free" copper wire, impede signal by forcing it to continually "jump" grain boundaries in its path.

OCCS at 200X Zaolla's exclusive casting process all but eliminates grain boundaries improving audio transference over copper

ZAOILLA
SILVERLINE

ZAOILLA 6920 Hermosa Circle Buena Park, CA 90620 PHONE: (714) 736-9167 Fax: (714) 522-4540 www.zaolla.com

Candiloro also used an API Lunch Box, which included two 560 and two 550 EQs, on guitars, which were kept at the forefront of the mix. "I wanted to make this a f*** you guitar record," he says. "Just undeniable guitar sounds. Ryan's got great savvy for getting around his pedals and knowing what pickups to use. Everyone knows you can make a kickin' snare sound really big if it's loud, but I wanted [that effect] with the guitars, and the 550s were a big part of that."

With Johnny T. positioned in the main room behind the drum kit and Adams in an adjoining iso booth, the two watched each

other and played as if they were still holed up in their tiny basement rehearsal space. Candiloro kept all of the mics up all the time to capture any spontaneous, stream-of-consciousness jams. "My thing is to make the recording process transparent to the art that's happening," he says. "I don't want the red light to be a big deal. I want the artist to feel like they can just show up, put their coffee down, put that song on and go for it."

Staying in the moment was apparently crucial on this project, as the chameleon-like Adams can change genres and moods faster than he can write a song, which can

happen in a matter of minutes. "He doesn't have a lot of patience," Barber says. "He gets bored. And if you spend too long dawdling over something, you're going to lose him."

Even if his attention wavers, Adams produces ingenious work—and lots of it. He had four albums' worth of material written for his 2001 release, *Gold*, some of which ended up on his third album, *Demolition*. *Rock N Roll* was culled from yet another batch of rapidly composed songs, not perfect by any means, but flawed and sloppy in a way that can only be allowed in, well, rock 'n' roll. Because quite simply, Barber believes, "Rock music is all about just breaking stuff." ■

WHAT MICS AND INSTRUMENTS DREAM ABOUT



The Brick

Tube Microphone & Instrument Preamplifier

- 3-tube preamp for stage or studio
- +55 dB gain for microphones; +30 dB for instruments
- Perfect for DAW or traditional analog recording
- Balanced I/O via custom xformers
- Rugged steel construction
- Only \$499 US MSRP!

ViPRE

Variable Impedance Preamplifier

- Variable impedance input multiplies the performance potential of every mic
- Variable rise time offers five styles of amplification
- All-tube, Class A design provides low noise and flat bandwidth from 7Hz to over 100kHz
- Precision gain control with ceramic attenuators controlling ViPRE's incredible 75dB of total gain!



800-459-5687
www.groovetubes.com

GROOVE TUBES LLC
CUSTOM SHOP PRODUCTS

MILES DAVIS

FROM PAGE 129

inch 3-track format," Wilder explains, "and the quintet material was recorded on 4-track. The *In a Silent Way*, *Bitches Brew* and most of the *Jack Johnson* material was on 1-inch 8-track, with some of the final sessions from 1970 on 1-inch 16-track."

Famously, the original producer of the music, Teo Macero, applied some of the most intense post-production ever witnessed at the time to Davis' music. Some of the material on *In a Silent Way* was looped in a manner reminiscent of dance music today, while several of the tracks on *Bitches Brew* contain dozens of tape edits to construct new musical structures. Macero was at his most outrageous on the three main previously released tracks that appear on the *Jack Johnson* boxed set: "Right Off" and "Yesternow" (both were on *A Tribute to Jack Johnson*), and "Go Ahead John" (which appeared in 1972 on the *Big Fun* collection of outtakes).

On the original versions of these three tracks, there's no attempt made to hide the edits: Wild, unexpected tape splices are apparent to even the most casual listener. Macero also threw in orchestra, arco bass segments and even a bit of *In a Silent Way*, and combined them with an unrelated solo by Davis. On top, "Go Ahead John" was spiced up with some technical devices invented by Columbia's research department. One was the "electronic switcher," which made it possible to instantly move a channel to specific positions in the stereo spectrum. The other was the "instant playback," which allowed entire passages to be played back at 30- to 40-second intervals, again in a manner



One of the original Miles Davis session masters, along with track sheets and other documentation

now commonplace in electronic music.

While Belden, Cuscuna and Wilder had chosen on earlier boxed sets to retrace Macero's steps and replicate all of the edits and effects he applied, the approach on the new *Jack Johnson* boxed set is notably different. "Right Off" and "Yesternow" are included exactly as they were released in 1971—remastered from the original 2-track masters; the rest of the boxed set includes many different versions of the original takes from which Macero culled his edits, plus many outtakes that he never used.

Cuscuna explains some of the rationale: "On *Bitches Brew*, the edits aimed to blend together performances of a certain track that were recorded in sections. But in the *Jack Johnson* era, there were only jams and the focus was on the playing. Very little from this era had been released, and the three main tracks were heavily edited and manipulated. So the idea of the boxed set was to capture the performances as the musicians played them at the time."

"The aim was for this to be more of a documentary of the sessions," clarifies Wilder. "We weren't trying to equal Teo. This was a great period for Miles and we wanted listeners to understand what happened during this period, and so we eliminated all the technical elements that Teo added. We really wanted to bring out the communication between the musicians. Also, there were ingredients that appeared on the original versions of 'Right Off' and 'Yesternow' that we couldn't trace, and Teo's work is so great it would have been a chore to try to re-create it, even if we had been able to.

"Also, the original *Jack Johnson* tapes were all in great shape. I mastered 'Right Off'

and 'Yesternow' directly from the 2-track mixes. It's actually the third time I mastered these tapes. I first did them in the late 1980s for the *Contemporary Jazz Masters Series*, then the newer CD version that's been out for a while and then again for the boxed set. They're among my shortest mastering sessions, because the music is fantastically recorded and mixed. 'Right Off' and 'Yesternow' take the same EQ, and the whole thing is done before lunch!"

The sonic quality of the digital masters Wilder made of "Right Now" and "Yesternow" increases noticeably with each new version. According to the engineer, this is due to the improvements in digital technology during the years. He elaborated on some of the technical details involved in the making of *The Complete Jack Johnson Sessions*, beginning with his approach to mixing the original sessions.

"All mixes were done in Studio C at Sony Studios, where there's an SSL 9000 J Series desk and a Studer with a custom 8-track tape recorder. The original music was recorded extremely well by Stan Tonkel, who knew how to hit the tape well and how to record electric instruments—in smaller studios, and with more isolation than was customary for most jazz records at the time. The tracks were clean and loud and punchy. Somehow, he also knew who was going to play when, because it was rare that I had to deal with two instruments playing on the same track at the same time and worry about how to create separation. Drums were in mono—it wasn't until the 16-track period that you began seeing drums on more than one track at Columbia.

"We did listen to Teo's and Stan's mixes,

This is one of the best converters ever made...

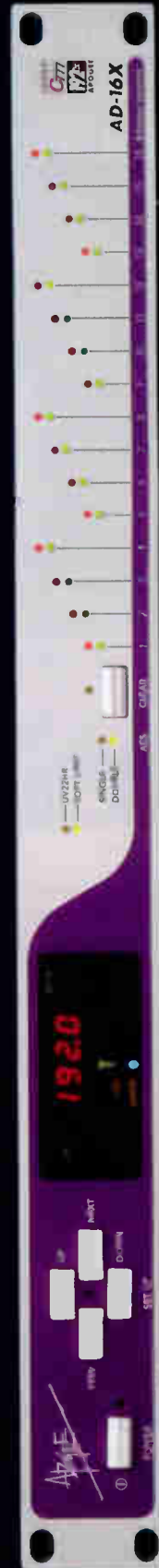

AD-16X

get info here: www.apogeedigital.com/ad16x



"The most important tool we use in our industry just got taken up about 10 notches. ADAMs will change your life."

Ted Curtis, Upstairs Productions, Oklahoma City, OK



Distributed in the United States by ADAM Audio USA (805) 413-1133



Come meet the entire ADAM family at www.adam-audio.com



but mainly what I did was set up an image placement for each session, and I'd just leave the instruments there," Wilder continues. "So John McLaughlin would be on the left, Miles in the middle, the drums slightly right of center and the bass left of center, and they would remain there. So there was a foundation of listening where you felt like you were experiencing the session. Reverbs and delays I added by taste, mainly using EMT plates and a Lexicon 960L for the surround. I also used a full range of Pultec EQs and AP 1550 EQs and compression as needed, such as LA-2A, dbx or UREI 1176.

"From the SSL, the signal went straight into the Sonoma via a set of Meitner DSD converters. The Sonoma is Sony's proprietary, custom-built digital workstation for SACD work. SACD is based on DSD technology, which works by 1-bit sampling at a 2.83MHz sampling rate. I have always found DSD sounds better than PCM: Because DSD samples use a much larger slice of music, it allows for the music to retain its analog curve rather than being broken up in loads of tiny individual components, as with PCM.

"Both the stereo and the 5.1 mixes ended up in the Sonoma system, and I'd then use an SBM-Direct box to take the DSD signal down to 44.1k/24-bit PCM level. I then used a Daniel Weiss Pow-R noise-shaping device to bring it down to 16-bit. So I get the full DSD version at the front, and then I'm able to bring things down to Red Book CD spec. However, for the *Jack Johnson* boxed set, I also sent an analog stereo mix to a Studer 1/4-inch, and I actually ended up using that. My mixing style is 20 years old, and I have a great sense for how to hit the tape and get the most back from it. Analog 1/4-inch left me room to add a little bit more during final mastering, when I added a bit more EQ and compression, mainly using Tim de Paravicini's EAR EQ and compressor, just to give it a little more punch and snap. Finally, the material ended up in Sonic Solutions, which I used purely as a digital razor blade. It went to the factory on U-matic."

Wilder has remastered and, in many cases, remixed almost the entire Miles Davis back-catalog for SACD. At the time of this writing, very little of this has been released, and there are no immediate plans to issue the *Jack Johnson* surround mixes on SACD. While Sony may be slow to drag Miles Davis into the 21st century, what everyone can sample in detail than ever before on the regular stereo CD is how the great man kicked rock 'n' roll ass in 1970s. Did he really manage to "put together the greatest rock 'n' roll band you've ever heard"? For one glorious session on April 7, 1970, you bet he did. ■

Acoustics First® Materials To Control Sound And Eliminate Noise

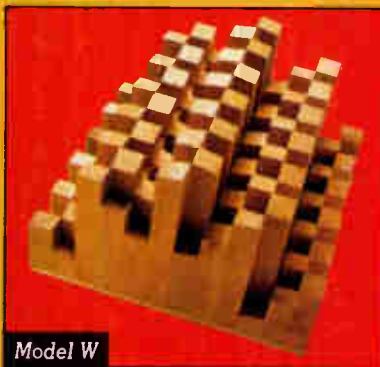

Model W

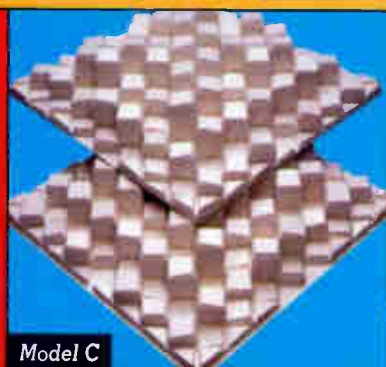

Model C

The Art Diffusor® The original, patented, extended range "binary array". Exclusive angled tops scatter upper spectral reflections. Increases the apparent acoustic space and controls flutter. Class "A", thermoformed models are now available from stock. Traditional wood versions are built to order.

Toll Free

1-888-765-2900

Web <http://www.acousticsfirst.com>

Cool Spins, FROM PAGE 131

from a downer effort. The plaintive lyrics and warm, wistful melodies are worth repeated listens no matter where you sit on the emotional roller coaster.

Producers: Roger Moutenot, Miles Kurosky. Engineers: Moutenot, Eli Crews. Assistant engineer: Rob Clark. Studios: Tiny Telephone; The Bank; New, Improved Recording; Masterlink Studios. Mastering: Steve Fallone/Sterling Sound. —Heather Johnson

Eric Bibb, Rory Block, Maria Muldaur: *Sisters and Brothers* (Telarc)

This is definitely one of the feel-good albums of the year, a marvelous collaboration between three excellent and distinctive singers on a fine cross-section of acoustic gospel, blues and R&B-flavored material. Each of the three brings something special to the disc: Bibb's soulful style is the perfect blend of "church" and "street"; Block has that bluesy authority and incredible guitar chops—she's had a following since the mid-'70s, but it's amazing she's not even better known. And Maria Muldaur, whose career has undergone a deserved resurgence since hooking up with Telarc a few years ago, still sings the sassy blues as well as anyone, while also shining on more delicate and nuanced material.

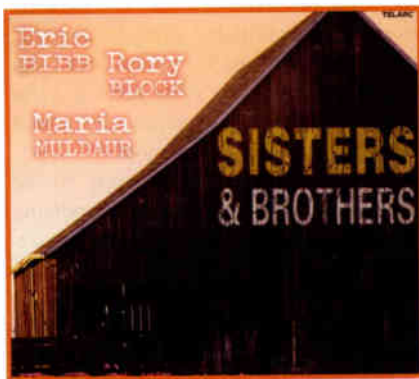

This far-ranging collection of 13 tunes is bracketed by a pair of gospel tunes: The a capella opening, "Rock Daniel," harkens back to earlier times (it was popularized in the late '30s by Sister Rosetta Tharpe), while the closing track, "My Sisters and Brothers," by the Sensational Nightingales, is from the 1970s. In between, there's a terrific range of old and more recent tunes, including Bill Withers' "Lean on Me" (sung by Block, with lovely backup from Muldaur), Dylan's "Gotta Serve Somebody" (a Bibb showcase), "Rolling Log" (Block blues at its best) and Muldaur's sensuous take on "Bessie's Advice." The disc was recorded in a performing arts space in a former barn in Unity, Maine, and the sound is impeccable. So are the arrangements, which are spare but always musical as can be. A great uplifting album to start the year with!

Producer: Randy Labbe. Recording, mixing and mastering engineer: Lincoln Clapp. Recorded at UCPA (Unity, Maine).

—Blair Jackson

Yes: *Going for the One* (Atlantic Reissue)

Rhino Records has just remastered the classic Yes album catalog, including landmark albums

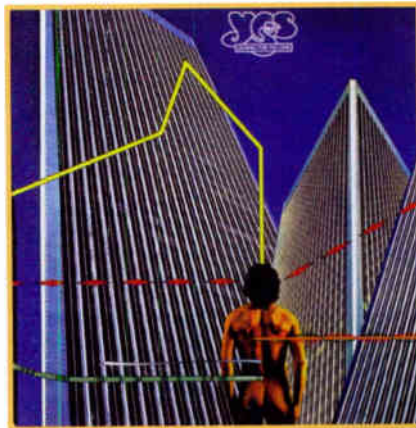

like *The Yes Album*, *Fragile* and *Close to the Edge*. *Going for the One*, released in 1977, has particularly benefited from the sonic fine-tuning. At the time of its release, the album was eagerly anticipated by fans, as it marked the return of keyboardist Rick Wakeman to the lineup. It kicks off with the title track, one of the band's hardest rocking recordings, on which Steve Howe delivers sheets of blistering slide guitar, while lead singer Jon Anderson humorously dishes out, "I'm thinking I should go and write a punch line/But they're so hard to find in my cosmic mind." While the album contains "Wonderous Stories," one of the band's most enduring radio tracks, fans of Yes' more extended works should check out the 15-plus-minute "Awaken," one of their finest works. Chris Squire's mighty "Parallels" benefits from particularly muscular rhythm section work and Rick Wakeman's grand organ work, recorded at St. Martin's Church in Vevey, Switzerland.

In previous CD versions of the album, the huge cathedral ambiances sometimes tended to reduce some of the more rocking moments to a kind of sonic mush. While some of that is still present, Rhino's remastering has gone a long way toward articulating the sound stage and giving the music a little more visceral punch. All in all, *Going for the One* is perhaps Yes' most unfairly overlooked album. Any fan of the band's classic albums would regard this remastering as a real find.

Producers: Yes. Engineer: John Timperly. Recorded at Ars Laeta (Laussane, Switzerland), Eglise des Planches (Montreux, Switzerland) and St. Martin's Church (Vevey, Switzerland).

—Rick Clark ■

...this is the other one.



DA-16X

get info here: www.apogeedigital.com/da16x

Apogee
SOUND AMAZING

L.A. GRAPEVINE

by Maureen Droney

Things are jumping at Hollywood's Mastersuite. Only officially open a year-and-a-half, the company is celebrating 2004 Grammy nominations for three of its mastering projects: Intocable's *Nuestro Destino Estaba Escrito* (Best Latin Pop); Jim Brickman's *Peace* (Best



PHOTO: MAUREEN DRONEY

Jay Frigoletto, engineer and founder of Mastersuite

Pop Instrumental); and The Yellowjackets' *Time Squared* (Best Contemporary Jazz).

Mastersuite was founded by engineer Jay Frigoletto, former owner of Georgia's Atlanta Digital. It's also become home base for veteran mastering engineer Dave Collins and Collins Audio. Recently, a third engineer was added to the staff: up-and-comer Gabriel Wallach. Between the three, business has been pretty much nonstop with projects of all genres, from the *X-Men 2* and *Under the Tuscan Sun* soundtracks to Fu Manchu, INXS, Andy Summers, Blondie, the Rhino Records 2-CD set *The Very Best of War*, and compilations featuring Dave Matthews, Neil Young, The Who and Kumbia Kings.

It's located in a bustling music business-populated complex just off the 101 freeway, but once inside, Mastersuite seems worlds away from its Western Avenue address. The quiet and cozy studio, which sports a restful, subtly Asian-themed décor, was designed by Frigoletto, a musician and gearhead who obviously has a passion for his work.

A graduate of Berklee College of Music, Frigoletto honed his chops in both mastering and post houses before opening Atlanta Digital, where he worked with such artists as India.Arie, Dallas Austin and Arrested Development. After moving to L.A., he initially worked independently out of Sony Studios in Santa Monica. When Sony closed in 2000, he became a roving mastering engineer, traveling with clients from studio to studio in between editing and mixing for the television series *Touched By an Angel*. "It was difficult," he admits. "I kept clients the whole time, but they had to follow me around. I'd work at Capitol, Paramount—wherever I could get a room!"

Mastering rooms tend to be very personal affairs and Mastersuite is no exception. The carefully chosen equipment encompasses standard mastering tools like Millennia EQ, Manley compression, a TC Electronics System 6000, some rare items and a main Sonic Solutions-based hub. "The console and rack were built by Dieter Fust of Atlanta at his company, Dieterbilt," says Frigoletto. "We've got a Weiss EQ, which is the best digital equalizer out there. Our Mark 2 version is especially cool because it has the M/S EQ function. It allows you to EQ the center separately from the stereo information, which gives amazing flexibility with things like vocals and cymbals."

Other gear includes a custom A&M Mastering EQ (designed by Collins), a Pendulum transformerless variable-MU compressor, a Waves L2, Lavry converters, an Ampex ATR-102, Z-Systems routing and a Benchmark half-rackspace D/A converter, which Frigoletto calls "very cool, with a little sample rate converter chip that relocks everything, so it's very jitter-immune. Currently, we're just using it for a headphone amp, but for its price, it's really fabulous."

Also high on cool factor is the Sintefex FX 2000, designed by Mike Kemp, one of the original founders of SADiE. "It samples analog signal paths," Frigoletto explains. "Mike

—CONTINUED ON PAGE 141

NASHVILLE SKYLINE

by Rick Clark

I got a call last week from my friend Andrew Mendelson, the chief mastering engineer and manager for Georgetown Mastering. Mendelson wanted to let me know that our mutual friend, Brian Ahern, was dropping in with surround mixing engineer Doug Beal to check out their mixes for the upcoming Rhino Records DVD-Audio release of Emmylou Harris' acclaimed 1981 album, *Roses in the Snow*.

When I arrived, Beal and Mendelson were comparing two mixes of the H.W. VanHoos song "Green Pastures," which features the harmony vocals of Dolly Parton and Ricky Skaggs, as well as Willie Nelson's distinctive gut-string guitar work. Beal felt that one of the two mixes had the "hair standing up on your neck" factor when he mixed it, but he wanted to see if it still had that magic in another setting. After playing it for Mendelson and myself separately, it was clear that one mix had the mojo.

While I sat there in the Denny Purcell chair, Beal and Ahern's surround rendering of an already great song was pretty amazing. It is great when you get to hear a surround mix that is dead-on at capturing the emotional essence of a performance—and this one did.

"We just tried to make it sound like they were breathing the same air at the same time," says Ahern of the mix. "We had the autoharp and the dobro come in at the same time, and they are kind of rear-ish in the mix. I built some 'clouds' that they bounce off of in front with my Lexicon 960. So when the dobro comes in, you hear the sound bouncing off the clouds up front. It's subtle, but it's there. I also put a Memphis-style slap on Willie's gut-string guitar and Dolly's vocal, so I linked them in time. That slap comes from the dead center of the room and that is what you were hearing over your head. It was a mix idea that we had that we couldn't do when we were working in stereo."

Ahern feels that having a fine mastering engineer to reference is key to maintaining

objectivity in one's work. "It's foolish to mix and master in the same room. You are bypassing a great opportunity to jump realms and go through another filter. Denny Purcell used to say, 'You only get to hear it the first time once.' Having someone who is hearing your music for the first time is a valuable tool. That 'first-listen' experience is already lost to you, because you've already heard the music a million times."

Concerning "Green Pastures," Ahern shared a story about Nelson's involvement on that track: "Willie often came in to sing and overdub guitar. He was always willing to play and he's great to work with," recalls Ahern. "One day, I got really impatient with that old guitar of his, the one with the hole in it, because it wouldn't stay in tune. I said, 'Willie, this isn't going to work.' He just looked disappointed and he left. A couple of days later, he pulled up in a big limo and walked in with a \$30,000 gut-string classical guitar ready to do that overclub. He did it, climbed back in the limo and left. This really impressed me and made me realize that he really is a professional fellow."

The other tracks Beal and Ahern referenced from *Roses in the Snow* with Mendelson were "Jordan" and "Gold Watch and Chain."

Prior to his arrival at Georgetown, Mendelson had mastered for the Cleveland-based audiophile label, Telarc, which has not only released many award-winning and commercially successful orchestral

—CONTINUED ON PAGE 142

NEW YORK METRO

by David Weiss

Is there life beyond the recording studio? For the legions of experienced audio engineers who find themselves in a world of highly capable personal facilities, there had better be. In New York City, where new sounds and production techniques are created every day, new business models were bound to be close behind, and as some metro-area pioneers are finding out, there's a world of opportunity for anyone with audio expertise, niche marketing acumen and just a touch of the mad scientist inside.

For XII Audio's president Dan Williams and producer/chief engineer Suketu "Kato" Khandwala, an interest in boosting client creativity spurred a microportable concept of packing up the recording studio and taking it directly to their rehearsal space, home or any other comfy location to make music. Equipped with Mac laptop-based Digidesign Pro Tools|HD rigs and mobile gear racks custom-designed to fit in the back of Khandwala's Volkswagen Jetta, XII Audio can quickly establish a high-quality recording environment virtually anywhere, without the bulk of a remote truck.

XII was born when Williams, an experienced live sound engineer, and Khandwala, who had been producing voluminous jingles for New York City's North Forty Music and mixing front of house for Moby and Kool & The Gang, had a brainstorm. "I said, 'We make records in the studio and we're always trying to capture the live feel,'" Khandwala recalls. "We started talking about using my Pro Tools rig on live shows, so we developed this mobile Pro Tools|HD rig. We were al-



XII goes where the music leads them: Suketu "Kato" Khandwala shown here at the board.

ready getting called out to do stuff on the road with bands, so we said, 'Let's make a record while we're doing it.'

"Sometimes, it's complicated to get a band together for weeks at a time to go somewhere else other than where they live, so instead of that, let's bring the studio to them. A commercial facility is always preferred, but if that's not possible, let's not tell those guys no. This is all a means to an end, and the end is we love to make music. We try to give our clients the best product we can and have it be fun."

Traveling with a select list of Class-A gear such as Neve mic pre's, Ampex tube mixers, vintage compressors and Langevin passive EQs, along with small-footprint NHT monitors, Williams and Khandwala can get the mics set up and the room ready in as little as 45 minutes, depending on conditions. Using the DVI out of their Powerbooks, XII connects to a travel-ready 17-inch Studio Display monitor and they're ready to record. "This is low impact," Khandwala says. "We can walk in and turn a space—warehouse, gym, garage—into a commercially viable recording studio. This is at a huge cost-savings for my clients. I don't have to charge what commercial facilities do." Once tracked, mixing can be completed at XII's personal studio headquarters in Fort Lee, N.J., or any other mix facility their clients choose.

—CONTINUED ON PAGE 143



Emmylou Harris' producer Brian Ahern (in boots), Georgetown Mastering's Andrew Mendelson (center) and surround mixer Doug Beal

PHOTO: RICK CLARK

Ross says



"I've used my Royer's on every recording I've done since 1998. These mics have made a huge difference to me in my quest for real sounding records. From blues to heavy metal, I keep finding new and effective ways to use the mics and by far they have become my main electric guitar mic. I just finished producing and engineering Ziggy Marley's new record and single and the Royers are everywhere. I used them on the drums, organ, percussion, the four piece horn section and of course the guitars. I brought in my old friend David Lindley to play his arsenal of stringed instruments and he was very impressed with the size and detail translated from the mics. 'Irie!' I don't look back now, only forward and the bottom line is, I won't ever make a record again without these mics."

Ross Hogarth Grammy winning Producer/Engineer - Ziggy Marley, Gov't Mule, Keb Mo, Coal Chamber, Jewel, Roger Waters, Black Crowes



Visit royerlabs.com to look in on Ross in the studio and see some of his electric guitar setups.

www.royerlabs.com
818.760.8472

#2 in a series

COAST TO COAST

SESSIONS & STUDIO NEWS

NORTHEAST

The Vanguard Jazz Orchestra, featuring trombonist Slide Hampton, tracked at Bennett Studios (Englewood, NJ) with engineer Gary Chester at the board...

Loho Studios (NYC) hosted Universal rock band Flaw, who were in tracking their spring release. Producer David Bottrill, engineer Brian Sperber and assistant Gus Oberg were on hand...Rock/hip hop talent Mos Def (with engineer Dylan Margerum) and Boston-based group Rubicon (with producer Mark Jordan) were at The Cutting Room (NYC) re-cording and mixing new releases.

MIDWEST

Chicago Recording Company (Chicago) engineers Steve Weeder and Stuart Hoverson took the CRC mobile unit out to record Guster and Howie Day at the State Theatre (Portland, ME)...Castle Recording Studios (Franklin, TN) hosted rock band Seven Mary Three while they tracked their latest release, *The Hi-Lo*. Brian Paulson oversaw production duties...Cheap Trick's Rick Nielsen was in Million Yen Studios (Chicago) to hone new material for the band.



Norah Jones made tracks through New York in 2003, creating her follow-up album to *Feels Like Home* at various New York studios—including mixing at Sear Sound (pictured) and mastering at DB Plus—alongside her golden production team. Left to right: Walter Sear (owner, Sear Sound), Lee Alexander (bassist), Norah Jones (vocalist/pianist), Steve Mazur (Pro Tools engineer and Sear assistant), Arif Mardin (producer) and Jay Newland (engineer)

NORTHWEST

San Francisco world music group Stellamara recorded at El Mundo Bueno Studios (San Francisco); co-owner/engineer Winter helmed the session...Mike Love recorded in his studio, The Loveshack (Lake Tahoe, NV), for his spring 2004 release, *Mike Love, Not War*.



Pictured at Steakhouse Studios (North Hollywood), left to right: Dirk Vanouchek (Pro Tools), Lionel Ritchie, David Bradley (songwriter), engineer Tony Sheppard, Dave Levita (guitarist), Chucki Booker and songwriter/guitarist John Dixon (seated)

The recordings were engineered by Tom Gordon and produced by Paul Fauerso...Nettlesingham Studios' (Vancouver, WA) latest sessions included a compilation for Deep Elm records that featured Sounds Like Violence, Desert City Soundtrack and Slowride; Kevin Nettlesingham engineered.

SOUTHWEST

Gospel group Caedmon's Call (Essential Records) was in Sunrise Sound Studio (Houston) to track their upcoming release, *Chronicles*...SugarHill (Houston) hosted a series of winter sessions, including dates with Solange Knowles. Engineer John Griffin captured tracks for the follow-up to her debut, *Solo Star*. Also in at SugarHill was Austin's own Sarah Sharp, recording her first feature-length CD. Producer Dan Workman, engineer Steve Christensen and arranger Kevin Ryan headed production on the session.

Send your session news to blingle@primediabusiness.com.

calls it a dynamic convolution processor. Instead of taking a single snapshot, it tracks how things happen with different frequencies and levels that come into it. There are two versions: The 2000 just plays back the samples, and the 8000 actually takes the samples and analyzes the piece of gear you're using."

Monitors are Questeds set up for surround. "There's just something about the English speakers that I really like," comments Frigoletto. "The Questeds are very flat. You get plenty of detail, and top and low extension, but you don't have that hyped, 'smiley face' sound you get with some other speakers. Because you get it flat and plain, it helps you make proper decisions."

Mastersuite's collaboration with Collins came about because, Frigoletto says, "We're kind of kindred spirits. Dave has always been one of my favorite mastering engineers, and he's also a great designer. I asked him over to listen, and he had me do a couple of edit projects for him to try the studio out. It worked out, and he's been here a year."

Wallach, who previously worked in production engineering and quality control at Future Disc, came onboard to develop the business' demo side. As an added plus, he's a native Spanish speaker and has become actively involved in many of Mastersuite's Latin projects, including the Grammy-nominated Intocable.

Frigoletto is particularly proud of Rhino's *The Very Best of War* compilation, remastered from the original tapes, which includes such classic hits as "Low Rider," "Spill the Wine" and "Why Can't We Be Friends." Collins had done earlier work with War. When it came time to do the comprehensive 2-CD set, his presence sealed the gig for Mastersuite.

"Stylistically, we do a lot of different things," Frigoletto says. "That's how I want it to be. I love all kinds of current music, and for me, doing the same thing all the time gets boring. If I have to describe what we do, I'd say we take a rational approach to audiophile. Actually, I think that's a nutshell description of mastering. There are so many details, so much that you can do, and you have to be able to balance art, science and—these days, especially—budgets. I think we're filling a niche here in a very creative, proactive way."

The e-mail posts were flying as New Found Glory fans checked out the band's 24/7 Webcam setup at Sunset Sound. The most frequently asked question: "What's the release date?" Stopping in for an answer, I followed some very cool guitar sounds back to Studio 3. That's where the band and producer/engineer Neal Avron (Everclear, Yellowcard, The Wallflowers) were recording finishing touches on their upcoming Geffen Records CD.

Purveyors of a uniquely hook-y blend of hardcore, pop and punk, NFG hails from southern Florida but now calls Southern Cali home. A tight five-piece with a rabid fanbase, they're known for straight-ahead lyrics and high-octane live shows. The quintet hooked up with Avron two releases ago and it's been a fortuitous collaboration. The full-length CDs, *New Found Glory* and *Sticks and Stones*, along with a show-stealing slot on the 2002 Warped tour, have built buzz to a critical mass. They'll headline on Warped '04 and the new as-yet-untitled album is scheduled for a May debut.

Movies, malls, games and the energetic mix of transplanted Northerners and Latin

Americans that defines South Florida all contributed to NFG's genesis, as did the very different mindsets of its members—singer Jordan Pundik, guitarists Chad Gilbert and Steve Klein, bassist Ian Grushka and drummer Cyrus Bolooki—who each, according to Avron, "contribute an equal percentage."

Six weeks of pre-production in a (very) small warehouse space kicked off the sessions. "We work with Hurley, the clothing manufacturer, and they offered us their warehouse to rehearse in," says Bolooki with a laugh. "We were expecting a huge space we could really stretch out in. Instead, it turned out to be smaller than this [Sunset Sound's Studio 3] lounge with a very low ceiling."

THE INDUSTRY STANDARD GUIDE TO PROFESSIONAL AUDIO

MIX MASTER N DIRECTORY

The *Mix Master Directory* is the complete information source for businesses in the professional audio industry. Backed by more than 25 years of editorial expertise, this definitive resource includes comprehensive national listings of audio manufacturers, audio professionals, facilities and services.

Available wherever *Mix* is sold.
Free to *Mix* subscribers.

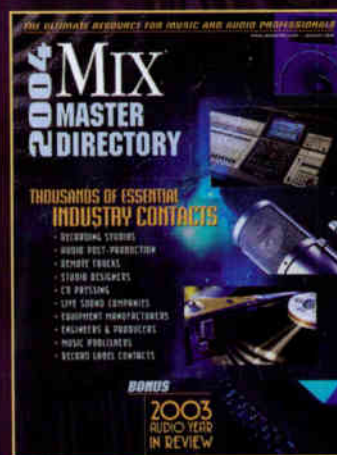

A PRIMEDIA publication

www.mixonline.com

Shared Storage Technology Questions?

A Must Read: Guide to SAN Software

free at commandsoft.com



Learn why the **FibreJet®**
SAN solution is the
professional's choice.

800 447 0144

See us at
NAB booth SL2769A



COAST TO COAST

"It ended up great, though," comments Avron. "We put everybody in a semicircle and it was, 'Just do the work and don't fool around, because you don't want to sit there forever.' We also talked a lot about direction. Some of the details may sound minute—like tuning snare drums lower for a sound that was more dead than on previous records—but we decided to go for the particular sound that suited each song. In the end, we used a completely different drum kit on almost every song, from a mono setup with just four mics to another song where we used a 28-inch marching drum, with both heads completely ringing, for the kick. On another track, we recorded the kit in a tiny, completely dead iso booth."

"The comfort factor was a big thing overall for this record," observes Bolooki. "I think we were able to experiment because of the relationship we all have with each other now. Writing and recording, you can get really frustrated. You don't have to worry so much when you've got a good team."

The band kept in close touch with fans through the Website (www.newfoundglory.com), with the (soundless) Webcam, studio



New Found Glory with assistant engineer Ryan Castle (fourth from left) and producer Neal Avron (to Castle's right) at Sunset Sound Studio A

logs and photo postings. "Our fans are on the Internet all the time," explains Bolooki. "We added some new features to make it easy to talk and interact while we were in the studio, and a month ago, we did a live broadcast where we leaked 30 seconds of one of our new songs. We had 80 comments in 90 minutes and they all loved it. Of course, somebody figured out how to download the stream and it's already up on a bunch of Websites—complete with the talking on it and the fade."

Well aware of the double-edged sword the Internet wields, the band maintained tight security with their recorded material. "No armed guard," says Avron, "but the main computer is password-protected and I take the hard drives home with me. All the band's rough mix CDs are numbered, and they have

to bring the old ones back to get a new one."

"We're very conscious," says Pundik, "because on one of our earlier records, songs got out early. We never figured it out. Everybody thinks it was somebody else's friend or family member. These days, nobody gets a copy. That was kind of hard when we went home over Christmas. I mean, not even my mother gets a CD!" ■

Got L.A. news? E-mail MaureenDroney@aol.com

NASHVILLE SKYLINE FROM PAGE 139

recordings, but they have also great jazz and blues releases. Capturing the sonic essence of many of those fine releases is multi-Grammy Award-winning Telarc engineer and producer Michael Bishop.

I was tipped off that Bishop was doing a jazz project in town, so I hooked up with him while he was doing mixes on Hiromi Uehara over at Chuck Ainlay's great Back Stage recording studio, with Jim Cooley assisting. The project, titled *Key Talk*, is Uehara's second album for the label. The tracks were recorded at The Sound Kitchen in the Big Boy room, with Matt Weeks assisting.

"The Big Boy is one of the best-sounding rooms I've ever worked in," Bishop says. "I captured ambience tracks on everything that could actually be used for the surround mixes. Recording in Big Boy gave me lots of options in recording ambience around each of the three musicians. It may seem like overkill to place an acoustic trio in such a large room, but I needed that space for creating the right surround field to be used in the mix later."

Bishop's experience in Nashville wasn't his first by any means, but he says his positive results and supportive interactions with the recording community have made the city a preferred destination for future projects. "I have long been trying to get more of our Telarc jazz sessions to Nashville, largely because of the cost-effective studio facilities here, many great rooms without the high costs of Manhattan, convenient and affordable hotels within walking distance, and an extremely friendly and creative atmosphere," Bishop points out. "It's so cool that should we have a need for a particular piece of gear, one can call someone within the local recording community and get immediate assistance. Tracy Martinson, Chuck Ainlay, George Massenburg and Michael Wagener were among those to be of tremendous help here in many ways and at a moments notice. Instead of being territorial, the pros in Nashville will bend over backward to help a colleague out of a bind."

The musicians on the album dates were Anthony Jackson (Fidora contra bass), Tony Gray (Fidora bass), Martin Valihora (drums) and Uehara on piano and keyboards. Uehara (a Yamaha artist) was provided a Yamaha CFIIIS Concert Grand piano, courtesy of Yamaha Artist's Services.

"I should also mention that, because of the piano-intensive nature of this project, we had contracted with Max Michimoto, one of Yamaha Artists Services' top piano technicians, to stay and work with us throughout the entire session," says Bishop. "The Yamaha CFIIIS Concert Grand had to be able to hold up to the scrutiny that DSD high-resolution surround affords."

When I arrived at Back Stage, Bishop was very accommodating and eager to play me the



Engineer Michael Bishop (l) with Hiromi Uehara

tracks. While Uehara does utilize what one might call a classic jazz piano, bass and drum lineup, calling her a "jazz" artist is almost misleading. The tracks I heard ranged from "Kung-Fu World Champion," with its progressive, rock-like melodic and rhythmic passages, to reflective moments on "Wind Song," which possesses the rich lyricism of some of Windham Hill's most thoughtful recordings. The dynamics and technique of Uehara and the other players were quite astonishing, particularly the unison bass and piano lines on a couple of the tracks.

"Hiromi has a distinct vision for her music," says Bishop. "She goes into the studio with a very detailed idea of what she wants to achieve there. That is a great quality in a musician, especially at just 24 years old. Working with Hiromi is a real pleasure—she composes exciting and provocative music and she gives her all with absolutely every take."

With regards to Back Stage, Bishop states, "My compliments to Chuck Ainlay and everyone at Sound Stage for creating such a great-sounding mix room and making it so easy to mix surround there! The ATC SCM-300s, SCM-50s and Nova Applause speakers all gave me lots of options in mixing, while helping give me a mix that translates very well on anything elsewhere. Very little has to be done after the fact in master-

ing with mixes I've done in the back room. Sound Stage is probably the most accommodating facility I've worked in. Did I mention that I like working there?"

The Uehara project will be released simultaneously on CD and SACD early this summer. Bishop tracked the session in multitrack DSD on a Genex 9048 and the SADiE System 5 DSD workstation and mixed through the SSL 9K at Sound Stage to the Sony Sonoma DSD workstation. The SADiE System 5 is going to be used again for the SACD and CD mastering and authoring back at Telarc. ■

Send your Nashville news to MrBlurge@mac.com.

NEW YORK METRO FROM PAGE 139

XII doesn't claim to be the only company working like this, but they're not aware of any local competition, either. "If there is someone [else] doing this, I don't know them!" Khandwala says. "This is a viable business model because this is how I want to do business. It puts the focus back on the artist rather than on the production."

Enhancing a process was also on the agenda for Steve Puntolillo, creator of the Soniccraft A2DX Lab (www.soniccraft.com) in Freehold, NJ. A dedicated multichannel A/D transfer facility, Soniccraft's objective was to design a system capable of performing the ultimate A/D transfer, bringing out extreme levels of quality and clarity from the tape not heard since the original material was recorded.

Puntolillo first got started on his unique path, which would soon become an all-consuming quest for perfection, in 2001, when he was preparing to mix and master some early 1970 recordings for 5.1 surround. Not set up himself to do the transfer from 1-inch analog tape, he innocently advised his client to take it to the best place he could find in Manhattan. The ensuing nightmare of logistics and sound quality showed Puntolillo the need for a facility committed to performing ultrahigh-quality A/D (as well as A/A) transfers, and that he would have to be the one to fill it.

"I believe in any business you want to solve a problem—isn't that why someone comes to you?" Puntolillo says. "My thought here was that, when the need arose, there would be a place that people could take their tapes to that wouldn't be a dragged-out machine stuck into a corner next to a Pro Tools rig with questionable converters. I don't know how to get it any better than the A2DX Lab."

With painstaking attention to detail, Puntolillo and a skilled team of experts fully restored and extensively modified two Ampex MM1200 24-track 2-inch tape machines (one



www.sae.edu

New York – Miami – Nashville
over 40 schools
worldwide

focus
practical
audio
education
experience
incredible

Open House 2pm–5pm:
February 7th: Miami, Nashville
February 8th: New York City



call for a brochure

877-27-AUDIO



*Our Nashville campus is accredited by the Accrediting Commission of Career Schools and Colleges of Technology (ACCSC)

COAST TO COAST

optimized for playback, the other for recording). Performing thousands of man-hours of research, testing, prototyping and comparing, Puntolillo's group changed components, upgraded signal paths and added myriad new innovations that would help to noticeably improve analog playback. Next, Puntolillo applied his findings to 1-inch, 4/8/12-track machines for total format coverage. The sound is captured into the computer via Mytek 8X96 converters capable of up to 96kHz/24-bit sampling.

"We're talking about small improvements and how they accumulate," explains Puntolillo. "For instance, by adding tape rollers to the tape paths where static guides used to be, you get a little bump in clarity. Add that to all the other things that give a bump in clarity, and all of a sudden, you don't need that EQ any more, or as much of it.

"Where I sit is between the audiophile camp and the pro audio camp. The audiophile is going to spend an inordinate time on one piece of wire to make his stereo sound better, and you have your pro audio guy who might simply tweak his EQ a little bit to be perfectly happy. By combining those two philosophies, I'm basically getting the purest, clearest, sweetest sound possible off the tape and making sure every bit gets captured into the computer."

While XII Audio and Soni-craft are focused on solutions to current audio quandaries, the future is unfolding at The Cooper Union for the Advancement of Science and Art. A small art, architecture and engineering school known for its extremely selective enrollment and hip East Village campus, it also has a well-equipped acoustics lab and an inspired professor, Jim Abbott, who isn't afraid to use it. Armed with a doctorate in physics from MIT, a night-time DJ career and a past profession of designing live sound systems, Abbott has the ears and the vision needed to produce audio innovators and innovation.

"Cooper Union is known for having incredible students, small classes and project-based learning," Abbott says. "At the acoustics lab, I interact with artists, architects and engineers. What we end up with is a one-of-a-kind curriculum and my three interests are brought together as one discipline. Our downtown location in the center of the world's music industry completes the picture."

Besides the expected sound-analysis

workstation, Abbott has something that he believes makes his lab stand alone in New York City: a full-coverage anechoic chamber that he and his students use for loudspeaker design, psychoacoustic measurements and extra-extra-dry vocal recordings. "It is echo-free down to about 150 Hz and very quiet," says Abbott. Meanwhile, a binaural headset with microphones on each side allows students to prepare some intriguing compositions in Pro Tools for Abbott's Sound and Space course. "They were derived from sound recordings they made themselves with the headset, recording things like jet flyovers at LaGuardia. The students built acoustical physical sculptures with some unique sonic features, and that class culminated in an exhibit here called 'Aural Fixation.'"

The result at Cooper Union is a fast-moving think tank that's already having an impact on how progressive audio hardware and software are evolving. "There are a



Soniccraft's Steve Puntolillo with his two Ampex MM1200s and "Bridgeport" Scully 284 12-track.

number of places where our program can contribute and give back," Abbott says. "On a project-to-project basis, we are available to do prototype development and psycho-acoustic experiments that are too laborious for the industry. We've already gotten started, and I'm looking to really involve some industry partnerships." With corporate sponsors including Native Instruments and Designatronix, word is already getting around.

Abbott hopes his initiatives indicate where the next big ideas in music are going to come from. "I think that the next generation of engineers is going to have an increased sensibility to musical issues and an increased ability to integrate the two disciplines in their work. The idea that the artist and the scientist can become one person in certain pursuits is not a new idea, but it seems to be, in my opinion, a revolutionary idea." ■

Send your Metro news to david@dwords.com.



www.mogamicable.com

In the Professional world there can be no compromise. That's why the cable of choice is Mogami. We don't use a bunch of Consumer Marketing hype to try and justify why our cable is better. Just ask any recording engineer or studio owner and you'll find out why. It is simply the finest, most neutral sounding cable available, at any price. At one time if you wanted a Mogami Cable it was only available in bulk through Professional Channels. Finally, "The Gold Series" by Mogami, packaged and configured for Live Performance or Project Recording. No magic, no hype, just the best at a price Mogami, "The cable of the Pros"

NOW Available at a Guitar Center near you!

MOGAMI

The Cable of the Pros

Toll Free: 800-800-6608

—FROM PAGE 26, WHAT A TANGLED WEB

cause no viable integrated pro option exists.

We need a modular but fully integrated desktop suite that can adapt to each user's needs if the dream of a true virtual studio is ever to be realized. We just might need a hardcore professional version of exactly what Apple has done for the Great Digital Masses to get our virtual studio dream off the ground.

Segregation and evolution cannot co-exist. They never have, as history has shown a thousand times, in a thousand ways. I should tell you here that I have believed for decades that social models, business models, technology models and economic models are all the same damn thing. As they are all aspects of human interaction, attitudes and beliefs, people, not science, shape them.

Integration is the only way to produce long-standing growth and advancement, in everything from society to technology. Segregated societies and isolated technologies may produce temporary pockets of seeming advancement—at the cost of all excluded until those excluded rise to overthrow them. Proprietary technologies, if not successfully integrated into the mainstream, *will* fail. And they should. No one should be trapped, no one should be a slave to any closed system.

This is why technologies such as ReWire and open architectures in general are so important. This is why Apple's amazing ability to integrate represents the type of thinking that can, along with a little more hardware evolution, eventually deliver unto us, the New Digilliterati, our coveted desktop studios. And man, do I want this. I would take 100 ponies off my fastest toy for a real desktop system right now. No, wait. Okay, 35 HP—gotta make sure I can still scare the locals and impress visitors.

NOTICE ANY CONTRADICTIONS?

I talk about GarageBand and the rest of iLife as examples of how powerful integration can be, yet regular readers know that I promote standardization that allows us to freely choose our tools.

First of all, we can't choose our tools until they exist, and Apple's flavor of extreme integration is probably the best and only hope of achieving a cohesive virtual workspace, even though it must be born as a closed system. But *then*, once the functional integrated system proves itself, amalgamation of standards could open such a virtual studio to third-party contributions.

Like a star mass condensing in space to eventually reach the critical proportions re-

quired to supernova, there has to be somebody, somewhere who can be the nexus, someone who can pull it all together and integrate it so tightly that it re-emerges as the bright foundation for a new beginning. I think that might just be Jobs.

Over the top? Maybe, but from what I have seen in the past five years, I don't believe that the industry will linearly evolve a true virtual 3-D workspace. I think we need an explosive kick in the ass, a concentrated integration that actually works and shows other manufacturers what this kind of thinking can produce. Consolidation, inte-

gration, compression, explosion: rebirth.

We are poised. Users have been asking for tighter integration and universally translatable file formats and metadata for a long time now. And if the segregated DAW giants won't do it all the way, some hot new giant just might have to step in and do it for them. You gotta break a leg to make an omelet. Maybe two. ■

SSC will not let this go until he can track and mix a tune on his lap on a boat off the Yucatan. He already has his tequila-proof rubber keyboard cover...

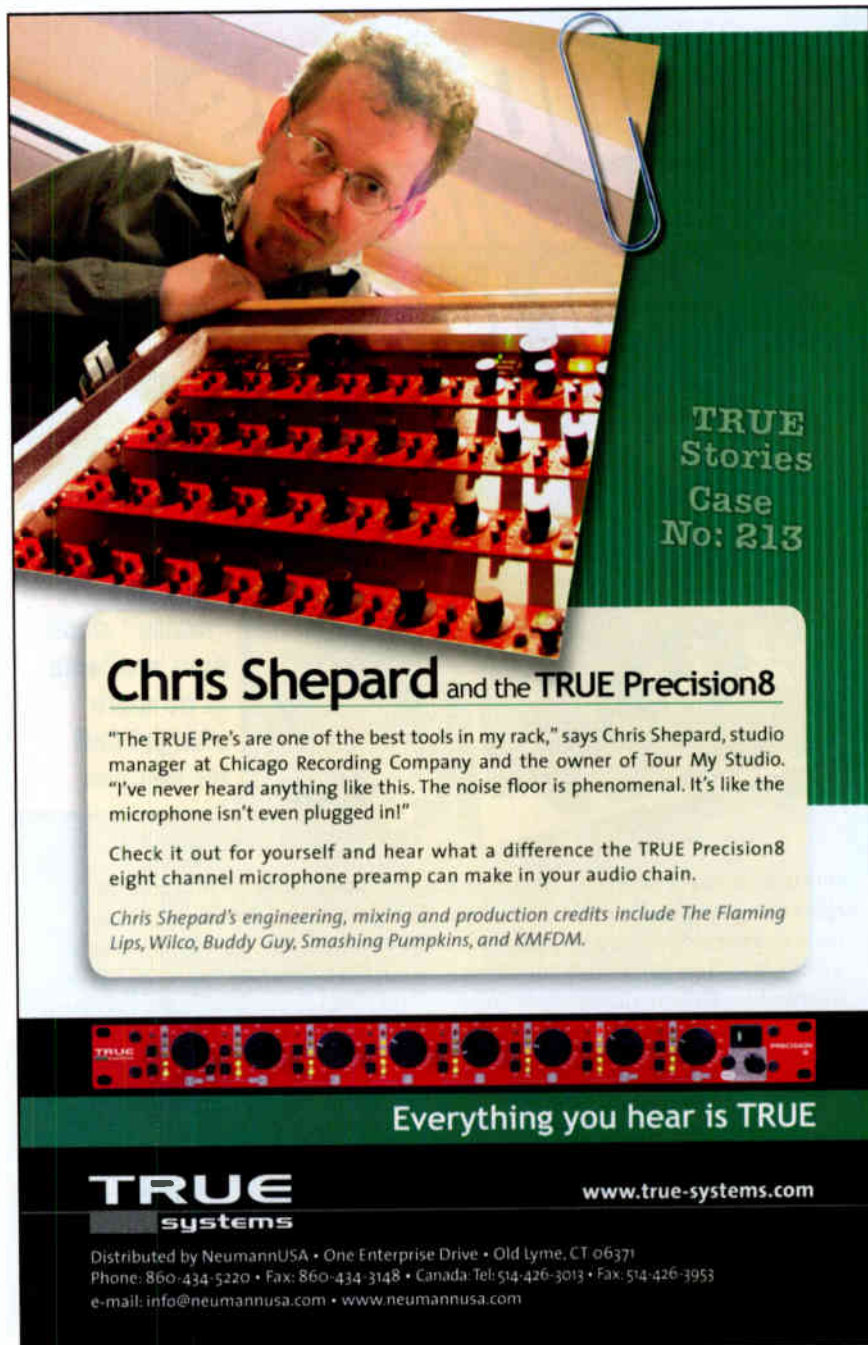

Chris Shepard and the TRUE Precision8

"The TRUE Pre's are one of the best tools in my rack," says Chris Shepard, studio manager at Chicago Recording Company and the owner of Tour My Studio. "I've never heard anything like this. The noise floor is phenomenal. It's like the microphone isn't even plugged in!"

Check it out for yourself and hear what a difference the TRUE Precision8 eight channel microphone preamp can make in your audio chain.

Chris Shepard's engineering, mixing and production credits include The Flaming Lips, Wilco, Buddy Guy, Smashing Pumpkins, and KMFDM.

TRUE
systems

www.true-systems.com

Distributed by NeumannUSA • One Enterprise Drive • Old Lyme, CT 06371
Phone: 860-434-5220 • Fax: 860-434-3148 • Canada: Tel: 514-426-3013 • Fax: 514-426-3953
e-mail: info@neumannusa.com • www.neumannusa.com

—FROM PAGE 30, WHY IS EVERYTHING SO LOUD? cause of it. I recently saw a one-man, one-set historical play in a 350-seat theater performed by an actor with a well-trained, but not overwhelming, voice who didn't need a sound system to be heard over the minimal music and sound effects. The audience came out chattering excitedly about how close they felt to the character, and how extraordinary it was to spend all that time in the same "room" with him. You don't hear that kind of reaction when actors wear mics, no matter how well-concealed and amplified.

People are so used to oppressive noise

levels that they don't even know when they're being assaulted. Some years ago, I moved to a town where a fire horn (the locals called it a "whistle," but it was actually around 300 Hz) blew three times a day. The first 18 months I lived there, the horn was broken, so I was completely unaware of it. But then they fixed it, and when I first heard the thing—which was well over half a mile from my house—blow at noon one day, I literally fell off my chair. And when it blew the next morning at 6:45 a.m., which I found out it was supposed to do *every day* (as well as at 6:45 p.m.), I got furious.

A few of us recent arrivals who hadn't known about the horn—a group that included healthcare workers, teachers, psychologists, scientists, journalists and other low-lives—started a referendum drive to get it shut off. (We also considered getting a by-law that would require real estate agents to show properties in the area only at noon and 6:45 p.m.) But we were outvoted by older members of the community who wanted to keep the monstrosity for its nostalgic value: Once upon a time, it seems, the signal was used to wake up local mill workers so they could be sure to get to their jobs on time—menial, dangerous and

People are so used to oppressive noise levels that they don't even know when they're being assaulted. Sadder still is when people don't know when the sounds around them are actually beneficial.

underpaid as they were—and a whole lot of people felt it was somehow crucial to the character of the town to preserve that miserable tradition.

Eventually, we got an engineer from the state's Environmental Protection Agency to come in with a sound level meter and measure the thing from inside the apartment of one of our members—a nurse who worked the night shift—in a new high-rise right across the street from the monster. It checked in at 138 dB, which was high enough for the state agency to tell the town that if they kept blowing the wretched thing, they would be fined \$1,000 a day.

Sadder still is when people—and governments—don't know when the sounds around them are actually beneficial. At the end of last year, the agency that runs the Boston subway system declared that live music played in the stations created a safety hazard and tried to shut down the practice. The recommendation to do so, the agency said, came from a task force on security that was set up in response to the September 11th attacks. The music, the agency conjectured, might drown out crucial security announcements on the P.A. system. The decision set

1,000 CDs
in full-color jackets
for just \$990

Regularly \$1,290
— Save \$300!

NEW!
Uncoated
"matte" stock
now available
at no extra
charge! Call
for sample.

This is a complete package — not some stripped down version — with no hidden extra charges and no surprises. You'll get Disc Makers' high quality at the lowest price anywhere. We'll also help you sell more CDs with extras like a FREE bar code, a FREE Disc Makers *Ultimate Indie Resource CD*, FREE Disc Makers Digital Audio Distribution, FREE worldwide distribution with CD Baby, and a FREE review of your music by TAXI's A&R staff.

Call **1-800-468-9353** for
your FREE catalog and jacket sample.

DISC MAKERS®
7905 N. Route 130, Pennsauken, NJ 08110 • 1-800-468-9353 • www.discmakers.com/mix

off a flurry of activity in the newspapers and on the Web, and within a couple of days, 8,000 supporters of subway music—including Grammy-winner Tracy Chapman, whose career was launched in these same subways, and singer Peter Mulvey, who actually had the guts and patience to recently record an album in the Boston underground—signed a petition supporting the performers.

In the face of the petition, and after a number of newspaper articles pointed out that the musicians are often the only ones who actually *understand* what the P.A. systems are saying, and that they, with their reasonably good vocal mics and modern amplifiers, would be much more effective at getting an important message to a crowd of people than a station agent with a Dorchester accent in a glass booth 50 yards away squawking through a moldy carbon mic and a 50-year-old grime-encrusted speaker, the transportation agency backed off. But they stipulated that there were to be no drums or even electronic simulations of drums, and no trumpets, although French horns, soprano saxes and electric violins were perfectly okay. So Roland Kirk would be fine, but not Miles.

Furthermore, sound levels were limited to 80dB SPL at 25 feet from the source (not, as one of the local NPR stations reported, 800dB SPL, which would be roughly the sonic level of the Big Bang). That rather odd spec works out to about 98 dB at three feet, which is pretty respectable, even on a subway platform. One official described the new spec as "akin to positioning your ear directly over a garbage disposal while it's operating." While he's not too far off, my guess is that this guy is not a music lover. I imagine he's happy that there's little danger the music would ever cover up the hideous sounds the train wheels make as they grind their way around the old system's tight curves.

Like children who grow up in the city having never seen the Milky Way, we've lost our appreciation for silence. Those who question how their world is changing for the louder and noisier are few and far between, and are easily drowned out. And it's particularly ironic that it's getting worse while the dynamic range of our audio systems is getting bigger. What's the point of being able to deliver 24-bit recordings to a world where the ambient noise level never drops below 60 dB? Well, I guess if we can't find a time machine, there's always headphones. ■

Paul Lehrman sometimes finds himself looking for a way back to 1968. It was noisy, but at least it was fun.

WE WILL BEAT ANY DEAL!

EVERY MAJOR BRAND~IN STOCK!

Guitars • Amps • Drums • Keyboards • Synthesizers • Samplers
Sound Systems • Recording Equipment • Software • Accessories



West L.A. Music's Derek Snyder with guitarist Robben Ford Saxophonist Tom Scott and keyboardist Ronnie Foster Everly Brothers singer Phil Everly with West L.A. Music's George Adjell Actor and musician Kevin Bacon with West L.A. Music staff member



West L.A. Music's Glenn Noyes with BEO Speedwagon singer Kevin Cronin West L.A. Music's Mark Spiwak with singer Barry Manilow Back keyboardist Greg Kurstin with West L.A. Music's Richard Jeschke ARIA drummer Chris Slade with West L.A. Music's Glenn Noyes

Shop Where the Pros Shop • Call Us Today!



West L.A. Music

call now: 310-477-1945 • sales@westlamusic.com
We will beat any price from any authorized stocking dealer anywhere in the United States



Learn Audio Recording Like Nowhere Else.

The Conservatory of Recording Arts & Sciences 1.800.562.6383

All students train, hands-on, in cutting edge 48-track Analog/ Digital Recording Studios that feature:

- SSL -Studer -Otari -Neumann
- Neve -Neotek -Lexicon -Hafler

- Plus...
- eMac/Logic Platinum Digital Lab
 - Tascam Analog/Digital Mix Down Lab
 - Individual G4 Pro Tools Workstations
 - And Much, Much More!

No more than 12 students per class - taught by award winning professionals.

Every student completes an internship in the industry for graduation.

Only recording school authorized by Avid/Digidesign, T.C. Electronic, Waves, and SIA to certify students in the use of their products.





2300 East Broadway Road Tempe, Arizona 85282 www.audiorecordingschool.com

ADVERTISER INDEX

ADVERTISER	WEBSITE	PAGE	ADVERTISER	WEBSITE	PAGE
Acoustical Solutions	www.acousticalsolutions.com	30	M-Audio	www.m-audio.com	125
Acoustics First	www.acousticsfirst.com	136	Mesa Engineering	www.mesaboogie.com	39
Adam Audio USA	www.adam-audio.com	136	Mogami Cable	www.mogamicable.com	144
AKG Acoustics (WMS 4000)	www.akgusa.com	53	MOTU	www.motu.com	BC
AKG Acoustics (Headphones)	www.akgusa.com	73	Neumann/USA	www.neumannusa.com	65
ALTO	www.alto@artproaudio.com	115	Neutrik USA	www.neutrikusa.com	61
Amphenol	www.amphenol.com.au	12	Professional Audio Design	www.proaudiodesign.com	79
Antares	www.antarestech.com	21	Radial	www.radialeng.com	105
API Audio	www.apiaudio.com	IBC	Recording Workshop	www.recordingworkshop.com	48
Apogee Electronics	www.apogeedigital.com	135	Remix Hotel	www.remixmag.com	127
Apogee Electronics	www.apogeedigital.com	137	Rolls Corporation	www.rolls.com	56
Applied Research & Technology	www.artproaudio.com	45	Royer Labs	www.royerlabs.com	140
Argosy Console	www.argosyconsole.com	81	Sabine	www.sabine.com	46
Audio Technica	www.audio-technica.com	85	SAE Institute of Technology	www.sae.edu	143
Audix	www.audixusa.com	113	Sam Ash	www.samashpro.com	117
Auralex	www.auralex.com	55	Schoeps	www.schoeps.de	12
Aviom	www.aviominc.com	1	Sennheiser	www.sennheiserusa.com	15
B&H Photo-Video	www.bhphotovideo.com	101	Sony Pictures Digital Media Software	www.sony.com/mediasoftware	2
B&H Photo-Video	www.bhphotovideo.com	121	SRS Labs	www.srslabs.com	23
Broadcast Supply Worldwide	www.bswusa.com	107	Steinberg	www.steinbergusa.net	31
Cakewalk (Sonar 3)	www.cakewalk.com	5	Studio Network Solutions	www.studionetworksolutions.com	32
Carvin	www.carvin.com	94	Sweetwater Sound	www.sweetwater.com	25
CommandSoft	www.commandsoft.com	142	Sweetwater Sound	www.sweetwater.com	164-165
Conservatory of Recording Arts & Sciences	www.audiorecordingschool.com	147	Sweetwater Sound	www.sweetwater.com	166-167
Crest Audio	www.crestaudio.com	87	Tascam (Gigapulse)	www.tascam.com	3
dbx Inc.	www.dbxpro.com	109	Tascam (FW 1884)	www.tascam.com	35
Digidesign	www.digidesign.com	57	Toft Audio Designs	www.toftaudiodesigns.com	38
Disc Makers	www.discmakers.com	146	True Systems	www.true-systems.com	145
Discrete Drums	www.discretedrums.com	48	Universal Audio	www.uaudio.com	37
Dolby Labs Inc.	www.dolby.com	IFC	Waves Ltd.	www.waves.com	59
Dynaudio Acoustics	www.dynaudioacoustics.com	89	West LA Music	www.westlamusic.com	147
DPA Microphones	www.dpamicrophones.com	7	Yorkville Sound	www.yorkville.com	19
Earthworks	www.earthworksaudio.com	54	Zaolla	www.zaolla.com	133
Echo Digital Audio	www.echoaudio.com	49	Z-Systems Audio Engineering	www.z-sys.com	26
Emagic	www.emagic.de	13			
E-MU	www.e-mu.com	27			
E-MU	www.e-mu.com	74-75			
E-MU	www.e-mu.com	76-77			
Event Electronics	www.event1.com	71			
Fairlight	www.fairlightau.com	11			
Fiberplex	www.fiberplex.com	29			
Focusrite	www.focusrite.com	69			
Full Compass	www.fullcompass.com	111			
Full Sail	www.fullsail.com	67			
Furman Sound	www.furmansound.com	64			
Future Sonics	www.futuresonics.com	83			
Grace Design	www.gracedesign.com	47			
Groove Tubes	www.groovetubes.com	134			
Guitar Center	www.gcpro.com	97			
HHB	www.hhbusa.com	119			
IMWS	www.discmakers.com/mu04	109			
innovaSON	www.innovason.com	82			
Institute of Audio Research	www.audioschool.com	126			
JBL Professional	www.jblpro.com	4			
Key Code Audio	www.keycodeaudio.com	142			
KRK Systems	www.krksys.com	99			
Lawson, Inc.	www.lawsonmicrophones.com	100			
Lexicon	www.lexicon.com	9			
Lynx Studio Technology	www.lynxstudio.com	95			
Mackie	www.mackie.com	40-41			

MARKETPLACE

Alter Media	www.studiosulte.com	154
Answer Planet	www.midiwarehouse.com	151
Benchmark Media Systems	www.benchmarkmedia.com	155
C & C Music	www.candcmusic.com	155
Clearsonic	www.clearsonic.com	152
Crystal Clear Sound	www.crystalclearcds.com	155
D.W. Fearn	www.dwfearn.com	154
Good Life Audio	www.goodlifeaudio.com	152
Ground Support Equipment	www.biomorph.com	150
Hot House	www.hothousepro.com	154
House Ear Institute	www.hei.org	153
Media Services	www.mediaomaha.com	152
Multiloops	www.multiloops.com	153
New Song Media	www.newsongmedia.com	152
Pendulum Audio	www.pendulumaudio.com	152
Play-It Productions	www.play-itproductions.net	154
Progressive Music	www.progressivecds.com	155
Rainbo Records and Cassettes	www.rainborecords.com	151
Rockingham Sound, LLC	www.sonicasystems.com	150
Sonic Circus	www.soniccircus.com	150
Sound Anchors	www.soundanchors.com	155
Toaster Audio	www.toasteraudio.com	151
Wunder Audio	www.wunderaudio.com	151

MIX ADVERTISER SALES REGIONS AND REPRESENTATIVES

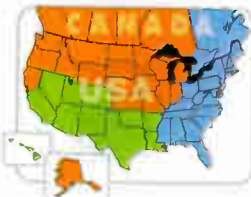

Northwest/North Central

Greg Sutton

847/968-2390

gsutton@primediabusiness.com

Southwest

Albert Margolis

949/582-2753

amargolis@primediabusiness.com

East Coast/Pange

Michele Kanatous

718/832-0707

mkanatous@primediabusiness.com

Classifieds

Kevin Blackford (West Coast)

Jason Smith (East Coast)

800/544-5530 or 510/653-3307

mixclass@primediabusiness.com

Introducing the all-new

MIX ONLINE

THE PAGES OF MIX COME ALIVE WITH SIGHTS AND SOUNDS!

IMPROVED NAVIGATION

provides fine-tuning of searches.

ONLINE EXTRAS

enhance selected stories with bonus material from audio clips to extended interviews and photo galleries.

FEATURED CONTENT
CATEGORIES

offer broader and categorized content searches in the fields of Recording, Products, Live Sound, Sound For Picture, New Media, Design, and Education.

EXPANDED

applications, daily news, current issue previews, access to reviews, archives and subscriber resources.



There is so much to see on the new mixonline.com, you won't believe your eyes. Or your ears.

WWW.MIXONLINE.COM

World Radio History

MARKETPLACE

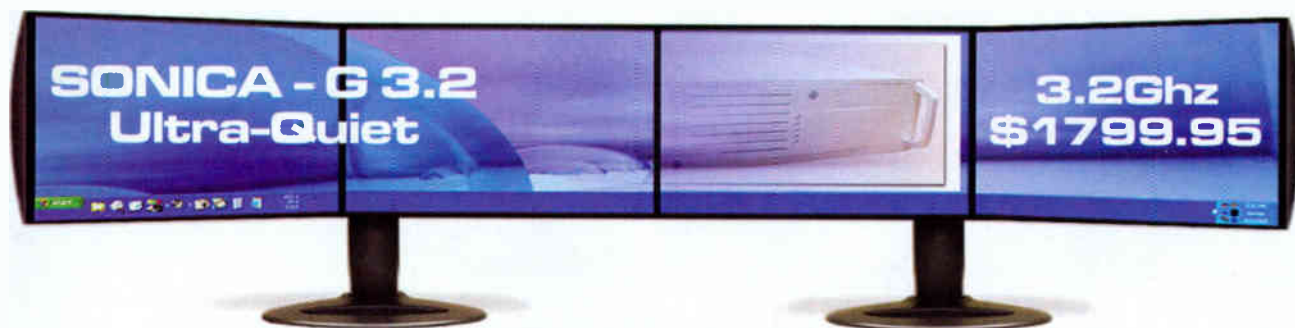

Call toll free: 1-888-298-5322
www.sonicasystems.com



SONIC CIRCUS
 Serious Studio Infrastructure



The most comprehensive selection of recording equipment in the world

Shop online and take advantage of frequent buyer benefits.
www.soniccircus.com



617.696.9360

the ultimate in studio ergonomics



with sit-to-stand adjustability



the ergonomic furniture system for today's digital workplace

biomorphⁱ

free catalog 888 302-DESK order online at biomorph.com

Biomorph is a registered trademark of S Barlow-Lawson ©2003 Ground Support Equipment (USA) Ltd. 11 Broadway, New York, NY 10004

S.S.L 4000G+ CONSOLE
STUDER 827 2" ANALOG
PRO TOOLS HD 102K
KILLER OUTBOARD GEAR
WORLD CLASS CONTROL ROOM
---TOTALLY MOBILE III

Where do you want to record?
www.toasteraudio.com 206.234.8973

Toasteraudio

WITH OVER 60 YEARS OF EXPERIENCE & IN-HOUSE FACILITIES, WE'LL PRODUCE YOUR CD, VINYL & CASSETTE PROJECT WITH THE EXCELLENCE IT DESERVES!

300	1000	NEW PRICE!
CD PACKAGE:	NEW PRICE!	\$1099
\$975	\$775	\$1249

INCLUDES: ORIGINATION • 1-COLOR 1-PAGE BOOKLET AND TRAY CARD* • 1-COLOR CD LABEL IMPRINTING • JEWEL BOX & SHRINK WRAP • QUICK TURNAROUND
* from your print-ready film (in Rainbo's specs)

INCLUDES: ORIGINATION • FULL COLOR 4-PAGE BOOKLET* (INSIDE 8&W) and 4-COLOR TRAY CARD* • 2-COLOR LABEL IMPRINTING* • JEWEL BOX & SHRINK WRAP • QUICK TURNAROUND
* from your print-ready film (in Rainbo's specs)
 ASK FOR OUR FREE BROCHURE!

Rainbo Records and Cassettes
 1738 Berkeley St. • Santa Monica, CA 90404 • (310) 829-3476
 Fax: (310) 828-8765 • www.rainborecords.com • info@rainborecords.com

Part of the Real
since 1937

VISA
MasterCard

'BIGGER this,
 Better that...
 the BEST???'

Hold the BULL!



Just honest **VALUE**, great **SELECTION** and friendly, professional **SUPPORT**.

MIDIWarehouse.com
888-567-2311

Shop online at MIDIWarehouse.com

2004 something wonderful is about to happen.



wunder audio

Introducing the **PEQ1** mic pre/EQ module that replaces the 1073. **512-338-6777 • wunderaudio.com**

VIDEOSYSTEMS

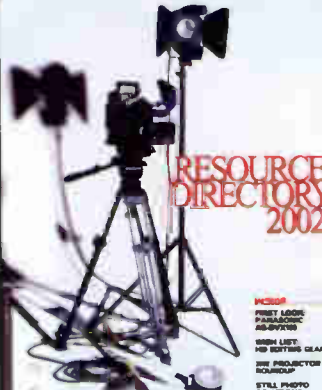

RESOURCE DIRECTORY 2002

INCLUDES:
 FIRST LOOK! PARADOXIC ANSWERS
 VIDEO LIST: THE SORTING GEAR
 THE PRODUCER ROUNDUP
 STILL PHOTO SOLUTIONS

Wish you had a comprehensive guide of all of the products and services in the video technology industry?

Now, you do.

Video Systems' Resource Directory, delivering complete product and service listings, is just around the corner.

Check out **Video Systems'** November issue in print or online and find the video technology product sourcebook you've been anticipating all year long.

To subscribe to **Video Systems**, go to www.videosystems.com and make sure you receive each monthly issue today.

Quartet II Mercenary Edition

Four Element Tube Recording Channel



- Dual Transformer Mic/DI Preamp
- $\Delta\mu$ Compressor/Limiter
- Passive/Aggressive Inductor EQ
- JFET/MOSFET Peak Limiter

Pendulum Audio www.pendulumaudio.com
(908) 665-9333

CLEARSONIC PANEL

SORBER Absorption Baffles

NEW! **LID SYSTEM & AX12 Height Extenders**

Cost Effective
Free Standing
Portable

QUICK & EASY ISO!

www.clearsonic.com
1.800.888.6360

CLEARSONIC manufacturing



On stage or in the studio



GoodLife audio

Call the others first
Then Call Us!

Not only will be beat any reasonable price but we will do our best to offer the highest level of service.

Call toll free 1.877.815.3027 or visit www.goodlifeaudio.com



Strut your stuff and watch the projects come a knocking.

Mix Studio Showcase found monthly in Coast-To-Coast

(800) 544-5530

1,000 CD's in full color sleeves



\$890

Full Package with no hidden costs!
Includes: Full Color Sleeve, 3 Color Disk, Films, UPC.
Distribution with CD Baby & Same Day Online Proofing.

MEDIA SERVICES Call 1-888-891-9091 for a FREE catalog.
110691 St. Omaha, NE 68137 • www.mediaomaha.com

CDs FAST!



7 to 10 Day Turnaround

NEWSONG MEDIA

telephone number 800-964-DISC

fax number 714-704-1733 + newsongmedia.com
* Limited time offer. Please call for details.

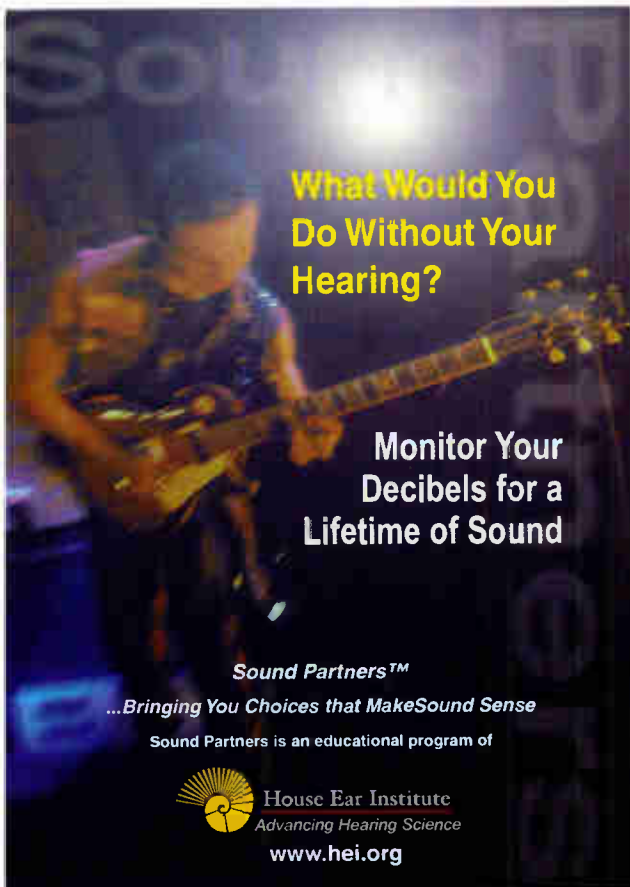

What Would You Do Without Your Hearing?

Monitor Your Decibels for a Lifetime of Sound

Sound Partners™
...Bringing You Choices that Make Sound Sense

Sound Partners is an educational program of



House Ear Institute
Advancing Hearing Science
www.hei.org

MULTILOOPS

The original "Naked Drums" multi-track drum loop sample libraries

WHAT PEOPLE ARE SAYING

"Naked Drums are an amazingly powerful songwriting tool...With the variety of beats and tempos, you can create infinite musical combinations in almost any genre." David Franz, author - Producing in the Home Studio with Pro Tools

"Naked Drums are the drum tracks you would record if you had an expensive studio and a rock-solid drummer at your disposal every time you wanted to write a song." David Darlington, Home Recording Magazine - March 2002

"Awesome loops! Since I am not a sequencing and MIDI guy, composing drum tracks has been a nightmare. Until now, Naked Drums have come to the rescue. How can something so simple to use sound so great? Even my musician friends can't tell I using loops and not live drums! Thanks so much!" B. D., Washington

"I use Rock Vol. 1 just about every day. These loops have changed how I create music." C. B., TN

"Great product! Love the Pro Tools integration which, for me, beats the competition hands down. Keep up the great work!" A.W., U.K.

"I think I have all the acoustic rock drum loop CDs available (and then some!) ... but today MultiLoops came in with a bullet! Also great ease of use, I already finished programming a complete drum track for a song of which the original demo was too sloppy to use. This is going to make all the difference!" M.S., Netherlands

Visit our site for expedited delivery • www.multiloops.com

groovin' since 2001 615-331-5148

Classified Advertising

get your company name into the minds of thousands of customers.



emclass@
primediabusiness.com



svc_class@
primediabusiness.com



remixclass@
primediabusiness.com

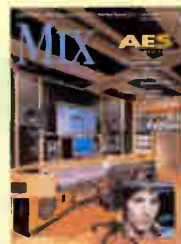

mixclass@
primediabusiness.com

West Coast Sales
 Kevin Blackford
 (510) 653-3307

For Classified advertising rates and deadlines
 please call: (800)544-5530
 or contact your sales representative directly.

East Coast Sales
 Jason Smith
 (510) 985-3276

Anyone who has heard it knows . . .



VT-4 Vacuum Tube LC Equalizer

D.W. FEARN
www.dwfearn.com

610-793-2526
West Chester, PA • U.S.A.

You're a Performer, not a Promoter...
but with Play-It Productions,
no one has to know.

LET US HELP YOU GET YOUR NAME OUT THERE

CD REPLICATION
DVD REPLICATION
CDR DUPLICATION
CASSETTE DUPLICATION
GRAPHIC DESIGN & PRINTING
PACKAGING & FULFILLMENT
CD/DVD/VHS DUPLICATION
WEB SITE DESIGN
MULTIMEDIA PORTFOLIOS
DVD/CD-ROM AUTHORIZING



PLAY-IT
Productions
Incorporated

259 W. 30th Street, NYC 10001
212-496-4530 Fax: 212-695-4304
www.play-itproductions.com



STUDIO SUITE
STUDIO MANAGEMENT SOFTWARE **5.0**

Office	Studio	Tech
Contacts	Projects	Sessions & Events
Calendar	Invoices	Library & Labels
Communications	Services	Titles & Tracks
Petty Cash	Media Inventory	Recall
Purchase Orders	Bar Codes	Samples & Clips
		Rooms
		Equipment
		Maintenance Log
		Patchbay Labels
		Parts

Setup Open All Open Preferred About A Set Menu Log Out

The #1 choice of top studios worldwide!
You KNOW YOU NEED IT!

1.800.450.5740
1.818.752.3900 International
by **altermedia**

www.studiosuite.com

Macintosh/Windows compatible & networkable across platforms



Electronic Musician introduces
A **NEW** quarterly publication dedicated to
providing a better understanding of technology
issues and solutions for today's music
educators and their students K-12.

MUSIC EDUCATION TECHNOLOGY

Find out how you can place your classified ad
in **Music Education Technology**, the definitive
technology resource for music educators.

Call our classified sales associates at:

(800) 544-5530
metclass@primediabusiness.com

Lightning-fast, ruler-flat, wide bandwidth,
ultra-low distortion, phase-coherent
professional monitoring tools
designed to excel...
not voiced to sell



Also available:

HOS 115 High Output Modular Main Monitors & ASB Series Active Subwoofers



bothousepro.com
Tel 845-691-6077



SDX
Crossover
Equalizer

SBX
Subwoofer
Crossover
Controller

M500HV
High Voltage
Monoblock
Amplifier

High Resolution
Control Room
Amplifiers



PRM 165 Passive Reference Nearfield
ARM 265 Active Reference Midfield
MRM 250 Master Reference Midfield
HOS 312 High Output Main Monitor

GET IT FAST

There's a reason we've been here 27 YEARS!



Available: VISA & Master Card

2116 Southview Ave.
Tampa, FL 33606

progressivecds.com

Toll Free: (800) 421-TAPE

"Fastest Turn-Around in the Known Universe!"

CD, DVD & Cassette Retail Ready Packages & State of the Art A/V Facilities Mastering • Editing • Authoring Award Winning Art Dept. The Best Customer Service

CDs • CD-ROM • CD-R • SHAPED CDs • AUDIO CASSETTES

NEED CDs?

the choice is

CRYSTALCLEAR

DISC & TAPE

Trusted experience for over 30 years.

1-800-880-0073

visit us at www.crystalclearcds.com

DIGITAL MASTERING • ART DESIGN • PRINTING • PACKAGING

ANCHOR Your Speakers With Sound Anchor Stands

SOUND ANCHORS is your first choice when it comes to speaker stands for your studio. We have a complete range of designs to fill any speaker stand requirements. The Adjustable Stand in this picture is designed to support small to mid sized monitors behind the console.

STABLE.....RIGID.....DAMPED

Sound Anchors Inc.

Phone/Fax (321) 724-1237

<http://www.soundanchors.com>

ADJUSTABLE MONITOR STAND



all under one roof!

deal direct & SAVE

Compact Disc Replication
Cassette Duplication
Complete Packages
Digital Mastering
Graphics and Printing

FREE CATALOG or CUSTOM QUOTE

C&C MUSIC Toll free **www.CandCmusic.com**
OUTSIDE THE U.S. CALL: 631-244-0800

You'll Hear & Feel the Difference **800 ☆ 289 ☆ 9155**

Can you really hear what's going on in your mix?

"The DAC1 lets me hear what's really going on in my mix."
Michael Wagener
Recording Engineer for Ozzy Osbourne, Metallica, Janet Jackson, etc.



"I found the Benchmark DAC1 incredibly transparent sounding. It made my mastered 16-bit CDs sound more like the original 24-bit master recordings full of rich detail, with stable stereo imaging and a clear high end."
Barry Rudolph
Recording engineer/mixer for Pat Benatar, Lynyrd Skynyrd, Hall and Oates, BB Mak, The Corrs and Rod Stewart.

"The Benchmark is a killer... I've NEVER heard a \$850 DAC that sounds as good as this Benchmark."
Bob Katz Mastering Engineer
Digital Domain Orlando, FL.

The DAC1 is a 2-channel, 24-bit, 192kHz capable D-to-A converter that is unveiling digital audio all over the world! At \$850, it's probably the studio's smartest investment. You too will produce better music by using a DAC1!

Call or write Benchmark Media Systems today for your FREE catalog. 800-262-4675 www.BenchmarkMedia.com

Mix presents the

2004 MIX MASTER DIRECTORY

The Industry Standard Guide to Professional Audio

Now expanded to include musicians' resources with bonus newsstand distribution!

The Mix Master Directory is the complete information source for businesses in the professional audio industry. Backed by more than 25 years of editorial expertise, this definitive resource includes comprehensive national listings of audio manufacturers, audio professionals, facilities and services.

Available in January 2004 wherever Mix is sold!

Free to Mix subscribers!

A PRIMEDIA publication www.mixonline.com

CLASSIFIEDS

MIX Classified Ads are the easiest and most economical means to reach a buyer for your product or service. The classified pages of Mix supply our readers with a valuable shopping marketplace. We suggest you buy wisely; mail-order consumers have rights, and sellers must comply with the Federal Trade Commission, as well as various state laws. Mix shall not be liable for the contents of advertisements. For complete information on prices and deadlines, call (800) 544-5530.

Acoustic Products

ACOUSTIC DRYWALL

FOR STRUCTURAL ACOUSTICS. USE VIRTUALLY ANYWHERE FOR EFFECTIVE SOUND CONTROL.



198 Acoustic Design Inc.
925-828-9314

HILL ACOUSTIC DESIGN, INC. ARE MANUFACTURERS OF STANDARD AND CUSTOM DESIGNED BASS ABSORBERS, BROAD BAND PANELS AND DIFFUSORS FOR USE IN ANY APPLICATION.

WWW.HILLACOUSTICDESIGN.COM

See us as NSCA booth #3705

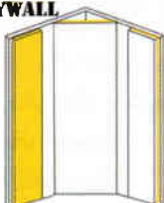

Alpha-DST Roominators

Complete Acoustical Control Kit



www.auralex.com

AcousticsFirst™
Toll Free: 888-765-2900

Full product line for sound control and noise elimination.
Web: <http://www.acousticsfirst.com>

(423)472-9410 ControlRoom™ Studio Pack
Base Traps \$199.99
Diffusers
Tiles
Contact your studio's acoustics for better recordings
(42) 2'x12'x12' (4ea)
(8) 12'x12'x24' (base traps)
mounting adhesive

FLAME RETARDANT
www.hsfacoustics.com

VIBRANT TECHNOLOGIES

DIFFUSER PANELS
WAVE-FORMS™ ACOUSTIC PANELS
800-449-0845
www.vibrantech.com

WhisperRoom INC.
SOUND ISOLATION ENCLOSURES

Celebrating over 13 years of reducing sound to a Whisper!

Recording, Broadcasting, Practicing

MDL 102126S
(8.5'X10.5')

19 Sizes and 2 Levels of Isolation Available

New! SoundWave Deflection System
(Change parallel walls to non-parallel)
Immediate Shipping!

www.whisperroom.com
PH: 423-585-5827 FX: 423-585-5831

STEVEN KLEIN

Acoustic products for less.

SHOP ONLINE AT
www.soundcontrolroom.com

SoundSuckers.com

1-888-833-1554
*Soundproofing Products & Supplies
*Full line of Professional booths
*Custom Projects of all kinds
E-mail: sales@soundsuckers.com

VocalBooth.com
MODULAR SOUND REDUCTION SYSTEMS

Listen to your dreams.
Follow your heart.
Don't ever stop.

- Calvin Mann

541-330-6045
WWW.VOCALBOOTH.COM

Control the Power of Sound

• Improve Acoustics • Noise Control

ECHO BUSTERS™
DECORATIVE ACOUSTICAL TREATMENTS
1-888-324-6287 www.echobusters.com

SILENT
58 Norwalk St., Northampton, MA 01082
INFO (413) 884-7944 • FAX (413) 884-2377
ORDER (800) 583-7174
Info@silentsource.com • www.silentsource.com

AcoustiCore Fabric Panels • Sound Barrier Isolation Hangers • A.S.C. Tube Traps
Silence Wallcovering • WhisperWedge Melaflex • S.D.G. Systems • TecniFoam R.P.G. Diffusers • Sonex • Sound Quilt

SILENCE CASES
Record, Edit, Mix, Master...

THINK in PEACE.
Attenuation cases keep your PC gear QUIET and COOL
Multiple designs available starting at \$429
510-655-3440
www.silencecases.com

aps
acoustical panel systems

Acoustical Panel Systems
Mfg. of absorber and diffuser panels for all Sound reduction applications.
1-800-277-7978
www.acpansys.net



"Our control room at Le Crib Studios needed serious help. After installing MiniTraps the room sounds better than we believed possible, with clear, round bottom and vastly improved imaging. Fantastic product, great company." —Nile Rodgers
Call us toll-free: 866-REALTRAPS (866-732-5872) www.realtraps.com

When you call a classified advertiser, let them know you saw their ad in MIX!

Batteries & Cables



We specialize in service, dependability and price.

Production Supplies

Jireh Supplies stocks a full line of expendable supplies including: Duracell PROCELL batteries, Gaffers Tape, Board Tape, Glow Tape, Hazard Tape, and many more.

Jireh Supplies
(800) 478-2591

or visit our web site:
www.jirehsupplies.com
gbyce@jirehsupplies.com

Cases & Covers

UNDER COVER

Custom Covers and Bags
Speaker Cabinets / Consoles
Anything!
www.undercovernyc.com
917 237 1535

Get your gear Under Cover!

Subscription Questions?
Call (800) 532-8190

Employment

Wanted Recording Studio Salesman in Las Vegas area.

Call for details.
SoundBroker
(702) 736-3003

Sonic Circus Sales Position Available- High end recording supply/systems integration company expanding. Min. 5 yrs of pro audio engineering experience required, previous sales experience a plus. Must be familiar with all facets of music prod. and have hands on knowledge of high-end pro audio equipment. Service/support oriented, no high pressure tactics. Systems training, some travel required. Relocate to Boston. Salary-commission based. 401K, Health benefits. Email: jobs@soniccircus.com

Sonic Circus seeks Pro Audio Sales Assistant: High end recording supply/systems integration company. Must be detail oriented, personable, patient, organized and willing to work in a fast paced office. Min. 3 years music retail or studio manager. Knowledge of music prod and high-end pro audio equipment a plus. Responsibilities: Client acct management, quotes, customer support, industry relations, purchasing. Great people/ problem solving skills required. Relocate to Boston. 401K, Health benefits. Email: jobs@soniccircus.com



"Mix and EM Marketplace & Classified readers are looking for innovative ideas, quality products, cutting-edge technology & outstanding services that can help advance their music. These magazines help me reach these demanding professionals, giving me the opportunity to communicate that the choice is crystal clear for all their CD manufacturing needs!"

—Jim Cocke, Crystal Clear Disc & Tape

Computer Products

VISION DIGITAL AUDIO WORKSTATIONS

Professional Audio PC's

- > PC's engineered for the professional studio
- > Turnkey professional audio workstations
- > Short 2U/3U rackmount chassis
- > Whisper quiet operation
- > Custom system configurations



... CREATING DIGITAL TOOLS FOR ARTISTS
call 800.326.9994 or find us online at www.VisionDAW.com



COMPUTERS FOR MUSIC

We sweat the details, you make the music!

PCs and MACs optimized for Pro Tools, Steinberg, Sonar, MOTU and Emagic.

Call 1-866-WAVEDIGI
or visit

www.wavedigital.com



Join the best staff in pro audio.

At Sweetwater we're passionate about two things - music technology and customer service. That passion has helped us grow at a phenomenal rate, and in order to keep up with that growth, we're looking for a few more great people who want to turn their love of music technology into a rewarding career.

Our Sales Engineers enjoy the best benefits in music retail:

- Tremendous earning potential
- Exceptional health and dental benefits
- Retirement and profit sharing plans
- The best salesperson accommodation pricing anywhere
- Thousands of dollars in additional income through manufacturer sales incentive programs

If you're looking for an opportunity to build lasting security in the music industry, look no further. Call us today.

Kristine Haas Ext. 1050
www.sweetwater.com/careers
5335 Bass Road
Fort Wayne, IN 46808

Sweetwater
music technology direct™ (800) 222-4700



Fully Loaded and Tuned for Sound!

SONIC call 1-888-50 SOUND **BLADE**

Rack-Mount PC's for Live and Studio **\$1,499**

www.SonicBlade.com

Also - NEW! the SonicCube 7x8x12" small

call for latest price!

Equipment Financing

A/V EQUIPMENT FINANCING

***\$100,000 Tax Write-Off in 2004**
***\$99 Payments For The First 6 Months**

Specializing in Audio-Video

Visit Our Web Site

No Financials Required

New & Used Equipment

New Businesses

(With Clean Personal Credit!)

For Application & Qualifications

LFCI www.lfci.net
Call: 800 626 LFCI

Atlas Pro Audio

atlasproaudio.com

Neumann - Mytek - Empirical labs
 Soundelux - Vintech - Millennia
 Crane Song - Benchmark - Great River
 Bryston PMC - Chandler - Daking
 ADK - Pendulum - DPA - Royer...
Toll Free 1.866.235.0953

Equipment For Sale

Nashville Audio Connection

Professional Audio Broker
 SSL • Neve • Studer

www.nashvilleaudio.com
 (615) 847-3798



Quartet II Mercenary Edition
 Pendulum Audio
www.pendulumaudio.com

Neve 8068 & 8058 MK II

The finest (2) vintage Neve Consoles on the planet are available. Both consoles have been meticulously refurbished and can be easily joined together or sold separately for immediate use. No detail of the refurbishment has been overlooked. For a complete list of the refurbishments and enhancements contact:
craig@higestudios.com
(312) 337-0008
Serious inquiries only

SoundBroker

Linking buyers & sellers together
 for all your studio needs
(702) 736-3003
www.SoundBroker.com



Active Thermal Management
 Cool answers to hot problems...

Equipment to keep your equipment cool and quiet...
 See us at www.activethermal.com or
 call (661) 269-8864.

(Mention this ad for free freight on your first order!)
 13484 Sawtooth Road, San Diego, California 92129
www.activethermal.com • atmcools@aol.com

SOUTHERN CALIFORNIA PRO AUDIO

NEW, USED AND VINTAGE
 THE LAST CALL YOU'LL
 HAVE TO MAKE!

Phone: (818) 222-4522
 Fax: (818) 222-2248
www.socalproaudio.com



The outlet for the finest new & pre-owned
 recording equipment anywhere.

www.odysseyprosound.com
1-800-249-1821
 Phone: (978) 744-2001 Fax: (978) 744-7224

VINTAGE EQUIPMENT: SSL4072E/G/TR \$89.5k* SSL4100G+w/ULT* Otari Concept Elite 24/48 Eagle auto.\$8.5k* DDA DMR12 32-in./24 monitors w/eq \$13.5k* API LEGACY 48in w/Uptown990* Neve V3/96w/GML* Neve 8068MKII Neve8108* TridentTSM w/Uptown \$18.5k* Sennheiser1046 touring system: active antennas, 8 receiver modules, 8SKM hand held transmitters,9ME5005 supe cardioid capsules \$40k* DolbySRXP24* DolbySRSP24* Lexicon960L/480L/PCM80/PCM70/60* Studer a-827/820/800/80* OtariMTR90I&II* Sony 3324/3348*
WE BUY: Neve 1073/1066/1081/1083*Pultec*Telefunken*Neumann U47/M49/U87/AKGC12*
NEW EQUIPMENT: VINTECH*DEMETER*CRANESONG*UNIVERSAL AUDIO*DPA*TC*TUBE-TECH*EVENTIDE*QUESTED*LEXICON* SOUNDELUX*DRAWMER*DW FEARN*MILLENNIA* HHB*DYNAUDIO*
 LIST FOR SALE ITEMS FREE*MAJOR CREDIT CARDS ACCEPTED*WE BUY VINTAGE GEAR*



Phone: (781) 231-0095 Fax: (781) 231-0295

Vintech



Introducing the Vintech X73!

We put this piece head to head with vintage Neve 1073's at this year's AES show. It is 100% guaranteed to meet your expectations and is an incredible value. List price \$1595 **Special \$1375**



THE "X81 CLASS A"

1-877-4-MIC-PRE



The Vintech X73

Custom hand wired concentric style switches with gold plated pins. Swiss made military grade attenuator switch. List price \$1995 **Special \$1795**



The Model 473

www.vintech-audio.com

VOLUME discounts.



From microphones to turnkey studio systems, we have a huge stock of new, used and vintage equipment from over 100 manufacturers. Including pre-owned SSL consoles. All serviced and warranted by our technical experts. Call, fax or stop by. And hear why our deals are better.

Professional Audio Design Inc.

ALWAYS A SOUND DECISION

Tel: 781.982.2600 Fax: 781.982.2610
 info@proaudiodesign.com www.proaudiodesign.com
 Exclusive SSL Factory Authorized Reseller www.UsedSSL.com

ATR-102 recorders by Michael Spitz • Class A discrete Aria electronics by David Hill

Your mixes will thank you.

717 • 852 • 7700
 www.atrservice.com

ATR
 Services, Inc.

THE NEXT GENERATION IN POWER CONDITIONING TECHNOLOGY
SERIES II POWER CONDITIONERS



AVAILABLE NOW AT

Sweetwater
 music technology direct

LEARN MORE AT
 www.FURMANSound.com

CONSOLES FOR SALE
 SSL 9080 J, 80 Series Neves
 60- & 72-channel Neve VRs
 Flying Faders or GML
 Contact Gary Belz
 House of Blues Studios
 (818) 990-1296

VINTECH AUDIO
 CLASS A MIC PREAMPS MADE WITH



NEVE™ 1272 COMPONENTS
 www.vintech-audio.com
 call toll free: 1-877-4-mic-pre

IT'S A GREAT TIME TO BUY USED GEAR!

We list over 700 recording and live boards, plus mics, amps, effects, more. We can help sell your used equipment, too!

- dbx 165a\$600
- Crown MA3600VZ amps\$1300
- Otari Status\$12K
- Harrison Series - 12!\$70K

Call/E-mail for details & FREE catalog.

Those Cheerful Folks at H.T.I.C.S.
 (610) 865-9151 • Fax (610) 758-9999
 E-mail: HTICS@aol.com
 www.hticsproaudio.com

Any Questions?



"this is not a problem"

TEL (508) 543-0069
 www.mercenary.com open 24 hrs

THE MIC SHOP

TUBE MICROPHONES
 BOUGHT/SOLD/SERVICED
 Mic Power Supplies & Cables
 Bill Bradley: (615) 595-1717
 Fax: (615) 595-1718
 www.micshop.com

VT-2 Vacuum Tube Mic Preamp
 www.dwfearn.com



D.W. FEARN

SINGERS! REMOVE VOCALS

Unlimited Free Backgrounds from Original Standard Recordings!
Thompson Vocal Eliminator™
 VE-4 Free Brochure & Demo
 24 Hour Demo/Info Line
 (770) 482-2485 - Ext 8
 LT Sound Dept MX-1 7980 LT Parkway Lithonia, GA 30058
 www.VocalEliminator.com/g.o/MX
 Better Than Karaoke for Over 25 Years!

API Legacy Plus Console

48ch, Uptown 990 auto, built-in API compressors, gates, filters, and Dis, absolutely immaculate condition. \$199G best offer.
 www.echobayproductions.com/api

SONIC CIRCUS
 A SOUND ALTERNATIVE
 617.696.9360
 soniccircus.com

CALISTRO MUSIC

All The Best
 Recording Gear
 (203) 891-8918
 www.CalistroMusic.com

CLASSIC MICS FROM RUSSIA

VINTAGE TUBE & FET
 Telefunken, NEUMANN
 AKG, LOMO, OKTAVA, etc.
 TEL/FAX: 011-7-095-250-4200
 E-mail: aeg210268@mtu-net.ru
 www.valvemics.webzone.ru/

Don't just sit there, call Vintage King Audio.

(Then call your Mom, she only nags because she cares...)



vintagekingaudio
 www.vintageking.com
 (248) 591-9276

2-Day Public Webcast Auction

By Order of Vivendi Universal Net USA Group, Inc.

MP3.com, Inc.

March 10 & 11 AT 10:00AM(PST)

Inspection: March 8 & 9, 9:00AM- 5:00PM

4780 & 4790 Eastgate Mall, San Diego (La Jolla)

DIGITAL AUDIO & VIDEO PRODUCTION & EDITING EQUIPMENT

Complete Liquidation of 100,000 sq ft facility • 100s of Servers • Clarion EMC Storage • 100s of PCs, Notebooks, Printers • HM Aeron Chairs • 10,000 sq ft Health Club - Game Room Equipment • Artwork • Collectable Musical instruments • Contemporary Furniture & more...

www.CowanAlexander.com 888-875-SOLD



The VINTAGE NEVE SPECIALIST

CONSOLES IN STOCK AND IN IMMACULATE CONDITION. PRICES IN STERLING

NEVE 8078 CLASSIC CONSOLE P.O.A.

NEVE VR36 FRAME 36 INPUT FLYING FADERS P.O.A.

SSL 4064G PLUS FITTED ULTIMATION P.O.A.

CALREC FULLY DISCRETE 8 CHANNEL CONSOLE P.O.A.

EMI 1959/60 CLASSIC TUBE CONSOLE SERIAL NO. TGCI01/1 P.O.A.

ALL EQUIPMENT OWNED BY A.E.S. PRO AUDIO (WE DO NOT BROKER). SEE OUR WEBSITE FOR FULL DETAILS.

TEL INT. 44 1932 872672 FAX INT. 44 1932 874364

email: aesaudio@intonet.co.uk www.aesproaudio.com



512.338.6777 • mistyhillaudio.com

EXCLUSIVE FACTORY AUTHORIZED RESELLER

www.UsedSSL.com

PROFESSIONAL AUDIO DESIGN, INC.
(781) 982-2600

Upgrade Your Vocals

with **Variable Acoustic Compression™**

Pop filters that adjust for the best combination of pop protection and sonic transparency BEFORE the sound reaches the microphone.

Get professional sounding vocals and protect your microphones.

ORDER TODAY!

www.popfilter.com

Popless Voice Screens

Tel: 1(800) 252-1503 email: info@popfilter.com



BAE REPRO 1272 PREAMPS with D.I.



\$989 Single w/p.s. \$1659 Two channel

BAE REPRO 1073 \$2350 Single w/PS

Brent Averill
ENTERPRISES

14300 Hortense Street • Sherman Oaks, CA 91423
818 784-2046 FAX 818 784-0750
www.brentaverill.com

Furniture

SOUND ANCHOR SPECIALTY AUDIO STANDS (321) 724-1237

DESIGNED FOR ULTIMATE PERFORMANCE BEHIND CONSOLE AND FREE SPACE APPLICATIONS. STANDARD & CUSTOM MODELS



www.soundanchors.com

OMNIRAX STUDIO FURNITURE



CDDA DB with Sidecars

OMNIRAX 800.332.3393 415.332.3392
FAX 415.332.2607

www.omnirax.com

DREAM STUDIO



70 Series for Control 24

\$1,049.90 delivered! details online (other models available)

studio furnishings by **ARGOSY**
WWW.ARGOSYCONSOLE.COM
800.315.9878 573.348.3333

Check Out mixonline.com

Instruction

BE A RECORDING ENGINEER

★ **TRAIN AT HOME**

Easy Home-Study practical training in Multi-track Recording. Join our successful working graduates or build your own studio. Career guidance... Diplomas... Licensed. **FREE INFORMATION:** Audio Institute of America 114 46th Ave. Suite AL, San Francisco, CA 94121 Or visit us at www.audioinstitute.com

ART1 Audio Recording Technology Institute
ORLANDO, FLORIDA

- Extensive Hands-On Training
- Music, SFX Design, Audio Post
- Low Student/Teacher Ratio
- Placement Assistance
- Financing to Qualified Applicants
- Accredited by ACCSCT

FEATURING **THX pm3** MIX THEATER

888-543-ART1 • audiocareer.com

Music Mastering

MASTERING

Guaranteed to give you that "Big Label" sound.

Located in New York... Serving the US!... Since 1989

Call Today!
1-800-692-1210

Quality you can afford!
www.musichouseproductions.com

Music Products & Software

LMG Mastering Lab

Want world-class mastering?
From slammin', in-your-face rock and hip hop, to pristine jazz and classical. 315.492.6854
www.lakewoodmusic.com

Killer "Real" Drum Tracks from Chet McCracken. ProTools, send me your files. For credits, rates, formats & info call Chet: (818) 888-6687 or e-mail: ddrruumm@aol.com www.chetmccracken.com

DRT Mastering
the Analog Specialist

You will have the fat, slammin' major-label sound that sells discs.

Or the work is free...
Custom gear. 1st-class results. Free broch
800-884-2576 www.drtmastering.com

Records Tapes CD Services

AMERICA'S BEST CD PACKAGES **HANDS DOWN**

1000 CD's Only \$1,099.00 Includes:

- Full color booklets • design • film • glass master
- Shrinkwrap • 2 colors on disc • priority proofs
- Free barcode • fast turnaround!
- Manufactured by SONY for the very best quality!

100 CD's Only \$299.00 Includes.

- Full color booklets • color on disc • design
- Shrinkwrap • priority proofs • free barcode
- Ready in 5 days!

100 Full Color Posters \$99.00

ELECTRIC

Records

800-367-1084
www.electricrecords.com



1.888.655.2272

We keep our overhead low - so you don't have to pay for it. Now get 1,000 bulk discs for only \$490.00!

For more deals, see us online at tapeanddisc.com

digital duplication solutions

CD • CD ROM • CD R • SHAPED CD • AUDIO CASSETTES

CRYSTALCLEAR

DISC & TAPE

1-800-880-0073 www.crystalclearcds.com

DIGITAL MASTERING • ART DESIGN • PRINTING • PACKAGING

1000
Retail Ready CD's
\$949
(800) 836-7962
www.cheapcduplications.com

Our CD & Cass's are
BETTER & CHEAPER!
(800) 421-8273
Progressive Music

RECORDING & DUPLICATING SUPPLIES



Audio, Video & Data Storage
Media & Accessories

1-800-272-2591 FAX 650-369-7446
Visit our web site: www.arcal.com

We take manufacturing your CD as seriously as you take your music.

Complete retail ready CD pressing including all types of packaging, bar codes, graphic design and film services, enhanced CD creation, with super pricing and customer service reps specialized in all types of music.

Also vinyl pressing, cassette duplication, mastering, short run CD, DVD pressing and authoring.

We've been doing it for 16 years.

This is what we call

THE **ART** OF MANUFACTURING MUSIC

MUSIC
MANUFACTURING
SERVICES

1.800.MMS 4CDS • mmsdirect.com



The publishers of *Mix* and *EM* present:

MUSIC EDUCATION
TECHNOLOGY

The definitive technology resource
for music educators, K-12.

To subscribe, log on to:

www.metmagazine.com

DIGITAL
DOMAIN™

Mastering
CD Manufacturing
Booklet Printing
Graphic Design

Unsurpassed mastering quality
by **Bob Katz**

CD Mastering is an art

The Definitive, Award-Winning
CD Mastering Website
<http://www.digido.com>

(800) 344-4361 in Orlando

For Mix Classified Rates
Call (800) 544-5530 or email at mixclass@primediabusiness.com

CDs, DVDs, VHS & more!!
 CD • CD-ROM • DVD • Enhanced CDs • DVD Authoring
 Video Editing • Mastering • Web Development • Tape Duplication
 Design • Printing/Packaging

BUY DIRECT AND SAVE MONEY \$\$\$!

1000 CDs \$499
 Bulk 3 color Silkscreen CD on Spindle!

100 CDs \$299
 Includes FULL COLOR Insert, Traycard,
 direct-on-disc printing, jewel case and shrinkwrap

Serving the World Since 1985 www.eastcomult-media.com
1-800-365-8273

EASTCO MULTI MEDIA SOLUTIONS

1,000 Store Ready CDs - \$999 www.TrackmasterAV.com
 Toll Free: 888-374-8877

1,000 Bulk CDs - \$490

YOUR 1-STOP SHOP FOR CD, AUDIO & VIDEO CASSETTE PROJECTS!

CASSETTES
 GRAPHIC DESIGN & POSTERS
 STUDIO MASTERING
 CD-R MEDIA

www.yourmusiconcd.com

100 BULK CDRS \$59 300 FULL COLOR PACKAGE \$349

100 BASIC CDRS \$99

100 FULL COLOR CDR PACKAGE \$199

300 FULL COLOR PACKAGE \$799

1000 FULL COLOR PACKAGE \$1149

CD Duplication

FREE DESIGN

RETAIL READY CDs
 MANUFACTURING not CD-R
 SAME AS CAPITOL RECORDS
 PRINTED BOOKLET
 INSERT IN BACK TRAY
 2 COLORS ON DISC
 SHRINK WRAPPED with BAR CODE
 IN-HOUSE GRAPHIC DESIGN
 using your files / images / photos

ONE PRICE ALL INCLUDED
1000 @ \$1099
 Call Free 888-565-8882
dbsduplication.com

KLARITY MULTIMEDIA INC
888-387-8273

CDs, CDROM, Cassettes, Vinyl, Mini Discs, VHS

Our Customers have trusted us with their projects for over 15 Years! We care and work with you to create your project the way you want it.

Total Fulfillment, Graphic Design, Illustration
 Digital Mastering, Complete Packaging, Mailing Services
 Warehousing, Package Pricing, Custom Pricing
 Online Music Store, Free Barcode
 Quality Service • Personal Attention • Quality Products

www.Klarity.com www.KlarityMusic.com

For the best price in CD Replication
 there is only one number you'll need!

1.888.891.9091

MEDIA www.MEDIAOMAHA.COM

46 PRODUCTIONS

25 CD-Rs - \$45.....50 CD-Rs - \$88
 100 CD-Rs - \$150.....200 CD-Rs - \$290

ASK ABOUT OUR DISCOUNT FOR ASCAP MEMBERS

From CD or CD-R master. Includes CD-R in jewel box with text printing on CD label. Add \$35 for other digital master, \$55 for analog master. Orders must be pre-paid. Shipping not included.

42 W. 557 Hawk Circle
 St. Charles, IL 60175
 Phone: (800) 850-5423
 E-mail: info@46p.com
 Visit our web page at:
www.46p.com

Lowest Price Period!

CD ROM, DVD Replication
 CD Audio Replication
 Video Replication
 Multi-Media Development
 Graphic Design
 Printing/Packaging
 Web Design

1-888-256-3472
www.ballmedia.com

BALL MEDIA CORPORATION

MIXLINE

www.mixonline.com
 Sign up to receive the FREE Mix e-mail newsletter!

Musicians-Bands-Studios

HIGH BIAS BULK/BLANK AUDIO CASSETTES

BASF maxell TDK

C-10.....	.18 / ea.	PERFECT DEMO LENGTHS
C-20.....	.22 / ea.	
C-30.....	.28 / ea.	

CHROME Cr02 C-94..... .50 / ea.
 Clear Norelco Box/Round Edge .12 / ea.

All Lengths Available From 1 to 126 minutes

DAT Quantegy, Maxell BASF or Sony

124	94	64	48	34	15
\$5.40	\$4.75	\$4.20	\$4.00	\$3.60	\$3.10

All Formats and Brands Available.
 Please Contact our Sales Department For the Lowest Prices!!!

COMPACT DISC Recordable CDR'S

TDK OR MITSUI BLANK FACE WITH JEWEL BOX			
10-99.....	.78	100-499.....	.73
500+.....	.68		

BULK / SPINDLES

Diamond/Silver.....	.30/ea.	Mitsui.....	.60/ea.
Generic.....	.25/ea.	TDK.....	.40/ea.
Taiyo Yuden.....	.30/ea.		

Volume Discounts
 CD Jewel Boxes With Trays .15 / ea.

2" ANALOG

QUANTEGY 499.....	\$145
QUANTEGY GP9.....	\$148
BASF SM-900.....	\$145

WE WILL MATCH ANY ADVERTISED OR CATALOG PRICE!

adat

QUANTEGY.....	\$8.96
BASF.....	\$8.50
SONY.....	\$8.50
HBB.....	\$7.00

Master Distributors of:

QUANTEGY maxell PROFESSIONAL

DK BASF SONY Taiyo Yuden

MITSUI

MICHELEX MELLEX

SAMSUNG SKC MICROBOARDS

R IMAGE PRINCO TELEX

In the Studio?

FREE Guide
 Saves You Time and Money!

Contact Us Today:
1-800-468-9353
www.discmakers.com
 info@discmakers.com

DISC MAKERS

If the quality SUCKS... who cares how cheap it was?

WE DELIVER THE HIGHEST QUALITY CD AND CASSETTE PACKAGES, STUNNING GRAPHIC DESIGN AND HELPFUL CUSTOMER SERVICE.

Call now for a quote that can't be beat!

TOTAL TAPE SERVICES
(727) 446-8273
www.totaltapeservices.com

764 5th Avenue,
 Brooklyn, New York 11232
 In NY: (718) 369-8273
 24 Hour Fax: (718) 369-8275

NRS
 National Recording Supplies Inc.

CONTACT US FOR A FREE FULL LINE RECORDING SUPPLIES CATALOG

<http://www.TAPES.com> • e-mail: sales@NRSTAPES.com
TOLL FREE 1-800-538-2336 (Outside NY Only)

Records Tapes CD Services

EUROPADISK, LLC

CD Replication • Vinyl Records • Mastering • Graphics Design/Printing



COMPLETE CD PACKAGES

Molded, commercial quality CDs, with finest quality computer-to-plate printing - no film needed! Full-color silk screen CD label, no extra cost!

VINYL RECORDS

Complete Packages with Direct Metal Mastering, labels and jackets. BB charted hits produced in our DMM Mastering Studio every week!



No middleman - all manufacturing in our plant.

Free Color Catalog for One-Stop Audio Manufacturing:

800 455-8555 www.europadisk.com
email: info@europadisk.com

Let our 26 years experience work for you ...

EUROPADISK, LLC

24-02 Queens Plaza South, LIC, NY 11101 • 718 407-7300

Retailers

Every major brand of everything Millions of dollars of musical gear In stock. **ALTO MUSIC** Guitars, recording, keyboards, amplifiers, drums, pro sound, new and used. One of the largest selections in the country. We ship everywhere!

680 Rt. 211 E.
Middletown, NY 10940
sales@altomusic.com
ph (845) 692-6922
fax: (845) 346-0016
www.altomusic.com

Miscellaneous

SoundBroker

Linking buyers & sellers together for all your studio needs

(702) 736-3003
www.SoundBroker.com

CD - R DUPLICATION 100 - \$1.39 ea. With Color Inserts 1.99 ea. (2 Page & Tray)

Price Includes: CD - R, Duplication, Thermal Imprinting, Jewell Box, Inserting of cover, & Shrinkwrapped
(936) 756-6861



Lonely Records

Friendly, knowledgeable service - 10% National Price Guarantee

\$990

2 PAGE CD PACKAGE

100	1000	\$199
500	1000	\$275
1000	1000	\$390
1000	1000	\$1090

GET A FREE CATALOG
WWW.LONELYRECORDS.COM
1.800.409.8513

CD, DVD, CASSETTE, GRAPHIC DESIGN
MASTERING, POSTERS, DVD AUTHORIZING
BUSINESS CARDS
POSTCARDS
BARCODES

MANY OF OUR
COMPETITORS WILL CHARGE
YOU UP TO 30% MORE FOR
THE SAME PACKAGES!
LONELY RECORDS HAS A 10%
PRICE GUARANTEE.
WHY PAY MORE?

VHS-DVD TRANSFERS
MAKE A MUSIC VIDEO!
1000 BULK DVD \$1090

Inesor Media

Stand Alone Duplicators, Printer & CD/DVD Retail Replication Services
200-\$1.25, 500-\$1.05, 1000-\$0.555

2000-\$0.45, 5000-\$0.295

(all prices include 5-clr. & mastering)

Toll Free (866) 943-8551 • www.inesormedia.com

If you built it... let the world know it!

Mix Studio Showcase found monthly in Coast-To-Coast

(800) 544-5530

Studios

HOT STUDIO SALE

Busy multi-room rehearsal complex with 24 track recording suite. All fully equipped and regularly maintained. 5,000-sq. ft. Full A/C. Centrally located in NYC area, with easy access. Large room popular with well known and other high end clients. 3 medium and 3 small rooms are also popular and reach all market levels. Medium and large rooms have full stages. Excellent comfort throughout, including large front lobby and sizable rear lobby. Exceptional construction specifically for a studio with double wall and door construction, high soundproofed hung ceilings. Recording suite has awesome sound, a vocal isolation booth and two instrumental isolation booths. 7 years remaining on bldg. lease. Excellent turnkey opportunity for owner/operator. \$225k.

Call 516-742-9339 if seriously interested.

BUILDER
RECORDING STUDIOS
AND ALL TYPES OF
SOUND ROOMS
25 YEARS EXPERIENCE
(805) 493-5794

CHECK OUT
MIXONLINE.COM

The MOTU Virtual Instrument Studio

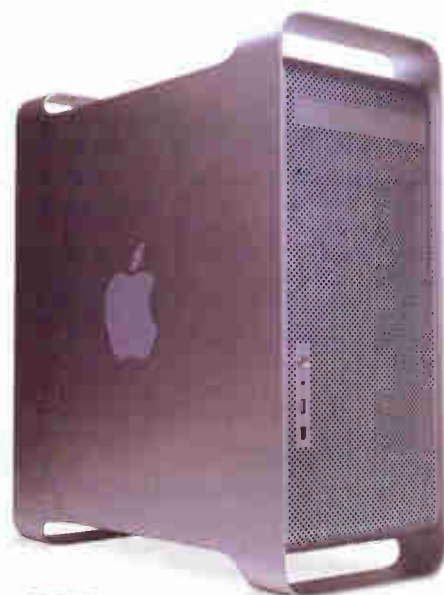

"...another winner for MOTU."
 — *Electronic Musician Magazine*
2004 EDITOR'S CHOICE



"Digital Performer 4 is better than ever."
 — *Electronic Musician*
2004 EDITOR'S CHOICE

"MachFive is unquestionably a winner."
 — *Electronic Musician*
2004 EDITOR'S CHOICE



Use DP4, the 828mkII and the G5 Power Mac to run MachFive, MX4 and a wide array of virtual instruments

Apple Power Mac G5 The world's fastest personal computer

Your all-native MOTU desktop recording studio just got bigger. A LOT bigger. The new Power Mac G5 is like doubling your studio's square footage, and then adding several additional floors. Run more virtual instruments, more plug-in effects, more tracks, more busses, more processing, more everything than you ever thought possible. Yes, it's time to bask in the glory of your MOTU native studio. Starting at just \$1999, the G5 Tower transforms DP4 into a production powerhouse.

MOTU MachFive™ and MX4™ Put this universal sampler & unique multi-synth in your DP4 arsenal

MachFive could very well be the last sampler you ever purchase. Consolidate all of your sample libraries for instant access in DP4, including Giga, Sample Cell, Akai, K2xxx, Roland and others. Play up to sixteen different parts per instance, and apply automatable synthesis effects powered by the renowned UVI™ engine. To add vintage and fresh analog synth sounds, look no further than MX4, MOTU's new multi-synth. Inspired by legendary subtractive synthesizers, MX4 combines several core synthesis techniques in a unified, hybrid synthesis engine that delivers fat basses, nasty leads, analog pads, vintage electronica — it's all at your fingertips.

Studiologic TMK-88 88-note semi-weighted MIDI keyboard controller

Don't let the size, weight, and price fool you. The Studiologic TMK-88 is a professional MIDI keyboard controller for serious MOTU users, but the amazing price makes it a technological breakthrough that's affordable for a MOTU studio of any size. Boasting full size keys with semi-weighted piano action, this is an 88-note MIDI keyboard controller that weighs in at a mere 13 lbs. Its lightweight and highly durable design makes it perfect for studio or stage. The keyboard action is light, but nicely weighted giving it an expressiveness that must be played to be appreciated. It is the perfect hands-on control for your MOTU studio virtual instruments. The TMK-88 is velocity sensitive with a mod wheel, one MIDI output, program change and bank select. Suggested retail is \$399.95.

CALL Sweetwater
 music technology direct
800-222-4700
 Authorized Reseller



THE MOTU VI STUDIO • CALL SWEETWATER 800-222-4700
 World Radio History

UltimateSoundBank Charlie™ Virtual retro organ module

Charlie delivers famous electric organ sounds to your Digital Performer desktop studio via a 3 GB sound library that captures the real sound quality of genuine organs recorded with the vintage equipment favored by purists. Charlie is powered by the UVI Engine™, allowing you to play complex parts with unlimited polyphony. A gorgeous, clearly-designed, feature-rich synth interface, including amazing filters and mono/legato modes, lets you customize the sounds, or completely mangle them. Most patches are available with slow and fast rotary speaker effects. Use real-time MIDI control of every parameter to enhance expression and live use. Included instruments cover the gamut of vintage, classic American and European organs. Enjoy unsurpassed realism for your DP4 organ tracks.



MAS
MOTU AUDIO SYSTEM

Native Instruments Pro-53™ The second coming of a virtual synth legend

The PRO-53 carries on the tradition of the legendary days of vintage cult synthesizers. Fashioned after the unique original Prophet Five, the PRO-53 casts in software those qualities which have been a major influence on popular music in the past twenty years: brilliance, power, warmth and beauty. Through Native Instruments' creative development philosophy, these timeless aesthetics have now reached the next step in their evolution. The result is the manifest re-definition of an original that was regarded as unrivalled until now. Call Sweetwater and add Pro-53 to your DP4 studio today.



AU
AUDIO UNITS

East West / Quantum Leap Symphonic Orchestra™ World class strings / woodwinds / brass / percussion

This stunning new 24-bit orchestra sample library was recorded in a state of the art concert hall by GRAMMY award-winning classical recording engineer Keith O. Johnson with custom-designed recording equipment. And now it can be at your fingertips in DP4. Just open the included Kompakt™ sample player and then mix together any combination of three recorded mic positions (close, stage and hall) to alter the tone and ambience of any instrument or section. For example, you could use the stage mics for that big Hollywood sound, boost certain instruments with a hint of the close mics, and bring in a touch of the hall mics for reverb or even surround mixing. This library was produced by Doug Rogers and Nick Phoenix, recipients of over 30 international awards.



AU
AUDIO UNITS

Arturia CS-80V™ Reproduction of the legendary Yamaha® CS-80 polysynth

In 1976, Yamaha introduced the CS-80. The price tag (\$6,900) put it out of reach of most musicians... But the qualities of the CS-80, considered as Japan's first great synthesizer, made it immediately famous in the music industry. Popularized in the late 70's and early 80's by artists and groups like Toto, Jean-Michel Jarre, Keith Emerson, Stevie Wonder and Vangelis, the CS-80 soon became myth. The Arturia CS-80V offers all the features of the original synth, plus a new generation of innovative features. Does CS-80V really sound like the original? We humbly say a resounding "yes!", thanks to Arturia's TAE®, the proprietary technology developed by Arturia, and already successfully used in the Moog Modular V.



AU
AUDIO UNITS

Universal Audio UAD-1 Studio Pak™

Accelerated effects processing for Digital Performer

With power-on-demand DSP and 20 award-winning UA plug-ins, the new UAD-1 Studio Pak plug-in bundle is an unbeatable addition to your MOTU studio. For less money than comparable native plug-in bundles, you get a real DSP card running at 44.1 to 192 kHz plus world class plug-ins like the legendary LA-2A, 1176LN, Cambridge,



Pultec EQP-1A, and the Fairchild 670. Give your Mac a break, improve your workflow, and save a bundle with the UAD-1 Studio Pak.



KORG Legacy Collection™

Virtual instruments and effects plug-ins with MS-20 Controller

The KORG Legacy Collection is the ultimate virtual instrument pack, consisting of software versions of the MS-20, the Polysix, and the WAVESTATION bundled with a special-edition MS-20 Controller. It also contains the revolutionary "Legacy Cell" for making combinations of the MS-20 and Polysix including Insert and Master effects. Features native support of the microKONTROL for a complete hands-on music experience.



Metric Halo ChannelStrip™ X

Console-style, integrated EQ and dynamics processing for DP4

Metric Halo's ChannelStrip is the recognized leader in console-style channel strip audio processing for Digital Performer. As the first plug-in to offer the combination of exceptional audio quality, incredible DSP efficiency and a comprehensive user interface, ChannelStrip lets DP4 users work as efficiently and interactively as they would with a dedicated, world-class mixing console. ChannelStrip comes with more than 100 presets included to help you get your mix started. Use the presets to compress your drums, EQ your vocals, get your sessions ready for mastering and much more. With ChannelStrip for DP4, you get an unparalleled EQ, Gate, and Compressor, all in one easy to use interface. ChannelStrip is the critical mixing tool for thousands of top engineers and producers world-wide.

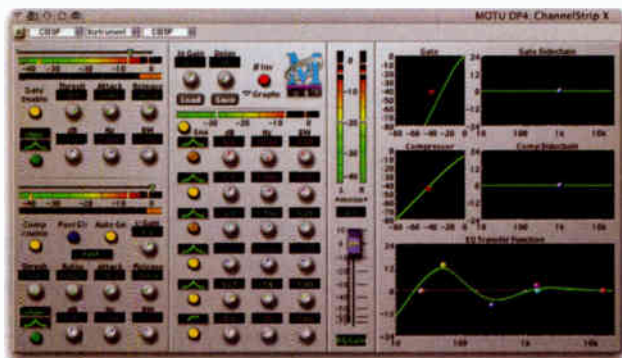

RØDE NT2000™

The World's first fully variable control microphone

The new RØDE NT2000 is the latest brainchild from Australian master microphone designer Peter Freedman and represents a huge investment on RØDE's part. Never before has this much control and versatility been available in a superlative class large capsule recording microphone. The NT2000 features totally variable polar pattern, totally variable high pass filter and totally variable pad — all located directly on the body of the microphone! The heart of the NT2000 is the Australian designed and manufactured TYPE HF1 dual diaphragm capsule. Frequency and transient response have been voiced to complement today's modern recording techniques, and yet still evoke the silky smooth character of the legendary microphones of the 50's and 60's.



THE MOTU VI STUDIO • CALL SWEETWATER 800-222-4700

World Radio History

PreSonus Central Station™ A Console Master Section Without the Console!

The PreSonus Central Station is the missing link between your MOTU recording interface, studio monitors, input sources and the artist. Featuring 5 sets of stereo inputs (3 analog and 2 digital with 192kHz D/A conversion), the Central Station allows you to switch between 3 different sets of studio monitor outputs while maintaining a purely passive signal path. The main audio path uses no amplifier stages including op amps, active IC's or chips eliminating coloration, noise and distortion enabling you to hear your mixes more

clearly and minimize ear fatigue. In addition, the Central Station features a complete studio communication solution with built-in condenser talkback microphone, MUTE, DIM, two separate headphone outputs plus a cue output to enhance the creative process. A fast-acting 30 segment LED is also supplied for flawless visual metering of levels both in dBu and dBfs mode. Communicate with the artist via talkback. Send a headphone mix to the artist while listening to the main mix in the control room and more.



Mackie Control Universal™ Automated hands-on control for the DP4 studio

Imagine the feeling of touch-sensitive, automated Penny & Giles faders under your hands, and the fine-tuned twist of a V-Pot™ between your fingers. You adjust plug-in settings, automate filter sweeps in real-time, and trim individual track levels. Your hands fly over responsive controls, perfecting your mix — free from the solitary confinement of your mouse. Mackie Control delivers all this in an expandable, compact, desktop-style design forged by the combined talents of Mackie manufacturing and the MOTU Digital Performer engineering team. Mackie Control brings large-console, Studio A prowess to your Digital Performer desktop studio, with a wide range of customized control features that go well beyond mixing. It's like putting your hands on Digital Performer itself.



Mackie HR-series Active Studio Monitors Nearfield monitors for your MOTU studio

Mackie's HR-Series Active Studio Monitors are considered some of the most loved and trusted nearfield studio monitors of all time, and with good reason. These award-winning bi-amplified monitors offer a performance that rivals monitors costing two or three times their price. Namely, a stereo field that's wide, deep and incredibly detailed. Low frequencies that are no more or less than what you've recorded. High and mid-range frequencies that are clean and articulated. Plus the sweetest of sweet spots. Whether it's the 6-inch HR-624, 8-inch HR-824 or dual 6-inch 626, there's an HR Series monitor that will tell you the truth, the whole truth, and nothing but the truth.



Sweetwater SweetCare™ Your personal MOTU studio expert advisor

When setting up and maintaining a MOTU desktop studio, there are many considerations to factor in to your decision making. Both the hardware and software landscape are constantly changing, and it's hard to keep up with all of the advancements. That's where Sweetwater comes in. Your personal Sweetwater sales engineer offers much, much more than just a great price. They do the research, day in and day out, to ensure that you'll fine-tune your MOTU system to fit your exact needs.



**Call now for your MOTU studio
personal consultation: 800-222-4700**

www.sweetwater.com • info@sweetwater.com • 800-222-4700

World Radio History

Ableton Live Version 3

Take Your Loops to the Next Level

The fact that Ableton Live can instantaneously preview any .WAV, .AIFF or SDII file at any tempo with the click of a mouse without additional slicing or preparation, combined with the software's capability to run alongside Pro Tools (via ReWire) or function as a disk streaming software sampler, has made the product popular with both film and television music composers and loop-minded producers. Now, Ableton has upgraded Live to Version 3.

LOOPS ETERNAL

Live 3's new Link/Unlink envelope may be its most powerful button. Unlinking an envelope means that any given loop is no longer a monotonous, repeating loop, but rather an extendable or contractible amount of time for each independent envelope. In other words, while your looped audio file goes 'round and 'round, Live enables you to create automation envelopes of any length, similar to the way an LFO or filter modulation can cross bars and beats.

Say you are working with a two-measure drum loop and would like to create a longer, more interesting (i.e., dynamic) drum loop. To do this, open the loop by double-clicking on it in Live's Clip View. Next, make sure that Clip View's envelope window is open, and that the Device Chooser reads "Clip" and the Modulated Control Chooser says "Volume" (all default settings). Click on the Linked button so that it now toggles to Unlinked. To the right of the Unlinked button, enter in the desired length for your new Volume envelope (for example, 4,0,0 in the three successive boxes to designate exactly four bars). Your sample region, visible on the right, will now be extended to four measures and the original loop remains its original length. Next, edit the envelope by drawing in a volume curve. I often use this trick to silence unwanted drum hits or parts of a sample, as well as to add variety to a static loop. For instance, I may cut a couple of notes out in measures one and two so that bars three and four add a bit of intensity. Keep in mind, this is a two-bar loop with a four-bar volume envelope working over the top of it. You can take this further by automating the sends, panning or any other ef-

fect parameter, as long as it is active on the given track. Better yet, any automation pattern can be cut, copied and pasted to any other clip or parameter.

DRAG TO REPLACE

This vanilla-sounding feature is easy to overlook; however, try it once and you'll be hooked. Here's how it works: Now that you have set up a volume curve, drag another two-measure drum loop from Live's browser to the previously edited loop's Clip View. All settings and envelopes on the original clip will now be superimposed onto the new clip. This tactic allows you to multiply your editing efforts. For instance, you have created a complex drum pattern with multiple Unlinked envelopes (as described above) and now you want to sample another drum sound with those same edits. By dragging your new sample to any point on the original sample's Clip View, even while the clip is playing, you will immediately hear a brand-new loop. Note: This drag-and-replace feature is different from Live Clip View's Replace/Locate Sample, which will swap out all copies of the clip in question throughout your Live set.

DUPLICATE (SIMULTANEOUS COPY AND PASTE)

By pressing Ctrl (Cmd) + D, you can duplicate almost anything in Live, be it a clip, loop, a group of loops or samples, or even the complex automation envelopes described above. You can also quickly copy and paste at once with this simple command. To duplicate a scene (a row of clips in Session View), hold down the Shift key along with Ctrl (Cmd) + D.

RE-PITCH MODE

When a clip is in Re-Pitch mode, Live ceases to apply its magical pitch correction (aka, warping) to your loop. If this sounds a little counterintuitive, then think of Re-Pitch



Ableton Live's Version 3 comes with new features, such as the Link/Unlink envelope.

mode as "old-school sampler" mode, where the clip changes pitch with regard to tempo. I use this mode as my default whenever I am recording into Live at the final project tempo. Live will then simply stream the recording from disc unaffected. I also use Re-Pitch to fatten up drum loops that are near the tempo I am working in. For instance, if a drum set loop is recorded at 95 bpm and I am working at 90 or 92, I will change the clip's mode to Re-Pitch, thus producing more punchy and slightly lower drum tones with absolutely no warping.

REWIRE WILDFIRE

At the risk of sounding obvious, I want to stress that if you have not tried linking Live via ReWire to Reason, Project 5, Orion, Logic, Pro Tools or any other ReWire application, you simply must do so now. (You've reached the end of this magazine, anyway!) It's as easy as opening your desired master application first, designating the future ReWire inputs and then opening your slave application. Ableton's Website (www.ableton.com) hosts several DAW-specific tutorials on how to set up ReWire. When running Live as the master, you can apply all of your VST effects to your ReWire slave application's tracks, as well as record the ReWire input for creative tweaking inside of Live. ■

The author would like to thank Dave Hill Jr., author of Ableton Live 2 Power! (www.brainboxing.net/abletonlive), for his help in writing this piece.

Embrace YOUR DAW

Pristine analog audio
from your Digital Audio Workstation

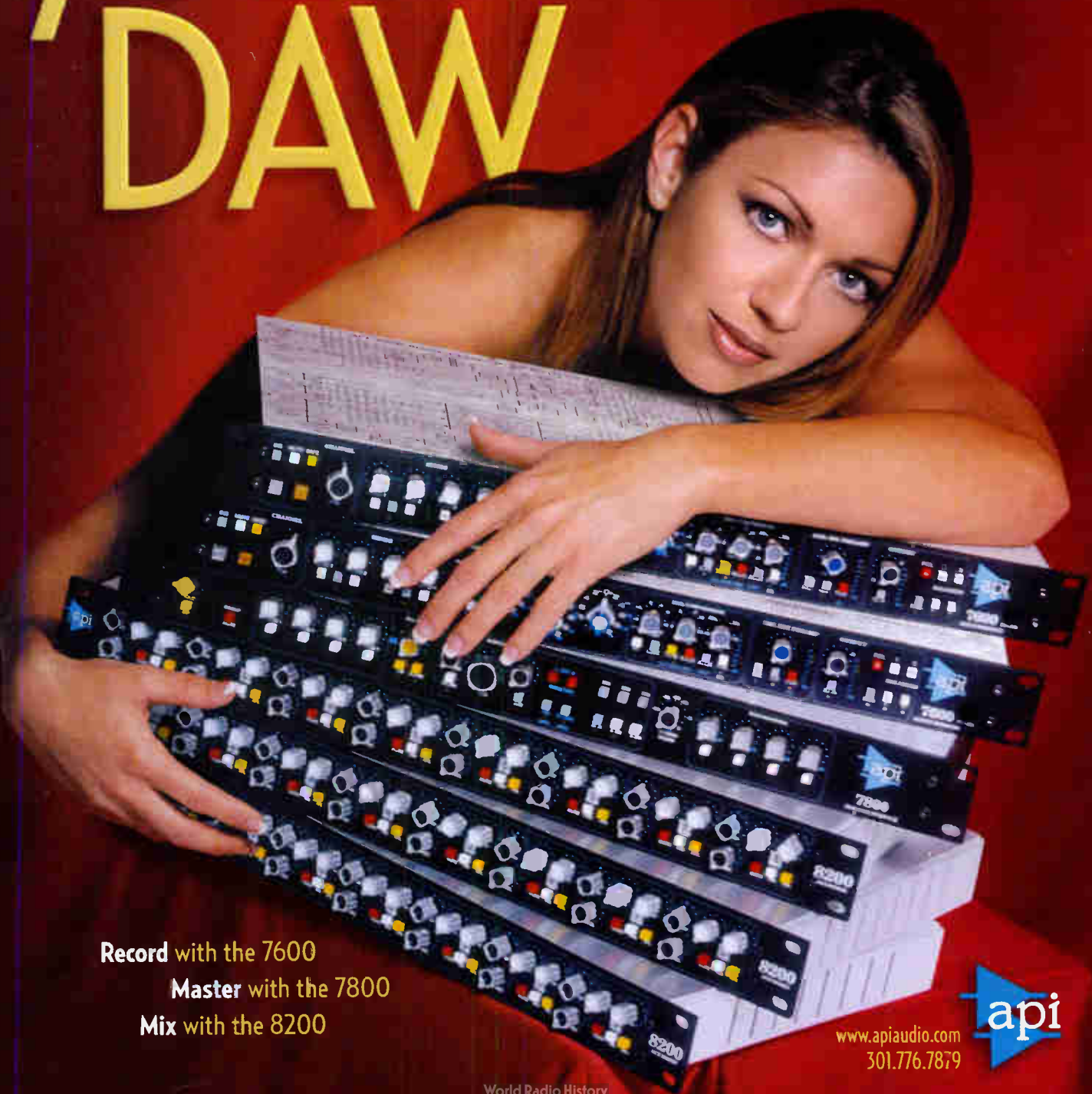

Record with the 7600
Master with the 7800
Mix with the 8200

www.apiaudio.com
301.776.7879



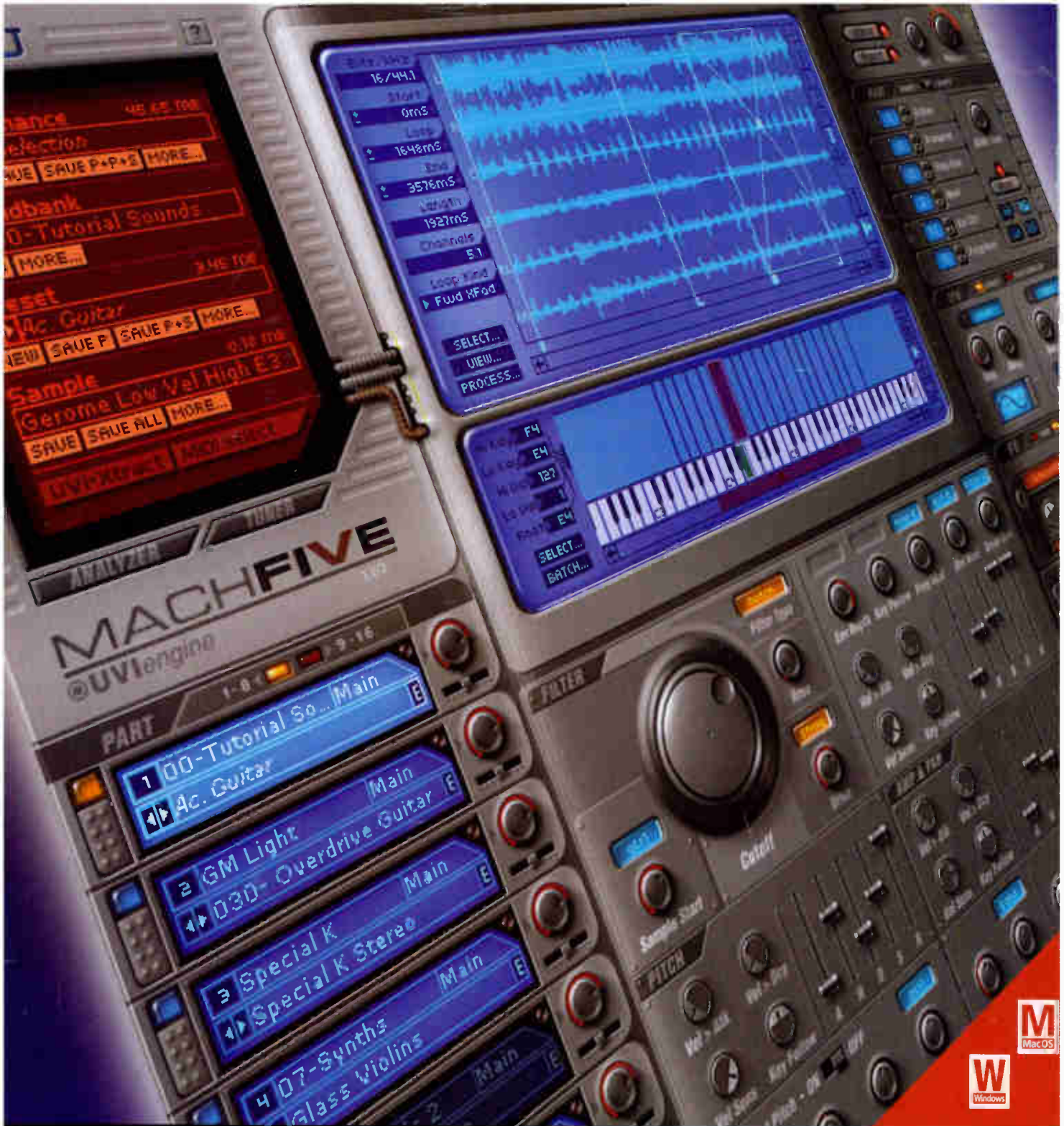

MACHFIVE

UNIVERSAL SAMPLER PLUG-IN

AU • HTDM • MAS • RTAS • VST • DXI



MOTU
www.motu.com

"A full-featured all-in-one
sound design environment."
— *Electronic Musician*



"The most powerful
sampler ever."
— *Future Music*

• Universal compatibility

Supports all major plug-in formats, host applications, soundbank libraries and sample formats, including REX, Acid, Wav, Giga, Sample Cell, Akai & Roland.

• Plug-in convenience

Open MachFive directly within your host software. Save all MachFive settings with your audio sequencer projects for 100% recall. No separate files or settings.

• Multitimbral operation

One instance of MachFive gives you 16 separate parts, each with assignable MIDI channel (for instant stacks) and separate audio output (if your host software supports this feature).

• Intelligent file management

Concentrate on the music, not file handling chores.

• Advanced real time waveform editing

Draw cross-fade loops while the sample plays in the context of your music. Apply destructive edits. Normalize, fade, reverse and process.

• Built-in effects processing

Dozens of effects are included. Save up to four effects with each preset as part of the preset. Work with a staggering 85 discrete effects paths and 136 effect slots.

• Subtractive synthesis engine

Work with six filter algorithms and three separate envelopes. Automate cutoff frequency, resonance and drive. Powered by the award-winning UVI engine.

• Support for surround and 192kHz audio

Design, load, edit and play 5.1 surround samples.

