

hi-fi music at home



devoted to hi-fi music from records, tape & FM radio

CAUTION!



Before fiddles start sounding like flutes...
switch now to "Scotch" Brand Magnetic Tape!

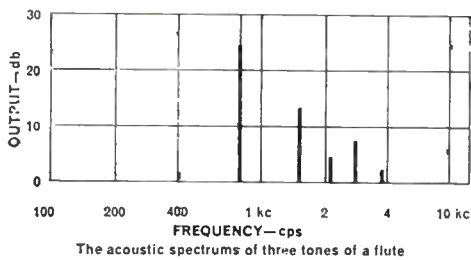

Acoustic spectrums of a flute tone (above) and fiddle tone (below), reproduced by a worn magnetic head, would look almost identical if the violin's high frequencies (shaded area) were lost by the worn head. Result is a lack of instrumental definition.

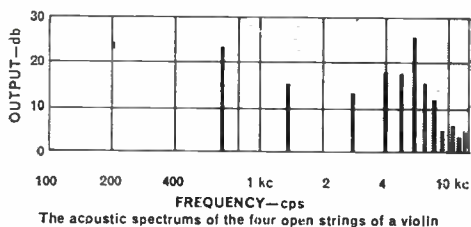

Don't blame your recorder when one instrument sounds like another. Your present magnetic tape may be causing this annoying loss of harmonics—wearing down your machine's delicate magnetic head until high frequency response is noticeably reduced.

Put an end to head wear by switching now to "SCOTCH" Brand Magnetic Tapes . . . the only tapes with built-in dry lubrication... permanent silicone lubrication. "SCOTCH" Brand Magnetic Tapes guard your recorder head from wear—pass over it so freely you'll never suffer loss of harmonics.

Treat your machine to a reel of "SCOTCH" Brand Tape soon—and hear what a difference it makes!

ONLY "SCOTCH" BRAND HAS SILICONE LUBRICATION



The term "SCOTCH" and the plaid design are registered trademarks for Magnetic Tape made in U.S.A. by MINNESOTA MINING AND MFG. CO., St. Paul 6, Minn, Export Sales Office: 99 Park Avenue, New York 16, N.Y. © 3M Co., 1957.

*when you measure perfection
in fine records...*

Mercury LIVING PRESENCE

sets the standard

NEW RELEASES:

**BARTÓK VIOLIN CONCERTO. YEHUDI MENUHIN;
MINNEAPOLIS SYMPHONY, DORATI. MG50140**

**GERSHWIN PIANO CONCERTO; RHAPSODY IN BLUE.
EUGENE LIST; EASTMAN-ROCHESTER ORCHESTRA,
HANSON. MG50138**

**RACHMANINOFF SYMPHONY NO. 2. DETROIT
ORCHESTRA, PARAY. MG50142**

**HINDEMITH SYMPHONY IN B-FLAT;
SCHOENBERG THEME & VARIATIONS;
STRAVINSKY SYMPHONIES OF WIND INSTRUMENTS.
EASTMAN WIND ENSEMBLE, FENNELL. MG50143**

**ALBENIZ IBERIA; FALLA LA VIDA BREVE DANCE.
MINNEAPOLIS SYMPHONY, DORATI. MG50146**

**HAYDN "MIRACLE" SYMPHONY; MOZART "HAFFNER"
SYMPHONY. DETROIT ORCHESTRA, PARAY. MG50129**



**TAPE-MEASURE, TOO. THE VERY NEWEST TRIUMPH OF HIGH FIDELITY...ASK YOUR DEALER TO
PLAY FOR YOU A MERCURY LIVING PRESENCE "SEEING-EAR" STEREOPHONIC TAPE RECORDING.**

PHOTO / HOCHMAN



NEW!

MODEL TPA/10 THE DISTINGUISHED TRANSCRIPTION TONE ARM

BY

Garrard

Some of the
significant questions
being asked about it
... and their
exciting answers

Q

How much is the
Garrard Tone Arm?

\$24.50

Is it built to give me
professional-quality
performance?



Yes... because this precision design, by incorporating the smallest number of pivots, reduces traversing friction to an absolute minimum. This also results in the least amount of wear and tear on records, through the use of spring-loaded, cone-type ball-bearing pivots... similar to those you will find in the finest chronometers. The vertical pivot is a specially-designed bearing, combining the features of a ball-bearing journal suspended on a single ball thrust.

What else is
"different" about
this Tone Arm?



Infinite versatility! It is the only tone arm which is fully adjustable in length and tracking angle. This means that with the Garrard arm, you can make every adjustment you would conceivably wish to make on a tone arm.

Why is it important
for me to be able to
set it to any length?

For two reasons: (1) You can set it for the longest position permitted by the space you have available now. (2) If you change the installation, you will be able to readjust this arm, keeping the important benefits of using a "longer" arm... playing a full 16" record.

Doesn't this require
changing tracking
angle?

Yes, of course. In fact, there are many opinions regarding optimum tracking angle for any given length.

How do I adjust the
tracking angle?

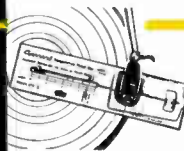

With the protractor which is supplied with the tone arm. In a few seconds, this ingenious accessory lays out the recommended angle on which to align the cartridge for the arm length you are using. Since there are various opinions regarding the optimum tracking angle at various radii, this protractor will also enable you to set the angle at any desired radius.

Will it take any
cartridge, and is it
easily installed?



Yes, the removable head will take just about any cartridge on the market. This tone arm is designed to be used with any transcription turntable, and adjusts easily for height and stylus pressure. The special templates supplied show you the exact mounting location. Incidentally, the instructions are the clearest and most complete we have ever seen with a tone arm.

Where can I see
the Garrard Tone
Arm, and how can
I recognize it?



It is at your high fidelity dealer, and you will certainly recognize it through its handsome appearance... glistening chrome with white enamel. Look for it in a distinctive blue and white box.

DEPT. GM-37 GARRARD SALES CORPORATION • PORT WASHINGTON, N. Y.



THERE'S A
Garrard
WORLD'S FINEST RECORD PLAYER
FOR EVERY HIGH FIDELITY SYSTEM



301
Turntable
\$89.00



RC98
Super Changer
\$67.50



RC88
Deluxe Changer
\$54.50



RC121
Mixer Changer
\$42.50



Model T Mark II
Manual Player
\$32.50

Milton B. Sleeper
Publisher

James Lyons
Music Editor

Shirley Fleming
Editorial Assistant

Elli Zappert
Art Director

William Leftwich
Photography

Mary Yiotis
Production Manager

Frederic R. Anderson
Circulation Manager

Contributors to This Issue

Ward Botsford
Jean Bowen
Herman Burstein
Warren De Motte
Leonard Feather
Shirley Fleming
P. Glanville-Hicks
Gary Graffman
Edward Jablonski
Alfred Kaine
Richard Kaye
C. J. Luten
James Lyons
George L. Mayer
Ruby Mercer
David H. Miller
Eleanor Morrison
Fred Reynolds
Abraham Skulsky
Milton Sleeper
Ruth Slenczynska
John J. Stern, M.D.
Harold Taplin

HI-FI MUSIC AT HOME* is published bimonthly by Sleeper Publications, Inc., Hi-Fi House, 105 E. 35th St. at Park Ave., New York 16. Telephone: MUrray Hill 4-6789. THIS OFFICE IS CLOSED FROM THURSDAY NIGHT TO MONDAY MORNING.

Subscription rates are \$5.00 per year 17 issues including the Hi-Fi Yearbook issue) or \$10.00 for 3 years (21 issues including 3 Hi-Fi Yearbook issues). Single copies 50¢ except for the Hi-Fi Yearbook issue which is \$2.00. Outside the USA, Canada, and the Pan American Postal Union, rates are \$5.00 per year, or \$13.00 for 3 years. Copies are mailed on the 10th of January, March, May, July, September, October, and November. Allow time for delivery by second class mail.

Editorial contributions and interesting photographs are welcome, and will be paid for upon publication. No responsibility can be accepted for unsolicited manuscripts, and they will not be returned unless they are accompanied by return postage.

Entered as second class matter at New York City, and additional entry at Concord, N. H., under the Act of March 3, 1879. Printed in the U. S. A. by Rumford Press, Concord, N. H.

The cover design and contents of HI-FI MUSIC AT HOME* are fully protected by copyrights, and must not be reproduced in any manner or form. Quotations are not permitted without specific authorization in writing from the Publisher.

* Registered U. S. Patent Office

Copyright 1957 by

Sleeper Publications, Inc.

Milton B. Sleeper, President and Treasurer

Ethel V. Sleeper, Secretary

EDITORIAL & CIRCULATION

105 East 35th Street at Park Avenue, New York 16

ADVERTISING

Charles Graham, 105 E. 35th Street, New York 16
Telephone MU 4 6789
Fletcher Udall, Hearst Bldg., San Francisco 3
Telephone Exbrook 2-5107
James Claar, 111 N. LaCienega Blvd., Beverly Hills
Telephone Olympia 2-0837

THIS ISSUE: OVER 37,500 COPIES



COMPLETE GUIDE TO HI-FI REPRODUCTION FROM
RECORDS, TAPE AND FM RADIO

CONTENTS

VOLUME 4 • NUMBER 4 • SEPTEMBER, 1957

SPECIAL FEATURES

Editorial: Audio League Report; a Change; FM up to Date
The Hi and the Fi 27 29

HI-FI MUSIC

LP's Build Reputations—Eleanor Morrison 30
Guide to Record Collecting—Gary Graffman and Alfred
Kaine 32
Orbit of a Chila Prodigy—Ruth Slenczynska 33
Tape Reviews and Ratings 34
Collectors' Corner 36

Record Reviews and Ratings

Orchestral Music 37	Keyboard 44
Concertos 40	Folk Music 45
Chamber Music 41	Miscellany 45
Opera 42	Jazz 46
Vocal 43	Popular Albums 47

HI-FI EQUIPMENT

Hi-Fi Home in Baltimore—Randolph S. Rothschild 48
Help! It Doesn't Work!—John J. Stern, M.D. 50
Hi-Fi without Complaints—Herman Burstein 51
How to Plan a Stereo System—Milton B. Sleeper 52
Workshop Project No. 14: The Regency Amplifier—
Harold Taplin 56
"Inside Information" on Commended Designs 58

DEPARTMENTS

Records, Tape, and FM Radio 4
Advertisers Index 79
Buy, Sell, and Swap 80
Information and Subscription Service Facing 80

COVER As far as we know, Elli Zappert is the first artist to produce covers for a magazine in the hi-fi group. This time, we gave her what we realized afterward was an almost impossible task. We asked for a cover representing her impression of an audio show. And what is an audio show without speakers at work? Nevertheless, we think she got the idea across. Don't you?





Eugene List
makes his tape recordings on



That alone is not the reason
why you should use



Here's why you should use



It's the best-engineered tape in the world... gives you better highs... better lows... better sound all around! Saves your tape recorder, too - because the **irish** FERRO-SHEEN process results in smoother tape... tape that can't sand down your magnetic heads or shed oxide powder into your machine. Price? Same as ordinary tape!



Available wherever quality tape is sold.
ORRadio Industries, Inc., Opelika, Alabama
Export: Morhan Exporting Corp., New York, N.Y.
Canada: Atlas Radio Corp., Ltd., Toronto, Ontario



Hi-Fi Shows

Dates are now being set for fall and winter shows. The list below will be supplemented in future issues as fast as information is received.

- CHICAGO, Palmer House, Sept. 13-15.
- CHICAGO, Morrison Hotel, Sept. 17-21.
- CINCINNATI, Sheraton-Gibson Hotel, Sept. 20-23.
- BOSTON, Hotel Touraine, Oct. 18-20.
- MIAMI, McAllister Hotel, Oct. 18-20.
- NEW YORK, New York Trade Show Building, Oct. 7-12.
- PORTLAND, ORE., Multnomah Hotel, Nov. 1-3.
- SEATTLE, New Washington Hotel, Nov. 8-10.
- ST. LOUIS, Statler Hotel, Nov. 22-24.
- WASHINGTON, D. C., Shoreham Hotel, Mar. 14-16.

Noise on Tape

There is every reason to expect recorded tapes to be as free from background noise as the very best discs. Yet some of the new tapes sent to us for review have been decidedly unsatisfactory in that respect. One tape even had an irregular sort of heart-beat effect from start to finish.

Ray Bohnert

A subscriber in Medford, Wisc., suggests: "Since there is renewed interest in FM radio and hi-fi music now that the novelty of TV has worn off, it should be noted that outside TV antennas of the all-wave type can be used for FM reception. It saves putting an additional antenna on the roof, and may help to keep the landlord happy. Regular FM antennas are better, of course, but millions of TV antennas can be put to additional use on FM sets."

American Airlines' Stereo Show

Carried on KCBS San Francisco, KNX Los Angeles, and WCBS New York. For exact schedule, write the stations.

Continued on page 8

JOIN THE 
**STEREOPHONIC
MUSIC SOCIETY**
and enjoy
these
benefits...

- MAXIMUM SAVINGS ON STEREOPHONIC TAPES
- NO MINIMUM PURCHASE REQUIREMENT
- IMMEDIATE SHIPMENT FROM MOST COMPLETE STOCK ANYWHERE
- CATALOG OF STEREO TAPES DISTRIBUTED QUARTERLY

plus

**4
STEREO
TAPES
FREE**

S.M.S.'s 1st anniversary new membership bonus gives you almost 1 hour playing time . . . featuring highlights from the superb stereo recordings of Concertape, Livingston, Omegatape and Replica, attainable only through S.M.S.

**ALL FOR
\$9.00 FULL YEAR
MEMBERSHIP**

Use this handy
application
form:

TO: STEREOPHONIC MUSIC SOCIETY, INC.
303 Grand Avenue, Palisades Pk., N. J.
Please enroll me for a 1 year period as a member of the Stereophonic Music Society. I understand that I am under no obligation to purchase any specified minimum of tapes under the Society's Group Purchase Plan. I am to receive the S.M.S. 1st Anniversary Bonus of 4 stereo tapes by return mail, as well as quarterly listings of all stereophonic tapes currently on the market.

My Check for \$9.00 is enclosed herewith (payable to the Stereophonic Music Society, Inc.)

NAME

ADDRESS

CITY.....ZONE.....STATE.....

MAKE OF RECORDER.....

Stereophonic Staggered
 Stacked Monaural

Please send additional information concerning the Society.

WESTMINSTER'S

20

FOR SEPTEMBER ONLY



%

FESTIVAL OF RECORD VALUES

OFF

...on all records
in the current
Westminster Catalog

Here's a unique opportunity for you to stock up on the records you need — at substantial savings.

Westminster's September Festival of Record Values offers you your choice of all the fine records in the Westminster catalog — at 20% off the regular price.*

You can make your selection from a wide range of music including symphonies, concertos, sonatas, chamber music, choral works, opera, folk and popular music and striking instrumental combinations.

If you know Westminster, you'll hurry to your dealer and stock up while the sale lasts. If you've never heard the natural balance, the dynamic range — the richness of Westminster recordings — then you owe it to yourself to buy them for a new exciting experience in record listening.

**Sale does not include Samplers and "Specials".*

If your dealer cannot supply you with the Westminster catalog or records, write to Westminster Recording Sales Corp., 275 Seventh Avenue, N. Y. C.

Dept. M-9.



Westminster's catalog is not just a routine listing of records. It is, in its own special way, a treasure trove for the music lover.

Not only is it one of the most complete catalogs in the record world — but it contains recordings which have made history throughout the music world.

For instance, Westminster's recording of "THE MESSIAH" — just one of the more than 1,000 classical masterpieces listed in the catalog — is regarded as the definitive recording of this great classic.

As you look through the catalog, you'll discover how extraordinarily complete it is. You'll find, for example, the complete symphonies of Beethoven, Brahms, Mozart, Schumann, Tchaikovsky, Haydn (London Symphonies). Westminster's is the only catalog which contains the complete chamber music of Mozart, Schubert and Beethoven. And you'll find complete works in all important classical categories. You'll discover — if you haven't already — the famous Laboratory series. These recordings are the ultimate in high fidelity sound. If you've never heard one, you've never heard perfection.

Westminster's test and demonstration records have been cited time and time again by the leading high fidelity critics as indispensable for testing high fidelity equipment in the home. The truly remarkable range of this catalog even covers such unique adventures in sound as "Soundproof" and "Soundblast".

In short, you'll find the Westminster catalog not simply a cold listing of titles — but rather a guidebook to the greatest in recorded music.

Be sure you get your catalog from your dealer — or (see opposite column) write directly to Westminster.

NEW!

10 BRILLIANT STEREOS FROM RCA VICTOR,



ACS-54, \$6.95.



BCS-52, \$8.95.



CCS-53, \$10.95.



DCS-51, \$12.95.



ECS-67, \$14.95.

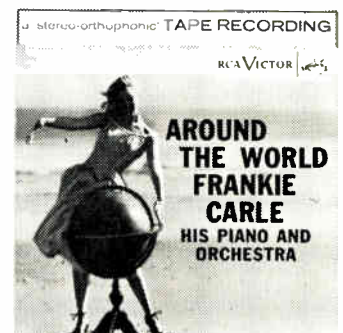

CPS-70, \$10.95.

FREE! the first complete catalog in RCA Victor's recorded tape history! Up-to-date, handy, and easy-to-read, this catalog gives detailed listings of the entire RCA Victor tape repertoire. Get one at your RCA Victor dealer's or in a new RCA Victor tape package today!





From:
Scott D Schaub
 11 E Univ Ave
 Furniture Lounge
 Champaign , IL 61820-4007
 United States
 (217) 418-5388

www.furniturelounge.net

Ship to:
David Gleason
 80960 Bellerive
 La Quinta , CA 92253-5647
 United States

Invoice / Packing Slip

		Order #	Date	Record #	
		27-06401-93771	Jan-13-2021	10217	
Quantity	Item #	Picture	Item Name	Price	Subtotal
1	192913690317		1958 HI-FI Music AT HOME Audiophile Stereo Magazine 50's drum design mcm Zappert	\$14.00	\$14.00
1	192913697727		September 1957 HI-FI Music AT HOME Audiophile Stereo Magazine 50's mcm Zappert	\$14.00	\$14.00

Subtotal: \$28.00
 Shipping & Handling (USPS Media Mail): \$6.66
 Seller discounts (-) or charges (+): \$0.00
Total: \$34.66

Thanks so much for your business! Please be sure to check out our website @ www.furniturelounge.net. Any problems or questions....Please contact us at furniturelounge@sbcglobal.net or call 217-418-5388

THE GREATEST NAME IN RECORDED TAPE!

RCA VICTOR adds 10 *new* titles to the world's most extensive library of pre-recorded tape! From the glittering bravura of Ibert to the lush romance of Tchaikovsky, from the nostalgic piano stylings of Frankie Carle to the smooth vocal blending of the Ames Brothers, here are dual track stereo tapes that rival the sound of live, in-person performance.

With this new release, RCA Victor gives you your choice of 54 stereo tapes, more than 100 monaural tapes, all in brilliant New Orthophonic High Fidelity Sound! Handsomely boxed in album style, complete with liner notes, these tapes come on standard 7-inch reels for all lengths, each clearly labeled for instant identification.

The world's greatest artists . . . the greatest advances in sound . . . the widest range of selections—RCA Victor brings you *more* on tape!



CPS-73, \$10.95.

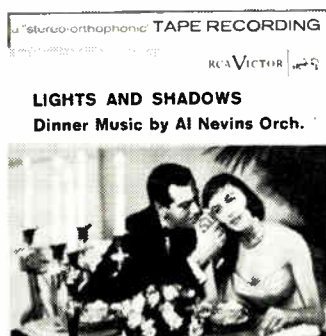

CPS-74, \$10.95.

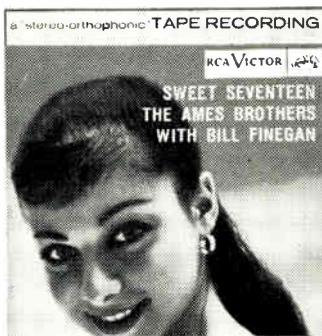

CPS-75, \$10.95.

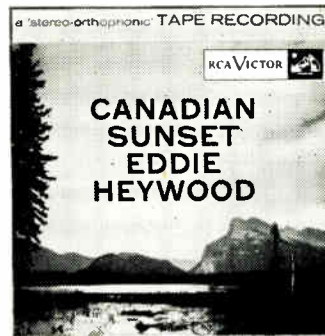

CPS-76, \$10.95.



RCA VICTOR
TRADE MARK RADIO CORPORATION OF AMERICA



Nationally advertised prices

September 1957

Largest
Tape
Treasury
in
STEREOPHONIC

STEREO DANCE FESTIVAL
Spectacular arrangements of such favorites as La Cumparsita, Moonglow, Limelight, etc. in brilliant stereo recording.
Livingston 719 BN

STRAUSS IN STEREO
Vienna State Opera Orch. perform The Emperor Waltz, Fire Festival and other selections.
Livingston 721 BN

A STRAUSS-OFFENBACH BOUQUET
Orpheus in the Underworld Overture, New Pizzicato Polka, etc. by Vienna State Opera Orch.
Livingston 722 BN

THE NEW YORK JAZZ QUARTET GOES NATIVE
A remarkably incandescent foursome in stereo.
Elektra EL 7-7 BN

RENDEZ-VOUS WITH OFFENBACH
Well-loved excerpts from Tales of Hoffmann, Beautiful Helena, etc.
Livingston 720 BN

CONTINENTAL BANDSTAND
A sparkling recording reminiscent of outdoor concerts — in traditional Viennese style.
Livingston 718 BN

EDI CSOKA — GYPSY MAGIC
All the grace, charm and verve one expects of authentic Gypsy music.
Livingston 723 BN

DANCING WITH CHAUNCEY GREY TO THE MUSIC OF GERSHWIN
A new Stereo treatment . . . continuous dancing.
Riverside RT 7-14 BN

THE JAZZ MESSENGERS
Pulsating jazz with a driving beat and modern ideas.
Elektra EL 7-8 BN

KENNY DORHAM: JAZZ CONTRASTS
With Sonny Rollins, Max Roach, Oscar Pettiford and Hank Jones collaborating on an interesting and varied program.
Riverside RT 7-19 BN

and ANNOUNCING VOLUME 2 BY LIVINGSTON . . . containing complete selections and excerpts from the newest Livingston releases. A real stereo festival. LS 5-4 BN

5" STEREO \$6.95

Yours to choose and enjoy — from Bach to "Pops" — on such famous independent labels as:

- ELEKTRA
- EMPIRICAL
- BOSTON
- ATLANTIC
- RIVERSIDE
- ESOTERIC
- LIVINGSTON

ALL LIVINGSTON tapes are splice-free, fully guaranteed and packaged in attractive individual boxes.

STEREO, Stacked or Staggered (1200', 7" reels) \$11.95

Audition LIVINGSTON tapes at your High Fidelity — Audio Dealer or Record Shop. Send for our complete catalog, and the name of your nearest dealer.

NEW RELEASES

STEREOPHONIC

LIVINGSTON

LIVINGSTON AUDIO PRODUCTS CORP. Box 202 CALDWELL, N. J.

power output would be about 0.0005 acoustic watt. To keep distortion within limits, the power output must be sacrificed.

"The remedy lies in 3 attacks: 1) providing horn loading so the diaphragm can produce its power at higher pressures and lower amplitudes and velocities of motion; 2) the use of a corner, whereby the mirror images produce larger effective radiating surfaces and smaller motional amplitudes; and 3) dividing the frequency spectrum into at least two ranges."

This is an argument in favor of the electronic network so that low and high frequencies can be separated at the low-level output from the preamp, and then amplified in separate amplifiers.

Stereo Recorder-Playback

The new Ampex 601-2 is a stereo version of the famous portable 601 monaural unit. The 601-2 is a beautiful job, one that a lot of stereo enthusiasts will gladly give their eye teeth to own. Probably some of them will almost have to, for the price is \$995. But it is a handsome machine to own and operate.

New IHFM Headquarters

Office of the Institute of High Fidelity Manufacturers, Inc. is now at 125 E. 23rd Street, New York 10. Telephone number is Algonquin 4-3532. Newly appointed executive secretary is Edwin Cornfield.

New FM Program Plan

All four Westinghouse FM stations are to be programmed separately from their AM counterparts, in accordance with a new plan announced by Donald H. McGannon, president of WBC. The change was made at KDKA-FM Pittsburgh and KEX-FM Portland, Ore. last August. This will be done at WBZ-FM Boston and KYW-FM Cleveland as soon as their transmitters are moved to new locations and new facilities are installed. For the present, the stations will operate from 4:00 P.M. until midnight.

Interesting Things for You

A pocket-size booklet from Leslie Creations carries this novel introduction from Jack Leslie: "We like to think that we're contributing in a small way to living the good life at home, by rounding up a few things devoted to casual living that are somewhat off the beaten path, and presenting them to you in this little catalog." And he really rounded up some intriguing items that make the catalog worth a postcard request. Address is Lafayette Hill, Pa.

It's Still Not Stereo

From Dr. Howard G. Laskey, of Carolina, R. I., this letter: "Mr. Sleeper wrote a good article in the April issue about stereo. However, I cannot agree with him that 'Stereo by Holt' can be compared with a Brownie camera.

Continued on page 15

RECORDS, TAPE, AND FM

Continued from page 4

Listening Vs. Looking

According to current Sindlinger "Activity" reports, TV looking is currently down, while radio listening is up. In fact, it seems as if a definite trend toward radio and away from TV has set in. FM is credited for part of this shift.

Distortion in Speakers

This communication from Paul (Cornerhorn) Klipsch: "When a loudspeaker diaphragm is vibrating at large amplitude at some low frequency, say 50 cycles, and simultaneously is radiating some higher frequency, say 5,000 cycles, the higher frequency is caused to flutter. As a car horn appears to change pitch as the car

passes the observer, so the pitch of the upper frequency changes as the cone motion at a lower frequency moves the source of the high frequency. When the cone motion at 50 cycles is 0.04 in. amplitude (0.08 in. total excursion) the flutter effect is about 1%, a figure considered just barely tolerable in good tape machines which are truly rated for wow and flutter.

"In 1943 Beers and Belar wrote a paper entitled 'Frequency Modulation Distortion in Loudspeakers' for the *Proceedings* of the Institute of Radio Engineers. They showed distortions of the order of 50% for ordinary magnitudes of cone motions for two frequencies.

"Since it would take about 2.8 ins. excursion for a 10-in. piston radiator to produce one acoustic watt at 30 cycles, it follows that for 0.06-in. excursion the

Louis
"Satchmo"
Armstrong

sounds of
our time are
timeless
on

SOUNDCRAFT TAPES

with MYLAR* BASE

Ageless "Mylar" base and ageless plasticizer-free Soundcraft oxide coating — these are the reasons why lifelike sound is yours forever, only with Soundcraft "Mylar" base tapes. Because no other tapes offer comparable quality, a Soundcraft product is inevitably the choice of those who immortalize historic events, masterworks in music, or the sound in a great CinemaScope film! When you record sounds worth saving... enjoy their re-creation... their re-living... on Soundcraft "Mylar" base tapes! Write for free booklet Buy these Soundcraft tapes:

PLUS 50 - 50% longer play— PLUS 100 - twice as much on a reel — LIFETIME - guaranteed for life

© 1957 Reeves Soundcraft Corp.



REEVES SOUNDCRAFT CORP., 10 E. 52 St., N. Y. 22, N. Y., West Coast: 338 N. LaBrea, Los Angeles 36, Calif.

The World's Most Extensive

Now you can select your Jensen loudspeaker

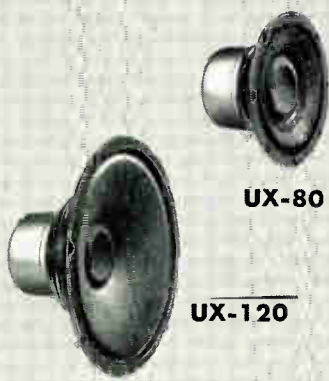

New Performance Levels in New Price Ranges

UNAX* SINGLE ELEMENT



The new Jensen UX Series provides a new high in single-cone single voice coil loudspeakers at unusually low cost, actually outperforming comparable (and even more complex) units selling for much more. A listening test will convince you that this is a maximum value buy in hi-fi listening pleasure.

Of course, there are special design elements that enable us to give so much for so little. The cone is artfully dual acting, the center sector operating effectively for unusually extended highs, while the whole moves to reproduce the lows.

Withal, there is superb balance and cleanliness. And, if you choose, you can step up performance later with the inexpensive KTX-2 Step-Up Kit which substitutes a compression driver tweeter for the top.

UX-80. 8-in. Speaker. Net \$14.50
UX-120. 12-in. Speaker. Net \$19.50

DUAX* 2-ELEMENT SYSTEMS

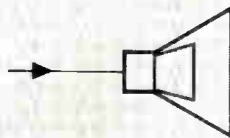

A step-up in the reproduction scale is the DX Series in which two carefully coordinated cones are driven by one voice coil. (Some call these "coaxials," but we reserve the name for still more elaborate systems and higher performance.)

The separate auxiliary radiator gives the designer a chance to attain a wider frequency range than with a single cone (albeit dual acting as in UX Series). The result is, with low cost, additional performance and added listening pleasure. We know of no similar speakers with equal sound, none with as high efficiency or as low distortion at anywhere near DX Series cost. Again you can step-up performance easily at anytime with KTX-2 Kit to substitute high-order compression driver tweeter operation at the high end.

DX-120. 12"; 1-lb. mag. Net \$25.50
DX-150. 15"; 1-lb. mag. Net \$35.50

COAXIAL 3-ELEMENT SYSTEMS

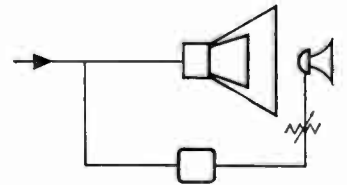

Still better than the "all paper" system with single voice coil is the use of a compression driver tweeter for the highs. The least expensive way to do this is to nestle a super-tweeter coaxially inside the cone; it must cross over high in the frequency scale at 3500 to 4000 cycles. The third element is the diffusion radiator which shapes and disperses middle-high response. (Some call such speakers "Triaxial," though Jensen alone is entitled to use this registered name, applied by us to true 3-way speakers only.) Again, we guarantee more and better sound, cleaner hi-fi at lower cost, than all comparable speakers. And you can step up performance correctly and impressively with a real C.D. horn 600-4000 cps mid-channel (KTX-3 Kit) that leaves you with a *real* 3-way system.

12" Models. CX-120* \$49.50
CX-225 \$59.50
15" Models. CX-150* \$66.50
CX-255 \$76.50

*Denotes 1-lb. magnet; others 1 3/4 lbs.



SELECTING A HI-FI SPEAKER? YOU'LL WANT THESE HELPFUL, INFORMATIVE BOOKS

"How to Select a High Fidelity Loudspeaker." A comprehensive, authoritative manual covering all types of high fidelity loudspeakers and systems, their operating principles, performance and relative advantages. 24 pages, profusely illustrated. Write for Manual 1061. Price 25¢.
"Guide to Jensen High Fidelity Loudspeakers." Complete specifications and detailed descriptive information on all Jensen high fidelity loudspeakers and accessories. 24 pages. Send for Brochure 1021. Price 25¢.



High Fidelity Loudspeaker Line

from this new complete range of types and sizes.



... All with Traditional Jensen Quality

COAXIAL 2-WAY SYSTEMS

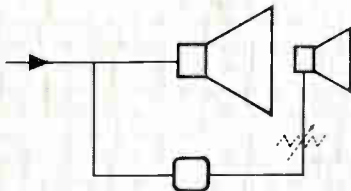

By using two completely independent (but carefully coordinated) speakers, each with its own magnetic system, voice coil and cone, the true two-way system spans the frequency range to obvious advantage in smoothness and extent, cleanness, low distortion and uniformity of angular dispersion.

Coaxial mounting makes them a convenient unitary package. Please note that we at Jensen use the term "coaxial" only in referring to a speaker with two completely independent systems.

Lowest in cost in the Jensen coaxial family is this fine group of speakers employing "cone" type direct radiator units for both tweeter and woofer. Available in 8, 12 and 15-inch models, they provide a maximum of value in true two-way system speakers.
K-80. Coaxial, 8-in. Net \$16.75
K-210. Coaxial, 12-in. Net \$27.50
K-310A. Coaxial, 15-in. Net \$39.75

The highest type of performance in the coaxial two-way loudspeaker is attained by the use of a compression-driver horn-loaded tweeter for the high end. When properly designed, there results an outstanding clarity, realism and instrumental separation not achieved by lesser designs. By adopting the expensive "thru bore" construction, the tweeter horn can be made long enough to operate at the lowest practicable crossover frequency, a very desirable feature for the very best sound.

In this manner, the very popular Jensen H-222 and H-520 give you the "tops" in fine coaxial performance. Crossover is at 2000 cycles. Though many will see no need to, you can step-up performance to full three-way with KTX-1 Range-Extender Supertweeter Kit.

H-222. Coaxial, 12-in. Net \$62.50
H-520. Coaxial, 15-in. Net \$79.50

TRIAxIAL* & TRIAX* 3-WAY SYSTEMS

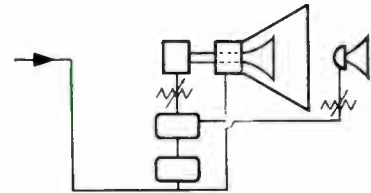

The true three-way speaker system divides the range in three parts with three electrically and acoustically distinct and independent elements, each designed to perform near-ideally in its portion of the range.

The famous G-610A TRIAXIAL was the first (and until our new G-600), the only speaker made in accordance with this concept! It employs a heavy woofer and two compression driver horn-loaded elements for m-f, and h-f channels. (The woofer cone acts as the final section of the m-f horn.) Its performance is so outstanding that it easily rates as the world's most wanted hi-fi speaker.

Now, for those who would like a G-610A, but are dissuaded by the price tag, Jensen announces the new lighter, less expensive G-600 TRIAX with similarly outstanding features and performance.

G-610A. Triaxial, 15". Net \$252.75
G-600. Triax, 15". Net \$129.50

Jensen MANUFACTURING COMPANY
 6601 South Laramie Ave., Chicago 38, Illinois

SEND FOR FREE DATA SHEET 165-B

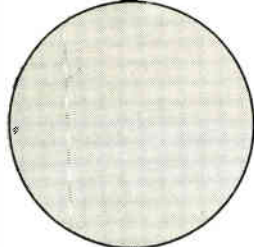

the **FINEST** on **TAPE!**

**IN-LINE
(Stacked)
STEREOPHONIC
ONLY**

RECORDED TAPES - All Brands and Issues.
Shipment from Stock the Same Day
at Lowest Prices Available.

WE PAY POSTAGE to your door.

BLANK TAPES for Highest Quality Recording.

TAPE EQUIPMENT - All Quality Hi-Fi Components.

COMPLETE LINE AMPEX STEREO SYSTEMS.
Audio and Professional.

Send for Free Catalog and Prices

Tape House is the first and only source devoted exclusively to supplying Tapes (both blank and recorded) and Tape Recording Equipment.

In ordering by mail it is possible for you to have selections when you want them — without delays or back ordering. All Tapes delivered **POSTAGE FREE** in original manufacturers package unopened. **WE PAY THE POSTAGE.**

WHEN ORDERING specify Tapes by name and number. Stereophonic only—In-Line Heads. Enclose check or money order. Sorry, No C.O.D.'s.



new dimensions in sound

The Tape House

228 Crissey Street
P.O. Box 150, Geneva, Ill.

MAIL THIS COUPON NOW:

THE TAPE HOUSE
P.O. Box 150, Geneva, Illinois

Please send me your free catalog of tapes, prices and recommended "Best of the Year."

name _____

address _____

city _____ zone _____ state _____



Electro-Voice®

INCOMPARABLE PATRICIAN IV HIGH FIDELITY'S FINEST

Patrician IV four way performance achieves true high fidelity. You can hear it. You can see it. You can have it in your home. Thrill to Electro-Voice high fidelity.

Octaves
and Frequencies



Model T350
VHF Driver



Model T25A
HF Driver with
Model 6HD Horn



Model 828HF
Drivers with
A8419 Horns



Model 18WK
LF Driver



The Patrician IVB Similar to Patrician IV but with new T3500 Ionovac ionized air VHF driver. Shipping Weight 400 lbs. Mahogany Complete—Net \$1060.00. Blonde Lined Oak or Walnut Complete—Net \$1085.00.

Low-Bass Section Employing the Klipsch principle of folded corner-horn loading, the new Patrician IV utilizes an 18-in. low-frequency driver, Model 18WK. The taper rate has been extended to 35 cps. The first three octaves, to the first crossover point at 200 cps, are reproduced by a tremendous bass driving section . . . the largest, most highly developed ever designed for a home audio system. When the Patrician is placed in a corner, the entire room becomes part of the bass horn, allowing the large wave lengths of the second and the upper part of the first audible octave to be formed properly.

Mid-Bass Section A separate horn employed as an indirect radiator with its two complementary Model 828HF driver units takes over for only the next 1½-octave range to 600 cps. Because no metal horn presently developed satisfactorily reproduces down to 200 cps, the horn load for the intermediate bass drivers is fabricated of wood and phenolic tubes. These are a part of the overall interior assembly.

Treble Section From 600 to 3,500 cps or the next 2½ octaves, the Electro-Voice Model T25A treble driver exhausts into a 600-cycle Model 6HD diffraction horn. This diffraction horn is the latest design and employs the principles of optical diffraction to disperse high frequencies uniformly, without the losses typical of cellular and lens type horns. Thus, the important "presence" range is assured of complete and proper transmission by this specialized driving unit. Other frequencies, not a part of this range, are completely excluded from this driver.

Very-High Section The range above 3,500 cps, extending beyond the range of hearing, is reproduced by the Model T35 Super-Sonax very-high-frequency driver. This driver, a recent Electro-Voice development, utilizes an integral diffraction horn. Through the Model T35, the remaining octaves of the upper audible register are completely accomplished with practically no measurable distortion.

Crossover Network To allocate the various portions of the spectral energy to the respective driver units, the Model X2635 crossover network divides the amplifier power into four separate portions, and eliminates upper harmonic and intermodulation distortion from one driver in the region covered by the next.

This is the famous Electro-Voice Patrician IV speaker system and enclosure, an indirect radiator folded corner horn system for covering the lowest bass region, and using multiple integrated compression drivers for direct radiation of the upper 7 octaves with four-way speaker system. Other Electro-Voice speaker enclosures of the superior indirect radiator type are the Georgian IV, the Centurian IV and the new Cardinal.

The Patrician IV

Complete 4-way speaker system in custom-crafted corner cabinet for very finest in reproduction. Divides audio spectrum between four drivers, each specifically designed for distortion-free fidelity. Entire system wired and installed in cabinet of selected woods. Heirloom finish in exquisite hand-rubbed mahogany, walnut or blonde lined oak. Special models available to custom-finish specifications at higher price. Size 62" h., 39" w., 29" d. Shipping Weight 390 lbs. Mahogany Complete—Net \$970.00. Blonde Lined Oak or Walnut Complete—Net \$996.00.

See your Electro-Voice Distributor. For facts about high fidelity, write for Bulletin H79-

Electro-Voice

ELECTRO-VOICE, INC. BUCHANAN, MICHIGAN

Export: 13 East 40th Street, New York 16, U.S.A. Cables: ARLAB

NOW

only with the new

STUDIO

PHONO REPRODUCER

PRICE \$79.50

THOUGHT THIS NEW

You can obtain superb fidelity—with a new 0.7 mil radius Diamond stylus—at one gram tracking force!

You can completely avoid accidental scratching of your records—and practically eliminate record and stylus wear!

You don't have to worry about groove jumping or leveling turntables! You obtain the silk-smooth action of a fully jeweled bearing movement!

You obtain the low distortion of a dynamic pickup with the ruggedness and convenience of a magnetic pickup!

The exceptional performance and remarkable features of this revolutionary new Shure Studio Dynetic cartridge and arm assembly are reflected in the data shown below.

1 GRAM TRACKING—0.7 MIL RADIUS NEEDLE

The new Studio Dynetic tracks at only 1 gram! This is 1/6 of the usual tracking force—It makes it possible to use the new 0.7 mil radius diamond tip needle, compared to the usual 1 mil radius—which affords a remarkable improvement in fidelity over conventional high fidelity reproducers. The 1 gram force also means that the record will not scratch if you accidentally slide the arm across it. Your mint LP's stay that way . . . no matter how often you play them.

BALANCED DESIGN

The Studio Dynetic Phono Reproducer is fully balanced about a ruby pivot on its vertical axis. This means that there is equal mass on both sides of the pivot. The cartridge is mounted on a low-mass beam provided with two sleeve-and-cap ruby bearings of amazing strength and negligible friction—with counter balance adjustment of 1-2 grams. When something causes vibration—be it motor board rumble or heavy-footed people walking by—the balanced design causes the vibration in the front part of the

arm to be compensated for in the back, thus *cancelling it out!* Balanced design, combined with low mass cartridge mount, means that the Studio Dynetic at 1 gram is far more stable than most high fidelity reproducers at 4-6 grams.

BALANCED DESIGN AND THE LAW OF GRAVITY

When you use the Studio Dynetic, you don't have to worry about leveling your turntable. Balanced design compensates for the law of gravity, and keeps the stylus perfectly in position, even if you tilt the motor board while the record is playing. Yes, and you also get fine reproduction from your warped records.

PERFECT FIDELITY WITH PERFECT CONVENIENCE

The Studio Dynetic phono reproducer was designed with your convenience in mind. Exclusive push-button groove selector helps you find the desired groove on the record—avoids the possibility of damage! The stylus can easily be replaced by the user. Adequate output eliminates the need for transformers—will provide full volume from your present high fidelity equipment.

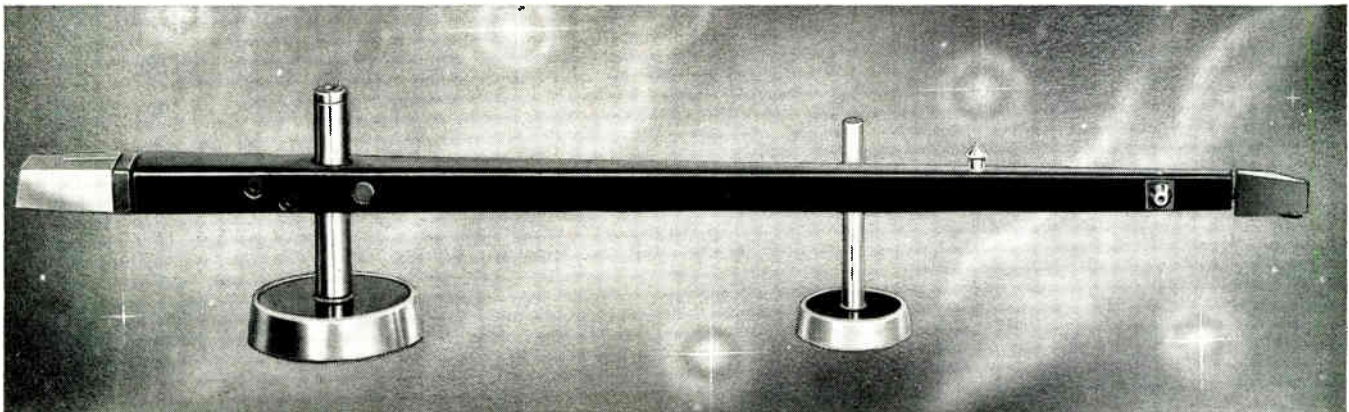

WHY HAVEN'T WE SAID ANYTHING ABOUT FREQUENCY RANGE?

Because we felt these other features—being unique to the Studio Dynetic—had more interest. If we didn't have these unique features to talk about, we could still talk about the exceptional performance of the Studio Dynetic. The Studio Dynetic has a Laboratory Verifiable frequency range from 20 to 20,000 cycles per second, plus or minus 2 db, with measurable response to 30,000 cycles! Its straight line shape reduces arm resonance to an absolute minimum; and its Dynamic Damping eliminates "boom," low frequency rumble, and motor noise. Its "groove oriented" stylus gives an optimum tracking condition. Its high vertical compliance and low needle-tip mass practically eliminate "needle talk". For truly high fidelity performance the Studio Dynetic is your best buy.

For reprints of informative published articles, write to attention of the Sales Department.
See your hi-fi dealer for a demonstration of this amazing unit.

SHURE

The Mark of Quality

41 IN ELECTRONICS SINCE 1925

SHURE BROTHERS, INC., 218 HARTREY AVENUE, EVANSTON, ILLINOIS

RECORDS, TAPE AND FM

Continued from page 8

"There is no space for me to engage in semantics of what stereo is or is not. All hi-fi is an illusion of live music. Anything that improves this illusion has its place. I have heard adverse comments many times by 'experts' that the Holt Stereo was just another sales notion. But none of them had heard one! Since it is sold on a trial-and-money-back basis, I bought one. It is a superb and very wonderful addition to my system. It has to be heard to be believed.

"I added this 'Holt Stereo' circuit, plus two \$9.90 8-in. speakers, as recommended by Mr. Holt, to a 60-watt McIntosh amplifier, McIntosh preamp, Fisher FM tuner, Rondine turntable, and 13 Bozak speakers in a 16-ft. infinite baffle.

"All listeners agreed that the sound improvement is superb. I thought I had something before the addition of the 'Holt Stereo'. Now one cannot tolerate listening without it. Also I saved a good monaural source of excellent records from limbo and saved the expense of duplicating this high-grade equipment right down the line.

"I hope that you will publish the letter in justice to Mr. Holt. I would be glad to demonstrate this to Mr. Sleeper at any time if he is in this vicinity."

Comment from M.B.S. — The article in our March-April issue did not refer to the *performance* of the Holt equipment. No matter what degree of improvement is obtained by Holt, it does not alter the fact that the separate reproduction of two tracks, recorded by separate mikes and audio channels, is specifically implied in any installation described as a "stereo" system. Since the Holt system is strictly monaural, it cannot be stereophonic, and to identify it as "stereo" cannot be other than misleading, and a misrepresentation. For a splendid article on "augmented" sound and genuine stereo reproduction, see David Hall's report on developments in the United States and Europe, to appear in the October Hi-Fi Yearbook issue of Hi-Fi Music.

For Juniors and Adults

FM station WASH in Washington, D. C., is taking over as the leading local hi-fi music station. Manager Everett Dillard explains that, with AM station WDON programmed separately, his AM service is planned for the younger set, and FM for the discriminating adult audience.

Low-Print Tape

For important tape recordings where extra high-frequency response is required, or for longer life in storage, Minnesota Mining & Manufacturing Company has developed a new magnetic tape No. 131, identified as "Low-Print" on the container. "Print" is an effect that causes one layer of tape on a reel to slightly magnetize adjacent layers.

Concluded on page 18

September 1957

AGAIN!



Regency®

WORLD'S ONLY SPECIALISTS IN TRANSISTORIZED EQUIPMENT

**ALL-TRANSISTOR
HUM FREE
NON-MICROPHONIC**



Miniature All Transistor Preamplifier-Equalizer Model HFT-1K (KIT) only \$34.95 audiophile net Available Now—Kit or factory assembled

The use of transistors and a self-contained battery supply give you for the first time a high fidelity preamplifier-equalizer completely hum-free, absolutely non-microphonic that drives any power amplifier to rating.

The exclusive Regency design has gone beyond experimental units described in publications and through precise selection of transistor types available has achieved such important requisites as low internal noise and low intermodulation distortion—less than 0.5 percent at output to drive most hi-fi power amplifiers to maximum. Only 7½" x 2½" x 3¾", 29 ounces with batteries, four input circuits, calibrated tone controls.

At leading Electronic Parts distributors everywhere as kit (HFT-1K \$34.95 audiophile net) or factory assembled (HFT-1A \$47.50 audiophile net)—full performance specifications available.

When you are looking, examine other Regency transistor products:

-  RC-103 FM Televerter, \$19.95 to convert your TV set to receive regular FM broadcasts—do it yourself installation; ATC-1 \$79.50 net, Short wave converter for any radio receiver; and the Regency line of 8  portable and home all-transistor radios and Conelrad monitors.
-  See also the Regency deluxe High Fidelity Power Amplifier Kit HF-50K—50 watts undistorted power, a tremendous reserve for superior performance at a remarkably low cost \$74.50 audiophile net. Factory assembled and tested—HF-50A—\$89.50 audiophile net.

Regency®

Division I.D.E.A., Inc. • Indianapolis 26, Indiana

Transistorized portable and home radios, amateur equipment, and FM converters

SPECIFICATIONS GUARANTEED

McIntosh guarantees performance
at all listening levels, 0 to 60 watts.
Compare these guaranteed specifications . . .

GUARANTEED

Harmonic Distortion: 1/3%, 20 to 20,000 cycles.

GUARANTEED

Intermodulation Distortion: Less than 1/2% any two frequencies in the audio spectrum, provided power does not exceed 120 instantaneous peak watts.

GUARANTEED

Impulse Distortion: Negligible — greatest stability for cleaner sound.

GUARANTEED

Frequency Response: ± 1 db at 60 watts 20 to 30,000 cycles; ± 0.5 db at 60 watts 16 to 60,000 cycles; ± 1 db at 30 watts 10 to 100,000 cycles.

GUARANTEED

Total Noise and Hum: 90 db or more below rated output.

GUARANTEED

Maximum Phase Shift: less than $\pm 8^\circ$, 20 to 20,000 cycles.

Unity coupling introduced by McIntosh through the patented Bifilar McIntosh Circuit* results in the finest reproduction of sound even under the most adverse loading conditions. Compare at your Franchised McIntosh dealer today.

*U.S. patent #2,477,074; 2,545,788; 2,654,058.

HFM 9-57

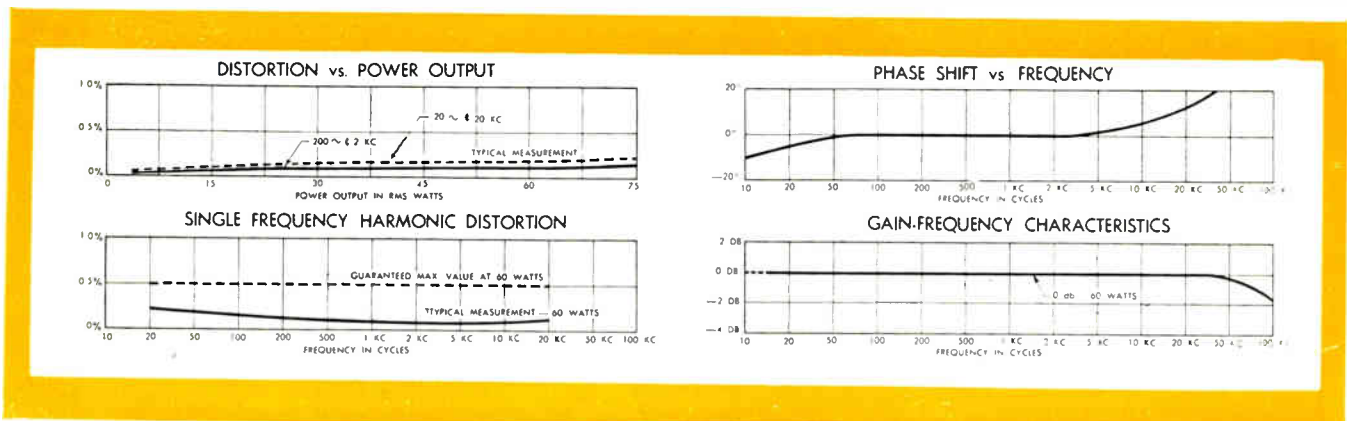

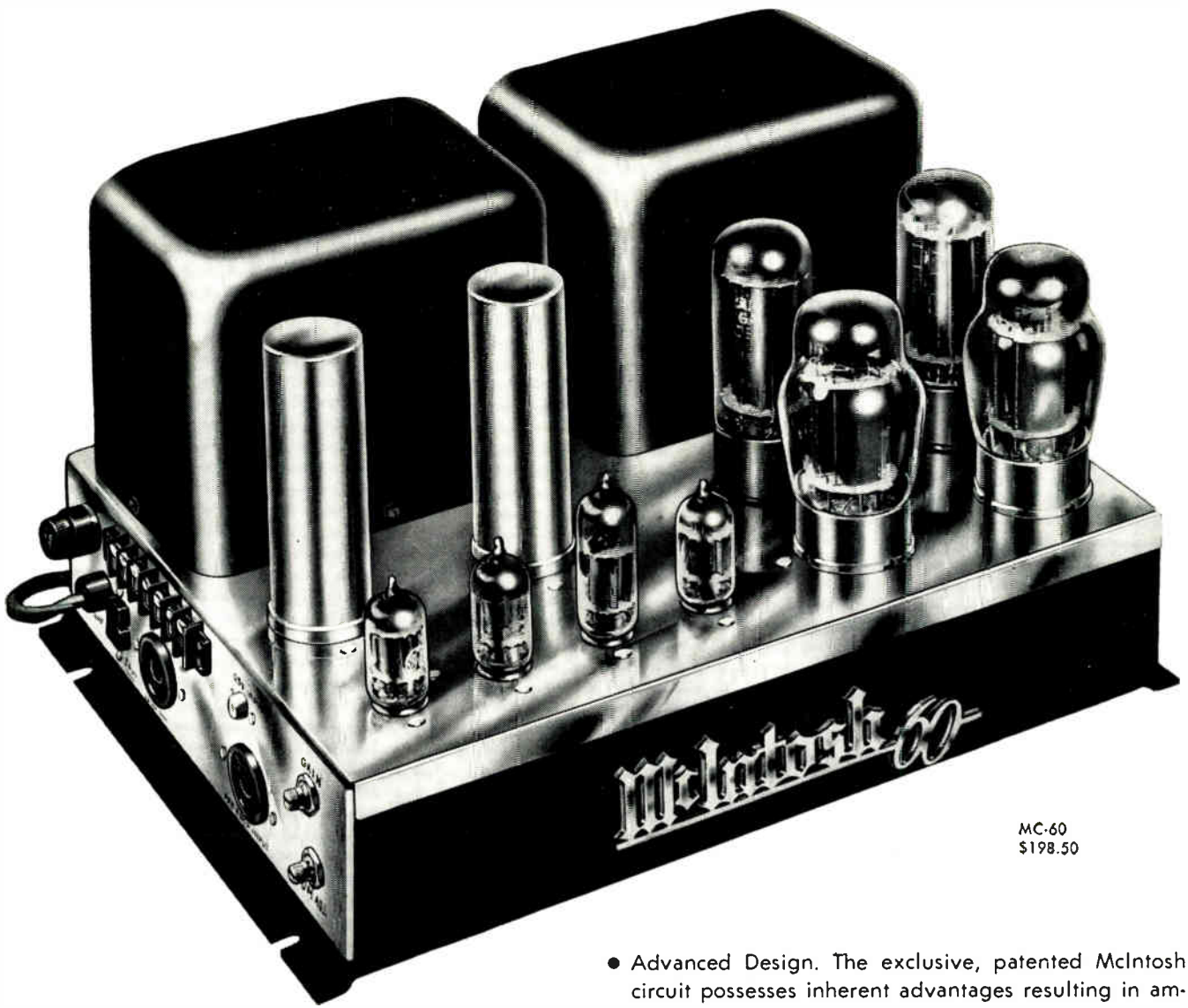

MC-60
\$198.50

*Unlimited
listening
pleasure!*

- Advanced Design. The exclusive, patented McIntosh circuit possesses inherent advantages resulting in amplification 99.60/100% perfect.
- Purity of Signal. Low Harmonic distortion of $\frac{1}{3}$ of 1%, from 20 to 20,000 c.p.s.; $\frac{1}{2}$ of 1% Intermodulation Distortion if instantaneous peak power is below 120 watts. **No Lost Instruments!**
- Adequate Power Reserve. 60 watts continuous, 120 watts peak to meet the power demands of natural sounds under any room conditions.
- Designed Stability for clean bass, long dependable life.
- Highest Efficiency means less heat dissipation, less power consumption for greater output.
- Unexcelled Performance **guaranteed**. Your protection for quality sound.

Get Complete Details from Your Nearest Franchised Dealer

McIntosh

LABORATORY, INC.

4 Chambers St., Binghamton, N. Y.

EXPORT DIVISION: 25, WARREN ST., NEW YORK 7, N. Y. CABLE: SIMONTRICE NEW YORK

IN CANADA: MANUFACTURED BY McCURDY RADIO INDUSTRIES, LTD., 22 FRONT STREET WEST, TORONTO, CANADA

NOW—
from the leader in sound...

CAPITOL STEREO TAPE!

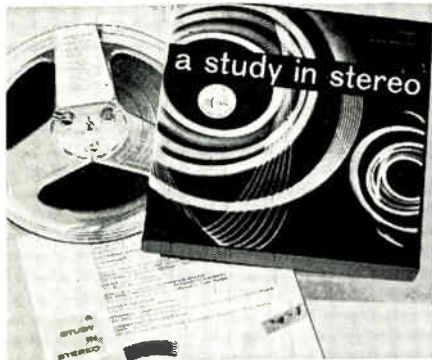

A Study in Stereo

A breathtaking showcase of stereo's vast range featuring Capitol's big-name artists. 20-page booklet with introduction by Edward Tatnall Canby included. (ZH-2)

Other "Full Dimensional Sound" stereo releases

LEOPOLD STOKOWSKI:

The Orchestra (ZH-8)

ROGER WAGNER CHORALE:

House of the Lord (ZF-9)

WM. STEINBERG, PITTSBURGH SYMPHONY:

Toch: Third Symphony (ZF-7)

HOLLYWOOD BOWL SYMPHONY ORCHESTRA:

L'Italia (ZF-3)

Gypsy (ZF-6)

Symphonic Dances (ZF-5)

Bolero & Capriccio Espagnol (ZF-4)

Intro to Stereo

A narrated journey through the wonders of stereo — music and real-life sounds. (ZA-1)

Top Stars in Stereo

NAT "KING" COLE:

Love is the Thing (ZD-11)

KENTON IN HI-FI (ZD-10)

GEORGE SHEARING: Black Satin (ZC-13)

FRED WARING & THE PENNSYLVANIANS IN HI-FI (ZD-12)



2 CHANNEL — 7½ IPS — FOR IN-LINE HEADS

RECORDS, TAPE AND FM

Continued from page 15

This may cause a faint echo to be heard on high-gain playback from equipment which operates at very low noise level.

Program Guide Change

Copies of Hi-Fi Music going to the Boston area have contained the WCRB program guide in the past. With this issue, we have changed to the Concert Network schedule, because this network is being expanded to carry the same program over WXCN Providence (formerly WTMH); WHCN Hartford (formerly WFMQ); the new Boston station WBCN on 104.1 mc.; a new station under construction on Mt. Washington; and WYCN New York City. In this way, one program guide edition will serve a much larger number of our readers.

One-Man Pushbutton Band

Do you have a suppressed desire to be a one-man band, so you can accompany the music from your hi-fi system? If so, Electronic Organ Arts has made it easy for you. Some ten instruments, from drum and cymbals to triangle and sleigh bells are mounted in a case, with actuating solenoids connected to keys on a separate box. Details can be obtained by writing to Eagle Rock Boulevard, Los Angeles 41.

Tape Wanted

Did you, by chance, make a tape of the Entertainment Press Conference carried by New York station WABD at 8:30 last July 23rd? If so, Arlene Stevens is very anxious to borrow the tape long enough to make a copy. She will be grateful if you will write her at 1250 Ocean Parkway, Brooklyn, N. Y.

Electronic Speed-Changer

Instead of using a mechanical means for changing turntable speed, Fairchild has designed a turntable with a synchronous motor driven from an AC operated oscillator. Speed is changed merely by a switch which changes the oscillator frequency.

Which Tape?

With several different varieties of magnetic tapes now available, there is sometimes confusion as to which tape to use for a particular job. Reeves Soundcraft has just issued a very helpful pamphlet entitled "How to Choose the Right Recording Tape", in which the special purposes of each type of tape are explained. Incidentally: Reeves has just brought out leader tape of 1½-mil. Mylar in gold, red, white, and blue, supplied in reels of 150 ft., and a kit containing all four colors.

Hi-Fi Yearbook Issue

The first Hi-Fi Yearbook issue of Hi-Fi Music Magazine will be out October 15th. This special (7th) issue at \$2.00 per copy, will be published annually hereafter. For details, see page 20.

**OPERA
IN
STEREO**
Vienna State Opera
Omegatape
LEHAR
the merry widow

**FIRST
RECORDING**
Opera
from Vienna
in **STEREO**
Omegatape
KALMAN
gypsy princess

MOZART CLARINET
OBOE-HORN
BASSOON
CONCERTOS
BERNHARD
PAUMGARTNER
CONDUCTOR
ORCHESTRA OF THE
CAMERATA ACADEMICA
OF THE SALZBURG
MOZARTEUM
Omegatape

854A north vine/hollywood 38 california

Better Results With
ROBINS' AUDIO ACCESSORIES!

GIBSON GIRL® TAPE SPLICERS		
1. Semi-Pro	SP-4	\$ 3.50
2. Junior	TS-4JR	6.50
3. Standard	TS-4STD	8.50
4. De luxe	TS-4DLX	11.50
5. Industrial (5 sizes to 1")		(net) 55.00
ROBINS PHONO AND TAPE ACCESSORIES		
6. Splicing tape	ST-500	\$.39
7. Jockey Cloth for Tapes	JCT-2	1.00
8. Tape Threader	TT-1	.98
9. AUD-O-FILE	AF-50 (net)	23.99
10. Changer Covers	CC-1, 2	2.00
11. Turntable Covers	CC-3	2.50
12. Disclosures	E10, 12 (pkg)	1.20
13. Jockey Cloth for Records	JC-1	1.00
14. KleeNeedLE	NB-1	1.50
15. Phono-Cushion, 10", 12"	PC-10, 12	1.50
16. Atomic Jewel	SE-90	5.00

At Dealers Everywhere
ROBINS INDUSTRIES CORP.
BAYSIDE 51, NEW YORK

**Removes all static and dust while record is played;
new moving coil microphones and transistor amplifier**

ESL DUST BUG

The problems of dust, lint, and static buildup on phonograph records and pickup styli have been solved by this ingenious new invention which cleans the record as it is being played. The plush pad is slightly moistened with special, harmless activating fluid supplied in a replaceable applicator. This helps to loosen groove dust and dirt, which is then collected by the pad. It also neutralizes the static charge present in all records. Every point on an LP record is cleaned by the wide pad approximately one hundred times during a single play.

ESL Dust Bug, complete with Dust Bug Fluid in applicator \$5.75

The automatic record cleaner



ESL MOVING COIL MICROPHONES



Highest fidelity at moderate cost

Electro-Sonic Laboratories is pleased to announce a complete new line of superb moving coil microphones, microphone transformers, and miniature earphones. For every application—broadcasting, professional recording, home recording, dictating machine, and public address—there is a low impedance ESL microphone specifically designed to provide the highest quality of performance at sensible cost.

A brochure describing the entire line of ESL moving coil microphones and accessories is available free upon request.

ESL TRANSISTOR AMPLIFIER

This hum-free, low-distortion amplifier can provide improved performance with moving coil microphones, for which it is a preamplifier, and with ESL electrodynamic cartridges, for which it is a pre-preamplifier. As its frequency response is flat and unequalized, it does not replace the conventional phono preamplifier. It permits use of greatly superior low-impedance microphones—such as the ESL—with medium-price tape recorders.

*Voltage gain: 20-30 db (1:10-1:20 voltage step-up) • Signal-to-noise ratio: minus 50 db
Frequency response: 20-20,000 cps \pm ½ db • IM distortion: 1/10 of 1% • Input impedance: 100 ohms • Output impedance: 2,000 ohms • Battery life: 1 year • Hum level: zero*

ESL-1A, complete with battery \$16.50

Hum-free low impedance amplification



FOR LISTENING AT ITS BEST

Electro-Sonic Laboratories, Inc.

Dept. M • 35-54 Thirty-sixth St • Long Island City 6, N.Y.

*Additional information available
free upon request to ESL*

1958 HI-FI YEARBOOK

a Special Issue of

HI-FI MUSIC

*for Hi-Fi Enthusiasts
and Music Listeners*



Essential Information on Records, Tape, FM, and Hi-Fi Equipment and Installations

To accommodate special information and articles too long for regular magazine issues, Hi-Fi Music has added a special (extra) Hi-Fi Yearbook issue, the largest issue ever published by any magazine in this field.

This is not a reprint book nor an equipment catalog, but a collection of outstandingly important, exclusive feature articles prepared specifically for this Hi-Fi Yearbook issue. Some have required months of research.

In addition, this special issue contains a compilation

of reference data and industry statistics that have never been made available before. Thus, this 7th issue of Hi-Fi Music Magazine, now an annual publication, combines a wealth of fascinating reading with essential information that you will use constantly during the year ahead.

Printed as an ordinary book, it would contain at least 500 pages, and would cost \$6.50 or more per copy. Whether you are a music listener or a hi-fi enthusiast, you'll say: "I must have a copy."

PARTIAL CONTENTS OF THE HI-FI YEARBOOK ISSUE

EDITORIAL SECTION

The Importance of Music Listening

A fascinating study that explains what different types of music do for listeners—by Manly P. Hall
Musical Instruments, Composers, Compositions

Relating the invention and development of instruments to the works of composers from the 16th Century Renaissance period to the present day, with lists of records representing each period—by Shirley Fleming

The Art of Record Collecting

An authoritative discussion, with specific recommendations for those who are starting to build record collections—by James Lyons

Beware the Hi-Fi Hermeneuts

More and more advertising is being written by Hermeneuts (Greek for interpreter) whose ideas of hi-fi performance bear little resemblance to the facts. Here are simple rules by which the difference between phony and genuine hi-fi equipment can be recognized—by Milton Sleeper

20 Fine Hi-Fi Installations

Illustrated with photographs and diagrams of

installations that are as handsome in appearance as they are fine in performance

Index of Record & Tape Reviews & Ratings

Listing all records and tapes that have been reviewed in HI-FI MUSIC Magazine since March 1955, each with the reviewer's ratings for the composition, performance, and audio quality

How to Plan a Stereo Installation

Covering every step from an explanation of stereo tape reproduction to the details of a complete installation for playing tapes, records, and FM radio—by Milton Sleeper

The Importance of FM Radio

Explaining the advantages of FM reception, and the reasons for the present expansion of FM broadcasting—by Charles Graham

Record and Tape Reviewers

Introducing the 28 members of HI-FI MUSIC's board of reviewers, each of whom is a specialist in one or more types of music

Stereo Developments in Europe

A complete report on the latest European Stereo Techniques, and "augmented sound" developments. First-hand information from an American

recording engineer who has spent the past year abroad—by David Hall

INDUSTRY INFORMATION SECTION

Directory of Associations

Listing of associations concerned with the hi-fi industry, with the names of their officers

Phonograph Record Sales

Statistics on the sale of records, by years

Commendation Seal Awards

A list of products that have been granted the HI-FI MUSIC Seal, which bears the inscription "A Commended Design in Its Price Class"

HI-FI MUSIC, 105 E. 35th St., New York 16, N. Y.

- Please find enclosed my remittance for
- \$2.00 for the 1958 Hi-Fi Yearbook issue
 - \$5.00 1-year subscription to HI-FI MUSIC (7 issues, including the Hi-Fi Yearbook issue)
 - \$10.00 3-year subscription to HI-FI MUSIC (21 issues, including 3 Hi-Fi Yearbook issues)

Name

Address

to the satisfied perfectionist...



Congratulations. Traditionally, the high fidelity enthusiast is a restless seeker after perfection, constantly changing, altering, trading... But the man who owns JBL Signature loudspeaker components is different. He has reached a condition of serenity, confident that further search would be superfluous. Our records show that most JBL Signature owners have previously owned other speakers. The man who uses a JBL Signature D130 knows he has the most efficient fifteen-inch extended range loudspeaker available — the only one made with a four-inch voice coil. He knows that he can employ the D130 as a superb low frequency unit when he progresses to the ultimate excellence of a JBL Signature two-way divided network system by adding either an 075 or 175DLH high frequency unit. With an acoustical lens he knows he has the only completely successful solution to the problem of high frequency beaming. And the man who owns a Hartsfield knows he possesses the most desirable loudspeaker system ever made. The man with a JBL Signature loudspeaker enclosure in his living room possesses an exquisite piece of cabinet work — a permanent home furnishing accessory — as well as a meticulously engineered acoustical enclosure. Yes, you owners of JBL Signature loudspeaker components are to be congratulated... on your taste, judgment, and foresight. You still own the finest ever made.

For the best sound available today — and in the foreseeable future — write for the name and address of the Authorized JBL Signature Audio Specialist in your community. He is standing by to fulfill your dream of verbatim reproduction.

"JBL" means **JAMES B. LANSING SOUND, INC.**



3249 casitas avenue, los angeles 39, california

a perfect beginning



...a perfect ending



The BARRINGTON
—a powerful 12-speaker system
capable of filling an auditorium
—yet precisely controlled for
comfortable small room volume.

Weathers high fidelity achievements are not measured in words—but dramatically in sound! Weathers new, improved FM Pickup system is perfectly balanced to a one-gram stylus force, faithfully tracks the finest record engravings, causes *no* record wear. Only such dependable design results in perfect tone quality. Weathers Speaker systems are just as finely engineered. Here you have sound reproduction in the exact middle register—sound with startling realism because it is perfectly natural!

Write for full
information on
all Weathers
components.



The DECORATOR
—a beautiful, compact system
achieved only by Weathers ex-
clusive hi fi developments
through scientific use of sonic
principles...a functional décor
for any room.



The MONTE CARLO
—a new six-speaker system,
presenting a graceful elegance
patterned after the Barrington
design...rounds out Weathers
selective line of systems for
audiophile or beginner.



WEATHERS STYLUS GAUGE
—a simple, accurate measure
for balancing a phonograph
pickup for its specifically de-
signed tracking force...makes
records last longer, sound
better.

Export:
Joseph Plasencia, Inc.
401 Broadway, New York 13, N. Y.

Weathers

Industries, Div. of Advance Industries, Inc.
6 E. GLOUCESTER PIKE BARRINGTON, N. J.

h.h. Scott

- Green Dot Controls
- 22 Watts Undistorted Power Output
- 5 Position Record Equalizer
- Tape, Tuner and TV Inputs
- Handsome Styling
- Matches all Scott Tuners
- Separate Rumble Filter
- Separate Scratch Filter
- Volume-Loudness Switch
- Separate Loudness Control
- 2 Magnetic Inputs With Selector Switch On Front

- NARTB Tape Playback Compensation
- Separate Tape Output For Recording
- Separate Tape Output For Monitoring
- Separate Bass and Treble Tone Controls
- Accessory AC Outlet
- Output Connections For Any Speaker Impedance
- Frequency Response Flat 20cps to 30kc.
- Harmonic Distortion Less Than 0.8%
- First-Order Difference-Tone Intermodulation Distortion Less Than 0.8%
- Separate Level Control To Match Any Cartridge
- Hum Level: 80db below Full Output
- Easy To Connect
- Beautiful Accessory Mahogany Case
- Compact, Only 15½"x5"x12½"
- Easy to Panel Mount
- Completely Fused To Protect Amplifier
- Crystal Input With Compensation.
- Heavy Duty, Conservatively Designed Power Transformer
- Only The Best Parts Used—Mica-Filled Tube Sockets, Plastic-Sealed Condensers
- Self-Balancing Phase Inverter
- Clean Symmetrical Clipping

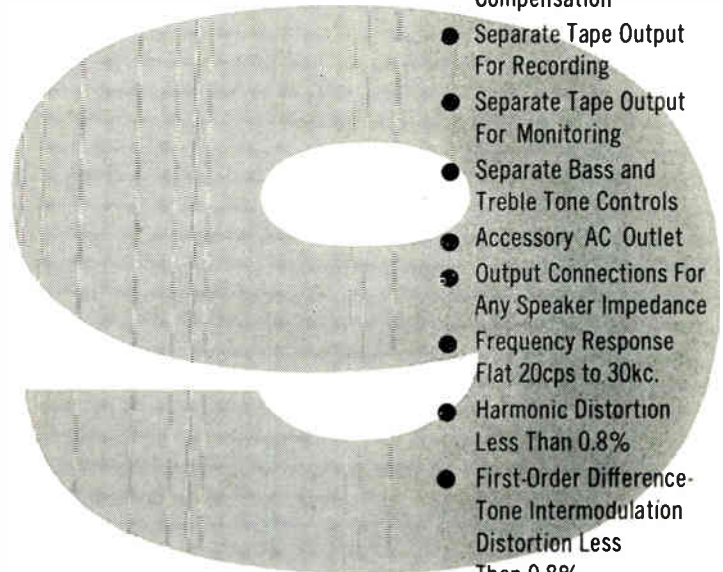
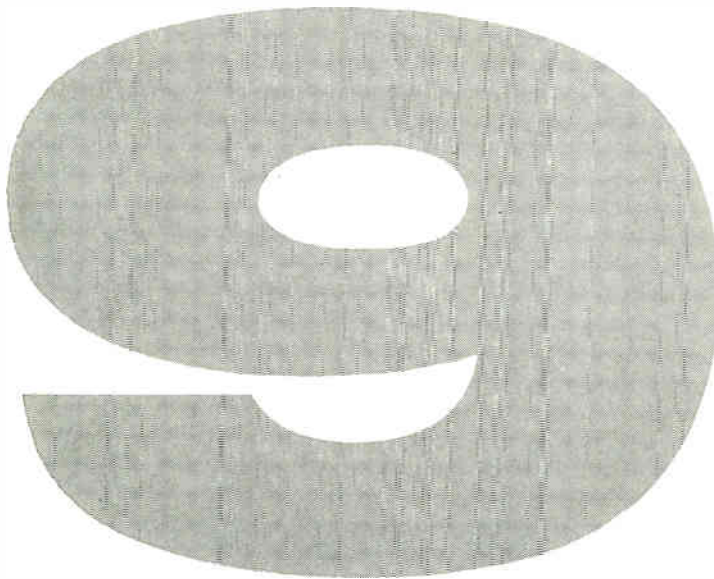

Reasons why the H. H. Scott '99' Complete Amplifier is your **BEST BUY** at \$99⁹⁵

All prices slightly higher west of Rockies.

There are hundreds of reasons for buying H. H. Scott components. They're easy to install, easy to connect and easy to play. They're packed with years ahead features that defy obsolescence. They're backed by award-winning engineering. Prove Scott superiority for yourself . . . listen to H. H. Scott amplifiers, tuners and turntables at your nearest high fidelity dealer.

H. H. Scott, Inc., 385 Putnam Avenue, Cambridge, Mass.

Export Dept.: Telesco International Corp., 36 West 40th St., N. Y. 17, N. Y.

Rush me your new catalog M-9 showing the complete H. H. Scott line for 1957, including question and answer section explaining hi-fi.

Name

Address

City State

**OUT OF SPACE!
FOR 67
MORE
REASONS
SEE YOUR
DEALER**

or write for
H. H. Scott's
free catalog.

ROCKBAR introduces

The new *Collaro* World's First

First models of the 1958 line of Collaro changers, featuring the new transcription-type tone arm are brought to America by Major Christopher Collaro (see photo), Managing Director of Collaro, Ltd. The company is the largest manufacturer of record playing equipment in the world.

The transcription-type arm, exclusive with Collaro, literally transforms the conventional record changer into a new instrument—a TRANSCRIPTION CHANGER, with features of the finest professional equipment.

The arm is a one-piece, spring-damped, counter-balanced unit which will take any standard high fidelity cartridge. It is free of any audio spectrum resonances. It permits the last record to be played with the same low stylus pressure as the first record. Between the top and bottom of a stack of records there is a difference of less than a gram in tracking pressure as compared with 4 to 8 grams on conventional changers. Vertical and horizontal friction are reduced to the lowest possible level. These qualities—only found in the Collaro Transcription changer—insure better performance and longer life for your precious records and expensive styli.

Because the record player is so critical in a fine music system, you cannot afford to compromise with quality. Your loudspeaker may reproduce 20 to 20,000 cps; your amplifier may put out 50 watts of undistorted power—but the music begins at the record player.

That's why today's high fidelity systems require the all new Collaro changer. In its performance the new Collaro meets the rigid requirements for high fidelity equipment. *Here, for the first time in a changer—you get professional quality at a price you can afford.*

There's a Collaro to fit your budget. Prices begin at \$37.50.



**Major Christopher Collaro
Brings Changers From England**



FREE: Colorful new Collaro catalog—describes complete Collaro record changer and accessory line. Includes helpful guide on how to build a fine record library. Send postcard for your copy today to the

ROCKBAR CORPORATION, Dept. F-009, Mamaroneck, N. Y.

Rockbar is the American sales agent for Collaro, Ltd., and other fine manufacturers.



High Fidelity Transcription Changer

Featuring The New Transcription-Type Tone Arm



The Collaro Continental, Model TC-540: Featuring the revolutionary new transcription type tone arm (see description on opposite page.) Here, for the first time, is professional quality at a moderate price.

The Continental features include:

4 speeds; manual switch to permit playing of a single record or portion of a record; wow and flutter specifications — $\frac{1}{2}\%$ RMS at 33 $\frac{1}{2}$ RPM — superior to any changer in the world; automatic shut-off after last record; automatic intermix, plays 7", 10" or 12" records in any order; heavy duty 4-pole, shaded pole induction motor; heavy, rim-weighted balanced turntable; muting switch and pop-click filter for elimination of extraneous noises; removable heavy rubber turntable mat; jam-proof machinery; pre-wiring for easy installation; attractive two-tone color scheme to fit any decor; tropicalization to operate under adverse weather and humidity conditions; easy mounting on pre-cut board or base. All Collaro changers are custom tested at the factory for wow, flutter, stylus pressure and correct set down position.

*The Continental — \$46.50**



The Collaro Coronation, Model RC-440: Combines the custom qualities of The Continental, with the flexibility of a standard plug-in arm and universal head shell. Will accept all standard high fidelity cartridges.

Special features include:

wow and flutter less than $\frac{1}{2}\%$ RMS at 33 $\frac{1}{2}$ RPM; extra heavy duty 4-pole, shaded pole induction motor; heavy, rim-weighted, balanced turntable for fly-wheel action; 4 speeds plus manual switch for turntable operation; automatic intermix; automatic shut-off after final record; elimination of extraneous noises through muting switch and pop-click filter; removable heavy rubber turntable mat; attractive two-tone colors to fit any decor; pre-wiring for easy installation, mounting on pre-cut mounting board or base; tropicalization to operate under adverse weather and humidity conditions.

*The Coronation — \$41.50**



The Collaro Conquest, Model TC-340: A radically new, simplified precision changer with a tone arm that automatically changes and finds the record to be played. Incorporates many precision features, including the new Collaro dynamically balanced transcription type tone arm, for superb high fidelity performance.

Other features include:

heavy duty 4-pole, shaded pole induction motor; heavy removable rubber turntable mat; 4 speeds and manual switch for turntable operation; heavy, rim-weighted turntable; automatic shut-off after last record; jam-proof machinery; muting switch and pop-click filter to eliminate extraneous noises; wow and flutter less than 0.25% RMS at 33 $\frac{1}{2}$ RPM; fast eight-second change cycle, independent of record speed; handling of 7", 10" and 12" records stacked in order of decreasing size; two-tone color fits any decor; easy mounting on pre-cut mounting board or base; tropicalization to operate under adverse weather conditions.

*The Conquest — \$37.50**

**Prices slightly higher west of the Mississippi.*

BOZAK

Quality Loudspeakers

ONE LINE — ONE QUALITY

You will find the Bozak name on only one grade of loudspeaker —

*The very finest we know how to build —
because we build them for only one man —
The experienced listener who will settle
for nothing less than the best.*

All Bozak Speaker Systems are identical in the quality of their components, consonant in their tonality . . . differ in power and realism only because of the number of speakers and size of infinite-baffle enclosure employed.

The quiet elegance of Bozak cabinetry, like the unequalled listening ease of Bozak Sound, will never outlive its welcome.

Your nearest Franchised Bozak Dealer will be happy to show off his Bozak Speakers. Write for his name. Careful comparison, using the finest associated equipment and program material, will show you why the Bozaks are known the world over for

The Very Best in Sound

All Bozak Products are Designed and Built
by the R. T. Bozak Manufacturing Company

BOZAK

EXPORTS: ELECTRONICS MANUFACTURERS' EXPORT CO. • PLAINVIEW • N. Y.

THE R. T. BOZAK SALES COMPANY • BOX 1166 • DARIEN • CONN.

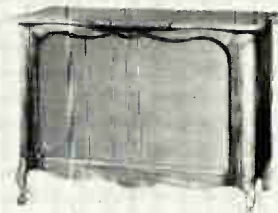

The Charming B-305 Provincial

Two-woofer, three-way system to grace the traditional living room. 35 to 16,000 cycles, 16 Ohms, 30 Watts.

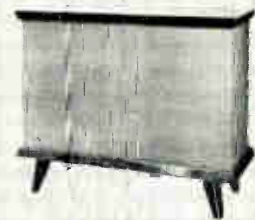

The Elegant B-305 Contemporary

In acoustical specifications and performance a twin to the Provincial. Unrivalled for the average living room with modern decor.

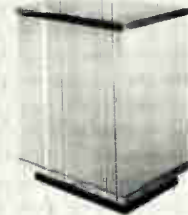

The B-302A Gem

One-woofer, three-way speaker system in the smallest practical enclosure. 40 to 16,000 cycles, 8 Ohms, 15 Watts. B-300 two-way system in the same enclosure with the same specifications.



The Distinguished B-400

Four-woofer, three-way speaker system, offering in a low-boy enclosure the only rival of the B-310. 28 to 16,000 cycles, 8 Ohms, 50-60 Watts.



The B-304 Stereo-Fantasy

Single-cabinet two-channel stereophonic speaker system. Each Channel 40 to 16,000 cycles, 8 Ohms, 30 Watts. Also available in graceful provincial styling.



Milton Sleeper discusses

MUSIC IN YOUR HOME

THE NEED for an independent audio engineering laboratory to serve the hi-fi industry has long been recognized. Adequately equipped and staffed, such an organization could perform invaluable services in checking new products, calibrating test and measuring instruments, and in consultations on research and design projects.

This was the plan behind the formation of The Audio League when it was founded in 1954. Income to operate the laboratory was obtained through consulting work for manufacturers, and subscriptions to *The Audio League Report*, a publication which did not accept advertising.

However, after three years, even with the support of nearly 5,000 members who subscribed to *The Report*, the revenue was not sufficient to support even one full-time engineer. Finding it impractical for the staff to continue on a part-time basis, the management found it necessary to discontinue its services. The following is quoted from a proposal made by The League to Hi-Fi Music:

"Circumstances beyond our control have made it necessary to discontinue publication of *The Audio League Report*, and we wish to do so with most careful concern for fulfilling our obligation to the subscribers who have loyally and faithfully supported The League.

"We believe your fine publication Hi-Fi Music offers our subscribers the best possible medium of impartial advice and information regarding home audio equipment in particular, and hi-fi music in general."

We are pleased and honored that The Audio League has chosen Hi-Fi Music to complete its obligation to subscribers of *The Report*. We shall give them the factual, impartial information they expect and deserve to receive. We have taken great care in consolidating the subscription list of *The Audio League Report* with that of Hi-Fi Music, to ensure that each reader will receive the full value of his unexpired subscription. In fact, we shall give Audio League members a bonus by delivering to each one as many copies of Hi-Fi Music as the number of issues of *The Report* still due him.

We are sorry that the activities of the League have come to a stop. At the same time, we welcome this opportunity to serve, through Hi-Fi Music, the elite group of hi-fi enthusiasts who comprise *The League* membership, and we extend our sincere good wishes to the four engineers who, recognizing the need for an independent audio testing laboratory, founded The League. They are Julian

Hirsch, editor of *The Report*; Gladden B. Houck, consultant; Milton Weiss, executive director; and Paul Bernard, founder.



YOU PROBABLY noticed a change on the front cover of this issue. Over the years, we have made a series of changes in Hi-Fi Music, each designed to improve the appearance of the Magazine, or its usefulness to readers. Looking back to our first issue, you'll see that there has been a gradual but complete metamorphosis except for the lettering of the title. Now this, too, has been modified to a more clean and simple form, as you will see on the cover of this issue. We hope you'll like it.

IF YOU OWN a radio set with FM tuning that is three years old or more, and you haven't listened to a current FM model, there is probably a pleasant surprise in store for you. Many FM-AM sets were made with FM circuits comparable to the short-wave tuning in cheap sets back in the 30's. That is, the FM part was merely a point-of-sale feature. When people heard nothing on FM (or short-waves), they just switched over to AM broadcasting, and that was the end of it.

Some of the postwar sets weren't too bad on FM, but they were sold for operation on built-in antennas, and they didn't have enough sensitivity to be used that way. Others had circuits so designed that they were only noisy when FM stations were tuned in! Another fault was that the sets drifted on FM, making it necessary to readjust the tuning. Then, too, the older FM receivers that were really good when they were built did not hold their alignment, with the result that their performance today is very poor.

Within the last two or three years, those faults have been overcome. Practically all the factory-built cabinet models give good FM performance, and reception on a high-quality tuner, used with fine amplifier and speaker, is so much better than on AM that there's no comparison.

Only the other day, I helped a friend of mine connect a new tuner to the amplifier and speaker he had been using for records. He listened to the FM reception for a few minutes, and then he said to me: "That music doesn't sound like radio. It's beautiful! Why, it's as good as my phonograph." Indeed, the station was playing a phonograph record. Up to that time, of course, he had owned only an AM set.

Because of a continued increase in the demand for Pickering high fidelity products—manufacturing facilities have been expanded, and more efficient fabrication techniques have been developed. As a result—we are happy to announce new low audiophile net prices for the Series 350  Twin Fluxvalve Cartridge, and the Series 3500  “T-Guard” Styli. Prices of the Series 350 Fluxvalve Cartridge now start at a modest \$24. Now! Everyone can afford the world’s finest cartridge.

Pickering & Company, Inc.

P.S. We are also excited about our new Series 370 Single Fluxvalve Cartridge—why not see and hear the 370 at your hi-fi dealer today—we know that you will be excited too. P.C.



At better Hi-Fi Shops everywhere—Write for complete brochure and prices to Dept. MH1



“For those who can hear the difference” FINE QUALITY HIGH FIDELITY PRODUCTS BY
PICKERING & COMPANY, INC., Oceanside, N. Y.

THE HI AND THE FI

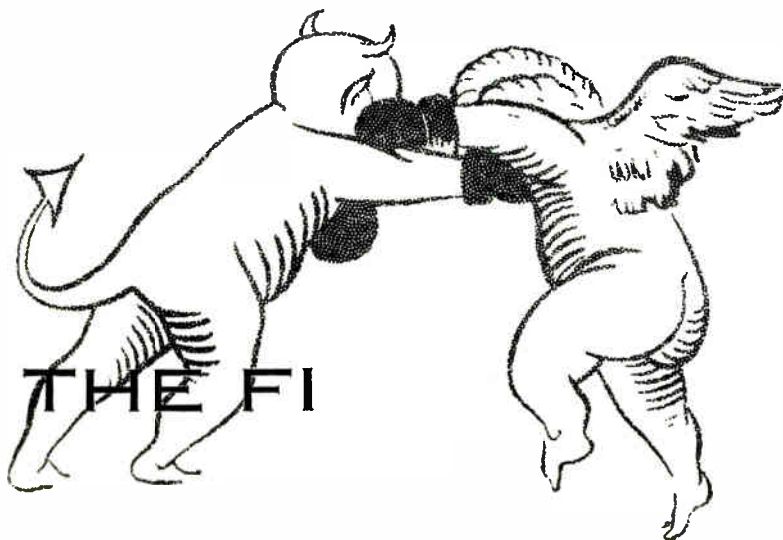

RELECTING ON 1) the current issue of a certain foreign journal and 2) some snippets deleted from our most recent overseas column by Dennis Andrews, it suddenly struck me that for all the One-World aspects of the international culture market, there still exists a startling dichotomy as to musical taste here and abroad. Some of this can be attributed to national pride and prejudice. Some of it has to do with availability, which must in turn derive from the whimsy of conductors and record companies. A few other thoughts suggest themselves — but first, these lines from London:

BLACHER is known [in England] only by a handful of works, such as the *Concertante Musik* for orchestra, which reveal an alert and lively imagination coupled with a singular restraint and economy in scoring. The total effect is almost like chamber music for full orchestra. Deutsche Grammophon has now issued his *Variations on a Theme by Paganini, Op. 26* in a sensitive and at the same time brilliant performance by the R.I.A.S. Symphony Orchestra of Berlin under Ferenc Fricsay. Slightly less than spontaneous in its flow, this work nevertheless has moments of delightful wit.

Sir Thomas Beecham has a connoisseur's eye for works that many of us tend to condemn outright as second-rate but which, under his restorative treatment, often reveal glimpses at least of unique and valuable *objets d'art*. Liszt's *Thirteenth Psalm* ("Lord, how long?") for tenor solo, chorus and orchestra, is a case in point. Few will acclaim it as a masterpiece; fewer still, I suspect, will relish the rather cloying sentimentality of a Lamartine that hangs about it, but it is good to have it available in such a masterly performance. Beecham's magical and affectionate phrasing brings out the best in both the Beecham Choral Society and the Royal Philharmonic Orchestra. These same forces are heard again in Brahms' "*Song of Destiny*", on the reverse side of this Columbia disc, but this performance I find too dull and heavy.

Delius, another composer who found an untiring champion in Beecham, has in recent years suffered a decline in reputation. Certainly his larger orchestral pieces and operas are but rarely heard today, but

a new Argo release calls rightful, if somewhat belated attention to his solo songs and unaccompanied part-songs. Here one feels the words — often settings of German and Scandinavian poems — are not so important in themselves as the moods to which they give rise. Some are exquisite, for example, *Twilight Fancies* for soprano and piano, and the two part-songs "to be sung of a summer night on the water", later transcribed for strings by Eric Fenby and entitled "Aquarelles". Joan Stuart, a young Australian soprano, sings with feeling, if at times a little genteelly. — D. A.

NOW, THEN, the Boris Blacher work and the choral pair (both otherwise coupled) are known here as Decca DL-9769 and Angel 35400 respectively. The third disc was declined by Argo's American affiliate. So much for the excision of these items. They are restored herewith because I wanted to point out that 1) the Swiss Blacher's *Variations* may be new to England but they have been performed in America repeatedly; 2) not being so Lisztophilic as the English we are surprised at the passing mention given to this first LP version of the Brahms — and by the way the latter's singularly incompatible *Academic Festival* was added for the release in bargain-conscious America; and finally 3) that Delius is, alas, just now out of the hit parade everywhere, although ironically we know several of his works as elements of the omnibus score for Tudor's ballet, *Romeo and Juliet*. Maybe the Argo record would not have sold well over here, but if the same composer's magnificent *Violin Concerto* ever reaches LP you may be sure that a Delius revival will follow.

THESE RANDOM observations lead more or less logically to the conclusion that all partisans of recorded music should invest \$3.50 for a subscription to *The Gramophone*, a uniquely informative if sometimes exasperating monthly published at 49 Ebrington Road, Kenton, Middlesex, England. While staunchly British in its attitudes, this magazine does have its finger on the hi-fi pulse of Europe. As to Britain proper, the profusion of display and classified advertisements give evidence of intense and widespread public interest, although the

"Federation and Society Notes" suggest that the English listener is more apt to be a "joiner" than an "I know what I like" type.

THE REVIEWS do, occasionally, leave something to be desired. Astute and even scholarly as most of them are, a few also display either disinterest in or ignorance of the musical scene outside England, lending a sort of ingenuousness to their tone of authority. This applies principally to matters technical, so that the finest American engineering is apt to be slighted as often as our worst is esteemed highly. But it applies to matters musical too. In the July issue, for instance, a staff man discussing a certain Rimsky-Korsakov disc confers total approval — "No reservations at all" — on performances that are miles from the printed score. To be sure, this kind of review is encountered rarely enough, and heaven knows that we oracles are none of us without caprice. As a rule, indeed, the vagaries are not vagaries but rather consequences of tastes or traditions alien to us but quite admissible. The British admire certain artists who have failed utterly to win acceptance on our shores, and vice versa; they like the irreducible minimum of horsepower in certain scores of inherently high octave; and so forth.

MOST ASTONISHING, however, is the separation (better, perhaps, the unsummed marriage) of *The Gramophone* and the pre-recorded tape. From the advertising one infers enormous tape activity, but nowhere in the editorial columns is this reflected. In the same July issue English Columbia lists seventeen new "stereosonics" on one page, His Master's Voice ten more. Yet none is reviewed. How unreal this seems, especially in a day when tapes are being reviewed even in the magazine's equally conservative and collectorish counterpart on this side of the Atlantic, *The American Record Guide*.

LET THE THEME of these variations be the coda: If music is to be truly a universal language, it behooves critics and listeners alike to lend their ears to what is going on elsewhere.

— J. L.



Concert Master Josef Gingold, Dr. George Szell, and the American Ambassador to Poland Joseph Jacobs, after the first Warsaw concert

LP's

build reputations

It Took Ten Years for Conductor George Szell to Realize His Plan to Take the Cleveland Orchestra on Its First Tour of Europe. Meanwhile, Through Its Recordings, This Orchestra Had Become Well and Favorably Known to Concert-Goers There — *By Eleanor Morrison*

NO LONGER bounded by American living room walls, our records are being played around the world. And, as more of our artists and orchestras are introduced abroad in this way, and foreign performers are made known to us as well, phonograph records are becoming a leading means of international cultural exchange.

The influence of records, which is to say LP's today, extends still farther. Reputations are being built and fostered by this medium to such a degree that they can assure SRO signs for personal appearances. Consider, for example, the fantastic ticket lines at the box offices in New York and Chicago when David Oistrakh and Maria Callas came to the United States for the first time, previously known to us chiefly by their records.

Our most recent cultural export — which, as indicated, amply reaffirmed its record-made reputation — was America's leading inland orchestra, the Cleveland, which extended good-will far beyond the usual channels of the striped-pants diplomats. Playing 29 concerts in ten countries in six weeks, the Clevelanders, under their musical director George Szell, clearly proved that all America's culture is not confined to the northeast shores. Europeans learned first-hand what critic Paul Henry Lang of the *New York Herald Tribune* reported last winter: "The usual orchestral routine of Carnegie Hall — the Big Three — was broken last night by the visiting band from Cleveland, and I defy anyone who happened to drop in without warning to tell them from the best anywhere."

This is not to pass lightly over the impact that many American soloists have made all over the globe, for it is fact that in this air age, our artists can appear on three or four continents during a single concert season. To transport full symphony orchestra with instruments, however, is far more complicated.

The manner in which records serve as advance agents is beautifully illustrated by the Cleveland Orchestra's first European tour which was made this year.

Conductor George Szell first thought of taking his orchestra abroad nearly a decade ago. During the ensuing years, Szell's reputation had become firmly established, and the orchestra had gained steadily in the favor of concert-goers. No small part of this progress was due to recordings that the Cleveland orchestra has made, some eighteen of which have been released by Columbia, and seven by Epic.

A European tour is a major undertaking in finance as well as organization. All the leading symphony orchestras in this Country operate at a deficit, with public funds and private contributions necessary to insure each regular season at home. The prospects of touring conjure up even larger figures in red ink on the orchestra's balance sheet. However, the problems of a six-week tour were finally solved, the Clevelanders departed with the blessings of the



Left: A standing ovation for the Clevelanders, first American orchestra to perform in Poland since the last war. Left below: Kiosk in Paris carries the announcement of a forthcoming performance by the Cleveland Orchestra

Beneath: Dr. Szell and George Goslee confer in preparation for a recording session



State Department, and tangible support given through ANTA, the American National Theatre and Academy.

Many Americans still hold to the theory that the grass is greener wherever they are not, and it is the blaze of the success abroad that fires local pride and elicits new support for an orchestra. Thus do our visiting artists and orchestras have a two-fold goal when touring away from home; first, to enhance their own reputations, and second, to extend American good-will wherever they perform.

As Cleveland's years of planning drew to a close and financial backing was assured, the tour schedule evolved as a tightly-knit unit. The ocean- *Continued on page 73*





GARY GRAFFMAN
Chooses Basic Piano Concerti

From the enormous repertory of works for keyboard and orchestra, this distinguished American pianist recommends sixteen of his special favorites to those listeners who want to own the concerti that belong in every record library. All of these do.

GUIDE TO RECORD COLLECTING

Notes and Comments by
Alfred Kaine

A PROPER INTRODUCTION to the standard repertory of piano concerti, and an evaluation of the many recordings of each, would be difficult in twice this space. Moreover, the most basic of lists would have to be longer than the practical maximum appropriate to this regular series. The gifted Mr. Graffman gets around the dilemma neatly by limiting himself to nine composers, but extending his selection to sixteen concerti. Whether or not by accident, his sampling of the great masterworks in the genre turns out to be sufficiently close to a cross-section for us to use it as a primer in tracing the growth of the piano concerto as a musical form. It takes us throughout the evolution to date, from the primitive pedal-less *Klavier* to the massive concert grand, and from the guileless *galant* style to the tonal and structural complexities of modernism. In terms of music appreciation, this is a lot of ground to cover and we can go over it but lightly. The interested listener, however, will find it worth-while to take up where this article leaves off.

Mozart: K.271: The four Mozart concerti chosen by Mr. Graffman clearly mark the four distinct periods of the composer's creativity. He was only twenty-two, in 1777, when the K. 271 (in E flat) made its appearance, but already he was famous as a *Wunderkind* in the courts of Europe. Father and son had just made their last grand tour of the Continent and settled down in the service of the Archbishop of Salzburg at the time. The prelate was a man of small artistic bent to put the best light on it, and working for him was a drudgery to the young genius. Indeed, much of his output in this period contains internal evidence of boredom. One shining exception is the K. 271, which was commissioned by a renowned French virtuoso of that day who happened to be concertizing in Salzburg. The challenge "aroused all his fire", as C. M. Girdlestone puts it neatly. There are three fine versions of the K. 271: Haskil and Sacher (Epic LC-3162), Hess and Casals (Columbia ML-4568), and Kempff and Münchinger (London LL-995).

Mozart: K.453: By the time the K. 453 (in C) came to be written, in 1784, Mozart's music had become rather fashionable. He frequently gave private concerts for such wealthy families as the Eszterházy and the Gallizins, and the modicum of security thus assured had ushered in what was perhaps the most fertile twelvemonth in the life of any composer — six concerti, two sonatas, a quartet, and a quintet in that one year! For all its brilliance, however, much of this glister was not gold in terms of the Mozart to come. It may be categorized with relative accuracy as "society music" — expressively impersonal for all its perfection. For better or worse, alas, Mozart's welcome in the salons soon enough ran out, and his descent from social grace was made further painful by the fiasco of "Le Nozze di Figaro". The K. 453 and the "other" *C Major* (discussed next) are coupled in effective performances by Serkin and Szell (Columbia ML-5169).

Mozart: K.503 and K.595: It was a questioning, soberly reflective artist, therefore, who wrote the K. 503 (also in C), during 1786. Furthermore, knowing of the terrible years of abject poverty and professional failure that were ahead for him, it seems doubly incredible to us that Mozart could then so detach himself from worldly travail as he must have to create "The Magic Flute", the final quintets, and (in 1791, the year of his death) the K. 595 — the magnificent *B flat Concerto* that the late Alfred Einstein once so aptly described as "so perfect that the question of style becomes meaningless". Serkin and Schneider approach the sublime in their performance (Columbia ML-5103).

Beethoven: Concerti Nos. 3, 4, 5: With the *Third Piano Concerto in C minor, Op. 37*, Beethoven came into his own as a master of form, rather than as a student of it. But by

1805, when the *Fourth* came out, the *Appassionata Sonata* and the *Eroica Symphony* already were musical history. The second movement of the *Fourth* speaks eloquently of the meaningful depths that Beethoven had reached. Unlike Mozart, who transcended the world around him, Beethoven mirrored his own reactions to the times, as witness the martial flavor of the so-called *Emperor Concerto* (No. 5), composed in the year of Napoleon's invasion (1809), from which Beethoven was forced to flee.

One of the great recorded treasures is the complete edition of Beethoven's Concerti with Artur Schnabel as soloist (Victor LCT-6700). Mention must be made also of Serkin (with Ormandy on Columbia MLs-4914, 5037, 4738, and 4373) in this literature, as well as Gilels in the *Third* (Angel 35151 — a uniquely Schubertian approach), and Backhaus in the *Fourth* and *Fifth* (London LLs-417, 879). An unforgettable interpretation of the latter, now withdrawn but perhaps up for reissue, is that of Fischer and Furtwängler (His Master's Voice LHMV-4).

Brahms: Concerti Nos. 1, 2: It was Brahms, with his *First Piano Concerto*, who instituted a return to the classic concept of the form. Until then, the solo instrument had dominated the orchestra for many long years. The biographer Walter Niemann sums up succinctly: "The intrinsic evidence of Brahms' concerto style is in the first place the suppression of all display of technical virtuosity by the soloist as an end in itself; next, the equal footing maintained by soloist and orchestra and, lastly, the approximation of the concerto to the symphony in intellectual content." No more need be said.

Several performances of the earlier concerto can be recommended, two of them without reservation: Serkin and Szell (Columbia ML-4829) and Rubinstein and Reiner (Victor LM-1831). Another, more restrained but quite elegant version is that by Firkusny (Capitol P-8356), which may or may not be to your taste. In the later masterpiece there is one performance which, though sonically dated, stands head and shoulders above all the rest. It is that by Horowitz and Toscanini (Victor LCT-1025). Of the two recorded versions by Serkin and Ormandy the first (Columbia ML-4014) remains the more impressive. Backhaus and Schuricht (London LL-628) elect rather slow tempi but are otherwise excellent.

Chopin: Concerti Nos. 1, 2: Chopin and Schumann are ideal representatives of the romantic style. Their departure from earlier schools is chiefly in harmonic and structural design within the basic architecture, which remained strictly classical. It is interesting that the concerto form twice prompted Chopin to attempt orchestration, neither time very successfully. One is not startled to learn that, having composed

Continued on page 76



The author as she appears today, and at the age of six, after her Berlin debut. An account in The New York Times called her "the most astounding of all prodigies heard in recent years on either side of the Atlantic Ocean".

INEVITABLY, as my recent American recordings find their way into hi-fi homes across the country, they will stir memories of a chubby little girl with a boyish bob, white knee socks, and a shapeless smocked peasant dress, who clambered up to piano stools in city after city some twenty years ago, astonishing an older generation of music lovers with her incredible dexterity and making the childhood of many a contemporary utterly miserable because their parents would drag them to the concert hall and hold little Ruth up as a shining example of what little Johnnie and little Jane might be able to do if they, too, buckled down to serious practice.

Well, little Ruth has finally grown up (it wasn't easy, either) and little Johnnie and little Jane probably have youngsters of their own by now. Being somewhat more enlightened than their own mothers and fathers, they earnestly question what is the best and most effective way to introduce their children to music so as to make it a lasting and healthy influence in their lives, and what to do about the occasional little genius who pounds out *Chopsticks* at age two and seems destined to become another Horowitz or Rubinstein.

It is only natural that they should put these questions to me as I make my way back and forth across the continent on concert tours. Many people who know my story — a professional concert artist at four, an international sensation at six, a money-maker with an annual income bigger

ORBIT OF A PRODIGY By Ruth Slenczynska



than that of the President of the United States at eight, and then at fourteen unemployed for the first time and nothing more than a lonely and unhappy girl who just didn't seem to belong — must suspect that I retain a bad taste for the child prodigy phase of my life. If they have heard how my father chained me to the piano for eight hours of practice a day from the time I was three, how he deprived me of toys and playmates, and how he didn't hesitate to use physical violence whenever I showed signs of rebelling against the rigid discipline he imposed, they usually expect me to feel pretty strongly about other parents who urge talented youngsters to tackle musical instruments before reaching maturity. They may be somewhat taken aback when I tell them that I am actually *grateful* to my father for what he did.

Without his driving I might have enjoyed a normal childhood and become an artist anyway, to be sure. But it would have been twenty or thirty years later, and I would not have what I have to look forward to now. If today music holds none of the technical problems for me that it does for most performers, I must say that I owe this largely to the fact that the technique was pounded into me before my mind and fingers could develop any conflicting habits. Now it is so automatic that I am completely free, as few pianists are, to [Continued on page 71]

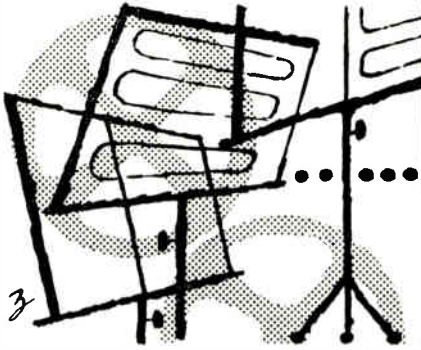

RECORDED TAPES

Reviews & Ratings

For Names of Reviewers and Explanation of Ratings, See the Record Review Section

**A Stereophonic Study
in Double Choruses**
Masterwork Chorus under
David Randolph

A
A-C
A



7 1/2 ips. Stereo
Sonotape (Westminster) SWB-8020 Randolph

Our sometime reviewer "DR" is the same widely known choral conductor whose scholarly enterprise resulted in this unique tape—unique because it is the first ever to avail itself of stereo for the reproduction of great music actually composed for stereo. Not to be cryptic, this is of course the antiphonal and "echo" writing of the pre-classical masters (in this case Schütz, Lassus, Lotti, Allegri, and Monteverdi) whose habit it was to station choirs on opposite walls of the church and thus literally to fill the edifice with sound. Randolph's forces here are not always impressive; the over-all effect, however, decidedly is. The spoken explanatory interpolations are helpful initially, but obtrusive on repeated hearings. JL

BEETHOVEN: Symphony No. 2 in D
Frankfurt Opera Orchestra
under Carl Bamberger

B
A
A



7 1/2 ips. Stereo
Concert Hall Society CHT/BN-35 Beethoven

This is music that does not strain the technical abilities of the orchestra and consequently the performance has an element of ease that is distinctly pleasurable. Bamberger has an excellent understanding of the symphony and he has no difficulty in communicating his requirements to his players. The performance is deft, with a backward glance at Mozart and Haydn and a forward peek at the mature Beethoven. The slow movement has elegant lyricism and the finale rhythmic bumpiousness. The recording permits air into the texture of the orchestration as well as clarity-in-depth in over-all sound. WDM

**MENDELSSOHN: Symphony No. 4
in A ("Italian")**

A
A
A



Pro Musica Symphony Orchestra, Vienna, under Edouard van Remoortel
7 1/2 ips. Stereo
Phonotapes-Sonore (Vox) S-705 Remoortel

When and if Vox gets around to issuing this performance on a disc, it will have to exercise special care in its cutting. This is an excellent taping, and if grooves are to produce sound competitive with that held captive in magnetic dust they must be flawless. Remoortel is something of a perfectionist. The Pro Musica seems to play for him with a greater regard for style and polish than it does for any other conductor. He lets the beautiful Mendelssohn melodies sing enchantingly and, in the finale, his highly developed rhythmic sense enables him to wind up matters in exhilarating fashion. WDM

**MOZART: Symphonies in F and A,
K. 130 and 134**

B-B
A-A
A-A



Philharmonic Symphony Orchestra of London under Erich Leinsdorf
7 1/2 ips. Stereo
Sonotape (Westminster) SWB-8018 Leinsdorf

Those who have been inclined to write off Mozart's early-middle works as formative or otherwise unworthy of his genius are invited to check their conviction via stereo. Only in this sonic milieu, it seems to me, does Salzburg-scale scoring come through with its spatial balances absolutely intact, the instrumental relationships always clear—and clarity is everything with this music. Leinsdorf being a Mozartean of note and his ensemble here being superbly responsive, the present tape would be a corker even if it did not offer, as indicated, something over and above an illusion of live performance. For once, that is to say, the microphones have preserved more than ears could hear in a concert hall. JL

MOZART: Clarinet Concerto, K.622; Horn Concerto, K.417; Oboe Concerto, K.314; Bassoon Concerto, K.191; Masonic Funeral Music, K.477

A to C
B to C
B to C



Orchestra of the Camerata Academica of the Salzburg Mozarteum under Bernhard Paumgartner
7 1/2 ips. Double Track
Omegatape 9005 Paumgartner

The idea of a Mozart wind concerto compendium on a single double-track tape is a good one, but it has been made less than valuable in execution. With the exception of the horn player, the soloists (anonymous for reasons I fail to perceive) perform in no better than routine manner, and there are patches of ugly tone from the clarinet and the bassoon. The accompaniments are rather heavy, and the absence of brio is apparent from start to finish. Disappointing, too, is the woody sound of the tape. CJL

The Music of Johan Strauss
Sinfonietta under Leonard Sorkin

A
B-C
B



7 1/2 ips. Stereo
Concertapes 101-A J. Strauss

Stereo or no stereo, the company that skimps with information about what is on the tape and who is performing is merely begging for trouble. The Overture to "Die Fledermaus", the Pizzicato Polka, the Blue Danube Waltz, the Emperor Waltz, Perpetual Motion and Tales from the Vienna Woods are played in this order, the label notwithstanding. The size of the orchestra may be inferred from its designation as a Sinfonietta. No matter, Strauss waltzes may be done very nicely indeed by an orchestra of about twenty pieces—but not Strauss overtures. The A & R man and Sorkin should have been more practical in their selection of repertory. Sorkin's conducting exhibits more drive than Gemütlichkeit. WDM

Novaes Plays Chopin
Guiomar Novaes, pianist

A to B
A
B



7 1/2 ips. Double Track
Phonotapes-Sonore Cameo (Vox) PMC-1014 Chopin

The Minute Waltz and the Waltz in C Sharp Minor, the Revolutionary Étude, the E flat Nocturne, Op. 9, No. 2, the Étude in thirds and the Butterfly Étude comprise this short piano recital. All of these compositions have appeared on Novaes discs, but this tape offers truer sound than the earlier incarnations. As the months and the years roll by, more and more is learned about processing and cleaning up the sound of old master tapes, and current pressings or duplications have definite advantages over their predecessors. Coupling these advantages with the beautiful playing of Novaes produces this attractive entry in the Cameo catalog. WDM

**STRAVINSKY: Symphony in Three
Movements; Firebird Suite**
Cento Soli Orchestra under
Rudolph Albert

A-A
C-C
C-B



7 1/2 ips. Double Track
Omegatape 3008 Stravinsky

It is questionable whether or not it is worth-while to issue on tape—in sound that is not up to the highest disc standards—fair to good performances of music already available in masterful renditions. This release, for example, unfavorably competes with Stravinsky's own recordings, not to mention a couple of other fine Firebirds. The ensemble is second rate; the conducting, just a bit better than that. What might have made the tape desirable is excellent, faithful sound. Such is not available here. CJL

TCHAIKOVSKY: Violin Concerto
in D, Op. 35
Erica Morini, violinist; Philharmonic
Symphony Orchestra of London under
Artur Rodzinski
7½ ips. Stereo
Sonotape (Westminster) SWB-8016 Morini



Until recently the same artist's earlier performance was to be had on the Bluebird label (a dubbing of her 78 version with the Chicago Symphony). Now, under new auspices, we have a resplendent replacement, both on LP (XWN-18397) and stereo tape. Westminster's engineers have outdone themselves in capturing the very special Morini tone, although Rodzinski perhaps goes a bit too far in his deference (as to tempi principally). For all its aspects of display this is, to be sure, quintessentially Tchaikovskyan music, which means that it can accommodate a wide range of subjective preconceptions. If you seek the spectacular, therefore, seek elsewhere. But this is admirable music-making. JL

Black Satin
Gerge Shearing Quintet
and Orchestra
7½ ips. Stereo
Capital ZC-13 Shearing



This is not extemporized jazz or cocktail jazz but inventively superior good music. The quintet is augmented by strings and the general air is of tonal luxury, some of it in Latin-American rhythm. Ten songs, two combined in a medley, make up the program, and with numbers like *If I should Lose You*, *The Folks Who Live on the Hill*, *What Is There to Say?* and *One Morning in May*, it is an attractive one. The arrangements are by Shearing and Billy May and they offer many more piquant twists and turnings of melody and harmony than the usual mood music set, and if the sound does not have the darkness of Black, it certainly does have the smoothness of Satin. WDM

Fred Waring and the Pennsylvanians in Hi-Fi
Chorus and Orchestra
under Fred Waring
7½ ips. Stereo
Capital ZD-12 Waring



The Waring standards of musicianship and showmanship have been maintained over the years. The arrangements are tasteful, the execution virtuosic. The orchestra plays the *Hora Staccato* as one fiddle; the chorus sings the hill-billy *Lolly Toa Dum Day* with deftness and humor. *I Hear Music*, *Hit the Road to Dreamland*, *Smoke Gets in Your Eyes*, *You'll Never Walk Alone*, *Cigarette Sweet Music* and *You, In the Still of the Night*, *The Wiffenpoof Song* and *Sleep* are in the mainstream of popular favorites, but the measure of the organization's art is in the rendition of Irving Berlin's setting of the inspired words of Emma Lazarus inscribed on the Statue of Liberty: *Give Me Your Tired, Your Poor*. Beautiful and moving. WDM

Guitarra Espanol
Richard Pick, Guitarist
7½ ips. Stereo
Concertapes 24-1

A very interesting and worth-while tape—one you must hear if you think that stereophonic sound has little to offer with a single, narrow sound source such as this! The key word here, as with most stereophonic tapes, is realism. And lucky for us, too, that coupled with this excellent recording Concertapes has brought us a great artist, Richard Pick, whose playing is all one could ask. The music itself does not, by any means, lay claim to greatness, but the selections by Tarrega, Albéniz, Torroba, Pedrell, Granados, and by Pick himself do go together to make a highly enjoyable recital. RLK

House of the Lord
Roger Wagner Chorale
7½ ips. Stereo
Capitol ZF-9 R. Wagner



These performances of religious music of several faiths are polished and spirited. In the Russian Orthodox *Hospodi Pomilui*, the choir exhibits virtuosity in tempo and dynamics. The Greek Orthodox communion hymn, *Enite, Enite*, is sung tenderly, while *A Mighty Fortress Is Our God* and the old Dutch Hymn of *Thanksgiving* stride forward with great positiveness. Franck's *Panis Angelicus*, Malotte's *The Lord's Prayer* and Schubert's *Ave Maria* are appealingly lyrical, and the Jewish *Kol Nidrei* is emotionally gripping in its intensity and fervor. Stereo affords the choir more spaciousness than it has had on discs. Every detail is sharp, yet there is no lack of integration. An enjoyable tape. WDM

L'Italia
Hollywaad Bowl Symphony Orchestra
under Carmen Dragon
7½ ips. Stereo
Capital ZF-3 Dragon



There is a universality about Italian melodies that makes them at home in any medium. The *Intermezzo* from "Cavalleria Rusticana" can evoke a mood at La Scala or cause a brood of urchins to hum along with a hurdy-gurdy. *Santa Lucia* and *Come Back to Sorrento* maintain their simple sentimentality even in symphonic garb, while the *Dance of the Camorristi* from Wolf-Ferrari's "Jewels of the Madonna" and Bohm's *Tarantella* demand only a brisk pace. Surprisingly, only the finale of Tchaikovsky's *Capriccio Italien* is played. Not much point to this. Dragon has a flair for this music and the engineers a similar flair for getting it onto tape. WDM

Oistrakh Cameo
David Oistrakh, violinist; Vladimir
Yampalsky, pianist
7½ ips. Double Track
Phonotapes-Sonore Camea (Monitor)
PMC-1017 D. Oistrakh



The famous march from Prakofiev's "Love for Three Oranges", Suk's *Song of Love*, Kodály's *Two Hungarian Dances* and Wagner's *Album Leaf* make up this program of encore pieces. As the tape was processed from authorized masters, it is a cut higher in fidelity than most recordings out of Russia. I often wonder why the Russians do not acquire some American, English, French, or German tape recorders and microphones. Their own seem to be of lower quality. It does seem strange that it should be possible to build an H bomb more easily than a good tape recorder. Moralizing aside, Oistrakh is in superb form and Yampolsky lends competent support. WDM

Organ Concert—Austin Lovelace
Austin Organ at First Methodist Church,
Evanston, Illinois
7½ ips. Stereo
Concertapes 24-3

The complaint here is not so much with the performance or the recording, but with the instrument chosen. Though Lovelace obviously tries, particularly in the Pachelbel *Vom Himmel Hoch*, he just can't get a truly brilliant baroque sound from this organ. The playing is good, the music is interesting, and the technical aspects of the recording are well served (as witness the very effective sound of the antiphonal organ). Other selections included are two charlate preludes and the *Prelude & Fugue in A minor* of Bach, an aria by Peeters, two brief works by Hermann Schroeder, and the familiar *Grand Jeu et Duo* by D'Aquin. RLK

Pete Seeger Sings
Pete Seeger with 5-String Banjo
7½ ips. Double Track
Phonotapes-Sonare Camea
(Folkways) PMC-1015 Seeger



This short program offers engaging minstrelsy of high order. Seeger sings *East Virginia*, *Kisses Sweeter Than Wine*, *Wimaweh*, *I'll Sing Me a Love Song* and *T for Texas*. There are very few singers around who can do these traditional numbers with the verve and authority that Seeger brings to them. He really seems to enjoy singing for its own sake and that is a most valuable concomitant in this area of entertainment. He never has any difficulty in communicating with his audience and, with the presence afforded by the clarity of this tape, he is in closer rapport with his public than ever. WDM

Play Melancholy Baby
Matt Dennis, vocalist and pianist,
with instrumental ensemble
7½ ips. Double Track
RCA Victor BP-54 Dennis



Intimate singing and piano playing of twelve songs inspired by the uncertainties of love are the basic ingredients of this entertaining tape. Dennis has a light, pleasant style, whether singing or playing, and an appreciation of the meaning of words. He is assisted by Ray Leatherwood, bass, Bill Pitman, guitar, Richmond Frost, drums, Don Fagerquist, trumpet, and Ronny Lang, alto flute. Their accompaniments are imaginative and deft, adding greatly to the charm of these interpretations. As Dennis arranged all of the numbers, his imprint is all over the place and it is one to be proud of. The sound is clean and bright. WDM

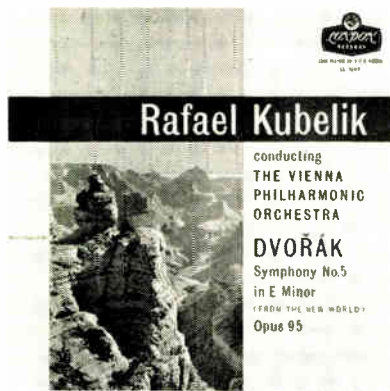

COLLECTORS' CORNER

CONDUCTORS win both blue ribbons this time around — the often underestimated director of the Boston Pops Orchestra for an album more or less aptly entitled "Hi-Fi Fiedler" (RCA Victor), and the just as often underrated Rafael Kubelik (now of Covent Garden) for his stunning *New World Symphony* (London).

AND STILL THEY COME — Latest to jump on the tape wagon is Columbia. At press time an all-stereo initial release was just being readied. On it: a New York Philharmonic *Symphonic Fantastique* under Mitropoulos; a *Firebird* suite by the same orchestra under its new co-conductor, Leonard Bernstein; "The Romantic Music of Rachmaninov" by Kostelanetz and his own ensemble; "The Strings of the Philadelphia Orchestra" (contents undecided but a simultaneous disc contains the Tchaikovsky *Serenade* and short pieces by Borodin, Vaughan Williams, and Samuel Barber); the Philadelphians under Ormandy again in Prokofiev's *Peter and the Wolf* with Cyril Ritchard narrating; and the Budapesters with extra violist Walter Trampler in Mozart's *B flat Quintet*.

HOLDOUTS ARE few any longer, now that Mercury and Capitol have joined the parade. At this writing the only labels not yet represented on both reels and discs are Angel, London, and Decca. Angel is due to come in this fall, barring production mishap. London isn't talking, but the *ffrr* sound is so much a natural for stereo that it probably won't be long.

FELICITATIONS to one of the industry's oldest and best jazz outfits — Fantasy — for its decision to enter the longhair field. There is always room for one more when it comes to serious repertory because all the majors and minors put together

couldn't exhaust the works that deserve to be recorded and are not. Fantasy's initial releases are the Skalkottas *Twelve Dances* and a Hindemith program comprising the *Kammermusik, Op. 24, No. 1*, the *Concerto for Harp, Woodwinds, and Orchestra*, and the *Concerto for Trumpet, Bassoon, and Orchestra*. The Little Symphony of San Francisco performs all under Gregory Millar — and all but one are LP firsts. All releases will be made available both on microgroove and stereo tape.

PRIce-CONSCIOUS collectors who have been concerned over rumored increases may take a modicum of assurance from London's recently raising *certain* of its \$3.98 items to \$4.98. What may hurt (but it is forgivable if you concede its salutary consequences elsewhere) is that the hike affects only the most popular records — the Tebaldi and Flagstad recitals, operettas, grand opera "highlights", and, odd in this company, Gregorian Chants!

By "salutary consequences elsewhere", needless to say, we mean the label's continuing to offer a large assortment of valuable but admittedly limited-interest repertory that undoubtedly would not amortize itself by itself. All the other major labels have similar price differentials as regards Broadway shows, but London hasn't gone in for that sort of thing and is therefore due no censure for its latest adjustment to supply and demand.

GOOD NEWS, speaking of price, is that Experiences Anonymes has reduced its list from \$5.95 to \$4.98. This firm has made an especially worth-while contribution in the year it has been around, and all collectors of the early music ignored by so many other labels will be grateful. Would it not be wonderful if one could say that connoisseurship is costing less and less?

The truth is, of course, that the less it costs the more you want to own. In fact, that wouldn't be a bad one-sentence history of record collecting, would it?

GIMMICK-MINDED entrepreneurs of LP's or tapes might do themselves a favor by getting in touch with one Charles Michelson. There was a piece about him in *The Saturday Evening Post* entitled "He Collects Noises", and while few cash customers would be willing to buy "bacon frying" or "thousands of ants devouring the body of a murder victim", these are but two of the many thousands of authentic and/or convincing entries in the Michelson cacophonous catalogue. Remembering the horrors of Audio Shows past, we hand out this idea with some hesitation. But somebody might thank us.

RECORD SHOP personnel are unhappy about the profusion of list prices among the many tape labels. We don't blame them. It is about time that the companies made some attempt at standardization. We like the RCA Victor system: The catalogue numbers are prefixed by "A", "B", and so forth through "G", each one designating a \$2 difference in progressive steps, from \$6.95 to \$18.95 inclusive.

Also, each Victor tape contains a booklet detailing the maximum time involved at the various price levels for both monaural and stereo. For example, an "A" monaural or stereo will give you 32 or 16 minutes. At the other extreme, a "G" will give you 92 or 46 minutes. Sensible.

SOMETHING NEW has been added, and one doesn't know whether to laugh or cry about it. There developed recently and briefly, it seems, a lively trade in LP album covers — that's right, empties.

For various reasons, dealers now and then need new sleeves for stock LPs. Maybe they were split by repeated trips between the shelves and the listening rooms, or maybe a clerk spilled ink on them, or what have you. Anyway, the industry has always made extra covers available to retailers at a nominal price.

But one dealer got the bright idea that if the moguls of the industry were right — that is, if art work *did* sell records — then there was no reason why it shouldn't sell all by itself, and even more so if the customer didn't care about the contents.

Anyway, this fellow did quite well for a short while. Then the manufacturers shut him off — but only after he had proved what we viewers-with-alarm have insisted all along, which is that sexy or otherwise irrelevant hard-sell packaging does a disservice to music and, in the long run, to the business of music as well. For the consumer who buys a record for its cover isn't really a music lover at all, and it is the music lover — may his tribe increase — who in the long run will determine the rise or fall of commerce in culture.

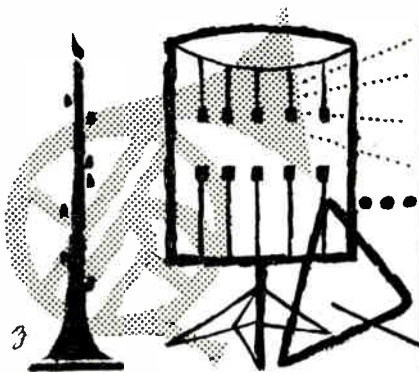

LP RECORDS

Reviews & Ratings

BOARD OF REVIEWERS: Ward Botsford • Jean Bowen • Arthur Cohn • Oliver Daniel • Warren DeMotte • Leonard Feather • Shirley Fleming • Charles Graham • David Hall • Peggy Glanville-Hicks • Edward Jablonski • Alfred Kaine • Richard L. Kaye • Ezra Laderman • C. J. Luten • James Lyons • George Louis Mayer • Ruby Mercer • David H. Miller • Robert Prestegard • David Randolph • Fred Reynolds • Abraham Skulsky • Walter Stegman • Saul Taishoff

ORCHESTRAL MUSIC

ARNOLD: Homage to the Queen—
Ballet

Philharmonia Orchestra under
Robert Irving
RCA Victor LM-2037 12''

B
A
A



It may well have been the tribute tendered Elizabeth II by this coronation ballet which changed the name of England's leading company from Sadler's Wells to Royal. Arnold, contributing much to its success, pays homage also to Prokofiev, Tchaikovsky, and other great ballet composers. This matters little, however, for the score is always admirable in its extroverted exuberance. The imaginative orchestration makes full use of vibraphone and other atmospheric sounds. Irving once again proves himself a master ballet conductor.

GLM

BEETHOVEN: Symphony No. 3
in E flat ("Eroica")

Symphony of the Air conducted by
Igor Markevitch
Decca DL-9912 12''

A
A
A



Markevitch

Reams have been written about the "Eroica". Its identity with Napoleon, the stress under which it was composed, its grandiose proportions are all fodder for the program annotators. Historically, it is notable for the clashing dissonances in its first movement development section; the introduction of a new theme in the relative minor in the development section; the return to the first theme in the French horns in E flat while the strings are still in B flat; the sudden shifting of keys in the coda. To the musician, then, this symphony is not only a feverish emotional experience, but also the score that broke down the barriers of classicism. Markevitch misses none of this in his spirited, knowledgeable reading, and the Symphony of the Air has its first team in there.

EL

BIZET: Carmen Suite; L'Arlésienne
Suites

Bamberg Symphony Orchestra under
Marcel Couraud
Vox PL-10.230 12''

A-B
B-A
A



Couraud

Beecham's performance of the Carmen Suite has long been admired; I am especially fond of his old 78 version with the London Philharmonic. This new one lacks his magical touch, but it is quite respectable nevertheless. The L'Arlésienne Suites come off better, I feel, and make this disc really worth-

while. The Bamberg rarely has sounded better, especially its solo instrumentalists. The use of a saxophone in No. 1 was an innovation for its day; hearing it still causes an initial shock, but it is really effective in its sweetness. Couraud has feeling for this music. He conducts it in a style which can be described as forgivably sentimental.

DHM

BIZET: Carmen Suite; L'Arlésienne
Suites

Detroit Symphony Orchestra under
Paul Paray
Mercury MG-50135 12''

B
A
A



Paray

There is no dearth of competitive recordings. However, Paray always manages to have a little extra to say in his performances of French music and this particular instance is no exception. An invigorating freshness pervades his treatment of these scores. He vivifies their appeal, which is somewhat faded from over-familiarity. The orchestra plays with lively spirit and bright tone, and the splendid acoustics of the recently built Henry and Edsel Ford Auditorium of Detroit, the new home of the orchestra, contribute to the radiance of the sound.

WDM

BORODIN: Polovetsian Dances
from "Prince Igor"

RIMSKY-KORSAKOV: Le Coq d'Or
Suite

London Symphony Orchestra and
Chorus under Antal Dorati
Mercury MG-50122 12''

A-A
C-C
C-C



Dorati

Bad marks for this record. To begin with, the recording is well below Mercury's standard. Blame mike placement and mechanical trouble, which gives both sides a loud tape hiss that should have been corrected. Dorati is not an exhilarating hand with either piece. Heavy is the word. The orchestral playing is fairly good but this music requires more. Oddly enough, the Borodin has yet to receive one really good LP presentation. The best performance I have ever heard is still Beecham's old Columbia set.

WB

BRAHMS: Symphony No. 1
in C minor, Op. 68

Vienna Philharmonic Orchestra
under Josef Krips
London LL-1608 12''

A
C
A



J. Krips

An impressive opening leads only to a frustratingly slow and restrained exposition of the remainder. To be sure, when played at this tempo, long hidden harmonic elements are able to emerge in bold relief, but in most instances they are better left in their proper places of accompaniment. Krips' baton tends toward rigidity and the blandly literal where an orchestral tutti or a

RATINGS OF CLASSICAL MUSIC

The following explanation of the Record Ratings which accompany the Record Reviews is given so that you will understand exactly the significance of the three letters which appear at the left of each review.

COMPOSITION (Top Letter)

A: Outstanding

Indicates that the composition is one of the composer's best works, or that it is outstanding in a particular class of music. Assignment of this rating is an unqualified recommendation.

B: Important

This rating is but slightly below the A rank.

C: Worthy

A composition which may merit representation in a library of the composer's works, or in a collection of that particular music.

PERFORMANCE (Middle Letter)

A: Outstanding

Indicates a superb performance. Assignment of this rating is an unqualified recommendation.

B: Excellent

A noteworthy performance, subject only to minor criticism.

C: Satisfactory

A performance not without flaws, yet deserving public notice.

RECORDING QUALITY (Bottom Letter)

A: Outstanding Realism

Representing the highest present attainments in acoustic and recording techniques.

B: Excellent Quality

Slightly below A rating because of minor faults in the acoustics or recording, or because the noise is considered somewhat above the minimum currently attainable.

C: Acceptable Quality

Representing the current average of the better LP records.

R: Indicates a re-issue.

Important Note: Records which are rated below C as to the composition, artist or orchestra, or recording quality are not ordinarily reviewed here. However, the omission of a record does not mean that it was rejected, as it may not have been submitted to HI-FI MUSIC AT HOME for review.

climactic build-up cries for a bit of tension and a quickening of pulse. The Viennese play with a thinner string tone than is desirable in this music. The acoustics are realistically clear. **AK**

BRITTEN: Young Person's Guide to the Orchestra A-B
ELGAR: Cockaigne Overture, Op. 40 B-A
 Philharmonic Promenade Orchestra under Sir Adrian Boult A
 Westminster W-LAB-7056 12" Britten



Westminster engineers have successfully captured the fascinating instrumental combinations of Britten's charming work—but where is the charm? Boult is so serious about this music that, to my ears at least, it fails to amuse and entertain as it should. Some very flat brass in the ending "chorale" section don't help matters, either. Other than this, the orchestra is technically splendid. The very English Elgar work is rather insignificant, consisting mostly of somewhat second-rate themes well orchestrated. Boult is more sensitive here. Especially copious and excellent program notes are supplied. **DHM**

CHAUSSON: Symphony in B flat, Op. 20 A-B
BERLIOZ: Benvenuto Cellini Overture, Op. 23 B
 A
 L'Orchestre de la Société des Concerts du Conservatoire de Paris and L'Orchestre de la Suisse Romande under Robert F. Denzler
 London LL-1505 12" Chausson



César Franck's highly flexible chromatic style is clearly evident in this sensitively written symphony. Denzler brings sympathy and understanding to his task, making this version one of the better ones. About the only criticism is that at times he lacks a firm beat, especially in the finale. In this respect he is slightly outclassed, I think, by the excellent Paray-Detroit disc. The "bonus" Berlioz Overture is quite well done. London engineers have etched some fine sound into these grooves. The Chausson is slightly the more brilliant. **DHM**

DEBUSSY-CAPLET: Children's Corner Suite A-B-B
BIZET: Petite Suite from "Jeux d'enfants"; Scènes Bohémiennes C-C-C
 C-C-C
 L'Orchestre des Concerts Lamoureux under Jean Fournet
 Epic LC-32BB 12" Debussy



The Caplet is much the best arrangement available of the Debussy—if it is played with a light hand, as it is not here. Fournet may have taken the elephantine suggestions of "Jimbo's Lullaby" too much to heart. The effect is ponderous. Ditto with the ever charming Bizet scores. The Cluytens is the preferred version of the Debussy and Lindenberg does a serviceable job with the Bizets. The orchestral playing here lacks precision and also the lightness of texture which often highlights orchestral recordings from France. The sound is cavernous, the tape hiss very objectionable, and there are a number of pre- and post-echoes. **WB**

DVOŘÁK: Slavonic Dances A
 Philharmonia Orchestra under Nicolai Malko A
 RCA Victor LM-2096 12" Malko B



Although the notes and the label are far from clear, this record contains the dances of Opus 46 and the first two dances only from Opus 72. Strictly speaking I can think of no more useless use of vinyl than in duplicating—or rather, trying to duplicate—the Talich version of these miniature masterpieces. But Malko, a badly under-rated conductor by the by, has ideas of his own which are thoroughly interesting. Better Talich he does not, but this is the best one-disc version available. The orchestral playing is superb, and the sound also is good if not exactly superb. **WB**

DVOŘÁK: Symphony No. 2 in D Minor A
 B
 Berlin Philharmonic Orchestra under Ferdinand Leitner B
 Decca DL-9909 12" Leitner



While Dvořák's Second Symphony has never attained the popularity of the New World or the Fourth, it has a greater intensity of feeling than either. Written in the shadow of Brahms, the D minor is a rather somber work with bursts of passion and even bitterness, rarities in the Dvořák lexicon and hence the more impressive. Leitner's performance is a strong one. The orchestra

plays with fervor, producing a tone which projects more solidity than transparency. It may be the engineering that causes the occasional fusion of timbres although, in the main, the sound has the depth and richness generally present in recordings of the Berlin Philharmonic. **WDM**

DVOŘÁK: Symphony No. 5 in E minor, Op. 95 ("From the New World") A
 A
 A
 Vienna Philharmonic Orchestra under Rafael Kubelik
 London LL-1607 12" Kubelik



Every so often some bright critic discovers that the "New World" really isn't such good music after all. Well, to the next one I would recommend a hearing of this record before he puts pen to paper. Here is a "New World" that shines as only a work can when it is reappraised by a conductor of talent. Is it the best to be had? I can't lay claim to having heard all the twenty-odd available, but I can certainly say that I haven't heard better. This is Kubelik's third on LP and by all odds his best version. The Viennese play like angels, and the sound is first at its blooming best. **WB**

GRIEG: Peer Gynt Suites; Four Norwegian Dances B
 A
 A
 Philharmonia Orchestra under Walter Susskind
 Angel 35425 12" Grieg



It seems there just cannot be too many versions of such as the Peer Gynt Suites. I know that ten years hence, or twenty, the good Lord willing, I shall be listening to new recordings of these favorites. The Philharmonia performs them with evident enjoyment, a credit to Susskind's leadership. The less often played Norwegian Dances are done with style and energy. Written for piano, four hands, they later were orchestrated by Hans Sitt. They are very attractive as played by the Philharmonia; I'd like to hear them sometime in Grieg's original conception. **WDM**

HAYDN: Symphony No. 86 in D; Symphony No. 92 in G ("Oxford") B-A
 B-B
 A-A
 Scarlatti Orchestra under Franco Caracciolo
 Angel 35325 12" Caracciolo



This is a superb recording and a fascinating issue in many ways. First, it reinforces the impression that postwar Italian string ensemble players are the very best in the world today. Then, it reveals the Italians' affinity for Haydn; last, it shows the value of having the woodwinds clearly heard at all times in Haydn symphonies. Caracciolo is not a star conductor who can point up with sharp inflections of phrase the multitude of wonders in a score such as the Oxford Symphony, but he is an able director with a real sympathy for Haydn and a genuine respect for the composer's indications. Nothing here but honest music-making. **CJL**

HAYDN: Symphony No. 101 in D; Symphony No. 104 in D A-A
 C-C
 B-B
 Pra Musica Symphony, Vienna, under Jascha Horenstein
 Vax PL-9330 12" Haydn



Lead, labored performances of the great Clock and London Symphonies. The pacing is for the most part much too slow for any kind of effectiveness. The rhythm is slack and nerveless far too often. As for the orchestral playing, it is routine; and the ensemble is ragged from time to time. Horenstein has given us some excellent performances on other occasions; this was obviously an off day. Moreover, one suspects that Haydn is not this conductor's dish of tea. **CJL**

KHACHATURIAN: Gayne Suite A to C
MUSSORGSKY: A Night on Bald Mountain B
 B
BORODIN: On the Steppes of Central Asia; "Prince Igor" Overture
RIMSKY-KORSAKOV: Flight of the Bumble-Bee
 Hallé Orchestra under George Weldon
 Mercury MG 50137 12" Weldon



Gads, what a mélange! Let's take it from the top. The Gayne "suite" is but three numbers, including you know what. Matter of fact performance probably doesn't hurt it much—but it sure doesn't enliven it either. The Mussorgsky cum Rimsky is downright dull. The Borodin cum Rimsky is only slightly less so. Borodin's own music needs a virtuoso conductor—Beecham for instance—and that Weldon is not. It also needs a virtuoso orchestra, and the Hallé

does not play for Weldon as it does for Barbirolli. Oh, Bumble-bee, where is thy sting? The sound is a little distorted. WB

**MOZART: Serenade No. 9 in D, B-A
K.320; Symphony No. 29 in A, B-A
K.201 B**
Concertgebouw Orchestra of Amsterdam under Eduard Van Beinum
Epic LC-3354 12'' Beinum



The Serenade is the featured composition, but it is the Symphony that is recommended. The Serenade is, I think, Mozart at his most uninspired. The less said about this opus the better. On the other hand, the Symphony is a gorgeous work, full of beauty and invention, and performed here with glowing delight. It is a work without tension, and yet it suggests the intense *Haffner* in its opening motif. Beinum has kept the original Salzburg orchestration of two oboes, two horns, and a moderate group of strings. The result should please the most critical. EL

**MOZART: Symphony No. 38 in D, A
K.504 ("Prague") Symphony No. B
39 in E flat, K.543 B**
Bamberg Symphony Orchestra under Joseph Keilberth
London Telefunken LGX-66054 12'' Mozart



Here are two much-recorded symphonies, but rarely have I heard them played with more warmth and understanding. The Bamberg Orchestra may not be up to the highest standards of orchestral polish, but its ensemble as well as its individual instrumentalists produce beautiful sounds indeed, and all display a remarkable sympathy for style. Keilberth's conception of the music is mature and forceful, yet always graceful and often delicate — he may well be one of our most important Mozart interpreters. If you swear by the other excellent LP performances, all right; but at least give these a try. The recording is fine. DHM

**RIMSKY-KORSAKOV: Tsar Saltan A to C
Suite; May Night Overture; Russian A to C
Easter Overture A**
L'Orchestre de la Suisse Romande under Ernest Ansermet
London LL-1635 12'' Ansermet



"The Tale of the Tsar Saltan" is the opera with the *Flight of the Bumble-bee*, but this Suite, which was arranged by the composer, does not include that ubiquitous miniature. However, the three colorful movements contain music of more lasting interest. Ansermet has been wending his way through the Russian repertory with distinction for the most part. He conducts a stunning performance of the *Tsar Saltan* in particular. Music so kaleidoscopic as this program provides perfect material for London's engineers and they make the most of their opportunities. WDM

**SCHUBERT: Symphony No. 7(9) in C A
Bamberg Symphony Orchestra under B
Jonel Perlea A
Vox PL-10,200 12'' Perlea**



Although this is a spirited and finely integrated effort, it suffers (some would say "gains") from a sameness of intensity and relentlessness of beat throughout. In tempi as well as temperament, that is, it resembles Toscanini's performance (except for a slower introduction). My own admiration has always been for the warm sentiment with which Walter infuses these pages, but there is no gainsaying Perlea. The playing of the orchestra here is commendable, as is the engineering. AK

**J. STRAUSS, JR.: The Blue Danube C-B
— Ballet B-B
BIZET: Jeux d'Enfants — Ballet R-R**
London Philharmonic Orchestra under Antal Dorati
RCA Camden CAL-365 12'' Bizet



This record is apparently aimed at those ballet lovers who remember these amusing items from the repertory of Colonel W. de Basil's Ballets Russes with affection and nostalgia. The Strauss pasticcio loses much when the great Danilova is not before us to enchant. The Bizet pieces, however, are thoroughly delightful musical toys filled with Gallic charm. Dorati's performances, both spirited and musical, add to the authenticity of the nostalgia. It is unfortunate that the sound and surfaces fall far short of present standards. GLM

**J. STRAUSS: The Blue Danube; Em- A
peror Waltz; Voices of Spring; B
Tales from the Vienna Woods; A
Roses from the South**
Philharmonic Symphony Orchestra of London under Artur Rodzinski
Westminster XWN-18500 12'' Rodzinski



This collection qualifies as a "big five" of the Waltz King's catalogue. They are probably the most popular and all possess the characteristics of their creator's genius. In this *Tales from the Vienna Woods* a zitherist twangs on his homely instrument with virtuosity tempered by nostalgia. How evocative this piece is of the Vienna of dreams! Rodzinski's baton is not the most lissome; his *Gemütlichkeit* lacks some of the easy flow of the native Danubian. But his orchestra plays with a fine rhythmic pulse, and Westminster obliges with splendid recording. WDM

**R. STRAUSS: Don Juan; Waltzes A
from "Der Rosenkavalier"; Till B
Eulenspiegel's Merry Pranks; A
Love Scene from "Feuersnot"**
Philadelphia Orchestra under Eugene Ormandy
Columbia ML-5177 12'' Ormandy



The magnificent playing of the Philadelphians cannot overcome the fact that these are rather routine performances. For all the appropriate Viennese lushness of sound, Ormandy has a tendency to drive the music too hard; what he gains in energy he loses in humor, satire, and sentiment. Krauss has recorded both tone poems for London, and his realization of these scores is, to my way of thinking, virtually unsurpassed. The "Feuersnot" excerpt, new to LP, is worth looking into despite its obvious allusions to Tristan. The recording, though slightly thin, is clear and brilliant. DHM

**R. STRAUSS: Ein Heldenleben A
Saxon State Orchestra, Dresden, B
under Karl Böhm A
Decca DL-9927 12'' Böhm**



The emphasis here is on the lyrical elements of the score, and it cannot be denied that Böhm weaves a beautiful sonic tapestry almost mystical in effect. What he does lack is that necessary sense of drama which makes the Reiner version such a moving experience. Indeed, there are times when Böhm seems bloodless, such as in the opening bars; alas, these gripping pages fail to grip. The orchestra is very good, though not in the Chicago's virtuoso class. The recording evidences balance and blend, but there is sometimes an excess of hall echo causing muddiness in sections which should be crisp and clean. DHM

**SUPPÉ: Overtures — Light Cavalry; A-B
Poet and Peasant; Morning, Noon A
and Night in Vienna; Pique Dame; A
Tantalusqualen; Die Infahrt ins Glück**
Philharmonia Promenade Orchestra under Henry Krips
Angel 35427 12'' H. Krips



Although he was not Austrian by birth, Suppé's style is in line with the Viennese tradition of light music: froth and foam. *Tantalusqualen*, especially, reveals a slight kinship to Offenbach, although Suppé is a little less light-headed. These performances are clean, vigorous, and thoroughly efficient; this means also that they are a bit too sedate and somehow miss the delightful humor. Boulton may reveal more of this sparkle, but Krips is not to be overlooked, for the Promenade Orchestra rarely has sounded better, and the recording is really tops. DHM

**TCHAIKOVSKY: Nutcracker Suite; A to C
CHABRIER: España; PONCHIELLI: A to B
Dance of the Hours; SUPPÉ: A to B
Morning, Noon and Night in Vienna**
Royal Philharmonic Orchestra under Sir Thomas Beecham
Columbia ML-5171 12'' Beecham

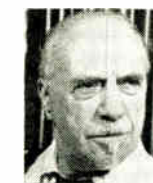

If you hear this disc, chances are you will feel like applauding after the Suppé and the Chabrier. No one plays either of these works quite like Sir Thomas. But his performance of the *Dance of the Hours* wants that final amount of excitement to lift it into a memorable experience. The *Nutcracker Suite* (and how delightful it is no matter how many times one has heard it) is performed in a somewhat curious manner: the tempi for the numbers after the "Arabian Dance" are surely too slow, and there are some accelerations and retardandos that appear to be mannerisms. CJL

TCHAIKOVSKY: Symphony No. 3 in D, Op. 29 ("Polish") C
C
London Philharmonic Orchestra under A
Sir Adrian Boult
London LL-1442 12''
Boult



The *Third Symphony* (called the *Polish* for its tempo *di polacca* finale) has never been very popular and is largely a curiosity. It contains a peculiar admixture of Tchaikovsky's impersonal and emotionally outspoken writing. A sure hand in regard to orchestration is, however, always apparent. This is the first top-quality recording we have had of this work, and for this one is grateful. The performance nevertheless lacks an adequate revelation of detail, and the orchestral execution is lagged from time to time. C.J.L.

WAGNER: Bacchanale and Venusberg Music; Ride of the Valkyries; Good Friday Music; Forest Murmurs; Siegfried's Rhine Journey and Funeral March A
B
A
Württemberg State Orchestra, Stuttgart, under Jonel Perlea
Vox PL-10.130 12''
Wagner



Of the various "Wagner Concerts" on LP you can't do much better than this one, at least as far as the conducting is concerned. The Württemberg orchestra is not the most polished ensemble in Europe, but Perlea does wonders with it. There is some pretty sloppy instrumental work, true, but for poetically expressive conducting this program is a real treat, for Perlea is not prone to excesses of tempi or to disturbing personal mannerisms of any other kind. These are performances of rare integrity and understanding. The recording is rich and full. DHM

Hi-Fi Fiedler A to B
Boston Pops Orchestra under Arthur A to B
Fiedler A
ECA Victor LM-2100 12''
Rimsky-Korsakov



Hi-Fi Fiedler, eh? Hmm, let's see now — clever album cover, clever R. D. Darrell notes. Let's put on the record. Rimsky-Korsakov's *Coq d'Or Suite* always a doozy for the decibels. Turn up the volume a little. Ahhh! Listen to that orchestra. When the chips are down you can't beat the Boston boys anywhere. Fiedler is good too — not as good as Beecham, perhaps, but this is a wow of a recording. *Marche slave* next. How's the timpani part? Turn up that volume a little bit more now. Man, listen to that roar! Best ever. Try the *William Tell Overture* at just a bit louder setting. Whoa, here comes the landlord and the neighbors. WB

CONCERTOS

DVOŘÁK: Violin Concerto in A minor, Op. 53 A-B
A-A
GOLDBLUM: Violin Concerto in A minor, Op. 28 B-A
Bronislaw Gimpel, violinist; Southwest German Radio Orchestra under Rolf Reinhardt
Vox PL 10-290 12''
B. Gimpel



Much has been said, in aesthetic circles, about the difference between sentiment and sentimentality. Let us beg the question here and say that the Goldmark Concerto has both, plus a good bit of sinew in the finale. It is music made for the violinist — if he is a good one, and Gimpel is. The Dvořák has more substance, however, and some rarely beautiful moments of its own, showing in vivid terms the composer's caliber as an orchestrator. Gimpel's playing is more feminine than Johanna Martzy's, but is has strength enough to live up to the music, nevertheless. The orchestra is good indeed, but its sound is slightly marred by pre-echo on one side of the review copy. SF

KHACHATURIAN: Violin Concerto B
B
Ruggiero Ricci, violinist; London Philharmonic Orchestra under Anatole A
Fistoulari
London LL-1537 12''
Ricci



The company that does not have an Oistrakh on its roster is at a disadvantage in recording this concerto. Both père and fils have done it to perfection. London's entrant is a violinist with technique, tone, and the willingness to take a dare. Ricci sails into the piece fearlessly and supplies virtuosic fireworks in abundance without neglecting musicianship and good taste. Regrettably, Fistoulari's conducting is not as high-stepping as Ricci's playing, although London's engineering is splendid indeed. However, the Oistrakh sovereignty remains intact. WDM

MENDELSSOHN: Piano Concerto No. 1 in G minor, Op. 25 B-B
C-C
RICHARD STRAUSS: Burleske in D minor C-C
Poldi Mildner, pianist; RIAS Symphony Orchestra conducted by Arthur Rother
London Telefunken LGX-66062 12''
R. Strauss



These pieces can be a lot of good clean fun. Both are hyper-romantic essays in piano writing and as such, both require an artist with a big technic, a sense of humor and an identification with the era. Poldi has the first — my, how the notes fly! — but of the others, nothing. Machine-tooled brilliance is hardly worth a yawn today. The Mendelssohn still needs a good recording. The *Burleske* is well done by Serkin. The recording is very clangorous. WB

MENDELSSOHN: Violin Concerto in E minor A-B
A-A
BEETHOVEN: Romances B-B
Johanna Martzy, violinist; Philharmonia Orchestra under Paul Kletzki
Angel 35236 12''
Martyz



Johanna Martzy is a musician and violinist of great strength and rock-solid skill. To say that she deals with music primarily as structure in sound rather than as a means of subjective expression is a blunt way of phrasing a rather rarefied phenomenon, but her performance of the Mendelssohn seems to make that point. It has not much of the dreamer in it, but it is a thing of beauty nevertheless. The *Romances*, in which Beethoven seems to let the violin think out loud, are treated with perhaps more tenderness. One's only quarrel with the record is a peculiar leveling of dynamics—a solo flute has a decibel power about equal to the full orchestra's, and neither varies appreciably from loud to soft throughout the performance. SF

MOZART: Piano Concerto No. 17 in C, K.453; Piano Concerto No. 25 in C, K.503 A-A
B-A
C-B
Denis Matthews; London Mozart Players under Harry Blech
Capitol P-18048 12''
Rudolf Serkin; Columbia Symphony Orchestra under George Szell
Columbia ML-5169 12''
Serkin



Both pairs of performances are on the dedicated level, but there is considerable stylistic disparity. Matthews and Blech favor a chamber music approach of narrower dimensions and a smaller, thinner-sounding ensemble, while Serkin and Szell project in broader and more emphatic tones. The concepts are at their widest divergence in the later concerto, where the Capitol tends toward particularly restrained dynamics and tempi and subdued colorations. But Mozart's indications (*Allegro Maestoso*—first movement; *Allegretto*—third movement) are toward the brighter contrasts more fully realized by Serkin and Szell. From the latter, however, one would prefer a real *andante* in the second movement of the K.503 instead of the trudging pace employed. I likewise find more that suggests the true Mozartean humor in the performance of the K.453 on Columbia. Serkin is abetted no little by Szell, whose immaculate bowings and warm but exact definition I find preferable to Blech's liquid sweetness. The cadenzas (by Casadesu) used by Serkin are of greater musical value than those written by Matthews, who indulges in considerable ornamentation. None of the four sides is ideally recorded. AK

PAGANINI-KREISLER: Violin Concerto in One Movement C-B
A-A
SAINT-SAËNS: Violin Concerto No. 3 in B minor A-A
Campoli, violinist; London Symphony Orchestra under Pierino Gamba
London LL-1624 12''
Campoli



Most of us are as susceptible as the next to flights of a violinist up and down his fingerboard, but we have become spoiled by music which offers more than just the element of show-off. By this token, side 1 here is of limited interest. But perhaps it is unfair to ask of Paganini more than a glittering display of bouncing-bow technique and left-hand pizzicato, along with some rather lush melodies, and if so we can do worse than this Kreisler transcription. The Saint-Saëns is another matter; the violinist shines and the listener has something to think about too—mainly during the slow movement, in which there is some wonderful communication between soloist and woodwinds. Campoli lives up to it all, and so does the orchestra. SF

RACHMANINOV: Piano Concerto No. 2 in C minor, Op. 18 A
C
CHOPIN: Nocturne in D flat, Op. 27, No. 2 A
Eugene Malinin, pianist; Philharmonia Orchestra under Otto Ackermann
Angel 35396 12''
Malinin



Eugene Malinin, twenty-six years old, is one of the several Soviet cultural warriors now at large in western Europe and South America. He has a strong technique and also he is the possessor of a most lovely tone, which he is able to color with many hues. But it must be said that he gives a poor account of himself on this occasion. His rhythm is often wayward, and his tempi are somewhat ill chosen. In both his Rachmaninov and his Chopin there is a curious leaden quality that will, I suspect, charm no one. CJI

SCHUMANN: Piano Concerto in A minor, Op. 54 A-B
R. STRAUSS: Burlesque in D minor B-A
 Rudolf Serkin, pianist; Philadelphia Orchestra under Eugene Ormandy A
 Columbia ML-5168 12" Schumann



The Schumann Concerto is treated here in too much a "tour de force" manner for my taste. I prefer the poetry and sensitivity of Novaes or Lipatti. On the other hand, the reverse side offers one of those rare fusions of artistic insight of pianist and conductor, and in consequence a truly thrilling performance of the early Strauss hair-raiser. This is a virtuoso performance *par excellence*, and a resplendent recording. There are times when you literally can't believe your ears! The work itself is more fireworks than musical substance, perhaps, but if you like color and excitement, don't miss it. DHM

SCHUMANN: Cello Concerto in A minor, Op. 129 A-B-C
HAYDN: Divertimento A-A-A
FALLA: Suite populaire espagnole; Ritual Dance of Fire A-A-A
 Daniel Shafran, cellist; State Orchestra of the U.S.S.R. under Kiril Konradshin; Nina Musinin, pianist
 Vanguard VRS-6028 12"



You can't say this record hasn't variety, but it seems a waste to devote so much of side 2 to works which do not do much for the cello, nor the cello for them. Shafran deserves better. The Schumann he handles expressively, and it is hard to see why this work was so long regarded as a thankless task. Its solo part is musical and celloistic, and the orchestral scoring is more transparent and interesting than Schumann is usually given credit for. As for the *Divertimento*, Haydn was obviously feeling fit when he wrote it, and Shafran treats it with appropriate sauciness. The Falla doubtlessly provides a workout for the soloist, but the cello is just in the wrong pew. SF

TCHAIKOVSKY: Piano Concerto No. 2 in G, Op. 44 B
 Shura Cherkassky, pianist; Berlin Philharmonic Orchestra under Richard Kraus C
 Decca DL-9916 12" Cherkassky



Since its première in 1941, *Ballet Imperial*, Balanchine's tribute to Petipa, has been hailed as a masterpiece in New York, London, and Milan. The revised version of this concerto recorded here is the one used for the ballet. Its neglect in our concert halls and the temporary absence of the ballet make a superlative recording essential. Unfortunately, blemishes in both performance and recording prevent this disc from filling the gap. Cherkassky handles the difficulties impressively but, in the first two movements, often loses control. More rehearsals, greater polish, and a stricter regard for tempi might have done the trick. Let's wait and hope. GLM

VIVALDI: 4 Concerti A
 Ensemble Instrumental Sinfonia B
 under Jean Witold B
 London International TWV-91052 12" Vivaldi



There are four concerti here, all with string orchestra: for oboe in D minor Op. 8, No. 9; for 2 violins in B flat, F. I., No. 42; for 2 violins and 2 cellos, F. IV, No. 4; for bassoon in E minor, F. VIII, No. 6. If competition were not so stiff in the baroque league these days, this group would rate better than merely adequate. As it is, they lack the electric touch of I Musici or the Virtuosi di Roma. But the record is worth having for Vivaldi's sake; there are delightful reflections of *The Four Seasons*, and some unusual writing for bassoon. At times, too, the line-against-line character of the music is especially vivid. SF

CHAMBER MUSIC

BEETHOVEN: Sonatas for Violin and Piano, Op. 12, Nos. 1 and 3 B-B
 Leonid Kogan, violinist; Gregory Ginsburg, pianist A-A
 Vanguard VRS-6029 Kogan



A critic of Beethoven's time was perturbed by these "strange sonatas". Today, however, one must make an effort to take them out of a merely historical pigeonhole which reveals the composer with a mind of his own, not yet advanced to the boldness of the Opus 18 quartets. No. 1 presents the violin and piano on very cordial terms, occasionally building up a drama which our hindsight recognizes as prophetic of later style. No. 3 seems to me the more engrossing work, and its slow movement, even without hindsight, is poetry. Kogan is energetic and precise, with perfect co-operation from Ginsburg. Sound is very good. SF

R. CASADESUS: Quintet for Piano and Strings in C, Op. 16; Sonata No. 2 in A for Violin and Piano, Op. 25 A-B
 Gaby Casadesus, pianist; Daniel Guilet, violinist; Guilet String Quartet B-B
 M-G-M E-3521 12" Casadesus



You pick up this record, of course, thinking "Ah! Pianist-composer." After five minutes you think simply "Ah! Composer". The *Quintet* offers much: a first movement of rather thick contrapuntal textures; an ingratiating second and even more ingratiating third movement, in which the oir is cleared and violin and viola step forth to shine in pure melody; and a vigorous and discordant finale which brings the piano back to prominence. There are a goodly number of adventurous harmonies in the two outside movements, but (without benefit of score) it is one's hunch that the discords are hung on as external decoration and do not occur as an intrinsic part of the tonal scheme. A weakness, perhaps. The sonata is very much alive, with alert rhythms and a fine display of violinistic writing, but my vote goes to the quintet. There can be no doubt that to consider Casadesus as pianist alone is to seriously underestimate him. The performances are excellent. SF

Julian Bream Plays Dowland A
 Julian Bream, lutenist A
 Westminster XWN-18429 12" Bream



The music on this disc consists of fourteen cameos that bear such attractive titles as *Queen Elizabeth's Galliard*, *Lachrimae Antiquae Pavan*, *Mrs. White's Nothinge*, *Orlando Sleepeth*, *My Ladye Hunsdon's Puffe*, *Sir Henry Umpton's Funerall*, and *Forlorne Hope Fancy*. They possess the beauty of finely carved miniatures and a broad range of expressiveness. As Dowland was a virtuoso lutenist at a time when even the Virgin Queen played the instrument "pretily and sweetly," these pieces are quite difficult. Bream plays them with polish and temperament and reminds us that, though the lute is a gentle instrument, it can sparkle or evoke tears in the hands of a master. Fine sound. WDM

DVOŘÁK: String Quartet No. 7 in A flat, Op. 105 B
 Janacek String Quartet A
 Decca DL-9919 12" Dvořák



The superb playing of the Janacek Quartet dominates this recording. Interesting as it might be to hear an unfamiliar Dvořák work, the interest wanes as it becomes apparent that this is a minor achievement. Not until the second half of the third movement, *Lento e molto cantabile*, is there anything that comes close to being first rate Dvořák. This is all the more surprising since his opening introductory motive is pregnant with the possibility of exploitation. Why he only casually refers to it, and in the most obvious way, is a mystery, for Dvořák despite his Middle European background had a strong classic streak in him. It is not in evidence here. EL

MEYERBEER: Sonata in D for cello and piano A-A
STRAUSS: Sonata in F, Op. 6, for cello and piano A-A
 André Navarra, cellist; Ernest Lush, pianist
 Capitol P-18045 12" Navarra



This record pairs two works which are beautifully matched as well as completely engaging in themselves. The Mendelssohn is full of air and sunshine, even in its meditative third movement; the early Strauss makes more of romanticism's bigness and strength, and is in addition an extraordinarily grateful piece for cello. Both deserve the best in performers, and they get just that. Navarra is a trifle more self-contained on the Strauss than Schuster in the version of a few months ago (see May-June '57) but the warmth is all there. Lush has just the right touch in both accompaniments. Sound is first-rate. **SF**

MOZART: Serenade for Wind Instruments, No. 10 in B flat, K.361 B
A
Members of the Berlin Philharmonic A
Orchestra under Fritz Lehmann
Decca DL-9918 12" Lehmann



More credit to Mozart that his "outdoor music", written with an eye to carrying power and easy assimilation, comes off as well indoors via recording. In the case of the Serenade No. 10, the composer's skill in scoring accounts for a good bit of its interest—each instrument has the kind of part it can handle best, and often several of them together step forth for a bit of concerto grosso display. The performance is excellent, and the sound clear as crystal. **SF**

Mischa Elman Program B
Mischa Elman, violinist; Joseph Seiger, B
pianist A
London LL-1467 12" Elman



Ah, that Elman tone! How luscious it is in Achron's Hebrew Melody and Bloch's Nigun! Yet this is not a record of miscellaneous short encore pieces, although the title might lead one to believe it is. Erich Korngold's Suite from Much Ado About Nothing and a Werner Josten Sonatina complete the program and they are neither short nor lacking in seriousness. The Josten is the more interesting composition; it is skillfully put together, with melodies and modernism nicely balanced. Elman performs the whole program with style and conviction, and Seiger misses none of his opportunities. The mating of frr and the Elman fiddle has an element of inevitability. **WDM**

Segovia and the Guitar: Pieces by A-B
Manén, Narváez, Dowland, A.
A
Scarlati, D. Scarlati, Espiá A
Andrés Segovia, guitarist
Decca DL-9931 12" Segovia



Jaan (Catalan for Juan) Manén wrote his twenty-minute Fantasia-Sonata "for and because of Andrés Segovia". Its single movement, sectionalized like a Liszt concerto, exhaustively exploits the technical and musical resources of the guitar. The idiom is modern, tinged with the languor and sudden outbursts of the Spanish temperament, and Segovia performs it with intensity and lyricism. The overside pieces range from the sixteenth century to today and originally were written for the vihuela, ancestor of the guitar, the lute and the piano. The guitar transcriptions are skillful and Segovia's wizardry does the rest. **WDM**

OPERA

Geraldine Farrar in "Carmen" A
Geraldine Farrar, Giovanni Martinelli, B
Pasquale Amato C
RCA Camden CAL-359 12"



Farrar, rather than Bizet, is the *raison d'être* of this compilation of old 78's, and the damage to the composer's intentions is appalling. Missing voices, truncated ensembles and other patchwork are much in evidence. Of Farrar, who is heard in the "big" scenes, as well as in Micaela's aria, there is little to say. She sang "Carmen" with style and conviction but with none of the mezzo timbre that gives the gypsy girl her memorable quality. Sound-wise, too, this disc is disappointing. Uneven and often distorted, it is hardly a fair sample of the work of any of the artists heard on it. **JB**

DANKEVICH: Bogdan Khmel'nitski C
Mikhail Grishko, others from the Kiev A
Raras Shevchenko Theater; Chorus A
and Orchestra under Vladimir Piradov
Westminster OPW-1403 4-12"



This is the first opportunity the western world has had to hear the music of the new Ukrainian Opera that was premiered in Moscow in 1951. Its proportions—four acts plus a prologue—put it in the "Boris Godunov" class. It is reminiscent of "Boris" also in its treatment of musical line for individual voices, the use of the chorus, the accent on the famed Russian basso voices, and the climactic orchestra and ensemble scenes with bells ringing as in Mussorgsky's Coronation Scene. You may find the music heavy fare, but the recording itself is excellent, the cast of high level, the chorus outstanding, and the orchestra good. **RM**

GLUCK: Alceste A
Kirsten Flagstad, Raoul Jobin, Alexander Young, Marion Lowe, Thomas Hemsley, Joan Clark; Geraint Jones Orchestra and Singers under Geraint Jones
London set XLLA-49 4-12" Gluck



The artistry of Kirsten Flagstad has become legend and, in this recording, made last year in London, this amazing voice still sounds fresh, young, and smooth. Only in the highest phrases are limitations evident. Jobin, former tenor of the Metropolitan, portrays Admetus most capably and offers some thrilling moments. The original Italian version is used except for this role, which is entrusted to a tenor as in the revised French version of 1776. This is an altogether remarkable recording in that it has no weak elements. The music, antedating our American Revolution by almost a decade, sounds vital and up to date; the cast is superb; the chorus is of exceptionally high quality, the orchestra top-notch; the sound is clear, full, well-balanced, and Mr. Jones keeps the tempi moving. A high point in the album is the touching scene between Admetus and Alceste in Act Three. **RM**

MEYERBEER: Les Huguenots B
(Abridged) C
Renée Doria, Jeanne Rinella, Simone B
Couderc, Guy Fouché, Adrien Legros, Charles Cambon, Henri Médus, Orchestre de l'Association des Concerts Padeloup; Académie Chorale de Paris under Jean Allain
Westminster set OPW-1204 2-12" Meyerbeer



It would be a pleasure to report that the long-awaited first recording of "The Huguenots" is a masterpiece. But unfortunately this is not possible. The cast is below par except for tenor Fouché (Raoul) and bass Adrien Legros (Le Comte de St. Bris). Couderc's fast tremolo and Doria's vibrato leave much to be desired in their interpretation of the roles of the Page and Queen Marguerite respectively. Two especially agreeable examples of good ensemble singing and technical balance should be noted: the tria *Sombre chimère* in Act II and the dramatic septet in Act III. Jeanne Rinella in the all-important role of Valentine sounds strained and forced. Meyerbeer fares better at the hands of chorus and orchestra, but the opera does require seven star voices. **RM**

MOZART: La Finta Semplice B
Dorothea Siebert, George Maran, B
Alois Pernerstorfer, August Jaresch, B
Edith Oravez, Karin Küster, Camerata Academica of the Salzburg Mozartium under Bernhard Paumgartner
Epic set SC-6021 2-12"



"La Finta Semplice", like "Bastien and Bastienne", was composed when Mozart was twelve. From listening to this recording one wonders why the work never has enjoyed the popularity of its companion piece. The devotion of the members of the Camerata Academica and Paumgartner toward the authentic re-creation of Mozart's works is rewardingly apparent. The cast, on the whole, is made up of young, fresh-voiced, musically sensitive artists with the ability to capture the youthful spirit and charm of both the story and the music. However, it is the veteran Alois Pernerstorfer (Don Cassandro) who steals the show. **RM**

OFFENBACH: La Périchole B
(Abridged) A
Patrice Munsel, Theodor Uppman, Cyril Ritchard, Ralph Herbert, Paul Franke and others with the Metropolitan Opera
Chorus and Orchestra under Jean Marel
RCA Victor H2RP-3768 12" Offenbach



This is opera at its lightest, gayest and most melodic. Patrice Munsel, Theodor Uppman, et al. repeat their Metropolitan triumphs, putting words across with clarity, savor, and fine vocal style. Ritchard, who staged the work at the Met, has said that he joined the roster of singing artists in spite of his voice! However, you will find it a strong baritone (of uniquely individual quality) that is infectious as each word is clearly enunciated. Marel seems to have a special affinity for the Offenbach score and his direction, combined with the excellent quality of the recording, make this album a delightful treat

The recording was made originally for the Metropolitan Opera Record Club, sponsored by the Book-of-the-Month Club. RM

R. STRAUSS: Die Frau ohne Schatten A
B
A
Leonie Rysanek, Christel Goltz, Elizabeth Höngen, Hans Hopf, Paul Schoeffler, Kurt Böhm; Vienna State Opera Orchestra and Chorus under Karl Böhm
London set XLLA-46 5-12''



A strong cast of seasoned artists, a magnificent orchestra, and authoritative direction by Kurt Böhm combine to make this a forceful first recording of the Strauss masterpiece. The orchestral sound is brilliant; the themes and phrases emerge clean and clear; the conducting is in the "big line". The string section, a bit thin at times, is more than compensated for by the unusually fine brass and timpani. Even in the most fortissimo passages (and there are many of them in the rich Strauss orchestration) only the minimum of distortion can be detected in this album, which boasts an over-all hi-fi quality. Outstanding among the soloists are Hans Hopf and Paul Schoeffler. RM

TCHAIKOVSKY: Eugene Onegin A
C
B
Galina Vishnevskaya, Larissa Avdeyeva, Eugene Belov, Sergei Lemeshev, Ivan Petrov, others; Bolshoi Theater Chorus and Orchestra under Mikhail Shorin
Westminster set OPW-1303 3-12''

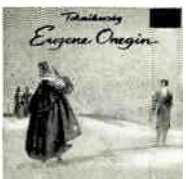

This cast from the Bolshoi Theater is generally disappointing. Vishnevskaya (Tatiana) is an artist both sensitive and musical who is handicapped by an insecure vocal technique and a wide vibrato. Belov, in the title role, forces badly and has a wooden quality in top phrases. Furthermore, interpretatively, he lacks the necessary subtlety for the role. Lemeshev is expressive as Lensky, but his singing is too often restricted and throaty. Avdeyeva (Olga) and Petrov (Gremm) are the most satisfying artists in the performance. The orchestra and chorus are satisfactory. RM

WAGNER: Tannhäuser (Abridged) A
A
C
Leonie Rysanek, Wolfgang Windgassen, Eberhard Waechter, Josef Greindl
Various orchestras and conductors
Decca DL-9928 12'' Windgassen



Another in the Decca series of grand opera highlights. These excerpts are of good quality, in spite of the variety of orchestras and conductors represented. Rysanek's Elizabeth has the stamp of sincerity, and she does some notably expressive singing, particularly in the *Dich, teure Halle*. She has a beautifully sustained legato, and the faint signs of wear audible in the lower middle part of her voice are not yet disturbing. Windgassen is represented by the Rome narration, which he delivers with fresh voice and considerable vigor. Waechter's Wolfram, too, is admirable. The review copy had pre-echo. JB

WAGNER: Tristan und Isolde (excerpts) A
C
C
Various artists and orchestras
Decca DL-9897 12'' Varnay



"Tristan" is hardly the opera to be presented in such truncated form. Musically and dramatically it is woven into a whole that cannot be torn apart without the loss of rich shades of meaning. Here it is sung by a variety of singers under a number of conductors and treated as a succession of separate arias, one of which, the *Liebestad*, is presented without the voice part — a procedure that is barely acceptable in the concert hall. If the singing were extraordinary, one's conscience might be appeased, but Astrid Varnay's Isolde is hard indeed and very free with indicated tempi, while Windgassen's Tristan is more naive than heroic. Uneven sound. JB

Operatic recital by Anita Cerquetti B
B
A
Anita Cerquetti, soprano; Orchestra of the Maggio Musicale Fiorentino under Gianandrea Gavazzeni
London LL-1601 12''



A soprano of immense potentiality is revealed here. In arias by Verdi, Bellini, Spontini, and Puccini, Cerquetti discloses a voice of dramatic timbre, extensive range and apparent size. A number of technical matters are still to be worked

out, among them a true pianissimo (in contrast to her present half-voice one), a less audible manipulation of the breath, and flexibility in trills. But work will attend to these matters, and meanwhile the voice is young and healthy. Musically the delivery is straightforward, avoiding mannerisms, but still leaving much nuance undiscovered. Good sound. JB

Albert Da Costa Opera Concert A-B
C
C
(Arias by Wagner, Meyerbeer, Leoncavallo, Bizet, Bellini, Verdi, and Strauss)
Albert Da Costa, tenor; Concord Philharmonia under Hans-Jürgen Walther
Concord 3004 12'' Da Costa



It is regrettable that certain discs are made when they are. At present, Da Costa is attempting to fill the heroic tenor label which the Metropolitan has given him, and his medium-sized voice, once so effortlessly and attractively produced, is not yet ready for the taxing program he has chosen here. His lack of authority and finesse are excusable at this point but the awkwardness created by his disregard of note values and his tendency to rush are not. In his defense, it must be pointed out that the orchestral support is incredibly poor. The four Wagner excerpts come off best. Da Costa has elsewhere proven himself capable of much finer singing. GLM

The Art of Rosa Ponselle A-B
A
R
(Arias by Spontini, Verdi, Bellini, Meyerbeer & Ponchielli as well as selected songs)
Rosa Ponselle, soprano, assisted by Martinelli, Pinza, and Telva
RCA Victor Camden set CBL-100 2-12'' Ponselle



All concerned are to be congratulated on the choice of material for this comprehensive review of the artistry of one of the greatest operatic stars of all time. It will serve voice student and just plain music lover alike to hear the effortless flowing freshness of voice in the "Ernani" (1924), the rich beauty and full outpouring of tone in the "Vestale" (1926), the limitless resources in "Africana" (worth the price of the record in itself), the famous *Costa Diva* recording (vocally less nearly perfect than others), and the haunting beauty of the *Mira Norma* duet sung with Marian Telva. The fourth side of the set is a welcome reprint of some of the favorite numbers from the Ponselle concert repertory. Though the quality is obviously "old" in some of the earliest numbers, it is still good. RM

Giulietta Simionato Operatic Recital A to C
B to C
B
Giulietta Simionato, mezzo-soprano; Orchestra of the Accademia di Santa Cecilia, Rome, under Franco Ghione and Fernando Previtali
London LL-1580 12'' Simionato



This program of four French and four Italian arias (some of them previously available on a ten-inch disc) is further evidence of the declining quality of Italian operatic singing since World War II. Simionato is very likely the finest Italian mezzo we have; and still, though she has many qualities to recommend her, she represents for this reviewer only the highest journeyman standards. She has not quite the style nor the temperament for the French selections, but is heard at her best in two Rossini arias. Though the latter are extremely difficult, they do not reveal her limitations as evidenced in the other Italian areas—the need for additional power in *O dan fatale*, a perfect legato in the lovely and rarely heard excerpt from Bellini's *I Capuleti ed i Montecchi*. CJL

VOCAL MUSIC

Bach and Handel Recital A-B
B
A
Kirsten Flagstad, soprano; London Philharmonic Orchestra under Sir Adrian Boult
London LL-1641 12'' Flagstad



In these performances (in English) of familiar Bach and Handel arias, Flagstad's phenomenal voice and unerring technique seem untouched by the passing years. Her singing, too, can serve as a model of just intonation, rhythmic accuracy, and careful attention to diction. But in spite of her many musical gifts, she fails here to achieve communication, for her placid temperament does not allow her to explore the meaning of what she is singing about. In the broad lines of the Handel arias this coolness is unfortunate; in the Bach arias, which are the essence of personal conviction, it is disastrous. JB

BRITTEN: Les Illuminations A
RAVEL: Don Quichotte; A to B
Shéhérazade A
DEBUSSY: Trois Ballades
 Janine Micheau, soprano; Camille Mourane, baritone; Orchestre des Concerts Lamoureux under Jean Fournet and Paul Sacher
 Epic LC-3355 12'' Ravel



One of the happiest couplings in many a moon. There is also much to recommend on the artistic level. Although her voice is a trifle on the white side, Micheau's version of the Britten easily takes top honors among current recorded versions. Perhaps a bit more probing on her part would have made for a deeper penetration, but this will do. The *Shéhérazade* is on a subtler level than the Bernstein-Tourel effort, but lacks some of the atmosphere and color of their memorable performance. Mourane proves an able interpreter. More flexibility with the narrative line in the Debussy, however, might have improved the interpretation vastly. Fine sound. **AK**

KLEINSINGER: I Hear America C-C
 Singing B
 Victor Symphony under Nathaniel Shilkret with I.L.G.W.U. Chorus; Orchestra and chorus under Victor Young; Carroll Hollister, pianist
 John Charles Thomas Sings
 Songs and Spirituals
 RCA Camden CAL-367 12'' Thomas



One aspect of John Charles Thomas' gift for putting a song across, amply illustrated here, is his ability to give dignity and stature to material notable more for sentiment than for musical values. Thus, he is a natural for the narrator-singer role in Kleinsinger's setting of Whitman texts which proclaims the greatness of the "American Way" in no uncertain terms. *Annie Laurie, Ol' Man River, and The Lord's Prayer* are all attractively presented. *Steal Away*, however, best exhibits the beauty and the control of the voice. The delightfully whimsical *Green-Eyed Dragon* alone is worth the economical price of admission. The sound varies but is satisfactory. **GLM**

Rita Streich sings Mozart A
 Rita Streich, soprano; Erik Werba, piano A
 Decca DL-9915 12'' Streich



Coloratura Streich sings this well-chosen group of Mozart lieder with lovely voice, accurate musicianship, and limited imagination, in which there is little play of light and shadow. Part of the trouble lies in tessitura, for many of the songs are in the low part of the voice, where the high soprano has few resources upon which to draw. But Miss Streich's own temperament seems to cause the major part of the difficulty. At home in the amusing songs, she appears to be ill at ease in the presence of melancholy. Time will probably be her cure, but at the moment she leaves much unsaid. Good sound. **JB**

Pancratius Royal Men's Chorus of Heerlen B-C
 Henri Heijndael, director B
 Angel 35406 12'' Lassus



Choral music devotees will be grateful to Angel for introducing them to another fine European group. This one, with a history dating back to 1878, is made up of 120 men. The bulk of their unaccompanied program is from the 16th and 20th centuries with the 18th and 19th represented. And while no concert including the works of Lassus, Jannequin, Schubert, Vaughan Williams and Milhaud could be considered musically slight, it is to lovers of the medium to whom this disc will have greatest appeal. The chorus is an excellent one; the voices are attractive in all registers; the expressive range is wide, and the performances polished. **GLM**

KEYBOARD MUSIC

BEETHOVEN: Sonata No. 30 in E, Op. 109; Sonata No. 32 in C minor, Op. 111 A
 Victor Schioler, pianist B
 Capitol P-18046 12'' Schioler



Schioler's technique is brilliant, his phrasing well nigh perfect (although his rhythm slips a bit at the recapitulation of the E minor theme in the second movement of the Op. 109). The variations in both sonatas, as well as the Arietta of the later work, are paragons of impeccable clarity. Yet the entirety is pervaded by a certain austerity and coldness, as if Schioler has placed the works on a high esthetic pedestal, to be admired but never tarnished by human emotions. Surely, an interpretation can possess soul without losing classicism. The sound — atypical for this label — is fuzzy. **AK**

BUXTEHUDE: 6 Preludes and Fugues A
 Alf Linder at the Organ of Vårfrukyrka in Skänninge, Sweden A
 Westminster SWN-18221 12'' Linder



This is Volume 4 of Alf Linder's survey of Buxtehude's organ music. His playing is alert and sure; the music swings along with vitality and sensitivity. And these Preludes and Fugues are solid musical fare; they abound in attractive melodies, skillfully interwoven and built up to impressive climaxes. It is easy to understand why Bach walked two hundred miles to hear Buxtehude perform and no surprise at all that his own style was influenced. This series could prove to be only a labor of love on the part of the organist and Westminster. I do hope, however, that enough organ aficionados exist to make it profitable financially, for it certainly is artistically. **WDM**

DEBUSSY: Preludes, Book 1 A
 Guiomar Novaes, pianist A
 Vox PL-10,180 12'' Novaes



There are already two excellent recordings of this set of *Preludes*, yet Novaes proves quite handily that neither Gieseking nor Casadesu has said the last word on these pieces. Her playing is more pianistic than Gieseking's, more personal than Casadesu's. She caresses and colors subtly, weaving Debussy's tonal strands into harmonic webs of rare delicacy without sacrificing any of the music's strength. The clarity of her tone and the sensitivity of her touch bespeak the master pianist. The imaginative perceptiveness of her interpretations bespeaks the master musician. The Vox engineers are fully appreciative of this wonderful playing and have recorded it flawlessly. **WDM**

The Art of Frescobaldi A-B
 Gustav Leonhardt, organist and harpsichordist A
 Vanguard/Bach Guild BG-568 12'' Leonhardt



Side 1 is organ and side 2, harpsichord. Both are played with sensitivity and taste by the talented Leonhardt. The music is an assortment of short keyboard pieces by the early Italian master. In style, Frescobaldi sounds to me closely akin to the later Italian, Corelli, in that his music is relatively simple contrapuntally and has a charming lyric and harmonic sweetness. One defect — the organ has a serious air leak, and it squeaks badly on certain notes. This is such an evident fault that I am surprised the engineers did not catch it. Otherwise, both recording and performance are noteworthy. **DHM**

MENDELSSOHN: 17 Songs Without Words B
 Walter Gieseking, pianist B
 Angel 35428 12'' Gieseking

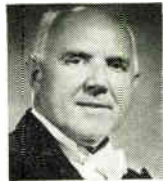

Not what one might have expected from Gieseking in his prime. His touch here is heavy and his technique unsure. A shame, for he was ideally suited to these whiffs of music. All the favorite *Songs* are here. For those who wish all of these charming melodies in really excellent performances there is the Ania Dorfmann set on Victor. If Angel has more Gieseking in its archives let us hope that the quality is better, for records such as this are a poor service to so great a musician. The recording is inclined to be a mite clangy. **WB**

MENDELSSOHN: Variations sérieuses, Op. 54; SCHUMANN: Three Romances, Op. 28; SCHUBERT: Sonata in A minor, Op. 164 A-B-B
 Gonzalo Soriano, pianist B-C-B
 Boston B-303 12'' Mendelssohn



This is a well-selected recital drawn from not-too-hackneyed, superior quality

nineteenth-century romantic keyboard compositions. The Mendelssohn Variations show Soriano at his best, but even here there is a suggestion of the brittleness of tone and expression that subsequently mar the Schumann Romances. The adorable Schubert sonata lacks the degree of virility that best becomes it, but it moves along with grace under Soriano's accurate fingers. The sound of the piano is generally good, but it is occasionally a bit twangy and shallow in tone. C.J.L.

PROKOFIEV: Sonata No. 4, Op. 29; Sarcasm Op. 17, No. 3 A
BEETHOVEN: Sonata No. 21 in C, Op. 53 ("Waldstein") B
SCRIABIN: Two Poems Op. 32, Nos. 1 and 2 A
 Eugene Malinin, pianist
 Angel 35402 12"



Prokofiev

Very polished, restrained, and conservative performances—the Beethoven especially. It is filled with liquid lyricism and beautifully rounded phrasing, and in these respects comes close to the approaches of Gieseking and Kempff. I would prefer more force and bravura, especially in the climactic ending pages which I feel are just too "goody-goody" here. Much the same can be said of the Prokofiev, which sounds impressionistic under Malinin's controlled but somewhat lethargic fingers. This young pianist can produce a carefully shaded tone, to be sure. But these pieces call for more energy. Realistic sound. DHM

Baroque Organ Music A to C
 Robert Noehren, organist B
 Concord 4002 12" B
 Frescobaldi



Here is a generous program of baroque organ pieces by Arnolt Schlick, Jan Sweelinck, Antonio de Cabezon, Girolamo Frescobaldi, Samuel Scheidt, and Johann Pachelbel efficiently played by the worthy American artist Robert Noehren on the excellent Schlicker Organ in Kenmore Presbyterian Church, Buffalo, N. Y. A few of the works presented are superb; some of the variations on devotional hymns will seem remote to listeners today either because the tunes are less than first-rate quality or because the emotional feeling about the hymn is not present in the hearer. C.J.L.

FOLK

Martha Schlamme Sings Jewish Folk Songs A
 Martha Schlamme; orchestra under Robert DeCormier A
 Vanguard VRS-9011 12" Schlamme



Viennese-born Martha Schlamme is virtually unrivaled in this repertory. She sings sixteen songs that were born in the ghettos of eastern Europe, some a century or two ago, some within recent years. O Never Say was inspired by the heroic World War II uprising of the Warsaw ghetto against the German armed hosts. She sings it with deeply felt emotion, as well she should, having herself barely escaped from the tender clutches of the Nazis. Many of the songs are serious, but several are lively and gay, and none is maudlin. They make a splendid collection and they are beautifully performed and recorded. WDM

A Hungarian Rhapsody A-B
 Orchestra of the Hungarian State Folk Ensemble A-B
 Vox VX-25,240 12" A



The paradoxes of the record world are cause for wonderment. Take a hackneyed composition and the record sleeve is sure to provide full, authoritative notes. But take this record, where three of the four compositions are completely unknown, and the notes consist of skimpy platitudes. No name for the conductor, no description of the unusual instrumentation, no names of the music's arrangers. And the notes are signed! Liszt's *Second Hungarian Rhapsody* is one of the pieces, but its performance as a folk composition is unsuccessful. The other three works, *Pictures from Sopron*, *A Paloc Fantasy* and *Transylvanian Rhapsody*, are fascinating. The playing is very good, quite exciting, and the recording is brilliant. WDM



America's Best Loved Folk Songs A
 Milt Okun B
 Baton BL-1203 12" A

The title describes this record accurately. These are the songs that are basic in the repertory of the folk singer. All sixteen of them are beauties and even the hardened aficionado does not mind listening on occasion to *Shenandoah*, *Rock Island Line*, *I Gave My Love a Cherry*, *On Top of Old Smoky*, *Big Rock Candy Mountain*, and the others. With New York University for his Bachelor's and Oberlin for his Master's, Okun did not mature in folksong country, but he brings to these songs a good voice, sincerity, enthusiasm, and unassuming musicianship. His own guitar and Roger Sprung's banjo accompany him effectively. WDM

MISCELLANY

The Music of George Gershwin A
 Sondra Bianca, pianist; Pro Musica and A to C
 Philharmonia Orchestras of Hamburg R
 under Hans-Jurgen Walther
 M-G-M set 3EL 3-12"



Gershwin

All the large Gershwin orchestral works plus the Piano Preludes and the Bennett "Porgy and Bess" suite, in one package. Young American pianist Bianca is in the proper Gershwin groove through most the pieces, and the German orchestras disport themselves admirably considering their recent introduction to the Gershwin idiom. This is a more nearly complete set than Victor's "Serious Gershwin" (which omits the *Second Rhapsody*, "Variations on I Got Rhythm," Cuban Overture) and is played well enough to satisfy even the Gershwin specialist. It can be highly recommended to the incipient Gershwin fan. Sonically an improvement over the original releases. EJ

Romance—The Mood of Enchantment C
 Eric Robinson and his "Music for You" Orchestra A
 Westminster WP-6011 12" Robinson



"The Magic Moment of Romance. The lights are turned low. The moon begins to appear from behind the clouds, and faintly, as from the distance, the gentle, soothing sound of a melody is heard. Music which lends to the mood of enchantment." This from the program notes by John Watt. Maybe he heard something I did not. I heard things like Chabrier's *España Rhapsody* twisted into a trite, cliché-ridden pretzel of a piece by an arranger who just does not seem able to let well enough alone. He tampers and meddles unconscionably; even the *Flight of the Bumble-bee* spins into a desultory nose dive as the result of his attentions. Romance? WDM

Boardwalk Pipes B
 Robert Elmore, Organ B
 Mercury MG-50109 B
 Elmore



You might call this one "The Big Surprise", for if you think that in buying it you are going to get a collection of tunes that are familiar to every board-walker you are going to get one helluva shock. The "boardwalk" gimmick, for such it is, comes about only because Elmore happens to be playing the organ in Atlantic City's famed Steel Pier. The program consists of such far-from-the-boardwalk numbers as *The Stars and Stripes Forever*, *Kreisler's Stars in My Eyes*, *Caprice Viennois*, *Old Refrain*, and *Liebesfreud*, *Kramer's Eklog*, *Weaver's Squirrel*, *Boex' Marche champêtre*, *Clarke's Trumpet Voluntary*, and *Elmore's Fantasy on Nursery Themes*. FR

Exotica B
 The Sounds of Martin Denny A
 Liberty LRP-3034 B

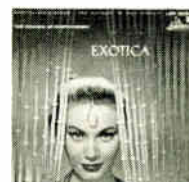

The Martin Denny Combo made its reputation playing in the Shell Bar of Henry Kaiser's famous Hawaiian Village. Combined with the ordinary—August Colon on bongos, Art Lyman on vibes, John Kramer on bass and Denny on piano—are such unusual sounds as these that come from glasses, small cymbals, bamboo sticks with drum heads, and exotic Oriental effects. Believe it or not, all of this adds up to music, and a strangely compelling music at that. The varied program runs the gamut from Tiomkin's *Return to Paradise* and Hoagy Carmichael's *Hong Kong Blues* to Les Baxter's *Stone God* and Francis Brown's *Waipu*. An interesting record, with an excellent cover by the way. **FR**



Honky-Tonk in Hi-Fi
Nickelodeons
Westminster WP-6033 12''

A
A
A

In Deansboro, N. Y., Mr. and Mrs. Hardi Sanders and their son Arthur, three dedicated souls, are restoring nickelodeons and housing them in their Musical Museum. Several of these mechanical monsters are heard on this record: the Seeburg Orchestron, which combines piano, bass drum, snare drum, cymbal, tambourine, castanets, Indian block, mandolin effect, xylophone and triangle; the Link Piano, which offers only a piano, xylophone and mandolin effect; the Nelson-Wiggen Orchestron, twin of the Seeburg leviathan, and a couple of others. Whatever they play is played fast and loud. Archduke Otto of Austria used to clear his castle of long-lingering guests by turning on his mechanical orchestra. With this record, you can do as much. **WDM**

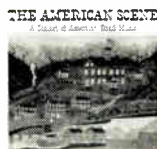

The American Scene: A Concert of American Band Music
Band of Her Majesty's Welsh Guards
under Major F. L. Statham
Vox VX-25.280 12''

B-C
A-B
A

Selections include *An American Scene* (Grundman); *Cranberry Corners* (Klien); *Brass, Woodwind Clique* (Palange); *Kentucky 1800* (Grundman); *Night Piece* (Klien); *Bright Eyes* (Finlayson); *A Pair* (Palange); *Jazz Rhumba*; *Sons of the American Legion* (Palange); *Waltz in Blue* (Grundman); and *Dixie Fantasy* (Cailliet). Hardly a collection of great music, but it may prove interesting to the non-sophisticate. Most interesting to me is Klien's soft and sentimental *Night Piece*. The band is fine, though not superb. Miniature band conductor's scores are included, so the customer gets some free lessons in band instrumentation. The recording is alive and balanced. **DHM**



Johnny Puleo and His Harmonica Gang
Harmonicas and Mouth Organs
under Johnny Puleo
Audio Fidelity AFLP-1830 12''

A
A
A

Little Johnny Puleo used to be the comedy relief of the late Borrah Minevitch's Harmonica Rascals. Now he carries on as the leader of his own group and, in this record, he proves worthy of his old mentor's mantle. The playing is skilled, the tones of the variously sized instruments blend well, and the ultra-wide-range recording serves them up with startling presence. The program consists of twelve numbers, among them arrangements of *Peg O' My Heart*, Ravel's *Bolero*, the *St. Louis Blues*, and the *Peanut Vendor*, performed with an enthusiasm that will warm the cockles of any harmonica aficionado's heart. **WDM**



Adventure in the Sun
Percy Faith and His Orchestra
Columbia CL-1010 12''

B
A
B
Faith

In a very real sense, we have a sparkling musical travelogue as Percy Faith and his splendid orchestra perform *Tropical Merengue*, *Bluebell*, *Carmelita*, *The Fiddling Bullfighter*, *Eleanora*, *Tambora*, *Hey José!*, *Bahama Lullaby*, *Bubbling Over*, *Italiano!*, *Tropic Holiday*, and *The Bandit*. At this kind of affair, Faith is just about as able as they come. His music has an effervescence about it that seldom becomes saccharine. His arrangements throughout this recording show both color and movement. While the record is hardly a substitute for high adventure in foreign lands, it is pleasant, sometimes dazzling listening for the home. **FR**

JAZZ



Marching Along with . . .
Dukes of Dixieland (Vol. 3)
Audio Fidelity 1851 12''

B
C
A

There isn't the slightest question that the Dukes achieve some stunning and startling affects in their fine high fidelity sound. It's only a shame their music isn't somewhat more polished, and I am not of that school who believes that spirit makes up for ability. Believe me, though, you can make a lot of noise with this record. Among the selections, the one that intrigues me most is *Scobey Strut*, a Norman Kaye composition which, I'll guess because further information is not given, was written in honor of the leader of the great Frisco Jazz Band, Bob Scobey. **FR**

One O'Clock Jump
Count Basie and his Orchestra
Columbia CL-997 12''

B
A
R
Basie



In 1936 Count Basie hit the big time. That is, he arrived in Chicago, and soon afterward won a recording contract with Decca. He made many memorable swing recordings, later switching to Columbia. Eight of the dozen instrumentals in this grouping are reissues from Columbias of 1946-51, all in the less-than-three-minutes that the 78 rpm, ten-inch disc of pre-LP days dictated. They have solid rhythm sections, clean tight brass, and well-phrased, full-sounding sax ensemble work, along with first-rate trumpet, sax, and piano solos. Famous, fabulous blues shouter Jimmy Rushing is found, sad to say, on only one number. Both he and the Basie band recorded much of their best work on even earlier Deccas, but this album is nevertheless a fine sampling. **CG**

They're Playing Our Song
Billy Butterfield & his Orchestra
RCA Victor LPM-1441 12''

B
B
A
Butterfield



This is top-drawer dance music played by a swing band. The voicing is similar to that of Benny Goodman's Band: 4 sax, 5 brass, 4 rhythm, and Butterfield, who is a graduate of the bands of Bob Crosby, Art Shaw, and Goodman. Thus it's not surprising that the sound of these powerful big-band arrangements is often reminiscent of the Goodman band. Butterfield has gathered together 13 superb studio musicians—men like Bernie Glow, Toots Mondello and Hank D'Amico—and the results are as intended. Butterfield's full-bodied, lyrical, and frequently hot trumpet and Mondello's smoothly letter-perfect alto saxophone are surrounded by excellent, swinging arrangements of well-known favorites like *Time on My Hands*, *Stormy Weather*, and *Ghost of a Chance*. Comparison with the Gleason-Mondello-Bobby Hackett albums of recent vintage is inevitable, but this is less mechanical, swingier, better music. For old grads it offers rare nostalgia, too. **CG**

RATINGS OF JAZZ AND POPULAR RECORDS AND TAPE

It must be obvious to everyone that popular music, jazz, and music of the theatre and motion picture, cannot be rated in the same manner as classical music, save for the audio quality of the records. Therefore, the following explanation is given so that you will fully understand the significance of the three letters which appear at the left of reviews of popular, jazz, theatre and motion picture albums:

COMPOSITION (Top Letter)

A: Extraordinary

Indicates that the collection is of superior character, both from a standpoint of material and programming. Assignment of this rating means an unqualified recommendation.

B: Good

In general the collection is excellent, but additions or substitutions might have made the work more attractive and more lastingly enjoyable.

C: Satisfactory

A collection that is highlighted by only a few numbers, yet the over-all is quite acceptable. This might often apply to collections that have a limited appeal, yet are important to those who specialize in specific types of music. It might often apply to collections of historic importance where the artistic performance is the primary factor.

PERFORMANCE (Middle Letter)

A: Extraordinary

Indicates a superior performance throughout the collection. Assignment of this rating means an unqualified recommendation.

B: Good

In general the performance is excellent, save that there are minor imperfections or breaches of artistry.

C: Satisfactory

To all intents and purposes an enjoyable recording, yet one that does not qualify for B rating.

RECORDING QUALITY

(Bottom Letter)

A, B, C: The same as for classical recordings.

R: Indicates a re-issue.

Swing From Paris
Django Reinhardt & Stephane Grappelly
London LL-1344 12''

B
A
R



Twelve recordings of the incredible Gypsy guitarist and his talented hot violin colleague, cut in 1937-39 for European Ultraphone and later reissued in part here by Decca. Reinhardt and Grappelly made up the creative center of the Quintet of the Hot Club of France, uniquely comprising bass viol, three guitars, and violin. Django, a legend even before his death in 1953, was an authentic Gypsy who lived his music as few jazzmen ever are able to, playing only when, what, and where he wished. The selections here, strictly prewar acoustically, are a fair sampling. Repeated listening will yield serious students much insight into what great jazzmen are after. But don't be put off—it's jazz, man. CG

Swing Goes Dixie
Roy Eldridge & His Central Plaza Band
Verve MGV-1010 12''

B
A
B
Eldridge



The title is entirely accurate, for trumpeter Roy "Little Jazz" Eldridge is one of the few giants of jazz still playing hard-driving swing after almost 30 years of blowing the roof off nightly. Here he sparks six veterans. Three are longtime Basie alumni: drummer Jo Jones, bassist Walter Page and trombonist Benny Morton. Others are clarinetist Eddie Barefield, who's currently running Cab Calloway's band, and law student Dick Wellstood, whose vigorous piano work often recalls Fats Waller. The tunes are mostly good traditional standbys like *Royal Garden*, *Jazz Me*, and *Tin Roof Blues*. Other recorded Dixie sessions have been smoother; some even more inspired, but Roy leads with his customary fire and excitement. The sound is loud, but good. CG

West Coast Jazz Compositions, Vol. 1

Bobby Scott & 2 Horns
ABC-Paramount 148 12''

A
A
A
Scott



One of the pleasantest jazz surprises of the year. In this tribute to what he calls the California style of arranging, the material is all new—eight originals by the 20-year-old pianist-leader—as are the featured soloists, John Murtaugh on tenor sax and Mart Flax on baritone. It's a welcome change from the almost incestuous recurrence of the same musicians and tunes from album to album in the two games of musical chairs that make up so much of the LA and NY jazz scene. Scott's writing and playing are modern yet earthy; the funky *Box Car Blues* is a highlight. Thoroughly enjoyable. LF

POPULAR

Hi-Fi Shades of Gray
Jerry Gray and His Orchestra
Liberty LRP-3038 12''

B
C
B

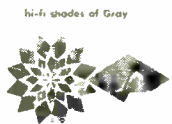

For those of you who may not know (and there are millions who do not know despite the statement in the liner: "Here is one of the few orchestras that has stood as a Gibraltar against the times and tides."), Jerry Gray was an arranging star for Artie Shaw and Glenn Miller before forming his own band in 1946. This band didn't do at all well, and Jerry went back to arranging, etc., on the West Coast. He doesn't, as far as I know, have a traveling band today. But he does, obviously, have a recording band, which isn't anything special—rather a watered-down Billy May. Nice dance music, period. FR

London Hit Parade
London LL-1613 12''

B
B
B

This is, shall we say, a gathering. For the London Hit Parade, a dozen singles were re-processed into one LP, and what you have are *Now Is the Hour* by Gracie Fields, *Charmaine* by Mantovani, *Third Man Theme* by Anton Karas, *Ebb Tide* by Frank Chacksfield, *Anna* by Stanley Black, *Cara Mia* by David Whitfield, *Wedding Samba* by Edmundo Ros, *Underneath the Arches* by Primo Scala, *Happy Wanderer* by Frank Weir, *Skokiaan* by the Bulawayo Band, *Rock Island Line* by Lonnie Donegan, and *Auf Wiederseh'n* by Vera Lynn with Roland Shaw's Orchestra and members of H.M. Forces. It's a good collection, if collections are your cup of tea. FR

Old Wine
Dana Lawrence Orchestra
Concord 3005 12''

A
C
C



This is one of the duller records I've heard in a long, long time. And, so help me, it isn't easy to take songs of the calibre of *Begin the Beguine*, *Dancing in the Dark*, *In the Still of the Night*, *You Do Something To Me*, *Body and Soul*, *Old Man River*, *The Touch of Your Hand*, *That Old Black Magic*, *I Cover the Waterfront*, *You're Devastating*, *Time on My Hands*, *Sweet Lorraine*, *Who's Sorry Now?*, and *Night and Day* and mold them into a dull record. Dana Lawrence, whoever he may be, managed very well indeed. FR

Star Eyes
Ted Nash and His Orchestra
Columbia CL-989 12''

A
A
B
Nash



An excellent recording. Ted Nash is a versatile, warm, altogether professional musician from Hollywood who plays alto and tenor saxes and alto flute. The three instruments are heard in equal amount in this album. The fine arrangements, not at all incidentally, were contributed by Paul Weston, Frank Comstock, Billy May, Spencer-Hagen, and Heinie Beau. It's a splendid orchestra, with Ted Nash brilliantly soloing in front for *Star Eyes*, *Flamingo*, *Tangerine*, *Black Sapphire*, *Without You*, *'Round Midnight*, *Candy*, *Speak Low*, *That Old Feeling*, *Serenade in Blue*, *What's New*, and *Old Devil Moon*. FR

Rockin'
Frankie Laine
Columbia CL-975 12''

B
A
B
Laine



Frankie Laine is one of the few singers alive who can sing with an honest-to-God beat. He knows about rhythm and he knows about lyrics, and he's had the experience necessary to give a truly finished performance. Aided as he is here with arrangements by Billy May, Paul Weston, and Russ Case and Paul Weston's expert orchestra, Laine zings through such standards as *By the River Ste. Marie*, *So Black and Blue*, *That's My Desire*, *Blue Turning Gray Over You*, *Shine*, *Rockin' Chair*, *We'll Be Together Again*, *West End Blues*, and *On the Sunny Side of the Street*. I do wish he'd substituted for *That Lucky Old Sun* and *Give Me a Kiss*, for these two songs simply aren't in the same class with the others. FR

Kenton with Voices
Stan Kenton
Capitol T-810 12''

C
B
B
Kenton



This, as the album states, is "the smooth voices of the Modern Men and Ann Richards combined with the great Kenton orchestra in fresh stylings of familiar songs—*Dancing in the Dark*, *Sophisticated Lady*, *Softly*, *Eager Beaver*, *Women Usually Do*, *After You*, *Temptation*, *Walk Softly*, *Opus in Chartreuse*, *All About Ronnie*, *Interlude*, and *Lullaby of the Leaves*." Of the dozen numbers, three were written by Joe Greene, who is no George Gershwin, believe me. All the arrangements, it states, are by Kenton. I guess maybe this was a good idea, but the main trouble is that I've been listening of late to the Hi-Lo's, and the Modern Men just are not in the same class. FR

Leháriana
Heinz Sandauer, pianist,
with rhythm accompaniment
Vox VX-25,440 12''

B
B-C
B
Sandauer



How nice it would be for Vox if lightning would strike twice along the keyboard trail. Alas, George Feyers are rarer than jumbled metaphors. Bluntly, Heinz Sandauer is no George Feyer, if that is what he aspires to be. Of course, he may not. His playing is emotional and vigorous, but not particularly imaginative. Also, it is deficient in charm and rhythmic appeal, and what is the music of Lehár without these? He plays twenty-six melodies from the popular operettas of the Viennese master, assisted at times by an ambiguous rhythm accompaniment executed anonymously. WDM



Fig. 1. There is no audio equipment in this living room. Even the speaker is behind the upper section of the large panel at the left

HEARD BUT NOT SEEN

An Unusual Installation at the Home of Randolph Rothschild, President of the Chamber Music Society of Baltimore

THERE is a prevailing opinion that musicians and people who are active in the world of music have very lo-fi tastes when it comes to audio equipment. If that generalization is justified, the accompanying photographs taken in the home of Randolph Rothschild prove that he is an exception.

A study of the living room, Figs. 1 and 2, discloses that this is an exceptional hi-fi system, too, for other than a 1945 Scott phono-radio console which has been retained for standby use, there is no audio equipment in it. Instead, Mr. Rothschild's installation is in a separate, air-conditioned room behind the panel of pandanus cloth above the book shelves at the left in Fig. 1. The top section covers the front of a down-slanted bass reflex enclosure for an Altec Lansing speaker, but the two lower sections drop down behind the shelves, as you can see in Fig. 2, to disclose the double-glass window of the control room shown in Figs. 3 and 4.

The control room measures 8 by 8 ft. A long bench under the window, Fig. 3, carries a Presto turntable with two Pickering pickups, an FM antenna rotator control,

Presto 90-B disk recording amplifier, Ampex 3761 preamp and mixer, Fairchild thermo-stylus control, Presto record-cutting lathe and microscope, and a small microphone used to talk to people in the living room when a recording session is in progress there. Under the lathe is a water jar to receive the thread cut from the discs, and just on the

Fig. 3. Mr. Rothschild installed his system in a separate room. Even the window can be covered by the panel seen at the left in Fig. 1 above

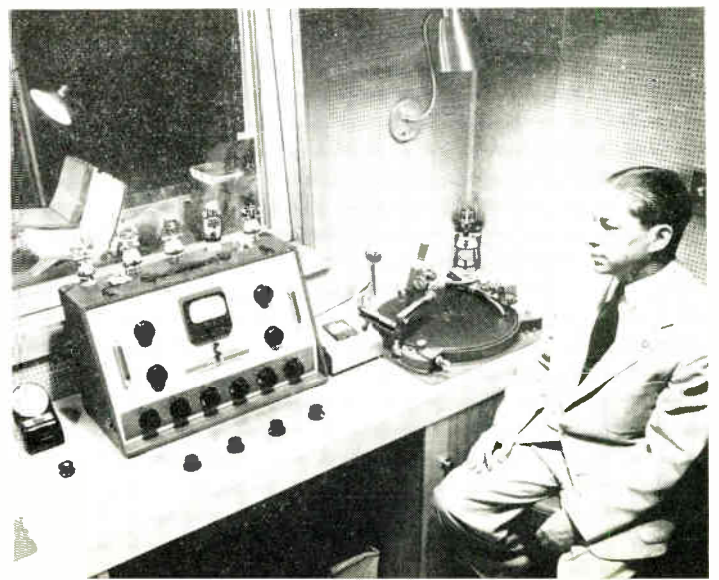



Fig. 2. A view of the living room from another angle. Here the panel in front of the control room had been lowered behind the book shelves

other side of the control room wall, a motor and suction pump to draw off the thread.

Fig. 4 shows the Ampex tape-recording console, with

Fig. 4. The tape recording and playback machine and the turntable are installed in the air-conditioned control room at the left of the window



the FM tuner on the vertical panel at the right. Mr. Rothschild is particularly interested in recording off the air, specializing in performances of music by modern composers. In his collection of tapes are such prized items as the world premiers of Gian Carlo Menotti's opera "The Unicorn, the Gorgon, and the Manticore", *Suite for Cello and Piano* by Paul Creston, and performed by Raya Garbousova with the composer at the piano; and *Cinque Canti* by Luigi Dallapiccola, with Frederick Fuller and an orchestra composed of first-desk players of the National Symphony, conducted by Paul Callaway. These were made from broadcast of concerts presented at the Coolidge Auditorium of the Library of Congress, Washington, D. C.

This installation is also used for tape recording of music performed in the Rothschild living room. Three outlets for plugging in microphones were provided when the house was built. One is in the kickboard at the right end of the book shelves, Fig. 1. It is hidden by the stacked stools. There is a small microphone at the right of the top center shelf, used for communication from the living room to the control room during recording sessions. A third outlet is in the kickboard behind the piano, Fig. 2.

Mr. Rothschild is in his fourth year as president of the Chamber Music Society of Baltimore, a long-established organization that has made a significant contribution to the community's music life, and to the encouragement of living composers through performances of their works.



HELP!

Don't Shoot Trouble Late at Night!

Wait until Tomorrow, When You'll Be

Fresh and Alert — By John J. Stern, M.D.

THE AUDIOPHILE'S feeling of blissful submersion in contentment as he builds a new piece of equipment for his hi-fi music system is equaled only by a proud sense of achievement on its completion. At the other end of the scale of the builder's emotions, however, is the flustered frustration when the product of his relaxed hours refuses to work.

Let's be honest. It happens more often than we like to admit; in fact, I believe it happens more often than our ego allows us to remember. The following lines are written to help the eager kit-builder keep his temper, and to check systematically instead of poking more and more frantically in the innards of his still-born music box.

It seems that the completion of a piece of work usually occurs late in the evening. This is logical. When you get close to the point in the instructions where it says, "This completes the assembly," the advancing hour hand of the clock and the beckoning of Morpheus receive little attention. You just speed up the process a little, the capacitors and resistors on the bench disappear rapidly inside the chassis, the soldering iron fills the air with aromatic incense of resin, and soon there is nothing to do but put in the tubes and switch the thing on.

Alas — nothing happens. Your heart skips a beat. You look at the clock. Never mind — who can go to bed now! My first advice is: **LEAVE THE THING ALONE!**

It takes more than average will power to do so. But most likely you will not achieve anything that night, anyway. You will get impatient, confused. You check soldering points, wiring, switches haphazardly. It gets late . . . pin 7 of V3 to C7 . . . ha! wrong connection . . . no, its OK . . . maybe the capacitor is faulty?

No, components are rarely faulty. It is the late hour, the lack of systematic checking. Leave it alone, get it at tomorrow, with a clear mind and rested eyes. Let's assume that the tubes light up correctly. They usually do. The wiring of the filament supply is straightforward, and is done early in the proceedings while you still re-

tained your full alertness. If they don't light up, make sure that the prongs of the line plug make contact in the outlet; new plugs sometimes have to be bent in or out a little to assure proper contact. When this is done, checking the wiring from power transformer to the tube sockets should show any mistake at once. The wiring of the rectifier tube is more complicated. Keep your hand on the power switch when you test it. If the plates get red hot or the tube fills with an eerie blue glow, don't admire the pretty effect but shut the thing off; you might ruin not only the tube, but also the power transformer. Check the wiring of the resistors and condensers of the rectifier and filter circuit. You may find a wrong connection, a short, or a component with a wrong value.

However, as I said, let's assume the tubes behave. In that case, the first thing is to check the external connections. Those devil's inventions, the phono plugs, are a challenge to the most experienced wielder of a soldering iron. Wriggle them, pull at them. Better yet, use a continuity checker¹. Either the "hot", inner lead of a shielded cable does not make contact, in which case the cable checks open and the bulb does not light up when you touch both pins of the cable; or there is a short between hot lead and shield, so that the bulb glows when you touch the pin and outer shield at either end of the cable. The same applies, of course, to multiple connectors like octal plugs. Resolder any doubtful plugs by heating the pin thoroughly with the iron and then depositing a bead of solder on the tip of the pin.

Next, check tube voltages. For this you need a voltmeter, either a vacuum tube type,² or one of the less expensive multitesters. Attach one clip to the chassis, and touch each tube pin with the probe. *[Continued on page 69]*

¹ A continuity checker is easily improvised by soldering a piece of wire to each pole of a flashlight battery; the end of one of them is soldered to the thread of a flashlight bulb. A third wire is soldered to the bottom contact of the bulb. The end of this wire and of the one on the battery are used to probe for shorts or open connections. Or use a testmeter, such as described in "Workshop Project No. 9", HI-FI MUSIC, July-August, 1956.

² A suitable type was described in "Workshop Project No. 7", HI-FI MUSIC, September-October, 1955.

HI-FI WITHOUT COMPLAINTS

Listen to Your System in a Spirit of Favorable Predisposition, Not Challenge. Then Try These Suggestions for Added Enjoyment — By Herman Burstein

IF A TREE FELL beyond earshot, would there be sound?" By way of introducing a helpful viewpoint rather than as a semantic exercise, I suggest that "No" is a proper and significant answer to a question which has often evoked an affirmative reply. From the audiophile's point of view, it is fitting and important to postulate that sound involves a relationship between a waveform and an ear — let us assume a human one. If no ear is within range, or if the ear fails to make an auditory impression upon the brain, it is arguable that there is no sound.

In short, we do well to distinguish between the waveform and the listener's reaction, and to recognize that sound is a product of the two.

From our basic postulate, it follows that a meaningful definition of hi-fi sound takes into account the individual listener as well as the physical nature of the waveform produced — or rather transduced — by a loudspeaker. Otherwise how explain the fact that music which delights one individual is construed by another as an onslaught upon his ears? Or how account for one individual's utter satisfaction with an audio system costing \$200 while a \$2,000 system leaves another less than satisfied? Admittedly, we are in philosophical territory when we seek the answers to these questions, but the cause of hi-fi would be advanced by wide recognition of the fact that listening satisfaction ties in with one's personal philosophy of listening.

To qualify as high-quality equipment, audio components must measure up to certain specifications. I submit that the listener, too, should not be admitted to membership in our fraternity unless he possesses certain qualifications. The qualifications I have in mind are a matter of attitude or philosophy, if you will. If not congenital, they can be acquired by a moderate effort. They are: 1) a predisposition to like what he hears, and 2) a propensity for variety.

The Favorable Predisposition

It has been noted that a musician can find a facsimile of

the original performance in a well-made recording even though the sound issues from an inexpensive portable phonograph with a garden variety pickup and chiseled stylus. This phenomenon is not confined to musicians but in fact is a matter of common experience, although along somewhat different lines. When listening to an inexpensive table radio with a 4-in. speaker, we are ordinarily forgiving of noise, hum, rattles, whistles, distortion, and other extraneous sounds. We "pull with" the source, and concentrate on the musical content to the virtual exclusion of all else. We employ the same faculty when we concentrate on one conversation amid a babble of talk at a social gathering. In the case of the table radio, we have a favorable disposition toward it which urges our senses to make the most of its virtues and the least of its faults.

In the presence of a hi-fi system, our psychology goes into reverse. Now we manifest the "show me" attitude. Stirred by pride and competitiveness, and likely jolted by the blow to the thrift impulse, the brain alerts the ear to the slightest imperfection, even though the exercise of this vigilance relegates the music into the background. Consciously or subconsciously, we question whether the system can indeed match the manufacturer's claims. And we do our utmost to provoke it into failure, hoping against hope that it will survive grueling tests and thereby prove itself. Why else would so many who care naught for locomotives, steel drums, breaking glass, or surf on the rocks spend so much time listening to these and similar sounds, which are warranted to expose the pretensions of any system?

To avoid misunderstanding, I should say hastily that I do not intimate that the cheap radio or phonograph is adequate for musical reproduction. By all means we should avail ourselves of technology's best. But once we have the best that exists or the best we can afford, let us then accept the offerings of the system in a spirit of forbearance rather than challenge. If we discipline ourselves to expect little, then whatever the system does provide is apt to seem like surprisingly much. Of course, like any fine instrument, it should be subjected to a periodic checkup, but between checkups we should relax about its merits, really, deeply relax.

The Propensity for Variety

As variety is the spice of life, so it is of hi-fi music. I have in mind not just a breadth of listening fare, but a sort of dynamic relationship between the listener and his audio system as well. Following are some suggestions for supplying the essential spice, and no doubt the reader who takes to this recipe can add more of his own.

1. Would you listen to your favorite orchestra — live, in the hall of your choice — playing your selections continuously for more than two or three hours without tiring? No, you want intermission periods as interruptions, and to renew your interest in the music. They will also be enjoyed by your wife, or your guests. *Try short listening sessions for a change*, and relish each one as you would a small but succulent steak. Or mix short sessions with long ones, but none so long as to bring on tedium.

2. Think back to the last time you [Continued on page 62]

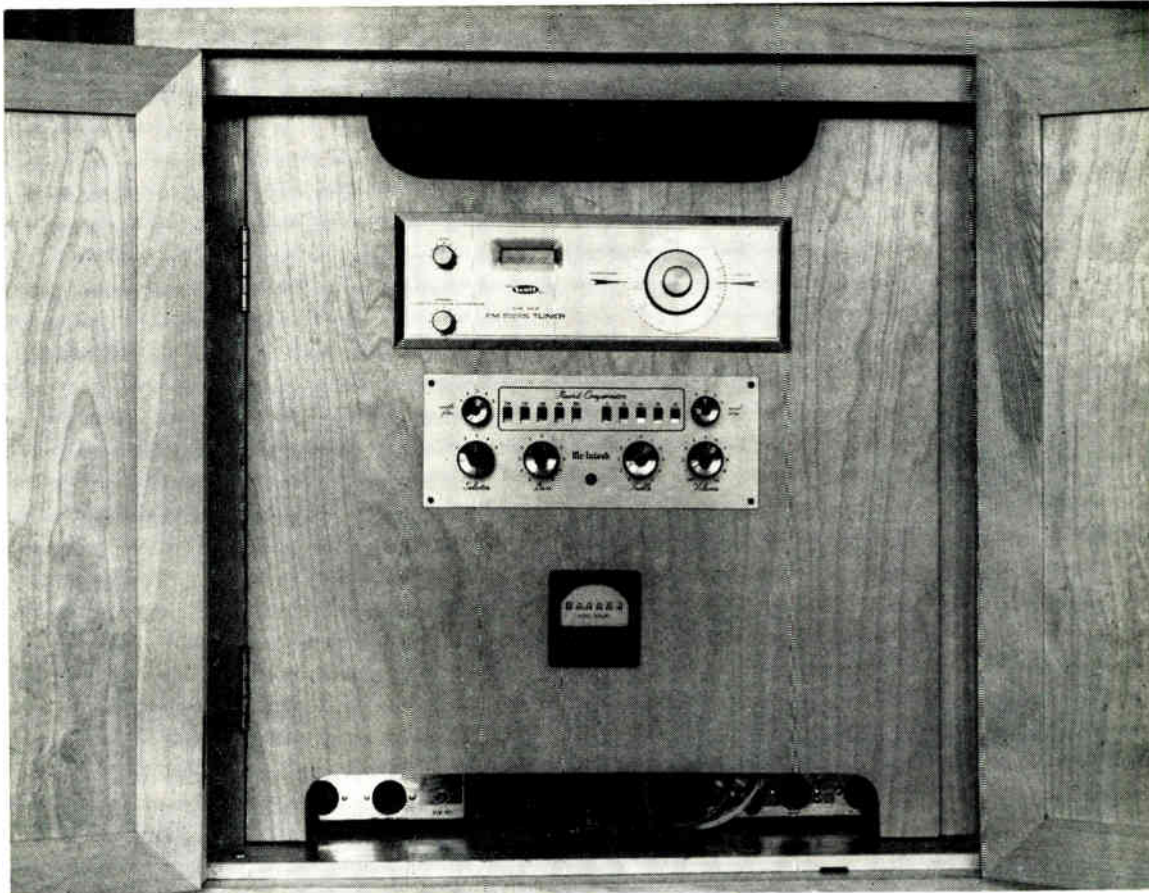

Fig. 16. In this section the tuner, preamp, and the meter that registers stylus use are mounted on the hinged panel, with the amplifiers inside

PLANNING A STEREO SYSTEM

Part 5, Conclusion: FM and Amplifier Section, and Wiring Diagrams — *By Milton B. Sleeper*

IF THE ACCOUNT of this hi-fi installation does not seem to follow an orderly progression, the reason lies in the impatience we all experience to hear a new system in operation before it is actually completed. That accounts for the fact that the stereo tape section, which includes the turntable, was finished and ready for photographing while the radio and amplifier section was still a jumble of equipment and loose wires.

There is certain justification for proceeding in this something-less-than-orderly fashion, however. In every installation unexpected conditions may be encountered, so it is wise to follow a try-and-test course as the work progresses. It is much easier to check each step of the construction and wiring before starting the next, than to shoot trouble or make after-thought corrections on a finished system.

Radio and Amplifier Section

Fig. 16 shows the outward appearance of the radio and amplifier section. There is a Scott 310-B FM tuner at the top, a McIntosh preamp below, and an elapsed-time meter at the bottom of the panel. This panel, like the one in the tape-phono section, is hinged so that it can be

swung out to provide access to the terminals at the rear.

You can see this in Fig. 17. The preamp is high enough to be well above the two McIntosh 30-watt amplifiers when the panel is back in place. The heavy lead from the preamp runs to the separate power supply located in the tape section. This could have been omitted by taking the power from one of the amplifiers, but the use of the separate power supply brought the hum in the speakers down to the point of being virtually inaudible. You might expect that hum would result from the proximity of the preamp to the two amplifiers, but the shielding is so effective that the very slight hum heard right at the speakers does not change whether the panel is swung out or in.

All leads to the components were cut to be just long enough to let the panel swing out all the way. Hanging loose, they made a very untidy appearance. Also, the big tubes in the amplifiers run so hot that, if a shielded lead should rest on one of them, the insulation would be melted and burned to the point of causing a short circuit. This actually happened before the leads were cabled as you see them in Fig. 17. Of course, everything else was checked, but to no purpose. Finally, the damage to the lead was discovered by accident!

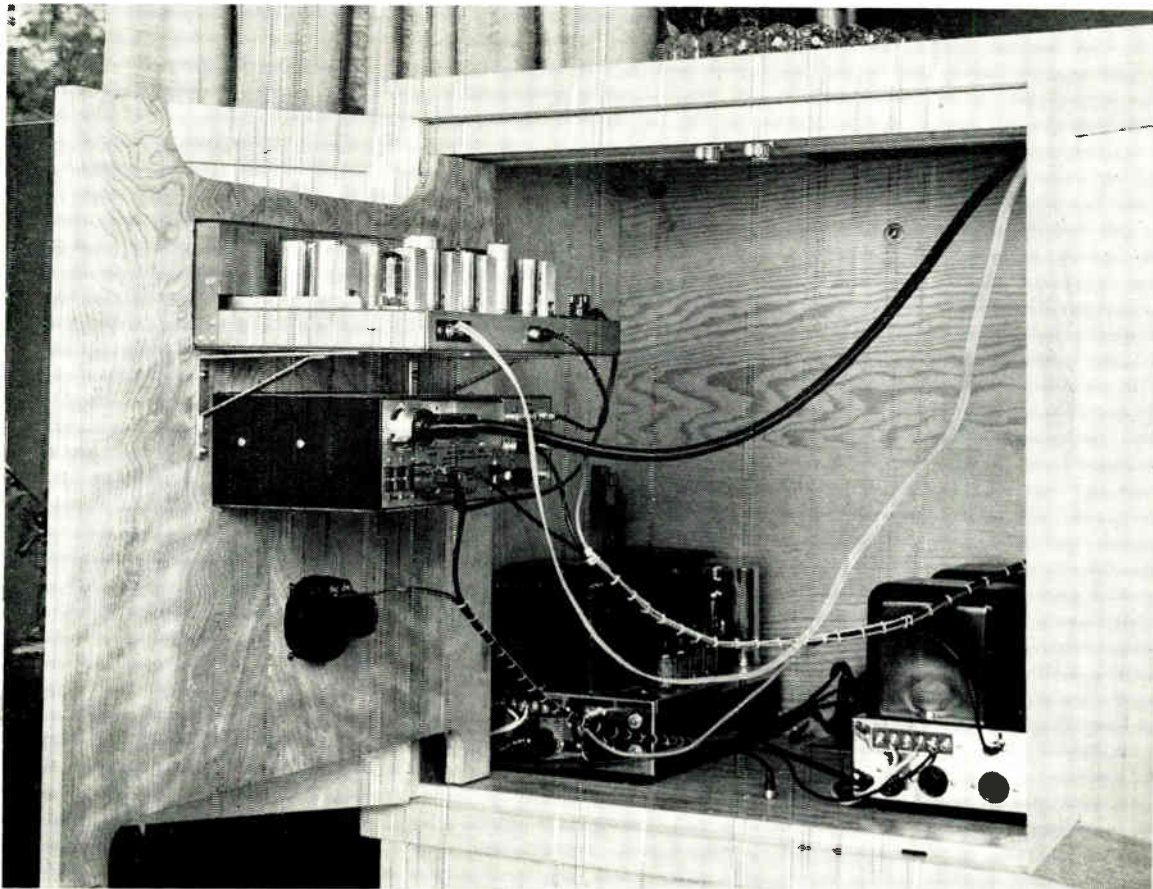

Fig. 17. Compare this view with the diagrams and explanations of the circuits. Note how the appearance was improved by cabling the leads

Notes and Comments

The photographs show the arrangement of the components so clearly that little additional information is needed. Besides, if you install a system of this sort, you will probably not follow this plan exactly, and you may choose components other than those shown in the illustrations. In that connection, it should be explained that one of the reasons for mounting the equipment on hinged panels was to anticipate future substitution of components, requiring only a new panel, and a shift of the hinges.

One suggestion born of experience with this installation: The extra cost of top-quality components is a good investment. A system of this sort should provide trouble-free entertainment for years to come. Having to tear up an installation every few months because of equipment failures spoils all the fun. Accordingly, this system was planned with the idea that it would be permanent except for changes to keep up with the future developments that can be anticipated in the audio art.

And here is a note for husbands: Your wife may be afraid to operate the equipment at first, but before long she will learn how, and she will get a great deal of pleasure out of it — so much, in fact, that she'll be very unhappy if you have to take it apart every little while to fix something that has gone wrong!

An unusual feature illustrated in Fig. 16 is the elapsed-time meter, connected to the phonograph motor. It is very reassuring to know, at a glance, exactly how many hours the stylus has been in use. This is a reliable record, since

the meter starts and stops whenever the motor is switched on or off. Such a meter can be found at one of the surplus equipment stores. The type illustrated shows tenths of an hour, but there is a model that indicates in minutes, so that it can be used to time records.

The special secret of success in making an installation of this kind is a careful study of the instructions that come with the components. Each has its special requirements as to mounting, wiring, or switching circuits. That is why it is wise to connect up the complete system and check it out before anything is made permanent.

And be sure to keep all the instruction books together, where you can find them for future reference. Between the preliminary check-out and the final installation, you may forget some circuit detail, and waste hours over a minor mistake that you would have seen at once in the instructions — if you hadn't mislaid them!

Wiring the Components

Whatever components you use, the basic circuits will be the same, with only minor changes. A complete diagram might look more complicated than it really is. That's why the elements are shown separately, in Figs. 19 to 24.

AC POWER WIRING: The first wiring done on this system was for the AC supply, Fig. 19. The outlet where the power comes in has two sockets, one for a male plug on a lamp or appliance, and one for a female plug on the cord which carries the AC to the equipment cabinet (see Fig. 14).

From the outlet box, wires run up to the master switch

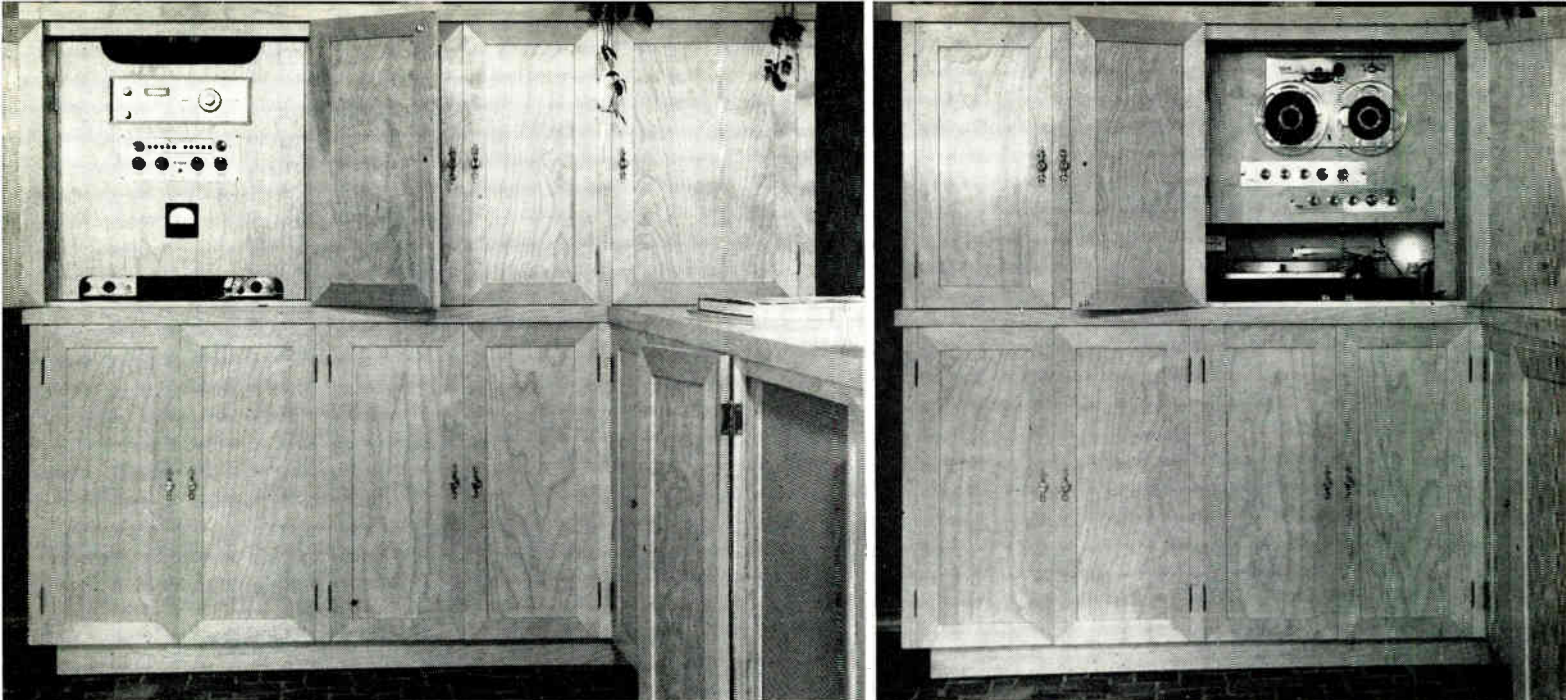

Fig. 18. Appearance of the equipment cabinet when the doors of the radio-amplifier section or the tape-phonograph section are opened

and pilot light, thence to double outlets in the radio section of the cabinet, and the tape-phono section.

TURNTABLE AND METER: Wiring for the turntable and the elapsed-time meter is diagrammed in Fig. 20. One lead from the meter must go to the motor side of the on-off switch, so that the meter will run only when the turntable is in use.

PICKUP AND OSCILLATOR: Fig. 21 shows the connections for the Weathers pickup. The instructions are very specific about using the full length of the lead from the pickup to the oscillator. It must not be cut, but it may be coiled up and tied if it is longer than necessary. There are two output jacks on the oscillator unit. In this system, the RIAA jack was connected to the No. 5 input jack on the McIntosh preamp, and the load adjustment set at 100, which is the maximum value.

TAPE DECK AND PREAMPS: The wiring of the Viking FF75SR tape deck and the RP61 and RP61-S preamps is simple enough, but requires careful study of the instruction book. The diagram in Fig. 22 is for stereo recording and playback.

The lead from RP61-S goes to the upper jack of the pair on the tape deck; the lead with the BLACK plug from RP61 goes to the lower jack of the pair; and the lead with the RED plug to the right-hand jack of the pair on RP61 S.

The output from RP61-S (which is the left-hand preamp when viewed from the front) goes to the input jack on the left-hand amplifier, while the output from RP61

runs to input jack No. 2 on the McIntosh preamp, from which it is switched to the right-hand amplifier.

AC connections run from one unit to the next, as in Fig. 22, so that the tape deck and preamps can all be turned off by the switch on the PLAYBACK LEVEL control on RP61. Note that the metal chassis of these units are connected together by a grounding lead. This particular installation has not been connected for monaural recording from radio or discs, but the instruction book shows the wiring and explains the method.

When the tape deck was first used, there was a loud mechanical hum as soon as the motor was switched on. Nothing seemed to be loose, and pressing on the various parts made no difference in the noise. Finally, however, someone suggested that the rubber-mounted plate that carries the motor might be touching the cut-out part of the wood panel. And that proved to be the case. The wood was chipped off just enough to provide a $\frac{1}{32}$ -in. clearance, and the hum stopped immediately! Since then, the tape-deck drive has been as quiet as could be desired.

PREAMP AND TUNER: The preamp and tuner wiring is indicated in Fig. 23. Here are the other ends of the connections from the pickup oscillator and the tape preamp for the right-hand speaker. Added are the AC cord from the Scott 310-B tuner and the output lead going to No. 1 input on the preamp, and the cable to the separate preamp power supply. A cable is furnished for getting the preamp power from one of the amplifiers, but in this case the

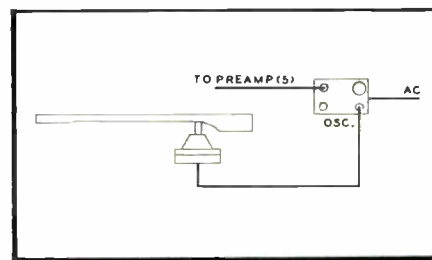
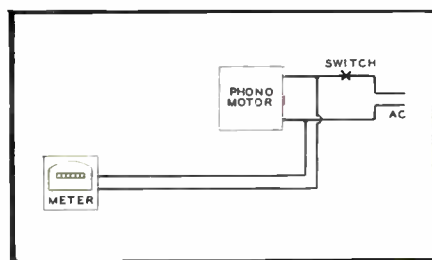
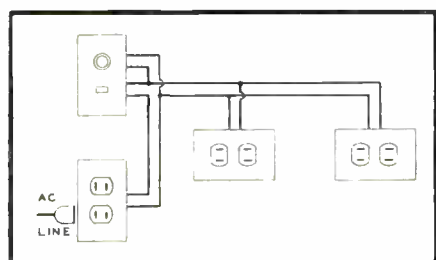

Fig. 19, left: The complete AC wiring. At the top are the master switch and pilot light mounted outside the cabinet at the left. Fig. 20, center: With this circuit, the elapsed-time meter registers only when the phono motor is running. Fig. 21, right: Wiring of the pickup and oscillator

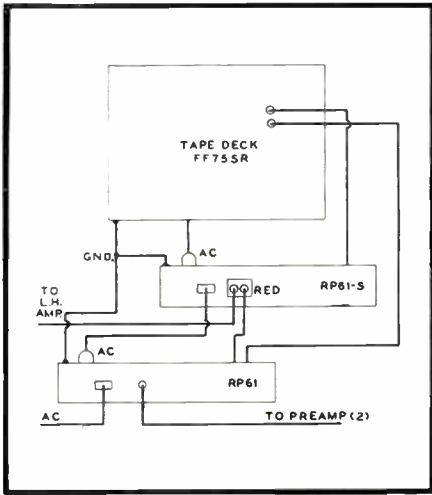
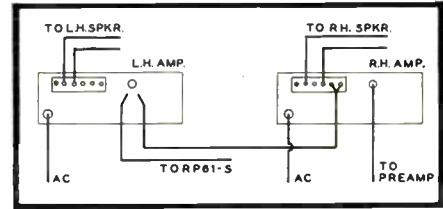
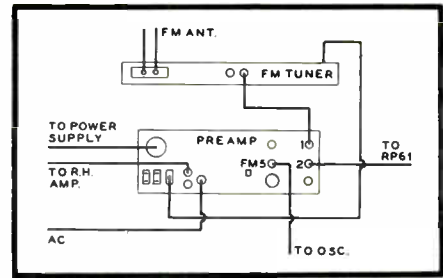

Fig. 22, left: Only the terminals in use are indicated in this diagram of the stereo tape deck and the two preamps

Fig. 23, right above: Circuits for the radio, tape, and phono inputs, power supply, output to the right-hand amplifier

Fig. 24, right below: Connections to the power amplifiers. Note the leads to the left-hand amplifier input. They are for either stereo reproduction, or the use of both speakers on radio and records



separate unit was employed. Note that the slide switch on the preamp, Fig. 23, is put at the FM position.

The Scott tuner is extremely sensitive. Operated at Monterey, Mass., nearly 100 miles from the Empire State Building, New York City stations could be heard on the indoor antenna supplied with the tuner. However, the reception was marginal, so that the stations faded out and came back again, sometimes slowly, sometimes quickly. But with an outdoor antenna, the signal pickup was increased so much that the audio level is steady at all times, even though the tuning meter shows substantial variations in the strength of the radio signals.

AMPLIFIERS: The Bozak speakers, of 8 ohms, are connected to the 8-ohm terminals of the amplifiers, Fig. 24. The output from the preamp is plugged into the input

jack of the right-hand amplifier. Two leads are shown running to the left-hand amplifier. For stereo, the lead from RP61-S is plugged into the amplifier, but to drive both speakers on radio and records, the input terminals of the right-hand amplifier are connected by the second lead to the input jack of the left-hand amplifier. In Fig. 17, you can see that the plug not in use is put into a hole in the bottom of the compartment. That is to keep it from touching the amplifier chassis accidentally.

In every respect, this has been a highly satisfactory installation in performance and in operation. What changes are indicated by the experience of putting in this system? Just one thing: a little more space in the equipment sections — perhaps another two inches in depth, and about three in width.

Fig. 25. Another view of the completed system for stereo tapes, radio, and records. All the operating controls are on the panel at the left

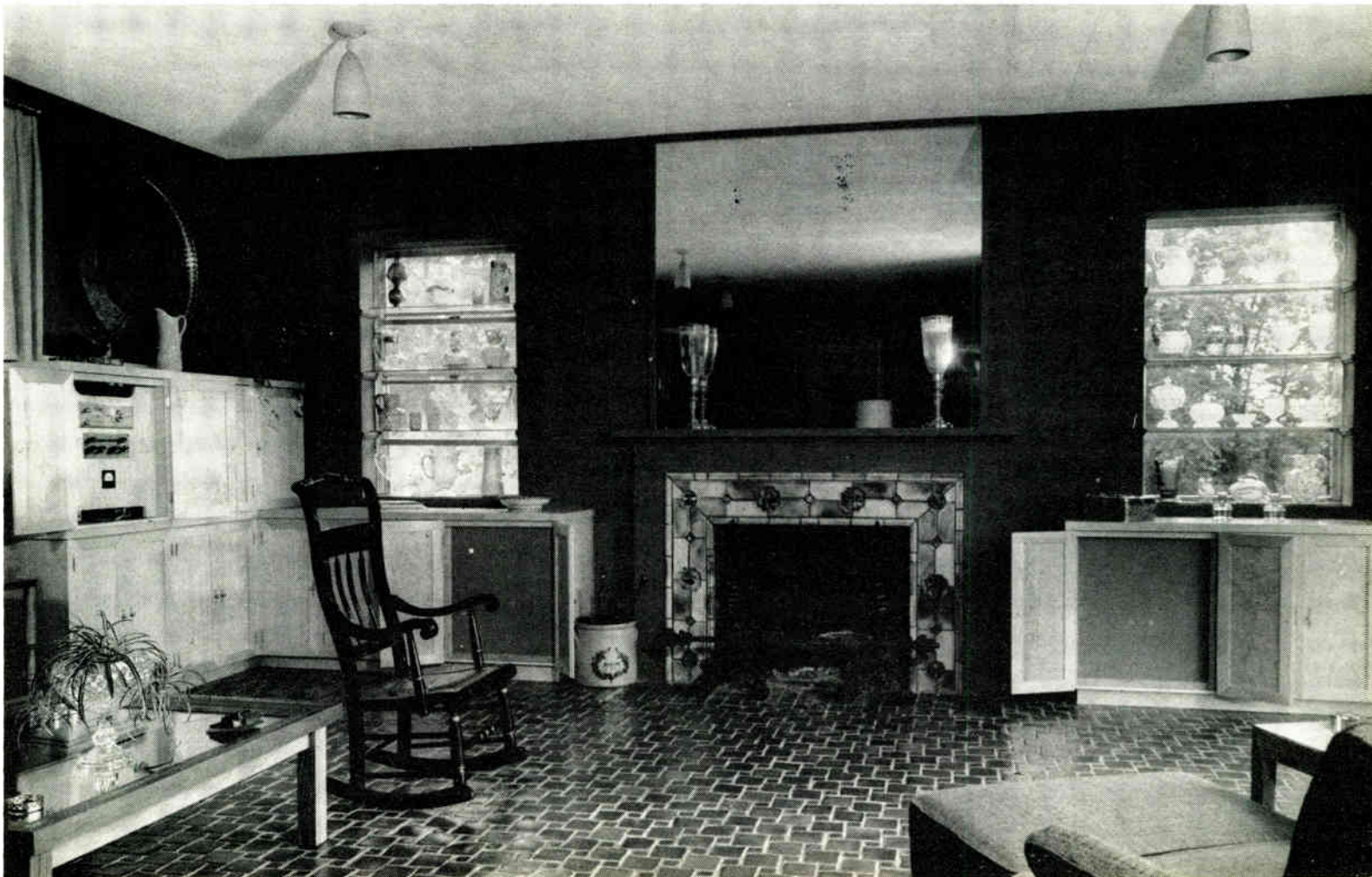

*Assembly Notes on the
Regency HF-50K Amplifier
—By Harold Taplin*



HI-FI WORKSHOP PROJECT NO. 14

THE Regency HF-50K amplifier, rated at 50 watts, is one of the easiest kits to complete because it comes already partly assembled. At least, the transformers and sockets are all in place, giving you a head start by eliminating the possibility of initial confusion and errors. This makes the HF-50K an easy job for a beginner to tackle as a first experience in kit assembly.

Features of This Amplifier

In appearance, this amplifier is unusual in that it has a pierced metal cage all around the chassis as you can see in Fig. 1, and a plate glass top cover to keep out dust or objects that might fall inside. The circuit follows conventional practice, with a pentode voltage amplifier connected to a triode split-load phase inverter. Half the load is in the plate circuit, and half in the cathode circuit. The output tubes are operated in push-pull. A selenium rectifier and filter supply a fixed bias, with separate potentiometers for adjusting the bias on each output tube.

Fig. 1. Top view of the amplifier, with the plate glass cover removed

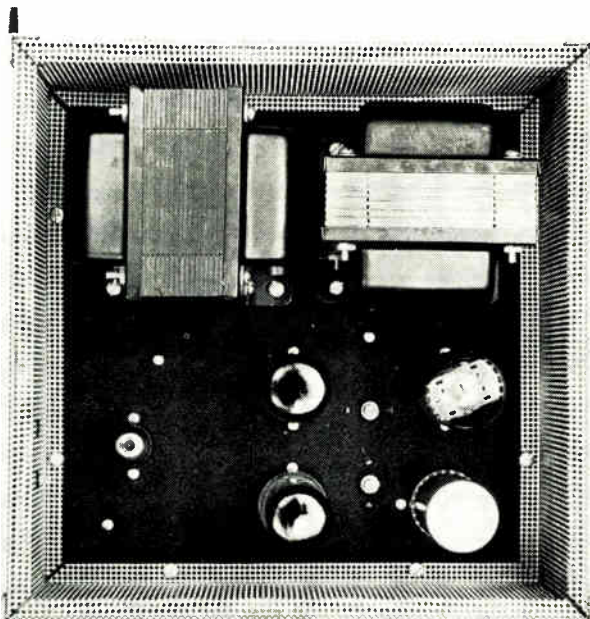

Specifications of the HF-50K call for an input of at least 1 volt. Thus the unit could be driven directly from a ceramic pickup, except that no volume control is provided. That is probably because this amplifier is designed to be operated in conjunction with the Regency HFT-1K transistorized preamp, although any other preamp with its own power supply can be used.

Thus a preamp is necessary even with a ceramic pickup in order to control the volume. In any case, you will probably want a preamp for switching your system to records, radio, or tape, and you'll have to have one anyway when you change eventually to a magnetic pickup, as you can expect to do. Incidentally, no external power supply is needed with the Regency model HFT-1K, as self-contained miniature batteries furnish all voltages.

Notes on the Assembly and Wiring

Frequent reference has been made in this Workshop Project series to the importance of proceeding without haste, and studying each assembly step, rather than rushing ahead without checking the instructions and the illustrations. In this kind of work, experience can breed mistakes, and that is just what happened, as disclosed by the photographs here.

Fig. 2 shows the under side of the chassis at the start, and Fig. 3 the wiring done during the first assembly stage. The instructions do not specify that the base, or "chassis wrap" as it is called, should be removed before this work is started, but the first illustration shows it clearly. In our haste to get the job under way, we left the chassis wrap in place. This made it awkward to get at some of the connections near the outside, but we made the best of the situation.

However, in the second assembly stage, the chassis wrap was so much in the way that we had trouble making the connections sockets V1 and V2, and to the electrolytic condenser. At this point, we decided to take off the chassis wrap as a matter of convenience. Only then did we realize that the pictures we had been following in the instruction book showed this, but we hadn't noticed it. That is why you will see the chassis wrap in Fig. 3, but not in Fig. 4. As a result of this mistake, we probably wasted half an hour, and caused ourselves much unnecessary annoyance.

Otherwise, the work went along very quickly. The instructions are explicit, and the picture diagrams easy to follow, leaving no excuse for mistakes. Total time to

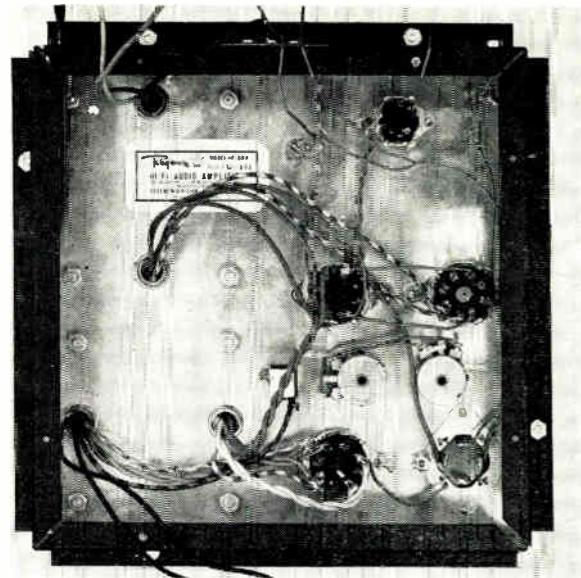
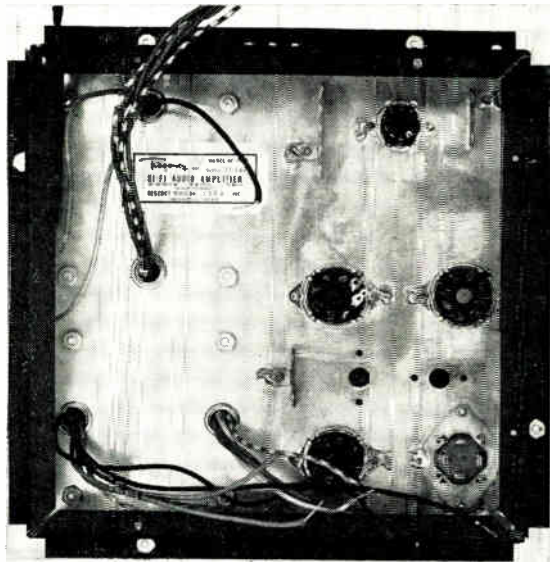

Fig. 2, left: The amplifier looks like this on the under side when it is unpacked. Fig. 3, right: Assembly and wiring done in the first stage

complete the assembly and wiring was 4½ hours, although it should have been at least 30 minutes less than that.

The photograph in Fig. 5 was taken at the conclusion of the last assembly stage, with the chassis wrap in place again. It carries the fuse holder, AC power switch, 8 and 16-ohm output terminals, and the input jack.

A rubber channel is furnished to fit around the top of the case as a cushion for the plate glass cover. This is not shown in Fig. 5, however, because reflections from the glass made it impossible to take a satisfactory photograph of the interior.

Adjustment and Installation

As is the case with most amplifiers assembled from kits it is necessary to insert the tubes *except* the 5U4G rectifier, and to switch on the AC power for a few minutes to form the electrolytic condenser. Then the rectifier tube should be inserted. Otherwise, the condenser may be damaged.

The Final Adjustments

Before the bottom plate is fastened on, the bias potentiometers must be adjusted. These can be seen in the underneath views, while Fig. 1 shows the slotted shafts at the right of the two output tubes. A vacuum-tube voltmeter or a DC meter of 20,000 ohms per volt is required for this. The procedure is explained in the instructions. Be sure to keep this book for, if you should ever substitute 6550 output tubes for the 6CA7/EL34's supplied, the bias must be set at a different value.

The instructions specify that the input to the amplifier must not contain a DC component. If it does, a paper condenser of .1 mfd. or more must be inserted in the lead going to the center connection of the input jack. In case you are not certain about the output from the preamp that you plan to use, add the condenser anyway, as it will not affect the audio performance.

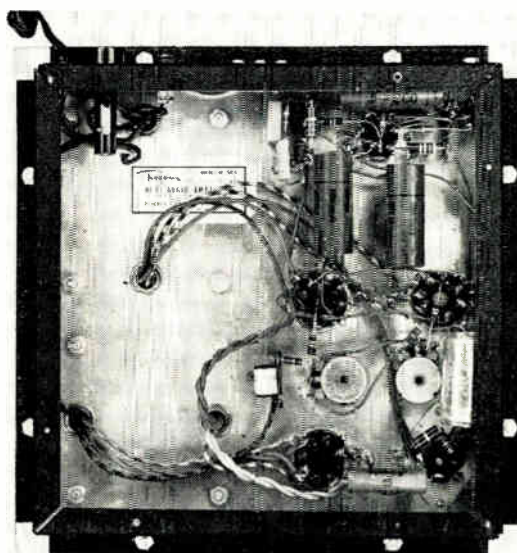
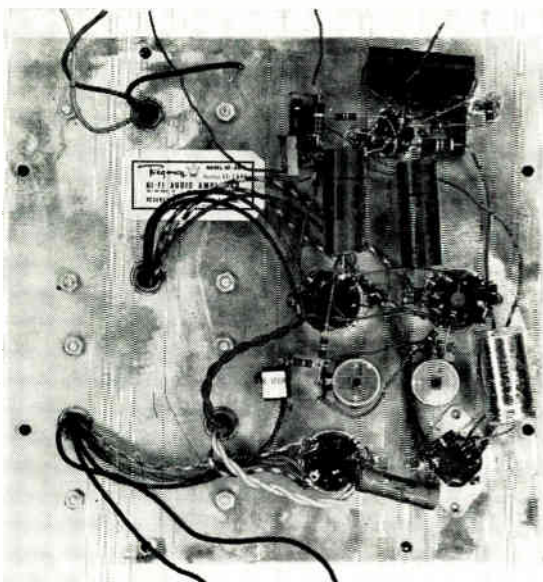
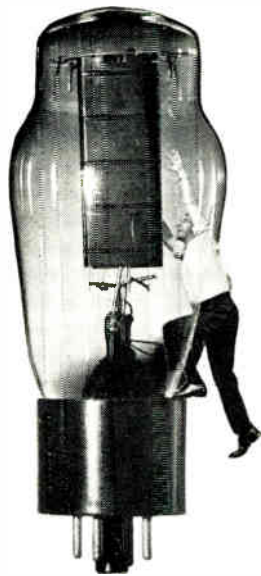

Fig. 4, left: Completion of the second stage. The text explains the removal of the chassis wrap. Fig. 5, right: Completed and ready to use



*You Can't Judge a Book By Its Cover,
nor Hi-Fi Equipment By Its Outward
Appearance. Here Are Photographs
Showing the Inside Construction
of New Components Which Have Been
Granted the Commendation Seal*

“INSIDE INFORMATION”



The Hi-Fi Music Commendation Seal, which bears the inscription "A Commended Design in Its Price Class", has been awarded to the specific models described and illustrated in this department.

In making these awards, five factors are considered. They are: mechanical design, electrical design, workmanship, performance, and facilities provided. These factors are then related to the retail price.

Thus, designation as "A Commended Design in Its Price Class" represents a composite of the various points which must be taken into account in the selection of hi-fi equipment.

It should be clearly understood that the Commendation Seal is not a confirmation of the manufacturer's specifications. However, when we have received such confirmation from an independent engineering laboratory, this is so stated in the discussion of the equipment, and the name of the laboratory is given for purposes of identification.

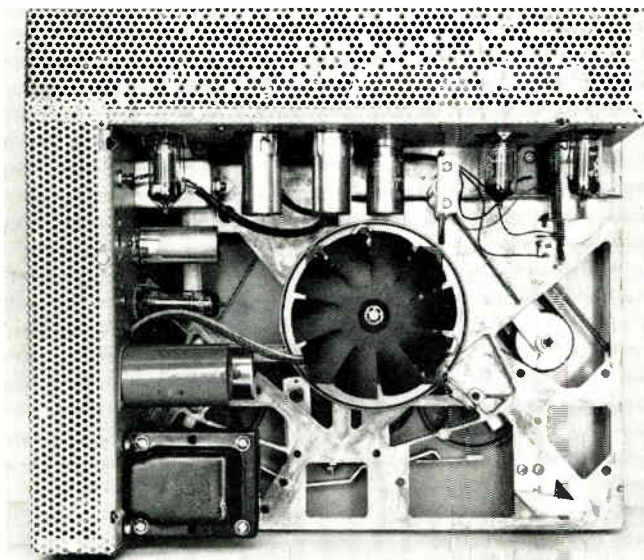

Award No. 18: Ampex model A122 portable tape machine for stacked stereo, or full-track and half-track monaural playback, and half-track monaural recording. The same assembly is available without the case, or in a table-top cabinet.

Reels up to 7 ins. in diameter can be used; tape speed is adjustable to $3\frac{3}{4}$ or $7\frac{1}{2}$ ips. The mechanism and controls are complete, convenient, and positive in action. As seen in the top view, the controls are, from left to right: tape position counter, power and function switch, dual volume control, fast forward and rewind, record and stop buttons, play and record, radio or record level, microphone record level, and recording level meter. A button between the reels selects the tape speed.

The record-playback lever can be moved to the RECORD position only if the record button is pressed down. Then if the stop button is pressed, the record button is automatically released. This is a valuable feature as insurance against accidentally moving the record-playback lever to the RECORD position when there is recorded tape in the machine.

The circuit includes preamps for connection to external amplifiers and speakers of Ampex or other makes. An excellent instruc-

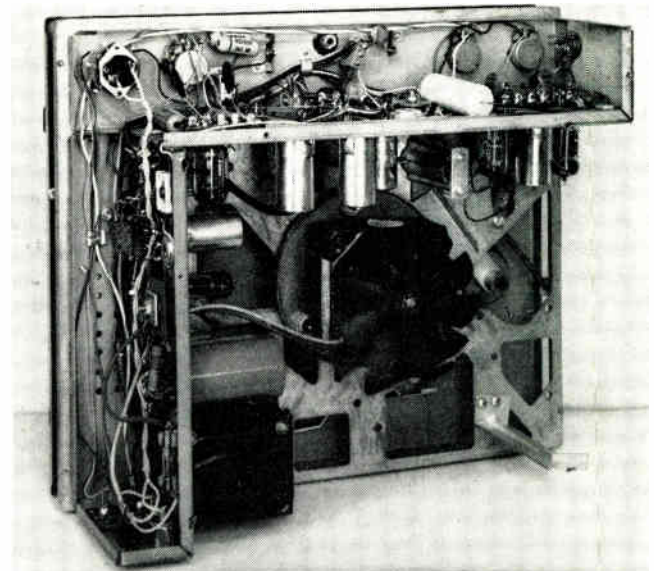

tion book details the use of this unit for recording from radio, records, or microphone, mixing two inputs, and making connections to auxiliary equipment. Price \$495.00; without case \$479.50.

Award No. 19: Acoustic Research model AR-2 speaker. Aside from the extremely flexible construction of the cone suspension employed for the 10-in. speaker, the special feature of this unit is its airtight construction on which the performance depends.

The illustration shows the front with the grille cloth and its frame removed, and the adjustable network mounted on the inside of the enclosure at the rear. The woofer and the casting which carries the tweeters are tightly sealed to the front of the enclosure, and the front, in turn, is sealed to the cabinet. Since the air cushion within the enclosure functions as a "return spring" for the woofer cone, no leakage can be tolerated. This is an exclusive feature of AR speakers.

Therefore, during the final inspection, a 30-cycle oscillator is used to drive the

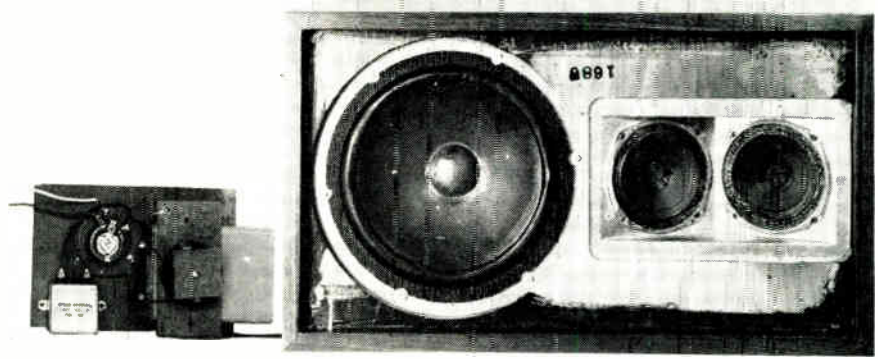

cone at its maximum excursion while the inspector checks all the sealed joints with a stethoscope. In this way, the tiniest leak can be detected. It is this sealed construction that accounts for the excellent quality

of bass reproduction from a cabinet measuring only 24 ins. wide, 13½ high, and 11¾ deep. Price with cabinet of unfinished fir is \$89.00; in mahogany or birch \$96.00; in walnut \$102.00.

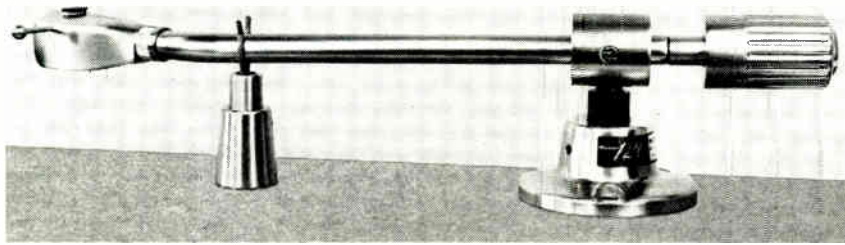

Award No. 20: Rek-O-Kut tone arm model A120 (12-in.) and A160 (16-in.). Although they can be used on any make of turntable, the A120 and A160 match the mounting holes in the two sizes of Rondine turntable bases. The pickup shell is intended to take practically all types of cartridges, including the GE models.

Vertical and lateral movements are free and smooth, and the arm has an excellent "feel" in use. Precise stylus pressure adjustment can be obtained by turning the counterweight on the threaded portion of the arm. A full turn forward on the 12-in.

arm, or two turns on the 16-in. arm add 1 gram at the stylus pressure. Height of the arm can be adjusted by

loosening a set-screw in the base, and sliding the ball-bearing support up or down. Similarly, the height of the rest can be changed. With the stylus on the record, the arm should be horizontal.

Mounting radius from the center of the turntable to the center of the pivot base is 8¼ ins. for the short arm, and 11 ins. for the longer one, so that the stylus overhang is 17/32 or ¾ in. beyond the center

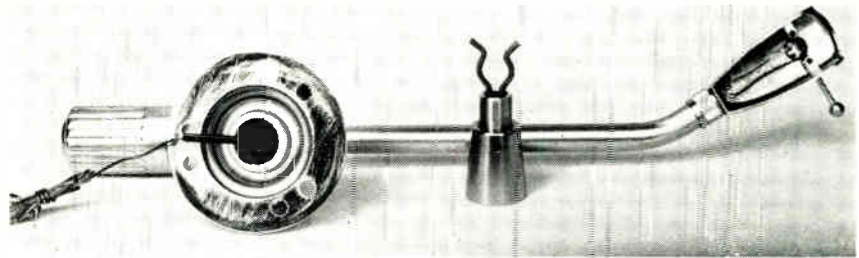

of the turntable. This provides minimum tracking error. Price without pickup is \$26.95 and \$29.95.

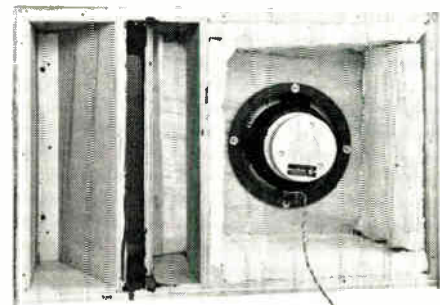
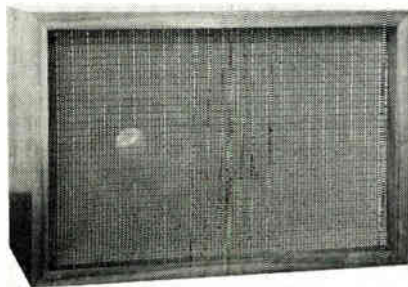
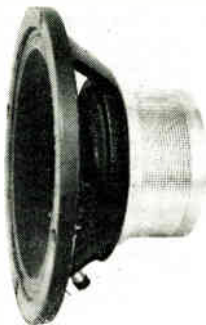

Award No. 21: Stephens Tru-Sonic model 810W speaker and enclosure. The enclosure illustrated here was brought out in response to the increasing demand for cabinets of small dimensions. While size may not be important to people who live in private homes, the enjoyment of music

is shared by apartment dwellers who simply cannot accommodate large speakers.

This model combines a new enclosure design, and a newly-developed 8-in. wide-range speaker that has a 2-in. voice coil and a 1-lb. magnet. Impedance is 16 ohms. The speaker is so attractive in appearance

that it seems a shame to keep it out of sight! Dimensions of the enclosure are 23½ ins. wide, 15¾ high, and 11¾ deep. While larger than the "book-shelf" models, the performance amply justifies the difference in size. Price in walnut, mahogany, or blonde finish \$79.50; Speaker only \$31.50.

Award No. 22: Thorens 4-speed turntable. This Swiss-built turntable is note-

worthy for fine workmanship, and the completeness and simplicity of its design.

The control at the left front of the plate changes the speed, releasing the rim-drive

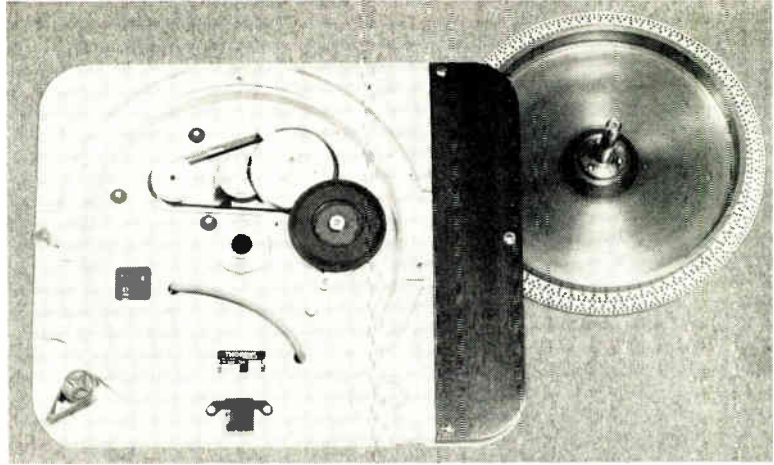
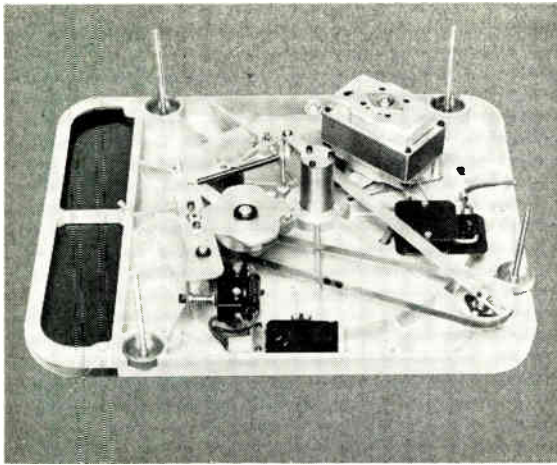

pulley and switching off the AC current between the operating positions. At the center of the lever is a knob which can be turned for the fine adjustment of the turntable speed. Dots under the turntable, lighted by a neon lamp, can be observed in a mirror at the front while the speed is being adjusted. The wood strip at the right is for mounting any type of tone arm.

Unlike other turntables, it is not necessary to cut off the motor in order to stop the record. That is because the record is not carried on the turntable, but on a separate plate or cover. The small knob at the left actuates three thin arms which

lift the plate from the turntable, stopping the record while the turntable continues to revolve. To start a record, the knob is pushed to withdraw the arms, and the plate drops on a series of friction buttons on the turntable. Result is that the record starts almost instantly, without waiting for the motor and turntable to get up to speed.

The four threaded legs serve as supports for the unit until it is mounted. Their special purpose, however, is to carry the leveling adjustments. Rubber shock absorbers fit under them, resting on the mounting base. Then the nuts can be

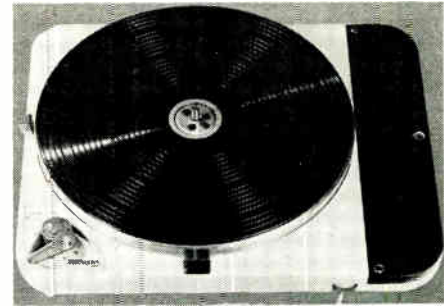

turned until the bubble indicator shows that the unit is level. Price without mounting base as illustrated here is \$99.75.

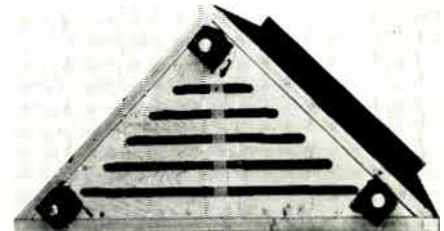
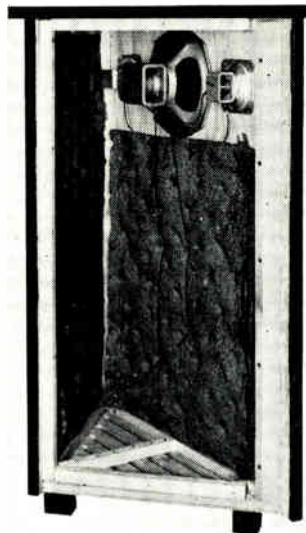
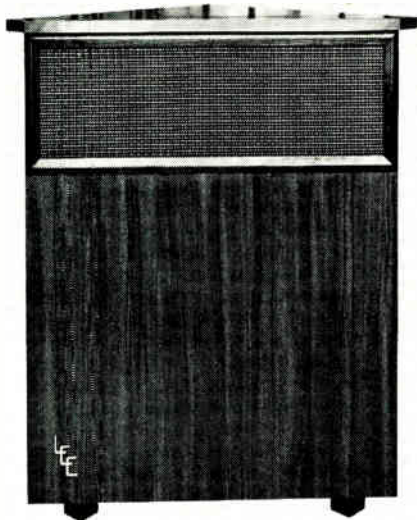

Award No. 23: L.E.E. Trio model corner speaker. This design results from an undertaking to arrive at an optimum balance of

performance, appearance, and moderate cost. A damped Helmholtz resonator design was chosen for the enclosure, of such

dimensions as to resonate below the cone resonance in order to extend the bass range of the speaker, since a direct radiator does not give any audible output below the resonant frequency of the cone. By introducing the proper value of acoustical resistance in the form of the slots in the bottom of the enclosure, the low-end response was extended and smoothed out.

The speaker compliment is made up of an 8-in. woofer and two tweeters. Dimensions of the cabinet are $33\frac{3}{4}$ ins. high, and 19 ins. along each side. Price \$119.95.

INDEX OF AWARDS

Following is the list of Commendation Seal Awards up to date, showing the manufacturers and their model numbers, and the 1957 issues of Hi-Fi Music in which the Awards were announced:

Amplifiers

No. 10: Scott 240 May-June

FM-AM Tuners

No. 1: Sherwood S-2000 March-April

No. 11: Newcomb 200 May-June

FM-AM Tuner-Preamp

No. 8: Bogen R775 May-June

FM Antenna

No. 5: Marjo indoor type March-April

Pickups

No. 2: Electro-Voice Power Point March-April

No. 9: Weathers MT-1 May-June

No. 16: Pickering Fluxvalve July-August

Preamp-Amplifiers

No. 13: Pilot AA903B July-August

No. 14: Sonotone HFA-150 July-August

Speakers

No. 4: Klipsch March-April

No. 19: Acoustic Research AR-2 September

No. 21: Stephens 810W September

No. 23: L.E.E. Trio September

Concluded on page 62

PROOF UNIVERSITY SPEAKERS STAY SOLD!

To insure valid statistics, this tabulation covers the largest selling brands, based on a four-year survey (April 1953 to March 1957) of classified and "Swap or Sell" ads for used high fidelity loudspeakers. All ads authenticated as placed by private individuals in *Audio*, *High Fidelity* and *Music At Home*

PERCENTAGE OF TOTAL INSERTIONS			
SPEAKER "A"	SPEAKER "B"	SPEAKER "C"	UNIVERSITY
46 1/2 %	23 1/4 %	16 1/4 %	13 %

Fewest number of ads offer University equipment ... outstanding testimonial of user satisfaction.

We have always believed that the tremendous volume of University speakers sold in the past to hi-fi enthusiasts attested to the genuine listening satisfaction designed into all our products.

We think that all legitimate hi-fi loudspeakers sound pleasing, but the acid test of listening satisfaction is a speaker's "staying power". Does it grow with your hi-fi tastes, continue to please year after year . . . or is it obsolete before its time . . . ready for swap, sale or discard?

Yes, in the "Swap or Sell" columns of the leading audiophile magazines, you soon know which of the prominent brands of loudspeakers readers outgrow . . . and, by the absence of such ads, which of these leading loudspeakers remain in the home!

The record speaks for itself. This accurate survey, taken over a span of four years, shows that speaker "B" has almost 50% more "for sale" listings than University . . . while speaker "A" is offered more than three times as often! Here is indisputable unsolicited testimony from average hi-fi users themselves that University *stays sold*, continues to serve year after year as a source of rich musical pleasure.

University offers the largest selection of speakers and components to meet every size and budget requirement



WOOFERS

TWEETERS

DIFFAXIALS

NETWORKS

ENCLOSURES

LISTEN

University sounds better

UNIVERSITY LOUDSPEAKERS, INC., 80 SOUTH KENSICO AVENUE, WHITE PLAINS, N. Y.

... and here's why

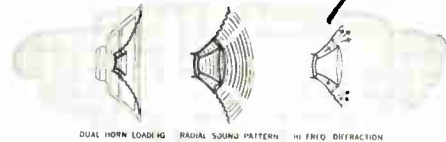

PATENTED DIFFUSICONE PRINCIPLE.

Available only on University Diffaxials. Mid and high frequencies are extended with remarkable efficiency through coaxial dual horn loading at the apex of the loudspeaker cone. A radial projector combined with aperture diffraction provides uniform, wide-angle dispersion, assuring *full fidelity* no matter where off speaker axis you may be listening.



EXCLUSIVE BI-SECTIONAL CONSTRUCTION

Typical of University's advanced design and fabrication techniques is the unique bi-sectional construction of completely independent basket and magnet assemblies. This results in a precision product—vibration and shock-proof in operation, built for trouble-free long life.

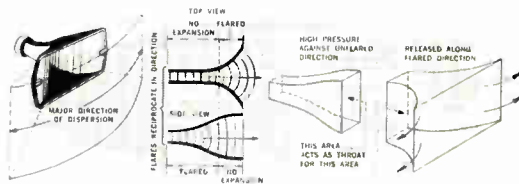

PATENTED "RECIPROCATING FLARE" DESIGN

On all University tweeters the compression driver is coupled to a "reciprocating flare" horn designed to provide *maximum* uniformity of wide-angle dispersion in the horizontal plane with optimum vertical coverage. This is the greatest single advance in wide-angle horn development in over a decade.

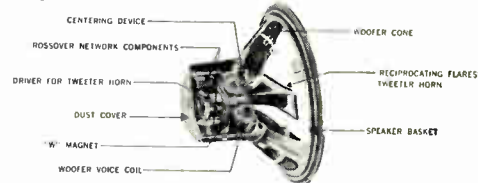

TRUE THRU-THE-AXIS DESIGN

In *true thru-the-axis* design, the tweeter driver unit is fitted to the "reciprocating flare" horn *thru the center* of the woofer magnet assembly. Only with *this* thru-the-axis design is it possible to project high frequencies thru a horn of scientific formula-correct length and configuration . . . and thus achieve highest efficiency, lowest distortion and uniform wide-angle treble reproduction.

MAXIMUM COMPONENT FLEXIBILITY

To meet the ever varying technical needs of expanding aspirations and improvements, University components are designed to provide a maximum of application and operational flexibility, e.g.: woofers with dual impedance voice coils, networks and filters to match all popular impedances and crossover frequencies, speakers having adjustable response devices, etc. *Therefore . . .*

Only University can offer . . .

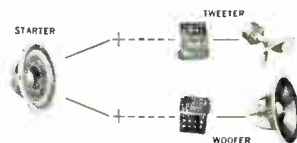

GENUINE PROGRESSIVE SPEAKER EXPANSION

The "Master Blueprint" that prevents your speaker from becoming obsolete, because you can *improve* without discarding existing speakers or systems! You choose from literally dozens of different starter speaker set-ups to suit your present taste and purse. Then, when and as you wish, you integrate these components into *tomorrow's* magnificent deluxe system . . . safeguarded by unmatched engineering flexibility and variety that makes "step-by-step" improvement a wonderful reality.

These are just a few of the reasons why University assures you superior sound that lives and lasts through the years. As other satisfied purchasers know . . . you might spend more—but you can't equal University.



INDEX OF AWARDS

Continued from page 60

Tape Box

No. 3: Concertape 7-in. box March-April

Tape Machines

No. 6: Viking stereo May-June

No. 18: Ampex A122 September

Tape Reels

No. 17: Audio Devices 7-in. July-August

Tone Arms

No. 9: Weathers MM-1, MM-5 May-June

No. 16: Pickering Unipoise July-August

No. 20: Rek-O-Kur A120, A160 September

Turntables

No. 7: Garrard 301 May-June

No. 12: Rek-O-Kur B12, B12H

July-August

No. 15: Garrard T Mk. II

July-August

No. 22: Thorens 4-speed

September

POST OFFICE RULES

At Hi-Fi Music, we process changes of address within 48 hours after we are notified. However, many letters of complaint say: "I did not receive the last issue. Please sent it to me at once. By the way, change my address to _____." If you move and do not notify us in advance, the Post Office where you lived formerly will take the magazine out of its wrapper and throw it away. Then they cut your address off the wrapper and send it to us with your new address if you left it behind. Magazines mailed 2nd Class are not forwarded. That is why we charge for extra copies.

WITHOUT COMPLAINTS

(Continued from page 51)

were away from your music system for an appreciable length of time, perhaps on vacation. On your return, did it not have a fresh, appealing quality, reminiscent of when you first heard it? Absence generally makes the ear grow fonder, too. If you lived next door to a concert hall and admission to you were free, it is unlikely that you would attend every concert. Silence revivifies our appreciation of music. The quickest way to tire of your hi-fi system is to get into the *habit* of turning it on every evening.

3. Do you play everything at high volume? This is a good way to dull your ears. Not everything was meant to be played in that fashion. On the other hand, subdued compositions can sometimes take on an attractive guise if electronically magnified. *Vary the level at which you listen.* I am not advocating that you change the volume control setting with every selection, but perhaps once or twice during a listening session or from one evening to the next.

4. *Vary your listening fare.* Whatever your favorite type of music, indulge your desires of course, but not to the exclusion of all else. Let your children play *their* favorite records occasionally. When you return to your preferred program material, the contrast should heighten your enjoyment.

Continued on page 68

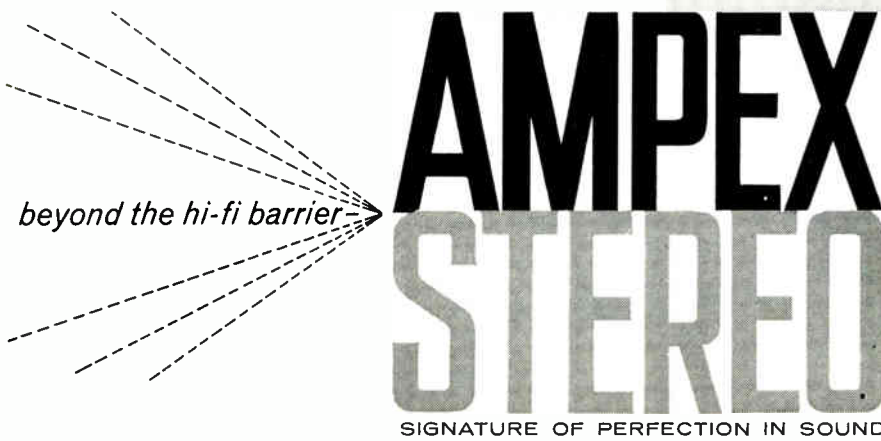

*Here's the authentic story of authentic realism in sound—Ampex **true** Stereophonic Sound—written especially for you by the makers of America's most-wanted and best-engineered home music systems. Send the coupon today for free copy of the new full-color brochure, "**Ampex Stereophonic Sound.**"*

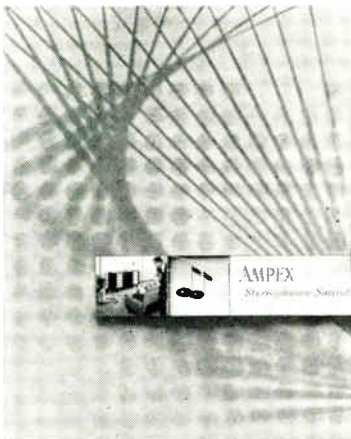

AMPEX

CREATORS OF THE VIDEOTAPE TELEVISION RECORDER; MAKERS OF AMERICA'S BEST-ENGINEERED, MOST-WANTED AUDIO EQUIPMENT

AMPEX AUDIO, INC.

1036 KIFER ROAD, SUNNYVALE, CALIFORNIA

Please rush my free copy of "Ampex Stereophonic Sound"

NAME _____

ADDRESS _____

CITY _____

NEW G-E VR_{II} CARTRIDGE

increased compliance...4-gram tracking force
...frequency-range 20 through 20,000 cycles

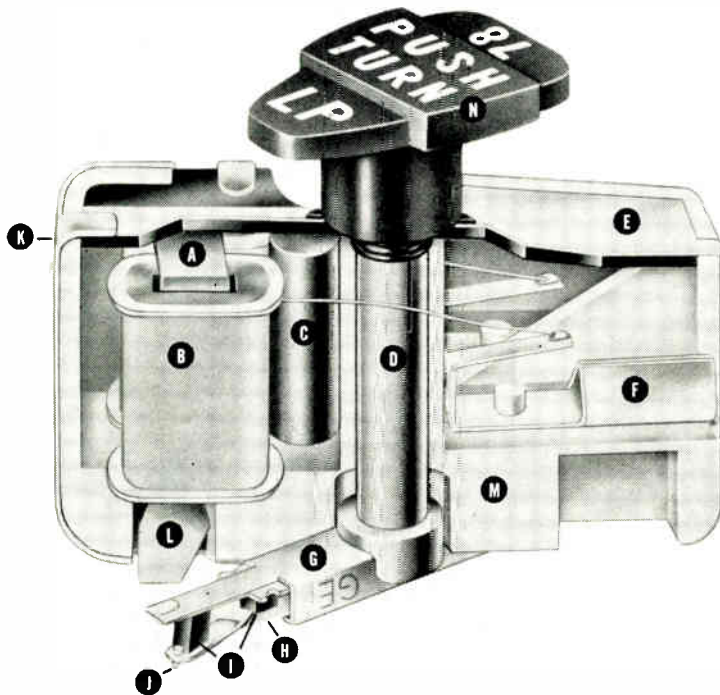

- Ⓐ Highly permeable laminations
- Ⓑ Hum-cancelling wound coils
- Ⓒ Alnico V Magnet
- Ⓓ Pivot Post
- Ⓔ Electrostatic Shield
- Ⓕ Plug-in Terminals
- Ⓖ "T"-Channel
- Ⓗ VR_{II} Clip-In-Stylus
- Ⓘ Special G-E Damping Blocks
- ⓷ Stylus Jewel
- Ⓚ Mu-Metal Electromagnetic Shield
- Ⓛ Magnetic Pole Pieces
- Ⓜ Plastic Body
- Ⓝ Triple Play Knob



A dramatic new design to bring out the best in every Hi-Fi system

New Full-Range Reproduction. General Electric's new VR_{II} magnetic cartridge makes possible faithful reproduction from 20 through 20,000 cycles. Crystal clear reproduction from the lowest fundamental to the highest harmonics.

New 4-Gram Tracking Force. Lateral compliance of the VR_{II} has been extended to 1.7×10^{-6} cm per dyne, permitting a tracking force of only 4 grams to minimize record and stylus wear.

Instant CLIP-IN-TIP Stylus. Stylus replacements can be made instantly at home without removing cartridge from tone arm. There is no need to discard an entire dual assembly when only one tip is worn.

New Electrostatic Shielding. In the VR_{II} cartridge a new electrostatic shielding prevents pickup of electrostatic interferences and hum. This shield also grounds the stylus assembly, thus preventing the build-up of electrostatic charges from the surface of the record.

New Lightweight Construction. The new VR_{II} has been reduced in size and weight, with a new stylus guard.

Terminals and knob have been improved. The G-E VR_{II} is built to withstand continued usage under the most exacting conditions.

Frequency Response See typical curve below.
Output Voltage Nominal, 22 millivolts at
10 cm per sec. at 1000 cycles
Horizontal Compliance 1.7×10^{-6} cm per dyne
Inductance 520 millihenrys nominal
Resistance 600 ohms nominal
Cartridge Weight 8 grams (single type); 9.5 grams (dual type)

For further information write to: Specialty Electronic Components Dept., Section HEM-957 West Genesee Street, Auburn, New York. In Canada: Canadian General Electric Company, 189 Dufferin Street, Toronto 3, Canada

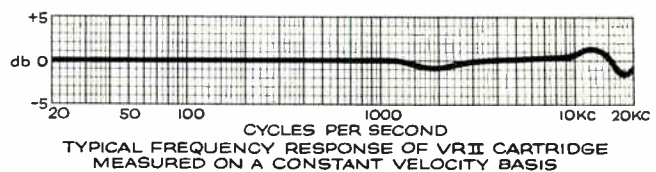

GENERAL  ELECTRIC

*treat your family
to all the fun and enjoyment
of fine high fidelity at
one-half the price you
would expect to pay*



HERE'S ALL YOU NEED

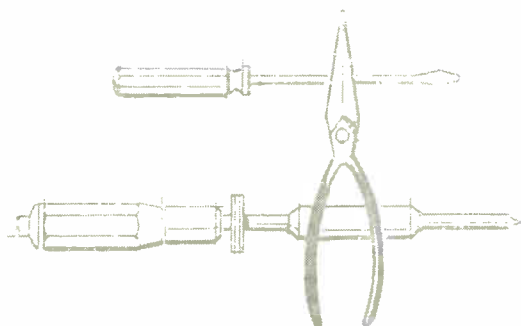

to build your own



HI-FI



FM TUNER

AM TUNER

PREAMPLIFIER

**HEATHKIT
HIGH FIDELITY FM TUNER KIT**

This FM tuner is your least expensive source of high fidelity material! Stabilized oscillator circuit assures negligible drift after initial warmup. Broadband IF circuits assure full fidelity, and 10 microvolt sensitivity pulls in stations with full volume. High-gain cascade RF amplifier, and automatic gain control. Ratio detector gives high-efficiency demodulation. All tunable components prealigned. Edge-illuminated dial for easy tuning. Here is FM for your home at a price you can afford. Shpg. Wt. 7 lbs.

MODEL FM-3A \$25.95 (with cabinet)

**HEATHKIT
BROADBAND AM TUNER KIT**

This tuner differs from an ordinary AM radio in that it has been designed especially for high fidelity. The detector uses crystal diodes, and the IF circuits are "broadbanded" for low signal distortion. Sensitivity and selectivity are excellent. Quiet performance is assured by 6 db signal-to-noise ratio at 2.5 uv. All tunable components prealigned. Incorporates AVC, two outputs, and two antenna inputs. Edge-lighted glass slide rule dial for easy tuning. Your "best buy" in an AM tuner. Shpg. Wt. 8 lbs.

MODEL BC-1A \$25.95 (with cabinet)

**HEATHKIT "MASTER CONTROL"
PREAMPLIFIER KIT**

This unit is designed to operate as the "master control" for any of the Heathkit Williamson-type amplifiers, and includes features that will do justice to the finest program material. Frequency response within $\pm 1\frac{1}{2}$ db from 15 to 35,000 CPS. Full equalization for LP, RIAA, AES, and early 78's. Five switch-selected inputs with separate level controls. Bass and treble control, and volume control, on front panel. Very attractively styled, and an exceptional dollar value. Shpg. Wt. 7 lbs.

MODEL WA-P2 \$19.75 (with cabinet)

**HEATHKIT "BASIC RANGE"
HIGH FIDELITY SPEAKER SYSTEM KIT**

The very popular model SS-1 Speaker System provides amazing high fidelity performance for its size because it uses high-quality speakers, in an enclosure especially designed to receive them.

It features an 8" mid-range-woofer to cover from 50 to 1600 CPS, and a compression-type tweeter with flared horn to cover from 1600 to 12,000 CPS. Both speakers are by Jensen. The enclosure itself is a ducted-port bass-reflex unit, measuring 11½" H x 23" W x 11¾" D and is constructed of veneer-surfaced plywood, ½" thick. All parts are pre-cut and pre-drilled for quick assembly.

Total frequency range is 50 to 12,000 CPS, within ±5 db. Impedance is 16 ohms. Operates with the "Range Extending" (SS-1B) speaker system kit later, if greater frequency range is desired. Shpg. Wt. 30 lbs. **MODEL SS-1 \$39.95**

**HEATHKIT "RANGE EXTENDING"
HIGH FIDELITY SPEAKER SYSTEM KIT**

The SS-1B uses a 15" woofer and a small super-tweeter to supply very high and very low frequencies and fill out the response of the "Basic" (SS-1) speaker system at each end of the audio spectrum. The SS-1 and SS-1B, combined, provide an overall response of ±5 db from 35 to 16,000 CPS. Kit includes circuit for crossover at 600, 1600 and 4000 CPS. Impedance is 16 ohms, and power rating is 35 watts. Measures 29" H x 23" W x 17½" D, and is constructed of veneer-surfaced plywood, ¾" thick. Easy to build! Shpg. Wt. 80 lbs.

MODEL SS-1B \$99.95

...and save!

**HEATHKIT "LEGATO"
HIGH FIDELITY SPEAKER SYSTEM KIT**

The fine quality of the Legato Speaker System Kit is matched only in the most expensive speaker systems available. The listening experience it can bring to you approaches the ultimate in esthetic satisfaction.

Frequency response is ±5 db 25 to 20,000 CPS. Two 15" theater-type Altec Lansing speakers cover 25 to 500 CPS, and an Altec Lansing high frequency driver with sectoral horn covers 500 to 20,000 CPS. A precise amount of phase shift in the crossover network brings the high-frequency channel into phase with the low-frequency channel to eliminate peaks or valleys at the crossover point. This is one reason for the mid-range "presence" so evident in this system design.

The attractively styled "contemporary" enclosure emphasizes simplicity of line and form to blend with all furnishings. Cabinet parts are pre-cut and pre-drilled from ¾" veneer-surfaced plywood for easy assembly at home. Impedance is 16 ohms. Power rating is 50 watts for program material. Full, smooth frequency response assures you of outstanding high fidelity performance, and an unforgettable listening experience. Order HH-1-C (birch) for light finishes, or HH-1-CM (mahogany) for dark finishes. Shpg. Wt. 195 lbs.

MODELS HH-1-C or HH-1-CM \$325.00 each



"BASIC" SPEAKER SYSTEM

RANGE EXTENDER

HEATHKITS

*World's finest
electronic equipment
in kit form...*

*Pioneer in
"do-it-yourself"
electronics*

HEATH COMPANY

A subsidiary of Daystrom, Inc.
Benton Harbor 5, Mich.

"LEGATO" SPEAKER SYSTEM

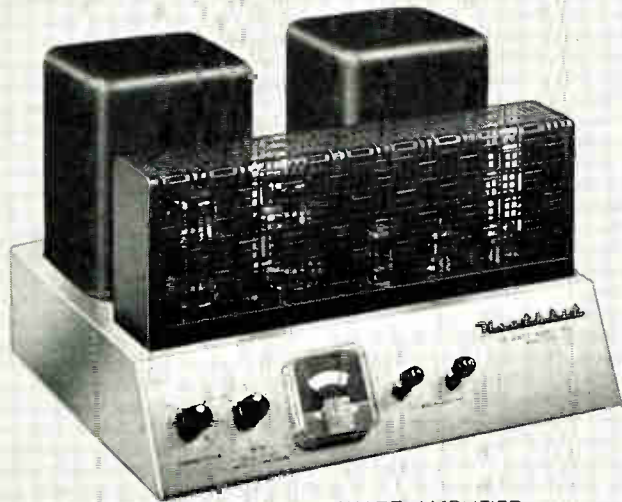

70-WATT AMPLIFIER



25-WATT AMPLIFIER



ELECTRONIC CROSS-OVER

easy-to-build designs by **HEATH** *insure*

You get more comprehensive assembly instructions, higher quality circuit components, and more advanced design features, when you buy HEATH hi-fi!

HEATHKIT 70-WATT HIGH FIDELITY AMPLIFIER KIT

This new amplifier features extra power reserve, metered balance circuit, variable damping, and silicon-diode rectifiers, replacing vacuum tube rectifiers. A pair of 6550 tubes produce full 70-watt output with a special-design Peerless output transformer. A quick-change plug selects 4, 8 and 16 ohm or 70 volt output, and the correct feedback resistance. Variable damping optimizes performance for the speaker system of your choice. Frequency response at 1 watt is ± 1 db from 5 CPS to 80 KC with controlled HF rolloff above 100 KC. Harmonic distortion at full output less than 2%, 20 to 20,000 CPS, and intermodulation distortion below 1% at this same level. Hum and noise are 88 db below full output. Variable damping from .5 to 10. Designed to use WA-P2 preamplifier. Express only. Shpg. Wt. 50 lbs. MODEL W-6M \$109.95

HEATHKIT 25-WATT HIGH FIDELITY AMPLIFIER KIT

The 25-watt Heathkit model W-5M is rated "best buy" in its power class by independent critics! Faithful sound reproduction is assured with response of ± 1 db from 5 to 100,000 CPS at 1 watt, and harmonic distortion below 1% at 25 watts, and IM distortion below 1% at 20 watts. Hum and noise are 99 db below rated output, assuring quiet, hum-free operation. Output taps are 4, 8 and 16 ohms. Employs KT66 tubes and Peerless output transformer. Designed to use WA-P2 preamplifier. Express only. Shpg. Wt. 31 lbs. MODEL W-5M \$59.75

HEATHKIT ELECTRONIC CROSS-OVER KIT

This device separates high and low frequencies electronically, so they may be fed through two separate amplifiers driving separate speakers. The XO-1 is used between the preamplifier and the main amplifiers. Separate amplification of high and low frequencies minimizes IM distortion. Crossover frequencies are selectable at 100, 200, 400, 700, 1200, 2000, and 3500 CPS. Separate level controls for high and low frequency channels. Attenuation is 12 db per octave. Shpg. Wt. 6 lbs.

MODEL XO-1 \$18.95

HEATHKIT W-3AM HIGH FIDELITY AMPLIFIER KIT

Features of this fine Williamson-type amplifier include the famous Acrosound model TO-300 "ultralinear" transformer, and 5881 tubes for broad frequency response, low distortion, and low hum level. Response is ± 1 db from 6 CPS to 150 KC at 1 watt. Harmonic distortion is below 1% and IM distortion below 1.3% at 20 watts. Hum and noise are 88 db below 20 watts. Provides output taps of 4, 8 or 16 ohms impedance. Designed to use WA-P2 preamplifier. Shpg. Wt. 29 lbs. MODEL W-3AM \$49.75

HEATHKIT W-4AM HIGH FIDELITY AMPLIFIER KIT

A true Williamson-type circuit, featuring extended frequency response, low distortion, and low hum levels, this amplifier can give you fine listening enjoyment with a minimum investment. Uses 5881 tubes and a Chicago-standard output transformer. Frequency response is ± 1 db from 10 CPS to 100 KC at 1 watt. Less than 1.5% harmonic distortion and 2.7% intermodulation at full 20 watt output. Hum and noise are 95 db below full output. Transformer tapped at 4, 8 or 16 ohms. Designed to use WA-P2 preamplifier. Shipped express only. Shpg. Wt. 28 lbs. MODEL W-4AM \$39.75



W-3AM
20-WATT AMPLIFIER



W-4AM
20-WATT AMPLIFIER

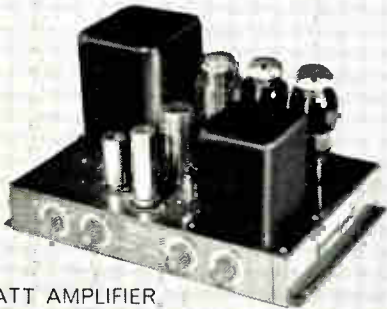

A-9C
20-WATT AMPLIFIER



A-7D
7-WATT AMPLIFIER

HEATHKITS

*World's finest
electronic equipment
in kit form...*

...top HI-FI performance

HEATHKIT A-9C HIGH FIDELITY AMPLIFIER KIT

This amplifier incorporates its own preamplifier for self-contained operation. Provides 20 watt output using push-pull 6L6 tubes. True high fidelity for the home, or for PA applications. Four separate inputs—separate bass and treble controls—and volume control. Covers 20 to 20,000 CPS within ± 1 db. Output transformer tapped at 4, 8, 16 and 500 ohms. Harmonic distortion less than 1% at 3 db below rated output. High quality sound at low cost! Shpg. Wt. 23 lbs. **MODEL A-9C \$35.50**

HEATHKIT A-7D HIGH FIDELITY AMPLIFIER KIT

This is a true high fidelity amplifier even though its power is somewhat limited. Built-in preamplifier has separate bass and treble controls, and volume control. Frequency response is $\pm 1\frac{1}{2}$ db from 20 to 20,000 CPS, and distortion is held to surprisingly low level. Output transformer tapped at 4, 8 or 16 ohms. Easy to build, and a fine 7-watt performer for one just becoming interested in high fidelity. Shpg. Wt. 10 lbs. **MODEL A-7D \$17.95**

Model A-7E: Same as the above except with extra tube stage for added preamplification. Two switch-selected inputs, RIAA compensation, and plenty of gain for low-level cartridges. Shpg. Wt. 10 lbs. **\$19.95**

HOW TO ORDER ...

Just identify the kit you desire by its model number and send check or money order to address below. Don't hesitate to ask about HEATH TIME PAYMENT PLAN.

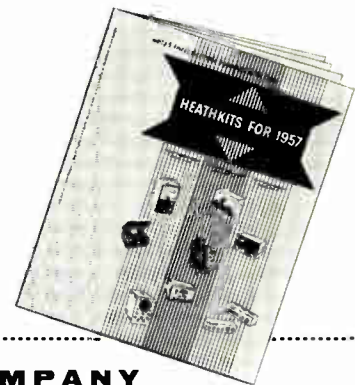

*Pioneer in
"do-it-yourself"
electronics*

HEATH COMPANY

A subsidiary of Daystrom, Inc.
Benton Harbor 5, Mich.

FREE CATALOG

NAME _____

ADDRESS _____

CITY & STATE _____

Please send **FREE** Heathkit Catalog



The "King of Instruments"—an Aeolian-Skinner organ installation.

The sound of the organ is one of the most difficult to reproduce, because of its wide tonal and dynamic range, and because of the large amount of fundamental energy that appears at extreme bass frequencies.

At a recent public demonstration, staged by the Audio League at St. Mark's Church, Mt. Kisco, N. Y., the recorded sound of an Aeolian-Skinner organ (from stereo tape) was instantaneously alternated with that of the "live" instrument. The reproducing equipment selected included four AR-1 speaker systems. Here is some of the press comment on the event:

The Saturday Review (David Hebb)

"Competent listeners, with trained professional ears, were fooled into thinking that the live portions were recorded, and vice versa. . . . The extreme low notes were felt, rather than heard, without any 'loudspeaker' sound . . ."

AUDIO (Julian D. Hirsch)

"Even where differences were detectable at changeover, it was usually not possible to determine which sound was live and which was recorded, without assistance from the signal lights. . . . facsimile recording and reproduction of the pipe organ in its original environment has been accomplished."

audiocraft

"It was such a negligible difference (between live and recorded sound) that, even when it was discerned, it was impossible to tell whether the organ or the sound system was playing!"

The price of an AR-1 two-way speaker system, including cabinet, is \$185.00 in mahogany or birch. Descriptive literature is available on request.

ACOUSTIC RESEARCH, INC. 24 Thorndike St., Cambridge 41, Mass.

WITHOUT COMPLAINTS

Continued from page 62

5. The most readily available source of music in great variety is FM radio. You are particularly fortunate if you live within range of FM-only stations, or stations which program FM separately from their AM affiliates. The reason for this is that stations which carry the same programs on FM and AM use compression amplifiers in order to put out maximum power on AM. Then the same signal is fed to both transmitters.

A compression amplifier boosts low audio levels, and cuts down the peaks to prevent overloading the AM transmitter. This not only limits the dynamic range but introduces distortion. Since it is standard practice to monitor only the AM signals at FM-AM stations, and because AM listeners are accustomed to accepting considerable distortion, no serious efforts are made to clean up the elements of the chain from microphone, records, or tapes to the antenna input. On the other hand, when FM is programmed separately, the entire system is usually maintained at top-quality performance.

Many music listeners depend solely on records simply because they have not discovered that they are served by FM hi-fi music stations. Most of these stations have record and tape libraries which include thousands of compositions, and the number they add each month far exceeds the record purchases of the most extravagant private collectors. So: investigate the FM service in your area as an additional music source.

6. Before we leave the subject of radio, I would like to suggest that you break up any steady date which you may have with a particular spot on the dial. *Change stations from time to time.* The quality of transmission differs from one station to another, and by the turn of a dial you may find an entirely different grade of sound coming out of your audio system.

7. Change your equipment. For the sake of emphasis, I have indulged in hyperbole. The recommendation actually is not that you periodically replace each audio component, even if you could afford to. What I have in mind is that in practical and not so expensive ways you can vary the tonal characteristics of your system through temporary equipment substitutions. A desirable practice is to switch occasionally to another pickup, for even though its overall quality does not match that of your preferred cartridge, it may nevertheless more clearly reveal certain facets of the music or provide a refreshing change in frequency balance. Another approach is to listen to a different speaker. This is less formidable than it seems because you probably have a portable speaker used as a secondary outlet in your den, workshop, bedroom, or elsewhere about the house. Do some serious listening to

Concluded on page 69

Hi-Fi Music at Home

the Ultimate



0.95

0.95 μ v sensitivity

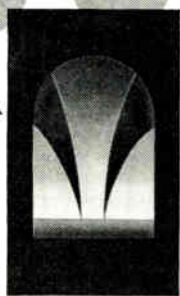

"Feather-Ray" Tuning Eye

Sherwood
TUNERS

Indeed the Ultimate! Under one micro-volt sensitivity for 20 db FM quieting increases station range to over 100 miles with the newly engineered Sherwood tuners. Other important features include the new "Feather-Ray" tuning eye, a local-distance switch to suppress cross-modulation images, AFC switch, fly-wheel tuning.

MODEL S-2000 FM-AM Tuner . . . \$139.50 net
MODEL S-3000 FM only Tuner . . . \$99.50 net

Write for literature—Dept. M-9

Sherwood
Electronic Laboratories, Inc.

2802 West Cullom Avenue, Chicago 18, Illinois



The "complete high fidelity home music center."



WITHOUT COMPLAINTS

Continued from page 68

this speaker at something above the usual background level. If nothing else, this will serve as contrast to bring out the superior qualities of your master speaker. In the same vein, I suggest that now and then you cart some of your records over to a friend's house and listen to his system, or visit an audio salon to acquaint yourself with the performance of the latest components.

8. There is nothing sacrosanct about a flat setting of the knobs on your control amplifier. They are there for a purpose, to please your ears. Often a record departs substantially from its nominal recording characteristic, usually in the direction of shrillness. If your ears protest, don't hesitate to turn down the treble, or cut in the scratch filter. On occasion, you may find that the music comes out considerably cleaner by reducing bass or utilizing the rumble filter. Don't let the craving for low-low bass prevent your enjoyment of the substance of the music. *Use the tone and filter controls freely* when you are not completely satisfied with the reproduction of a particular composition.

9. For a brand new kind of listening experience, investigate reproduction from stereo tapes. You will be amazed at the difference between what you have heard from a particular record and what you will hear from a copy of the stereo tape used to cut the master of that same record. Already, a large library of stereo tapes is available, and all the major record companies will be releasing a continuing series of new tapes this fall.

10. In short, help your hi-fi system to entertain you, and you will be gratified to discover how it will maintain your enjoyment of fine music, and your appreciation of your home music installation.

HELP!

Continued from page 50

Most kit instructions give the voltages in tabular form. Make sure you are in the right range — you can ruin a voltmeter by attempting to measure 450 volts in the 0-25 volt range. Also make sure you use the right probe, and that you have set the voltmeter correctly to AC or DC. Sometimes direct current will not register when the voltmeter is set for AC, or it may burn out the meter rectifier and, worse, alternating current will register as only 50% of the total voltage when it is set for DC.

If you find an incorrect voltage outside the permissible range of 10-20% above or below what it should be, you are close to the trouble. Check all connections and components concerning this pin. You may find a wrong connection, or a poor soldering point. Any soldered connection which does not look clean and smooth should be touched with the hot soldering iron

AR-1

WHEN the AR-1 speaker system first made its appearance on the hi fi market, our published specifications were sometimes greeted with skepticism; for a speaker to perform as claimed, particularly in such a small enclosure, was contrary to audio tradition.

Now, two years later, the AR-1 is widely accepted as a bass reference standard in both musical and scientific circles. There is general understanding of the fact that, due to the patented acoustic suspension design, the small size of the AR-1 is accompanied by an advance in bass performance rather than by a compromise in quality.

AR-2

The AR-2 is the first application of the acoustic suspension principle to a low-cost speaker system. Prices are \$89 in unfinished fir cabinet, \$96 in mahogany or birch, and \$102 in walnut.

We would like to suggest, as soberly as we invite comparison between the AR-1 and any existing bass reproducer, that you compare the AR-2 with conventional speaker systems which are several times higher in price. No allowances at all, of course, should be made for the AR-2's small size, which is here an advantage rather than a handicap from the point of view of reproducing quality.

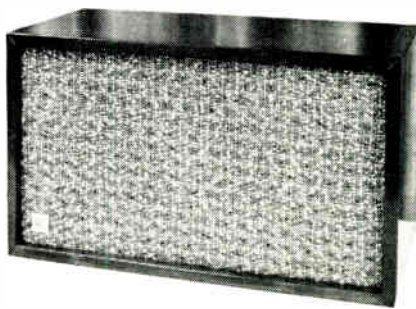

Literature is available on request.

ACOUSTIC RESEARCH, INC.
24 Thorndike St., Cambridge 41, Mass.

ALLIED'S OWN knight® HI-FI COMPONENTS



MONEY-SAVING HI-FI • COMPARABLE TO THE FINEST

- ★ Advanced Design, Performance and Styling
- ★ Outstanding For Superior Musical Quality
- ★ You Get the Very Finest For Less
- ★ Each Unit Guaranteed For One Full Year

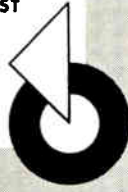

EASY TERMS AVAILABLE



Model KN-700 **\$7950**
Only \$7.95 down

NEW knight Stereophonic-Monaural Preamplifier

Features:

- For Stereo or Monaural Use
- 2-Channel Tape or FM-AM
- Channel "Reverse" Switch
- DC on All Tube Filaments
- Full Equalization
- Scratch Filter
- Rumble Filter
- Loudness Switch

For use with any monaural or stereo Hi-Fi System. Instant switching to monaural or stereo and reverse left and right channels. Separate gain controls; Master volume control; separate Bass and Treble; full phono and tape equalization (monaural); response, ± 1.0 db, 20-20,000 cps; inputs—G.E., Pickering, Ceramic Phono, Tape Head A, Tape Head B, Mic., Tuner, Tape Pre or Crystal; outputs—A and B Recorder (20,000 ohms imp.), A and B Main Outputs (cathode followers). Size: 15 x 4½ x 7¼". U.L. Approved. Shpg. wt., 10 lbs.

Model KN-700. Net, F.O.B. Chicago, only **\$7950**

NEW knight 32-Watt Basic Hi-Fi Amplifier

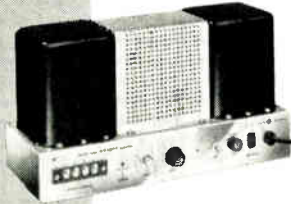

Model KN-632
\$7450

Only \$7.45 down

- More Power For Your Hi-Fi Dollar
- Ideal For Stereo Systems
- Distortion: 0.5% Mid-Frequencies
- Variable Damping Control

Amazing value—ideal for use with preamp above, either singly for monaural use or in pairs for stereo. Response, ± 5 db, 20 to 40,000 cps. Harmonic distortion at rated output, 0.5% (at mid-frequencies); never exceeds 1½% from 30 to 20,000 cps. Intermod. distortion at full output, 2%. Sensitivity, ½ volt for rated output. Size: 7½ x 14¾ x 5½". Shpg. wt., 24 lbs.

Model KN-632. Net F.O.B. Chicago, only **\$7450**

SELECT FROM A COMPLETE LINE OF MONEY-SAVING knight HI-FI COMPONENTS



STEREO-MONAUROAL PREAMPLIFIER



32-WATT BASIC HI-FI AMPLIFIER



30-WATT DELUXE HI-FI AMPLIFIER



15-WATT "BANTAM" HI-FI AMPLIFIER



DELUXE FM-AM HI-FI TUNER



"BANTAM" FM-AM HI-FI TUNER



"UNI-FI" TUNER-AMPLIFIER COMB.



10-WATT "MINI-FI" HI-FI AMPLIFIER

FREE!

404-PAGE
1958
ALLIED
CATALOG

Your Buying Guide to the world's largest selection of Hi-Fi components, complete music systems, recorders, Public Address Equipment—as well as Everything in Electronics. Send for your FREE copy today.



See our 1958 Catalog for full details

ALLIED RADIO
America's Hi-Fi Center

ALLIED RADIO, Dept. 76-J7
100 N. Western Ave., Chicago 80, Ill.

Ship the following KNIGHT Hi-Fi Components:

_____ \$ _____ enclosed

Send FREE 1958 ALLIED 404-Page Catalog

Name _____

Address _____

City _____ Zone _____ State _____

our
37th
year

HELP!

Continued from page 69

until the solder flows freely, but don't let it flow too far and make contact with a neighboring point! It is also advisable to protect any condenser or resistor attached to the point which is re-soldered by providing a heat shunt. This is done by grasping the lead firmly with pliers so that the heat is absorbed by the jaws, rather than by the sensitive component.

You may also find a wrong component; it should not happen if you are building a kit in which all components are counted out. If you use a component with a wrong value in one spot, you should miss it later and find your mistake at this point—or else you have to make two mistakes, which has been known to happen.

By now you should have found the reason for your temporary fiasco. If the phono plug connections are beyond the shadow of a doubt, if the tube voltages check correctly, all components are in the right place and all solder points reliable, there is really no door left open for trouble. The thing should work, and it probably will.

Just remember that "work" means that music should come out of your speaker. If you forget to connect the speaker, or to connect the newly-built tuner to the amplifier, or to switch on the amplifier as well as the tuner . . . well! It has happened to me that I wasted half an hour in baffled amazement only to find that I had switched on the amplifier, but had forgotten to plug the darned thing into the AC outlet.

It will be noted that no mention has been made of faulty components. The truth is that they are very rarely defective—if they are new. If you build something with capacitors salvaged from an old TV set which has been struck by lightning, you are courting disaster. Otherwise it is pretty safe to assume that the parts are intact. Moreover, it is a heartbreaking task to check a completed instrument for faulty components. Almost all of them have to be disconnected at one end, and capacitors can only be checked satisfactorily with a special instrument which is uneconomical for the occasional audio-builder to own. So let's just hope that the components are all right, and that you have not ruined any by mistreating them with your soldering iron.

It is hardly conceivable that any mistake in assembling an audio component could escape this method of checking. It avoids the tedious and time-consuming going-over of the assembled opus piece-by-piece, wire-by-wire and crossing off every connection on the schematic. The schematic becomes a frightening mess, patience gets ruffled, and probably new mistakes are made. I speak from experience again. I have unsoldered components only to discover that they were right in the first

Concluded on page 71

Hi-Fi Music at Home

HELP!

Continued from page 70

place, and have replaced correct ones with wrong ones just because I had become so flustered that I misread the color code. It is much more efficacious to isolate the mistake first, and then to concentrate on the small section of the circuitry involved. It might not be out of place to mention that it is even better to work carefully from the start. It is easy to make this resolution at the beginning of a building adventure; what counts is to keep up this slow pace and not go faster and sloppier as the work progresses.

ORBIT OF A PRODIGY

Continued from page 33

devote myself to the intellectual and emotional challenges of interpretation.

My father's *motive* in doing what he did was something else again, and when I hear of other parents' urging young children to music, I first want to know *their* motives. It puts me in mind of the geese of Strasbourg, famous for its *pâté de fois gras*. These geese are stuffed full of the very best feed available from the time they are born, not with the purpose of producing the best geese, but in order to fatten up the liver so that it can then be extracted to reap a handsome profit at the expense of the dead birds. If a parent exposes his child to good music early in life because he wants the child to amass a wealth of musical experience, well and good. But if he is doing it merely in the hope of winning fame and fortune for himself, this is reprehensible!

Although talent and performing ability may be present to a greater or lesser degree, a love for music is latent in all human beings, and even the tiniest baby can derive pleasure from listening to music. If exposed to music of a high quality from the very beginning, he will retain an affinity to great music throughout his life. But the exposure should be a gentle one, and the wise parent will avoid making a "thing" out of listening to music. For the child who is told to "listen to Brahms because it is good for you" will probably come to feel pretty much the same about Brahms as he does about spinach. If, on the other hand, there is an abundance of good music in the household, with the parents listening to records and singing and playing for their own pleasure, and if the child is free to listen or participate whenever he feels like it, music will become important to him without his realizing it.

Actually, there are a number of good reasons for starting musical training early, too, if a child's talent and interest seem to warrant it. Many young people rebel at practicing because they have not learned the language of music from infancy and it becomes a chore to them later on to develop the co-ordination between mind, ear, and hand which is necessary for the

Continued on page 72

ALLIED knight-kit HI-FI EQUIPMENT

EASY-TO-BUILD HI-FI EVERYONE CAN AFFORD



- ★ World's Finest Hi-Fi in Kit Form
- ★ Beautiful Custom-Styled Line
- ★ Advanced, Easiest-to-Build Design
- ★ Money-Saving Hi-Fi At Its Best



EASY TERMS AVAILABLE

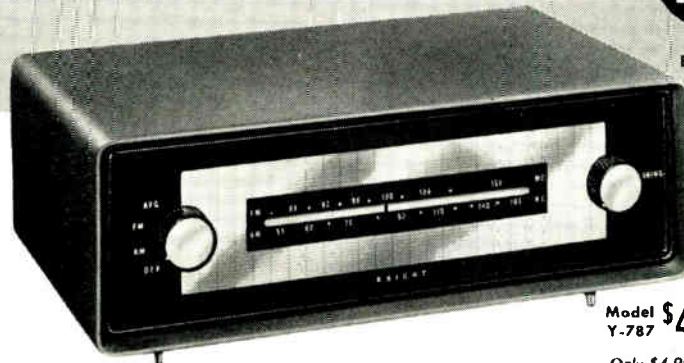

Model Y-787 \$49⁹⁵

Only \$4.99 down

NEW knight-kit FM-AM Deluxe Hi-Fi Tuner Kit

featuring:

- Full FM-AM Coverage
- 2.5 μ v FM Sensitivity
- Automatic Frequency Control
- Printed-Circuit Board
- Pre-aligned RF & IF Coils
- Tuned RF Stage on FM
- Neon Glow Tuning Pointer

The best-looking, best-performing Hi-Fi tuner your money can buy! Covers full AM broadcast and 88 to 108 mc FM. Sensitivity is 2.5 microvolts for 20 db of quieting on FM; 3 microvolts for 10 db signal-to-noise ratio on AM. Also has drift-compensated oscillator; built-in AM ferrite antenna; cathode follower outputs; two outputs—one for recorder, one for amplifier. Handsome, custom-styled case, 4 x 13 x 8". Ready for easy, money-saving assembly.

Model Y-787. Net. F.O.B. Chicago, only \$49⁹⁵

NEW knight-kit 30-Watt Complete Hi-Fi Amplifier Kit



Model Y-762 \$76⁹⁵

Only \$7.69 down

- All-New Custom Styling
- New Printed-Circuit Switches
- 3 Printed-Circuit Boards
- 8 Inputs • Full Equalization
- Full 30-Watt Hi-Fi Output

Build the best and SAVE! Linear-deluxe Williamson-type power amplifier—flawless response $\pm 1/2$ db, 15-100,000 cps at full 30-watt level! Equalization for all records within $1/2$ db of recommended accuracy. Extra features: separate Bass and Treble, Level and Loudness Controls; Rumble Filter; Variable Damping; A-AB-B speaker selector; custom cabinet, 4 1/4 x 15 x 15", 32 lbs.

Model Y-762. Net. F.O.B. Chicago, only \$76⁹⁵

THERE IS AN EASY-TO-BUILD knight-kit FOR EVERY HI-FI NEED

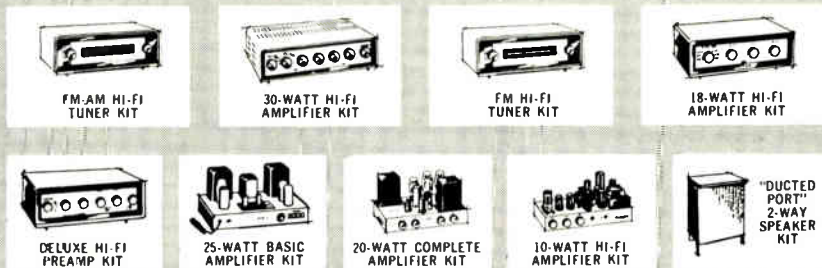

FREE!
404-PAGE
1958
ALLIED
CATALOG



Send for this value-packed catalog featuring the world's largest selection of Hi-Fi Kits, components and complete music systems, including Everything in Electronics. Send for your FREE copy today.

See our 1958 Catalog for full details

ALLIED RADIO

America's Hi-Fi Center

ALLIED RADIO CORP., Dept. 30-J7
100 N. Western Ave., Chicago 80, Ill.

our
37th
year

Ship the following Hi-Fi KNIGHT-KITS:

_____ \$ _____ enclosed.

Send FREE 1958 ALLIED 404-Page Catalog

Name _____

Address _____

City _____ Zone _____ State _____

It's AM! It's FM!

It's SW!
Chapman
ffr*

**"GLOBEMASTER"
HI-FI TUNER**



- Excellent sensitivity and selectivity with drift-free tuning
- Worldwide shortwave bands
- Fine tuning with Mullard Tuning Eye
- High quality wideband ratio detector
- Preset volume control
- Twin outputs including 600-ohm cathode follower
- 300-ohm balanced and 75-ohm unbalanced FM aerial inputs

Available in America for the first time, a fine example of England's custom craftsmanship. Fulfills the most demanding requirements of audio perfectionists. Excellent circuitry assures noise-free reception of even weakest signals without interference or distortion . . . delightful performance. FM Sensitivity: less than 4 mv for 20 db quieting at 22.5 kc deviation and 30% modulation on 300-ohm antenna. Selectivity: 200 kc bandwidth at -3db, 250 kc bandwidth at -6 db. Three short wave ranges from 12.5 meters (24 mc) to 250 meters (1.1 mcs).

Chassis only — **\$149.95**

Finished hardwood cabinet, mahogany or blonde korina—\$17.95

Custom craftsmanship limits our production to moderate quantities. At quality hi-fi dealers, or order direct.

* Full Frequency Range (total FM bandwidth of 45 kc, assures maximum fidelity)

ERCONA CORPORATION

(Electronic Division)

Dept. 91

551 Fifth Ave., New York 17, N. Y.

ORBIT OF A PRODIGY

Continued from page 71

expression of musical language. Thus, instruction should be begun when performing ability first manifests itself. It is far easier to develop young muscles, and even the habit of memory can be acquired early as part of muscle co-ordination rather than as a separate effort. Furthermore, a young child is more apt to accept discipline as a matter of course and can develop musical proficiency much more readily before the years of rebellion come around. It takes about five years to learn how to read music of even medium difficulty, so the earlier the start, the better.

As a matter of fact, the piano is the best of all instruments on which to start a young child, since it is the easiest means of establishing healthy habits of harmonic association for the young ear. But it is important that the family instrument be kept regularly in tune, and also that the child be given specific assignments for practice to know exactly how long to work on what and thus to develop a feeling of accomplishment.

The fact that some children are able to startle family, friends, and even the public by performing finger feats unselfconsciously at an early age does not necessarily indicate that they have greater musical talent than others. In this connection I am reminded of Josef Hofmann's interesting observation concerning the difference between a "precocity" and a true prodigy. "At the age of four", Hofmann once told me, "a precocity plays like a twelve-year old, and at the age of twelve he plays like a four-year old. A real prodigy, on the other hand, plays like a twelve-year old at the age of four and continues to develop throughout his life."

Where a really great talent does exist, early performances in public, constant practice, and exposure to fine teaching and great musical literature can do only good. But upon reaching emotional and intellectual maturity, the individual must be given freedom to sift the best from that which has been taught him, and to add his own highly personalized thinking and feeling. As a child I had the privilege of studying with such incomparable masters as Cortot, Schnabel, and Rachmaninov, and whatever success I had on the concert stage in those years came because I learned my lessons well and played as I was taught. Then came a time when critics began to call my playing "imitative" and "immature". I realized they were right and made up my mind to do something about it. For twelve years I withdrew from the concert stage and turned for the first time in my practice to seek the true spirit of Chopin, Beethoven, Bach, and Brahms. Where formerly I had reveled in the glorious sounds of music and attempted to tonalize irrelevant childish pictures — for instance, of sunlight streaming through

Concluded on page 73

NEW!

AN ARKAY EXCLUSIVE

STEREO HI-FI

KITS AND PREWIRED

**The First Integrated
Stereo Hi-Fi System at the
Cost of Ordinary Hi-Fi!**



ST-11—a binocular tuner designed to provide the listener with stereo Hi-Fi of exceptional quality. Because each section contains own tuning condenser I.F. strip, detector and cathode follower outputs, monaural tuning of AM or FM is possible. Arkay "Miracle Ear" sensitivity on FM gives 4 mv. for 20 db. quieting; Bandwidth 200 KC, 6 db. down; freq. resp. \pm .5db. 20 to 20,000 cycles; Hum level—65 db.; AFC: adj. cathode follower output: 75 microsecond de-emphasis network. Arkay "Miracle Ear" sensitivity on AM gives 3mv. for 20 db. quieting; Bandwidth — 8 KC; freq. resp. 20-8,000 cycles; adj. cathode follower output.

Kit \$47.95

Wired \$69.95



SP-6—Dual channel, preamp with cathode follower outputs. Can be used with tape deck, mag. phono, tuner, or aus. equipment. The construction of the SP-6 allows for use as a conventional pre-amp. Features include 6 position func. switch: Simultaneous volume control; Loudness control; Bass control \pm 16 db. @ 60 cps; Treble control \pm 16 db. @ 10,000 cycles; 3 position Hi-filter and Lo-filter; Freq. response \pm .5 db. 20 to 40,000 cps; Sensitivity—tape, 4 mv. for .5 volt output—phono, 6 mv. for .5 volt output—tuner and aux. .3 volt for .5 volt output; DC fil.; Built-in power supply.

Kit \$34.95

Wired \$47.95



MODEL SA-25—dual channel pre-amp drives a monaural 25 watt Linear Williamson amp, with your present amplifier for unsurpassable realism of Binaural sound.

Channel 1—25 watt amp: freq. resp. \pm 2 db. @ 20 watts, 20 to 20,000 cycles; sens. tape phono—4 mv. for 20 watts; tuner aux.—.3V for 25 watts; Loud. Control; Volume Control—controls dual channels; Bass Control and Treble Control 2 pos. "Lo-Cut" and "Hi-Cut" filters; Equal. switch for all labels plus NARTB tape head.

Channel 2—.5V output—same sens. as channel 1; same pre-amp. features. Just add your present Hi-Fi amp. to channel 2 and prepare yourself to enjoy the sound reproduction only ARKAY stereo can offer.

Kit \$59.95

Wired \$89.95

Get the new, big catalogue and specifications of the remarkable ARKAY radio, Hi-Fi and TV line — Now at your local dealer!

arkay

120 CEDAR STREET N. Y.

ORBIT OF A PRODIGY

Continued from page 72

the stained glass of the Madeleine in Mendelssohn's *Rondo Capriccioso* or Revolutionary soldiers charging up Bunker Hill in the *Winter Wind Étude* of Chopin — I began for the first time to explore music's architecture, to question what the music itself had to say. Because I was no longer concerned with producing an effect or winning approbation, I found myself responsive as never before to the meaningful messages underlying the dotted sixteenth notes and the double descending *glissandi*. Soon I was playing not only with ten fleet, obedient fingers but also with a creative mind and a full heart. This was my preparation for returning to the concert stage. In the long run, that is the only way.

The fabulous child prodigy of two decades ago, Ruth Slenczynska, has returned recently to the concert scene as a mature artist. This year, her first recordings under a new long-term contract with Decca were released — two twelve-inch LP's comprising the twenty-four Chopin *Études* together with the four *Impromptus*. Here is the story of her earlier experiences.

LP'S BUILD REPUTATIONS

Continued from page 31

hopping of 100 men and their valued instruments is no small job. As in the case of the "Big Three" (Boston, New York, and Philadelphia) and the Amsterdam Concertgebouw, this part of the job was entrusted to KLM, Royal Dutch Airlines.

THE CLEVELAND ORCHESTRA on Epic Records George Szell, Conducting

- LC 3195 **Beethoven:** SYMPHONY NO. 5
Schubert: SYMPHONY NO. 8
- SC 6015 **Dvorak:** SLAVONIC DANCES (complete)
Smetana: FROM MY LIFE (QUARTET IN E MINOR)
- LC 3196 **Haydn:** SYMPHONY NO. 88
SYMPHONY NO. 104
- LC 3287 **Mozart:** SYMPHONY NO. 40 IN G MINOR (K. 550)
SYMPHONY NO. 41 IN C MAJOR (K. 551)
- LC 3321 ORCHESTRAL HIGHLIGHTS FROM WAGNER'S "RING OF THE NIBELUNG"
- LC 3330 **Rachmaninoff:** RHAPSODY ON A THEME OF PAGANINI, Op. 43
Cesar Franck: SYMPHONIC VARIATIONS Leon Fliester soloist
Debuss: IRMELIN PRELUDE
- LC 3379 **Brahms:** SYMPHONY NO. 1 IN C MINOR, Op. 68

The first "Cleveland Orchestra Special" departed Idlewild on Sunday, May 7, with the second leaving the following day. Szell, who was already in Europe, was at the Brussels airport for both arrivals to greet his players personally.

Continued on page 74

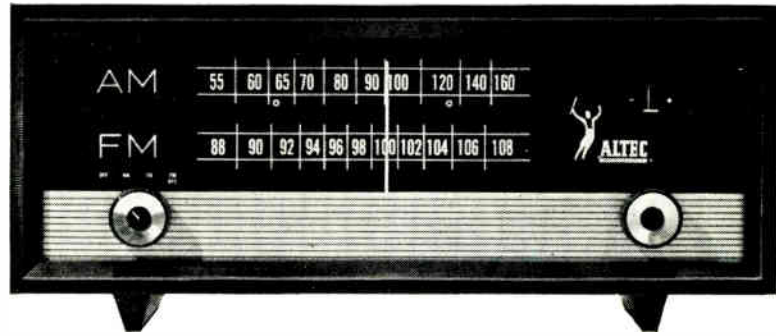

What makes this tuner outstanding?

One of the nation's leading electronic testing laboratories has reported that, to their knowledge, the new Altec 306A is the most sensitive tuner ever manufactured. At the Chicago High Fidelity Show, one of these tuners equipped with only 23" of 300 ohm antenna lead provided perfect reception on twenty-four FM stations, including one in Grand Rapids, Michigan. This is a performance which we believe approaches the theoretical limit of sensitivity that can be obtained at the present stage of electronic science.

But why is it so good? Its basic circuitry is quite conventional, using the latest Foster-Seeley (Armstrong) detector circuit. The difference lies in the application of these basic circuits; in the careful selection of the finest components regardless of cost; in the hundreds of hours spent designing a chassis with the shortest possible wiring distances between components; in the development and application of circuits to achieve their full performance capabilities.

Among these *extra* points of superiority are a fully shielded six gang tuning condenser, complete isolation between the transformer and power mains, and a dry rectifier of very long life and stability. Besides the Foster-Seeley detector, the FM section features a "cascode" low noise RF stage, a triode low noise mixer stage, AFC and two limiter stages. The AM section has three IF transformers with optimized coupling for flat pass band and maximum noise rejection and a special high Q ferrite rod antenna. Naturally, the 306A far exceeds FCC radiation requirements and is approved by Underwriters Laboratories for safety in the home.

The specifications given below reflect fully the quality inherent in the Altec 306A. Compare them with any other tuner specifications, the superiority of this latest Altec product will be obvious. See it at your nearest Altec dealer's showroom. Its quality is fully evident in its beautiful appearance and craftsmanship.

NOTE: Sensitivity figures are given for the standard 300 ohm antenna, and can not be compared with figures derived from special 75 ohm antennas. To convert 75 ohm antenna sensitivity to standard 300 ohm sensitivity, double the published figure. For example: a 2.5 microvolt sensitivity on 75 ohm antenna is a 5.0 microvolt sensitivity on 300 ohm antenna.

Frequency Modulation — antenna: Standard 300 ohm • maximum sensitivity: 1.1 microvolts • quieting sensitivity: 2.5 microvolts for 20 db*, 4.0 microvolts for 30 db* • selectivity: 6 db band width 185 kc, 20 db band width 300 kc • frequency range: 87–109 MC • image rejection: 48 db • IF rejection: 72 db • frequency response: ± 0.5 db, 20–20,000 cps • distortion: Less than 1% at 100% modulation, Less than 0.4% at 1 volt output
*standard 300 ohm antenna

Amplitude Modulation — antenna: Built-in Ferrite Rod "Loopstick" plus external antenna connections • maximum sensitivity: 3 microvolts • loop sensitivity: 50 microvolts per meter • selectivity: 6 db band width 11.0 kc, 40 db band width 27 kc • frequency range: 534 kc–1675 kc • image rejection: 66.5 db • IF rejection: 58.5 db • distortion: Less than 1.5% at 30% modulation • output: 1 volt cathode follower matched for 440 and 339 • power supply: 117 volts; 60 cycles; 65 watts • tubes: 2-6BQ7A, 1 each 6AB4, 6BA6, 6AU6, 6AL5, 6BE6, 12AU7 • controls: Tuning; on-off, AM, FM-AFC

Price: less cabinet \$183.00; blond or mahogany cabinet \$15.00

ALTEC FIDELITY IS HIGHEST FIDELITY



Dept. 9M
1515 S. Manchester Ave. Anaheim, Calif.
161 Sixth Avenue, New York 13, New York

From the desk of
**ROBERT D.
NEWCOMB**



Dear Mr. Newcomb:

My Classic 2500 is absolutely tops to me but one of my friends seems to believe he should buy more power. I can't begin to use all the 25 watts of my amplifier's rating so I can't understand why anyone would need more. Could you throw any light on this problem?.....

Dear Mr. Anderson:

Your friend may simply be following the old adage which implies that if 25 watts is better, then 50 must be still better and so on. In some cases, more power may not be harmful but in others it may. The manufacturer's emphasis on power may lead him to tube overloading, or may even lead to a sacrifice of low and average level performance in favor of watts output.

The power rating of our Classic Series is the highest practical with 6L6 tubes operating conservatively and without introducing conditions which inevitably mean higher distortion. We have taken advantage of a natural set of conditions at this power to achieve the best possible performance in the range of normal usage. Then, we have balanced this highly perfected output system with infinite care in the front end and in every detail of the amplifier's design, construction, testing and finishing. We have felt justified in stopping at this power for our finest amplifiers because we believe the class of customer that will desire such a perfect product would surely select his loudspeaker from among the very best available. By far the majority of these are relatively high in their conversion efficiency and thus deliver much more sound per watt input than some of the low efficiency speakers. Therefore, in a properly matched system, the purchaser of our Classic Series can enjoy the perfection he seeks at all usable levels. He will, as you have found out, need no more power.

Actually, it is not the amplifier power itself which should concern him but the acoustic output of his entire system. If his choice of loudspeaker happens to be one with but a fraction of the efficiency of the majority, he could conceivably have a case for higher power. But, he should realize that for these very inefficient speakers, a few additional watts may be meaningless. For example, the least efficient of the available Hi-Fi speakers require up to 50 times as much power for a given sound output as the most efficient and perhaps 20 times as much power as the average good loudspeaker or about 30 times as much power as the average of the best available speakers. Obviously one can lose output in the loudspeaker faster than he can make up for it in the amplifier.

So, whether your friend needs more power or not depends on the loudspeaker he selects. And, almost any of the best will give him more sound than he can enjoy in a home with seldom more than a watt input. Your speaker choice matched your choice of amplifier, consequently, you not only have the quality you sought but more than adequate volume.

I do hope the above will be of some help to you and your friend and appreciate this opportunity to be of help. It's always a pleasure to hear from Newcomb owners.

Sincerely yours,

Bob Newcomb

The Newcomb Classic 2500 Power Amplifier includes full controls and sensitive preamplifier. This laboratory standard instrument reproduces sound with the greatest precision and purity ever. Newcomb Model 2500R includes full remote control.

Mr. Newcomb is founder and President of NEWCOMB AUDIO PRODUCTS CO., Hollywood's leading manufacturer of precision products for the control and amplification of sound... since 1937! Mr. Newcomb will be happy to answer your questions about high fidelity amplifiers if you will write to him at

NEWCOMB AUDIO PRODUCTS CO.
Department MH-9
6824 Lexington Avenue
Hollywood 38, California

LPS BUILD REPUTATIONS

Continued from page 73

Completing the transportation was yet a third craft—the special KLM cargo plane which has carried the precious in-

THE CLEVELAND ORCHESTRA
on Columbia Records

- ML 4857 **Berg:** VIOLIN CONCERTO. Louis Krasner violinist; Artur Rodzinski cond.
- ML 4829 **Brahms:** PIANO CONCERTO NO. 1 IN D MINOR, Rudolf Serkin pianist, George Szell cond.
- ML 4967 **Dvorak:** PIANO CONCERTO IN G MINOR, OP. 33, Rudolf Firkisny pianist, George Szell cond.
- ML 4785 **Dvorak:** SLAVONIC DANCES, OP. 46, Nos. 1, 3, 8; OP. 72, Nos. 2, 7, George Szell cond.
- ML 4541 **Dvorak:** SYMPHONY NO. 5 IN E MINOR, "FROM THE NEW WORLD", George Szell cond.
- ML 4268 **Haydn:** SYMPHONY IN G MAJOR, NO. 92, "OXFORD", George Szell cond.
- ML 4177 **Hindemith:** SYMPHONIC METAMORPHOSIS ON THEMES BY WEBER, George Szell cond.
- ML 4588 **Liszt:** PIANO CONCERTO NO. 2 **Weber:** KONZERTSTUCK, Robert Casadesu pianist, George Szell cond.
- ML 4498 **Mendelssohn:** SYMPHONY NO. 4 IN A MAJOR, OP. 90, "ITALIAN" OVERTURE AND MUSIC TO "A MIDSUMMER NIGHT'S DREAM" George Szell cond.
- ML 4109 **Mozart:** SYMPHONY IN E FLAT, K. 543, George Szell cond.
- ML 4884 **Ravel:** DAPHNIS & CHLOE SECOND SUITE RAPSONDIE EXPAGNOLE **R. Strauss:** TILL EULENSPIEGEL'S MERRY PRANKS ROSENKAVALIER WALTZ, Artur Rodzinski cond.
- ML 4794 **Schumann:** SYMPHONY NO. 1 IN B FLAT MAJOR, OP. 38, Erich Leinsdorf cond.
- ML 4817 **Schumann:** SYMPHONY NO. 2, George Szell cond.
- ML 4794 **Schumann:** SYMPHONY NO. 4, George Szell cond.
- ML 4881 **Shostakovich:** SYMPH. NO. 1 **Sibelius:** SYMPHONY NO. 5, Artur Rodzinski cond.
- ML 5102 **Stravinsky:** BAISER DE LA FEE, Igor Stravinsky cond.
- ML 4830 **Stravinsky:** "PULCINELLA," Ballet with song in one act. (Mary Simons, Glenn Schnittke, Phillip MacGregor) Igor Stravinsky cond.
- ML 4899 **Stravinsky:** SYMPHONY IN C MAJOR, Igor Stravinsky cond.

struments of all our touring orchestras in Europe. Cargo, in these circumstances, means not only instruments but also music, white ties, tails, and other concert necessities. Flying the Atlantic at 18,000 feet, special climatic procedures had to be adopted. So well were they observed that

Continued on page 75

LP'S BUILD REPUTATIONS

Continued from page 74

the tuning of the instruments at the first concert was no more difficult than if the orchestra had traveled from Cleveland to Hartford.

The opening night of the tour was in Antwerp, where an American orchestra had never before appeared. Although he is no stranger to most European audiences, it was Szell's debut in Antwerp. A capacity audience gave the Clevelanders a standing ovation at the conclusion, and the overwhelming response brought Szell back to the podium for an encore. According to an Antwerp critic, the concert was the "most beautiful" the city had ever heard.

The relation between an introduction via records and first concert appearances is illustrated by the comments of *The Manchester Guardian's* music critic:

"Record collectors in this Country have known of the high quality of the Cleveland Orchestra for a number of years. George Szell has done some splendid discs with them, and Stravinsky chose this orchestra when making his definitive recordings of his ballet *Pulcinella* and his *Symphony in C*. For most of us, it was left until last night to judge that quality in the flesh when it made its first appearance in a concert at the Royal Festival Hall."

How well the orchestra lived up to the reputation established by its recordings is disclosed by the further comment: "This is a magnificent orchestra," remarkable for "the fantastic degree of precision with which it played."

And in *The New Statesman and Nation*: "No finer orchestra playing has yet been heard in the Festival Hall, and I doubt whether anything superior is to be heard anywhere else. They play with the loving spontaneity of a fine European orchestra, as well as with the discipline, blend, and unanimity characteristic of America."

Recording colleagues of Szell and the Cleveland Orchestra added a touch of familiarity to the tour programs in the persons of pianists Rudolf Serkin, Leon Fleisher, and Robert Casadesus. Other soloists were soprano Elisabeth Schwarzkopf and violinist Wolfgang Schneiderhan. Also, a work by a contemporary American composer was performed at every concert.

Countries on the itinerary included Austria, Belgium, England, France, Germany, Holland, Poland, Portugal, Spain and Switzerland. In Madrid, one concert was played at 11 A.M. so that the audience could attend an important bullfight in the afternoon. Orchestra members helped George Szell celebrate his 60th birthday in Vienna on June 7th, and the orchestra participated in the Holland Festival for its final two concerts, both with Fleisher as soloist.

Once the pattern was established in Antwerp, the musicians, Szell, and the remaining audiences seldom varied it.

Continued on page 76

MIRATWIN

world famous quality cartridge — now at
NEW LOW PRICES



MIRATWIN mst-1 single

with diamond stylus for LP or standard diamond stylus

Formerly \$34.50 **NOW \$26.50**



MIRATWIN mst-2 turnover

with sapphire stylus for standard and diamond stylus for microgroove

Formerly \$45.00 **NOW \$31.50**

If you have a hi-fidelity system, bring out its finest tonal values . . . and save money at the same time! Because . . . thanks to the tremendous popularity of our MIRATWIN cartridges, we have been able to effect considerable manufacturing savings . . . and we're passing them along to you! Remember, MIRATWIN is as smooth and sensitive a cartridge as man can make . . . acclaimed by audio engineers and music appreciation enthusiasts alike. So enjoy it in *your* system. Instant Stylus Replacement . . . Ask your dealer to give you an A-B Test tomorrow.

MIRATWIN CARTRIDGES

MST-1D Single Diamond _____ **\$26.50**
MST-1S Single Sapphire _____ **10.00**
MST-2D Dual-1 Sapph., 1 Diam. _____ **31.50**
MST-2A Dual Sapphire _____ **15.00**

REPLACEMENT STYLI

DM-2 Micro-Diamond _____ **\$16.50**
DN-2 Standard Diamond _____ **16.50**
SM-2 Micro-Sapphire _____ **5.00**
SN-2 Standard Sapphire _____ **3.00**

FAR AHEAD > THE FINEST BY FAR



AUDIOGERSH CORP. 514 BROADWAY, NEW YORK 12, N. Y.
WORTH 6-0800 IN CANADA: Atlas Radio Corp., Ltd., Toronto

SPEAKING OF
speakers

always look
for this
symbol for
sound. Then
compare...
when you
listen...
you'll always
hear more
from:



© STEPHENS TRUSONIC INC.

8538 Warner Drive
Culver City, California

LP'S BUILD REPUTATIONS

Continued from page 75

Rave reviews and standing ovations became as much a part of the tour as did the scheduled works on the program. Penetrating the Iron Curtain, enthusiasm for the Clevelanders reached its highest peak in Poland, where an American orchestra had not been heard since the last war. Wild applause and stamping feet greeted the players after each performance. Said the *Dziennik Polski* critic: "The Cleveland Orchestra plays like one magnificent soloist . . . A thing like yesterday's concert was never before seen or heard here."

There were five concerts in Poland (Katowice, Posnan, Warsaw, and Krakow), and some of the strongest impressions about Americans were made here. Mingling with Polish musicians, the Clevelanders found them starved for news of the outside music world, and eager to examine and perform on American-made instruments. Polish musicians found their American visitors friendly and generous, for the Clevelanders left tangible proof of their good-will, in the form of extra strings for fiddles and harps. Reeds and mouthpieces were contributed also. *Time* reported that Cleveland's first trumpeter Louis Davidson gave one of his \$300 trumpets to Francisek Stockfisz for which the Pole gave thanks and added: "You have changed my life."

In a scant six weeks, the Cleveland Orchestra did much to dispel those European theories which regard America's mid-west as the epitome of provincialism. Its double goal was well met: superb musicianship won many followers for the orchestra, while its actual presence and performances gathered praise and esteem for America in the international cultural competition.

The young orchestra had ended its 39th season at the peak of its career. If it be true that "life begins at 40", the 1957-58 season should be a momentous one.

RECORD COLLECTING

Continued from page 31

concerti for his Warsaw and Paris debuts, Chopin at once and permanently reverted to the solo forms. The melodic richness of his two concerti, however, have had enough appeal to both virtuosi and public to insure them honored places in the repertory for all their poor orchestral writing. As to the *E minor* (called the *First* but actually second in order of composition), it is beautifully delineated by Rubinstein and Steinberg on Victor (LM-1810). Ashkenazy, on Angel (35403), has given us perhaps the best LP version of *F minor*, identified as the *Second*.

Schumann: *Concerto in A minor*: Schumann's only attempt, dating from 1841-45, was a total success, but virtually none of the contemporary critics thought so. They excoriated it as being harsh on the ears —

Continued on page 77

NEW

Pilot

**High Fidelity
TUNERS**

Now Feature

Beacon Tuning*

and

Modern Styling

Plus Advanced Circuit

Design Features



FA-550 FM-AM TUNER
with built-in preamp

***A Pilot Exclusive . . .**

Newly developed tuning indicator brings new ease and accuracy to FM and AM station selection.

Pilot Radio Corp. Dept. CE-9
37-06 36th St., L.I.C. 1, N.Y.

Send complete details about new Pilot tuners with Beacon Tuning.

Name.....
Address.....
City.....Zone...State.....

Hi-Fi Music at Home

RECORD COLLECTING

Continued from page 76

incredibly, for it poses no problem to any listener today. Be that as it may, it is a fact that the coolness with which it was received, despite the advocacy of his famous pianist-wife, much aggravated the condition that led to the composer's mental breakdown.

Interpretative success has eluded most exponents of the Schumann — even such as Gieseking, Novaes, and Serkin. Only one extant version can be endorsed wholeheartedly, and that is the old one by Lipatti and Karajan (Columbia ML-4524). Victor, which is especially in need of an *A minor*, might do well to look to the artist on whose suggestions this article is based.

Tchaikovsky: Concerto No. 1: With the ascendancy of Wagner and Bruckner, romanticism moved gradually eastward, acquiring exotic colorations and ethnic characteristics, and taking on the rhythms of the masses in place of the manners of the gilt salons. With Tchaikovsky, Glinka, and Rimsky-Korsakov the migration ended; romanticism had found a new home. The concerto remained the same in basic form, but became voluptuous.

Seeking technical advice from the virtuoso Nicholas Rubinstein, to whom he intended to dedicate his *First Concerto*, Tchaikovsky began by playing the work through from manuscript. Rubinstein's reaction ("worthless, absolutely unplayable") caused the composer to inscribe the score instead to Hans von Bülow, who gave its premiere not in Russia or even in Europe but at Boston, Massachusetts, in 1875. Success was instantaneous, there and almost everywhere else. To his credit, Rubinstein eventually saw the error of his ways and became a champion of the work.

Back in the 40's, Horowitz and Toscanini set a standard for performance of the *B flat minor* that remains unequalled. This treasurable experience is still available (Victor LCT-1012). Somewhat less successful, but of very high caliber nevertheless, is the version by Gilels and Reiner on the same label (LM-1989).

Rachmaninov: Concerto No. 2: When the pioneers departed, their natural heir was Rachmaninov. He sustained the dramatic elements with which Tchaikovsky had infused the form, but his handling of the rhythmic and dynamic scheme was quite individual. His *Second Concerto*, which dates from 1901, stands as a peak of achievement not only in his own *corpus* but also in the entire romantic literature.

Needless to say, Rachmaninov's own historic recording of this *C minor Concerto* (with Stokowski on Victor LCT-1014), must be regarded as the paragon despite its vintage. However, no small praise must be reserved for Istomin (Columbia ML-5103), and also Rubinstein and the late William

Continued on page 78



WHAT? TR and TV for 3D!

For a high fidelity sound system that will play stereophonic tapes at their best we recommend the *Stereophonic Ampro Hi-Fi Tape Recorder*. This new Ampro recorder has built-in stereophonic playback heads and a preamplifier that can be used with any television or radio

set that has a "phono jack." You just set up your Ampro recorder on one side of the room and plug the stereophonic lead into the "phono jack" of your TV or radio. Then you, too, can enjoy living presence sound . . . at a budget price!

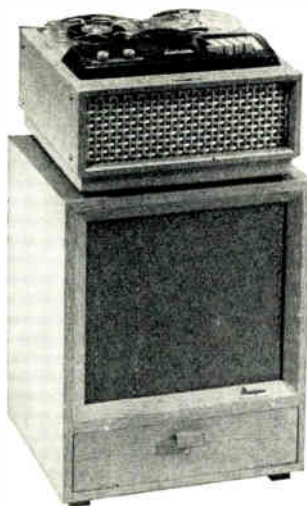

ampro

- Hi-Fi Tape Recorder \$249.95
- Hi-Fi Recorder with AM Tuner 284.45
- Stereophonic Hi-Fi Recorder 284.45
- Hi-Fi Console Speaker 69.95

Prices include federal tax where applicable and are subject to change without notice. Graflex, Inc., Rochester 3, N. Y. Dept. HF-97

GRAFLEX®

A SUBSIDIARY OF GENERAL PRECISION EQUIPMENT CORPORATION



GRAY'S NEW "MICRO-BALANCED" DUAL VISCOUS-DAMPED HIGH FIDELITY TONE ARM

... guarantees maximum tracking stability, because of sealed viscous-damping on BOTH vertical and horizontal pivots, and complete static balance around the vertical pivot.

The Gray "Micro-Balanced" arm offers a maximum of compliance and responsiveness with all popular cartridges, that is beyond the experience of most High Fidelity enthusiasts. For details, please write.

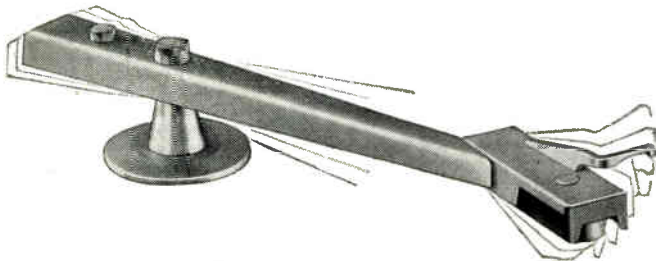

THE GRAY MANUFACTURING CO.
ARBOR STREET • HARTFORD, CONN.

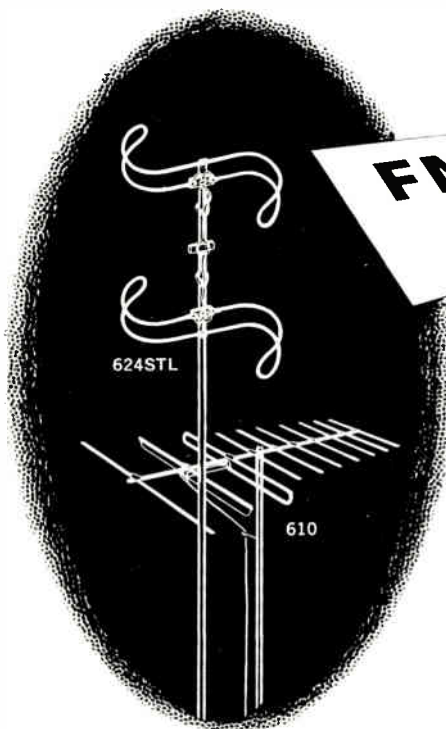

**FM becomes
Hi-Fi**

when you use
the right antenna

Taco FM antennas are engineered to provide the ultimate in FM reception. Any FM tuner takes on a new meaning for realism and all-around performance when connected to a Taco FM antenna... and Taco FM antennas cost so little.

Taco 624 is an omnidirectional type. Available as single (624L) or stacked array (624STL). Ideal for medium signal areas.

Taco 644 6-element yagi antenna for high performance in weaker signal areas

Taco 610 is a high-gain yagi type. Offers greatest gain for weakest signal areas.

WRITE FOR COMPLETE INFORMATION...



TECHNICAL APPLIANCE CORPORATION
SHERBURNE, N. Y.

RECORD COLLECTING

Continued from page 77

Kapell (both Victor, respectively LM-6039 and 1097). The original Rachmaninov recording is available now in enhanced sound, but only in Victor set LM-6123, which contains all four of his concerti and the *Rhapsody*.

Prokofiev: Concerto No. 3: By now, chronologically, the melodious gentility of Chopin's day and the soulful dramatics of later years had become things of the past. France was experimenting with impressionism; in Germany, Richard Strauss and Schönberg were seeking new paths. In Russia, however, there was shaking of traditional heads at the *enfants terribles* who insisted upon writing for the twentieth century. It was not until later that Stravinsky turned to the abstract forms, but already the piano was Prokofiev's instrument and he knew it well, including its untapped potential. The *Third Piano Concerto*, his most famous, is roughly contemporary (in sketch) with the *Classical Symphony*, if altogether different in character. Both mark the close of Prokofiev's first compositional period, prior to his embarking for an American tour. There was great curiosity as to the "new Bolshevik music". The premiere of the *Third* took place in Chicago with the late Frederick Stock conducting, and the composer as soloist. The biting sounds were new to American ears and, if nothing else, the audience could not help but be impressed by the young artist's audacity. Repeated hearings have made the *Third* a great favorite on these shores. Let us hope that RCA Victor will reissue the old recording by Prokofiev himself (with Coppola), but the superb performance by Kapell (Victor LVT-1028) must have pleased the composer in its complete realization of his complexities. (Incidentally, a new version with Mr. Graffman as soloist as due for release this month.)

Bartók: Concerto No. 2: Bartók wrote his *Second Piano Concerto* in Switzerland during 1931. He was still struggling for the recognition that was to come later in life, but this was a period of comparative happiness, and there was no hint yet of the personal tragedies that were to befall him. The *Second* was a huge success at its Frankfurt premiere in 1933. More recently it has been overshadowed by the popularity of its successor.

Unfortunately, the only recording now in the catalogue is inadequate. Little about the album shows a real sympathy or understanding except the first-rate program notes. Here is another project that would seem to be a natural for Mr. Graffman.

Alfred Kaine is more familiar to Hi-Fi Music readers as Reviewer "AK". In New York he is well known as an accompanist, vocal coach, and conductor.

BUY HI-FI HERE

ALLIED RADIO CORP.
100 N. Western Ave., Chicago 80, Ill.
EVERGREEN ALLIED HIGH FIDELITY, INC.
2025 W. 95th St., Chicago 43, Ill.
VOICE AND VISION, INC.
921 N. Rush St., Chicago 11, Ill.
ALLIED HIGH FIDELITY STORES, INC.
602 Davis St., Evanston, Ill.
WEST SUBURBAN ALLIED HIGH FIDELITY, INC.
7055 W. North Ave., Oak Park, Ill.



High gain Broadband Yagi for max. sensitivity to both 72 and 300 ohm tuner input. Designed for fringe FM.
APPARATUS DEVELOPMENT CO.
FM Dept. Wethersfield 9, Connecticut

EVERYTHING IN HIGH FIDELITY . . .
from pickup to speaker. Try and compare your choice of hi-fi components on the "AUDIOMAT" in ASCO's air-conditioned demonstration studio.
ASCO SOUND CORPORATION
115 W. 45th St., 3rd floor, New York 36, N. Y.
Write for free catalog, or phone JUdson 2-1750

AUDIO EXCHANGE

The Trading Organization in the HI-FI FIELD

Write department MH-1 for free catalog of used, fully-guaranteed equipment

159-19 Hillside Ave., Jamaica 32, N. Y. AXtel 7-7577
367 Mamaroneck Ave., White Plains WH 8-3380

STEREOPHONIC TAPES

Now in stock (all of them) send 30 cents for tape catalog. Latest stereo equipment lists and details of stereo conversion kits. See our ad on next page.

BOSLEY HI FI AND STEREOPHONIC
316 N. Glendale Ave., Glendale 6, Calif.



A LITTLE DEPRESSED? DON'T BE . . .
We know something about keeping mail-order Hi-Fiers happy
Write us your Hi-Fi needs
Phone: EVERgreen 4-6071
KEY ELECTRONICS CO.
120 LIBERTY ST., N. Y. 6, N. Y.

CRAWFORD'S OF BEVERLY HILLS

Records and tapes of all labels
Pioneers in radio and hi-fi since 1922
Manufacturers of Telemusic
Operators of KCBH-FM 98.7 mc.
456 N. Rodeo Drive—BR2-3231

IN CANADA —
There's one place where you can find — and hear — all your high-fidelity equipment needs. We carry a complete stock . . . come in, or write in, for a chat, a look, and a listen.
ELECTRO-VOICE SOUND SYSTEMS
141 Dundas St., West, TORONTO

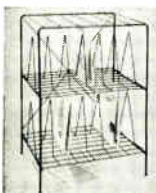

"Hi-File" RECORD CABINET
Table-size wrought iron music-center holds 250 albums in 12 compartments! Top holds largest Hi-Fi set. Sturdy, 30h, 22" w, 17" d. Please remit \$14.95, or charge Diner's Club acct. Shipping chgs. collect.
© LESLIE CREATIONS, Dept. 6 Lafayette Hill, Pa.

INDEX of ADVERTISERS

Acoustic Research, Inc.	68, 69
Allied High Fidelity Studios	79
Allied Radio Corp.	70, 71
Altec Lansing Corp.	73
Ampex Audio, Inc.	62
Apparatus Development Co.	79
Arkay	72
Asco Sound Corp.	79
Audio Exchange	79
Audiogersh Corp.	75
Bogen Co., David	Inside Back Cover
Bosley Hi-Fi & Stereo	79
Bozak Speakers	26
British Industries	2
Capitol Records	18
Collaro	24, 25
Crawford's of Beverly Hills	79
Electro Sonic Laboratories	19
Electro-Voice, Inc.	13
Ercona Corp.	72, 79
Fidelity Music, Inc.	79
Garrard Changers	2
General Electric Co.	63
Graflex, Inc.	77
Gray Research & Development Co.	78
Heath Company	64, 65, 66, 67
Hollywood Electronics	79
Jensen Mfg. Co.	10, 11
Key Electronics	79
Klipsch Associates	80
Lansing Sound, Inc., J. B.	21
Leslie Creations	79
Livingston Electronics	8
McIntosh Laboratory, Inc.	16, 17
Mercury Records	1
Minnesota Mining & Mfg. Co.	Inside Front Cover
Newcomb Audio Products Co.	74
Omegatapes	18
Orradio Industries	4
Pickering & Co., Inc.	28
Pilot Radio Corp.	76
RCA Victor Records	6, 7
Reeves Soundcraft Corp.	9
Regency Div., I.D.E.A.	15
Rek-O-Kut Company	80
Rockbar Corp.	24, 25
Robins Industries Corp.	18, 19
Scott, Inc., Herman Hosmer	23
Sherwood Electronics Lab.	69
Shure Brothers	14
Stephens Tru-Sonic Inc.	76
Stereophonic Music Society	4
The Tape House	12
Technical Appliance Corp.	78
University Loudspeakers	61
Viking of Minneapolis	Back Cover
Weathers Industries	22
Westminster Recording Co., Inc.	5
Wholesale Supply Co.	79

BUY HI-FI HERE

HOLLYWOOD ELECTRONICS
"HI-FI COMPONENTS EXCLUSIVELY"
Since 1944
7460 MELROSE AVE., L. A. 46. WEB 3-8208

FINE RECORDS . . . FINE SOUND EQUIPMENT . . . FINE TAPES . . . FINE FM RADIOS
FIDELITY MUSIC, INC.
Fifty-one O'Farrell San Francisco 8
Home of KEAR-FM YUkon 2-1982

GIBSON GIRL TAPE SPLICERS



splices in a wink!
NO SCISSORS!
NO RAZOR BLADES!
Diagonal cuts tape ends and trims splice edges
At Your Dealers
ROBINS INDUSTRIES CORP. Bayside 61, N. Y.



FM RECEIVING ANTENNAS
Standard and Special Designs
WHOLESALE SUPPLY CO.
Lunenburg, Mass.

the **Magnificent Ferrograph**

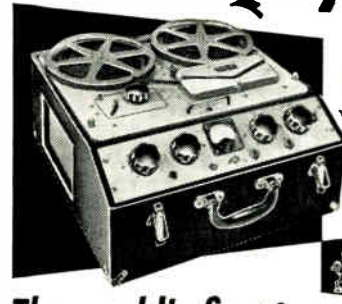

Model 3A/N (portable) with built in speaker. 3 3/4-7 1/2 ips \$379.50

The world's finest hi-fi tape recorder

The ultimate in high-fidelity tape recorders for home and professional use. Dual-speed, dual-track FERROGRAPH recorders are also available in custom models (tape decks available, from \$195.) and with 7 1/2 and 15 ips speeds. Independent field performance tests rate Frequency Response at ± 2 db between 50 and 10,000 cycles with wow and flutter less than 0.2% at 7 1/2 ips.

Quality standards have restricted our production and unforeseen demand may delay delivery, write TODAY for literature.

ERCONA CORPORATION
(Electronic Division)
551 Fifth Ave., Dept. 89, New York 17, N. N. Y.
In Canada: Astral Electric Co. Ltd.,
44 Danforth Road, Toronto 13



When music sounds like it is being played in the subway...you've got RUMBLE*. You can eliminate this extraneous, undesirable noise with a Rondine Turntable as the heart of your hi-fi system. Listen to a Rondine at your dealer. Compare its accuracy, silence, construction and styling with what you now own. It's like coming out into the sun...the difference is that great! Rek-O-Kut Rondine Turntables from \$59.95. Send for FREE colorful booklet and strobe disc.



*produced by conventional phono motor—reproduced by speaker.

REK-O-KUT

HIGH FIDELITY TURNTABLES • TURNTABLE ARMS
Dept. HFM, 38-19 108th St., Corona 68, N. Y.

BUY, SELL or SWAP

The opportunity to buy, sell, or swap items of equipment or records through the use of this department is made available as a service to readers of HI-FI MUSIC without charge.

Copy should be limited to 35 words. Items are not accepted from business firms. The Publisher reserves the right to reject copy which, in his opinion does not conform with the standards of this Magazine. No box numbers, please.

SELL: Cabinart mahogany base pre-cut for Thorens E-53PA or E-53NPA turntable. New condition. \$12. Original cost \$25. R. W. Egberts, 243 Diamond Hill Rd., Berkeley Heights, N. J.

SELL: Garrard RC-88 record-changer, new condition, \$42.50; Cascade 2-speed disc recorder-radio-phonograph, \$42.50; Pickering S-120M cartridge, \$5.00; portable radio, \$5.00; Alliance TV booster, \$5.00. Postage additional. Marilyn Phillips, 311 Penfield, Rockford, Ill.

SELL: BJ arm with Goldring 500 professional pickup. Unused, in original carton. \$26.00. Keating, 78 Grey Lane, Levittown, N. Y.

Sell: GE self-charging portable radio \$15.00; 3-speed record changer \$15.00; Shure 737-A microphone \$15.00; Pickering D-220 miniature diamond cartridge \$15.00; Mrs. Carolyn Barga, 3007 Rice Ave., Rockford, Ill.

SELL: DeJur TK-820 tape recorder, new condition, original carton \$300; Pickering 230-H preamplifier \$22.50; G.E. 3-speed 20" window fan, \$20. Shipping charges additional. V. R. Hein, 418 Gregory, Rockford, Ill.

SELL: Mounted Garrard RC-121 4-speed manual/auto changer, GE cartridge diamond LP, sapphire standard; Newcomb CO-1020 20-watt control amplifier; Electro-Voice 12-in coaxial speaker,

Jensen bass reflex cabinet. \$298 value for \$180. All new. L. C. Llamas, 1530 University Ave., Madison 5, Wisc.

SELL: Concertone 20/20 tape recorder equipped with Bodine motors, and amplifier, in single carrying case, \$400; Brociner Mark 12 amplifier, \$60; Euphonic U-25 speaker system, \$20. Write for details. Michael Henry, 406 Prospect Ave., Hackensack, N. J.

SELL: 4-speed Components Corporation "Professional" turntable, with gold skirts, with B-J arm, new condition, \$125 fob; Approved model A-800 preamplifier-control unit, \$20 fob. Donald P. Bagren 417 N. Winnebago, Rockford, Ill.

SELL or SWAP: Stromberg Carlson custom 10-watt preamp-amplifier model AR-411, 1½ years old, perfect condition. Sell for \$30 or swap for speaker, preferably a tweeter. Morris Weiss, 4638 Bedford Ave., Brooklyn 35, N. Y. DE 2-2029.

SELL: GE deluxe A1-500 Baton tone arm, 12-in., in fine condition, plus extra cartridge slide, \$16 in original container. Sidney Feldman, 549 Riverside Drive, New York City, N. Y. AC 2-9059.

SELL: Garrard record-changer \$27.50; Pickering 230-H preamplifier \$22.50; Pickering D-120M diamond cartridge \$12.50. All in like-new condition. Postage extra. Mrs. Carolyn Barga, 3007 Rice Avenue, Rockford, Ill.

BUY: Lansing C435 back-loaded folded horn, enclosure only. State condition and price, delivered. H. E. Fairman, 41-41 41 Street, Long Island City 4, N. Y.

BUY: Good used basic FM tuner, preferably in cabinet. Jerome Ganz, 102-09 Metropolitan Ave., Forest Hills 75, N. Y.

SELL: Scott 99A preamp-amplifier, metal cabinet,

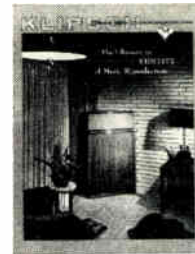

For the
Ultimate
in
HIGH
FIDELITY



WRITE for this new 1957 free booklet. It explains how loudspeaker systems designed by Paul W. Klipsch utilize the corner walls of your room to give you full range reproduction of music — with fidelity.

KLIPSCH AND ASSOCIATES
POST OFFICE DRAWER 96
HOPE, ARKANSAS

CREATORS OF
THE
AUTHENTIC

Klipschorn
CORNER HORN
LOUDSPEAKER SYSTEM

\$60. Components Jr. 33½ rpm. turntable, Fairchild 280A arm, mounted on walnut base wired, ready to play, \$65. All in excellent condition. Kushen, 63-61 99th St., Forest Hills, N. Y. TW 6-3192.

SELL: Concertone playback preamp, like new, \$100. Also, record head, good condition, \$25 F. S. Hummel, 1622 E. Sepulveda, Wilmington, Calif.

SELL: Genuine Klipschorn, laboratory model, style B, original cost \$539. Sell \$475. Marantz audio console \$125.00. J. M. Edelman, M.D., 700 Commerce Bldg., Baton Rouge, La.

SELL or SWAP: V. T. pickup and arm, 16-in. record size, moving coil vertical pickup, new diamond stylus. Swap for University N-3 crossover, cobraflex-2 with driver, or \$75. John Cooley, B 461 Georgetown Univ., Washington, D. C.

SELL: Pilot HF56 FM-AM tuner-preamp-amplifier, 35 watts, one solid unit. Original cost \$220. One year old, excellent condition, sell for \$125. Jerome Metzger, 3542 — 73rd Street, Jackson Heights, N. Y. Illinois 8-1913.

SELL: Altec Lansing 600B speaker, unused, \$30; Altec Lansing 600B speaker, used but A1, \$23; University 4401 tweeter, used slightly, \$7. All in factory cartons, fob. J. W. Townsend, 606 Sunset Court, Davis, Calif.

SELL: Bogen AM-FM tuner \$50. Bell 20-watt amplifier \$50. Jim Lansing 15-in. speaker \$50. Altec Lansing 11-in. tweeter, horn, and crossover, \$80. 21-in. Philco TV with remote control. W. Kalish, 18016 Baseline, Fontana, Calif.

SELL: Grommes 10-watt amplifier model LJ-3, good condition, \$25. Also, some 78-rpm. classical records. Chris Moore, Litchfield, Conn.

SELL: Brociner Mark 30C preamp; Dynakit 50-watt amplifier \$110.00. Harman-Kardon Theme AM-FM tuner \$75.00; G. E. RPX-061A used 1 month \$10.00; Wharfedale Super 12/CSAL \$50.00; Electro-Voice Aristocrat enclosure \$50.00; Stephens 800 CPS crossover \$20.00; Scott 99-A \$40.00. All excellent condition. John D. Young, 462 Prospect Pl., Brooklyn 38, N. Y. MA 2-1017.

SELL: Pentron HF400. Excellent condition. New August 1956. \$145. postpaid. Quality AM-FM tuner kit. Fully assembled and aligned, no cover, \$25 postpaid. Leslie Richter, 32 Gales Drive, New Providence, N. J.



Bogen

because it sounds better...

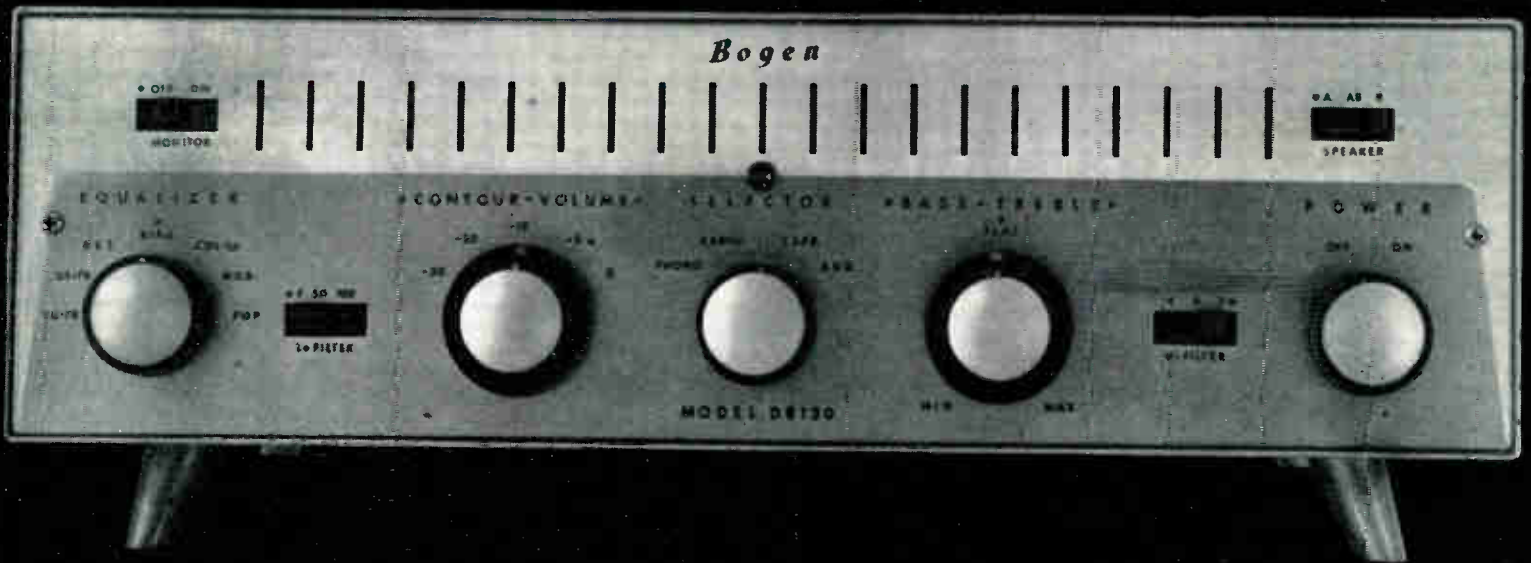

BOGEN DB130 35 WATT AMPLIFIER

There are good reasons why the Bogen DB130 is preferred by most experts. First, it is the only high-fidelity amplifier and pre-amplifier combination rated by all three independent consumer organizations as "best" regardless of price! Second, it is one of the few high-fidelity amplifiers with sufficient undistorted power output to drive the latest type extended-range speakers.

But, judge for yourself...read the adjoining specifications, then put a Bogen DB130 through its paces at your local high fidelity shop.

David Bogen Co., Inc., Paramus, N. J.



SPECIFICATIONS

POWER: 35 WATTS. PEAK: 100 WATTS • FREQUENCY RESPONSE: 15-30000 CPS WITHIN 0.5 DB • DISTORTION: 0.3% AT 35 WATTS • INPUTS: LOW MAGNETIC, HIGH MAGNETIC, HI-FI CRYSTAL, TUNER, TAPE, AUXILIARY (2) • OUTPUTS: SPEAKER(S), TAPE • CONTROLS: POWER (ON/OFF), CONTINUOUSLY VARIABLE BASS AND TREBLE, SEPARATE CONTINUOUSLY VARIABLE LOUDNESS CONTOUR SELECTOR, INPUT SELECTOR (PHONO, RADIO, TAPE, AUX.) 7-POSITION RECORD EQUALIZER, INFINITE DAMPING CONTROL, LO FILTER (FLAT, 50C, 100C), HI FILTER (FLAT, 8KC, 4KC), SPEAKER SELECTOR SWITCH (A, AB, B), TAPE MONITOR (ON/OFF), AUX ADJUSTER, HUM ADJUSTER • CHASSIS: \$115.00 • BLONDE OR MAHOGANY-FINISHED ENCLOSURE: \$7.50

look to the "RP" Factor... *

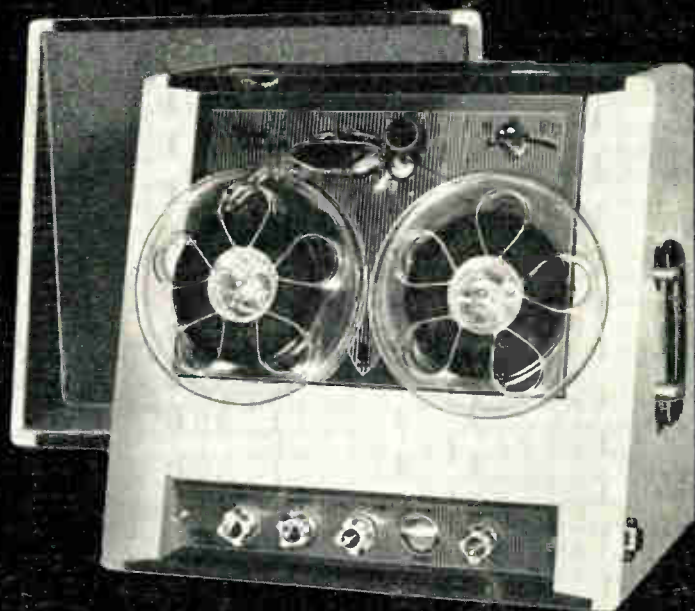

Available now — attractive new metal consolets for shelf or table mounting of Viking decks and pre-amplifiers. Write for Viking's new 12 page catalog.

The degree to which a tape recorder records and plays back with absolute naturalness and fidelity can be termed the "RP" factor. Contributing to the Viking "RP" factor are exclusive features normally associated only with fully professional recorders:

- Short gap record and playback heads (.00015 inch gap) — the shortest achieved in the industry.
- 68 kc bias, permitting clean recording of frequencies to 12,000 cycles. (A five to one ratio is essential.)
- NARTB equalization, compatible with professional recording practice.
- A linear tape transport, flutter and wow below audibility.

This combination of Viking features, still exclusive as we enter the 1957-58 season, are responsible for Viking's outstanding "RP" performance.

Ask your dealer for a demonstration, recording from LP records, or an FM radio source. Hear for yourself a demonstration of Viking *record-playback* realism — the Viking "RP" factor.

Your dealer will help you with integration of Viking components with your present system . . . or write directly to Viking's Customer Service Department.



Viking OF MINNEAPOLIS

9600 Aldrich Avenue South, Minneapolis 20, Minnesota

EXPORT DIVISION: 23 Warren Street, New York City, 7, New York
Cable: SIMONTRICE, NEW YORK (All Codes)