

Music AT HOME

JAN.-FEB. 1955

Published by MILTON B. SLEEPER

PRICE 50¢



NATURAL TAPE RECORDING

Regency

RIVER EDGE CABINETS designed expressly for REGENCY HIGH FIDELITY COMPONENTS

Day by day more and more people are making High Fidelity a part of their everyday life. These handsome River Edge cabinets have been designed to make it effortless to assimilate High Fidelity equipment into any home decor.



Model TM Table model cabinet for HF-80 or HF-150 amplifiers or any Regency tuner.

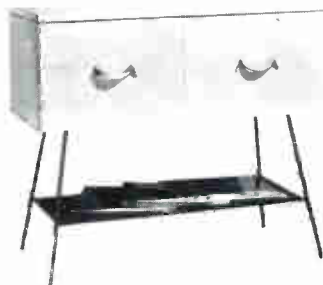

Model CTC Console cabinet for combination of changer, AF-220 tuner and HF-80 or HF-150 amplifiers.



Model TMC Table model or a chairside console for changer and HF-80 or HF-150 amplifiers or AF-220 tuner.

River Edge cabinets are priced from \$17.50 to \$85.55. Pre-cut, pre-drilled panels are available to specifications at nominal charge.

**Regency Division, I.D.E.A., Inc.
7900 Pendleton Pike
Indianapolis 26, Indiana**

World Radio History

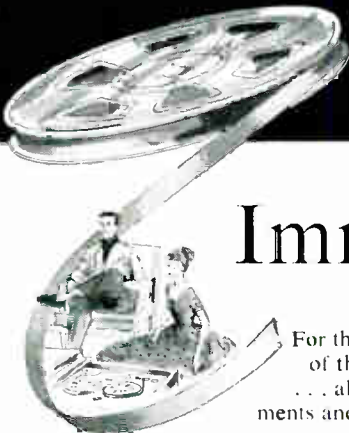
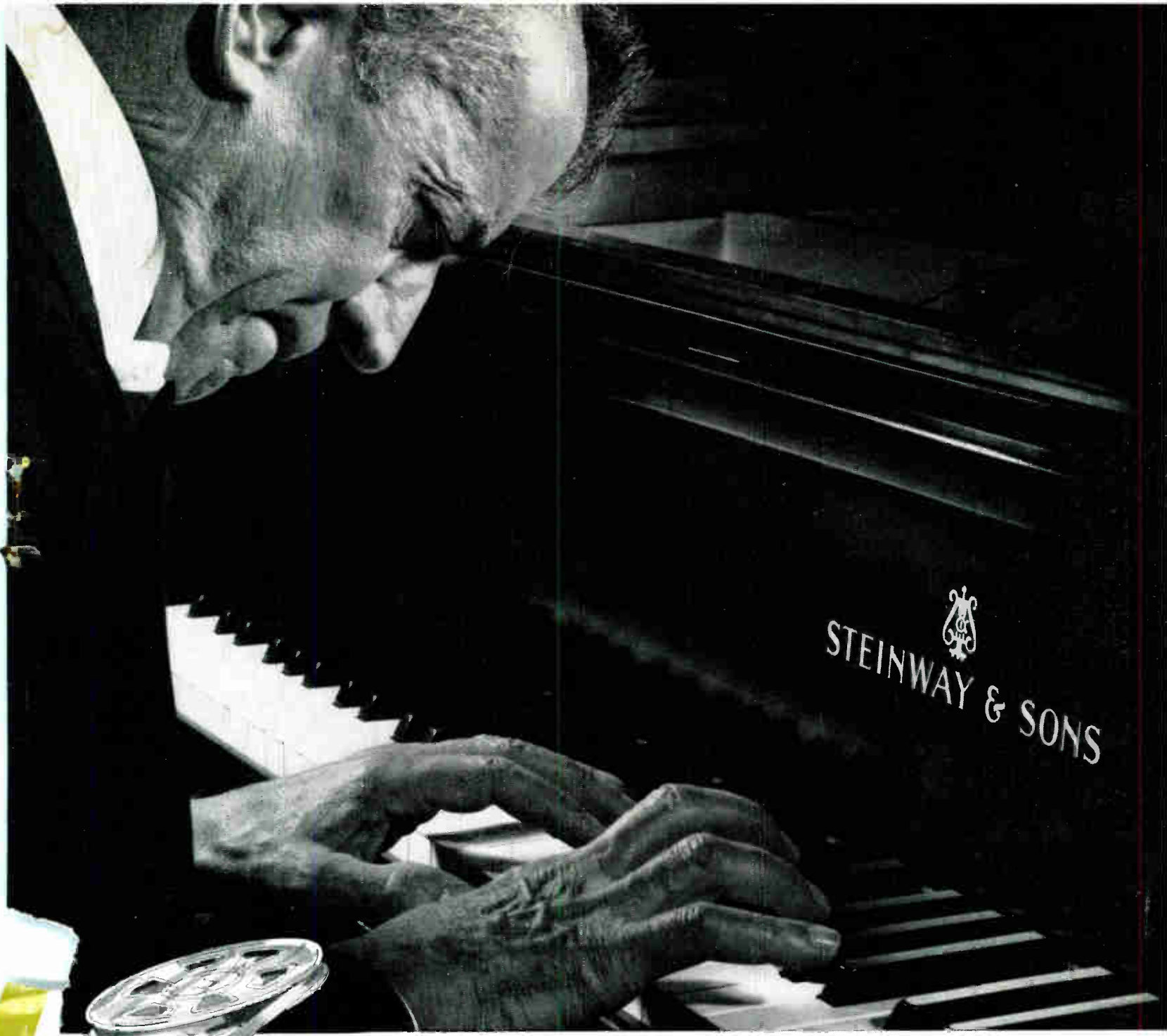

Immortalizing the instrument...

For the "Instrument of the Immortals" . . . all great instruments and voices, there are now magnetic recording tapes of matching quality. They are Soundcraft Tapes, created by engineers with the maximum of recording experience.

We believe them to be the world's finest tapes, because Soundcraft Tapes *alone* combine:

- Constant depth oxide for uniform middle- and low-frequency response.
- Micro-Polished® coating, a patented Soundcraft process that eliminates unnecessary head wear and gives uniform high-frequency response right from the start.

- Pre-Coated adhesive applied directly to base—anchors oxide, no flaking, cracking.
- Surface-lubrication on *both* sides! No friction, no chatter, no squeal.
- Chemical balance throughout to prevent cupping, curling, peeling, chipping.
- Uniform output of $\pm \frac{1}{4}$ db. within a reel, $\pm \frac{1}{2}$ db. reel-to-reel.

SOUNDCRAFT TAPES FOR EVERY PURPOSE

Soundcraft Red Diamond Tape for all high-fidelity recording.

Soundcraft Professional Tape for radio, TV and recording studios. Splice-free up to 2400 feet. Standard or professional hubs.

Soundcraft LIFETIME® Tape for priceless recordings. For rigorous use. For perfect program timing. DuPont "Mylar" Polyester Plastic base. A third as strong as steel. Store it anywhere. Guaranteed for a lifetime!

Get the Soundcraft Recording Tape you need today. Your dealer has it.

REEVES

SOUNDCRAFT

CORP.

Dept. Z-1

10 East 52nd St., N. Y. 22, N. Y.



FOR EVERY SOUND REASON

THE WORLD'S FINEST TAPES . . . YET THEY COST NO MORE

World Radio History



NOW . . . the first and only complete R-J unit . . .
 the definitive combination among compact,
 high performance speakers . . . ready for use . . .
 a brilliant pairing of two great names.

\$54⁵⁰ net

Model S8MC . . . Mahogany COMPLETE (Speaker, Enclosure, and Grille)
 Model S8BC . . . Blonde \$57.50 net

The R-J Wharfedale

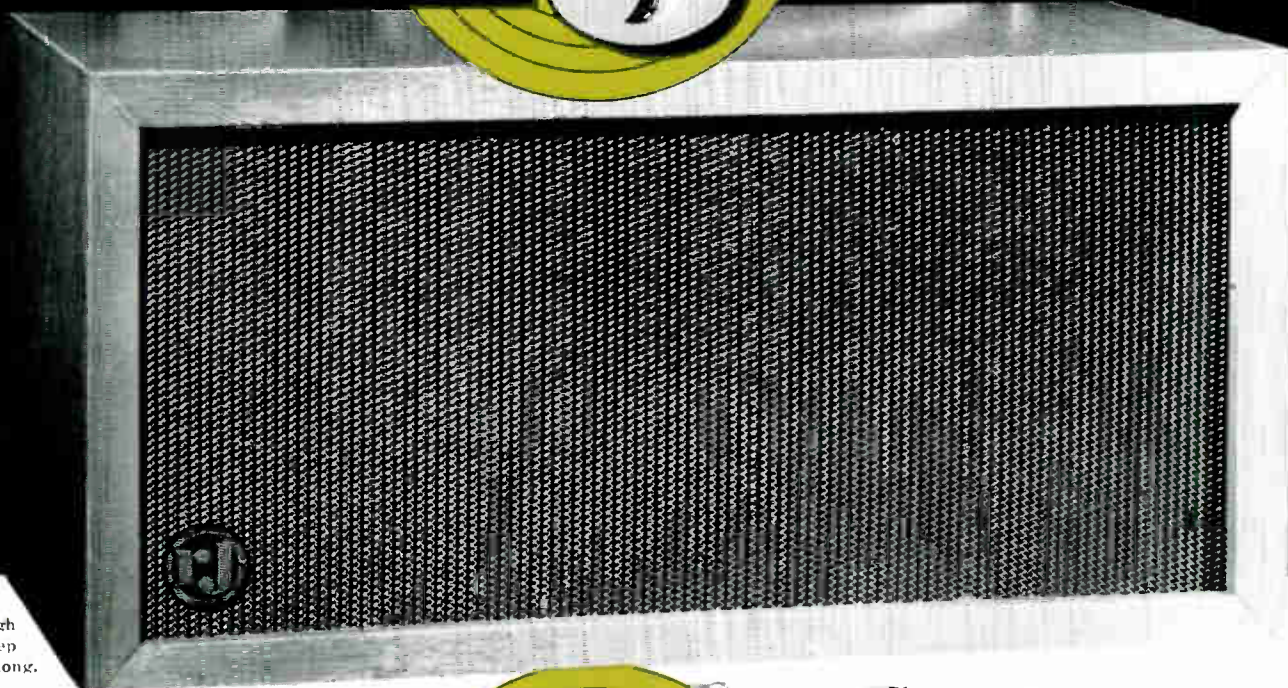

11" high
 10" deep
 23 1/2" long.

The enclosure is the original, authentic R-J Single Shelf model . . . the revolutionary idea which literally "established" today's trend to small speaker enclosures. Expertly built of heavy, top quality genuine Mahogany or Korina veneers, in hand rubbed dark or blonde finish.

Other R-J Enclosures
 "Maximum Bass . . . Minimum Space!"

(Use with any loudspeaker)

With any well-designed speaker, each R-J unit offers thrilling performance . . . smooth bass fundamentals, without peaks, down to low organ pedal notes . . . unobstructed "highs".



Floor models (for 12" or 15" speakers) 20" high x 20" long x 16" deep, plus legs. Mah., Blonde or unpntd.



Single Bookshelf Model (for 8" speakers) 11" high x 10" deep x 23 1/2" long. Sanded, unpainted.



Double Bookshelf Model (for 12" speakers) 24" high x 21" long x 10" deep. Sanded, unpainted.

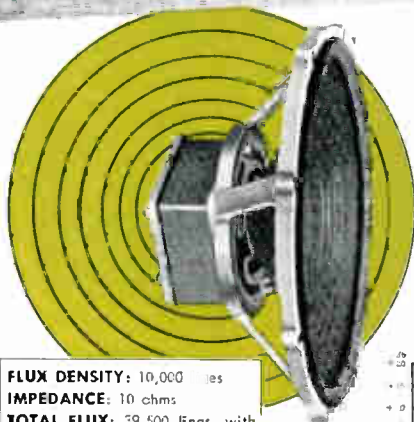

FLUX DENSITY: 10,000 oes
IMPEDANCE: 10 ohms
TOTAL FLUX: 39,500 lines, with ample power handling capacity
FREQUENCY RESPON.
 50 16,000 cycles

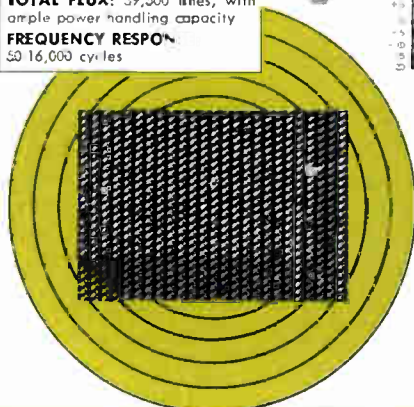

The speaker - a Wharfedale, designed and constructed under personal supervision of G. A. Briggs, specifically to match this R-J Enclosure! This 8" speaker incorporates all the advanced Wharfedale elements . . . aluminum voice coil; cast chassis; a felt "buffer" between the speaker cone and frame. Demand for Wharfedales has always exceeded supply - making them highly valued as components. Now pre-package, this great speaker lends its brilliance to the first and only R-J combination.

Full efficiency at normal room listening levels!

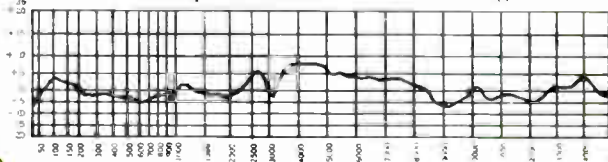

The grille is formed of British "Expamet" . . . expanded golden aluminum . . . a product relatively new to the popular American market, but used throughout the world in the most expensive loudspeaker combinations. There are good reasons for this. Expamet is more than a speaker covering . . . adds its own fine performance to that of the R-J Enclosure. This permanently beautiful metal is acoustically "perfect", will never cause distortion, and transmits the entire sound of the speaker, uninhibited.

R-J AUDIO PRODUCTS, INC. Dept MH-1
 164 Duane Street, New York 13, N. Y.
 Please send "Sound Craftsmanship" to:

Name _____
 Street _____
 City _____ Zone _____ State _____

NOTICE: R-J construction principles are patented. Other enclosures of similar size and shape do not incorporate the authentic R-J performance features.

Mail coupon today for a complimentary copy of "Sound Craftsmanship". 16 pages illustrating and describing R-J Enclosures and the other products of the British Industries Group.

World Radio History

R-J AUDIO PRODUCTS, INC.

164 Duane Street, New York 13, N. Y.

Music AT HOME

THE GUIDE TO HI-FI REPRODUCTION FROM RECORDS, TAPE AND FM RADIO

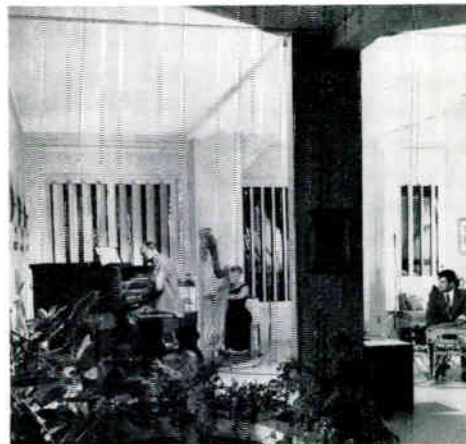

Photo by William Leftwich

Publisher:

Milton B. Sleeper

Art Director

Walter Buehr

Photography

William Leftwich

Fred Lyon

Winthrop Morton

Editorial Assistant

Ethel V. Sleeper

Advertising Manager

Frederick A. Klingenschmitt

Circulation

Myrna Sossner

Contributors to this issue

Oliver Daniel

Ben Deutschman

E. J. Quinby

Fred Reynolds

Harold H. Smith

Jan Syrjala

Dr. Hans Wolf

Sleeper Publications, Inc.

207 East 37th Street, New York 16, N. Y.

Milton B. Sleeper, President

MUSIC AT HOME is published bimonthly by Sleeper Publications, Inc., Hi-Fi House, 207 East 37th Street, New York 16, N. Y. Telephone: Oxford 7-0542. Editorial, advertising, and circulation departments are located at the address above. MUSIC AT HOME is not connected or associated with any other magazine.

Subscription rates are \$3.00 per year (6 issues) or \$6.00 for 3 years (18 issues). Single copies, 50c. Outside the USA, Canada, and the Pan American Postal Union, rates are \$4.00 per year, or \$9.00 for 3 years. Copies are mailed on the 10th of January, March, May, July, September, and November. Allow time for delivery by second class mail.

Editorial contributions and interesting photographs are welcome, and will be paid for upon publication. No responsibility can be accepted for unsolicited manuscripts, and they will not be returned unless they are accompanied by return postage.

Entered as second class matter at New York City, and additional entry at Concord, N. H., under the Act of March 3, 1879. Printed in the U. S. A. by Rumford Press, Concord, N. H.

The cover design and contents of MUSIC AT HOME are fully protected by copyrights, and must not be reproduced in any manner or form. Quotations are not permitted without specific authorization in writing from the Publisher.

Copyright 1955 by Sleeper Publications, Inc.

Vol. 1, No. 6 • CONTENTS • January-February, 1955

SPECIAL FEATURE

Binaural Tape Recording—E. J. Quinby 19

MUSIC

Music in Education—Ben Deutschman 22

Richard the Melody-Hearted—Fred Reynolds 24

Music Tape Reviews 27

Harry Partch—Oliver Daniel 30

Albums of Popular Music 34

EQUIPMENT

Better Bass Reproduction—Milton B. Sleeper 42

Inside Information 44

INSTALLATION

New Designs, New Ideas 28

Installation for Discs and FM—Harold H. Smith 35

Drawing Board Project No. 3—Jan Syrjala 38

OPERATION

Binaural Tape Recording—E. J. Quinby 19

DEPARTMENTS

Records, Tape, and FM Radio 4

Music for Your Home—Editorial 17

Directory of Hi-Fi Record and Equipment Dealers 48

Ideas for You 52

Advertisers Index 63

Buy, Sell, and Swap 64

COVER PHOTO: This picture might well be titled "Music at Home." It was taken in the music room at the home of Mr. and Mrs. E. J. Quinby, of Summit, N. J. They had been using a monaural tape machine for practice at the organ and harp, but on the occasion when this photograph was made, they were having their first experience with binaural recording. Mr. Quinby's comment on the playbacks: "This approaches realism." Mrs. Quinby beamed and said: "It's really wonderful!" Alex Francois, who operated the machine added, "We are going to have a lot of fun with this."



PENTRON TAPE RECORDER

with exclusive MONOMATIC® control

This sensational new Pentron gives you the recording-playback quality and all the features of recorders selling for up to twice this price . . . plus fool-proof Monomatic Control, featured in no other recorder at any price!

With Monomatic Control, a flick of the finger instantly gives you selection of Record or Play, in either 7½" or 3¾" tape speeds, or Fast Forward and Fast Rewind.

Simplest control ever devised for recording. MONOMATIC Control is your error-proof assurance of getting what you want, when you want it, every time.

- 2 tape speeds—7½" and 3¾"
- 2-hour recording and playback
- Straight line slot loading
- True fidelity performance
- Horizontal or vertical operation
- Instantaneous braking—no tape spilling

See it—hear it—to believe it! Ask your Pentron dealer to demonstrate Monomatic Control.

Send for complete details today!



Canada: Atlas Radio, Ltd., Toronto

PENTRON CORPORATION
 Dept. MH-1, 777 S. Tripp Ave., Chicago 24, Illinois

Please send detailed literature on Pentron with Monomatic.
 Please send name of my nearest Pentron source.

Name _____
 Address _____
 City _____ Zone _____ State _____

Records,
Tape, and FM Radio

Binaural for Conductors

Because the conductor stands so close to his musicians, he does not hear what is heard by the audience. The suggestion has been made, and it may be tried soon, of providing the conductor with binaural headphones connected with microphones placed where they would be put for recording purposes — at least during rehearsals. The playback of binaural tapes would also help the conductor to check the performance of the orchestra.

Our Music Editor

Fifteen years ago, a young chap who had come to the advertising department of the *Chicago Times* via Peddie Prep and Wesleyan University told his boss: "Congratulate me! I've got a new job. I'm going with WGN."

So, Fred Reynolds made his start in radio broadcasting, and in making friends



among the music lovers within the vast area which clear-channel WGN covers with 50,000 watts. On the way up to his present post, which carries the title of Assistant Director of Continuity, he married Donna Jean Ed, daughter of Carl Ed, the cartoonist who draws Harold Teen. Thus it came about that, when Harold Teen became a disk jockey in the comic strip, and WGN started airing a show called "Swinging at the Sugar Bowl", Fred Reynolds was chosen to play the part of Harold Teen at the microphone.

From that start, Fred graduated to the production of "Collector's Corner", featuring old and memorable records. This program was so successful that WGN listeners demanded more. He was then scheduled for

Continued on page 6

HIGH-FIDELITY MUSIC-APPRECIATION RECORDS

TO HELP YOU UNDERSTAND MUSIC BETTER AND ENJOY IT MORE



ON ONE SIDE there is a full performance of a great musical work, featuring orchestras and soloists of recognized distinction in this country and abroad. You listen to this performance first, or afterward, as you desire, and then . . .



ON THE OTHER SIDE is an illuminating analysis of the music, with the themes and other main features of the work played separately with running explanatory comment, so that you can learn *what to listen for*.

A NEW IDEA OF THE BOOK-OF-THE-MONTH CLUB

ALL TOO FREQUENTLY, most of us are aware, we do not listen to good music with due understanding and appreciation. There is no doubt about the reason: we are not properly primed about *what to listen for*. MUSIC-APPRECIATION RECORDS meet this need—for a fuller understanding of music—better than any means ever devised. After hearing several of these records, all the music you listen to is transformed, because you learn in general what to listen for. This highly enjoyable form of self-education can be as thorough as the Music-Appreciation courses given in many universities.

YOU SUBSCRIBE BUT TAKE ONLY THE RECORDS YOU WANT . . . A new MUSIC-APPRECIATION RECORD will be issued—for subscribers only—every month. Ultimately

all the great masterpieces of music will be included. The announcement about each forthcoming record will be written by Deems Taylor. After reading this descriptive essay (presented in a form that can be kept for long use) you may take the record or not, as you decide at the time. *You are not obligated as a subscriber to take any specified number of records.* And, of course, you may stop the subscription at your pleasure—at any time!

TWO TYPES OF RECORDS AT A RELATIVELY LOW COST . . . All MUSIC-APPRECIATION RECORDS will be high-fidelity, long-playing records of the highest quality—33 $\frac{1}{3}$ R.P.M. on Vinylite. They will be of two kinds: first, a so-called Standard Record—a *twelve-inch* disc—which will present the performance on one side, the analysis

on the other. This will be sold at \$3.60, to subscribers only. The other will be an Analysis-Only Record—a *ten-inch* disc—priced at \$2.40. The latter will be made available each month for any subscriber who may already have a satisfactory long-playing record of the work being presented. (A small charge will be added to the prices above to cover postage and handling.)

TRY A ONE-MONTH SUBSCRIPTION—NO OBLIGATION TO CONTINUE . . . Why not make a simple trial, to see if these records are as pleasurable and as enlightening as you may anticipate? The first record, BEETHOVEN'S FIFTH SYMPHONY, will be sent to you at once—at *no charge*. You may end the subscription immediately after hearing this record, or you may cancel any time thereafter.

As a demonstration
**WILL YOU ACCEPT
WITHOUT CHARGE**



Beethoven's Fifth Symphony

A NEW HIGH-FIDELITY RECORDING BY THE LONDON SYMPHONY ORCHESTRA

Norman Del Mar, Conductor

Analysis by Thomas Scherman

YOU HAVE HEARD this great work countless times—what have you heard in it? And what may you have failed to hear? This demonstration will show you what you may have been missing in listening to great music.

PLEASE RETURN ONLY IF YOU HAVE A RECORD PLAYER WHICH CAN PLAY 33 $\frac{1}{3}$ R.P.M. LONG-PLAYING RECORDS

MUSIC-APPRECIATION RECORDS

R19-1

c/o Book-of-the-Month Club, Inc.
345 Hudson Street, New York 14, N. Y.

Please send me at once the first MUSIC-APPRECIATION RECORD, Beethoven's Fifth Symphony, without charge, and enter my name in a Trial Subscription to MUSIC-APPRECIATION RECORDS, under the conditions stated above. It is understood that, as a subscriber, I am not obligated to buy any specified number of records, but may take only those I want. Also, I may cancel this subscription after hearing the first record, or any time thereafter at my pleasure, but the introductory record is free in any case.

Mr. }
Mrs. }
Miss } (Please Print)
Address

City..... Zone..... State.....

MAR 1

January-February 1955

Continued from page 4

A remarkable NEW development!

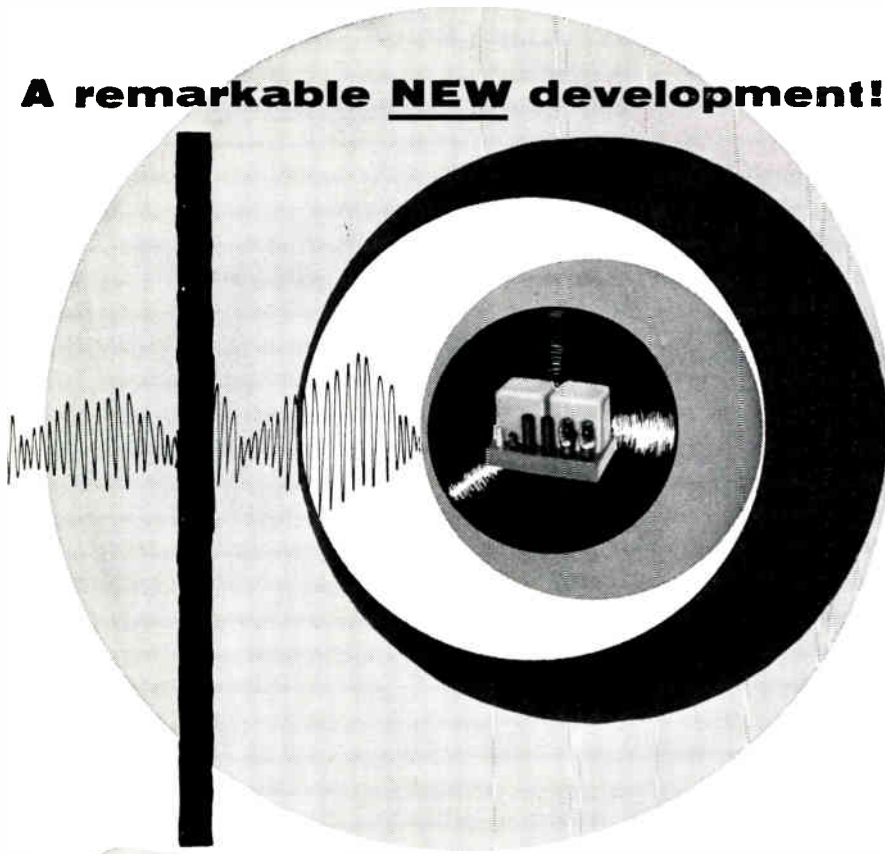

**THE FAIRCHILD
50 watt
audio
AMPLIFIER**

An extraordinary guarantee!

Now Fairchild introduces a professional-type amplifier so infinitely stable that it is *guaranteed not to ring at any level* — even where two-way or three-way speaker systems are used.

Full undistorted power is available for crashing crescendos and other passages which often overload ordinary amplifiers. Yet the Fairchild 260 is a single, compact unit, easy to install almost anywhere.

See the superb Fairchild 260.
You'll agree—
there's nothing finer.

\$149.50

Amazingly low intermodulation distortion —less than 0.3% at 45 watts and less than 1.5% at 50 watts—coupled with harmonic distortion under 0.1% at 45 watts and under 0.5% at 50 watts—helps provide truly breathtaking performance.

Best of all, original performance can always be maintained! New Fairchild Balance Control *balances out* distortion . . . and it's easy to use at any time.

When you visit your audio dealer, see, too, the NEW Fairchild 220 Cartridge. Listen to the *only* cartridge that gives completely uniform response to 17,000 cycles—with smooth roll-off beyond.



\$37.50

FAIRCHILD RECORDING EQUIPMENT
156th STREET AND 7th AVE., WHITESTONE, N. Y.

five nights a week on a show called "Reynolds on Records", and later "The Big Spin", a four-hour Saturday afternoon program of popular and jazz records. Meanwhile his reputation as an authority on records grew to such an extent that the *Chicago Tribune* asked him to do a weekly column of reviews and news about records, and *Look Magazine*, in an article on the resurgence of interest in Dixieland Jazz, rated him as one of the four broadcasters responsible for it.

As you might expect, Fred Reynolds started collecting records long before he began to talk about them on the air. A census taken some time ago showed that his shelves were then populated by more than 25,000 discs. His acquaintance with composers, artists, and musicians is equally comprehensive, and the list of those he has interviewed or introduced on various radio shows in the last decade seems endless.

The foregoing is by way of introducing you to the new Music Editor of *MUSIC AT HOME*, for Fred Reynolds will take over in that capacity on February 1st.

His coming with us seems to have been the inevitable consequence of common interests. Fred studied music before he started to collect records, and as he learned more about both, he wanted original music and its reproduction to sound the same. Thus, he became a hi-fi enthusiast in the truest sense, for he is both music listener and an audio perfectionist.

We first learned of him through Chicago adman Burton Browne, who recommended him as "a writer of great ability who knows more about records than practically anyone." That accounts for our selecting him to do the Jazz Programs right from the first issue of *MUSIC AT HOME*. Until we met him in person, for a preliminary discussion of his "Story of Jazz in Chicago", we assumed that his interests were confined to this one type of music. We were surprised, therefore, to find that he is equally informed on all types of music except Gregorian chants, to which he has a pet aversion!

But what impressed us even more about Fred Reynolds was that he talks and writes in such a way that his comments sparkle. He makes artists come to life as flesh-and-blood people, he can comb back the mane of long-hair music to disclose what is interesting, vital, and worth hearing, and he knows all the news behind the people who make news in the concert halls and studios. And he puts the same broad, friendly grin into what he writes that is in his voice at the microphone, making his radio listeners feel that Fred must be a pretty wonderful character, which he really is!

As this account is being written, Mr. and Mrs. Reynolds and their children Joan, Ward, and Jean are preparing to move from

Continued on page 13

introducing **PILOTROL**
Professional Preamp-Equalizer by **Pilot**

a triumph in audio control
for the home



the *Ultimate* in
control interpreted by the exclusive

decibel meter



Exclusive FEATURES OF PILOTROL PA-913 . . . \$119.50*

- *Exclusive*—calibrated meter for precision indication of either the recording output level or monitor output level by panel control.
- *Exclusive*—master level setting control and loudness control.
- *Exclusive*—push button input selection with illuminated indicators.
- *Exclusive*—push button control provides five positions of treble roll-off and five positions of bass turn-over for precise playback equalization.
- *Exclusive*—direct current supply to preamplifier tube heaters.
- *Exclusive*—dual cathode follower outputs—one for recording—one for monitoring.
- *Exclusive*—variable phono preamplifier input loading for precise matching of all magnetic and variable reluctance cartridges.
- *Exclusive*—control for mixing microphone with any other channel.
- *Exclusive*—dual monitor output jacks for multiple monitoring.
- *Exclusive*—professional sloping control panel for ease of operation.
- *Exclusive*—chassis construction provides for either vertical panel mounting in custom cabinet, or as supplied in attractive mahogany sloping panel cabinet.
- *Exclusive*—self powered from 117 volts, 60 cycle, AC source.

MATCHED COMPANIONS TO PILOTROL



**AA-410 PILOTONE
AMPLIFIER \$49.50**



**AA-904 PILOTONE
AMPLIFIER \$89.50**

Write for Free brochure M-1

*Slightly Higher West of Rockies

PILOT RADIO CORPORATION LONG ISLAND CITY 1, NEW YORK

January-February 1955



don't play with

T-N-T*

You're not really getting Hi-Fi reproduction when your turntable furnishes a sound track of its own. And, most distracting noises do come from turntables—the heart of your hi-fi system.

For clear, true, brilliantly accurate performance—free from throbs, flutters and wows—you need the new PRESTO T-15 Turntable. Here is a truly *professional* mechanism—12" heavy aluminum table, 3 speeds, precision "deep-well" bearing, single control lever. Dynamically balanced and precision engineered like the most expensive PRESTO units. And PRESTO is standard equipment in broadcasting studios all over the world!

All you have to do is *listen*—to be convinced that the PRESTO T-15 is the answer to your turntable problems. It's only \$53.50—your best buy in hi-fi.



The New

PRESTO T-15 TURNTABLE
One Control Lever Does Everything!

1. Engages and disengages idler wheel
2. Automatically switches motor off and on
3. Selects 3 speeds—33 $\frac{1}{3}$, 45, 78 rpm

Mail this coupon today!

PRESTO RECORDING CORPORATION, SALES DIV. MH
PARAMUS, NEW JERSEY

Please send me illustrative data and specifications on the new, improved PRESTO T-15 turntable.

NAME _____
 ADDRESS _____
 CITY _____
 ZONE _____ STATE _____

***Throbbing, Noisy Turntables**



Export Division: 25 Warren Street, New York 7, N. Y.
 Canadian Division: Instantaneous Recording Service, 42 Lombard St., Toronto

WORLD'S LARGEST MANUFACTURER OF PRECISION RECORDING EQUIPMENT AND DISCS

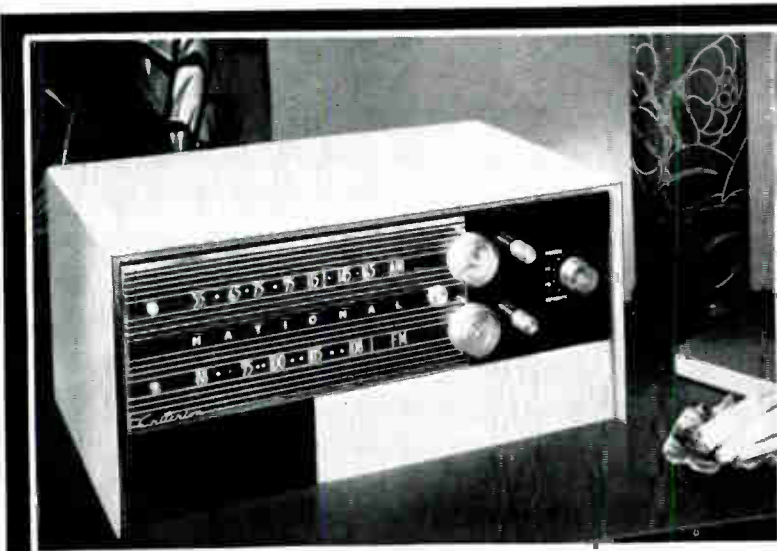

INSIST ON National ... DON'T COMPROMISE!

National "Criterion" AM-FM Tuner . . . \$169.95

Make sure you get your money's worth! Before you invest another dollar in high fidelity equipment, ask yourself if you're sure you are going to be satisfied with it for years to come. When you invest in the New National Horizon line you are getting the most advanced engineering, the finest construction and the greatest versatility that audio science affords . . . truly "tuned to tomorrow". Feature for feature National high fidelity equipment is your best buy today!

Binaural
AM
FM
FM Mutamatic



FM "Mutamatic" TUNING
Exclusive circuit eliminates hiss and noise when tuning between stations found in other FM tuners. Fine tuning is unnecessary. Whenever there is sound — station is tuned perfectly.

COMPARE THESE OUTSTANDING "CRITERION" SPECIFICATIONS

FM SECTION

Sensitivity: .5 uv for 20 db quieting. Capture ratio: rejects interfering signal up to 80% as strong as desired signal. No distortion from reflective ghosts.

Image rejection: better than 60 db I.F. pass band is flat within ± 1 db over band of 200 kc. Audio distortion: less than 0.5% from all levels of modulation.

Output: Cathode follower output. Hum & Noise level 60 db below audio signal. Full A.G.C. maintains I.F. band pass regardless of input signal level. Instantaneous limiters provide lowest impulse noise of any tuner.

Selectivity provides complete adjacent channel rejection.

AM SECTION

Sensitivity: 10 uv at antenna terminals for signal-to-noise ratio of 10 db.
Image ratio: better than 60 db.

I.F. Pass band flat within ± 1 db over a 14.5 kc range.

BINAURAL OPERATION

Individual tuning condensers, volume controls and output jacks for simultaneous operation. FM free of AM signal up to 100 times the FM signal input. AM free of FM signal up to 100 times AM signal input.

NATIONAL HORIZON 5 PLUG-IN PREAMPLIFIER CONTROL

Plugs into either Horizon 20 amplifier or "Criterion" tuner. 10 position selector switch for 3 high level inputs and phono input with 7 equalization positions. Bass boost: +25 db and bass cut -15 db at 30 cps. Treble boost +12 db and cut -25 db at 10 kc. Frequency response 20 cps - 20 kc, ± 25 db. Loudness control switch. Distortion: Harmonic — less than .2% at 1.5 Volts out; Intermodulation — less than .3% at 1.5 Volts out. Hum & Noise: 70 db below 1.5 volts on high level inputs.

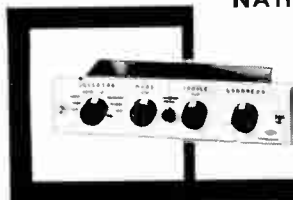

"HORIZON 20" . . . 20 Watt amplifier \$84.95

(At 20 watts rated output)

Harmonic distortion: less than .3% (.6% at 25 watts). **Intermodulation distortion:** less than 1%. **Sensitivity:** 1.6 volts. **Hum & Noise:** 80 db below 20 watts. **Frequency response:** 20 cps-20 kc, ± 1 db; 10 cps-100 kc, ± 1 db. **Power response:** 20 cps-20 kc, ± 15 db; 10 cps-60 kc, ± 1 db.

UNITY-COUPLING

Exclusive circuit eliminates impulse distortion characteristic in conventional amplifiers. Transformer supplies only matching impedance to speaker.

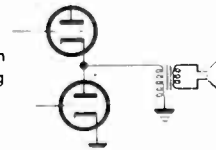

"HORIZON 10" . . . 10 watt amplifier with preamp control unit. \$79.95

Harmonic distortion: .5%; **Intermodulation:** 1%. **Frequency response:** 20 cps-20 kc, ± 1 db. **Power response:** 20 cps-20 kc, ± 2 db. **Hum & Noise:** 70 db below full output on high level inputs (low level inputs — 50 db below.) Preamp Control has 2 high level inputs for tape and tuner. Record compensation positions for R.I.A.A., A.E.S. and Foreign. Treble boost: 11 db and 10 db treble cut at 10 kc. Bass boost: 15 db at 30 cps. Built-in loudness compensation.

tuned to tomorrow

National

For complete specifications see your dealer or write to Dept. M-155, National Company, Inc., Malden, Mass.

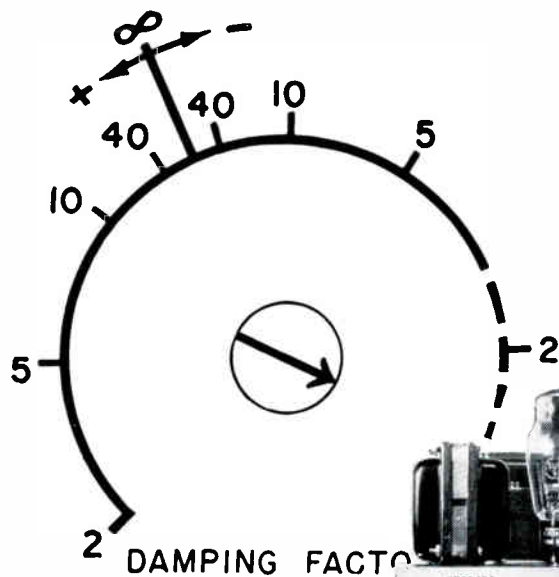

PATENT PENDING



Did you know you can reduce speaker distortion* by 76% with an amplifier?

Meet Bogen's new amplifiers with 'ultimate damping'

Now you can enjoy more hours of perfect listening without fatigue. The famous Bogen DB20 and DO30 amplifiers are now available with the exclusive BOGEN VARIABLE DAMPING FACTOR CONTROL (VDFC) which permits you to minimize speaker distortion and eliminate system resonances.

The Bogen control is the first to offer a range from +2 through infinity to -1 . . . which is that magical point, we call it "Ultimate Damping", at which the speaker resistance is negated and distortion reduced to an imperceptible value.

Yes, now you can get *true bass with any speaker!*

It is easy to set your Bogen VDFC for Ultimate Damping . . . no instruments are needed. As you can see from the enlarged control shown above, you merely turn the slotted shaft with a screwdriver to the desired setting when you install your system. No later adjustment is required.

**Acoustical measurements by an independent laboratory using a quality hi-fi speaker system operating at 5 watts and 25 cycles showed 96% distortion with damping factor of 10 (typical amplifier), and only 20% with Bogen Ultimate Damping. (Amplifier distortion itself was well under 0.5%.)*

THE DB20DF AMPLIFIER



This is our famous Bogen DB20 amplifier, rated as having "Best Overall Quality" by a leading consumer testing organization, with the added feature of the Variable Damping Factor Control. This amplifier gives you 20 watts of power at

0.3% distortion with a 5-position Loudness Contour Selector, a 10-position input selector-phono equalizer, output jack for tape recorder and non-resonant, separate bass & treble tone controls. *With Variable Damping Factor:* \$108.00 (DB20 without VDFC: \$99.00.)

BOGEN DO30A POWER AMPLIFIER



This brilliant unit now features the exclusive Bogen variable damping factor control as standard equipment . . . which adds to its stature as the perfect companion to the all-control tuners—such as the Bogen R750 FM-AM Tuner where

tuning, volume, bass tone, treble tone and selector controls are all on the tuner panel. The DO30A amplifies all frequencies uniformly from 10 to 20,000 cycles within 0.2 db at rated output of 30 watts. Variable Damping Factor Control is the same as that on DB20DF. \$99.00

SECOND PRINTING:

"Understanding High Fidelity" is fast becoming a standard manual of hi-fi theory and application. Clearly and concisely, this new enlarged 56 page edition presents invaluable practical information to help you get more out of any sound system. "For the Audiophile first seeking his way . . . a surprising introductory work," says the Saturday Review. Send 25¢ for your copy.



Bogen
HIGH FIDELITY
BECAUSE IT SOUNDS BETTER

David Bogen Co., Inc. Dept. AA
29 Ninth Ave., New York 14, N. Y.

Send "Understanding High Fidelity" (25¢ enclosed).

Name _____

Address _____

City _____ Zone _____ State _____

Send only free catalog and where-to-buy-it guide.

**A TRULY
PROFESSIONAL
PERFORMANCE**



20/20 recorder and TWC case

introducing

the NEW **CONCERTONE**
20/20 recorder

(20 to 20,000 cycles useable frequency response)

This brilliant performer is the result of three years of research, design and testing. To give you the ultimate in dependability, simplicity and performance, Berlant Associates have produced a home model of their professional Broadcast recorder which has set new standards for radio stations and sound studios. Now, for the first time the music lover and sound enthusiast who demand the ultimate in sound reproduction can own a recorder of the highest possible quality to complete his home audio system . . . at a price he can afford to pay!

**\$445 IS THE USER'S
NET FAIR TRADED PRICE**

The NEW **CONCERTONE 20/20**
has all these outstanding features:

- *Provision for five heads (three are standard) allows optional switching arrangement for both single and dual track operation.*
- *Three motors for minimum wow and flutter. Two-speed capacitor induction motor for direct drive. Shaded pole motors for take-up and supply.*
- *Unified Control . . . one simple convenient error-proof lever system.*
- *A-B Test Fader . . . monitors between incoming signal and playback without transients or clicks.*
- *Built-in two-channel mixer . . . line signal can be mixed with mike input to put both on tape simultaneously.*
- *Color scheme specially designed for home installation.*

Berlant  *Concertone*

4917 W. Jefferson Blvd. • Los Angeles 16, Calif.

MANUFACTURERS OF BERLANT STUDIO RECORDER
AND ACCESSORIES



NOW... *Beautiful Cabinets* TO HOUSE THE FINEST
 QUALITY HI-FI COMPONENTS *only \$89⁹⁵**

THESE handsome cabinets make Hi-fi desired in every home. They're finished on all sides... beautiful from any angle. And, at this low price, your complete ensemble becomes inexpensive to own. Select one that matches your furniture and install the components yourself. You can use it as a chairside piece... as a room divider... or anywhere else in the home.

Yes, for finest hi-fi performance at realistic prices see G-E matched components. Ask for a demonstration before deciding on a custom or cabinet installation.

Local dealers in most cities are showing this cabinet. See it as soon as possible or write for the name of a nearby store.

*General Electric Co., Radio & TV Dept.,
 Sec. R9615, Electronics Park, Syracuse, N. Y.*

**In Mahogany, Cherry, Blond Oak
 — same low price!
 It matches G-E speaker enclosure!**

- • • • •
- G-E Speaker Enclosures (Blond, Mahogany, or Unfinished Veneers) ...
- A1-406 from \$50.37* to \$59.95*
- G-E Dual Coaxial Speaker
- Model A1-400 \$41.95*
- G-E Pre-amplifier-Control Unit
- Model A1-200 \$57.95*
- G-E Power Amplifier
- Model A1-300 \$47.75*
- G-E Variable Reluctance Cartridges
- from \$8.57* to \$34.74*
- G-E Baton Tone Arms:
- Model A1-500 (12") . . . \$31.95*
- Model A1-501 (16") . . . \$35.50*
- • • • •

*Subject to change without notice.
 Slightly higher West and South.

GENERAL  ELECTRIC

Records, Tape and FM

Continued from page 6

Wilmette, a suburb of Chicago, to Darien, Connecticut, which is within commuting distance of our publication office in New York City.

Meanwhile, new plans are being formulated for our editorial coverage of music. Fred Reynolds will have a free hand in making changes and introducing new ideas born of his long experience with music and with people who enjoy it. In carrying out these plans, he will be working with many of the specialists who are top ranking authorities on various types of recorded music. You will see the beginning of these projected changes in the March-April issue.

To Fred Reynolds a warm and hearty welcome from the staff of MUSIC AT HOME. We expect that he will earn the enthusiastic approval of all our readers, too. Keep an eye on him, and let him know what you think of his efforts.

Los Angeles Audio Fair

Office of the management is at 350 S. Bentley Avenue, Los Angeles 49. Information



regarding this show, to be held at Hotel Alexandria, February 11 to 13, can be obtained from manager William L. Cara. At the planning session pictured above are Harry Shaffer, Cap Kierulff, and Herb Farmer, of the show management.

Crystals for FM Tuners

If you, too, want to know who manufactured the crystals used in the Syrjala-Stevens receiver described in our November-December issue, the company is: R. E. Nebel Laboratory, 1634 E. 21st Street, Brooklyn 29, N. Y.

About Zarzuelas

In our September-October issue, Dr. Herman Neuman gave some interesting information about the seldom-heard zarzuelas in the introduction to his program of music from the Spanish theatre. Now, Columbia has announced the release of three

Continued on page 58

8 MASTERPIECES

COMPLETE TO THE LAST NOTE!

NO STRINGS ATTACHED!

Without obligating yourself to buy another record, you can enjoy all advantages of trial membership.

\$1.00



Not \$1 each, but \$1 for all 8!

SCHUBERT

Symphony No. 8
(The "Unfinished"),
Zurich Tonhalle Orch.,
Otto Ackermann, Conducting

BEETHOVEN

The Ruins of Athens
(March and Choir),
Netherlands Philharmonic
Choir and Orch.,
Walter Goehr, Conducting

BRAHMS

Academic Festival Overture,
Utrecht Symphony
Paul Hupperts, Conducting

MOZART

Piano Concerto in E Flat, K 107
Artur Balsam, piano,
Winterthur Symphony Orch.,
Otto Ackermann, Conducting

BACH

Toccatina and Fugue in D Minor,
A. Schreiner; Organ of the
Tabernacle, Salt Lake City

WAGNER

Die Meistersinger, Prelude, Act 1,
Zurich Tonhalle Orch.,
Otto Ackermann, Conducting

DUKAS

Sorcerer's Apprentice,
Utrecht Symphony,
Paul Hupperts, Conducting

MOUSSORGSKY

Night on Bald Mountain,
Netherlands Philharmonic
Walter Goehr, Conducting

Internationally Acclaimed!

"The recording is of such perfection it seems to bring the artists into your living room"
—Glorious Sounds, Amsterdam, Holland.
"The discs can be recommended without reservation to record lovers"
—The Action, Zurich, Switzerland.
"Excellent series of records"
—The Saturday Review, New York.
"The beautiful reproduction is a great merit of the Society"
—Evening Post, Frankfurt, Germany.

NOW YOU can get a real start on a complete record collection. You get ALL EIGHT masterpieces—complete to the last note—for only \$1.00. NOT \$1 each, but \$1 for ALL EIGHT!

Of course, this price bears no relation to the value of the recordings. Even for TWENTY times that amount, you could not buy these masterpieces in recordings of equal quality.

Why We Make This Amazing Offer

We were FORCED to make this "give-away" offer . . . for only by putting our recordings in your hands can we convince you how extraordinary their tonal quality is. Performed by internationally-renowned orchestras, conductors, and soloists. Custom-pressed on the purest vinyl plastic. Reproduced with a fidelity of tone which encompasses the entire range of human hearing . . . 50 to 15,000 cycles!

HOW CLUB OPERATES: As a trial member, you are not obligated to ever buy another record from us. You do, however, have the right to try—free of charge—any of the Society's monthly selections which interest you. You receive prior notice of these. You pay nothing in advance. And you are not obligated to keep those you try . . . even after you have played them and read the interesting music notes which accompany each selection. You pay only for those which—after having tried them—you decide you really want to own. And for these, you pay only the low member's price of \$1.50 per long-playing disc, embodying on the average about 40 minutes of music by the great masters. A saving of about 2/3 off the usual retail price!

Think how much beauty and serenity these recordings will add to your life—at a trifling cost. Think what a cultural advantage your children will gain by having great music as an everyday inspiration.

Mail Coupon Now

We obviously cannot keep "handing out" such magnificent long-playing recordings indefinitely. Production capacity limits the membership rolls; once filled, the offer has to be withdrawn. So avoid disappointment. Rush coupon with a dollar today. The Musical Masterpiece Society, Inc., Dept. 931, 43 West 61st Street, New York 23, N. Y.

The Musical Masterpiece Society, Inc. Dept. 931
43 West 61st Street, New York 23, N. Y.

ALL 8 MASTERPIECES—\$1.00

Here is my dollar in complete payment; please send me ALL 8 of the masterpieces listed above and enroll me as a trial member. Send me notice of future selections which I may try for 5 days without cost or obligation. For those future l.p. discs I decide to keep after I have tried them, I will pay only the special member's price of \$1.50 each, plus few cents shipping. I may cancel my trial membership at any time.

Name.....

Address.....

City.....State.....

In Canada address: 686 Bathurst St., Toronto 4, Ont.

931

V-M

Authentic

High Fidelity



Pleasure



Fidelis

WITH TONE-O-MATIC

brings music vibrantly alive

When you first realize that *you* control the perfect—precise—balance of reproduction in your favorite records . . . that with *tone-o-matic* *you* decide how strong the high or low tones will be played—then, you understand the perfect gift V-M's "Fidelis" offers in authentic high fidelity pleasure.

Within the acoustically correct cabinet, V-M has provided an audible range of 40 to 15,000 cps. Silently, gently, records of all three sizes and speeds are automatically changed to bring you their full tonal beauty. And, after the last record plays, Siesta Switch™ shuts off even the amplifier, automatically.

Choose either African Mahogany or Champagne blonde in lustrous hand-rubbed finish at the same price. \$149.50* (Legs, black or brass finish, are optional.)

24
MODELS
TO CHOOSE FROM

V-M

the Voice  of Music

*Slightly higher in the west.

UL Approved.



V-M MODEL 556 Portable High Fidelity Phonograph— with *tone-o-matic* Hi-Fi pleasure wherever you go! Your choice of rich brown or rose and gray leatherette case. \$119.95*

V-M CORPORATION, Benton Harbor 6, Michigan

Please send illustrated folder. "Bring Concert Halls Within Your Walls."

NAME _____

ADDRESS _____

CITY _____ ZONE _____ STATE _____

WORLD'S LARGEST MANUFACTURER OF PHONOGRAPHS AND RECORD CHANGERS



**NOW! SEE – HEAR
THE LATEST IN
AUDIO EQUIPMENT**

AUDIO FAIR / LOS ANGELES*

OVER 100 HI-FI AUDIO COMPONENT MANUFACTURERS from all over the world will exhibit the newest innovations in audio equipment at the 3rd Annual West Coast Audio Fair. Don't miss this year's great "Audio Roundup – Western Style" – presented in cooperation with the Audio Engineering Society, the Audio Components Distributors Association and the Audio Components Industry at large.

YOU WILL SEE – HEAR – APPRAISE the newest and latest high fidelity components, specially designed for home-music systems – an exciting "Audio Roundup" of all nationally advertised audio equipment representing the greatest developments yet offered for the reproduction of recorded or broadcast program material. **PLAN NOW TO ATTEND . . .**
ADMISSION FREE TO ALL EXHIBITS

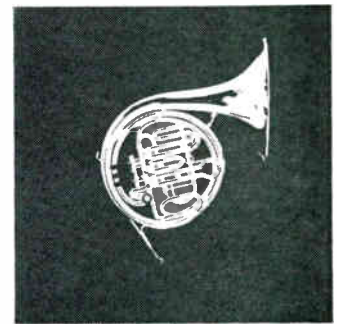

FOR FURTHER INFORMATION
WRITE, WIRE, PHONE:

WILLIAM L. CARA, FAIR MANAGER
358 S. BENTLEY AVE.
LOS ANGELES 49, CALIF.
RICHMOND 7-4650

THE ALEXANDRIA HOTEL / FEBRUARY 10, 11, 12, 13, 1955



**In the interests of the consumer as well as the Audio Components Industry, Audio Fair Los Angeles exhibition space has been limited to Audio Component Manufacturers. Products to be displayed are subject to approval of the AFLA Admissions Committee.*

January-February 1955

Silky Highs

IMPOSSIBLE TO OBTAIN WITH ANY OTHER TYPE SPEAKER
3500 cps to beyond audibility / 180° Dispersion / + 56 db RETMA Rating



T35 and T35B

Super Sonax®

VERY HIGH FREQUENCY DRIVERS



The T35B—for lower powered systems and existing quality AM-FM radio or radio-phonographs, finished in flat matte black. Requires only X36 to attach to music system. AT37 level control optional. Impedance 16 ohms. Shipping wt. 2 lbs.

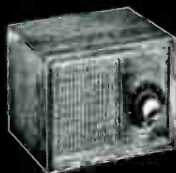

Beautiful Piccolino Accessory Enclosure for T35 or T35B, mahogany or blonde. List \$15.00, Audiophile net \$9.00.

The Piccolino, complete, Super-Sonax, X36 crossover and AT37 level control, wired to connect to music system: with T35 List \$90.00, Audiophile Net \$54.00; with T35B List \$70.00, Audiophile Net \$42.00.



Prove It To Yourself at Your E-V Distributor's—Test the T35 for yourself with this special demonstrator. You operate the switch that cuts the T35 in or out of an actual high fidelity system. Your ears give you the proof of T35 performance!

Any high fidelity music installation shows amazing improvement in the last two octaves with the addition of the easily installed T35 or T35B. The E-V T35 is without equal in its ability to reproduce highest audio frequencies with distortionless purity. At least one more octave of silky highs is afforded through use of T35 for systems over 20 watts, or T35B for systems under 20 watts. Solid 180° dispersion is accomplished by the E-V developed diffraction slit type horn. E-V Model X36 crossover and Model AT37 level control are designed for use with the T35 and T35B. Impedance 16 ohms. Shipping weight 2 lbs.

T35	List \$55.00	Audiophile Net \$33.00
T35B	List \$35.00	Audiophile Net \$21.00
X36	List \$14.00	Audiophile Net \$ 8.40
AT37	List \$ 6.00	Audiophile Net \$ 3.60

TODAY— write for Bulletin 194 and name of nearest E-V dealer.

Electro-Voice®

ELECTRO-VOICE, INC. • BUCHANAN, MICHIGAN

MUSIC in YOUR HOME

WHEN an author is asked by a newspaper or a general magazine to comment on some topic of popular interest, the assumption is that he will contribute an original thought or two on the subject, or start a controversy that will prove interesting and constructive.

Measured by such an editorial yardstick, most current discussions of activities in the hi-fi field do not earn a high rating. Rather, they indicate a paucity of ideas since, as writers run out of subject materials, they turn to matters about which they can complain at length.

For such purposes, the hi-fi perfectionists, and the limited interest in the works of modern composers are convenient targets. So we are being told that the hi-fi clique — that group of individuals who listen to sounds instead of music — has outlived its usefulness; and that the modern composers — those who are using new sounds and instruments — cannot expect recognition until they have been dead so many years that children who were brought up on the Three B's will demand a change of musical fare.

Could be. However, you'll notice that these current animadversions are the products of writers who discovered hi-fi some time after LP records had won public acceptance. Because they are Johnny-come-latelys, they view the scene as outsiders looking in on the phenomenon of widespread interest in high-quality reproduction. Many of them were still in school when Major Armstrong's early live-talent programs from Alpine offered a degree of realism not yet equalled by any phonograph discs, and Paul deMars was putting on FM demonstrations of thrilling quality via the Yankee Network's Paxton transmitter. Most of them weren't born when, in the early 20's, the transition from the morning-glory horn to the cone speaker marked the beginning of serious efforts to improve audio reproduction!

Those of us who, in one capacity or another, have had a part in this activity over the last 30 years don't quite agree with the new crop of commentators and their latest observations on the hi-fi scene.

THE ENGINEERS and the experimenters who listened to *sounds* were the first to become dissatisfied in a constructive way with the electro-mechanical reproduction of music. And whatever may be said of the weird jargon, the loud noises, and the heated disputes emanating from that group characterized as hi-fi nuts, it was they who encouraged and supported individuals and companies in their efforts to develop equipment and methods characterized by more realistic sound reproduction. If such attention to *sounds* is a fault, we must still be grateful to them, for is not all music expressed by creating sounds?

Nor has the work of the engineers, the experimenters, and the sound-listeners come to an end. Sound reproduction through recordings or broadcasting is an art as well as a science. The degree of realism achieved depends, therefore, not on the equipment alone, but equally on the

capabilities of the individuals who use it. To be specific:

The least elaborate audio installation now includes bass and treble controls, and some kind of an equalizer. They are provided as means of improving the quality of reproduction. But if "improving the quality of reproduction" means a further approach to realism, it must be admitted that these controls are being misused. The achievement of realism presumes a knowledge of the real and authentic. The average listener, when he has adjusted his tone controls and equalizer until "this is the way I think it sounds best," would have much more accurate reproduction if his equipment had no adjustments at all.

It is my personal belief that some day the combined efforts of the engineers, the experimenters, and the sound-listeners will materialize in the form of audio installations which will have just two controls, marked VOLUME and ACOUSTICS. The latter will be a new kind of adjustment permitting the reproduction, in a room of large or small dimensions, of the acoustic effects of the concert hall or studio where the music was originated.

QUITE possibly this group will add to its laurels in another direction: The distinguishing characteristic of modern music is the use which the composers make of sounds and sound effects not found in what we have come to call classical music. In music, as in all the elements of our conventional living habits, we shy away from what is strange or what, to others, may seem to make us conspicuous and, thereby, subject to criticism.

But the very presence of new sounds, and the use of new kinds of instruments make the works of modern composers of special interest to the audio perfectionists. In this issue, by the way, Oliver Daniel tells of the Partch records, made with new instruments he has devised. These records challenge the capabilities of any audio system.

As time goes on, the audio enthusiasts may prove to be the *avant-garde* in creating a demand for, and appreciation of music by the modern composers, just as they did the ground work from which public interest in high-quality reproduction has grown and spread. This is no mere speculation for, right now, the principal sale of records by the modern composers is through the hi-fi equipment stores, rather than the record shops.

Meanwhile, let's not disparage the sound-listeners. They have already accomplished so much for the benefit of so many. They may be a smug, disputatious, opinionated, annoying lot, but we need them to spark the further improvement of reproduction from records, tape, and FM.



Pickering Audio Components...

SYNONYMOUS WITH HIGHEST QUALITY

Design... Manufacture... Performance

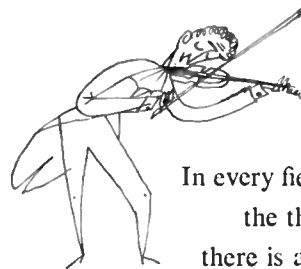

In every field of endeavor . . . manufacturing,
the theatre, concert or contest . . .
there is always one standout.

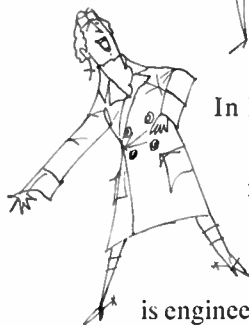

In HI-FI equipment the standout is Pickering . . .
pioneer in this field, responsible
for the development and introduction of outstanding
components for highest quality performance;
every product bearing the Pickering name

is engineered to conquer the challenge of
optimum performance . . . in their manufacture
the most stringent quality controls are
exercised to assure and maintain the "Ne Plus Ultra"
reputation for products featured by the  emblem.



It's with good reason that professionals use
Pickering Audio Components . . . they know
the values built into Pickering equipment.

INVESTIGATE and you too will use Pickering
components for your HI-FI system. . . .

You'll thrill to new listening experiences . . .

you'll have the same high quality performance

as leading FM/AM good music stations, network
and recording studios . . . REMEMBER, leading
record companies use Pickering Components
for quality control.

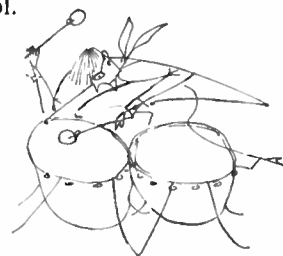
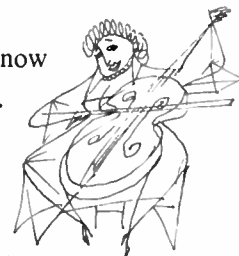

PICKERING and company incorporated •

Oceanside, L. I., New York

PICKERING PROFESSIONAL AUDIO EQUIPMENT

"For those who can hear the difference"

. . . Demonstrated and sold by Leading Radio Parts Distributors everywhere.

For the one nearest you and for detailed literature; write Dept. X-6



First experiments in picking up the harp and piano were made with bi-directional Shure microphones. Stands are the Atlas collapsible type

BINAURAL TAPE RECORDING

By E. J. QUINBY

MY FIRST experience with binaural recording was very thrilling indeed. Until that time, I had maintained that the greatest step in the improvement of recorded music for the home was the advent of the all-electric system, when the microphone, the electric recording head, and the amplifier electric pickup, and dynamic speaker replaced the original methods of recording and reproduction.

I had had a part in some of the work done on those developments at the RCA laboratories. I still remember the bewildered and dumb-founded expressions on the faces of the Brunswick board members when we first demonstrated our all-electric equipment to them. That was back in 1926. It left them simply breathless and speechless. When they recovered their voices, they said, in effect: "Well, gentlemen, there is only one course for us to follow. This will revolutionize the whole

industry. All we can do is to ask: How much will it cost?"

A contract with RCA was signed immediately, and Brunswick came out with their Panatrope phonograph, which soon became so famous that the Victor group, which had previously rejected the electrical system, came flying to us for a similar agreement. In time, of course, this resulted in the absorption of the Victor Company by RCA in March, 1929.

All this has nothing to do with binaural recording, of course, but that milestone in the history of recorded music flashed back in my mind as I listened to the playbacks of tapes that Mrs. Quinby and I had made from the harp and organ, and of Alex Francois at the piano.

Mind you, we had been using a portable magnetic machine for our practicing, but this was our first experience with binaural tape. You will understand my enthusiasm over the results when

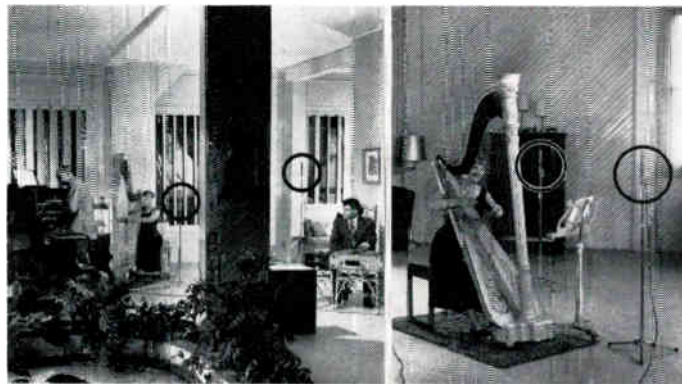

The mikes are so inconspicuous in the large illustrations that you may not have seen both. In these pictures, they are spotted by the circles



Electro-Voice mikes and stands were used to pick up the organ and piano. The effect obtained with binaural reproduction was to maintain the identity of each instrument, while on monaural reproduction the music seemed to come from a single source as, indeed, it must when one microphone and tape channel are used

I tell you of one small incident which, nevertheless, was most significant:

Alex had made a tape while I was playing the organ. I was still sitting at the console, and Mrs. Quinby was standing with her back toward me when Alex started to play back the tape. Just then, Mrs. Quinby turned around and, seeing that I was sitting with my hands folded, she looked at me with the strangest expression of surprised bewilderment, as if to ask: "How can the organ play when you're not touching the keys?" — The binaural playback was good enough to have deceived her, at least for a moment!

What surprised me was that, without experience in handling the equipment or setting up the microphones, we were able to get such wonderful results. Our music room is 45 by 30 ft., with a 12-ft. ceiling. The walls and ceiling are of oak boards, tongue-and-grooved and laid diagonally, as the illustrations show. The floor is a hard, highly reflective, polished terrazzo surface. Some of my audio-minded friends have asked me if I plan to give the room some kind of acoustic treatment — not because they find fault with the acoustics, but because they take it for granted something would be gained. My answer is that, having installed a pipe organ to produce reverberation, I'm not going to silence that effect with sound-absorbing surfaces! A better answer, however, is that the room is large enough that there is all the absorption necessary in the space enclosed. There may be an area for theoretical discussion on that point, but that is my opinion, based on experience with the pipe organ, harp, and piano. Moreover, an appropriate amount of reverberation is desirable to preserve realism.

Because we wanted to do some serious experimenting with binaural tapes, we used quite a collection of equipment. We chose a Berlant Concertone recorder. It has stacked heads, a simple mechanical system that practically precludes mistakes in operating, and is moderate in price.

For microphones, we used two types, a pair of Electro-Voice type 666's which have a high ratio of front-to-back pickup, and a pair of Shure 300 mikes which are bi-directional. I had assumed that it would be immediately apparent that we should or should not use directional mikes, but I began to learn very quickly that microphone techniques are not that simple. In fact, it will take a lot of experience in making tapes and playing them back in order to develop the critical listening capacity on which to base any final judgment. With all due respect to those who issued pronouncements on this subject, I am already convinced that there is no single design that is the best under all conditions.

The Concertone binaural machine is intended for use with high-impedance microphones. Thus it was necessary to use the Electro-Voice model 502 matching transformers with the 666 E-V mikes, since they are of low impedance.

The only mistake we made in operating the recorder was when we didn't shift the double switch from record to playback, but that wasn't the fault of the machine,

Fig. 1. Part of the time, this 25-watt, two-channel Neucomb amplifier was used with the Berlant Concertone binaural machine for the playback



If radio or records could do justice to the harp, it would probably win recognition as the most beautiful solo instrument. Binaural tape, however, provided the extra dimension that realistic reproduction requires. The result was truly magnificent. One of the University speakers can be seen here. The other was about 10 ft. to the left



since it can't be asked to read the operator's intentions. Interlocks on the other controls make it impossible to do anything wrong. Only the spring which rides on the tape, and cuts off the power if the tape breaks, was a little troublesome until we got the hang of it.

In the accompanying illustrations you will see how the mikes were set for picking up the different instruments during our first efforts. They may not be the best locations, but they certainly gave us beautiful results. For the harp and piano, one mike was put quite close to the harp. The other was set back from the piano to reduce the pickup and to get a proper balance between the instruments. To pick up the harp alone, one mike was put close in, and the other about 15 ft. away, to give an added dimension to reproduction from the harp. This instrument, by the way, is a Lyon & Healy concert grand, size 23.

Picking up the organ seemed to pose more complicated problems. You can see the arrangement of the organ pipes from the front cover photograph. Behind the swell-shades, from left to right, are the pipes of the great organ, swell organ, and the choir organ, while the echo organ is located at the head of the stairs. In these, there are 6, 8, 6, and 1 ranks, respectively. You may be interested

to know that there are 1,000 pipes. These comprise 537 metal flues, 255 wood flues, and 208 metal reeds. In addition, there are 143 percussions, comprised of 37 wood bars, 86 metal bars, and 20 metal tubes. The longest pipe is 16 ft., and the shortest $\frac{3}{4}$ in., covering 8 octaves from C_{III} to C_{VIII}. The blowers and DC generators driven by two 5-hp. AC motors, together with 5 reservoirs, and 5 tremolos, are in the basement below the organ.

The console is mounted on a platform which can be moved over a considerable area, since it is connected by a large cable running through the floor, with ample slack.

Perhaps it was beginner's luck, or maybe it was favorable acoustic conditions, but we were very successful in making tapes of the organ with the harp and piano. For the former, one mike was put between the swell and choir organs, and the second mike was close to the harp, where it picked up the great organ, too. The result, on the playbacks, was to locate the harp exactly in relation to the three sections of the organ. Moving the second mike near the piano, as the photograph shows, brought the piano right out front, dimensionally, on the playback.

I suspect that a large part of our success was due to the way the controls on the recorder were handled. Before

a recording was started, the loudest passage of the music was played. Then Alex Francois set the level controls so that each half of the volume-indicator eye almost closed. After that, the controls were not changed during the recording. By leaving the volume fixed, we got the full dynamic range on the tape, and maintained the true relation between the microphones. I can recommend this practice emphatically for recording from any source.

I have left the discussion of the playback equipment and its arrangement until the last although, as you would imagine, we listened to each tape as soon as we made it.

Continued on page 60

Fig. 2. Rear of the two Scott 99 amplifiers and the binaural Concertone, showing the connections. Full volume was obtained with the 10-watt 99's well below maximum output

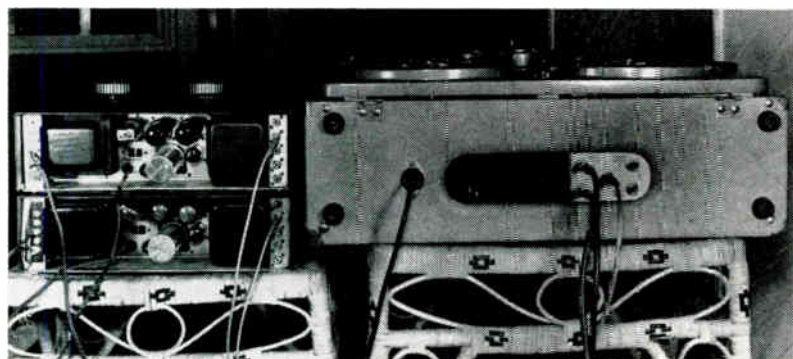



A student leads the 2nd and 3rd grade classes in singing at Brookings Elementary School, Springfield, Mass., under the supervision of Richard Berg

NOW IT'S MUSIC-IN-EDUCATION

By BEN DEUTSCHMAN

THE horn book disappeared from our classrooms about the time the Colonies became a nation, and the slate went out with the 19th century, but music is still being taught in many schools much as it was when those two pillars of education were in general use.

Fortunate indeed is the child who attends a school today where it is recognized that music as a compartmentalized segment of the curriculum is of limited significance, but that music as *an integral part of the total curriculum* is of great importance. This observation is not offered as a gem of pedantic wisdom. It is a conclusion reached through observing some of the most successful teachers of music in our schools.

Notice the phenomenal growth of music interest and enthusiasms in North Carolina, under the leadership of Arnold Hoffman, or in Wisconsin, where G. Lloyd Shultz has created a program of music-in-education. Observe the accomplishments in correlating music with other phases of teaching in Ohio, where Edith Keller has done such great work. These are but a few of the pioneers who believe in music not just as a subject unto itself, but as a part of the children's whole intellectual development.

What is the difference between music education and music-in-education? First of all, it does not mean sinking music to a secondary place in the program. It most certainly does not mean the elimination of teaching music skills. No, it does not mean these or any faults that have been attributed to the idea of music-in-education. It simply means using music as a means to a richer and more rounded education for all children, rather than merely an end in

education for a few children who are talented, or who are mistakenly judged to have talent.

Musical Experience Should Begin at Home

The next time you are on an automobile trip, and you stop along the road for a cup of coffee, if a noisesome juke box competes with your efforts to carry on a conversation, you may dispose of the annoyance by remarking that you can't understand what has happened to young people that they seem to enjoy that ghastly racket, to say nothing of throwing away their pocket money for the privilege of listening to it.

But you might look more deeply into what's behind the musical taste of our boys and girls that has caused them to make juke-box operation a multi-million-dollar industry in the United States:

Children are introduced to the language arts almost at birth, as their parents teach them their first words. Auditory recognition of sounds, and the association of words with objects and actions begin immediately. Then, after five or six years of continuous training at home, the child is sent off to school, where he will continue his education in language arts in a formal manner. If he, or she, can read simple words by the end of the first school term, the parents are very proud and happy.

With music, it's all different. Few children are given any pre-school experience with music, although it is the one subject they can learn at home as easily and as naturally as they learn to express themselves in speech!

Instead, they first encounter this subject after they enter school, and at a time when they are struggling to acquire a working knowledge of English grammar and

spelling. At that point they are told: "Now it's time for you to start learning a foreign language called Music." Unlike other foreign languages, however, this one not only has an alphabet and spelling and grammar all its own, but it must be expressed in musical tones, frequently in competition with other students who are trying to say the same thing, but in other tones.

Later, if the same children take French or German, and can carry on a halting and disjointed conversation in either language at the end of their first year, they will be considered to have made excellent progress. How, then, can music teachers feel disappointed if, after intensive training in the first grade, children fail to show appreciation for the literature of Mozart? Yet such are the miracles still expected in many of our schools. And is it any wonder that the musical standards of so many boys and girls are measured by the annual take of the juke boxes?

Children should be introduced to the experience of listening to music at pre-school age. Most convenient for this purpose is the phonograph, and the better the quality of music it produces, the more discriminating will be the child's judgment of what he hears.

The busiest mother has time to select and play selections from the music of Mercury's Childcraft records, for example, or the Victor Little Nipper series, and Capital's Music Story records. These and others are smartly selected and arranged to provide excellent music, also serving the dual purpose of keeping children quiet, or accompanying and guiding them in activities which help them let off their seemingly tireless energies. There are records which direct the children to march, sing, play Indians, imitate animals, and play games. At the same time, they are unknowingly introduced to some of the best in music, and to the enjoyment of music in association with the activities of everyday living.

The Significance of Music-in-Education

The foregoing observations on children's music at home are not altogether idealistic, for in many schools today the growing interest of parents in the subject of music, and the association of the more advanced music teachers with the parents through the parent-teacher organizations are accomplishing much to advance the idea of planned music at home for pre-school children as an introduction to music in education.

It is interesting to recall, in this connection, that as late as 1949, an executive of one of the major record companies made the statement that: "Records will never be a factor in the schools because their use is too limited." Currently, however, his company is spending a considerable part of its advertising budget to highlight the educational value of the records it is producing.

The use of records for music-in-education was initiated by music teachers who came to recognize the value of the opportunity to hear in classrooms, from kindergarten through college, the folksongs of the world, and the music of the masters. And they saw that there is a place for recorded music not merely in the teaching of the music itself, but in conjunction with physical education, languages, sociology, and the arts.

In Detroit, for example, Pat Poster began the use of Folkway records to teach children to sing the folksongs of various nations as a means of understanding the people in other countries. Edna Doll, in Orange, N. J., developed the use of recorded music for creative rhythms, and Ruth Evans, in Springfield, Mass., worked out a series of records which she uses for physical education. At Ohio University, Dr. Nels Glenn now employs a list of discs from the Children's Record Guild and Young People's Records to show teachers how to correlate music listening with various other subjects.

Laura E. Ross, in Philadelphia, has compiled a special catalog of records to show how music can contribute to almost every phase of the elementary curriculum. Many other teachers are working along these same lines.

In discussions at their various associations meetings, they have repeatedly mentioned two points which concern the parents: They hope to see more children start their experience with music listening at home, at pre-school age, and continue this activity during their school years under parental guidance. Also, they need still more active support from parents in their efforts to obtain a wider selection of records for classroom use, replacements for worn records, and equipment of better audio performance for record reproduction.

An Example of Music-in-Education

The question is sometimes asked: exactly what do you mean by the use of music-in-education? Can you give me a specific example? That is very easy, and an hour's listening will tell you more than anything you can read. Following are records particularly related to the language arts which, at the same time, develop music appreciation as a by-product:

Trojan Horse — Capital DAS 3207 — Grades 2 to 6

Waltz of the Flowers — Capital DAS 3204

Diana and the Golden Apples — Capital DAS 3208

These are records of amusing stories, told to background music that belongs in the elementary classroom experience. Tchaikovsky's *Waltz of the Flowers* is made a part of the story of mice who came to dance dressed as flowers, and the fable of the Trojan Horse is told to the music of the *Love of Three Oranges*, by Prokofieff.

Rolito — Decca DL 8021 — Grades 2 to 6

Frank Luther and Jesse Crawford tell a delightful story in music about the life and adventures of a little Mexican boy in this record. In that way, they present a fascinating picture of life in Mexico. At the same time, they explain the meaning of common Spanish words, and give their correct pronunciation.

American Folksongs — Folkways FP 701 — Grades 3 to 7

In Songs like *Jim Along Jo*, *Jessie*, *This Old Man*, *Billie Barlow*, and *All Around the Kitchen*, Pete Segar and his five-string banjo make a picture of America in the early stages of its development.

You have probably never heard these records, and you may not even be aware that there is such music. But if you will listen to these typical examples, you'll quickly understand how wisely music that all children should know is presented in a way to attract and hold their attention.



Richard the Melody-Hearted

Part 1: A story of the man who has given us so many of our finest American melodies—*By Fred Reynolds*

THE LADY said: "And that's where they separate the men from the boys in the show business." The lady was so right. She was and is my wife, Donna, and we were just walking away from the Rodgers and Hammerstein offices at 488 Madison Avenue, New York City, after a delightful visit with Richard Rodgers. The very same Richard Rodgers whom many consider our finest composer of American melodies. In the past decade, certainly, no one else has come close to him in the creation of songs that will endure forever. In the over-all picture, only George Gershwin, Jerome Kern, Irving Berlin, Harold Arlen, and Cole Porter sit with him astride the same diamond-bright

star. All these men have composed primarily for the theatre, but this is more true of Rodgers than of the others.

Actually, Richard Rodgers' office is a clue to the man and the team. As we walked into the spacious, modern surroundings, we were impressed with the activity, the sense of getting things done well and right. His conference room has the atmosphere of a lovely home, tastefully furnished with antiques. This, as Mr. Rodgers will readily tell you, is the work of Mrs. Rodgers. Here the talk comes easily. Here you can get to know this warm, brilliant, gentle man. And getting to know Dick Rodgers is grand pleasure, indeed. To meet Oscar Hammerstein, you must

go elsewhere, for he seldom comes to the Rodgers and Hammerstein offices, preferring to leave the business details to his partner, who accepts the burden cheerfully.

Richard Rodgers was born on June 28, 1902, the second son of Dr. and Mrs. William A. Rodgers of Mount Morris Park, New York. His elder brother, Mortimer, eventually followed in Dr. Rodgers' footsteps, and is today a prominent obstetrician. But Dick can hardly remember the time when he didn't want to be a musician. And towards that goal he was enthusiastically helped by his parents, who loved music and the theatre.

As a boy, Richard soon learned to play the piano, and began dabbling in the creation of songs. He did something at camp titled *Campfire Days*, and then turned to a more worldly ditty, *My Auto Show Girl*. However, though he was achieving a certain success of composing, it was increasingly evident to him and to others that he badly needed a lyricist. So it was that Phil Leavitt, a friend of Mortimer's introduced Dick to Lorenz Hart, who could turn a nifty rhyme, but could get nowhere with the notes. Thereby was struck an immortal partnership, lasting for more than 25 years and only broken by Hart's untimely death.

When Rodgers was sixteen, he and Hart were introduced to the famous comedian, Lew Fields, the ex-partner of Weber, and the father of Herbert and Dorothy. After hearing a brace of Rodgers and Hart songs, Fields decided to incorporate one, *Any Old Place with You*, in his musical revue, "A Lonely Romeo". At long last Rodgers and Hart were professionals. But it didn't stick. For the next five years, two of which Rodgers spent at Columbia University where he wrote music for "The Varsity Show", the two composed tunes for a succession of amateur productions, from which they never received a penny in royalties. The situation was becoming desperate. So much so, in fact, that Rodgers almost went to work selling babies' underwear for a neighborhood store.

Before this could happen, however, another friend of the Rodgers family, Benjamin Kaye, called to ask if Rodgers and Hart would be interested in writing music for an intimate revue to be done by the Junior Group of the New York Theatre Guild. That Theatre Guild part was oil in the well. Here was just another amateur production, yet it proved to be a great deal more than that; much more, as it turned out, than Rodgers and Hart had dared dream.

Such was the prestige of the Guild that most of the top drama critics were in attendance when "The Garrick Gaieties", for such the little revue had been christened, was given what was supposed to be its only two performances, on Sunday afternoon and evening May 17, 1925, at the Garrick Theatre. The reviews next day ran the gamut from good to crackerjack. Two more performances, therefore, were scheduled for the next Sunday. When these were sold out four days in advance, Rodgers went directly to the executive director of the Theatre Guild, Theresa Helburn. He had the audacity and, may I add, the perspicacity, to suggest that she immediately close "The Guardsman" which, with Alfred Lunt and Lynn Fontanne, was then nearing the end of its run at the Garrick. "In its place," he said, "let's put on 'The Garrick Gaieties' as a regular

Broadway show." This is the first recorded evidence of that infallible sense of theatre that has carried Rodgers from one success to another throughout his career.

History does not record Miss Helburn's exact retort, but after a further week of matinee experiments, she did close "The Guardsman". Thereafter, the Rodgers and Hart intimate amateur revue played full scale for 161 performances.

So the tide changed, much as it does at the Bay of Fundy. Broadway producers, who a short time ago had given Rodgers and Hart little more than the back of the hand, now listened with both ears to ideas the boys had to offer. And very seldom within the next seventeen years did Rodgers and Hart lack for ideas. In fact, the very next year, 1926, the team had four musicals — "The Girl Friend", the second edition of "The Garrick Gaieties", "Peggy Ann", and "Betsy" — on Broadway, while "Lido Lady" was playing in London. Of these, all save "Betsy" were financial and artistic successes. Amazingly enough, during their careers together, Dick Rodgers and Larry Hart wrote words and music for twenty-seven shows, and only three of them ran in the red.

So the years of practically unbroken success flowed by. One musical show was followed almost immediately by another, each a little better, a little more mature, a little more artistic. There was one spell, however, of several years, when Rodgers and Hart left the footlights of Broadway shows for the Klieg lights of Hollywood. Their long and profitable association with the motion picture industry began in 1930 with the score for the Maurice Chevalier film "Love Me Tonight", for which they wrote the two great hits *Mimi*, and *Lover*.

From the very beginning, it is true, Rodgers and Hart worked on the theory that a musical show should be something far more than a mixture of un-integrated songs, plot, and dance routines. All, of course, are important, but songs and dances should enhance the action of the plot. As Rodgers so definitely points out: "None of my music was composed with popularity as its goal. All of it was composed to provide an illustrative musical setting for a situation in a musical play or motion picture. Its popularity has been a corollary to its main purpose, that of translating into musical terms the quality of the characters who performed the music and the nature of the scenes in which they performed them."

How far he will go to conform to this principle can best be shown by the fact that, no matter how much Rodgers likes one of his tunes, if it doesn't fit the situation, if it doesn't strengthen the story, out it goes. "I may like some of my music," Rodgers says, "but I am not married to any of it." Still, if a certain Rodgers song does achieve enormous popularity, and so many have, it is entirely OK with him. "Never let it be said that I resist the idea of large sheet-music and record sales," states Dick Rodgers. "I have formed the habit of eating, and I like it."

A notable event of the theatre took place on April 13, 1936, when the Rodgers and Hart show, "On Your Toes" opened at the Imperial Theatre. This was the first of the American musicals to put ballet, and the music for it, on an equal level with story, songs, and humor. Ray Bolger

was its star, and very few who saw that production will ever forget his dancing to *Slaughter on Tenth Avenue*. "On Your Toes" was revived late last year.

But of all the Rodgers and Hart shows, the one that seems most vital, certainly the one that was most provocative, the one that moved forward most daringly, was their next to last, "Pal Joey," in 1940. It was, counting the award-winning and richly applauded revival of 1952, their most successful. And for it they created their most sophisticated and bewitching score.

How did it start? A letter from John O'Hara, who had created Pal Joey in a series of stories in the *New Yorker* magazine, got the ball rolling. By the time the three of them — O'Hara, Rodgers, and Hart — got to work on the show, the two leading parts had been cast and George

the press and public was startling, to say the least. Approximately one-half the first night audience applauded wildly while the other half sat in stoney, stunned silence. The press the next day reacted in somewhat the same ratio, with those in favor slightly in the lead. Louis Kronenberger, not precisely an illiterate, thought it was the most unhackneyed musical show since 'Of Thee I Sing'. Brooks Atkinson, that usually kind and temperate man, said, 'If it is possible to make an entertaining comedy out of an odious story, this is it.' His review closed: 'Although it is expertly done, can you draw sweet water from a foul well?'

Well, twelve years can make a mountain of difference. "Pal Joey" ran for 11 months in 1940, and a year and four months starting from January of 1952. That '52 edition

THE PRINCIPAL RODGERS AND HART SHOWS, AND THE TOP SONGS FROM EACH			
1925 GARRICK GAETIES Manhattan	Spring Is Here	Where or When My Funny Valentine The Lady Is a Tramp Johnny One Note	1940 HIGHER AND HIGHER It Never Entered My Mind
1926 DEAREST ENEMY Here in My Arms	1930 SIMPLE SIMON Ten Cents a Dance	I'D RATHER BE RIGHT Have You Met Miss Jones? I'd Rather Be Right	PAL JOEY I Could Write a Book Bewitched, Bothered, and Bewildered What Is a Man? You Mustn't Kick It Around Take Him
GARRICK GAETIES Mountain Greenery	AMERICA'S SWEETHEART I've Got Five Dollars	1938 I MARRIED AN ANGEL I Married an Angel	1942 BY JUPITER Nobody's Heart Belongs to Me
THE GIRL FRIEND The Blue Room The Girl Friend	1935 JUMBO The Most Beautiful Girl in the World My Romance Little Girl Blue	THE BOYS FROM SYRACUSE This Can't Be Love Falling in Love with Love Sing for Your Supper	SONGS FOR MOVIES Blue Moon — Soon Isn't It Romantic Mimi — Lover You Are too Beautiful Down by the River Dancing on the Ceiling
1927 A CONNECTICUT YANKEE My Heart Stood Still Thou Swell	1936 ON YOUR TOES There's a Small Hotel Quiet Night Glad to Be Unhappy It's Got to Be Love Slaughter on 10th Avenue	1939 TOO MANY GIRLS I Didn't Know What Time It Was Give It Back to the Indians	
1928 PRESENT ARMS You Took Advantage of Me	1937 BABES IN ARMS		
1929 SPRING IS HERE With a Song in My Heart			

Abbott had come in as the producer. Let Dick Rodgers tell the rest:

"It was a weird sort of enterprise to be trying to put on a musical show in which none of the characters (with the exception of one) had even a bowing acquaintance with decency. Even that one character didn't have a brain in her head; she was the ingenue. It seemed time to us, however, that musical comedy get out of its cradle and start standing on its own feet by looking at the facts of life. The facts of life in this case were to be learned in and around a night club in Chicago's south side. Some of the songs like *That Terrific Rainbow* were what is known as performance numbers, and were done on the floor of the night club. Not having had much experience writing that sort of songs, they became great fun for Larry and me to do, but we got our greatest pleasure in trying to make these characters of O'Hara's actually sing. Even when Joey sings *I Could Write a Book* to the girl, he isn't as sweet as he sounds. He is simply trying to ingratiate himself with her because it isn't within the range of his capabilities to let anything good pass by. The girl, of course, is sincere, but as I pointed out, she is the innocent one.

"When 'Pal Joey' finally reached the stage of the Ethel Barrymore Theatre on Christmas night, 1940, the effect on

captured the New York Critics' Award, the Pulitzer Prize, and the Donaldson Award.

"By Jupiter," which came to the Shubert Theatre in June of 1942, was the last Rodgers and Hart show. In all of their long and marvelous collaboration the two had exhibited rare gifts.

Though like needle and thread in artistry, these partners in temperament and characteristic were as far apart as the two ends of Broadway. Small in stature and somewhat sensitive in nature, Hart delighted in such things as fabulous parties, enormous swimming pools, long cigars, and bachelorhood. He might be as much as two weeks late for an appointment, and he continually mislaid the scraps of paper on which he scribbled ideas. In fact, Hart wasn't at all keen on working. His job was to write the lyrics after Rodgers had composed the melody, and oftentimes it was quite a chore to get him down to brass tacks. Quite honestly, Hart had a superb facility for avoiding work. Once, so the story goes, Rodgers took Hart to his Connecticut home with the thought that Larry might concentrate more fully on the task at hand when away from the gay distractions of Broadway. But ingenious Hart made a deal with Rodgers' younger daughter, Linda. After swearing her to secrecy, he calmly stowed himself

Continued on page 61

Music at Home

Music Tape Reviews

By DR. HANS WOLF

THE EXPANSION of the pre-recorded tape library as a new kind of music product has encouraged many of the independent record companies to enter this relatively unexplored market.

Latest news is that Livingston will distribute a number of new tapes made from masters owned by several of the independent record companies. For the most part, they will be sold by hi-fi equipment dealers, rather than record shops. A varied catalogue of selections has been made up for 7½-in. tapes, representing six companies as follows:

Atlantic Records has released masters recorded by Erroll Garner, Mary Lou Williams, Jimmy Yancey, Barbara Carroll, Sylvia Syms, Dizzy Gillespie, Wilbur De Paris, Mabel Mercer, Mae Barnes, and Vernon Duke. An interesting item in the Atlantic library will be a complete performance of *Romeo and Juliet*, starring Eva Le Gallienne, Dennis King, and Richard Waring. Much of their material will be made available on binaural tapes.

Empirical Records, a label gaining recognition for its unusual work in Dixieland recordings, will release its library on tape on a regular schedule. All Empirical masters are being made binaurally.

Esoteric has released five reels of a diversified repertoire which includes their famous *English Medieval Christmas Carols* with the Primavera Singers of the Pro Musica Antiqua of New York, *Seven Canzonas* of Giovanni Gabrieli with the New York Brass Ensemble, and an album of 18th Century music played by harpist Nicanor Zabaleta.

Oceanic's first tape release includes Beethoven's *Battle Symphony*, Bizet's *Symphony No. 1*, and one reel of 18th Century concertos, together with 5-in. reels of *Melody Cruises* to Italy, Paris, Latin America, and Israel.

An unusual entry in the tape field is the Riverside label. In this group the accent is primarily on the rarity of the material, and the desirability of preserving it on a permanent medium.

Beethoven, *Piano Concerto No. 5*

Vladimir Horowitz and Fritz Reiner
RCA Victor Symphony Orchestra
7.5 speed, double track, 36:30 min.
TC-4 RCA Victor

Brahms, *Piano Concerto No. 2*

Artur Schnabel and Charles Munch
Boston Symphony Orchestra

7.5 speed, double track, 34:15 min.
TC-6 RCA Victor

Gershwin, *Rhapsody in Blue* Grove, *Grand Canyon Suite* (Excerpts)

Byron Janis, Hugo Winterhalter and his Orchestra

7.5 speed, double track, 32:10 min.
TB-3 RCA Victor

There could not be a better demonstration of music on tape than these three RCA Victor releases. The piano instrument, the sound of which has always been difficult to reproduce on discs, seems to gain in clearness and quality when heard on tape. With such eminent artists as Rubinstein and Horowitz, and an electrifying *Rhapsody in Blue* by Byron Janis, tape is coming into its own.

There is a secret about great interpretations. It has much to do with the artist's imagination, with his capacity to recreate emotional content or atmosphere. Of course, the work must at all times be performed authentically, but performers have various temperaments and by the very nature of their individuality, they lend a personal touch to their performances.

For example, Mr. Rubinstein has a way of accelerating his tempo at certain vital spots in the Brahms work which seems to be part of the secret of this artist's tremendous interpretive sweep and dynamic intensity. Knowing when and how long to retard and to accelerate can make or break a performance, and no "authentic" reading of the score could save it in case of failure. To do justice to Mr. Rubinstein interpretation, I like to quote an anecdote. It was after the opening performance of Puccini's opera "The Girl from the Golden West," under Arturo Toscanini, when the enthusiastic Puccini exclaimed: "Toscanini has composed my opera a second time." Brahms might have said just that about his concerto, could he have heard Rubinstein at the piano.

In recordings like these, where only one microphone is being used, increased attention should be paid to woodwind passages and clean bass definition.

Schumann, *Carnaval op. 9* Liszt, *La Campanella* Clementi, *Sonata in G major, op. 40, No. 1* Mozart, *Pastorale Variee*

Sondra Bianca, pianist
7.5 speed, double track, 51 min.
A-V Libraries, Inc. 1031

We have previously commented on the clear and natural reproduction of the piano by the medium of tape. That is also true of this reel, which presents the young

pianist Sondra Bianca. Especially the Liszt *Campanella* offers ample opportunity to demonstrate the masterly technique of this fine musician who, at the age of 10, made her debut with the New York Philharmonic Orchestra, and is the winner of a Carnegie Hall Award. In the spirited *Sonata* by Clementi, we listen to a composer who, having lived in the shadow of the great musical geniuses of his time, has been unduly neglected. Sondra Bianca does full justice to the sparkling gaiety of this little work. We would like to hear this artist on a tape recording of one of the classical concertos.

Mozart, *Cello Concerto* Vivaldi, *Concerto in D major* Boccherini, *Cello Concerto* Corelli, *Sonata in D minor*

Janos Starker, Cello
7.5 speed, double track, 55:05 min.
Connoisseur Tape Library D-104

This recital on tape features the Boccherini and Mozart cello concertos. The work was originally written for the French horn (K 477). The transcription for cello, by Alexander Sandor Fischer, was intended for Casals but, due to the war, was never performed by that great cellist.

The most striking feature of this tape is the musical personality of the soloist Janos Starker, who is at present solo cellist with the Chicago Symphony under Fritz Reiner, and has been heard on the regular TV series of that orchestra. Starker is soloist of great stature among the artists of the younger generation. The beauty and strength of his tone, and his power of expression doubtlessly put him in the first ranks of the world's great cellists.

Vivaldi, *Concerto Grosso in D minor op. 3 No. 11* Mozart, *Serenade (Eine kleine Nachtmusik)* Bach-Stoessel, *Prelude in E major* Tchaikowsky, *Serenade for Strings, op. 48* Bolzoni, *Minuet*

The Sorkin Symphoniette
7.5 speed, double track, 60:58 min.
Webcor 2923-3

Especially in the Vivaldi, Bach, and Tchaikowsky works, the effective bowing and the expertly-treated phrasing of the strings show that an enthusiastic stringman rehearses and leads the Symphoniette. The results are expressive, and the strings have vigor and conviction. However, the *Kleine Nachtmusik* by Mozart I found a
Concluded on page 58



Open and closed views of a radio-phono-TV installation. Note that the TV screen and speaker are in line, and that the screen is high enough for comfortable viewing

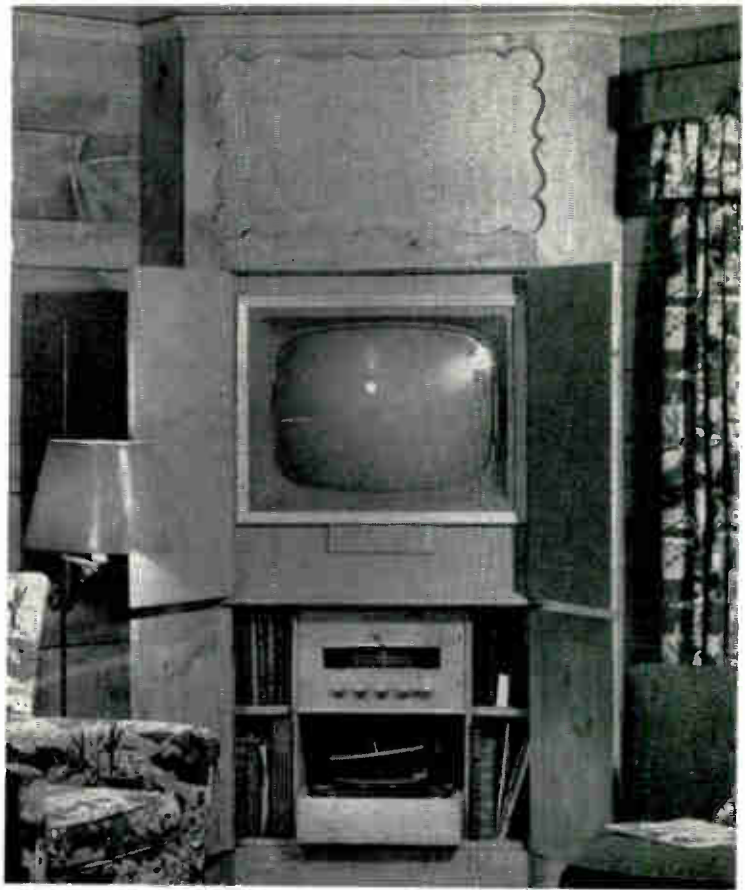

In this radio-phonograph cabinet, the speaker is at the right, with record storage in the center section



Handsome in Appearance. . .

Two views of a radio-phonograph chest, used with a separate speaker. All cabinets on these pages were designed and built by The Pine Shop, Glen Head, N. Y.

Music at Home



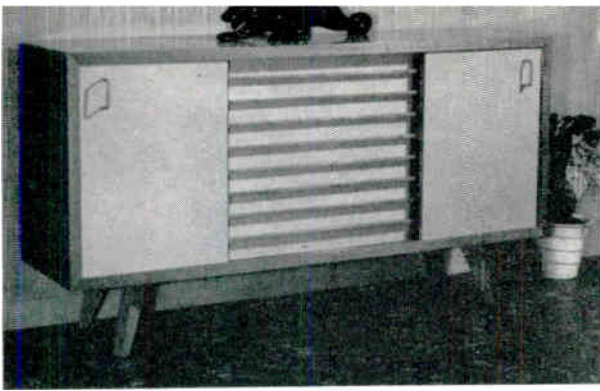

Above: Radio and phonograph are in one end, records in the other, with the speaker between. Right: Simple lines make this a handsome speaker cabinet. Below: This cabinet is supported from the wall. Speaker is separate

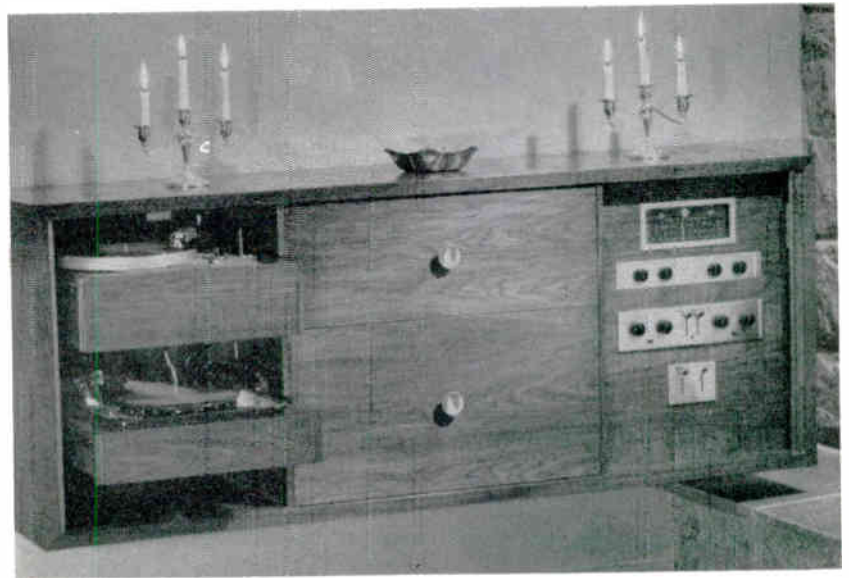
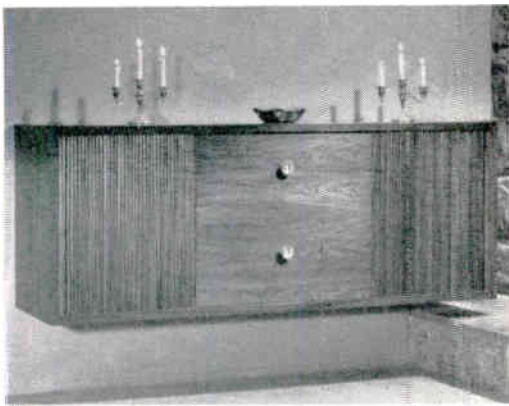
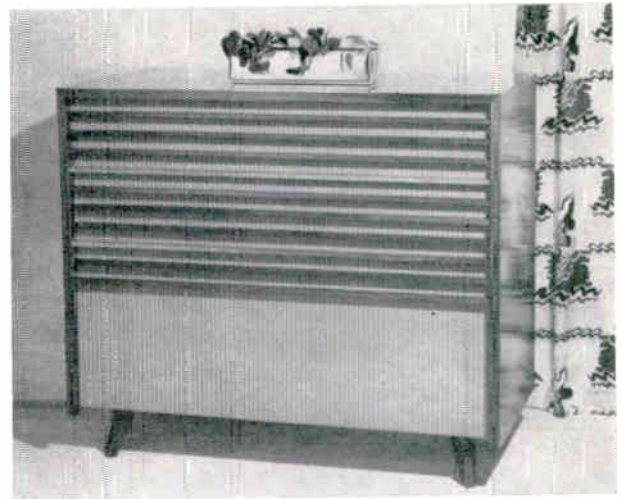

and Fine in Performance



Left: You can sit on this type of cabinet. Right: An attractive mounting for a phonograph and loudspeaker

January-February 1955



PHOTOS BY
FRED LYON

HARRY PARTCH

By OLIVER DANIEL

"He has added some of the most deliciously provocative new sounds that have come to the music world in a long time. . . ."





The Gate 5 Ensemble playing Plectra and Percussion Dances to a capacity audience in the former office building of a World War II shipyard

Is your Kithara in tune? Are your Cloud-Chamber Bowls all bright and shiny, and have you been practicing faithfully on your Chromelodeon? If this sounds enigmatic, then you are unaware of the latest developments by Harry Partch, who is adding to our music new sounds, new combinations of sounds, and fascinating new instruments to produce them. And along with the physical additions to our music he has supplied an impressive philosophy that has been seized upon by many who have become devoted to Partch's theories. Like Cowell and Varèse, who have used all kinds of sounds and noises as their *materia musica*, or like Otto Luening and Vladimir Ussachevsky, who have incorporated all kinds of altered and distorted sounds to their tapesichord experiments, and have finally added them to the symphony orchestra, Partch has added some of the most deliciously provocative new sounds that have come to the music world in a very long time. He has made the fabric of music become more varied; he has given new textural possibilities to sound-stuff. What will come of it we shall learn as more people have the opportunity of hearing his concerts and his records.

The audiophiles — the hi-fi addicts — are discovering Partch more rapidly than the musicians. It is perhaps because they are more open-minded toward experiment, and less bound by aesthetic rules. Partch has certainly veered quite far away from the academic tenets. Classicists and the dowdy opera sponsors might just as well spare themselves the annoyance of listening to Partch's creations. They would certainly not approve, and they would undoubtedly devote much energy to being vocal about it.

Left: Harry Partch and his 10-string guitar, ranging from cello C to G above middle C. The cloud-chamber bowls, struck by soft mallets, give the bell-like tones of a struck crystal goblet, but more powerful

Why, they would ask, should anyone make such whining sounds when Verdi sounds so pretty? And for the answer to "What Makes Harry Hum?" one must refer to the provocative 399-page book "Genesis of a Music" by Harry Partch.

In the subtitle of his book, Partch explains the scope of the work in part. It reads: "Monophony; the relation of its music to historic and contemporary trends; its philosophy, concepts, and principles; its relation to historic and proposed intonations; and its application to musical instruments." The foreword to the book is by Otto Luening. What he has to say is most important for he, himself, has realized how positive and sometimes violent the reaction to Partch's music can be; and he has phrased well his own reactions both to the philosophy and the resultant music.

"With new music itself as his goal," Luening writes, "Partch did not stop with solving theoretical problems on instruments. He has devised systems of notation, taught

Bull session: Harry Partch, drummer Shelley Manne, and Stan Kenton



January-February 1955

himself to play his instruments, and composed music for them. Imbued with a strong desire to utilize the new physical means in as direct and human a fashion as possible, he has applied himself to projecting more clearly the subtleties, refinements, and inflections of language itself. Partch became an intoner, a singer . . . Anyone who has heard Partch in a program of music or in a lecture-recital knows how effective his message is. Musicians,

world for thirty years because he cannot, and could not as a youth, swallow the unscrutinizing acceptance of European musical forms and values by the music business, the music critics, and the music academicians. As early as 1923, he had begun to abandon the traditional scales, instruments, and forms, and came to the realization that the spoken word was the distinctive expression his constitutional make-up was best fitted for, and also that

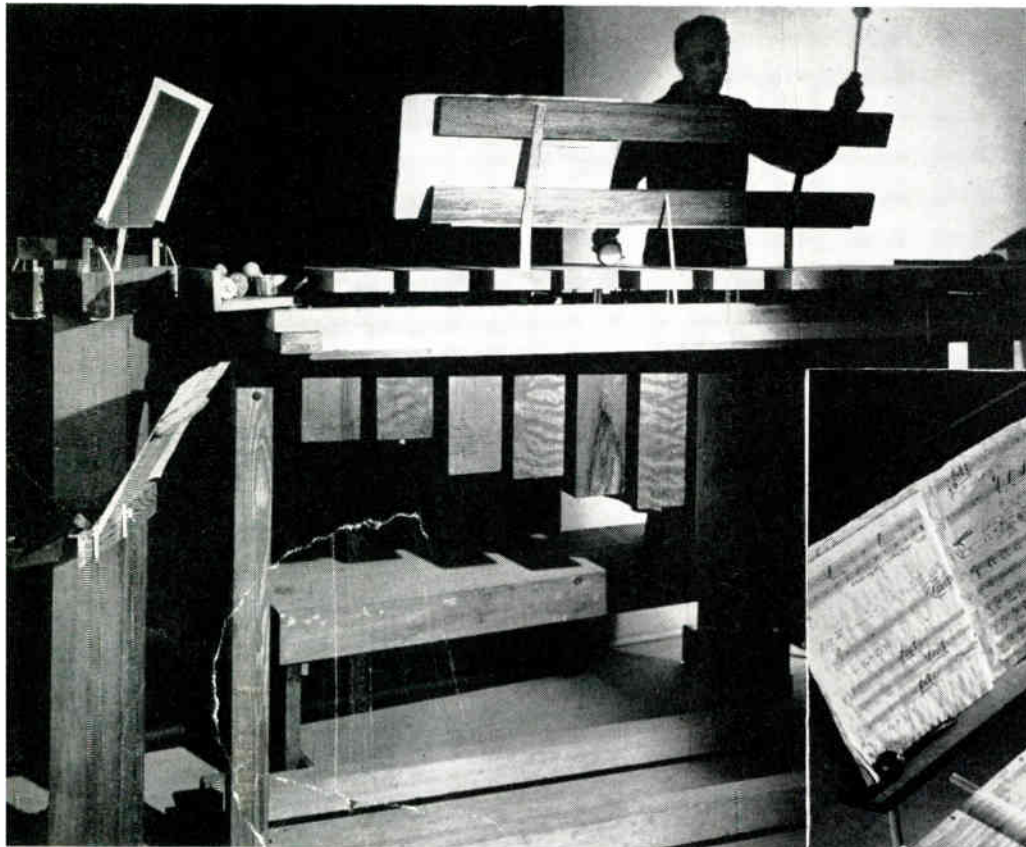

Above: Largest of the instruments is the massive bass marimba, made of 11 Sitka spruce blocks over redwood resonators. It is a percussion instrument whose deep, sonorous tones are produced by mallets of different sizes, or with the palms of the hands. At the left is the eroica and woodblock, a Pernambuco block giving the A below cello C, and a high, multi-toned wood block

Below: The surrogate kithara has sets of strings on long, resonating boxes, used mostly to produce sliding tones. In order to perfect his instruments, Harry Partch had to learn to play them himself. Then, from his own experience, he taught others. The musicians in his orchestra are mostly jazzmen



both highly trained and less experienced, have listened soberly and reacted violently, for or against his music and arguments. A few have felt that his was the voice of their time and of the future; others have come to shocked resistance, in highly vocal opposition. Those who are interested in the future of music are under some obligation to listen to one about whom there is so great a diversity of opinion. It is time for Harry Partch to speak for himself." And through the records that are now available, Partch is able to do so.

In a recent letter which I received from him, Partch remarked that he has been isolated from the musical

to express himself he needed both new scales and instruments. He then began to write music on the basis of harmonized spoken words, music for new instruments that could play the new scales he felt he needed. He set to such music everything from the Bible and Li Po to a hobo's letter and some hitchhiker inscriptions copied from a highway railing. One of his earlier sets of five 78-rpm. records¹ contains some of these, and on the introductory side Partch introduces himself, saying, "I am Harry Partch, a composer. My compositions, a few of

¹ Available from Radio Recorders, 7000 Santa Monica Blvd., Hollywood, Calif.

which are here recorded, employ instruments, a scale, and manner of performance different from that of current practices. The scale provides, in pure intonation, 43 notes to the octave. Pure intonation is a mathematical and acoustical solution to tuning, scale, and harmonic problems. With it the ear is final judge in the question of consonance and dissonance." He follows this with a demonstration of several of his instruments: the chromelodeon, the harmonic-canon, the adapted guitar, and the bass marimba. It is immediately exciting to imagine the possible subtleties and intricacies of a 43-note scale; and the delicate chromatic rise and fall that his instruments can produce is fascinating for any musician who is interested in the expansion of instrumental resources.

In the matter of setting his texts, as they are heard on records, I cannot feel any such excitement, for they sound unabashedly amateurish. Partch himself, having first evolved his theories and composed his music, then built the instruments to play it, trained his players, and lastly intoned and spoke many of his own lines. Should we even expect him to be equally convincing in each activity? Unfortunately, I have directed too many radio and television dramas to award even an A for effort to Partch for all his thought-out singsong intonings. But what is most interesting and, in fact, truly important, is the music itself, for it is an unending out-spinning of new sounds, deeply felt and filled with intended meaning. The instrumental parts are all intriguing. A piece played on the poetically-named cloud-chamber bowls is a carillon-like prelude that is a truly satisfying vignette.

Cloud-chamber bowls are the sawed-off tops and bottoms of Pyrex carboys suspended from a beam. His other instruments are equally unorthodox: the marimba eroica has three large redwood blocks and resonators, the largest sounding the lowest note on the piano (but sounds like the lowest sounds of a 'cello); the kithara has 72 strings of equal length, arranged chordally in groups of 6; and the harmonic canon, an elaboration of the Greek monochord of 44 strings and movable parts.

One of Partch's major and most impressive efforts is the setting of *Oedipus*, in the version of William Butler Yeats. Partch had visited the poet in 1934 while he was conducting research on unusual instruments in England. Yeats became absorbed in his musical plans and was eager to hear the union of dialogue and music as Partch conceived it. But not until seventeen years after their first meeting did the work finally appear. The actual composition of the music was begun in March, 1951 and completed in July of the same year. The orchestra for which the score of *Oedipus* is written is composed of a marimba eroica, bass marimba, kithara, harmonic canon, chromelodeon sub-bass, chromelodeon, diamond marimba, cloud-chamber bowls, microtonal string bass, bicrotonal cello, clarinet, soprano saxophone, and adapted guitars. Nearly all of the performers were jazz-band musicians. While the Greeks had intoned their dramas, Partch did not attempt to recreate any ancient Greek concepts other than a synthesis of language, music, and dance as a dramatic unity.

Partch stated that he had not consciously linked the

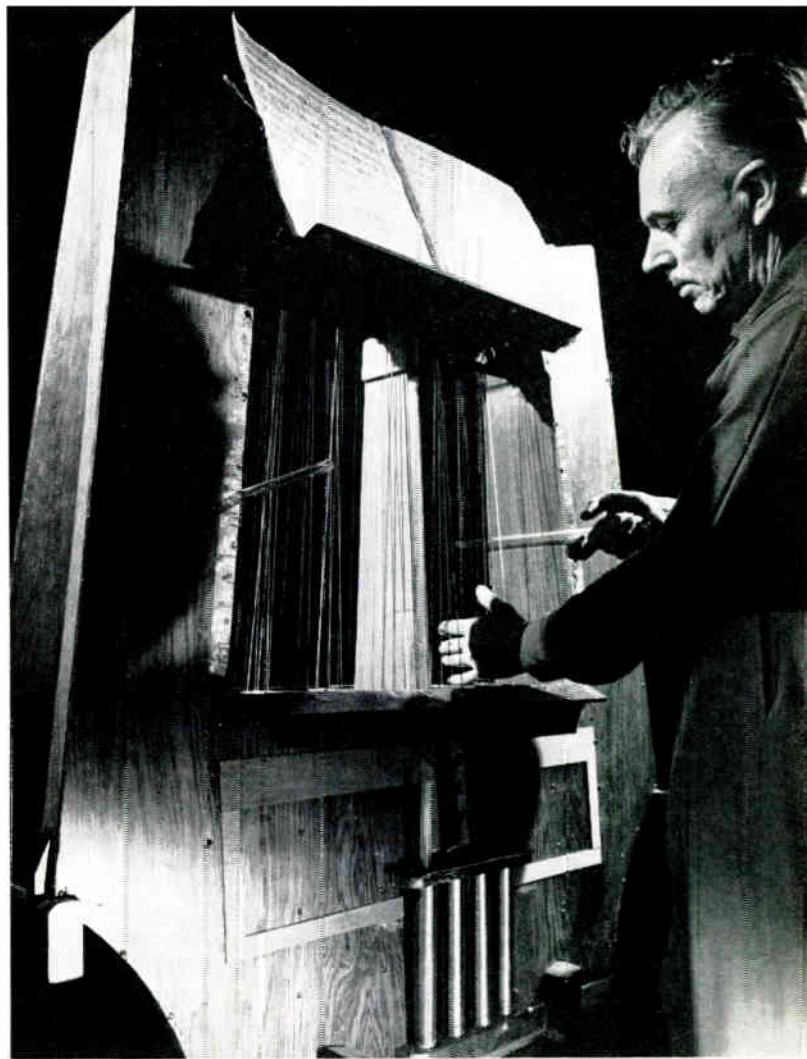

Kithara has 72 strings of equal length, arranged chordally in groups of 6; each group represents a tonality. Sliding rods produce higher chords

ancient Greece of Sophocles and this conception of his drama — twenty-four hundred years later. Instead, he wanted to present it as a "human value, necessarily pinned to a time and place, necessarily involving the oracular gods and Greek proper and place names; but still not necessarily Greek." *Continued on page 46*

The chromelodeon is a converted reed organ, with a 43-tone-to-the-octave scale spread over 3½ octaves. Painted keys indicate subtlety of tones



January-February 1955

REVIEWS of POPULAR ALBUMS

Songs You've Heard Before — Voices You'll Still Remember

POP RECORDS literally pop across the musical horizon so quickly that this term by which they are known describes them literally. Among the great number in that category, some have sufficient merit that, months or years later, they are revived. Of these, a few have such vitality as to achieve the status of "popular" records. It's a nice word, popular. It covers so much.

There is no way to guess which of the pop records will become popular. Record reviewers won't risk their reputations by trying to guess, and most of them are forgotten by the time reviews could get into print.

Only when they prove to be so important that they reappear in popular albums is there justification for reviewing them, since such recognition implies that they are worthy of a place in the collections of people who enjoy tuneful music.

Following are reviews of 15 popular albums which represent the best offerings of music, artists, and orchestras in this category. You are sure to find some of your special favorites among them.

Songs in Intimate Style



that she just doesn't have it like she used to. Decca DL 5539.

A 10-in. LP of songs by Peggy Lee, running from *Baubles, Bangles, and Beads to Love You So*. This record may please Miss Lee's fans, but it shows all too convincingly to these ears

Music for a Rainy Night

A pleasing 12-in. LP of warm, memorable standards by Paul Weston's orchestra. Besides Mr. Weston's obvious artfulness, one of the things I like best about his music is its complete lack of saccharine monotony. Occasionally Weston writes in a key to a solo break, so that the musicians themselves can feel a sense of freedom and of personality with the music. He maintains a constant beat, and paces his selections well. Columbia CL 574.

All Time Dance Party

For this one your sense of humor and rhythm must be somewhere near at hand. What Paul Whiteman and this "New" Ambassador Hotel Orchestra did was simply to re-record at fairly high audio quality a flock of his great old hits — *Avalon, Japanese Sandman, Whispering, Oh Me, Oh My, Oh You, You're Driving Me Crazy*, etc. — to the exact arrangements he was using in the Roarin' 20's. So it's corny! It's peppermint candy too! Coral 56119.

The Honor Roll of Hits

Here is a series of 10-in. LP's, of which one side of each is devoted to four of the top songs of each year, 1926-1945. As far as I can figure out, none of the selections was freshly recorded, although all have a fresh quality. RCA Victor simply dug into its catalog and picked out older records to fit the occasions. Nor did the year of recording matter in most cases. In other words, a record originally issued in '42 might be used for the '27 album, etc. The records run roughly from the period of the inevitable Glenn Miller and Tommy Dorsey to Eddie Fisher, Perry Como, Dinah Shore, and Hugo Winterhalter.

It's rather a pleasant series, somewhat innocuous, but here was the opportunity for a great recording firm to release a work of monumental significance and entertainment, and it didn't happen. Each year should have had its separate 12-in. LP, and wherever possible the original recording should have been used. Or when the old disk wasn't serviceable, a new platter should have been cut re-creating as nearly as possible the arrangement and feeling of the song and the time. Thus the series would have become a documentary of the best in popular music, together with a documentary of RCA-Victor's mighty part in its creation. I feel strongly that RCA-Victor, by this present "Honor Roll of Hits", didn't do in any way, shape, or form what, by its own giant prestige in the record world, it is capable of doing. What other record company has the catalog!

Let's be specific as a further point. Take 1926. This single side has *When Day Is Done* by Perry Como, *One Alone* by Ralph Flanagan, *The Birth of the Blues* by Dinah Shore, and Eddie Fisher sings *Remember*, a song Irving Berlin happened to write in 1925. Therefore, overlooked and un-honored are marvelous 1926 hits such as *The Black Bottom*, *The Blue Room*, *The Girl Friend*, *Someone to Watch over Me*, *Bye Bye Blackbird*, *When the Red, Red Robin Comes Bob*, *Bob Bobbin' Along*, *In a Little Spanish Town*, *Breezin' Along with the Breeze*, *Gimme a Little Kiss*, *Lonesome and Sorry*, *Moonlight on the Ganges*, and *Sweet Georgia Brown*. Plenty of tunes here for a whole wonderful album of '26 hits. And that goes for all the other years too. RCA-Victor LPM 3175 — LPM 3184.

Crewcuts on the Campus

A flock of old varsity pigskins are tackled hard by this fantastically popular quartet. If you like the feeling of being jarred right smack out of the middle of your living room, then this may be just your brand of bourbon. Actually, the Crewcuts sound

like nothing so much as four guys all selling apples for the same firm on different corners of 52nd Street. They may be fresh and youthful, but they sure can shout out of tune. Mercury MG 25200.

While We're Young

Mrs. Rosemary Clooney Ferrer is a young woman who excels in a number of artistic endeavors. Her husband, Jose Ferrer, may have some other notions, but for my money her excellence lies chiefly in the charming and brilliantly clear way she sings popular songs, especially very good songs like these. Columbia CL 6297.

Great Music Themes of Television



In full dress, the polished Mr. Winterhalter and his orchestra bring you arrangements of the themes of the Eddie Fisher Show, the Hall of Fame, Jackie Gleason Show, Voice of Firestone, Chesterfield Supper Club, Philco Playhouse, Robert Montgomery Presents, Mama, Arthur Godfrey Show, Studio One, I Love Lucy, and Kraft Theatre. This affair is wonderfully enjoyable, even though several of the themes are little more than musical strains. Actually, the word "great" can only be applied to Ferde Grofe's *On the Trail*, which was composed long before the days of "I Love Lucy" and will be remembered long after the banalities of Desi and Lucy are completely forgotten. The audio quality gets a high rating. RCA-Victor LPM 1020.

Barrelhouse, Boogie, and the Blues

Well, man, if you've ever had a belt in the back, this is it! So maybe I'm getting old, but I can't take it too well. I mean, sometime you've got to let up. But not this Ella Mae Morse. She swings, she drives, and it's all about as subtle as coal going down a chute. Capitol H513.

A Star Is Born



Recorded directly from the sound track of the Judy Garland film. Unquestionably, Harold Arlen and Ira Gershwin have written better music and words than they did for "A Star Is Born".

Still, *The Man That Got Away* and *Someone at Last* are out of the next to top drawer, and the others are from the one directly below. And even a mediocre tune in the hands of a marvelous artist such as Judy Garland can become something fine. I confess to being one of her warmest fans, and

Concluded on page 51

Music at Home



Fig. 1. This speaker system, one of two in the installation, contains 4 woofers, an intermediate speaker, and 8 tweeters

A Record Collector Built This

INSTALLATION for DISCS and FM

MY INTEREST in music at home goes back 23 years and 25,000 records. Not long ago, a friend who was visiting me asked very casually: "Do you have *The Night We Did the Boom-Boom by the Sea?*" Just as casually, I walked over to a section of my files and said, "Why, of course. Here it is — a 1923 disc by OKEH, recorded by Fred Hall and his Sugar Babies." I could have pulled out just as quickly any of the discs that there are of Jerome Kern's music or Gilbert and Sullivan, Victor Herbert, or Rudy Newman. My collection of the first recording of such stars as Maurice Chevalier, the Harvey Girls, Rudy Vallee, Al Jolson, and the Boswell Sisters — to name a few — is almost complete, and I'm not missing many of the opera and symphonic records, either.

In 1931, when I brought home my first package of six discs, I had no in-

tenion of becoming a record collector. My audio equipment has undergone some drastic changes, too, since that time, as you can judge from the photographs here. Naturally, as my interest in records grew, I wanted the best equipment for playing them. Then, when I became a critical listener, I wanted FM reception, so that I could have the best reception of radio programs.

By Harold H. Smith



From experience in improving my installation as new equipment was brought out, I came to the conclusion that what I needed was a very flexible setup that could be changed, when necessary, without tearing everything apart, or building a new cabinet. Also, I needed connections and switches so that, if I wanted to try out a new instrument I could hook it up and disconnect it easily. Then, although I must confess that it may seem like putting two kinds of frosting on one cake, I

built an enclosure for a set of Bozak speakers in one corner of my listening room, Fig. 1, and put an Electro-Voice speaker in their standard cabinet in the adjacent corner. The equipment cabinet, Fig. 2, is at the opposite end of the room in what I call the listening area, so that I can adjust the equipment from a point where I can hear the music to best advantage, and switch from one speaker to the other, or use both at the same time.

The equipment cabinet is 36 ins. wide, $30\frac{3}{4}$ ins. high, and $18\frac{1}{2}$ ins. deep outside, constructed of $\frac{3}{4}$ -in. mahogany plywood, with $\frac{1}{2}$ -in. shelves. The top is double-hinged, so that it folds back to expose the turntable. Each compartment is made up of a front panel on a sliding shelf, a type

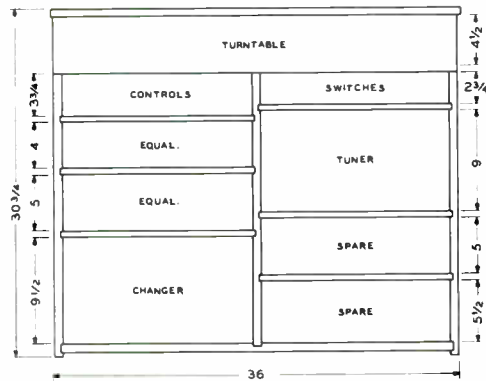

Fig. 3. Dimensions of the equipment drawers. Cabinet is $18\frac{1}{2}$ ins. deep

of construction that I can recommend highly, since it provides access to each unit without having to move the cabinet.

Although the dimensions of each compartment are generous, and there are two spares at the bottom right, the cabinet is not awkwardly large. Fig. 3 shows the size of each section.

At the top there is a Rek-O-Kut B-12H turntable, an Audak arm and cartridge, and a Clarkstan arm with a GE cartridge. Since this photograph was taken, I added a Weathers arm and cartridge and a Gray viscous-damped

arm for Fairchild and GE cartridges for the turntable.

The control panel is simple enough in design, yet it gives me almost as many combinations of equipment as you find in most dealers' demonstration rooms. From left to right, there are wafer-type switches for:

5-position pickup selector.

16-position preamplifier input.

Above: impedance switch for an Interelectronics amplifier.

Below: impedance switch for a McIntosh 50W-2 amplifier.

6-position preamplifier output.

Above: impedance switch for a McIntosh MC-30 amplifier.

Below: speaker switch to cut in either or both speakers.

5-position amplifier output.

5-position amplifier input.

3-position tuner output, for connection to the main tuner output, the detector, or the detector and a $\frac{1}{2}$ -megohm resistor for the McIntosh amplifiers.

4-position tuner output for connection directly to an amplifier, or to any of 3 preamp input connections.

Telephone jacks under the switches are for plugging in instruments for test and comparison. This is particularly useful when my friends bring in equipment, and ask me to try it out in my system.

Next down the left side is a Fisher audio control and the Scott Dynaural preamplifier. The latter is particularly useful for old records, to reduce the noise characteristic of shellac disks. The bottom section houses a Garrard changer. On the right, the AC panel carries 4 pilot lights and switches for the turntable and the three amplifiers. Under this control panel is a Fisher FM-AM tuner, with its own preamplifier.

What the remaining compartments will be used for I don't know now, but I'm sure they won't be holding records much longer!

The speaker enclosure, Fig. 1, is a modification of the usual corner type. Instead of the usual 45° angle, it was



Fig. 2. Operating controls, and the turntable and changer are in this cabinet, at the opposite end of the room from the speakers



designed to face the corner diagonally opposite, in a room 24 by 15 ft. This provides direct radiation to the listening area. A 45° enclosure would be aimed at a point 15 ft. down the 24 ft. wall, so that part of the sound would be heard in the listening area directly from the speaker, and partly by reflection.

Details of the enclosure are shown in Figs. 4 to 6. The

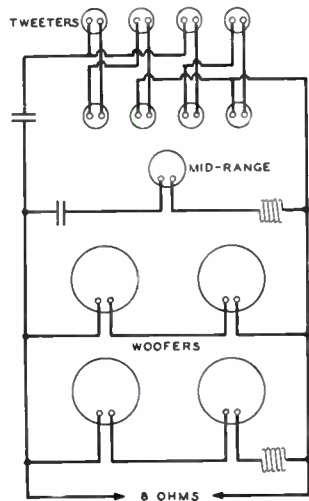
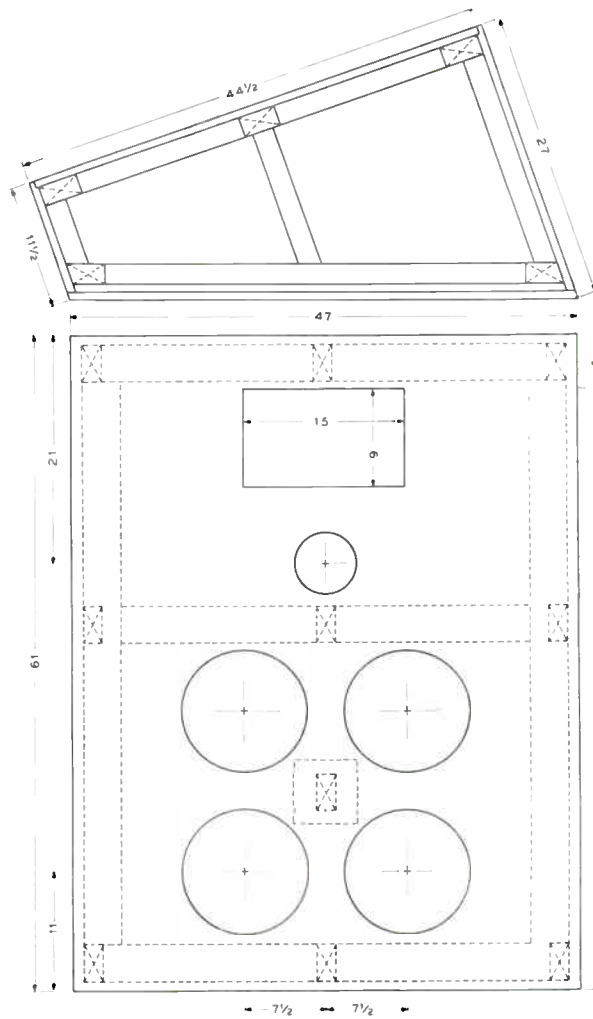

Fig. 7. Wiring diagram of the speaker system. Inductors and capacitors are contained in the standard Bozak network assembly

framing is of 2 by 4's with a 1½-in. front panel made up of a ¾-in. pine plywood panel and a ¾-in. mahogany panel on which the speakers are mounted. The two panels are glued and screwed together. Fig. 6 shows the overall dimensions, adding up to about 25 cubic feet. The enclosure is lined with 2 ins. of fibre glass. All joints are secured with screws and glue.

The speakers are the standard Bozak *Continued on page 62*



Figs. 4 and 5, below: rear and front views, showing the construction of the speaker cabinet, emphasizing heavy, well-braced design. Fig. 6, above: front and top of the cabinet, with the overall dimensions

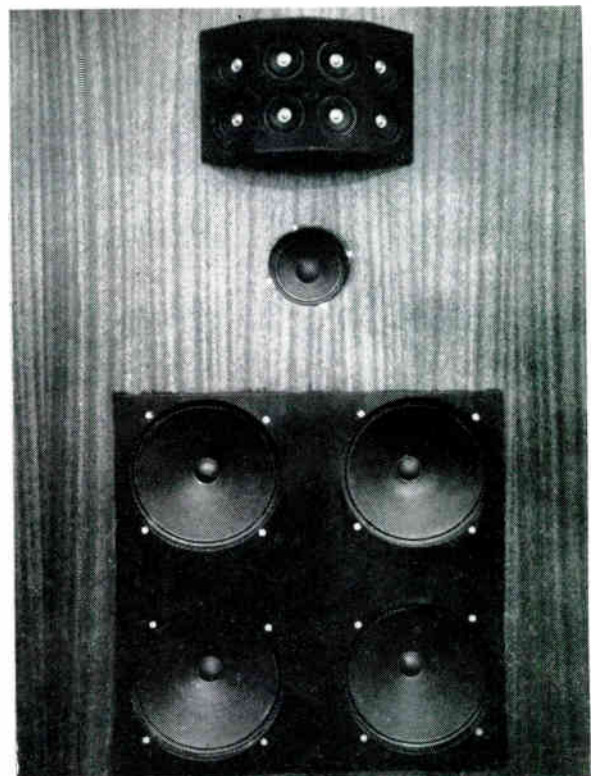
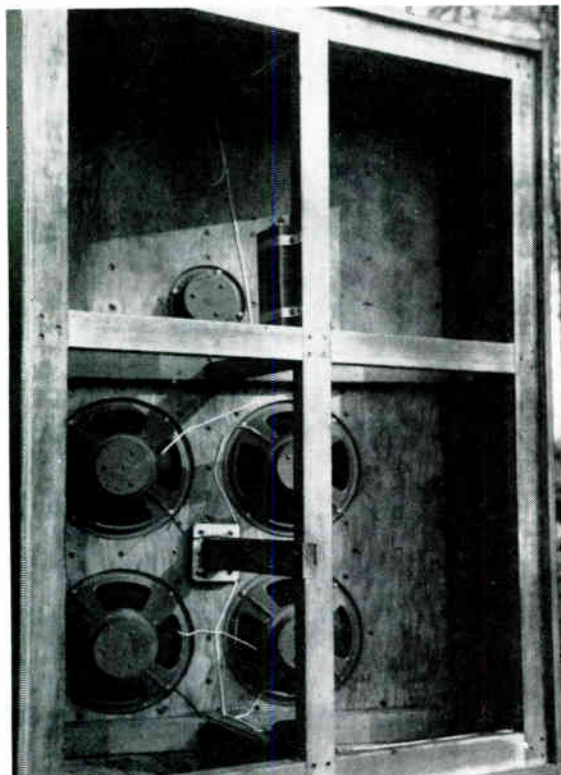

Hi-Fi Projects for the DRAWING TABLE WORKSHOP • No. 3

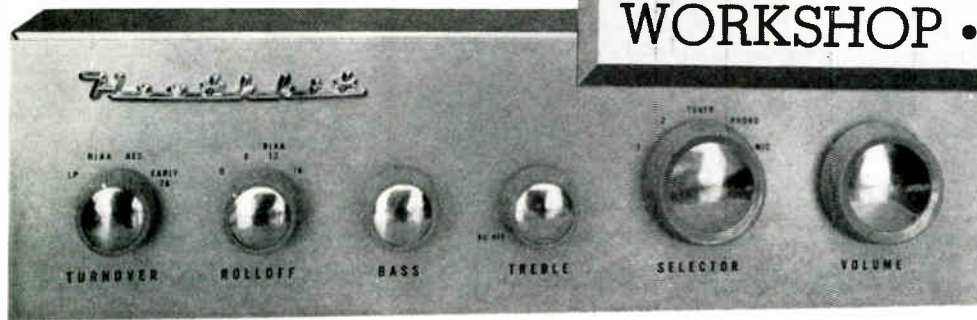

The assembled Heathkit preamplifier, model WA-P2

By JAN SYRJALA

WHEN you look at the Fig. 1, showing the parts supplied for assembling the Heathkit preamplifier model WA-P2, you may want to ask: "How much time did it take to find and remedy all the mistakes you made in the wiring?" To which I hasten to reply: We put this unit together without a single error. It worked when we first hooked it up to the W-4M amplifier described in Project No. 2, with which this preamp is intended to be used.

If you like crossword puzzles and scrabble, or doing

given in the book. Here are some general suggestions that should prove helpful if you are not experienced in putting audio equipment together:

Use a light-weight soldering iron, with a tip not more than $\frac{1}{4}$ in. in diameter. A heavy iron will tire your wrist, and the tip will be too big to reach into some of the tight places. Unless you are accustomed to the gun type, a straight electric iron will be much easier to handle.

You probably have most of the tools shown in Fig. 2, but you may need to add the tweezers, wire-stripper, and crochet hook. The tweezers and crochet hook are essential for pulling and pushing leads into places where the pliers

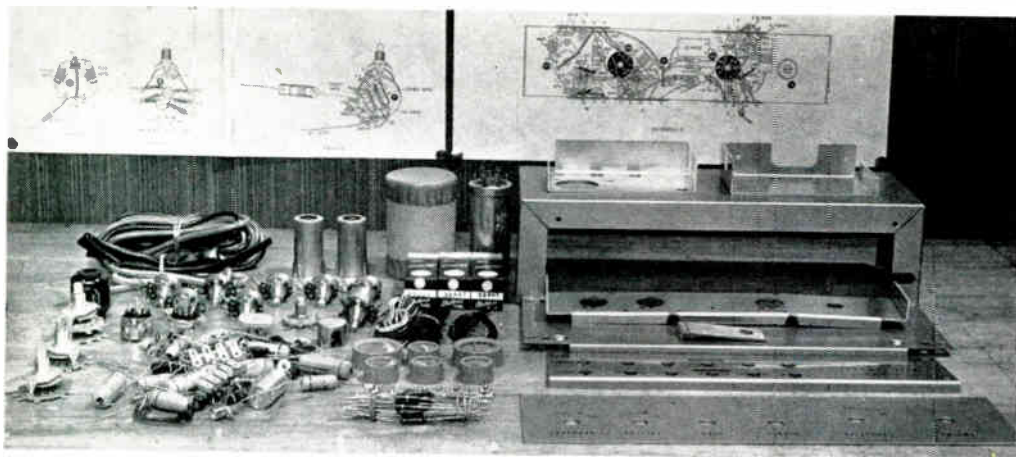
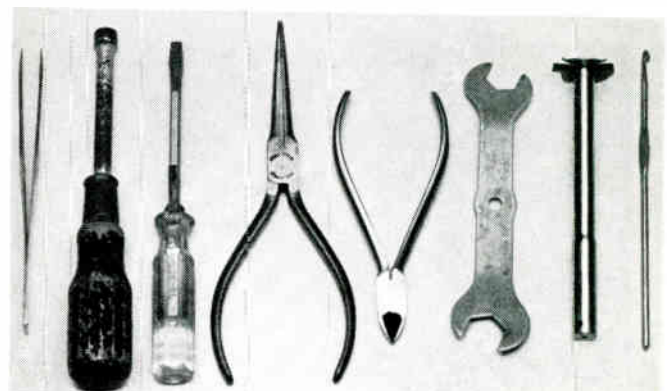

Fig. 1. Parts for the preamplifier. Round box at rear is filled with screws, nuts, small hardware. Fig. 2. Only these tools, plus a soldering iron, were required for assembling and wiring.

things that require mental agility and manual dexterity, you'll have fun with the WA-P2. But let's face it — if you're all fingers and thumbs when you must use the tools shown in Fig. 2, plus a soldering iron, you'd better get an assistant to do the actual work while you read and check off the step-by-step instructions from the book which accompanies the kit. It's easy if you know how, but sloppy workmanship won't do. However, while this job does take a certain amount of skill, you can compensate for what you lack in that respect by studying the instructions thoroughly, and by proceeding without the slightest deviation from the succession of assembly steps as they are



won't go. The wire-stripper is a must; it is so easy to nick the wire if you use cutting pliers to pull off the insulation on the hook-up wire supplied in the kit. The wire-stripper in Fig. 2 had a handle originally, until it came into close association with a hot soldering iron.

did, for I had an assistant to read the instructions for me, pick out the components, and to follow my work to make sure I didn't go wrong.

The first stage, Fig. 3, merely involves mounting the sockets, hum control, and terminal strips on the chassis,

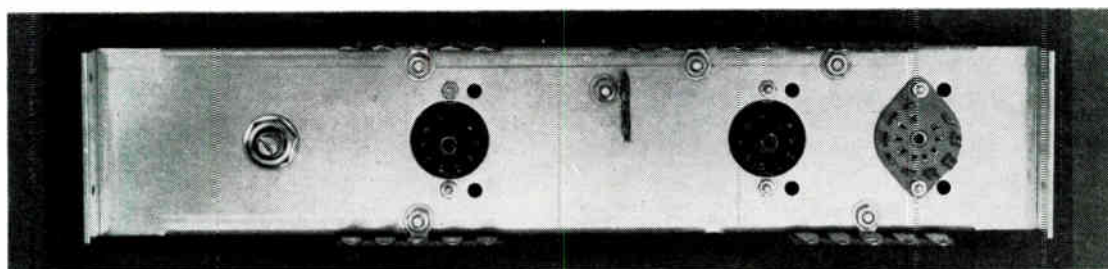

Fig. 3. First assembly calls for mounting these parts on the chassis. This view corresponds with Pictorial B in the instruction book

TIMETABLE FOR PREAMPLIFIER ASSEMBLY STAGES

Chassis, 1st stage	Steps 1 to 11	15 minutes	Bracket sub-assembly	Steps 53 to 68	25 minutes
Volume Control sub-assembly	Steps 12 to 16	20 "	Rear Panel	Steps 69 to 92	70 "
Selector Switch sub-assembly	Steps 17 to 24	20 "	Chassis, 2nd stage	Steps 93 to 97	35 "
Treble Control sub-assembly	Steps 25 to 31	10 "	Chassis, 3rd stage	Steps 98 to 138	140 "
Bass Control sub-assembly	Steps 32 to 36	10 "	Final Assembly, 1st stage	Steps 139 to 162	65 "
Rolloff Switch sub-assembly	Steps 37 to 40	5 "	Final Assembly, 2nd stage	Steps 163 to 197	115 "
Turnover Switch sub-assembly	Steps 41 to 52	65 "	TOTAL TIME:		9 hours, 55 minutes

Above all, don't allow yourself to be tempted into taking short cuts. Sure as the world, you'll get into trouble of one sort or another, and lose more time than you hoped to save. If you have one of those signs over your work bench that says "Think," add another bearing the two words "Be Patient!"

The illustrations in this article correspond to the various drawings in the instruction book, and each is identified

without any wiring at that point. Then come six sub-assemblies, Fig. 4. These are, from left to right, the volume control, selector switch, treble control, bass control, roll-off switch, and the turnover switch. Also, there is a bracket sub-assembly, Fig. 5. At step 52, the sub-assemblies had been mounted on the control panel, as shown in Fig. 6.

As you can imagine, the assembly work is made much

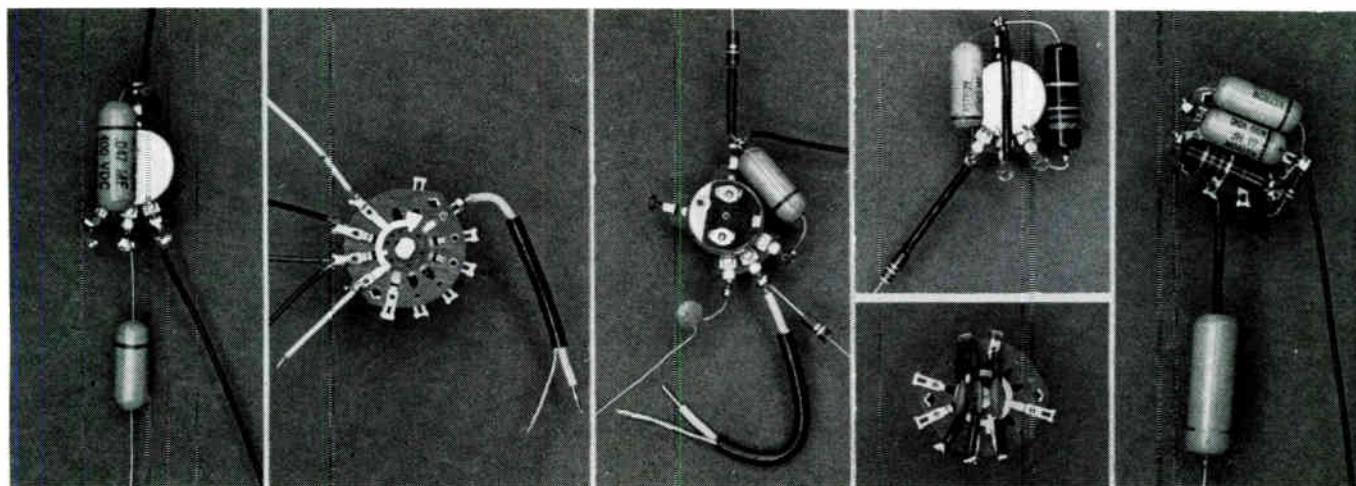

Fig. 4. Next come these six sub-assemblies, called for in steps 12 to 65. Compare these with Figs. 5, 7, 9, 11, 12, and 13 in the book

by the same numbers or letters that appear in the book. You'll find it helpful to compare each sub-assembly and the larger assemblies with these photographs, because they supplement the information conveyed by the drawings.

A timetable is given here, against which you can check your progress at each stage of the assembly. Don't try to beat it by hurrying. If you are very skillful, you may do better. But don't feel embarrassed if you take longer than I

easier by breaking it down in this manner, rather than mounting the controls first, and doing all the wiring afterward. The total time to do the assembly and wiring represented by Figs. 3 to 5 inclusive was 2 hours and 50 minutes. We made a few notes as we went along:

1. Study the drawing of the rolloff switch carefully. We made a mistake on the wiring, but caught it when we found an extra wire on one of the contacts.

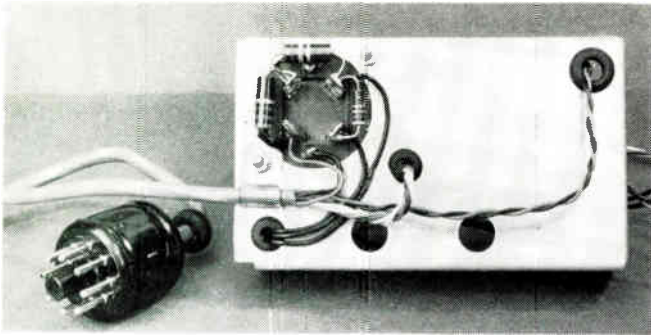

Fig. 5. In the instructions, this bracket sub-assembly is mark Fig. 14

2. At step 45, do not let the lead touch the end of the frame that holds the switch wafer.

3. At step 67, we tinned each wire very smoothly before inserting it in the corresponding pin of the plug. That

Assembly and wiring of the rear panel, Fig. 7, started at step 69. This looks easy enough in the picture, but it was necessary to proceed with great care, because connections had to be made at very close quarters. The soldered joints must be made quickly, so as not to damage the insulation on the wires. Also, we checked the pin jacks carefully to be sure that they were concentric with the holes in the panel.

Things began to get still more complicated when we tackled the second and third stages of the chassis assembly, steps 93 to 138. Not that there were any special difficulties other than a little confusion due to the fact that Fig. 16 in the instruction book showed the tube socket upside down, as we viewed it. However, the tweezers and the crochet hook came into more and more use for pulling and pushing the leads into the holes of the soldering lugs. In many cases, the easiest way to get the leads into the holes was to

Fig. 6. At step 69, the sub-assemblies are mounted on the front panel, and the first wiring has been done. This corresponds to Pictorial C

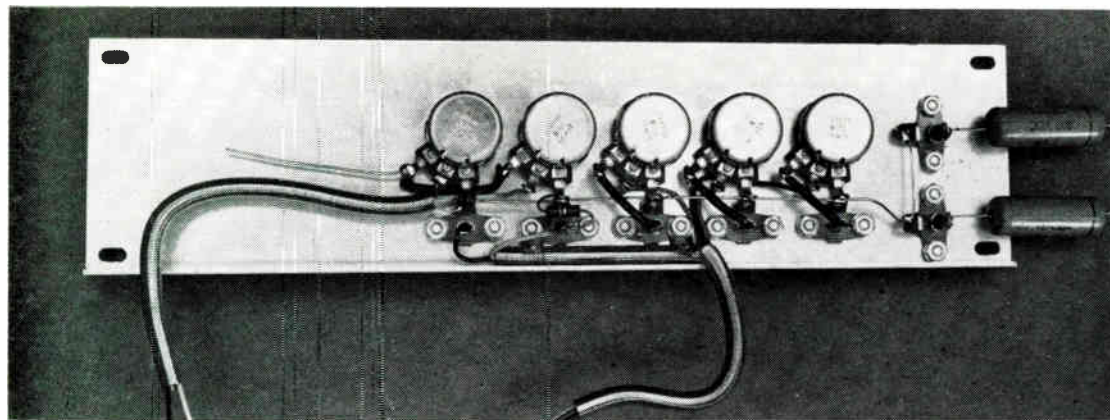
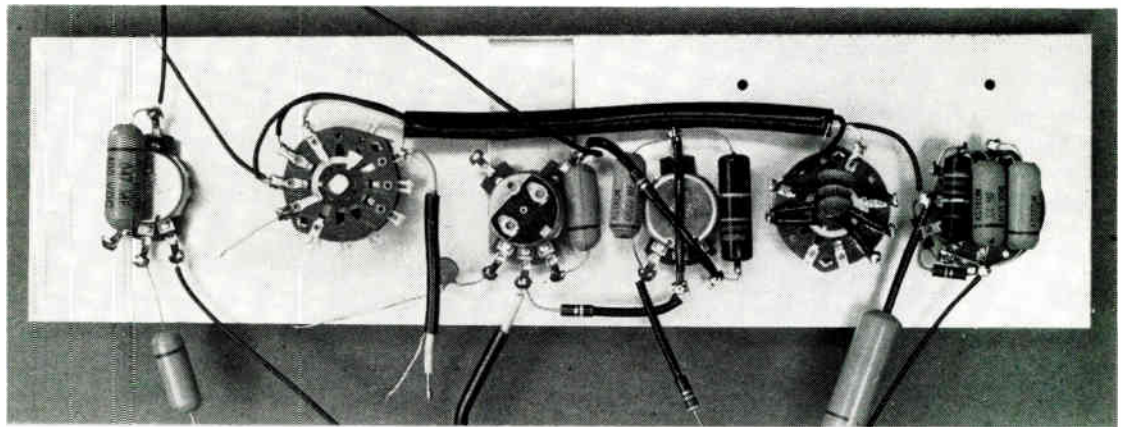
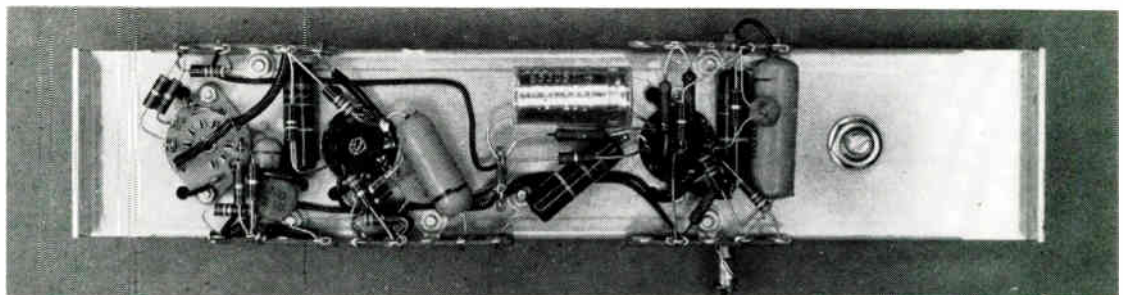

Fig. 7. Mounting and wiring these parts on the rear panel, steps 69 to 92, took 70 minutes. In the book, the drawing of this unit is Pictorial D

helped to make the solder run down inside the pin. Then we pulled on each wire to make sure that it was soldered, and not just held by the rosin flux.

cut the leads so they were just a little extra long. Then, after soldering, we snipped them off close. It is necessary to watch those snippings and any drops of excess solder, to

Fig. 8. Second and third stages of the chassis wiring called for very careful workmanship. This corresponds to Pictorial E



make certain they don't lodge at points where they could cause short circuits! Here are some other notes:

1. Be very careful about bending leads near the ends of the resistors. The right way is to hold the lead with flat-nose pliers and then bend the lead at a point next to the

struptions. The views in Figs. 9 and 10 correspond to the last drawings in the book. Our caution really paid off, for it wasn't necessary to make a single change in the work on these final stages. With the chassis fitted into the cover and the knobs in place, that completed the assembly of

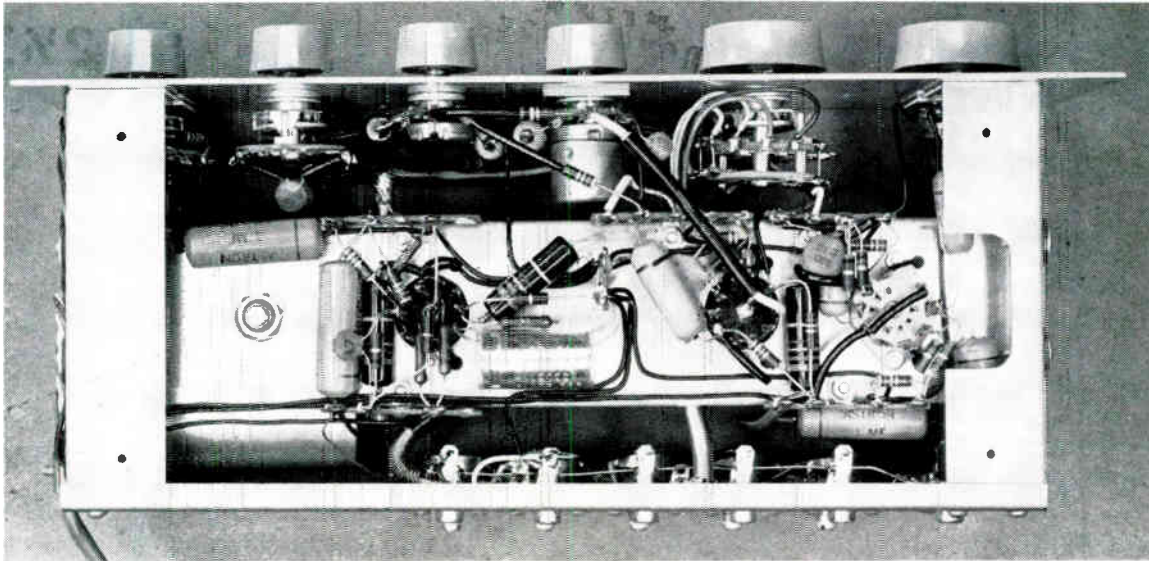

Fig. 9. The unit begins to take form in the first stage of the final assembly. This under-side view corresponds to Pictorial F

pliers and away from the end of the resistor. Unless you hold the lead in that way, you may break the end of the resistor when you bend the wire!

2. Special precaution must be taken when soldering short leads from the low-noise resistors. Hold the lead close to the resistor with flat-nose pliers while you apply

the preamplifier. Hooked up to the W4-M amplifier, a turntable, and speaker, out came the music.

And there's nothing like the satisfaction of doing a job of this sort and having it operate perfectly when its all hooked up and the current is switched on! Incidentally, this is an excellent way to become acquainted with the

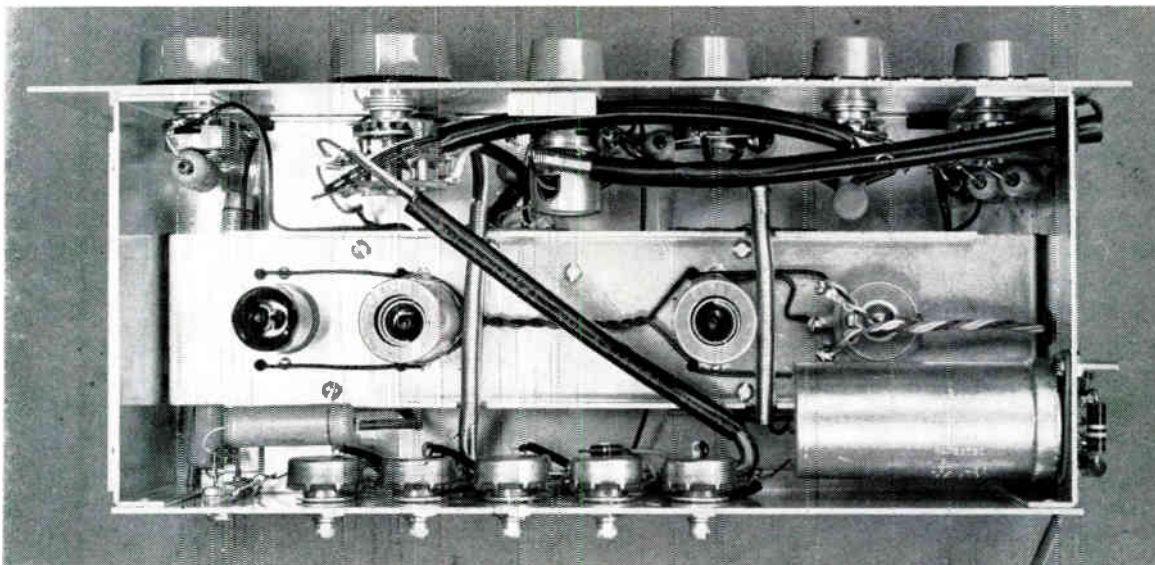

Fig. 10. Top view of the final assembly, ready for mounting in the metal case. In the instruction book, the drawing is marked Pictorial G

the soldering iron. This draws heat from the lead, so that the resistor will not be over-heated.

Work on the final assembly stages, step 139 through 197, proceeded more slowly as we approached the end, for we studied and checked each step with extra care, to be sure we were doing it exactly in accordance with the in-

components which go into audio equipment, and to gain an understanding of the careful workmanship that must go into factory-built units.

JAN SYRJALA is an audio consultant, and a designer of custom-built equipment. With Alex Stevens, he designed and built the crystal-controlled FM receiver described in the November-December issue of MUSIC at HOME. His address is 250 W. 14th Street, New York 11, N. Y.



Better Bass Reproduction

Part 3. Answers to Questions about the Air-Coupler; Details of the VAN-AMP, a Variable Audio Network and Amplifier—By Milton B. Sleeper

BEFORE taking up the subject of variable networks, it may be helpful to discuss some of the letters received from audio enthusiasts who have built Air-Couplers. Here are typical questions and answers which may supply information that will be useful to you, too:

QUESTION: After I completed my Air-Coupler, I tried it out by connecting it across my coaxial speaker. Results were disappointing. Would I be justified, under the circumstances, in going to the expense of adding a network?

ANSWER: You cannot expect to get satisfactory results without a network. With the Air-Coupler across your coaxial speaker, neither one can operate efficiently.

QUESTION: Is it all right to mount the Air-Coupler vertically, or must it be horizontal?

ANSWER: It can be mounted in any position without affecting the results *provided* the enclosure is braced solidly, and not merely held by its own weight. Otherwise, part of the energy from the speaker is consumed in vibrating the enclosure; it should all go to moving air.

QUESTION: The output of the Air-Coupler seems low compared to my mid-range speaker. Is there a remedy for this lack of balance?

ANSWER: All loudspeakers are inefficient at the lowest frequencies; some more so than others. The Air-Coupler enclosure simply enables the speaker to operate more efficiently. Mid-range speakers in conventional mountings vary widely in efficiency, also. Consequently, a given combination of Air-Coupler and mid-range speakers may be so much out of balance that this condition cannot be remedied by the level controls on the network. Probably, then, the fault lies in the particular type of speaker used for the Air-Coupler.

QUESTION: Are finished Air-Couplers sold in any of the hi-fi equipment stores?

ANSWER: Not as far as we know at this time. However, we have been advised by Stromberg-Carlson, owners of the patent on this type of enclosure, that they have issued licenses to several manufacturers, and two companies are advertising Air-Couplers and accessories for sale by mail.

QUESTION: I have an 800-cycle network. Will it be all right to use it with the Air-Coupler?

ANSWER: Any well-designed network is intended for use with speakers of specific impedance values. That point must be checked first. Also, level controls are necessary to balance the Air-Coupler and the mid-range speaker.

Finally, if the Air-Coupler is spaced from the mid-range speaker, you will want to keep voice frequencies out of the Air-Coupler, so that the crossover point should be down at 175 cycles.

QUESTION: I want to build an Air-Coupler between the beams under my living room floor, but the space is only 14 in. Will that change the results?

ANSWER: This will not affect the performance, since the inside of the standard design is 14½ in. However, the enclosure between the beams must be so constructed that the inside depth will not be more than 4½ in. Any increase in that dimension will affect the results adversely. (See September-October issue for the dimension drawings.)

QUESTION: I want to mount the Air-Coupler behind a 4-in. partition. How should I arrange the opening through the partition in front of the slot?

ANSWER: It is advisable to flair the opening at about 45° on the two long sides.

QUESTION: Where can I get the winding data for the network inductors? I'd like to make my own.

ANSWER: Details of the coils were not published, partly because dealers do not generally carry the wire required in a single length, and because the inductance obtained from a given number of turns may vary considerably if the coils are random-wound. In any case, the inductance should be checked by actual measurement, because if there are shorted turns the inductance value will be reduced. However, if you want to wind your own coils, the Readers' Service Department will furnish you with the data.

Purpose of the VAN-AMP

The VAN-AMP is to be used in place of a fixed network. As the name indicates, however, it is a variable audio network which provides voltage amplification of approximately 8 times. Thus, in addition to permitting the adjustment of the crossover to any value from 80 to 1,000 cycles, it introduces gain, whereas a fixed network causes a loss of power between the power amplifier and the speakers.

There is another important difference in favor of the VAN-AMP over a fixed network which, while adding slightly to the cost of an audio system, contributes substantially to the performance. Instead of being connected between the amplifier output and the speakers, as is the case with a fixed network, the VAN-AMP is connected to the output of the preamplifier. Then its upper-range

and lower-range outputs are connected to separate power amplifiers. This has several advantages:

1. The VAN-AMP operates at a point in the system where it handles the least amount of power; a conventional fixed network must carry the full output of the power amplifier going to both speakers.

2. Only one range of frequencies is fed to each amplifier, thereby reducing intermodulation distortion.

3. Independent control of each range is possible since, in addition to separate level controls on the VAN-AMP, the output of each amplifier can be adjusted by its own control. With a fixed network, adjusting the level for one range affects the level of the other, and neither can be reduced to zero for checking the speakers one at a time.

4. The VAN-AMP answers the problem of feeding

The use of the VAN-AMP is by no means limited to Air-Coupler systems. It is suited to any combination of low- and high-range speakers. Also, in 3-speaker systems, the VAN-AMP can be used between the woofer and mid-range speaker, with a fixed network between the mid-range speaker and tweeter.

For the two amplifiers, an output of 15 to 30 watts is recommended for the lower range, and 10 to 15 watts for the upper range. It is interesting to check the speakers by listening to them separately, and varying the crossover point. You'll be surprised to hear the results of such a test, and it will help you to understand how to go about selecting the optimum crossover, and balancing the amplifier outputs. When you make these tests, play the same music while you listen to each speaker.

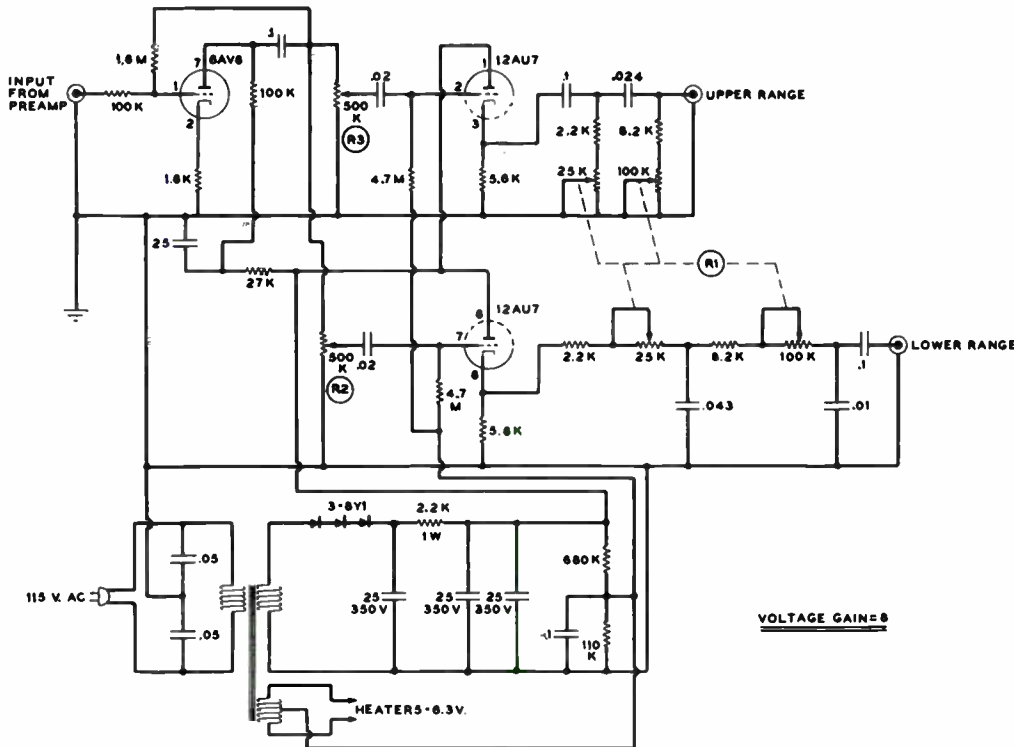

Fig. 14. Schematic and component values for the VAN-AMP. This device is connected between the preamplifier and two separate power amplifiers

extra power into the bass speaker, if a particular system requires it for exact balance.

5. If you want to experiment with various speakers, the VAN-AMP is the practical device to use, not only as a matter of convenience, but economy.

Installation and Adjustment

You can put a VAN-AMP together in breadboard style, or assemble it on a small metal chassis. The only unusual feature is the concentric mounting of the four variable resistors marked R1 in Fig. 14. Several types are available for this purpose. R1 varies the crossover point, while R2 and R3 control the input to the separate halves of the 12AU7 tube.

While the idea of such a unit is not altogether new, there are several refinements in this circuit, most important of which is that the output of the upper range does not cut off the top frequencies. Also, the level controls are on the input side, where they should be.

When you have completed the balancing operation, you should have the level controls on the VAN-AMP and on the amplifiers set in such a way that the only level control you will then need is that on the preamplifier. At the start, therefore, put the level controls on the preamp and the VAN-AMP at the center, and adjust the amplifier outputs for moderate audio volume. In that way, each part of the system will be operating well below its maximum rating, and no part will be overloaded when the volume is turned up at the preamplifier.

After that has been done, you can make the final adjustment of the crossover frequency to best advantage. No doubt you will go through the entire process several times before you feel that all the controls are just right. But then you will have the satisfaction of knowing that you are getting the finest performance obtainable from the component parts of your installation.

Illustrations in Part 4 will detail interesting ways to install and conceal the Air-Coupler.

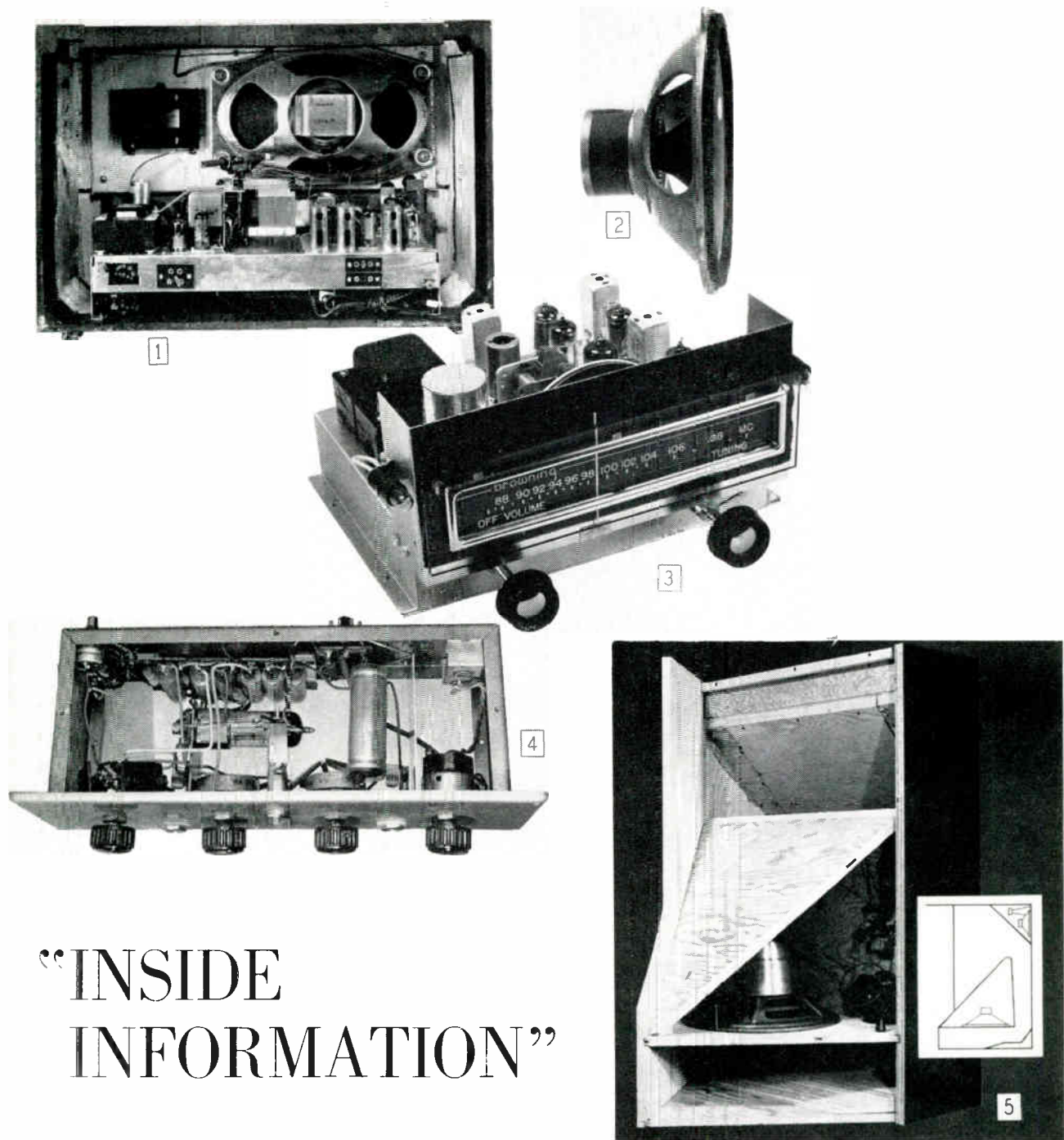

“INSIDE INFORMATION”

ON THIS PAGE are inside photographs of interesting items of equipment, specially posed to show construction details that you seldom have a chance to see in the hi-fi equipment stores. In No. 1 you will see an FM-AM-shortwave receiver which differs in appearance from familiar models. That is because it comes from the famous Siemens & Halske Aktiengesellschaft, in Germany.

Like the Telefunken portable illustrated in the last issue, it is filled with fussy details and special tricks, including an AM antenna that can be rotated from the front panel for maximum pickup, pushbutton controls for band-switching, and separate FM and AM tuning. The construction seems less sturdy in some respects than American-built receivers, but that is a characteristic, rather than a fault. Particularly noteworthy is the cabinet work of this and

other Siemens & Halske models. Wood grains and inlays are beautiful, and the lacquer finish is as smooth as glass.

The photograph of the Bakers Selhurst model 300-K 12-in. speaker, No. 2, was posed particularly to show the flair of the cone. Most English manufacturers prefer to obtain wide response with a single cone, rather than employing coaxial construction. To that end, this English-built Bakers model has a cone of approximately exponential shape, treated at the apex to a "bakelized" hardness for high-frequency reproduction, and tapering off to greater pliability at the outside. The purpose of this treatment is to provide smooth crossover characteristics. Mounting for the cone is a cloth of high compliance, so woven as to eliminate stress or strain in any one direction. Model 300-K is rated at 15 watts. Other *Concluded on page 57*



Musically Authentic Reproduction

THE Styrocone speaker system, a basic de Mars invention, is outstanding for its amazing ability to deliver authentic reproduction over the entire audio frequency range. That is, the de Mars Styrocone neither adds nor omits, but reproduces with complete accuracy the audio frequencies fed to it. In that respect, it provides a performance standard, for if the reproduction is not literally perfect, it is certain that the fault lies in some part of the installation preceding the Styrocone speaker system.

de Mars Styrocone cabinet speakers are available in four models. All de Mars cabinets are noteworthy for the excellence of the design, materials, workmanship, and finish, comparable to the quality of cabinetwork found in fine pianos.

Also, the 17-in. and 20-in. Styrocone speakers and associated tweeters are available unmounted. Following are detailed descriptions.

"CONCERT" Cabinet

ESSENTIALLY FLAT RESPONSE FROM 40 TO BEYOND 13,000 CYCLES

Combines the 17-in. No. 225 Styrocone speaker and two tweeters in a rigid, highly-damped cabinet available in mahogany or blonde finish. The cabinet can be used vertically or horizontally. Legs are furnished separately, so that they can be secured after you have decided how you want to use the cabinet.

SPECIFICATIONS, Model S-225VH

Cabinet height..... 35¾ ins.
Width..... 22 ins.
Depth..... 16 ins.
Internal capacity..... .6 cubic feet
Price, Model S-225VH..... \$250.

"SYMPHONY" Cabinet

ESSENTIALLY FLAT RESPONSE FROM 35 TO BEYOND 13,000 CYCLES

Your choice of cabinet designs for wall or corner location, with the 20-in. No. 300 Styrocone speaker and four tweeters. Both cabinets are completely enclosed and highly damped to prevent

resonance effects. Audio performance is independent of the background wall, so that the cabinet can be placed in any part of the room where acoustic conditions are favorable. Your choice of walnut, mahogany, or blonde finish.

SPECIFICATIONS, Models SW and SC

Cabinet height..... 38 ins.
Width..... 41 ins.
Depth, wall cabinet..... 15 ins.
Depth, corner cabinet..... 26 ins.
Internal capacity..... 8 cubic feet
Price, Model SW wall cabinet..... \$450.
Price, Model SC corner cabinet..... \$450.

"MAJESTIC" Cabinet

ESSENTIALLY FLAT RESPONSE FROM 25 TO BEYOND 13,000 CYCLES

This cabinet is of a size and design intended to give performance virtually equivalent to that obtainable from an infinite baffle mounting. A 20-in. Styrocone speaker and four tweeters are provided. Very heavy construction and bracing eliminate all cabinet resonance. Furnished in mahogany or blonde finish.

SPECIFICATIONS, Model SA-300

Cabinet height..... 60¾ ins.
Width..... 35½ ins.
Depth..... 20¾ ins.
Internal capacity..... 8 cubic feet
Price, Model SA-300..... \$450.

Unmounted Speaker System

For the benefit of those who are making special installations, components of the Styrocone speaker system are offered unmounted, complete with mounting brackets. Used with a suitable baffle, the Styrocone system is ideal for installation in the home or in a public auditorium for reproduction from records, tape, and FM radio. The Styrocone system is particularly recommended for use with electric organs, because of its magnificent tone quality and high output in the lower register.

A 20-in. Styrocone speaker, 4 tweeters, mountings and the network comprise the Model S-300 series. The Model

S-225 system comprises a 17-in. Styrocone, 2 tweeters, mountings, and network.

SPECIFICATIONS, 20-in. Model S-300

Impedance..... 8 ohms
Response..... 16 to 15,000 cycles
Capacity..... 25 w. RMS; 50 w. peak
Weight, unpacked..... 30 lbs.
Dimensions..... 24 by 34 ins.
Price..... \$250.

SPECIFICATIONS, 17-in. Model S-225

Impedance..... 8 ohms
Response..... 20 to 15,000 cycles
Capacity..... 20 w. RMS; 40 w. peak
Weight, unpacked..... 25 lbs.
Dimensions..... 34¾ by 20¾ ins.
Price..... \$200.

Unmounted Styrocone

Both the 17-in. and the 20-in. Styrocone speakers can be purchased individually, for use with auxiliary units to cover the range above 3,000 cycles, the crossover point ordinarily used with either Styrocone. Mounting hardware is provided.

The distinguishing feature of the Styrocone, by which remarkably high output at low frequencies is obtained, is the large radiating surface. The 20-in. Styrocone, for example, drives a surface at low frequencies, when piston action is the mode of vibration, equivalent to four 12-in. woofers, or two 15-in. woofers.

SPECIFICATIONS, 20-in. Styrocone speaker

Cone piston..... 20 ins. diam.
Response..... 16 to 3,000 cycles
Capacity..... 25 w. RMS; 50 w. peak
Magnet..... 1½ lb. Alnico V
Resonant frequency..... below 20 cycles
Dimensions..... 24 by 24 ins.
Price..... \$125.

SPECIFICATIONS, 17-in. Styrocone speaker

Cone piston..... 17 ins. diam.
Response..... 20 to 3,000 cycles
Capacity..... 20 w. RMS; 40 w. peak
Magnet..... 1½ lbs. Alnico V
Resonant frequency..... below 20 cycles
Dimensions..... 20 by 20 ins.
Price..... \$115.

For further information, and the name of your nearest dealer, address:

deMars Engineering & Mfg. Corp.

361 Merrimac Street, Lawrence, Mass.

Phone: LA 8-5964

January-February 1955

45

Exciting High Fidelity Firsts!

INTERELECTRONICS

Now . . . in these superb matched instruments . . . enjoy the foremost advances in High Fidelity . . . startling realism, greater power, lowest distortion, precision craftsmanship.



INTERELECTRONICS

"Coronation 100"

40 WATT Amplifier \$99.50

Greatest amplifier buy today and here's why. RESERVE POWER — 80 watt peak. EXCLUSIVE NOVALOOP CIRCUITRY — completely new, non-ringing multiple path feedback design, over 50 DB feedback. 40 WATT HIGH EFFICIENCY, WIDE RANGE OUTPUT TRANSFORMER — sealed multiple-section winding, thin strip core. FOOLPROOF DAMPING CONTROL — continuously variable, exactly matches loudspeaker for startling performance. S to 200,000 cycle response. DISTORTION FREE — less than 0.05% at 30 watt level, ex-

ceeds FCC requirements for FM broadcasting. POWER RESPONSE—at 30 watts = 0.1 DB from 16 to 30,000 cycles. HUM AND NOISE LEVEL—virtually non-measurable. DESIGNED FOR THE FUTURE — finest sealed components mounted on Bakelite terminal board for decades of trouble-free listening pleasure. Plug-in filter capacitor. Critical networks of precision components, lifetime encapsulated. BUILT-IN PREAMPLIFIER POWER SUPPLY. BUILT-IN POWER FOR NEWEST ELECTRO-STATIC TWEETERS. Other firsts.



INTERELECTRONICS

"Coronation"

\$79.50 CONSOLE PREAMPLIFIER-EQUALIZER

Worthy companion to the incomparable "Coronation 100" 40 watt amplifier. ADVANCED EXCLUSIVE CIRCUITRY — the only preamplifier-equalizer operating entirely thru negative feedback. REVOLUTIONARY NEW INPUT TUBE, Z-729, phenomenal low noise followed by premium 12AY7 tube. HUM INAUDIBLE with all controls on full. DISTORTION FREE—virtually non-measurable, exceeds FCC requirements for FM broadcasting. S to 200,000 cycle response. HIGHEST GAIN — no transformers required with all present phono cartridges. LOUDNESS CONTROL—continuously variable to your exact prefer-

ence. MAXIMUM BASS AND TREBLE COMPENSATION — over 20 DB distortion-free boost and attenuation. FIVE INPUT SELECTIONS. 16 PRECISION PLAYBACK CURVES — lifetime encapsulated precision plug-in networks, instantly replaceable if equalization curves change. ULTRA COMPACT, EASY MOUNTING. Built-in power for Weathers cartridge, film projector photocells, condenser microphones. Distinguished satin-gold LUCITE front panel. Custom finished table cabinets available. Many extras.

For the hi-fi thrill of your life, hear the Coronation Twins today! Some dealerships still available.

INTERELECTRONICS

2432 Grand Concourse
New York 58, New York

Harry Partch

Continued from page 33

Partch further stated in his program notes that the music is "conceived as emotional saturation, or transcendence. That is the particular province of dramatic music to achieve. My idea has been to present the drama expressed by language, not to obscure it either by operatic aria or symphonic instrumentation. Hence, in critical dialogue, music enters almost insidiously, as tensions enter. The words of the players continue as before, spoken, not sung, but are a *harmonic part* of the music. In these settings the inflected words are little or no different from ordinary speech, except as emotional tensions make them different. Assertive words and assertive music do not collide. Tone of spoken word and tone of instrument are intended to combine in a compact emotional or dramatic expression, each providing its singular ingredient. My intention is to bring human drama, made of words, movement, and music to a level that a mind with average capacity for sensitivity and logic can understand and therefore evaluate."

While one can wholeheartedly follow Partch in his endeavor, one sometimes finds the final result puzzling. This is probably due to the fact that the problem seems to lie more in the dramatic reading than in the music itself.

I doubt whether a similar group of performers would have made a performance of Caccini, Wagner, or Gluck any more convincing, but that Partch has something significant to say and is trying to say it is evident in his work. It would be fascinating to hear background music in his medium with a Greek play produced according to the presently accepted standards of the theatre. This very suggestion would probably be anathema to Partch. Still I believe that his music might have the power to enhance such a production greatly.

The instruments Partch has created are too massive to be moved in and out of concert halls. We need more recordings of his music that it can be widely evaluated.

And if Harry Partch, through his experiments and efforts, can succeed in expanding our instrumental resources, and even more importantly expand our musical horizons, he will have fulfilled a significant task as a creative musician. In a recent letter to me he wrote, "I think it would be fine and wonderful for a few cracks to appear in the specialized walls of *serious* and too *serious* music; that is, in the walls of the exoteric and sometimes precious *modern idioms* respectively. I hope I do not sound arrogant; I am convinced that there will be no real musical reward for us, there will be nothing really significant to us or to any future generations through us, unless our sights broaden."

While Partch may not yet have

Continued on page 47

REVOLUTIONARY NEW CIRCUITRY!

Harry Partch

Continued from page 46

achieved all that he has projected with considerable vision, he does succeed in making us realize the inhibiting limitations of many of our currently accepted practices. Perhaps Partch may lead us into new tonal territories just as Varèse, Lou Harrison, Henry Cowell and Messrs. Luening and Ussachevsky have done.

If you do not find Partch records on the shelves of your local music stores, information can be obtained from the Harry Partch Trust Fund, P. O. Box 387, Marin City, California. Whatever your reactions may be, these records will give you new sounds to challenge the performance of your audio equipment, an experience in listening such as you have never had before, and subject material for unending discussions with your friends.

OLIVER DANIEL, author of "Harry Partch" and other articles which have appeared in *MUSIC AT HOME*, joined Associated Music Publishers, Inc. last December as Director of Contemporary Music Projects, and serves in an advisory capacity to Broadcast Music, Inc., the parent AMP organization. During the previous 12 years, he was producer-director of radio music for CBS. He produced and directed such programs as the Stokowski 20th Century Music Hall, New York Philharmonic Sunday Broadcasts, CBS Invitation to Music, and the current Louisville Symphony Broadcasts. His address at AMP is 589 Fifth Avenue, New York City.

Harry Partch Records

A letter just received from Harry Partch contains this information about his records: The two available now are *Plectra and Percussion Dances*, a 12-in. LP, at \$7.50, and *Oedipus*, a set of two 12-in. LP's, at \$12.50 postpaid. They can be ordered by mail from The Gate 5 Ensemble, Box 387, Marin City, Calif., or from:

The Book Clearing House, 423 Boylston Street, Boston, Mass.

The Record Shop, 14 Tillmann Place, San Francisco, Calif.

Custom Sound, 3687 Atlantic Avenue, Long Beach, Calif.

Two other pressings were made. They were *U. S. Highball*, and settings of *Poems by Li Po*, which were available from Gilson Medical Electronics Co., 14 Market Place, Madison, Wisc. Mr. Partch thinks that the supply of these records has been exhausted although, presumably, more copies can be pressed if the master is still intact.

Mr. Partch added: "Regarding the *Intrusions*, there are about 25 sets of these left, but since the text copyrights were released only for records on a non-profit subscription basis, I question whether it would be advisable to stress their availability."

Our comment: Any of the Partch records is a collector's item, not only to hear but to keep because it will appreciate in value. We suggest, however, that rather than playing the record repeatedly, you play it just once to make a tape, so as to keep the disc in mint condition.

Outstanding noise and interference rejection with the new

H. H. Scott



FM TUNER

- Lowest ignition noise
- Lowest interference
- Wide-band detector and limiters
- Single-sweep tuning
- Interstation noise suppressor
- 2-microvolt sensitivity
- Tuning-signal strength meter
- Unique convenience

Quality of FM reception is determined largely by what is not heard, particularly in Metropolitan areas where noise, interference and reflection effects are high. The new 310 FM Broadcast Monitor Tuner features wide-band circuit design permitting outstanding rejection of ignition noise, image and other station interference. Multi-path fading and spurious responses (which show up as reception of the same station at many spots on the FM band) are virtually eliminated. The 2 mc wide-band detector and limiters and full 150 kc wide flat bandpass IF characteristics make tuning completely non-critical and drift-free and give essentially distortionless reproduction at all signal levels. The 2 microvolt sensitivity at 20 db quieting (4 microvolt at 40 db quieting) allows interference-free reception with full limiting action even on weakest signals. The inter-station noise suppressor is adjustable on the front panel and allows complete inter-station noise elimination but also reception of very weak stations. The fine-tuning control and combined tuning meter and signal strength indicator are useful for tuning weak signals and antenna orientation. Rejection of spurious responses resulting from cross-modulation by strong local signals is better than 85 db, an outstanding design accomplishment. We believe that the 310 provides the best overall design balance possible at this stage of the art, incorporating all significant features and refinements known today. Unique convenience of operation, attractive styling and moderate cost enhance its desirability to the serious music lover.

H. H. SCOTT inc.

FREE BOOKLET

A pioneer in sound reproduction and instrumentation, H. H. Scott, Inc. received the **ELECTRICAL MANUFACTURING Award** for outstanding instrument design and the Medal of Merit at the International Sight and Sound Exposition. The John H. Potts Memorial Medal of the Audio Engineering Society was awarded to H. H. Scott for outstanding contributions to audio science.

385 PUTNAM AVENUE,

CAMBRIDGE 39, MASS.

Directory of Hi-Fi Record & Equipment Dealers

To keep this Directory up-to-date, it is revised for each issue of MUSIC at HOME and, in order to make it as complete as possible, new names are added as soon as they are reported and checked

NOTICE TO DEALERS

Listings in this Directory are available without charge to hi-fi record and equipment dealers as a service to our readers. If you operate a hi-fi record or equipment store, and do not find your company listed, please write to the Directory Editor, MUSIC at HOME Magazine, 207 E. 37th Street, New York City 16. Information for qualifying for a listing in this Directory will be sent to you at once.

ARIZONA

Bisbee
The Music Box, Box 340

CALIFORNIA

Berkeley
U. C. Corner, 2350 Telegraph Ave.
Burbank
Valley Electronic Supply Co., 1302 W. Magnolia
Hollywood

HOLLYWOOD ELECTRONICS

"HI-FI COMPONENTS EXCLUSIVELY"

Since 1939

7460 MELROSE AVE., L. A. 46. WEB 3-8208

Pacific Radio Exchange, 1407 Cahuenga Blvd.
Radio Recorders Equip. Co., 7007 Melrose Ave.
La Jolla
The Audio Workshop, 2211 Camino Del Reposo
Long Beach
Custom Sound, 3687 Atlantic Ave.
Los Angeles
Arco Electronics, Inc., 103 S. Vermont Ave.
Figart's Sound Un-Ltd., 6320 Commodore Sloat
Henry Radio Co., 11240 W. Olympic Blvd.
Kierulff Sound Corp., 820 W. Olympic Blvd.
Magnetic Recorders Co., 7120 Melrose Ave.
Shelley Radio Co., Inc., 2008 Westwood Blvd.
Universal Radio Sup. Co., 1729 S. Los Angeles
Oakland
Elmar Electronics, Inc., 140 11th St.
Ontario
Rudi Pock—Records & Hi Fi Sound,
604 N. Euclid Ave.
Pasadena
Dow Radio, Inc., 1759 E. Colorado St.

HIGH-FIDELITY HOUSE

Largest distributor in the West
specializing in custom sound equipment
Phone: RYan 1-8171

536 S. Fair Oaks, Pasadena 1, Cal'f.

Sacramento
The Sound Shoppe, Inc., 1910 16th St.
Tower Record Mart, 1518 Broadway

San Diego
Breier Sound Center, 3781 Fifth Ave.
Southern Calif. Music Co., 630 C Street

San Francisco
Hol Cox Custom Music, 2598 Lombard St.
Eber Electronics, 160 10th St.
Music San Francisco, 562 Kearney St.
Television Radio Supply Co., 408 Market St.
The Hi-Fi Shop, 3525 California St.

West Coast Radio & Elec., 409 Market St.
Zack Radio Supply Co., 1424 Market St.
San Jose
Peninsula Telev. & Radio Sup., 881 S. 1st St.
San Pedro
Bower's Music, 810 S. Gaffey
Santa Barbara
The Gramophone Shop, 9 E. Canon Perdido
Thermal
Custom Classics, 82-321 Ave. 56
Van Nuys
House of Sight & Sound, 14513 Victory Blvd.

COLORADO

Denver
Allegro Music Shop, 2410 E. Third Ave.
Chas. E. Wells Music Co., 1629 California St.

CONNECTICUT

Danbury
Heims Music Store, Inc., 268 Main St.
Hartford
Nothan Margolis Shop, 28 High St.
Westport
Music Systems of Westport, Inc., Post Road

DELAWARE

Wilmington
Radio Elec. Serv. Co. of Pa., 3rd & Tatnall
Wilmington Elec. Spec. Co., 405 Delaware Ave.

DISTRICT OF COLUMBIA

Washington
Discount Record Shop, 1327 Conn. Ave., NW
Electronic Wholesalers, 2345 Sherman Ave., NW
Hollywood Record Shop, 1706 Columbia Rd., NW
Shrader Mfg. Co., Inc., 2803 M St., NW
Sound Crafters, 1744 Columbo Rd., NW
Sun Parts Distr., 520 10th St., NW

FLORIDA

Jacksonville
Southeast Audio Co., 930 W. Adams St.
Melbourne
McHose Electronics, New Haven Ave.
Miami
Flagler Radio Co., Inc., 1068 W. Flagler St.
Pensacola
Grice Radio & Electronic Supplies, Inc.,
300 E. Wright St.
St. Petersburg
Better Listening Studio, 24 Beach Dr. North
Hi-Fi Music Shop, 6821 Central Ave.
Tampa
Burdett Sound & Recording Co.
3619-21 Henderson Blvd.

GEORGIA

Atlanta
Baker Fidelity Corp., 1429 Peachtree St., NE
High Fidelity SSS, 606 Peachtree St., NE

ILLINOIS

Champaign
The New Sound, 35 E. Springfield Ave.
Chicago

World's Largest Stocks of
High-Fidelity Music Systems
and Components
ALLIED RADIO

CORPORATION
100 N. WESTERN AVE CHICAGO 90, ILL.

Audio Distributors, 14300 S. Indiana Ave.
Audio Workshop, Inc., 2734 W. Touhy Ave.
Chicago Electronics Distr., 420 E. 87th St.
De Haan Hi Fi Co., 1655 W. 79th St.
Electronic Expeditors, 2909 W. Devon Street
The Lukko Sales Corp., 5024 Irving Park Blvd.
Marquette Records, 3215 W. 63rd St.
Newark Electric Co., 223 W. Madison
Voice & Vision, 53 E. Walton St.

INDIANA

Columbus
Ernie's Record Shop, 910 25th St.
Indianapolis
Graham Elec. Supply, Inc., 102 S. Penna St.
Lafayette
Golden Ear, 610 Main St.
Muncie
Seward B. Price, 105 Rose Court

IOWA

Iowa City
Woodburn Sound Service, 8 E. College St.

LOUISIANA

Baton Rouge
Louisiana Radio & Telev., 1645 Plank Rd.
Ogden Park Record Shop, 618 N. 3rd St.

MAINE

Portland
Bartlett Radio Co., 625 Congress St.

MARYLAND

Baltimore
Custom Music Systems, 2326 N. Charles St.
High Fidelity House, 5123 Roland Ave.
Hi-Fi Shop of American Distr. Co., Inc.
2 N. Howard St.
Radio Elec. Serv. Co., 5 N. Howard St.
Wholesale Radio Parts Co., 308 W. Redwood St.

MASSACHUSETTS

Boston
DeMambro Radio Supply Co.,
1095 Commonwealth
Lafayette Radio 110 Federal Street
The Listening Post, 161 Newbury St.

FREE 224-PAGE CATALOG

LARGEST STOCKS in the EAST

Cook and Audiophile Records, Too

RADIO SHACK CORP.

167 Washington St., Boston 8, Mass.

Yankee Electronics, 257 Huntington Ave.
Holyoke
Tel-O-Wire Sound Co., Inc., 24 Newton Place
Lunenburg

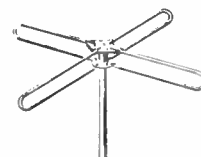

**FM RECEIVING
ANTENNAS**

Standard and
Special Designs
WHOLESALE SUPPLY CO.
Lunenburg, Mass.



The Dean. For use in a corner or equally efficient flat against a wall. You'll be amazed at the results from the C15W 15" woofer, Cobreflex-2 with T-30 driver for the mid-range and the HF-206 for the highs. N-3 network used to cross over at 350 and 5000 cycles. The enclosure is a newly designed compression type folded front-loaded horn so completely independent of the walls and floor of a room that it is truly the one and only "cornerless corner" cabinet. By unique internal design, wasted space has been eliminated so that the overall dimensions of this sensational system are only 36 1/4" high, 36" wide, 22" deep. Available in Cherry Mahogany or Blond at no extra cost. Impedance 8 ohms, power capacity 50 watts. The DEAN enclosure is available separately as Model EN-D in Cherry or Blond.



The Classic. Containing the incomparable C15W 15" woofer, Cobreflex-2 with T-30 driver for rich full-bodied middles, the new HF-206 Super Tweeter and the N-3 network complete with "Brilliance" and "Presence" controls, the Classic incorporates some of the finest University engineering achievements. The enclosure is the versatile, newly designed folded front-loaded horn which operates the C15W woofer as a compression driver for maximum efficiency. Due to this design, the acoustic performance of the CLASSIC is independent of the walls and floor of the room and may be used either as a "lowboy" console or "highboy." Base is adjustable for this purpose. Dimensions: 34 1/2" x 40 1/2" x 24 3/4". Available in Cherry Mahogany or Blond at no extra cost. Impedance 8 ohms, power capacity 50 watts. The CLASSIC enclosure is available separately as Model EN-C in Cherry or Blond.

CUSTOM DESIGNED FOR *University* SPEAKER SYSTEMS

A selection of fine speaker enclosures engineered to acoustically enhance the performance of University speakers. Tastefully styled to complement the decor of your home rather than dominate it.



EN-15 Master. The EN-15 is a continuation of the principle refined by University in which the best features of rear-horn loading, phase inversion, and direct radiation are integrated to result in a highly efficient, extended range enclosure capable of unusual power handling capacity and excellent transient response.

The EN-15 is equipped to mount either a 12" or 15" coaxial or triaxial speaker. Accommodation has also been made to take University mid-range and high-frequency reproducers for use in 2 or 3 way combinations. A 12" woofer such as the C12W Adjustable Response Low Frequency Reproducer, or the Dual Impedance Range C15W 15" woofer may also be used.

Made of heavy, fully-cured woods throughout and finished on 5 sides, the EN-15 may be used in either a corner or flat against a wall. Available in Cherry or Blond Mahogany at no extra cost. Dimensions: 37" x 28" x 19 1/4".



EN-8 Mighty Midget. Hit of every Audio Fair across the nation, University now makes available this special 8" speaker enclosure which was originally designed to demonstrate the remarkable Diffusicone-8 coaxial speaker. Incorporates combination rear horn loading for unexcelled power handling and distortion control, and tuned horn mouth for phase inverter action for increased bass efficiency. Only 25 5/8" x 18" x 12".

The EN-8 may be used ideally with the new Model 308 Triaxial speaker. It also has cut-outs for the 4401 tweeter and C8W 8" woofer combination, if desired. Available in Cherry or Blond Mahogany at no extra cost; also in unfinished Mahogany.

When Building Your Own Bass Reflex Cabinet . . .

Popularity of the bass reflex type baffle is due to its relative ease of construction, small space requirements, and satisfactory overall performance. Decide upon the dimensions of the baffle to be built, in accordance with physical requirements, but try to keep the inside depth of the cabinet to not less than 12". All sides should be made of heavy, seasoned wood (preferably 3/4" plywood). All corners must be thoroughly braced to prevent buzz noises at cabinet resonance. The removable slide (usually the back) should be secured at the corners, as well as approximately every 4" along the edges. All of the back side and fifty per cent of the remaining inner surfaces of the cabinet should be lined with a sound ab-

sorptive material, such as celotex, rockwool, etc.

Tuning the Port. The port of a bass reflex baffle is considered properly tuned for best low frequency response of the speaker system when the bass response has been equalized and spread out over as wide a range as possible. Peaking or excessive boominess is an indication of an improperly dimensioned port.

The chart shown indicates optimum port area for given cabinet volumes and loudspeaker free air resonances. Once the port area is determined, the actual dimensions will not be found to be critical. The heavily shaded lines on the chart are for use with the size University speakers indicated.

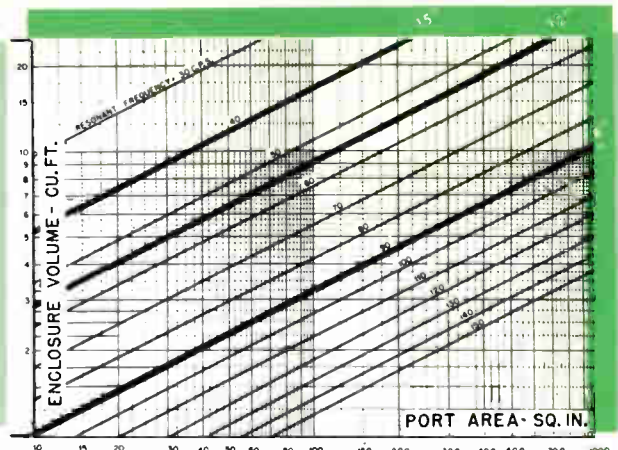

University Loudspeakers

WHITE PLAINS, NEW YORK

Write for latest catalog describing the entire University high fidelity line of speakers and accessories.

A
Model 6201 Dual Range System. Acknowledged as the industry's finest value in a high quality 12" loudspeaker. Complete with coaxial tweeter driver and wide angle horn, it is one of the few true dual range systems. Built-in L/C network and balance control. Eight ohms impedance, 25 watts power capacity.



B, C
Diffusicone—8" and —12" Coaxial Speakers. Exclusive patented "Diffusicone" design with 1000-cycle mechanical crossover results in full fidelity anywhere in the room . . . full undistorted response without loss of highs at listening points progressively off speaker axis. Eight ohms impedance, 25 watts power capacity.



D
Model 6200 Extended Range Speaker. Full bodied response to beyond 10,000 cycles makes it ideal for radio, TV and phono applications. Excellent basic unit. Eight ohms impedance, 25 watts power capacity.

For Listening Pleasure That is Performance



F
Model 308 8" Triaxial Speaker. For high fidelity installations where space is at a premium and quality is not to be compromised. Eight ohms impedance, 25 watts power capacity.



G
Model 312 12" Triaxial Speaker System. Embodies the "Diffusicone" principle for full bodied mid-range and incorporates the HF-206 Super Tweeter for clean, brilliant highs. Built-in L/C network and "balance" control. Eight ohms impedance, 25 watts power capacity.



H
Model 315 15" Triaxial Speaker. Reproduces entire range with such full-bodied clarity that its superior quality of "presence" is readily apparent. "Diffusicone" device for mid-range, driver type horn assembly for highs. Built-in L/C network. Eight ohms, 50 watts power capacity.

University Loudspeakers — A Complete

Exclusive University speakers, utilizing "automatic rim centering" of the voice coil, are fabricated to such close mechanical tolerances that they are the only speaker with "bi-sectional" design in which the voice coil/diaphragm and the magnetic assemblies can be interchanged in the field. This ensures everlasting buzz-free, shock and vibration-proof performance.



I
Model C15W Dual Impedance Range Super 15" Woofer. Acme of attainable perfection in the specific reproduction of low frequencies. Host of exclusive engineering features. Adjustable voice coil permits match to 4-8 ohms and 10-16 ohms. Defies obsolescence. For 50 watt systems.



J
Model C12W 12" Adjustable Response Woofer. Contains exclusive built-in facilities for limiting high end response to 700, 2000 or 5000 cycles, thus suiting crossover requirements of most tweeters.

Designed for Value and Engineered for

L
Model 4401 Tweeter. Uses "reciprocating flares" wide angle horn and bona fide compression driver. Exceptional performance for such low cost. Eight ohms impedance. Suitable for crossover down to 2000 cps.

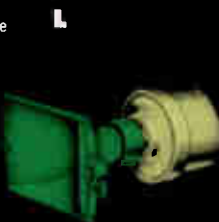

M
Model 4402 Wide Angle Dual Tweeter. Electrical and acoustical characteristics make it the most versatile high frequency tweeter available. 120° dispersion; can be connected for use in 4-8 and 10-16 ohm systems. High power capacity. For 2000 cycle crossover or above.

N, O
Models 4408 and 4409 Tweeters. For crossovers down to 600 cycles. Model 4408 for moderate power systems 4409 is heavy duty version. "Reciprocating Flares" wide angle horn. Eight ohms impedance.



to Meet Every Speaker Need and System

Q
Model N-1 Adjustable High Pass Filter. Built-in continuously variable high frequency control. Matches 15 ohms to 1250, 2500, 5000 cycle crossover; eight ohms to 2500, 5000, 10,000 cycles; four ohms to 5000 and 10,000 cycles.



R, S
Model N-2A, N-2B Adjustable L/C Dividing Network. With either or both of these network units, any combination of speakers can be used in a great variety of popular crossover points from 350 to 5000 cycles at 4, 8 and 16 ohm impedances in two or three-way systems. Adaptable for use as either 6 or 12 db rate of cut-off.



T
Model N-3 Three-way Crossover Network. Complete with built-in continuously variable "Presence" and "Brilliance" controls. For 8 ohm 3-way systems using 350 and 5000 cps crossovers. Flexible mounting arrangements.

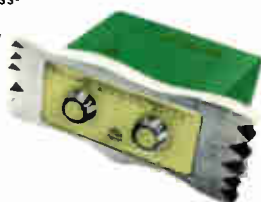



E

Model Cobreflex-2/T-30 Assembly. For use in 2 or 3-way systems when crossover as low as 350 cycles is desired. Exclusive dual wide angle horn. Eight ohms impedance; suitable for heavy duty operation.

Proven—

Exclusive The University heavy duty all-nioco 5 "W" shape magnet reduces by 50% the reluctance and surface leakage losses common to the conventional "slug" and "ring" type assemblies. This means tremendous power saving, increased efficiency and superior handling of "transients".

Line



K

Model C8W 8" Low Frequency Reproducer. Ideal for assembling a compact, limited space, high quality system . . . Perfect, too, as mid-range unit in low cost three-way system. Can also be used in multiples as expanding woofer. Eight ohms impedance, 25 watts power capacity.

Quality



P

Model HF-206 Super Tweeter. High frequency response far beyond audibility. Super-efficient, new driver and horn assembly using exclusive "reciprocating flares" principle. Suitable for crossover 3500 cycles or above. Eight ohms impedance.

Requirement

Exclusive The patented "reciprocating flares" principle used in University tweeter horns avoids the erratic polar response of multi-cellular and other type wide angle horns. Serious acoustic phase cancellation and distortions are eliminated, and vertical field energy never exceeds horizontal dispersion as occurs in other types in portions of the working range. Uniformity of response and dispersion is the signature of University tweeters.

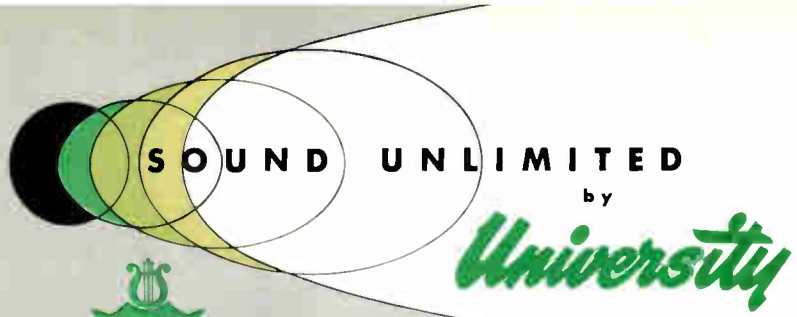

- | | | | |
|---------------------------|-----------------|-----------------|-------------------|
| A — 6201 | F — 308 | K — C8W | P — HF-206 |
| B — Diffusicone-8 | G — 312 | L — 4401 | Q — N-1 |
| C — Diffusicone-12 | H — 315 | M — 4402 | R — N-2A |
| D — 6200 | I — C15W | N — 4408 | S — N-2B |
| E — Cobreflex-2 | J — C12W | O — 4409 | T — N-3 |
- with T-30 driver

SPEAKER CODE

START WITH	BUILD TO	BRIEF DESCRIPTION
KLQ		low cost 2-way space saver
	KLQJ KKKKLQ	economy 3-way using 12" woofer 2-way with quadruple 8" woofer
B		wide-range 8" coaxial with mechanical crossover
	BLQ	low cost 3-way space saver
	BLQJ BLQK	economy 4-way using 12" woofer 3-way space saver with dual 8" woofer
D		low cost extended range 12" speaker
	DLS	economy 2-way system
	DDMS	dual 12" woofer 2-way system
	DJLQ DIPRS	economy 3-way system with 12" woofer 3-way system with 15" woofer
C		wide-range 12" coaxial speaker with mechanical crossover
	CLQ	low cost 3-way system
	CJMQ	dual 12" 3-way system
	CJPS	4-way system with 12" woofer
	CIPRS	4-way system with 15" woofer
F		modestly priced 8" triaxial speaker
	FK FJ	low cost 3-way space saver with dual 8" woofer low cost 4-way system with 12" woofer
A		2-way dual range speaker
	AJ	dual 12" woofer 2-way system
	AIR AJR	3-way system with 15" woofer 3-way system with 12" woofer
G		12" triaxial speaker
	GJ GIR	dual 12" woofer 3-way system 4-way system with 15" woofer
H		15" triaxial speaker
JNR		dual 15" woofer 3-way system
	JNRLQ	modestly priced 2-way system with 12" woofer economy 3-way system with 12" woofer
IOR		2-way medium power system with 15" woofer
	IORPS	3-way medium power system with 15" woofer
IER		2-way high power system with 15" woofer
	IERPS	3-way high power system with 15" woofer
IEPT		deluxe 3-way system

NOTE: Circuit diagrams available for each system listed. Write Technical Service Department.

PROGRESSIVE SPEAKER EXPANSION

a new approach to personalized listening . . .

by *University*

A modest budget need no longer limit the quality and caliber of your hi-fi aspirations. University offers, for the first time in audio history, a tremendous selection of uniquely designed speaker and network components so brilliantly conceived and executed that it is now possible to develop your loudspeaker system in successive, relatively inexpensive stages . . . until what you have meets your listening requirements.

Progressive **S**peaker **E**xpansion by University makes it possible for you to buy a speaker today in terms of the system you want tomorrow! You are thus able to devote your present budget primarily in the initial selection of quality amplifying and program source equipment which cannot be economically altered or substituted at a later date. **P-S-E** makes your speaker choice an easy one. Depending upon your goal and space limitations, there are numerous University speaker systems that can be started at minimum cost with immediate listening satisfaction.

start planning today . . .
the *University* way!

- Buy good amplifier and program source equipment which will do justice to your eventual University speaker system . . . and start with one of the versatile top quality speakers or combinations recommended in the **P-S-E** chart.
- Build up to a deluxe speaker system with University components so designed that speaker and network can be easily integrated for better and better sound reproduction—without fear of obsolescence.
- Own a **P-S-E** speaker system which meets hi-fi quality standards from the very beginning—and reach the highest standard of all—YOUR OWN.

Do it with University **P-S-E**! Only University products can meet such flexibility of application and demanding performance requirements.

University Loudspeakers

80 SOUTH KENSICO AVENUE, WHITE PLAINS, NEW YORK



Springfield
Custom Audio Lab, 808 State St.
Soundco Electronic Supply Co., 47 Dwight St.
Taunton
David B. Dean & Co., 85 Cohasset St.

MICHIGAN

Birmingham
McCallum & Dean, 409 E. Maple Ave.
Detroit
Audio House, Inc., 19771 Conan
Haco Distributing Co., 9730 Burnette
The J. L. Hudson Co., 1206 Woodward Ave.
K. L. A. Labs, Inc., 7422 Woodward Ave.
Pecor Electronics, 10729 Morang
Reno Radio Co., 1314 Broadway
Sihler's Radio Shop, 15822 Grand River
Lansing
Tape Recording Industries, 3335 E. Michigan
Sault Ste. Marie
John P. LeBlanc, 321 E. Spruce St.

MINNESOTA

Minneapolis
Lew Bonn Co., 1211 LaSalle Ave.
Disc & Needle Record Shops, 1439 W. Lake
Paul A. Schmitt Music Co., 88 S. 10th St.
St. Paul
Fine Cameras & Records, 2060 Ford Pkwy.
Gopher Electronics Co., 370 Minnesota St.

MISSOURI

Independence
Don Cook's Electronic Equip.,
1020 W. Truman Rd.
Kansas City
Barnard's, 4724 Broadway
David Beatty Custom High Fidelity Sound,
1616 Westport Road
St. Louis
Walter Ashe, 1125 Pine St.
Commercial Electronic Serv., 2609 Olive St.
Van Sickle Radio Co., 1113 Pine St.

NEBRASKA

Omaha
Mass Recording Studios, 1910 California St.

NEW JERSEY

E. Orange
Custom Music Systems, 426 Main St.
Morristown
M & M Telev. Co., Inc., 7 Maple Ave.
Newark
Hudson Radio Co., 35 William St.
Lafayette Radio, 24 Central Ave.
Paramus
Music Age, Inc., Route 4
Paterson
TV & Electronics Co., 152 Paterson St.
Princeton
Princeton Listening Post, 164 Nassau St.

NEW MEXICO

Albuquerque
Sound Engineering & Equip.,
601½ Yale Blvd. SE

NEW YORK

Albany
Hi-Fidelity Centre, 11 N. Pearl St.
Otisonde, Inc., 380 Clinton Ave.
Binghamton
Audio Service Co., 145 State St.
Buffalo
Frontier Electronics Inc., 1503 Main St.
Radio Equipment Corp., 147-151 Genesee St.
Hempstead
Island Radio Distributor, Inc., 412 Fulton Ave.
Standard Parts Corp., 277 N. Franklin
Jamaica
Harrison Audio Shop, 144-24 Hillside Ave.

EVERYTHING IN HIGH FIDELITY . . .

from pickup to speaker. Try and compare your choice of hi-fi components on the "AUDIOMAT" in ASCO's air-conditioned demonstration studio.

ASCO SOUND CORPORATION

115 W. 45th St., 3rd floor, New York 36, N. Y.
Write for free catalog, or phone JUdson 2-1750

Long Island City
Electronic Supply Corp., 4108 Greenpoint Ave.
New York
Arrow Electronics, 65 Cortland St.
Bennett Radio, 565 3rd Ave.
Dorosin Distributing Corp., 149 W. 13th St.
Federated Purchaser, Inc., 66 Dey St.
Goody Audio, 235 W. 49th St.
R. Gordon & Co., 32 E. 59th St.
Grand Central Radio, 124 E. 44th St.
Harrison Audio Shop, 225 Greenwich St.

HARVEY RADIO CO., Inc.

The best place to see, hear, and buy the newest and finest in hi-fi equipment. Out-of-towners—make Harvey Radio your audio headquarters. One block from Times Square.

103 W. 43rd St., New York 36 Phone JU 2-1500

Heins & Bolet Co., 68 Cortlandt St.
Hudson Radio Co., 48 W. 48th St.
Hudson Radio Co., 212 Fulton St.
Lafayette Radio, 100 Sixth Ave.
Leonard Radio, Inc., 69 Cortlandt St.
Midway Radio & TV Corp., 60 W. 45th St.
Music Masters Records, 53 W. 47th St.
Niagara-Concord Corp., 55 Vesey St.
G. Schirmer, Inc., 3 East 43 St.

SUN RADIO & ELECTRONICS, Inc.

Largest Audio Demonstration Facilities!

3 completely-equipped sound studios. Ask for Free Catalog. Write or Phone OR 5-8600

650 6th Ave., Cor. 20th Street, New York 11

TERMINAL RADIO CORP.

LARGEST AUDIO DEPARTMENT
FAMOUS FOR "SOUND" VALUES

85 CORTLANDT STREET, NEW YORK 7, N. Y.

Rochester
Craig Audio Laboratory, 12 Vine St.
Jerry Fink Co., 358 Averill Ave.
Music Lovers Shoppe, 370 E. Main St.
Syracuse
Cambridge Electronics Co., 1014 E. Fayette St.
W. E. Berndt, 655 S. Warren St.

NORTH CAROLINA

Burlington
High Fidelity Sales, Box 1676
Chapel Hill
Kemp's, 207 E. Franklin St.
Charlotte
Music, Inc., 212 N. Independence

NORTH DAKOTA

Fargo
Walter Electronic Co., 402 N. P Ave.

OHIO

Cincinnati
Customcrafters Audio, Inc., 2259 Gilbert Ave.
Rex Dale Hi-Fi, WA 4541, Price Hill, 4114 Francis Ave.
Steinburg's, Inc., 633 Walnut St.
Cleveland
Audio Craft Co., 2915 Prospect Ave.

Custom Classics, 13421 Euclid Ave.
Publix Book Mart, 930 Prospect Ave.
Radio & Electronics Parts Corp., 3235 Prospect
Columbus
Anderson's High Fidelity Sound Center,
2244 Neil Avenue
Electronic Supply Corp., 134 E. Long St.
Fairview Park
Counterpoint, Inc., 20971 Westgate
Lakewood
Music Unlimited, 13410 Detroit Ave.
Toledo
Torrence Radio, Inc., 1314 Madison Ave.
Warren Radio Co., 1002 Adams St.

OREGON

Eugene
Abar Radio & Television, 298 W. Broadway
Portland
Hawthorne Electronics, 700 S. E. Hawthorne
Salem
Cecil Fornes Co., 442 N. Church St.

PENNSYLVANIA

Allentown
Baker Communications, 9 S. 12th St.
Hazleton
S. J. Pensock, 136 N. Wyoming
Philadelphia
Almo Radio Co., 412 N. 6th St.
Audio Electro Co., 4923 N. Broad St.
Danby Radio Corp., 19 S. 21st St.
W. P. Kelly Electronics, 6239 Frankford Ave.
Penn Electronic Parts Co., 5303 Frankford Ave.

in the PHILADELPHIA area

YOUR
COMPLETE
SUPPLIER IS

Radio Electric
SERVICE CO. OF PENNA., INC.

HI-FI & COMMERCIAL SOUND STUDIO
709 Arch Street, Philadelphia 6, Pennsylvania
Phone: Lombard 3-7390

ten Cate Associates, 6128 Morton St.
Walker Radio Serv. & Sales, 3rd & Fern Sts.
Roslyn
High-Fidelity Music Center, 1373-83 Easton Rd.
York
York Radio & Refrigeration Parts
263 W. Market St.

RHODE ISLAND

Providence
DeMambro Radio Supply Co., 90 Broadway
Leo Miller—TV-Radio-High Fidelity
790 N. Main St.

TENNESSEE

Memphis
Ferguson's Record Shop, 173 South Cooper St.

TEXAS

Fort Worth
Audio Associates, 2804 Race St.
Houston
Audio Center, Inc., 1633 Westheimer
Gulf Coast Electronics, 1110 Winbern St.
Sterling Radio Prods., Co., 1616 McKinney Ave.
Wrye Company Ltd., 2045 Welsh St.

UTAH

Salt Lake City
O'Loughlin's Radio Supply Corp.,
113 E. South St.

VIRGINIA

Arlington
Whitney's Audio Services, 3131 N. 10th St.
Charlottesville
Charlottesville Music Center, Inc.,
117 E. Main

PRECEDENT



Collectors' choice

► Modern masters in the art of gracious living wisely insist upon the superlative new PRECEDENT: the modern masterpiece in radio reception.

► They have found that no home listening experience can compare with the undreamt-of realism of live FM broadcasts — conveyed with the perfection which only PRECEDENT can provide.

► And they're delighted to discover that this FM tuner which has everything costs but \$325 in a handsome metal cover. So little for a lifetime of incomparable enjoyment!

RADIO ENGINEERING LABORATORIES • INC.
36-40 Thirty-seventh Street • Long Island City 1, N. Y.

A brief pictorial history of FM reception is available without cost. Write today for your copy of FM GROWS UP.



VIRGINIA

Continued from page 49

Richmond
Harry Dalton—"Audio Workshop"
5813 S. Crestwood Ave.

WASHINGTON

Puyallup
Music Shop, 111 W. Main St.
Seattle
Electricraft, Inc., 622 Union St.
High Fidelity Headquarters, 603 Broadway N.
Olympic Engineering Co., 2008 Westlake Ave.
Pacific Electronics Sales, 1209 First Ave.
Radio Products Sales Co., 1214 First Ave.
Seattle Radio Supply Co., 2117 Second Ave.
Tacoma
C & G Radio Supply Co., 2502 Jefferson
Wm. T. Raymond & Associates
17 Oak Park Dr., SW

WEST VIRGINIA

Wheeling
James M. Black & Sons, 952 Market St.

WISCONSIN

Milwaukee
Television Parts, Inc., 714 W. State St.

ALBERTA

Lethbridge
Leister's, Paramount Theatre Bldg.

BRITISH COLUMBIA

Vancouver
Hygrade Sound Sales, 971 Richards St.

ONTARIO

Toronto
Custom Sound & Vision, Ltd., 390 Eglinton West
Custom Sound Reg'd, 23 Park Road

IN CANADA —

There's one place where you can find—and hear—all your high-fidelity equipment needs. We carry a complete stock . . . come in, or write in, for a chat, a look, and a listen.

ELECTRO-VOICE
SOUND SYSTEMS
141 Dundas St., West, TORONTO

QUEBEC

Montreal
Canadian Elec. Supply Co., Ltd.
275 Craig St. W.
Payette Radio Ltd., 730 St. James W.
Savard Radio Co., 910 Bleury

SASKATCHEWAN

Regina
National Musical Supply Co., 1780 Hamilton St.

CUBA

Havana, Vedado
"California" Alta-Fidelidad, LaRompo 23Y "P"

ENGLAND

Croydon, Surrey
Classic Electrical Co.,
352 Lower Addiscombe Rd.

JAPAN

Tokyo
Nippon Gakki Seizo Kabushiki Kaisha, Takyo Br.,
No. 1, 7-chome, Ginza, Chuo-ku

MEXICO

Mexico City
Audio-Vision, S. A., Alencaster 345

SOUTH AFRICA

Johannesburg
Recordia Photo & Gramophone Co.,
Ltd., Box 2400

Popular Albums

Continued from page 34

I love many of the things she does in this album, especially the big *Born in a Trunk tour de force*, which is a kind of Garland of roses. Columbia BL 1201.

I Only Have Eyes For You

A collection of Harry Warren songs, which may well prove that Harry Warren's music is better than Spencer-Hagen's orchestra, although the whole, wistful affair is pleasant enough. But oh how they do drag out some of the songs! "X" LXA-1000.

Dinah Shore TV Favorites



Well, Dinah is Dinah, and songs like *I've Got a Crush on You*, *Little Girl Blue*, *A Fellow Needs a Girl*, and *How Long Has This Been Going On?* are pretty darned fine songs.

I'd have preferred a more intimate, a softer accompaniment, but so few people in TV ever think about doing anything in an easy, intimate way. RCA-Victor LPM 3214.

To My Love

Still another 12-in. LP, this one by Richard Hayman's orchestra, devoted to soft moods and sweet music. To a background that is both lyrical and ordinary, young Hayman, who is a wizard on the harmonica, adds a haunting line of melody. Mercury MG 20048.

Just One More Dance

An octet of dreamy favorites played by Les Elgart's polished band in an intimate, yet rhythmic fashion. For dancing late at night you'll go a long way to find better music than this. Columbia CL 6284.

Mark Twain and Other Folk Favorites

Harry George Belafonte is superb talent. It is not too absurd to say that he may become to folk music what Carl Sandburg is to Abraham Lincoln. Accompanied simply, splendidly by guitarist Millard Thomas, and orchestra and chorus, Belafonte dips his unique voice and personality into the cup of folklore. The brew is magnificent. RCA-Victor LPM 1022.

Presenting Frank Chacksfield

Mr. Chacksfield, on the strength of his haunting *Ebb Tide*, has become an Englishman of definite appeal in the United States. This LP does credit to his orchestra. London LL 1041. — Fred Reynolds.

NEW!

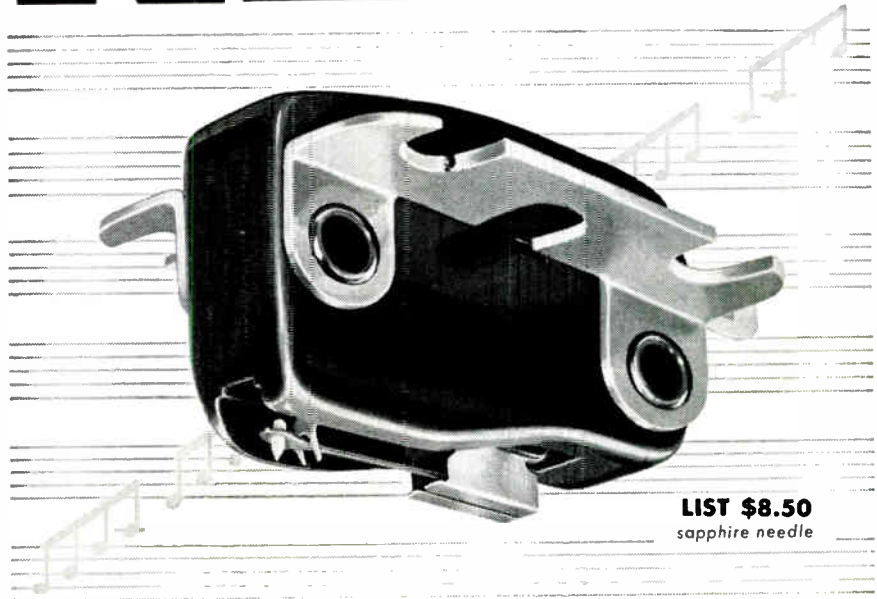

LIST \$8.50
sapphire needle

... another first from

SONOTONE

wide-range
high-compliance
single-needle ceramic cartridge



Here at last is a high fidelity cartridge at a moderate price,
available in either of two needle sizes —
one for 45 and 33 1/3 rpm, the other for 78 rpm.

Performance is at the same high level as the world-famous
Sonotone "Turnover."

Send coupon for free bulletin showing the exceptional specifications
of this new cartridge.

ELECTRONIC APPLICATIONS DIVISION

SONOTONE CORPORATION

Elmsford, New York

SONOTONE CORPORATION, DEPT. M
ELMSFORD, N. Y.

Please send me free bulletin describing your new 1P Cartridge.

NAME _____

ADDRESS _____ APT. _____

CITY _____ STATE _____

QUALITY
you can hear
and feel

FME
TAPE RECORDER



two-speed, dual-track

When buying any recording equipment you, as a high fidelity enthusiast, are interested in its many technical aspects. Frequency response, signal-to-noise ratio, flutter and wow are, certainly, all important. And in these aspects the FME Tape Recorder is incomparable in its price class.

Yet, in the truest sense only your ear can really distinguish the quality of fine recorded sound. Only your trained touch can really judge the simple, smooth operation of a tape recorder. It is for this reason that Federal, without bold reference to technical specifications, invites you, the real jury, to listen to the FME.

Hear for yourself Federal's triumph in sound. Feel for yourself its quality construction, its smooth, simple operation. Playback any tape—either 3¼ or 7½ IPS. Test its single knob control, its fast forward and rewind, its separate volume and tone controls and many other wanted features.

Then look at the price—we're sure you'll be delightfully surprised.

Only \$139.95. Slightly higher on West Coast. Supplied complete with ceramic microphone, reel of magnetic tape, take-up reel, power cord and plug. L-39

FEDERAL MANUFACTURING AND ENGINEERING CORP.
 215 Steuben Street, Brooklyn 5, N. Y.
 EXPORT DIVISION: 25 Warren St., N. Y. 7, N. Y.
 Cables SIMONTRICE NEW YORK all codes

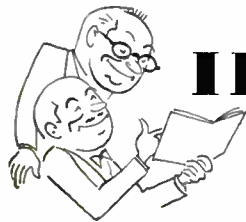

IDEAS for YOU

THE PURPOSE of this Department is to call attention to new products of interest to our readers. No attempt is made to rate performance of equipment shown, as that is not considered to be a proper function of this Magazine. Detailed specifications and descriptive literature can be obtained on request by writing the manufacturers. Music at Home will appreciate your mentioning this Magazine.

Table or Chairside Phonograph

Has Garrard RC-80 3-speed changer, GE cartridge, 8-watt push-pull amplifier, 8-in.



woofer, and a 6-in. tweeter, with a 3-step equalizer. Wrought iron legs are optional. Pilot Radio Corp., 37-06 36th St., Long Island City 1, N. Y.

Speaker System

Model E-300 cabinet, of 5 cu. ft., contains a B-199A woofer and a coaxially-mounted B-200X dual tweeter. The B-209 mid-range



speaker and N-101 network can be added. Dimensions are 30½ ins. high, 24 wide, and 17 deep. R. T. Bozak Co., P. O. Box 966, Darien, Conn.

45-RPM Record Changer

Plays 12 45-rpm. records and then re-stacks them automatically. Dial at front can be set for any number of plays, for continuous



playing, or to shut off automatically. Stylus is cleaned by a brush after each record. Gramercy Sound Associates, 175 5th Ave., New York 10

25-Watt Amplifier

Model AR-420 features continuously variable turnover and de-emphasis controls, rumble filter, and a volume control which

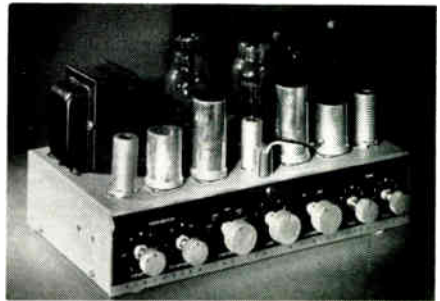

can be switched over to function as a loudness control. Bass and treble controls are continuously variable. Stromberg-Carlson Co., Rochester 21, N. Y.

Tape Cabinet

Attractive storage chest holds three 600-ft. reels of No. 211 tape, a roll of splicing tape, and a 150-ft. roll of leader stock, to-



gether with an empty 600-ft. reel and an empty 150-ft. reel, with 20 reel tabs. ORRadio Industries, Inc., T-120 Marryn Rd., Opelika, Ala.

Two-Way Speaker System

An improved and redesigned version of the

Ideas for You

Continued from page 52



Tru-Sonic model 617 cabinet includes a 103LX speaker, cellular horn, and 800-cycle network. Dimensions are 36 ins. high, 26 wide, and 20½ deep. *Stephens Mfg. Corp., Culver City, Calif.*

50-Watt Amplifier

New circuit is designed to match automatically the voice-coil impedance at all fre-



quencies. Called Z-Matic, this control is also available for adding to Fisher 70-A and 50-A amplifiers. *Fisher Radio Corp., 21-21 44th Drive, Long Island City 1, N. Y.*

Single-Needle Cartridge

Ceramic type has snap-in needle for easy replacement. Diamond or sapphire stylus is

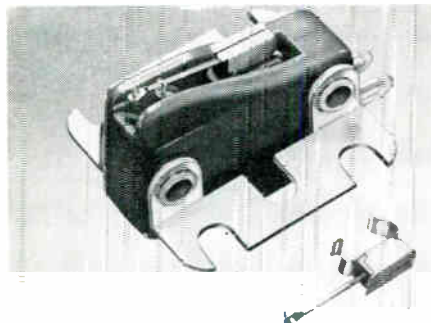

furnished for fine-groove or 78 records. With an output of 1 volt on 33 records, no

Continued on page 54



NOW — *Highest quality performance*
at a reasonable price

Now, for the first time, a quality hi-fidelity FM tuner has been designed that is priced to fit your pocketbook. By utilizing new circuit techniques and the latest miniature tubes, Browning Laboratories have been able to maintain their traditional standards of highest quality at a greatly reduced cost. The "Brownie" is extremely compact, yet has all the features of larger models. It gives you undistorted, noise-free reception, can be used with the most expensive amplifiers and speakers, and opens the door to many new, exciting installation ideas.



Buy the "Brownie" — superb, high-priced performance for only **\$8750**



THE WORLD'S OLDEST AND LARGEST EXCLUSIVE
MANUFACTURER OF HI-FI TUNERS

check these design features

High sensitivity — 3.5 microvolts for 20 db quieting — ±22.5 KC at 400 cps in accordance with I.R.E. standards · Overall frequency response — 20 to 20,000 cycles · Smooth Automatic Frequency Control · High gain 6BQ7A cascode RF amplifier · Cathode follower output · Full vision, illuminated easy-to-read slide rule dial · Armstrong circuit · Velvet tuning control · Low interstation noise · Front panel volume control · Tape recorder output · Compact size: 9" wide x 4½" high x 8" deep.

For more information see your local hi-fi dealer, or write the Browning Laboratories, Inc.

Klipschorn
CORNER SPEAKER SYSTEM

**BIG
VOICE
IN A
SMALL
SPACE**

Only a big speaker system can authentically reproduce big instruments. And only the authentic Klipschorn offers you a big speaker system in a small space.

Exclusive Klipsch design makes use of room walls as well as every cubic inch inside the system to reproduce the largest, as well as the smallest, instruments. By mounting all three of its carefully balanced speakers in specially designed horns, Klipsch gives you over nine full octaves of true tones and timbre.

Write for the new brochure on the authentic Klipschorn.

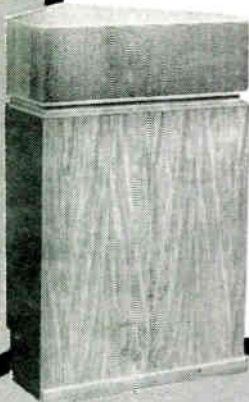

KLIPSCH & ASSOCIATES

HOPE, ARKANSAS

TELEPHONES

PRospect 7-3395 PRospect 7-5575

PRospect 7-4538 PRospect 7-5514

Ideas for You

Continued from page 53

preamp or equalizer is necessary. The cartridge fits practically all standard tone arms. *Sonorone Corp., Elmsford, N. Y.*

3-Speed Changer

Plays 7, 10, and 12-in. records intermixed without presetting, if they are all of the



same speed, with a changing cycle of 6 seconds. Design features include automatic idler disengagement, weighted steel table, and automatic muting switch. *Collaro Div., Rockbar Corp., 215 E. 37th St., New York 16*

15-Watt Amplifier

Williamson-type has 6 tubes plus rectifier, with push-pull output. Dual equalization switches provide 5 positions of bass turn-



over and 5 for treble rolloff. There are individual level controls for 3 inputs. *Pilot Radio Corp., 37-06 36th St., Long Island City 1, N. Y.*

Dynamic Microphone

Omni-directional slim-type mike, intended



general-purpose use, is 1¾ by 7½ ins. Choice of high or low impedance by chang-

*Only the Sound
You were meant to hear
with the*
**FAIRCHILD
280 SERIES
TRANSCRIPTION ARM**



The Series 280 new-type transcription arm permits the cartridge alone to lift all the tone color from high fidelity recordings—eliminates the adverse effects of arm resonance. Dual pivoting, plus a precision engineered offset provide continuous midgroove tracking, while an automatic built-in arm rest safeguards the stylus. Designed for any standard cartridge. A Fairchild professional quality achievement!

\$29.50

**NEW FAIRCHILD
220 CARTRIDGE**

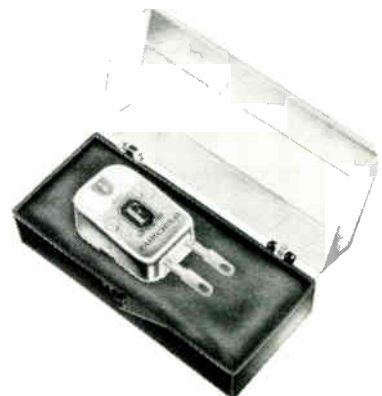

An unparalleled achievement in high fidelity cartridge design. No peaks! No sharp cut-offs! Completely uniform response to 17,000 cycles — and slow roll-off beyond — giving smooth natural sound. Identify the NEW Fairchild 220 by its sparkling silver finish, symbolizing peerless performance.

\$37.50



These Fairchild products are now available at better audio dealers.

**FAIRCHILD RECORDING
EQUIPMENT**

156th Street & 7th Ave., Whitestone, N. Y.

Ideas for You

Continued from page 54

ing one wire in the cable connector. Output level is -55 db. *Electro-Voice, Inc., Buchanan, Mich.*

FM Tuner

Pancake chassis is designed for minimum panel height. Meters show signal strength

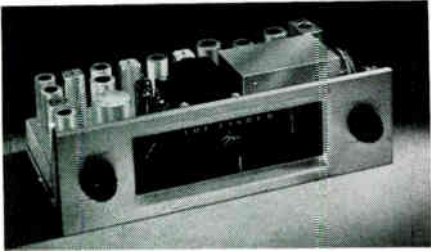

and tuning. Armstrong circuit has 11 tubes with cascode RF, two IF stages, and dual limiters. Controls are for variable AFC and line switch, volume, and tuning. The chassis is 12 3/4 ins. wide, 4 high, and 8 1/2 deep overall. *Fisher Radio Corp., 21-21 44th Drive, Long Island City 1, N. Y.*

12-Watt Amplifier

This unit has switch-controlled inputs for a magnetic pickup, microphone, tape, and tuner, bass and treble controls calibrated

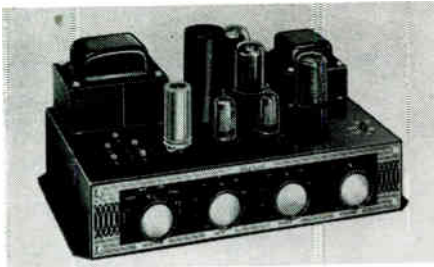

in db, an adjustment which serves as a volume or loudness control, and settings for frr, RIAA, and scratch reduction. Control shafts can be extended for any panel thickness. *Rauland-Borg Corp., 3515 W. Addison St., Chicago 18*

Pickup Arm and Cartridges

Arm of chromium-plated tubing rides on a double ballbearing swivel, with stylus

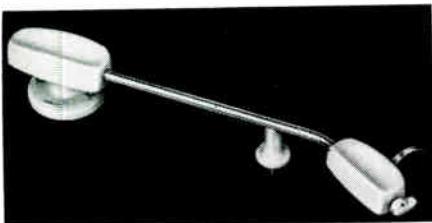

pressure adjustable from 1 to 8 grams. Pickup has two non-interacting sapphire styli or a diamond and sapphire. Recommended pressure is 3 grams. Supplied for 12- or 16-in. records. *Ronette Acoustical Corp., 135 Front St., New York 5*

Continued on page 56

"Best Buys" in Hi-Fi Systems

Selected from the new 308-page ALLIED 1955 CATALOG



New "Space Saver" Phono System

Now you can have authentic high fidelity performance in minimum space. No investment in cabinetry required. Components carefully selected and matched. Simple plug-in installation. System includes: quality Knight 12-Watt Amplifier (featuring 3-position record compensation, calibrated bass and treble controls, loudness-volume control, response ± 0.75 db, 20-20,000 cps at 12 watts) in black-wrinkle metal case only 3 1/2 x 13 x 10 1/4"; Webcor 1127-270 Three-Speed Changer (9 x 14 x 14") with G. E. RPX-050 triple-play magnetic cartridge (dual-tip sapphire stylus); Permo-flux "Diminnette" speaker system (3 speakers in modified bass reflex enclosure, for bass, middle range and treble reproduction), 11 1/2 x 23 1/2 x 12", choice of mahogany or blonde finish. System comes ready to plug in. Hi-fi demonstration record included. Shpg. wt., 56 lbs.

94 PA 129. Net only \$156.50
93 SX 312. Knight 12-Watt "Space Saver" Amplifier only. Shpg. wt., 14 lbs. Net only \$59.50

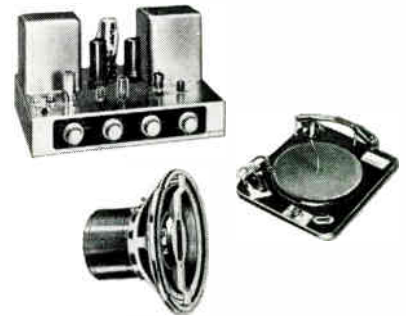

"Golden Knight" Phono System

The super-value high fidelity system. Top quality matched components at a remarkably low price. Complete system includes: "Golden Knight" 24-Watt Amplifier (3-position record compensator, response ± 0.75 db, 20-40,000 cps, 4 inputs, separate bass and treble controls), satin-gold finish, 8 x 14 x 9"; famous Garrard RC-80 Record Changer; deluxe G. E. RPX-052 triple-play "Golden Treasure" magnetic cartridge with dual-tipped stylus (diamond LP tip, sapphire standard tip); Electro-Voice 12TRX 3-way speaker with 3 coaxially mounted sections (response ± 5 db, 30-15,000 cps). This superb system is complete with all plugs, cable and hardware, plus hi-fi demonstration record—ready for plug-in connection. Shpg. wt., 92 lbs.

94 PA 134. Net only \$261.75
93 SX 321. "Golden Knight" 24-Watt Hi-Fi Amplifier only. Shpg. wt., 30 lbs. Net only \$79.50

SEND FOR FREE CATALOG

Write today for ALLIED'S 308-page 1955 Catalog—your complete guide to the world's largest selections of Hi-Fi home music systems, amplifiers, tuners, speakers, enclosures, changers, recorders and accessories. If it's anything in Hi-Fi, it's in stock at ALLIED.

ALLIED RADIO

Everything in Hi-Fi

EXPERT HI-FI HELP

Our Hi-Fi consultants are always available to help you select components and systems to satisfy your listening desires at the lowest possible cost to you.

EASY TERMS

Hi-Fi is available from ALLIED on easy payments: only 10% down, 12 months to pay. Write for details.



Free Send for our 16-page illustrated booklet: "This is High Fidelity"

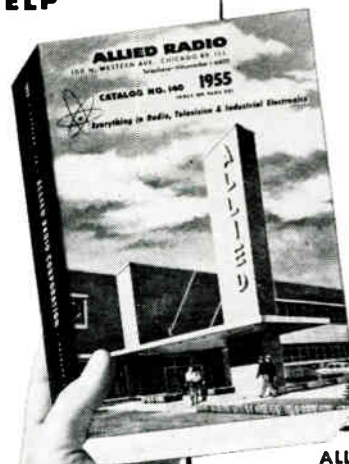

ALLIED RADIO CORP., Dept. 76-A-5
100 N. Western Ave., Chicago 80, Ill.

- Send FREE 1955 Catalog
- Send FREE Hi-Fi Booklet

Ship the following: _____
\$..... enclosed.

Name _____

Address _____

City _____ Zone _____ State _____

"SHALL I BUY A TURNTABLE OR A RECORD CHANGER?"



GET THE FACTS
from one of America's
leading manufacturers of
professional recording
and playback equipment.
Plus a FREE Strobe Disc
for checking Turntable
Speeds. Write today.

REK-O-KUT COMPANY, Dept. PA-16
38-01 Queens Blvd., Long Island City 1, N. Y.

Please send me the facts on turntables and
record changers . . . plus the Free Strobe Disc.

Name

Address

City Zone State

My Dealer is

Ideas for You

Continued from page 55

20-Watt Amplifier

Model LH-20 follows the general design of
Langevin equipment for broadcast station

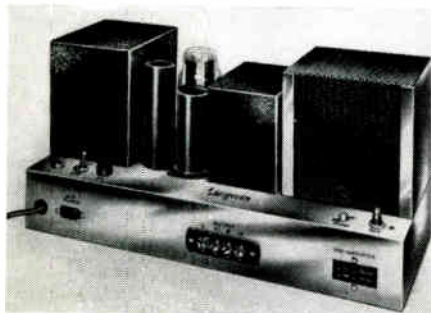

use, where continuous operation is re-
quired. Sensitivity is .4 volt for 20-watt
output. Companion preamp is available.
Langevin Mfg. Corp., 37 W. 65th St., New
York 23

Preamplifier

The model TM-15P preamplifier kit is in-
tended for use with the Tech-Master TM-15



amplifier. This unit has a selector switch
for 4 inputs, the usual audio controls, and
a cathode follower output. Tech-Master
Corp., 75 Front St., Brooklyn 1, N. Y.

Tape Clamp

This device will be welcomed by everyone
who has struggled to start a tape on a reel.

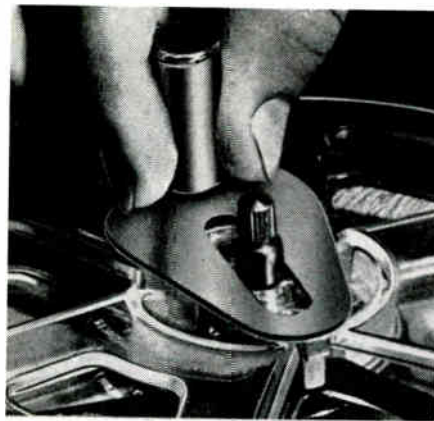

For use on all reels up to 7 ins., this clamp
holds the tape for the first few turns. Then
it can be slipped off, or used as a crank.
Flahan Co., 7517 Pelham Drive, Cleveland 29,
Ohio

YOUR EYE
ON THE ROAD
YOUR EAR IN
SYMPHONY HALL

Hastings
HIGH FIDELITY-F.M.
Car RECEIVER



*You get Concert Hall
Quality AS YOU DRIVE.*

AVAILABLE IN 6 OR 12 VOLT MODELS
FOR USE WITH ANY AM CAR RADIO OR
WITH HASTINGS HI FIDELITY POWER
AMPLIFIER.

THESE FEATURES, PLUS DOZENS OF
OTHERS, ASSURE UNEQUALLED
PERFORMANCE.

- Covers 87 to 109 megacycles
- Full Armstrong circuit
- Automatic frequency control, locks in sta-
tion signal
- 2 microvolt sensitivity. Full limiting action
with 5 microvolts input
- Optimum selectivity for maximum image
rejection. Adjacent channel 60 DB down
- 200 KC IF bandwidth
- New crystal limiter — superior clipping
action
- Electronic tone control — increases bass
response without attenuating highs
- Compact size: From panel 6½" wide x
4" high. Depth 7½" for case plus 1" for
power cable input plug at rear and 1½"
for knobs on front
- Chrome panel and metal knobs. Gray
Hammer-tone case
- Rigid, rugged, non-critical construction
- Only highest quality components used.
- Fully guaranteed

CAR TUNER COSTS YOU

JUST \$99.50 FOB BOSTON

Hastings High Fidelity Car Power Amplifier
(for cars without existing AM
Radios) **\$63.50**

SEND FOR IT TODAY!

This colorful folder that contains
all the facts about this outstand-
ing Hi Fidelity FM Unit. Your
copy is free and there's no
obligation.



Hastings
PRODUCTS, Inc.

171 Newbury St., Boston 16, Mass.

The Next Issue

Now that we are starting our first tests on news stand sales, the experts in that method of distribution have insisted on a modification of our front cover

People who will see *MUSIC AT HOME* on the stands for the first time, so we are told, are more likely to associate this Magazine with instrumental music than with hi-fi activities. Accordingly, they feel that the expression *Hi-Fi* should appear on the cover, as a means of identification

We have been experimenting with this idea. So far, nothing has been finalized. In any case, the characteristic lettering of *MUSIC AT HOME* will not be changed, but if we can find an acceptable way to do it, you will see *Hi-Fi* added to the name on the cover of the next issue. It is important, of course, to have the cover indicate what is inside the Magazine.

Inside Information

Continued from page 44

models range from 9 to 18 ins., rated at 8 to 40 watts capacity.

Browning Laboratories has brought out twin tuners, model L-300 for FM, and L-500 for AM, featuring miniaturized design. Photo No. 3 shows the FM type. Both chassis measure 9½ ins. long by 6½ deep and 4⅞ high overall, behind the panel. There are 8 tubes, comprising a 6BQ7 cascode RF amplifier, 12AT7 mixer-oscillator, 12AT7 AFC, two 6AU6 IF amplifiers, 6AU6 limiter, 6AL5 discriminator, and a 6AV6 cathode follower, plus a 6X4 rectifier. The controls are for volume and tuning. A predetermined amount of AFC action is in operation at all times, since no cut-out switch is provided. There is a second output for off-the-air recording, so arranged that the signal can be monitored from the associated audio system. Blonde and mahogany cabinets are available for the twin tuners.

No. 4 is an unfamiliar view of a well-known English preamplifier. It is the Leak Point One, a neat and tidy companion to the TL/10 amplifier. In spite of its seeming simplicity, circuits and connections accommodate all the standard pick-ups, microphone and radio receiver, and tape recording and playback, in addition to the regular controls for bass, treble, volume, and equalization.

Photo No. 5 was taken of the LEE Catenoid speaker cabinet to show how the construction indicated by the drawing is actually achieved. In this view, one back plate was removed. The other, as you can see, is cut away to provide an opening at the side, with a configuration which follows the catenoid shape of the horn. When the top plate is in position, and the cabinet is put in a corner, the sides are spaced out from the wall, making the wall a part of the horn mouth. A mid-range speaker and tweeter are set into the upper front section of the cabinet.

HERE IS **TELEVISION** FOR YOUR HIGH FIDELITY SOUND SYSTEM

Specifically designed and custom-built to operate through your high fidelity amplifier and speaker system (or independently, if you wish). In this way, you enjoy the VIDEO QUALITY of Tech-Master's advanced 630-type design and the audio quality of your own high fidelity sound system.

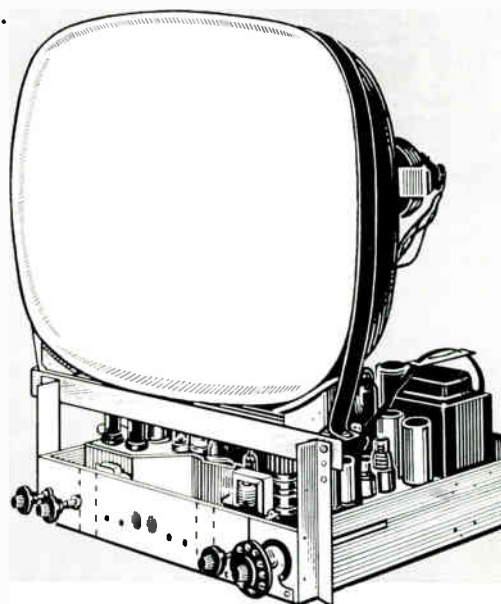

TECH-MASTER

Custom-Built TV Chassis

DESIGNED FOR USE WITH
HOME HIGH FIDELITY SYSTEMS

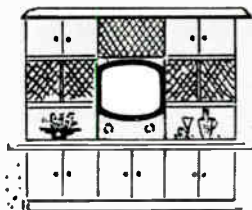

Illustrated Brochure Upon Request

TECH-MASTER CORPORATION

75 Front Street, Brooklyn 1, New York

ASK FOR THE GOLD MEDAL SERIES

Models 2430 and 2431 for 21" and 24" picture tubes, model 2430-9 for 27" picture tubes.

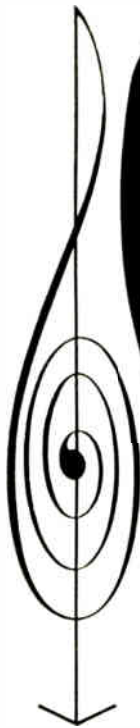

HIGH FIDELITY FM STARTS WITH THE antenna

Good FM reproduction demands a good antenna. To realize the full potentials of any Hi-Fi FM system the full signal from the station must be captured by an antenna specifically designed for FM. TACO, the oldest name in receiving antennas, has designed such antennas and is offering the following models for greater enjoyment of Hi-Fi . . .

TWIN-DRIVEN YAGI

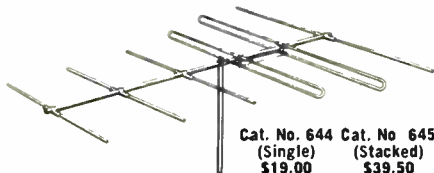

Cat. No. 644 (Single) \$19.00
Cat. No. 645 (Stacked) \$39.50

High-gain design for fringe or weak-signal areas. Provides FM signals at their best. Minimizes interference from other sources. Uni-directional—recommended for areas where all FM channels are received from one direction, or for use with mechanical rotator.

OMNI-DIRECTIONAL

The most popular FM antennas ever offered. Ideal for the average FM installation. Unique design provides equal reception from all directions with excellent gain. May be used as single antenna or stacked as illustrated.

Cat. No. 624L (Single) \$7.15
Cat. No. 624STL (Stacked) \$14.10

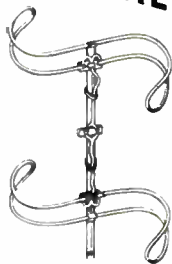

TACO

TECHNICAL APPLIANCE CORPORATION
SHERBURNE, N. Y.

WRITE FOR YOUR FM ANTENNA BULLETIN

Box MG,
Technical Appliance Corporation,
Sherburne, N. Y.

Name

Address

Music Tape Reviews

Continued from page 27

little too much matter-of-fact, especially in the tender second movement.

With the introduction of tape to a wider audience, it is interesting to observe a deviation from the usual kind of program-making, developing out of the time element. Quantitatively, more music can be recorded on a reel of tape than on a disc. Thus, it becomes possible to present orchestral music in the form of a complete concert program. This principle makes for greater listening variety, without causing a break of style.

Consider, for instance, this Webcor release. The reel represents several style periods, and at first glance one might think that various works are mixed together under the general label of "string music" when, actually, a complete concert program is presented.

Records, Tape and FM

Continued from page 13

LP's containing six zarzuelas by the Coro Lirico de Madrid, and the Agrupación Sinfónica "La Zarzuela", with F. Moreno Torroba conducting. They are exceptionally fine examples of the lyric theatre and opera peculiar to Spanish culture. The record numbers are ML-4930, 4931 and 4932.

Technical Terms Defined

A very fine reference dictionary of audio, radio, and general electronics terms has been produced by Gordon R. Partridge, associate Professor of Electrical Engineering at Purdue University. Titled "A Dictionary of Electronic Terms", the volume of 72 pages 6 by 9 ins. contains 3,500 definitions and 150 illustrations. It is published by Allied Radio Corporation, 100 N. Western Avenue, Chicago 80. Price prepaid is 25¢.

Audio Show at Washington, D. C.

Will be held again at Hotel Harrington, from March 4 to 6 inclusive. This has always been a highly successful show, with excellent exhibits drawing large attendance. Dan R. Cavalier is the manager.

Alexander M. Poniatoff

The story of Alexander Poniatoff, president of Ampex Corporation, is a fascinating romance of the audio industry. Ampex was founded in November 1944 to manufacture precision motors and generators for airborne radar. While searching for a new product to manufacture after the war, Mr. Poniatoff attended a demonstration of the German Magnetophon tape recorder. Believing that he could improve on that design, he started in April, 1947, to build the first Ampex tape machine, assisted by engineers Harold Lindsay and Myron Stolaroff. Their first recorder was completed

Continued on page 59

THE FIRST Major Advance IN A Decade!!

THE LABORATORY of ELECTRONIC ENGINEERING

Presents

"The Finest in Speaker Systems"

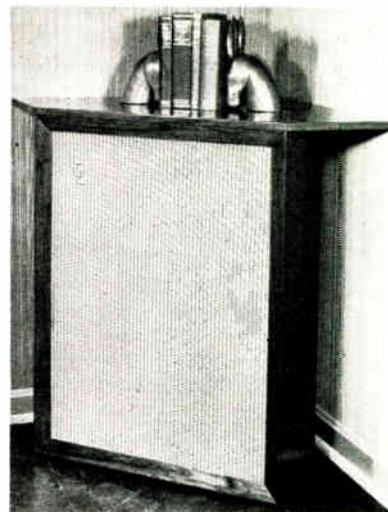

PRICED AT A MODERATE \$295

THE CATENOID

A THREE-WAY CORNER HORN SYSTEM

*Designed by Engineers
Built by Engineers*

WRITE FOR INFORMATION TO



LABORATORY of ELECTRONIC ENGINEERING, INC.

413-4 L ST., N. W., WASHINGTON, D. C.

Records, Tape and FM

Continued from page 58

the following April, but there was no market for such equipment. Meanwhile, Bing Crosby, who had changed from live broadcasts to discs as a matter of personal convenience, found that his Hooper rating had dropped. Searching for a method of recording that could not be distinguished from live broadcasting, he learned of the Ampex tape recorder. Using tape instead of discs, Bing Crosby's Hooper rose, and he was so pleased with the taped programs that he ordered 20 machines at \$4,000 each.



That gave the company its start in the recording-machine business. At that time, Ampex had eight employees, working in a small shop at San Carlos. Now, the main plant at Redwood City and a subsidiary in North Hollywood cover 75,000 square feet, housing 500 workers. Another building of 30,000 square feet is under construction.

Tape Machine Review

The tape machine business has grown to amazing proportions. In the current issue of *Audio Record*, there are illustrations of 95 different models from 35 manufacturers. They range from 12-lb. machines that are really portable to huge rack-mounted jobs that can be moved only with a lift-truck, for use at broadcast and recording studios. You can get a copy of *Audio Record* by writing to Audio Devices, Inc., 444 Madison Avenue, New York 22.

15-In. Speakers for Air-Couplers

Many readers have written to ask about using a 15-in. woofer for the Air-Coupler, instead of the 12-in. size recommended in the September-October issue. Our own experiments did not show any improvement in the use of a 15-in. speaker. Scaling up the dimensions of the enclosure showed a definite loss at the very low frequencies. However, we do not feel that our results are final, by any means, and we hope to have reports on experiments carried out by readers who have compared the perform-

Concluded on page 60

NOW! YOU SAVE UP TO \$50

WHEN YOU BUY A REALIST

HI-FI TUNER AT RADIO SHACK

1955 MODELS! HUNDREDS SOLD TO ENTHUSIASTIC USERS!

FM TUNER \$39.95

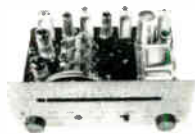

- ARMSTRONG FM WITH FOSTER-SEELEY DISCRIMINATOR!
- 5 MICROVOLT SENSITIVITY FOR 30 DB QUIETING!
- TUNED RF STAGE! DOUBLE-TUNED LIMITER! AC SUPPLY!
- AUTOMATIC FREQUENCY CONTROL (AFC)! 180kc BANDWIDTH!
- AUDIO OUTPUT 1V FOR 100% MODULATION! HUM 60 DB DOWN!
- FREQUENCY RESPONSE 20-20,000 CYCLES PLUS-MINUS 1/2 DB!
- DIRECT-FEED TAPE RECORDER JACK! AUX. PHONO INPUT!
- POWER AND TUNING CONTROLS — USE WITH ANY AMPLIFIER!
- ULTRA-COMPACT 4 1/4" H x 9 1/2" W x 6 3/4" D! COMPLETE!
- ORDER NO. 36-888M BY MAIL! ADD POSTAGE FOR 6 1/4 LBS.



AM TUNER \$29.95



- EXACT MATCH OF REALIST FM TUNER! SAME COMPACT SIZE!
- TUNED RF STAGE! AC SUPERHET CIRCUIT! AC SUPPLY!
- 5 MICROVOLT SENSITIVITY! 8kc BANDWIDTH 6 DB DOWN!
- BUILT-IN FERRITE STICK ANTENNA! BUILT-IN TAPE JACK!
- PLUS-MINUS 3 DB 20-5000 CYCLES! HUM 60 DB DOWN!
- POWER AND TUNING CONTROLS — USE WITH ANY AMPLIFIER!
- ORDER NO. 36-887M BY MAIL! ADD POSTAGE FOR 6 1/4 LBS.



REALIST 10 WATT HI-FI AMPLIFIER!

- BUILT-IN RIAA-EQUALIZED PREAMP!
- 20-20,000 CPS ±1 DB AT 3 WATTS!
- SEPARATE BASS AND TREBLE CONTROLS!
- 5 TUBES! PUSH-PULL TWO 6V6GT!
- ORDER NO. 33-303M BY MAIL! 10 LBS.

\$29⁹⁵



RADIO SHACK CORPORATION

167 Washington Street, Boston 8, Massachusetts

and 230-234 Crown St., New Haven 10, Conn.

every
note
in the
score

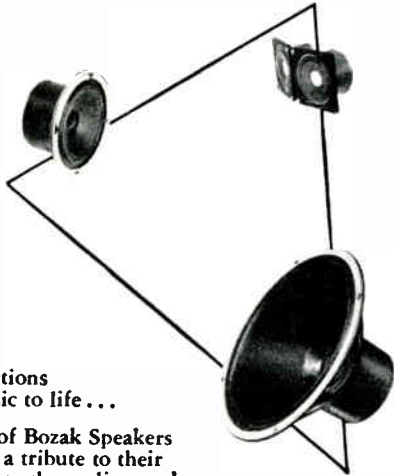

plus the subtle inflections
that bring the music to life . . .
the wide acceptance of Bozak Speakers
and Speaker Systems is a tribute to their
subtle perfections, to the realism and
listening ease they bring to a good music system.

The Very Best in Sound
Catalogs of Bozak Loudspeakers
and Speaker Systems on Request

the R. T.

BOZAK

co. *Quality Loud Speakers*

P. O. Box 966 • Darien • Connecticut
Export Office: Electronics Manufacturers' Export Company, Hicksville, New York

THE TAPE THAT MIRRORS THE ORIGINAL SOUND

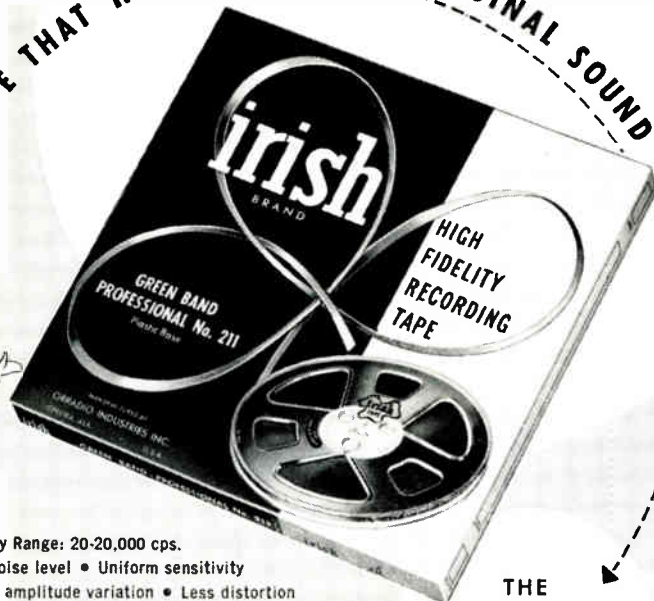

- ▶ Frequency Range: 20-20,000 cps.
- ▶ Lowest noise level • Uniform sensitivity
- ▶ Minimum amplitude variation • Less distortion

600 feet on plastic reel.....net \$2.10
1200 feet on plastic reel.....net 3.30
2400 feet on plastic reel.....net 7.71

At All Leading Sound Dealers

ORRADIO INDUSTRIES, INC.
OPELIKA, ALABAMA

Export Division: Morhan Exporting Corp., New York
In Canada: Atlas Radio Corp., Ltd., Toronto



THE
FINEST TAPE
YOUR RECORDER
CAN USE

Records, Tape and FM

Continued from page 59

ance of the standard Air-Coupler with modifications they have worked out.

Proposed Revision

Letter from R. Stewart, 9967 Grandmont Road, Detroit: "Maybe it takes an understanding wife to appreciate her husband's sense of humor, but mine gave me a wry smile when I suggested that the musical scale be changed to read Do, Re, Mi, Hi, Fi, La, Te, Do."

For Your Information

In letters from our readers, there are frequently questions asking if our Publisher still has any connection with *High Fidelity*. In case you, too, have wondered, here are the facts: That magazine was founded by Milton B. Sleeper in 1950, and published by him until he withdrew at the end of 1953, but the corporation was owned by Mrs. Sleeper until, in June, 1953, Mrs. Sleeper gave a part of her stock to Charles Fowler, John Conly, Fred Michalove, and Roy Allison. She retained control, however, until October 30, 1954, when she sold the balance of her holdings. The omission of her name from the sworn statement of ownership dated October 1, and published in the November issue of *High Fidelity*, was an error.

Tape-Length Counter

We'd like to see counters on tape machines that would show the number of feet run across the head. Revere's counter is very useful, but particularly since thin tape has come out, with more feet per reel, it would help a lot to check running time and to go back to particular spots on the tape if we had a counter to show how many feet of tape have been run at a particular point. Such a counter could be driven directly from the tape-drive spindle.

Binaural Recording

Continued from page 21

By way of experimenting, we used both a Newcomb 3D-12 25-watt binaural amplifier and a pair of 10-watt Scott 99's. Both worked perfectly. These are shown in Figs. 1 and 2. The use of a 3-way jack on the recorder for connecting to the amplifier inputs posed something of a problem, because we had to get a special plug, and connect both pairs of leads from the amplifiers to the tiny terminals of the plug. Then we couldn't get the insulating sleeve on the plug in place, so we wound up by discarding the sleeve and taping the plug terminals.

Also — but this was no fault of the equipment — if we turned on the amplifiers and switched the tape machine to RECORD, we got a terrific yowl from the speakers, as might be expected.

Concluded on page 61

Binaural Recording

Continued from page 60

I had been told that, with binaural reproduction, 10-watt amplifiers would be sufficient, and that excellent quality could be obtained from speakers of moderate price. That explains the use of two University EN-8 cabinets with the new C8W 8-in. woofers and 4401 tweeters. The cabinets were provided with legs, but we did not use them, as the illustrations show, so they would sit solidly on the floor. In the middle of the room, about 10 ft. apart, those speakers performed beautifully, and there was all the volume we could use when the Scott 99's were at much less than full output. I don't mean that the speakers reproduced all the pipes of this organ, but they gave an overall effect from the two channels that was very satisfying indeed. No doubt we shall become more and more critical as time goes on, but we were really thrilled with the playbacks from the equipment we used.

I am convinced that binaural recording and reproduction are a highly significant advance in the audio art, a step from the shadows of imitation toward the brilliance of realism.

E. J. QUINBY (Cdr. USNR) is president of Monrobot Corp., a subsidiary of Monroe Calculating Machine Co., Morris Plains, N. J. After acquiring an E. E. degree at CUNY, he joined de Forest, later going to the American Marconi Company and RCA. During World War 2, he was Officer in Charge, Naval Ordnance Electronic Weapons Laboratory, at Key West. Mrs. Quinby, who plays the organ, harp, and piano, majored in organ music at Rollins, Winter Park, Fla.

Richard Rodgers

Continued from page 26

away in her playhouse, located in a maple tree and fully hidden by the thick foliage.

Yet Hart, whom Rodgers describes as "a brilliant conversationalist, full of wit and charm, and one of the kindest and most tolerant men I have ever known," more than made up for any anxiety he might have caused over his lyrics. For these in every respect are brilliant. His rhymes are infinitely clever, and his lines sparkled with wit, or warmed the tenderest heart, as the situation demanded. Sometime soon, read over the lyrics to *Give It Back to the Indians*, *My Funny Valentine*, *Mountain Greenery*, *It Never Entered My Mind*, or *There's a Small Hotel*.

Rodgers was married on March 5, 1930 to Dorothy Feiner of New York City, and the happy couple have two daughters, Mary and Linda. I somehow have the feeling that nothing short of an earthquake under his favorite theatre would ever ruffle him, for his sense of organization is fully as keen as his orderly approach to every day problems. He seldom drinks, hasn't smoked in years because "there was too much satisfaction in having given it up."

Concluded on page 62



Build it
YOURSELF

Heathkit HIGH FIDELITY PREAMPLIFIER



MODEL WA-P2

Here is the complete preamplifier. Designed specifically for use with the Williamson Type circuit, it provides equalization for LP, RIAA, AES, and early 78 records, 5 switch-selected inputs with individually preset level controls, separate bass and treble tone controls, special hum control, etc. Outstanding in performance and most attractive in appearance. Fulfills every requirement for true high fidelity performance. Shpg. Wt. 7 lbs. **\$19.75**

Heathkit WILLIAMSON TYPE (PEERLESS TRANSFORMER)

This latest and most advanced Heathkit hi-fi amplifier has all the extras so important to the super-critical listener. Featuring KT-66 tubes, special Peerless output transformer, and new circuit design, it offers brilliant performance by any standard.

Bass response is extended more than a full octave below other Heathkit Williamson circuits, along with higher power output, reduced intermodulation and harmonic distortion, better phase shift characteristics and extended high frequency response. A new type balancing circuit makes balancing easier, and at the same time permits a "closer" dynamic balance between tubes.

Aside from these outstanding engineering features, the W-5 manifests new physical design as well. A protective cover fits over all above-chassis components, forming a most attractive assembly—suitable for mounting in or out of a cabinet. All connectors are brought out to the front chassis apron for convenience of connection.

Model W-5M consists of main amplifier and power supply on single chassis with protective cover. Shpg. Wt. 31 lbs. **\$59.75**

Express only. Model W-5 consists of W-5M, plus WA-P2 Preamplifier shown on this page. Shpg. Wt. 38 lbs. **\$79.50**

Express only

Heathkit HIGH FIDELITY 20 WATT AMPLIFIER

This particular 20 watt Amplifier combines high fidelity with economy. Single chassis construction provides preamplifier, main amplifier and power supply function. True hi-fi performance ± 1 db, 20 cps to 20,000 cps. Preamplifier affords 4 switch-selected compensated inputs. Push-pull 6L6 tubes used for surprisingly clean output signal with excellent response characteristics and adequate power reserve. Full tone control action. Extremely low cost for real high fidelity performance. Shpg. Wt. 18 lbs. **\$35.50**



MODEL A-9B

HEATHKIT High Fidelity "BUILD IT YOURSELF" amplifier kits

Heathkit WILLIAMSON TYPE (ACROSOUND TRANSFORMER)

This dual-chassis high fidelity amplifier kit provides installation flexibility. It features the Acrosound "ultra-linear" output transformer, and has a frequency response within 1 db from 10 cps to 100,000 cps. Harmonic distortion and intermodulation distortion are less than .5% at 5 watts, and maximum power output is well over 20 watts. A truly outstanding performer. W-3M consists of main amplifier and power supply. Shpg. Wt. 29 lbs., Express only. **\$49.75**
Model W-3 consists of W-3M plus WA-P2 Preamplifier listed on this page. Shpg. Wt. 37 lbs., Express only. **\$69.50**



Heathkit WILLIAMSON TYPE (CHICAGO TRANSFORMER)

This hi-fi amplifier is constructed on a single chassis, thereby affecting a reduction in cost. Uses new Chicago high fidelity output transformer and provides the same high performance as Model W-3 listed above. An unbeatable dollar value. The lowest price ever quoted for a complete Williamson Type Amplifier circuit. Model W-4M consists of main amplifier and power supply on single chassis. Shpg. Wt. 28 lbs., Express only. **\$39.75**
Model W-4 consists of W-4M plus WA-P2 Preamplifier. Shpg. Wt. 35 lbs., Express only. **\$59.50**

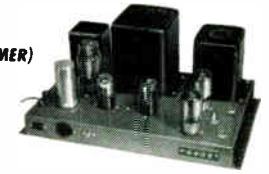

COMBINATION W-5M and WA-P2



BENTON HARBOR 5,
MICHIGAN

Write FOR FREE CATALOG AND SCHEMATICS



**"It's
'SONODYNE'
MULTI-IMPEDANCE DYNAMIC MICROPHONE
at Recording Time"**

— say actual users* in the field
and here are a few reasons why . . .



"This microphone has been used for tape recording 15-minute shows for future airing on a nearby radio station. We like it fine, and it does take a beating."
Speech and Drama Director, Ind.



"We are using this microphone with good results on our recorder."
Audio-Visual Librarian, Va.



"Wonderful for wire recording purposes and P.A. use. I use it mainly for recording."
Sound Service, Massachusetts



"Used for recording organ music. Performance is very satisfactory; especially good on highs."
Recording Professional, Colorado



"Very good output and fidelity. Used for recording for broadcast purposes."
Producer and Director, Canada



"Excellent results in recording and for comments in the showing of motion pictures."
Amateur, New York

Model "51" Sonodyne • List Price \$47.50

Available at
Shure Distributors Everywhere!



*Individual names
available on
request.



SHURE BROTHERS, Inc.
MICROPHONES and ACOUSTIC DEVICES
225 West Huron St., Chicago 10, Illinois
Cable Address: SHUREMICRO

Please send me FREE Shure Microphone catalogs.

Name

Address

City State MHS-1

Richard Rodgers

Continued from page 61

He rarely visits night clubs, hates dancing, is cordial, hospitable, and genuinely interested in people and in what they have to say. He is attentive to a whole world of things, and yet he makes no secret of his preference for the stage: "I cannot imagine a life without the theatre." Mary Martin once said, "When he is conducting the orchestra and you see him from the stage, you're looking at another man. The walls are down and you see something of what lies beneath the surface. The expression on his face — it isn't happiness or sadness, but rather an expression of utter tranquility, of completeness. And you think here, at last, are all the things he feels. Here is Richard Rodgers as he really is."

The greatest difference between Rodgers and Hart was their manner of working. For Rodgers, incredible speed at composing has become legend. Oscar Hammerstein spent three painstaking weeks writing the words for the famous *Soliloquy* in "Carousel". Two hours after he had given them to Rodgers, the melody was completed. Rodgers took five minutes to write the melody for *Bali Ha'i*; *It Might as Well Be Spring*, five minutes; *June is Bustin' Out All Over* was completed in the twenty-minute interval while his wife was driving Linda to the movies and returning home. But, while there is no substitute for genius, is there a real answer to how long it takes to write a song? "No," says Rodgers. "Do you begin from the time you sit down at the piano with the lyric, or from the time you first discussed the idea for the song? Remember that before a song ever gets written, it must first be decided that there is to be a show." From then on, conferences are held on the conception of the play, the development of the story, where the music should be placed, what kind of numbers they should be, who should sing them, and all the innumerable details.

The concluding part of this article, including a list of Rodgers and Hammerstein shows and music, will appear in the next issue.

Collector's Installation

Continued from page 37

combination of 4 type B-199A's for the bass, a B-209 for the mid-range, and a B-200XA tweeter array at the top. Capacitors and inductors make up the Bozak network designed for the group of speakers.

In case you, too, are a record collector, I might add that this installation has attracted much attention from other collectors and audio enthusiasts, who have come to hear my installation, to check their equipment, and to listen to records. Many of the friends I have made in that way have, in turn, helped me to locate records I wanted, or to exchange duplicates.

HAROLD H. SMITH is a member of the Bridgeport Police Department. His home is at 1144 Huntington Turnpike, Bridgeport 10, Conn.

Over
500,000
record
collectors
read
"schwann's
long playing
record
catalog"
every month
before
buying.
are you one
of them?

Available
at your
record dealer
now.

Pick up your
copy today.

schwann
long
playing
record
catalog

131 Clarendon St., Boston 16, Mass.

Music at Home

CUSTOM RE-TIPPING
OF PHONOGRAPH
NEEDLES WITH
Fine Diamonds

For more than 10 years, the Transcriber Company has been replacing worn-out diamonds and sapphires in phonograph needles with new, fine diamonds, precision ground and polished in our own plant. Modern equipment and long experience assure you of the highest quality at the lowest price.

Write:

The Transcriber Co.

Diamond Needle Manufacturers
70 Pine Street Attleboro, Mass.

**Back Issues of
MUSIC at HOME**

The idea you saw yesterday may be the very one you will need tomorrow!

Unlike books, magazines aren't reprinted. When the publisher's supply is gone, that's all there is.

And the very copy you can buy now for fifty cents may be the one you'd pay five dollars to own at some future time.

So check your file to see what issues are missing. Order the copies you need right now, while they are still available.

SINGLE COPIES, 50¢ EACH

FIRST FIVE ISSUES, \$2.00

add 20¢ each for foreign postage

Sleeper Publications, Inc.

207 E. 37th St., New York 16

**INDEX of
ADVERTISERS**

Allied Radio Corp.....	48, 55
Asco Sound Corp.....	49
Berlant Associates.....	11
Bogen Co., Inc., David.....	10
Book-of-the-Month Club.....	5
Bozak Speakers.....	60
British Industries.....	2
Brociner Electronics Laboratory.....	64
Browning Laboratories.....	53
Concertone.....	11
deMars Engr. & Mfg.....	45
Electro-Voice, Inc.....	16
Electro-Voice Sound Systems.....	50
Fairchild Recording Equip.....	6, 54
Federal Mfg. & Eng. Corp.....	52
Garrard Sales Corp.....	2
General Apparatus Co.....	63
General Electric Co.....	12
Goodmans.....	Back Cover
Harvey Radio Co.....	49
Hostings Products, Inc.....	56
Heath Company.....	61
High Fidelity House.....	48
Hollywood Electronics.....	48
I.D.E.A.....	Inside Front Cover
Interelectronics.....	46
Klipsch Associates.....	54
Laboratory of Electronic Engr., Inc.....	58
Los Angeles Audio Fair.....	15
Music Appreciation Records.....	5
Musical Masterpiece Society.....	13
National Company.....	9
Orradio Industries, Inc.....	60
Pentron Corp.....	4
Pickering & Co., Inc.....	18
Pilot Radio Corp.....	7
Presto Recording Corp.....	8
Radio Electric Service Co.....	49
Radio Engineering Labs., Inc.....	50
Radio Shack, Inc.....	48, 59
Reeves Soundcraft Corp.....	1
Regency Division.....	Inside Front Cover
Rek-O-Kut Company.....	56
Rockbor Corp.....	Back Cover
Schwann Catalog.....	62
Scott, Inc., Hermon Hosmer.....	47
Shure Bros., Inc.....	62
Sonotone Corp.....	51
Stephens Mfg. Corp.....	Inside Back Cover
Sun Radio & Electronics, Inc.....	49
Tech-Master Corp.....	57
Technical Appliance Corp.....	58
Terminal Radio Corp.....	49
Transcriber Company.....	63
University Loudspeakers, Inc.....	Insert
V-M Corporation.....	14
Walco-Electrovox Co., Inc.....	64
Wholesale Supply Co.....	49

**G. A. NETWORKS
AND
AIR-COUPPLERS**

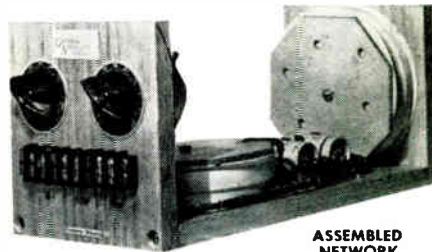

ASSEMBLED NETWORK

G.A. Crossover Networks

As an added service to audio enthusiasts, G.A. is now supplying completely assembled networks, for use with the G.A. Air-Coupler. If you are not certain as to which networks you should use, send 10¢ for the G.A. network data sheet. Complete, as illustrated:

No. 9C, 8 ohms, 175 cycles.....	\$32.50
No. 5C, 16 ohms, 175 cycles.....	32.50
No. 6AC, 8 ohms, 2,200 cycles.....	18.00
No. 1C, 16 ohms, 2,200 cycles.....	19.50

G.A. Network Kits

Of the various G.A. crossover networks, the following are recommended for use with the Air-Coupler. Complete kits include capacitors and level controls.

No.	Impedance	Crossover only	2 Coils only	Complete
9	8 ohms	175 cycles	\$20.00	\$24.00
5	16	175	20.00	24.00
6A	8	2,200	6.00	12.00
1	16	2,200	7.00	13.50

G.A. Air-Couplers

Since 1950, only G.A. is authorized to offer the officially approved Air-Coupler design in knocked-down or assembled form. Parts are precision-cut from high-quality 3/4-in. fir plywood.

Air-Coupler knocked down, ready to assemble, opening cut for 12-in. speaker.....	\$29.95
Air-Coupler assembled and glued.....	39.95
Alter 600B 12-in. speaker, 8 ohms.....	42.00
University 4408 tweeter, 8 ohms.....	17.50

G.A. Variable Networks

Type A-VAC permits the crossover frequency to be varied from 90 to 1,100 cycles; type B-VAC, from 900 to 11,000 cycles. Eliminates power loss experienced with fixed networks. Kit is complete with punched chassis and tubes. Also supplied as a finished unit, laboratory-tested, ready to use.

A-VAC or B-VAC, knocked-down kit.....	\$39.95
Either type assembled and wired.....	56.95
Instruction book with circuits.....	1.00

PRICES ARE FOB NEW YORK

**GENERAL
APPARATUS
COMPANY**

Formerly at Sheffield, Mass.
346 E. 32nd St., New York 16, N. Y.

**Walco
PRODUCTS**

Just for
the Record



**WALCO
STATI-CLEAN
ANTI-STATIC
RECORD SPRAY**

STOPS STATIC DUST. Walco Stati-Clean is your best defense against dust—major cause of record and needle wear. Stati-Clean spray cleans the disc surface, stops static electricity that attracts dust. Handling and "dusting" no longer builds up static. Stati-Clean improves fidelity, eliminates static "crackle." Lasts dozens of plays, no need to reapply each time. Tested safe—thousands sold. Complete with special applicator cloth.

**WALCO
DISCOVERS
PROTECTIVE SLEEVES
FOR RECORDS**

Walco DISCOVERS—now with the new contoured bottom—are the perfect answer to record protection. You slide your records into DISCOVERS, then into the original jacket. No more scratches, moisture or finger marks from handling. DISCOVERS seal out dust, protect against extremes of temperature, accidental spillage of liquids. They keep the sound safe and sound! Packaged 12 12-in. sleeves or 15 10-in. sleeves.

**WALCO
REPLACEMENT
NEEDLES
FOR LONGER RECORD LIFE**

Osmium and sapphire-tipped styli are rated only about 20 to 60 hours of play, after which they develop chisel-edged flats. These flats shear highs from your records, ruin groove walls. Periodic needle replacement is an *absolute necessity* for the serious music lover. You replace with the finest when you replace with Walco needles (and the superb Walco Diamond)—first choice of major cartridge manufacturers.

SEND FOR FREE SAMPLE DISCOVER
AT LEADING MUSIC DEALERS EVERYWHERE

Walco Trade Name of Electrovox Co., Inc.
60-M Franklin St., East Orange, N. J.

BUY, SELL or SWAP

The opportunity to buy, sell, or swap items of equipment or records through the use of this department is made available as a service to readers of MUSIC at HOME without charge.

Copy should be limited to 35 words. Items are not accepted from business firms. The Publisher reserves the right to reject copy which, in his opinion, does not conform with the standards of this Magazine.

SELL: Wharfedale Super-12 speaker, perfect condition, \$55.00 plus shipping costs. T. R. Sayers, 265 Scott Rd., Toronto, Ontario, Canada

BUY: Want a copy of "A Portrait of Bert Williams" by Duke Ellington (around 1940-41) and Lawrence Welk "South". Francis Locatelli, 130 Woodland Ave., Laurium, Mich.

SELL: Newcomb A-15, 15-watt hi-fi amplifier for \$40.00, less than half price, perfect condition. Harry J. Bunn, 1352 New Jersey Ave., Marysville, Mich.

SELL or SWAP: For ham transmitter—Ferranti arm, microgroove head with diamond stylus, Mounted 3-speed Presto turntable. Cost \$131.00, sell for \$100.00. Fisher 50-CM control amplifier \$77.50. All perfect, virtually unused. J. Foy Guin, Jr., Russellville, Ala.

SELL or SWAP: Presto 75-A portable recarder, 16-in. turntable 33 and 78 rpm., with 5-C cutting head, 33 blanks, 20-watt PP-6L6 amplifier with VU meter, excellent condition \$145.00. Dr. C. F. Tuma, 13201 Miles Ave., Cleveland 5, Ohio

SELL: Scott 112-B suppressor with adjustable pre-amp. Like new, priced right. Donald Ausheim, Canton, S. D.

SELL: Brand new Craftsmen C-900 FM tuner, original box, instructions, guarantee. Reason: no FM here. Walter Puterbaugh, Grand View Drive, Peoria, Ill.

SELL: Aristocrat enclosure, Jensen RP-302, tweeter, A-402 network, Altec 600-B 12-in. speaker \$115.00. Baronet enclosure, Lorenz tweeter, high-pass filter, Altec 400-B 8-in. speaker \$50.00. Manuel Favorito, 467 42nd St., Brooklyn 32, N. Y.

SWAP: Have Hallicrafter 540-B. Want SX-62-A and James Lansing 12-in. D-131 speaker. George Grandy, 1315 E. Ramsey, Banning, Calif.

SELL: Stephens 409 speaker in back-loaded baffle (Sieler corner type) \$125.00. Same as new. D. J. Parks, 1555½ Settle Ave., San Jose 25, Calif.

Change of Address

The Post Office does not forward magazines when you move. To avoid missing copies of MUSIC at HOME, you must give us your new address at least one month in advance of your moving. A charge of 50¢ is made for each replacement copy.



MODERN — \$396
GOLDEN MAHOGANY

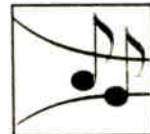

**BROCINER
MODEL 4
CORNER HORN**

• Performance of unrivalled purity and smoothness over the entire audible range! Powered by a remarkable twin-cone driver unit designed expressly for horn loading, this dual horn achieves naturalness that simply cannot be put into words or expressed in terms of specifications. Moderate in size as well as price, it lends itself to graceful, attractive, decorative treatment that renders it a complement to the finest decor.

• Hear the Brociner Model 4 Horn. You will agree that its unobtrusive naturalness places it in a class by itself.

The middle range and high treble tones are dispersed uniformly by a reflector horn of unique design. In the bass range, the driver unit is efficiently coupled to the air by means of a folded horn utilizing the corner of the room as a prolongation of the horn structure.

Literature upon request.

**BROCINER
ELECTRONICS LABORATORY**

Dept. MH-1, 344 E. 32nd St., New York 16



TRADITIONAL
MAHOGANY \$462

GET YOUR INFORMATION FASTER!

To get literature and prices to you more quickly, the Readers' Service Department of MUSIC at HOME now provides request cards that you can send directly to the manufacturers. This arrangement eliminates the extra time required to forward your requests, as has been done in the past. However, your Readers' Service Department is always ready to help you get any special information you may require.

HOW TO USE THE INFORMATION REQUEST CARDS

1. When you fill in a card, please PRINT your name and address clearly, so that the reply will not be misdirected.
2. Indicate the name of the product and the page number of this issue of MUSIC at HOME, for exact identification.

3. On the opposite side of the card, put the name and address of the manufacturer. Use the amount of postage required for an ordinary postcard. (2¢ in the USA and possessions)
4. If you do not have the address of the manufacturer, send the card to MUSIC at HOME, 207 E. 37th Street, New York 16. The card will be forwarded by the Readers' Service Department.

Please send me details and prices of your

As shown on page.....of MUSIC at HOME, Jan.-Feb. issue.
Also, give me the name and address of my nearest dealer.

My Name.....

Address.....

I am an Audio Enthusiast Custom Set Builder Dealer

I am preparing to build my first installation

planning to improve my installation

Please have your representative phone me at.....

Please send me details and prices of your

As shown on page.....of MUSIC at HOME, Jan.-Feb. issue.
Also, give me the name and address of my nearest dealer.

My Name.....

Address.....

I am an Audio Enthusiast Custom Set Builder Dealer

I am preparing to build my first installation

planning to improve my installation

Please have your representative phone me at.....

Please send me details and prices of your

As shown on page.....of MUSIC at HOME, Jan.-Feb. issue.
Also, give me the name and address of my nearest dealer.

My Name.....

Address.....

I am an Audio Enthusiast Custom Set Builder Dealer

I am preparing to build my first installation

planning to improve my installation

Please have your representative phone me at.....

Please send me details and prices of your

As shown on page.....of MUSIC at HOME, Jan.-Feb. issue.
Also, give me the name and address of my nearest dealer.

My Name.....

Address.....

I am an Audio Enthusiast Custom Set Builder Dealer

I am preparing to build my first installation

planning to improve my installation

Please have your representative phone me at.....

Please send me details and prices of your

As shown on page.....of MUSIC at HOME, Jan.-Feb. issue.
Also, give me the name and address of my nearest dealer.

My Name.....

Address.....

I am an Audio Enthusiast Custom Set Builder Dealer

I am preparing to build my first installation

planning to improve my installation

Please have your representative phone me at.....

Please send me details and prices of your

As shown on page.....of MUSIC at HOME, Jan.-Feb. issue.
Also, give me the name and address of my nearest dealer.

My Name.....

Address.....

I am an Audio Enthusiast Custom Set Builder Dealer

I am preparing to build my first installation

planning to improve my installation

Please have your representative phone me at.....

Keep up-to-date on New Products

Planning a new installation? An addition to your present equipment, or a change that will give you better performance? To be sure that you choose wisely, study the brochures and catalogs which the manufacturers have prepared to help you.

Use the cards on this page to obtain detailed information on equipment you plan to buy, and the name and address of the nearest dealer who handles it.

If you want to ask the manufacturer for special advice, write a letter stating your requirements as briefly as possible, fill out one of the cards below, and attach it to your letter.

MUSIC at HOME
January-February

STAMP

To: _____

MUSIC at HOME
January-February

STAMP

To: _____

MUSIC at HOME
January-February

STAMP

To: _____

MUSIC at HOME
January-February

STAMP

To: _____

MUSIC at HOME
January-February

STAMP

To: _____

MUSIC at HOME
January-February

STAMP

To: _____

Portrait of Sound

Unique New
STEPHENS CAVALCADE
brings you concert hall sound
with a living room look

sleek contemporary

ENCLOSURE

houses popular

STEPHENS

coaxial two-way

SPEAKER

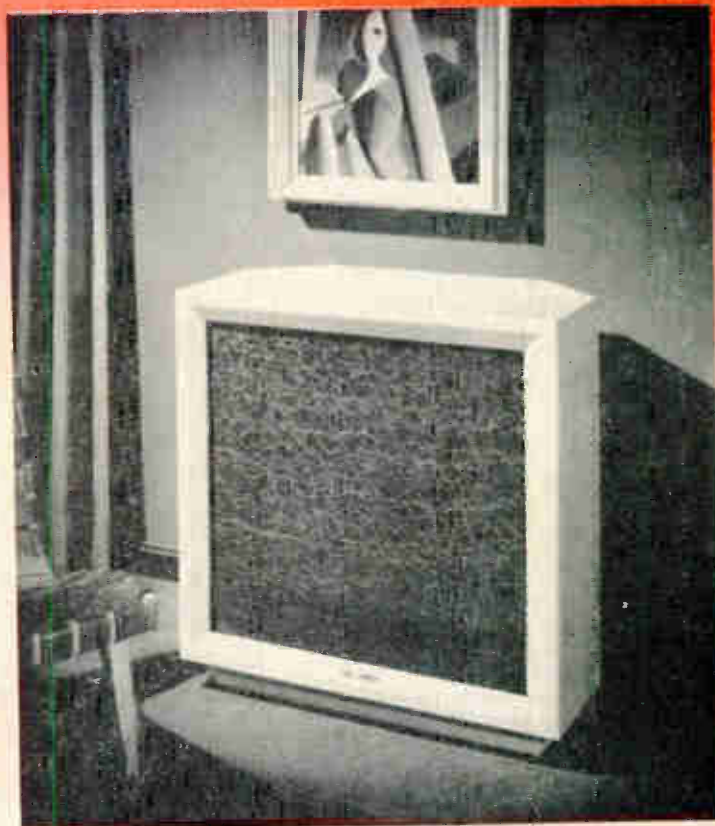

Designed for gracious listening, the Stephens Cavalcade combines direct radiating cone with dual horn loading. Affords distortion-free bass reproduction heretofore possible only with much larger enclosures. Exclusive with the Cavalcade are the two curved exponential horns. Each horn ports to the front of the cabinet, allowing the Cavalcade to be used either as a corner or wall enclosure with equally good results. Beautifully crafted in blonde or mahogany with choice of beige, bronze, or the luxuriant random gold grille as illustrated. Complements the Stephens 206AXA 15" coaxial speaker, accepted internationally as the finest. True multicellular horns provide even wide-angle dispersion of high frequencies. 25 watts power capacity.

Enclosure Dimensions: 32" wide,
34" high, 17" deep

Shipping Weight (enclosure) 128 lbs.
with 206AXA installed 159 lbs.

Model 627 Cavalcade with 206AXA Speaker
Net Price \$264.75

Model 206AXA 15" Coaxial Speaker alone
Net Price \$133.50

STEPHENS
TRU-SONIC

Stephens Manufacturing Corporation
8538 Warner Drive, Culver City, California

**...BECAUSE
THEY
SOUND
BETTER...**

Admittedly, the performance quality of a loudspeaker depends upon design and construction. But we know that you intend neither to design nor build one. You will select one already designed and built. And when you sit back to an evening of musical enjoyment, the chances are you won't be thinking of flux density, impedance or cone suspension.

Certainly, the facts and figures are available for Goodmans High Fidelity Speakers...and we know they will impress you. But, the point we make is that you select *your* speaker as you intend to use it... not on paper but by critical listening. The more critical you are, the more confident are we that your choice will be **Goodmans**—for the best reason in the world—*because they sound better.*

Complete Service Facilities maintained for your convenience

Sold by Leading Sound Dealers • Prices Slightly Higher on West Coast

For Complete Literature, write to:

ROCKBAR CORPORATION 215 East 37th Street, New York 16, N. Y.



AXIETTE
8-inch
5 watts
40-15,000 cps
\$23.20

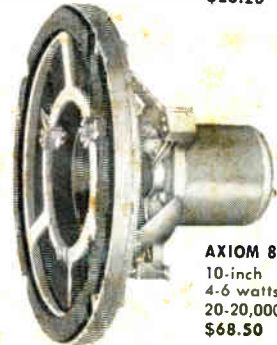

AXIOM 80
10-inch
4-6 watts
20-20,000 cps
\$68.50



AXIOM 150
12-inch
15 watts
30-15,000 cps
\$53.50

GOODMANS
High Fidelity
LOUDSPEAKERS



AXIOM 22
12-inch
20 watts
30-15,000 cps
\$72.95