

EQ

Defining
the Future
of Recording

**SSL HITS THE
PROJECT STUDIO**



www.eqmag.com

Preamps!

- **Choose the Right One**
- **Tube vs. Solid State**
- **Designer/Engineer Seminar**
- **Buyer's Guide**



12 Studio Tests
Mackie Tracktion
Waves IR-1
Sony Sound Forge
and more!

APRIL 2004

U.S. \$5.99 CAN. \$7.99



A MUSIC PLAYER PUBLICATION

CMP
United Business Media

World Radio History



Come Hear the World



through Waves...



Waves signal processing software and hardware has become central to professional production for Music Recording, Mixing and Mastering, and in production for Television, Film and Broadcast. Waves is committed to the continued development of the finest tools for audio signal processing available. Waves has a comprehensive selection of Award winning bundles to suit your needs including: The New IR-1, and Musicians bundle and Diamond, Platinum, Gold, Transform, Restoration, 360°, Surround, Renaissance Maxx bundles, and more. Waves has the right tools for the job, and Sweetwater can help you determine which if those tools to use to get the job done.

14 DAYS DEMO AVAILABLE AT YOUR WAVES DEALER OR AT WWW.WAVES.COM

(Headquarters) Azreili Center, Tel-Aviv, 67011 Israel,
phone: +972-3-608-4000, fax: +972-3-608-4056
(North & South America) 306 W. Depot Ave., Suite 100,
Knoxville, TN 37917, phone: 865-909-9200, fax: 865-909-9245



EQ

Defining
the Future
of Recording

**SSL HITS THE
PROJECT STUDIO**

www.eqmag.com

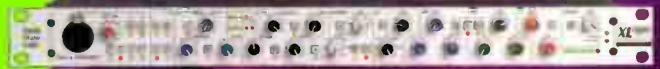

Preamps!

- **Choose the Right One**
- **Tube vs. Solid State**
- **Designer/Engineer Seminar**
- **Buyer's Guide**



12 Studio Tests
Mackie Tracktion
Waves IR-1
Sony Sound Forge
and more!

APRIL 2004

U.S. \$5.99 CAN. \$7.99



A MUSIC PLAYER PUBLICATION

CMP
United Business Media

World Radio History



Come Hear the World



through Waves...



Waves signal processing software and hardware has become central to professional production for Music Recording, Mixing and Mastering, and in production for Television, Film and Broadcast. Waves is committed to the continued development of the finest tools for audio signal processing available. Waves has a comprehensive selection of Award winning bundles to suit your needs including: The New IR-1, and Musicians bundle and Diamond, Platinum, Gold, Transform, Restoration, 360°, Surround, Renaissance Maxx bundles, and more. Waves has the right tools for the job, and Sweetwater can help you determine which if those tools to use to get the job done.

14 DAYS DEMO AVAILABLE AT YOUR WAVES DEALER OR AT WWW.WAVES.COM

(Headquarters) Azreili Center, Tel-Aviv, 67011 Israel,
phone: +972-3-608-4000, fax: +972-3-608-4056
(North & South America) 306 W. Depot Ave., Suite 100,
Knoxville, TN 37917, phone: 865-909-9200, fax: 865-909-9245



**NEW!
2488**

24-track digital hit factory for under \$1500*.

TASCAM's Portastudio[®]
has really
grown up.

- Mute/Solo, Record Arm and Select buttons on every channel
- Twenty 45mm faders



- Four XLR/1/4" mic/line inputs with phantom power
- Four 1/4" mic/line inputs (one of which is also a Hi-Z guitar input)
- Hi-speed USB 2.0 port
- MIDI In/Out
- S/PDIF digital In/Out
- Balanced 1/4" Monitor Out
- RCA stereo outputs
- Two external effects sends

Twenty-five years after our first Portastudio comes the incredible new 2488.

With 24-channel recording at 44.1kHz/24-bits just like the pros use. Plus a 36-channel mixer, 64-voice MIDI sound module, 3-band EQ, up to 8 assignable dynamics processors and 40-GB hard drive.

Did we mention the built-in CD-RW drive that burns your tunes right onto a CD?

Get those hits out of your head and into a 2488. Visit your TASCAM dealer or our web site today.

- 8-channel simultaneous recording
- 24-tk, 24-bit 44.1kHz recorder with 250 virtual tracks
- Built-in CD-RW drive!
- Hi-speed USB 2.0 port
- 64-voice MIDI sound module
- 3 aux sends (one internal, two external)
- Guitar multi-effects processor

- Internal Stereo effects processor provides reverb, delay, chorus and many more EFX on internal effects send
- Up to 8 assignable dynamics processors for compression during tracking or mixdown plus dedicated compressor on stereo output
- 36-input-to-stereo mixdown

TASCAM[®]



*MSRP. Street price may vary. Your life may vary. Heck we may all perish in a collision with an asterisk while you're on your way to your nearest TASCAM dealer.
©2004 TASCAM All Rights Reserved. All specifications are subject to change without notice.

World Radio History

DJ AND
PRODUCER

www.
tascam
.com

CONTRACTOR

PROFESSIONAL
AUDIO

CONTENTS

APRIL 2004

FEATURES

THE FRONT END

24 Intro

The road to better recording starts here.

25 Assessing Your Needs

The first steps to choosing an ideal front end

26 Preamp Fact and Fiction

Do you know what makes your preamp tick?

30 Preamps In Paradise

A recap of the recent developer's summit

36 DIY Front-End Workshop

Guitarists, this one's for you

40 Preamp Buyer's Guide

Get your front-end lust on here



DEPARTMENTS

4 Talk Box

6 Punch-In

14 Tool Box

92 Coming Attractions

Native Instruments Guitar Rig

112 Room With a VU

Ruby Red Productions; Atlanta, GA

97 Advertiser Index

102 Product Spotlight

105 Classified Ads

EQ REVIEWS

56 SSL XLogic Channel

Single-channel preamp/compressor/EQ

58 Apogee Mini-MP

Dual-channel preamp/compressor/EQ

60 Mackie Tracktion

Sequencer/audio recorder for Mac & PC

66 PSP EZ-Verb

Reverb plug-in

70 Focusrite Trak Master

Single-channel preamp/compressor/EQ

72 Toft ATC-2

Dual-channel preamp/compressor/EQ

74 Sony Sound Forge

Audio editor

80 Fishman Pro-EQ

Platinum and Platinum Bass DI/preamp/EQs

82 Waves IR-1

Reverb plug-in

88 Tapco S-5

Nearfield monitors

112

Sounds

90 Cycling '74 Sustained Encounters

90 East West ProSamples 8, World Vocals

COLUMNS

94 Session File

Drums: SlipKnot

Power App Alley

96 AAS Tassman

Exchanging virtual synths & presets

98 Digidesign Pro Tools LE

Surround mixing

100 Cakewalk Sonar

Create the perfect pad loop

104 IK Multimedia T-Racks

Turbo charge your mixes



14



56

72



Freedom

Access all Areas



PowerCore is the open DSP-platform that adds stacks of professional signal processing to any native VST or Audio Units recording solution. Ten virtual TC-quality processors are included right out of the box, providing creative tools as well as covering mastering applications.

PowerCore is the only DSP platform that provides a choice of PCI or FireWire hardware and an ever-growing choice of outstanding optional tools by TC and respected 3rd parties like Sony, Waldorf, D-Sound, TC-Helicon - and Access!



VIRUS | POWERCORE - by ACCESS Virtual Synth & Multi-FX processor

OPTIONAL
SOLD BY TC-ELECTRONIC

Based on the Access Virus Indigo hardware synthesizer, the Virus|PowerCore plug-in transforms your system into a synthesizer featuring 16 voices, three main oscillators, two filters, three LFOs and two envelopes for every voice. With built-in effects like chorus, phaser, ring modulators, multiple distortion, delay and reverb, you can create stunning pads, screaming leads, punchy bass sounds and a bunch more – your imagination is the limit!

Exclusively available for PowerCore.



PowerCore - The open DSP solution with multiple quality effects included

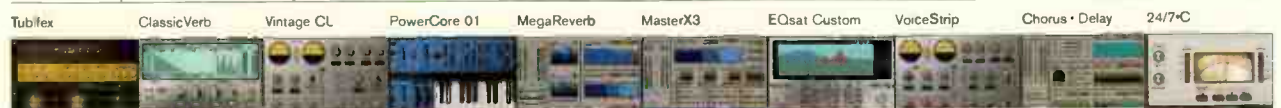

The Innovation continues...

t.c. electronic
ULTIMATE SOUND MACHINES

TC ELECTRONIC A/S DENMARK • ☎ + 45 8742 7000
TC ELECTRONIC INC USA • ☎ (805) 373 1828 • [FAX] (805) 379 2648

WWW.TCELECTRONIC.COM

Talk Box

EQ

Vol. 15, No. 4
April 2004



A GREAT YEAR

Time flies. It's hard to believe that a year has passed since I came onboard for the "new EQ" project. Having spent the previous 13 years with *Keyboard* magazine, I knew this would be an excellent opportunity to work more closely with Mitch Gallagher, Craig Anderton, Dan Hernandez, and other EQ staffers whom I'd admired and respected from across the corporate divide. With *Keyboard* tech editor John Krogh added to the roster, the new EQ crew secretly went about crafting the cover-to-cover redesign that would launch on June 1, 2003. What an incredible year it was working with this brilliant team (listed on the masthead at right), and watching EQ transform into a powerful new force in recording-technology publishing.

Today, I'm pleased to announce that EQ is in the most dynamic position of its 14-year history. No other American magazine devotes itself so wholly, passionately, and aggressively to the bleeding edge of recording technology. With a silver Ozzie Award now in the trophy case for Best Redesign, a MaggieZine Choice award, and a beehive's worth of positive buzz coming from readers and manufacturers, we've all enjoyed the progress this magazine has made over the past 12 months, and the solid foundation on which it now stands.

So on that note, with my year-long project leading EQ through its redesign now complete, it's time for me to sign off and move on to my next endeavor. By the time you read this, my family and I will have relocated from San Francisco to Los Angeles, where I'll be working with Roland as the editor of *Roland Users Group* magazine.

It has been an honor and pleasure serving the EQ community for the past year. I depart knowing that the magazine is in excellent hands, and that what's planned for future will delight you even further. I'm wishing you all much peace, love, and righteous recording sessions. —Greg Rule

The BAND STAND

What's the best musical joke or April Fool's prank you've witnessed or participated in?



Greg Rule,
Executive Editor

Wish I could say this was a prank, but it was actually a huge screw-up. I was once hired to play a gig out of state. The production company assured us that a complete backbone would be waiting. I was the drummer, so imagine my surprise when I turned up and discovered a stack of drums and cymbals — with no accompanying hardware. Ouch!



Mitch Gallagher,
Editor

The best (or worst, depending on how you look at it) was a keyboard player who had created a patch that sounded like mic feedback. He drove monitor engineers crazy, they'd pull all the mics down, and still the system would be ringing at crazy frequencies.



Craig Anderton,
Editor at Large

There was one particularly sadistic keyboard player who carried samples of hums, crackles, and buzzes. As the sound company was setting up, he'd play some of these just as someone was connecting a cable or moving a fader on the PA. Cruel, but funny!



John Krogh,
Technical Editor

Since this is a family show, I'll keep it PG-rated. I played keyboard for a theme park country show, and as the season went on, I would get bored with the parts, so I'd break into a polka at key moments, just to throw the singers a curve ball.

Executive Editor: Greg Rule, gregrule@musicplayer.com
Editor: Mitch Gallagher, mgallagher@musicplayer.com
Managing Editor: Debbie Greenberg, dgreenberg@musicplayer.com
Technical Editor: John Krogh, jkrogh@musicplayer.com
Group Copy Chief: Kevin Owens, kowens@musicplayer.com
Editor at Large: Craig Anderton, canderton@musicplayer.com
Contributing Editors: Gerry Bassermann, Dan Daley, David Frangioni, Chris Gill, Steve La Cerra, Jerry McPherson, Gary Mraz, Lisa Roy
Art Director: Doug Gordon, dgordon@musicplayer.com
Staff Photographer: Paul Haggard, phaggard@musicplayer.com
Publisher: Valerie Pippin, vpippin@musicplayer.com

Associate Publisher/Northwest Advertising Sales: Dan Hernandez, Tel: 650-513-4253, Fax: 650-513-4646, dhernandez@musicplayer.com

East Coast Advertising Sales: Joe McDonough
Tel: 212-378-0492, Fax: 212-378-2158;
jmcdonough@musicplayer.com

Southwest Advertising Sales: Pete Sembler
Tel: 650-513-4544, Fax: 650-513-4646;
psembler@musicplayer.com

Northeast/Europe Advertising Sales: Gary Ciocci
Tel: 603-924-9141, Fax: 603-924-9209; gciocci@musicplayer.com

Sales Administration Manager: Lauren Gerber
Tel: 650-513-4528, Fax: 650-513-4646;
lgerber@musicplayer.com

Manager of Specialty Sales: Joanne McGowan
Tel: 650-513-4376, Fax: 650-513-4646;
jmcgowan@musicplayer.com

THE MUSIC PLAYER GROUP

Vice President: Louise Rogers
Group Publisher: Valerie Pippin
Editorial Director: Michael Molenda
Financial Analyst: Cheri McElroy
Credit Manager: James Wallace
Production Manager: Amy Santana
Marketing Manager: Laney Erokian
Circulation Manager: Heather Harmon
Newsstand Sales and Marketing Manager: Pam Santoro
Assistant Circulation Manager: Rosario Perez
Assistant Circulation Manager: Maribel Aleman
Classified Ad Sales Assistant: Darlene Labrecque
Imaging Technicians: Joe Ging, Martin Ruiz
Reprint Coordinator: Karen Jacobs
Administration Support: Sandra Pollard

WWW.EQMAG.COM

Web team: Matt Dula, Joe Gero, Coral Xu, I-Hsun Huang, David Pak, Greg Rule

Published By
UNITED ENTERTAINMENT MEDIA, Inc.
a CMP Information Company
PRESIDENT/CEO: Tony Keefe
CONTROLLER: Doug Krainman

Please direct all editorial and advertising inquiries to:
eq@musicplayer.com

Please direct all subscription orders, inquiries, and address changes to: 888-266-5828, outside the U.S. 937-280-0011, eqmag@sfsdayton.com

Websites: www.eqmag.com & www.keyboardmag.com

Publisher assumes no responsibility for return of unclassified manuscripts, photos or artwork. EQ (ISSN 1050-7888) is published monthly by United Entertainment Media, Inc., a CMP Information company. Reproduction of material appearing in EQ is forbidden without written permission. Periodicals postage paid at San Mateo, CA and additional mailing offices. POSTMASTER: Send address changes to EQ, P.O. Box 369, Vandalia OH 45377-0369. SUBSCRIPTIONS: U.S. \$29.95 for 1 yr.; Canada/Mexico add \$15, International add \$25. All copies ship via Airmail. All subscriptions outside the U.S. must be pre-paid in U.S. funds by International Money Order, checks draw from a bank located in the USA Visa, MasterCard or American Express. Back issues \$10. All product information is subject to change; publisher assumes no responsibility for such changes. All listed model numbers and product names are manufacturers' registered trademarks. Printed in the U.S.A.



Inter BEE 2004

International Broadcast Equipment Exhibition 2004

November 17-19, 2004 Nippon Convention Center (Makuhari Messe)



The Big Picture of Broadcasting

What does the future hold for broadcast communications? Professionals in broadcast, video, and audio technology can encounter the latest trends at this year's International Broadcast Equipment Exhibition (Inter BEE 2004).

One of the most important events of the year, Inter BEE 2004 promises to attract a larger turnout than ever before, with more than 600 exhibitors and 30,000 visitors from around the world. Symposiums and seminars by prominent producers, systems hardware developers and broadcasters, as well as opportunities for marketing and networking, make this an essential forum for the interchange of new ideas.

See where you fit into the changing future of broadcasting, and bring your message and image to the world. Join Inter BEE 2004 and assure your position in the big picture of opportunity.

For more information on Inter BEE 2004, contact:

Japan Electronics Show Association

Sumitomo Shibadaimon Bldg. 2 Gokan, 1-12-16, Shibadaimon, Minato-ku, Tokyo 105-0012, Japan
Fax.: +81-3-5402-7605 E-mail: bee.info@jesa.or.jp URL: <http://bee.jesa.or.jp/>



Exhibition Categories

- Audio Equipment ● Cameras and Related Equipment
- Recording Equipment
- Editing and Production Equipment
- Electronic Displays ● System Conversion Equipment
- Output Systems ● Relay Systems
- Transmission Systems ● Lighting Equipment
- Measuring Equipment ● Transmission Cables
- Electric Power Units ● HDTV Systems
- Satellite Broadcasting Systems ● Virtual Systems
- CG Production Systems ● DVD Systems
- Multimedia Systems ● Software
- Multiplex Broadcasting Systems ● Others

Punch-In

Tips & News You Can Use
BY GREG & CRAIG



CD of the Month **Cheap Trick**

The Essential, Sony

Few rock bands have stood the test of time like the colorful quartet from Rockford, IL — Cheap Trick. With nearly three decades behind them, Cheap Trick has amassed a legendary body of work. Their relevance to the rock community is as vital as ever. No collection punctuates this point more effectively than the new 2-disc retrospective on Sony Music, *The Essential*. From their breakthrough hits to their latest hook-rock single "Scent of a Woman," the collection delivers smash after smash: "Surrender," "Ain't That a Shame," "Dream Police," "Way of the World," "Tonight It's You," "She's Tight," "The Flame," and more. Also included are live versions of "Mandocello" (with Billy Corgan), "Gonna Raise Hell," "Hard To Tell," and perhaps the band's biggest hit of all, "I Want You to Want Me." Plenty of other great music rounds out the double-set, including the under-recognized gem "Woke Up With a Monster."

EQ Awards Arrive

The *EQ* editors had the pleasure of handing out the first-ever batch of *EQ* Award trophies on the NAMM show floor last January. The stylish sculpture (pictured right) features a brushed metal logo medallion — designed by *EQ* art director Doug Gordon — suspended in a laser-etched translucent base. We debuted the *EQ* Awards program in our January issue, and have since doled out honors to the deserving products in each issue (see product review section). Subsequent trophies will be handed out twice a year at the Winter and Summer NAMM shows.

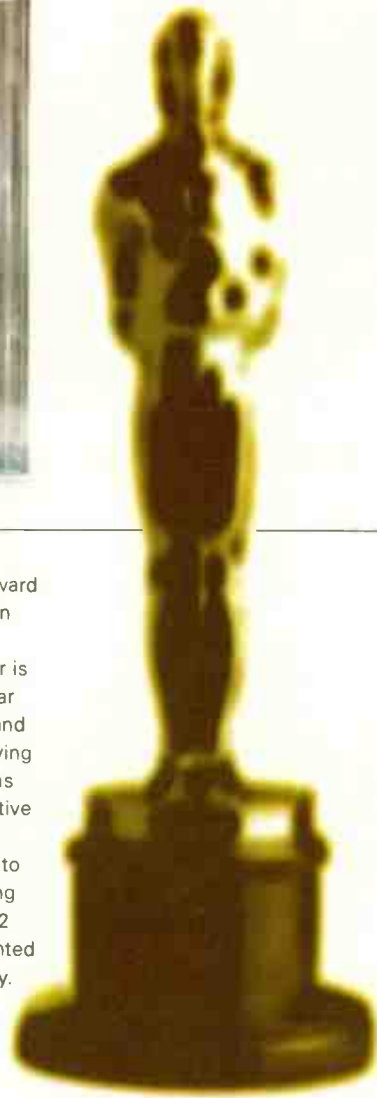

News

OSCAR

They won a Technical Grammy in 2001, now **Digidesign** has learned that another prestigious award will be headed for their trophy case — an Academy Award of Merit from the Academy of Motion Picture Arts and Sciences (a.k.a. an Oscar). The award is in recognition of Digidesign's design, development, and implementation of the Pro Tools digital audio workstation. "Winning an Oscar is an incredible honor for us," says David Lebolt, Digidesign general manager. "We've come this far thanks to the amazing dedication and hard work of our entire staff and third-party developers, and the incredibly valuable input we've received from the post community. It feels extremely gratifying to everyone on the Digidesign and Avid team to see the Academy recognize how Pro Tools has profoundly changed the creative process for audio postproduction, allowing increasingly innovative and inventive use of sound in motion pictures."

The Academy of Motion Picture Arts and Sciences presents Scientific and Technical Awards to the creators of devices, methods, formulas, discoveries, or inventions of special and outstanding value to the arts and sciences of motion pictures. In the 76-year history of the Academy, only 42 Oscar statuettes have been awarded for scientific and technical achievements. The award presented to Digidesign is the Academy's fifth Oscar statuette to recognize innovations in sound technology.



THE QUIRKS FILE

Documentation is a beautiful thing in the studio, but in today's computer based age, documenting a session isn't quite enough: You need to document software and hardware quirks.

Here's why. Suppose you're working on a special project and run into some strange incompatibility problem. Finally, you figure out a clever workaround. This is a candidate for the Quirks file (e.g., "The SuperBlurfle audio interface generates spikes in the left channel when recording at 48kHz if the DAT machine is the master clock. Changing the interface to master and slaving the DAT to it solves that problem."). Sure, you think you're going to remember it. But if it's not gear you use everyday, and the problem crops up again a few months or years hence, you may not remember exactly what you did to make things work.

It's probably best to enter this info into a word processor document, as that makes it easy to use the "find" function when you want to locate a quirk involving a specific piece of gear.

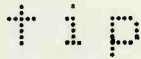

BATTLE OF THE BURNERS

Is your favorite CD burning program having problems running under Windows XP? There are a number of possible reasons, but one is a conflict with XP's own CD burning program (which isn't bad, but as expected, it's not as flexible as the better third party software).

Open My Computer, then right-click on the drive designation for your CD-R drive and select Properties. Go to the recording tab, and uncheck Enable CD recording on this drive. That may seem counter-intuitive — of course, you want to use the drive for recording — but this check box applies only if you want to use XP's CD recording program. Third party programs will know to use the drive for recording (assuming they support the drive of course), even if this box isn't checked.

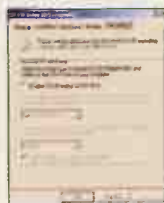

STUDIO SPY CAM

Studio City Sound (Studio City, CA) capped off 2003 with a bang, as Tom Weir mixed and Richard Feldman produced the legendary reggae artists Toots And The Maytals. The sessions featured a veritable *Who's Who* of greats: Eric Clapton, Willie Nelson, Bonnie Raitt, Ryan Adams, Trey Anastasio,



No Doubt, Bootsy Collins, The Roots, Bunny Wailer, Keith Richards, Rachel Yamagata, and others. Weir also recorded and mixed Phantom Planet and Pete Yorn at Studio City for NPR's *New Ground* hosted by Chris Douridas. Visit SCS online at www.studiocitysound.com.

Pictured from left to right: Alex Greenwald, Tom Weir, Jess Conrad, Jacques Brautbar, Sam Fariar, and Darren Robinson.

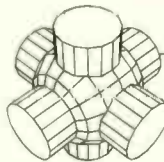

Gadgetphile

Axio Hardshell Backpacks

Our February '04 issue touted the virtues of a laptop studio. Are you among the portable? If so, protect that investment with an attractive Axio Hardpack carrying case from Harodesign. The bags are lightweight and eye-catching, and are designed to protect your laptop computers, controllers (such as M-Audio's popular Ozone), PDAs, cell phones, cameras, and other electronic devices. The Hardpack line comprises four models, each with unique interior and exterior features and colors. The current models include the Chicane, Fuse, Tekno, and Urban. The Axio Hardpack is the brainchild of freestyle BMX innovator and action sports guru Bob Haro, and is the first in a line of innovative products that epitomize the company's philosophy of producing products anchored on the foundation of leading edge design, functionality, and quality. Questions? Email inquiry@axio-usa.com, or visit the Axio site at www.axio-usa.com.





Little Kids Rock

You're looking at a photo from a special day at the Plant in Sausalito, CA, hosted by a very special organization: Little Kids Rock. The event was the first in a new series called "Little Kids, Big Fans: Stars United for Music Education." For school kids interested in music, it doesn't get much better than this. "It is essentially a tribute album, in reverse," explains Executive Director David Wish. "Established artists are doing cover versions of our students' songs. The message we are trying to send is clear: Today's musicians support and salute tomorrow's musicmakers and are working to promote music education. We have two studios that are running the recording sessions pro bono: The Plant in Sausalito and The Manhattan Center Studios in NY. These will be ongoing and, additionally, artists may choose to receive backing tracks sent from the studio to anywhere in the world where they could add a track at their convenience. The project is getting a lot of media attention and this is helping us to no end!" For more info, visit www.littlekidsrock.org.

tip

'TIS BETTER TO RESTART THAN CURSE

Did your computer just burp? Maybe dump a program and do something anti-social, but then recover? The natural temptation is to keep on working, but should your computer act up, it's always prudent to stop and reboot. In the case of small problems, your computer will repair itself and all should be well. But if you continue running your machine, this might compound the problem to the point where it's not so easy to bail out.

tip

SONAR REMOTE CONTROL

Novation's ReMOTE 25 now has a template available for Sonar. Download it from www.novationmusic.com/nov_route/docs/tech_support/resource.htm

News

GRAMMYS

Our congrats to the 2004 Technical Grammy award winners: mastering engineer/technologist/record producer Douglas Sax and audio console manufacturer Solid State Logic.

In his long career as a mastering engineer, **Douglas Sax** has worked with many of the industry's top artists, including The Who, Tina Turner, the Dixie Chicks, James Taylor, Rod Stewart, Carly Simon, Pink Floyd, Bette Midler, Ray Charles, and Aerosmith. With partners Lincoln Mayorga and older brother Sherwood, Sax opened The Mastering Lab — one of the world's first independent mastering facilities — in 1967. Featuring all hand-built equipment, the studio was soon turning out many of the top hits of the '70s, including *Who's Next*, *Nilsson Schmilsson*, the Rolling Stones' *Sticky Fingers* and the Eagles' eponymous debut. As a part of The Mastering Lab, Sax established a pioneering set of procedures for testing and evaluating audio components by ear. The Lab also manufactured loudspeakers and preamps that have been used industry wide.

In 1970, Sax and Mayorga realized a lifelong dream with the founding of Sheffield Lab Recordings, an audiophile label dedicated to producing state-of-the-art, direct-to-disc classical and jazz albums. Sax acted as Executive Producer on all of Sheffield Lab's recordings, which were distributed worldwide and elevated the public's awareness of sound excellence. For this, Sax was awarded the prestigious AES honorary lifetime membership in 1988. Additionally, the three-time Grammy nominee pioneered test methods to correctly evaluate the effects of passive components such as resistors, switches, relays, potentiometers, capacitors, wire, inductors, and transformers. Through his body of work, Sax has inspired a generation of engineers. He continues to play an active role in the contemporary music scene, mastering many of today's top albums, including Rod Stewart's Grammy-nominated *As Time Goes By* and the recent surround sound SACD release of Pink Floyd's *Dark Side Of The Moon*.

Solid State Logic (SSL), the world's largest manufacturer of pro analog and digital audio consoles for music, broadcast, post production and film, has pioneered advances in console technology with the relentless goal of providing an intelligent and efficient means to assist the creative process. When SSL debuted its SL 4000 B Series console in 1977, it revolutionized the music industry. The console was the first production blend of an advanced in-line audio console with a computer-automated operation. It was followed four years later by the SL 4000 E Series, which took automation to yet another plateau with its Total Recall system. This earned SSL the prestigious UK Design Council Award, a Queen's Award for Export Achievement, and the respect and admiration of generations of audio professionals as it set the bar for future console performance.

The SL 4000 Series consoles were followed by other industry-leading audio platforms. SSL's ScreenSound pioneered the use of nonlinear digital audio for video; SoundNet became the world's first multi-purpose digital audio networking system; and the award-winning SL 8000 G Series was introduced for music and film surround sound work. When SSL launched the SL 9000 J Series mixing console and its all-new "Super Analog" technology, top music recording facilities around the world quickly embraced it. The C200 introduced a powerful new digital operational core, and the XL 9000 K Series established new standards in analog console performance. Solid State Logic also set benchmarks for customer technical support by establishing regional offices around the world. With more than 3,000 SSL-equipped facilities operational today, the unrivaled sonic quality, superb ergonomics and outstanding automation of SSL consoles is universally recognized. Whether tracking, overdubbing, mixing, or scoring film and television, an estimated two-thirds of the popular music made over the last 30 years was in some way touched by SSL.

The first Technical Grammy was awarded in 1994. Past recipients include Geoff Emerick, Shure Incorporated, Robert Moog, Apple Computer, Les Paul, Digidesign's Pro Tools, Dr. Thomas Stockham Jr., Ray Dolby, Rupert Neve, George Massenburg, Sony/Philips, Georg Neumann GmbH, Bill Putnam, and AMS Neve, plc. Technical Grammy Award recipients are determined by the vote of the members of the Recording Academy's Producers & Engineers Wing and presented to individuals and/or companies who have made contributions of outstanding technical significance to the recording field.

SONAR3

PRODUCER EDITION



Inspiration > Speed > Precision

In today's fast-paced production world, it's not enough to have all the features at your fingertips. SONAR 3 offers a complete software-based production environment that expands your creativity with fast, intuitive controls that capture and excite your inspiration; and powerful, precision tools for true real-time editing. And SONAR 3 provides unparalleled customization, allowing you to fine-tune your studio to match your workflow. Take your music to new heights with SONAR 3 today.

Completely redesigned UI

Cutting edge mixing environment

Advanced MIDI routing & synth layering

Integrated per-channel EQ and assignable FX controls

Universal Bus Architecture

Smoother audio engine with gapless effects patching

ACID™ loop & MIDI Groove Clip support

DX, DXi, ReWire, VST, VSTi support

Integrate MIDI-compatible control surfaces

Import/export OMFI & Broadcast WAV

VSampler 3.0 DXi multi-format digital sampler

Ultrafunk Sonitus:fx audio effects suite

Lexicon Pantheon Reverb

ASIO & WDM compatibility

Multi-port MTC transmission

Confidence recording

Full plug-in delay compensation

Multiprocessor optimization

\$719 MSRP



cakewalk

Get more information & download the trial version at: <http://www.SONAR3.com/eq>
Or call 888.CAKEWALK (617.423.9004 outside the U.S.)

World Radio History

Surfboard

As we peruse the inner recesses, nooks, and crannies of the web, we're constantly flagging sites, news items, and useful tidbits that we feel will be of interest to you. Such as:

News

Industry Blotter

Talk about starting the New Year right. **Roland** made headline news at NAMM with their sleek new Phantom X series synths and plug-in capable VS recorders. Shortly afterward, Roland Founder and CEO, Ikutaro Kakehashi, was honored at Museum of Making Music in Carlsbad, CA, with the opening of the "Ikutaro Kakehashi/Roland Corporation Gallery." Featuring more than 500 vintage instrument exhibits, performances, and education outreach programs, the Museum of Making Music honors the innovators and inventions that shaped popular music. Get the facts at www.museumofmakingmusic.org



The Roland plug-in party at NAMM. **Front row:** Uffe Kjems Hanson, TC Electronic; Ken Bogdanowicz, Sound Toys; Keiji Akamatsu, President Roland ED Corporation; Mr. Ikutaro Kakehashi, Founder of Roland Corporation; Steve Tritto, Antares; Tom Stephenson, Roland Corporation; Michael Logue, Antares; Matt Ward, Universal Audio. **Back row:** Colin McDowell, McDSP; Jim Pace, Massenburg DesignWorks; Enrico Iori, IK Multimedia; Greg Hendershott, Cakewalk; Marco Alpert, Antares; Neil RiCharde, Antares; Gary Kerzner, IK Multimedia.

When **CreamWare** Datentechnik GmbH, makers of DSP based audio products Pulsar and Noah, filed for insolvency in June 2003, the 30,000-plus users of CreamWare systems had cause for concern. "Today we are proud and happy to announce good news," reports CreamWare founder and managing director Frank Hund. "Effective February 1, a new company, CreamWare Audio GmbH, will be able to continue development of existing CreamWare products, technology, and customer relations. We can now finally close our insolvency chapter."

This fresh start of the company became possible after CreamWare Audio GmbH reached an agreement to purchase all major assets from CreamWare Datentechnik GmbH. "In fact, this transaction means that we can continue to build and grow our business, even if we are initially starting on a slightly smaller scale," explains managing director Wolf Roth. "The new CreamWare has great products, technology, and financing. And last but not least, we're looking forward to working with many of the same people we have enjoyed working with in the past."

CreamWare Audio GmbH will continue to provide technical support, repair and warranty services for CreamWare's existing user base. The new company plans to exhibit and introduce new product at the upcoming Musikmesse in Frankfurt. Email: info@creamware.de.

■ www.StudioSchedule.com

Pacifica Software, a provider of online business solutions, today announced the availability of StudioSchedule.com, a website designed specifically for managing recording studio schedules. Using StudioSchedule.com, studio managers can track their sessions from any Internet connected computer without installing additional software. Facilities of any size can customize the site with the names of their studios. Managers can add logins for users to view the schedule, and any number of users can be granted access for just one monthly fee. The website can also generate custom, printable track and take sheets for each session.



■ www.access-music.de/garageband_freebee

Here's a deal that's hard to beat: Provide Access Music with your email address (don't worry, they don't sell addresses), and they'll send you download links to a 40MB archive of free loops for Apple's GarageBand. These are all royalty-free loops generated with a Virus C synthesizer, and feature arpeggiator patterns, pad sounds, filter sweeps, and a bunch of other cool sounds. Go and get 'em!

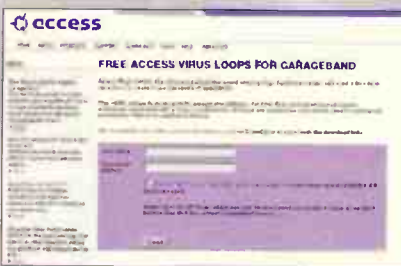

■ <http://linux-sound.org>

Considering a move to Linux? Long considered not quite ready for prime time, the quantity and quality of Linux applications for MIDI, recording, and synthesis continues to grow... as does the passion of Linux fans, who have cut the cord from both Microsoft and Apple. This site contains links to a plethora of programs, and serves as a great introduction to making music on the Linux platform.

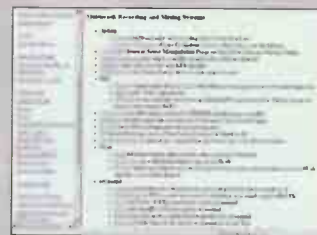

A | A | S
APPLIED ACOUSTICS SYSTEMS

A W H O L E N E W S T A G E

What do you get when you take the world's most advanced and critically-acclaimed **Physical Modeling** engine and feed the results through a gorgeous sounding, outrageously easy-to-use **Output Stage**, complete with tempo-synced delays and reverb?

TASSMAN 4

"There's a warmth and fullness here that some other products just don't have... If you have the need for a powerful yet simple way to create a huge diversity of sounds, musical or otherwise, I strongly recommend Tassman."

—REMIX, March 2004

\$499



New Features:

- All NEW Output Stage with tempo synced delays and reverbs, recorder and Performance Mode for saving and loading complete layouts.



- All NEW library of sounds created by top ILIO and AAS sound designers.
- NEW Audio Inputs. Audio processing that defies description!
- NEW and improved acoustic models that sound better than ever.
- Same great core software that has already won an EM Editors Choice Award, Future Music Platinum Award and Computer Music Performance Award!



Contact ILIO for specific format information and system requirements.



Exclusive distributors

800.747.4546

www.ilio.com

applied-acoustics.com

Forum Exchange

MusicPlayer.com Forum Watch

In another hot thread, a forum member speculates that producing a complex software program is equivalent to producing and releasing three or four good quality musical albums. So because albums sell for about \$20, he concludes that something like a sequencer should sell for about four times that, or \$80; and as the average audio app sells for around \$200-700, much software is overpriced. Do you agree? —Anderton

■ As a manufacturer, I found that people's low perception of software value was based on the tangible aspect of having paid hundreds of dollars for this round, shiny disc. The instantaneous perceived value wasn't near that of a new guitar, mic, or other hardware tool. Yet, somewhere in the back of their heads, consumers are aware that the initial (often massive) costs of R&D and continual expenses of technical support are what they paid for . . . not the little disc and the package. —Jeff Klopmeier

■ I'm surprised that music software is as cheap as it is. \$1,000 for the center of your entire studio/livelihood? Come on; in the microvolume that music software ships, I cannot believe that any of them can even afford to do R & D for future product. I work with Oracle every day in some capacity. I'd estimate 80% of all large companies run Oracle as their "everything" system, and 100% of them run either Oracle or something similar. Oracle 11i is free. Absolutely free. You can call them and get a copy. But if you want support, it starts at about \$100,000. Complexity and mission-critical anxiety are their dongles. —Bunny

■ Software is not overpriced, I'm just underpaid. —Ron Montiel

■ I don't know, but I've been told a pro-level app will not be regarded as a serious tool by pro studios if it is priced too low. So, the price is inflated. But, overall, I don't think software's overpriced. Much of that perception comes from people who use cracked software and are accustomed to using it for free. But another post makes a good point — when you take software's short life cycle into consideration, your dollar doesn't go very far. I still prefer hardware to plug-ins. —Dementia13

■ Well . . . for those who think software is overpriced, let's try an experiment. Get rid of all your software; keep your computer just to check e-mail and this forum. Then get hardware to do what you achieve with software, you know, MIDI sequencers, audio recorders (ADAT and HDR24 are accepted) and try to sync them. Next get all those cool synths in hardware . . . crunchy virtual analogs, samplers, drum machines . . . how about a real B3 and DX7, and a CS80? Now try to get all those cool FX in hardware, and don't forget to get a decent mastering unit/CD burner for the final step. What would that cost? —Gus Lozada



Candid Camera Alicia Keys

Platinum-selling R&B singer/songwriter/keyboardist Alicia Keys checked into Kampo Studios in New York City for work on her latest album *The Diary of Alicia Keys*. Pictured here in Kampo's lobby are Kerry Brothers, Alicia, and Kampo manager Kenji Shimoda.

OOPS

In our rush to return from Anaheim and get the NAMM report filed before the print house closed, we committed two big, bad boo-boos. Spectronics' Stylus RMX is priced at \$299, not \$99 as the write-up led readers to believe. Also, Spectronics' website is located at www.spectrasonics.net. That's .net, not .com. We apologize for the mix up.



We'd like to correct an error in *Keyboard & EQ's Virtual Studio Survival Guide*. The Glen Ballard "Inspiration" feature was credited to Howard Massey and Greg Rule collectively. The main portion of the article should have been credited to

Howard Massey solely, and the "Computer Programming" sidebar to Greg Rule. We apologize for the mix up.



Magic Wand

The cold, hard facts of room acoustics challenge every studio, large and small. JBL engineers thought it was time for a little magic. Introducing the LSR6300 Studio Monitors, the first reliable solution for tackling the real-world problems inherent in every room. Featuring the exclusive JBL RMC™ Room Mode Correction system, you can accurately measure boundary-induced low frequency modes with the included hand-held acoustic analyzer and then adjust each speaker's 1/10th octave parametric equalizer to correct problems in your room. Designed from the ground up, the LSR6300's uncompromising specs and features give you total control of your music production. See your JBL Dealer today and experience the power of LSR6300 Studio Monitors with RMC - magic you can really put your hands on.

LSR6300 Studio Monitors – Mix Without Boundaries.

Learn more about the power of the LSR6300 Studio Monitors and RMC at www.jblpro.com/LSR



H A Harman International Company

Tool Box

BY KEVIN OWENS



Moog MuRF Analog effects module

Hailed as the "mother of all Moogerfoogers," **the MuRF (\$435)** features eight resonant, tuned bandpass filters laid out in a manner similar to a graphic EQ, each with a slider controlling the gain of that frequency band. Each filter's gain is controlled by the "Animator," a pattern generator that supplies envelopes to the eight filters, adjusting their levels in 12 different rhythmic patterns. The MuRF accepts any line-level or instrument level signal, and can be controlled by the front-panel knobs, expression pedals, or via analog synthesis instruments.

Moog, www.moogmusic.com

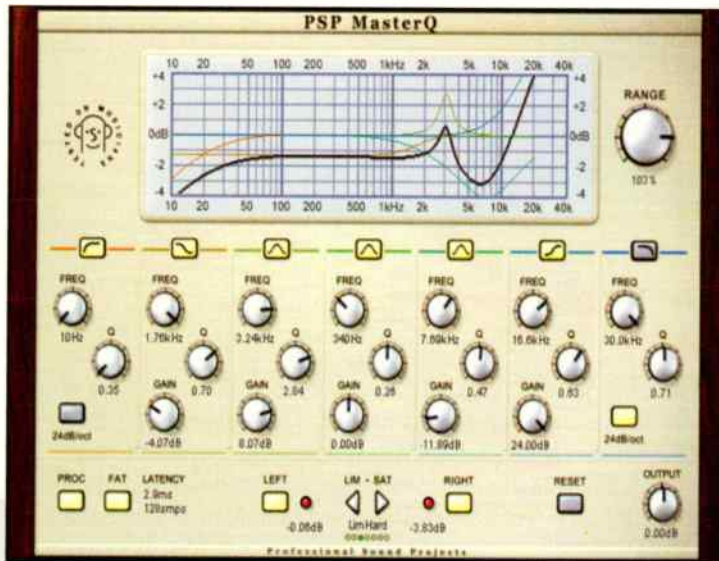

PSP MasterQ Parametric EQ plug-in

MasterQ (\$149) is a parametric EQ designed to operate at sampling rates ranging from 44.1–192kHz. The plug-in (VST, DirectX for PC; VST for OS X) contains seven filters — 12 or 24dB/octave low cut and high cut; low and high shelf; and low-mid, middle, and high-mid peaking — all with adjustable frequency and Q. MasterQ also includes a precision graph that displays an overall EQ curve and individual curves for each active filter.

PSP, www.pspaudioware.com

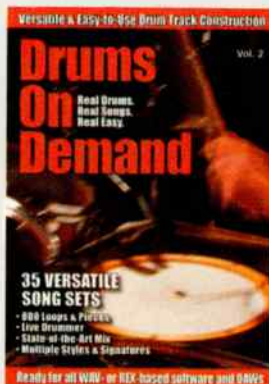

Drums on Demand, Vol.2 Drum track construction kit

Developed as a companion CD to the first volume of the same name, **Drums on Demand Vol. 2 (\$49.95)** is a collection of hundreds of royalty-free loops in 35 "Song Sets." Each Song Set lets you create realistic drum parts from as many as 36 verse, chorus, fill, bridge, break, intro, ending, and other loops that range in length from one to eight measures. Vol. 2 is currently available in 24- or 16-bit Acidized WAV format.

Drums on Demand, www.drumsondemand.com

Kjaerhus GEQ-7 Parametric EQ and filter plug-in

The **GEQ-7 Golden Equaliser (\$98)** is a 5-band parametric EQ with a selectable shelf setting on the highest and lowest bands, four selectable EQ types, separate left and right channel adjustment, and low and high cut filters with slopes from 6–48dB/octave. Other features include silent knobs and push in/out buttons, zoom and scrollable frequency response display, 64-bit internal processing, full VST automation, and sampling rate support up to 192kHz.

Kjaerhus, www.kjaerhusaudio.com



Daking Mic-Pre IV 4-channel preamp

The **Mic-Pre IV (\$2,895)** consists of four class-A preamps in a stainless steel enclosure. The single rackspace unit features four XLR/TRS Neutrik combo jacks on the back panel, four switchable line/Hi-Z inputs on the front, and an outboard DC power supply in a separate housing. Each input has a variable gain control, a 20-segment LED level meter, switchable phantom power, switchable input phase, and a 20dB pad button.

**Daking, dist. by TransAmerica Audio Group,
www.transaudiogroup.com**



Alienware Ozma Digital audio workstations

Available in "conspiracy" blue, "plasma" purple (pictured), "Martian" red, and "cyborg" green, **Alienware's Ozma Workstations (\$1,959–\$4,598)** are Intel- and AMD-based computers that are optimized for audio production, recording and editing, and sound engineering. The made-to-order machines are constructed with top-of-the-line components and were developed in conjunction with top DAW companies such as M-Audio, Cakewalk, Propellerhead, and Steinberg.

Alienware, www.alienware.com



TDL Model 432

Mic pre

The Model 432 (\$283) is a 2-channel microphone preamp with phantom power that was specially designed to drive a computer soundcard's line-in. Its internal shielding isolates the power supply from the amplifiers, resulting in low noise compared to the line-in maximum signal level, and its cast aluminum enclosure minimizes the pickup of unwanted signals. The unit features two input connectors for each channel (XLR, RCA), three outputs (left RCA, right RCA, and 1/4"), and a 4-pole Butterworth lowpass filter with a 25kHz cutoff frequency.

TDL Technology, www.zianet.com/tdl



Universal Audio Fairchild 670 Compressor plug-in for UAD-1

Modeled after the famed stereo tube compressor at L.A.'s Ocean Way Studios, the **Fairchild 670 (\$149)** compressor plug-in for the UAD-1 DSP card maintains all the features of the original unit, but adds some digital improvements such as a sidechain link modification that couples attack and release between both channels, DC bias controls, a Time Constant control (which allows six unique attack and release times), lat-vert functionality, output level controls, and a Controls Link function that allows the linking of all of the unit's seven dual controls.

Universal Audio, www.uaudio.com



Brauner VMA Tube microphone

Using circuitry and biasing instead of filter networks, **the VMA (\$7,000)** combines two high-grade tube mics in one capsule, offering a choice between original and vintage sounds at the flick of a switch. One setting represents the multi-purpose sound of the Brauner's famed VM1, and the other provides "a sweet and mellow tube sound reminiscent of the greatest vintage mics ever built."

Brauner, dist. by TransAmerica Audio Group, www.transaudiogroup.com



London to Los Angeles. Now.



Introducing DigiDelivery

Faster and less expensive than overnight delivery services.
More secure and reliable than FTP. Able to leap across planet Earth with a single click.

- Exchange any kind of file of virtually any size with anyone in the world
- Robust network appliance easily installs on your existing network, DSL, or cable modem
- 128-bit encryption for military-grade security from sender to recipient
- One-click secure downloads — Recipients don't need accounts, passwords, etc.
- No per-use or subscription fees
- All administration managed with standard Web browsers
- Automated reporting for billing clients



Visit www.digidesign.com/digidelivery for the full story on DigiDelivery.

World Radio History



RML Labs SAWStudio Basic Editing/mixing application

A trimmed-down version of its high-end big brothers, **SAWStudio Basic (\$300)** brings the SAWStudio environment to a wider group of users. An acronym for "software audio workshop," SAWStudio Basic has the look and feel of a fully controllable console, and includes a high-powered, 24-bit hard disk engine and a newly designed multitrack recording/editing interface.

SAWStudio, www.sawstudio.com



Groove Tubes Glory Comp Tube compressor

The Glory Comp (\$2,999) is an all-tube compressor designed for "serious recording applications." The high-end Glory employs a total of seven tubes, and its feature list includes: dual isolated output taps on its custom-wound transformer; Attack, Release, and Compression controls; a built-in sidechain EQ with adjustable low and high frequency filters; ceramic multi-decked switches instead of potentiometers; and the Glory knob, which affects second-order harmonics and lets you adjust between Earth (no effect) and Heaven (full effect) settings.

Groove Tubes, www.groovetubes.com

Ultrasonne HFI Series Headphones

Both the **HFI-550 (\$189; \$239 PROline)** and **HFI-650 (\$249; \$299 PROline)**, pictured) feature Ultrasonne's S-Logic technology, which uses centralized transducer positioning to reflect sound off the listener's outer ear, creating a natural three-dimensional sensation.

S-Logic also reduces sound pressure levels at the eardrum by up to 40%, reducing the risk of hearing damage. Both foldable models are available in a PROline version, which reduces typical harmful magnetic emissions by up to 98%. The HFI-550 features a heavy-duty 50mm transducer that makes it ideal for drummers, bass players, and DJs, while the HFI-650's gold-plated Mylar foil drivers provide maximum transparency and are intended for music production and studio use.

Ultrasonne, www.ultrasonne.net



While the other guys were busy adding switches and knobs, we reinvented the whole thing.

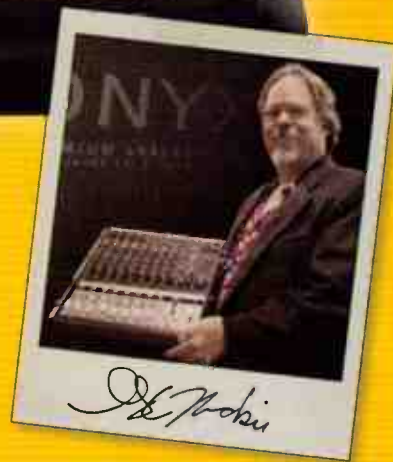

GREG MACKIE,
our founding father, shows off a killer shirt... And the Onyx 1220.

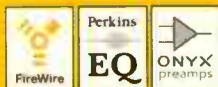

ONYX™
PREMIUM ANALOG MIXERS
w/PERKINS EQ & FIREWIRE OPTION

It's time to rethink your mixer. We did.

Introducing Onyx, the next generation of premium analog mixers from Mackie. Over two years in the making, Onyx mixers boast all-new circuitry, incredible sounding Onyx mic preamps, a built-in Talkback section, balanced direct outs on every channel, and our own Perkins EQ, which gives you the warm, musical sound of "British" EQ with a true hardware bypass. And if all that wasn't enough, Onyx mixers also sport a FireWire I/O option – making them superb multi-channel audio interfaces for your Mac or PC.

Put simply, Onyx is the compact mixer, reinvented. Visit your Mackie dealer to learn more.



© 2005 Mackie International, Inc. All rights reserved. "Mackie" and the "running man" logo are registered trademarks of Mackie International, Inc. "Onyx" is a registered trademark of Mackie International, Inc. All other trademarks are the property of their respective owners.

- ☎ 800.258.6883 (Toll free within U.S.)
- ☎ 425.487.4333 (Outside U.S.)
- info@mackie.com

MACKIE®
www.mackie.com

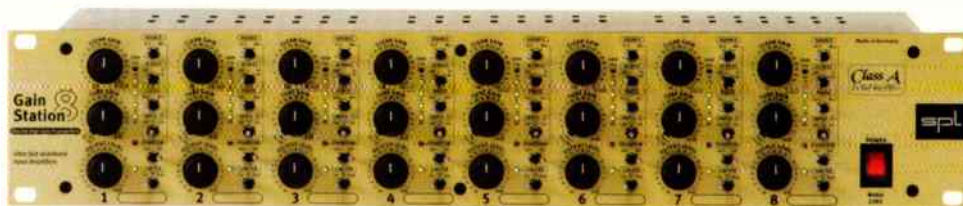

SPL GainStation 8

8-channel mic and instrument preamp

The GainStation 8 (\$6,499) boasts separate, independently controllable solid-state and tube preamps on each of its eight channels. Features include peak and FET limiters, switchable mic impedance, custom-designed 60-volt op amps, encapsulated relays with gold-plated contacts, and an internal 24/96 AD converter.

Sound Performance Lab, www.spl-usa.com



AiRR Support Stands

Professional grade boom stands

Available in three sizes, **AiRR stands (\$335-\$449)** are designed for overhead recording applications such as drums, background vocals, orchestral recording, and more. The recently upgraded stands feature a second sandbag for additional counterweight, an improved height adjustment crank, a removable 3-wheel tripod base, telescopic locking legs, fast locking and unlocking of the boom angle, and a custom carrying bag.

Network Pro Marketing, www.networkpromktg.com

CreamWare Noah 1.1

Software update for Noah

Noah Remote Software version 1.1 (free upgrade) adds OS X compatibility to CreamWare's Noah DSP rack synthesizer (reviewed November 2003). New features include an ASIO driver, as well as improvements to Noah's individual instruments, and an overall optimization. Existing Noah users can download the upgrade from the company's website.

CreamWare, www.creamware.com



BUYING GEAR?

>> You Owe it to Yourself to Call Sweetwater!



dbx DriveRack Studio *The Swiss Army knife of studio monitoring!*



RØDE NT2000
The most flexible studio condenser under \$600!



Digidesign Mbox
Get into Pro Tools for a song!

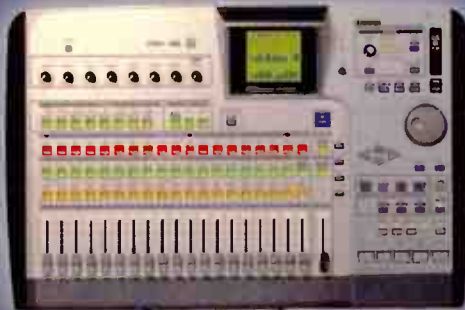

TASCAM 2488
Killer 24-track recording!



Roland V-Pro Series Drum Kit
State of the art in electronic percussion!

ADAM Audio P11A
Uncompromising studio monitors!



Kurzweil K2661
VAST power in a portable package!

We know that great prices are important.

It's the first thing that most people look at when deciding where to buy their gear, and we've worked hard to offer our customers prices that are as good as or better than you'll find anywhere.

With most retailers, a good price is the end of the story, but at Sweetwater, it's just the beginning. In addition to great prices, our customers get the benefit of an expert sales staff, an incredible selection of music technology gear, the largest website in music retail, access to a factory-authorized service center for the biggest names in pro audio and the best technical support staff in the industry.

With all of this at your disposal, why would you buy from anyone else?

25th Sweetwater Anniversary

music technology direct

FAX: (260) 432-1758 • 5335 Bass Road, Fort Wayne, IN 46808

(800) 222-4700 • www.sweetwater.com



EXPERT SALES STAFF



HUGE SELECTION



WEBSITE — SHOP 24/7!



FACTORY-AUTHORIZED REPAIR CENTER



AWARD-WINNING TECH SUPPORT

World Radio History

Best FREE Shipping Deal Anywhere
Ask your Sales Engineer for details.



VGA output and monitor optional. Plug-ins and Roland VSRF-3 Effect Expansion Board sold separately. All trademarks are owned by their respective companies. For direct contact info, call 323.890.3700.

With the optional VS8F-3 Expansion Board,
you get the best software plug-ins on top.

ANTARES
AUTO LEARN V3

cakewalk
SOUNDSTAGE™ & FX REVERB™

FL
MULTIMEDIA
1 TRACKS V3™

Massenburg
DesignWork3
HI RESOLUTION PARAMETRIC EQ™

CHROME TONE AMP

Soundtoys™
SOUNDLENER V3™

t.c. electronic
TCR 1000

UNIVERSAL AUDIO
V3 LA2A & V3 1176LN



THE NEW VS-2000CD IS THE MOST INDULGENT DIGITAL WORKSTATION IN THE HARDWARE WORLD.

Just plug it in and go. 8 XLR mic inputs, 40 channels of automated mixing, PCM drums with sequencer, onboard COSM® effects and harmony generator, and USB 2.0. Top it off with stunning VGA output and crash-free, mouse-based graphical editing. Eat it all up, but make sure to save room for the plug-ins.

Roland 
WWW.ROLANOUS.COM / VS2000CO

World Radio History

Front End

The search for a better signal path can be a long, windy road.

If your studio is anything like mine, things are always in a state of flux. It could be anything from updating to a new operating system, adding a new word clock generator, rewiring the patchbay, installing acoustic treatment — it never ends. Recently, I've been considering the signal path going into my computer, which functions as both a multitrack recorder and full-blown (albeit virtual) mixing console. After all, the "front end" is an important consideration — whatever comes before the analog-to-digital conversion can significantly affect the sound quality of your tracks. Of course, this shouldn't come as a surprise to anyone reading *EQ*. But nonetheless, the idea of front-end devices has gained an increasing amount of attention from the pro audio community, and for good reason.

So what does *front end* really mean? For some it means the analog-to-digital converter. To others, it could be a stereo or 2-channel class A mic preamp. How you define the term depends largely on your needs, which, not surprisingly, play a critical part in determining the best route for upgrading the component (or components) that satisfies your lust for the "ideal front end." All hype aside, our goal with this feature is to help you identify what you want from a front end. Start by checking out *Assessing Your Needs* on page 24.

To many, the term "front end" is interchangeable with "pre-amp." If you fall into this camp, you won't want to miss *Preamp: Fact Or Fiction* (page 26), where we take an in-depth look at how impedance, circuit design, tubes, transistors, and other aspects can affect your sound. Then put all that knowledge to work. Build your own guitar input on page 36.

Along these lines, we have an exclusive report from a recent preamp design summit held at Middle Tennessee State University, where industry leaders and high-end designers such as George Massenbourg from GML, Dave Hill from Crane Song, and Craig "Hutch" Hutchinson from Manley Labs were on hand to discuss the philosophical element to signal path design. Turn to page 30 to read what these heavyweights had to say.

Last but not least, a buyer's guide aimed squarely at front-end processors. If you're looking to fuel your gear lust, look no further than page 40.

The bottom line is that you want your tracks to sound great, right? Maybe that means it's time to invest in a better analog chain. It's our hope that the information presented here helps you get a clear picture of what the next step holds for your studio as you consider the all-important front end. Enjoy! — JOHN KROGH



Assessing Your Needs

The first steps to choosing your ideal front end

by John Krogh

WHY THE FRONT END?

What is it about your recording path that you want to change? In other words, why do you need a front end? This should be the first question you ask yourself before leafing through a gear catalog or rushing out to the local pro audio shop.

We all want our recordings to sound better, but what does better mean to you? To answer this, start by scrutinizing the individual tracks and final mixes you've done in your studio. What's missing? Lack of depth? Punch? Is there noise building up on tracks recorded through a particular preamp? Are the highs too strident? Are your mixes cohesive or do they sound like a bunch of disparate overdubbed parts all playing at the same time? Maybe you already know how to record good-sounding tracks, but the results are too colored (or more likely, not colored enough) for the style you work in. If you can't identify the problem areas, you won't be able to make an informed decision about what to fix or upgrade.

CHOICES

Broadly speaking, front end devices are anything used in the signal path before audio is committed to the hard disk. By this definition, we're talking microphones, preamps, compressors, EQs, "flavor" boxes, and even A/D converters. That's a wide range of gear; in-depth coverage of all these categories is beyond what we can manage in these pages. I've limited the scope of this article to preamps — whether you record your own vocals, overdub studio musicians one at a time, or track stereo keyboards, a good preamp is necessary for producing quality recordings. So with this in mind, let's look at a variety of session scenarios and which type of preamp would work best in each situation.

■ **2-track classical recording.** If you record classical music (quartets, piano and flute duos, brass ensembles, classical guitar, and so on), you want the clearest, cleanest path from the microphones to the recorder. A stereo or 2-

channel preamp with as few extra components and stages as possible is ideal. There's little need for processing such as EQ, de-essing, and compression. In general, tubes will provide more color to the sound, so a Class A solid-state device may be preferred; however, some manufacturers claim excellent noise and distortion specs for their tube preamps. If you feel your recordings are too clinical or sterile, a modern tube preamp might give the recording just enough "warmth" without adding unwanted tube character.

■ **Vocals.** The choice here is dependent on the style of music. For pop, hip-hop, and R&B, you may want a punchy, present sound, but for jazz or '60s and '70s-style rock a more "old school" tone would be appropriate. There are other factors to consider: How a vocalist approaches the mic, the timbre of their voice, choice of microphone, etc., all play a big part in the overall sound. Having a flexible single-channel preamp with tonal shaping tools such as EQ and dynamics is a must. If you have a variety of mics — tube, ribbon, condenser, dynamic — a preamp with variable impedance would be a smart option. Likewise, the ability to switch between solid-state and tube stages will give you a wider tonal palette.

■ **Electric guitar and bass.** If you're laying guitar tracks down in your bedroom or home studio, chances are you don't have a big room for a multi-miked amp-in-a-room setup. However, close miking is likely a viable option — one mic directly on the speaker grille, and another mic 1–3 feet away is a common approach. If this works for your space, a 2-channel preamp with EQ will be your best bet. EQ will be handy for carving out frequency ranges to produce a good blend between the mics. A compressor isn't as essential though, as the output from an amp is already compressed to a certain degree. That said, I've heard some amazing guitar tracks that owed much of their vibe to a compressor in the chain.

If the idea of reamping appeals to you, consider a preamp with instrument inputs. That way, you could use one channel to record the direct sound from the guitar, and the other channel for miking the cabinet. Matching the level and impedance from the recorder to work with a guitar amp isn't an issue if you reamp through plug-ins. But if you plan to send the direct signal back out to an amp or outboard guitar processor, consider a dedicated "reamping" box.

■ **Stereo keyboards.** Synths and samplers are capable of producing a seemingly infinite number of sounds and textures, but even so, most keyboards can benefit from passing through a quality preamp before hitting the hard disk. A preamp can give you more grunge or a smoother top end, for example. On a more practical tip, keyboards don't all work at the same operating level — a preamp can help "optimize" the output signals.

So what should you look for? A stereo or 2-channel preamp with EQ and variable types of compression, and possibly a "saturation" stage, will give you the most flexibility for tracking keys. And remember, you're not limited to recording "real" sources, either — running software instruments through a preamp is an effective way to beef up otherwise flat-sounding synths.

THE NEXT STEP

Obviously, there's a lot to ponder when it comes to investing in the front end. And it is an investment. You can expect to pay anywhere from a few hundred bucks to \$4,000 or more, depending on what you're after. So do your homework. Read the other segments in this feature. Then gather opinions from engineers you trust. Call around to see if you can rent the gear on your front-end wish list. Try the front ends with the same test sessions and a variety of mics, if possible. Record the results for A/B comparison. Let your ears be the judge of what's best. It might sound like a lot of work, but aren't your recordings worth it? 

The Art of Recording: Preamp Fact and Fiction

Do you REALLY know what makes your preamp tick?

by Craig Anderton

Front ends — just like mics, speakers, and record company lawyers — are shrouded in mystery. The front end (or “preamp” to those who eschew obfuscation) typically provides that crucial link between a mechanical transducer, such as a mic or guitar pickup, and the circuitry that follows it, such as a mixer or computer audio interface.

It used to be that the idea of buying expensive mic preamps for a home studio was outlandish. But as the cost of recording has nose-dived (it wasn't that long ago we were thrilled to get 16 tracks of digital audio on tape for \$8,000), that leaves more disposable income for devices like monitor speakers, mics, preamps, and other accessories. Furthermore, with many “owner-operator” studios where instruments are recorded one at a time, you need only one good-quality preamp. If you need to mic a drum set, well, you can always use the good preamp on part of the kit and the ones in your mixer for the other tracks. (I won't tell. . . .)

“There's a lot of mythology surrounding preamps — some true, some half-true, and some flat out wrong.”

There are a lot of front-end boxes out there, from cheapo tube preamps to audiophile devices that cost thousands of dollars and sound like electronic silk. People get very passionate about their

preamps, but that's because there are distinct, subtle differences among the various types that even those without golden ears can hear. However, as with most “golden ear” topics, there's a lot of mythology surrounding preamps — some of it true, some of it half-true, and some of it flat out wrong. Let's sort out fact from the fiction.

■ **A preamp has to use a Class A amp design to sound any good.** Well . . . there's no denying that a Class A amplifier, where one or more transistors are conducting current all the time, is theoretically capable of the lowest amount of distortion. Class B amps, which are far more common, use separate transistors to conduct a waveform's positive and negative portions. They got a bad rep because in their formative years, there would be delays as the signal switched back and forth between the two transistors, thus leaving a “notch” in the waveform. (Class A/B amps tried to fix this by overlapping the conduction, but this wasn't always an ideal solution.) These days, though, Class B circuits can be designed that have no audible, and often no measurable, distortion; and they save energy because they don't dissipate the significant amounts of power that Class A circuits do. Still, when only the best will do, it's hard to go wrong with a good Class A design.

■ **The higher the impedance with guitar, the better.** This is true only with passive pickups, and then only if you add “up to a certain point.” An excessively high impedance is more likely to pick up hum, noise, and other interference. Usually, an impedance of 250k Ω –2M Ω is more than sufficient to avoid loading down a guitar with passive pickups. (Note

It's Miller Time!

No, I'm not talking about what happens when the session's over, but about the *Miller effect* — perhaps one of the reasons people like triode tubes (e.g., the 12AX7, or even pentode tubes operated as triodes), although the effect is also present to some degree in transistors.

In a nutshell, a tube's plate and grid form a capacitor (Fig. 1), which is charged and discharged through the source resistance of the stage driving the tube. This resistance and capacitance (which combines with the grid-to-cathode capacitance) creates a primitive lowpass filter. The capacitance increases at higher gains, which of course, is the situation when you're amplifying mics and guitars. So, some of that “warm” sound is simply due to high frequency rolloff.

It's convenient that as you increase the gain, the capacitance increases. Thus, for heavily distorted leads, the sound is not as shatteringly bright as it might be otherwise. But also note that some companies have worked very

hard to reduce the Miller effect, particularly with vocal preamps. This can be done by decreasing the output resistance driving the triode stage, reducing the tube's overall gain, or avoiding the use of triodes altogether (with tetrode and pentode tubes, the screen grid reduces the amount of capacitance, thus reducing the Miller effect.)

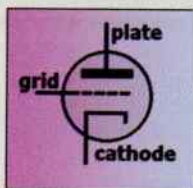

A triode's plate and grid exhibit a certain amount of capacitance, as does the grid and cathode. At high gains, this can create enough lowpass filtering to influence the sound.



TUBE VERSATILITY

**Announcing the redesigned
TPS II™ Tube Preamplifier
System and DPS II™ Digital
Preamplifier System from ART.**



V3™ Based on the success of our award-winning TPS and DPS preamp systems, the TPS II™ and DPS II™ feature our improved V3™ Technology (Variable Valve Volting), which delivers a complete range of newly enhanced presets designed to compliment every microphone, musical instrument and direct signal you process. ART Engineers have improved key feature sets on these units that exceeds that of units costing much more.

Both the TPS II and DPS II also feature variable input impedance, LED input meters, automatic mic/instrument switching, OPL™ (Output Protection Limiting) and more tube warmth than their predecessors. These newly enhanced preamps can accept +20dB peaks while maintaining over 120dB dynamic range and incredibly low distortion. The DPS II includes a versatile insert loop on each channel which provides access for additional signal processing or direct access to our high quality A/D converter. Separate gain controls on analog and digital outputs allow you to optimize the unit for simultaneous applications. Digital outputs include S/PDIF, TOSLINK or ADAT (front panel selectable).

The A/D is front panel adjustable from 44.1 to 96K or syncs to ADAT or external word clock (32KHz to 100KHz). You can patch into any ADAT stream and select which pair (or all) of channels the DPS II transmits.

Out of the box, these preamps are ideal for any studio environment or live sound rig. Housed in a single rack space design, for musicians and engineers alike, there is a multitude of uses for the TPS II and DPS II. Use your TPS II or DPS II for any front end signal processing to smooth out your tones and control levels to your outboard devices. Now that's versatile!

Check one out at your local retailer today! For more info on these or any ART product, visit our website at: www.artproaudio.com.

Celebrating Twenty Years of Audio.

A R T
APPLIED RESEARCH AND TECHNOLOGY

The Art of Recording: Preamp Fact and Fiction



Universal Audio and Avalon are just two of several companies making high-end, audiophile-quality preamps.

that mics with built-in preamps and guitars with active electronics are almost always relatively unaffected by the input impedance of the stages they feed.)

- **High impedance is the only way to go with guitar.** Not always. It's certainly true that lower impedances reduce a passive pickup's high-frequency response and overall level, but this may be desirable if you're feeding a subsequent distortion stage (which is a common scenario in today's "all-in-one" recorders where guitar effects are built-in). Rolling off the highs by loading down the pickup can produce a creamier distortion effect.

- **Tubes sound better than solid state.** The reason why many people prefer the

Do I Really Need Expensive Mic Cables?

Not necessarily, but you do need *good* ones. The first thing I look for in cables is low capacitance per foot (specified in picoFarads). This capacitance can rob high frequencies when devices with high output impedances feed input stages with high input impedances — if I'm going to reduce the highs, I'd rather specify the amount myself. Some cables designed for audiophiles go heavy on the shielding, which is a good idea given the interference-prone average household, but can increase cable capacitance. This has no significant effect on the line-level signals used in hi-fi gear, but can definitely alter the sound of devices such as mics and guitars with high-impedance outputs.

“Most people can hear the difference between a high-end boutique preamp, and the ‘let’s-hit-a-price-point’ preamps found in budget mixers.”

sound of tubes is not because they sound more accurate, but because they can color the sound in a subjectively pleasing way. Tubes add a natural compression, slight high-frequency reduction (see sidebar, “It’s Miller Time!”), hiss, and harmonic accentuation. Regarding solid state, a well-designed preamp — whether using bipolar or field-effect transistors — can certainly sound transparent and accurate to my ears; although conversely, there are some highly skilled tube designers who make extremely accurate tube-based products. In any case, even though computer emulations of tubes get better all the time, there’s still nothing quite like a tube sound.

- **The preamp has a huge influence on the way a dynamic mic sounds.** Yes, but I think a more accurate phrasing is

that the *mic* has a huge influence on the how the *preamp* sounds — a preamp may have a certain “color” with one mic, but not with another. This is because a dynamic mic presents an inductive load that interacts with the preamp’s input stage, which can alter the overall frequency response. Some preamps have adjustable input impedances, so you can dial up the best sound for your particular set of mics.

- **You want to match the output impedance and input impedance of the mic and preamp.** That’s true if you’re installing telephones, where the object is a maximum transfer of power. What we want is a maximum transfer of *voltage*, which means that for the most accurate signal transfer, a stage’s output impedance should be 10–20% of the impedance of the stage it feeds. However, note that the impedance changes with frequency; for example, a guitar pickup’s high frequencies exhibit higher output impedance than low frequencies (this is why low impedance inputs reduce highs). Add other variables to the equation, and it’s no wonder different combinations of gear can sound very different.

- **An expensive mic preamp will always sound better than a cheap one.** All things being equal, most people can hear the difference between a high-end boutique preamp, and the “let’s-hit-a-price-point” preamps found in, say, budget mixers. However, it’s important to remember that certain combinations of preamp, mic, and cable may lead to an inexpensive preamp sounding better for that particular combination of gear, or with a particular signal source. So, even if you have a really great preamp that cost as much as the GNP of some third-world nations, try out some of your other preamps as well. They may do the job better in some cases.

The bottom line on front ends is simple: You can’t really go too much by other people’s advice, unless you’re recording the same type of material using the same gear. Subtle differences among devices might sway you toward one or the other. In any event, though, try out as many preamps as you can. At some point, you’ll find the one that sounds best to your ears. EQ



TransX
Transform Transients,
Get Rhythmic Control

SoundShifter
Transform Time and Pitch



Morphoder
Transform
Sonic Identity



Doubler
Transform Dimension

Waves NEW Transform bundle is for anyone looking to push the envelope in sound transformation. Take creative control—shape time, pitch, instrument sound, presence, rhythmic contour, dimension and punch. Four processors using pioneering technologies allow you to easily and intuitively sculpt your sound with clarity and precision.

TRANSFORM YOUR SOUND

› TransX › SoundShifter › Morphoder › Doubler

FEATURING:

SoundShifter shift the pitch or shift the time or both
3 TOOLS: Parametric, Graphic, Realtime; 4 ALGORITHM MODES: Sync, Smooth, Transient and Punchy; MULTIPLE CONTROL/DISPLAY OPTIONS: Time, Tempo, Bars, Samples, SMPTE, Pitch, Interval, Frequency; FLEXIBLE LINK MODES: Unlinked, Time, Pitch, Strapped

Doubler a dedicated and specialized tool for this popular effect
2 or 4 voices with independent control of Detune, Pan, Delay, EQ and Volume, wide modulation options.

Morphoder for Vocoding and beyond
8 voice stereo synth, on screen keyboard control, format correction, Q optimized bands, Noise generator with filter for articulation control.

TransX specialized for shaping transients
Control room sound, adjust mic distance, control the pick and stick on guitars and drums, ad punch or soften attacks, highlight sustain, subtle and extreme.



- TransX—Transform Transients, Get Rhythmic Control
- SoundShifter—Transform Time and Pitch
- Morphoder—Transform Sonic Identity
- Doubler—Transform Dimension



Available in an upgrade to, or purchase of the New **Diamond** bundle

14 DAYS DEMO AVAILABLE AT YOUR WAVES DEALER OR AT WWW.WAVES.COM

(HEADQUARTERS) Azreili Center, Tel-Aviv, 67011 Israel, phone: 972-3-608-4000, fax: 972-3-608-4056

(NORTH & SOUTH AMERICA) 306 W. Depot Ave., Suite 100, Knoxville, Tennessee 37917, phone: 865-909-9200, fax: 865-909-9245

powered by



Preamps in Paradise

Today's top preamp designers gather to discuss the state of the art

by Mitch Gallagher and Frank Wells

Gather a group of recording engineers in a room and you'll quickly learn that everyone has an opinion about microphone preamps. You'll hear that a preamp should be transparent, colored, clean, dirty, present, slow, fast, accurate, fat, round, open, (insert your favorite ambiguous adjective here). . . .

Perhaps the only group with more definite opinions about preamps than recording engineers is the designers behind the devices. To gain enlightenment on the topic of preamps, Lynn Fuston, of Franklin, Tennessee's 3D Audio (www.3daudioinc.com), gathered together some of the industry's leading design luminaries as well as prominent engineers. What started as a simple gathering of preamp designers for the purpose of casual conversation originally slated to be held in Hawaii — thus the "Preamps In Paradise" moniker — quickly escalated into two free-ranging panel discussions held at Middle Tennessee State University. All we can offer here is a brief summary of what was discussed. Fortunately, the panels were filmed, and will be released on DVD later this year. Companies sponsoring the panels included Manley Labs, McPherson Guitars, Sweetwater, Universal Audio, Gordon Audio, Mercenary Audio, Great River Electronics, and Crane Song.

The first panel comprised ten preamp designers. In attendance were Geoff Daking (Daking), Doug Fearn (DW Fearn), Greg Gualtieri (Pendulum Audio), Dan Kennedy (Great River Electronics), Dave Hill (Crane Song), Grant Carpenter (Gordon Instruments), Craig "Hutch" Hutchinson (Manley Labs), Oliver Archut (AMI TAB-Funkenwerk), George Massenbourg (GML), and John Hall (Langevin, Electrodyne, Quad 8). As panel moderator and host, Lynn Fuston, pointed out, ". . . a pretty amazing brain trust!"

The second panel saw recording engi-

neers taking the stage. Attending were Michael Wagener (Dokken, Skid Row, Motley Crue, Extreme), Russ Long (Newsboys, Sixpence None The Richer, Rich Mullins, Carolyn Arends), Brian Tankersley (Brooks and Dunn, Gino Vannelli, Charlotte Church, Shania Twain), Fletcher (Mercenary Audio), John Wheeler (Hayseed Dixie), Bil VornDick (Asleep at the Wheel, Bela Fleck and the Flecktones, Allison Krauss, Ralph Stanley), and Chris Huston (Led Zeppelin, The Who, War, The Rascals).

THE MYSTIQUE

Preamps seem to have developed a certain mystique in the modern studio. But things weren't always that way. Once upon a time, preamps were found primarily in mixing consoles. Engineers began using outboard preamps for the same reason Bil VornDick pointed out, because he "wanted another color" rather than running everything on a session through the console preamps.

But what makes preamps so intriguing? Doug Fearn kicked things off: "The preamp is the interface between the microphone and the rest of the world. If it gets messed up there, you can't get it back."

Greg Gualtieri continued, "It's an interaction between the microphone and the preamp that determines the sound," which gives the question, "what does my mic sound like?" no single answer.

A given combination of mic and mic pre, one that has produced successful results in the past, may or may not work in a similar situation said Dave Hill, "When it works, you just go with it."

George Massenbourg suggested that a great preamp design isn't always enough to get a great sound. "What humbles me," he explained, "is that sometimes factors like humidity in the room can be the variable, not the gear." John Hall concurred, "The mistake a lot of people make is that they don't go out in the room and listen to what they're recording." Hill added, "Everybody

here makes great preamps that will work in most situations," but when faced with a problem, you have to trace it to its source — the humidity, the player, the room or other factors beyond the technology.

COLOR MY WORLD

"Outboard mic pres, at this point," said Brian Tankersley, "are just a godsend to get us back to where we were 30 years ago." Having a selection of mic pres can offer an advantage while recording digitally, added Michael Wagener, coloring the sound "on the front end" since the recording media itself isn't providing character.

"If we consider ourselves artists, they're giving us a wide palette," VornDick says of mic preamps." On a good day," commented Fletcher, "the equipment will help support the emotion of the musical statement."

Wagener started appreciating outboard preamps, "when I went from recording in 20 different studios to recording in my own place." He said, "Little tiny changes the mic pre made during recording" made the difference between getting what he wanted instead of having to work to fix what he got.

Tankersley agreed, saying an "articulate and musical sound" on the front end helps fight the "constipation" of much of modern recording.

But the factors that play into the use of a given preamp are numerous. "There's no way to overstate how interactive it all is," Tankersley said, offering wire, connectors, cable length, the room, the player, and the instrument all as pieces of the sonic puzzle.

HOW DO YOU GET THAT SOUND?

So do designers just plug in components until the preamp sounds right, or do they go for a particular tone? Fearn commented, "I spend a lot of time listening, figuring out what it is about a sound I *don't* like," then the design goal would be to eliminate those elements. Craig "Hutch"

WHY PAY LESS?

I'm amazed at the recent price drop of entry level condenser microphones. \$99, \$49.

Is the \$1.99 microphone coming?



Are they any good? Well the short answer is yes!

Today, there are many cheap guitars, drums and keys for sale. These novice instruments serve a purpose by allowing kids and those who want to begin to experience music, to do so at a relatively low cost. If they don't continue playing, they haven't lost a lot of money. The cheap microphone does the same thing for recording.

The **NT1-A** was not designed for this purpose. The **NT1-A** is a studio quality microphone designed for people who are serious about their music. This is a creative tool that can be relied upon to capture your art.

Thousands of serious musicians and engineers have invested in this microphone, thus making it an industry standard.

While the **NT-1A** isn't the lowest cost microphone available, its worth every penny and continues to win prestigious awards for quality and performance.

Please listen to the **NT-1A** before you buy any microphone, and you too will hear why you should invest just a little more for the real thing.

Peter Freedman
President

Rode Microphones

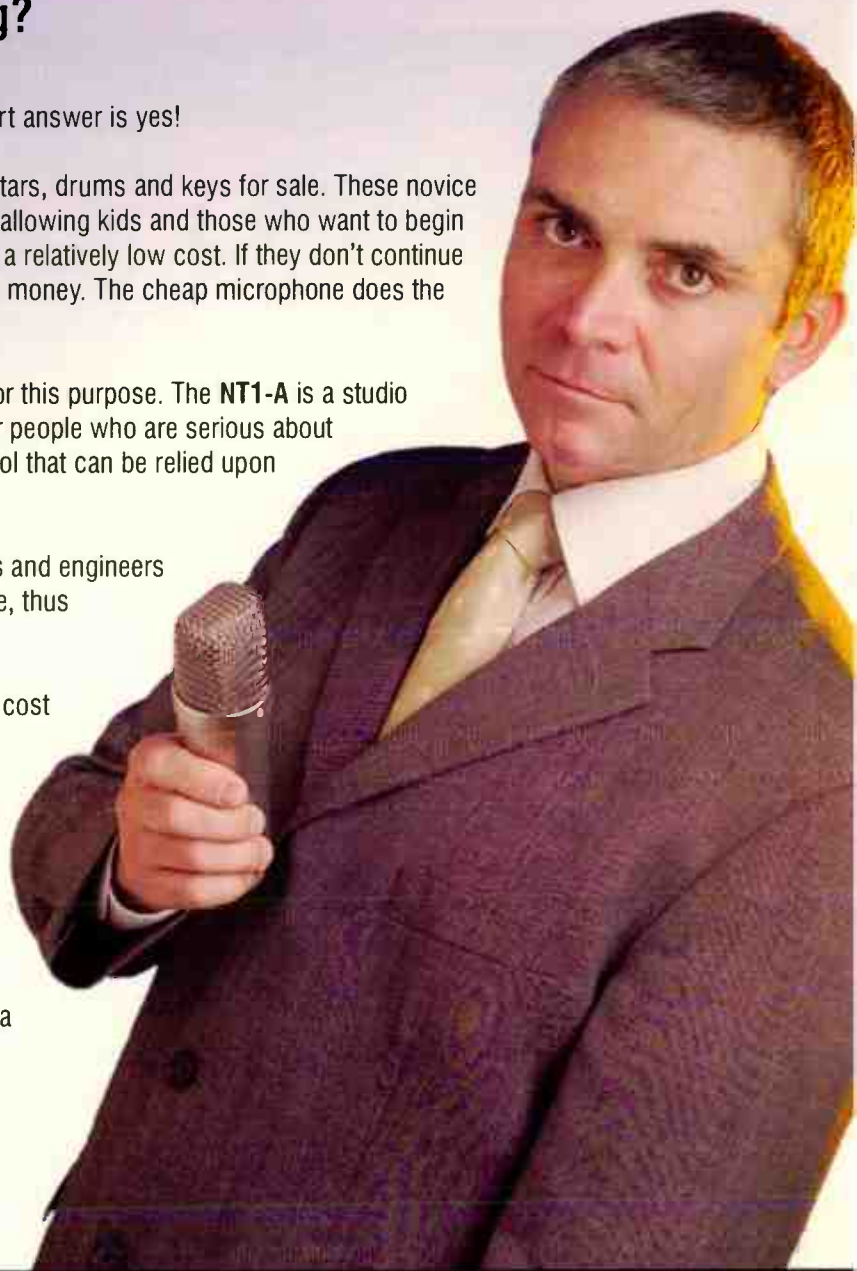

INTERNATIONAL RØDE MICROPHONES

107 Camarvon Street, Silverwater
NSW 2128 Australia
Ph: 61 2 9648 5855
Fax: 61 2 9648 2455

USA

P.O. Box 3279 Torrance,
CA 90510-3279
Ph: 877 328 7456 (toll free within the U.S.)
Ph: 310 328 7456
Fax: 310 328 7180

TECHNICAL SUPPORT

For information and technical support questions-
In the United States and Puerto Rico,
contact: usasupport@rodemic.com
or call 877 328 7456 toll free or 310 328 7456

RØDE
MICROPHONES

www.rodemic.com

Preamps in Paradise

Hutchinson agreed, saying, "I would say I spend 90% of my time designing things out." Also agreeing was Gualtieri, who added, "Sometimes these are very small factors that, if you're not the designer, you don't hear."

DESIGN AND RELIABILITY

Queried about the design process, Hill

revealed that when developing a product he generally spends "six months or more" listening before anyone else hears it. Hutchinson said he divides his time between listening and testing, then turns the product over to end users for their input. Gualtieri said the process for him doesn't include measuring with test gear until late in the process. As Archut said,

"What we're measuring is static . . . what we're hearing is dynamic."

Carpenter concurred, comparing sonic anomalies to "a fly in the bedroom," with testing sometimes providing the tools to "swat the fly."

Reliability testing is crucial, said Massenburg: "All these subtle things we're talking about mean little if it's unreliable."

MUSIC VERSUS TECHNOLOGY

"You can destroy the emotional content of a performance with a piece of gear," says Hill, who asked the semi-rhetorical question, "Are we making technology or are we making music?" Fearn related that he often asks students to name the most important part of the recording chain, and that they usually miss listing the artist. "The job of recording, is to do as little damage to that as you can."

TRANSFORMERS AND COMPONENTS

"Somehow," Dave Hill began the discussion on the use of transformers, "you have to get from the mic into the preamp, and somehow you have to get from the preamp to the outside world." Several of the designers on the panel eschew the use of transformers, while others readily employ transformers for interfacing.

Fearn related that designers taking a "systems" approach would integrate and spec a transformer as one part of achieving their design goals — as "one part of the

The Phantom Topic

An interesting side topic arose during the preamp conversations: phantom power. The 48v phantom power system for microphones was universally decried as insufficient for condenser mic circuits. Manley's Hutchinson said, "I think this is part of the draw of vintage microphones [which frequently have outboard power supplies]." He added that phantom power can cause problems, with sonic performance reduced by DC blocking capacitors or noise from dirty patch cables.

According to John Hall, with a transformer-coupled mic, having phantom power present when plugging and unplugging the mic can cause transformer core magnetization, which has the potential to degrade mic performance and ruin parts. Gualtieri called phantom power a factor of "convenience over absolute sound quality," ultimately a compromise.

Associate of Science & Bachelor of Science Degree Programs

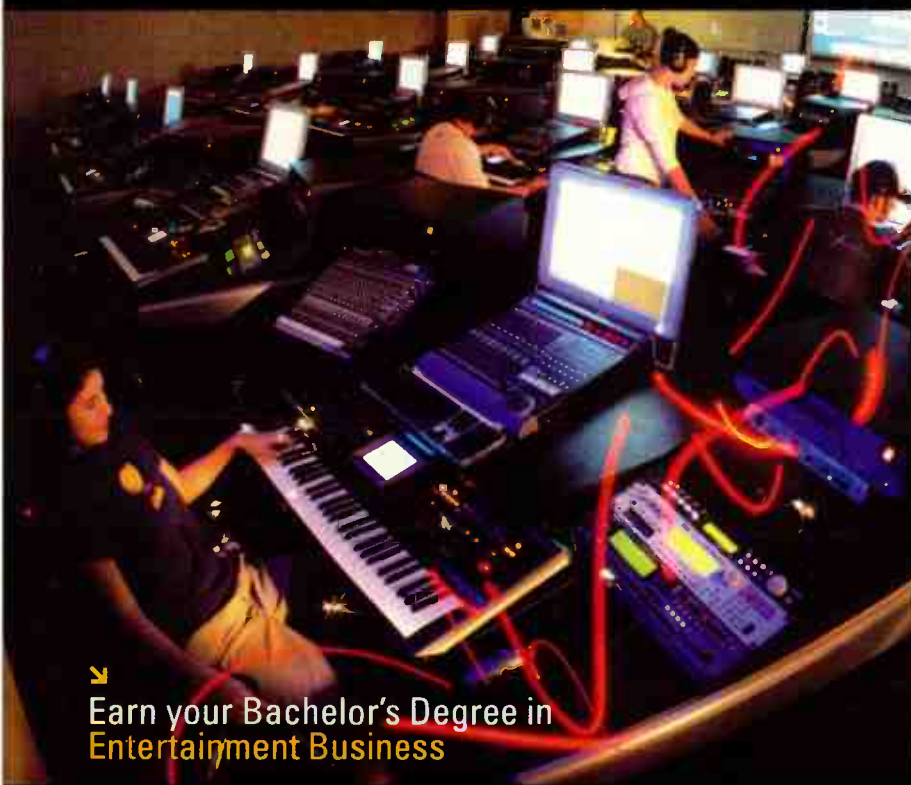

➤ Earn your Bachelor's Degree in Entertainment Business

FULL SAIL
Real World Education

800.226.7625
fullsail.com

*If you're serious about your dream,
we'll take your dream seriously.*

school of

Computer Animation

Digital Media

▶ Entertainment Business

Film

Game Design & Development

▶ Recording Arts

▶ Show Production & Touring

3300 University Boulevard • Winter Park, FL 32792

Financial aid available to those who qualify • Job placement assistance • Accredited College, ACCSCT

© 2004 Full Sail, Inc. All rights reserved. The terms "Full Sail," "If you're serious about your dream, we'll take your dream seriously," "Full Sail Real World Education," and the Full Sail logo are either registered service marks or service marks of Full Sail, Inc.

Look Into Your Future @

www.recordingcareer.com



Center for the Recording Arts

recordingcareer.com
818-763-7400

One of the Best-Equipped
Recording Engineer Schools on the Planet

Home

900-hour
Recording Engineer
Program

900-hour
Recording Engineer
Curriculum

Start Dates

Dorm Housing

Get a School Catalog

Newsletter

Subscribe to
our Newsletter

Location

Federal Student
Financial Aid

Scholarships

Job Placement

Job Leads

Internships

Graduate Awards

Contact Us



A great career starts with a great education. If you're interested in a professional career as a Recording Engineer, we invite you to learn more about our hands-on training facilities, our extensive equipment, our curriculum and our outstanding staff and faculty by visiting our new website at www.recordingcareer.com.

818-763-7400

5278 Lankershim Boulevard, North Hollywood, CA 91601

World Radio History

Preamps in Paradise

whole design." Oliver Archut outlined transformer considerations, saying that "the ideal transformer is colorless," but when size is reduced as a practical design consideration, coloration is added, making transformers a "compromise between various factors."

Whether employing transformers or not, building their products from dis-

crete components — tubes and transistors — as opposed to preamps using integrated circuits, was the methodology of choice for the assembled designers. "You can't build a great amplifier of any kind using IC circuits," said Hall, surmising the panel's consensus. "As much as you can, use class A," added Hutchinson, speaking of design topolo-

gies, though he qualifies that as being "tougher" to do in output stages.

Transformer-based mic preamps were often the choice of the recording engineer panelists, with credit given to the transformers for a good deal of the sonic character. "The ringing and overshoot you get from transformers," said Fletcher, "is often part of the event."

PARTS SUPPLIES

Economics of scale and size of the potential market for high-end outboard preamps were cited as keeping the prices for such products relatively high. An additional consideration is the availability of high-quality discrete components. "If you're building discrete preamps," said Massenburg, "every year you have a part that goes away." The vacuum tubes available today "are garbage" for studio use, according to Archut, adding that "there's a good possibility that good transistors will soon be priced like old tubes — NOS [New Old Stock] — are now."

Archut stated that transformers for modems are what is supporting today's transformer manufacturers, a business that might be threatened as communications technology changes. Through a discussion of winding their own transformers to the arcane art of tube manufacturing, the designers reveal that they have found ways to obtain the parts they need. "Today, it's not a big investment" said Archut, to buy certain component manufacturing hardware off eBay, as he did with transformer winding gear. Though he admitted that for some parts, the overhead of "making your own" might prove prohibitive.

THE FUTURE

Looking to the future, according to Daking, "There will always be a small market," at least, for high-performance microphone preamplifiers. "Pre-amps," predicted Hall, "will evolve in a direction of more accuracy," while he says the market will still have a place for preamps that add a particular color or sound.

Daking added that designers like himself are basically building a product "the way we want it, and if they [consumers] don't like it, that's okay." Hutchinson concurred, stating that designers are "competing against ourselves . . . as good as we are now, there's room for improvement." **ED**

1,000 CDs in full-color jackets for just \$990

Regularly \$1,290
— Save \$300!

NEW!
Uncoated
"matte" stock
now available
at no extra
charge! Call
for sample.

This is a complete package — not some stripped down version — with no hidden extra charges and no surprises. You'll get Disc Makers' high quality at the lowest price anywhere. We'll also help you sell more CDs with extras like a FREE bar code, a FREE Disc Makers *Ultimate Indie Resource CD*, FREE Disc Makers Digital Audio Distribution, FREE worldwide distribution with CD Baby, and a FREE review of your music by TAXI's A&R staff.

Call **1-800-468-9353** for
your FREE catalog and jacket sample.

DISC MAKERS®

/905 N. Route 130, Pennsauken, NJ 08110 • 1-800-468-9353 • www.discmakers.com/eq

- Amplifiers
- Cables
- Cassette Recorders
- CD Players/Recorders/Copiers
- Digital Recorders
- Headphones
- Lighting
- Microphones
- Mixers
- Signal Processors
- Speakers
- Sound System Packages
- Used Equipment



BOYNTON PRO AUDIO

8 0 0 - 7 7 2 - 8 9 1 6

High on a hill in the farmlands of New York State sits a trio of red barns that is Boynton Pro Audio. Hidden inside our humble exterior are the most advanced technologies from the biggest names in the audio business. We know every nuance of our systems, because we have more than 50 years of experience in sound equipment. Sometimes we get loud, but the cows don't seem to mind. **Before you buy, call Boynton. Now That's Sound Advice.**

Phone 607-263-5695 TOLL FREE 800-772-8916 FAX 607-263-2373 www.boyntonproaudio.com sales@boyntonproaudio.com



Build FEG — the Front End for Guitars

Low noise and proper impedance make your guitar sing

by Craig Anderton

Some people enjoy the synergetic interaction between a passive guitar pickup and an electronic load, while others prefer as clean and accurate a sound as possible. If you're of the latter persuasion, keep reading.

As detailed elsewhere in this issue, a passive guitar pickup should feed a reasonably high impedance for maximum signal transfer at all frequencies (1MΩ is typical, but you can go as low as 250kΩ or so without hearing any significant degradation). A preamp or other "front end," such as a direct box, can provide a suitable match between a guitar and line-level mixer output (and add a little gain, too). But you may be able to get equal or even better results, at a fraction of the cost, by building FEG. It may not have the bells and whistles of other devices, but you can't beat the sound quality-to-price ratio.

BUT FIRST, THE BAD NEWS

For best results, FEG and a 9v battery need to mount inside your guitar. You'll also need

"FEG may lack bells and whistles, but you can't beat the sound quality-to-price ratio."

to add an on-off switch. Ideally, FEG wants to insert between the pickup selector and volume control. However, there is a workaround for mounting FEG outside your guitar (described later), so internal mounting isn't absolutely necessary.

HOW IT WORKS

An 8-pin op amp is hooked up in a non-inverting amp configuration. The reason

for using a dual op amp is that many of them use the same pinout, so if you use an IC socket, you can "taste test" different op amps to determine if one sounds better to you. Also, some single ops require frequency compensation and some don't, which is a whole other can of worms. Besides, the creative among you might find uses for the other amp, such as providing an out-of-phase signal for driving a balanced line.

What makes FEG special is its unusual input structure. With conventional preamps, the input usually couples through a capacitor, which is discharged by a resistor. To avoid loading down a guitar's passive pickup, this resistance must be very high (greater than 250kΩ or so). However, this creates three problems:

- Resistors generate noise; higher-value ones generate more noise.
- A bipolar input stage wants to see a fairly low impedance to ground for minimum noise.
- The coupling capacitor can introduce phase shift.

This circuit takes advantage of the fact that the input signal's characteristics are known. It isn't necessary to add a capacitor, because the pickup doesn't generate any offset voltage. Therefore, we can get rid of the cap, and the high-value resistance too.

Furthermore, the pickup sees the op amp's "naked" input stage, which has fairly high impedance. So, there's no real pickup loading. A bipolar op amp like the NE5532 has a typical input resistance of around 300kΩ, which is fine for most purposes. If you want a higher impedance input, go for a FET-based input structure, such as the OPA2604 op amp (Burr-Brown, distributed through TI) although the tradeoff may be a bit more noise. Meanwhile, the pickup itself provides about a 5kΩ to 10kΩ resistance to ground

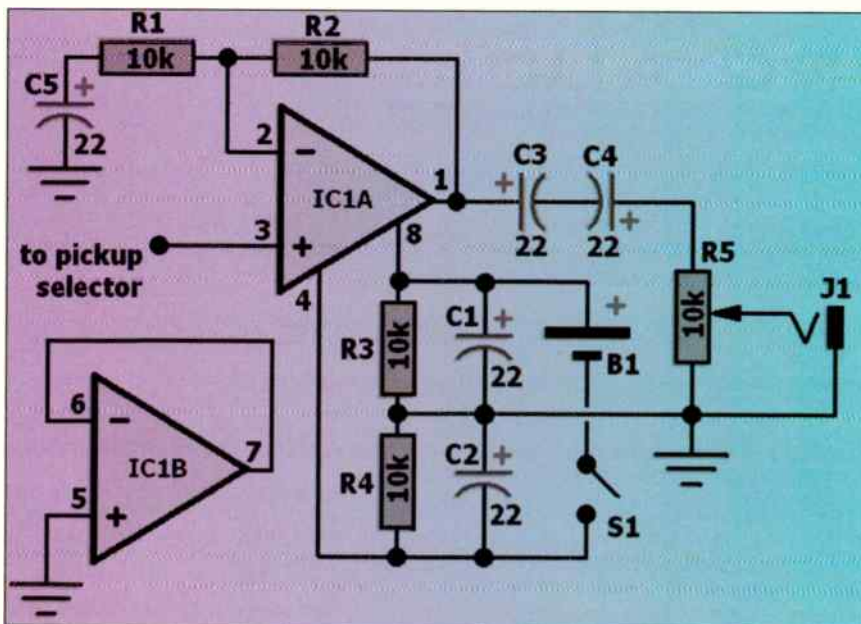



Feeling
Adventurous?



TD-1 customized
travel accessories include
travel bag and leather handle

Employing *RCAMP*[®], *Speaker Soak*[®], *Twin Topology*[®], Millennia's acclaimed HV-3 mic preamp, pliant DI, multi-impedance bridging, fully parametric NSEQ, three audio transformers, nine outputs, and military build quality.

"Adventure travel has been a big part of my life, having set foot on every continent, with the most recent being Antarctica..." says Gary Paczosa, Grammy winning engineer for Nickel Creek, Dixie Chicks, Alison Krauss, Dolly Parton...

Designed with "take me anywhere" versatility, TD-1 is geared for adventure. Finally, a no-compromise analog recording channel priced within reach of small studios and home recordists (\$1,495).

Hand-made in Northern California with features too numerous to list (and audio integrity too gorgeous to ignore), TD-1 is packed to explore uncharted sonic territory.



www.mil-media.com

Millennia
Music & Media Systems

530-647-0750

REAMP is a registered US trademark
used under license - U.S. Pat. no. 8,005,950

World Radio History

Front End for Guitars

for the op amp input — as luck would have it, the “sweet spot” for minimum noise with bipolar devices.

Although there are newer, hipper devices than the NE5532, it's cheap, made by multiple manufacturers (do a Google search to find who's selling it for what price), quiet, difficult to destroy, has a great slew rate, and can drive low

impedance lines. I also like the way it sounds with guitar.

NOTES AND MODS

Typically, a guitar's pickup selector switch output goes to the volume control (shown as R5 in the schematic). You want to insert FEG between these. But I strongly suggest you replace the stock volume control

with a 10kΩ or 5 kΩ type, as this will drive a line better.

The effect of your guitar's tone control may change. If it's connected at FEG's input, the effect may be more pronounced; lower the capacitor value if this is a problem. If it's strapped across the volume control, then it will have little effect — increase the capacitor value. It's impossible to give an exact value, so get an assortment of capacitors, some alligator clips, and experiment.

Here are some other mods:

- FEG provides a gain of two. For unity gain, short out R2. To add gain, increase R2's value (gain = $(R1+R2)/R1$).
- If you use two 9v batteries in series, you'll have a phenomenal headroom of $\pm 16v$ or so.
- Turn off the battery when not in use.
- C5 filters out subsonics. For even less low frequency response, lower its value.
- If switching pickups causes popping, add a 1M resistor from pin 3 to ground. This will not increase noise, as the pickup will be in parallel with it except during the actual switching.
- Test the circuit outside of the guitar before committing yourself to installing it. Disconnect the wire going from the pickup selector to the volume control, and hook it into the circuit for testing.
- If you don't want to build FEG inside your axe, you can make a belt pack. For best performance, mount the circuit and volume control inside a small box, and rewire your guitar so the pickup selector output goes directly to the guitar's output jack. Run as short a cable as possible from the guitar to the FEG box. You could also build FEG into a floor box, and patch its output to your amp or mixer.

PARTS LIST

- R1-R4** 10kΩ resistor, 5% metal film preferred
- R5** 10kΩ audio taper potentiometer
- C1-C5** 22μF electrolytic capacitor, 12V or higher
- IC1A** Dual op amp in 8-pin DIP package (e.g., NE5532)
- B1** 9v transistor radio battery
- J1** 1/4" phone jack (guitar output jack)
- S1** SPST miniature on-off switch
- Misc.** Circuit board, solder, wire, battery clip, IC socket, etc. **EQ**



Ricky Skaggs and the TRUE Precision8

“We had a fixed budget, but obviously had some high sonic requirements. We wanted to find mic pres that weren't outrageously expensive to buy or rent, but would deliver sonic integrity when putting it to tape. The TRUE mic pre sounded good on acoustic instruments and vocals and, being a one-rack space unit with eight channels, it ended up being one of the key pieces of gear in our project.”

— Lee Groitzsch, one of the recording engineers for five time Grammy nominee (and 2004 Grammy-winner) Ricky Skaggs, stays true to True Systems mic preamps (Lee is a Grammy nominee himself...)

Check it out for yourself and hear what a difference the TRUE Precision8 eight channel microphone preamp can make in your audio chain.



Everything you hear is TRUE

TRUE
systems

www.true-systems.com

Distributed by NeumannUSA • One Enterprise Drive • Old Lyme, CT 06371
Phone: 860-434-5220 • Fax: 860-434-3148 • Canada: Tel: 514-426-3013 • Fax: 514-426-3953
e-mail: info@neumannusa.com • www.neumannusa.com

A woman with long dark hair is singing into a Samson CL7 condenser microphone. The microphone is mounted on a silver boom stand with a black pop filter. The background is a dark, solid color.

It's a beautiful thing.

Introducing another musically empowering Samson condenser mic.

Never before has a studio mic this good been available at this price. Like the finest studio mics costing hundreds, even thousands of dollars, the CL7 has a true capacitor condenser mic element. Capacitor-based elements are warmer, brighter and bigger sounding than electret based elements. The CL7 also has a large (1.1") gold-sputtered Mylar diaphragm, another key to the richest vocal and acoustic tones. At just \$169*, Samson's CL7 brings legendary studio style condenser technology to everyone. Now that's beautiful.

SAMSON[®]
A U D I O

Mini Buyer's Guide: PREAMPS

Compiled by Tom Fulton & Greg Rule

Ready to get your front-end on? On the following pages are listings from some of the world's top manufacturers of standalone preamps.

A few important notes before diving in: Prices and specs are subject to change, so consult the manufacturers for up-to-the-minute info; you'll find phone numbers and URLs in the sidebar on page 50. If you don't see it here, refer back to our March 2004 "New Gear Nirvana" and December 2003 AES cover stories. Finally, be sure to peruse the product review section of this issue, where you'll find in-studio tests of the latest from SSL, Focusrite, Apogee, and more.

Happy shopping!

Alto AlphaMicTube, \$114

Alto's AlphaMicTube is an affordable mic preamp with gain, drive, phantom power, phase switch, and pad.

Aphex Systems Model 207, \$649

This 2-channel tube microphone preamp and instrument DI features MicLim, a mic level limiter for controlling the transient spikes that could ruin an otherwise perfect take. The instrument DI is quiet (over 90dB dynamic range). The MicLim provides distortion-free peak protection for the DI inputs.

Apogee Mini-Me, \$1,295

Mini-Me features two channels of Apogee A/D conversion at sample rates of up to 96k, two premium mic/instrument preamps and line level inputs, and Push-It, a unique new 3-curve stereo comp/limiter: ideal for location recording. Mini-Me is equipped with optional USB for a direct connection to your laptop with a direct/return monitor. I/O: AES/EBU, S/PDIF, and optional USB. (For info on Apogee's Mini-MP, see the product review section of this issue.)

ART Tube Preamp System, \$219

Tube mic preamplifier with V3 Variable Valve Voicing, OPL Output Protection Limiter, +20db, 48v phantom power, and phase reverse.

ART Tube MP OPL, \$114

Tube mic preamplifier with OPL Output Protection Limiter, +20db, 48v phantom power, and phase reverse.

ART Tube MP Studio (\$129) and MP Studio V3 (\$149)

Tube mic preamp with OPL Output Protection Limiter, analog VU metering, +20db, 48v phantom power, and phase reverse. V3: Tube microphone preamplifier with ART's V3 Variable Valve Voicing, OPL Output Protection Limiter, analog VU metering, +20db, 48v phantom power, and phase reverse.

ART Tube MP, \$99

Tube mic preamp that features +20db, 48v phantom power, phase reverse.

ART Digital MPA, \$749

Tube microphone preamplifier with variable input impedance, ADAT, Toslink and S/PDIF Output.

ART DPS - DIO Preamp System, \$319

Tube mic preamplifier with ART's V3 Variable Valve Voicing, OPL Output Protection Limiter, plus ADAT, Toslink, and S/PDIF output, +20db, 48v phantom power, and phase reverse.

Barbetta Channel One, \$2,399

The Channel One is a low noise mic preamp with phantom power, parametric EQ, bandpass filters, noise gate, full-feature compressor, and level, compression and clipping meters. It comes with an additional input stage for ultra-high impedance

instrument pickups. Its MosPath FET signal path contributes to the Channel One's clarity and warmth.

Behringer Tube UltraGain T1953, \$249.99

Features discrete input stages, input gain adjustment, phantom power, mic/line capability, switchable high-pass filter, and a phase inversion switch. Twin 12AX7 tubes and Behringer's Ultra-Tube circuitry allow you to add the precise amount of tube warmth without introducing noise or sacrificing audio quality. (Also available: the UltraGain Pro MIC2200, \$129.99, with integrated parametric EQs that give you extra sound-shaping power, while its built-in tube adds warmth and transparency to your signal.)

Behringer Ultra-Voice VX2000, \$159.99

The Ultra-Voice is a mic preamp, equalizer, compressor, expander/gate, de-esser and tube emulation in a single rack space unit. Designed for both direct-to-disk recording and demanding live situations.

Behringer Ultravoice Digital VX2496, \$200

The Ultravoice Digital VX2496 is a high-quality mic preamplifier/voice processor based on the VX2000. Features an AES/EBU output (digital output up to 24-bit/96kHz), including opto compressor, dynamic enhancer, expander, de-esser, and tube simulation.

Behringer Ultragain MIC100, \$50

The MIC100 is a tube mic/line preamp with integrated limiter for studio, live, and hard disk recording applications. It features a 12AX7 vacuum tube with UTC technology for warmth and low noise.

DACS MicAmp, \$2,250

A 2-channel, discrete-component-based microphone amplifier, the MicAmp offers a triple, low-noise, matched-pair transistor input stage. There are two mic inputs for each amplifier, one with 48v phantom power. Non-powered inputs bypass the high value polyester input capacitors necessary to block the 48vDC. Low frequency response for the phantom powered input is flat to below 20Hz, with subsonic rolloff at 6dB per octave. The high frequency response reaches its -3dB point around 48kHz.



Daking Mic-Pre IV, \$2,895

The Mic-Pre IV is the latest addition to Daking's range of pro recording studio products. Features include continuously variable gain control, a 20-segment LED level meter with +24db peak indicator, switchable mic/line or Hi-Z instrument, switchable +48v phantom power, switchable input phase and 20dB pad, and gold-bifurcated contacts on all relay switching. The Mic-Pre IV is housed in an all-stainless steel enclosure with an outboard DC power supply in a separate housing. It offers durability and immunity from noise and RF interference. The supplied universal power supply can operate at any voltage for use worldwide.

Daking MicPre/EQ, \$1,995

The Mic-Pre/EQ is a 1-channel mic pre and includes EQ with five stepped frequencies per band, continuously variable boost and cut (+16db), switchable +48v phantom power, and a 20dB pad on the mic input. It features discrete transistor circuitry, transformer-balanced inputs and outputs with Class A amplifiers, and steel construction for strength and noise immunity.

dbx 286A, \$300

The dbx 286A is a single channel studio quality mic preamp plus five dynamics processors. It offers an internal power supply, +48v phantom power, and a frequency controllable de-esser, as well as a premium preamp section and expanded metering 2-knob compression, spectral enhancer, and an expander/gate.

dbx Mini-Pre, \$150

Mini-Pre features roadworthy construction,

a12AX7 vacuum tube to add warmth and tone to any microphone signal, selectable 48v phantom power, and 20dB pad and phase-reverse switches.

dbx 386, \$600

Features dual premium vacuum tube preamp channels with front panel instrument input, noise-shaping algorithms, and selectable dithering and sample rates. Also offers digital outputs in AES/EBU and S/PDIF formats.

dbx 376, \$600

Offers a premium vacuum tube preamp with a 3-band parametric EQ, compressor, de-esser, a front panel instrument input, and selectable sample rates. Also offers digital outputs in AES/EBU and S/PDIF formats.

dbx 786, \$3,500

With its M8 mic preamp module, the dbx 786 boasts a pristine signal path with ultra high-drive transformer-coupled outputs, a dbx Type IV Conversion System digital output option, 20dB pad, phase invert, +48v phantom power and super-low Z input switch.



dbx ProVocal, \$449.95

This mic pre is combined with 24-bit effects/signal processing: mic modeling, EQ, gate, compressor and de-esser, as well as a 24-bit reverb. Additionally, the ProVocal features chorus and delay and 44.1/48kHz S/PDIF digital outs.

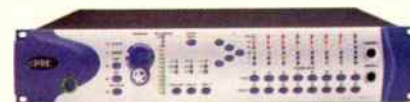

Digidesign PRE: \$2,495

Featuring eight discrete, matched-transistor, hybrid mic-preamp circuits, PRE offers a transparent signal path designed specifically for the Pro Tools|HD environment. PRE accepts nearly any input signal, easily accommodating mic, line, and direct instrument (DI) level inputs on all eight channels. Comprehensive remote-controllable operation via the Pro Tools software interface or Digidesign control surfaces allows you to place PRE anywhere in the studio and retain the ability to take

advantage of its entire feature set remotely. PRE also functions as a stand-alone device, making the same high-end sonic quality available for non-Pro Tools applications and all standard MIDI controllers.

Earthworks 1021 (1-channel \$1,200), 1022 (2-ch. \$2,000), 1024 (4-ch. \$3,500)

David Blackmer's Zero Distortion mic preamps feature stepped gain from 5-60dB in 5dB steps and variable gain control, 48v phantom power, polarity and standby switches, XLR balanced transformerless input, XLR balanced transformerless output and a 1/4" TRS output. The ZDT preamp boasts flat frequency response from 2Hz to 100kHz +/- 0.1dB, distortion of under 0.0001% and EIN of -140dBV @ 40dB of gain.



Focusrite Liquid Channel, \$3,495

The Liquid Channel is a revolutionary professional channel strip that's designed to replicate any classic mic-pre and compressor. Combining radical new analog preamp technology with Dynamic Convolution techniques, the Liquid Channel fuses cutting-edge analog design with ultra-fast SHARC DSP, and is augmented by fully digital controls and optional remote software.

Focusrite OctoPre, \$1,200

Providing eight discrete channels of Focusrite Class A mic pre and compression, OctoPre routes directly to any digital audio workstation via eight standard analog outputs, or via a choice of two optional 24-bit, 96kHz A/D converters. OctoPre offers the unique qualities associated with the Focusrite name at an affordable price, and features the same mic pres utilized elsewhere in the award-winning Focusrite Platinum range. Each channel features a compressor/limiter circuit, providing a warm-sounding compressor, which morphs into a brick wall limiter to avoid those critical overs, ensuring total control over all eight channels.

Focusrite ISA 428 Pre Pack, \$1,995

The ISA 428 Pre Pack is built to function as a multi-channel front end for any professional

Mini Buyer's Guide: PREAMPS

DAW. It features four classic Focusrite ISA transformer-based preamps with switchable impedance and direct instrument inputs, and an optional eight channel 192kHz ADC.

Focusrite Red 1 Quad Mic-Pre (\$2,795) and Red 8 Dual Mic-Pre (\$1,895)

The Focusrite Red Range products are designed for professional recording applications. The Red 1 features four matched preamp channels (using the same topology as Focusrite's ISA 215 preamps).



George Massenburg Labs GML 2032, \$3,500

GML's renowned transparency, reliability, musicality, and precision are now available at a more affordable price. The all-new GML 2032 mic preamplifier and parametric equalizer boasts discrete class A design in a single rack space unit, and provides an elegant front-end solution for recording engineers. For the first time in GML history, the 2032 features an ultra-low-noise internal AC power supply.

George Massenburg Labs 8302, \$2,100

This all-discrete-transistor, transformerless unit is regarded for its accuracy and transparency, high headroom, and low noise. Affordably priced, the model 8302 is hand built and calibrated in limited production quantities using select components. Includes switchable phantom powering, fits into a 1U, 19" rack space, and requires the external GML 8355 power supply.

George Massenburg Labs 8304, \$2,900

The 4-channel version of the 8302, the model 8304 is also hand built and calibrated in limited production quantities using select components. Like the 8302, it also includes switchable phantom powering, fits into a 1U, 19" rack space, and requires the external GML 8355 power supply.

George Massenburg Labs 2020, \$6,600

This flagship product wraps George Massenburg's mixing and gear mastery into a single-channel mic/line/instrument input with GML EQ and GML Dynamics control. Like all GML equipment, it's constructed of all discrete-transistor, balanced/symmetrical Class-A components, and delivers wide-bandwidth, low-noise, extended dynamic range, and extremely high slew-rate audio.

Joemeek MicroMeek MQ3, \$299

The MQ3 1/2-rack mic pre features an optical compressor, Meekqualizer 3-band EQ with phase leveling, a TRS mix in for adding a second sound source, LED input and overload indicators, phantom power, and balanced outs.



Langevin Dual Mono Mic Pre w/EQ, \$1,475

An all-discrete mic preamp/EQ combo based on the AM4 design.

Langevin Dual Vocal Combo, \$2,000

The Dual Vocal Combo is an all-discrete stereo mic preamp/EQ/LA-3A-type ELOP limiter combo.



Manley Dual-Mono Mic Pre, \$2,400

A 2-channel tube microphone preamplifier with phase reverse, phantom power, and direct inputs. Gain switches vary the feedback amount, allowing for different tonal changes. Transformer coupled balanced outputs as well as direct unbalanced outputs are provided.

Manley Mic/EQ 500, \$2,900

A mono tube mic preamplifier with built-in passive EQ. Phase reverse, phantom power, and insert point switches are provided, as well as input and output level controls. 2-band peak and shelving ± 10 dB passive "EQ500 design." Transformer coupled balanced topology throughout.

Manley Micpre, \$1,600

A mono tube microphone preamplifier with phase reverse, phantom power, and direct input. Gain switch varies the feedback,

allowing for tonal changes. Transformer coupled balanced output as well as direct unbalanced output are provided.

Manley VOXBOX, \$4,000

An all-tube mic pre, compressor, EQ, and de-esser/limiter combo unit.

M-Audio Audio Buddy, \$119.95

Audio Buddy is a 2-channel mic pre/direct box with phantom power. Each channel has independent gain controls, an XLR balanced input, a 1/4" unbalanced high impedance input ideal for electric guitars, signal and clip LEDs, and 1/4" balanced TRS/TS outputs.

M-Audio DMP3 / Model 1B-FET Bundle, \$649.95

An affordable, pro-quality mic and preamp bundle combining Groove Tubes' Model 1B and M-Audio's DMP3 mic pre.

M-Audio Octane, \$749.95

Brand spankin' new from M-Audio is Octane — a pro 8-channel microphone preamp with ADAT lightpipe output. This 2U rack delivers 24-bit resolution throughout the signal chain, outstanding signal-to-noise ratio, and a dynamic range that's difficult to achieve on multi-channel devices — 133dB for instrument inputs and 120dB for microphone inputs. Frequency response is 20Hz to 20kHz for all inputs (± 0.11 dB at mid gain for mic inputs, ± 0.03 dB at mid gain for instrument inputs).



M-Audio TAMPA, \$800

TAMPA is a single-channel mic pre that uses harmonic time alignment to provide tube-like warmth across the entire frequency spectrum. It features an onboard optical compressor, VU meters for gain and compression levels, variable input impedance for use with any mic, phantom power, Neutrik XLR/ 1/4" balanced input, AES/EBU and coaxial out for up to 96kHz digital conversion, and balanced 1/4" analog outputs.



Metric Halo 2882 (\$1,495) & 2882+DSP (\$2,195)

Four!



INTRODUCING THE NEXT GENERATION OF THE WORLDWIDE STANDARD IN PROFESSIONAL PITCH CORRECTION

Since its introduction in 1997, Auto-Tune has stood alone as the overwhelming tool of choice for professional pitch correction. Featuring transparent processing, superb audio quality, and an easy-to-use interface, Auto-Tune is used daily in thousands of commercial, project, and home studios around the world to save editing time, ease the frustration of endless retakes, save that otherwise once-in-a-lifetime performance, or create unique special effects.

Now, with Auto-Tune 4, we've added a host of new features that are designed to provide powerful new capabilities, while at the same time actually streamlining operation.

KEY NEW AUTO-TUNE 4 FEATURES INCLUDE:

- >> 192kHz compatibility (host and hardware dependent)
- >> The ability to specify target note behaviors in individual octaves
- >> Virtual keyboard for realtime pitch display and target note control
- >> Improved Targeting option for problem vibratos
- >> Enhanced Vibrato functions for more realistic (or wacky) vibratos
- >> A Hold function to help analyze pitch errors in Auto Mode
- >> Larger Graphical Mode Pitch Editing Display
- >> Seriously expanded and reworked Graphical Editing Tools
- >> Multi-level Undo/Redo (up to 20 levels)
- >> Vibrato Scaling for modifying the depth of vibrato while maintaining its shape and character
- >> Streamlined Graphical Mode navigation controls
- >> Selectable Edit Display color schemes
- >> And lots more...

Auto-Tune 4 will be available in a veritable plethora of formats for Mac and PC. Upgrades are available for registered Auto-Tune owners.* Check it out at your local Antares dealer or come to our website for more details and a fully functional 10 day trial version.

*If you purchase any version of Auto-tune 3 after December 1, 2003, you will be entitled to a free upgrade to Auto-Tune 4. See our web site for details.

**ANTARES**

WHERE THE FUTURE'S
STILL WHAT IT USED TO BE

DR. STURGEON SAYS:
"SOMETIMES MORE IS MORE."



4.0

ANTARES AUDIO TECHNOLOGIES 231 Technology Circle, Scotts Valley, CA 95066 USA
voice: 831 461 7800 | info@antarestech.com | www.antarestech.com

World Radio History

Mini Buyer's Guide: PREAMPS

The 2882+DSP is a versatile 8-channel mic pre/AD/DA FireWire box. It has eight analog inputs switchable to mic, line, or instrument level; eight digital ADAT format inputs and outputs; two channels of S/PDIF or AES/EBU input and output; eight analog outs switchable to pro or consumer levels; and a headphone jack with a mute/dim switch on the box. Add the +DSP for on-the-metal signal processing, including channel strips, compression, limiting, M/S processing, and EQ without taxing your computer's native processors.

Metric Halo ULN2 (\$1,195) & ULN2+DSP (\$1,895)

Besides its AD/DA FireWire functionality, the ULN2 provides two high-quality mic preamps with inserts, phantom power, volume and trim controls, as well as a headphone amp and AES/EBU and S/PDIF connections. The ULN-2 also features balanced analog inserts for each input.

Millennia HV-3B, \$1,995

With two channels of Millennia's acclaimed HV-3 microphone preamp, the HV-3 is a mainstay of classical music and critical acoustic music recording. The HV-3 is a discrete-hybrid design of exacting quality designed with vintage grade components and roadworthy electro-mechanics. With +32dB output headroom and +23dB unpadding input headroom, the HV-3 will not overload or clip under any condition. (High voltage input option \$200/ch.)



Millennia HV-3D, \$4,195 (4-channel build \$3,095)

Eight channels of Millennia's HV-3 microphone preamp in a new, lower cost-per-channel 2U chassis.

Millennia M-2B, \$3,495

A 2-channel, high voltage, transformerless, Class A-biased, all vacuum tube stereo microphone preamp. The M-2B circuits employ differential topologies, ultra-high headroom, transformerless coupling, high-voltage rails, hand-selected mil-spec components, and more.

Millennia Origin STT-1, \$2,995

The Origin STT-1 is a single-channel music recording system that offers a selection of Millennia's core vacuum tube-or-solid state circuits at every function, including transformer or transformerless mic preamps, line input with gain, opto-compressor/limiters, parametric equalizers, DI instrument input with gain, and opto-de-essers. With 134 different product combinations in one 2U rack chassis, and the associated range of sonic possibilities, the STT-1 vastly expands the sonic palette.

Millennia TD-1, \$1,495

This twin topology, half-rack recording channel features selectable vacuum tube or all discrete solid-state DI amplifiers, multiple input impedances from 470K to 10M, dual Reamp outputs carefully modeled after vintage Les Paul and Strat pickups, Speaker Soak input, line input with 20dB switchable pad, HV-3 microphone preamp with 65dB gain, and more.



Mindprint En-Voice II, \$749

This rev-2 rack features a tube preamp and compressor with adjustable saturation in a 1U chassis. It provides a mic input with 48v phantom power, instrument input, line input, balanced insert, low-cut 80Hz switchable filter, and a 3-band parametric EQ.

Mindprint DTC, \$1,999

Meet the Mindprint monster. DTC provides two channels of boutique-quality microphone preamplification. Features include 24/96 converters, 4-band parametric EQ, tube compressor/limiter, dynamic range of >113dB(a), S/PDIF coaxial and optical I/O, AES/EBU I/O, and more.

Nady TMP Series, \$135-\$260

Three 1U rack size units: the TMP-1 (\$135) mono tube mic preamp, the TMP-2 (\$200) stereo tube mic preamp, and the TMP-3 (\$260) single-channel tube channel strip with mic preamp, EQ and compressor. All three units feature 12AX7 tubes and analog meters.

Nady PRA-8, \$135

An 8-channel mic preamp in a 1U rack housing.

Peavey TMP-1, \$290

This single-channel mic pre features tube design (through signal path), transformer balanced XLR inputs, unbalanced 1/4" inputs, transformer-balanced XLR output, unbalanced 1/4" outputs, and a switchable, 40Hz highpass filter in a 1U rack design.

Pendulum Audio MDP-1, \$2,495

The MDP-1 is a 2-channel, all-tube mic/DI preamp with transformerless outputs. It features high voltage Class A circuitry capable of delivering +35dB.



Pendulum Audio Quartet, \$3,295

The Quartet is an all-purpose recording tool comprising four elements: a tube mic/DI preamp, a tube opto-compressor, an opto-inductive de-esser, and a 3-band tube EQ. It features an all-tube signal path, transformerless or transformer-balanced outputs, and the ability to patch out the elements separately.

[Update! the Quartet II Mercenary Edition (pictured above) is now available for \$5,000. See the Pendulum Audio website for details.]

Phonic Micro 1, \$109.99

The Phonic Micro I is a low-noise preamp that offers four balanced 1/4" inputs for mics, each with its own level control with global phantom power supply. An additional unbalanced Aux input provides audio or line source such as a CD player or karaoke machine. A 7-segment LED level meter offers instant master level output monitoring from -20dB to 6dB. All this packed into a 1/3 rack chassis.

PreSonus Acousti-Q and DigiTube, \$300 each

The Acousti-Q Tube 1/2U acoustic instrument preamp/EQ/blender features two tube preamps for both pickups and condenser mic inputs. An internal mixer allows the signals to be blended. Other features include EQ with a tunable notch filter, brilliance and bass controls, sweepable midrange control, external footswitch control, and a stereo effects loop. The DigiTube mic pre offers a single-channel tube preamp, EQ, and 24-bit digital output. ▶

PLATINUM FUNKMASTER



Masters of Funk, Vol I: Bootsy Collins

You'll find Focusrite's award-winning Platinum range in the studios of thousands of musicians around the world, but few squeeze more groove from their gear than the Godfather of Funk, Bootsy Collins. Legendary performer and bassist with everyone from James Brown to Snoop Dogg, Bootsy has gone Platinum since the dawn of funk, and each new Focusrite model has been eagerly embraced into the beezilla rack. He won't funk without them.

The Platinum range offers all the classic Focusrite circuits in a series of individual tools that are not only professional sounding, but affordable as well. Visit your local Focusrite dealer and find out how the versatility of the Platinum range can enhance your DAW, and fulfill your live setup or personal recording needs. Or, as Bootsy says: "Dope-a-delicious size your Gig, with the whole Platinum series 'Future Funkateer' rig." We couldn't agree more.



BOOT UP!

d digidesign

North American Distributor: www.digidesign.com

PAMA

ff
Focusrite

Mini Buyer's Guide: PREAMPS

PreSonus DigiMAX LT, \$1,000

The DigiMAX LT is an 8-channel mic preamp with 24-bit ADAT lightpipe output. Each channel features a dual servo mic pre-amp with mic/line level inputs, 20dB pad, and 48v phantom power. Each channel also has a TRS insert point for patching in outboard gear before the A/D converter. Digital synchronization is achieved by offering word clock in/out via BNC connectors. The sample rate can be set on the front panel to 48kHz, 44.1kHz, and 32kHz.



PreSonus Eureka, \$699

A combination mono preamp/compressor/parametric EQ, Eureka features Class A electronics, line and mic input, variable impedance, tube saturation emulation, and more in a single rack chassis.

PreSonus M80, \$2,300

The M80 is an 8-channel microphone/instrument preamp featuring low noise, balanced input transformers, low impedance mix bus, and vintage warmth control. Designed with a low-impedance stereo mix bus for assigning and panning any channel to the main stereo output connectors. It also has a high gain headphone output for monitoring the main bus. Each channel features 48V phantom power, phase reverse, -20dB pad, and 80Hz roll-off.

PreSonus MP20, \$700

Features 2 channels of Class A mic preamplification with a dual servo, transformer-coupled input stage. Each channel offers 48V phantom power, phase reverse, -20 dB pad, and 80Hz rolloff. The MP20 also has a low impedance stereo mix bus with headphone monitoring. Each channel includes balanced send/return jacks for patching in outboard gear.

PreSonus VXP, \$800

The VXP is built with the same design parameters as the MP20 and M80 preamplifiers. The VXP provides a Class A/transformer-coupled mic pre, compressor, expander, de-esser, semi-parametric EQ, and peak limiter all in one rack. An optional 24-bit digital output card is also available.

Rane DMS 22, \$549

Designed for studio recording in direct-to-tape or hard disk applications, the



DMS 22 is a dual channel studio-grade microphone stage with EQ and a stereo mixer.

Rane VP 12, \$599

The VP 12 is a mic and line-level voice processor incorporating a studio-grade microphone stage, low and hi cut filters, de-esser, gate/compressor, and two channels of parametric equalization.



Roland MMP-2, \$695

The MMP-2 is a 2-channel mic preamp with 24-bit/96kHz A/D converters. Features include COSM mic modeling, 4 bands of fully parametric EQ, modeled tube compression, an enhancer and de-esser, plus control software for your Mac or PC. Analog I/O includes two XLR Mic inputs and two XLR Line outputs, plus coaxial digital I/O and AES/EBU digital output. Its USB port allows computer control.

Samson C-Valve Tube Pre-amp, \$160

The C-Valve features variable gain and variable tube process saturation for adding harmonics, a large analog VU output meter, a 6-segment LED, 48v phantom power, phase and peak limiter, and digital output. Use its insert points along with a C-Class compressor for a direct path.

SM Pro Audio PR4, \$99

The PR4 is a 4-channel 1/2-rack size mic pre. Features include independent gain controls, high-quality JRC4558 op amps, XLR I/O, and phantom power.

SM Pro Audio PR8 \$199

Each of the eight channels in this rack-mount mic preamp has its own gain control, peak light indicator, phantom on/off, and phantom light indicator. Included are eight balanced XLR inputs and eight TRS balanced/unbalanced outputs at +4dB.

SM Pro Audio PR8 MKII, \$399

The 2U rack-mount version of the PR8, with ADAT output, eight -10dB 1/4" line outs. The ADAT lightpipe output option is \$199.



Solid State Logic X Logic Super Analogue Channel

(See product review section of this issue)

Sonifex RB-MA1, \$300

The RB-MA1 is a mic preamplifier with all controls and connections on the rear panel. The input is an XLR-3 type, and is electronically balanced. The input gain for each input can be adjusted individually by a recessed preset potentiometer.

Sonifex RB-DMA2, \$915

The RB-DMA2 is built around two independent low-noise microphone preamps for converting microphone level signals to a digital AES/EBU or S/PDIF output. The mic inputs are XLR-3 type and are electronically balanced. The input gain for each input can be adjusted individually by a volume control on the front panel, and each has an LED indicator.



Summit Audio 2BA-221, \$695

A powerful new microphone preamp with a host of features and I/O, the 2BA-221 is both a vacuum tube and solid-state preamp that features variable microphone input impedance. The 2BA-221 also has an array of inputs and outputs, all available simultaneously, including mic, line, Hi-Z, and stacking in, +4dB and -10dB tube outs, stacking (solid state) out, plus an insert jack before the tube stage. Other features include a swept highpass filter, a polarity switch, an internal power supply, and a stackable design for linking multiple units.

Summit Audio MPC-100A, \$2,290

A high-quality single channel processor designed for direct-to-digital mic, line, or instrument recording. It includes a vacuum tube mic and instrument preamp stage



followed by a fast-attack compressor/limiter. The preamp stage includes -15 and -25dB pads, Hi-Z input impedance control, a clip indicator, polarity switching, and a stepped attenuator control. The compressor/limiter section has continuously variable threshold and slope controls, with 3-position switches for attack and release times, compressor make-up gain, and a final output level control.

Summit Audio MPE-200, \$5,000

A 2-channel, digitally controlled, analog 4-band parametric EQ and mic preamp designed by the legendary Mr. Rupert Neve. It features a classic high-quality discrete Class A transistor and transformer-coupled design, which gives minimal distortion. Coarse and fine gain controls for each

section allow greater control of all parameters, and onboard memory allows 25 setups to be stored and instantly recalled.

Summit Audio TPA-200B, \$2,790

The TPA-200B is a variable input/output, 2-channel mic preamp that offers a wide range of sounds, from clean to full-tube overdrive. A hybrid vacuum tube in/solid-state out design gives this preamp the best of both worlds. The TPA-200B also features balanced mic, line, and high-impedance inputs to accommodate a wide range of input sources.



TC Electronic Gold Channel, \$2,495

The Gold Channel is both a digitally enhanced mic preamplifier and a signal refinement toolbox. Following the gain stage, the signal is converted from analog to digital. The Gold Channel provides two

channels that can be linked for stereo operation, along with a range of DSP tools such as compression/expansion, EQ, de-essing, and TC's dynamic equalization.

TL Audio 5001, \$749

The Ivory 2 Series 5001 preamp offers four tube mic preamps in a 2U package with discrete mic preamp stages, 30dB pad, instrument DI inputs, comprehensive metering, and optional 24-bit digital output. Each channel employs one half of an ECC83/12AX7A Sovtek dual triode tube, run from a stabilized 150V DC supply. The tube stage is positioned just after the initial mic preamp stage.

TL Audio 5050, \$469

The 5050 is a valve front end that combines a mic/line/instrument preamp and mono compressor, making it a cost-effective way of processing audio sources. The 5050 features include a 30dB pad, hard/soft knee compression modes, a balanced line output, and an optional digital

GRACE

d e s i g n
HIGH FIDELITY

Built to a higher standard

Welcome to the inside of our model 801 microphone preamplifier. While few manufacturers would freely advertise the inner workings of their products, we are proud to show them off.

At Grace Design, we are seriously *passionate* about what we do. The near obsessive approach we take with our circuit designs, component selection, and manufacturing process is the means to one end- delivering the finest high fidelity audio products money can buy.

From our eye-popping model 101 single channel mic preamp, to our flagship model 801R remote controlled mic preamp system, or our new m904 and m906 reference monitoring systems, we build products to help you realize your highest level of excellence.

We invite you to contact your friendly Grace Design dealer for more information or to schedule a product demo. Once you do, you'll discover why our products are truly built to a higher standard.

|||

◎

Thanks to all of our friends for helping us celebrate ten years of audio excellence

For complete product information, please visit us at www.gracedesign.com or call 303.443.7454

Mini Buyer's Guide: PREAMPS



output. The 5050 has two valve stages: one in the preamp circuit, and one in the gain control element of the compressor. These Sovtek valve stages are run from a stabilized 150V DC power supply.

TL Audio 5051, \$749

The 5051 combines a preamp, compressor, equalizer, and noise gate in one package. The compressor section is identical to the TL Audio 5021, and includes hard/soft knee modes. The 4-band equalizer section is based on the EQ-1. The 5051 features six tube stages, supplied by three twin triode ECC83/12AX7A tubes running from a stabilized 150V DC power supply. One valve stage is located in the preamp, one in the compressor gain control circuit, and four in the EQ section.

TL Audio PA-1, \$1,199

The PA-1 Pentode Preamp features MIL spec ECC83/12AX7A valves, gold-plated ceramic valve bases, and circular back-lit VU meters that monitor output level. The preamp design features a transformer-coupled mic input followed by a low-noise, high-gain EF86 pentode valve. Two further triode valve stages (supplied by 250V DC) are incorporated in each channel. The instrument input bypasses the transformer, and feeds straight into the pentode valve. TL Audio's usual high drive solid-state output stage completes the signal chain.

TL Audio VP-1, \$2,399

The VP-1 combines all the best elements of TL Audio's PA-1 pentode preamp, C-1 compressor, and EQ-2 parametric equalizer to create a flexible valve front end. The VP-1 features seven valve stages, run from a stabilized 250V DC supply. The first stage is a Siemens EF86 pentode in the front end of the preamp, followed by

six Sovtek ECC83/12AX7A stages — one in the secondary stage of the preamp, one in the compressor and four in the EQ section.

True Systems P2 Analog, \$1,750

The P2 Analog offers two mic preamp channels, individual phantom power selection, and balanced input and output connectors. Comprehensive filtering allows for adaptability to a variety of inputs and audio environments. Front panel DI inputs, MS decoding, and a stereo phase correlation meter are standard.

True Systems Precision 8, \$2,850

The Precision 8 offers eight channels of mic preamplification in a single rack space. Individual channel metering, selectable peak level indication, individual phantom power selection, and balanced input and output connectors make this a flexible and comprehensive unit. Built in DI inputs on channels 7 and 8 and MS decoding on channels 1 and 2 provide



Toft Audio Designs

The Legend Continues...
BY MALCOLM TOFT / INNOVATIVE DESIGN



INTRODUCING
ATC-2 TWO CHANNEL MIC PRE / COMPRESSOR / EQUALIZER
AFC-2 DUAL CHANNEL EQ / MIC PRE

Malcolm

PMI Audio Group Tel: 877 563 6335 • fax: 310 373 4714 toftaudiodesigns.com Toft Audio Designs® is a Registered Trademark of PMI Audio Group. ©2003 PMI Audio Group. All Rights Reserved

SPANKIN' NEW BEATZ

ROYALTY FREE

Sound Samples



\$29 VOL

STREET DRUMZ
"REP'IN" THE STREETZ

REASON MEDIUM REFILL

.WAV & .AIFF FILES

\$69 VOL

STREET DRUMZ
MPC PRODUCTION KITZ

MPC 2000 XL
VOL. 1

ZIP

\$99 VOL

MORE THAN STYX
TODD SUCHERMAN

AUDIO

1000 ROCK & POP DRUM LOOPS

ROYALTY FREE

2

\$39 VOL

STREET DRUMZ
MPC PRODUCTION KITZ

MPC 2000

12 VOLUMES

FLOPPIES

MORE THAN STYX
TODD SUCHERMAN

1000 ROCK & POP DRUM LOOPS

REASON REFILL

2
CD-ROMS

SAMPLE CD STORE
ROYALTY FREE

\$99.00

MAADD JOINTZ
HIP-HOP & R-B LOOPS

Audio

900 LOOPS

ROYALTY FREE

4
CD SET

\$99.00

AMBIENT DRUM
LOOPS & KITS

1600 DRUM LOOPS
1640 PERCUSSION SAMPLES

.WAV FILE FORMAT

ROYALTY FREE

2
CD-ROM

\$99.00

Electronica DRUM
LOOPS & KITS

1600 DRUM LOOPS
1640 PERCUSSION SAMPLES

.WAV FILE FORMAT

ROYALTY FREE

2
CD-ROM

\$99.00

Great British Beats

2 GIGABYTES

.WAV FILE FORMAT

COMPATIBLE FORMATS

ROYALTY FREE

3
CD-ROMS

"MORE THAN STYX" TODD SUCHERMAN

Features the playing of amazing grooves by an amazing drummer.

"These loops are indeed plug 'n play, and the production is both meticulous and grand."

--Craig Anderton
EQ Magazine

\$99.00



Visually experience the most exciting collection of sound samples...visit!!!

www.samplecdstore.com

866-815-2424 • 234 WEST 30TH ST • NEW YORK, NY-10001

Mini Buyer's Guide: PREAMPS

a set of features not found on most other units.

Universal Audio 2-610, \$2,295

Designed by Bill Putnam, the Universal Audio 610 was among the first modular recording consoles. The UA 610 was particularly well noted for its preamplifier, and has left its mark on countless classic recordings. Unlike many vintage-style mic pre's, the 2-610 is true to the design of its predecessor. UA has taken great care to preserve the quality and character of the original, while adding functionality with more boost/cut settings, phantom power, direct inputs, and impedance controls.



Universal Audio 6176, \$2,495

Universal Audio combines their 610 tube mic preamp with their 1176LN compressor to create the award-winning 6176 Channel Strip. The 6176 mic preamp section maintains the quality and character of the 2-610, while adding high-tension power regulation for improved bass response and a front-panel 15db pad switch. UA has recreated the 1176LN for the compressor section of the 6176 with the same attention to detail and design.

Universal Audio 2108, \$1,695

The Universal Audio 2108 is a 2-channel discrete, Class A solid-state microphone preamplifier based on the legendary Universal Audio 1108. The 1108 was a widely used single-stage modular preamplifier designed by Bill Putnam. Its characteristic design later became the basis of the 1176LN Limiting Amplifier. The 1176LN and 2108 share identical output amplifier circuits and components, including the custom transformer, which is a critical element to the trademark sound. Universal Audio's analog design specialists added a multi-impedance J-FET input stage, which allows for a harmonic enriched soft saturation of the input signal if desired.

Universal Audio M610, \$1,295

The Universal Audio M610 is mono version of the 2-610, with a simplified EQ section. Other than that, the sound and features are identical to the 2-610. It has the same high

frequency response and deep low end that has graced countless recordings. **EQ**

MANUFACTURER CONTACT LIST

Aphex

818-767-2929
www.aphex.com

Apogee

310-915-1000
www.apogeedigital.com

ART

585-436-2720
www.artproaudio.com

Barbetta

805-529-3607
www.barbetta.com

Behringer

425-672-0816
www.behringer.com

DACS

+44 (0)191 438 2500
www.dacs-audio.com

Daking

(dist. by TransAmerica Audio Group)
www.transaudiogroup.com

dbx

801-566-8800
www.dbxpro.com

Earthworks

603-654-6427
www.earthwks.com

Focusrite

(dist. by Digidesign)
650-731-6284
www.focusrite.com

GML

(dist. by TransAmerica Audio Group)
www.transaudiogroup.com

Joemeek

877-563-6335
www.joemeek.com ▶

www.mogamicable.com



In the Professional world there can be no compromise. That's why the cable of choice is Mogami. We don't use a bunch of Consumer Marketing hype to try and justify why our cable is better. Just ask any recording engineer or studio owner and you'll find out why it is simply the finest, most neutral sounding cable available, at any price. At one time if you wanted a Mogami Cable it was only available in bulk through Professional Channels. Finally, "The Gold Series" by Mogami, packaged and configured for Live Performance or Project Recording. No magic, no hype, just the best at a price Mogami. "The cable of the Pros"

**NOW Available at a
Guitar Center near you!**

MOGAMI

The Cable of the Pros

Toll Free: 800-800-6608

Completely Amazing

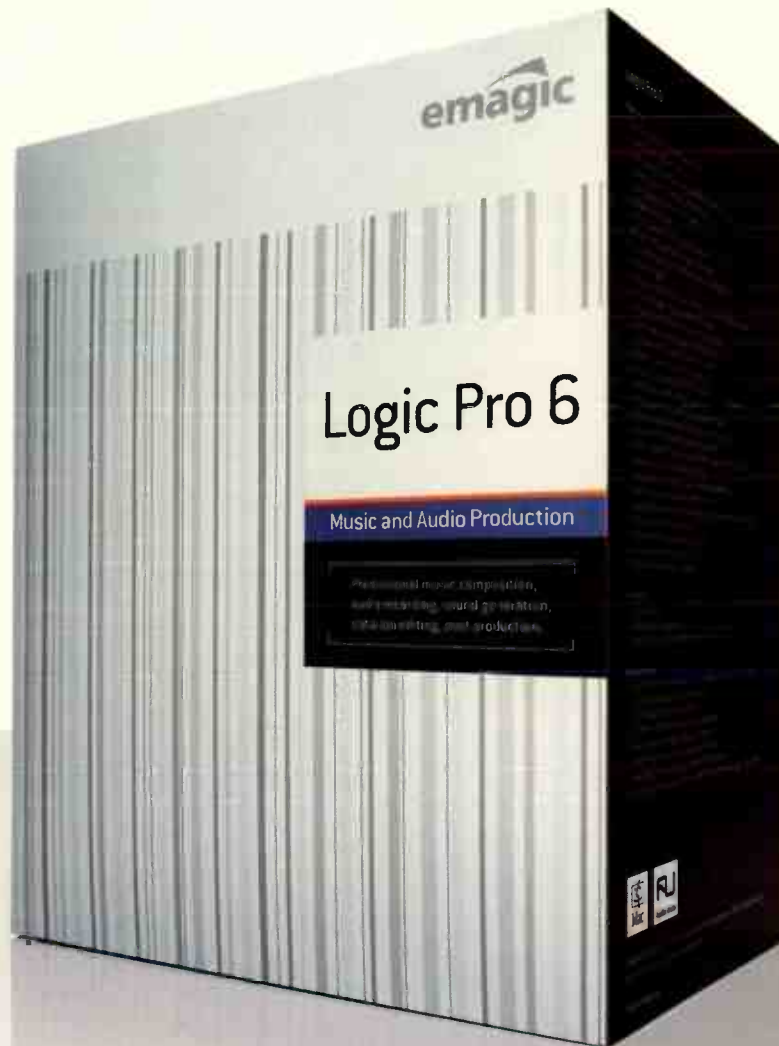

Introducing the new Logic Pro 6, the most flexible, most advanced and best equipped music production software for the Mac. At an impressively low price you get all the highly praised professional software instruments and plug-ins from Emagic. Also included is the renowned EXS24 mkII software sampler. Plus you'll get incredibly realistic sounding vintage instruments such as the EVP88 electric piano, EVB3 organ and EVD6 clavinet, and a range of software synthesizers that provide amazing options for creative sound design. Even the new convolution reverb – Space Designer – is included. While Logic Pro 6 includes an outstanding array of impressive capabilities and options, if you're just looking to get started, check out Logic Express 6, an even lower cost way to experience the key benefits of Logic. Either choice will be music to your ears.

Total Sound Control

Auralex
ACOUSTICS

www.auralex.com

Since 1977, thousands of satisfied Auralex® Acoustics customers have experienced improved acoustics, solid advice and exceptional customer service.

Visit
www.auralex.com
to learn why.

**YOUR STUDIO
YOUR SOUND
YOUR CHOICE**

Auralex®, Studiofoam® and LENRD® are registered trademarks of Auralex Acoustics, Inc.

Mini Buyer's Guide: PREAMPS

Langevin

(see Manley Labs)

Manley Labs

909-627-4256

www.manleylabs.com

M-Audio

626-445-2842

www.m-audio.com

Metric Halo

(dist. by TransAmerica Audio Group)

www.transaudiogroup.com

Millennia Media, Inc.

530-647-0750

www.mil-media.com

Nady

510-652-2411

www.nady.com

Peavey

601-483-5365

www.peavey.com

Pendulum Audio

908-665-9333

www.pendulumaudio.com

Phonic

813-890-8872

www.phonic.com

PreSonus

225-216-7887

www.presonus.com

Rane

425-355-6000

www.rane.com

Roland

323-890-3700

www.rolandus.com

Samson

516-364-2244

www.samsonetech.com

SM Pro Audio

514-633-8877

www.smproaudio.com

Sonifex

+44 (0) 1933 650700

www.sonifex.com

Solid State Logic

212-315-1111

www.solidstatelogic.com

Summit Audio

775-782-8838

www.summitaudio.com

TC Electronic

805-373-1828

www.tcelectronic.com

TL Audio

+44 (0)1462 492090

www.tlaudio.co.uk

TransAmerica Audio Group

702-365-5155

www.transaudiogroup.com

True Systems

520-721-2735

www.true-systems.com

Universal Audio

866-823-1176

www.uaudio.com



HUNGRY FOR MORE PRODUCT INFO?

Browse the front and back ends of the signal path — mics and monitors — in our *Mics & Monitors Buyer's Guide*, presented by *EQ* and *Keyboard* magazines. Order by calling 800-444-4881 or via email at orders@cmp.com.

All those late nights in the studio
Doing that 99th take
Finding a rhyme for orange . . .

(Did you try "door hinge"?)

DON'T YOU DESERVE OASIS®?

Look, there are plenty of disc manufacturing companies out there. You know this, we know this. But you only have one shot to make your project the best it can be. So come to a place that will take your project seriously. Oasis.

OASIS®
CD MANUFACTURING
oasisCD.com

toll free (888) 296-2747
tel (540) 987-8810
fax (540) 987-8812
email info@oasisCD.com
web oasisCD.com
12625 Lee Hwy, Box 214
Sperryville, VA 22740



INCLUDED WITH YOUR CDs—THE OASIS TOP™ (TOOLS OF PROMOTION) SUITE OF SERVICES:

Your Music on an
OasisSampler™
Distributed to
Radio Nationwide



Distribution for Your CD:



amazon.com

CDNOW

BORDERS.com

Waldenbooks.com

XM Radio Airplay
for Oasis Clients



SATELLITE
RADIO



Electronic Press
Kit® Service and
Exclusive Live
Performance
Opportunities:



Priority
Consideration by:



Soundtrack
Express
The Voice of Media

Digital Distribution,
Upload of Your Album
Info to SoundScan®,
Bar Codes, Display
Boxes and More



Nielsen
SoundScan®

E-MU® Digital Audio Systems

Professional PC Audio at an Unbelievable Price

E-MU's Digital Audio Systems deliver everything you need to produce audio on your PC with professional results – 24-bit/192kHz converters, (the same A/D converters used in Digidesign's flagship ProTools® HD 192 I/O interface), hardware-accelerated effects and mixing, and seamless compatibility with your favorite PC audio and sequencing software for less than \$500. These Digital Audio Systems stand toe-to-toe with the most advanced and expensive audio systems in the world, and will change your expectations of desktop recording forever.

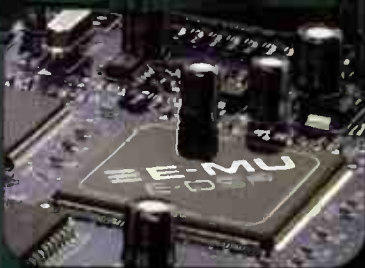

- Complete analog, digital and MIDI I/O, plus sync and FireWire® interfaces
- TFP Pro™ Mic/Line/Hi-Z preamps – plug your microphones, keyboards and guitar straight into your system (no mixer needed)
- E-DSP hardware-accelerated effects with over 500 presets
- Zero latency hardware mixing and monitoring
- Works with your favorite audio/sequencer software (ASIO 2.0, WDM and DirectSound® drivers included)
- Audio recording, editing, mixing and effects software package included

WINSTON GRADE
24-bit/192kHz
120dB SNR-measured
A/D & D/A Converters

Works with
Windows
**2000
& XP**

CUBASE
VST
Full version included
1820 and 1820M only

© 2004 E-MU is a registered trademark of E-MU Systems, Inc. in the US and other countries. All other brand names are the property of their respective owners.



1820M \$499.99*

I/O Configuration:

- Two TFFPro™ Mic/Line/Hi-Z preamps (w/48V phantom power)
- Six 1/4" Balanced Inputs
- Eight 1/4" Balanced Outputs
- Turntable Input (w/ground lug and hardware RIAA preamp)
- 24-bit/192kHz ADAT In/Out (switchable to S/PDIF)
- 24-bit/96kHz coaxial S/PDIF In/Out (switchable to AES/EBU)
- 24-bit/96kHz optical S/PDIF Out (switchable to AES/EBU)
- Two sets of MIDI In/Out
- Four stereo 1/8" Speaker Outputs (configurable from stereo to 7.1)
- Stereo Headphone Output
- FireWire™ Interface

Sync Configuration:

- Word Clock In/Out
- SMPTE In/Out
- MTC Out



1820 \$399.99*

I/O Configuration:

- Two TFFPro™ Mic/Line/Hi-Z preamps (w/48V phantom power)
- Six 1/4" Balanced Inputs
- Eight 1/4" Balanced Outputs
- Turntable Input (w/ground lug and hardware RIAA preamp)
- 24-bit/192kHz ADAT In/Out (switchable to S/PDIF)
- 24-bit/96kHz coaxial S/PDIF In/Out (switchable to AES/EBU)
- 24-bit/96kHz optical S/PDIF Out (switchable to AES/EBU)
- Two sets of MIDI In/Out
- Four stereo 1/8" Speaker Outputs (configurable from stereo to 7.1)
- Stereo Headphone Output
- FireWire™ Interface



1212M \$199.99*

I/O Configuration:

- Two 1/4" Balanced Inputs
- Two 1/4" Balanced Outputs
- 24-bit/192kHz ADAT In/Out (switchable to S/PDIF)
- 24-bit/96kHz S/PDIF In/Out (switchable to AES/EBU)
- MIDI In/Out
- FireWire™ Interface

*estimated street price



for a complete tour visit:
www.emu.com
 8 7 7 . 7 4 2 . 6 0 8 4
 World Radio History



by Mitch Gallagher

The king of super-consoles hits the mark with great sound, awesome power, and amazing flexibility in the XLogic Channel. Finally, a way for the rest of us to own an SSL

SSL XLogic Channel

Could this be SSL for the rest of us?



Type: Single-channel preamp/compressor/EQ

Price: \$3,595

Contact: Solid State Logic,
www.solid-state-logic.com

Channels: 1

Connections (per channel): XLR input (rear panel), 1/4"/XLR combi input (front panel), XLR key in, 1/4" dynamic link, XLR output

Microphone input gain: 72dB in 6dB steps

Microphone pad: 20dB

Frequency Response: 20Hz–20kHz, +0.05/–0.1dB (–3dB @ 130kHz)

EIN: <–127dB

Headroom: >28dB, any gain setting

Lowpass filter: sweepable 3–70kHz, 12dB/octave

Highpass filter: sweepable 15–600Hz, 18dB/octave

Number of EQ bands: 4

EQ boost/cut: high, high-mid, and low-mid, ±20dB; low, ±16.5dB

EQ frequencies

Low: 40–600Hz, switchable shelf/bell response

Low-mid: 200Hz–2.5kHz, with variable Q

High-mid: 600Hz–7kHz, with variable Q

High: 1.5–22kHz, switchable shelf/bell response

Here's a minor understatement for you: Solid State Logic consoles are just a wee bit beyond the financial grasp of most of us. Which isn't to say that we don't lust after having a huge expansive console arrayed before us in our state-of-the-art, top-of-the-line, professionally designed and decorated studios, located, of course, in sumptuous mansions perched majestically on hill-sides overlooking pastoral trees, valleys, beaches, and the glorious blue sea. . . .

Whoa, somebody stop me! What I'm saying is that many of us would love an SSL, but there ain't no way we're getting one. At the last AES trade show, SSL introduced a new series of products aimed at those of us without megabudgets: The XLogic series includes the XLogic Channel strip, a 6-channel compressor, the 4-channel preamp and accompanying remote control, and 2-channel compressor. EQ managed to score time with one of the first XLogic Channels off the production line.

WHAT IT IS

The XLogic Channel is the equivalent of a channel strip in a Solid State Logic XL 9000 K series console. The single rackspace unit comprises a "SuperAnalogue" mic/line/instrument preamp, a compressor, expander/gate, high- and lowpass filters, and a 4-band equalizer switchable between G and E series console

EQ responses. You can add an optional analog-to-digital converter card to the unit for directly interfacing with a DAW or digital recorder.

PREAMP

The preamp in the XLogic sounds great. It's present and big-sounding, whether used with mics, line level signals, or electric or acoustic guitar or bass. The bottom end is thick and rich, while the mids are full without being bloated or boxy. There's a lot of detail on top, but not a trace of harshness or sterility.

Dynamic response is excellent; the XLogic Channel follows right along with the performer in this regard, feeling and sounding very natural. There's plenty of gain available for even quiet sources.

DYNAMICS

The XLogic compressor is incredibly flexible. It can switch from peak to RMS response, be switched pre- or post-EQ, be linked to a second XLogic for stereo operation, and keyed from an external sidechain source. You can switch the high- and lowpass filters into the key (sidechain) path. You can also switch the EQ into the sidechain for frequency-dependent processing like de-essing. And yes, you can switch both the filters and the EQ into the sidechain if you really want to get carried away.

The expander/gate can switch between, well, expansion and hard gating, with separate controls. Both the compressor

and the gate can be switched to fast attack response.

TWICE AS NICE

The XLogic Channel EQ is like two equalizers in one . . . you can change the response between two classic SSL curves: E and G series. The EQ is a 4-bander. The low and high bands can switch between shelf and bell (peaking) response. The two mid bands are fully parametric, with control over frequency, bandwidth, and boost/cut. The bands can overlap, frequency-wise.

The EQ is incredibly powerful; combined with the two filters and the ±20dB of gain (±16dB on the highs) per band, whatever tone shaping you need is available.

SSL FOR THE REST OF US?

So is the XLogic Channel the "affordable" SSL we've all been waiting for? I'd definitely say yes. It literally is a channel from an SSL XL console, with all the power and sonics that entails. Features abound, amazing flexibility is available, and the sound is there. The price is still steep — \$3,600 for a single channel ranks right up there — but it's by far the least expensive way most of us can even consider getting an SSL into our rooms. If an SSL front end is what you've lusted for, this is the way to get it!

Strengths:

- It's an SSL!
- Great sounding preamp
- Dual-response EQ
- Outstanding flexibility
- Full-featured compressor
- Did I mention it's an SSL?

Limitations:

- Price of entry to SSL-land is still high

THINK AN SSL IS OUT OF REACH FOR YOUR STUDIO? THE XLOGIC CHANNEL MAY JUST CHANGE YOUR MIND.



Create. Record. PROduce.



D32XD

With the new D32XD and D16XD (Xtended Definition) Digital Recording Studios, Korg has all but erased the line between "home" recorders and full-blown professional studio hardware. The easy-to-use XDs deliver true pro sound, advanced mixing, editing and recording features and built-in CD-RW burners - right at your fingertips using Korg's intuitive TouchView interface. So now, you can finally PROduce at the hottest studio in town - yours.

COMING IN APRIL - Version 2 OS with more simultaneous record tracks at 24-bit resolution, a new noise reduction function, the ability to load backup data from other D-Series recorders and much more!

FEATURES: Up to 24-bit/96 kHz resolution • 8 simultaneous record tracks @ 48/44.1 kHz (16 with optional AIB-B) • 32 track playback, 80GB hard drive (D16XD: 16 track, 40GB) • Built-in analog compressor on each input • Final effect, two Master effects and 24 insert effects (D16XD: 8 insert) • 100

scene automated mixing • Motorized flying fader event automation (D32XD only) • Pinpoint editing, including audio scrubbing • USB and S/P DIF; plus MMC, MTC (all formats) • Import & export .WAV files • Options: 8-input expander, 8 additional analog compressors, ADAT I/O

D16XD



KORG

WWW.KORG.COM

©2004 Korg USA, 316 S. Service Road, Maitland, NY 11747 • (516) 333-8737

Recorders shown with optional AIB-B analog input board.

Other recorders available from Korg: D1600mkII, D1200mkII, PXR4, CR-4.

by Mitch Gallagher

Apogee Mini-MP

Portable and tiny, this preamp rocks



Type: Dual-channel microphone/instrument preamp
Price: \$995, Mini-series rack (holds three units), \$29.95, Mini-series carrying case, \$29.95

Contact: Apogee Electronics, www.apogeedigital.com

Channels: 2

Connections (per channel): 1/4"/XLR combo balanced/unbalanced input, XLR balanced output

Microphone input gain: 70dB (plus up to 6dB output gain)

Instrument input impedance: 2.2MΩ

Frequency response: 4Hz–160kHz (–3dB) @ 40dB gain

EIN: <124dB

Highpass filter: 18dB/octave @ 80Hz

One of the first pieces of high-end gear in my studio was an Apogee AD1000 A/D converter. A bonus of that box was its surprisingly tasty mic preamps. Years later, I reviewed the company's Trak2 for the February '02 issue of *EQ*. Once again, I was impressed with the quality of the unit's built-in preamps. Now I hold before me (literally in the palm of my hand) the 1/3-rack-space Mini-MP — a dedicated mic/instrument preamp.

EASE OF USE

The Mini-MP is straight-ahead to operate. Plug a mic or instrument into the combi jacks on the back, and hook the XLR outs to your recording chain. There's a gain control, and switches for the highpass filter, polarity, and phantom power for each channel. You have to push the phantom switch over and hold it to engage or disengage 48v; it pops back when you release it. While this seems strange, it makes it nearly impossible to accidentally turn phantom power on or off.

The only other controls are the power switch and the output level knob. When you switch power on, a blue glow emanates from around the output knob. Cranking the output knob provides an extra 6dB of gain.

Metering is by way of dual 4-stage LED ladders. Distortion could sometimes be heard before the clip indicators lit,

especially when the output gain was above 0dB.

Power-wise, the Mini-MP comes with an external supply. But it can operate on any regulated 6-14v DC supply that can provide 1.25 amps of current. This includes battery packs, making the Mini-MP ideal for remote work.

FRONT END

As a preamp, the Mini-MP offers a dynamic, pure tone with good presence and excellent top end. This isn't the preamp to turn to when you want grunge or heavy low-end coloration. I used it on vocals, electric and acoustic guitars, as a DI for acoustic and electric guitars and basses, and for tracking percussion. I was pleased with it in each instance. The Mini-MP has a fast attack and clear high-end that provides lots of detail. The bottom end is tight and compact. For my taste the highpass filter is tuned too high, and impacts the audible range too much.

Even with the input and output gain cranked, the signal is clean and noise-free. This means the Mini-MP provides a total of 76dB of usable gain, enough for almost any source.

M/S

The Mini-MP brings a cool extra to the table: its ability to decode M/S (Mid/Side) recordings. With M/S, two mics are used, a cardioid mic ("Mid") facing forward, and a figure-8 mic ("Side" coincident with and facing 90 degrees to the cardioid mic.) The two signals are combined in a stereo matrix, with one side having the mid+side signal, and the other having mid-side (Side switched out of phase). This

gives you a stereo image that combines totally in-phase for mono. You change the stereo width by changing the balance of Side to Mid.

The Mini-MP does M/S matrixing internally and outputs the stereo result. The Mini-MP has a 3-position power switch. To enter M/S mode, you click the power switch over to the third position. The left input gain controls the Mid signal level, the right controls the Side signal level. It all works well; I used it to track solo steel- and nylon-string guitars with great results. You can adjust the M/S balance after the fact, but getting the balance right on the Mini-MP from the start is easier. Typically, you'll want the Side level well below the Mid level.

SIZE DOESN'T MATTER

The Mini-MP brings some powerful strengths to the table, not the least of which is its great sound. That, coupled with the fact that it's small and light and can be powered from batteries, should make it a remote recordist's dream. But don't dismiss it as just for remote work: The Mini-MP shines in the recording studio.

It sounds clean and pure, it's tiny, it has M/S encoding, and the price is right . . . what more could you ask for? **EQ**

Strengths:

- Plenty of gain
- Clear, pure sound
- M/S encoding
- Tiny and portable
- Can be powered from a variety of sources

Limitations:

- Wobbly output knob
- Coarse metering



The Legacy Continues



Octane

8-channel preamp and A/D converter

M-Audio's audio/MIDI interfaces, Studiophile monitors and USB MIDI controllers are legends in their own time. Now, the new Octane is the latest addition to M-Audio's line of award-winning preamps. Designed to enhance the front end of any multitrack digital recording system, the Octane delivers 8 channels of the pristine preamp technology found in our critically acclaimed DMP3. In addition to 8 analog outs, ADAT Lightpipe out allows direct connection to digital mixers, hard disk recorders and digital audio interfaces such as M-Audio's new FireWire 1814.

Octane is ideal for miking drum kits or full bands—and the two mic/instrument channels are great for guitar, bass and other instruments. M-S matrix encoding lets you employ stereo miking techniques previously available only in pro studios. Word clock also syncs multiple Octanes for as many channels as you need when your studio grows. Octane—another legend in the making.

Octane

8-channel preamp and A/D converter



8 microphone ins, 2 instrument ins

ADAT Lightpipe and analog outs

24-bit audio resolution throughout

word clock syncs multiple digital devices

M-S matrix encoding on channels 7 & 8

TAMPA

advanced preamp /compressor



"Tampa is a fine sounding preamp... the compressor alone is worth the price."
—Bruce Bartlett, Pro Sound News

"Tampa rocks..."

—George Petersen, Mix



DMP3

dual preamp and direct box



"One of the quietest preamps available anywhere, regardless of price."
—Pro Audio Review

"Our studio technicians use the DMP3 for everything." —Jonathan Wolff & Chris Lee, ("Will & Grace," "Seinfeld," "Reba")



Where do you want to take your music?

M-AUDIO

www.m-audio.com



Anything that delivers this kind of bang for the buck definitely deserves an EQ Award.

by Craig Anderton

Mackie Traktion

Cheap and cheerful, but can it compete?

Type: MIDI sequencing/hard disk recording software

Price: \$80

Contact: www.mackie.com

Platform: Windows, Mac

Minimum system requirements: (PC)

500 MHz Pentium III or Athlon, Windows 98/ME/2000/XP, DirectSound or ASIO-compatible audio interface; (Mac) OS X 10.2, G3/G4/G5, Core Audio-compatible audio interface

Copy protection: Net registration, load key file

Version reviewed: 1.5.0.254

Internal resolution: 32-bit floating point

Supported sample rates:

44.1/48/96kHz

Driver support: DirectSound/ASIO (Windows), Core Audio (Mac)

ReWire mode: Host

Plug-in support: VST, VSTi

Included plug-ins: Volume/pan, level meters, basic sampler, reverb, 4-band EQ, compressor, delay, pitch shifter, chorus, phaser, low/highpass filter

Import formats: WAV, AIFF, Ogg Vorbis, MIDI

Export formats: WAV and AIFF (sample rates from 22.05 to 96kHz, 8-32 bits), MIDI, Traktion Archive

Sync: Internal sync only

Traktion, by Raw Material Software and distributed by Mackie, has a premise: Current digital audio/MIDI host software is too bloated, too expensive, and too complex. It offers a completely different take on the user interface and workflow (for example, there's no conventional "mixer," although of course you can mix tracks), yet doesn't lack too many significant features compared to hosts costing much more. As with anything this different, reaction is polarized — from refugees of other programs who were immediately smitten by the Traktion way of life, to those who find it too unconventional for their tastes ("dude, where's my mixer?").

In any event, Traktion demolishes the rationale some software thieves use that "software is too expensive." At \$80, and with a free demo so you can find out if it's for you or not, no one could argue this program is overpriced.

INSTALLATION

Just pop in the distribution CD (or run the download) and go — no dongles. Traktion checks for ASIO, then scans your plug-ins. In my system, when it encountered the SampleTank dll, the program crashed; upon rebooting, it reported that it had disabled the plug-in because it didn't load properly. No big deal, I've moved on to SampleTank 2 anyway (which worked fine).

I started off with an early version, and program authorization was a major hassle. To make a long story short, it took about an hour to figure out how to authorize the program, because the procedure wasn't described on either the Mackie or Raw Material Software site. This has since been addressed, and I did download an update (once I found out from Mackie where to look) that went smoothly. I've been assured the registration and updating process will be more transparent in the future.

THE INTERFACE

Once installed, you start to realize what Traktion is all about. Screen layouts are clean and open, with extensive pop-up help that really does make the concept of "read the manual" optional. The program has only three pages — project management, settings, and editing — and editing uses a "unified," one-screen interface with five main sections. Clockwise from upper left, these are:

- Track view, which shows I/O and audio/MIDI clips. This is pretty standard — trim clips, resize, add graphic fades, crossfade clips, time-stretch (hold Alt while resizing — Traktion doesn't recognize acidized or REXed files), cut/copy/paste/move, select a particular region for editing, and the like.
- The "filter" area, to the right of the track view. This concept will give some pause, as it replaces the traditional mixer concept; a filter can

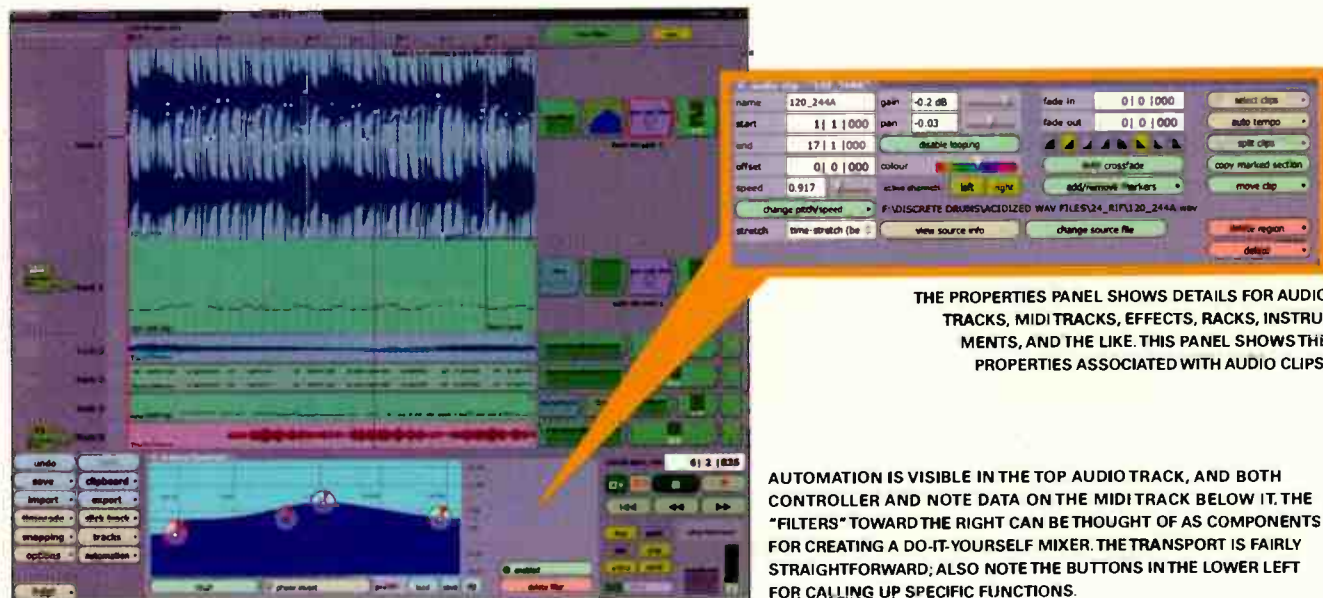

THE PROPERTIES PANEL SHOWS DETAILS FOR AUDIO TRACKS, MIDI TRACKS, EFFECTS, RACKS, INSTRUMENTS, AND THE LIKE. THIS PANEL SHOWS THE PROPERTIES ASSOCIATED WITH AUDIO CLIPS.

AUTOMATION IS VISIBLE IN THE TOP AUDIO TRACK, AND BOTH CONTROLLER AND NOTE DATA ON THE MIDI TRACK BELOW IT. THE "FILTERS" TOWARD THE RIGHT CAN BE THOUGHT OF AS COMPONENTS FOR CREATING A DO-IT-YOURSELF MIXER. THE TRANSPORT IS FAIRLY STRAIGHTFORWARD; ALSO NOTE THE BUTTONS IN THE LOWER LEFT FOR CALLING UP SPECIFIC FUNCTIONS.

FOR OVER 30 YEARS LEXICON HAS BEEN IN WORLD-CLASS RECORDING STUDIOS

NOW YOUR HOME CAN BE ONE OF THEM

ΩMEGA
DESKTOP RECORDING STUDIO

Lexicon has taken a whole-system approach to desktop recording. Omega Studio is an integrated computer recording system that includes the Omega 8x4x2 USB I/O mixer, Pro Tracks Plus 32-track recording software and Pantheon world-class Lexicon reverb plug-in. Omega Studio contains all of the components necessary to transform your computer into a professional 24-bit recording studio.

Whether you're working on your first demo or your fifth gold record, Omega has the performance to produce your masterpiece.

Maybe you don't have the coin to record in the city of Westminster on Abbey Road, but that's no reason your music shouldn't sound like it.

Visit your local Lexicon dealer today and see what Omega can do for your studio.



Omega 8x4x2 USB I/O mixer

Differentiating itself from standard computer I/O boxes which are typically based on a patch-bay paradigm, the Omega 8x4x2 USB I/O mixer is based on a mixer paradigm and includes input, output and mixing functions that support a variety of tracking/monitoring applications while requiring no additional mixing hardware. The I/O mixer is packed with professional features such as ultra-transparent, high resolution A/D converters, extremely low-noise mic preamps with 48-volt phantom power and active balanced line level inputs. MIDI and S/PDIF ports allow connection to a variety of digital equipment.

Pro Tracks™ Plus PC Recording Software

Pro Tracks Plus is an easy-to-use, comprehensive 32-track recording suite that includes all the modules you'll need to track, edit, process, sequence and mix your masterpiece. Not only does it include intuitive non-linear editing, plug-in support, and acidized looping features, it contains a full featured MIDI sequencer with outstanding event editing and powerful automation features as well as soft synth support.

BIAS Deck™ 3.5 SE Mac Recording Software

BIAS Deck 3.5 SE turns your Mac into a full-fledged recording studio. Easily record up to 64 tracks, with full CD quality and then edit your work instantly, while always being able to revert to your original recordings.

Pantheon™ Reverb Plug-in

From the name synonymous with "world's best reverb", Lexicon brings you Pantheon. With 35 factory presets, 6 reverb types and a simple yet powerful user interface, Pantheon is an indispensable tool for your recording studio.

lexicon PRO

Lexicon Pro 8760 So. Sandy Parkway, Sandy, Utah 84070 • Tel: (801) 568-7567 | Fax: (801) 568-7662 • www.lexiconpro.com • www.protracksrecording.com

H A Harman International Company

World Radio History

Mackie Traktion



SOUNDMINER

asset management system

Soundminer LE

Powerful yet affordable database and search engine, digitize your commercial SFX libraries, built in clip editor, high resolution playback engine, Rewire and REX support....



Soundminer 3.1

...add multi-channel support, VST Plug in support, built in dictionary and thesaurus, multi-channel Rewire, Supervisor Controls, ServerX and mSoft support and much much more...



ServerX 3.1

...true shared enviroment with complete MySQL integration, control privileges and permissions, serve up multiple databases, Soundlok....

www.soundminer.com

1-866-FINDSFX

info@soundminer.com

be a VST instrument, audio plug-in, mix/pan control, level meter, etc. Essentially, this is a "do it yourself" mixer. Filters can also be dropped onto individual clips for localized processing, on to the master bus, or into "racks" for complex track or bus processing.

- Transport (lower right), with loop, punch, tempo indicator, automation enable (write/playback), master controls, etc.
- Properties page, which shows details on a selected clip or element of the interface.
- "Toolbar" that provides functions like save, import, snap, options, automation, and the like. Click on a button, and a pop-up presents you with the associated options.

Mackie says there's no learning curve, and while I wouldn't go quite that far, if you're familiar with typical host programs, Traktion will make complete sense after a (very) brief period of familiarization.

UNEXPECTED PLEASURES

Traktion has several features you wouldn't expect at this price. In addition to ReWire 2.0, editable automation, the ability to rip CD tracks into a project, and "freeze" (premixes tracks with plug-ins to conserve CPU power), you can select a loop that's cut to a specific tempo, click on Auto-Tempo, and bingo — the tempo matches the clip. Clips are easy to loop multiple times, and in addition to up to 200 levels of Undo, there's a very clever auto-save feature: If you close a project, you have the option to discard any edits since the last manual save.

There's also a complement of simple plug-ins, including a basic sampler, with delay compensation on a track basis for all plug-ins. They're plain vanilla, but when exchanging a file with another Traktion owner — made easy by its archive option — you don't have to be concerned with whether or not your pal has the same plugs.

MIDI editing is basic (no MIDI FX, for example) but does much of what you need: Transpose, quantize (several modes, including groove quantization), make lengths or velocities equal, and it has a unique ability to "mirror" notes vertically or horizontally (changes notes as if you were seeing them in a mirror). Clicking on an individual note shows an editable "inspector" for pitch, start and end times, and velocity.

You can record on multiple tracks simultaneously, including a mix of MIDI and audio tracks. Furthermore, you can layer audio (or MIDI) clips on top of each other in a track, and they'll both play back.

A big complaint I'd had about Traktion was the lack of busing, but literally 24 hours before the magazine's deadline, I downloaded a new version from the Raw Material Software site with a "racks" feature. What a surprise! You can load various effects into a graphical box, interconnect the effects however you'd like with software patch cords, and create multiple inputs and outputs. You then drag an instance of this "rack" into any track.

In addition to allowing extremely sophisticated effects routing within a track, if you create a track and insert a rack, this becomes the equivalent of a bus. Dropping more instances of the rack into tracks and editing ins and outs as appropriate essentially provides send signals to the bus track. Each rack instance also has a dry/wet adjust, so the "bus rack" can be effect sound only, while an individual track output can be dry only, although it's still sending a signal to the effect.

Maybe this breaks the straightforward paradigm a bit. But what you get in return is in some ways more powerful than what you can find on other hosts — a rack is like having a Spark FX Machine or BIAS Vbox built in, as you can do series, parallel, and series/parallel combinations of effects, for individual tracks or as bus effects. Cool.

Speaking of updates, Traktion is "dribbleware": Small changes appear periodically, rather than occasional massive updates. Check the web site often to see what's new.

WHAT'S MISSING

Traktion lacks several important features, such as sync to external sources, loop recording (you can loop record MIDI data, but it all gets dumped into one track), and DirectX plug-in support for Windows (AU support is rumored for the Mac version). Audio editing is primitive — trim silence, change sample rate and bit depth, reverse, and stereo to mono; for anything else, you'll need to launch an external editor. Nor is there any video window. And MIDI-wise, forget event list editing, notation, extensive MIDI edit

FW-1884

"TASCAM's FW-1884 is the answer for desktop musicians who like the Digi 002 design concept but don't want to switch to a new DAW."

ELECTRONIC MUSICIAN MAGAZINE JANUARY 2007

Logic, Cubase, Sonar, Digital Performer or Nuendo goes here.

Assignable foot-switch jack for punch ins or MIDI control.

Eight analog outputs for L/R and 5.1 surround sound matrices.

Fourteen DAW shortcut buttons including Save, Reverb, All Safe, Marker, Loop, Cut, Delete Copy, Paste, ALT/CMD, Undo, Shift and CTRL.

Eight channel inserts

Eight channel strips with 100mm, touch-sensitive motorized faders, Mute, Solo and Select buttons, Pan, trim and access to 4-band parametric EQ*. Rotary encoders can be assigned to 8 Auxes or Pan via keypad.

Optional FE-8 expander.

And here's the optional FE-8 expander with 8 channel strips with motorized faders.

Separate Monitor and Solo (AUX) controls.

Eight channels of ADAT lightpipe I/O and stereo S/PDIF inputs & outputs.

Extra Firewire port so you can connect to external hard disks or daisy-chain to our FE-8 expander.

Word Clock in and out for accurate sync with computer systems.

Four MIDI inputs and four MIDI outputs for sound generation and timing.

Eight balanced 1/4" XLR analog Mic/Line inputs with studio-grade, high-headroom, low-noise mic preamps and switchable phantom power. XLR Input 8 is even switchable from Mic/Line to Guitar level.

It's an 18-input-Firewire audio I/O box, a 4-in/4-out MIDI interface...and a motorized fader controller for popular DAW programs!

Co-developed with Frontier Design Group, the FW-1884 has everything you need to maximize workstation productivity in a single intuitive tool. For far less than the cost of a piecemeal approach.

Fire up the FW-1884 at a TASCAM dealer or visit our web site for more information.

Potency Logic™

4-way mouse and keyboard board plug-in. Dedicated function buttons plus a touch-sensitive cursor, locate, and solo keys. Locate, function and Bank Select keys.

24-bit A/D, 20-bit D/A, 96kHz sample rate with appropriate DAW software.

Mapped controls for Digital Performer™, Nuendo®, Logic™, Sonar™ and Cubase®.

CO-DEVELOPED WITH FRONTIER DESIGN GROUP

TASCAM



*EQ feature set of compatible DAW software.

©2004 TASCAM. All Rights Reserved. All features and specifications are subject to change without notice. Sonar is a trademark of Twelve-Tone Systems. Nuendo and Cubase are registered trademarks of Steinberg Media Technologies AG. Digital Performer is a trademark of Mark of the Unicorn. Logic is a trademark of Emagic/Apple Computer.

CONTRACTOR

www.tascam.com

DJ AND PRODUCER

PERSONAL CREATIVITY

WE WILL BEAT ANY DEAL!

EVERY MAJOR BRAND~IN STOCK!

Guitars • Amps • Drums • Keyboards • Synthesizers • Samplers
Sound Systems • Recording Equipment • Software • Accessories



Shop Where the Pros Shop • Call Us Today!



West L.A. Music

call now: 310-477-1945 • sales@westlamusic.com

We will beat any price from any authorized stocking dealer anywhere in the United States

DISCRETE DRUMS

Drums - Greg Morrow - Percussion - Eric Vulkan



Earthbeat

a new multitrack drum and percussion series

WWW.DISCRETEDRUMS.COM

Mackie Tracttion

options (e.g., compress velocity data), and other niceties.

Control surface support? Nope. However, given the Mackie affiliation, you can expect a future version with Mackie Control integration.

Another issue is more a weirdness than an omission: If you render a MIDI track driving a soft synth, it replaces the MIDI track with the audio so there's no going back (except for undo, of course) if you want to make changes. It's better to freeze a track, or render to a separate audio file and bring it into a different track.

CAN AN \$80 PROGRAM CUT IT?

Surprisingly, yes. Tracttion not only holds its own against "lite" versions of major hosts, but will do everything needed by most users who are willing to think a bit outside the box. In any event, you can always check out the demo to find out for sure; and updates seem to be fairly regular (although the program is pretty much the work of one person, Julian Storer, so let's hope he takes good care of himself).

Tracttion comes out of left field with bang for buck that's so extreme it's not hard to forgive the various omissions. Yet it's not just about cost. The stability, ease of use, responsiveness, and workflow are pretty hot by any standards. It will be interesting to see what happens in the future, as the demand for features butts heads with the desire for simplicity. But for now, Tracttion pulls off that balancing act, at a price that's hard to believe. **EQ**

Strengths:

- Extremely cost-effective
- Surprising level of sophistication
- Can do series/parallel track and bus effects
- Efficient workflow with minimal learning curve
- Acceptable time/pitch-stretching
- Includes basic plug-ins and sampler
- Unified, uncluttered interface
- Exceptionally good online help
- Search engine for audio files

Limitations:

- Racks, while powerful, can be complex
- Doesn't accept external sync
- No loop recording to separate tracks
- No DirectX or AU support
- MIDI editing lacks event list or notation
- No control surface support or video window
- Doesn't read acidized or REX format files

75 years later... Nothing has Changed!

Neumann is a trademark of Sennheiser Corp. Use of the Neumann name is for historical reference only. Gefell is not associated with Sennheiser in any way. All trade marks are the property of their respective owners.



Gefell M930 Stereo XY



The original 'Baby-bottle'.

Gefell microphones are still hand made in Germany with the care and precision that one can only equate with old-world craftsmanship and a commitment to excellence. From the early days with Georg Neumann, through the relocation of the factory during the 2nd World War, and the many years separated behind the Iron Curtain, Gefell has remained true to its roots. And these roots run deep...

From the 1st generation multi-pattern UM57 to the fabulous UM92.1S, Microtech Gefell continues the tradition with the legendary 'tube sound' that is only possible with the original M7 capsule. That's right, the original M7, with gold sputtered PVC, hand made in the Gefell factory.

That's not to say we have rested on our laurels... Since the beginning Gefell has set the pace for microphone innovation and continues to elevate the bar: The Gefell UM900 Phantom, the world's only 48V phantom powered tube mic; the Gefell M930 Compact, a large-diaphragm studio condenser with optical isolation and the lowest self-noise in the business; and now the Gefell MV230 digital for better than 140dB performance. But wait, there's more...

Today, Gefell measurement microphones lead the world in metal diaphragm technology. For those 'in the know', nothing compares to the precision of an ultra-thin 0.8-micron pure nickel membrane for true, full bandwidth performance. This incredible technology is now available with the new Gefell M295, a low profile cardioid that will absolutely blow you away.

Of course there are lots of mics to choose from and for the average person, a mass-produced copy is just fine. But if you want something truly special and a cut above, visit one of our exclusive Gefell Dealers and listen to the difference that quality, tradition and pride can make. You may be surprised at how good a hand-made microphone can truly be.

Gefell - Quality, Tradition and Innovation



2003 - UM92.1S capsule.



1957 - UM57 capsule.



(Left to Right) Tube mics: Original UM57 (1957), UM57 V.E.B. (1972), and today's Gefell UM92.1S



Gefell UM900



www.gefell-mics.com

GefellTM
the original hand-made German microphone

DISTRIBUTED BY C-TEC - CABLETEK ELECTRONICS LTD. - 1638 KEBET WAY, PORT COQUITLAM BC V3C 5W9 TEL: 604-942-1001 FAX: 604-942-1010 EMAIL: info@gefell-mics.com

PSP EasyVerb

by John Krogh

High-quality native reverb has never been this easy to use

Type: Native reverb plug-in
Price: \$69
Contact: PSPaudioware.com,
www.pspaudioware.com

Algorithms: ambience, room, chamber, club, hall, arena, cathedral, spring, plate
Formats supported: VST, DirectX for PC; VST for Mac OS X (AU; RTAS in development)
Minimum system requirements: Mac: OS X 10.1, VST host, G4 processor; PC: Windows XP/2000, VST/DirectX host, P4 processor
Copy protection: Serial number

PSP is probably best known for their excellent tape saturation and multiband compressor, Vintage Warmer, and the equally impressive Lexicon PSP 42 delay. This Poland-based developer has been on the plug-in scene for a while; however, they've only just added reverb to their virtual offerings. EasyVerb aims to recreate natural room sounds as well as emulate the kind of "vintage" 'verbs you'd expect to hear from the '60s and '70s. It's a refreshing departure from the current trend of convolution reverbs — EasyVerb certainly provides a different flavor from sampled rooms and halls.

OVERVIEW

Many native 'verbs have historically been efficient, CPU-wise, but lacked the kind of depth, richness, and programmability of their hardware counterparts. Where reverb is concerned, it's always been a trade-off: efficiency or quality.

"As its name implies, EasyVerb is straightforward and simple to use. Aside from wet/dry balance and overall output level, there are only four controls."

However, in the past couple of years, as CPU power has shot up and programmers have learned to optimize their code, we've started to see more impressive results from native plug-ins of all sorts. EasyVerb is a perfect example. According to PSP, each of EasyVerb's nine algorithms is designed with quality, not

quantity, in mind. As a result, it's a bit of a CPU hog, but the resulting sound is smooth, thick, and virtually free of the grainy, ringy tone that plagues many native reverbs.

As its name implies, EasyVerb is straightforward and simple to use. Aside from wet/dry balance and overall output level, there are only four controls: time (decay), damping, and two shelving EQ bands, variable from 25Hz–10kHz and 50Hz–20kHz, respectively. Oddly, there's no pre-delay. The obvious work-around is to insert a short delay before the reverb. Not ideal, but not a deal-breaker.

If you're a tweaker, you might feel a bit cramped by EasyVerb's Spartan interface. In practice, I found I could dial in a variety of sounds just by learning how each algorithm sounded, and then adjusting the time and damping to fit my tracks. That's the beauty of this plug-in: Parameters such as early reflection, room materials and dimensions, diffusion, etc. are behind the scenes, which means there's less to concern yourself with. Working with EasyVerb becomes about using your ears — what a concept!

Also worth noting: Unlike many other plug-ins, EasyVerb operates in true stereo. Input signals aren't summed before processing.

IN USE

I tested the plug-in on several systems: a 1GHz Titanium and 1GHz dual-processor G4 tower, both running Logic 6.3.3 and OS X 10.2.8, and a 2.66GHz P4 with Sonar 3 and WinXP. (AU support wasn't



EASYVERB'S FEW PARAMETERS GIVE YOU EVERYTHING NECESSARY TO TAILOR YOUR SOUND. PLENTY OF PRESETS ARE PROVIDED TO GET YOU STARTED.

- Max Ambience
- Control Room Kit
- Basic Room
- Small Room
- Big Room
- Basement
- Underground
- Piano Room
- Basic Chamber
- Damped Chamber
- Empty Chamber
- Long and Dark
- Basic Club
- Small Club
- Empty Club
- Theatre
- Long and Warm
- Basic Hall
- Small Hall
- Big Hall
- Rock Hall
- Basic Arena
- Bright Reflections
- Dark Reflections
- Very Long
- Basic Cathedral
- Wooden Room
- Wooden Church
- Stone Room
- Great Cathedral
- Sacred Space
- Stairwell
- Festival Hall
- Basic Spring
- Short Spring
- Typical Spring
- Long Spring

project5

SOFT SYNTH WORKSTATION

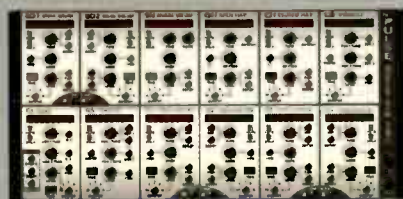
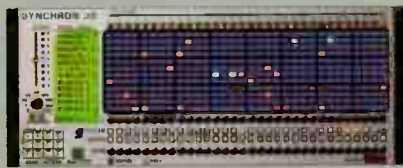

“Highly Addictive” – *EQ, June 2003*

Project5 Soft Synth Workstation is the cutting edge tool for the next generation of music production. Project5's dynamic interface combines the best of pattern-based and live-input sequencing, with powerful looping tools- making your compositions come to life faster than ever. Project5 comes loaded with inspiring synths and samplers, creative effects, and professional sample content. Combined with its support for industry-standard effects, synths, and samples* you can take your sound beyond the rack.

“Project5 is meant for those trying to create the in-sounds of now where the groove is king”

– *DJ Times, November 2003*

“Its instruments and effects are phenomenal”

– *Computer Music, May 2003*

“There's something about Project5 that just makes music happen”

– *Sound on Sound, June 2003*

“There's no need to wait any longer, Project5 has arrived”

– *Keyboard, June 2003*

Experience the addictive qualities of Project5: available at music retailers world wide. Visit www.project5.com for more information and to download the demo.

* Supports ReWire™, ACID™-format loops; DirectX & VST™ Effects; DXi & VSTi™ soft synths; and AIF, Akai™, Kurzweil™, LM4™, SF2™, WAV samples



cakewalk



World Radio History

PSP EasyVerb

implemented at the time of the review, so I used FXpansion's VST-AU wrapper.) Installation was up and down. With the PC and laptop, everything went off without a hitch. But on my tower G4, EasyVerb's installer continually gave me an error. Apparently, it couldn't find my VST folder. My solution was to copy the plug-in from the Titanium to the tower.

I ran some comparison tests to see how many instances I could load. On the laptop I hit the processor ceiling with six EasyVerbs. I was able to load eight instances before the computer gave up. The PC was a different story — I was able to load ten instances without a hiccup. In all cases I was bussing a single stereo audio track to multiple instances, each of which used a different algorithm. Taking a more practical position, one has to wonder how many reverbs are necessary for the average pop track. I'm guessing a couple of EasyVerbs will be just fine for most applications.

I auditioned the 50-plus presets with a variety of material including acoustic

and electric guitar, female vocals, and multitracked acoustic drums. To my ears, the stand-outs were the ambience, smaller room, and club selections. As promised, reverb tails were smooth and artifact-free. EasyVerb did an admirable job at creating intimate, warm spaces — perfect for thickening sampled instruments or live tracks recorded in dead rooms. Close-miked fingerpicked acoustic bloomed nicely without sounding artificial in the "mid-sized" spaces, many of which employ the room or club algorithms. I was able to dial in a fairly retro-sounding surf electric guitar using a combination of a tremolo plug-in and EasyVerb's spring algorithm.

I wasn't as happy with the larger spaces. In particular, the arena algorithm leaned toward ringy. Nor was I thrilled with the plate on vocals. It didn't have the kind of richness or "silkeness" of better plate algorithms. To be fair, though, I still tend to use trusted outboard gear for critical tracks such as lead vocals.

CONCLUSIONS

EasyVerb strikes a nice balance between sound quality and ease of use. For smallest to mid-sized spaces I wouldn't hesitate to stick it on a bus. I have other effects that can handle the bigger spaces, and really, how often do you need to drench a track in reverb? I like that PSP kept the emphasis on useable room simulations. And while there aren't many parameters with which to shape the sound, I found the seeming lack of tweakability wasn't an issue. The plug-in simply sounded good without much need for fussing with it. **EQ**

Strengths:

- Room and ambience algorithms
- Smooth tails, nice decays
- Easy to get good sounds

Limitations:

- CPU hog
- Few parameter controls
- Larger-space algorithms can sound ringy

A BRIGHT IDEA JUST GOT BRIGHTER



Series II POWER CONDITIONING

We've increased the features, not the price.

LED rack lights last much longer than traditional bulbs and produce no heat.

All models have rear BNC connectors for gooseneck LED or incandescent lights for rear rack illumination.

All models employ Furman's NEW SMP non-sacrificial surge protection.

FURMAN
PURIFY YOUR POWER

FURMAN'S SMP TECHNOLOGY

•SMP (Series Mode Protection)

This new technology represents the highest level of power conditioning available for your sensitive equipment. Unique to Furman's SMP is its unparalleled clamping voltage of 188 Vpk compared to 330 Vpk found in other designs. This unprecedented level of protection with no ground wire contamination is only available with Furman's SMP technology. Surges are safely absorbed, clamped and dissipated. No sacrificed parts, no service calls, no down time.

•Extreme Voltage Shutdown

Protection against over-voltage is achieved by automatically shutting off the incoming power until the over-voltage condition is corrected.

•LiFT (Linear Filtering Technology)

LiFT significantly lowers the noise floor in a linear fashion allowing your system to perform at its best.

For more information on SMP and Series II products visit us online.

www.FurmanSound.com

No other EQ handles the curves better

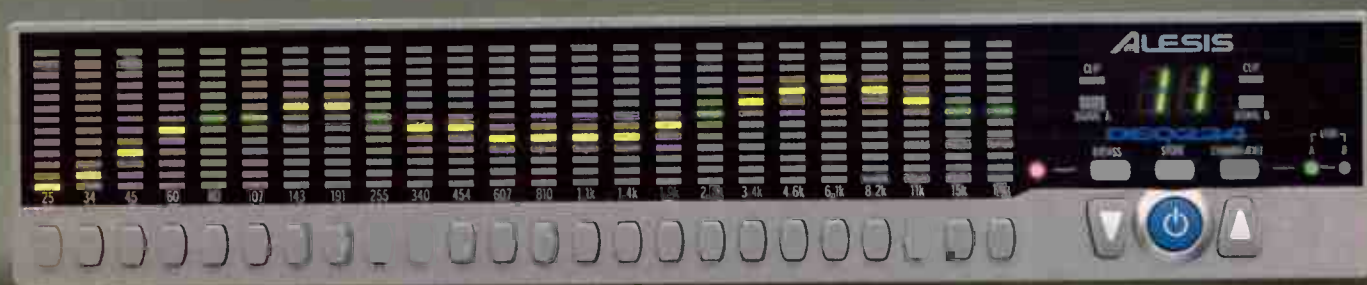

Alesis Digital EQ Series

Fast and flawless graphic equalization

- Precision 28-bit internal DSP processing
- Extensive graphic LED matrix with intuitive operation
- Many useful EQ templates and user storage locations
- Balanced 1/4" TRS audio connections
- Up to 8 individual channels of 30-band digital graphic EQ
- Spectrum Analyzer, Digital and MIDI I/O (DEQ230D and DEQ830)

The Alesis Digital EQ Series gives you illuminated graphic EQ with lightning control right at your fingertips. Once you experience this 28-bit digital precision, you won't want to make EQ curves any other way. Start with preset curve templates, then customize and store your EQ settings with ease. Only this type of performance can take your sound to the next level. And only the Alesis Digital EQ Series gives you this performance at such value. Give your music the perfect finishing touch it deserves with the Alesis Digital EQ Series.



DEQ224 2-Channel, 14-Band Digital EQ in half rack space



DEQ230 2-Channel, 30-Band Digital EQ



DEQ230D 2-Channel, 30-Band Digital EQ with SPDIF and MIDI I/O



DEQ830 8-Channel, 30-Band Digital EQ with ADAT Optical and MIDI I/O

The Digital EQ Company

ALESIS

For the Alesis Retailer nearest you or for more information give us a call or visit our website.
(401) 638-5760 ~ alesis.com

World Radio History

by Greg Rule

Focusrite Trak Master

Platinum-range power for fool's-gold price



Type: Single-channel mic pre, compressor, and EQ

Retail price: \$450

Contact: Focusrite, www.focusrite.com

Channels: 1

Inputs: XLR with +48v phantom power; 1/4" instrument

Outputs: balanced +4dBu 1/4"; unbalanced -10dBV 1/4"

Frequency response: 0dB at 20Hz to -3dB at 250kHz (mic input); 0dB at 20Hz to -3dB at 200kHz (line input); 0dB at 20Hz to -3dB at 200kHz (inst. input)

Headroom: 22dB

Noise: EIN = -121dB measured at 57dB of gain with 150Ω source impedance and 20Hz/22kHz bandpass filter (mic input); -94dB using 20Hz/22kHz bandpass filter (line input); -94dB using 20 Hz/22kHz bandpass filter (inst. input)

THD+N: 0.002% at 1kHz using 20Hz/22kHz bandpass filter (mic input); 0.003% at 1kHz using 20Hz/22kHz bandpass filter (line input); 0.007% at 1kHz using 20Hz/22kHz bandpass filter (inst. input)

Gain: -3dB to +57dB (mic input); -10dB to +10dB (line input); -3dB to +40dB (inst. input)

Optical compressor: -22dB to +12dB threshold; 3:1 soft knee ratio; 6:1 hard knee ratio; 3ms or 45ms attack/punch; 100ms release; +20dB makeup gain

Treble EQ: shelving EQ, 10kHz frequency (Vocal mode); 3.3kHz frequency (Instrument mode); +/- 14dB boost/cut

Bass EQ: bell EQ, 50Hz to 800Hz frequency range, +12/-14dB boost/cut (Vocal mode); shelving EQ, 25Hz to 400Hz frequency range, +12/-14dB boost/cut (Inst. mode)

Presence EQ: bell EQ, 1.5kHz frequency, +12/-20dB boost/cut

Phantom power: +48V

Misc.: Optional 24/96 A/D option (\$250 SRP), which adds S/POIF, Word Clock input, and sample frequency selector (44.1, 48, 88, and 96kHz)

If you've been craving a boost in the front end, but are a bit short in the pocketbook, Focusrite would like to be your hero. Trak Master, is a Platinum-range class-A preamp — with mic and instrument inputs, plus compression, EQ, and tube emulation — and is streamlined enough feature-wise to hit a budget-friendly price point (a mere \$450 MSRP).

Trak Master has been around for a while, actually, but it recently popped back into the headlines thanks to a special bundle offer called the Trak Master Pak. For \$1,335 (\$899 end-user net), you can score not only a Trak Master, but a BLUE Bluebird condenser mic and accessories. Check the Focusrite website for details.

Since we reviewed the Bluebird mic last month, and since this month's cover feature is about preamps, we thought it would be appropriate to fire up the Trak Master and put it through its paces for a proper review. File this one in the Better Late Than Never drawer.

QUICK TOUR

Those who want instant gratification will surely appreciate Trak Master's ease of use. Focusrite has eliminated much of the guesswork, with simplified controls that are named for the musical results they're intended to impart: Punch, Tight, Presence, Tube Sound, etc. They've also built response curves into the EQ section for vocal and instrument

applications. In other words, this isn't what you'd call a "tweakhead's dream machine," but rather a friendly, get-results-quick device.

SESSION NOTES

Straight out of the box, Trak Master was racked up and put into service for a vocal session. The timing was fortunate, as the arrival of Trak Master dovetailed with the exit of Presonus's Eureka (reviewed Feb. '04). How could we not compare the two? Both are silver 1U rack units, both have similar front-panel layouts (mic pre > compressor > EQ > master section), and both are affordable. How would the two units handle the same source material in terms of sound quality?

They both did a fine job adding presence, gain, and "air" to the vocal — and they were both able to compress the performance in a musically pleasing way. This vocal needed it, big time, as the dynamics were all over the map. Neither box gave me quite the convincing, creamy "tube warmth" effect I was hoping for, although Eureka's Tube emulation was more pronounced than Trak Master's. Trak Master's preamp section was clearly the star performer here, and the most worthy of the Focusrite name. The compressor and EQ were useful — they certainly got the job done — but I'd be remiss to recommend Trak Master for those features alone.

EQ tech editor John Krogh put Trak Master to work on a

session for his new commercial-music demo reel; he recording live trumpet through Trak Master en route to Logic Audio (props to our in-house brass pro Pete Sembler.) "On solo muted trumpet, Trak Master did an admirable job of preserving the natural tone," John reports. "Setting up and using it was straightforward, and using just a bit of the 'tube sound' stage helped liven things up."

JURY

If you want Focusrite, and want it cheap, Trak Master is the way to get it. And if you could use another nice condenser mic in your cabinet, run don't walk to get the aforementioned Trak Master Pak, complete with BLUE Bluebird and accessories. Such a deal.

The most direct competitor for Trak Master, spec for spec, is Presonus's Eureka. Eureka has more control options, but is also more expensive. Another consideration — Trak Master, like Eureka, lacks the honest-to-goodness tube stage of MindPrint's En-Voice II, to name one, but the trade-off is reliability. Tubes, for all their perks, can be finicky beasts. In terms of performance, Trak Master stands out in its price range. This box will surely help budget-conscious project studio owners who lack a decent front end to up their game a notch. **EQ**

Strengths:

- Easy to use and get results with
- Class-A circuitry
- Digital expansion option

Limitations:

- Lean feature set
- Coarse visual metering



Don't you deserve more?

GC PRO ACCOUNT MANAGERS

Southern California: Donovan Stark

909.318.0285
donovan@gcpro.com

Hollywood: Susan Wheeler

323.878.0660
susan@gcpro.com

Northern California: Chris Lawrence

415.999.0045
chris@gcpro.com

Pacific Northwest: Michael Gardner

206.953.8885
michael@gcpro.com

Rocky Mountains: Walt Beery

720.308.7011
walt@gcpro.com

Texas: Adrian Peritore

512.632.0581
adrian@gcpro.com

Florida: John Sawyer

954.629.6346
john@gcpro.com

Georgia: Jason Block

678.641.0244
jason@gcpro.com

New York: Blue Wilding

917.297.7675
blue@gcpro.com

New Jersey: Steve Jacobson

201.294.5366
steve@gcpro.com

New England: PK Pandey

508.341.3499
pk@gcpro.com

GC Pro thinks you do. After all, you're serious about music recording, production, or live sound. And perhaps your ideal scenario for choosing a new DAW or mic preamp involves more than ordering it off a web site, or dealing with some anonymous salesperson on the other side of the country.

That's where GC Pro can help. We give you more than just the low prices you'd expect from the world's largest pro audio retailer. You also get extraordinary personalized service, including the ability to evaluate professional products in the comfort of your own studio. And more, like our extensive expertise in all aspects of music and audio, from project studios to commercial recording, post production, live sound and stage lighting.

Need more details? Check out our web site at **www.gcpro.com**, or just contact one of our Account Managers directly. You'll get a level of service that's unsurpassed, and that may take some getting used to. But it's okay — you deserve it. Don't you?

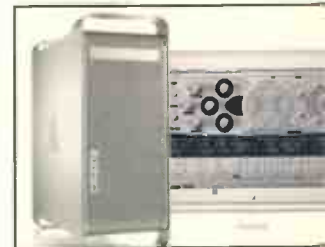

Music • Post • Live Sound • Lighting

GC PRO
www.gcpro.com

© 2004 Guitar Center, Inc. All rights reserved.
All images and trademarks are property of their respective holders.

by Mitch Gallagher

Toft ATC-2

High-end analog without the high-end price

Type: Dual-channel preamp/compressor/EQ

Price: \$1,299.99

Contact: Toft Audio Designs,
www.toftaudiodesigns.com

Channels: 2

Connections (per channel): 1/4" instrument in, XLR (bal) and 1/4" (unbal) line in, XLR (bal) and 1/4" (unbal) line out

Microphone input gain: 60dB

Instrument input impedance: 100kΩ

Frequency Response: 20Hz–20kHz, ±1dB

Signal to noise: –128dBu (mic input)

Lowcut filter: 12dB/octave @ 50Hz

Number of EQ bands: 4

EQ boost/cut: ±15dB

EQ frequencies

Low shelf: switchable 60 or 120Hz

Low mid: sweepable 100Hz–1.5kHz

Hi mid: sweepable 1–15kHz

High shelf: switchable 8 or 12kHz

Toft Audio Designs may be new to the industry, but Malcolm Toft has a long history as both a recording engineer/mixer and as a gear designer. As an engineer, he can count work with artists such as David Bowie, James Taylor, T-Rex, and the Beatles among his credits. He began designing mixing consoles while at Trident Studios in the early '70s, creating the Trident A Range, Series 65, TSM, and Series 80 desks.

Now Toft brings his expertise to bear on rack-gear production. His first release is the ATC-2, a dual-channel unit comprising a mic/line/instrument preamp, EQ, and compressor.

PREAMP

The preamp section of the ATC-2 can accept mic-, line-, or instrument-level signals. Despite its 60dB rating, I found the preamp to have barely enough gain for some applications. Fortunately, the unit is squeaky clean, so even cranking it all the way up didn't add objectionable noise.

For instrument input, in particular, the ATC-2 could have used more juice. My Taylor steel-string has fairly hot output, yet with the ATC, I ended up running the gain almost all the way up. On the plus side, the instrument input sounds really nice. In fact, the ATC-2 has one of the most natural-sounding DI inputs I've heard. It somehow manages to be full sounding, without as much sterility as other DIs.

With microphones, the ATC has a robust tone. I was

very happy with the sound on guitar amps using both condenser and dynamic microphones. It's thick and punchy, with good presence, but no harshness.

On acoustic guitar, the ATC provides a round, meaty sound, with smooth top end, but it's not extremely detailed — this helped in reducing "noise" such as fingernails on the strings, although at the expense of a bit of "air." (A touch of top-end boost with the EQ opened things up nicely.)

The ATC-2 worked great on vocals. The sound is present and vibrant, with controlled, open top end, and round bottom. Its dynamic response felt and sounded natural.

COMPRESSION

The compressor in the ATC-2 is a FET design, with a fixed threshold. You determine the amount of compression using the input and ratio controls. Basically, you set the input and make-up gain controls for unity gain, then turn up the ratio control until you get the results you want. At that point you adjust the make-up gain, attack, and release controls to taste. In practice it works very well.

The compressor is smooth sounding, and capable of everything from subtle to highly squashed effects. You can link the two compressor channels. When you do so, both channels' controls remain active, but the one with the heaviest gain reduction sets the attenuation for both sides, preventing image shifts.

EQ

The ATC-2 has a very powerful

EQ section. In addition to high- and low-shelving bands (each with two selectable frequencies) and two overlapping sweepable mid bands, there's a 50Hz lowcut filter. I really like the sound of this EQ, which Toft says is extremely similar to that found in the Trident Series 80 console. With the combination of dual-frequency high and low shelves and two sweepable bands, you can really get in and tweak the tone to where you want it. It's possible to get pretty aggressive with the gain (±15dB!) and not destroy your signal.

I wasn't, however, as big a fan of the lowcut filter. In just about every case I found it to be audible when switched on. Yes, it removed rumble, thumps, and other low-frequency noise, but at the expense of also cutting desired signal. I'd like to see it either tuned lower or with a steeper cutoff slope.

ALL-IN-ONE

As a complete analog front end, the Toft ATC-2 offers high-end performance, and manages to do it for a surprisingly moderate price: two channels of preamp, EQ, and compressor for \$1,300? I'd call that a sweet deal. **EQ**

Strengths:

- Vintage-based design
- Full, robust sound quality
- Excellent instrument input
- Smooth compression
- Powerful EQ

Limitations:

- No sidechain input on compressor
- Barely enough gain for quiet sources and instrument input
- Lowcut filter is heavy-handed



Instant studio . . . just add Freeport™ and mix!

Introducing Freeport, the great sounding, go-anywhere, turn-any-room-into-a-studio solution by Primacoustic.

Everyone knows that treating a room with acoustics makes recording easier. The problem is, most rooms are difficult to treat; they have doors & windows in the way, or they're temporary spaces that can not have acoustical panels permanently applied.

Primacoustic has a solution. . . It's called Freeport™.

Freeports are designed to give you the freedom to set-up anywhere and the portability to take your acoustic environment with you wherever you go. With Freeport, any room can be instantly turned into a usable, working recording space. Freeport also makes a great recording gobo to isolate instruments and is a quick and easy solution for a voice-over booth.

Made of high-density open-cell acoustic foam with a solid PVC frame and backboard, Freeport sets up in minutes and can be stored just as fast! It's that easy. And it really works... just ask BNL's **Steve Page**:

"Once upon a time, I had a studio setup in a room in my basement. A room with enough space for my gear and my instruments and a comfortable chair and some bookshelves. I liked to record in there. I spent hours and hours recording and mixing, and then I would proudly march my mixes to my car stereo, where they sounded terrible. What a huge disappointment to know how I'd been misled by my own basement. To the rescue came Primacoustic, with a whole bunch of affordable solutions. With the addition of some Freeports and some Australis bass traps, I could actually HEAR what I was mixing! Then, later, in my car, I could proudly crank mixes with confidence! See, it doesn't take a million dollars to help out your room!"

~ Steve Page, Barenaked Ladies



Steven Page and Jim Creeggan with Primacoustic's Peter Janis.

Don't pay more than \$129*

Price \$1,000,000

* estimated street price per unit



PRIMACOUSTIC™
STUDIO ACOUSTICS

www.primacoustic.com

by Craig Anderton

Sony Sound Forge 7.0

The original PC editor rolls a seven

Type: Digital audio editing/mastering software

Price: \$499.95

Contact: <http://mediasoftware.sony.com/pictures.com>

Platform: Windows

Minimum system requirements:

Windows 2000/XP with DirectX 8 and Internet Explorer 5.0 or later, 400MHz CPU, 64MB RAM,

Windows-compatible soundcard

Copy protection: Net registration, enter unlock code

Version reviewed: 7.0a

Internal resolution: 8-, 16-, 24-, 32-, 64-bit floating point

Supported sample rates: 2 to 192kHz

Driver support: Microsoft Sound Mapper, MME, WDM

Plug-in support: DirectX

Included plug-ins: Acoustic Mirror convolution reverb, amplitude modulation, chorus, delay/echo, distortion, dynamics, envelope, flange/wah, gapper/snipper, noise gate, pitch change, reverb, stutter, vibrato, and Wave Hammer (dynamics/loudness maximizer)

DSP: Trim/crop, bit depth converter, channel converter, DC offset, EQ, fade, insert silence, invert/flip, mute, normalize, pan/expand, resample, reverse, smooth/enhance, swap channels, time stretch, and volume

Supported samplers: Akai S1000/S2000, E-mu ESI-32/E-64/E-IV, Kurzweil K2000/K2500, Peavey SP, Yamaha A3000, SDS, SMDI

Import/export formats: AIF/SND, AU/SND, AVI, SD1, IVC Intertec, MOV, MP3, MPEG-1/MPEG-2 video (requires the MainConcept MPRG plug-in, standard version \$29.95, professional \$99.95), OGG, PCA, QT, RAW, VOX, W64, WAV, WMA WMV, 24fps DV video files

Export only: RM RealAudio9, RM RealVideo9

Sync: MIDI Time Code

Sound Forge (SF for short) set the standard for digital audio editing on Windows. Over the years it has faced serious competition from Steinberg Wavelab, Adobe Audition (formerly Cool Edit), Magix Sequoia, and others, but it continues to combine a serious feature set with ease of use. So how does Version 7 — the first one released since Sonic Foundry's desktop products were taken over by Sony — stack up?

THE SOUND FORGE GESTALT

Like other Sonic Foundry — er, Sony — software, Sound Forge has always been a straightforward, no-nonsense program. The emphasis is on fluid navigation around a no-frills interface; once you learn the various key commands and become familiar with the menus, you can really fly around the program.

THE NEW STUFF

First up: An Explorer window that greatly simplifies file operations such as preview,

delete, and drag into the main editing window. It may not be sexy, but it's utilitarian.

The integrated Spectrum Analyzer (formerly a separate plug-in) offers both a spectrum graph and sonogram. Also regarding plug-ins, SF now includes ExpressFX Vinyl Restoration, which has many more uses than just fixing vinyl — it can also remove digital clicks fairly easily.

Detect Clipping is another very cool new feature. This function will scan audio, and mark where distortion occurs so you can redraw the waveform or perform other repairs.

For recording, you can set up recording parameters — begin recording at a certain time, upon detection of MIDI time code, or when audio exceeds a certain threshold (with a prerecord buffer so you don't miss initial transients). Also, fade curves for fades, envelopes, FM synthesis, pitch bend, and pan/expand are now higher resolution and easier to adjust; additional meters monitor playback and recording levels.

Another change is the introduction of Project Files. When you create a project file, in addition to saving the media on which you're working in a subfolder, it also adds temp files created by editing operations. This means you can undo operations *prior* to your last save — it's no longer necessary to "save as" under multiple names when you want to play it safe. However, deleting the folder toasts your project... so back it up. Of course, when you're done, you can render the entire file (including edits) and delete the project folder.

Automation is now available for automatable effects and volume/pan. You can either move controls to create an automation envelope (this isn't real time, it's more like an easier way to draw an envelope), or draw an envelope from scratch. Envelopes are editable via break points. Finally, the synthesis options, which make it easy to generate test tones and even the occasional sound effect, now include white, pink, and brown noise. ►



THE SPECTRUM ANALYSIS VIEW, FORMERLY A SEPARATE PLUG-IN, IS A USEFUL TOOL FOR CHECKING AUDIO ENERGY DISTRIBUTION IN A FILE.

SOUND FORGE HANDLES VIDEO WELL — NOTE THE THUMBNAILS AND VIDEO PREVIEW WINDOW. THE PLUG-IN CHAINER (LOWER LEFT) ADDS A VARIETY OF EFFECTS, INCLUDING AUTOMATABLE ONES; TWO AUTOMATION ENVELOPES ARE VISIBLE SUPERIMPOSED ON THE WAVEFORM. THE EXPLORER MAKES IT EASIER TO FIND AND USE FILES, WHILE THE KEYBOARD CAN SEND NOTE DATA TO A SOUND CARD OR SAMPLER.

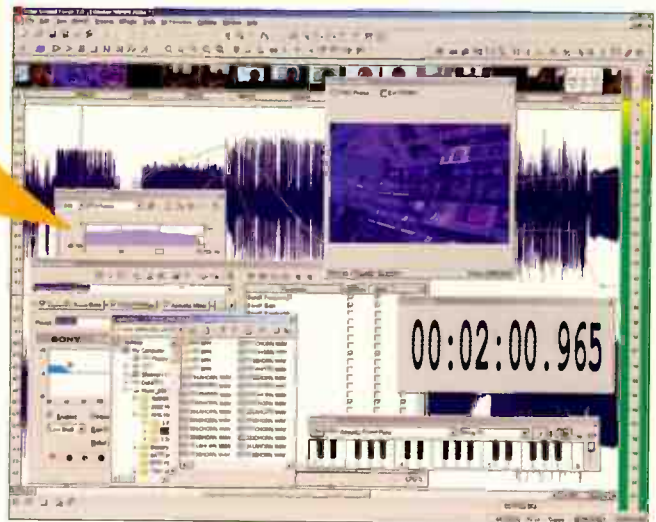

NEED PRO AUDIO GEAR?

THEN YOU SHOULD SPEAK TO THE PROS.

What is a real Pro, you ask?

Here at Full Compass we offer the most knowledgeable sales professionals in the audio world. Many of us have been serving our customers for 15 or 20 years, and they keep coming back. Why? Because of what a real Pro offers: loyalty and long term service. We build relationships.

You and Full Compass, where the Pros are.

Call us at 800-356-5844 and talk to a real professional, 8am to 8pm Central Time Monday through Friday or 10am to 4pm Saturday. We will give you the attention you need... and deserve.

Call us – you'll want to stay on the phone for decades.



Call us today
& talk to a real pro!
1-800-356-5844

FULL COMPASS
WHERE THE PROS ARE.

www.fullcompass.com

Sony Sound Forge 7.0

CD AND VIDEO HANDLING

Sound Forge can rip audio and burn CDs. However, the only available mode is Track At Once; for Disc At Once, you'll need something like Sony's own CD Architect. If CDs are too 20th century for you, you can now export to portable devices — either Net MD (Minidisc) or as an MP3 to Clie handheld PDAs. Clever, eh?

SF's rock-solid video window remains an effective way to edit audio for video. You can attach video to, or detach it from, an audio file, as well as preview on an external monitor (assuming you have a suitable OHCI-compliant, IEEE-1394 device). You still can't edit video — that's what Vegas is for, and of course, you can open Sound Forge from within Vegas — although you can re-render to a different frame rate.

WHAT ABOUT LOOPING?

SF lets you specify a number of beats and a root note for transposing if you want to use a sample within Acid. Acid will take this data and insert default acidization markers. However, I noticed something interesting: If you take a loop that already has tweaked acidization markers (not the default ones), import it into SF, process it, save it, then bring it back into Acid, the acidization markers will remain as you set them manually. But if you bring them into Sonar, although Sonar recognizes the loop as being acidized, the markers revert to default settings.

There's more — processing a loop within Adobe Audition retains tweaked acidization markers in either Sonar or Acid, while processing a loop within Wavelab retains tweaked acidization markers in Acid, but Sonar doesn't even recognize it as an acidized loop — just a standard WAV file. Go figure. . . .

Other looping tools allow marking off a loop via a grid, and moving selection areas left or right. This reminds me of BIAS Peak's "loop surfer" function, although Peak's implementation is more flexible. Another function, rotate audio, moves beats like a shift register. In other words, if the beats in a measure are 1-2-3-4, rotating once changes the order to 2-3-4-1, rotating again changes to 3-4-1-2, etc. SF can also display tempo based on the loop length. You cannot, however, insert acidizing markers.

PLUG-INS

SF comes with a decent selection of plugs, however I would rate the Wave Hammer dynamics processor/loudness maximizer and Acoustic Mirror convolution reverb as outstanding. Almost 60MB of reverb impulses are available on the Sony website, which you can download in one big glob, or *à la carte*.

FILE FIXING

To get rid of clicks, the "interpolate" feature is much slicker than using the "pencil" tool. Locate the click, select a region around it, choose Interpolate, and SF kills the click. Another option, Replace, is more for fixing short audio regions (like vinyl scratches) than isolated events. It replaces selected audio with the audio that preceded it, with crossfading to prevent glitching. For small regions, it's quite effective. With stereo files, another option is to copy data from one channel to replace corrupted data on the other channel.

If you're into one-stop cleaning, the Vinyl Restoration plug-in rocks. Despite the name, its ability to repair clicks, pops, and noise is useful for far more than vinyl, such as digital clicks or background hiss from tape. While not as sophisticated as Sony's Noise Reduction plug-in, SF's tools will take care of many, if not most, of your repair needs.

SAMPLING

Sound Forge continues to provide sampler support, using SCSI and/or MIDI. A loop tuner tweaks loop start and end points, and there are crossfading tools — which also come in handy when making acidized loops, as you can create a smooth transition from beginning to end.

STIFF COMPETITION

Compared to Steinberg WaveLab and Adobe Audition, there's no way to go beyond a stereo file with SF. For most people, this won't be an issue; but when burning CDs, it's sometimes helpful to be able to add a transition or sound effect. It's possible to do the same type of thing in SF by mixing/pasting a file from the clipboard, but it's more awkward. And although I seldom use Wavelab's montage feature, there have been times it has been essential.

Overall, though, the differences have more to do with working style. I'd say SF





Nemo
Music Festival

Nemo PRESENTS THE OPPORTUNITY TO:
GIVE YOUR PARENTS THEIR

GARAGE BACK

SEPT.30-OCT.2 ² BOSTON MASSACHUSETTS
₀
₀
₄

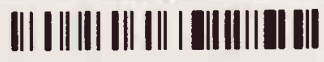

STAGE		
SECTION	ROW	SEAT
OVER 250 BANDS		
AT OVER 25 VENUES		
NEMOBOSTON.COM		
FOR AN APPLICATION		
PHONE 617-348-2899		
FAX 617-348-2830		

Go to nemoboston.com and sign up now for the chance you've been waiting for.

Take Control

With the StudioComm for Surround Model 78 Central Controller and companion Model 79 Control Console, your surround audio monitoring needs will be under control.

Ideal for a variety of applications where 7.1 surround monitoring is required, the 78/79 system features multiple source selection, extensive downmix capability, and integrated bass management. And, of course, delivers the sonic performance you demand.

So there's absolutely no reason for control to be an issue. Visit our website or call today for more information.



**STUDIO
TECHNOLOGIES
INC.**

Skokie, IL USA | Ph 847-676-9177 | www.studio-tech.com

Sony Sound Forge 7.0

is more of an industrial type of sound editor that concentrates on getting work done with a finely-honed tool set, optimized for efficiency. Wavelab is a more ambitious, music-oriented tool — for example, there's no video support — but it lacks automation, so doing fine edits requires defining regions and applying DSP, not just drawing a quick curve.

Wavelab has more extensive ways to deal with burning CDs, and it accepts VST plug-ins. However, with Cakewalk's wrapper, SF can accept VST plug-ins and automate automation-friendly ones. SF also has no limitations on how many effects you can stuff into the plug-in chainer.

As to Adobe Audition, it remains extremely cost-effective and includes a multitrack option. It has much in common with SF, but doesn't handle plug-ins as elegantly, and I find the interface slightly less intuitive.

The Wavelab/Sound Forge/Audition debate has gone on for years, with passionate partisans on all sides. Yet while they share similar functionality, they do so with different styles and a somewhat different feature set. Ultimately it comes down to personal preference, and what type of work you do — the requirements for chopping up dialog or straight-ahead mastering are different than adding a cymbal crash transition to a CD you're about to burn.

In any event, the cumulative advances that led to SF 7 have managed to add more power while retaining a friendly, efficient interface. Throw in goodies like vinyl restoration, Wave Hammer, Acoustic Mirror, automation, video support, and MIDI sync, and you have an environment that's built for speed, but also includes the tools for serious digital audio editing. **EQ**

Strengths:

- Obvious, clean interface
- Wave Hammer is a fine loudness maximizing plug-in
- Built-in convolution reverb
- Useful click repair and vinyl restoration tools
- Good handling of video

Limitations:

- No Disc at Once CD burning
- No "montage" option like Wavelab
- No ASIO support, scripting, or batch processing

PHONIC

Full line of recording and live sound equipment

800.430.7222

www.phonic.com

Tampa, FL

Luaka Bop Artist Jim White



Musicians Friend

The World's Largest Music Gear Company

Musicians Friend
Platinum Member

SAVE
with
Special
Financing!*



SHURE

KSM27 Studio Mic
The latest in Shure's line of high-quality, affordable studio mics!
270278 List \$575.00

\$15/mo

\$299⁹⁹



Focusrite

ISA220 Session Pack
Audio precision tools to infuse your sessions with Focusrite's renowned sonic performance.
188209 List \$1,995.00

\$45/mo

\$1499⁹⁹



Auralex

Roominator Alpha 1
Turn any room into a studio.
4226329 List \$319.00

\$15/mo

\$299⁹⁹



TASCAM

2488 24-Track Digital Recording Workstation
The most affordable 24-track recording and mixing workstation for your home studio.
241112 List \$1,499.00

\$36/mo

\$1199⁹⁹



MACKIE.

HR624 Active Studio Monitor
Biamped, transparent reference sound at a sweet price!
605258 List \$599.00

Call For Sale Price



For Your **FREE** One-Year Catalog Subscription
Call **800-436-6981** or
Click **musiciansfriend.com/free**

Check out our **FREE** weekly gear giveaway worth up to
\$2,500 @ musiciansfriend.com/free

- Order 24/7
- 45-Day Best Price Guarantee
- 45-Day Satisfaction Guarantee
- More Than 36,000 Products
- Over 250,000 Square Feet of Gear Ready to Ship to Your Door
- Rapid Delivery, Most Orders Shipped the Same Day*

To get your **FREE** Catalog subscription, fill out this handy coupon and mail to: Musicians Friend, Dept. CR, P.O. Box 1117, Draper, UT 84020-1117

Name _____

Address _____

City _____ State _____ Zip Code _____

E-mail address _____

Area(s) of interest: Guitar & Bass Drums & Percussion Keyboard Live Sound
 Brass Woodwind Orchestral Strings Concert & Marching Percussion

SOURCE CODE: EQDD

Limited to stock on hand; prices subject to change; standard catalog shipping rates apply. *On orders received by 5PM ET Mon.-Fri.
† Cannot ship via air due to FAA regulations.

** Visit www.musiciansfriend.com or see your Musicians Friend Catalog for details!

by Mitch Gallagher

Fishman Pro-EQ Platinum and Pro-EQ Platinum Bass

Why settle for plain ol' direct boxes?



Type: Instrument direct box/preamp/EQ

Price: Pro-EQ Platinum, \$249.95; Pro-EQ Platinum Bass, \$249.95

Contact: Fishman Transducers, www.fishman.com

PRO-EQ PLATINUM

Connections: 1/4" instrument input, 1/4" tuner send, 1/4" output, XLR output

Input impedance: 10M Ω

Signal to noise: -90dB (A weighted)

Number of EQ bands: 4

EQ frequencies/range

Bass: ± 12 dB @ 60Hz and ± 3 dB @ 350Hz

Mid: ± 12 dB, sweepable from 250Hz-5kHz

Treble: ± 12 dB @ 10kHz and ± 3 dB @ 2.4kHz

Brilliance: ± 9 dB @ 10kHz and ± 3 dB @ 7kHz

Other controls: Input Gain, Volume, Phase switch, Smooth (high-frequency compression), Notch (sweepable notch filter), XLR ground lift, XLR pre-EQ/post-EQ switch

Power: 9v battery, AC adapter, or 48v phantom power

PRO-EQ PLATINUM BASS

Connections: 1/4" instrument input, 1/4" tuner send, 1/4" output, XLR output

Input impedance: 10M Ω

Signal to noise: -89dB (A weighted)

Number of EQ bands: 5

EQ frequencies/range

Bass: ± 12 dB @ 30Hz

Low Mid: ± 6 dB @ 200Hz

Mid: ± 6 dB @ 1.25kHz

Hi Mid: ± 9 dB @ 5kHz

Treble: ± 12 dB @ 10kHz

Other controls: Input Gain, Volume, Phase switch, Depth (12dB/octave lowcut filter sweepable from 15-125Hz), Compression (up to 14dB gain reduction), XLR ground lift, XLR pre-EQ/post-EQ switch

Power: 9v battery, AC adapter, or 48v phantom power

A regular DI works well for getting pickup-equipped acoustic guitars, basses, and other stringed instruments into a recording system or PA. For those who want to go beyond the ordinary DI, Fishman Transducers has created the Pro-EQ Platinum series. There are two models, the Pro-EQ Platinum for guitar (and other acoustic instruments), and the Pro-EQ Platinum Bass, for, well, bass. Both units comprise direct boxes, preamps, EQs, and other processing.

PRO-EQ PLATINUM

As a direct box, the Pro-EQ Platinum (P-EP) is voiced for non-bass instruments. There's a pretty substantial cut in low frequencies, presumably designed to help reduce feedback in live situations. With regular guitar tunings, you won't even be aware of it. If you're into low guitar detunings, you'll notice.

The P-EP has a 4-band EQ: low, sweepable mid, treble, and brilliance. The bass and the treble controls affect two frequencies each; they're fairly broad. The EQ frequencies are well

chosen. Whether you're using the Fishman to fatten up and add sparkle to solo fingerstyle or to punch up hard-strummed rhythm tracks, the EQ works well. It's also great for carving away unnecessary low end when you're trying to seat a guitar part in a track.

The P-EP has other processing as well: There's Notch, a sweepable filter designed for cutting feedback onstage. The Smooth control provides what Fishman calls "Acoustic Compression"; what sounds like frequency-dependent compression, designed to remove the hard edge a DI'd acoustic can have. It works well. If you set it correctly, all the brilliance will be there, but the edge will drop away. Too much, and the sound will be dull.

You can power the P-EP using a 9v battery, an optional 48v power supply, or phantom power. The XLR output can take its signal either pre- or post-EQ.

PRO-EQ PLATINUM BASS

The Pro-EQ Platinum Bass (P-EQB) has full low-end response — as you'd expect. The two models are otherwise very similar, but the P-EQB

has five fixed bands of EQ. Instead of Smooth and Notch controls, you get "Depth," a sweepable lowcut filter, and "Compression," an automated compressor. Compression is easy to dial in to smooth things out, solidify the tone, or control slapping and popping.

RECORD PLATINUM

Both boxes are simple to use. The phantom powering is especially nice for studio work. I tracked several electric basses as well as my Taylor steel-string direct into a mic preamp. As pure DI boxes, the Platinums stacked up well with the other active transformer-less DIs in my locker (aside from the low-end on the guitar unit). The sound is full and round. The top end isn't sterile on the guitar; there's a warmth, even without the Smooth control engaged. With Smooth turned up, guitars sound even more natural. Utilizing the EQ, you can shape the tone into whatever you want.

As live stage tools, the Pro-EQ Platinums' usefulness is readily apparent. As all-in-one acoustic instrument and bass recording tools, the Pro-EQ Platinums have what it takes to get good tones down. Why use a DI when you can have so much more?

Strengths:

- Complete direct input solution
- Operate off phantom power
- Well-chosen EQ frequencies
- Flexible tone-shaping controls

Limitations:

- No mute switch for use with tuner output



WE MAKE GREAT ROOMS HAPPEN



Latin Grammy Award Winning Producer Sergio George's private production facility, NJ

Great Gear, Great Value.

Whether you're building a personal project studio, a world-class facility, or something in between, Professional Audio Design can help you make the most of your investment. Our staff of real-world engineers and technicians understands what makes a great recording facility, and can recommend solutions that meet every budget. We carry over 150 brands of new, refurbished and vintage equipment, including Certified Pre-owned SSL Consoles.



Service, Support and Satisfaction

Professional Audio Design has a world-renowned technical services team that provides in-shop repair, refurbishment, custom electronics, and modifications for many stock items. Our on-site support includes wiring, system commissioning, installation and maintenance. We stand behind our work with full warranty coverage and after sale support. We service the top studios in the world, and your studio should experience that same level of satisfaction.



Before you settle for something less, visit us online, or call (877) 223-8858, and find out how our personalized service approach will make your room happen.

www.proaudiodesign.com

Equipment Sales

Consultation

Technical Services

Wiring Systems

Installation

Custom Monitors

Custom Furniture

Certified Pre-owned SSL's

DAW Systems

**Professional
Audio
Design
Inc.**

ALWAYS A SOUND DECISION



by John Krogch

IR-1 combines a knock-out impulse response library with the kind of parametric control you'd expect from a professional digital reverb, making it the undisputed champion of convolution reverbs.

Waves IR-1 Parametric Convolution Reverb

The next step in sampled reverb

Type: Convolution reverb plug-in for Mac and PC

Price: \$1,200 (TDM), \$800 (native)

Contact: www.waves.com

Platform: Mac OS X, Windows XP

Channels: mono, mono-to-stereo, stereo (surround planned for a future version)

Impulse response source file support: WAV

Sample rate support: up to 96kHz

Demo period: 14 days

For the last 25 years or so, the method for creating artificial reverb (*i.e.*, simulated ambience) has been to synthesize room characteristics such as early reflections, room size and shape, etc. But thanks to huge leaps in processor technology, today's consumer-grade computers are capable of serious number crunching — the kind of math that makes a different kind of reverb processing possible. It's no surprise, then, that plug-in developers have started capitalizing on this, resulting in a new type of reverb based on convolution.

Simply put, convolution reverb blends together an input signal with another signal called an *impulse response*. An impulse response (IR for short) is a recording, or

"snapshot," of a real space or hardware processor. In the case of Waves' IR-1, an impressive collection of acoustic spaces and high-end hardware units were recorded at 24-bit/96kHz resolution, resulting in the single largest, most comprehensive commercially released IR library to date.

Tipping the scales at just over 1GB, IR-1's library includes top-flight recording studios, night clubs, concert halls, churches, and more from all around the globe, as well as a choice sampling of presets from what is likely a high-end "L"-brand reverb unit (I'm guessing here, but with names such as LX 48L Concert Hall, what else could it be?). But there's more to IR-1's story than its rich library, so let's get to it.

OVERVIEW

There are advantages and disadvantages to convolution reverb. Because it relies on samples of acoustic spaces, convolution sounds much more natural and convincing compared to synthesized 'verb. On the flip side, you can't change the characteristics of a sampled space the way you can with digital reverbs. Early reflections, density, size — it's all part of the IR recording. What Waves has done is combine the best of both worlds: IR-1 is a hybrid processor that uses convolution as the basis of its reverbs, but also offers the ability to tailor the IRs in a similar way to working with synthesized digital reverb.

To make this possible, impulse responses were captured in a multi-channel format,



DAMPING AND EQ CHANGES CAN BE MADE FROM THE SAME WINDOW BY DRAGGING THE CONTROL POINTS.



IMPULSE RESPONSES ARE REPRESENTED GRAPHICALLY IN THE CENTER WINDOW. HERE I'VE CHANGED PREDELAY FOR THE EARLY REFLECTIONS AND REVERB TAIL TO SHOW HOW AN IMPULSE CAN BE SEPARATED INTO THREE PARTS.

**It's hard enough making it
in the MUSIC BUSINESS.**

Why fly by the seat of your pants?

GC PRO

presents:

Music

Business Chops

**2004
Regional
Seminars**

**Half-day Business Intensives for
Pro Audio and Music Professionals**

Music Industry Leaders Discuss:

- *The latest in record and game production, songwriting, music supervision, project and commercial studio operation*
- *Business Tips and Techniques for Independents*
- *New Revenue Sources Roundtable*

Plus: Exhibits of Professional Products and Services
One-on-one Career Counseling and Song Demo Clinic

Facilitated by award-winning management coach
John Stiernberg, author of "Succeeding in Music"

The 2004 Spring West Coast Tour

www.studiobusinesschops.com for venues and details

Saturday, May 15 **San Diego**
Sunday, May 16 **Los Angeles**
Tuesday, May 18 **San Francisco**
Wednesday, May 19 **Sacramento**
Friday, May 21 **Portland**
Saturday, May 22 **Seattle**

In association with:

EQ

KEYBOARD

GuitarPlayer

**BASS
PLAYER.**

prosound

surround

Produced by David Schwartz and Giovanna Imbesi

World Radio History

Waves IR-1 Parametric Convolution Reverb

which IR-1 divides it into three components — direct sound, early reflections, and reverb tail. Each of these can be engaged independently and have its own gain and pre-delay. Direct is the portion of the IR that was recorded with a microphone placed in a straight line from the speaker used to drive the space. It's not the same as the Dry signal — an important distinction, as Direct-processed signals will include characteristics of the IR.

By itself, having this kind of control is powerful. For example, you're free to use just the early reflections of a large hall to create a sense of space without causing the track to sound cluttered from the reverb tail.

But it gets better. Gain envelopes can be created and applied to the IR shape, allowing you to redesign the decay and other aspects of the recorded sound. For creative applications, using an envelope can produce wild results. Or you can use an envelope to do something as simple as make a gated reverb.

Because it relies on samples of acoustic spaces, convolution sounds much more natural and convincing compared to synthesized 'verb.

There are other, more familiar reverb controls, such as damping, reverb time, density, and so on. As parameters are adjusted, the display updates to show how the IR source signal has been changed — it's pretty cool, and adds a certain "wow factor." Any change

requires a recalculation of the IR, though, which is an offline process that can take a second or two to complete. On my 1GHz dual-processor G4, for example, changes to density, decorrelation, resonance, and other controls along the lower half of the plug-in were made almost instantly, even when audio was being processed. Tweaks to low- and high-frequency damping and EQ took a few seconds longer.

It might go without saying, but all this processing magic comes at a price — IR-1 is more of a processor hog than your average host-based reverb. Fortunately, Waves has provided less CPU-intensive options. Stereo IRs can be used in different channel configurations: Efficient and Full. Efficient mode processes signals as dual mono sources, with a control for summing left and right sides of an input. It takes less CPU power, since only two convolution processes are required (one for each channel). Full mode uses four channels, left input to stereo and right input to stereo, which takes twice as much processing



Learn Audio Recording Like Nowhere Else.

The Conservatory of Recording Arts & Sciences
1.800.562.6383

All students train, hands-on, in cutting edge 48-track Analog/Digital Recording Studios that feature:

- SSL
- Studer
- Otari
- Neumann
- Neve
- Neotek
- Lexicon
- Hafler

Plus...

- eMac/Logic Platinum Digital Lab
- Tascam Analog/Digital Mix Down Lab
- Individual G4 Pro Tools Workstations
- And Much, Much More!

- No more than 12 students per class - taught by award winning professionals.
- Every student completes an internship in the industry for graduation.
- Only recording school authorized by Avid/Digidesign, T.C. Electronic, Waves, and SLA to certify students in the use of their products.

L2 electronic **SIA** **ADD** **CD**

2300 East Broadway Road
Tempe, Arizona 85282
www.audiorecordingschool.com



RME
INTELLIGENT AUDIO SOLUTIONS

HDSP9632
24 Bit/192 KHz 32 Channel I/O Card

The world's most flexible audio solution is now even more affordable

Create Your Next Masterpiece

samplitude 7
It just sounds better...

Download the demo today...
samplitude.com

Electronic Musician
2004 EDITORS CHOICE

Best Audio Editor

More info on products and upgrades:
info@synthax.com Voice: 330.259.0308 www.synthax.com

synthax 2001

THE SOURCE FOR HARDWARE



- The Ultimate Information Source for Pro Audio Hardware
- B&H Audio Professionals Choose the Newest Products & Technology
- Over 700 Pages of New Mixers, Recorders, Loudspeakers, Mics, Processors, Workstations, Power Amps, Sound Reinforcement/PA, Studio Monitors

THE PROFESSIONAL AUDIO SOURCEBOOK

Volume 1 (Hardware) Volume 2 (Software)

420 Ninth Ave., New York, NY 10001

Toll Free
800 875-6951

800.947.7008

www.bhphoto.com



FOCUSRITE

RED 3

Dual-Channel Compressor/Limiter

Employing an unusual and original single VCA design, the Red 3 provides two perfectly matched channels of compression-quantity and ratio independent compression and limiting. Incorporating a TEC sound following Class A VCA design results in a short signal path and extremely low noise, allowing the Red 3 to achieve truly transparent compression/limiting. This same compression is provided from a single set of controls, ensuring perfect phase coherence between both channels when working with stereo audio signals. A frequency response of 5 Hz to 200 kHz provides excellent linear audio performance. With its distinctive deep burgundy completed aluminum chassis and solid design, the Red 3 is at home in any critical audio recording application where the ultimate sonic integrity is so desired.

FEATURES

- The Red 3 VCA is a proprietary Focusrite design. Fully stereo and balanced, offering superb low noise and distortion, and excellent transient response.
- To take on stereo compression and limiting, the 600-ohm ohmic resistors within the VCA do not require any external resistors, which allows the VCA to be used in any critical audio recording application where the ultimate sonic integrity is so desired.
- The Red 3 VCA is a proprietary Focusrite design. Fully stereo and balanced, offering superb low noise and distortion, and excellent transient response.
- To take on stereo compression and limiting, the 600-ohm ohmic resistors within the VCA do not require any external resistors, which allows the VCA to be used in any critical audio recording application where the ultimate sonic integrity is so desired.
- Each channel has dual and identical controls, for compression ratio, threshold, attack/release, and auto gate.
- A program-dependent auto-release mode is available, and the VCA can be used in any critical audio recording application where the ultimate sonic integrity is so desired.



BLUE 230 Broadcast Dual-Channel Compressor/Limiter

The Focusrite Blue 230 is a specialized version of the Red 3, optimized for broadcast applications. It features the same award-winning signal path, but with additional control of critical parameters for broadcast use.

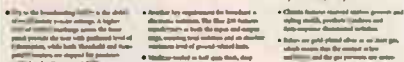

- The Blue 230 is a specialized version of the Red 3, optimized for broadcast applications. It features the same award-winning signal path, but with additional control of critical parameters for broadcast use.
- The Blue 230 is a specialized version of the Red 3, optimized for broadcast applications. It features the same award-winning signal path, but with additional control of critical parameters for broadcast use.

FOCUSRITE

RED 7

Mc Preamp and Channel Strip

The Red 7 combines a single channel of classic Focusrite microphone preamplification with two channels of stereo processing. In addition to the mic preamp, the Red 7 features a single channel compressor from the Red 3 and adds a de-esser. So now you can get the warmth of classic Focusrite mic preamps and the transparency, smooth characteristics of their compressors in one affordable package. With its superb signal path, outstanding ease of use, and integrated all-in-one design, the Red 7 is a powerful tool for your recording in all instances from main studio to your production.

- Features the classic, broadcast standard dual inputs and outputs for professional applications and superb low noise and distortion.
- The mic preamp design is a classic Focusrite design, featuring a high impedance input and a low impedance output. The mic preamp is a classic Focusrite design, featuring a high impedance input and a low impedance output.
- The compressor design is a classic Focusrite design, featuring a high impedance input and a low impedance output. The compressor is a classic Focusrite design, featuring a high impedance input and a low impedance output.
- The de-esser design is a classic Focusrite design, featuring a high impedance input and a low impedance output. The de-esser is a classic Focusrite design, featuring a high impedance input and a low impedance output.



The Source for Professionals

800-947-5518 • www.bhphotovideo.com

World Radio History

Waves IR-1 Parametric Convolution Reverb

juice. You can choose the mode for any stereo IR when the plug-in is instantiated.

Additionally, from the plug-in interface you can choose between Full and Low CPU modes; the resolution of convolution processing is lower with Low, which saves anywhere from 20–45%, according to Waves. In practice, I couldn't hear any difference between the two modes in the context of a mix, so it's conceivable you could operate in Low CPU mode entirely without any audible compromises.

IN USE

This was the first Waves product I've tested that uses a USB iLok dongle for copy protection. Installation and authorization on the dual-processor G4 running OS 10.2.6 went off without a hitch. In minutes after installation I was up and running within Logic 6.3.3. Set-up on my 1GHz Titanium was a different story — I could install the plug-in, but Logic refused to see it. According to Waves, this was due to a known bug in OS X 10.3.x; contact

Waves for a workaround if you encounter similar difficulties.

After auditioning a cross-section of presets ranging from ambiences and rooms to halls and Lexicon-like samples, I was convinced: This is a remarkably real and complex-sounding reverb. "The sound is very natural," commented *EQ*'s Mitch Gallagher. "There's an organic quality to the ambience that sits very well around acoustic instruments and vocals. Even when using IR-1 on a delicate solo instrument such as nylon-string classical guitar, the reverb doesn't seem artificial."

I agreed. I applied IR-1 to bone-dry cello, rock vocals, close-miked and overhead drums, steel-string acoustic guitar, and even solo Tuvan singers. IR-1 delivered in every case, whether it was a smaller room or cavernous sound I was looking for.

CONCLUSIONS

Waves has a hit on their hands. IR-1 raises the bar for convolution reverb plug-ins. It's not the only game on the market, but Waves'

IR-1 is the best for several reasons. It's available for Mac and PC. It's unmatched in its programmability. And the library covers more ground than other reverbs in its class. I'd have to nitpick to find fault, and even then I can't really make a case. If you're looking to add a convolution reverb to your plug-in arsenal, this is the one to get. **EQ**

For details on the making of IR-1's library, point your browser to www.eqmag.com.

Strengths:

- Comprehensive, high-quality impulse response library
- Switchable between high and low CPU usage
- Impulse responses can be tailored with gain envelopes
- WAV files can be imported and used as IRs
- Smooth, natural tails

Limitations:

- Won't run on Mac OS 9, unlike other Waves version 4 plug-ins
- No printed manual

Vintech Introduces the X73i!



We put this piece head to head with vintage Neve 1073's at this year's AES show. It is 100% guaranteed to meet your expectations and is an incredible value. List price \$1595 **Special \$1375**



The X73

The Vintech X73 features custom hand wired concentric style switches with gold plated pins. Swiss made military grade attenuator switch. List price \$1995 **Special \$1795**



The "X81 CLASS A"



The Model 473

www.vintech-audio.com
1-877-4-MIC-PRE

SONIC CIRCUS Serious Studio Infrastructure

Proudly announcing North American distribution of AMS/Neve outboard.



- 1073 mic pre/eq
- 1081 mic pre/eq
- 1084 mic pre/eq
- 33609J discrete stereo comp/limiter
- 1081R/AIR remote mic pre system

Accepting orders
Toll Free: 1-888-SC-4-GEAR



www.soniccircus.com

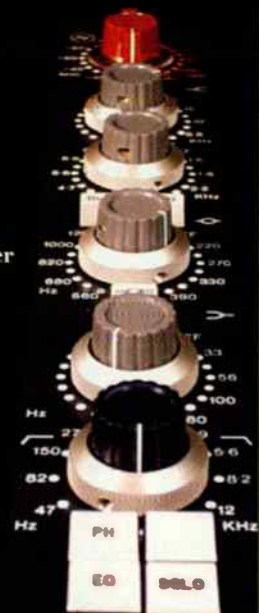

It's not easy being the best ...

Times and technologies change, but some things remain the same. Since opening our doors in 1924, it has been our goal to keep musicians on the cutting edge of music technology - from analog to digital and beyond. The **Sam Ash Professional Audio Group** was created with the special needs of studio and live sound professionals in mind and is the only pro supplier backed by over **79** years of experience. We pride ourselves on offering an unbeatable selection of the latest gear backed by unmatched expert service and the guaranteed lowest prices in the industry. Visit our totally new website online at www.samashpro.com. If you are in the New York City area, stop by our newly renovated showroom. Call (212) 586-1100 for an appointment.



... but we've been doing it for 80 years!

SELECTION

The nation's largest selection of name-brand recording, live sound, DJ and computer solutions!

SUPPORT

Professional Service.
Professional Training.

PRICE

The Guaranteed Lowest Price backed by our 30-Day Satisfaction Policy!



162 West 48th Street • New York, NY 10036 • (212) 586-1100 • www.samashpro.com

Tapco S•5 Nearfield Monitors

by John Krogh

Price: \$499/pair

Contact: Tapco, www.tapcogear.com

Strengths:

- Multiple input choices
- Voltage switchable between 115 and 230 VAC
- Tone shaping controls

Limitations:

- No control for switching between +4/-10 operation



Tapco isn't a name commonly associated with quality nearfield monitors, but that may all change with the S•5 powered monitors. Their back-story is short and sweet: Tapco was the company Greg Mackie started back in '69. They built inexpensive, dependable (*i.e.*, roadworthy) live sound mixers with enough headroom to handle the signal levels of a typical rock band. Fast-forward to the present: Tapco has been reborn as a brand of parent company Loud Technologies, and like the tank-tough mixers of yore, the S•5 powered monitors are aimed at budget-minded musicians.

The S•5 features a 5-1/4" woofer, a 1" silk tweeter, and a separate 60-watt power amplifier for both high and low

frequency drivers. Cosmetically, the exterior has a modern, rubber-like look with smooth edges and soft curves. On the rear you'll find balanced XLR and 1/4" and unbalanced RCA connectors, all of which can be used simultaneously. This is useful if you want to monitor a CD and noodle along on your stereo keyboard, for example.

There's not much protection for the tweeter, and as I was moving the speakers around my studio one of the cones was accidentally pushed in. No biggie — I was able to coax it back into shape.

For tonal shaping, high-frequency shelving (± 2 dB at 5kHz) and low-frequency peak controls ($+2$ or 4 dB at 65Hz) are available. Tapco claims a flat frequency response from 20kHz down to 64Hz. Indeed, the S•5s

are easy on the ears. (I listened for hours on end without significant fatigue.) If anything, there's a slight low-end bump and a high-frequency roll-off that I found to make the sound a bit boxy. Even with the high-frequency shelving, I had trouble hearing as much detail on the top end as I like. Mixes never sounded muddy, though. In fact, lower mids were clear, focused, and kick drums could be heard *and* felt without being too boomy or clicky.

As with most pro audio gear, choosing a nearfield monitor is largely based on personal preference. I happen to like a brighter sound, but if you're the sort who prefers a darker, more rounded character from their studio speakers, the S•5 is a solid contender that should be given a close look. **ED**

Learn the Art of Recording



Powerful Practical Professional

- World-class (yet affordable) education in Recording Engineering & Music Production
- Full-time, two month experience to chart your career and change your life

Recording Workshop

www.recordingworkshop.com

REC info@recw.com
800-848-9900

740-663-1000 outside US

Founded 1971 • 455 Massieville Rd., Chillicothe, Ohio 45601
Licensed by State Board of Career Colleges and Schools

"The most important tool we use in our industry just got taken up about 10 notches. ADAMs will change your life."

Ted Curtis, Upstairs Productions, Oklahoma City, OK



Distributed in the United States by ADAM Audio USA (805) 413-1133

Come meet the entire ADAM family at www.adam-audio.com





The John Lennon

SONGWRITING CONTEST



Categories

- Rock World
- Gospel/Inspirational
- Hip-Hop Children's Electronic
- Pop Folk Rhythm & Blues
- Jazz Country Latin
- new** Lyrics

Awards and Prizes

- Grand Prize Winners in each Category
- \$20,000 for the Maxell Song of the Year
- \$60,000 in EMI Music Publishing Contracts
- \$60,000 in Yamaha Project Studio Equipment
- 13,000 full color custom CDs courtesy of Discmakers
- Open to Songwriters, Lyricists and Bands!

Sponsored by: **YAMAHA** **maxell** **Musician's Friend** **DISCMAKERS EQ**

To **ENTER** your original song(s) fill out this application and...just imagine

NAME _____

ADDRESS _____

APT. _____

CITY _____ STATE _____ ZIP _____

PHONE () _____ AGE _____

EMAIL _____

SONG TITLE _____

CHECK ONE: LYRICS INCLUDED INSTRUMENTAL COMPOSITION

CIRCLE ONE (IF PAYING BY CREDIT CARD): VISA MASTERCARD

CARD # _____

EXP. _____ SIGNATURE _____

Mail your entry to: **John Lennon Songwriting Contest**
620 Frelinghuysen Avenue Suite #131
Newark, NJ 07114

Each entry must consist of:

- Completed and signed entry form (or photocopy). All signatures must be original.
- CD(s) or audio cassette(s) containing one song only, five (5) minutes or less in length.
- Lyric sheet typed or printed legibly (please include English translation if applicable). Sheets not required for instrumental compositions.
- Check or money order for \$30.00 per song (U.S. currency only) payable to John Lennon Songwriting Contest. If paying by credit card, \$30.00 per song will be charged to your account.

Entries must be postmarked no later than September 28, 2004.

Please read all rules carefully, and then sign your name in the space provided. If entrant is under 18 years old, the signature of a parent or guardian is required.

1. Each song submitted must be contestant's original work. Songs may not exceed five (5) minutes in length. Songs may have multiple co-writers, but please designate one name only on the application. Contestant may submit as many songs in as many categories as he/she wishes, but each entry requires a separate cassette, CD, or MP3 file, entry form, lyric sheet, and entrance fee. One check or money order for multiple entries/categories is permitted. (Entrance fee is non-refundable. JLSC is not responsible for late, lost, damaged, misdirected, postage due, stolen, or misappropriated entries. The JLSC is not responsible for faulty file uploads accompanying online entries.)
2. Twelve (12) Grand Prize winning songs (words with music or instrumentals) will receive \$5,000 in Yamaha project studio equipment, a \$5,000 advance from EMI Music Publishing, and 1,000 CDs in full color, premium 4-panel

3. Digipaks, worth \$1,990 courtesy of Discmakers. One (1) Grand Prize winning song (words with music or instrumentals) will receive \$20,000 for the "Song of the Year" courtesy of Maxell. Thirty-six (36) Finalists will receive \$200 gift certificates from MusiciansFriend.com.
 4. Contest is open to amateur and professional songwriters. Employees of J.L.S.C., their families, subsidiaries, and affiliates are not eligible.
 5. Winners will be chosen by a select panel of judges comprised of noted songwriters, producers, and music industry professionals. Songs will be judged based on melody, composition and lyrics (when applicable). The quality of performance and production will not be considered. Prizes will be awarded jointly to all authors of any song; division of prizes is responsibility of winners. Void where prohibited. All federal, state, and local laws and regulations apply.
 6. One (1) winning songwriter's band will be selected by WARPED TOUR '05 organizers to tour and perform for one week on WARPED TOUR '05. Performance will be considered.
 7. Winners will be notified by mail and must sign and return an affidavit of eligibility/recording rights/publicity release within 14 days of notification date. The affidavit will state that winner's song is original work and he/she holds all rights to song. Failure to sign and return such affidavit within 14 days or provision of false/inaccurate information therein will result in immediate disqualification and an alternate winner will be selected. Affidavits of winners under 18 years of age at time of award must be countersigned by parent or legal guardian. Affidavits subject to verification by J.L.S.C. and its agents. Entry constitutes permission to use winners names, likenesses, and voices for future advertising and publicity purposes without additional compensation.
 8. CDs, cassette, and lyrics will not be returned. Winners will be announced on January 18, 2005 on the contest's website www.jlsc.com.
- I have read and understand the rules of the John Lennon Songwriting Contest and I accept the terms and conditions of participation. (If entrant is under 18 years old, the signature of a parent or guardian is required.)

www.jlsc.com

SIGNATURE _____

DATE _____

"Lennon" and "John Lennon" are trademarks of Yoko Ono Lennon. All artwork © Yoko Ono Lennon. Licensed exclusively through Bag One Arts, Inc. Design: Barea Fehrenbach

Sounds



CYCLING '74

Sustained Encounters

Sustained Encounters is a top-notch library full of sonic surprises sure to please sound designers, post houses, and composers alike.



CYCLING '74

Sustained Encounters

Contact: Cycling '74,
www.cycling74.com

Format: 1 audio CD, 1 WAV DVD
Price: \$99

S*ustained Encounters* encapsulates the bizarre and beautiful audio experiments of veteran sound designer Ron MacLeod, whose name you might recognize as the mastermind behind the *Poke In the Ear* sample libraries from the early '90s. His latest offering is the first in a series from Cycling '74 called *Cycles*. As the name suggests, *Sustained Encounters* is a collection of long, evolving environments and soundscapes. It's a refreshing change from the beat-dominated titles being pumped out these days.

The DVD includes material presented several ways: 24-bit stereo WAV files (44.1 and 48kHz) and 5.1 surround versions (saved as six separate mono files). The audio CD is intended for auditioning tracks. Files are organized into categories and subfolders such as Other Realms, Textural — Environs, and Immersion. Track names and lengths (in minutes, seconds, and milliseconds) are provided in the PDF documentation. I appreciate that actual names were used instead of simply saying "Track 1, Track 2," etc. because I find it's easier to remember specific names when trying to recall a

favorite sound as I'm racing to meet a deadline.

Sonically speaking, *SE* covers a lot of territory: throbbing low-frequency drones, LFO-modulated sound effects, jarring mechanical textures, atmospheres ranging from eerie and chilling to molten rich, harmonic "events" with

"Throbbing
low-frequency
drones, LFO-mod-
ulated sound
effects, jarring
mechanical
textures, atmos-
pheres ranging
from eerie and
chilling to molten
rich, harmonic
'events' with identi-
fiable tonal centers,
and whispering
ambiences . . ."

identifiable tonal centers, and whispering ambiances — there's a wealth of raw fodder that composers, sound designers, and post production houses should find invaluable.

I can't find fault with *Sustained Encounters* — it's expertly produced and thoughtfully organized. If you're looking for an immediate injection of cutting edge sound design, look no further. —John Krogh

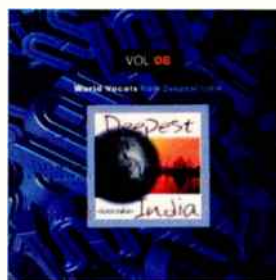

PROSAMPLES, VOL. 8

World Vocals from Deepest India

Contact: East West,
www.soundsonline.com
Format: Audio, Acidized WAV,
AIFF, EXS, FXP, Akai
Price: \$49.95

Sting's mega hit "Desert Rose" was a great example of multicultural pop fusion — Middle East meets United Kingdom with fantastic results. Want to stir up some international stew yourself, but don't have the funds to fly to India for a recording session?

ProSamples Vol. 8 from East West serves up over a dozen Indian singers, both male and female, for less than 50 bucks. An amazing bargain. Solo multi-bar phrases are the main event on this disc, but spoken phrases and group vocals are provided as well. Some of the group performances have hand-claps mixed in, which may or may not be a good thing in a production context. "These original samples reflect the timeless splendour, tradition, and heritage of the Punjab," say the disc's producers, "It embodies the widest variety of singing styles in the field of Indian music."

My favorite vocalist of the lot is the crisp and airy Maani. Her passages are beautifully sung — laced with intricate riffs, and all masterfully executed. I appreciate that all of her

material (and everything on the disc for that matter) is presented bone dry. Also, tempo and key signatures are provided for each performance in the liner notes.

In general, the recording quality is good, but there are a few tracks that sound as though they were recorded off a cheap TV or radio. Listen to the third, fourth, and fifth phrases on audio track 30, for example, or the noise-laden offerings on track 43. The plosive pops on track 47 are another low-light. Luckily these are the exception, not the rule.

The biggest fear or question about this collection is what the lyrics translate to. We'll assume that they're well localized and devoid of potentially offensive content, but non-native speakers must surely wonder what exactly they're singing and speaking about. A translated lyric sheet, either printed or online, would have been a nice touch.

The demo track on the audio CD beautifully demonstrates the exotic and rich potential of this collection. If you're in similar shoes as *EQ*'s own John Krogh, who cranks out a very wide range of commercial music, and who has to span a universe of sounds and styles, this CD will surely be a valuable resource. On the other hand, traditional Western pop music producers may have fewer opportunities to use this disc.

A final note for buyers: For \$149, you can get an expanded version of this collection in either Akai or Giga formats. —Greg Rule



D6

HOTTEST SELLING KICK MIC IN THE USA



**D-6
NICKEL**



**D-6
BLACK**

AND WITH GOOD REASON....

GROUNDSHAKING LOWS COMBINED WITH CLARITY AND ATTACK AND EQUALLY IMPRESSIVE IN THE STUDIO AS WELL AS ON STAGE.

STYLISHLY MACHINED FROM A SOLID BAR OF AIRCRAFT ALUMINUM, THE D6 IS DESIGNED TO SOUND GOOD IN ANY POSITION, WITH MINIMAL EQ, WITHOUT HAVING TO FIND THE 'SWEET SPOT' OF THE DRUM.

IN SHORT, THE D6 IS THE MIC TO BEAT.

MAIN FEATURES

- ◆ HUGE, CLEAN, UNDISTORTED SOUND
- ◆ CONVENIENT SIZE, EASY TO POSITION
- ◆ NO EQ REQUIRED
- ◆ PRECISION MACHINED FROM SOLID ALUMINUM
- ◆ FREQUENCY RESPONSE OF 30HZ - 15KHZ
- ◆ CARDIOID PICK-UP PATTERN

AUDIX
PERFORMANCE IS EVERYTHING

FOR A DEALER NEAR YOU CALL: 800-966-8261
TEL: 503-682-6933 FAX: 503-682-7114 WWW.AUDIXUSA.COM

World Radio History

AUDIX CORPORATION
PO BOX 4010
WILSONVILLE, OR 97070

IN CANADA, C-TEC
TEL 604-942-1001
FAX 604-942-1010

© Audix Corp 2002.
ALL RIGHTS RESERVED.
AUDIX AND THE AUDIX LOGO
ARE TRADEMARKS OF AUDIX
CORPORATION.

COMING ATTRACTIONS

"Coming Attractions" are previews of new products that haven't arrived in the marketplace. These aren't product reviews, but are designed to bring you up-to-the-minute information on the next generation of cool recording tools.

by Craig Anderton

What is it? A "virtual rack" for OS X or Windows XP, designed specifically for guitar players.

Who needs it? Guitarists who want flexible effects setups, particularly studio guitarists who'd like to carry a massive effects rig in a laptop.

Why is it a big deal? Native Instruments has a sterling reputation for virtual instruments and processors, but they've never before applied their talents to a guitar-oriented product.

Shipping: 2nd quarter 2004

Price: Under \$400 (exact price TBA)

Contact: www.native-instruments.com

Native Instruments Guitar Rig

Guitarists, start your computers . . .

Thanks to fast computers and driver protocols, the pieces are in place for guitarist-friendly, computer-based effects rigs. Already, IK Multimedia's AmpliTube, DSound's RT Player Pro, Steinberg's V-Stack, Line 6's Amp Farm, Universal Audio's Nigel, etc. have exploited the synergy between effects and computers. Now Native Instruments has thrown its "pick" into the ring with Guitar Rig.

Designed for Mac OS X or Windows XP, Guitar Rig offers standalone operation (ASIO, CoreAudio, DX, SoundManager) and plug-in capabilities (VST, DXi, AU, RTAS). Using the virtual rack interface shown in the preliminary screen shot below,

the program provides a total signal chain, including effects, amp, and speaker. Furthermore, the package includes a hardware foot controller, with appropriate audio interfacing/buffering for guitar.

You need a pretty powerful computer to play through this live (e.g., G4 or a 700MHz Pentium III). Most modern laptops, as well as desktop computers, will do the job.

GETTING AROUND

The interface's right half is the "rack" where you add (and rearrange) modules to create a custom "rig," by dragging from a list of component modules that shows up in the interface's left side. It's possible to split the signal and do parallel processing. The left side is also where you manage presets and search for rigs; you can save multiple rigs optimized for different styles of playing, and store up to 128 patches within each rig.

There's a plethora of processors, including distortion, modulation effects (phaser, flanger, spring reverb, ensemble, etc.), EQ, dynamics, delay, etc. The cabinet module features mic type and position parameters, along with "air," "distance," and other parameters to emulate miked guitar cabinets. But NI is proudest of their Dynamic Tube Response amp modeling, which

they've been working on for two years in their search for realistic tube response.

In addition to the various processors, there are several other modules: Input, tuner, metronome, output, and "tape deck," where you can load in files — ideal for solo performers who want a virtual backup band, or for testing setups — and it can also record what you play. These components have fixed positions, but you can show/hide the tuner, metronome, and tape deck; processors and amps insert between these modules and the output. The input (which includes a noise gate) handles stereo signals — ideal for stereo instruments such as the Chapman Stick, or for jamming with a friend as each output can feed different effects.

Another nice touch: An expert view contains additional controls for customizing and fine-tuning the various components. What's more, the number of modules isn't fixed, it's possible to update the system with new effects.

Guitarists have, by and large, shaken off the "not computer-savvy" stereotype as they've made the move to hard disk recording. With more processors like Guitar Rig now suitable for both studio and live use, it's conceivable we'll start seeing more computers on stage as well.



True Blue.



Introducing the Resolv™ Studio Monitor family from Samson.

Accurate reproduction. That's what it's all about. And that's exactly what you'll get from every member of the Resolv Monitor family. Custom-designed low frequency drivers and amplifiers, Titanium tweeters and perfectly tuned enclosures. You'll get useful features found no where else, like the 4-position mid-range control on the 6.5" and 8" driver models. There's a Resolv solution for every studio and a price for every budget. Resolv Monitors by Samson. True blue studio monitoring performance.



Resolv 120a Subwoofer



Resolv 50a



Resolv 65a



Resolv 80a

SAMSON
A U D I O

samsontech.com



Drums: Slipknot



When Rick (Rubin) first asked me to do this project, I was excited because I love working with Rick and I'm a Slipknot fan," confesses Rubin's mega-hot engineer of choice, Greg Fidelman, whose credits include Johnny Cash, Marilyn Manson, and The Red Hot Chili Peppers. Once all nine bandmembers arrived in Hollywood, and Fidelman contacted Ernie Woody at Ocean Way To Go for gear, they headed up to the Houdini Mansion to start writing, rehearsing, and recording. "The Mansion is perfect for this, because nine guys in any typical studio in town is just way too crowded. Everyone has a room here, so they don't have to stay at a hotel and they can creep down to record as they want. The bass player comes down in his pajamas to cut tracks.

"For this particular project the house is making a huge impression on what the record is going to sound like," Fidelman continues. "We were just listening to a bunch of new stuff we recorded, and Rick was really excited about what he was hearing." The impression the Mansion has had on the band can best be summed up by Slipknot's drummer, Joey #1, who felt the house was like another member of the band.

After Fidelman treated us to a sneak preview of "The Blister Exists," he shared his secrets for getting "blistering drum sounds" in any old house.

9 MEN IN MASKS, 1 SIGNAL PATH IN THE MANSION

"We're recording in Pro Tools," informs Fidelman. "There's no click and no drum machines; it's a rock and roll band playing really heavy music, and we're just letting them do it. The main drum set is coming up through the Neve 8068 MK-II console. Most of the mic-pre's are 31102s, and I ran the toms to the Neve 1073s. I'm using API-550A EQs in addition to the Neve EQs. I compress a lot of the tracks, because I'm not going to tape. I grew up in the rock world, and a lot of stuff gets compressed. I like to use UREi 1176s. They're adjustable, fast, and they color the sound a little bit, which is what I miss when not having a tape deck here. I just hit the mic straight to the mic-pre, then to a compressor, then into Pro Tools. A combination of EQ, the right amount of compression, and choosing the right microphones will get you the right drum sound."

MIC POSITION

"We set up the drums in what used to be a ballroom here in the Houdini Mansion," says Fidelman. "It's a good size; it's not Sound City Studios, but it's big and has hardwood

floors. The walls are hard surfaces too, so we put a lot of velvet material up and a big flag that droops down on the ceiling. It's a big room and it sounds big, but it's not too ambient. I used Neumann 47 FETs and Sennheiser 421s on the bass drums, and Shure SM-57s and Neumann KM-84s on the snare. On the toms, I have a combination of dynamic mics and condensers. There are six toms, two of which are really small, two are average size, and two are really big, almost as big as a small bass drum. I used AKG 414s on the large toms and 421/57s on the smaller ones. The overheads are Neumann U87s. The room tends to be a bit bright, and Joey really hits hard and has a lot of cymbals, so anything like a tube mic up on top gets a little harsh. I've got Neumann U67s in the room, but I keep those pretty close and low. There's also a Telefunken 251 that's sort of a monaural room thing that I hyper compress and chop most of the top end off to make it sound a little more powerful.

"For the drum corps parts, we put the snares out in the foyer, which has 2-story ceilings, stone floors, and plaster walls, making it a bit more ambient. We set Joey, Clown, and Chris up in there, each with a different size snare and a Telefunken 251 about eight feet above. That gave us the huge drum corps-style sound we were after for that song.

"He's a good drummer, and knows how to hit his drums to make them sound good. That's a big part of the sound. We spent an entire day checking out approximately 50 different snares. I have two mics on top of the snare: a Shure SM57 and a Neumann KM-84. They're taped together so the phase relationship is correct, and then I get the right balance between the two."

PROCESSING ARSENAL

"I ran most of Joey's drums through the 31102s, and the toms were 1073s," explains Fidelman. "I also used the API-550As. In the past I used to record drums using a Studer A-800, and I wouldn't need that much compression. I'm still such a fan of that sound, and I've figured out ways to get it by using a combination of the 31102s and the 1073s and compression. I like to use either an 1176, an LA3A, or a Neve 2264/33609 on pretty much everything. For the snare I put a little of the Neve, a little 1176, and some API 550 on one of the mics, which to me is always a good combination."

DRUM DOMINATION

"Joey has maybe one of the biggest drum sets I've had to record," Fidelman concludes. "He normally plays double bass drums, but on the other Slipknot records he had a double pedal on one bass. We decided on this record we wanted to actually do two separate bass drums. With the two hi-hats, one on each side, plus six toms and a lot of cymbals, it was a challenge keeping the imaging in the drumset we wanted." **EQ**

DATE: mid-September 2003 – January 2004
STUDIO: Houdini Mansion
LOCATION: Los Angeles, CA
ARTIST: Slipknot
PROJECT: tracking drums with Joey #1 (Jordison) on "The Blister Exists," for the yet-untitled Roadrunner Records spring release
PRODUCER: Rick Rubin
ENGINEER: Greg Fidelman



Engineer Greg Fidelman and the array of drum mics.



Disc Duplication

From demo CDs to professionally produced CD packages!

FastPak

50 CDs
with jewel cases
just \$49!
in 48 hours!

24-hour rush service available!

Your Band's
Name Here

The FastPak gives you:

- 50 Music CD copies on CDR discs.
- Up to 650MB or 74 minutes capacity.
- Upload music & cover art online or mail master disc.
- Thermal black text printing directly on the disc face.
- Enter your text with DiskFactory's Label Editor.
- Free jewel cases. Slimline cases available.
- Shrink-wrap optional.

Other Paks Available!

SuperProPak

100 CDs
Only \$299!

BulkPak

100 CDs
Only \$79!

ProPak

100 CDs
Only \$199!

Do It All
Online!

Upload your music
& cover art!

Order Today!

— click here —

musiciansfriend.com/dupe

SOURCE CODE: EQDDDF



Applied Acoustics Tassman

Exchanging Tassman Synthesizers and Presets

Objective: Share Tassman synthesizers and presets with other users.

Background: Tassman offers the possibility to share synthesizers with other users with the *Import* and *Export* functions. The exported material is stored in a Tassman Exchange File (.tfx) that can be sent by email or downloaded from the Web.

Step by Step: To import, follow steps 1 to 3. To export, follow steps 4 to 6.

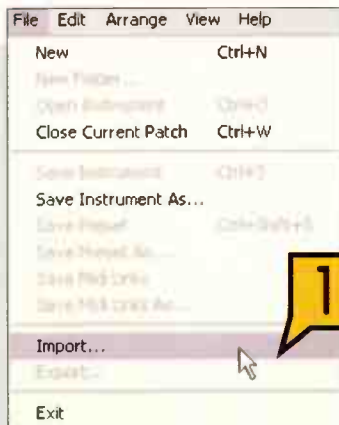

- 1 Choose **Import** from the File menu.
- 2 Locate and select the **Tassman Exchange File** on your drive, then click **Open**. Note that if the imported file contains a sub-patch you already have in your database, a message will be displayed and the original sub-patch will not be replaced.

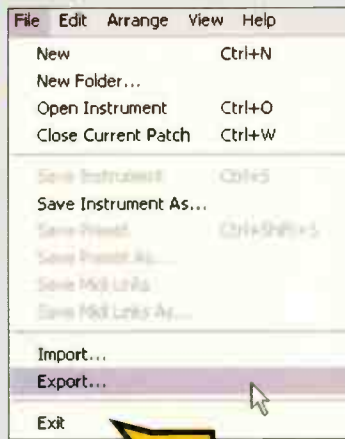

- 3 The newly imported material is located in its own folder under the **Imports** folder. You can then use it from there or classify it to another location in the **Instruments** folder.
- 4 Select the folder(s), synthesizer(s), or preset(s) in the browser that you wish to export. Note that by default, when an item is selected for exportation, all of its sub-items will also be exported.
- 5 Choose **Export** from the File menu.
- 6 Choose the location and the name of the **Tassman Exchange File** to be exported.

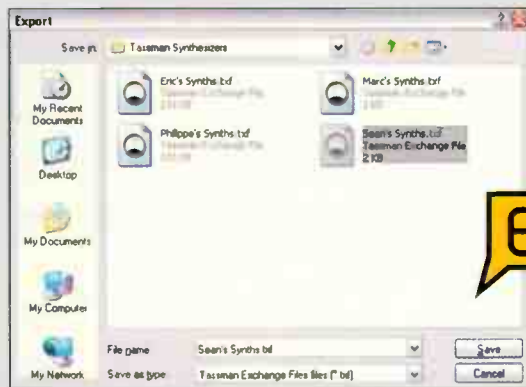

tips

- To get more synthesizers and share your own creations, visit the User Library at www.applied-acoustics.com.
- Before exporting presets alone, make sure that the recipient has the corresponding synthesizer. If you are not sure, include the synthesizer in the Tassman Exchange File.
- You can export individual items by disabling the *Include Sub-Items Of Selected Item* option in the *General Preferences* dialog from the *Edit* menu.
- MIDI links are exported in the same way as folders, synthesizers, and presets.

AdIndex

These companies would be very happy to assist you in obtaining more information about their products and services. Please contact them via phone or online.

For a better response, tell them "I saw it in EQ!"

COMPANY	PHONE	WEB	PAGE
ADAM	805-413-1133	www.adam-audio.com	88
Alesis	401-658-5760	www.alesis.com	69
Antares	831-461-7800	www.antarestech.com	43
Applied Research & Technology (ART)	585-436-2720	www.artproaudio.com	27
Audix	800-966-8261	www.audixusa.com	91
Auralex Acoustics	317-842-2600	www.auralex.com	52
B&H Pro Audio	800-947-5518	www.bhphotovideo.com	85, 101
Boynnton Pro Audio	800-772-8916	www.boynntonproaudio.com	35
Broadcast Supply Worldwide (BSW)	877-564-0560	www.bswusa.com	99
Cakewalk	888-CAKEWALK	www.SONAR3.com/eq	9
Cakewalk	888-CAKEWALK	www.project5studio.com	67
Conservatory Of Recording Arts & Sciences	800-562-6383	www.audiorecordingschool.com	84
Digidesign	800-333-2137	www.digidesign.com/digidelivery	17
Disc Makers	800-468-9353	www.discmakers.com/eq	34
Discrete Drums		www.discretedrums.com	64
Emagic	+49 4101-495-0	www.emagic.de	51
E-MU Systems	877-742-6084	www.emu.com	54-55
Focusrite	866-FOCUSRITE	www.focusrite.com	45
Full Compass	800-356-5844	www.fullcompass.com	75
Full Sail	800-226-7625	www.fullsail.com	32
Furman	707-763-1010	www.furmansound.com	68
George L's	615-868-6976	www.georgels.com	97
Grace Design	303-443-7454	www.gracedesgn.com	47
Guitar Center		www.gcpro.com	71
Ilio/Applied Acoustics Systems	800-747-4546	www.ilio.com, applied-acoustics.com	11
Japan Electronics Show Assoc. / Inter BEE 2004		bee.jesa.or.jp	5
JBL Professional	818-894-8850	www.jblpro.com/LSR	13
John Lennon Songwriting Contest		www.jlsc.com	89
Korg USA	516-333-8737	www.korg.com	57
LA Recording Workshop	818-763-7400	www.recordingcareer.com	33
Lexicon Pro	801-568-7567	www.lexiconpro.com	61
Mackie	800-258-6883	www.mackie.com	19
Mark Of The Unicorn	617-576-2760	www.motu.oom	C4
Marshall/Mogami	800-800-6608	www.mogamicable.com	50
M-Audio	800-969-6434	www.m-audio.com	59
Microtech Gefell	604-942-1001	www.gefell-mics.com	65
Millennia Music & Media Systems	530-647-0750	www.mil-media.com	37
Music Business Chops 2004 Spring West Coast		www.studiobusinesschops.com	83
Musician's Friend	800-436-6981	www.musiciansfriend.com/free	79, 95
Musician's Friend/DiskFaktory	800-391-8762	www.musiciansfriend.com/dupe	95
NEMO Music Festival	617-348-2899	www.nemoboston.com	77
Oasis CD Manufacturing	888-296-2747	www.oasisCD.com	53
Phonic	800-430-7222	www.phonic.com	78
PMI Audio Group	877-563-6335	www.toftaudiodesigns.com	48
Primacoustic	604-942-1001	www.primacoustic.com	73
Professional Audio Design	877-223-8858	www.proaudiodesign.com	81
Recording Workshop	800-848-9900	www.recordingworkshop.com	88
RODE Microphones	877-328-7456	www.rodemic.com	31
Roland	323-890-3700	www.rolandus.com/VS2000CD	22-23
Royer Labs	818-760-8472	www.royerlabs.com	76
Sam Ash Professional	212-586-1100	www.samashpro.com	87
Sample CD Store	866-815-2424	www.samplecdstore.com	49
Samson Audio	516-364-2244	www.samsontech.com	39, 93
Sonic Circus	888-SC-4-GEAR	www.soniccircus.com	86
Soundminer	866-FINDSFX	www.soundminer.com	62
Studio Technology	847-676-9177	www.studio-tech.com	78
Sweetwater Sound	800-222-4700	www.sweetwater.com	21
Sweetwater Sound	800-222-4700	www.sweetwater.com	108-111
Synthax	330-259-0308	www.syntax.com	84
TASCAM/TEAC America	323-726-0303	www.tascam.com	1, 63
T.C. Electronic Inc. USA	805-373-1828	www.tcelectronic.com	3
True Systems	860-434-5220	www.true-systems.com	38
Vintech Audio	877-4-MIC-PRE	www.vintech-audio.com	86
Waves	865-909-9200	www.waves.com	C2, 29
West L.A. Music	310-477-1945	www.westlamusic.com	64
Yamaha Corporation of America	877-YAMAHA5	www.yamaha.com, www.01xray.com	C3

This index is provided as a service to our readers. Publisher is not responsible for any omissions or errors.

YOU'VE GOT:

OVERDRIVE
WAH
DELAY
PHASER
EQUILIZER
COMPRESSOR

WHAT MORE DO YOU NEED?

George L's
CABLES

*It's just the effect
you've been looking for!*

(615)868-6976
www.georgels.com



Digidesign Pro Tools LE

You're Surrounded

Objective: Perform surround mixing in Pro Tools LE.

Background: Pro Tools LE doesn't have built-in surround support. If you have an interface with six or more outputs, here's how to make the leap to multi-channel.

Step by Step: You're just steps away from surround mixing in Pro Tools LE.

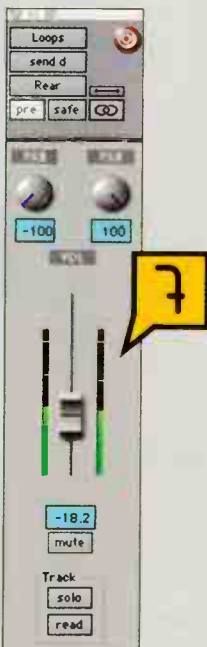
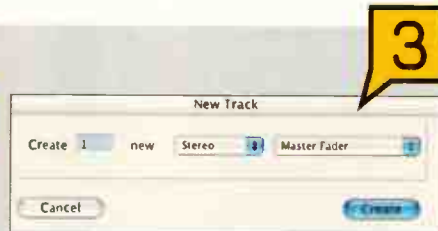
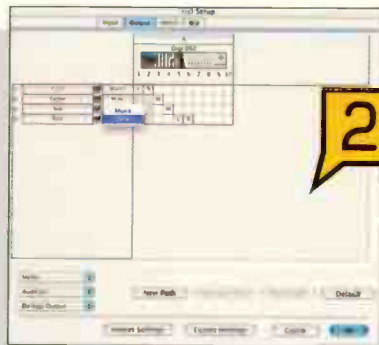

- 1 Connect your interface to your surround speakers. Route outs 1/2 to front left/right, out 3 to center, out 4 to sub, and outs 5/6 to rear left/right.
- 2 In Pro Tools, go *Setups > I/O Setup*. Create four paths. Label one "Front," make it stereo, assign to out 1 and 2. Label one "Center," make it mono, assign to out 3. Label one "Sub," make it mono, assign to out 4. Label the last one "Rear," make it stereo, assign to outs 5 and 6.
- 3 Create four master faders, two stereo and two mono. Label the stereo ones "Front" and "Rear," label the mono ones "Center" and "Sub."
- 4 Assign the master faders to the paths that match their names. Now any tracks that you route to the various master faders will feed the respective speaker(s) in your surround rig.
- 5 Group the four master faders.
- 6 Assign your tracks to the masters. I assign the main track outs to Front, then create three sends on each channel: one each for Center, Sub, and Rear. Make sure the sends are pre-fader.
- 7 If you raise a track's fader, it will come up in front, and can be panned as normal. Raise a send, and the track will come up in the corresponding speaker or sub. By balancing the fader and the sends, you can pan anywhere in the surround field.

tips

- You can change the output or send assignment for all tracks at once by holding *Option* while you change the assignment for any track.
- Moving pans can be done using automation to simultaneously increase and decrease complementary levels and pans.
- Level changes for tracks sent to more than one speaker may require automation to adjust multiple sends simultaneously.

ORDER 24/7 FROM OUR SECURE WEB SITE

All the best Pro Audio gear. From people who speak your language.

BSW specializes in pro audio. In fact, most of us here live, breathe and sleep this stuff. Our sales reps average over a decade of real-world experience in the recording or broadcast studio, on both sides of the mic. When you call BSW, you'll get someone who speaks your language. So for everything from finding a decent preamp to outfitting an entire production room, you can rely on us for expert, friendly advice.

And since we sell to the recording and broadcast industries in huge quantities, we're also experts at lining up the best pro gear at the lowest prices. We'll help you find what you need and get it to you for less.

Go online or call for your **FREE** catalog today and find out why we're the audio source more and more people are turning to for great gear, low prices and expert service!



Get your free 168-page catalog!

Amazing values! Stock up on these audio staples today.



AUDIO-TECHNICA
• ST95MKII PKG • dynamic handheld mic 5-pack • on/off switch

99



SENNHEISER
• HD202 PKG • sealed-ear headphone 5-pack

89



PROCO • M25 PKG • 25 ft. XLR mic cables 5-pack

49

BSW EXCLUSIVE
MONEY-SAVING 5-PACK DEALS!



ON-STAGE • 72010 PKG • boom stand 5-pack • padded heavy-duty travel bag included

89

WINDTECH • WS912 PKG • windscreen 5-pack \$24.00

MS200 PKG • mic stand 5-pack

89

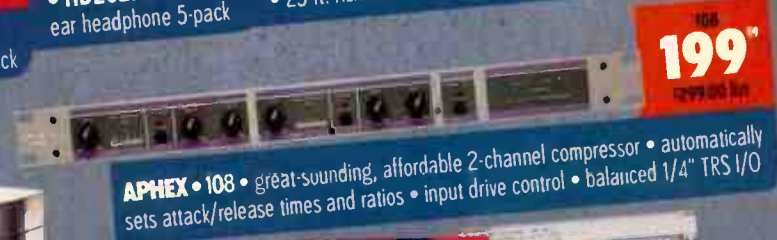

APHEX • 108 • great-sounding, affordable 2-channel compressor • automatically sets attack/release times and ratios • input drive control • balanced 1/4" TRS I/O

199



CBT SYSTEMS • ON-AIR LIGHT or RECORDING LIGHT • give your studio a true professional look with these retro classics • brightly-buffed aluminum housing • 14-1/4" W x 4" H x 2-5/8" D

269



SONY • SOUND FORGE 7.0 • powerful, industry-standard editing software for PC • drag-and-drop CD extraction • vinyl restoration plug-in • Windows Media/QuickTime import/export • RealMedia export • way, way more

349



GREAT VALUE MIC PACKAGE

AKG • C2000B PKG • incredible studio mic package • C2000B cardioid condenser mic with ruler-flat response • shockmount • quality boom mic stand • 25 ft. cable • all for only \$199.00!

199



TAPCO by MACKIE • S5 • pair of powered studio monitors • dual 60-watt internal amps • 5.25" woofers • 1/4" TRS, XLR and RCA inputs • flat, accurate monitoring at a great price!

349

www.bswusa.com • 1.877.564.0560

ORDER 24/7 FROM OUR FAST-LOADING WEB SITE • CALL US 6AM-6PM PACIFIC TIME



World's Best Source for Pro Audio Products



Cakewalk Sonar

Creating the Perfect Pad Loop

Objective: With sampler-type crossfade looping techniques, you can make a perfect loop with just about any pad or sustained sound.

Background: Looping a sustained sound, like a synth pad, drone, or held note, can be difficult as the loop start and end points seldom share the same level and timbre. Looping therefore creates a rhythm that degrades the pad effect. However, you can use Sonar's crossfade function to help make seamless, smooth pad loops, providing there's some audio prior to the intended loop start point.

Step by Step: Proceed through each step in sequence. Before starting, enable automatic crossfading.



1

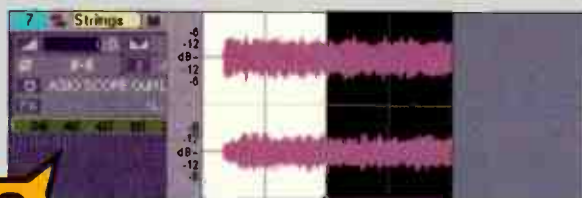

2

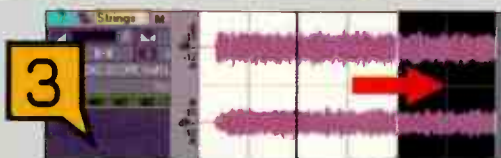

3

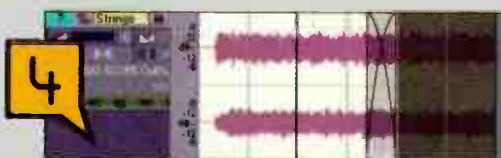

4



5

1 Isolate the section you want to loop by adding a split at the section's start and end. To do this, place the Now time over the start and type S, then do the same at the end (the region to be looped is highlighted in black).

2 Delete any audio to the right of the end split.

3 Ctrl-drag (copy and move) the clip so that the copied section's start point butts up against the end point of the original clip.

4 Slip-edit the beginning of the copied clip toward the left, dragging it over the end of the original clip. This creates a crossfade of the original clip's end section and the audio leading up to the clip's beginning.

5 Create a split at the end of the original clip, discard any audio to the right and left of the section to be looped, then draw a marquee around the slip-edited section and the original loop so they're both selected.

6 Go **Edit > Bounce to Clip(s)** to mix the crossfaded section in with the end of the original clip. Loop this clip, and it should transition seamlessly from beginning to end.

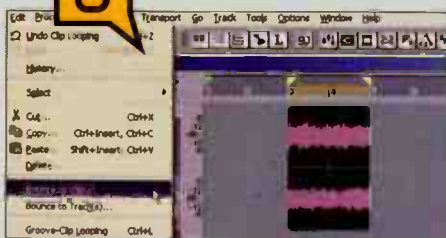

6

tips

- Under the Snap to Grid options, make sure that Mode is set to "Move To," and "Snap to Audio Zero Crossings" is unchecked. Otherwise the various split points might not end up exactly at measure boundaries.
- Do not normalize any audio prior to using this technique; crossfade looping may increase the level in some regions by a few dB, so there should be at least a few dB of headroom.
- Choose equal power looping (convex fadeout and fadein) in most cases.

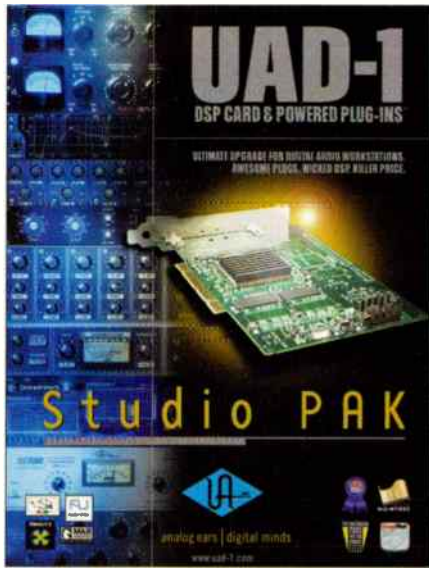

UAD-1 Studio PAK

Universal Audio Inc.

Now Available

The UAD-1 Studio PAK includes all 20 of UA's premium plug-ins including the Fairchild 670, LA-2A, 1176LN & SE compressors, Pultec EQP-1A, ReaVerb/DreamVerb and the powerful UAD-1 PCI DSP card. Supports Mac & Windows, AU, VST, DX & MAS. RTAS coming soon!

List: \$1199, Street: \$899

www.uad-1.com, www.uaudio.com

866-UAD-1176 (Toll Free)



Core Sound's PDAudio Digital Audio Recorder

Core Sound

Now Available

Core Sound's PDAudio-CF (\$199), Mic2496 (\$499) and your PocketPC PDA (or Win 2000/XP laptop) will record more than three hours of stereo 24-bit/96 kHz linear PCM to Compact Flash memory or hard disk.

SRP: \$199/\$499

<http://www.core-sound.com>

(+1) 888-937-6832 and (+1) 201-801-0812



XD Recorders OS Updates

Korg

Now Available

Version 1.1 adds a mixer setup utility for creating, storing and recalling commonly used routings, levels, effects settings, etc. User interface button functionality has improved as well. An upcoming Version 2.0 will be available late April.

SRP: Free Download

www.korg.com

516-333-9100



EQ Cap

Music Player Network

Now Available

Adjustable baseball cap of un-constructed cotton twill. Colors: black, white, mustard, or navy. One size fits all.

SRP: \$22

www.eqmag.com/store

To advertise in this section contact Joanne at 650-513-4376 jmcgowan@musicplayer.com
For more information about these products, visit www.eqmag.com/spotlight.htm



Studio Monitors—SM Series (SM-120 and SM250A)

Nady Systems

Now Available

Offering exceptional quality and unparalleled affordability. The SM-120 (passive—rated 120W peak) and SM-250A (active—100W bi-amped) are both full-range, 2-way near-field monitors with 6 1/2" shielded woofers and 1" Ferro fluid-cooled, shielded tweeters.

SRP: \$159.95 / 269.95

www.nady.com

510-652-2411

Project5 1.5

Cakewalk

Now Available

The free 1.5 update for registered Project5 owners provides: new Centralized Step Sequencer mode; Track Patches for one-click recall of mix, synth, effect settings; Resource Browser for MIDI patterns and Wav file access; CPU optimization for multi-output synths.

SRP: The Project5 1.5 update is a free download for registered Project5 customers, Project5 has an SRP of \$429

www.cakewalk.com

888-CAKEWALK, 617-423-9004 outside the U.S.



2-1176 Twin Vintage Compressor

Universal Audio

Now Available

With over 2000 UA reissues sold, the love affair with the legendary 1176LN sound lives on. After 36 years of compressor evolution, UA launches the 2-1176, a dual mono/stereo 1176LN with matched FET's & output transformers.

SRP: \$2,695 preliminary list.

www.uaudio.com

831-466-3737



Hypersonic

Steinberg

Now Available

Hypersonic is a compositional workhorse and an expandable, high-performance sample player/synthesizer. It takes the musical instrument workstation concept to computer-based music production environments with higher quality, easier use, and more effective playability than ever before.

SRP: \$399.99

www.steinbergusa.net

818-973-2788





IK Multimedia T-Racks

Turbo charge your mixes with these hot tips

Objective: Use these power-user T-Racks techniques to improve your mix sessions.

Background: T-Racks was originally released as a standalone stereo processor for mastering, but was later adapted as a plug-in. It features four components — a parametric EQ, a single-band compressor, a multi-band compressor, and a limiter with a saturation stage. These are all analog modeling devices aimed at recreating the “vibe” and sound of classic outboard gear. The analog version offers some interesting options that set it apart from other finalizing tools. The power user tips covered here will help you make the most of T-Racks.

Step by Step: Get more from IK Multimedia’s mastering suite of plug-ins with these hot tips.



- 1 **Efficient CPU usage.** T-Racks comprises four sections, or processors, which are often thought of as one plug-in, but each processor can be instantiated separately for more efficient CPU usage. With an acoustic guitar track, for example, you may only need the EQ and compressor.
- 2 **Cross-application preset management.** Custom settings can be saved and recalled from the host; however, presets saved in this way won't be available to any other compatible program such as a 2-track editor or loop-based sequencer, etc. By saving your settings from T-Racks' Save button (located at the top of the plug-in), you'll be able to recall all your favorite presets from any program.
- 3 **Rearrange the signal path.** T-Racks' interface arranges the plug-ins vertically, with the EQ being first, then the compressor, the multiband compressor, and finally the limiter. However, you can change the order of effects using the four small square Patch buttons. In this case, I've put the multiband compressor first, followed by the EQ, then the single-band compressor, and limiter.
- 4 **Individual bypass.** As you approach a final mix with T-Racks on the mix bus, start by bypassing all but the EQ. Once you feel you've nailed the balance, engage the next processor, and then fine-tune it to taste. Continue this way until all processors are active. Remember to periodically disable each section to hear how it's affecting the mix.
- 5 **Personalize the factory presets.** T-Racks includes a wealth of useful presets for mastering as well as individual channel processing. I'll often start with a preset I like, then tailor the parameters to fit my needs. Sometimes it's easiest to use the Reset button, which returns the selected component to a default state. From there I can dial in exactly what I'm after.

CLASSIFIEDS

CATEGORIES

TALENT AGENCIES
 MUSIC STORES
 COVERS / CASES & RACKS
 ACOUSTICAL PRODUCTS
 DUPLICATION / REPLICATION
 SOUNDS / SEQUENCES / SOFTWARE
 MASTERING
 PARTS / ACCESSORIES
 EQUIPMENT FOR SALE
 EQUIPMENT DEALER
 CAREER MARKETPLACE
 TRAINING / TUTORIALS
 VOCALS

TALENT AGENCIES

"LOOKING FOR A RECORD DEAL???"

Getting signed is very hard to do. But we will get the record deal you are looking for! Guaranteed Service. Call now to receive your FREE information.



Talent 2000
 800-499-6395



MUSIC STORES

The World's Best Online Music Store!

INSTRUMENTPRO has a huge selection of Live Sound and Recording Equipment, including Mixing Consoles, Microphones, and Studio Monitors at Discount Prices.

- We'll Beat any Advertised Price
- Free Shipping on Select Equipment
- Authorized Dealer of:
 Allen & Heath, Mackie, Shure, Sennheiser, and MORE!

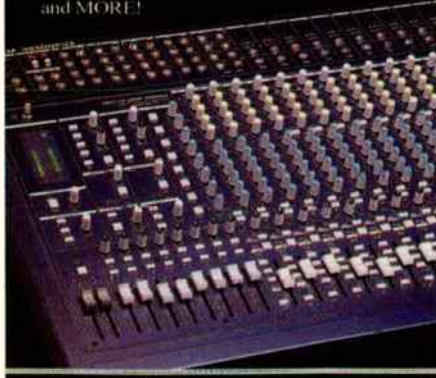

INSTRUMENTPRO.com
We'll Beat Any Price!
800-805-0852
www.instrumentpro.com

COVERS / CASES & RACKS

ROCKET STUDIO

"Rocket Ship"
 (1) Dual 15-RS
 (2) Spiro L10 Racks

\$2,349.90 delivered!
 details online

studio furnishings by
ARGOSY

(free catalog)

www.ArgosyConsole.com 800.315.0878
 573.348.3333

OMNIRAX
 STUDIO FURNITURE

Synergy
 professional console furniture

Synergy BBCB4
 for Digidesign Control 2-4

■ optional mahogany chassis as pictured
 ■ 2 rack bays
 ■ available for all popular mixers

P.O. Box 1792 Sausalito, CA 94965
 800.332.3383 Outside U.S. 415.332.3382 FAX 415.332.2807
 www.omnirax.com email: info@omnirax.com

VISIT US ONLINE!
www.EQMAG.com

ACOUSTICAL PRODUCTS

"Our control room at Le Crib Studios needed serious help. After installing MiniTraps the room sounds better than we believed possible, with clear, round bottom and vastly improved imaging. Fantastic product, great company." —Nile Rodgers

Toll-free: 866-REALTRAPS www.realtraps.com

Auralex acoustics www.auralex.com
 1-800-95WEDGE

• FREE Acoustical Room Analysis • Widest Range of Sound Control Products • Exceptional Customer Service

TOTAL SOUND CONTROL™

AcousticsFirst™
 Toll-Free Number: **888-765-2900**

Full product line for sound control and noise elimination.
 Web: <http://www.acousticsfirst.com>

SILENT INFO (413) 894-7944 FAX (413) 894-2377

58 Nonotuck St., Northampton, MA 01062
ORDER (800) 583-7174
info@silentsource.com • www.silentsource.com

Acousticore Fabric Panels • Sound Barrier Isolation Hangers • A.S.C. Tube Traps
 Silence Wallcovering • WhisperWedge Melaflex • S.D.G. Systems • Technifoam
 R.P.G. Diffusers • Sonex • Sound Quilt

ATA Protection Affordably Priced

GATOR CASES

ATA KEYBOARD FLIGHT CASES
MSRP STARTING @ \$199.99

- RECESSED LOCKABLE LATCHES
- E-Z ROLLING BUILT-IN WHEELS
- ADJUSTABLE INTERIOR
- INCREDIBLY LIGHTWEIGHT

Tel: 813.221.4191 / Fax: 813.221.4181
 for all your case needs: www.gatorcases.com

WhisperRoom INC.
 SOUND ISOLATION ENCLOSURES

Celebrating over 13 years of reducing sound to a Whisper!
 Recording, Broadcasting, Practicing

MDL 1021265 (8.5'X10.5')

19 Sizes and 2 Levels of Isolation Available
 New! SoundWave Deflection System
 (Change parallel walls to non-parallel)
 Immediate Shipping!

www.whisperroom.com
 PH: 423-585-5827 FX: 423-585-5831

DUPLICATION / REPLICATION

TALK WITH A
HUMAN BEING
ABOUT **CD REPLICATION**

OASIS® DUPLICATION OFFERS:

- Innovative Packaging, including the revolutionary Oasis Jewel-Free™ Box
- Free Radio Promotion on our OASISSAMPLER™ CD compilations
- NEW** National Distribution of your CD to Major Retail & Internet Chains
- The industry's best reputation for quality, for 12 years running

OASIS®
CD MANUFACTURING
oasisCD.com

*We do what a label does.
For you.*

(888) BY-OASIS (888/296-2747)
info@oasisCD.com
www.oasisCD.com



GET YOUR AD IN
THE JULY ISSUE
DEADLINE: MAY 10th
call 650-513-4217
or email
dlabrecque@musicplayer.com

CDs • CD-ROM • CD-R • SHAPED CDs • AUDIO CASSETTES

NEED CDs?
the choice is

CRYSTALCLEAR
DISC & TAPE

Trusted experience for over 30 years.

1-800-880-0073
visit us at www.crystalclearcds.com

DIGITAL MASTERING • ART DESIGN • PRINTING • PACKAGING

ELS
PRODUCTIONS

100 FULL RETAIL READY CDs \$244.00!

Includes 4/0 Full Color Cover and 4/0 Full Color Traycard Assembly and Shrink Wrap

Quality CD Duplication 50 to 500 copies in 24 to 48 hours!

VISIT US ON THE WEB
www.elsproductions.com

1-800-927-3472
Call for more info or free sample packet

Complete CD Packages in Just 7-10 Days

- CD & DVD Manufacturing FREE BANCORP WITH EVERY PROJECT
- Short-Run CD/DVD Duplication
- Commercial Printing NEWS • RING BROS.
- Full-Service Prepress

800-964-DISC
fax 714 704-1733 • web: <http://newsongmedia.com>

46 PRODUCTIONS

25 CDRs - \$45 / 50 CDRs - \$88
100 CDRs - \$150 / 200 CDRs - \$290

ASK ABOUT OUR DISCOUNT FOR ASCAP MEMBERS!

From CD or CD-R master. Includes CD-R in jewel box with text printing on CD label. Add \$35 for other digital master, \$55 for analog master. Orders must be prepaid. Shipping not included.
42W557 Hawk Circle, St. Charles, IL 60175
Phone: (800) 850 5423 • E-mail: info@46p.com
Visit Our Web Page at: <http://www.46p.com>

Lone Records
Priority, Speed, Quality Service - 10% Minimum Price Guarantee

\$990

100 CD's \$199
500 CD's \$875
1000 CD's \$1590
2000 CD's \$2750

424 N. Main Street
www.lonerecords.com - 1.800.409.8513

SOUNDS / SEQUENCES / SOFTWARE

Dopest Hip-Hop/R&B sound libraries on floppy disks. MPC-2000, MPC-2000xl, MPC-3000, ASR, EPS, SP1200 and .WAV. (310) 842-7670. www.soundsforsamplers.com.

DDAI 816 Fifth Avenue
Pittsburgh, PA 15219

DIGITAL DYNAMICS AUDIO INC.

- CD Mastering and Replication
- Cass. Mastering & Replication
- Digital Audio Post Production
- CEDAR Sonic Restoration

Full Service Digital House
<http://www.4ddai.com> 1-800-444-DDAI

MASTERING

CUTS from ABOVE

- Air-play & Distribution
- Advertise & Promotion
- Beyondmastering.com
- CD's from .39 cents

FREE NEWSLETTER
ArtistRecording.com
1-877-507-0130

www.youmusiconcd.com

100 BULK CDRS \$59
100 BASIC CDRS \$99
100 FULL COLOR CDR PACKAGE \$199
300 FULL COLOR PACKAGE \$549
500 FULL COLOR CDR PACKAGE \$799
1000 FULL COLOR CD PACKAGE \$1149

SNS DIGITAL INC.
ATLANTA 678-442-0933
TOLL FREE 1-877-442-0933

DRT Mastering
the Analog Specialist

You will have the fat, slamm'n' major label sound that sells discs... or the work is free. Custom gear. First-class results. Free 16-pg brochure
800-884-2576 www.drtmastering.com

JustStrings.com

World's Largest Selection of Guitar & Bass Strings!
www.juststrings.com (800) 822-3953

Cases Cases Cases Factory Direct! Any ATA Case For \$99 Mixers, Amps, Heads, or Keyboards www.discount-distributors.com 800-346-4638



STUDIO TRAPS
 INCREDIBLY
 VERSATILE
 SOUND SCULPTING
 TOOLS
ASC ACOUSTIC SCIENCE CORPORATION
 1-800-ASC-TUBE www.tubetraps.com

EQUIPMENT FOR SALE

ANTHONY DEMARIA LABS
 GET PHAT ON THE BEST
 ALL-TUBE HANDCRAFTED
 DIRECT BOX
**ADL
 300-G** 
 919-460-6042
www.anthonymarialabs.com

Can you *really* hear
 what's
 going on in your mix?



"The DAC1 lets me hear what's really going on in my mix."

Michael Wagener
 Recording Engineer for Ozzy Osbourne, Metallica,
 Janet Jackson, etc.

The DAC1 is a 2-channel, 24-bit, 192kHz capable D-to-A converter that is unveiling digital audio all over! At \$850, it's probably the studio's smartest investment. You too will produce better music by using a DAC1!

Call or write **Benchmark Media Systems** today for your **FREE** catalog:
 800-262-4675 www.BenchmarkMedia.com

EQUIPMENT DEALER

EVERY MAJOR BRAND OF EVERYTHING.
 MILLIONS OF DOLLARS OF MUSICAL GEAR IN STOCK.

ALTO MUSIC

Guitars, recording, keyboards, amplifiers, drums, pro sound, new & used. One of the largest selections in the country.

We ship everywhere.

(845) 692-6922 • Altomusic@Altomusic.com
 180 Carpenter Ave., Middletown, NY 10940
 Ask for Uncle Freddy - He loves Ya!

SMALL ADS WORK TOO!

CAREER MARKETPLACE

can you Picture Yourself at Sweetwater?

Name: You!

Position at Sweetwater: Sales Engineer

Education: A music or music technology degree is always good, but we also appreciate the value of real-world experience in the music biz.

Why did you apply for a job here? For the ability to make good money in the field you love - an opportunity for security in an ever-changing audio industry, where the one constant is that Sweetwater continues to grow every year, remaining leaders in music and music technology.

Technical Strengths: You've always been the tweak-head of the band. You're the one people come to for advice on the best gear. You love to talk tech, and you do it well.

Instruments you play: Keyboards and a little guitar, like most of us here.

Gear you own: Most of our employees have home studios from modest to Pro Tools HD.



Family info: Sweetwater's all about family. That's why we've chosen to stay in Fort Wayne, where it all started. Fort Wayne has great job opportunities for your spouse, an excellent school system, and one of the best salary to cost-of-living ratios in the country.

How would your boss describe you? Hardworking. Resourceful. Willing to do what it takes to succeed, yet easygoing and fun to be around.

Sweetwater
 music technology direct

Kristine Haas Ext. 1050
www.sweetwater.com/careers
 5335 Bass Road
 Fort Wayne, IN 46808

(800) 222-4700

The MOTU Virtual Instrument Studio



"...another winner for MOTU."

— *Electronic Musician Magazine*



"Digital Performer 4 is better than ever."
— *Electronic Musician*



"MachFive is unquestionably a winner."
— *Electronic Musician*



Use DP4, the 828mkII and the G5 Power Mac to run MachFive, MX4 and a wide array of virtual instruments

Apple Power Mac G5 The world's fastest personal computer

Your all-native MOTU desktop recording studio just got bigger. A LOT bigger. The new Power Mac G5 is like doubling your studio's square footage, and then adding several additional floors. Run more virtual instruments, more plug-in effects, more tracks, more busses, more processing, more everything than you ever thought possible. Yes, it's time to bask in the glory of your MOTU native studio. Starting at just \$1999, the G5 Tower transforms DP4 into a production powerhouse.

MOTU MachFive™ and MX4™

Put this universal sampler & unique multi-synth in your DP4 arsenal

MachFive could very well be the last sampler you ever purchase. Consolidate all of your sample libraries for instant access in DP4, including Giga, Sample Cell, Akai, K2xxx, Roland and others. Play up to sixteen different parts per instance, and apply automatable synthesis effects powered by the renowned UVI™ engine. To add vintage and fresh analog synth sounds, look no further than MX4, MOTU's new multi-synth. Inspired by legendary subtractive synthesizers, MX4 combines several core synthesis techniques in a unified, hybrid synthesis engine that delivers fat basses, nasty leads, analog pads, vintage electronica — it's all at your fingertips.

Studiologic TMK-88 88-note semi-weighted MIDI keyboard controller

Don't let the size, weight, and price fool you. The Studiologic TMK-88 is a professional MIDI keyboard controller for serious MOTU users, but the amazing price makes it a technological breakthrough that's affordable for a MOTU studio of any size. Boasting full size keys with semi-weighted piano action, this is an 88-note MIDI keyboard controller that weighs in at a mere 13 lbs. Its lightweight and highly durable design makes it perfect for studio or stage. The keyboard action is light, but nicely weighted giving it an expressiveness that must be played to be appreciated. It is the perfect hands-on control for your MOTU studio virtual instruments.

The TMK-88 is velocity sensitive with a mod wheel, one MIDI output, program change and bank select. Suggested retail is \$399.95.



THE MOTU VI STUDIO • CALL SWEETWATER 800-222-4700

UltimateSoundBank Charlie™ Virtual retro organ module

Charlie delivers famous electric organ sounds to your Digital Performer desktop studio via a 3 GB sound library that captures the real sound quality of genuine organs recorded with the vintage equipment favored by purists. Charlie is powered by the UVI Engine™, allowing you to play complex parts with unlimited polyphony. A gorgeous, clearly-designed, feature-rich synth interface, including amazing filters and mono/legato modes, lets you customize the sounds, or completely mangle them. Most patches are available with slow and fast rotary speaker effects. Use real-time MIDI control of every parameter to enhance expression and live use. Included instruments cover the gamut of vintage, classic American and European organs. Enjoy unsurpassed realism for your DP4 organ tracks.



Native Instruments Pro-53™ The second coming of a virtual synth legend

The PRO-53 carries on the tradition of the legendary days of vintage cult synthesizers. Fashioned after the unique original Prophet Five, the PRO-53 casts in software those qualities which have been a major influence on popular music in the past twenty years: brilliance, power, warmth and beauty. Through Native Instruments' creative development philosophy, these timeless aesthetics have now reached the next step in their evolution. The result is the manifest re-definition of an original that was regarded as unrivalled until now. Call Sweetwater and add Pro-53 to your DP4 studio today.



East West / Quantum Leap Symphonic Orchestra™ World class strings / woodwinds / brass / percussion

This stunning new 24-bit orchestra sample library was recorded in a state of the art concert hall by GRAMMY award-winning classical recording engineer Keith O. Johnson with custom-designed recording equipment. And now it can be at your fingertips in DP4. Just open the included Kompakt™ sample player and then mix together any combination of three recorded mic positions (close, stage and hall) to alter the tone and ambience of any instrument or section. For example, you could use the stage mics for that big Hollywood sound, boost certain instruments with a hint of the close mics, and bring in a touch of the hall mics for reverb or even surround mixing. This library was produced by Doug Rogers and Nick Phoenix, recipients of over 30 international awards.



Arturia CS-80V™ Reproduction of the legendary Yamaha® CS-80 polysynth

In 1976, Yamaha introduced the CS-80. The price tag (\$6,900) put it out of reach of most musicians... But the qualities of the CS-80, considered as Japan's first great synthesizer, made it immediately famous in the music industry. Popularized in the late 70's and early 80's by artists and groups like Toto, Jean-Michel Jarre, Keith Emerson, Stevie Wonder and Vangelis, the CS-80 soon became myth. The Arturia CS-80V offers all the features of the original synth, plus a new generation of innovative features. Does CS-80V really sound like the original? We humbly say a resounding "yes!", thanks to Arturia's TAE®, the proprietary technology developed by Arturia, and already successfully used in the Moog Modular V.

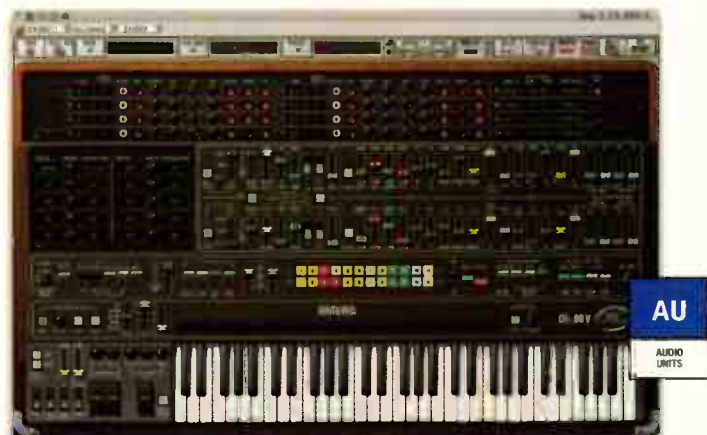

Universal Audio UAD-1 Studio Pak™

Accelerated effects processing for Digital Performer

With power-on-demand DSP and 20 award-winning UA plug-ins, the new UAD-1 Studio Pak plug-in bundle is an unbeatable addition to your MOTU studio. For less money than comparable native plug-in bundles, you get a real DSP card running at 44.1 to 192 kHz plus world class plug-ins like the legendary LA-2A, 1176LN, Cambridge,



Pultec EQP-1A, and the Fairchild 670. Give your Mac a break, improve your workflow, and save a bundle with the UAD-1 Studio Pak.



KORG Legacy Collection™

Virtual instruments and effects plug-ins with MS-20 Controller

The KORG Legacy Collection is the ultimate virtual instrument pack, consisting of software versions of the MS-20, the Polysix, and the WAVESTATION bundled with a special-edition MS-20 Controller. It also contains the revolutionary "Legacy Cell" for making combinations of the MS-20 and Polysix including Insert and Master effects. Features native support of the microKONTROL for a complete hands-on music experience.



Metric Halo ChannelStrip™ X

Console-style, integrated EQ and dynamics processing for DP4

Metric Halo's ChannelStrip is the recognized leader in console-style channel strip audio processing for Digital Performer. As the first plug-in to offer the combination of exceptional audio quality, incredible DSP efficiency and a comprehensive user interface, ChannelStrip lets DP4 users work as efficiently and interactively as they would with a dedicated, world-class mixing console. ChannelStrip comes with more than 100 presets included to help you get your mix started. Use the presets to compress your drums, EQ your vocals, get your sessions ready for mastering and much more. With ChannelStrip for DP4, you get an unparalleled EQ, Gate, and Compressor, all in one easy to use interface. ChannelStrip is the critical mixing tool for thousands of top engineers and producers world-wide

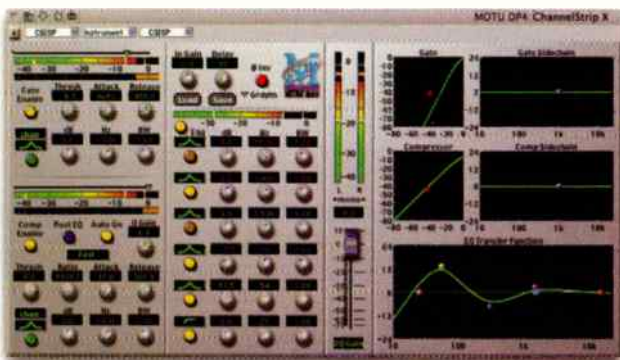

RØDE NT2000™

The World's first fully variable control microphone

The new RØDE NT2000 is the latest brainchild from Australian master microphone designer Peter Freedman and represents a huge investment on RØDE's part. Never before has this much control and versatility been available in a superlative class large capsule recording microphone. The NT2000 features totally variable polar pattern, totally variable high pass filter and totally variable pad — all located directly on the body of the microphone! The heart of the NT2000 is the Australian designed and manufactured TYPE HF1 dual diaphragm capsule. Frequency and transient response have been voiced to complement today's modern recording techniques, and yet still evoke the silky smooth character of the legendary microphones of the 50's and 60's.



PreSonus Central Station™

A Console Master Section Without the Console!

The PreSonus Central Station is the missing link between your MOTU recording interface, studio monitors, input sources and the artist. Featuring 5 sets of stereo inputs (3 analog and 2 digital with 192kHz D/A conversion), the Central Station allows you to switch between 3 different sets of studio monitor outputs while maintaining a purely passive signal path. The main audio path uses no amplifier stages including op amps, active IC's or chips eliminating coloration, noise and distortion enabling you to hear your mixes more

clearly and minimize ear fatigue. In addition, the Central Station features a complete studio communication solution with built-in condenser talkback microphone, MUTE, DIM, two separate headphone outputs plus a cue output to enhance the creative process. A fast-acting 30 segment LED is also supplied for flawless visual metering of levels both in dBu and dBfs mode. Communicate with the artist via talkback. Send a headphone mix to the artist while listening to the main mix in the control room and more.

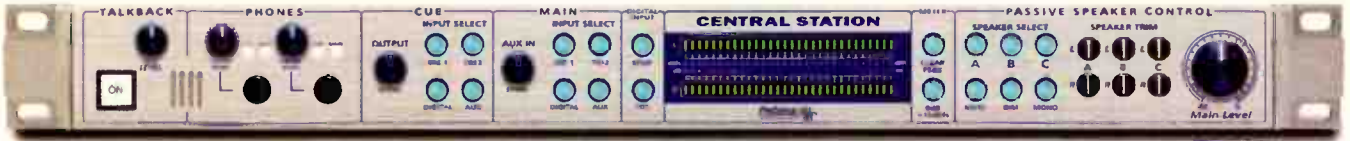

Mackie Control Universal™

Automated hands-on control for the DP4 studio

Imagine the feeling of touch-sensitive, automated Penny & Giles faders under your hands, and the fine-tuned twist of a V-Pot™ between your fingers. You adjust plug-in settings, automate filter sweeps in real-time, and trim individual track levels. Your hands fly over responsive controls, perfecting your mix — free from the solitary confinement of your mouse. Mackie Control delivers all this in an expandable, compact, desktop-style design forged by the combined talents of Mackie manufacturing and the MOTU Digital Performer engineering team. Mackie Control brings large-console, Studio A prowess to your Digital Performer desktop studio, with a wide range of customized control features that go well beyond mixing. It's like putting your hands on Digital Performer itself.



Mackie HR-series Active Studio Monitors

Nearfield monitors for your MOTU studio

Mackie's HR-Series Active Studio Monitors are considered some of the most loved and trusted nearfield studio monitors of all time, and with good reason. These award-winning bi-amplified monitors offer a performance that rivals monitors costing two or three times their price. Namely, a stereo field that's wide, deep and incredibly detailed. Low frequencies that are no more or less than what you've recorded. High and mid-range frequencies that are clean and articulated. Plus the sweetest of sweet spots. Whether it's the 6-inch HR-624, 8-inch HR-824 or dual 6-inch 626, there's an HR Series monitor that will tell you the truth, the whole truth, and nothing but the truth.



Sweetwater SweetCare™

Your personal MOTU studio expert advisor

When setting up and maintaining a MOTU desktop studio, there are many considerations to factor in to your decision making. Both the hardware and software landscape are constantly changing, and it's hard to keep up with all of the advancements. That's where Sweetwater comes in. Your personal Sweetwater sales engineer offers much, much more than just a great price. They do the research, day in and day out, to ensure that you'll fine-tune your MOTU system to fit your exact needs.



**Call now for your MOTU studio
personal consultation: 800-222-4700**

www.sweetwater.com • info@sweetwater.com • 800-222-4700

World Radio History

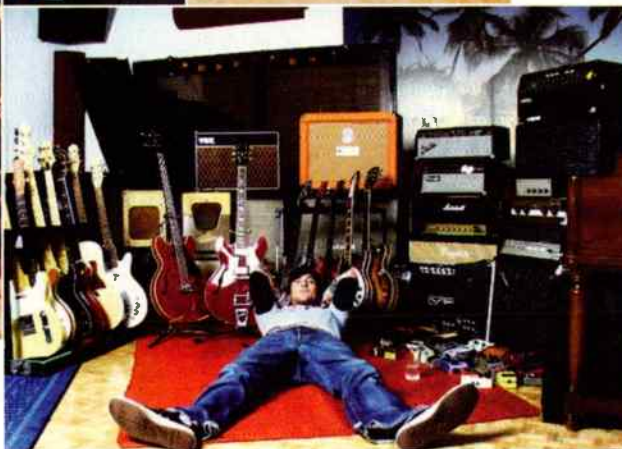
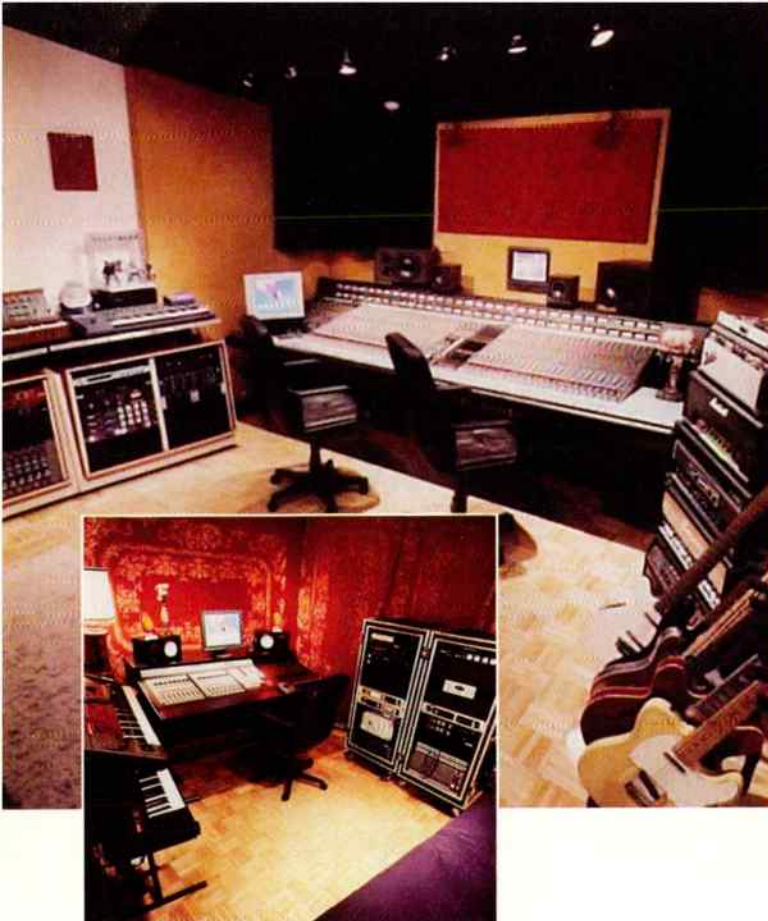

by Mitch Gallagher

Room with a VU

STUDIO NAME: Ruby Red Productions
LOCATION: Atlanta, GA
CONTACT: www.rubyredproductions.net
KEY CREW: Butch Walker, owner/producer/recording artist; Russ-T Cobb, engineer; Christie Priode, studio manager; Sean Loughlin, assistant engineer
CONSOLE: SSL 4048 E/G with Ultimatum, Digidesign ProControl
RECORDERS: Studer A-800 mkIII 24-track, Ampex APR 102 1/2" 2-track
MONITORS: Dynaudio BM-15, Aurotone reference monitors, KRK E8T-Custom, Yamaha NS-10
OUTBOARD: API 525 Feedback Compressor Limiter [2], 550B EQ [4]; Empirical Labs EL-8 Distressor [3], FATSO; Universal Audio 1176-LN, GML 5200 Stereo Mastering EQ
EFFECTS: Eventide H3000, Line 6 POD Pro, Bass POD Pro; AMS RMX16 reverb, Echoplex, Roland Space Echo
MICROPHONE PREAMPS: API 512C [4], Universal Audio 6176, 2-610; Neve 1073 [10]
MICROPHONES: Telefunken U47 [2], Neumann SM2, Coles 4038 ribbon [2], Royer R-121 ribbon [2], Soundelux U95, iFet7; Sennheiser MD421 [3], AKG C414B-ULS [3], Rode NT-2 [2], Shure SM81 [2], KSM44, SM57 [4], SM7; Beyerdynamic M88
MIDI/SAMPLERS/KEYBOARDS: Yamaha baby grand piano, KX88; Wurlitzer electric piano, Roland JP-8000, Hammond B3, Moog Minimoog
COMPUTERS: Apple PowerMac G4/933MHz, PowerMac G4/867MHz, Studio Network Solutions Fibredrive system
DAW: Digidesign Pro Tools HD 3, Accel cards [2], 192 I/O [3], Sync I/O, MIDI I/O, 96 I/O, 888 I/O

SOFTWARE: Digidesign Pro Tools 6.2, Reverb One, Propellerhead Software Reason 2.5, Serato Pitch 'n Time, Line 6 Amp Farm, Echo Farm; Antares AutoTune, tons of plug-ins, synths, and samplers

GUITARS: Gibson J45 (1967), EB-2 w/HSC (1967), Hummingbird, ES335 (1967), Rickenbaker 360, Taylor 810, Danelectro doubleneck guitar, Fender P-Bass (1978), Paul Reed Smith custom-made guitar [4], 5-string bass; Gretsch Stream Liner (1969), Hagstrom hollowbody, Alvarez Model WY-IK, Epiphone 12-string, National lap steel, Martin D35, and lots more

GUITAR/BASS AMPLIFIERS: Bogner Ecstasy, Vox AC15, AC 30/6TB; VHT Pittbull 50/CL, Orange AD-30, Fender Bassman, Matchless Phoenix 35, Marshall mkII, TV 412 cabinets [2]; Ampeg SVT Classic bass head, vintage 8x10 cabinet; tons more weird amps

CABLES: George Ls, Monster, Mogami

AC POWER CONDITIONING: Furman RackRider 15+, balanced power unit

STUDIO NOTES: According to studio owner Butch Walker, "The great thing about Ruby Red is that every computer in the studio is networked via Airport wireless and Fibredrives. We can work on the same session in both Studio A and B without transferring tracks onto external media, and when we're done with a mix, we burn an MP3 and wireless transport it to any computer in the studio (including the artist's laptop) for listening or CD burning. We also put them up on our password-protected studio FTP site so that the good ol' A&R guy in NYC or L.A. can check it out . . . we would hate to leave them out of the creative process!"

HEY, EQ READERS. WANT US TO FEATURE YOUR STUDIO? SEND PICS AND INFO TO mgallagher@musicplayer.com.

THE **01X** ONLY 1 OF ITS KIND



- 8 Mic Pre-Amps
- Digital Mixing
- Expandable Computer I/O
- Effects Processing
- Multi-Port MIDI Interface
- Remote Control Surface
- Firewire Connectivity
- mLAN Networking
- VST/AU Plug-in Suite
- Graphic Patchbay
- Comprehensive Software Support

01X

COMPLETE COMPUTER STUDIO

For the first time everything you need to turn your favorite audio/MIDI sequencing program into a complete computer music studio is available in one convenient and affordable package. Combining a 28 channel moving fader digital mixer, 8 mic pre-amps, 24/96 analog to digital converters, a multi-channel 24/96k mLAN Firewire digital audio interface, a multi-port mLAN Firewire MIDI interface and a DAW control surface that supports all the major software platforms. The 01X is the solution and clearly, the Only 1 of its kind.



Cubase SL/SX

cakewalk MOTU emagic



TOTAL INTEGRATION
COMPLETE CONVERGENCE
ONE CABLE



www.yamaha.com www.01xray.com

© 2004 Yamaha Corporation of America



828mkII

896HD

Portable

FireWire

High Definition

Audio Recording

with CueMix DSP™

for Mac

and Windows

World Radio History



MOTU
www.motu.com