

# Wireless Weekly

Vol. 6. No. 18.

DAVENTRY OPENS  
SPECIAL ARTICLE

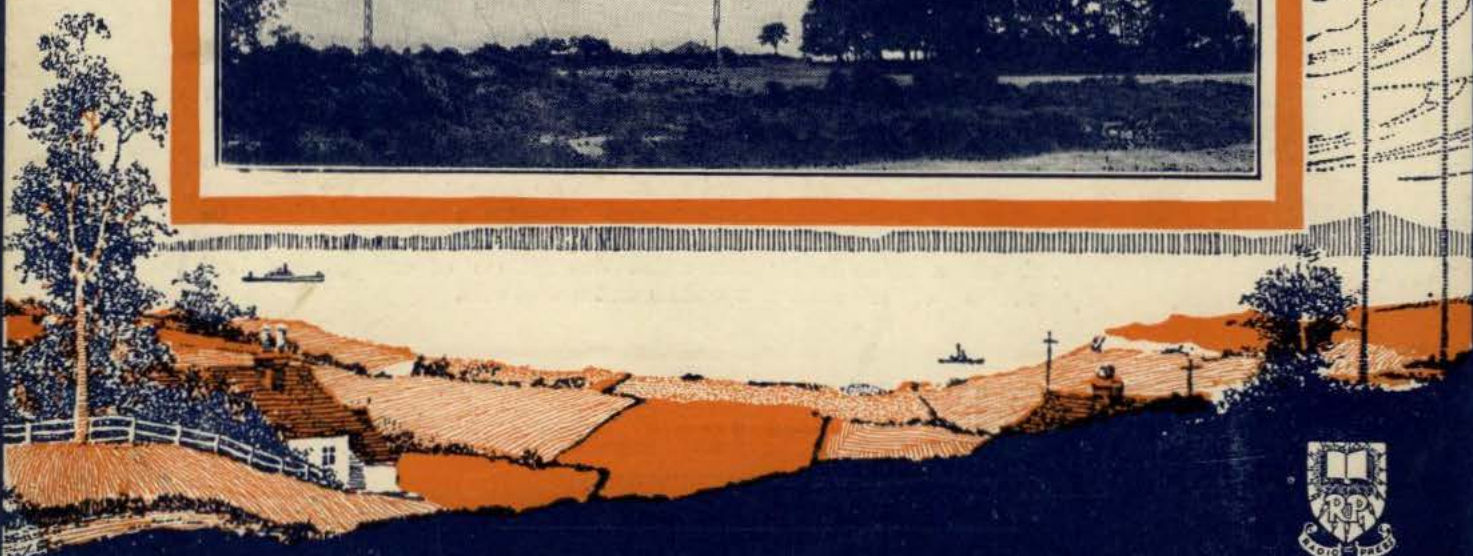

## For reliable filament control, use these Burndept Components

**I**F you fit your set with Burndept Rheostats and Fixed Resistors, you will be able to use any type of valve with only slight and simple alterations and will appreciate the efficient filament control provided by these Burndept Components.

The Burndept Dual Rheostat, which is probably the most popular of our range of Rheostats, enables you to use a bright or a dull-emitter valve without altering your set in any way. The first half of the element is wound to a resistance of 25 ohms, and the second half to a resistance of 5 ohms. The second half is used to control a bright valve, and the whole 30 ohms resistance, a dull-emitter valve. The wire, which is wound on a flexible former, cannot be displaced. As the windings yield slightly to the brush, perfect contact is made and the movement is smooth and "silky." The heat from the element cannot harm the panel, as will be seen by the above enlarged illustration.

Burndept Fixed Resistors each consist of a definite amount of resistance wire wound on a fibre rod. By means of a screw

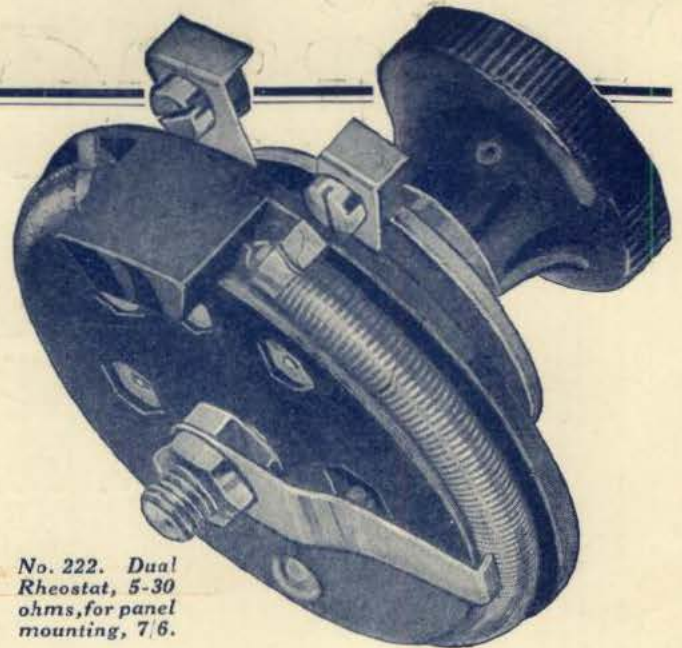

No. 222. Dual Rheostat, 5-30 ohms, for panel mounting, 7/6.

cap, each Resistor may be placed in a Screw Holder which is wired up in series with an existing rheostat or by itself in the filament circuit. This method of construction, which is employed in several Burndept receivers, enables one to adjust the filament current easily and quickly by inserting a Resistor suitable for use with each particular type of valve. Fixed Resistors are made in sixteen values from 0.75 to 55 ohms. Here is the complete list:—

Cat.No.	Ohms.	Amps.	Price	Cat.No.	Ohms.	Amps.	Price
735	0.75	2	1 6	728	13	0.5	1 9
722	1.5	2	1 6	737	15	0.5	1 9
723	2	1	1 6	729	20	0.25	2 0
724	3	1	1 6	730	26	0.25	2 0
734	4	1	1 6	738	30	0.25	2 0
725	5	0.5	1 9	736	40	0.25	2 0
726	7.5	0.5	1 9	731	48	0.25	2 0
727	10	0.5	1 9	732	55	0.25	2 0

No. 718. SCREW HOLDER for above Resistors, suitable for mounting on wood or ebonite, 1/6.

No. 720. Three BRASS SHORTING PLUGS, in carton, 1/6.

Further particulars of Burndept Rheostats and Fixed Resistors are given in the Burndept Components Catalogue, a copy of which will be sent free on request. This publication contains illustrated descriptions of components, loud speakers and accessories.

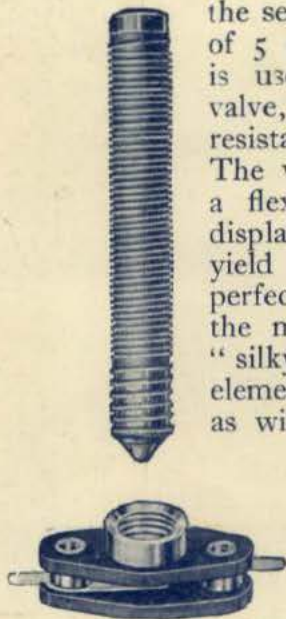

BRANCHES at Birmingham, Brighton, Bristol, Cardiff, Exeter, Glasgow, Leeds, Manchester, Newcastle, Northampton & Nottingham

# BURNDEPT

## WIRELESS LIMITED

HEAD OFFICE: Aldine House, Bedford Street, Strand, London, W.C.2  
Telephone: Gerrard 9072.  
Telegrams: Burndept, Westrand, London.

Assistant Editor:  
 Percy W. HARRIS,  
 M.I.R.E.  
 Scientific Adviser:  
 Prof. G. W. O. Howz,  
 D.Sc., M.I.E.E.  
 Advisory Editors:  
 Prof. R. WHIDDINGTON,  
 M.A., D.Sc.  
 Prof. C. L. FORTESCUE,  
 M.A., M.I.E.E.

# Wireless Weekly

Phone: City. 9911.

Staff Editors:  
 E. H. CHAPMAN,  
 M.A., D.Sc.  
 A. D. COWPER, M.Sc.  
 R. W. HALLOWS, M.A.  
 G. P. KENDALL, B.Sc.  
 A. JOHNSON - RANDALL,  
 STANLEY G. RATTEE,  
 M.I.R.E.  
 J. H. REYNER, B.Sc.,  
 A.C.G.I., D.I.C.



## The I.E.E. and the Radio Engineer

**W**E are glad to note that, as foreshadowed in our Editorial a fortnight ago, it has been decided that a separate institution of British Radio Engineers is unnecessary. A conference has been held between Mr. James Nelson, one of the founders of the proposed new society, and the Committee of the Wireless Section of the Institution of Electrical Engineers as a result of which it was decided that there is no need for a new body, and therefore the proposal may not be continued with.

The present position is set forth in the following statement issued by Mr. Nelson:—

### PROPOSED INSTITUTE OF RADIO ENGINEERS.

"I think it has been quite clear in all the correspondence that the above Society was proposed because there did not appear to be any body in existence in this country which catered sufficiently for the growing number of wireless engineers.

"I am very pleased to say that by invitation of the Committee of the Wireless Section of the Institution of Electrical Engineers, I was present at a meeting of the Committee which took place on Friday, July 21. Matters were discussed very fully, and I must thank the Committee for the businesslike manner in which they dealt with the subject. For the present it is sufficient for me to state that I am satisfied that entrance into the I.E.E. by those professionally engaged in wireless matters

is not as difficult as I had imagined, and that it is realised by the Institution that radio matters are of great and growing importance.

"Any further criticisms on the position after perusing any statement the Council of the I.E.E. may make in the Technical

There remains, therefore, the question of the qualifications which are necessary in order to obtain the A.M.I.E.E. We are decidedly of the opinion that if the reorganised Wireless Section of the Institution is to give the radio engineer in this country the necessary high status, it is essential that a high standard should be adopted in deciding the qualifications necessary for admission to membership of the Wireless Section.

The Council of the Institution of Electrical Engineers has recently and rightly increased the standard for the A.M.I.E.E. very considerably. Further, in order to cater for the radio engineer, papers are now set in radio engineering subjects. The standard of these papers, however, is, in our opinion, not sufficiently high, while at the same time certain fully qualified radio engineers might have difficulty in passing the first portion of the examination.

Since, however, the regulations of the Institution of Electrical Engineers permit the examination to be waived on the submission of a suitable thesis, we do not consider that the examination difficulty is very serious to the distinguished radio engineer.

It appears to us that the better course would be a distinct stiffening of the standard of the papers in radio subjects, with a reasonable amount of latitude in the general "mechanics" qualifications.

(Concluded on page 576.)

### CONTENTS.

	Page
Working with the MacMillan Expedition ..	554
Why One Valve Oscillates more easily than another ..	557
Inductance Design and Losses ..	560
Jottings by the Way ..	564
What I saw in American Research Laboratories ..	566
A Useful Short-wave Inductance ..	569
Wireless News in Brief ..	570
Inventions and Developments ..	571
The New 1600 Metre Station ..	572
Faults in Resistance and Choke-Coupled Note Magnifiers ..	577
Random Technicalities ..	580
Correspondence ..	581
Apparatus We Have Tested ..	585
Information Dept. ..	587

Press, can be sent to Mr. Y. W. P. Evans, 66, Oxford Road, Manchester. All our friends may rest assured that their interests will be well looked after."

It will be remembered that the modifications proposed were that only duly qualified radio engineers be admitted to the radio section, and that such members should be permitted to style themselves in some distinctive manner. In addition, we consider that the proceedings should be published separately.

# Working with the MacMillan Expedition

By C. W. GOYDER (2SZ)

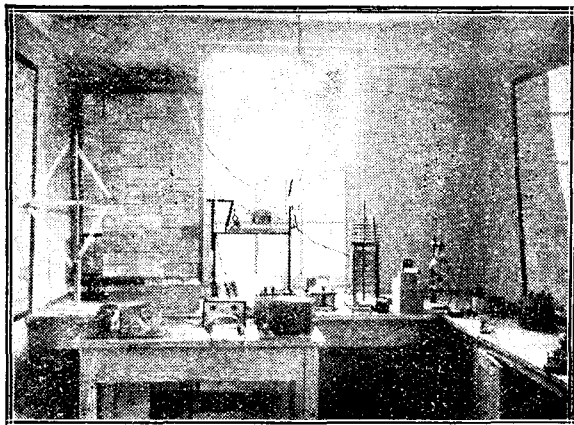

A general view of the equipment in use at Mr. Goyder's station at Mill Hill. The apparatus in front of the window is an experimental 5-metre receiver.

**D**URING the week ended July 25 the writer has been in communication with the MacMillan Arctic expedition on several occasions. Before giving any details a description of the expedition will be of interest, as, apparently, no very detailed accounts have been published previously.

The first MacMillan Expedition of interest to the wireless amateur left Maine, U.S.A., in June, 1923. On board was the first short-wave transmitting set ever taken to the Pole by any explorer. It was operated by an American amateur. The wavelength used was 200 metres. This was before the short-waves below 200 had been explored. With the aid of this set it was found possible to keep in touch with America only under favourable conditions; sometimes it was three or four days before a message got through; once the expedition was not heard for three weeks.

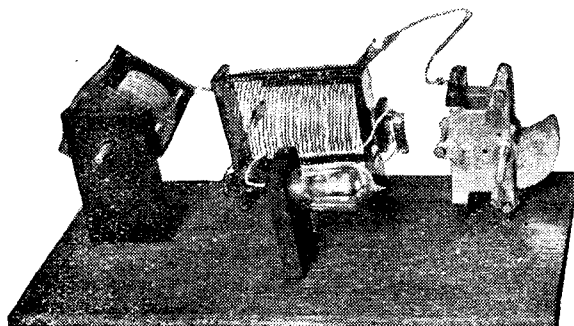

This photograph indicates the extreme simplicity of the 45-metre receiver. The panel and the condenser extension handles have been removed to show the components on the baseboard.

This, of course, refers to the time when the expedition was fairly near the Pole, during the long imprisonment in the ice, waiting for the summer break-up. This first expedition returned to America last year.

Early last month the explorers left Maine for a second trip. A summer exploration is being made, in an endeavour to locate a large Arctic continent which is thought to exist between Alaska and the North Pole.

## Transmission on Four Wavelengths

The advance made in amateur radio is demonstrated by the difference in wavelengths used by this expedition. In place of the former 200-metre transmitting set there is 20-, 40-, 80- and 150-metre

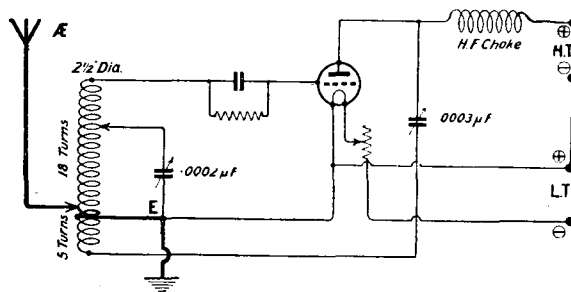

The circuit diagram of the detector portion of the set on which signals from WAP and WNP were picked up. Only one stage of low-frequency amplification is normally used.

equipment. It is doubtful whether the 150-metre set will be used at all except for experimental comparisons of range. The sets on these various wavelengths are all capable of an output of 250 watts.

There are two ships in this expedition, the *Bowdoin* and the *Peary*. The *Bowdoin* is the main ship, which carried out last year's trip. The advance made in other branches of science in the past year is well shown by the fact that the *Bowdoin* is accompanied by the *Peary* carrying three amphibian aeroplanes. These 'planes are equipped with motion picture and mapping cameras, and also wireless telephony sets, so that, while flying, they may be in constant touch with their ships.

## Strong Signals from 2SZ

On Saturday morning, July 18, while experimenting for the first time with a new 45-metre set and listening for American amateurs, the *Peary* (call-sign WAP) was heard giving a general call. I replied and received an answer at once to the effect that my signals were strong. We worked for a few minutes only, as the *Peary* had to close down. Immediately the *Bowdoin*

In recent issues we have given a brief account of the MacMillan Arctic Expedition and the wireless equipment with which they are provided. The news that a British Amateur, Mr. C. W. Goyder (2SZ), of Mill Hill, had established and maintained for some days reliable communication with the expedition no doubt came as a surprise to many. Below we have pleasure in presenting to our readers an exclusive account of this praiseworthy feat, together with complete details of the actual equipment used by Mr. Goyder.

(call-sign WNP) called, and we worked for half an hour. The *Bowdoin* was then at Hopedale, Labrador, due to a broken propeller, which had been very difficult to remove and so had delayed the expedition for a week. Hopedale is just halfway up the coast of Labrador. The *Peary* was at Disko Island, Greenland, shipping coal. Disko Island is 800 miles up the Greenland coast.

**Communication Lasts Two Hours**

On Sunday, July 19, at 2.30 a.m., the *Peary* was again worked, this time for half an hour.

The *Bowdoin* was next heard on Friday morning, July 24, and on this occasion we were in communication for two hours. The new pro-

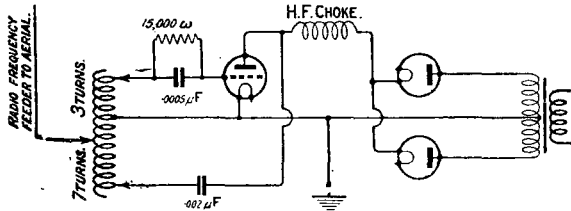

A simplified circuit diagram of the transmitter used by Mr. Goyder. Readers will recognise this as the familiar Hartley circuit.

peller had been fitted, and the ship, which had left Hopedale on Tuesday, crossed the Arctic Circle while we were working.

The operator on board the *Bowdoin* is well known to every amateur—John L. Reinartz—the designer of many transmitting and receiving circuits and the pioneer worker on the 20- and 40-metre bands which have just lately come into the field of operation.

**When to Listen for Signals**

For those who wish to listen for WNP and WAP, the best time is between 2 and 4 a.m. British Summer Time. Their wavelength at present is from 35 to 40 metres, but in future 20 metres will probably be employed, as the greater period of daylight near the Pole only allows communication between the expedition and America for an hour and three-quarters (from 1 until 2.45 a.m.). It is expected that the 20-metre band will overcome this difficulty.

The 45-metre transmitter uses at 2SZ the Hartley circuit, which needs no further description than is given by the diagram. A 250-watt power valve is used, supplied with 2,000 volts full-wave valve-rectified and smoothed A.C.

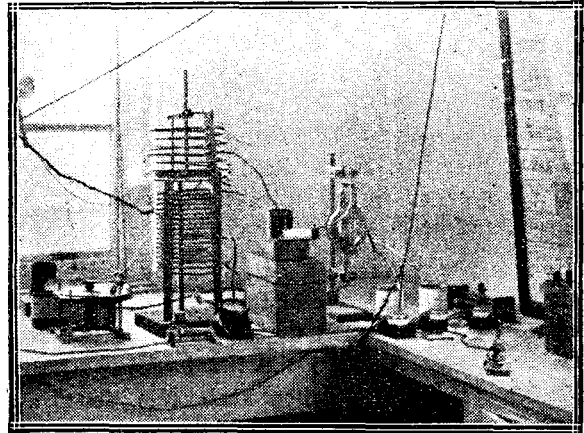

The layout of the transmitter, of which the simplicity is self-evident from the photograph.

The transmitting inductance is wound with 1/4-in. copper tubing. The two coils seen on the right in the photograph of the transmitter on this page are filament chokes. The choke in the positive high-tension lead may be seen on the left. From the inductance the aerial tap is seen connected to the aerial ammeter and from there to the aerial lead-in wire. The switches are for the power and rectifier valve filaments, and the high-tension supply. The accumulators just visible on the right operate the keying relay.

**A "Low-loss" Receiver**

The receiver is of the usual low-loss type using the Reinartz circuit. The coils are wound with bare wire spaced by two ebonite strips in which holes an eighth of an inch apart have been drilled. The wire coil is threaded through these holes. The coils are interchangeable. They slip into a small groove on the upright ebonite supports, and so make contact with the strip of copper foil fixed around the support. The filament tap and the condenser tap are clipped on to the wire. On the left of the photograph showing details of the receiver is the reaction condenser (Burndept, .0003 microfarad); on the extreme right is the tuning

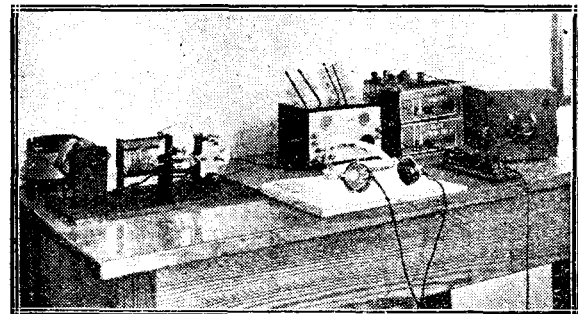

The receiver, amplifier and accessories at 2SZ. The instrument on the extreme right is a wavemeter.

condenser (Cardwell, .0002 microfarad). The detector valve has had the base removed to reduce capacity effects. Normally a detector and one stage of low-frequency amplification are used. Mullard valves are used throughout.

The Aerial System

The aerial is of an unusual type. It consists of a horizontal wire  $22\frac{1}{2}$  metres long (for the 45-metre wavelength), and is excited by means of a radio-frequency feeder. A bulb at the centre indicates when the transmitter is in resonance with the aerial. Experiments with two aerials of this type at right angles tend to show that this type of aerial is very directional.

The expedition is now only halfway to its destination. The real test of the merit of the short waves will come when the ships are locked for the winter months near the North Pole. If the wireless amateur can then keep this far-away expedition in touch with home he will render a service both creditable and useful.

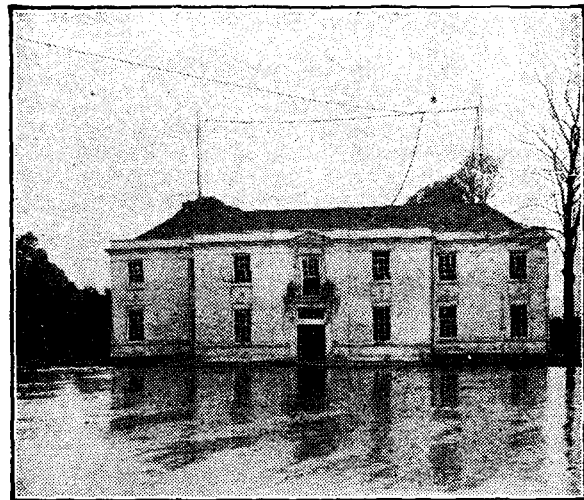

This photograph will give some idea of the height and arrangement of the aerial system in use at 2SZ.

ARE "WAVE-LENGTHS" PLAYED OUT?

By J. H. REYNER, B.Sc. (Hons.), A.C.G.I., D.I.C., Staff Editor.

**F**OLLOWING my article in last week's issue of *Wireless Weekly*, I have received one or two queries on the subject.

A correspondent remarks that it is much simpler to speak of 20 metres than 14,991 kilocycles. If the frequency viewpoint is adopted, however, one would operate one's set at the nearest round figure in kilocycles—in this case 15,000 kc., corresponding to a wavelength of 19.99 metres.

The question is really one of future development. At present

the very short waves are not overcrowded, and in consequence the adoption of round figures for the wavelength, such as 20 metres, is feasible.

As soon as this portion of the frequency spectrum becomes really popular, however, it will be necessary to adopt wavelengths such as 20.12 metres (corresponding to 14,900 kc.). It is then more convenient to work in kc.

Recent tests were carried out by the R.S.G.B. and the A.R.R.L. on a "wavelength band of 19-21 metres." How many stations

can work in this band simultaneously without interference?

Actually, assuming a 10 kc. separation, there is room for 150 stations, but this is not obvious from the wavelength figures.

If, however, the band were referred to as a frequency band of 14,250-15,780 kc. (the nearest round figures to 21 and 19 metres, the actual figures being 14,277 and 15,780), the number of channels is immediately obvious.

A second query was in connection with the kc. to metres (Continued on page 584.)

Station.	Call Sign.	Wave-length.	Frequency. Kc.	Station.	Call Sign.	Wave-length.	Frequency. Kc.
Sheffield ... ..	6FL	301	996	Petit Parisien ... ..	—	345	869
Stoke-on-Trent ... ..	6ST	306	980	Madrid ... ..	EAJ7	392	765
Bradford ... ..	2LS	310	967	Rome ... ..	1RO	425	705
Liverpool ... ..	6LV	315	952	Stockholm ... ..	SASA	427	702
Nottingham ... ..	5NG	326	920	Leipzig ... ..	—	454	660
Edinburgh ... ..	2EH	328	914	Ecole Superieure ... ..	FPTT	458	655
Dundee ... ..	2DE	331	906	Berlin ... ..	—	505	594
Hull ... ..	6KH	335	895	Prague ... ..	PRG	555	540
Plymouth ... ..	5PY	338	887	Lausanne ... ..	HB2	850	353
Leeds ... ..	2LS	346	867	Hilversum ... ..	NSF	1050	285.5
Cardiff ... ..	5WA	353	849	The Hague ... ..	PCGG	1070	280
London ... ..	2LO	365	821	Geneva ... ..	HBI	1100	273
Manchester ... ..	2ZY	378	793	Konigswusterhausen ... ..	LP	1300	231
Bournemouth ... ..	6BM	386	777	Daventry ... ..	5XX	1600	187
Newcastle ... ..	5NO	403	744	Radio-Paris ... ..	SFR	1780	168
Glasgow ... ..	5SC	422	711	Amsterdam ... ..	PCFF	1955	153
Belfast ... ..	2BE	439	683	Eiffel Tower ... ..	FL	2650	113
Birmingham ... ..	5IT	479	626	East Pittsburgh ... ..	KDKA	68	4409
Swansea ... ..	5SX	482	622	Schenectady ... ..	WGY	309	970
Aberdeen ... ..	2BD	495	606			380	789
Brussels ... ..	SBR	265	1131				

# WHY ONE VALVE OSCILLATES MORE EASILY THAN ANOTHER

By J. H. REYNER, B.Sc., (Hons), A.C.G.I., D.I.C., Staff Editor.

*A change of valve often necessitates an alteration in the reaction adjustments. This article explains why.*

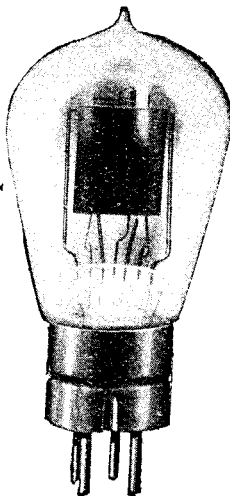

*The D.E. 5b valve has an amplification factor of 20.*

**SUMMARY**

**T**HE theory of the oscillating valve is investigated and it is shown that:—

(1) The mutual inductance required to produce oscillation is dependent upon the internal resistance of the valve and the amplification factor.

(2) An increase in the internal resistance of the valve employed will require an increase in mutual

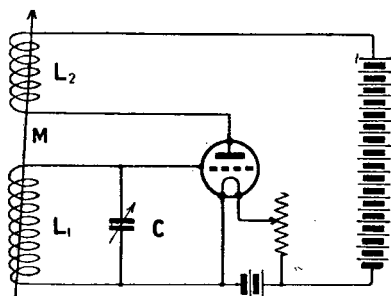

*Fig. 1—A typical oscillating valve circuit in which the grid inductance is tuned.*

inductance necessary to produce oscillation.

(3) Conversely, the higher the amplification factor of the valve, the less will be the mutual inductance necessary between the grid and anode coils.

(4) It is generally found that the higher the amplification factor the higher the internal impedance and conversely, so that

these two factors tend to neutralise each other. There is, however, a sufficient difference in the ratio of the internal impedance to the amplification factor to cause a considerable variation in the amount of reaction required to produce oscillation according to the type of valve employed.

It is often found that a reaction adjustment which is satisfactory for one make of valve will be either too small or too large if another type of valve is substituted in the place of the first. It may even be necessary to change the coil, or if the circuit is of the type which contains a built-in reaction adjustment, the circuit may prove quite unsuitable for the different type of valve.

The exact manner in which the reaction control is affected by the change in the valve is often not clearly understood, and it is the purpose of this article to examine the effects in some detail and to explain the mechanism of the production of reaction and oscillation by means of a valve. From this we shall be able to determine the exact effect of the valve characteristics upon the value of the reaction coil employed, and hence, if the valve is changed, to determine what alteration, if any, will be necessary in the reaction coil.

**The Mechanism of the Oscillating Valve**

The method by which the valve sustains oscillation is well known, and may be briefly described in a very few words. In any ordinary oscillating circuit, the current dies away very rapidly owing to the losses which are set up in the circuit by the resistance. If the power which is lost in these oscillations,

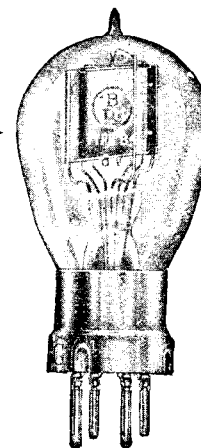

*The B.T.H. B4 valve is designed for L.F. amplification, and has a low amplification factor.*

due to the damping effects of the resistance, can be re-introduced into the circuit by some means, the oscillations will not die away but will be maintained at their original amplitude.

This is what is done in the case of a valve oscillator. Consider the circuit shown in Fig. 1. Here the main oscillating circuit comprises the coil L<sub>1</sub> with the

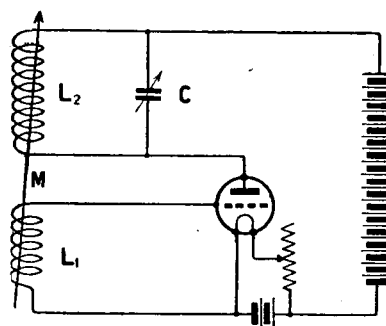

*Fig. 2—Another common form of oscillating valve circuit.*

condenser C connected across it, and this circuit is connected across the grid and filament of the valve. If now an oscillation is started in this circuit, voltage variations will be impressed upon the grid of the valve, and these will cause changes to take place in the anode current.

These changes in the anode current are made to pass through

the coil L<sub>2</sub> in the anode circuit, and this second coil is coupled to the first coil L<sub>1</sub> (which constitutes part of the oscillating circuit). The effect of the varying current in the coil L<sub>2</sub> is to induce voltages in the coil L<sub>1</sub>, by the usual laws of mutual induction.

It will readily be seen, therefore, that if the voltage impulses introduced into the oscillating circuit are in the right direction, the losses due to the damping of the circuit may be made up. Conversely it will be obvious that if the coil is connected in the opposite direction, the energy introduced into the circuit will not make up for the losses, but will rather increase them and hasten the damping, or die away of the oscillations.

**Coupling Necessary for Self-Oscillation**

We may now investigate the value of the coupling required to maintain this oscillation in the manner we have just described. As has been seen, the condition necessary for oscillation to be maintained is that the power fed back from the anode circuit into the oscillating circuit must be equal to the power which is lost due to the resistance in the circuit.

The mathematical theory, though not complicated, is extraneous to the present investigation. It will suffice to remark that there is a certain critical value of the mutual inductance

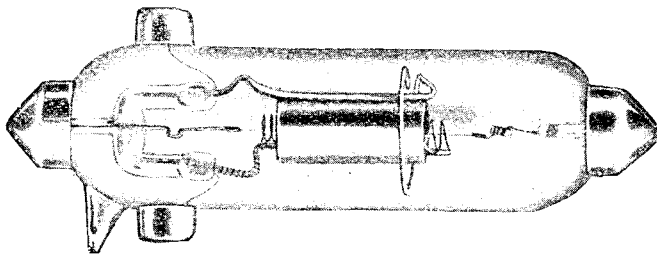

*A typical Marconi low-capacity valve.*

between the coils L<sub>1</sub> and L<sub>2</sub>, below which the energy fed back is insufficient to sustain oscillations.

The value of this critical coupling is given by

$$M = \frac{CRr_1}{\mu}$$

- where M=mutual inductance
- C=capacity of condenser in oscillating circuit
- r<sub>1</sub>=internal impedance of valve
- μ=amplification factor.

The mathematical theory from which this expression is deduced has been given in an appendix at the end of this article.

**Factors Controlling the Oscillation**

From these results we may summarise the various factors which affect the tendency of the valve to produce continuous oscillation. We see that the mutual inductance necessary between the two coils in the anode and grid circuits respectively depends upon:—

(1) The value of the capacity in the oscillating circuit, the mutual inductance required increasing with any increase in this capacity.

(2) The resistance in the oscillating circuit, the mutual inductance increasing for an increase in its resistance. This, of course, is what one would expect. The higher the damping losses in the oscillating circuit the higher would be the mutual inductance required to produce oscillation.

(3) The internal impedance or resistance of the valve. Here, again, the mutual inductance necessary would be higher the greater the internal resistance.

(4) The amplification factor of the valve. The higher the amplification factor the less will be the mutual inductance required. This, again, is in accordance with the dictates of common sense.

It will readily be seen, there-

fore, that the characteristics of any particular valve have a very considerable effect upon the tendency to oscillate. This tendency is, to some extent, discounted by the following considerations. It is an inherent feature in valve construction that an increase in the amplification factor of the valve is accompanied by an increase in the internal resistance. Reference to the equation just quoted will show that since the internal re-

sistance appears on the top of the equation, and the amplification factor appears underneath, if these two parameters increase together the value of the mutual inductance required will remain approximately the same.

**Practical Examples**

There is, however, a certain difference with different types of valve. We may examine this in

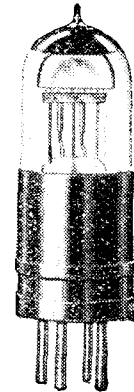

*One of the new Cossor valves*

two particular instances. In the case of a D.E.R. valve the internal resistance is 45,000 ohms and the amplification factor is 9. This gives a ratio of internal resistance to amplification factor of 5,000.

In the case of the D.E.3 valve, however, the internal resistance is 20,000 ohms and the amplification factor is 5, giving a ratio of internal resistance to amplification factor of 4,000. It will thus be seen that, other things being equal, the D.E.3 valve will produce oscillation with less reaction than a D.E.R.

**Other Considerations**

It should be observed that in the foregoing expressions the amplification factor is the actual amplification factor of the valve and not the theoretical amplification factor as determined from the characteristics of the valve. In the two examples just considered, the theoretical amplification factor was taken merely to obtain some form of comparison, but in actual practice the amplification actually obtained is very considerably less. The formula just given for mutual inductance, therefore, must not be taken as complete, because it will be found in practice that the values of mutual inductance obtained by



this formula are considerably too low.

It is not necessary, however, for the purpose of the present investigation to consider these additional complications. The simple theory as outlined is sufficient to indicate the dependence of the oscillating condition upon the valve characteristic.

**Other Forms of Tuned Circuits**

The circuit, as shown in Fig. 2, is also very commonly employed as an oscillating circuit. In this case we have the oscillating circuit itself in the anode circuit of the valve, the grid circuit containing the coil  $L_1$  coupled to the oscillating coil  $L_2$ . Voltage variations are thus impressed upon the grid of the valve which cause amplified current to flow in the anode circuit, and these make up the losses in the oscillating circuit in a similar manner to that obtaining in the original circuit considered. In this case, however, the impedance of the oscillating circuit in the anode circuit of the valve is not negligible, and, therefore, the anode current is not simply obtained by dividing the anode voltage by the internal resistance.

If proper allowance is made for this factor, the mutual inductance will be found to be given by the expressions

$$M = \frac{L_2 + CR_1}{\mu}$$

It will be seen that this expression is of the same type as the former, but that in this case the inductance in the oscillating circuit enters into the expression as well as the capacity.

As far as the characteristics of the valve itself are concerned, however, the expression is almost the same as before.

It may be pointed out that in the case of a circuit of this nature the actual amplification factor is not very much less than the theoretical amplification factor obtained from the characteristics. This point will be discussed in a future article in which the suitability of various forms of oscillating circuits will be considered.

**Use of Reaction**

The foregoing remarks apply equally well to a reaction coupling in which the circuit is not

actually caused to oscillate, but is brought up to the point of oscillation for the purpose of increasing the signals. Here the amount of reaction coupling necessary to produce the required effect will depend upon the valve characteristics in the manner already indicated.

**APPENDIX.**

**Theory of Self-oscillation**

Now let  $\mu$  equal the amplification factor of the valve, and let the voltage supply to the grid of the valve be  $V_g$ . Then the voltage produced in the anode circuit of the valve will be  $\mu V_g$  and the anode oscillating current will be  $\mu V_g / r_i$ , where  $r_i$  is the internal resistance of the valve.

This expression neglects the impedance of the coil  $L_2$  in the anode circuit, but this is small compared with the internal resistance of the valve, and is thus negligible. Now, the power in the anode circuit is the product of the anode voltage and the anode current. We have seen that the anode current is equal to  $\mu V_g / r_i$ , from which we have the anode power equals

$$\frac{\mu V_a V_g}{r_i}$$

where  $V_a$  is the anode oscillating voltage.

Now consider the oscillating circuit  $L_1 C$ . Let the resistance of this circuit be  $R$  and the oscillating current  $I$ . Then the power lost in this circuit is given by  $I^2 R$ .

Let  $M$  equal the mutual inductance between  $L_1$  and  $L_2$ . Then, if the oscillating circuit is carrying a current  $I$  at a frequency  $f$ , then the voltage induced from this circuit into the anode coil  $L_2$  can be shown to be  $IM\omega$ , where  $\omega$  is equal to  $2\pi f$ .

Now, if this voltage is existing at the coil  $L_2$ , this will obviously be the anode oscillating voltage  $V_a$ , which was referred to previously. We may write, therefore, that  $V_a$  equals  $IM\omega$ . We also know that the oscillating voltage  $V_g$  is equal to  $IL_1\omega$ ,  $L_1$  being the inductance of the coil in the oscillating circuit.

Hence, we may write down the following equations:—

$$\begin{aligned} \text{Power in anode} &= \frac{\mu V_a V_g}{r_i} = \frac{\mu IM\omega IL_1\omega}{r_i} \\ &= \frac{I^2 M L_1 \omega^2 \mu}{r_i} \end{aligned}$$

This is required to equal the power lost in the oscillating circuit  $= I^2 R$

$$\text{Whence } M = \frac{R r_i}{L_1 \omega^2 \mu}$$

Now, the frequency of the oscillations in the circuit  $L_1 C$  is

$$\text{given by } f = \frac{1}{2\pi\sqrt{L_1 C}}$$

$$\text{Therefore, } \omega = 2\pi f = \frac{1}{\sqrt{L_1 C}}$$

$$\text{and } \omega^2 = \frac{1}{L_1 C}$$

The equation above then simplifies to  $M = \frac{CR r_i}{\mu}$

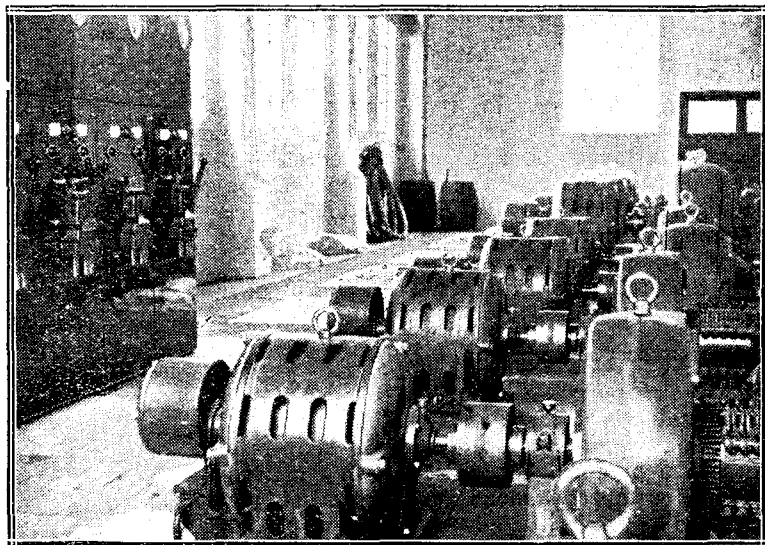

A close-up view showing the eight generators and the power control switchboard at the Daventry station. Normally only five of these machines are in use.

# Inductance Design and Losses

By A. D. COWPER, M.Sc., Staff Editor.

*In view of Mr. Cowper's observations on losses due to grid-current damping, detailed in our last issue, it becomes necessary to revise our ideas on the design of low-loss inductances if we are to preserve a proper sense of proportion in considering these losses. In this article the author reviews inductance design in this new light and discusses the practical aspect of the question.*

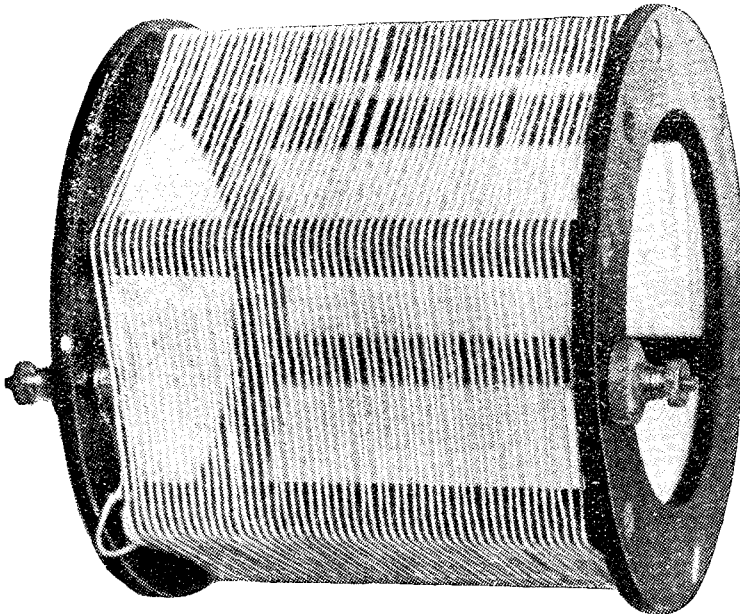

One of the typical low-loss inductances tested by the author.



As a corollary to the practical investigations into the question of low-loss inductance design made recently by the writer (*Wireless Weekly*, Vol. 6, No. 4, and subsequent articles), under conditions strictly parallel to those obtaining in a secondary circuit of an actual broadcast receiver, it seemed advisable to measure, in the same practical way, the relative effective resistance offered by some *alternative* types of tuning inductances, particularly of a more compact form than the large, ultra-low-loss type developed in the first series of experiments.

### Compactness Desirable

For special purposes and in experimental work, these very large coils may be justified, but for use in a practical broadcast receiver of compact dimensions there would be an obvious advantage if a smaller type could be developed without sacrificing much efficiency. Particularly in

view of the remarkably high damping effect of the ordinary detector-valve operating with a leaky grid condenser, shown recently by the writer to be equivalent actually to a series H.F. resistance of some 50 to 60 ohms inserted in the grid-tuning circuit, it would appear that any *small* difference in H.F. resistance of the tuning inductance might easily be inappreciable by comparison, so that but small loss of efficiency might be sustained through the use of a more compact type of tuning inductance.

### Comparative Tests

The practical problem is then to compare the working efficiency of differently-wound coils, with about the same inductance value (*i.e.*, that which enables one to tune over the lower broadcast belt in a secondary circuit with a small parallel tuning condenser of some .0002 or .00025  $\mu$ F maximum capacity), with approximately the same load (*i.e.*, the detector valve grid-damping in actual reception, and

some losses due to aerial coupling).

It is possible for those mathematically inclined to make calculations, based on certain assumptions (which may, however, be open to grave question on experimentally established grounds), and dealing necessarily with an ideal, hypothetical case, whereby the relative effect of the resistance of the inductance may be shown to depend also upon the relation of the inductance value, the valve damping, and the frequency. It is obvious, however, without calculation, that where the other damping effects in the circuit are relatively very large, any *small* variation in the actual ohmic resistance may be inappreciable in its effects; as the writer pointed out in his first article, this is the case in crystal reception to a large extent.

Hence, whilst the frequency is fixed within narrow limits by the broadcast authorities, and the

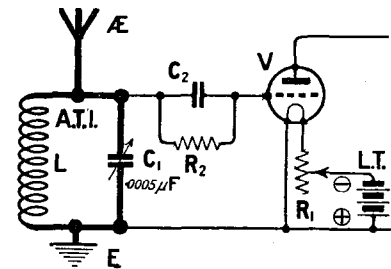

Fig. 1.—A heavily-damped circuit of which the selectivity is very poor.

inductance by practical considerations as to tuning condenser size and favourable inductance-to-capacity ratio, we have to determine by practical experiment at what point, if at all, the valve damping is going to make further improvement in inductance

design profitless, *i.e.*, how small and compact an inductance we may use without serious loss in efficiency, and how small a wire gauge. This will have to be re-determined practically for each broadcast frequency belt; what is correct for 2LO is very unlikely to be correct for Daventry or Pittsburg.

**Primary and Secondary Inductances**

Listeners are coming rapidly to realise that a direct-coupled

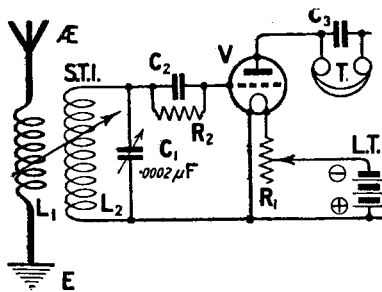
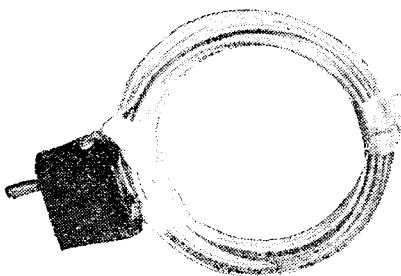

Fig. 2.—The aerial damping is minimised here by loose coupling and a semi-aperiodic primary.

aerial has no place under modern broadcasting conditions for selective reception. The writer has shown experimentally (*Wireless Weekly*, Vol. 6, Nos. 11 and 12) that the optimum signal-strength is obtained from a given aerial by a combination of semi-aperiodic aerial (*i.e.*, only roughly tuned by coarsely-tapped primary inductance of mediocre



A low-resistance hank-wound coil.

design), loose-coupled with a sharply - tuned ultra -low - loss secondary with small parallel tuning capacity, and that this combination gives a very useful degree of general selectivity, also that the matter of primary design is not of great moment.

The question which most interests the general listener is that of the most efficient and at the same time most compact and economical secondary tuning

inductance for use in filter-stages of low damping decrement, and also as the grid circuit tuning-inductance preceding the detector-valve (with its high damping effect) to cover the range from 300 to 500 metres (999.4 to 599.6 kc.) with a parallel tuning-condenser of, say, .0003  $\mu$ F maximum capacity and normal minimum capacity (together with casual panel and valve capacities of around 25-50  $\mu$  $\mu$ F), *i.e.*, a coil of from 250 to 300 microhenries inductance, corresponding roughly with a No. 75 plug-in coil.

**Method of Measurement**

Measurements were made of the relative effective H.F. resistance of different types of coils fulfilling these conditions, by the method described in a recent article (*Wireless Weekly*, Vol. 6, No. 4), by noting the "reaction-requirements" of a detector-valve with the particular tuning-inductance in use, tuned by about the same amount of added parallel tuning capacity in the form of a good tuning condenser with ebonite ends and low losses on a wavelength of around 370 metres (810.3 kc.).

**Standard Coil**

The degree of capacity-reaction just sufficient to give oscillation with a tuned-anode alone was measured by the setting of a small reaction-control condenser in series with the anode-tuning variometer and bridging a radio-choke; this device was later calibrated by direct comparison with H.F. resistor-units made up of No. 38 Eureka resistance wire carefully air-spaced and non-inductively wound. The large ultra-low-loss coil of 50 turns of No. 18 wire spaced on a 6-in. skeleton former so as to occupy a winding-space of about 3½ in. was used as a standard of reference, as it offers the lowest H.F. resistance for its inductance of any investigated by the writer.

**Precautions Necessary**

The greatest possible care must be taken in such measurements to eliminate direct magnetic reaction effects. With, for example, a large low-loss coil wound with No. 22 wire, placed

at a distance of 2 ft. from the reaction (tuned-plate) variometer and parallel with the stator windings of the latter, a difference of apparent H.F. resistance of no less than 6 ohms (measured) was observed according to the direction of connection of either coil.

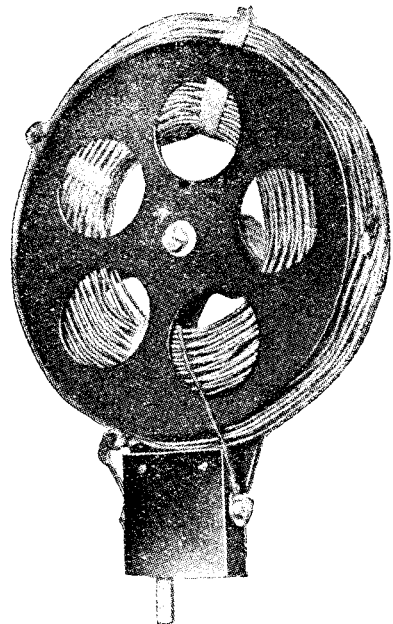

The large basket coil wound with No. 20 d.c.c.

This may be a great deal more than the actual difference in H.F. ohmic resistance it is sought to measure. Observations were therefore made necessarily with the inductances in question exactly at right angles and as far apart as practicable, and with wiring carefully arranged to minimise accidental couplings. Readings were also taken with connections reversed on the one coil; the mean of the two, direct and reversed, was taken as correct. This is mentioned because grave errors result and hopelessly false deductions may be made as to the efficiency of a particular coil if the point is ignored. Nothing short of complete enclosure of the inductances in an earthed metallic case appears to eliminate this coupling completely—which is hardly practicable for a broadcast receiver, though useful in commercial long-wave receivers and in the intermediate stages of a super-heterodyne. The evil effects of some types of "moulded mud" coil-plugs must also be guarded against.

**Large v. Small Low-loss Formers**

Measurements were made on low-loss coils wound with air-spaced No. 18 wire on 6-in. and 5-in. low-loss formers; and on the more compact standard former supplied by the Collinson Precision Screw Co., 3½ in. diameter and 6 in. long, with

A 5-in. diameter former of very dry cardboard wound with No. 18 d.c.c. wire with turns touching lightly gave a coil whose resistance, *when dry*, was only very slightly more than that of the air-spaced coil wound on a skeleton former. If allowed to stand in a damp room, however, there

22 and 20 d.c.c., and each was appreciably inferior to No. 18—though not to an extent that would be noticeable in a broadcast receiver in a rectifying-valve grid-circuit. With No. 24 d.c.c. wound with good spacing, 55 turns in 4-in. winding-space on a skeleton low-loss former 4 in. diameter, *i.e.*, spaced about 14 to the inch, the increase of H.F. resistance over the No. 18 low-loss was some 10 ohms.

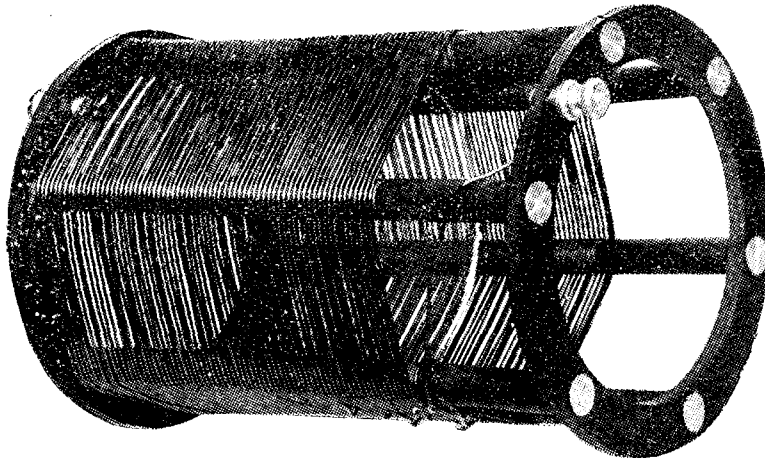

*The air-spaced coil wound with No. 20 gauge enamel-covered wire on a 3½-inch former.*

grooves arranged for a spacing of about 16 to the inch, wound with No. 20 enamelled wire. This latter is quite a practical size, which can evidently be accommodated in an ordinary cabinet receiver without any difficulty. No appreciable difference could be measured between the No. 18 coils on 5-in. and 6-in. formers, of about the same inductance-value; the No. 20 coil on the 3½-in. former showed a slightly higher resistance, but by about 2 ohms only; quite inappreciable in comparison with the detector-valve damping effect (equivalent to some 50 ohms) in any but the most critical experimental work. A difference of 4 per cent. in H.F. resistance would be absolutely unnoticeable in practical broadcast reception.

**Close-wound Solenoids on Dry Cardboard Formers v. Low-loss**

Solenoids of No. 20 d.c.c. wire wound closely on *dry* cardboard cylinders, 73 turns on a 3-in. and 60 turns on a 4-in. former, were compared with the standard low-loss coil. The former showed no appreciable difference between themselves, and an increased H.F. resistance of about 5 ohms as compared with the ultra-low-loss coil.

might be a very different story to tell.

A 3-in. solenoid of No. 22 d.c.c. wire wound on a bone-dry cardboard former showed very favourable results, whether 70 or 80 turns were taken, and with windings as close as ordinary careful hand-winding will give. The average increase in resist-

**Basket and Plug-in Coils**

The observations made in connection with my first article (*Wireless Weekly*, Vol. 6, No. 4) on large basket-coils and certain commercial types of plug-in coils were confirmed with this more accurate method of direct comparison with H.F. resistor-units. The large basket-coil of No. 20 d.c.c. wire, 50 turns, showed an increased resistance of some 15 ohms; the No. 22 basket was rather worse, while a good type of commercial No. 75 coil, with well-spaced windings of generous gauge showed only 8 ohms; a poor type of fine-wire crowded multi-layer coil gave some 50 ohms in the No. 75 size. Another type of plug-in coil with much poor dielectric present showed up still worse.

**Reception Tests**

A direct check on these observations was made by measuring

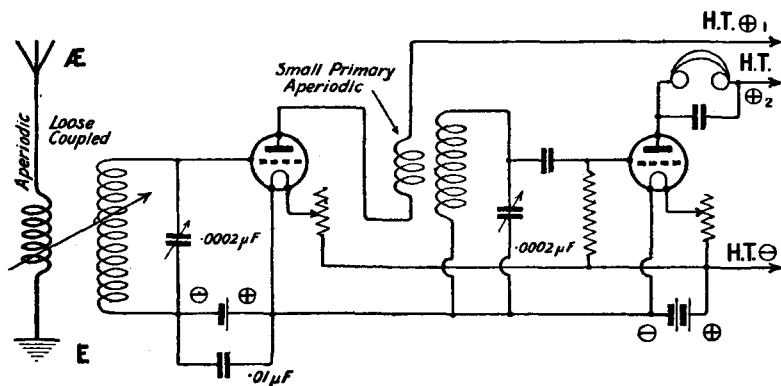

*Fig. 3.—In this circuit there is very low damping in the secondary and only moderate damping in the second grid inductance. A good degree of selectivity is thus possible.*

ance over the low-loss coil was about the same as with No. 20 wire, *i.e.*, 5 ohms.

**Wire Size**

As indicated, there was nothing to choose between Nos.

the signal-voltage registered on a valve (without reaction) arranged as a Moullin voltmeter, and carefully calibrated in the usual way by means of A.C. and potentiometer. The inductance was used as a secondary grid-

tuning inductance, and arranged at optimum coupling with a semi-aperiodic (*i.e.*, roughly-tuned) primary of 31 turns of No. 20 d.c.c. on a 3-in. cylindrical former, connected to a high and unusually efficient suburban aerial, measuring on the local station's wave. This arrangement is found to give the optimum signal-voltage available, and to be most sensitive, therefore, to added resistance. The inductance-value is about the same in each case.

**Measured Results**

The spaced No. 18, 6-in. diameter ultra-low-loss coil gave 4.5 units ("volts"); the 3½-in. "practical compromise" low-loss coil of No. 20 enamel-insulated wire gave sensibly the

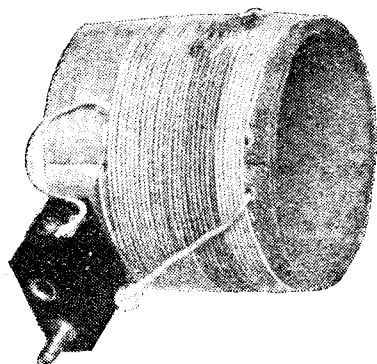

**No serious losses need be expected in close-wound coils on cardboard formers, so long as they are kept dry.** same; the No. 22 d.c.c. close-wound solenoid on dry cardboard gave 4.0 volts; and the spaced "low-loss" No. 22 coil about the same; the No. 24 spaced "low-loss" gave but 3.8 volts. The tuning capacity was around .0001  $\mu$ F, plus casual capacities, in each case, wavelength 365 metres nominal (about 820 kc.).

**Conclusions**

The results of these practical measurements under actual operating conditions indicate that for a detector-valve grid-circuit-tuning inductance, where compactness may be of greater importance than ultimate selectivity, and where in any case reaction may be used, no great loss is introduced through the use of No. 22 wire, d.c.c. and fairly close-wound, if kept dry, and on a dry 3-in. diam. former of small dielectric loss; 70 to 80 turns are indicated to cover the necessary range of wavelength with

a .0002 to .0003  $\mu$ F parallel tuning condenser. However, a skeleton "low-loss" former is evidently safer than a cardboard tube.

**Ultra-Low-Loss Coils**

In circuits where there is not the severe damping of the detector-valve (and negative grid bias can be successfully used), the ultra-low-loss type is called for,

tion of the current in crowded windings); or, as has lately been suggested, is due principally to eddy-current losses in the copper; or whether, indeed, these two phenomena are but two aspects of one and the same physical phenomenon. It is quite immaterial in any case to which of these hypothetical causes the observed effect is due, from the standpoint of actual broadcast reception, although of theoretical interest.

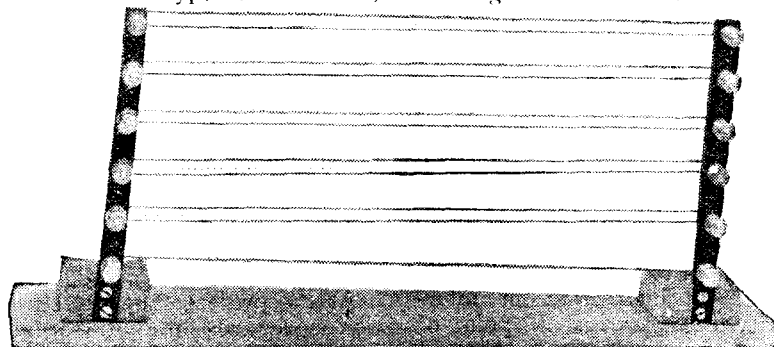

*The high frequency resistor used by the author.*

and a 3½-in. skeleton former with spaced No. 18 or 20 enamel-insulated wire, about 70 turns, is indicated; and this type can be used with advantage in some specially sensitive reaction-circuits with a detector-valve.

**NOTE.**—The foregoing practical conclusions are independent of the question as to whether the lowered resistance observed with properly-spaced wire is due to the "skin-effect" (which appears to give so unfavourable a distribu-

**Wireless in the Army**

In the Army manoeuvres which are taking place this year, we understand that experiments are to be carried out in wireless, not only in transmission and reception by telegraph and telephone, but also in interception. An attempt will be made to take a further step forward in the complicated co-operation of ground and air forces.

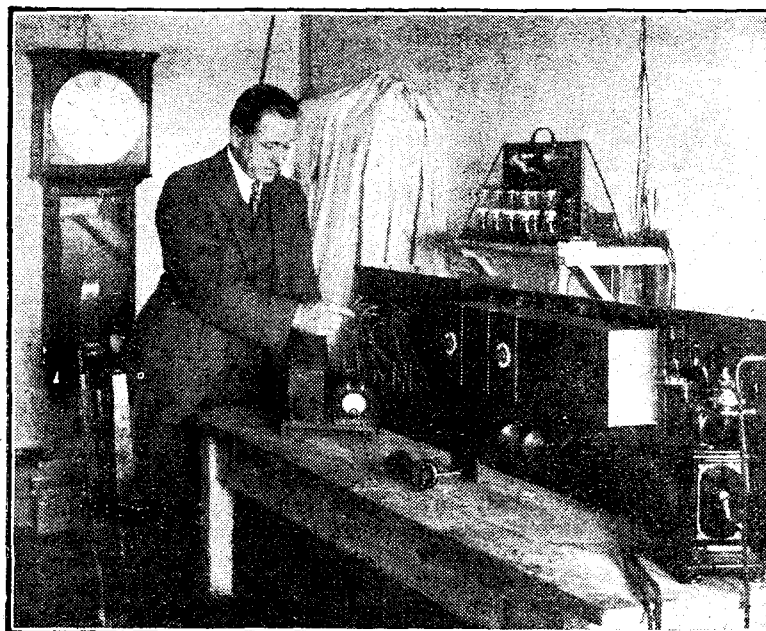

*The engineer-in-charge testing some of the apparatus in the amplifier room at Daventry.*

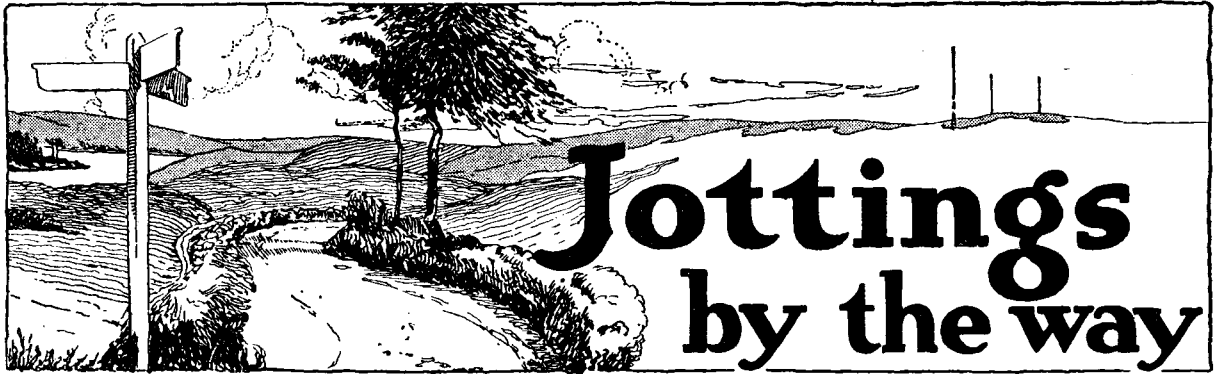

### A Noble Resolve

SOMETIME when I really feel like work—let us pause for a moment to let that beautiful thought sink in—some-time soon I am thinking of applying myself to taking a systematic course of instruction in international languages. In point of fact I do not suppose that I shall ever feel like work, but the good intention is there for all that, and the idea is really a splendid one. I have been giving quite a lot of thought to



... Sure of getting  
a steak ...

this question of international languages lately, and I think that there is a great deal in it. You see, you have only got to learn about twenty-five, and you can go simply anywhere and be sure of getting a steak when you want it and not the pen of the gardener's aunt. Also you can tune in Moscow and lots of other places with far less pronounceable names in the hinterland of Europe, and follow with bated breath (have you ever tried to bate your breath?) the local news bulletins and the patent medicine advertisements as they are broadcast. This is the kind of thing that I would simply love to be able to do. I do not know that I want to go simply anywhere, any more than I want to go on simply anyhow, but my heart yearns to be able to understand what some of those

announcer fellows are talking about as they waggle their beards—I am sure that they have beards—at a frequency of several thousand per second.

### Helpful Hints

At the present time the situation as regards international languages is perfectly clear and straightforward. Each country has adopted its own. Moscow, for example, uses Ido when it desires to address the world at large, whilst Paris gives free instruction in Esperanto as well as a certain amount of information in that pleasing tongue. America again appears to be specialising in Ail, whilst Volapuk has its votaries elsewhere. Armed with a working knowledge of these four, you can travel quite extensively, or glean heaps of information from your wireless set. One consoling thought is that should you happen to be in Moscow, for example, passing the time of day in Ido to a commissar, you can always fall back on English should you find that you have exhausted your supply of the international tongue. Another point is that there is safety in numbers. For example, let us suppose that you find yourself in Pzrwpsyl exchanging light badinage with the stationmaster. Pointing to a dear little dicky-bird that is picking up crumbs on the platform, you say, with a great effort at improvisation, "La birdo havas featheros." In the ordinary way he would probably have a fit on account of the terrible solecism perpetrated in the last word, but noticing the pained look upon his face you pull yourself together and explain that you had in a moment of absentmindedness slipped into

Dotti or Nufsed, the international languages of neighbouring states. Since you have this neat way out of any mistake that you may make, your vocabulary is at once enormously enlarged, for you can use any English noun or adjective, merely sticking an "o" or an "a" at the end of it as the case may be.

### The Linguist

You remember perhaps the little story of the sailing ship which suffered severely in the Bay of Biscay. So shrewd was the buffeting that she received



... They waggle their  
beards ...

from the gale that she crept into a Portuguese harbour minus all kinds of bits and pieces with queer names. The captain, who spoke not a word of the language, sought an interpreter among his officers and his crew. "Which of you fellers," he inquired, "speaks Portugoose?" Forth stepped a bright lad, who claimed to speak the language with the most complete fluency. The captain told him what he wished to say to those who stood upon the quay, and without a moment's hesitation he called: "Hi, you bloomingos lubberios, we wanta somos newos sparos and our riggingo reparado." This worked like a charm. The work was put into hand at once, and in record time the good ship, now trim and taut once more,

was on her way again. Thanks to the multiplicity of international tongues, you and I will soon be able to converse just as easily as this with the natives of any country, to obtain what we want, and to ensure that we are not done in the eye.

**Professor Goop Takes a Hand**

I mentioned this immense subject, whose possibilities are far reaching, to Professor Goop the other night as we sat in his den. The Professor, I regret to say, knows no international language. I am not sure on the whole, though, that I do regret it, for it gives one an opportunity of obtaining a little kudos at times. On that occasion he had tuned in an unidentifiable station on his newest receiving set, and the announcer was letting himself go like anything. "If only I knew the language!" sighed the Professor. I shrugged my shoulders and said with a modest smile, "Oh, it's Nobono, the international language of Yugo-Tobrazia." Thanks to this information the Professor was able to identify the station at once, but was a little puzzled over the wavelength. In the tables of transmissions the wavelength of Kastoff, the capital of Yugo-Tobrazia is shown as having a wavelength of 530 metres. The Professor's wavemeter showed that the set was tuned to something under 300. I explained to him that these Central European stations are very casual in these matters, as is only to be expected of people whose calendar is in such a state of confusion that to-day with us is a week ago last Tuesday with them. The Professor saw this at once and asked me to interpret the words of the good man at the other end. Since I had the evening paper upon my knee at the time this was quite easy, especially as there was a little paragraph from Kastoff on the front page. "The entire rank and file of the Yugo-Tobrazian army revolted yesterday morning." I read out. "Both have now been arrested. It is expected that these revolting soldiers will be tried by a court martial of seventeen generals to-night, and that they will be sentenced to stand for at least two hours in the corner."

**Inspiration**

The Professor was obviously very much impressed. He began to ask questions, and that is how I was able to discuss the question of international languages with him. He asked me all about those at present in use, and I told him



*The entire rank and file of the Yugo-Tobrazian army revolted . . .*

all that I knew about them, as well as a great deal that I did not. He requested me to give him specimens of the various tongues, a demand with which I readily complied. After remaining for a while in thought he said, "It is undoubtedly a splendid idea, my dear Wayfarer, that each country should possess its own international language. At the same time it seems to me that the great need for wireless purposes is what I may describe as a master international language, which should be taught in the schools to the inhabitants of every country. From the examples that you have given me, my dear fellow, I gather that English has been much too largely drawn upon in many of these tongues. (It certainly had in my samples.) Now this is the kind of thing that merely promotes international jealousy instead of international amity. What I think we want is a language which incorporates an equal number of the words of the language used by



*Forth stepped a bright lad . . .*

every civilised country. I propose to start at once upon developing my master international language. Here is the first sentence in that tongue: 'Avez vous mio father gesehen?' You see the perfect equality of the sharing

out of the words of this sentence between French, German, Italian and English. The reply would probably be: 'Rats, jeg cخرpz kaltr father niet gesehen.' In the reply I bring in the Swahili words 'rats,' meaning 'no,' the Scandinavian 'jeg' for 'I,' the Hottentot 'cخرpz,' meaning 'have,' the Magyar 'kaltr,' meaning 'your,' and the Dutch 'niet' for no. These sentences are, as you will see, truly cosmopolitan, and they will appeal to all nations alike. Further, the learning of my new language will be simplicity itself.

**All That is Needed**

"It may be necessary to acquire a smattering of the thousand or so chief spoken languages of the world—I shall exclude dialects—and perfect proficiency will be assured at once." This is how Goopo, the new cosmopolitan wireless language, was born. Possibly you had not heard of it until you read this, but you may rest assured that it is going to play a very large part in your wireless life in the future. Once Professor Goop takes up a thing he goes through with it, so you had better start taking your preparatory course in languages at once, so that you may be ready, when the time comes, to tackle Goopo itself. Personally, I intend to master one language a week, making a start as soon as I feel really like work.

**WIRELESS WAYFARER.**

**Return of . . . MR. HARRIS.**

*Readers of 'Wireless Weekly' will be pleased to hear that the Assistant Editor, Mr. PERCY W. HARRIS, M.I.R.E., has returned from his extended tour of the States. An exclusive series of articles written by Mr. Harris on his observations and experiences in America is appearing in this journal.*

*In this issue he continues his description of the most well-known American Research Laboratories under the title of "What I saw in American Research Laboratories."*

# What I Saw in American Research Laboratories

By

**PERCY W. HARRIS, M.I.R.E.,**  
Assistant Editor.

*In his previous articles Mr. Harris has made several references to the important work conducted at the Bureau of Standards at Washington; this he describes fully below.*

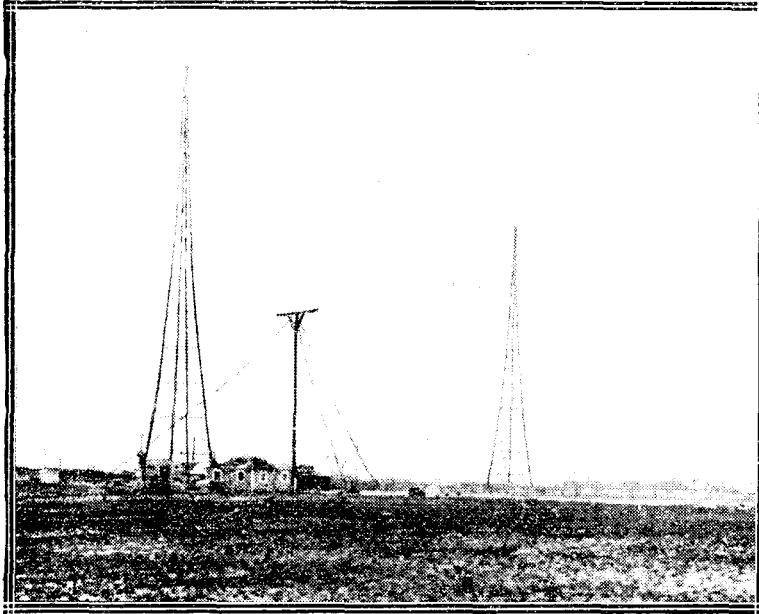

*This wooden mast, with T-shaped top, supports the 100-metre antenna at the short-wave experimental station of the General Electric Company at South Schenectady, N.Y.*



**T**HE buildings of the Bureau of Standards are situated a mile or two from the centre of Washington, on Connecticut Avenue, by Pierce Mill Road. The portion of the institution devoted to radio work is by no means large; in fact, taking into consideration the immense amount of valuable information periodically distributed to those interested in radio, the building devoted to wireless research can be termed small. There are two floors and a number of small laboratories on each. About half of the lower floor is under the charge of Dr. L. W. Austin, who, although he is working at the Bureau of Standards, conducts his experiments independently, this laboratory being supported partly by the Bureau of Standards and partly by the International Radio Telegraphic Union. Practically all! Dr. Austin's work is long-wave direction-finding research. Having already arranged an appointment with Dr. Austin, I

found him waiting for me, and we were soon busily engaged in studying a number of highly interesting graphs, showing the

angle variation of signals from European and other long-wave telegraphy stations. For this work a number of frame aerials of various types are used; some being exceedingly large.

As there is a certain amount of steel in the main building, and as, moreover, this is situated immediately adjacent to the bases of the two steel masts, it has been found necessary to conduct some of the work in a small building of wood, situated some little distance away from the main building.

## Direction-Finding

Readers who imagine that direction-finding work is merely the erection of a suitable frame aerial and the ascertaining of the

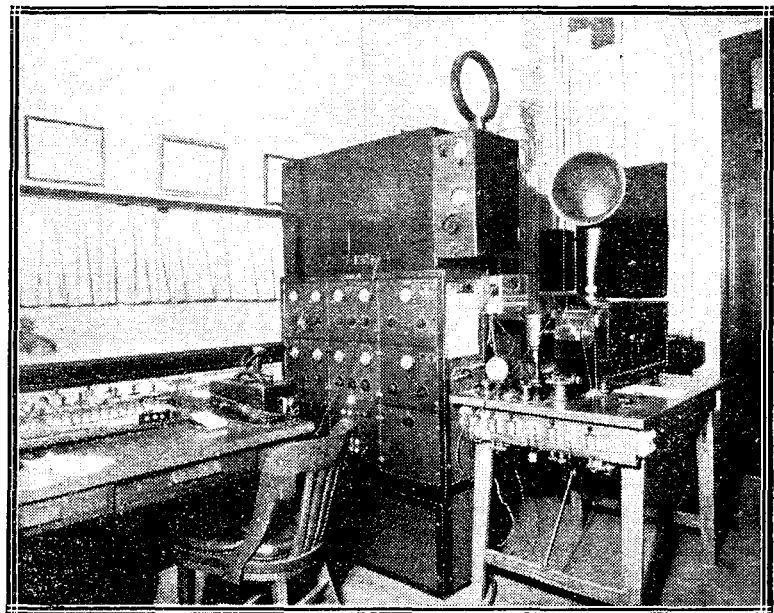

*Beneath the loud-speaker can be seen the ocellograph used for checking the modulation at WJZ, New York.*



angle at which signals are received at greatest strength, this giving the direction of the station, will learn with surprise that the apparent direction of signals varies considerably and often quite rapidly, and that sometimes, when adjusting a frame aerial, the signals appear to be coming in a direction about 90 deg. from that in which they are actually coming. Furthermore, the angle of the front varies, so that at times it is necessary to tilt the frame as well as to rotate it to get the best signals.

#### Fading

After showing me his own portion of the laboratory, Dr. Austin took me upstairs and introduced me to Dr. J. H. Dellinger, who is in charge of all radio work other than that conducted by Dr. Austin at the Bureau of Standards. At the present time a good deal of work is being done in Dr. Dellinger's laboratory in making records of fading. For this purpose a Western Electric super-heterodyne, with a specially-attached two-electrode valve as rectifier, passes rectified current to a micro-ammeter.

#### Recording Apparatus

The recording apparatus comprises a drum to which is attached a sheet of paper, this drum making a complete rotation about once every minute. A pen is arranged on the end of a handle, so that as the drum rotates this pen can trace a wavy line. Attached to the same handle as the pen is a pointer which the operator keeps above the needle of the micro-ammeter. Thus, as the needle swings backwards and forwards, so the pen is moved backwards and forwards in synchronism, it being found possible to make very accurate records, although to some extent they depend upon the accurate observation of the observer. In another laboratory I saw the special short-wave direction-finding apparatus; here it was explained to me that on, say, 40 or 50 metres, the apparent direction jumps all over the place, so that you cannot follow it rapidly enough, even from a station two miles distant in daylight.

#### Short Waves

There is still a tremendous amount of research work to be done on the short waves. Dr. Austin told me that the 15-metre signals were not audible at all, save at a mile or two, until they had traversed over a thousand miles. After this no further silent zones have been observed.

#### Insulation

I notice that Pyrex glass seems very generally used in all

moisture, which many people consider are the most important.

#### High Tension from Electric Light Mains

A number of Dr. Dellinger's assistants were very well known to me by name, and I was fortunately able to converse with many of them. I met, for example, Mr. F. W. Dunmore, inventor of the relay which bears his name. Mr. Dunmore has done a good deal of work on the elimi-

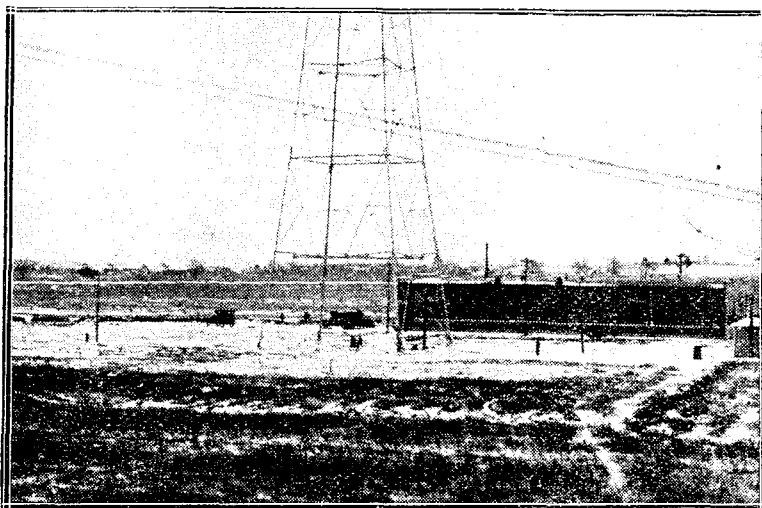

*The main experimental building at the special short-wave station at South Schenectady.*

the research laboratories in America, and that aeroplane dope is used in place of shellac or wax for waterproofing insulated wires. I noticed, for example, a standard wavemeter, which consisted of a variable condenser and a coil of bare copper wire wound on a Pyrex tube about 8 in. or 9 in. in diameter; the wire was secured in place with aeroplane dope. This use of aeroplane dope for coils is certainly worthy of the attention of experimenters in this country, for if the Bureau of Standards, after exhaustive investigation, have found this material to be satisfactory, there cannot be much wrong with it for the purpose. Dr. Austin explained to me, by the way, that the effect of moisture on coils was often to form a conducting ring which, acting as a short-circuited secondary, gave a considerable alteration of the apparent resistance. This effect is quite apart from the dielectric effects of

the high-tension battery and the use of electric light mains. He has, in fact, evolved several good arrangements which enable receivers to be worked direct from the electric light mains, both in regard to the low and the high-tension batteries. Mr. Dunmore has granted licences to two or three American manufacturers.

#### Personal Experiences

Digressing for a moment, I should mention that while in the States I had the opportunity of trying several of the "B battery eliminators," and found at least two which worked even with a detector-valve without the slightest trace of hum. In this country, with so many periodicities and voltages, direct current used in some towns and alternating current in others, it is very difficult to market such a device. In the United States practically everything is done on 110 volts 60-cycle alternating current, and I do not doubt that

before long practically all broadcast receivers will be operating from the electric light mains, save where awkward voltages or the absence of the electric current prohibit this.

**The Aerial**

The main aerial used by the Bureau of Standards is supported on two lattice steel masts, about 150 ft. high, and I should say about 200 ft. apart, though I have not the actual figure before me to give you the distance. Dr. Austin said that on a straight crystal detector without any amplifier whatsoever a large number of American broadcasting stations could be read direct at night up to distances of a thousand miles. In daytime Philadelphia, and sometimes New York, can be heard. To appreciate what this means I would suggest that the reader consults a map of the United States and sees the distance between Washington and these two places.

**Litzendraht**

There seems to be some uncertainty at the Bureau of Standards regarding the use of Litzendraht, or "Litz" wire, and I could not obtain an opinion whether this wire was better than solid copper of the same equivalent gauge. I am, of course, referring at the moment to short waves, for its use on long waves has been proved to be advantageous in practically all cases. In multi-layer winding the Bureau has found that bank winding is superior to any other form. This method of winding is used exclusively in their multi-layer coils, where efficiency has to be considered.

**Crystal Frequency Control**

In my last week's article I explained the general principle of the crystal control for maintaining a constant frequency in a transmitting circuit. The Bureau of Standards have a crystal control calibrated transmitter, which is used to send out the well-known calibration waves from this station. These have been found exceedingly useful to experimenters in America. In addition to sending out calibration waves the Bureau has frequently measured the wavelengths of the leading broadcasting stations, and has found that

certain of these maintain their frequency so accurately that they can be used as sub-standards. From time to time lists are published, giving what may be termed "approved" wavelengths.

**Travelling in America.**

On leaving Washington I proceeded to Pittsburgh. Incidentally, this "proceeding" from one place to another is no small problem in America. The length of my stay in any particular place was determined by a number of factors, so that it was not always possible to arrange a definite schedule beforehand. In this country, where a quick decision to travel is followed by a visit to the ticket office of the railway station with the practical certainty of obtaining accommodation, there is not much difficulty, but in the United States a fairly long dis-

tance journey, such as that from Washington to Pittsburgh, is not lightly decided upon. Most business men make such a journey at night, but where possible I preferred to travel during the daytime, so as to have an opportunity of observing to what extent wireless aerials are a feature in the small towns through which one passes and, in general, to get a better idea of the country. There is not a great number of trains between the big cities, and frequently the more important trains have "Pullman" accommodation only, all the seats in Pullman coaches being bookable in advance. On more than one occasion I had to defer travelling until the following day as there was not a seat available on the train I had chosen.

*(To be continued in a subsequent issue.)*

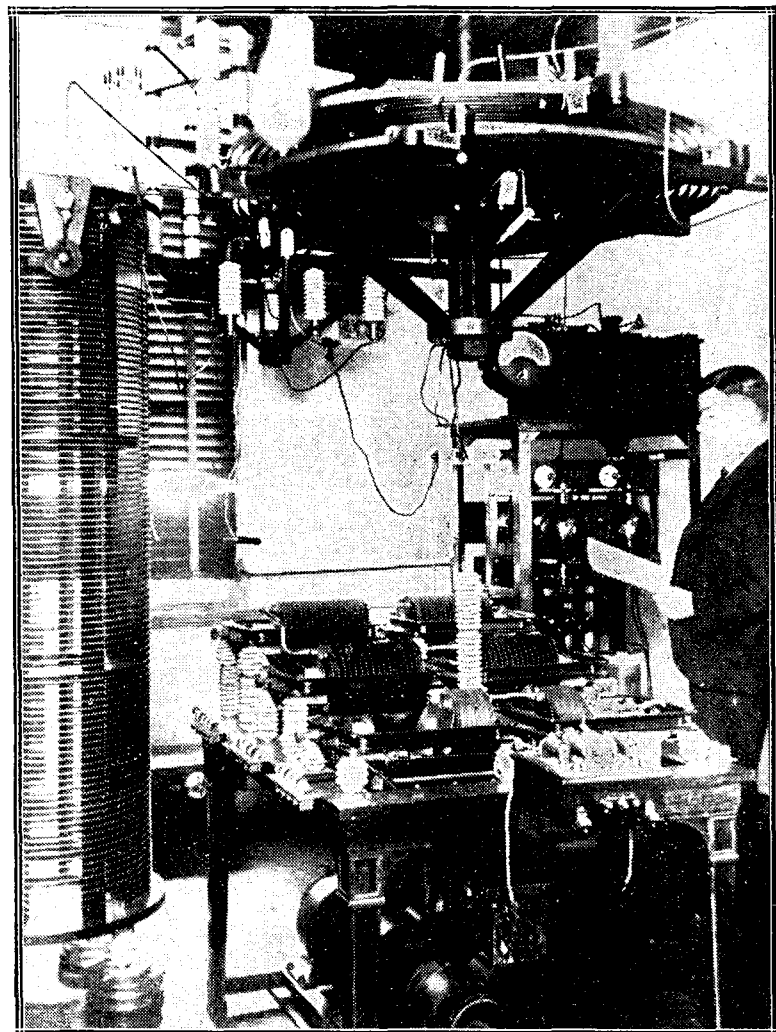

*In our last issue a photograph of the generator equipment at the Australian high-power station at Pennant Hills, Sydney, was published. Some of the transmitting gear is shown above.*

# A Useful Short-Wave Inductance

By C. P. ALLINSON (6YF).

*At the very high frequencies it is often a matter of difficulty to obtain oscillation unless suitable valves are chosen and attention is paid to the design of the inductances. Full details are given below for the construction of a short-wave inductance suitable for use in either a transmitter or a receiver.*

**W**HEN extremely short waves are used either in transmission or in reception it is usually accepted that a practically self-supporting coil of bare copper or enamelled copper wire is about the best to employ. If, however, the coil is to be rigid, as is of course necessary, a certain amount of supporting material is required, while some simple means of mounting it needs to be provided.

The coil shown in the photograph is built on these lines, and it will be clear that the construction is quite a simple matter. When it was substituted for the coil usually in use in a transmitter, no difficulty was found in getting the valve to oscillate, and although the usual four-pin valve and valve-holder were used, it would oscillate well in the region of 20 metres with only a small plate voltage, in a conventional Hartley circuit. The only adjustment that was found at all critical was the centre tap, which goes to L.T. negative, but once the correct position was found for this, the valve oscillated strongly.

The inductance itself consists of five turns of 10 S.W.G. bare copper wire. This is first wound on a 4-in. former and then allowed to spring out. With the particular sample of wire used the diameter when sprung out was found to be 6 in.,

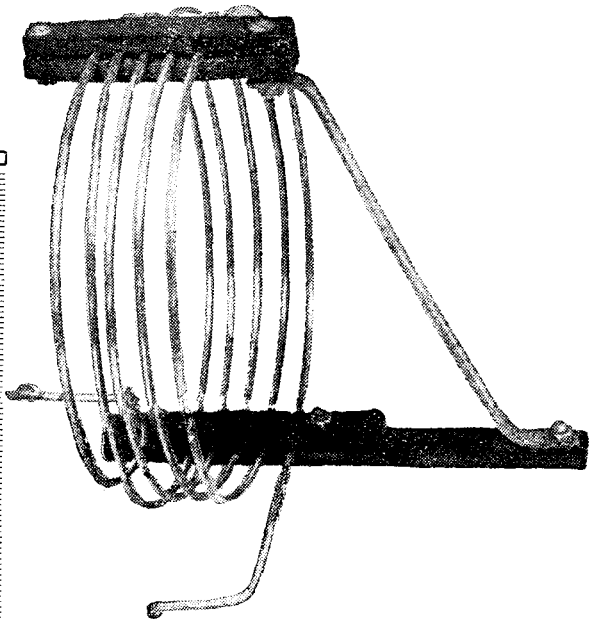

A view of the completed coil.

clearance holes drilled at both ends and the long piece has a third hole drilled about halfway down it, so that when the coil is erected as shown in Fig. 1, two 4 B.A. bolts, passed through the short piece of ebonite which clamps one side of the coil to the long piece, will pass through the latter. All these holes should be countersunk on one side so that the bolted heads may fit flush. The other two short pieces then clamp the other side of the coil as shown in the sketch, bolts and nuts being used.

## Making the Coil Rigid

In order to make the job quite rigid, a brass strip is carried from the top ebonite strips to the end of the long one which is used for fixing the coil; reference to Fig. 1 will show clearly how this is done. It is now only necessary to drill a couple of holes at two points, as shown at A and B in Fig. 1, of any desired size to fasten the coil either to a baseboard or to a panel as may be found convenient.

In order to obtain the greatest efficiency from the use of such a coil, any leads going to it should be soldered if possible, and the surface of the wire should be kept bright by cleaning it from time to time with fine glass-paper.

With suitable valves and careful design and layout, a receiver using this coil in conjunction with a very low minimum-capacity variable condenser should tune down to wavelengths in the region of 12 to 15 metres (about 25,000 to 20,000 kc.). It will probably be found, however, that quite a fair amount of experimenting may be necessary before the receiver can be made to function successfully on these short waves.

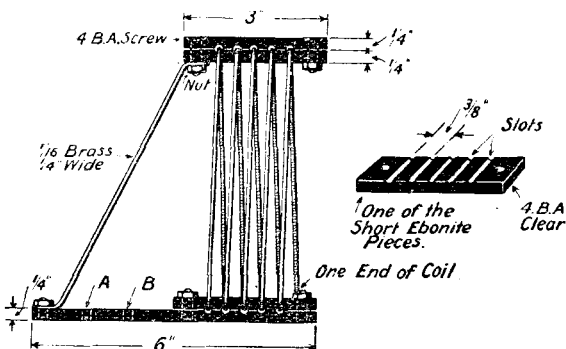

Fig. 1.—Assembling the coil will be a simple matter when the supports have been prepared as shown.

and as the turns were to be spaced  $\frac{3}{8}$  in. this gave a good diameter to length ratio.

The means adopted for supporting the coil are as follows:—Four pieces of ebonite,  $\frac{1}{4}$  in. thick and  $\frac{1}{2}$  in. wide, are required, three of these being 3 in. long and one 6 in. All four have lines marked on them  $\frac{3}{8}$  in. apart, starting about 1 in. from one end, and at these points half-round slots are filed with a small round file, of approximately the same diameter as the wire. These slots are quite shallow, and merely serve to space the turns of wire. Next all four pieces have 4 B.A.

WIRELESS NEWS IN BRIEF

**W**E understand that the commander of the American gunboat *Scorpion*, stationed at Constantinople, has reported to Washington that he has heard signals from the naval air station at Lakehurst, New Jersey—a distance of 5,300 miles. The signals were transmitted on a wavelength of 80 metres.

Signals from the Lakehurst short-wave set have also been heard in Honolulu, 5,000 miles distant, and Brazil, 4,000 miles away. Experiments with this recent development in radio are being carried on by the naval air station at Anacostia (Washington), the marine flying fields at Quantico and San Diego (California), and the Naval Research Laboratory at Bellevue (district of Columbia).

It is stated that the Navy Department intends to supply all naval vessels and shore stations with short-wave equipment if its use proves reliable under all conditions.

\* \* \*

Further to the recent announcement of the intention of the B.B.C. to inaugurate an exchange programme service with stations in other countries, we understand that work has already commenced on the site in Kent chosen for the necessary receiving station. The site, which occupies an area of 30 acres, is a plateau 600 ft. above sea-level. A large hut to contain the apparatus is already finished, as the station is due for completion by September.

The American programmes will be received on a special long and low aerial. It will point westwards—towards America.

\* \* \*

In the course of a "Merry Moments" programme on Wednesday, August 5, Mr. Granville Hill, F.R.C.O., L.R.A.M., a well-known pianist and musical critic in the North of England, will describe to listeners, with numerous illustrations, humorous items in pianoforte and vocal music. The pianoforte illustrations will include Scarlatti's Sonata in C, two "Conceits" by Goossens, and the "Gollywog's Cake-Walk" by Debussy. Among the vocal illustrations sung by Mr. Stephen Williams (bass) will be "My Heart Ever Merry," by Bach, and "Mephistopheles' Serenade," from both Gounod's and Berlioz's "Faust."

\* \* \*

In answer to many requests the 2ZY Chorus will, on Sunday, August 16, give a recital of popular hymns, including some of the Methodist favourites, such as "Rimmington." In the course of the same programme Mr. Don Hyden (violin) and Mr. W. E. Wright (piano) will play sonatas by Beethoven, Mozart, and Mendelssohn.

\* \* \*

On Wednesday, August 19, the Manchester programme will include a performance by the 2ZY Mermaid Club of a short, one-act American

play, "Mrs. Pat and the Law," by Mrs. Arthur Aldis. This play is of a type that is very popular in the little theatres of America. If the crispness of construction, which is the essential characteristic of this play, proves effective without visual action, the 2ZY Mermaid Club hope to produce a series of American plays of this type.

\* \* \*

Some of the aims of the Wireless League, as outlined by Sir Arthur Stanley, chairman of the League, may be summarised as follows:—

To perpetuate, consolidate and extend the public service character of broadcasting in the British Isles, and with that object to, support centralised executive control.

To exercise unceasing vigilance to protect broadcasting from any lowering of its standards and ideals.

To maintain the use of wireless broadcasting for educational as well as entertainment purposes.

To assist broadcast listeners to secure efficient reception.

To act generally as a link between the listening public and the authorities.

\* \* \*

On July 25 and 26 many English amateurs took part in a world's short-wave wireless test, arranged by the American Radio Relay League in conjunction with the chief radio societies of various countries, on a wave-band of 19-21 metres.

Mr. Gerald Marcuse, of Caterham, an official of the relay section of the Radio Society of Great Britain, stated that the object was to discover how far signals on low waves carry.

Up to the time of going to press we have received no information of the results of these tests.

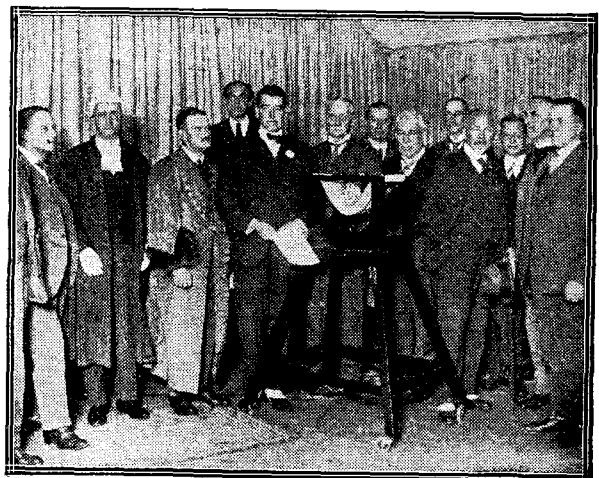

The Postmaster-General, Sir William Mitchell-Thomson, Bt., K.B.E., M.P. (centre), declaring the Daventry station open. On the extreme right is Mr. H. W. Litt, the Engineer in charge of the station.

# Inventions and Developments

*Under this heading it is proposed to review, from time to time,  
the latest developments in the radio world.*

## Absorption in the Upper Atmosphere

**S**OME interesting extensions of the theory of wave propagation have been put forward by Messrs. H. W. Nichols and J. T. Schelleng, of the Bell Laboratories, New York, in the Bell System Technical Journal for April, of which a very interesting, though somewhat mathematical, abstract appears in the *Electrician* for July 17.

It is well known that the ionisation of the atmosphere increases very rapidly as the height above the earth increases. As is generally accepted, an atom is normally composed of a series of positive charges and negative electrons, which normally neutralise each other. If, however, one or more of the electrons are removed from the atom or further electrons are added to the system, the system as a whole becomes unbalanced and exhibits electrical properties. This process is spoken of as ionisation.

### Effect of Earth's Magnetic Field

Now, the theory under consideration shows that a free ion in the upper atmosphere is affected by the electric forces in a wireless wave travelling through the atmosphere, and that the combined effect of the electric field and the magnetic field of the earth will set these free ions in a state of vibration. This accounts to some extent for the energy which is absorbed from the wave in its passage round the earth.

Perhaps the most interesting result of the research, however, is that it is found that the oscillation of these ions attains a resonant condition at a certain critical frequency, in which case the vibrations are relatively enormous. This critical frequency is in the neighbourhood of 1,400 kilocycles, which

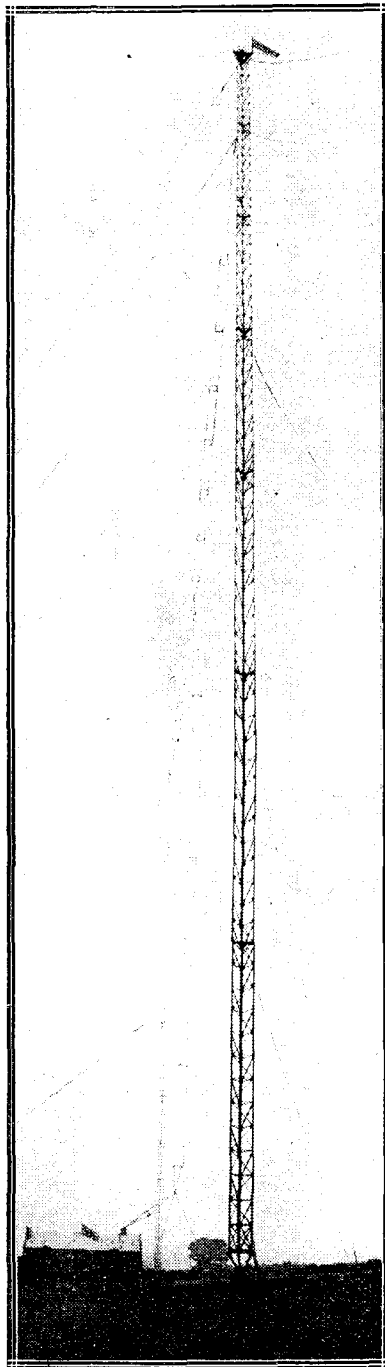

*A view of the aerial system at the new 1,600 metre B.B.C. station, which conveys a very good impression of the height of the masts.*

corresponds to a wavelength of 214 metres.

Now it has long been observed that transmissions on a wavelength of 200 metres or a little over are subject to peculiarly erratic behaviour. These facts were first noticed when this frequency band was explored by amateurs, and failing to get good results the amateurs used higher and higher frequencies (that is to say, shorter and shorter wavelengths). There would thus appear to be a very sound explanation for this peculiar state of affairs which has been observed in practice, that is to say, a resonance between the frequency of the wave motion and that of the natural period of the vibration of the free ions in the upper atmosphere.

### Bending of the Rays

A further interesting development is that which concerns the refraction of the rays of the waves at the Heaviside layer, that is to say, at this ionised layer of upper atmosphere. It is not only shown that it is possible for the rays to bend and so travel round the earth without any appreciable reflection, but it is also shown that under certain conditions the wave will split into two parts, which will reach the receiver by different routes.

Even more interesting is the fact that according to this theory it is possible for the *plane of polarisation* of the wave to rotate. That is to say, the electric field will not remain vertical as it does with a normal and well-behaved electrical propagation, but will proceed to rotate in its course round the world, so that there may be places where the reception is almost impossible.

### Blind Spots

It is possible that this rotation of the field may prove to be an explanation of "blind spots."

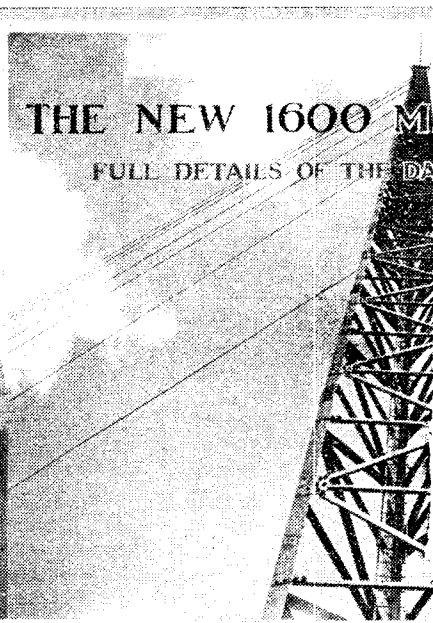
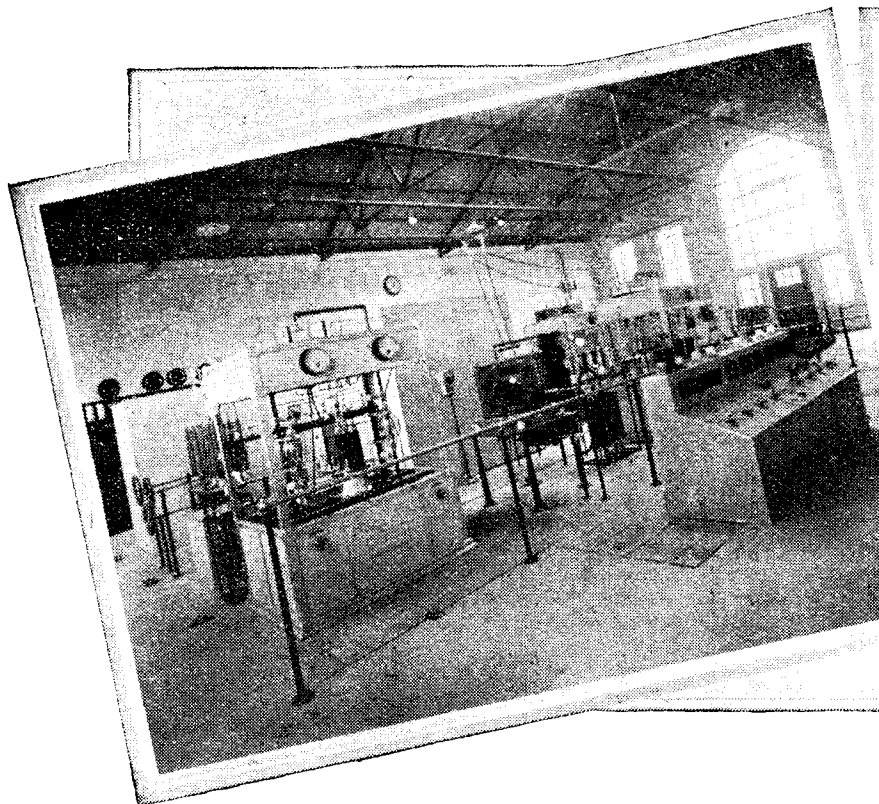

(Left) A general view of the transmitting room. On the right of the photograph is the main control panel. (Right) On left at the back is the metal shield

WHEN one looks back over the two or three years since the inception of broadcasting proper in this country with the opening of the London station by the British Broadcasting Company in November, 1922, he is at once struck with the rapidity with which progress has been made in the establishment of broadcasting as a national service and a fundamental part of our daily lives. Through the co-operation of the public, the manufacturers, the technical Press, and the B.B.C., we have established in this country a broadcasting service which, although it falls far short of the ideal, is nevertheless one of which, at this stage, we have reason to be proud.

The opening of the new high-power station at Daventry on Monday, July 27, marks another step forward in the improvement of the existing system. This station has been erected in furtherance of the policy of the

B.B.C. in aiming at providing programmes for crystal users throughout the greater part of the country, and alternative programmes for those in possession of more powerful receiving apparatus.

#### Choice of Site

The choice of a suitable site was thus naturally somewhat difficult, especially in view of the restrictions imposed by the authorities, but it was evident that a fairly central situation in the country was indicated. In this respect the B.B.C. has been fortunate in selecting a site about a mile south of Daventry, which appears to satisfy the essential conditions. Subsequent reports on reception from various parts of the country will prove whether the choice has been a wise one, but at the moment there is every indication that the results are fully up to expectations.

The station has been erected on a flat, elevated stretch of

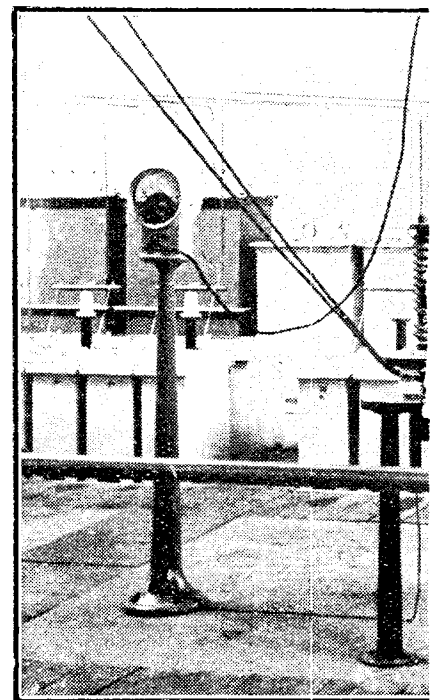

A close-up view of the aerial tuning aerial ammeter on the left. This in readings up to 60 an

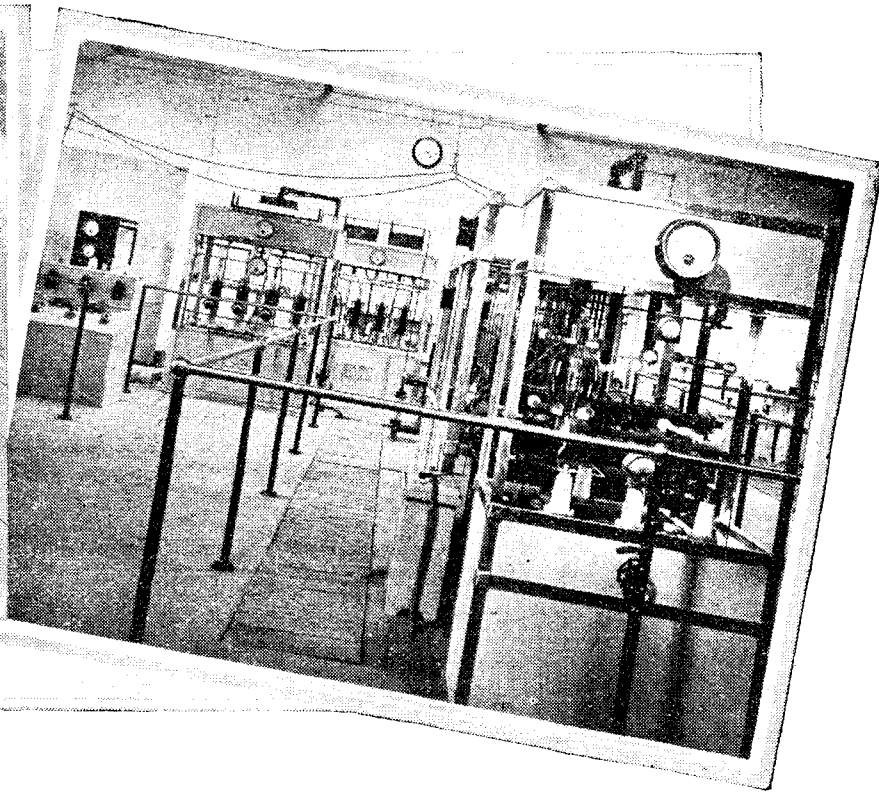
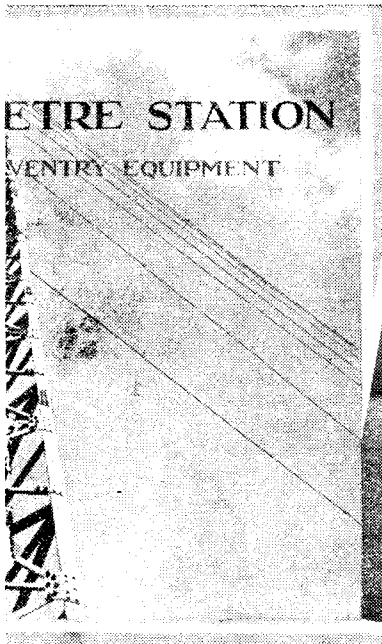

On the right of the photograph is the single air-cooled valve of the sub-modulator. The large rectangular case on the left is one of the air condensers.

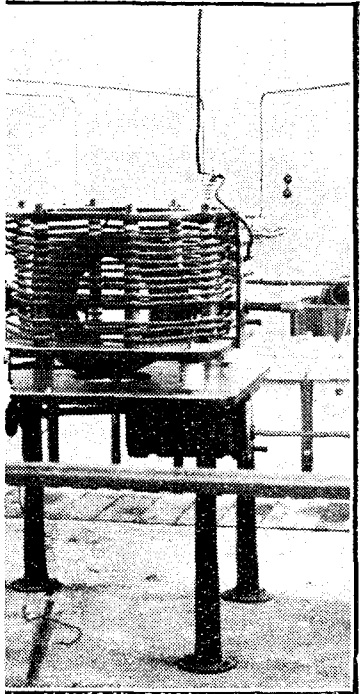

Close-up of the air condenser arrangement, showing the double scale with 120 amperes.

ground just south of Daventry, and actually about 650 feet above sea level. The general layout and equipment of the station have called for much thought but are well executed, and no radical departures from standard practice and modern design have been made.

**The Aerial System**

The aerial, which is an imposing landmark for many miles around, and within sight of the masts of the high-power Post Office Station at Hillmorton, near Rugby, is supported by two triangular steel masts of lattice construction, each weighing, it is stated by Capt. Eckersley, about 42 tons, 500 feet in height, and placed 800 feet apart. Some idea of their size may be gathered from the accompanying photographs. The flat base of each mast rests on a convex steel support embedded in large concrete foundations, and both the masts are well supported by a

large number of stays. An actual inspection was made by our representative on a windy day, but apart from a scarcely noticeable sway, the masts appeared to be perfectly rigid.

The aerial is actually a T-type cage, the horizontal portion of which is 600 feet long and consists of ten wires spaced in the usual manner on large hoops. The "down-lead" or vertical part is formed by six wires arranged in the usual manner around hoops 5 ft. 6 in. in diameter, and is supported by four stays to minimise the swaying. This down-lead is taken direct to a large insulated lead-in on the top of the transmitter building. A large winch is provided at each mast for raising and lowering the aerial, and is shown in one of the accompanying photographs.

**Two Earthing Arrangements**

An efficient earthing system has been provided in the form of a number of zinc plates, each 6 ft.

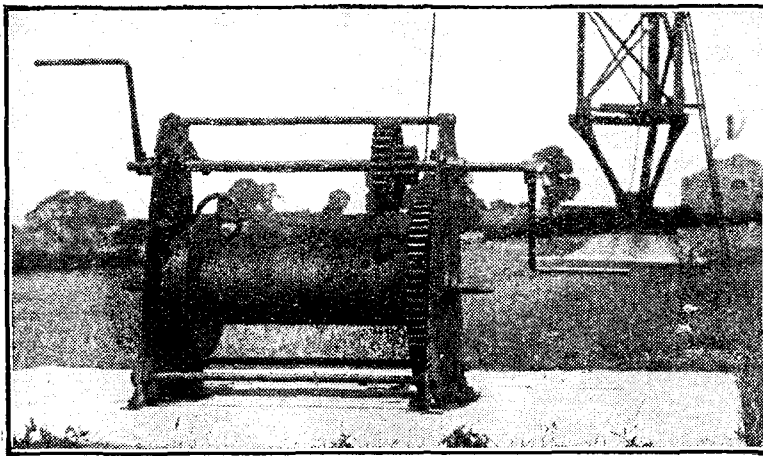

One of the winches used for raising and lowering the aerial.

by 3 ft., buried vertically in the ground at 10-degree intervals around the circumference of a circle 100 ft. in radius. A wire supported on a 10-ft. pole by a single insulator is carried from each of these earthing plates to a copper band just below the lead-in insulator. From this point the aerial and the earth leads are taken direct through the building from the roof to the actual transmitter, and are spaced about 2 to 3 ft. apart. A second earthing system is provided in the form of three long strips of sheet copper buried below the power house. To this second system are earthed the frameworks of the various panels and various metal parts of the other machinery.

**The Station Buildings**

Symmetrically between the two masts a red-brick station building has been erected. This particular building includes the power room, the transmitter room, a temporary studio, two offices, and further smaller rooms to accommodate the amplifier apparatus and batteries, and the various measuring instruments connected with their operation. A smaller separate building to house the power transformer equipment for stepping down the power supply to the station is also provided.

The supply is provided by the Northampton Electric Light & Power Co. direct from Northampton, a distance of some twelve miles. The 11,000 volts 3-phase supply is transformed down in the sub-station to 375 volts and is then fed into the machinery room. No special

comments are needed on the latter except to say that provision has been made in case of

breakdown for bringing some smaller machines, three in number, into operation to carry on the work when any of the five other machines has to be temporarily stopped.

**The Transmitter Circuit**

The actual transmitting equipment occupies by far the greater space in the main building, and ample room for any alterations or possible additions has been allowed. The layout of the various panels is shown in one of the accompanying diagrams, and we are also able to publish a simplified circuit diagram. The main point about the circuit is the master oscillator or independent drive system employed to maintain a constant frequency. At

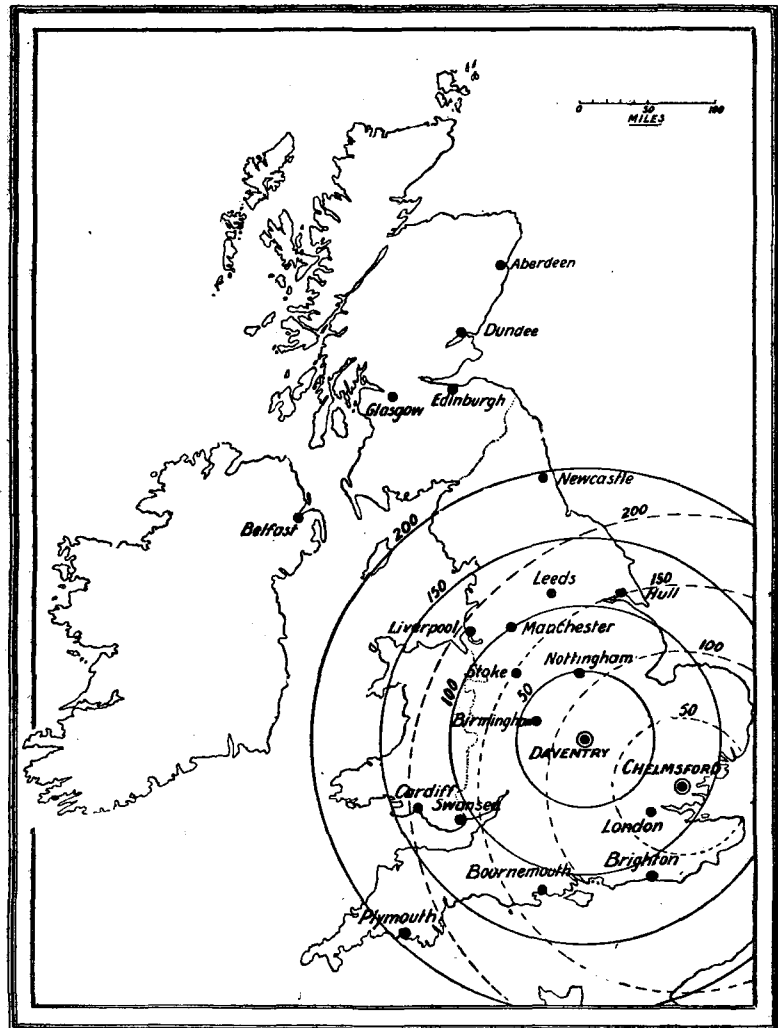

This map of the British Isles, with its accompanying scale, will give a good idea of the position of the new station with respect to the towns indicated. The dotted line circles are drawn with Chelmsford as centre and the full line circles have their centres at Daventry. The numbers on the circles indicate the distances in miles from the respective stations.



the end of the Post Office land-lines from London the special line amplifier is connected. The electrical impulses, after amplification, are fed to the modulator panels, which are two in number. The sub-modulator consists of one air-cooled valve of the M.T.7B. type, and the modulator has six 12-kw. water-cooled valves connected in parallel. The negative bias on the grids of these valves is of the order of 1,200 volts, and is provided by a number of large high-tension dry batteries. The anode voltage on these six valves is of the order of nine to ten thousand volts, supplied from a water-cooled valve rectifier.

formed our representative that by this means the leakage was only about one milliampere when the anode potential was about 10,000 volts.

room. These consist of zinc plates, appropriately spaced and immersed in oil in earthenware jars. Fuses are provided, and should any one of these con-

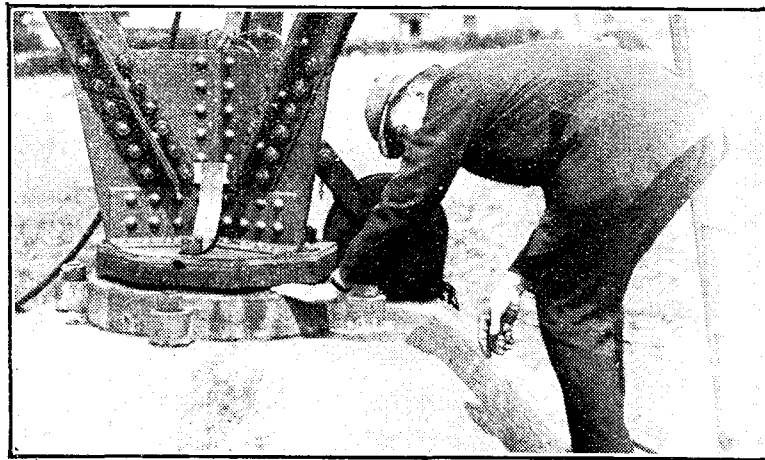

*It is possible to insert one's hand between the base of the mast and the convex surface of the metal support.*

**Water-Cooled Valves**

An interesting point arises in connection with the water-cooling of the valves. The anodes are at high potential, and it is necessary to insulate the water jackets from the main water supply. The arrangement by means of which this is effected is shown in one of the diagrams included in this article. From the main supply water is sprayed into a tank fixed at the top of the frames of the various panels. The water is then led into the lower end of the water jackets, and the overflow is taken from the top and again sprayed into the outlet tank. One of the engineers in-

The rectifier feeding the amplifier employs water-cooled rectifier valves, and the amplifier itself has three water-cooled valves. The master oscillator unit has one water-cooled oscillator, and is fed by two air-cooled rectifiers. The oscillator itself absorbs 25 kw.

condensers break down it is simply cut out of circuit.

These smoothing condensers are quite small in comparison with the two air dielectric condensers, encased in metal shields, which are about 10 ft. in height and occupy a considerable floor space.

**Large-Sized Condensers**

The banks of smoothing condensers employed in conjunction with the rectifiers take up a fair proportion of the transmitter

The controls of the transmitter are conveniently located on one panel placed in such a position that a good view of the whole equipment is possible.

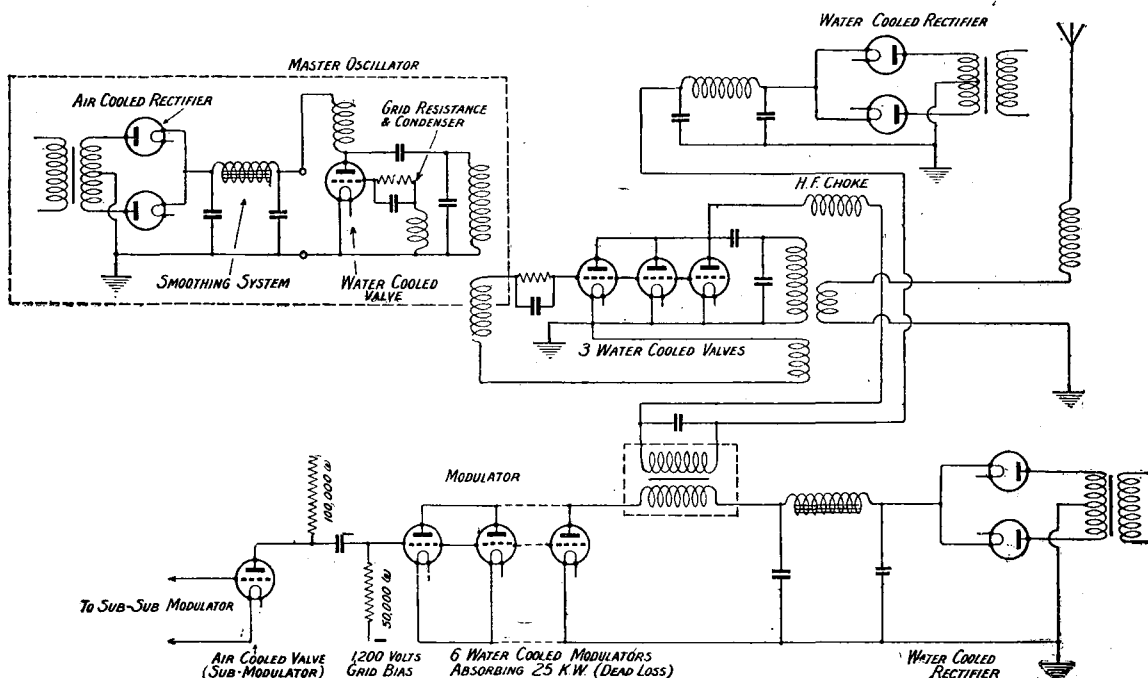

*A simplified diagram of the circuit employed in the Daventry transmitter.*

## Precautions Against Breakdown

We understand that spares have been provided wherever

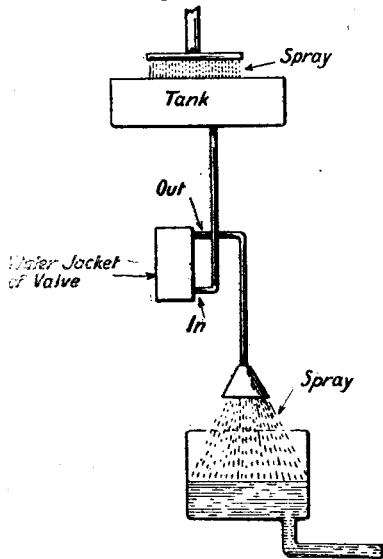

Very little leakage is experienced with the water cooling system indicated diagrammatically above.

### THE I.E.E. AND THE RADIO ENGINEER (concluded from page 553.)

It is required, however, that every candidate for admission as an associate member shall (a) have been regularly educated as an electrical engineer, and have had subsequent experience in a responsible position as an electrical engineer for at least two years, or (b) that he shall have had experience involving superior responsibility for at least five years in the applications of electricity. These clauses were naturally framed at a time when the radio engineer did not occupy a very prominent space in the electrical engineering profession. It certainly seems, however, that the terms "responsible position as an electrical engineer" and "superior responsibility" should be defined a little more adequately. Unless a fairly wide view of these terms is taken, a very valuable research worker might be completely debarred from admission as an associate member, whereas a comparatively junior shift engineer at one of the numerous power stations in the country, would be perfectly qualified.

We look forward therefore to a clear explanation from the Committee of the Wireless Section of the I.E.E., setting forth in detail the proposals for the modified form of constitution which shall cater adequately for the radio engineer in this country. Meanwhile, we remain strongly opposed to the formation of a separate body and expect to see the proposal dropped altogether.

possible to minimise the risk of a complete stoppage due to a breakdown in some part of the apparatus.

Thus part of the generator equipment has been duplicated; a certain number of spare valves are kept in a rack close at hand for use in the event of a breakdown. The sub-modulator panel, for instance, contains a separate holder wired into circuit, so that, should this valve break down, the spare may be instantly inserted. Duplication of all the existing apparatus is not, however, practicable, but the risk of a stoppage in the transmissions has been minimised. The Chelmsford station, which Daventry replaces, was, of course, only an experimental plant, and no duplicate equipment was provided. The many unfortunate failures of the transmitting gear which occurred at Chelmsford will, we hope, not be characteristic of Daventry.

intervals. A close-up photograph of one of these was given in our issue for July 8.

When the station was formally opened on Monday, July 27, by

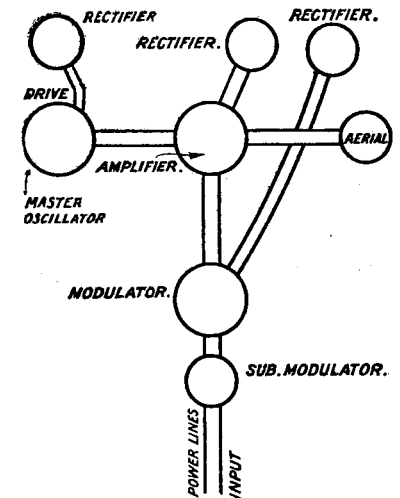

The layout of the apparatus in the transmitter room.

## Beacon Lights

A point of interest in connection with the aerial equipment is the provision of a large beacon light on the top of each of the masts to act as a warning to low-flying aircraft at night. These beacons are controlled by an automatic device in the transmitter room arranged to light and then extinguish them at definite short

the Postmaster-General, Sir William Mitchell-Thomson, our representative was able to observe the reading of the aerial ammeter when the transmitter was started up. The maximum current indicated was 45 amperes, and if the observation of one of the engineers that the efficiency is around 60 per cent. is correct, some idea of the radiation resistance may be obtained.

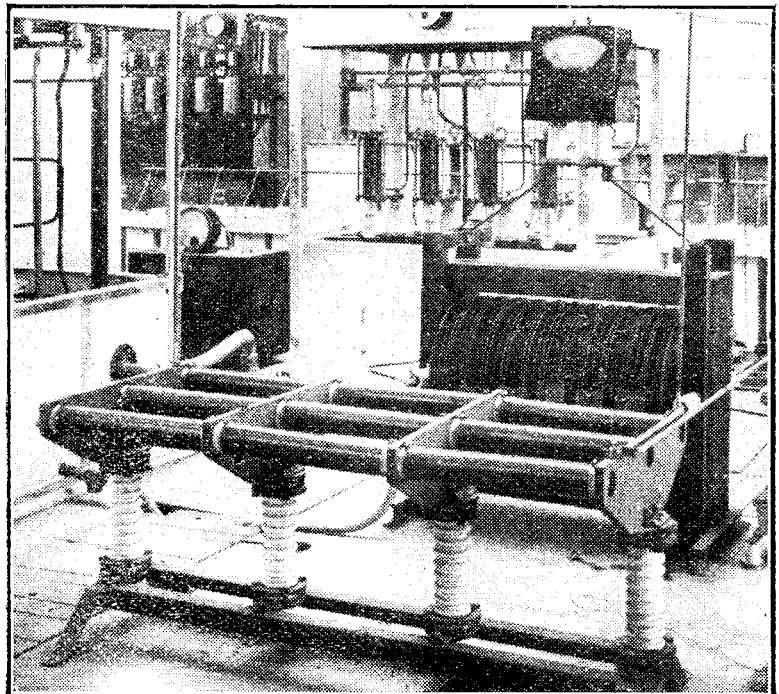

The radio-frequency choke is clearly seen in the foreground and the speech transformer in the rear.

# Faults in Resistance and Choke Coupled Note Magnifiers

By JOHN UNDERDOWN.

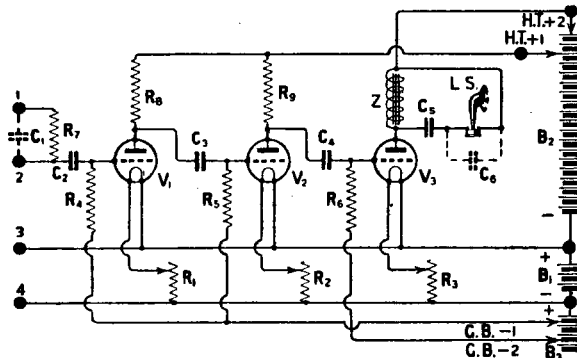

Fig. 1.—A typical three-valve resistance-coupled amplifier circuit. A filter circuit is provided for the loud-speaker.

LAST week attention was chiefly devoted to faults in transformer-coupled note magnifiers, and in this article I propose to complete the survey by dealing with troubles most commonly experienced when resistance or choke coupling is utilised, and also certain faults common to the three systems. The connections for passing on signal impulses are very similar with each of these methods, in that the varying voltages across either a resistance or a choke in the plate circuit of one valve are communicated to the grid of the next through a coupling condenser. It follows therefore that the observed symptoms will in many cases be similar when certain faults develop.

## Resistance Coupling

Fig. 1 shows a typical three-valve resistance-coupled amplifier circuit, this number of valves being required in most cases to obtain equivalent volume to that given by the transformer coupled two-valve (Fig. 1) arrangement of last week.

## Amplitude Distortion

"Amplitude distortion," due to the valves being worked with too little H.T. and wrong values of grid bias, or having characteristics which do not allow of them handling the signal input, is a fault often met with, and the remedies are obvious. Where ordinary loud-speaker strength, and by this I mean volume adequate for the average home, is required, two D.E.5B-type valves in the first two sockets, followed by a valve of the D.E.5 or B.4, etc., type, will give excellent reproduction; 120 volts H.T. is suitable for all three valves with  $1\frac{1}{2}$  volts grid bias for the first two and 6 for the last. For demonstration purposes V<sub>2</sub> may be a B<sub>4</sub>-type of valve, and V<sub>3</sub> an L.S.5-type with 200 volts H.T. and 12 volts grid bias.

In our last week's issue Mr. Underdown dealt with the faults and troubles peculiar to transformer coupled low-frequency amplifiers. In this article he deals with the two other common forms of L.F. amplification, and indicates some faults and their remedies, and also those faults common to all three types.

## Frequency Distortion

It is possible by using too low values for the coupling condensers, i.e., C<sub>2</sub>, C<sub>3</sub> and C<sub>4</sub> (Fig. 1), to obtain signals from the loud-speaker in which the high notes predominate and the lower notes are to a greater or less extent missing. This is due to the fact that the impedance of a condenser is greater to lower than to higher frequencies. Where this fault is present, the remedy is to increase the size of these condensers; a generally satisfactory value is .2 or .25  $\mu$ F. Values as low as .006  $\mu$ F, however, will not introduce distortion. The value of the by-pass condenser C<sub>1</sub>, shown dotted, since it is only required when reaction is incorporated in the set and in certain cases of howling, should be kept low, since it tends to pass the higher frequencies and cuts down the overall amplification. In practice, .0001  $\mu$ F will usually be found to give adequate reaction whilst complying with these conditions.

## Breakdown

Having dealt with what may perhaps be classed as lesser faults, we will now examine the major

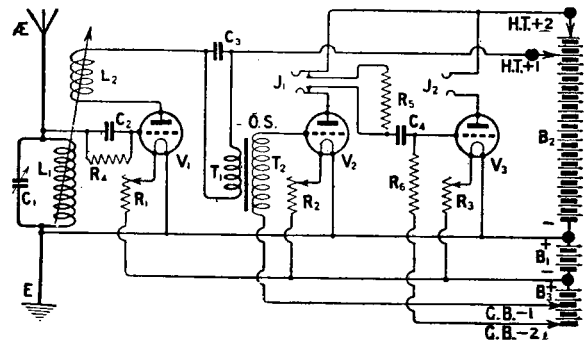

Fig. 2.—In the circuit shown the inclusion of the valve V<sub>3</sub> gave no increase in signal strength. The fault was traced to the anode resistance R<sub>5</sub>.

ones usually giving rise to complete breakdown or chronic distortion.

A by no means unusual letter from the Radio Press post-bag is one saying that the user of a resistance amplifier finds that on switching on the set signals are received at normal strength, but that they fade away more or less gradually,

and only after switching off for a minute or so can they be again received. This process is reproducible, even when the batteries have been replaced by others known to be satisfactory.

**Faulty Grid Leaks**

Faults of this nature are almost always traceable to a grid leak or leaks in the set having developed too high a resistance, so that the set becomes choked by the accumulation of negative charges on the grid or grids. When the set is switched off the charge gradually leaks away, so that signals may again be received until the action has again taken place. Fitting grid leaks of appropriate value removes this troublesome phenomenon. Values of 1 or 2 megohms are usually found satisfactory, but in general it is safe to use .5 megohm leaks or, in some cases, .25 megohm. The question of leak resistance is, of course, bound up with that of the valves used.

**Testing**

The application of the "click" test, explained last week, by means of a pair of telephones and a dry cell, will show whether a grid leak has completely broken down, no clicks being heard in this case, but will give no useful indication as to its actual resistance; in cases of doubt it is best to replace these components one at a time by new ones.

**Faulty Anode Resistances**

Where the anode resistances are suspected of causing trouble a similar test to that given for grid leaks will locate a complete breakdown, but not a partial one or an increase in resistances.

The effect of a completely broken down anode

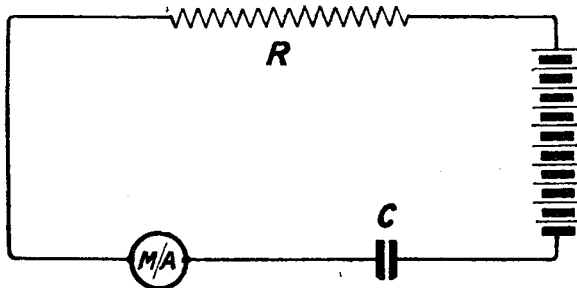

Fig. 3.—Here C is the condenser on test, while the resistance R should have a high enough value to prevent damage to the battery or the meter.

resistance may not be a complete cessation of signals, but only a decrease in strength, together with severe distortion in many cases. The writer recently experienced a difficulty of this type when using a set employing the circuit of Fig. 2, consisting of a detector valve, followed by a transformer and a resistance stage with plug and jack switching. Good loud-speaker strength was obtained using the first two valves, but on switching in the third and suitably reducing the grid bias on V<sub>2</sub> to compensate for the anode resistance, replacing the loud-speaker and consequently causing a drop in the potential applied to its plate, little or no increase in signal strength was observed, while distortion was very marked. A

B<sub>4</sub> valve was used for V<sub>3</sub> with 100 volts H.T. and 4½ volts grid bias. Decreasing this normal value of grid bias, that is GB<sub>2</sub>, improved signal strength, but did not remove the distortion. The fault was located by the "click" test in the anode resistance, this being tested when the batteries had been removed; no clicks were obtained. The substitution of a new resistance at once removed the trouble, and the set has since functioned excellently.

**"Background" Noises**

Partial breaks in anode resistances may give rise to somewhat similar symptoms, the signals received being distorted. In other cases, a less

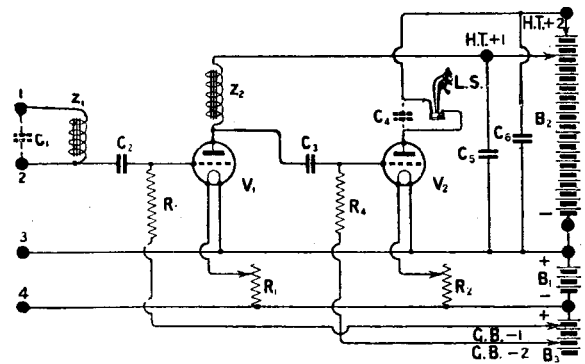

Fig. 4.—A circuit using chokes in place of resistances for the inter-valve coupling.

serious fault than that of a complete break, a very noisy background of sizzling or hissing, may be obtained. Sometimes this is so bad as to spoil signals completely. The substitution of a more suitable type of resistance will improve matters in such a case. Where heavy current has to be carried wire-wound resistances are to be preferred.

**Defective Coupling Condensers**

Further more fruitful causes of trouble in many cases are the coupling condensers, which are used to prevent the H.T. voltage being applied to the grids. Fairly large condensers of this type are somewhat difficult to test, but the possibility of faults here should not be overlooked when a complete cessation of signals or distortion is experienced and anode resistances and leaks are exonerated by test or substitution.

The "click" test with all the batteries disconnected will reveal the cause of the fault when the lug of the condenser makes no internal connection to the plates, no clicks being heard in the telephones. But this test will not necessarily locate a short circuit unless it is practically a "dead" short; in this case there will be no difference in the strength of click when touching the 'phones across the condenser and dry cell, or directly across the dry cell. If, therefore, a very loud click is obtained and a "dead" short suspected, connect a valve and an appropriate low-tension battery suitable for lighting the valve in series across the condenser. The valve will light if the diagnosis is correct.

### Insulation Tests

A less pronounced short, but one sufficient to make the grid so positive in practice as seriously to distort signals, cannot be thus located. Some test of the insulation may, however, be carried out if the condenser is charged by placing it across a small dry battery ( $4\frac{1}{2}$  volts upwards will give a good indication) and then removed, without allowing anything to rest across its lugs; it is then left standing for a few minutes, after which the 'phones are tapped across it. If the insulation is good a loud click will be obtained, and possibly several less loud on re-applications of the 'phones after short intervals. Do not use too high a voltage for this test, as an unpleasant shock can be experienced with a condenser of this type, that obtained from a  $1 \mu\text{F}$  condenser charged across a 100 volts H.T. being far from enjoyable.

### The Use of a Milliammeter

Where a milliammeter is available this may be used in conjunction with an H.T. battery in insulation testing of this kind, by connecting it as shown in Fig. 3, that is in series with a safety resistance R and an H.T. battery across the condenser. A steady reading will be obtained if a leakage fault of sufficient magnitude is present. The limiting resistance R should have such a value as to prevent damage to the meter in the case of a short; an anode resistance will be found satisfactory in most cases.

Incidentally a meter of the above type will prove handy in locating a break in the anode circuit of a valve, no reading being obtained if the circuit is not continuous when this is placed in the H.T. lead to the valve.

### Howling Due to Amplification of H.F. Currents

Where the condenser  $C_1$  (Fig. 1) is omitted when the amplifier follows a detector with reaction, control may be difficult, and in some cases the H.F. component in the plate circuit of the detector valve will be amplified and will cause the L.F. valves periodically to choke up, giving rise to a howl or ticking at audible frequency. This difficulty can be overcome by the inclusion of the necessary by-pass condenser of  $.0001 \mu\text{F}$ , or sometimes, if necessary, one slightly larger.

### Choke Coupling

A typical choke coupled amplifier circuit is shown in Fig. 4. It will be observed that the values of the coupling condensers and leaks are similar to those of Fig. 1. A breakdown in a leak or condenser may be similarly traced, the symptoms observed being very similar to those experienced with resistance coupling. In testing the chokes Z it should be remembered that breaks at certain points may still give slight clicks when the telephones and dry cell test for continuity is applied, but little difficulty should be experienced in deciding whether the component is satisfactory, if comparison is made with one known to be working correctly.

The value of the chokes employed has a considerable bearing on results, since their impedance

varies with frequency and a high value of inductance is required to give a uniform degree of amplification over the required frequencies for speech and music. Too low an impedance results in accentuation of the higher notes at the expense of the lower, and the same rule, of course, holds if the coupling condensers are too low in value. Generally a value of above 40 henries and up to 100 henries will give satisfactory results.  $C_1$ , the by-pass condenser required when the amplifier follows a detector with reaction, should be from  $.0001$  to  $.0005 \mu\text{F}$ .

### Low-Frequency Buzzing

Having now dealt with troubles peculiar to each system of low-frequency coupling, it remains to deal with certain troubles common to all three types. Buzzing or low-frequency oscillation may be caused in each type of amplifier by an H.T. battery whose internal resistance has become very high through use. This will act as a non-inductive resistance common to the plate circuits of all valves, and will provide unwanted coupling effects, giving rise to low-frequency oscillation. The best cure is to install a new battery, but some relief may be obtained if each H.T. tapping is shunted by a condenser of 1 or 2  $\mu\text{F}$ .

### "Crackling"

Crackling noises obtained when aerial and earth are disconnected may be due to a defective H.T. battery, the remedy for which is obvious, or to faulty panel insulation, etc. The telephone and dry-cell test, judiciously applied, will usually locate the faults in these cases.

### Microphonic Effects

With certain types of valves trouble may be experienced when movements take place in the region of the set, and the remedies to try are the effect of standing the set on a felt or rubber pad, or in extreme cases that of replacing the valve-holders with special vibratory types.

### Howling with Long Loud-Speaker Leads

Occasionally a somewhat peculiar difficulty arises where very long extension leads to a loud-speaker are employed, howling resulting when these are in use, but not with connections of the normal length. The effect of altering the tone-control condenser across loud-speaker terminals of the set should be tried; alternatively a 1 to 1 telephone transformer or filter circuit, such as that shown in Fig. 1, may be inserted at the set end of the leads.

THE AUGUST ISSUE OF  
**"MODERN WIRELESS"**  
 IS NOW ON SALE



PRICE 1/-

DO NOT FAIL TO SECURE A COPY



# Random Technicalities

By **PERCY W. HARRIS, M.I.R.E.**  
Assistant Editor.

*Some Notes of Interest to the Experimenter and Home Constructor.*



**T**HIS being the holiday season, I suppose that many readers will be regretfully preparing to abandon their wireless apparatus for a few weeks, and perhaps, in the case of the more fortunate, for a month or so. Before I went to America I had to face the same problem myself, and for this reason I can give you a few tips which may be helpful.

There are two matters which will require your particular attention before you go away. The first is the condition of your accumulators, and the second the exposure of your apparatus. Probably one or two of your cells are partially discharged, and in the normal way you would not get them charged for another week or so. Do not on any account leave the accumulators in this state, for they will deteriorate rapidly, and probably you will find them sulphated on your return. It is a wise rule to get every accumulator fully charged before you go, even if you have used it only once or twice.

\* \* \*

Another matter requiring attention is the "topping-up." The sun, pouring into a tightly-closed room, will raise its temperature very considerably, and the amount of evaporation possible in a hot room is almost unbelievable. If you are fortunate enough to possess high-tension accumulators, make sure these, too, are properly charged and "topped-up."

See that all wires are disconnected from both high- and low-tension batteries. Your wireless room may be a particularly private sanctum, and you may feel sure that you can leave things as they are; but, remember that there is always a possibility of a stray cat climbing through a sky-

light or other orifice, and a cat in a wireless room is at least as formidable as a bull in a china shop.

With regard to the other apparatus, see that it is not left in a position where the sun's rays can fall upon it. Ebonite, even of the highest grade, is peculiarly susceptible to the influence of sunlight, and will rapidly deteriorate if left exposed to its rays. Most of us pride ourselves on the appearance of our sets, and a dull greenish-brown panel is the last thing we desire to see. Not only is the appearance of ebonite spoiled by constant exposure to sunlight, but its insulating properties also deteriorate rapidly.

\* \* \*

Although, personally, I have always held that lightning risks in regard to receiving aerials are negligible, it is just as well to disconnect the aerial from the

lead-in and join it directly to the earth wire outside the house. If this is done other members of your family will possibly feel more comfortable about it, and, in any case, whatever happens, your aerial cannot be blamed!

Speaking of lightning, and the general idea that it strikes the highest structure, reminds me that just before I left New York a large building on Broadway was struck by lightning and some coping stones knocked off into the street below. This building was almost next door to the giant Woolworth structure (more than twice its height), while there were several other buildings close by considerably higher than the building struck. Furthermore, the large aerial of the adjacent City Hall Broadcasting Station was untouched, although this again was much higher than the building referred to.

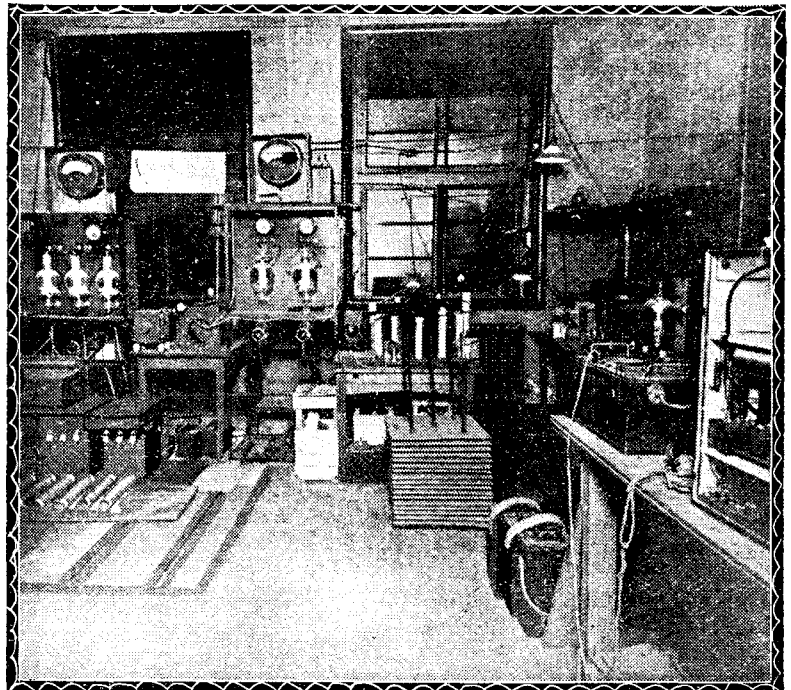

*The transmitting room of the broadcasting station at Hilversum, in Holland. This station uses a wavelength of 1,050 metres.*

# Correspondence

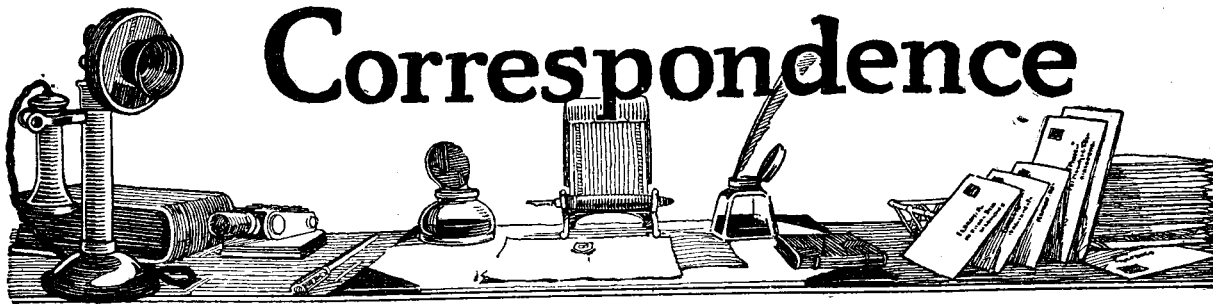

## THE "TRI-CELL"

SIR,—I enclose a photograph of a home-made "Tri-cell" one-valve reflex receiver made by myself to instructions given in the article by Percy W. Harris, M.I.R.E., in the September, 1924, issue of *Modern Wireless*. The wiring, values of components, etc., are exactly the same as in the article, except that I have

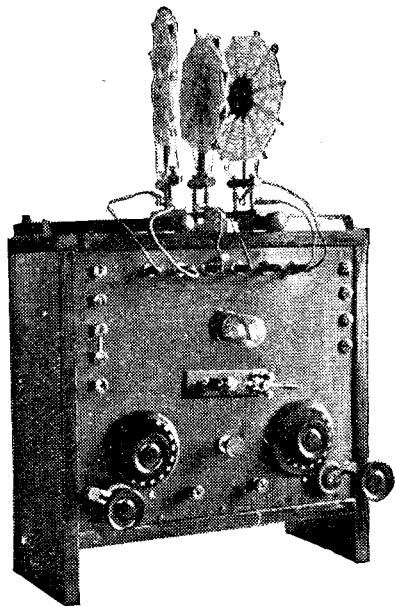

The "Tri-Cell" Receiver constructed by Mr. Stewart.

put the transformer on the base-board (since it was a different make from the one described in the article there was not room for it on the panel). Also I have put the coils on the top of the cabinet, both coil-holder and coils being home-made. I have tried all the one-valve reflex circuits that have appeared in *Modern Wireless*, and find this one the best. It is very selective for a reflex, and gives really good results on an indoor aerial.—Yours faithfully,

R. STEWART.

London, S.E.4.

## A JUNIOR READER'S SUCCESS

SIR,—I feel I owe you this letter informing you of the excellent results I am obtaining with your "Cabinet One-valve Re-

ceiver" (*The Wireless Constructor*, December, 1924, by Percy W. Harris) and the "Single Valve Choke Amplifier Unit" (*The Wireless Constructor*, April, 1925, by John W. Barber). I have built these two in one, making a two-valve set of them.

Although using only two valves, I am receiving 6BM at 90 miles, 2LO at 53 miles and 5XX at about 75 miles at good loud-speaker strength; 5NO (370 miles), Madrid (750 miles), 2ZY (200 miles), Bremen (450 miles), 5NG, FPTT, Petit-Parisien, Lyons, 5WA at 150 miles, FL and Radio-Paris are all received at comfortable 'phone strength.

The aerial is only 29 ft. high at far end, 20 ft. high at lead-in end and 37 ft. in length. The earth is a "Climax" copper earth tube.

I am only 15 years old, and have built this set with components bought with my own pocket money.

Thanking you and wishing your publications continued success. Good luck to *The Wireless Constructor*, the "best book on the market."—Yours faithfully,

F. G. MORRIS.

Brighton.

## THE "TWIN-VALVE" REFLEX

SIR,—I have been a regular reader of your three popular journals, *Wireless Weekly*, *The Wireless Constructor*, and *Modern Wireless*, ever since No. 1 of each book was printed. I just had an ordinary crystal set until three months or so back, when I naturally, like a real wireless enthusiast, developed a longing for a valve set, which I now have, and of which I enclose

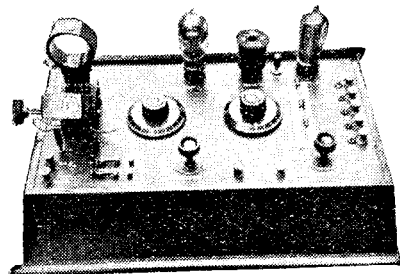

A "Twin-Valve Reflex" set built by Mr. Cornish, with which good loud-speaker results have been obtained.

a photograph. It is the "Twin-Valve Reflex" as described by John Scott-Taggart, F.Inst.P., A.M.I.E.E., in the January issue of *The Wireless Constructor*, and I am very proud to own a set so

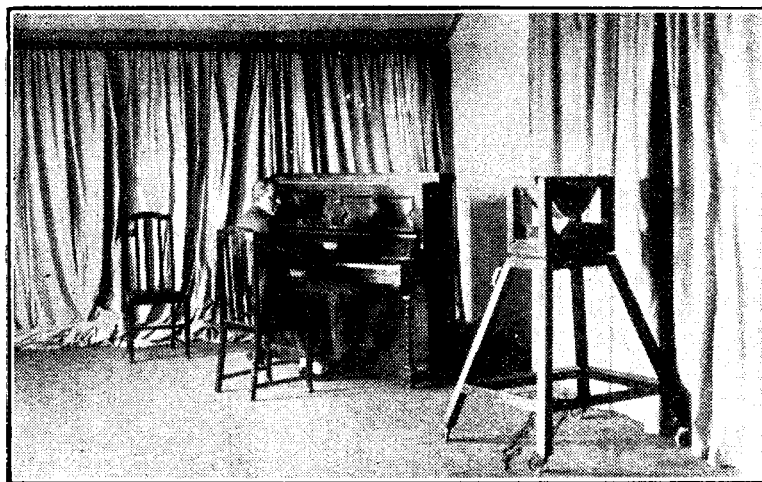

The Daventry Station is provided with a studio for occasional use. This is equipped in the same way as the other B.B.C. stations; most of the transmissions, however, will be sent via special land lines from London.

good, even though it is my first attempt at a valve set. I have kept to your directions almost to a screw; but some of the components are of different makes from those given, and I have incorporated a few switches. All the other parts that are used are the same as Mr. Scott-Taggart used. Also I have put the unsightly batteries in the box out of the way.

The small D.P.D.T. switch on the left is for using grid-bias as desired, which I find very useful for distant stations; the grid leak also helps a lot. The three switches are for cutting the L.T. and H.T. batteries completely out. The reason for my adding these is to enable my people at home here to use the set whenever I am not there, as they would not touch it otherwise, for fear of damaging the valves. Whenever I leave it I set it for London, and then all they have to do is to put the switches in and then enjoy the wireless. At night time when all the stations have closed down I just pull out these switches as well as a main aerial

strength. I also get quite a lot of unknown stations.

I have had quite a few wireless experts to view and listen to the set, and most of them say it is the clearest and loudest for its size they have ever heard. Considering my aerial is only 24 ft. high on low-lying ground and badly screened by houses, with the Metropolitan Railway Power Station close by, I think I get very good results. So I think it right to thank Mr. Scott-Taggart for publishing such a good set.

Thanking you once again and wishing your journals further successes.—Yours faithfully,

E. CORNISH.

Neasden, N.W.10.

A READER'S EXPERIENCES

SIR,—I think you will like to know of my results with your receiving sets. Ten months ago I built your famous "All-Concert" receiver (*Modern Wireless*, September, 1923, by Percy W. Harris), which I consider a most remark-

tried the set out two or three evenings, so far I have received Manchester and also Liverpool at good loud-speaker strength; Birmingham and Belfast are very strong in the headphones. I have had Bournemouth and Newcastle on the 'phones quite well; so I think the set is quite the best possible for two valves, but it is a little difficult to handle after a straight circuit; for instance, I find that using C.A.T. and shorting the reaction coil considerably improves reception from Birmingham, but with the same connections Manchester will howl badly, while, using an S.4 coil for reaction and S.3 for aerial, Manchester is almost perfect; so I feel that my present results are not the best possible, and I hope with further experience and experimenting with H.T. and grid bias to make it a thoroughly selective and stable receiver. I hope some time you will give us a three-valve dual set to try out.

I wish you and *The Wireless Constructor* every success.—Yours faithfully,

JACK H. GRINDELL.

Flintshire.

[A three-valve dual was described in *Modern Wireless*, March, 1924, by John Scott-Taggart, F.Inst.P., A.M.I.E.E., and also a simplified version in the March, 1925, issue of the same journal.—Ed.]

PRECAUTIONS IN CHARGING ACCUMULATORS

SIR,—With reference to my article, "Precautions in Charging Accumulators from D.C. Mains," which appeared in *Wireless Weekly*, Vol. 6, No. 11, I pointed out that accumulators being charged in series should be well separated. The importance of strict observance of this rule is illustrated by some recent fires which have come under my notice.

Apparently the firm concerned have tried to comply with the suggested regulations, and, at first sight, there seemed to be no apparent reason for the outbreak. Further careful investigation showed that in each case the corners of two celluloid cases were touching and were separated in the series on charge by some eight or more batteries, thereby causing a considerable difference of potential between the two touching cells.

In one case I calculated that the drop in potential between the two touching cells was 97 volts, and as this particular fire occurred whilst three persons were actually at the charging bench, the facts which were disclosed through careful questioning left no doubt as to the cause of the fire.

It is also interesting to note that

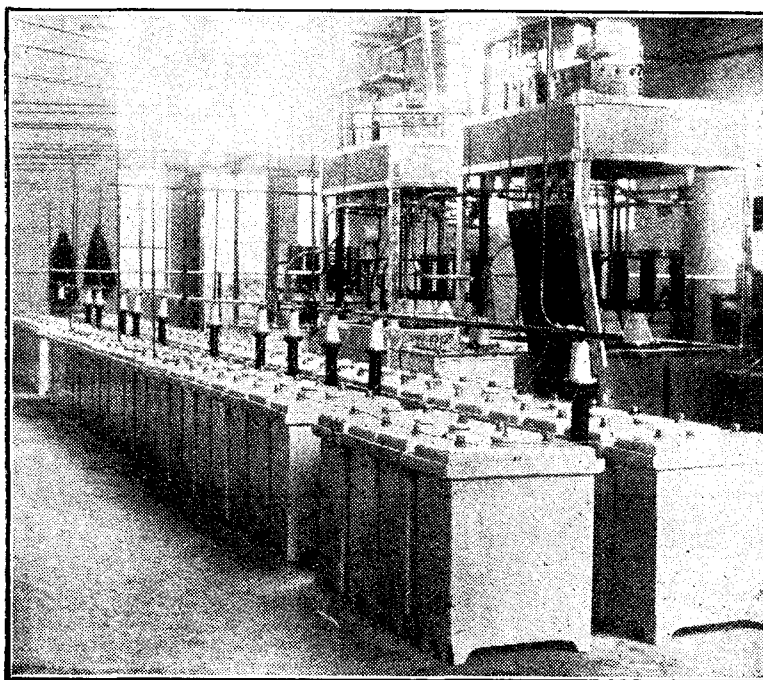

This bank of condensers used at the Daventry station forms part of the smoothing system used in conjunction with the rectifiers.

and earth switch which is outside and leave the valves and coils in. The valves are a D.E.R. and B3 (B.T.H.), and I use Igranic coils.

Now for a few results. London is really too loud on a Baby Sterling; in fact, when I point it to the window neighbours at 80 yards away can hear music comfortably. All the English and Scotch stations I get quite easily, most of them on the loud-speaker at a nice strength. Madrid, Hamburg and Petit-Parisien I receive at loud-speaker

able set for three valves, it being easily possible to get all the B.B.C. stations and many others at real good strength and two at loud-speaker strength, i.e., Manchester and Liverpool. I have now built Mr. John Scott-Taggart's "Twin-Valve" set (*The Wireless Constructor*, January, 1925). I have followed the given layout accurately, but I have a very bad aerial and 14 yards of earth lead, and at present I have only 80 volts H.T. After having



in that case the loud hissing attracted the attention of one person, who immediately turned off the current, and that the flames broke out about half a minute afterwards, thereby denoting that the charging current broke down the resistance, but that the current in the intervening batteries was sufficient to continue the work and actually ignite the celluloid after the original resistance had been broken down.—Yours faithfully,

S. H. PAGE.

Ramsgate.

**A SOUTH AFRICAN TRANSMITTER**

SIR,—I notice in *Wireless Weekly* dated May 27 a letter from Mr. W. A. Impett, of Buenos Aires, who states that "on one occasion Australian A4Z was copied for about an hour while working with RCB8."

It has occurred to me that Mr. Impett may be interested to know that this was not Australian A4Z, but was South African A4Z of Cape Town, who established two-way working with RCB8 early in April last.

I would take this opportunity to inform your readers that I am transmitting on 48 metres daily at 20.30 G.M.T. and on Saturday at 23.00

G.M.T., and shall be glad to have reports of reception. Input 120 watts pure c.w.—Yours faithfully,

J. S. STREETER (A4Z).

Cape Town.

**THE "TWIN-VALVE REFLEX"**

SIR,—I think you may be interested to hear the results obtained with the "Twin-Valve Reflex Receiver," described in the January Number of *The Wireless Constructor* (by Mr. John Scott-Taggart). I made the set almost exactly to your plans, except that I put the valves behind the panel eventually. It is a remarkably sensitive set and receives 5XX without aerial or earth. In this case the aerial was connected to earth outside the house, about 10 ft. away from the set. The reception was at moderate 'phone strength using a 200 coil in the aerial and a 150 for reaction, reversed.

On an indoor aerial consisting of 20 ft. of twin flex running along a passage, 5XX comes in at comfortable loud-speaker strength, and London, Radio-Paris and Newcastle quite loud on the 'phones.

With an outdoor aerial 100 ft. long and about 26 ft. average height, the following stations are

obtained with great regularity:—5XX, too loud on the loud-speaker (a Brown H2) to be comfortable, and easily heard all over the house, (I usually detune to a moderate strength); London, Newcastle, Bournemouth, Radio-Paris and Petit-Parisien are received at good loud-speaker strength.

All other main stations and relays come in easily on the 'phones and, of course, dozens of Continental ones. I am using one of the home-made H.F. transformers described by Mr. Donald Straker in *Wireless Weekly*, December 10, 1924, and also an auto-coupled X coil. I find the results are much better than with the bought transformers and standard plug-in coils. I am also agreeably surprised to find that the set is almost as easy to handle on the shorter waves as on the long ones. I have had a great number of amateurs on wavelengths varying from 125 to 300 metres; this also with a home-made transformer and X coils. I am delighted with the receiver and feel that it is only right to let you know how satisfied I am.

Wishing your excellent publications every success.—Yours faithfully,

HAROLD C. LEE.

Herne Bay.

**Quality RADIO The New Home of COMPONENTS**

Send for our new 30 page fully illustrated Catalogue which shows some reductions in price and describes many new lines.

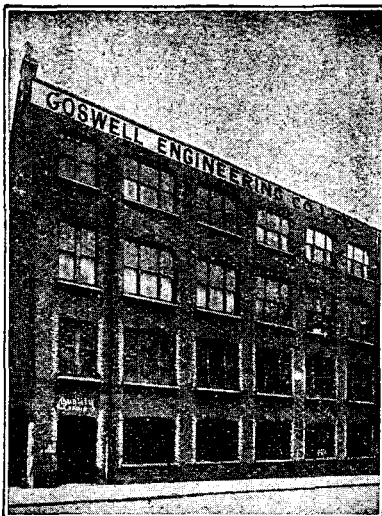

**GOSWELL ENGINEERING CO., LTD.**  
95, 96, 97, 98, WHITE LION ST., LONDON, N.1

Your dealer can supply you, if not we send post free if you mention his name and address.

**Experimenters:—**

If you want good reliable Radio apparatus at fair prices you'll get our Catalogue.

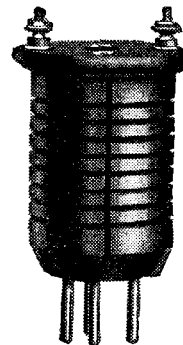

There is any amount of radio material being offered at low prices—but the seasoned experimenter who looks for good results won't have it at any price. Long experience has proved to him the folly of studying price first and reliability second. Every component we sell here has to pass the standard set by our technical staff. If it is not good enough for us to use in the Sets we build and guarantee, then we won't stock it.

**Oscillaformers**

Originally designed for Mr. Scott Taggart's 9-valve Super-Het, but suitable for all Super-Hets.

- No. 1. For broadcast wavelengths 12/6
- No. 2. 1,200 to 1,900 metres 13/6
- No. 3. 1,900 to 3,000 metres 14/6

**Switches**

Radius of 1/4 in. for portable and small Sets 1/3

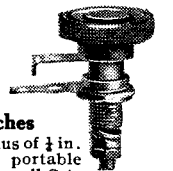

**Plugs and Jacks**

- Single circuit Jacks ... 2/3
- Double circuit Jacks ... 2/6
- Filament control Jacks ... 2/6
- Telephone Plugs ... 1/6

**Catalogue**  
Large illustrated catalogue of 48 pages.  
Post free 3d.



**PETO-SCOTT, Co., Ltd.**

Registered Offices, Mail Order and Showroom, 77, CITY ROAD, LONDON, E.C.1.  
Branches: LONDON—32, High Holborn, W.C.1.  
WALTHAMSTOW—230, Wood Street.  
PLYMOUTH—4, Bank of England Place.  
LIVERPOOL—4, Manchester Street.

**The Pilot Chart**

Before building your Set be sure to get this chart which contains specification of more than 30 well known Sets.

Post free 3d.

**AMATEUR TELEPHONY ON 45 METRES**

SIR,—I am now carrying out telephony tests on a wavelength of 45 metres, using A.C. for filament lighting. The first of these tests was made recently, and so far I have received reports from London and Newcastle, both of which report good strength.

These tests are usually made about 12 p.m. B.S.T. on Friday and Saturday nights, also between 2 and 3 p.m. and 7 and 7.30 p.m. on Sundays.

I shall esteem it a favour if you will mention this in your paper, as I should like to receive as many reports as possible, and in view of the fact that there is not much telephony taking place on this wavelength at present it will, no doubt, stimulate interest in what promises to be the most useful amateur wavelength.

It might also interest you to know that Saturday night, July 18, I carried on two-way communication (C.W.) for 45 minutes with U4KT (Mr. Pinero, Carolina, Porto Rico). The time was midnight G.M.T.; it would, therefore, be about 6 p.m. at Porto Rico, or daylight for at least two-thirds of the way across. The power used was 40 watts, and my wavelength 44.5 metres. 4KT reported my strength

as R.5 through very bad atmospheric. —Yours faithfully,  
J. W. RIDDIOUGH (5SZ).  
Morecambe.

**Are "Wavelengths" Played Out?**

(Continued from page 556.)

conversion table, in which a correspondent wished to know how to obtain intermediate frequencies not given in the table.

This is done by method of differences. If the frequency corresponding to 309 metres is required it would be obtained as follows:—

300 metres = 999.4 kc.  
310 metres = 967.2 kc.  
Difference = 32.2 kc. for 10 m.  
= 3.22 k.c. for 1 m.

Now, 309 metres is 1 metre less than 310, and therefore the frequency corresponding to 309 metres will be

967.2 + 3.22 = 970.42 kc.

It should be noted that as the wavelength decreases the frequency increases. Hence, if the wavelength is reduced by 1 metre (from 310 to 309), the frequency

difference (3.22 kc.) is added to the figure for 310 metres.

The same result could be obtained by subtracting the difference corresponding to 9 metres from the figure for 300 metres.

If 1 metre difference is 3.22 kc.  
9 metres " 28.98 kc.  
309 metres = 999.4 - 28.98  
= 970.42 kc. as

before.

The frequency difference per metre, however, is not constant (e.g., at 3,000 metres, the difference per metre is only .033 kc.), but for estimating points intermediate between two other points fairly close together the difference may be taken as constant.

For the convenience of our readers we have reproduced on an earlier page the table of the wavelengths and frequencies of the most well-known British and Continental broadcasting stations.

In my article in last week's issue on page 521, it will have been noted that the word "cycles" in the third column should, of course, read "metres."

# HAWK

MAXIMUM

Efficiency

—

Strength

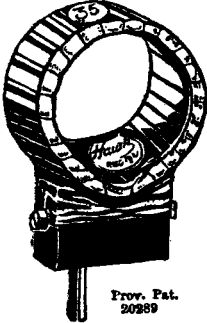

Prov. Pat. 20989

WATERPROOF

# COILS

MINIMUM

Capacity

Damping Effects

Resistance

Prices below      Tel. 832 Kingston.

Coil	Wave Length using .001 Variable Condenser in Parallel		PRICE.
	MAXIMUM	MINIMUM	
13	—	—	2/-
25	305	190	2/4
30	435	240	2/4
35	515	360	2/6
40	680	370	2/8
50	835	485	3/-
75	1250	600	3/4
100	1820	815	3/10
150	2300	980	4/8
200	3100	1870	5/4
250	3750	2200	5/8
300	4500	2300	6/-
400	4950	2500	6/6

Sold by all Wireless Dealers

Sole Manufacturers:

The Hawk Coil Co.,

LTD., ST. MARY'S ROAD,  
SURBITON, SURREY.

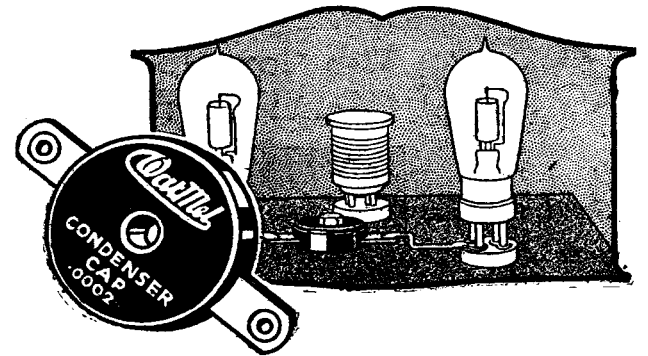

**—the new Watmel Product**  
**A LOW LOSS, HIGH GRADE FIXED CONDENSER**

**M**ONTHS of exhaustive research in the Watmel Laboratories has resulted in the production of a fixed condenser that can truly be called perfect.

It every detail of its design and construction the Watmel Fixed Condenser rises superior to other instruments of its type.

There is no wax whatever used in the construction of the Watmel Condenser. For this reason you will appreciate this immunity from temperature changes and consequent dielectric loss. And its case of ebonite with its polished contacts adds as greatly to the appearance of any set as the construction does to its efficiency. In every detail you will admire the Watmel Construction, Appearance and Efficiency—it sets a new standard in fixed condenser design. Better still, you will like the price. This condenser is the latest and best, yet it costs no more. If your dealer has not yet been stocked, you can be supplied direct.

**PRICES:**

- Capacities for Standard Grid Condensers.
- .0005 to .0005 . . . . . 2/6 each
- Standard Fixed Condensers.
- .302 to .001 . . . . . 2/6 each
- .0025 to .006 . . . . . 3/6 each
- Combined Grid Leak and Condenser 3/- each.



All goods of our manufacture bear this mark. It is your only guarantee.

**WATMEL WIRELESS CO., LTD.** 332a, GOSWELL ROAD, LONDON, E.C.1.

Agent for Lancashire and Cheshire—  
Mr. J. B. LEVEE, 23, Hartley Street, Levenshulme, MANCHESTER.  
Barclays Ad.



# Apparatus we have tested

Conducted by A. D. COWPER, M.Sc., Staff Editor.

### Panel Brackets

A sample of a new type of metal bracket specially designed for fixing the vertical panel on to the base-board in the American type of receiver, which is rapidly obtaining popularity on this side on account of its structural convenience, has been sent to us by Messrs. Richard Melhuish, Ltd. These brackets, which we understand are made in four sizes and retail at a very reasonable price, are apparently stampings of a stout gauge of metal, plated and provided with earthing screws and the necessary holes for bolting on the panel and for screwing to the base-board. The sample brackets, which were of the 5-in. by 1 3/4-in. size, were strong,

well finished and neat in appearance, and eminently suitable for their purpose. They can be well recommended.

### Small Constructional Components

A number of small components for practical radio home-construction have been submitted for our comment by Messrs. London and Provincial Radio Co., Ltd. These included samples of valve windows, both in the 1-in and the 1/8-in. diameter sizes, in plain and coloured celluloid (which proved on test to be only very moderately inflammable), and in gauze with nickelled rims and fitted with the necessary fixing screws, and a universal spanner and screwdriver (in

the form of a thin stamping) which should be handy in cramped places. We can recommend these accessories to the attention of the home constructor.

### Pull-and-Push Switch

A compact type of pull-and-push switch for single-hole panel mounting has arrived from Messrs. London and Provincial Radio Co., Ltd., for our trial. The fixing device is of a neat type with a single large plated bush which passes through a 3/32-in. hole in the panel, and on to which the insulating base of the switch screws behind the panel. A small knob controls the switch, a grooved metal collar making contact with two

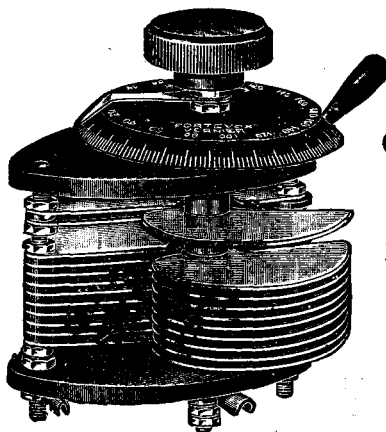

## If you fit a **FORTEVOX** Component

you get RELIABLE and EFFICIENT working, an ORIGINAL DESIGN giving you the "Something Different," and Skilled Workmanship with High Class Finish. Look, for example, at the

**FORTEVOX SQUARE LAW VARIABLE CONDENSER**

### This NEW DESIGN

is the only Condenser giving READINGS on both Main Condenser and Vernier. Full Instructions and Recording Charts with each instrument. One Hole Fixing.

	PRICE	
	Ordinary	Vernier
.001	16 6 each	20 6 each
.00075	15 6 "	19 6 "
.0005	12 6 "	16 6 "
.0003	10 6 "	14 6 "
.0002	10 0 "	14 0 "

Postage 5d.

For the Discriminating Buyer :

"We cannot recall having seen a better finished article."

THE BRITISH TRADE JOURNAL.

The NOVEL LIGHTNING ARRESTER  
Protects your Property and Eliminates ATMOSPHERICS



Prov. Patent 14127/25.

Price 2/6 each. Postage 2d.

Stocked by all reputable dealers, or obtainable direct from :

**FRASER & GLASS, LONDON, N.8.** Phone, Mountview 2225.

Scottish Agents : KEITH & IRWIN, 35, Robertson Street, GLASGOW.

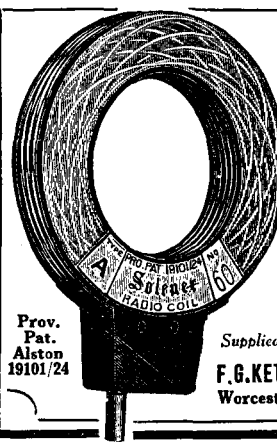

## The New "SOLENEX" RADIO COIL

The Coil you will eventually use! NO varnish impregnation, extra capacity losses, or undesirable wire kinks.

BUT totally enclosed in beautiful gold tinted celluloid case, hollowed patented coil mount and hollow plug pin and highly efficient eccentric generative winding.

The smartest and highest efficient coil on the radio market to-day.

Prov. Pat. Alston 19101/24

Supplied in all Wavelengths. From 4/6 to 10/- each

F.G.KETELBEY, A.M.I.E.E. Manufacturers and Main Wholesale Distributors, Worcester Chambers, 14, New St., Birmingham.

## Quite as Good as New at about Half Cost THINK WHAT WE SAVE YOU!!!

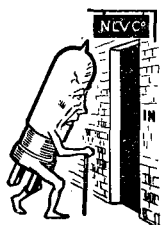

Send your Burnt Out or Damaged Valves to us and we will Restore them to Function with Original Characteristics EFFICIENCY MAINTAINED, RESULTS GUARANTEED! B.E. 4/6, D.E. 2V. -3 7/6, D.E. -06 9/6.

Price list for Power Valves on application.

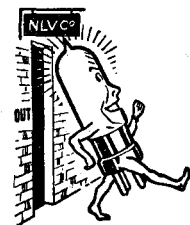

We return the actual Valve you send us, post free, within 7 days.

**THE NORTH LONDON VALVE CO., LTD.,**  
22 1/2, CAZENOVE ROAD, STOKE NEWINGTON, N.16.

Liberal discount to Wireless Agents.

spring fingers when pushed home. Small terminals, as well as soldering tags, are provided for connections. The operation of the switch proved to be reliable and positive; it is strongly made and neat in appearance, whilst the insulation was found to be adequate.

**"A.J.S." Variable Condensers**

Two samples of their .0005  $\mu$ F (nominal) variable condensers have come from Messrs. A. J. Stevens & Co. (1914), Ltd., for our test. These are of a sturdy, well-thought-out design, which can legitimately be characterised as "low-loss"; the plates have a peculiar shape, presumably to give a "square-law" effect, but both fixed and moving banks are given this unique form, with a pointed leading edge for fine adjustment at low capacities. Two small screws, with bushes, are provided for fixing behind the panel; the frame has substantial end plates of insulating composition. Heavy bushed bearings are provided, and a wide pig-tail for connection to the moving plates, but a very tiny bolt and nut respectively appear to fulfil the maker's ideas as to the provision of convenient and adequate terminals. Positive stops limit the motion in both directions; a knob and bevel scale are provided with each instrument. On test, the minimum

capacity came out at below 4  $\mu$ F in each case, a commendable figure, showing careful design; the maximum was in each case very close to the nominal .0005  $\mu$ F, the mean of the two being exactly .0005  $\mu$ F. Insulation resistance was irreproachable; tested in an oscillatory circuit, low resistance was recorded. Finish and workmanship appeared most satisfactory, though a set-screw for the knob and scale would prove to be a desirable addition.

**Tinned Eyelets**

A useful little fitting which will facilitate the wiring up of receivers with the customary square bus wire of large gauge is submitted for our inspection by the makers, Messrs. Sidney Jones & Co. (London), Ltd. This is a special tinned eyelet fitting snugly over the shank of a No. 4 B.A. size panel fitting, terminal, etc., and provided with a trough-shaped tag which can be readily closed on to the bus-bar by a nip with the pliers and as readily soldered securely by a touch with a clean, hot iron. This gives a neater and more professional looking finish than that produced by bending a loop in the wire, and will be easier for many to carry out than an end-to-end soldered joint, besides economising time.

**"Velvet" Filament Resistance**

A circular spiral wire filament rheostat with a simple but effective type of contact arm, ensuring silent working, is the "Velvet" resistance submitted for trial by Messrs. Leigh Bros. This, which on test showed a resistance in the neighbourhood of 5 ohms maximum, has the spiral wound with a triangular cross-section, with air core, but arranged around the usual grooved circular former. The curved spring contact finger makes rubbing contact with more than one turn of the resistance wire on the top of one of the (rounded) corners of the triangle and in a plane at right-angles to the axis. One very small terminal screw and a small soldering tag are relied upon for connections to the instrument. It was noticed that the contact finger is secured strongly on the spindle, but that for the controlling knob dependence is placed upon the (often insecure) method of jamming it on the screw-threads. The usual type of one-hole-fixing is provided, allowing for a panel thickness of up to 5-16 in., and a neat knob, pointer and engraved scale. On practical trial with an R valve good, silent control was obtained, and the resistance could handle the ordinary filament current for a bright-emitter valve.



**"TELWAVE"**

(Registered)

**RADIO COMPONENTS**

(MARTIN-COPELAND PRODUCTS)

**HIGHEST CLASS ONLY.**

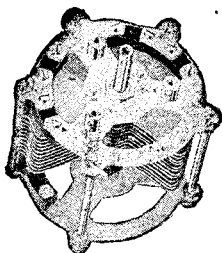

**"TELWAVE" LOW LOSS CONDENSERS  
SECOND TO NONE.**

**OUR NEW CATALOGUE IS NOW  
READY. WRITE FOR YOUR COPY.**

**THE ELECTRICAL EQUIPMENT &  
CARBON CO., Ltd.,**

**109/111, New Oxford St., London, W.C.1**

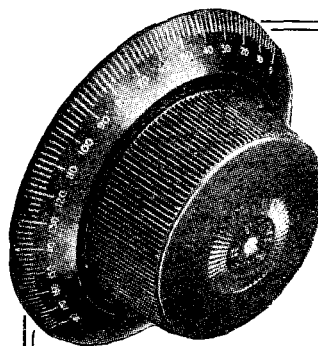

**Make your Set  
Micro-  
Selective**

Be able to get those elusive DX stations readily, clear and loud. Be able to get any stations you have logged by merely setting the

dials at the proper numbers; simply replace your dials with Pelican UNIVERNIERS without otherwise altering your set.

**It does away with Vernier Condensers**

Simply buy good plain condensers and fit with Pelican Univernier dials. The Pelican Univernier will make the finest receiver 100% more selective. The large single knob gives continuous 12 to 1 or alternatively direct control at will. The 12 to 1 ratio is proved the most efficient for selective control.

**Pelican UNIVERNIER complete, 6/-**  
at your dealer or post paid on receipt of P.O.

**PELL CAHILL & CO., LTD.,**

**64, NEWMAN STREET,  
LONDON, W.1.**

Telephone—  
Museum 9236.

Telegrams—  
"Pelcarad, Wesdo, London."

# Information Department

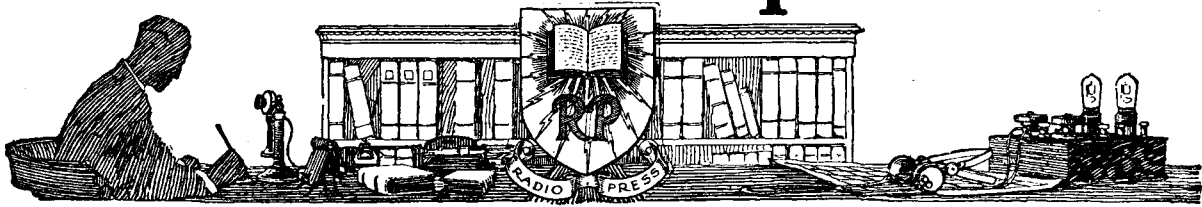

**F. C. (MAYFIELD)** states that he constructed the 4-valve Family receiver, described by Mr. Harris in Radio Press Envelope No. 2, some six months ago, and on completion received London, Chelmsford, and other British and Continental stations at good loud-speaker strength. He now finds that he is able to receive only London and Chelmsford at satisfactory loud-speaker strength, whilst other stations which he previously received on the loud-speaker are now only heard on the telephones, and often accompanied by crackling noises. He is certain that the accumulator is fully charged and the high-tension battery has been replaced by a new one. He asks whether we think that the set has developed some internal fault.

The symptoms given in our

correspondent's letter are those normally observed at this time of the year, and do not necessarily indicate that anything is wrong with the receiver. During the summer months reception conditions are usually considerably poorer than in the winter, when the evenings are darker. It is by no means unusual for a set which in the dark winter evenings satisfactorily received distant stations on the loud-speaker to give the same stations only at telephone strength during conditions such as are at present prevailing. The crackling noises are probably "atmospherics," which are to be expected during the summer months. If when aerial and earth are disconnected the crackling disappears, "atmospherics" are most certainly the cause of the trouble.

Some improvement may often be

effected if attention is paid to the aerial and earth system. For distant reception absence of screening is the main consideration, combined with a really efficient earth system. Steps should therefore be taken, where the aerial is low and screened, to increase the height if possible. The earth, if located in dry soil, should be periodically soaked with water and kept moist. Such treatment will often result in improved reception.

**C. T. A. (BOURNEMOUTH)** asks for a circuit diagram of a 2-valve set, employing a separate high-tension supply to each valve, with a switching arrangement so that one or two valves may be used at will. He has available a double-pole 2-way switch, a low-frequency transformer and two valves, one of ordinary general purpose type



## Chopping sticks with a razor

To put a good thing to a purpose for which it's not designed—that's supposed to be the essence of amateurism and bohemianism. Picturesque it may be; but hardly efficient and not inexpensive. There's no room in radio for the cheerful hit or miss of your bohemian. Here all must be delicate precision. Everything in its own place. Everything to its own job.

So for efficiency of contact you must have the Plugsocket CLIX. For contact is its job. And here CLIX excels.

The plug of one CLIX smoothly slips into the socket of the next CLIX or CLIX Adapter—and there is firmly held, with full surface contact. That's the CLIX secret. Simple? But it's withheld from every kind of switch, plug or terminal but CLIX.

### PRICES OF THE NEW CLIX

- CLIX with Locknut 3d.
- CLIX Adapter with Locknut 2d.
- CLIX Insulators (6 colours) 1d. each
- CLIX Bushes (6 colours) 1d. pair

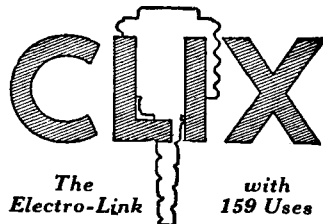

**AUTOVEYORS LTD., 84 Victoria St., LONDON, S.W.1**

## RADIO TANGENT

FITMENTS

Speech very very loud and very very clear, while the Transmission of music enchants the critical. No strain—you listen with pleasure. All with Loud Speaker on Two Valves. Try it on Daventry—even 100 miles away.

THE "TANGENT" TYPE "D" RADIOMATIC 2 VALVE.

Price—£7 0 0

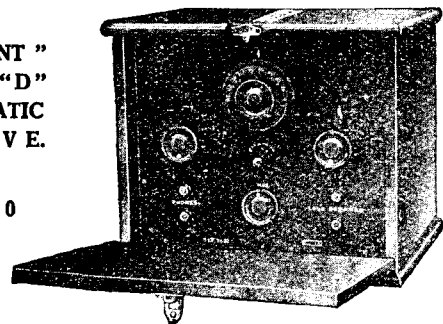

All gadgets completely enclosed. Not an eyesore—an ornament to your room.

So simple it is—a child can use it.

If not in stock, all good dealers can obtain by return—Insist on "Tangent."

**TANGENT & CO., LTD.,** Est. 1872. Faraday Wks., LEICESTER.

London: 25, Victoria Street, S.W.1.  
Newcastle/Tyne: "Tangent House," Blackett St.

and the other a small power valve, both having a similar filament rating, all of which he wishes to use.

A set fulfilling our correspondent's requirements was described in

cluded in the plate circuit of the detector valve, whilst the appropriate high tension for this valve is applied through the terminal marked H.T.+1. With the switch in position 2 the telephones are

it should be switched off by its own filament rheostat. Transformer coupling is employed and provision is made for grid bias so that the power valve may be used in the last stage with suitable values of high tension and grid bias.

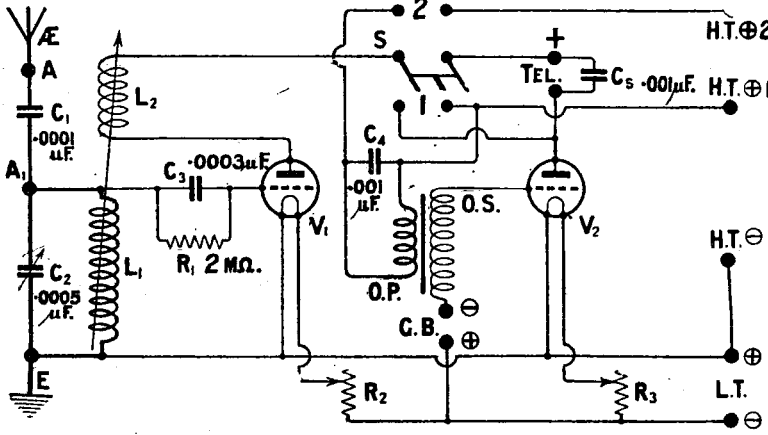

By means of the switch shown in the diagram either one or two valves may be used without disturbing the separate H.T. battery tapplings.—C.T.A. (Bournemouth).

Wireless Weekly, Vol. 6, No. 5, and we reproduce here the circuit employed. The switching arrangement adopted is a very useful one, and reference to the diagram will show that when the switch is in position 1 the telephones are in-

transferred to the plate circuit of the second valve, the detector valve still receiving the same high-tension voltage as previously, whilst the low-frequency valve is supplied through the H.T. + 2 terminal. When the last valve is not in use

E. G. G. (TONBRIDGE) has a 2-valve receiver using a loose-coupled circuit, with reaction on to the secondary, a detector, and one stage of low frequency amplification using transformer coupling. Until recently the set has been giving excellent results, being almost loud enough to work a loud-speaker on the London station, and giving most of the other British broadcasting stations on telephones. No signals can now be received, and all that is heard is a ticking noise, varying with reaction setting, etc. Our reader wishes us to tell him where the trouble is located.

With a set which has been working correctly and suddenly ceases to give signals, a ticking noise only being obtained, the trouble is usually located in the detector valve circuit and most often in the grid leak, which should be changed, when we think the trouble will disappear.

## A New Radio Press Handbook

Messrs. Radio Press, Ltd., wish to announce the publication on SEPTEMBER 1st of

# “RADIO ENGINEERING”

by J. H. REYNER, B.Sc (Hons.),  
A.C.G.I., D.I.C., Staff Editor of “Wireless Weekly,” “Modern Wireless” and “The Wireless Constructor.”

This book will fill a gap in Radio literature. It is a remarkable collection of data on every phase of radio engineering, giving information hitherto unpublished in book form. The book is in nine sections under the following headings:—

Radio Calculations and Measurements, Tuning and Radiation, Thermionic Valves, Radio Transmitters,

Radio Receiving Apparatus, Designs of Masts and Aerials, Telegraphy and Telephony, Miscellaneous.

There are, in addition, 196 pages of general mathematical, electrical and physical tables. The whole book, comprising 484 pages, 324 illustrations, and 111 tables, will prove invaluable to the serious experimenter.

**A COMPLETE REFERENCE LIBRARY FOR 15/-**  
**TO BE PUBLISHED ON SEPTEMBER 1st. ORDER**  
**YOUR COPY NOW and SECURE EARLY DELIVERY**

Radio Press, Ltd.,  
Sales Dept.,  
ENGINEERING, price 15/- (15/- post free)  
for which I enclose remittance of  
(Name).....  
Address.....  
ADVANCE ORDER FORM  
copies of “RADIO”



### "The Family Set"

The Family Four-Valve Receiver is the set for the man who desires to build something which will give good results even when operated by inexperienced hands. Such a set is of great value in every house where there is a family, where many people may have occasion to manipulate the same set in one day. The Family Four-Valve Set will give you good loud-speaker results from the local station. All the B.B.C. Stations and many continental ones are easily heard, usually at sufficient strength to operate a loud speaker.

These results are obtainable with an aerial of average efficiency. Under favourable conditions, and with reasonably efficient aerial and earth, American broadcasting can be frequently heard. The set can be used with one, two, three, or four valves, thereby saving filament current when the loud-speaker is not required.

ASK FOR RADIO PRESS ENVELOPE No. 2

Obtainable from all Bookstalls, Newsagents, your local Wireless Dealer or direct from Dept. S.

**Radio Press, Ltd.,**  
**Bush House, Strand, London, W.C. 2.**



#### Radio Press Envelope No. 2.

"How to make the Family Four-Valve Receiver," by Percy W. Harris, M.I.R.E., Editor of "The Wireless Constructor," Assistant Editor of "Wireless Weekly," and of "Modern Wireless," contains all the instructions needed in building this set.

The contents include two full-sized blue prints, twelve pages of working instructions, four pages of working drawings, three sheets of reproductions of photographs printed on special art paper, list of components required, hints on their selection, full instruction on soldering and wiring and many other hints.

**2/6** Post free **2/9**

12-04

365	4400	05
5	365	17
	750	10
	130	5
	2000	40
	1925	



"I hear it's  
very good"

# STERLING BABY LOUD SPEAKER

The most popular of all junior loud speakers. Gives ample volume for all usual requirements and a reproduction that is consistently faithful and pleasing in tone. In black enamel or in a particularly attractive brown tinted finish. At all dealers. PRICE 50/-



Announcement of **STERLING TELEPHONE & ELECTRIC CO., LTD.**, Manufacturers of Telephones and Radio Apparatus, etc.  
210-212, TOTTENHAM COURT ROAD, LONDON, W.1 Works: DAGENHAM, ESSEX

Printed for the Proprietors, RADIO PRESS, LTD., of Bush House, Strand, W.C.2 by THE AVENUE PRESS (L. Upcott Gill & Son, Ltd.), 55-57, Drury Lane, W.C.2 and Published by the Proprietors, RADIO PRESS, LTD., at Bush House, Strand, W.C.2, on Wednesday of each week. Address for Subscriptions and Editorial Communications:—Bush House, Strand, London, W.C. Advertisement Managers:—BARCLAYS ADVERTISING LTD, Bush House, Strand, London, W.C. Registered as a newspaper and for transmission by Canadian Magazine Post. Subscription rates:—32/6 per annum, 16/3 for six months, post free. Sole Agents for Australasia:—GORDON & GOUGH (AUSTRALASIA) LTD. For Canada:—IMPERIAL NEWS, LTD. For South Africa:—CENTRAL NEWS AGENCY, LTD For India:—SALE & FRAZER LTD



# Wireless Weekly

Vol. 6. No. 19.

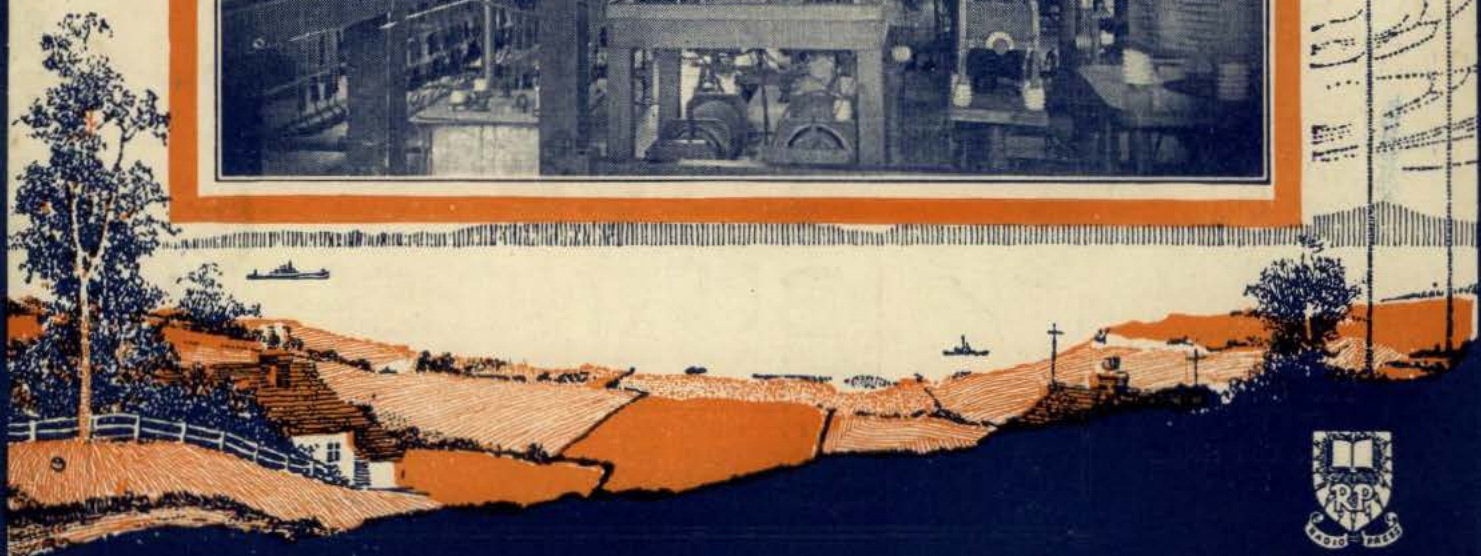



**Burndept  
Multi-Layer Coils.**

Prices from 5/- to 24/-  
Set of 9 Burndept Coils  
for all wavelengths  
from about 750 to  
25,000 metres, £3 16 6

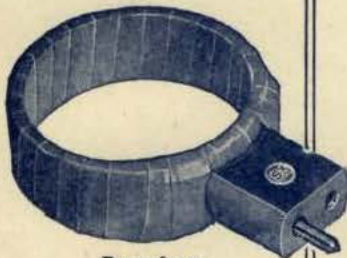

**Burndept  
Single Layer Coils.**

Set of 4 "Extra Short  
Wave" Coils (80-  
150 metres),  
16/- per set.  
Set of 4 Burndept  
"Concert Coils" (150-  
800 metres),  
16/- per set.  
Prices of single coils  
obtainable on request.

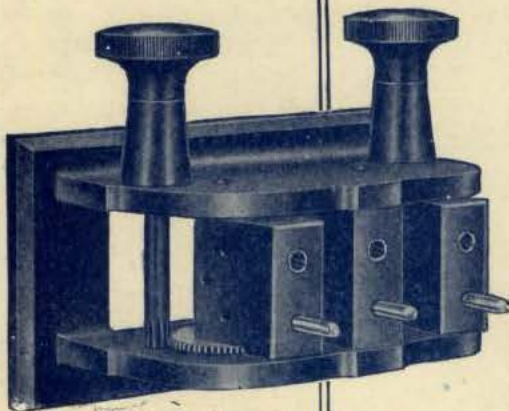

**Burndept  
Coil Holders.**

Two Coil Holder,  
15/-  
Three Coil Holder,  
20/-

# Burndept Coils and Coil Holders will add efficiency to your set

**T**O obtain best results from your wireless set, really efficient coils are absolutely necessary. Burndept Coils are thoroughly reliable, as they are correct in every detail. The special construction of the multi-layer coils provides for ample air space between each layer, thus reducing distributed capacity to a minimum. All Burndept coils are carefully wrapped to protect the windings from damage. They are mounted on non-reversible plugs fitted with spring contact pins. Burndept coils cover all wavelengths from 80 metres upwards.

Good coils should be used in well-designed coil holders. Burndept Coil Holders have a distinct appearance which cannot be mistaken. They are moulded in solid bakelite, highly polished and beautifully finished. The moving coils are operated through a concealed 5 to 1 gear, giving a smooth action and rendering vernier adjustment of the coils a simple matter. Burndept Coil Holders can be easily mounted. All wiring is well away from the hands and is concealed.

Whatever you buy from Burndept bears the guarantee which ensures satisfaction and free replacement or repair should any fault develop within twelve months of purchase. *The Burndept range includes everything for radio reception, from components to complete installations.*

Look out for the Burndept Super Valve, on sale very shortly.

# BURNDEPT

## WIRELESS LIMITED

HEAD OFFICE : Aldine House, Bedford Street, Strand, London, W.C.2

Telephone : Gerrard 9072. Telegrams : "Burndept, Westrand, London."  
BRANCHES at Birmingham, Brighton, Bristol, Cardiff, Exeter, Glasgow,  
Leeds, Manchester, Newcastle, Northampton and Nottingham.

**Assistant Editor :**  
 PERCY W. HARRIS,  
 M.I.R.E.

**Scientific Adviser :**  
 Prof. G. W. O. HOWE,  
 D.Sc., M.I.E.E.

**Advisory Editors :**  
 Prof. R. WHIDDINGTON,  
 M.A., D.Sc.  
 Prof. C. L. FORTESCUE,  
 M.A., M.I.E.E.

# Wireless Weekly

**Staff Editors:**  
 E. H. CHAPMAN,  
 M.A., D.Sc.  
 A. D. COWPER, M.Sc.  
 R. W. HALLOWS, M.A.  
 G. P. KENDALL, B.Sc.  
 A. JOHNSON - RANDALL,  
 STANLEY G. RATTEE,  
 M.I.R.E.  
 J. H. REYNER, B.Sc.,  
 A.C.C.I., D.I.C.

Phone: City, 9911.

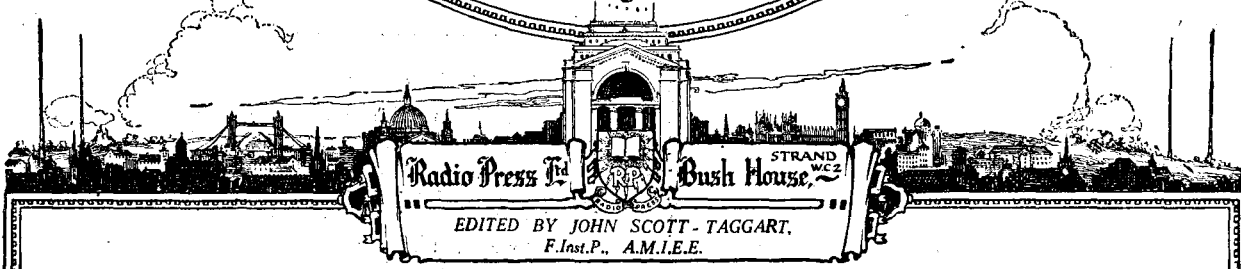

## The B.B.C. and Summer Radio

**G**OOD designs for portable sets, a number of excellent commercial models, and, above all, a wonderful summer, have combined to make "outdoor wireless" more popular than ever before in the history of broadcasting. This popularity, however, is far less than it should be, having regard to the technical progress that has been made in the art, and it is well, now that we are in the midst of a holiday season, to look into the reasons for this situation.

A careful consideration of the problem shows that the British Broadcasting Company, more than any other factor, is to blame. How many motorists carry a portable set with them? Put the question to the average owner who has tried a portable set on holiday and he will tell you the results are most disappointing. The disappointment does not come from lack of strength of signals, for it is comparatively easy to obtain good volume. The complaint is not on the score of lack of purity, for both sets and the transmission itself are good in this respect. The trouble is simply that the most interesting parts of the B.B.C. programmes start much too late.

Unquestionably, Saturdays and Sundays are the days when portable sets are most likely to be used in the countryside. Sunday, in fact, is often the only

day in which the busy man can enjoy a quiet picnic. During the first part of the afternoon he will probably be travelling, and at half-past four or five he will perhaps draw away from the busy road to find some sheltered and secluded spot for tea. At five or five-thirty the portable set will be unpacked and a tempor-

ary aerial rigged. Batteries are connected, the valves light, and the family waits expectantly. The result? Nothing! All the B.B.C. stations are shut down between five-thirty and eight-thirty p.m., and before eight-thirty he will be on the way home.

Temporarily, the portable set user. Take, for example, the London programme for Saturday, July 11. At four o'clock there was a short concert, after which we had, following one another, a talk by Dr. Josiah Oldfield, a "Garden Chat" by Marion Cran, F.R.H.S., the Children's Corner, a little play by the pupils of Kelvin House School, Ruislip, Children's Letters, and from six-forty to seven a little music. After the time signal from Big Ben at seven, came the weather forecast and the first general news bulletin, followed by a talk on Stockholm by Mrs. Hugh Spender. Not till seven twenty-five did we get "music," while at seven-forty there was a talk on "Small Craft" by Mr. W. H. Johnson.

All these items are, no doubt, excellent in their special way, but such a programme, quite typical of a Saturday afternoon transmission, is of little use to the owner of a portable set. The enjoyment of wireless away from home can never become popular while such items are the rule.

CONTENTS.	
	Page
The Effect of Valve Capacities on Self Oscillation ..	590
Some Selective Coupling Devices Broadcasting from KFI ..	593
Some further Notes on Straight-Line Frequency Condensers ..	596
Jottings by the Way ..	597
What I saw in American Research Laboratories ..	600
The Nature of Fading ..	602
Wireless News in Brief ..	605
The Ongar Station ..	607
Random Technicalities ..	608
Inventions and Developments ..	614
Correspondence ..	616
Apparatus We Have Tested ..	617
Information Dept. ..	620
	623

ary aerial rigged. Batteries are connected, the valves light, and the family waits expectantly. The result? Nothing! All the B.B.C. stations are shut down between five-thirty and eight-thirty p.m., and before eight-thirty he will be on the way home.

In the early days of the British Broadcasting Company, when limitations of staff and

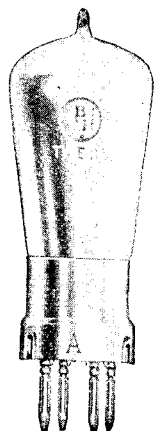

A low consumption valve, the B.T.H. B5.

# The Effect of Valve Capacities on Self-Oscillation

By J. H. REYNER, B.Sc. (Hons.), A.C.G.I., D.I.C., Staff Editor.

**SUMMARY:**—The theory of regeneration through the inter-electrode capacities of a valve is investigated, and it is shown that, at ordinary radio frequencies, capacity reaction only has a small effect in a circuit which already contains magnetic reaction.

At very high frequencies, however, the capacity reaction predominates, and under certain conditions oscillation will be produced even with the magnetic reaction in the wrong direction.

The conditions are analysed for the two possible cases, one where oscillation is required, and the other where it is undesirable, as in a high-frequency amplifier, and it is shown that the effects are quite different and distinct.

In last week's issue of *Wireless Weekly* (Vol. 6, No. 18) the theory of self-oscillation was discussed for the case of a valve employing magnetic reaction, and it was shown that there are certain definite conditions governing the value of the coupling required between the grid and anode circuits of the valve. It was further



One of the Mullard dull-emitter valves.

shown that the value of the coupling was dependent on the type of valve employed, so that certain valves would oscillate more readily than others.

## Other Forms of Coupling

Apart from the simple cases of magnetic coupling considered in that article, however, there are other methods of producing the necessary feedback or regeneration. The coils may be direct-coupled as in the well-known Hartley circuit (Fig. 1), in which case the problem may be treated by a simple modification of the magnetically coupled case.

Another very important form of coupling, however, is the electrostatic feedback produced by connecting a condenser between the anode and grid of the valve. This is a much more complicated case to deal with.

## Two Possible Conditions

There are, in practice, two quite distinct propositions to be considered. The first is the case

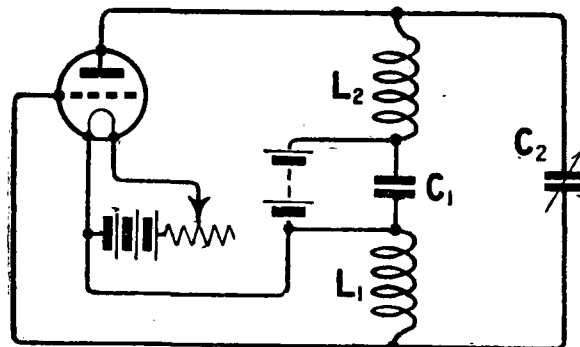

Fig. 1.—The Hartley circuit—an example of a direct-coupled oscillator.

where the circuit is required to oscillate and is actually assisted to do so, while the second is the case where oscillation is undesirable. This latter condition, of course, is that obtaining in a high-frequency amplifier, where the chief difficulty is to prevent the oscillations.

The two cases are somewhat different and will be considered separately. We will first analyse the case where oscillations are desirable.

## Capacity Coupled Oscillators

Consider a circuit such as is shown in Fig. 2. Here there is a tuned circuit in the anode circuit of the valve, and a coil  $L_1$  in the grid circuit. Connected between the anode and grid of the valve is a capacity  $C_1$ .

Now if the circuit  $L_2C_2$  is set in oscillation, the voltage on the anode of the valve will vary in accordance with the oscillations. There will thus be a voltage applied across the condenser  $C_1$  and the inductance  $L_1$  in series.

*This article should be read in conjunction with the article on "Why one valve oscillates more easily than another," in last week's issue.*

This voltage will divide into two portions, one across  $C_1$  and the other across  $L_1$ . This latter voltage will cause variations of grid potential, which will set up variations of anode current, and provided that certain conditions are fulfilled these anode currents will be in such a direction as to maintain the oscillations in the circuit  $L_2C_2$ .

It is thus not necessary for the coils  $L_1$  and  $L_2$  to be coupled magnetically in order for the oscillations to be continuously maintained.

It is simply necessary for the voltages produced across  $L_1$  to be in the correct direction and of sufficient magnitude.

**Conditions for Self-Oscillation**

In the case just considered, the conditions required to produce oscillation are as follow:—

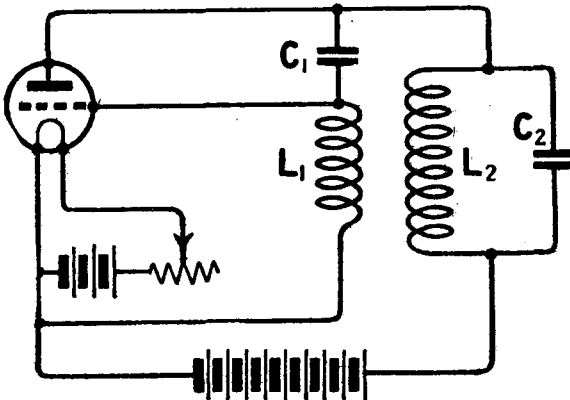

**Fig. 2.—A capacity coupled oscillator circuit. The capacity coupling is provided by the condenser  $C_1$ , and the grid to plate capacity of the valve,  $L_1$  and  $L_2$  being arranged so as not to couple magnetically.**

(1) The circuit  $L_1C_1$  must be below resonance. If  $C_1$  is made sufficiently large, it will tune with  $L_1$  to the same frequency as that of the oscillating circuit  $L_2C_2$ . If this happens, no feedback will occur, and if this value is exceeded the oscillations will be damped out instead of being sustained, so that  $C_1$  must be kept small.

This is the upper limit of the capacity.

(2) The capacity  $C_1$  must be greater than a certain critical value. For the circuit shown in Fig. 2 this critical value is given by

$$\omega^2 C_1 = \frac{L_2 + C_2 R r_1}{P}$$

where  $R$  is the resistance of the oscillating circuit,

$r_1$  is the internal impedance of the valve,



**The Marconi general purpose bright emitter valve, type R.5.V.**

$P$  is a complex expression involving the amplification factor  $\mu$ ;

$$\omega = 2\pi \times \text{frequency.}$$

It will be seen that the expression is of the same form as that which was deduced last week for the mutual inductance required between the two coils  $L_1$  and  $L_2$  if they are magnetically coupled together.

It follows, therefore, that the capacity reaction required depends upon the valve characteristics in a similar manner to the magnetic reaction.

**Magnetic and Capacity Reaction Existing Together**

If the coils  $L_1$  and  $L_2$  are magnetically coupled and the condenser  $C_1$  is also connected in circuit, both forms of reaction will be obtained. The effect produced by the two reactions will be in the same direction, i.e., the capacity reaction will assist the magnetic reaction if

$$\omega^2 C_1 \text{ is less than } \frac{I}{L_1 - M}$$

**Inter-Electrode Capacities**

The capacity  $C_1$  may be the inherent capacity between the anode and grid of the valve. This



**The Mullard D.06 valve.**

capacity is very small, being of the order of  $10 \mu\mu\text{F}$ . Various types of valve have grid-anode capacities ranging from about  $5 \mu\mu\text{F}$  up to  $15 \mu\mu\text{F}$ , while the stray circuit capacities will

probably increase the effective capacity up to 20 or 25  $\mu\mu\text{F}$ .

This capacity, under normal conditions, is well below the limit given above, so that the capacity reaction would assist the magnetic reaction.

At ordinary radio frequencies (within the broadcast band) it will not, with normal circuits, be sufficient to produce oscillations by itself, although any undue increase in the inter-circuit capacities will readily bring this factor into prominence.

**Practical Example**

Consider a practical case of an oscillator such as Fig. 3 operating at 750 kc. (400 metres). The grid and anode coils are both 100  $\mu\text{H}$ , and the anode coil is tuned with a 500  $\mu\mu\text{F}$  condenser.

A mutual inductance of 20  $\mu\text{H}$  between the coupling coil and the grid coil will produce oscillation.

Then if the valve capacity  $C_m$  is to assist the magnetic reaction,  $C_m$  must be less than about 550  $\mu\mu\text{F}$ . The upper limit thus does not enter into the calculations.

On the other hand, the capacity required to produce self-oscillation without any magnetic reaction is 55  $\mu\mu\text{F}$ , so that the valve capacity alone is insufficient.

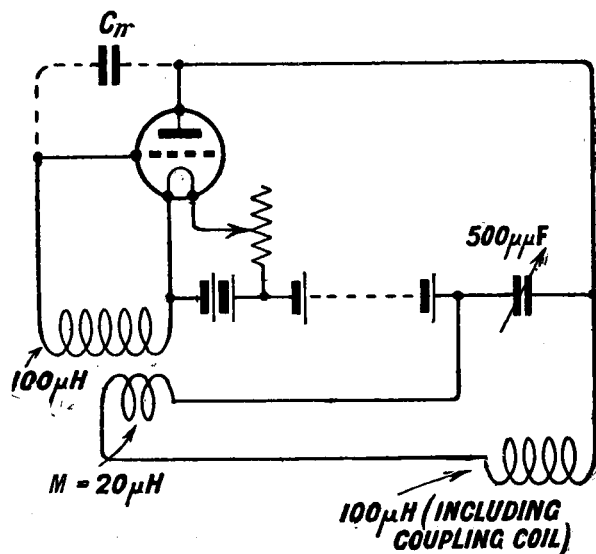

Fig. 3.—The practical form of oscillator circuit discussed in the text.

We see, therefore, that the magnetic coupling is assisted by capacity coupling, but is not overwhelmed thereby.

**Effect of Higher Frequencies**

If the tuning condenser is reduced to 125  $\mu\mu\text{F}$ , however, giving a frequency of 375 kc., the capacity coupling required is only 20  $\mu\mu\text{F}$ .

Hence at higher frequencies the valve will oscillate more readily, and at ultra-high frequencies the capacity reaction preponderates over the magnetic. At the same time the upper limit of  $C_m$  decreases rapidly as the frequency increases.

It may be remarked in passing that the high upper limit of  $C_m$  is solely due to the very small value of the grid inductance.

It will be seen later that if this value is increased considerably (as is often done in H.F. amplifier circuits), the upper limit of  $C_m$  becomes comparable with that of the valve itself.

E.g., if the grid coil was made 1,000  $\mu\text{H}$  instead of 100  $\mu\text{H}$ , the upper limit of  $C_m$  would be less than 50  $\mu\mu\text{F}$ .

**Tuned Grid Circuit**

If the grid circuit is tuned and the anode untuned, then it can be shown that the conditions for self-oscillation are similar to those with a tuned anode circuit.

Thus it will be seen that at ordinary broadcast frequencies the capacity reaction assists the magnetic reaction but is usually insufficient to cause oscillation by itself. As the frequency is

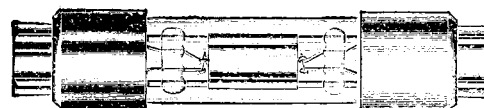

A low-capacity type of valve in which the grid and the plate leads are brought out at opposite ends.

increased, however, the capacity reaction preponderates, and at very high frequencies (short wavelengths) this factor becomes of the highest importance.

**Oscillations in Amplifiers**

We now come to the second of the two cases previously mentioned, that in which oscillation is not required. This condition arises in the case of a valve amplifier which is supplied with current at a certain frequency. In some cases it is found that self-oscillation occurs at the particular frequency which is supplied to the amplifier, and the set becomes unstable.

It can be shown that under certain conditions energy is fed back through the self-capacity of the valves employed, and this will produce continuous oscillation. The difference between this case and the case of self-oscillation should be noted carefully, as it is rather important.

**Not Free Oscillations**

In the case of a valve amplifier there is a certain energy being passed through the amplifier at a given frequency. Some of this energy may be fed back through the capacity of the valves and will so serve to increase the input. This process is cumulative, and the result is that the set oscillates at the frequency which is being supplied.

In the case of a valve having a tuned circuit connected thereto, however, free oscillations occur in the tuned circuit and feedback will occur at the frequency of such oscillations, provided the capacity coupling is small enough.

In the latter case, however, self-oscillation will not occur unless the value of the capacity exceeds a certain critical value, in order that the losses in the oscillating circuit may be made up

(Concluded on page 595.)

# SOME SELECTIVE COUPLING DEVICES

By A. D. COWPER, M.Sc., Staff Editor.

With the advent of more broadcasting stations in the already well occupied broadcasting band it becomes increasingly important to aim at selectivity in receiving sets. There are two aspects of the question with which Mr. Cowper deals, and practical suggestions are given.

WHILST it is now a comparatively easy matter to obtain a high degree of *special* selectivity, i.e., selectivity directed solely towards the elimination of a single unwanted station on one wavelength, by means of a series-acceptor trap of low-loss design arranged across a semi-aperiodic aerial primary inductance, and also

of coupling to make it worth while to pass on the suggestions to the serious experimenter, who will find in this field wide opportunities for interesting experiment. There is generally ample material to work on, in the way of local interference; in default of this it is an easy matter to fit up a buzzer-activated interference circuit close to the receiver, coupled with the aerial lead-in, but shielded from direct action on tuned secondary circuits.

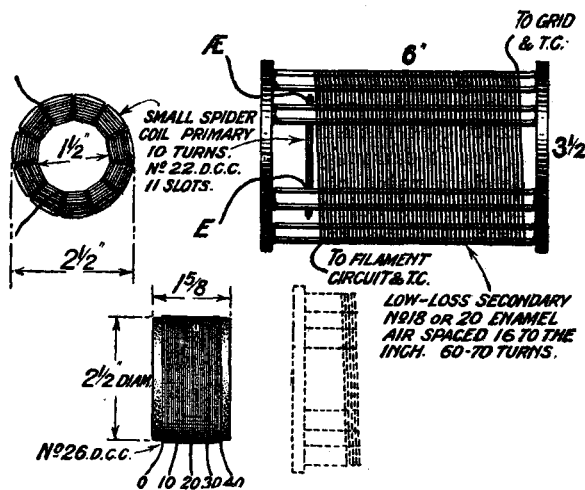

Fig. 1.—Practical details of a selective aerial coupling. An alternative tapped primary coil is shown below.

a degree of *general* selectivity sufficient to separate distant stations which are more than the usual limit of approximately 10 kilocycles apart, the problem of obtaining that degree of *general* selectivity which will also permit of tuning out a loud local station (when used with an effective outside aerial), so that distant telephony stations can be listened to with any degree of comfort and enjoyment under favourable circumstances, is of a very different order.

## Local Interference

In an endeavour to achieve this feat under conditions of very severe local interference, the writer has been carrying out a number of experiments with various types of selective loose couplings, and with arrangements in which an attempt has been made to eliminate largely the direct capacitative coupling that is found to be quite serious under such conditions. Whilst the problem set is not yet completely solved (i.e., the reception of Cardiff at good loud-speaker strength 13 miles from the London station without any interference from 2LO), a sufficient degree of selectivity is yielded by these methods

## Aerial Couplings

For maximum *signal strength* the optimum arrangement was found by the writer (*Wireless Weekly*, Vol. 6, Nos. 11 and 12) to be a combination of a low-loss secondary, tuned by a small parallel capacity, with a fairly loose-coupled "semi-aperiodic" primary, i.e., a primary which is only roughly tuned by tapping points every five or ten turns, and not of any particular "low-loss" design. The natural frequency of the resulting aerial circuit had to be adjusted to a little higher than the frequency of reception for best results. If too exactly tuned, reaction requirements became prohibitive.

## Maximum Selectivity

For maximum *selectivity*, however, an even roughly tuned aerial brings in so much signal energy over a fairly wide belt, that a weak distant station has no chance at all, on account of shock excitation, with a loud local station on

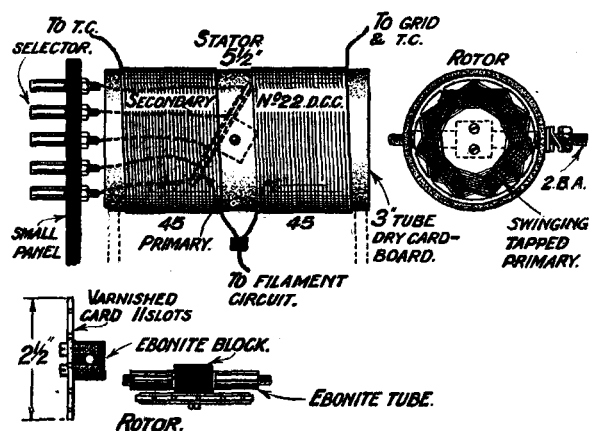

Fig. 2.—Illustrating the filter circuit coupling suggested by the author.

an adjacent wavelength. We must accept here an inevitable weakening of the signals, and detune the aerial so considerably that the local

interference does not reach this stage of strong shock excitation at all, and trust to making up in the amplifying circuits what we lose here in signal strength.

**Eliminating Capacity Coupling**

A suggestion is therefore given (Fig. 1) for a very small, "aperiodic" aerial coil, arranged so as to give loose-coupling to a low-loss secondary, and in particular to avoid, as far as possible, casual capacity couplings with the aerial. A purely magnetic coupling is aimed at (as in another circuit suggested by the writer in *Wireless Weekly*, Vol. 6, No. 14). Either a small spider-coil (a very narrow basket-coil wound on a slotted cardboard former of small size) may be used, inserted in the filament circuit end of the secondary tuning inductance, or else a small tapped solenoid, which need not be of a low-resistance type, arranged to slide backwards and forwards or to rotate at a distance of a couple of inches from the lower end of the same inductance. In the first case there is only the stray capacity effect between the edge of the narrow coil and the first few turns of the grid inductance on the filament side; in the latter case the capacity coupling is also a minimum, and some choice is available as to degree of magnetic coupling.

**Reducing Grid-Damping**

In order to reduce as far as possible the natural damping of this first grid circuit, a definite negative grid-bias should be given by a small grid-cell bridged for H.F. by a large fixed condenser. The writer has pointed out recently the relatively enormous effect of this in reducing natural grid-

damping, particularly when (as in this case) a small inductance is the sole load in the anode circuit.

**Intervalve Filter-Circuit Coupling**

Here very great care must be taken; firstly, to eliminate all direct magnetic back-coupling with the A.T.I., etc.; secondly, to minimise direct, aperiodic, capacitive coupling between the anode and the subsequent detector valve. The first is effected practically by very careful spacing of components and wiring: short leads direct to the inductances, and arrangement of the latter precisely at right angles (rather than at the conventional "neutralising angle" of around 60 degrees, which varies with every inductance), and in the form of a T in the same plane. For the same reason the second grid circuit tuning condenser should be mounted well away from the first.

**Sacrificing Signal-Strength for Selectivity**

At a sacrifice of something like one-half the available signal voltage, the second valve is tapped across only one-half its tuning inductance. The author has recently drawn attention to the high degree of damping exerted on its grid circuit by a detector valve operating with leaky grid condenser in the normal way, amounting to the equivalent of some 50 to 60 ohms series H.F. resistance inserted in the grid circuit. By tapping across one-half the inductance, this damping is somewhat reduced, at the cost of signal strength it is true (as actual measurement brings out), but the primary of an oscillation transformer linking it with the anode of the preceding valve

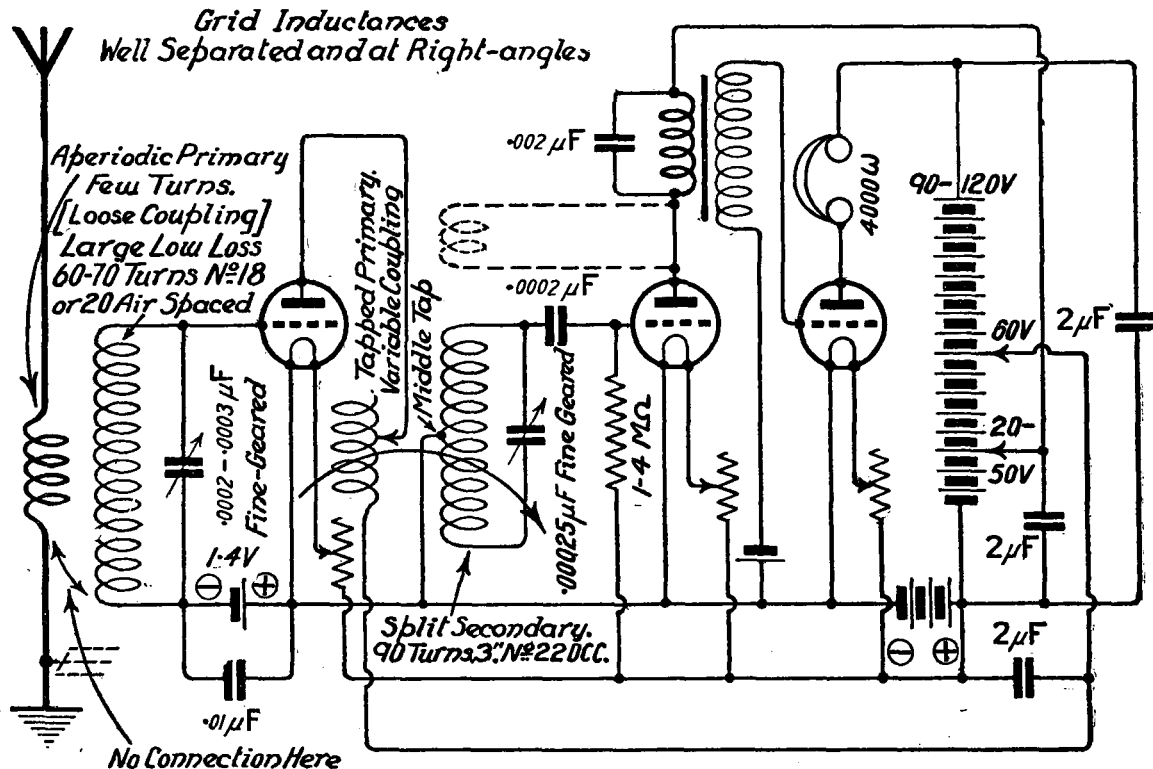

Fig. 3.—The circuit suggested by the author for extreme selectivity.



can now be arranged strictly symmetrically at the centre of the grid inductance, so eliminating almost completely the unwanted capacitive coupling.

### Eliminating the Local Station

The effectiveness of this heroic measure became apparent in actual trial; with full power of the local station applied to the first valve in a circuit as shown here, with the second grid inductance tuned to the same wavelength, but with the coupling primary coil at right angles so that the magnetic coupling was zero, the local station was reduced to a whisper in the 'phones.

### Compactness of Inductances

Fig. 2 gives a suggestion for practical construction of the coupler. A split secondary winding of 90 turns of No. 22 d.c.c. on a 3-in. dry cardboard tube, and a very small 85-turn spider-coil primary tapped at Nos. 30, 40, 50, 60, 70 and 85, to give the necessary range for the short broadcast waves, pivoted precisely in the centre of the former inductance, the tapings being connected to a selector device (made up of well-spaced valve sockets) on a small panel at one end. Switches of ordinary types should be avoided in such circuits. Since the damping effect of the valve is always present, and compactness in this inductance is very important to avoid casual magnetic couplings, there is no great advantage in making this secondary inductance of the ultra-low-loss type. The high turns-number is implied by the weakening of the coupling in the split

### THE EFFECT OF VALVE CAPACITIES ON SELF-OSCILLATION.

(Concluded from page 592).

so that there are two conditions to be complied with.

In the case of an amplifier, on the other hand, the only condition is that the capacity shall be less than a certain value, in order that the voltages produced across the grid coil may be in the right direction.

### Constant Input

This will be more readily understood when it is remembered that the input to an amplifier is approximately constant. Hence the smallest amount of feedback will make the input bigger than it was before, and this will cause increased regeneration, so that the effect is cumulative and self-oscillation is produced.

In the case of an oscillating circuit, there is a certain loss at each oscillation. Unless the feedback is sufficient to overcome this, each succeeding oscillation will not be bigger than it was before, and the oscillations will, in time, die away.

### Spurious Oscillations

This does not mean that free oscillations cannot occur in a high-frequency amplifier, but

winding, and the reduced casual capacity effect; as shown, the coupler covers from some 200 metres (1,499 kc.) up to well over 500 metres (599.6 kc.), with a low-minimum .00025  $\mu$ F tuning condenser.

### Practical Ultra-Selective Circuit

Fig. 3 indicates a type of extremely selective circuit utilising such coupling devices. This is quite a practical circuit for specially selective work, though not advisable for ordinary family broadcast reception. Spacing and arrangement is all-important, if the high standard is to be maintained. Reaction control is by varying the tapings and coupling in the oscillation transformer alone, though the setting will naturally depend on the aerial coupling. Magnetic reaction from a small coil in the detector valve anode circuit on this intervalve coupling might also be tried.

### Actual Results

On trial, under the extreme conditions of interference indicated above, Petit Parisien and adjacent relay stations came in at nearly L.S. strength on the three R valves, without 2LO, and Bournemouth at good L.S. strength, free from London. Cardiff and Manchester could be read, but not in comfort. The "general" selectivity was, of course, of a very high order; control was decidedly tricky, and a wavemeter was almost essential in handling it. It is given here mainly as a specific suggestion for experiments in ultra-selectivity by loose coupling.



such oscillations will, in general, be due to stray circuit and coil capacities, and will not, as a rule, be at the same frequency as the incoming signal.

Such oscillations will be governed by the laws just stated, whereas the regeneration at the signal frequency is controlled by somewhat different conditions.

### Conditions Necessary for Feedback

The condition for regeneration in an amplifier, therefore, is simply that the capacity shall be less than a certain value.

It is possible to examine all the possible types of circuit and to find out what the critical value is in each case, and this will be done later in a continuation of this article.

It will be found that there are only four cases in which feedback is possible, and that for three of these the conditions to be fulfilled are the same.

It will further be shown that the effect of the capacity is quite different from what it is generally supposed to be, and these points will be illustrated by numerical examples.

[In a subsequent issue Mr. Reyner will give a further article on this subject, in which he will discuss typical circuits.—Ed.]

# Broadcasting :: from KFI



**K**FI, which has grown since 1922 from a 50-watt home-made station into a 5-kw. super-station, is now located on the roof of the Packard Motor Car Building, Los Angeles.

Transmissions are carried out every night from 6.45 to 11 o'clock, and from 10 to 11 o'clock on Tuesday, Saturday and Sunday nights (local time) special programmes are given.

Three separate rooms are needed to house the control, generator and transmitting equip-

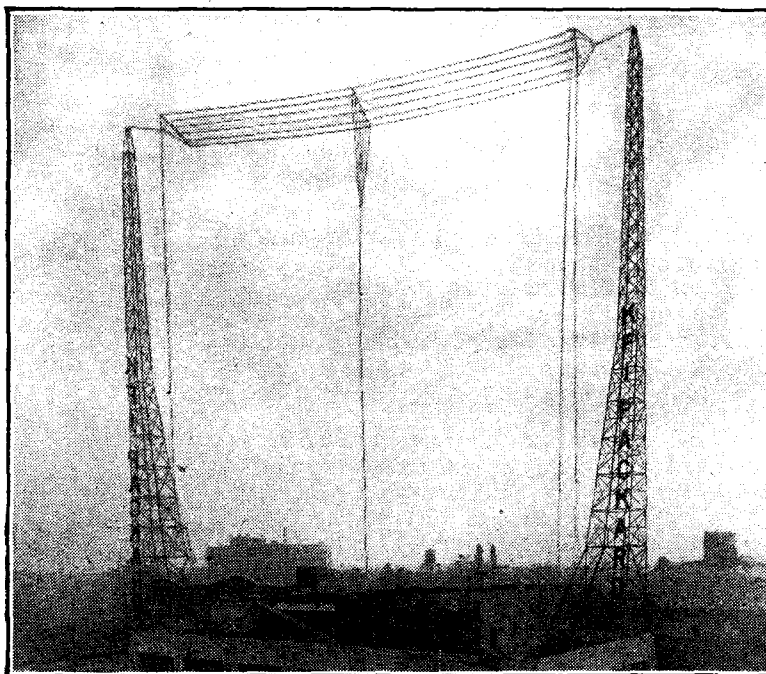

*Top — The six-wire T-type aerial in use at KFI.*

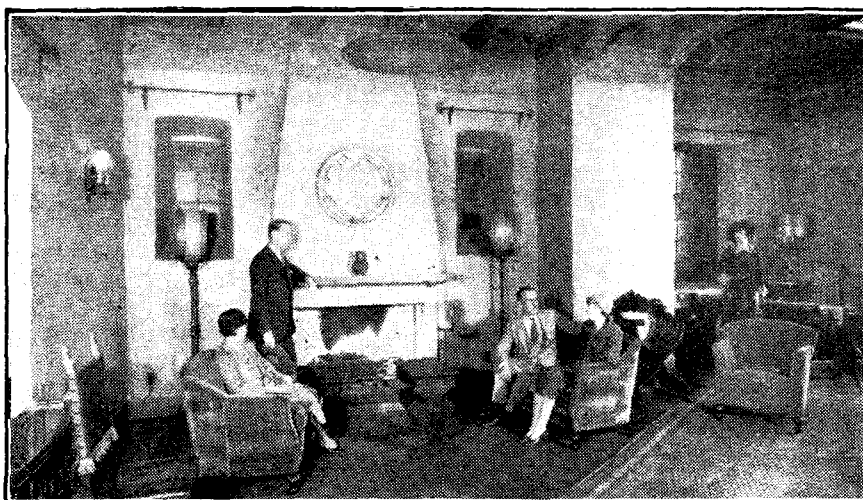

*Centre — The reception or waiting room provided for the convenience of the artists. Note the Western Electric cone-type loud-speaker suspended from the ceiling.*

*Below — The operator at the control panel. The transmitter is seen in the background.*

ment, a minimum of three operators being required.

The transmitter, 16 ft. long, 9 ft. wide and 7 ft. high, enclosed in a wire cage in the transmitter room, is made up of six units controlled from dials set in adjoining panels. Two 250-watt oscillator valves are used, a 50-watt speech amplifier, and two 250-watt modulator valves. The amplifier employs two water-cooled power valves, in which the glass is welded by a new process to a copper composition snout.

Three generators supply the current for the operation of the transmitter, a spare set being held in reserve in cases of emergency.

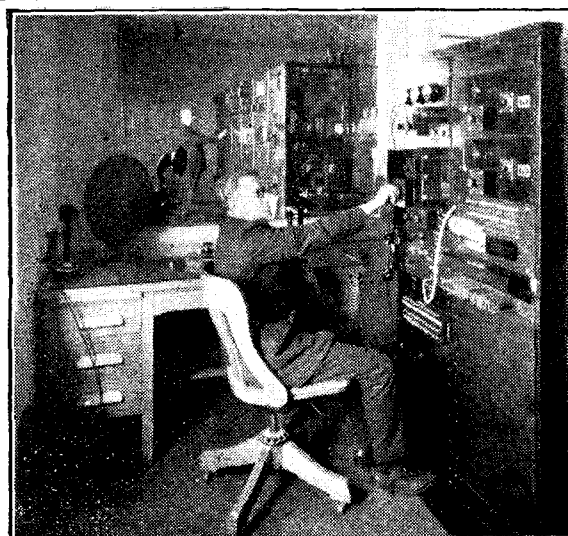

# Some Further Notes on Straight-Line Frequency Condensers

By SYLVAN HARRIS.

*The straight-line frequency condenser is becoming popular in America where the stations are allotted positions in the broadcast band on a frequency basis. In our issue of July 22 Mr. Sylvan Harris discussed the advantages of this type of condenser. Here he deals with some further points which have arisen in connection with its use in tuning radio circuits.*

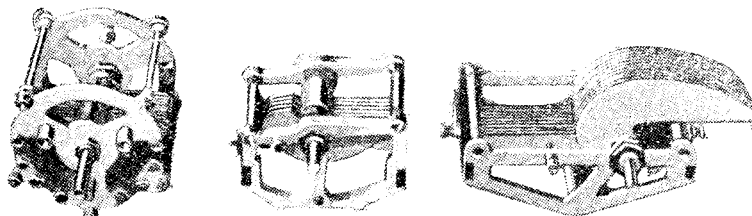
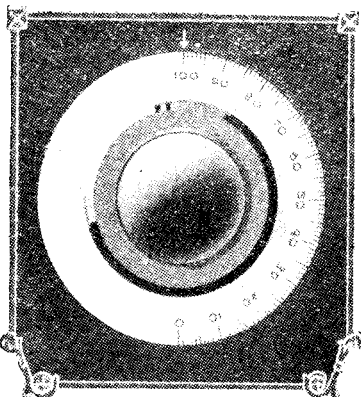

When the dial reading of the condenser is a maximum the position of the plates of the three types of condensers is shown on the right; reading from left to right these are: (i) circular plate, (ii) square law, (iii) straight-line frequency.

**I**N a recent issue of *Wireless Weekly* (July 22, Vol. 6, No. 16) a rather comprehensive article was presented on the straight-line frequency condenser, which explained various questions being raised as to its operation and advantages. In

straight-line frequency condenser, especially on its connection with the average user, the broadcast listener.

During the last year and the year previous we saw considerable confusion in the condenser situation, which was originally stirred up by the "low-loss engineers." Later on, there was

confusion in connection with the straight-line frequency condenser.

### Calibration

The main trouble will be, as far as I can discern the future, in getting the condensers to furnish the straight-line calibration which will undoubtedly be claimed for them. The question of the relations existing between the consumer and the manufacturer will enter here, and it is well to point out that the radio fan must not expect or demand too much.

### Minimum Capacity

Nearly all users of variable condensers in the past have insisted that the condensers have very low minimum capacities. Naturally, the manufacturers have given them what they asked for, regardless of whether or not they asked for the best thing. The fact is that the insistent radio fans decided that they wanted to cover the wide broadcast range in one step, without having to bother with tapped coils. It just simply *had* to be done—so it was done. It was done by making the minimum capacity as small as possible, so that the total capacity ratio of

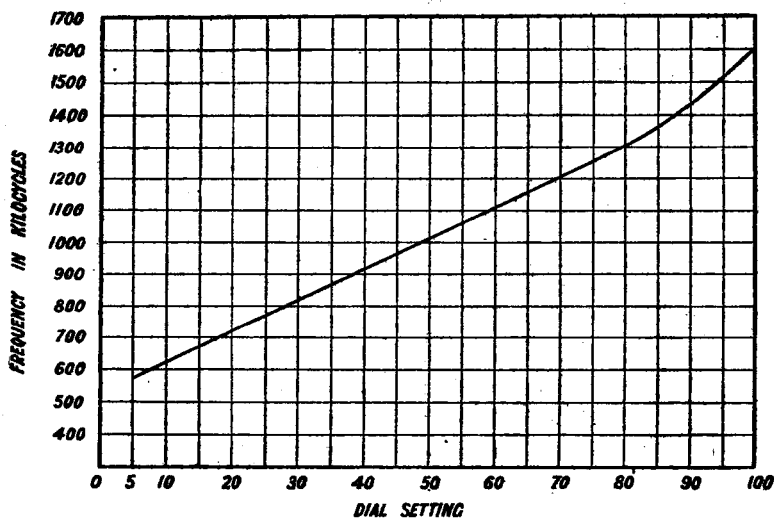

Fig. 1.—A calibration curve plotted by the author for a straight-line frequency condenser.

that article the principles only were discussed. In this article I will endeavour to talk in a somewhat general fashion on the

more confusion in connection with the straight-line wavelength type of condenser, and, it is very likely, this year we shall see more

the condenser should be as great as possible.

**A Difficulty**

The main point is that the radio fans will naturally continue to ask for low minimum capacities, and if the manufacturers attempt furnishing it they will not be able to build straight-line frequency condensers which will have a perfectly straight-line calibration.

In Fig. 1 we have the calibration curve of a straight-line frequency condenser recently measured by the writer. Over the greater part of the dial range the calibration is perfectly linear, but a microscope is not required to see the bend at the upper end of the curve. This is due to the efforts of the manufacturer to produce a straight-line frequency condenser with a very low minimum capacity.

**Crowding on the Dial**

A low minimum capacity could have been produced without destroying the straight-line characteristics of the condenser if the maximum capacity of the condenser had been small, but it was to the manufacturers' interest to make this a .0005 microfarad condenser, as this size is probably the best seller. It is for this reason that the calibration curve of the condenser shows the appreciable bend at the high dial settings.

But, at best, the curvature is not great enough to cause the user any alarm. The curve is certainly straighter throughout its whole length than the curve for a circular plate condenser; moreover, the curvature is so small that it will not produce any appreciable crowding on the dial.

**Incorrect Procedure**

I should like to call attention right here to the incorrectness of determining the straightness of the calibration curve by measuring the capacity at different dial settings, and then calculating the curve. This is the method that many experimenters will use, as a few have already done. It is incorrect for the reason that it does not take into consideration the operating conditions. A condenser is always used in combination with a coil and other associated apparatus. The capa-

city, inductance and resistance of the associated apparatus will have some influence on the operation of the condenser, so it is correct to make measurements only under the same conditions as apply in actual practice.

**Curve by Calculation**

If this method of measuring the capacity and calculating the curve is used, the calibration curve will generally *not* be a straight line. Take, for instance, the curve shown in this article. It is straight over its major portion. This curve was obtained by measuring the frequency of a driver exciting a circuit containing the condenser and a coil. The writer attempted to plot the curve by measuring the capacity and performing the cal-

such conditions, just in the same way as the resistance of a wire rises when its cross-section becomes very small. The tuning circuit of the radio receiver should be so designed that it is not necessary to tune so low on the condenser. This can be accomplished by using slightly larger condensers and slightly smaller coils. To tell the truth, the writer is more inclined to the .001  $\mu$ F condenser and the 100 microhenry coil, especially in the simple types of sets, than to the general practice of using very small condensers and large inductances. This is for two important reasons, *viz.*, the high resistance of large coils, and the high resistance of the condensers when the plates are almost all the way out.

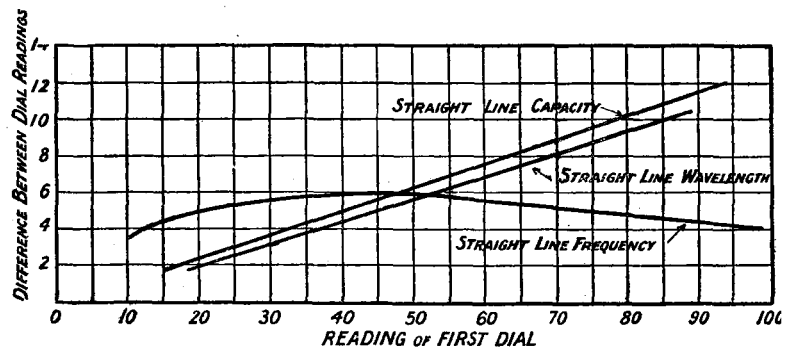

Fig. 2.—Curves showing the difference in the readings of the condensers tuning two H.F. stages, as the frequency is varied.

culations, and a decided curve resulted.

**Practical Aspects**

The radio fan must regard carefully the practical side of the question. Many straight-line frequency condensers will possibly be put on the market during the coming season which will have characteristics like this one. The slight curvature should not deter the radio fan from buying them or using them. Even with a slight curvature he will be surprised to find the relief that comes when tuning in the short-wave stations.

**H.F. Resistance at Low Dial Settings**

In a previous article I intimated that it is not well to tune on a variable condenser with the plates nearly all the way out. The reason for this is that the resistance of the condenser rises to relatively large values under

**A Disadvantage**

There is a point in connection with straight-line frequency condensers which may be of considerable interest. Although the writer has not yet made any measurements of the resistance of straight-line frequency condensers, he suspects that the resistance of this type may rise much more rapidly as the plates are turned out of mesh than does the resistance of the circular plate type. This is for the reason that the cross-section of conducting material in the plates is so much reduced in attaining the straight-line shape of plate. I have noticed the effect of this increase in resistance when using a straight-line frequency condenser in a regenerative receiver.

**Increased Resistance**

When the condenser plates were turned out about three-quarters of the way, it was found impossible to make the set oscillate

without either raising the plate voltage or adding turns to the reaction coil. This was probably due to the increased resistance of the tuning circuit, which was not changed excepting for the substitution of the straight-line frequency condenser for the circular type.

#### Dial Calibrations

A great deal of confusion may arise among the users of straight-line frequency condensers on account of their "left-handed" construction, as it might be called. Many will say that the dials read backward when used with this type of condenser. This is not so, because most of the manufacturers will design their condensers to open in such manner that the dials will read 100 when the plates are entirely out of mesh.

The reason for this is very easily understood with the aid of the illustrations in the heading. Here the three types of condensers are shown, set for a dial reading of 100. The number 100 is the maximum or largest number on the dial. Therefore, it is obvious that the conditions in the tuning circuit for which the condenser is particularly designed should also be maximum. This means that at 100 on the dial the capacity should be maximum for the straight-line capacity type, the wavelength should be maximum for the straight-line wavelength type, and the frequency should be maximum for the straight-line frequency type. In the last type, to obtain the highest or maximum frequency, the condenser plates should be all the way out of mesh.

#### Tuning Two Stages

We have now to consider how the straight-line frequency condenser acts in radio frequency amplifiers. Everyone is more or less acquainted with the way in which the settings of the dials change. Take any receiver, for example, which employs two stages of radio frequency amplification. We will not consider the condenser connected to the antenna coil, for the logging of this dial is influenced somewhat by the action of the primary connected to the aerial and earth. But if the H.F. transformers

tuned by the other two condensers are identical, and if these two condensers themselves are identical, they should log at identical points for all wavelengths.

#### Measurements

Nearly all of us know that this is not usually the case, generally because of differences in the inductances of the coil. Small differences in the capacities of the condensers would not, in most cases, account for the great difference in the dial readings. To investigate the matter a simple oscillator acting as a driver for a simple measuring

results are shown in Fig. 2, wherein the curves for the three different types of condensers are shown. To visualise this curve, the reader should think of the second and third dials of his three-dial tuner. The dial readings of one of the dials are shown at the bottom, and the differences between the dial readings are shown vertically at the left.

#### Greater Effect at Low Frequencies

Many have noticed that often the difference is at the long wavelengths, decreasing gradually as we turn the dials to the short wavelengths. This is the case shown by the curve marked

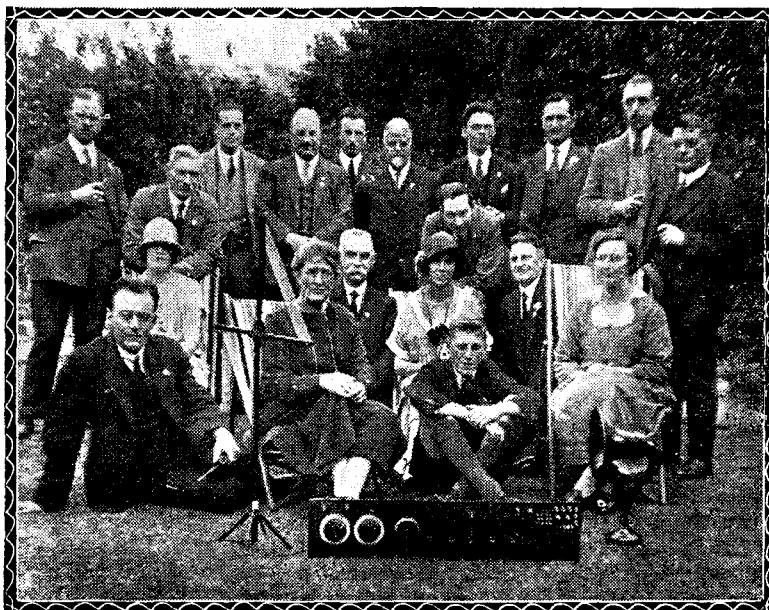

*Members and officials of the Sheffield and District Wireless Society assembled on the occasion of their field day. Reception tests with a Super-heterodyne in picking up transmissions from another party were carried out.*

circuit was employed. In this measuring circuit were included two coils which could be thrown in and out of circuit by the double-pole double-throw switch, putting the one or the other in series with a thermo-galvanometer and a condenser. The two coils were purposely made slightly different in inductance, so that when the condenser plates were all the way in, there would be an appreciable difference between the dial reading taken with one of the coils in circuit and the reading with the other coil in circuit.

Measurements were taken with this arrangement of the three types of condensers, *viz.*, circular plate, straight-line wavelength and straight-line frequency. The

"straight-line capacity" in the figure. In many other cases, however, the difference between the dial readings increases again at the lower end. This is due to excessive coil capacity in the H.F. transformers.

The variation is not as great when the straight-line frequency or wavelength condensers are used and, furthermore, the law of variation is not linear as is the case of the circular condenser. The curves show as straight lines in the figure because the curvature is extremely slight when the coil capacities are small. To be exact, the curves marked "straight-line wavelength" and "straight-line frequency" are combinations of straight lines and hyperbolæ.

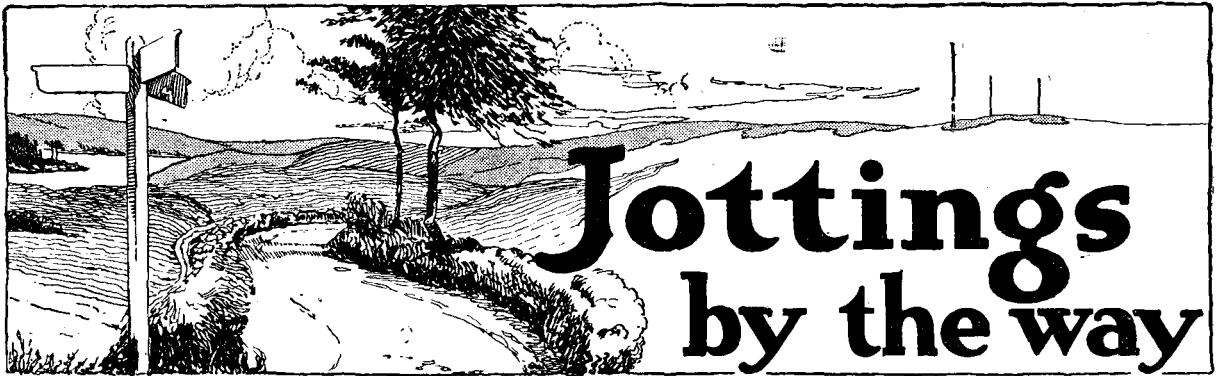

**A Missionary Journey**



HAVE just returned from a journey, the object of which was to convert a case-hardened sceptic into an enthusiastic wireless man. The said sceptic, Glumpson by name, lives at the delightful little town of Shrimpsville (Almost-If-Not-Quite-On-Sea). What I mean is that when you are on what is called the front



... Glumpson and his wife seemed rather put out ...

the sea appears to be about five miles away. You can reach it by walking along the pier, and if the day is hot the distance will seem even longer before your journey is over. Anyhow, I had just done an unusually hard spell of work, and feeling, in the circumstances, rather run down, I sent a postcard to Glumpson bearing the words, "How about a week-end?" Some people are very slow in the uptake. Glumpson, I fear, is one of these, for the next morning I had a wire, "Delighted. Will arrive five this evening." Lest there should be any doubt left in his mind as to my intentions, I telegraphed at once that I regretted the misunderstanding, that the whole of my household was stricken with hay fever, and that I had already left for Shrimpsville.

**Padding the Hoof**

I took with me a wireless set, of whose performances I am not a little proud. When I show it to friends I always pat it lovingly and say, "This is the fellow with which I receive KDKA." Being, as you know, a George Washington by nature, I add mentally, "When 2LO relays him." Anyhow, it is a very good set, constructed upon the well-known Goop-Wayfarer lines. Arriving at Shrimpsville I expected to find Glumpson awaiting me in his Rolls-Royce. Naturally the fellow was not there. The only taxi available looked like a second-hand tin kettle and sounded like several all at once when it got under way. Of

course, it broke down just outside the station, so I had to pad the hoof for ten miles, carrying the wireless set and my suit-case. Glumpson swears that it is not more than a quarter of a mile—but then, he has not walked it burdened as I was.

**Anticipation**

Both Glumpson and his wife seemed rather put out about something when I arrived. I do not know what it was, but possibly they had had a tiff with their neighbours or something of that kind. As I believe always in introducing a cheery atmosphere at the earliest possible moment, I slapped Glumpson heartily on the back and addressed a stream of airy badinage to his better half. After a little time I succeeded in rousing them from their gloom, and things began to look better. I then broke it to them that I had brought a wireless set with me, and that I proposed to give them a demonstration that evening. I threw out a hint or two about this, and suggested that they should ask two or three people in after dinner to participate in the revels.

**Erecting the Aerial**

Meantime, I explained, we must needs erect an aerial. I had brought a coil of wire with me, and a short reconnaissance disclosed the presence of a particularly handy tree. I told Glumpson



... I remained suspended and helpless ...

that his part was to climb the tree, carrying the end of the wire in his teeth. He demurred at once, saying that he would far rather see an expert do it, and that he felt sure that as a novice he would make a mess of the job. Nothing would move him from this attitude; so, groaning inwardly, I peeled off my coat and prepared for the worst. It was a nasty kind of tree. There were low branches first of all which enabled you to clamber without much difficulty for the

first few feet. Then the trouble began. That tree, as I told Glumpson later, had been neglected. There were branches everywhere. As you pulled yourself up you hit your head against one, and then found that your neck was wedged tightly into a fork, whilst you could not find a satisfactory hold for either hands or feet. Yet by a display of real British bulldog grit I arrived, at the end of a quarter of an hour or so, at the top, where the proverb tells us there is always room.



. . . It was I who plied pick  
and shovel . . .

That proverb is a lie. There was not room. So little room was there that I lost my footing, and if an obliging branch had not caught in my braces I should have crashed to earth. As it was, I remained suspended and helpless like a flounder at the end of a fishing rod, crying aloud to Glumpson to come aloft at once and release me. He came at last, but just before he got there my braces gave way and the ground flew up and hit me.

### Sympathy

Mrs. Glumpson screamed like anything, but I picked myself up and hastened to reassure her that no bones were broken. It is curious how hard a woman can be at times. "I don't care two hoots about your bones," she said. "Just look at my calceolarias." Certainly I had squashed a few of her mangy flowers, but they, as I told her, would soon grow again.

### Toil

Undaunted I braved that tree once more, and fixed the end of the aerial wire well and truly. Still undaunted, I climbed on to the roof of the house and secured the other end. As Glumpson refused even to bury the earth plate, it was I who plied pick and shovel like any navvy. When I had done all this and was being brought round with a little refreshment, Mrs. Glumpson asked sweetly whether the process must be repeated every night if you had a wireless set. "If so," she said, "I shall certainly get Horace—Glumpson answers to Horace—to take it up; it would be so good for his figure." Being by this time quite past explanation, I merely smiled wanly, and said that Horace looked as if a bit of hard work might do him good.

### Atmospherics

Then we went in, and having washed, brushed, donned a boiled shirt, cussed it, and dined, I turned to wireless once more. Very carefully I

connected up the receiving set. Just as I had finished there was a ring at the front door bell and the first party of revellers was shown in. All of them were strangers to wireless. I switched on and proceeded to tune in. . . . "Crrrrrash, crackle, fizz, crrrrrump," remarked the loud-speaker. "I am afraid," I said, "that atmospheric are rather bad to-night." My remarks were drowned by a perfect roar from the loud-speaker, followed by a noise like the casting downstairs of an entire dinner service.

"The music is beautiful," said a flapper, "but I don't think they keep very good time. It would be very difficult to dance to it."

### The Ships that Pass in the Night—

In desperation I twiddled my knobs until I had got 2LO. The strains of a foxtrot came through, despite the crashes and bangs, so well that the whole company instantly took the floor and began to dance. After about ten bars the loud-speaker said "Honk." It said it very emphatically indeed. It then paused for a fraction of a second and bellowed "Honk-honk-honk-hoooot, honk-honk-honk-hoooot." "That," I explained, when I could make myself heard, "is a ship upon the high seas calibrating." "If only it would go honk-honk-hoooot-honk; honk-honk-hoooot-honk," said the flapper, "we could waltz to it, but as it is it doesn't fit in with anything."

### —And Induction

Pale but determined I switched on once more, and tuned in to 5XX. The music was there all right, and the party got going once more. But hardly had they made three steps when a voice, loud and clear, said through the loud-speaker, "Of course, she is quite a good cook, but she will overdo the onions in her salads. And, by the



. . . "The music is beautiful," said a flapper . . .

way, did you dine with the Glumpsons last Tuesday? Oh, my dear, such a ghastly evening."

### We Part

Hastily I switched off. I had noticed one or two telephone lines knocking about when I rigged up the aerial, but it had never occurred to me that this kind of thing might happen. I told the revellers that the set had been struck by lightning, and that the entertainment was now at an end. The Glumpsons were still suffering from the hump at breakfast time next morning, and as I cannot bear dismal people I left by an early train.

**WIRELESS WAYFARER.**

# What I Saw in American Research Laboratories

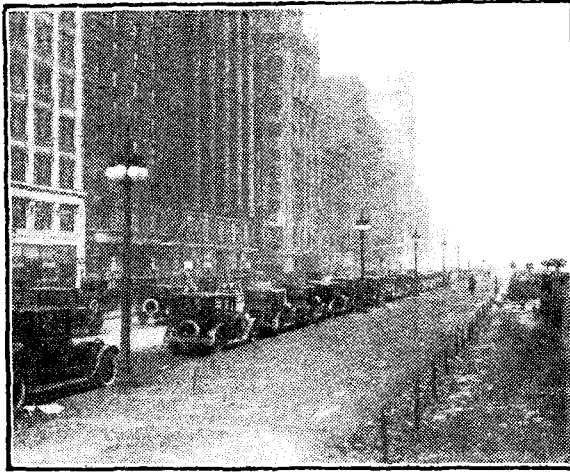

Michigan Boulevard, Chicago, outside station KYW.

By  
**PERCY W. HARRIS, M.I.R.E.,**  
Assistant Editor.

*In this article Mr. Harris describes further experiences during his American tour, and tells of a remarkable new loud-speaker.*

**L**AST week I described my visit to the Bureau of Standards, at Washington, from which city I proceeded to Pittsburgh, carrying letters of introduction to the Westinghouse Company and to the engineer in charge of the Experimental Station at East Pittsburgh. I arrived in Pittsburgh about midnight, and next morning set about finding the way to the Westinghouse works. It did not take me long to discover that East Pittsburgh is about twenty-five miles from the city of Pittsburgh, necessitating a further train journey. Pittsburgh itself cannot be called a beauty spot, and its immediate surroundings are uninspiring. Being the centre of the coal and iron districts, it is thoroughly dirty, resembling in this respect some of our North of England towns similarly situated. East Pittsburgh is situated in a valley, and consists almost entirely of the Westinghouse Company's big works, these occupying practically all the available building space. On the hills around are dwelling houses for many of the factory hands, although a great number of the employees travel to and from the city daily.

A pair of wireless masts on the factory buildings suggested that the KDKA station might be there, but on inquiry I found that, although the original KDKA station had been situated in this building, it was now a mile or two away on a hilltop. After sundry formalities (which gave a clear indication of the difficulties of any unauthorised person trying to enter the works), I was ushered into the office of the superintendent of broadcasting, Mr. C. W. Horne.

## Broadcast Pioneers

The Westinghouse Company are naturally very proud of their pioneer work in broadcasting, and they claim that station KDKA was the first to send out regular broadcasting pro-

grammes. Mr. Horne took me into the studio at the works and explained that much of the broadcasting from KDKA is carried on in conjunction with one of the Pittsburgh newspapers, the studio for this purpose being situated in the city itself. There were no remarkable features about the works studio, but I was interested in the microphones used, which are of the condenser type, with the first amplifier situated in the same casing as the microphone itself. Receiving sets, by the way, are not manufactured at this plant, the factory at East Pittsburgh being devoted almost exclusively to heavy electrical engineering work.

## Some Aerial Facts

After a short round of the works we climbed into a car and started for the experimental station on the hill. After a number of gradients, which made it perfectly clear why American motor-cars usually have high-power engines, we reached the location of the KDKA station—a high plot of ground with a fine view of open country all around. All the transmitting apparatus of KDKA—both for the long and the short wave—is situated in a small brick building, the appearance of which is familiar to every reader of this journal from photographic reproductions. The main aerial of the 309-metre broadcasting set is of the sausage type and has a triangular flat top, a large counterpoise radiating from the building in which the apparatus is situated. The lead-in for the 309-metre aerial is similar to that I have previously described for the short-wave transmitter at this station, and the aerial ammeter has to be read from the station building by means of field glasses.

## A Strange Experiment

While I was visiting the station the afternoon programme was going out, and I noticed that the aerial ammeter read 37 amperes! Although it was a dry, sunny day it was possible with a piece of wire held in the hand to draw from a nail in the wooden pole supporting the counterpoise a quarter-inch high-frequency arc, from which one could hear every sound transmitted from the studio.



Located around the field are a number of tall poles supporting copper tube aerials of the type I described in my article on short-wave work, while in a small wooden framework is a still shorter tube aerial, used for the very short-wave work, such as five- to fifteen-metre transmissions. The building itself is very neatly laid out, but is not generally so tidy as would appear from the photographs you have seen, for the apparatus is being constantly changed, the station being purely of an experimental character. In the basement are the power transformers, dynamos for filament lighting, and other power plant. Other details I have given in my previous article on the short-wave working of this station.

### In Chicago

From Pittsburgh I travelled to Chicago—a very active broadcasting centre. Within thirty miles of Chicago there are more broadcasting stations than all the British main and relay stations added together. As this series of articles is confined to visits to experimental and research laboratories, I must reserve particulars of the Chicago stations for another place. Several

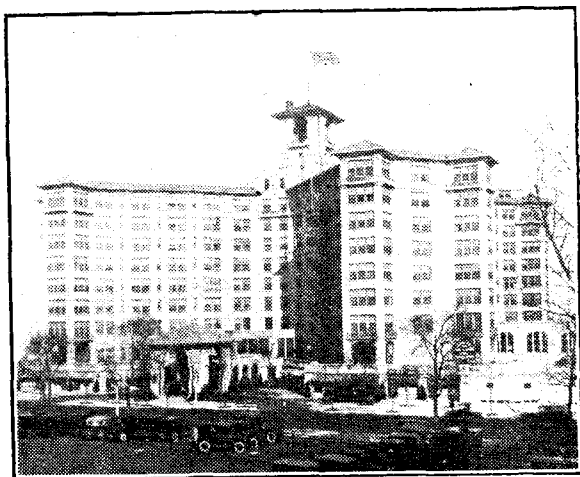

*The Edgewater Beach Hotel, Chicago, well known as station "WEBH."*

Chicago wireless people I met in New York, and one of my first visits was to Mr. F. W. Silver, whose work in connection with super-heterodyne receivers is well known everywhere in the United States.

Later in the day I visited the laboratories of Mr. J. Elliott Jenkins, who has been responsible for the design of several broadcasting stations in the Chicago district. Mr. Jenkins has a considerable consulting business in radio, and one of the best equipped private laboratories I had the opportunity of seeing while in the United States. In Mr. Jenkins' laboratory he and his assistants were busily working out the details of a new five-kilowatt broadcasting station which is being designed for the Zenith Company, the firm who supplied the wireless apparatus for the "Bowdoin" of the MacMillan expedition, on which J. L. Reinartz is now operating the short-wave set. In this, as in many other laboratories

I visited, I was shown a good amount of work of a confidential nature which cannot be described here. Of things that can be mentioned, however, I would like to refer to the very ingenious toroidal coil designed by Mr. Jenkins, and now being marketed by a Chicago radio firm.

### An Interested Experimenter

The problem of winding a toroidal coil of the spaced type is to prevent the inner turns touching one another without a large amount of insulating and supporting material being used. Mr. Jenkins has succeeded in producing a toroidal coil of exceedingly low high-frequency resistance and self-capacity, in which no two turns touch, although the minimum of insulating material is used. In this laboratory I had the opportunity of examining a number of American commercially built sets in detail, and in comparing their mechanical and electrical characteristics.

Mrs. Elliott Jenkins, who is English, is a very keen "radio fan," and assists her husband in a great deal of his work. Before her marriage she was well known to British playgoers as Miss Alexandra Carlisle, having played with Tree on a number of occasions. Now she can manipulate a milliammeter with the best of us. *Sic Transit Gloria Mundi.*

From Chicago, which was the farthest west I visited, the next journey was back eastward to Schenectady, known to every wireless enthusiast as the location of WGY, the General Electric Co.'s broadcasting station. I had expected to find Schenectady a busy manufacturing town after the style of Pittsburgh, and was agreeably surprised to find it a charming old-world little town with but one manufacturing plant, the General Electric Co.'s works on the outskirts. Schenectady itself is, for an American town, very old, the first settlers having built their homes there in the seventeenth century.

### G.E.C. Research Laboratories

The General Electric Co.'s research laboratories occupy a large, many-storeyed building, and are, I should venture to think, unrivalled in America in the completeness of their equipment. A large portion of the building, of course, is devoted to non-wireless research, but in the wireless section are engaged many scientists whose names are known throughout the world. I was particularly interested in a new loud-speaker recently developed by the General Electric Co., the inventors being Messrs. C. W. Rice and E. W. Kellogg. This loud-speaker is not yet on the market, but is now being manufactured for the autumn season, when it will be sold, so far as I can gather, for about \$200 (£40), a price which at first will seem to you to be high, but is not so great when you consider that the amplifier, a three-valve affair, is built into the same cabinet as the loud-speaker and is included in the price.

### H.T. and L.T. from Electric Light Mains

In the United States, where there is practically a single voltage (110) and periodicity (50 cycles), it is possible to design a good deal of electrical

equipment for wide sale to run off the electric light mains. This loud-speaker, or rather the amplifier connected to it, is made up so that by plugging into the nearest lamp socket you can provide the current for both high tension and low tension from the mains. Obviously this is a great advantage. It is no exaggeration to say that I was astounded with the quality, purity and general reproduction of this instrument, and the General Electric Co. were only too anxious to show me its capabilities. For example, they arranged for a lady pianist to play a grand piano in the main studio at WGY while I listened in a smaller sound-proof studio to the reproduction.

**Piano Reproduction**

This was arranged by picking up the piano music in the main studio by means of the ordinary studio microphone used at WGY (this is of the condenser type), amplifying the microphone current in the main amplifier and then, instead of putting "on the air," current was fed to the Rice-Kellogg loud-speaker in the studio in which I was listening. After the intensity adjustments had been made it was practically impossible to distinguish that one was not listening to the grand piano in the same room.

Following this, a passage from a book was read in the main studio. A minute or two later the same

man came into the room and read the same passage standing in the position of the loud-speaker. One then had an excellent opportunity of judging the absolute clarity and fidelity of reproduction. Fuller technical details will be published shortly in this paper, but I can state at once that the loud-speaker is of the hornless type, the main portion being a cone about nine inches in diameter, the cone being vibrated by means of a coil floating in a strong magnetic field. The edges of the cone are held in a rubber ring to give flexibility.

**Reproduction of Low Tones**

Having heard such excellent reproduction, I was anxious to find why it was so greatly superior to the best loud-speaker I had previously heard. Careful investigation showed that the secret lay in the perfect reproduction of very low tones, which usually come out badly in any loud-speaker. To demonstrate this Mr. Kellogg produced a number of musical notes by beating metal above deep glass jars, thus giving low booming notes, very rich in low tones. On the ordinary type of the loud-speaker (of which there were several in the laboratory) these notes came out quite different from the original sound, whereas on the Rice-Kellogg these were reproduced with perfect fidelity.

*(To be continued.)*

**MEMBERSHIP OF THE I.E.E.**

The following statement has been received from the Institution of Electrical Engineers and expresses their views on the recent discussion

RECENT correspondence in the Press indicates that there is some misconception as to the eligibility of wireless engineers for membership of the Institution, and it is therefore necessary to state that it is possible for an engineer to become a member of the Institution with qualifications of a purely wireless nature.

**The A.M.I.E.E. Examination**

For the admission of wireless engineers to the class of Associate Member (A.M.I.E.E.), it is necessary, in addition to the possession of adequate professional experience for a period of at least two years, in the case of those who do not possess an exempting examination qualification, or do not submit a satisfactory thesis, to pass the A.M.I.E.E. examination in the following subjects:—

(1) English Essay or Translation from a foreign language.

- (2) Applied Mechanics.
- (3) Heat, Light and Sound, or Inorganic Chemistry.
- (4) Electricity and Magnetism.
- (5) Wireless and High-Frequency Engineering.

The Committee of the Wireless Section of the Institution have recently considered the above syllabus and they are of opinion that it represents the minimum amount of professional knowledge which a qualified wireless engineer should possess. No conditions are laid down by the Institution as to how or where an applicant may have obtained his training.

**Class of Graduates**

For others who are unable to pass the examination there is provided the class of Graduates, but it must be pointed out that admission to this class does not confer any professional standing, the requirements being a good education and employment in an engineering or scientific capacity in the applications of electricity.

In order to become a member of the Wireless Section of the Institution it is necessary that the member of the Institution shall be actively engaged in the study, design, manufacture, or

operation of wireless or high-frequency engineering apparatus. The meetings of the Wireless Section are not, however, confined to members of the Section, but are open to all members of the Institution.

It has also been stated that the Committee of the Wireless Section consists nearly always of the same body of men. This is not the case, as the rules of the Section provide for the retirement of one-third of the ordinary members of the Committee each year.

Some valuable suggestions have emerged from the recent correspondence and will receive the careful consideration of the Wireless Section Committee, more particularly as regards the type and number of papers read and as to increasing the activities of the Wireless Section outside London.

As regards the suggested formation of a new Society, the Wireless Section Committee consider there is no need for it, because, as indicated above, wireless engineers can obtain membership of the Institution, and amateurs are already catered for by the Radio Society of Great Britain.

# THE NATURE OF FADING

By **J. H. DELLINGER, Ph.D.**, Chief of the Radio Division of the Bureau of Standards.

*Dr. Dellinger's reputation for careful and accurate work in radio research is world wide. Some of the apparatus used in these tests was described by Mr. Harris in "Wireless Weekly" for Aug. 5, 1925.*

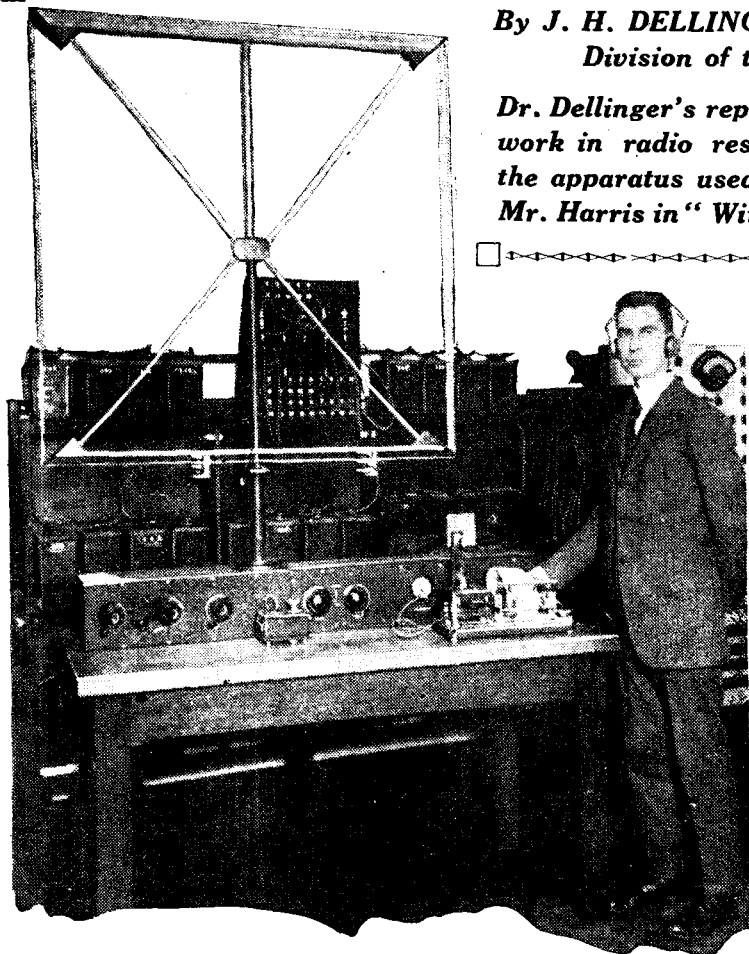

*A corner of the research department of the Bureau of Standards showing some of the apparatus used for recording signal strength.*

**R**ADIO is very much concerned just now with what is called fading. The term is probably an inaccurate one; it simply refers to the fluctuations of intensity of signals received from distant stations. It is not so likely to trouble you if the station is within 50 miles, but from that distance up to about 200 miles it is a genuine obstacle to satisfactory signal reception.

## Scientific Progress

The spotlight of radio progress is indeed revealing fading as its chief enemy. For many years fading played a minor rôle, but this waxing prominence of fading is a relative matter. It is not that fading is any worse than it ever was, but that other enemies to perfection of radio reception have been yielding to

the onslaught of scientific and experimental progress. We have been finding out what to do about interference of various kinds; that caused by other transmitting stations, electric power lines, radiating receiving sets and even atmospheric disturbances, but we have not yet found how to prevent or to substantially mitigate the irregular variations in the intensity of radio signals known as fading. There is a ray of hope. We are rapidly finding out many things about fading and its causes, and such knowledge is the usual preliminary to finding a remedy.

## Broadcast Crowding

It is interesting that radio broadcasting has been established just in the border-line territory between the low - fre-

quencies (or long waves), which show little fading, and the high-frequencies (or short waves), which fade badly. Very probably you have noticed that the shorter wave broadcast stations generally fade more than those on longer wavelengths. This is important when you consider the problem, a perennial and serious one, of finding frequencies to assign new broadcast stations, finding places to put the increasing tribe of would-be broadcasters. They cannot go to lower frequencies, because below the broadcast range the ether channels are few and they are not available; they are pretty well taken by ship and other radio telegraphic use. Broadcasting might go to higher frequencies, on the other hand, as the number of ether channels there is practically unlimited, if it were not for the unreliability introduced into radio reception by fading.

## Fading on High Frequencies

For the immediate future, therefore, broadcasting is in a straight-jacket in the band of frequencies which now confine it. It is difficult to see how more broadcast stations can be crowded into this limited band without destroying one another. Perhaps the solution to that problem is general acceptance of the view of those who maintain that there are too many stations already and that the multiplication of stations is economically unstable. I have strayed from my main subject, only to point out that a happy and complete solution of some of our most practical radio broadcast problems will be attained when we conquer the fading which troubles broadcasting on the higher frequencies.

### Causes of Fading

I said that the causes of fading are becoming known, and a most fascinating thing it is to study what happens to a radio wave in travelling from the transmitting station to the listener. What happens depends on the frequency, or wavelength. With low-frequency waves there is little or no fading. Radio was not formerly troubled with fading, simply because radio work was done on waves of lower frequency than those which are now used for broadcasting. The American amateurs were the only exception to this. They operated on frequencies above 1,500 kilocycles (or wavelengths below 200 metres), and it became increasingly recognised among them that their received signals were subject to peculiar and inexplicable fluctuations. The mystery was why their signals should vary in this unaccountable manner while other radio signals did not.

### Tests on Fading

In order to determine the facts about these fluctuations the Bureau of Standards organised a systematic series of tests, extending over a year, by a large group of amateurs. It was demonstrated that on these frequencies fading occurs at night and not in the daytime, that the average received signal strength is much greater at night, that fading is worse the higher the frequency, that weather conditions do not markedly affect fading, and that the amount and nature of fading are not characteristic of either the locality of the transmitting station or of the receiving station. From these facts (and others—see publications: *A Study of Radio Signal Fading*, Bureau of Standards Scientific Paper No. 476, and *Radio Signal Fading Phenomena*, Journal Washington Academy of Sciences, Vol. II, p. 245, June 4, 1921) it was possible to derive the following explanation of fading:—

### The Heaviside Layer

In the daytime the radio waves go out from the transmitting station attached to, and sliding along, the ground, just as the electric current comes into our

homes sliding along the wires. The waves do not penetrate very far up into the air because of the presence of a sort of electrical screen or barrier produced by the action of sunlight on the atmosphere. At night, however, this electrical screen disappears and the radio waves can penetrate into the very rarefied upper parts of the atmosphere which are permanently in an electrically conducting condition. The radio waves then slide along this upper conducting part of the atmosphere in just the same way that they slide along the earth's surface in the daytime, with this difference:—

In sliding along the earth's

waves have developed. Knowledge has accumulated, and it has verified and extended this explanation. We now know that there is a zone, somewhere between 50 and 150 miles around a transmitting station, in which fading is greater, and average signal intensity is less than at either greater or less distances. This is the main explanation of so-called *dead spots*. In this same zone fluctuations of the direction from which the waves reach the receiving station occur. Some of these direction shifts give a direct demonstration of the fact that the waves travel in the upper atmosphere. Some of the most remarkable changes in signal

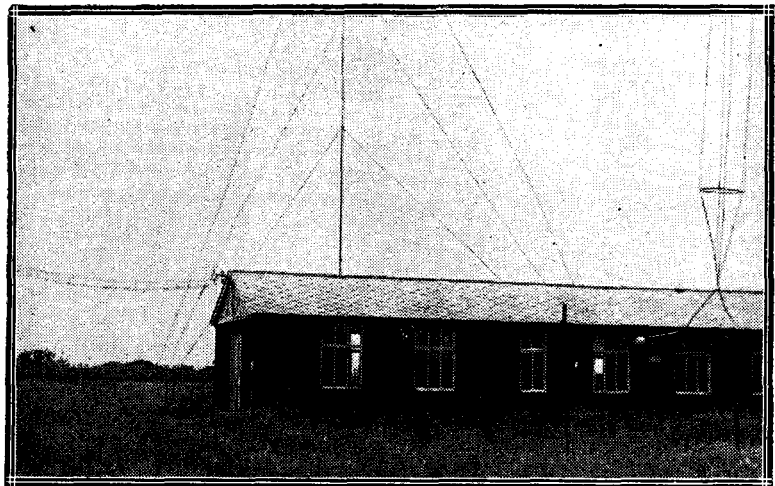

A photograph taken at the Bournemouth Station. The aerial down-lead is seen on the right and the land line connecting the studio with the transmitter on the left.

surface in the daytime the waves are rapidly absorbed by the trees, buildings and other obstacles they meet, while in sliding along the upper atmospheric conducting surface at night they are free from this, and go much greater distances. So the short waves, which should go farther theoretically, because they are of higher frequency, really do go farther at night. But this upper atmospheric conducting surface is not smooth; it is rough and turbulent like a wave-tossed sea, and these variations give rise to the fluctuations of received signal intensity which we call fading.

### Some Curious Phenomena

All of this, the investigation and the conception of the explanation I have described, was in 1920. Since then, broadcasting and the use of the very short

intensity, fading and wave direction occur daily during sunrise and sunset. As the earth's daily rotation makes the surface of separation between daylight and darkness swing over a given locality, the radio waves travelling in the upper atmosphere are actually tilted down and rapid and peculiar fading and direction changes occur. For certain very short waves it appears that there is an electrical conducting surface in the atmosphere which facilitates their transmission over great distances in the daytime, just as happens to other waves at night.

Work on this subject along these lines is in progress all over the world, and there is an organisation, the International Union of Scientific Radio Telegraphy, for the promotion of such research.

# WIRELESS NEWS IN BRIEF

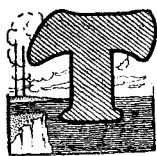

THE work of the Triennial Conference of the International Astronomical Union, held at Cambridge last month, is divided up into 31 "Commissions," each dealing with distinct subjects of astronomical investigation and each having its own members and president.

## Time Signals

That dealing with all questions of time, including, of course, wireless time signals, is No. 31, *La Commission de l'heure*, and includes distinguished astronomers from all parts of the world, presided over by our own Astronomer Royal for Scotland, Professor R. A. Sampson, F.R.S.

The first morning's sitting was devoted mainly to formal business and to an account by M. Baillaud of the method of time determination adopted in the Paris Observatory and its transmission from FL and LY wireless stations.

The suitability, adequacy or superfluity of the existing transmission programmes were systematically discussed, and whilst no formal resolutions were passed the conclusions arrived at were substantially as follows:—

The semi-automatic code, in which the time signal consists of a single dot at the end of each of three consecutive minutes (known as the old Paris code), is recommended to be dropped altogether. This involves the cancellation of the 9.0 a.m. signal from YN, 10.45 a.m. FL, and 10.45 p.m. FL as superfluous. The 8.20 a.m. YN Rhythmics are also to be cancelled.

## Six Dot-Seconds

The ONOGO automatic code in which every 10th second is indicated by a dot, each of its three minutes ending in three dashes (known as the International Code), to be altered in the manner recommended by the British Horological Institution, *i.e.*, by the substitution of six dot-seconds for the final dashes, and

to be transmitted at morning and at night, preferably with an interval of twelve hours between them, but whether at 8 or 9 a.m. and 8 or 9 p.m. is left to the discretion of the *Bureau de l'heure*.

The above morning and evening transmissions to be followed, after an interval of one minute, by Rhythmic signals commencing at the precise instant of G.M.T., consisting of 306 beats in five minutes, the beat beginning each minute, *i.e.*, the 1st, 62nd, 123rd, 184th and 245th to be of half-second duration, with a cor-

sists of the usual detector and low-frequency valves with special short-wave coils. He has been working on 15 metres, 40 metres and 90 metres, although the latter has been left alone lately owing to the unsatisfactory result it has given compared with those of the other two wavelengths. The transmitting apparatus is worked on 100 watts, the aerial being of the cage type, 60 ft. high and 50 ft. long.

On August 1 and again on August 2 he was successful in picking up and communicating with Mr. Edmundo Guevara, of



The transmitting equipment at Braybrook from where the programmes from 3LO, Melbourne, are sent out.

rection to be published promptly by the issuing observatory.

\* \* \*

AMATEUR WORKS CHILE. Another triumph was achieved in amateur wireless communication on the night of July 31, when direct contact was obtained between Chile and London.

This feat has been accomplished by Mr. J. A. Partridge, 2KF, of Wimbledon, who was the first amateur to establish two-way communication in 1923 between America and England.

Mr. Partridge's receiver con-

sists of the usual detector and low-frequency valves with special short-wave coils. He has been working on 15 metres, 40 metres and 90 metres, although the latter has been left alone lately owing to the unsatisfactory result it has given compared with those of the other two wavelengths. The transmitting apparatus is worked on 100 watts, the aerial being of the cage type, 60 ft. high and 50 ft. long.

On August 1 and again on August 2 he was successful in picking up and communicating with Mr. Edmundo Guevara, of

Mr. Edmundo Guevara, who is a former student of Bradford Technical College, sent a message through Mr. Partridge to Professor Midgeley, of that college.

(Concluded on page 613.)

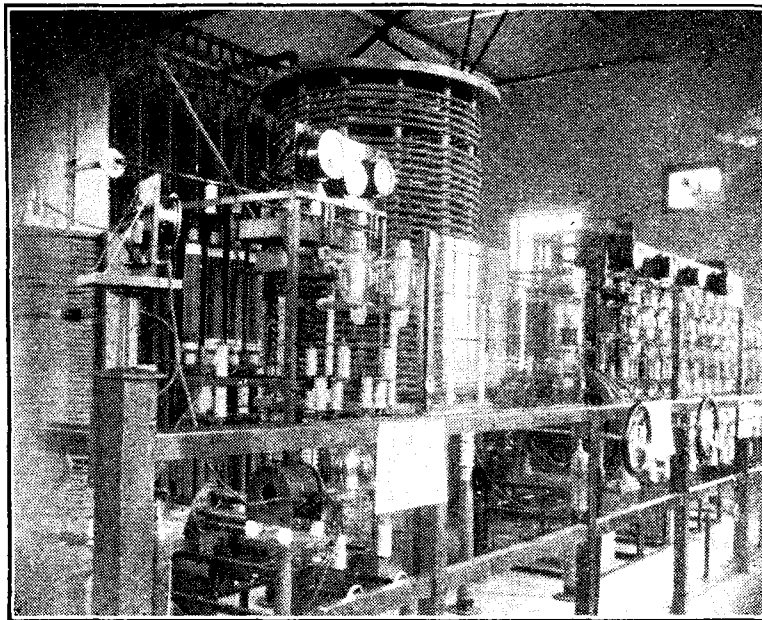

A view of the C station, showing the drive circuit on the left and the power amplifiers on the right. The tuned amplifier circuit is shown in the middle, the aerial inductances being at the far end.



IN connection with the recent summer meeting of the Students' Section of the Institution of Electrical Engineers a very enjoyable day was spent inspecting the Marconi Co.'s stations and works. The party visited the transmitting station at Ongar (North Weald) in the morning, whence they proceeded to Chelmsford, and were entertained to lunch there by the company. The afternoon was spent in a hasty inspection of the Chelmsford works, followed by a visit to the receiving station at Brentwood.

**The Ongar Station**

The transmitting equipment is situated at North Weald, between Epping and Ongar, on high ground, and is at present divided into three groups known as the A, B and C stations respectively.

Each group has its own aerial system and transmitter, but is supplied with power from a common source.

The A station has two transmitters working on the same

aerial (as described later), one to Paris on 3,800 metres (78.9 kc.) with a power of 8 kw., and the other to Berne on 2,900 metres (103.4 kc.) with a power of 15 kw.

The B station works to Canada (Glace Bay) and New York on a wavelength of 5,000 metres (60 kc.), the power being 50 kw.

The C station works to Austria (Vienna) and Spain (Madrid and Barcelona) on a wavelength of 4,350 metres (68.9 kc.).

**Power Supply**

The power for the station is derived from a common powerhouse at a central point on the site. The prime movers are of the semi-Diesel type direct coupled to 240-volt D.C. generators. These generators charge a floating battery, which supplies current to two motor generator sets giving alternating current at 500 volts, 350 frequency.

This alternating current is stepped up to 1,000 volts by means of static transformers, and is distributed at this pressure to the various transmitting buildings.

In order to maintain the volt-

**The ONGAR**

Few people have the opportunity of seeing the large commercial wireless station which is generally known about the world. It is a pleasure in publishing this description of the Marconi station at Ongar. The receiving station at Brentwood is described in a subsequent issue.

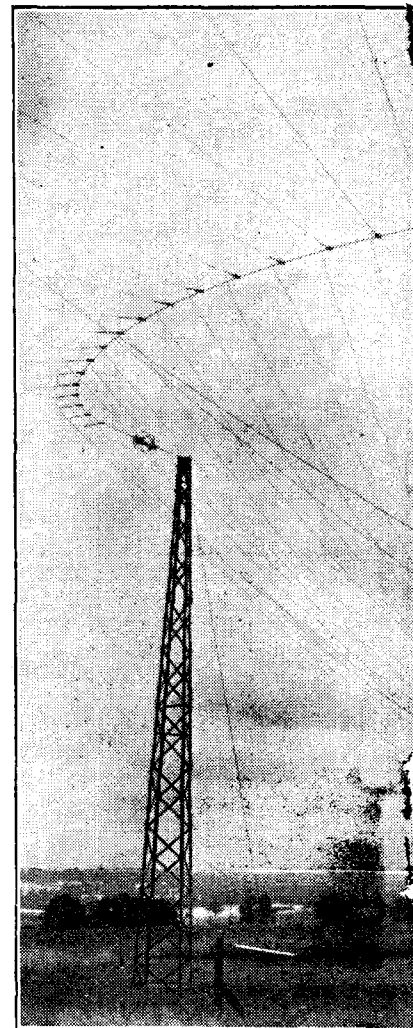

The lead-in arrangements at the C station for the aerial and the lower one for the power supply. The 20 wires 30 ft. apart, which are all brought to the building, as shown.

# STATION

tunity of visiting any of  
less stations and little  
their activities. We have  
s week a very complete  
Co.'s station at Ongar.  
Brentwood, which is  
with Ongar, will be de-  
sequent issue.

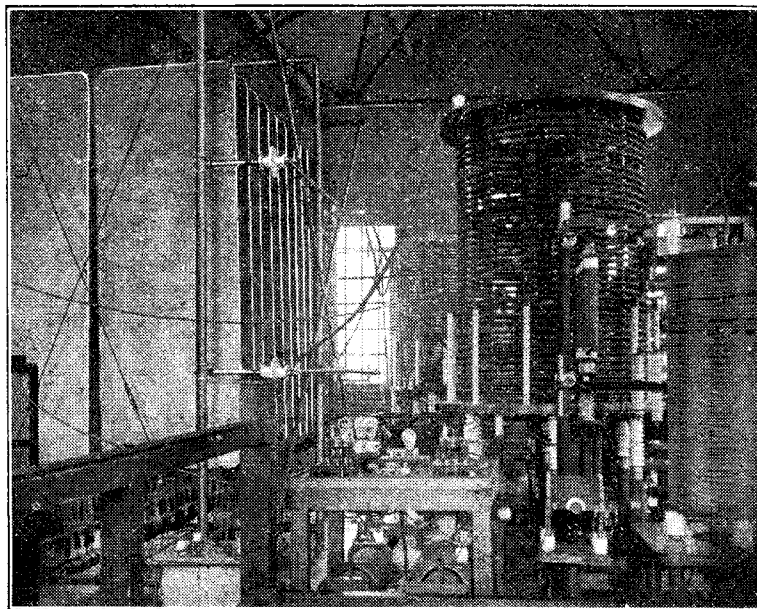

Another view of the C station showing the signalling keys in the foreground. The closed circuit condensers, composed of sheets of metal hung vertically, can be seen on the left.

age constant, a "booster" is connected in between the battery and the motor generators. This is a small D.C. motor generator set of which the voltage is controlled by the current flowing in the circuit. By this means the voltage is kept constant under all conditions of load.

The battery serves, in emergency, as a temporary stand by, and is capable of running the entire station for about three hours.

### Control

The control of the traffic for the whole system is in the hands of Radio House, in Wilson Street, London, E.1. Here the outgoing traffic is sent by land-line to the appropriate transmitting point, where the telegraphic currents operate relays and so cause the transmitter to radiate. The principal American traffic is transmitted via Carnarvon, all other traffic being sent via one of the Ongar groups.

All the reception is carried out at Brentwood, and the signals are relayed to Radio House where they are "written up."

There is thus no actual operat-

ing at any of the stations, all the traffic being handled at Radio House.

### The Transmitting Equipment

Owing to the courteous assistance of Mr. N. C. Rackstraw, the officer in charge at Ongar, we are able to give very full particulars of the equipment of the three stations.

The general principle of the transmitting plant is the same at all three stations, and it will be best to consider the system as a whole and to discuss the separate stations afterwards.

All the transmitters operate on the "independent drive" principle. There is one main oscillating circuit, of comparatively small power. The oscillations produced in this circuit are amplified by a bank of power valves, all connected in parallel, and the resulting currents are applied to the aerial circuits. The principle is illustrated in Fig. 2.

By this means the frequency of the oscillations in the aerial circuit, and, therefore, the wavelength radiated, is absolutely independent of the aerial circuit itself, and is therefore practically

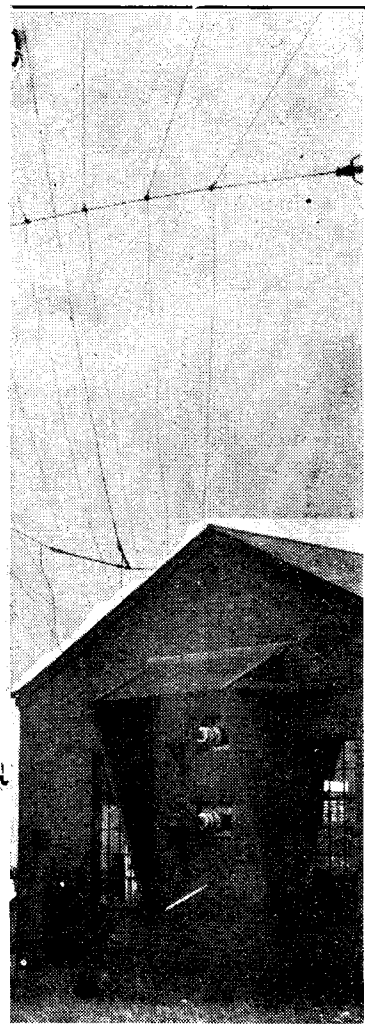

station. The upper insulator is the earth screen. This contains the equipment and is led into the building above.

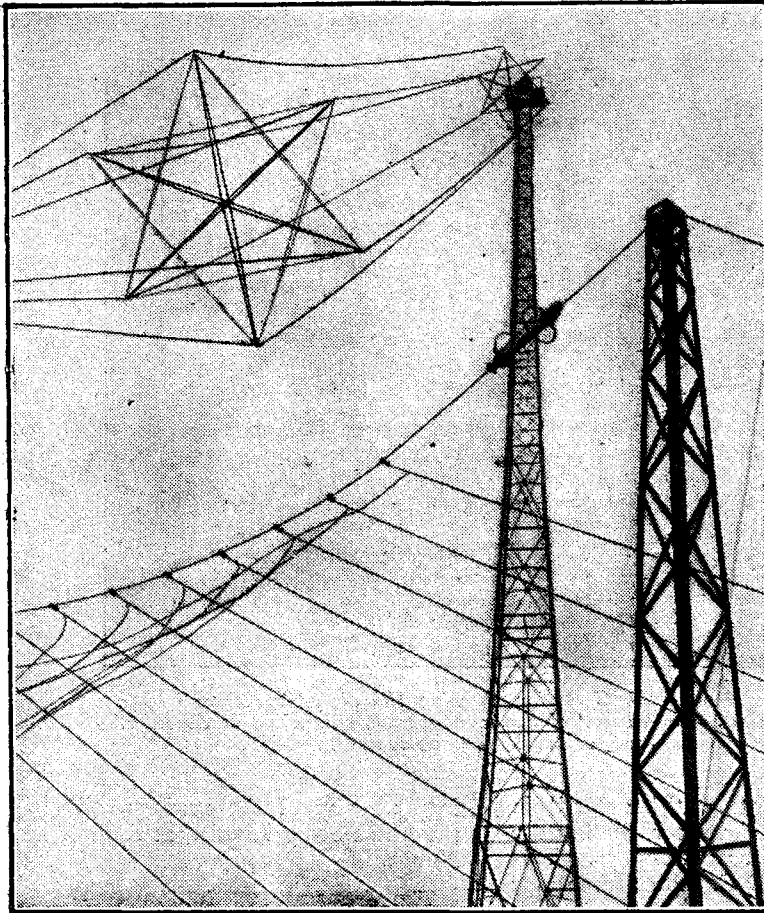

The aerial lead-up at the B station. The ends of the earth screen wires can be seen in the foreground.

dead constant. Unless this system is adopted the swaying of the aerial in the wind causes minute variations in the frequency, and this is sufficient to upset the adjustments at the receiving end. This may seem remarkable, but it will be seen later that the receivers are adjusted to cut off if the frequency varies more than 100 cycles, which is only 0.1 per cent. at a frequency of 100 kc. (3,000 metres).

In every case a coupled aerial circuit is employed; that is to say, the oscillations are first introduced into a closed circuit, which is weakly coupled to the aerial circuit. This not only assists in maintaining the frequency constant but also tends to eliminate the radiation of harmonics.

**Absorption Circuits**

A very ingenious arrangement in use on all the transmitters is the absorption circuit. With high speed signalling it is essential that the commencement of a

signal should be sharp and crisp, quite apart from the steadiness of note which is desirable at any speed of working.

It was found that the sudden variations of power from full load (key down) to no load (key up)

were apt to cause fluctuations of the supply voltage which produced variations in note and signal strength.

Absorption circuits are therefore arranged which take power from the line during the spacing interval.

**Steady Signals.**

There is thus no appreciable fluctuation of power, and the signals remain very steady. Anyone who has listened to the transmissions from Ongar will have noticed the clear cut beginning and end of the signals, produced by this means.

The actual absorption circuits consist of one or more valves arranged across the main H.T. supply, the grids of which are normally kept positive by means of a small 240 volt generator, and the valves thus absorb power from the mains. When the key is depressed this positive voltage is removed, and oscillations are applied to the grids through a condenser from a small coil, called the negative inducing coil, coupled to the tuned grid circuit of the amplifying valves. The grids of the absorbing valves then rapidly build up to a negative potential, and the valves become non-conducting.

The power is absorbed partly in the valves, but mainly in a resistance mat in the anode circuit. This mat has a resistance of about 15,000 ohms, and is capable of carrying 1 amp. A skeleton diagram showing the principle of the absorption circuits is given in Fig. 1.

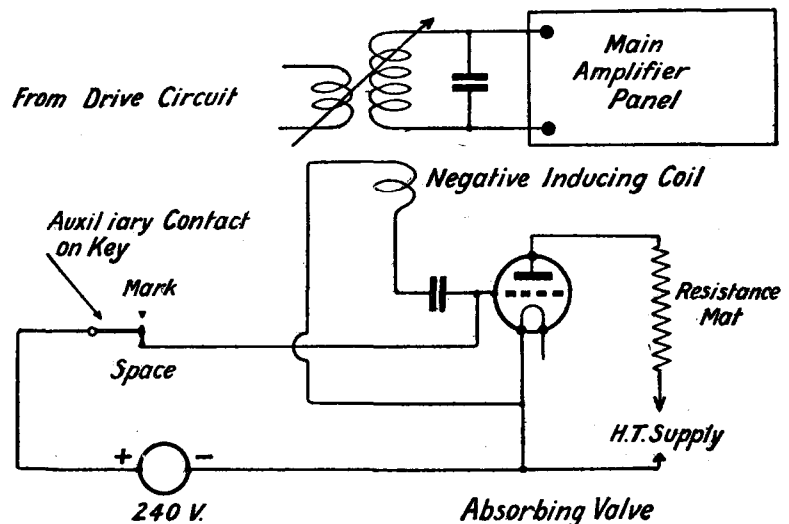

Fig. 1.—Illustrating the principle of the absorbing valves.



**Keying Arrangements**

The keying arrangements are also out of the ordinary. The oscillating circuit in the drive oscillator is coupled to the grids of the bank of amplifying valves and the keying is arranged to operate on this circuit.

The arrangement is shown in Fig. 3. There are two couplings from the oscillating circuit, and these couplings are arranged in opposition, and are normally balanced out so that no voltage is applied to the grids of the amplifying valves.

When the key is depressed, however, one of these couplings is short-circuited, so permitting the power to be transferred to the amplifiers.

**The "A" Station**

The A station contains two transmitters of the type just described. The Paris set comprises the following:—Drive panel, two rectifiers, one oscillator; main panel, four rectifiers, four oscillators, one absorber.

Aerial current, 30 amps., 103.4 kc.

The Berne set comprises:—Drive panel, two rectifiers, two

oscillators; main panel, four rectifiers, four oscillators, three absorbers. Aerial current, 40 amps., 78.9 kc.

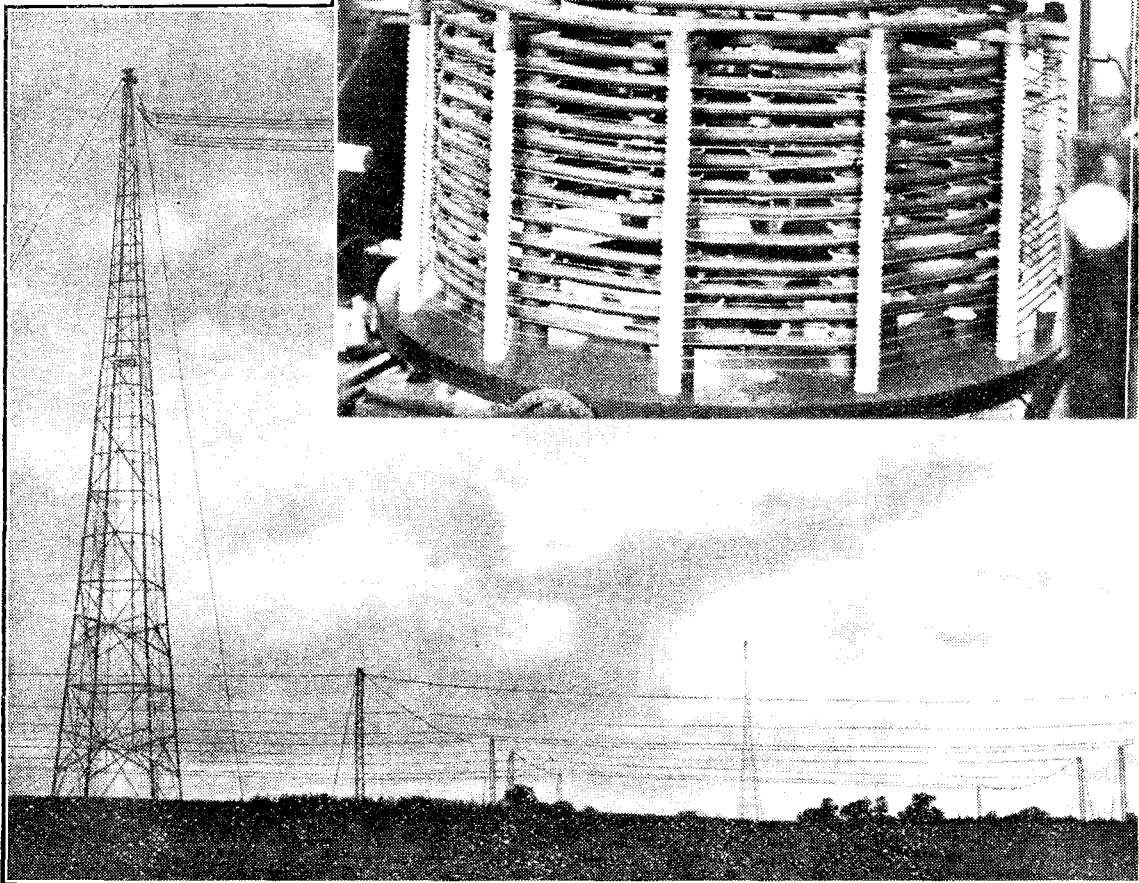
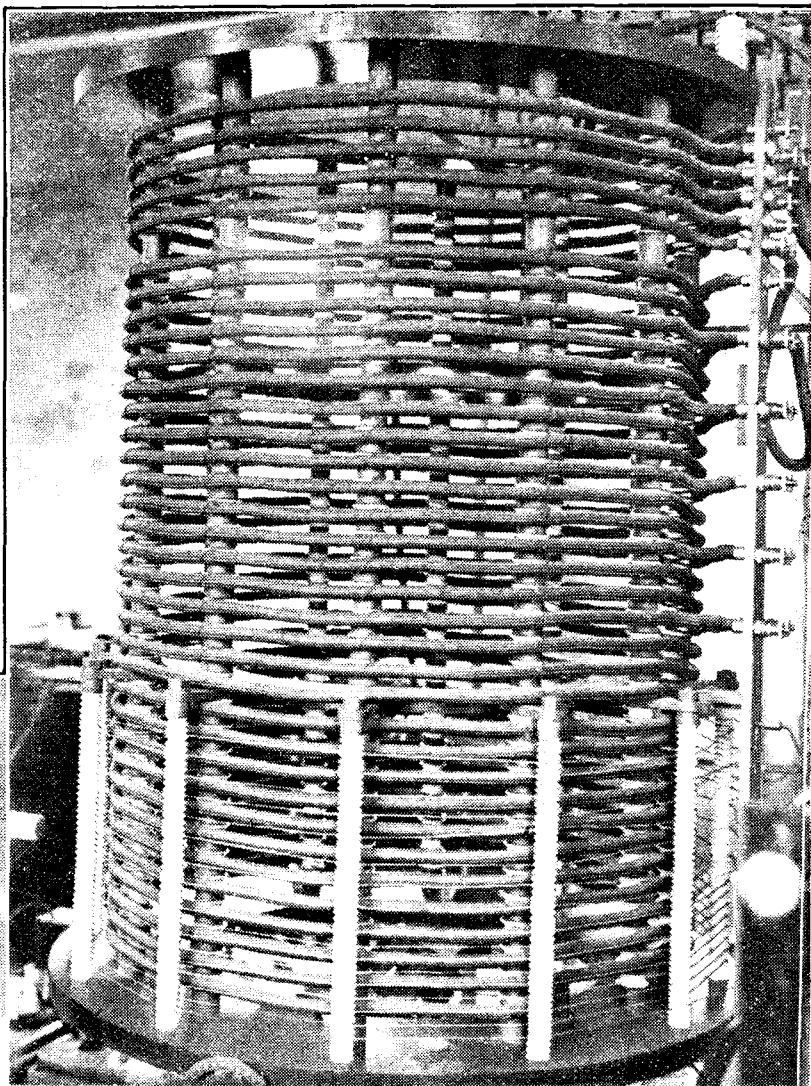

*The aerial system at the A station. The earth screen can clearly be seen underneath. The upper picture shows the tuned grid coil of the power-amplifying valves. The winding round the outside is the coupling from the independent drive oscillator. The fine wire used shows the relatively small power handled in the drive circuit itself.*

As has been stated, both these sets are worked on the same aerial by an ingenious use of the properties of coupled circuits.

extreme conditions, one when the currents are flowing in the same direction at any instant, as shown by the full arrows in the figure,

The two aerial circuits are each tuned to a frequency intermediate between those of the transmitters, and the coupling between  $L_1$  and

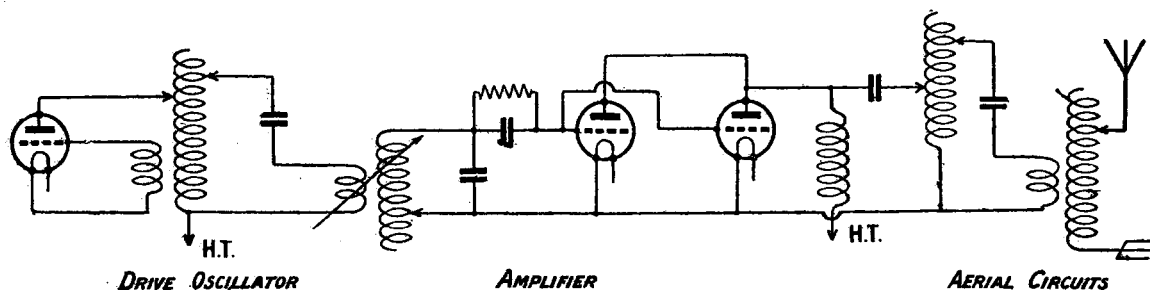

Fig. 2.—The skeleton circuit of the transmitting arrangements at Ongar, illustrating the principle of the independent drive.

**The Split-Wave System**

If two circuits are coupled together, it is found that there are two frequencies to which the system may be tuned.

and the other when the currents are in opposition, as shown by the dotted arrows.

These two conditions correspond to the two possible fre-

$L_2$  is then adjusted until the two tuning points (which appear one on each side of the frequency to which the circuits were originally tuned) correspond with the frequencies of the two transmitters.

The system works well in practice, the chief disadvantage being the interdependence of the two sets. In the event of a fault on one set great care has to be taken, in tracing the fault, not to disturb the working of the other.

**The Aerial System**

The aerial employed is a twin cage 750 feet long, supported from two towers 300 ft. high. An earth screen is employed in place of the earth, consisting of ten wires 30 ft. apart, 30 ft. above the ground, on each side of the aerial. The wires are supported from insulated triatics carried on small towers. The wires themselves are not insulated from the triatics as this was found to give less tendency to screen oscillation. The earth screen extends beyond the aerial for a distance equal to half the length of the aerial.

**The "B" Station**

This is the station employed for working to Canada and America, and comprises a drive circuit of

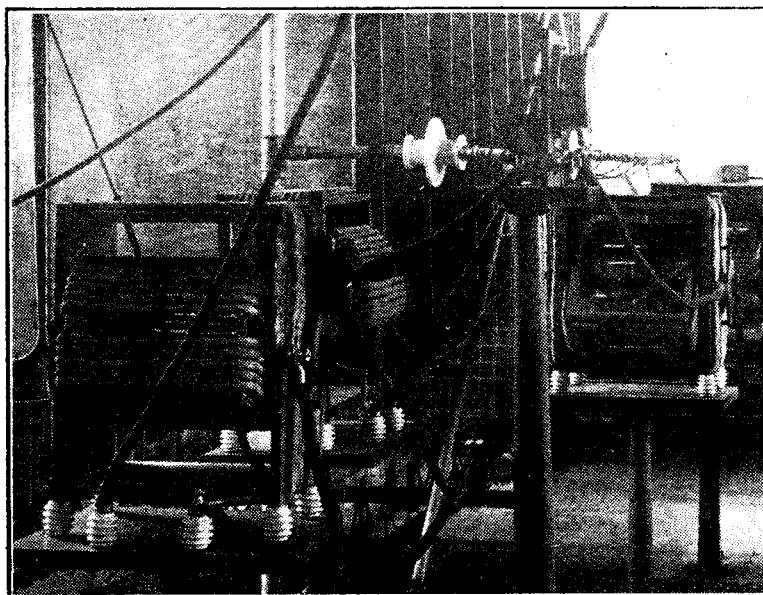

The coupling units employed in the split wave system at the A station. The closed circuit condensers can be seen in the background.

Consider the two circuits in Fig. 4. The circuit  $L_2 C_2$  has a certain effect on the circuit  $L_1 C_1$  through the mutual inductance between the coils.

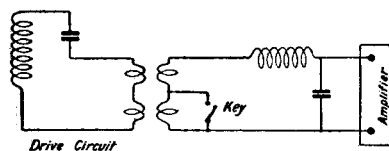

Fig. 3.—Illustrating keying arrangements.

It will readily be understood that this effect depends upon the direction of the currents in the circuits. There will be two

frequencies at which the system will tune.

The method of applying this principle at Ongar is shown in Fig. 5. There is a closed circuit,  $L_1 C_1$ , coupled to the aerial circuit. Each circuit contains two additional couplings,  $M_3, M_4, M_5$  and  $M_6$ , which introduce the energy from the two transmitters.

One transmitter is coupled by means of  $M_3$  and  $M_5$ , and the other through the couplings  $M_4$  and  $M_6$ . The coupling  $M_6$ , however, is reversed, so that in this case it is the second frequency of the aerial system which is brought into play.

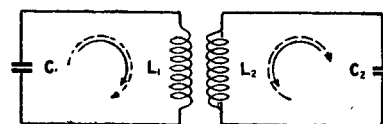

Fig. 4.—Two magnetically coupled circuits.

two oscillators, the H.T. being supplied from the main panel, and not from a separate rectifying system, as in the case of the other stations.

This latter panel consists of ten rectifiers, and ten oscillators, with an auxiliary panel carrying three absorbers.

This set was using the new valves with molybdenum anodes, which operate at a red heat—a somewhat alarming sight to any-

ft. long, carried on two towers 300 ft. high. The far end is carried over the tower and down towards the earth to increase the natural wavelength. Although this decreases the effective height, the increase in radiation efficiency due to the working wavelength

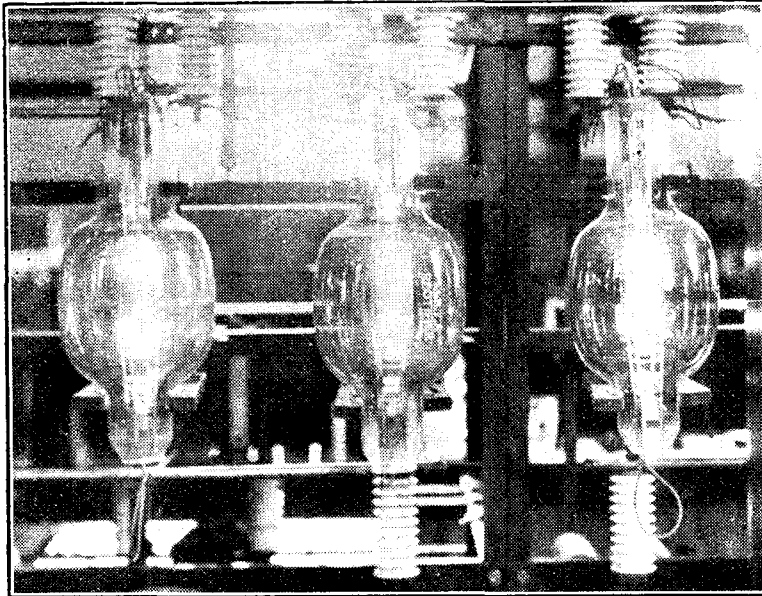

Three of the new M.T.7a valves having molybdenum anodes working normally at a red heat.

one used to the more common nickel anodes. These valves (M.T.7A), though little, if any, larger than the usual type (M.T.6), are rated to dissipate 5kw. The aerial current is 140 amps. at 60 kc.

**Aerial System**

The aerial consists of a 6-wire cage 20 ft. in diameter, 2,200 ft. long. It is supported on three towers 300 ft. high, being carried over the top on a large porcelain insulator. The far end is led down again and connected to the counterpoise through a tuned circuit, the aerial thus being of the Alexanderson multiple earth type.

The counterpoise arrangements are similar to those at the A station.

**The 'C' Station**

The C station is similar in most respects to the B station. It comprises a drive panel carrying two rectifiers and two oscillators, a main panel of ten rectifiers and ten oscillators, and three absorbers.

The aerial current is about 100 amps. at 68.9 kc.

The aerial is a twin cage 1,450

being nearer to the natural wavelength more than counterbalances this decrease.

**Wireless News in Brief**

(Continued from page 607).

EMPIRE Senatore Marconi, WIRELESS. presiding recently over the annual meeting of Marconi's Wireless Telegraph Co., said that during recent tests carried out for four days and four night communication was maintained with Australia and Canada during all the time of sending.

MACMILLAN Two further EXPEDITION. English amateurs have been in touch with the MacMillan Polar Expedition, one of them having received signals in Manchester and the other in Camberley. A 20-metre wave was being used, but the signals are stated to have been neither clear nor steady. They were received about midnight.

Mr. Goyder, of Mill Hill, was again in communication with the Expedition on July 31 and August 1 in the early morning. Signals were then strong, and it was reported that the two ships in which the Expedition is sailing, the Peary and Bowdoin, were lashed together in a dense mist. We understand that the

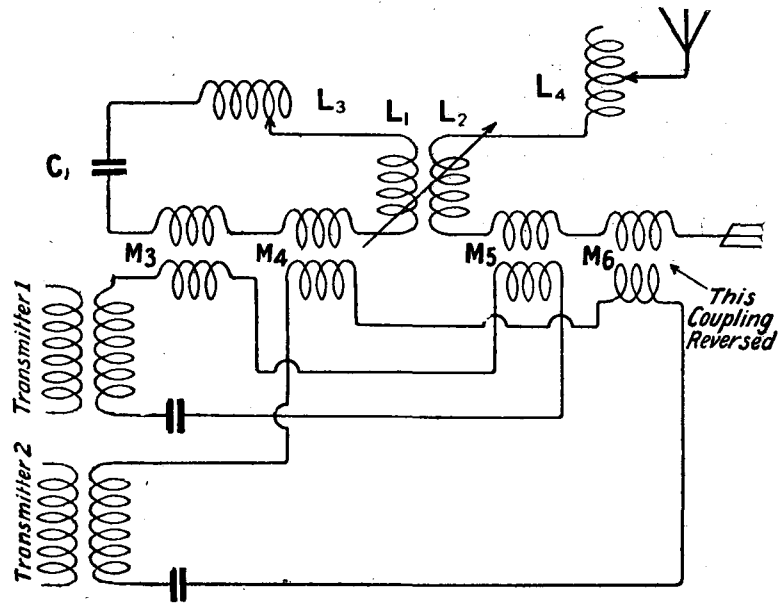

Fig. 5.—A skeleton circuit of the "split-wave" arrangement employed at the A station.

The earth screen is similar to those at the other stations, viz., ten wires 30 ft. apart on each side of the main aerial.

Expedition will transmit on 20 metres daily from 6 p.m. to 1 a.m. and on 37 metres from 1 a.m. to 6 p.m.



# Random Technicalities

By **PERCY W. HARRIS, M.I.R.E.**  
Assistant Editor.

*Some Notes of Interest to the Experimenter and Home Constructor.*

I AM just wondering what my next quarter's electric light bill will amount to! When you have had two battery chargers going continuously for about three weeks you begin to realise that you cannot get something for nothing in these commercial days. This is by way of introduction to those people who are fortunate enough to be able to have a long holiday, that even if you charge up your accumulators fully before you leave they will want a good charge at the end to bring them into condition again. Before leaving for the States I charged up every kind of accumulator on hand (those who have seen my laboratory know that this means quite a few), yet on my return I found they all needed attention; some, indeed, having lost a good portion of their charge.

\* \* \*

When recharging batteries after a long interval you will find it by far the safest plan to test the specific gravity and not to rely too much upon the fact that all cells are gassing. One large battery, for example, was on charge for a time equivalent to the usual full charge, and was gassing from the cells in what appeared to be a satisfactory way. I tested the specific gravity and found it was not up to the proper mark, and so left the battery on charge another twelve hours, at the end of which period it showed the correct reading, and indeed the plates appeared in a distinctly better condition than before.

\* \* \*

I often meet people who, in spite of regular warning from those who know, persistently disregard this point of deterioration of accumulators when not in use.

I frequently hear people say, "Oh, I haven't had my accumulator charged for a couple of months. You see, we have been away and we have not used it!" Such people are very disappointed when they find that after a year, or even less, their accumulator is practically worthless. Regular charging and a regular topping up with distilled water to make up for evaporation are not for faddists, but for every man or woman who wishes to

your set, or, indeed, hold near to the needle any object which has been cut, turned, or in any way fashioned from brass rod, and notice the deflection. You may find that one end of the condenser spindle is strongly magnetic and the other is not. Other spindles will show magnetic effects at each end. This question of magnetic brass may be of very great importance in short wave apparatus; indeed, since Mr. Collinson, of the Col-

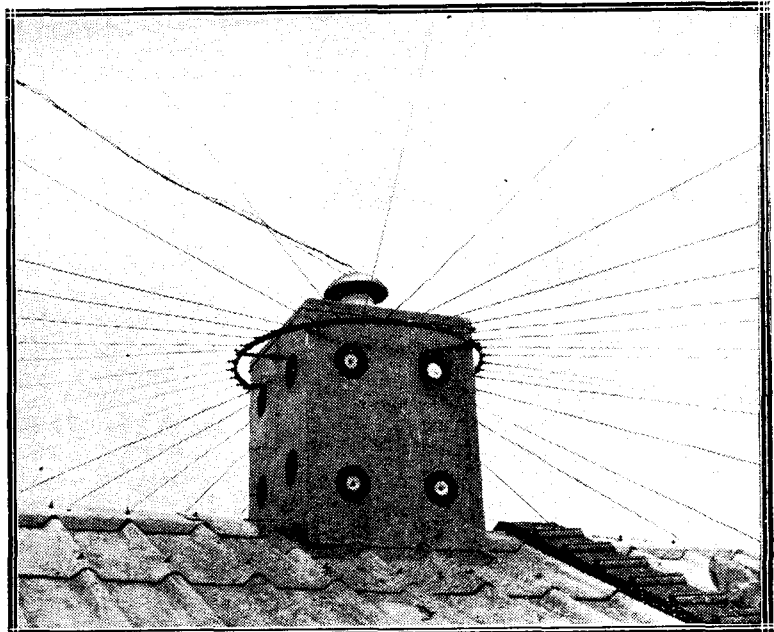

*A new photograph of the lead-in arrangements at Daventry. The wires attached to the ring are connected to the circle of earth plates.*

keep their wireless accumulator as it should be kept.

\* \* \*

Every now and then in wireless we come up against some astounding fact that we have not met before. Do you know, for example, that practically every piece of brass rod is magnetic? Take a compass needle and hold it near any brass terminal on

linson Precision Screw Co., demonstrated this fact to me recently I have been doing a lot of hard thinking.

\* \* \*

You need not think that school text-books are wrong, and what you have been taught about magnetic metal is erroneous; there is a simple explanation of this rather astounding fact. It

is that a certain proportion of iron is mixed with the brass so that it may be drawn into rod easily. It is possible to obtain non-magnetic brass, but I believe that it is not so easy to machine, and would certainly be dearer.

Before I went to America I was under the impression that our valve fitting (i.e., the four pins fitting into four sockets) was distinctly better than the American, and now that I have to accustom myself to fitting valves into my own sockets after a couple of months of using American valves, I am not so sure about it. The old American metal socket was thoroughly bad from the capacity point of view, but all the best sockets are now made of insulating material and have a very low self-

capacity. It is extremely convenient to be able to push the valve into the socket and give it a twist so that the catch engages with the notch just as one does with an electric lamp socket and electric light bulbs. The slight twist at the end of the motion makes a rub on the pin contacts, and, indeed, some of the sockets I have seen are made so as to give a slight scraping action upon the pins.

\* \* \*

There is one thing about American valves, however, that is most irritating, and indeed I wonder the American public puts up with it. I refer to the use of different size sockets and bases for the dry cell and battery tubes, as they are called. Dry cell valves correspond to our .06 ampere variety, and practi-

cally all the other valves are of the B.4 or D.E.5 type. This means that if you have a set you have made with sockets for dull emitter valves, you cannot use bright emitters (or the semi-bright emitters) without changing all the sockets.

Dr. Lee de Forest, who has just gone back to the States after a visit to England and the Continent, tells me that he was very greatly impressed by the Daventry station and its equipment. In fact, he was quite enthusiastic about it, and told me, when I met him in Romano's the other day, that he is looking forward to the time when they can have something like it in America! Lack of available funds, he says, is the great handicap.

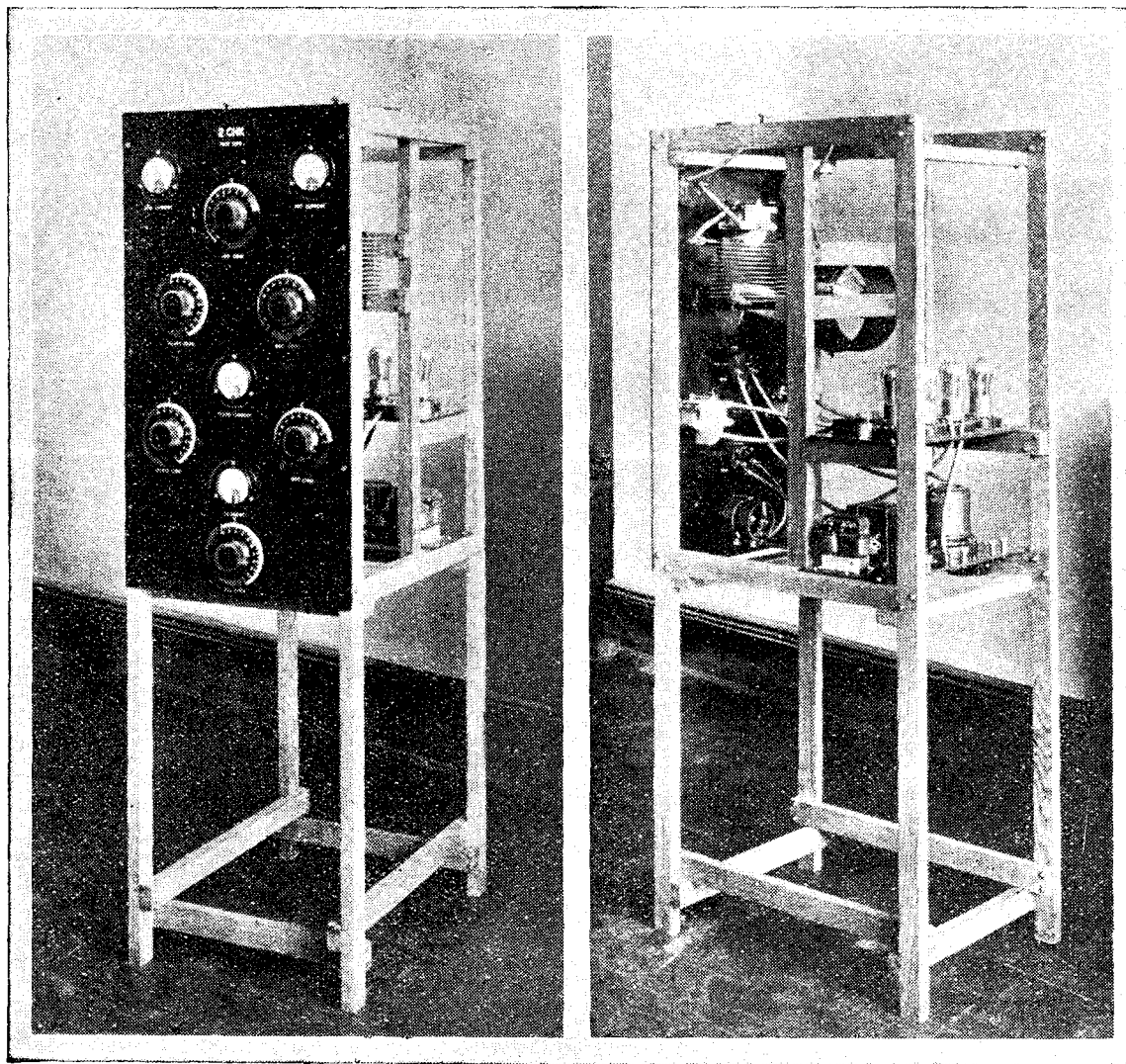

A very neat transmitter employing a 4-coil Meissner circuit used by Harold Sachs (U2CHK), the A.R.R.L. manager for Manhattan, N.Y.

# Inventions and Developments

*Under this heading it is proposed to review, from time to time, the latest developments in the radio world.*



VERY valuable contribution to the existing data on loud-speaker design has been made by Messrs. Rice and Kellogg, of the General Electric Co., of America. Despite the very marked improvements which have been made in loud-speaker design of recent years, the quality of speech and music has always been such as to leave a feeling that something was lacking.

It has recently, however, been recognised that the missing factor in satisfactory reproduction lies in the particularly low frequencies. The reproduction of such low frequencies of the order of 50 to 150 or 200 cycles per second is beyond the range of the average loud-speaker.

## Hornless Loud-Speakers

The hornless pattern of loud-speaker, using a comparatively large diaphragm with a low resonant frequency, has overcome this trouble to a certain extent, but the complete solution of the problem still baffled the designers for some time.

Messrs. Rice and Kellogg, however, appear to have overcome the difficulty in a very satisfactory manner by placing in front of the diaphragm a baffle plate considerably larger than the diaphragm itself but having a hole cut therein just a little larger in diameter than that of the diaphragm. It was found that the very low frequencies were radiated from both sides of the diaphragm, the resultant effect at a short distance being nothing. The insertion of this baffle plate, however, prevented this interference between the two sound radiations produced, the result being that the low-frequency air waves were permitted to travel outwards unhindered.

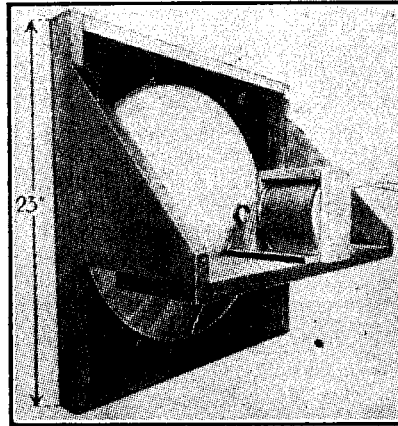

*A paper cone type of loud-speaker having a moving coil driving system.*

## Low-Frequency Amplifiers

The results achieved on this loud-speaker are so remarkable that it is hardly possible to distinguish the actual spoken voice from the reproduced tone from the loud-speaker. Mr. Harris,

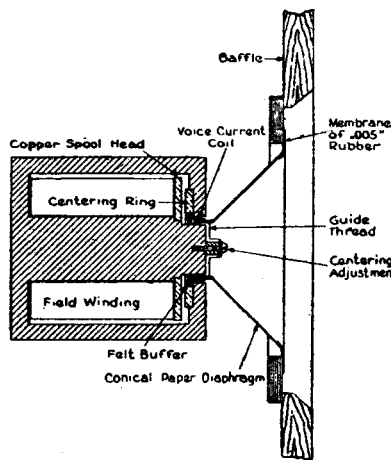

*Diagram of the Rice-Kellogg pattern of loud-speaker showing the baffle plate.*

who heard the instrument during his travels in America, describes his experiences with it on another page. The instrument in question undoubtedly marks a con-

siderable advance in the science of loud-speaker design, and it is interesting to note in this connection that as the low frequencies have such a marked effect on the quality of reproduction, it is essential for the low-frequency amplifier, which is used before the loud-speaker, to be able to reproduce such frequencies as well as the comparatively high ones.

## Improved Designs of Amplifier Required

A reference to the existing curves of low-frequency amplifiers will show that, although a comparatively straight line amplification may be obtained from 500 or 600 cycles per second upwards, the amplification produced falls off very rapidly below these frequencies. It would seem therefore that considerable research work is needed in order to produce low-frequency amplifiers to cope with this new development in loud-speaker design. It is worthy of note that the loud-speaker itself, as produced by the General Electric Co., of America, is to be sold only with the attendant low-frequency amplifier, which, of course, has been specially designed to give good amplification at these very low frequencies.

## Piano Music

Piano music, in particular, suffers when reproduced on the usual types of loud-speaker. When it is remembered that the frequency of the lowest note of the average piano is less than 25 cycles per second the need for faithful amplification at very low frequencies immediately becomes apparent.

The complete instrument is described in a paper read before the American I.E.E. in April, a more complete abstract of which will be given in a future issue.

# Correspondence

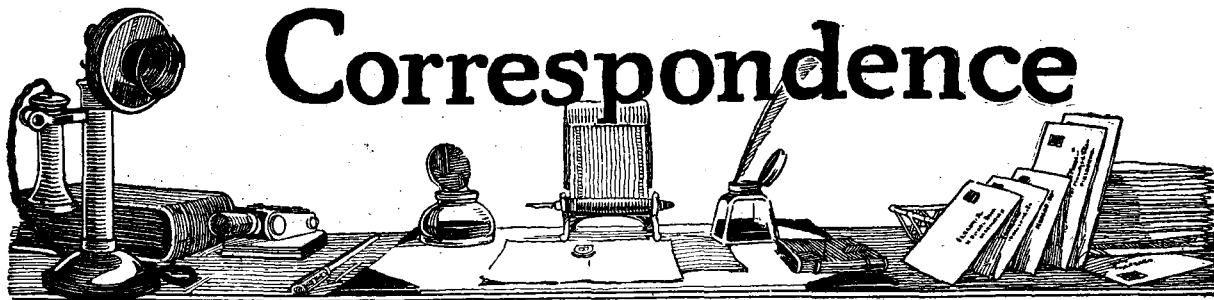

### MISUSE OF CALL-SIGN

SIR,—I should be extremely grateful if you could find space in an early issue to comment upon the fact that some person is illegally using my call-sign, G2MA. During the past three weeks I have received numerous QSL cards, but upon close investigation find they do not refer to my transmissions.

At times it appears that the illegal transmissions have been within a few minutes of mine, and thus cause considerable doubt and confusion in endeavouring to sort out QSL cards relative to my signals.—Yours faithfully,

P. L. SAVAGE.

Lowestoft.

### A SHARP-TUNING SINGLE-VALVE RECEIVER

SIR,—I am very pleased with the "Sharp-Tuning Single-Valve Set," by Mr. Stanley G. Rattee, M.I.R.E., published in the March issue of *The Wireless Constructor*. Chelmsford was very loud, and it gave fair loud-speaker results. Daventry is just as good; London, Bournemouth, Radio-Paris and Hamburg came in very well up till recently, but 6BM is very faint now. Cardiff, Glasgow and Nottingham were not so good. I am 72 miles from 2LO and 110 from 5XX.—Yours faithfully,

C. WESTON.

Walton-on-Naze, Essex.

### RE-ALLOCATION OF CALL-SIGNS

SIR,—Will you kindly publish the fact that the call letters of the Manchester Wireless Society are G6MX, and that the permits covered by 2FZ, 5MT, and 5MS have been returned to the General Post Office, since when they have been re-issued. Perhaps the present holders of these three permits will notify listeners of their whereabouts through the medium of your columns. All communications for the Manchester Wireless Society and referring to tests of G6MX should be addressed to Hon. Sec., 66, Oxford Road, Manchester.

Station G5MB is worked by the Hon. Treasurer of the above

Society, from 808, Stockport Road, Longsight, Manchester. — Yours faithfully,

Y. W. P. EVANS,  
Hon. Secretary.

Manchester.

### THE PROPOSED B.I.R.E.

SIR,—You will probably have read an announcement in the electrical journals to the effect that the question of a new wireless society was discussed at a recent committee meeting of the I.E.E., at which Mr. Nelson was present by invitation. The statement goes

I am to add that before this can be proved the statement which is shortly being issued by the Committee of the I.E.E. will have to be studied and commented upon by those engaged in the radio profession.—Yours faithfully,

Y. W. P. EVANS,

Hon. Secretary,

Proposed Radio Institute.

Manchester.

### A NINE-VALVE SUPER-HETERODYNE RECEIVER

SIR,—You may be interested to hear my results with the "Nine-

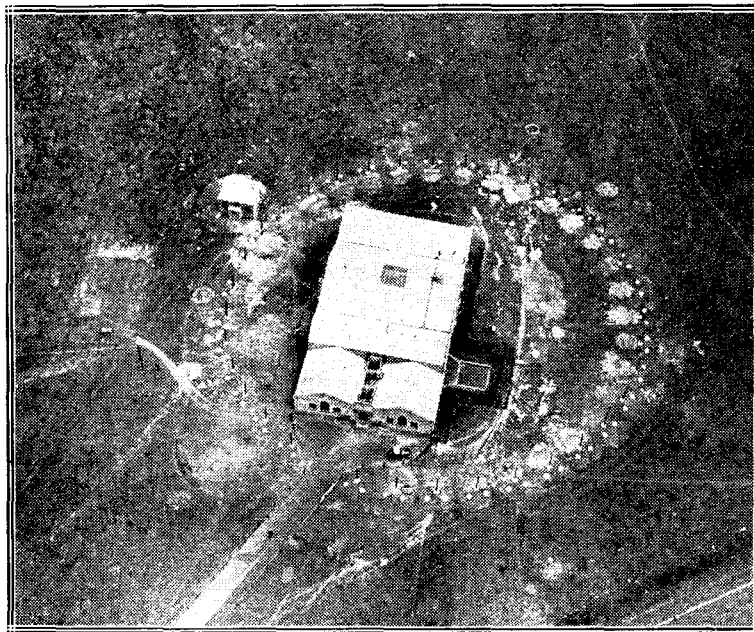

An unusual view of the Daventry station. Note the large circle of earth plates.

on to say that "the definite conclusion has been arrived at that there is no need for a new body." As Hon. Secretary of the proposed Association, I have been asked to state that the definite conclusion arrived at is only definite in so far that it should be augmented by the words, "Should it be proved conclusively that the Radio Engineering Section of this country is fully catered for by the Wireless Section of the I.E.E."

Valve Superheterodyne" Receiver (described by John Scott-Taggart, F.Inst.P., A.M.I.E.E., in the May issue of *Modern Wireless*). My pocket came largely into consideration, so, as far as I could, I used the components I already had. I kept to the lay-out more or less, except that I used a separate vernier for the S.W. transformer. I altered the switching arrangement as I wished to use some old switches I had, and have wired it so that I

can use seven, eight or nine valves. I was troubled at first with a very noisy background. I shunted a .005 condenser across the primary of the first transformer and took out the second transformer and replaced it by a choke coupling made out of an old telephone transformer.

Using a frame of 14 turns, I get all the B.B.C. main stations at full loud-speaker strength, so that I can hear loudly all over the house. I have had several relays, but have not had time to log them yet: I find a slight improvement by using a 50 loading coil. It is a delightful set to handle. From the time I have taken adapting it for unsuitable components I can well appreciate the time and care that the original design must have taken.—Yours faithfully,

PETER C. GORDON.  
Helsington, nr. Kendal.

GERMAN AMATEURS

SIR,—Please find enclosed a list of the German amateurs. Of these stations D<sub>9</sub>, Y<sub>4</sub> and Y<sub>5</sub> have already operated with the foreign countries, especially France.

During the great congress of the German "Funkkartell" at München from July 25 to 27, the operator of station D<sub>9</sub> was sent to this town to establish communication with station C<sub>8</sub> in order to transmit news about the congress; Y<sub>4</sub> participated also in these tests.

This was the first time German amateurs have actively co-operated in the service of bringing special news of their own congress. The communication took place on the 85-metre waveband.—Yours faithfully,

H. KRAUS.  
Berlin.

"THE TRANSATLANTIC FOUR"

SIR,—The sensitivity of this set (by Mr. Percy W. Harris, in *Modern Wireless*, November, 1924) is really remarkable, and the selectivity is better than anything I have heard before. Using two D.E. valves for H.F. and one as detector, I can pick up anything in this country, and with the fourth power valve put it on the loud-speaker beautifully.

I live less than three miles from 2ZY on the North side, but can cut them out for Liverpool, Nottingham, Sheffield, Stoke, Newcastle, Birmingham, French, German and Spanish stations. The aerial is badly screened and only 25 ft. high. I have three earths, but use for preference a counterpoise.

I had America several times early this year, but not of late. Madrid comes in beautifully, except when the howling fiends get to work.

I find myself that it simply is not necessary to oscillate to get results. The power is there. I should like to see an expert handle this set, because I don't presume to be able to manage it to its best advantage.

My coils are home-made, but quite good. No doubt you have had a whole heap of congratulatory letters on the Transatlantic IV. Please add mine to the list, for I assure you I am very delighted with the whole set. The whole is fitted into a very old Jacobean desk and is quite good-looking. The speaker I made; the paper diaphragm and Brown's headphone are also finished in the same style, and it works. Again thanking you,—Yours faithfully,

J. A. EDGE.

Kersal.

SIR,—I am just writing to let you know our results with the "Transatlantic IV" (by Percy W. Harris, *Modern Wireless*, November, 1924), which I made last April. The aerial, which is only a temporary one, has an effective height of about 6 ft., passing close to buildings. However, we get Birmingham, London, Manchester, Cardiff, Bournemouth, Liverpool and Nottingham very well on the loud-speaker.

Altogether we are getting very good results, being very satisfied with the set. I may add that I put in a variable grid-leak, which gives a useful adjustment for long-distance stations.—Yours faithfully,

A. B. DICK.

Alvechurch, Worcestershire.

THE TRANSATLANTIC V IN EGYPT

SIR,—You will like to hear how the "Transatlantic V" (by Percy

Annaberg (Erzgeb.)	Grosse Kirchgasse, Gewerbeschule. Radiovereinigung Obererzgeb. e.V., Ortsgruppe d. Mitteldutschen Radioklub Leipzig	Q 3
Berlin	Berlin W. 62, Kurfürstenstr. 112, Funktechnischer Verein Gruppe Elektrowerke	D 9
"	Schlachtensee, Gelände d. Güterbahnhofs F. T. V. Berlin N.W. 7, Dorotheenstr. 43	C 8
"	Charlottenburg, Cauerstr. 19, Dipl. Ing. A. Kofes, Ortsgruppe Berlin F. T. V. W. 9, Potsdamerstr. 4	B 7
"	Berlin N.W. 87, Sickingenstr. 71, F.T.V. Gruppe Osram	B 9
Berlin-Lichtenberg	Lichtenberg, Lessingstr. 19, Herrn Kohnert F.T.V. Ortsgruppe Lichtenberg	B 6
Berlin-Lichterfelde	Zehlendorf, Staatliche Bildungsanstalt, Deutscher Radio-Klub e. V. Charlottenburg, Windscheidstr. 35, für Ortsgruppe Wanneseebahn	D 6
Braunschweig	Braunschweig, Rebenstr. Städt. Berufsschule Deutscher Radio-Klub Berlin, O.G. Braunschweig	Q 2
Bremen	Bremen, an der Weide 33, Institut f. Radiokunde	P 5
Cassel	Cassel, Wilhelmshöhen Allee 31, Radio-Klub Cassel, Ortsgruppe des Radioclubs Frankfurt	Q 5
Cottbus	Cottbus, Spreestr. 14, Restaurant Uelz, Deutscher Radio-Klub Berlin, O.G. Cottbus	Q 7
Darmstadt	Kranichsteinerstr. 7, Verein der Funkfreunde Darmstadt Starkenburg, Südwestdeutscher Radio-Klub	I 8
Erfurt	Predigerstr. 6, Funkvereinigung e. V. Erfurt	Q 4
Enzweilingen	Hauptstr. 202, Ortsgruppe Veilingen des O.F.V.	Y 6
Frankfurt/Main	Robert Meyerstr. 2, Südwestdeutscher Radio-Klub	K 5
Fürstenwalde/Spree	Burgstr. 16, Gewerbeschule Deutscher Radio-Klub, Ortsgruppe Fürstenwalde u. Umg.	B 1
Hanover	Thalstr. 6, Gesellschaft der Funkfreunde e. V. Hanover	J 9
Liegnitz	Wilhelmstr. 32, Landwirtschaftsschule, Verein der Funkfreunde Schlesiens, Ortsgruppe Liegnitz	I 4
Magdeburg	Johannsfahrtstr. 16, F.T.V. Bezirksgruppe Magdeburg, Magdeburg, Augustastr. 36	P 0
Metzschkau	Schützenstr. 1 Funkwissenschaftliche Vereinigung Metzschkau	J 2
Münster Westfa.	Steinfurterstr. 42, Westdeutscher Funkverband e.V. Münster	J 1
Potsdam	Hasensprung 13, F.T.V. Ortsgruppe Funkfreunde Potsdam	B 0
Ringewalde	Ringewalde Kreis Templin, Schloss Deutscher Radio-Klub, O.G. Ringewalde	C 1
Stuttgart	Alexanderstr. 31, Oberdeutscher Funkverband, Stuttgart Pfitzerstr. 2	Y 4
"	Kernerstr. 69, Funkverein Stuttgart e.V.	Y 5



W. Harris, *Modern Wireless*, June, 1924) works in Egypt, whence I have just come on leave, and whither I return on the 22nd of this month.

I made up the set as Mr. Harris described it in *Modern Wireless*, and the results I obtained persuaded friends who had bigger sets of other designs to sell up and make "Transatlantic V's."

I seldom needed more than three valves to hold Aberdeen or Bournemouth with four pairs of headphones, and one night I borrowed a loud-speaker, which gave KDKA on five valves at a strength equal to my gramophone.

The nearest station is 800 miles from us, but I could get Europe or U.S.A. on any night, and disproved the current belief among owners of other sets that Egypt was a bad country for static, for I never at all seemed to get trouble, except with spark stations, which I always got rid of. Your circuit is a very quiet one.

You said in *Modern Wireless* that you would like to hear particulars of results, so I hope you will find the above interesting, even if scant in information.

Wishing you every success in your work.—Yours faithfully,

F. E. W. LEE.

Acomb, York.

**THE "WIRELESS CONSTRUCTOR" WAVE TRAP**

SIR,—I have made the Wave-trap described by Mr. Percy W. Harris in the March issue of *The Wireless Constructor*, and use it with an All-Concert de Luxe receiver, which receiver differs from that described in the Radio Press Envelope No. 4, only in that the three coils are in a three-coil holder on the front of the panel (reaction in the centre) instead of two coils on the panel and one in the cabinet. This receiver is quite the most satisfactory I have tried, but, being used to loose coupling, I found it not quite so selective as my previous receiver (ST50).

I find that when the wave-trap is in use the anode coil of the set can be brought much nearer the reaction coil, thus compensating to a certain extent for the loss of signal strength due to the trap and causing no click when the aerial terminal is tapped with a wet finger.

Used as a tuner, with the aerial coil removed from the set the trap appears to give about as good selectivity as loose coupling, is easier to handle and is very critical.

I am very pleased with the Wave-trap as it enables me to receive stations clearly which were almost blotted out by the local station before.—Yours faithfully,

Sheffield.

TRAPTOR.

**THE "ANGLO-AMERICAN SIX"**

SIR,—Although reception here is, I should think, at least as difficult as any other portion of the globe, owing to atmospherics and interference from high-power stations and H.M. ships, it may interest you to know that I am having really excellent results with an "Anglo-American" set described by Mr. Percy W. Harris in *The Wireless Constructor* for January and February which I have built to your design.

On an average decent night practically the whole of the European stations can be tuned in, Bournemouth at loud-speaker strength and other northern stations at not much weaker strength.

May I endorse your opinion as to the selectivity and purity of tone of this instrument, which are really remarkable.

Most of the components I have used are as described in the list given by you, the exceptions being "Fullstop" dual condenser, "Polar" neutralising condensers, McMichael fixed condensers, and Lissen T<sub>1</sub> transformer and rheostats.

If you think this of any interest to your numerous readers you are at perfect liberty to publish it.—Yours faithfully,

C. E. H.

Malta.

**Quality RADIO APERIODIC DUPLEX COIL**

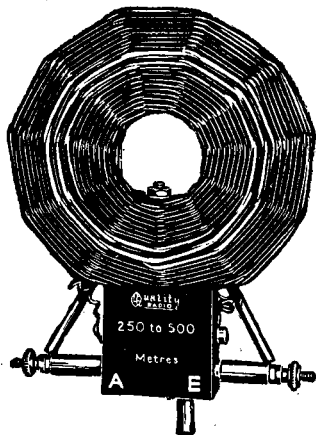

This consists of primary and secondary wound together in large gauge in different coloured wire, mounted on standard plug-in fitting. In a large measure eliminates interference and greatly improves the selectivity of tuning, made for the broadcast wavelength and with a .0005 condenser tunes from 250 to 500 metres.

Price 6/6, post 3d.

**Quality RADIO TERMINAL CLEANER**



A useful little tool which enables the terminal to be cleaned by a twist of the holder between thumb and finger. 6d. each, post 2d.

**GOSWELL ENGINEERING CO., LTD.**  
95, 96, 97, 98, WHITE LION ST., LONDON, N.1

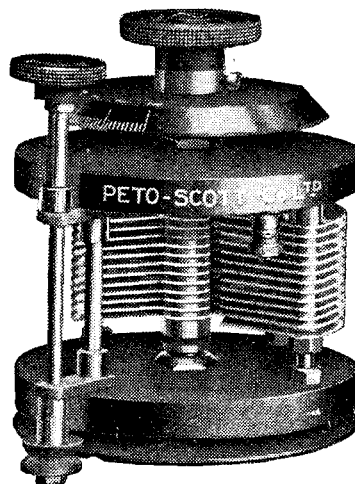

**This vernier Condenser was designed by a practical Wireless Engineer**

EVERYONE knows the disadvantage of the usual single plate vernier condenser. How impossible it is to record the exact dial reading, owing to the difficulty of knowing exactly where the vernier plate is situated. Everyone knows, too, how difficult it is to bring a distant station when contact to the moving spindle is made by rubbing instead of by a permanent spring. This new Peto-Scott de Luxe Square-law Condenser has been designed by a practical wireless engineer. It is the ideal condenser—built by a man who knows how imperative it is to use a slow motion for all the plates and not to use a separate vernier plate. Its slow movement is obtained by means of a smooth 8 to 1 rubber friction gearing. Only solid ebonite is used—no cheap substitutes. All metal parts are well plated and the whole Condenser is an excellent example of the instrument maker's art. Scrap your old-fashioned Condenser—invest in the Peto-Scott and get new delights from long-distance reception.

**Low Loss—Permanent Contact—No Backlash.**  
Prices: .0003—18/6; .0005—21/-

Send for the following Books:—**Pilot Chart**—showing illustrations of more than 30 Sets for Home Construction. 3d. post free.  
**Component Catalogue**—3d. post free.  
**Peto-Scott Wireless Book**—containing over 80 Circuit Diagrams. 1/5 post free.

**PETO-SCOTT Co. Ltd.**  
Head Office, Mail Order and Showrooms:  
77, City Road - - LONDON, E.C.1  
Branches:—LONDON—62, High Holborn, W.C.1. WALTHAMSTOW—230, Wood St. PLYMOUTH—4, Bank of England Place. LIVERPOOL—4, Manchester Street.

P.S. 3337.

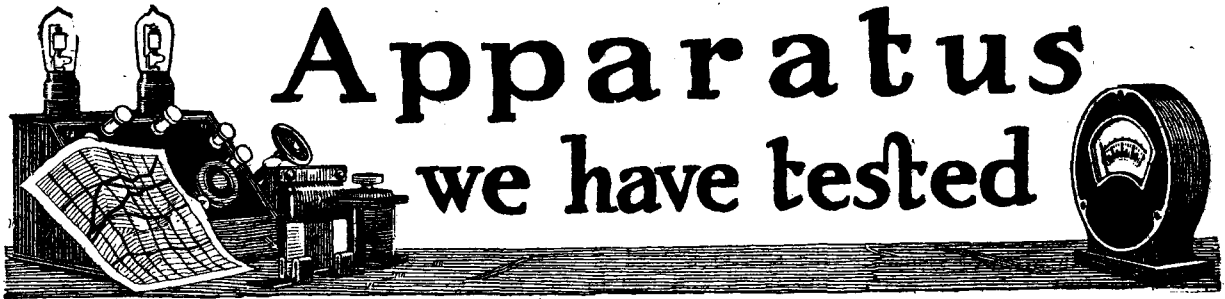

Conducted by A. D. COWPER, M.Sc., Staff Editor.

**A Low-Capacity Panel Valve-Holder**

A four-pin valve holder for the top of the panel which at first glance appears to be of the ordinary solid high-capacity type, but which showed itself on actual test to possess an extraordinarily low capacity between sockets, is that recently introduced by Messrs. Lissen, Ltd. In this the sockets are made in the ebonite base, as usual, but there are no metal sockets. In place of the latter small spring contact fingers project in through lateral holes near the top of the cylindrical base, so as to make a secure self-cleaning contact with the valve pins. These

fingers are mounted by screws externally, long soldering tags passing down through four well spaced small holes in the panel, or they can be arranged radially for external connections. On measurement, after eliminating capacities of leads, the plate to grid and grid to filament socket capacities came out at the very low figure of less than  $1/5 \mu\text{mF}$  each. The insulation resistance was unexceptionable. The sockets should therefore be extremely useful in very short-wave work, and for tuned high-frequency circuits where casual capacities, and particularly plate to grid capacity, should be kept low. The holder was finely finished and of attractive

appearance; it can be strongly recommended, particularly to replace the ordinary type in receivers wherein the valves are mounted on the panel top in full sight.

**"Efesca Vernistat"**

Messrs. Falk, Stadelmann & Co., Ltd., have sent for trial and criticism a type of wire-resistance filament rheostat which is designed to give an unusually fine adjustment by providing for three complete turns of the control knob in order to cover the whole resistance range available. Thus the adjustment is some three times as fine as with the more conventional pattern of wire resistance. The long

# HAWK

MAXIMUM

Efficiency

—

Strength

Prov. Pat. 20289

WATERPROOF

# COILS

MINIMUM

Capacity

Damping Effects

Resistance

Prices below Tel. 832 Kingston.

Coil	Wave Length using '001 Variable Condenser in Parallel		PRICE.
	MAXIMUM	MINIMUM	
15	—	—	2/-
25	395	190	2/4
30	435	240	2/4
35	515	360	2/8
40	680	370	2/8
50	825	485	3/-
75	1250	600	3/4
100	1820	815	3/10
150	2300	960	4/8
200	3100	1870	5/4
250	3750	2200	5/8
300	4500	2300	6/-
400	4950	2500	6/6

Sold by all Wireless Dealers.

Sole Manufacturers:

The Hawk Coil Co., LTD., ST. MARY'S ROAD, SURBITON, SURREY.

Folks, meet a really good Condenser!

**THAT'S** me! The Efficient Watmel, radio men call me. Efficient—it's my middle name, and you'll say it is when you hear the improvement I make in the results from your radio. Read my test report. Something to be proud of, isn't it? I possess all the good points you look for in a Fixed Condenser and a few more besides. If you're interested in better condenser efficiency—visit your dealer and ask for me. Closer acquaintance will prove to you my sterling qualities.

**Watmel Test Report.**

1. Mica Insulation up to 2,000 volts.
2. Complete Condenser up to 1,000 volts.
3. Capacity checked.
4. Insulation up to 500 volts After Final Assembly.
5. Final Capacity Test PASSED OUT 100% EFFICIENT.

**Prices.**

Capacities for Standard Grid Condensers.

-00005 to -0005 - 2/6 each.

Standard Fixed Condensers.

-002, -001 - 2/6 each.

-0025, -006 - 3/6 each.

Combined Grid Leak and Condenser is - 2/- each.

The Watmel Wireless Co., Ltd.

332a, GOSWELL ROAD - LONDON, E.C.1.

Representative for Lancashire and Cheshire—  
Mr. J. B. LEVIEE, 28, Hartley Street, Lovenshulme, MANCHESTER.

circular spiral of Eureka resistance wire of smaller cross-sectional diameter than usual is coiled three times round the former barrel in a groove. The contact finger is mounted on a longitudinal slide, so as to follow the spiral winding as the drum attached to it rotates; a guide pin rides in a narrow slot cut in the drum for this purpose. An insulated spring contact finger bears on the metal end ring of the drum and maintains connection with the one end of the resistance spiral. Positive stops at each end of the travel limit the motion. This ingenious mechanism was found, on trial, to work effectively, giving the required fine adjustment and silent operation, though there was considerable friction in the movement. The usual type of one-hole-fixing is provided, giving an unusually large range of available panel thickness; very small terminal screws are apparently considered adequate by the makers. No provision is made for securing the knob and pointer on the spindle other than the customary precarious method of a lock-nut. The device is strongly made and finished in bright nickel plate. It was noted that the spiral got very hot when passing a current of 0.7 amperes for a bright-emitter valve; the maximum resistance available was about 9 ohms.

**"Agnit" Coil Stand**

Two- and three-coil holders of the behind-panel geared type have been submitted for our comment by Messrs. Lotinga & Co. The two-coil type has single-hole-fixing; the coils when inserted stand out behind the panel, the actual panel space occupied being about 2 1/2 in. by 1 1/2 in. The moving coil-plug is pivoted, and carries a crown gear wheel, into which gears a smaller pinion on the inner end of the short control spindle, operated by the usual external knob. The gear ratio allows of fine adjustment; the back-lash was but small, whilst a motion of a little over 90 degrees was allowed for variation of coupling. Spring washers on the pivot made for smooth action; electrical connections were provided for by large soldering tags. The mechanism was sturdy enough to carry the largest sizes of plug-in coils.

The three-coil holder was a replica of the double-coil holder, but with a similar geared movement on each side of the fixed coil; two holes were required for fixing the instrument behind the panel. Hand-capacity effects should not be very troublesome with this type of holder, as the control spindles are insulated and the knobs some distance away from the coils; the spindles might with advantage be

increased in length with this factor in view. A little more latitude in respect to panel thickness might well be provided. Finish, workmanship and insulation appeared adequate.

**Inductance Selector Switch**

We have received from Messrs. Wilkins and Wright, Ltd., a useful little instrument embodying one of their well-known "Utility" low-capacity switches, a selector switch for putting into circuit either of two alternative plug-in inductances. The instrument consists of a small panel mounted behind the main panel and at right-angles to it on a metal bracket with the usual one-hole fixing device, and with a control knob projecting in front. Two coil holders or plug-in fittings—the conventional plug and socket—are mounted on opposite ends of this little panel, and two terminals are provided at the rear. By turning the switch-knob, either of these is inserted in circuit in series with these terminals, the other one being cut out entirely. Applications of this device in, for example, simple two-range crystal sets for the local B.B.C. station and the high-powered station alternatively, for tuned-anode coils mounted within a cabinet set, etc., are fairly obvious. An improvement which might be



# "TELWAVE"

(Registered)

## RADIO COMPONENTS

(MARTIN-COPELAND PRODUCTS)



"Telwave" Switch-Plug and Jack.

### The "Rolls Royce" of the Radio World.

Our New Illustrated Catalogue will interest you.

### HIGH-GRADE COMPONENTS ONLY.

## THE ELECTRICAL EQUIPMENT & CARBON CO., Ltd.,

109/111, New Oxford St., London, W.C.1

**All Post Free At Callers Prices**

Orders 5/6 value, carriage paid.

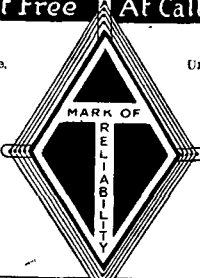

Under 5/6, 2d. per 1/4 for packing, etc.

<p><b>Ebonite Panels.</b></p> <table border="0"> <tr><td>9" x 6"</td><td>2 1/2</td><td>3/16</td></tr> <tr><td>12" x 9"</td><td>2/2</td><td>1/10</td></tr> <tr><td>12" x 12"</td><td>4/6</td><td>2/3</td></tr> <tr><td>15" x 9"</td><td>5/6</td><td>5/8</td></tr> <tr><td>15" x 12"</td><td>7/6</td><td>5/8</td></tr> <tr><td>4" x 4"</td><td>8d.</td><td>6d.</td></tr> <tr><td>7" x 6"</td><td>1/6</td><td>1/8</td></tr> <tr><td>8" x 6" x 1"</td><td></td><td>10d.</td></tr> </table> <p>Any size cut. Sq. in. 2" id., 1" 1d.</p>	9" x 6"	2 1/2	3/16	12" x 9"	2/2	1/10	12" x 12"	4/6	2/3	15" x 9"	5/6	5/8	15" x 12"	7/6	5/8	4" x 4"	8d.	6d.	7" x 6"	1/6	1/8	8" x 6" x 1"		10d.	<p><b>Square Law Var. Condensers with knob &amp; Dial.</b></p> <table border="0"> <tr><td>.001 panel type</td><td>6/6</td></tr> <tr><td>.0005 .. ..</td><td>5/-</td></tr> <tr><td>.0003 .. ..</td><td>4/6</td></tr> <tr><td>Verrier Bladeextra 1/4</td><td></td></tr> <tr><td>"J.B." "Ormond" &amp; "Utility" usual prices</td><td></td></tr> <tr><td>Verrier, no dial 2/6</td><td></td></tr> <tr><td>Swane 3/2, 7 2/3</td><td></td></tr> <tr><td>Polar types ..</td><td>10/6</td></tr> </table>	.001 panel type	6/6	.0005 .. ..	5/-	.0003 .. ..	4/6	Verrier Bladeextra 1/4		"J.B." "Ormond" & "Utility" usual prices		Verrier, no dial 2/6		Swane 3/2, 7 2/3		Polar types ..	10/6
9" x 6"	2 1/2	3/16																																							
12" x 9"	2/2	1/10																																							
12" x 12"	4/6	2/3																																							
15" x 9"	5/6	5/8																																							
15" x 12"	7/6	5/8																																							
4" x 4"	8d.	6d.																																							
7" x 6"	1/6	1/8																																							
8" x 6" x 1"		10d.																																							
.001 panel type	6/6																																								
.0005 .. ..	5/-																																								
.0003 .. ..	4/6																																								
Verrier Bladeextra 1/4																																									
"J.B." "Ormond" & "Utility" usual prices																																									
Verrier, no dial 2/6																																									
Swane 3/2, 7 2/3																																									
Polar types ..	10/6																																								

**SEND FOR NEW FREE Comprehensive Price List.**

**TRADE ENQUIRIES INVITED Generous Terms - Prompt Service.**

<p><b>Aerial Wire</b> 7/200 Eumid. Bright 100" 3/3 " Electron 1/8 " Mars 0/6 Lead-in 4d. yd.</p> <p><b>Insulators</b> Shall, 2 1/2" x 3/4" 3d. Crysox type 6d. Lead-in 4/- " 6" 9d. " 1"-, 12" &amp; 15" 1/3</p> <p><b>Valve Holders</b> Type A 7d., Polar 1/3 Screwed 8 nuts 5d. Ebonite " 10d. Do. Open Type 6d. "Security" Valve Holder 1/-</p> <p><b>Condensers.</b> Dubilier (Usual Edson-Bell prices) New Mansbridge, mfd. 3/6, 1 mfd. 2/6</p> <p><b>Coil Holders.</b> Ashley fixed .. 2/6 " moving .. 3/6 "granic 3 set 8/6 Ebonite 3 Coil 3/6 " 2 Coil 2/0</p>	<p><b>"Coil Plugs" 1000-</b> ohm. ex Govt. Choice Ebonite .. 10d. Superior .. 1/3 Narrow .. 6d. Basket .. 2/6 Athol " Ebonite 1/2 Do. Forceman 1/- Horned Coil Plugs 6d. Basket Coil Sets, C-1/8, 4-1/-.</p> <p><b>British Wires.</b> swg. dec. sec. dec. Type A 7d., Polar 1/3 5d. 1/11 2/11 3/6 20 2/2 3/4 4/2 22 2/6 3/9 4/7 24 2/11 3/10 5/- 26 3/4 4/2 5/9 28 3/9 4/9 6/6 30 4/10 5/4 7/6 32 5/6 6/- 8/6 36 8/- 8/6 12/- 40 17/- 14/8 20/-</p> <p><b>Variable Leaks.</b> Filtrom C-7 meg. 3/- Watmel C-5 meg. 2/6 Lissen type .. 2/6 " Resistances 2/6</p>	<p><b>R. T. Batteries.</b> With Wandler Plugs 100v. 8/- 30v. 4/10 80v. 4/- 10v. 2/- 4v. F.L. Dtry. 1d. 60v. Low-Drty. 15/0 80v. 1/- 10v. 1/0</p> <p><b>New Items &amp; Novelties.</b> One hole ring. 1/8 Standard Plugs 1/8 or Telephone type Potentiometer 800 ohms ex-Govt. 5/- Microphones .. 2/6 Alum. B-bands. 2/6 Ex-Govt. Dewar Switches 12 contact .. 2/6 All "Icronic" Lissen, "Eurodept.", Edson, Bell, "Atlas," &amp; "Sterling," goods supplied. A Reader writes: "Many thanks for your Catalogue. This is an admirable book, let, concise and well arranged and will be exceedingly useful." Have you got one? IT'S FREE.</p>	<p><b>Transformers L.F.</b> Radio Inst. (new) 25/- Silvertown .. 21/- "Granic 21/- &amp; 23/- Burnside (new) 24/- Reimilly 10/- &amp; 12/6 "Parants .. 12/6 "August 11/- &amp; 14/6 "Royal .. 20/- R.L.F. Modulation, or Telephone type 8/- H.P. August .. 5/- McMichael's .. 10/- Oclah 600 .. 5/6</p> <p><b>File Accessories.</b> Good quality 1/6 "Granic .. 7/- "General .. 7/- "Ormond 2/- Ajax .. 4/- "Burnside .. 5/- "T.C.B. 4/- &amp; 5/- "Microset .. 2/9 "Peerless Jr. .. 2/6</p> <p><b>Headphones.</b> 4,000 ohms. Brown's .. 20/- "T.H. Siemens, General Branders, .. 20/- "Radio .. 20/- "Ericson, Clarstone and Sterling 22/6 "Fellowes 16/6 "Air weight 9/- "Adjustable 10/3</p>
--	---	--	--

621

suggested is that of mounting the holders so that the coils when inserted are mutually at right angles.

**An Unsatisfactory "Permanent" Detector**

Samples of a new "permanent" detector have been received for test from E. Gwyther. These are mounted in an ebonite tube 2 in. long, with a substantial terminal at each end. On closer examination the sample dissected proved to be of a familiar type—a fragment of galena crystal and a cat-whisker fixed in a (presumably) favourable setting by means of wax, and the whole sealed in the tube with plaster of Paris or some similar material. The efficiency of this device depends evidently on the choice of the single setting and the certainty with which this can be maintained whilst assembling the unit; the permanence of the setting is measured by the life of a single setting of the whisker on a galena crystal, i.e., in hours at the most, for efficient service under practical broadcasting conditions. On actual trial, three out of the six samples submitted showed no rectifying powers at all, though in the case of the one dismantled the small fragment of crystal, when removed, showed normal behaviour on hand-setting of a whisker into proper

contact with it. Of the three which showed some activity, two were distinctly poor, the other showed the same rectifying efficiency as a standard hand-set galena.

We understand that this detector is to be marketed under the name of "H.C.B. Permanent Detector." We regard the instrument not merely of ineffective design, but the five out of six samples were thoroughly bad, and, on this test, we can only advise readers to have nothing to do with it.

**"Atlas" Filament Control**

A filament rheostat of the compression type, for which the makers claim an impossibility of "packing" with use, has been submitted by Messrs. H. Clarke & Co. (Manchester), Ltd.

This is a one-hole-fixing device enclosed in an oval case (apparently of porcelain) measuring about 2 in. by 1 in. by 1½ in. deep, fitted with generous and readily accessible terminals at the end remote from the knob, well spaced apart, and with a neat knob and indicator dial externally. On test, it was found possible to set it to a resistance of about 30 ohms, but the adjustment was rather precarious here, and with a .06 type of valve on a 6-volt accumulator control was not of the finest; but with a four-volt

accumulator and a .06 type valve, the adjustment was very smooth and noiseless, so that fine control over reaction was possible by this means alone. With a single bright-filament R valve the control was similarly fine and smooth, though some tendency to heat up when used continuously with a filament current of .65 amp. was noticed. For the control of D.E. valves on an L.T. battery adjusted to their needs, this "Atlas" filament control is commendable; the finish, design and workmanship appeared excellent.

**"Acme" Filament Rheostat**

A wire filament resistance with a roller contact, designed to give exceptionally smooth and silent operation, has been submitted for our criticism by Messrs. The Acme Production Co., Ltd. This has the usual one-hole-fixing; the resistance wire is wound as a flat spiral on a narrow cylindrical former; the contact arm, fitted with a phosphor bronze spring and a roller at the end, rotates inside this cylinder. The maximum resistance of the D.E. types tested was about 30 ohms; the wire would carry up to .3 amperes without undue heating. The component was well made and finished; it can be recommended with confidence.



**HONEYCOMB DUOLATERAL COILS  
NEW PRICES**

Effective from

August 10th, 1925.

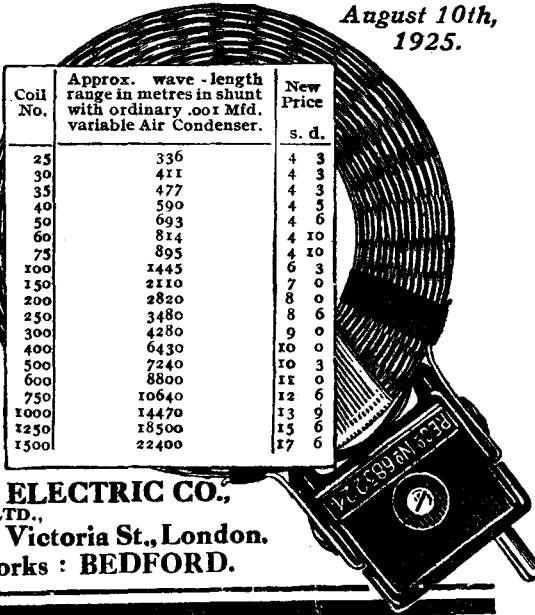

Coil No.	Approx. wave-length range in metres in shunt with ordinary .001 Mfd. variable Air Condenser.	New Price	
		s.	d.
25	336	4	3
30	411	4	3
35	477	4	3
40	500	4	5
50	693	4	6
60	814	4	10
75	895	4	10
100	1445	6	3
150	2110	7	0
200	2820	8	0
250	3480	8	6
300	4280	9	0
400	6430	10	0
500	7240	10	3
600	8800	11	0
750	10640	12	6
1000	14470	13	9
1250	18500	15	6
1500	22400	17	6

**IGRANIC ELECTRIC CO., LTD.,**  
149, Queen Victoria St., London.  
Works: BEDFORD.

**The easy way to build your Set**

**Radio Press Envelopes**

- |  |              |      |   |         |
|--|--------------|------|---|---------|
| No.  | Price. Free. | Post | Radio Press Panel Cards                         | Post    |
| 1  | 1/6          | 1/9  | 1 How to Build the W1 Receiver                  | 1/- 1/3 |
| By John Scott-Taggart, F.Inst.P., A.M.I.E.E. |              |      | By Herbert K. Simpson.                          |         |
| 2  | 2/6          | 2/9  | 2 How to Build the "Family" 4-Valve Receiver    |         |
| By Percy W. Harris, M.I.R.E.                 |              |      |   |         |
| 3  | 2/6          | 2/9  | 3 How to Build the "Simplicity" 3-Valve Set     |         |
| By G. P. Kendall, B.Sc.                      |              |      |   |         |
| 4  | 2/6          | 2/9  | 4 How to Build the All-Concert de Luxe Receiver |         |
| By Percy W. Harris, M.I.R.E.                 |              |      |   |         |
| 5  | 2/6          | 2/9  | 5 How to Build the Omni Receiver                |         |
| By John Scott-Taggart, F.Inst.P., A.M.I.E.E. |              |      |   |         |
| 6  | 1/6          | 1/9  | 6 How to Build the ABC Wave Trap Receiver       |         |
| By G. P. Kendall, B.Sc.                      |              |      |   |         |
| 7  | 1/6          | 1/9  | 7 How to Build a 2-Valve Amplifier de Luxe      |         |
| By Herbert K. Simpson.                       |              |      |   |         |
| 8  | 1/6          | 1/9  | 8 How to Make a 1-Valve Reflex Receiver         |         |
| By Herbert K. Simpson.                       |              |      |   |         |
| 9  | 1/6          | 1/9  | 9 How to Build an Efficient Single-Valve Set    |         |
| By Herbert K. Simpson.                       |              |      |   |         |
| 10   | 2/6          | 2/9  | 10 The Twin-Valve Loud-speaker Receiver         |         |
| By John Scott-Taggart, F.Inst.P., A.M.I.E.E. |              |      |   |         |
| 11   | 1/6          | 1/9  | 11 An Adaptable Crystal Set                     |         |
| By Percy W. Harris, M.I.R.E.                 |              |      |   |         |
- Radio Press Panel Transfers**  
Large packet of 80 Labels .. 6d. 6d.
- "Modern Wireless" Coil Table**  
for Aerial, Anode and Reaction Coils 6d. 6d.
- Simplex Wiring Charts**  
1 For 2-Valve Set .. 1/- 1/3  
2 For 3-Valve Set .. 1/- 1/3  
3 For 4-Valve Set .. 1/- 1/3
- All the above can be obtained from Wireless dealers, booksellers, bookstalls, or direct from Dept. S., Radio Press, Ltd.



**RADIO PRESS, LTD.,**  
Bush House, Strand, London, W.C.2.

# Information Department

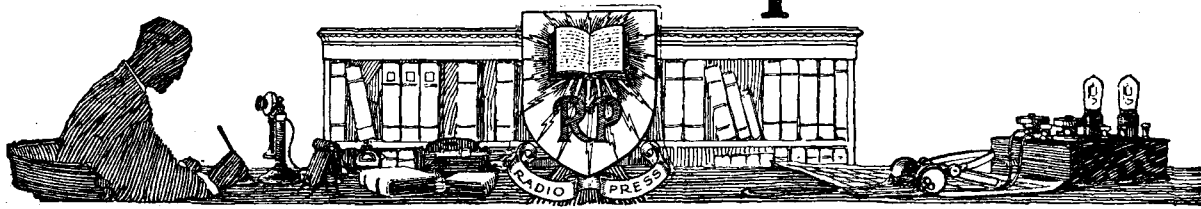

M. E. C. (HARROW) has a "Resistance-Four" receiver which is behaving in a somewhat puzzling manner. It will, at times, without warning, distort very badly, and signals then die down very considerably in volume. An extra strong passage in an item or a very strong atmospheric will give rise to the phenomenon. If the set is switched off for a short time, it will again work satisfactorily.

A set in which the low-frequency coupling used is by the resistance capacity method will sometimes develop trouble of this nature, which may be usually traced to a grid-leak of too high a value. The substitution of a grid-leak of suitable resistance, which may be of 2

megohms or even as low as  $\frac{1}{2}$  megohm with certain types of valves, almost always remedies the fault. Where such a tendency to choke up, such as our correspondent has experienced, is met with it may even be advantageous, with certain valves, to use a leak with as low a value as  $\frac{1}{4}$  megohm.

D. H. B. (GLASGOW) states that he has a six-volt 60 ampere-hour actual capacity accumulator and is charging it from 250 volt direct-current mains using ten 32 candle power carbon lamps connected in parallel. He states that the charging current for his battery, as given by the makers, should be 5 amperes, and wishes to know whether he is using the correct number of lamps

to obtain this current and what it should cost to charge the battery at 6d. per Board of Trade unit.

On a 250-volt supply one 32 candle-power carbon lamp will take a current of .5 ampere approximately. It will be seen, therefore, that ten lamps in parallel will pass a total current of 5 amperes, which is that required for charging the battery. Providing that the latter is not fully discharged, we can assume that the actual capacity of the battery in ampere-hours, that is 60, divided by the charging rate in amperes, that is 5, will give approximately the time in hours it will take to charge. The time taken in charging will be about 12 hours.

Since the voltage of the supply is 250 and the charging current 5

TO GET RESULTS WORTH HAVING YOU MUST INSTAL

## WADE CONDENSERS

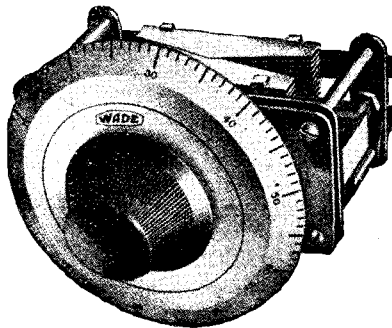

Pat. pending.

### ELIMINATES BODY CAPACITY.

Special design eliminates body capacity for all time. This is exclusively a Wade development and is destined to change the entire phase of condenser construction.

### SIMPLIFIES CLOSE TUNING.

Unique design of plates and their angular operation assures straight line wave length—spreads all stations evenly over the dial. Any station can be quickly located once a given station of known wave length is recorded. Special 360° dial incorporating slow motion spreads the scale and gives more tuning range between stations.

## WADE

Square law Condensers, complete with 4 in. Vernier dial for Short Wave .000125 ... .. 37/6  
Tuned Radio Frequency, etc., .00025 ... .. 40/-  
Standard size .0005 ... .. 42/-

Write or call for list of other high-grade components.

C. G. VOKES & COMPANY,  
(C. G. Vokes, A.M.I.Mech.E.)

38, Conduit Street, Regent Street, London, W.1.  
Tel.—Gerrard 4693. Telegrams—Folbarth, Piccy, Ldn.

## Scrap your H.T.

Batteries !! Use your Electric Lighting Mains!

### The "DYNIC" D.C. REGULATOR.

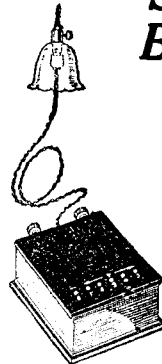

Does away with the necessity for H.T. Batteries with their attendant troubles. Simply plug into a convenient lampholder, and a perfectly smooth H.T. supply is obtained. Variable outputs used with ordinary wander plugs, like H.T. Batteries. No breakable parts. Entirely insulated. Can be supplied wound for special requirements—e.g., larger output. Impossible to burn out valve filaments even if they are inadvertently connected to the H.T. Infinitesimal running costs. For D.C. MAINS ONLY of any voltage above 50.

Send for Descriptive folder.

JONES & STEWART,  
59, Robertson Street, GLASGOW, C.2.

Price complete with Plug and Flex. 60/-  
Postage 9d.

## Peerless in name and in performance

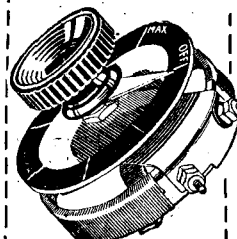

Size,  $1\frac{1}{2}$  in. dia.,  $\frac{1}{2}$  in. high  
6, 15, or 30 ohms.  
2/6

As soon as you use the "Peerless Junior" Rheostat you will find it gives the full degree of faultless service that the name implies. The resistance element is immune from damage and will safely carry the current of two valves. An off position is provided and definite stops are so arranged that it is impossible for a short circuit to occur. Complete, with handsome engraved nickel dial and one-hole fixing. Made in three types.

From your dealer, or  
THE BEDFORD ELECTRICAL & RADIO CO., LTD.  
22, Campbell Road, Bedford.

amperes, the number of watts consumed is 1,250, that is, the product of the voltage and the current. A Board of Trade unit may be defined as 1,000 watts flowing for one hour;  $1\frac{1}{4}$  units are therefore consumed during each hour whilst charging, so that the total units taken during the 12 hours will be 12 multiplied by  $1\frac{1}{4}$  or 15 units; 15 units at 6d. gives the cost per charge, namely, 7s. 6d.

From this example it will be seen that it is by no means economical to charge an accumulator in series with a bank of lamps across the mains, unless it can be arranged that the lamps are being usefully employed. Where an electric heater is used the method may be economically employed, this being substituted in place of the parallel bank of lamps. A less costly way of charging is to connect the accumulator in series with one of the leads from the switch where the supply is brought into the house. It should, of course, be placed in the lead which is earthed. Application to the local electrical supply authorities should be made to determine which lead is the one required, or alternatively this may be found by experiment. A lamp, such as is normally used on the house lighting system, connected in turn to each side of the supply, will light

when connected between earth and the side of the mains which is not earthed. The other lead should be broken to accommodate the accumulator. The current taken at all times by the house will now pass through the accumulator and charge it, providing it is connected the correct way round. Where, of course, but little current is taken by the house lighting system, and that only for a short time, the method is not to be advised, since the time taken to charge will be abnormally long.

**V. R. (LYNTON)** asks if it is possible to receive continuous waves using a crystal set.

Continuous waves, if pure, cannot be received on a crystal set without some external agency, such as another station heterodyning the continuous wave signals it is desired to read, or the use of a local heterodyne, or some other means of interrupting or breaking the waves up into groups of audible frequency.

**L. H. B. (BRUSSELS)** has constructed the Anglo-American 6-valve receiver described by Mr. Harris in "The Wireless Constructor," but states that he cannot obtain any stations below 390 or 400 metres in wavelength. He is

using ordinary barrel type of plug-in H.F. transformers as Neurodyne units, and these are of a reputable make, and known to be well matched. He asks why he cannot obtain stations below the previously-mentioned wavelengths.

In practice it has been found advisable when an H.F. transformer is used as a Neurodyne unit that the secondary winding, which is usually the larger winding of the two, should be used as the anode coil, which is tuned by a parallel condenser. This, together with factors peculiar to Neurodyne circuits, alone will account for the fact that stations below 390 or 400 metres cannot be received. The trouble is best overcome by using special Neurodyne units designed for this particular type of set. If three transformers, two of which are matched, one size lower in wavelength range, are available, these may be substituted, but Neurodyne units are to be preferred.

THE SEPTEMBER ISSUE OF  
**THE WIRELESS  
CONSTRUCTOR**  
WILL BE ON SALE ON AUG. 15.  
ORDER YOUR COPY EARLY



**WIRELESS PRODUCTIONS.**

32 years' manufacturing experience is behind every Production bearing our initials.

Write for particulars of  
*C.A.V. Wireless Productions.*

**C.A.V. Vandervell & Co. Ltd.**  
ACTON VALE LONDON W.3

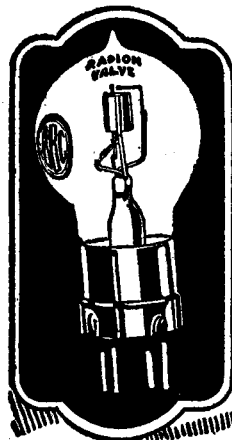

**EACH A KING IN ITS CLASS**  
—AND GUARANTEED BRITISH MADE.

- Radion G.P.** A 4-volt bright valve that only consumes 48 amp. **7/-**
- Radion D.E. '06** A wonderfully efficient 3-volt "very dull" filament valve **10/6**
- Radion D.E. '34** A 2-volt dull emitter of fine performance **10/6**
- Radion Pyramid (1) Valve, 22/6**

**THE POWER VALVE DE LUXE.** Can be used with largest loud-speaker without valve distortion. Filament robust: works at a low temperature, ensuring long life. SPECIAL CONSTRUCTION GIVES HIGHEST EFFICIENCY AND MECHANICAL STRENGTH. Fil. Volts, 5.5; Fil. Amps., 34; Anode Volts, 50-100; Neg. Grid Bias, 3-9.

From untied Dealers or direct, Post Free.  
**RADIONS LTD., BOLLINGTON, nr. Macclesfield, Cheshire.**  
Interesting literature concerning Radion Valves and our unique valve repair service gladly sent Free on request.



## ASK FOR RADIO PRESS BOOKS

They ensure satisfaction

No.	Price Free.	Post 9d. 11d.	No.	Price Free.	Post
1	Wireless for All	94.	13	500 Wireless Questions Answered	2/6 2/8
	By John Scott-Taggart, F.Inst.P., A.M.I.E.E.			By G. P. Kendall, B.Sc., and E. Redpath.	
2	Simplified Wireless	1/- 1/2	14	12 Tested Wireless Sets	2/6 2/6
	By John Scott-Taggart, F.Inst.P., A.M.I.E.E.			By Percy W. Harris, M.I.R.E.	
3	How to Make Your Own Broadcast Receiver	1/6 1/8	15	More Practical Valve Circuits	3/6 3/10
	By John Scott-Taggart, F.Inst.P., A.M.I.E.E.			By John Scott-Taggart, F.Inst.P., A.M.I.E.E.	
4	How to Erect Your Wireless Aerial	1/- 1/2	16	Home-Built Wireless Components	2/6 2/8
	By B. Mitchell, A.M.I.E.E.		17	Wireless Sets for Home Constructors	2/6 2/8
5	The Construction of Wireless Receiving Apparatus	1/6 1/8		By E. Redpath.	
	By P. D. Tyers.		18	Tuning Coils and How to Wind Them	1/6 1/8
6	The Construction of Crystal Receivers	1/6 1/8		By G. P. Kendall, B.Sc.	
	By Alan L. M. Douglas.		21	Six Simple Sets	1/6 1/8
7	How to Make a "Unit" Wireless Receiver	2/6 2/8		By Stanley G. Rattee, M.I.R.E.	
	By E. Redpath.		22	Switches in Wireless Circuits	1/6 1/6
8	Pictorial Wireless Circuits	1/6 1/8		By Oswald J. Rankin.	
	By Oswald J. Rankin.		24	Wireless Faults and How to Find Them	1/6 1/8
9	Wireless Valves Simply Explained	2/6 2/8		By R. W. Hallows, M.A.	
	By John Scott-Taggart, F.Inst.P., A.M.I.E.E.				
10	Practical Wireless Valve Circuits	2/6 2/8			
	By John Scott-Taggart, F.Inst.P., A.M.I.E.E.				
12	Radio Valves and How to Use Them	2/6 2/8		Elementary Text-Book on Wireless Vacuum Tubes	10/- 10/6
	By John Scott-Taggart, F.Inst.P., A.M.I.E.E.			By John Scott-Taggart, F.Inst.P., A.M.I.E.E.	

All the above can be obtained from Wireless dealers, book-sellers, bookstalls, or direct from Dept. S.

**RADIO PRESS, LTD.,**

Bush House, Strand,



London - W.C.2.



## EFFORT

WITH the primitive means at their disposal the ancients erected buildings which have survived the storms of ages. Such enduring results call for energy, resourcefulness and perseverance. ¶ The proper guidance and instruction of Radio enthusiasts necessitates a large and comprehensive organisation. The editorial staff of Radio Press is composed of experts in every branch of wireless activity and the results of their wide experience are at the service of all readers.

Upon a foundation of exhaustive knowledge Radio Press has built up, with untiring energy and enthusiasm, a world-wide reputation for sound work and the ever increasing sales of Radio Press publications are the outward and visible sign of Public Confidence.



# The WORLD'S TRANSFORMER



Write for R.I.  
Catalogue: free  
on application.

The R.I. Transformer is used in every quarter of the globe—by over half-a-million wireless enthusiasts—all of whom, hearing of its sterling qualities, did not hesitate to improve their wireless reception by purchasing this famous R.I. component. And every day hundreds of others are following their example, and they are proving for themselves that the R.I. Transformer means perfect balance and delicacy of tone. This tonal beauty is obtained with a remarkable degree of amplification, and that without any distortion whatever.

Behind the achievement of this success lie years of experience and careful research coupled with an excellence of workmanship which is second to none. Experience and science which have enabled R.I. to produce a Transformer whose self-capacity is only 18 micro-microfarads, a Transformer that prevents interaction, nay more, a Transformer whose curve gives a more uniform reproduction of all notes than that of any other Transformer.



12 HYDE ST. NEW OXFORD ST. LONDON W.C.1.

Contractors to the Admiralty and all Government Departments

Printed for the Proprietors, RADIO PRESS, LTD., of Bush House, Strand, W.C.2. by THE AVENUE PRESS (L. Upcott Gill & Son, Ltd.), 55-57, Drury Lane W.C.2. and Published by the Proprietors, RADIO PRESS, LTD., at Bush House Strand, W.C.2. on Wednesday of each week. Address for Subscriptions and Editorial Communications:—Bush House Strand, London, W.C. Advertisement Managers:—BARLAYS ADVERTISING, LTD. Bush House Strand London, W.C.2. Registered as a newspaper and for transmission by Canadian Magazine Post. Subscription rates:—32/6 per annum, 16/3 for six months, post free. Sole Agents for Australasia:—GORDON & GOTCH (Australasia), LTD. For Canada:—IMPERIAL NEWS, LTD. For South Africa:—CENTRAL NEWS AGENCY, LTD. For Japan:—SALE & FRAZER, LTD.



# Wireless Weekly

Vol. 6. No. 20.

## SUCCESS IN SHORT-WAVE RECEPTION

*By*

STANLEY GRATTEE, MIRE.,  
STAFF EDITOR.

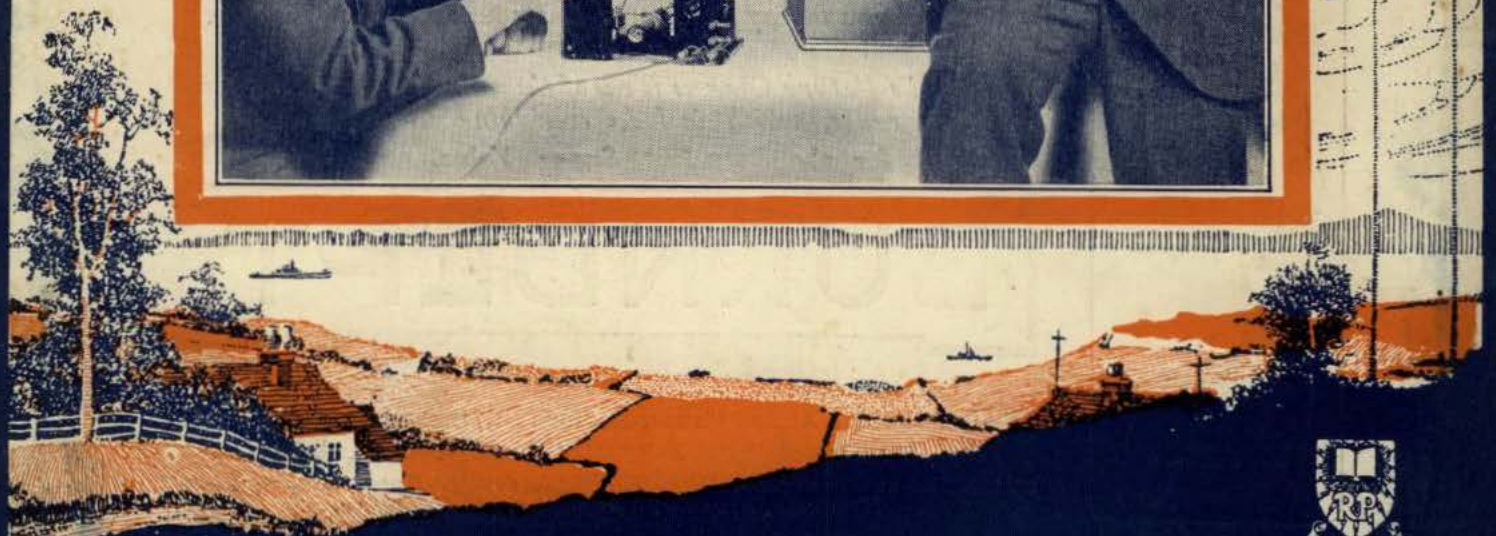

Balkite Battery Charger, without accumulator acid,  
for alternating current only :

No. 491. 200-240 volts, 50-60 cycles. £5 15s. 0d.  
No. 492. 100-115 volts, 50-60 cycles.

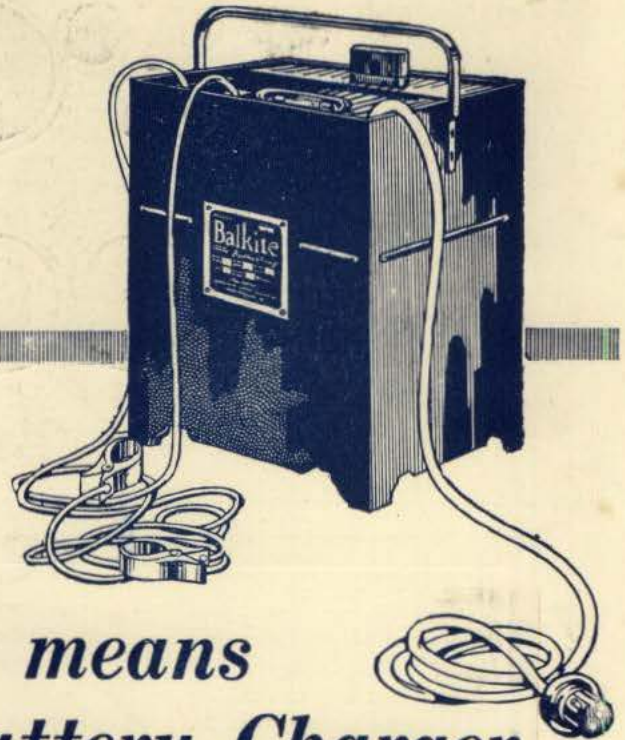

## The easiest way to charge your accumulator—by means of the *Balkite Battery Charger*



First of all, you put the connecting plug of the Balkite Charger into the ordinary electric light socket.



Then connect the clips of the Charger to the terminals of the accumulator.



Press the electric light switch and that's all! Isn't it simple?

**I**F you have alternating current electric light supply you can charge your accumulator at home easily and cheaply by using the Balkite Battery Charger. This simple Burndept accessory is absolutely silent in operation. It has no valves or moving parts, there is nothing to adjust or get out of order, and it cannot deteriorate through use or disuse. The Charger needs no attention except the periodical addition of a little distilled water. It rectifies *both* half cycles of the alternating current. The charging rate being  $2\frac{1}{2}$  to 3 amperes per hour, a 6-volt 50-amp. (actual) accumulator will be completely charged in about 20 hours at a cost of less than  $\frac{1}{2}$ d. per hour, based on a cost of 6d. per unit. A large accumulator in regular use can be re-charged overnight once weekly. Write for further particulars of the Balkite Battery Charger. It will save you money and ensure that your accumulator is always fully charged.

*The Balkite Battery Charger is one of the many items in the extensive Burndept range, which includes everything for radio reception. Look out for the Burndept Super Valve, on sale shortly.*

# BURNDEPT

## WIRELESS LIMITED

HEAD OFFICE: Aldine House, Bedford St., Strand, London, W.C.2

Telephone: Gerrard 9072. Telegrams: Burndept Westrand, London.

BRANCHES at Birmingham, Brighton, Bristol, Cardiff, Exeter, Glasgow, Leeds, Manchester, Newcastle, Northampton, and Nottingham.

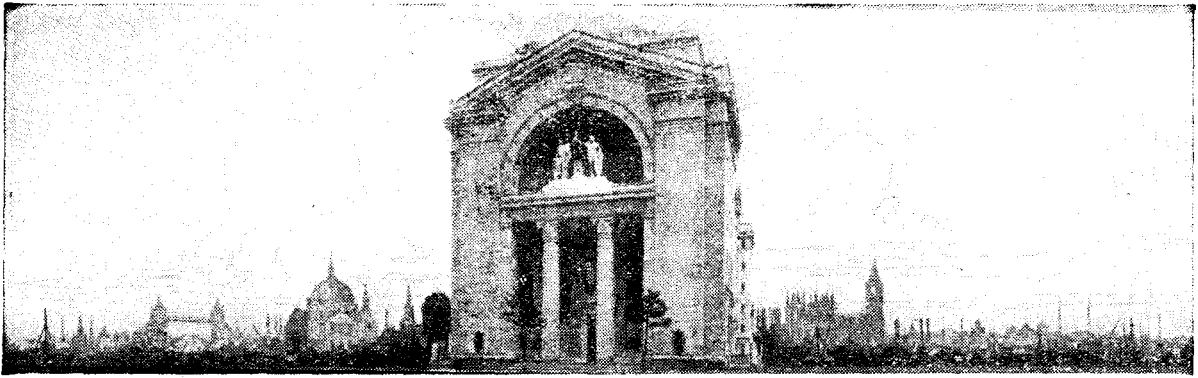

**Radio Press** LTD

**Wireless Weekly**  
Phone City, 9911

**Bush House** STRAND-WG2

## A Need of the Moment

**E**VERY student of wireless affairs has noticed at this time the tendency towards the use of short wavelengths not only for experimental work, but for such services as commercial and broadcasting. In this field the amateur has already distinguished himself, and even those who have in the past tried to belittle the work done by amateur wireless enthusiasts have been forced to admit their excellent work in such achievements as communications with Australia and New Zealand both by telephony and telegraphy, and the many other matters we have reported in our journals from time to time.

Ardent experimenters in short-wave work are at the moment considerably hampered by the lack of accurately calibrated short-wave signals. Owing to the demands of the various services the number of wavelengths available for experimental work is strictly limited, and it is essential that those who are

doing this kind of work shall keep strictly to the band allotted to them. In the United States the Government, through the Naval Laboratories, the Bureau of Standards, and other sources, have always been anxious to

issue clear indications of the attitude adopted.

On a few occasions in the past the National Physical Laboratory has sent out calibration signal on longer waves. Cannot this well-known institution provide for the amateur movement a strong and regular series of such calibration signals? Amateurs for their part are always willing to place the data collected at the disposal of responsible bodies, and such collaboration should be fruitful of excellent results for the art.

The Radio Press Experimental Laboratories are already engaged on some work of great importance for the amateur transmitter, and we hope to make an announcement regarding it shortly; meanwhile we suggest to amateur transmitters who are engaged upon the short wavelengths below 100 metres that they should check their apparatus as far as possible from the American calibration signals and place the information so gained at the disposal of their fellow experimenters.

### CONTENTS.

	Page
The Brentwood Receiving Station	626
Random Technicalities	631
Are You Restricting Your Tuning Range?	633
Success in Short-Wave Reception	638
Jottings by the Way	641
Wireless News in Brief	643
Some British Super-Heterodyne Components	644
A New Short-Wave System	646
A Wireless Magazine's Broadcasting Station	648
Experiments on Leaky Grid Condenser Rectification	649
Correspondence	653
An Opportunity for the Experimenter	656
Apparatus We Have Tested	657
Information Department	659

give every assistance in its power to the calibration of amateur apparatus, and our recently published reports regarding Dr. Taylor's transmissions from the Naval Laboratory station NKF and the interesting letter we publish from Dr. Taylor in this

*Assistant Editor:*  
 PERCY W. HARRIS, M.I.R.E.  
*Scientific Adviser:*  
 Prof. G. W. O. HOWE, D.Sc.,  
 M.I.E.E.  
*Advisory Editors:*  
 Prof. R. WHIDBINGTON, M.A., D.Sc.  
 Prof. C. L. FORTESCUE, M.A.,  
 M.I.E.E.

EDITED BY  
**JOHN SCOTT-TAGGART,**  
 F.Inst.P., A.M.I.E.E.  
 August 19, Vol. 6, No. 20.

*Staff Editors:*  
 E. H. CHAPMAN, M.A., D.Sc.  
 A. D. COWPER, M.Sc.  
 R. W. HALLOWS, M.A.  
 G. P. KENDALL, B.Sc.  
 A. JOHNSON-RANDALL,  
 STANLEY G. RATTEE, M.I.R.E.  
 J. H. REYNER, B.Sc. (Hons.),  
 A.C.G.I., D.I.C.

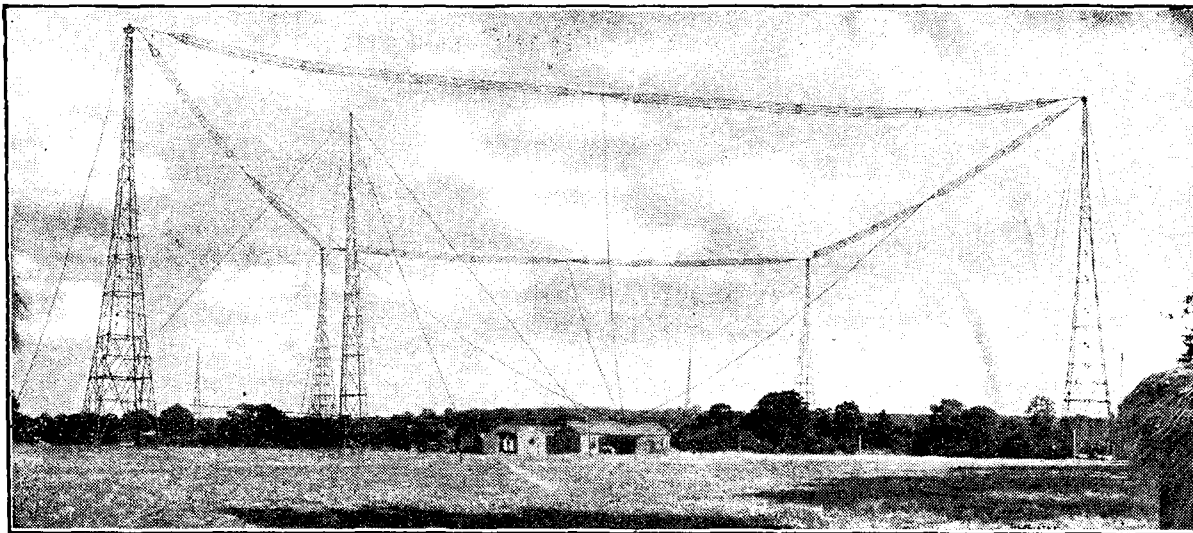

## THE BRENTWOOD RECEIVING STATION

*The methods employed in commercial practice to obtain the very high order of selectivity and freedom from atmospheric which are essential for reliable working are particularly interesting when contrasted even with the most complicated of amateur equipment. This article describes the visit of our special representative, Mr. J. H. Reyner, B.Sc. (Hons.), A.C.G.I., D.I.C., to Brentwood, which is the receiving station for the whole of the services of the Marconi Co.*

COMMERCIAL and amateur reception differs in one or two important particulars. The most important difference is that a commercial wireless service must work all day and every day. In order to compete successfully with existing methods of communication, principally the cable, a wireless service must inspire business men with a certain confidence that the message will be delivered rapidly and accurately whenever it is handed in at the traffic receiving office.

### Bad Periods

Now, there are bad periods each day when atmospheric are heavy, the extent of this interference varying from season to season, the best conditions being obtained in the winter.

There may again be certain sources of interference (such as other stations working on nearly the same frequency) which may only persist for half an hour or so.

Yet a reliable service must be capable of giving readable signals throughout the whole of the time. This means that the equipment must be considerably more elaborate than would appear necessary from a comparison with amateur apparatus, but the additional complications are all rendered essential by the necessity for a 24-hour service.

### The Brentwood Station

In order to obtain some details of modern commercial practice I visited the Marconi Receiving Station at Brentwood. This station, which is situated at Canterbury Tye, about one mile

from Brentwood, contains the receiving equipment for all the Marconi services.

As I explained last week, all traffic is handled at Radio House, Wilson Street, E.C., the outgoing traffic being sent via Carnarvon (for the main American traffic) or Ongar (for Continental and Canadian traffic).

The receiving station for Carnarvon used to be situated at Towyn, in Wales, but was moved to Brentwood about two years ago, so that all receiving is now carried out at the one point.

The wireless signals are relayed telegraphically or telephonically to Radio House, where the traffic is written up and despatched to its destination.

### General Principles Adopted in the Reception

The general scheme of operations at Brentwood was explained by Mr. Keen, the officer-in-charge, who, with Mr. Brown, the assistant officer-in-charge, rendered me every assistance.

The signals are first received on a directional aerial system. This comprises a Bellini-Tosi frame, together with an open aerial, which enables reception to be obtained:—

- (a) From all directions—with the open aerial.
- (b) From two principal directions only—with the frame.

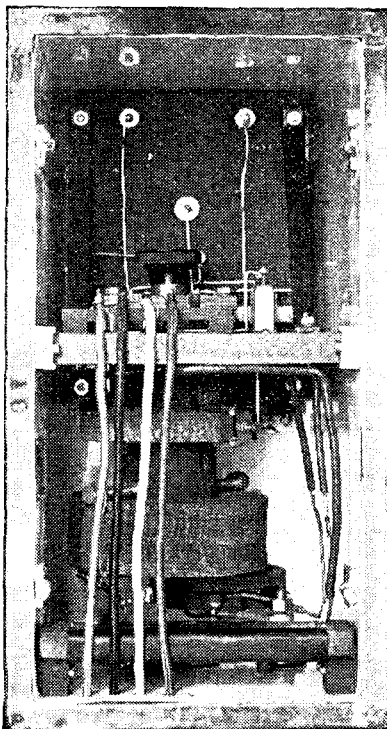

*The apparatus of one of the low-frequency filter stages used in the Brentwood receiver.*

This enables a certain proportion of the interference to be eliminated.

- (c) From one direction only— with the frame and aerial. This is useful against certain interference which cannot be dealt with by (b).

The signals are then passed through a number of H.F. filters, after which a strong heterodyne is introduced and the signals are rectified. They are then passed through four stages of L.F. filters, tuned to a 2,500 frequency note.

**Relaying Arrangements**

The signals are then applied to a special valve bridge, which produces a current change large enough to operate a relay, and so converts the wireless signals into telegraphic currents. These currents are transmitted by land line to Radio House, where they are transcribed.

If conditions are so bad that recording cannot be carried on satisfactorily, a state of affairs which usually lasts for a short time only, the 2,500 heterodyne note is re-heterodyned with another low-frequency oscillation to produce a note of 1,000 cycles frequency (which is more suitable for transmission over land lines and easier to read than the high-pitched note).

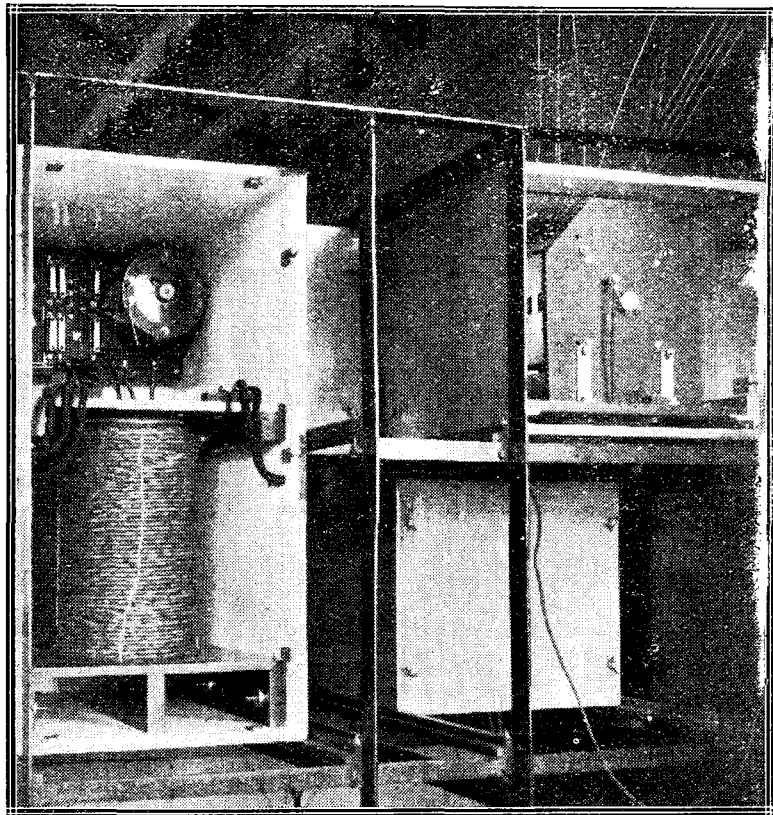

*The rear of the panel showing one of the low-resistance high-frequency filters. The end of one of the radio-goniometers can be seen on the right.*

The aural signals are then relayed telephonically to Radio House and transcribed by the operators there.

In order to check the signals

sent out from the transmitting stations, arrangements are made for these signals to be recorded at Brentwood. There are two checks, one on the land line signals and the other on the wireless signals. It is thus possible, in the event of the signals being poor, to see at a glance whether the fault is due to line trouble or bad adjustment at the transmitting station.

**Description of Apparatus**

The earlier apparatus installed at Brentwood was arranged in screened cabinets to avoid any possible interaction between the various sets. This has since been found unnecessary, and in the recent models the screening of the sets themselves is depended upon. A brief description of the latest pattern will be of interest.

The first unit contains a radio-goniometer for obtaining the directional effects (previously referred to), and associated with this is the phasing panel for obtaining any "balances" necessary.

**Directional Reception**

The methods employed to obtain directional reception are

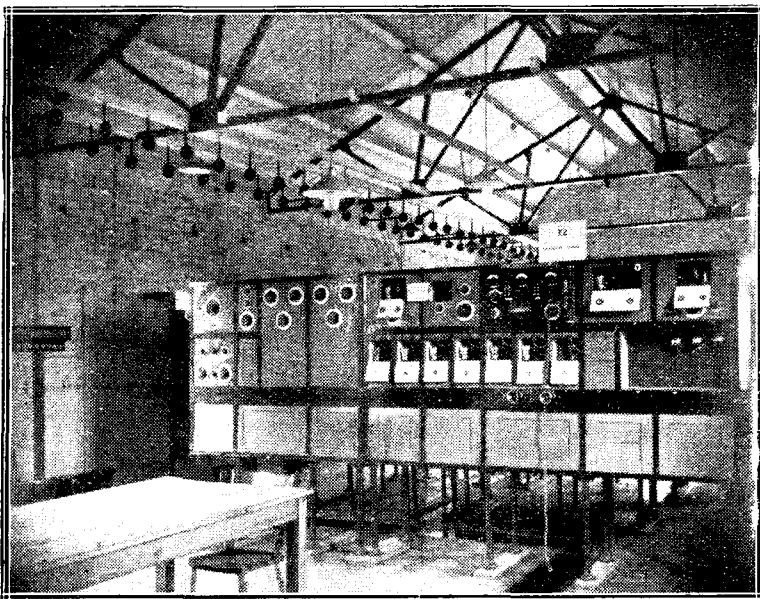

*A general view of the receivers at Brentwood. The circular black discs support the four leads from the outside aerials, and also the four leads from the dummy aerials. These leads are twisted to avoid induction effects.*

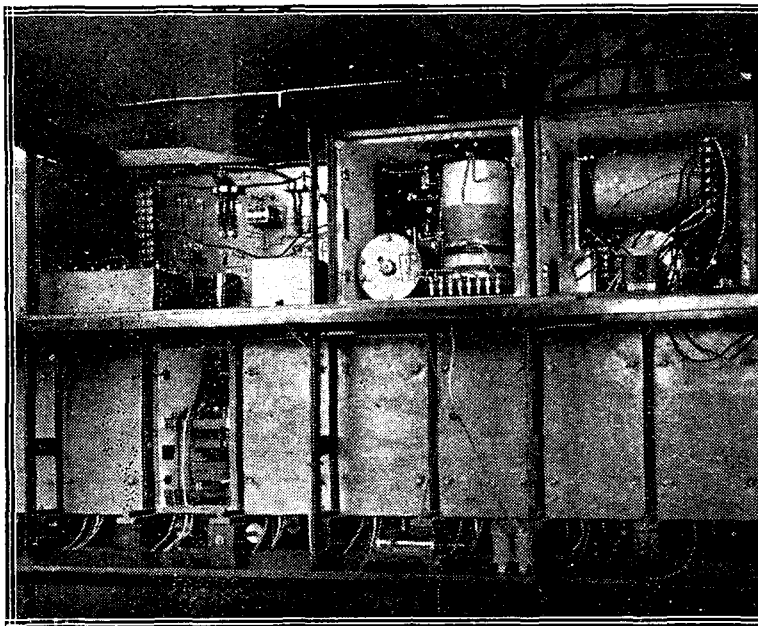

Part of the back of one of the receivers with the shielding plates removed. The heterodyne unit is in the centre of the top row.

aerial, and the two can be balanced out.

**Tuning Arrangements**

In this way all interference from one direction can be eliminated, the reception from the opposite direction being a maximum. This is known as "barrage" reception.

The aerial circuits are therefore tuned and the necessary coupling and phasing arrangements for the balances are incorporated in the same unit.

There are then two stages of high-frequency filters consisting of very low resistance coils, wound with stranded wire and tuned with air condensers. Each of these circuits, at a frequency of 30 kc., has a resistance of the order of 1 ohm only. These circuits are simply loosely coupled together, forming a chain of H.F. filter circuits. There are no H.F. valves.

of considerable interest. The Bellini-Tosi system (which was described in *Wireless Weekly*, Vol. 6; No. 15) consists of two large frames at right angles.

The ends of these frames (or more accurately loops, since they have only one turn) are led into the receiving room, and connected to the field coils of a radio-goniometer.

Inside these field coils is a rotating "search" coil, and the apparatus is so arranged that the rotation of the search coil has the same effect as rotating one of the large loops.

Hence, using this instrument a certain directivity is obtained, there being two maximum positions and two minima as with a simple frame.

It sometimes happens, however, that interference is experienced on the same line as the station being received, but from the opposite direction. In such a case a simple frame is useless.

Now, an ordinary aerial receives almost equally well from all directions. It is thus possible to arrange for the receiver to be coupled both to an aerial and to a frame, as shown in Fig. 1. When the signal comes from the A direction, the aerial and frame assist each other. When the signal comes from the B direction, however, the current in the frame opposes that in the

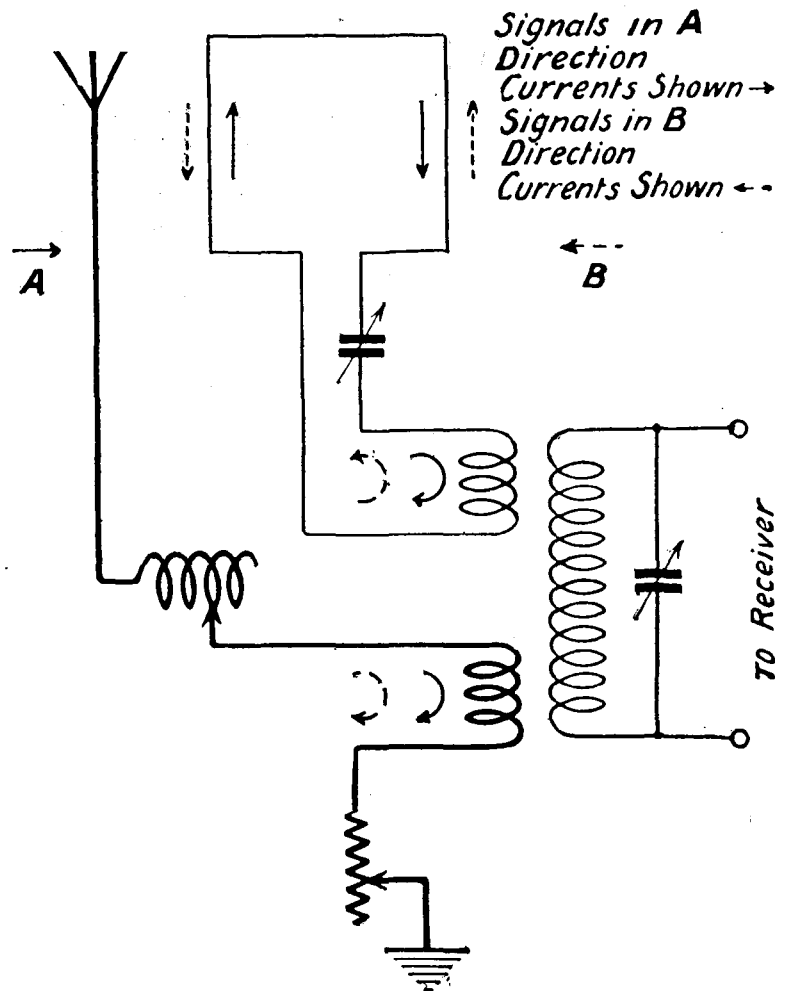

Fig. 1.—Illustrating the use of a frame and an outside aerial, to produce "barrage" reception.

**Methods of Obtaining Selectivity**

There are two frequencies, one on each side of the heterodyne, which will give a 2,500 frequency beat note. E.g., with a heterodyne frequency of 30,000 cycles (10,000 metres), a beat note of 2,500 frequency would be produced by frequencies of 27,500 cycles and 32,500 cycles.

The H.F. filters are for the purpose of accepting one of these frequencies only, and thus need only have a selectivity of 2,500 cycles, which in the case just considered, is only about 8 per cent.

The L.F. filters again have a selectivity of about 100 cycles in 2,500, which is 4 per cent. This again is not particularly difficult to achieve.

The net result, however, is a selectivity of 100 cycles in 30,000, or 0.3 per cent., which is very sharp indeed.

**Powerful Heterodyne**

A strong heterodyne is then introduced, which is arranged to give a beat note of 2,500 cycles. The heterodyne is made strong because the signal strength obtained with a C.W. signal depends on the product of the signal and the heterodyne (see

*Wireless Weekly*, Vol. 6, No. 16), and if no H.F. amplification is employed it is essential to and has a marked effect on the signal strength. The signals are then passed

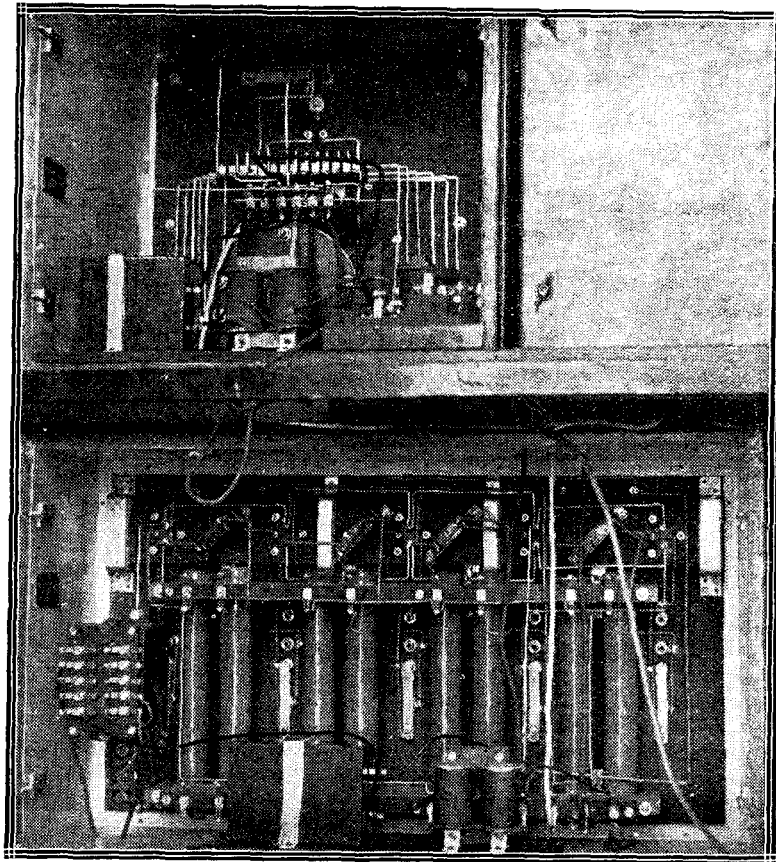

*The resistance amplifier employed for increasing the strength of the 1,000 cycle note used in aural reception, prior to relaying the signals over the land line. Note the wire-wound resistances.*

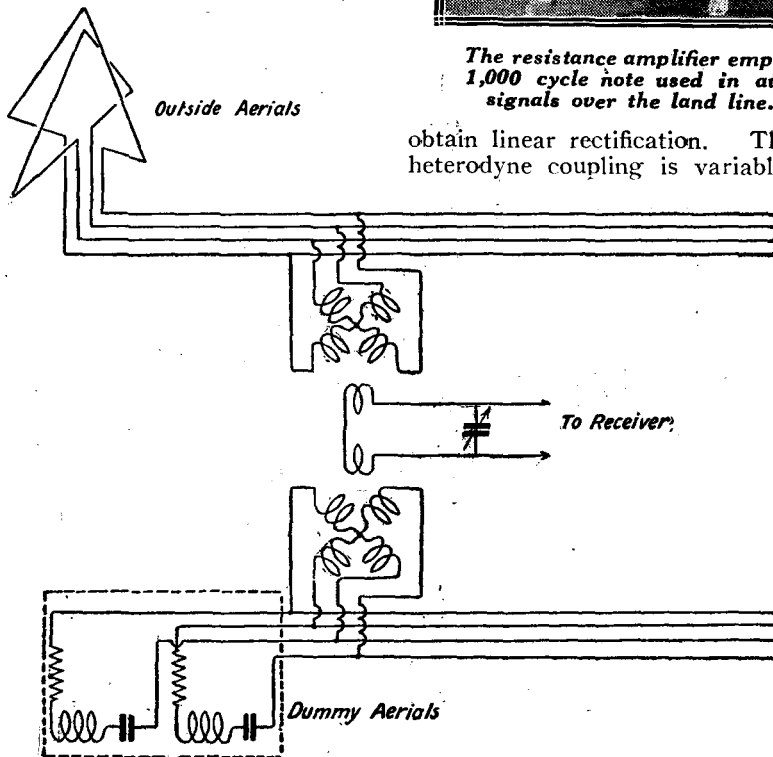

**Fig. 2.**—Schematic diagram of the arrangement of several receivers on one set of aerials. The receiver is coupled both to the outside aerials and to a pair of dummy aerials.

obtain linear rectification. The heterodyne coupling is variable,

through the low-frequency filters, which comprise a series of tuned circuits applied to the grid of a valve. The anode circuits of the several valves are untuned and are loosely coupled to the succeeding stages.

Each filter consists of a simple multi-layer coil tuned with a fixed condenser. When the set is first installed the tune is adjusted once and for all by means of a variometer incorporated in the set, and beyond this adjustment the tune is not variable.

The coupling of all the L.F. filters is controlled by a single handle, and there is also an arrangement for introducing resistance into the filter circuits themselves, and so broadening the resonance band. This is also controlled by a single handle.

**Recording Arrangements**

At this point the signals are taken away to a valve bridge if

suitable for recording, and transformed into telegraphic currents, as previously described. If aural reception is required, a second heterodyne is introduced

aerials, and there is no interference between the sets.

These four aerials thus provide for eight sets, which are all allotted for Con-

**Power Supply**

Another interesting point is that all the filament and high-tension supply is obtained from one common battery.

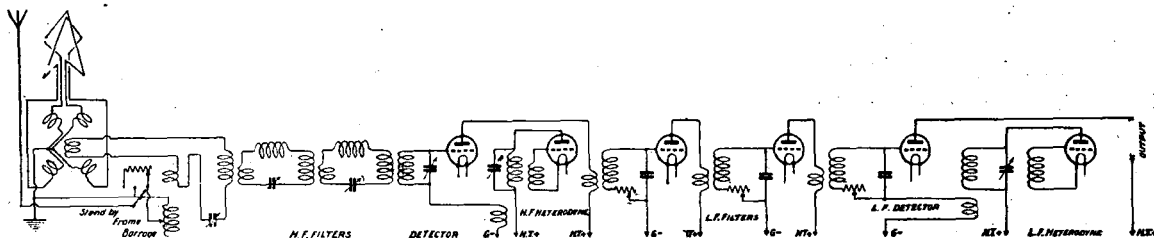

Fig. 3.—Skeleton circuit diagram of the latest pattern of receiver. The points marked 'output' go either to a recorder or through a resistance-coupled note magnifier to the telephone lines.

to convert the signals to 1,000 cycles.

Three stages of resistance note magnification are then employed to allow for the attenuation of the signals in travelling over the telephone line.

The low-frequency heterodyne itself is audible, and would normally drown the signals themselves. A low pass filter is therefore included in the circuit, which will only allow frequencies below about 1,200 cycles per sec. to pass. Since the re-heterodyne frequency is 3,500, this frequency itself is cut out and only the 1,000 cycles beat note heard.

**Aerial System**

The aerial system itself is perhaps the most interesting part of the station. There are four small Bellini-Tosi aerials erected on 90-foot towers. Each of these, by an ingenious arrangement, serves two receivers.

If two radio-goniometers are connected to the same system of aerials, there will be a certain induction from each receiving set back into the aerials, so that the two sets will interfere.

This effect can be overcome, however, by using two goniometers, of which the search coils are connected in series. One set of field coils is connected to the outside aerials, and the other set is connected to a pair of dummy aerials having the same electrical properties as the actual ones. It is found that by this means the reaction of the search coils on the actual aerials is counterbalanced by the reaction of the second set of search coils on the dummy

continental work, but are not all in use at the present moment.

**Transatlantic Aerials**

For the Transatlantic reception there are two large rectangular frames erected between four towers 200 ft. high, from which 6 sets are operated. Large cage aerials are slung between the four towers, which are used as the open aerials for "all round" reception or for the heart-shaped balance.

The leads from these large frames are run the whole length of the receiving room, and are twisted to avoid induction from outside sources. The leads from the dummy aerials are run in a similar manner parallel to the other leads, and tappings are taken off at convenient points for each set.

The filaments are run from 8-volt mains (to allow for the voltage drop and to permit adequate regulation), these mains being connected to one of two batteries, one of which is in use while the other is on charge. The consumption is of the order of 1,000 amp.-hrs. per day.

The H.T. supply is 240 volts (maximum) supplied from 12 amp.-hr. cells, tappings being taken at convenient lower voltages for the receivers. The full voltage is only required for the recorders.

Tappings are taken from these mains to the various sets, these tappings, in the case of the H.T. supply, being provided with an arrangement of chokes and condensers to avoid any interaction between the sets.

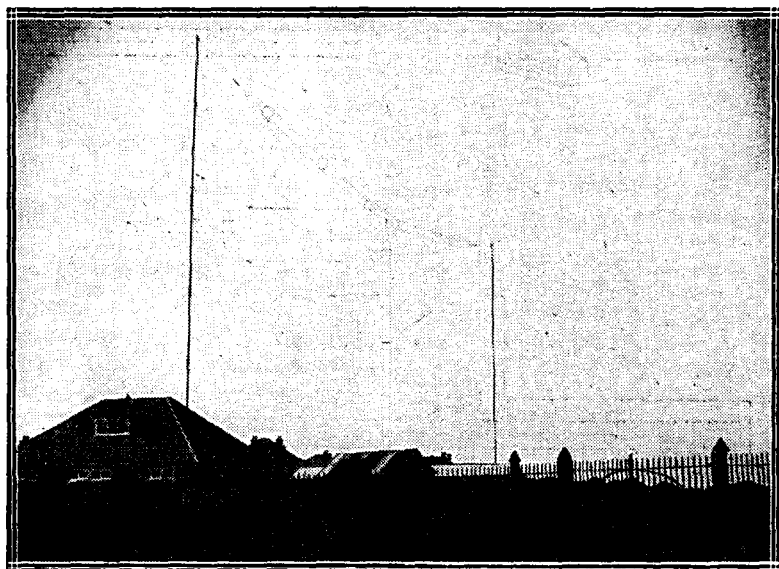

The aerial of the transmitting station for Bournemouth is situated at Five Ways, some little distance from the town.





# Random Technicalities

By **PERCY W. HARRIS, M.I.R.E.**  
Assistant Editor:

*Some Notes of Interest to the Experimenter and Home Constructor.*

**I**F you set about building any kind of receiver in which the valves and other accessories are placed behind the panel, you must decide whether your terminals shall be on the front panel or in the rear. If you choose this latter course—and it is becoming increasingly popular, for the reason that it keeps long trailing wires out of the way—you will need some kind of strip to support the terminals. You will require two terminals for your low-tension supply, a terminal for high-tension negative, one for the high-tension positive, which goes to the high-frequency and perhaps to the detector valve, and a separate high-tension positive for the L.F. amplifier valve or valves. You may, of course, use several high-tension positive terminals if you desire to place separate voltages on the different valves, but in most cases you will find it quite satisfactory to use one high-tension positive for high-frequency and detecting valves and one for the amplifier. You will also need two terminals for grid bias, or perhaps three if you are using two low-frequency valves.

\* \* \*

Now, the cutting of this little strip and the mounting of the panel is a fiddling and uninteresting job. We all have to do it, and we all have to make the same kind of terminal strip. Here is an excellent chance for the manufacturer. Terminal strips, say, 2 in. wide, with terminals ready mounted and with the strip engraved should command a ready market. As a start it might be well to market one with two terminals for low-tension, three for high-tension, and two for grid bias. Such a strip should be drilled at the bottom for wood screws to hold it

against the back edge of the baseboard. If such strips were readily available, those of us who design sets would soon make them standard.

\* \* \*

The same strip idea could be extended, and an alternative type could be made to screw straight down on to the baseboard and not edgewise. It is just such ideas as these that become very popular, and, strangely enough, manufacturers seem to be much more anxious to turn out superfluous low-fre-

quency transformers than to give us those things which everybody wants.

gave me a great deal of his valuable time one afternoon in New York to talk about problems, such as selectivity, range, and what can be expected from a radio set. He was emphatic about the absurdity of selling receivers by their alleged "range." In America, as here, manufacturers far too frequently refer to their sets as having a "five hundred mile range" or a "thousand mile range." As he pointed out, there are times during the year when a single-valve receiver with reaction will give good head-phone reception

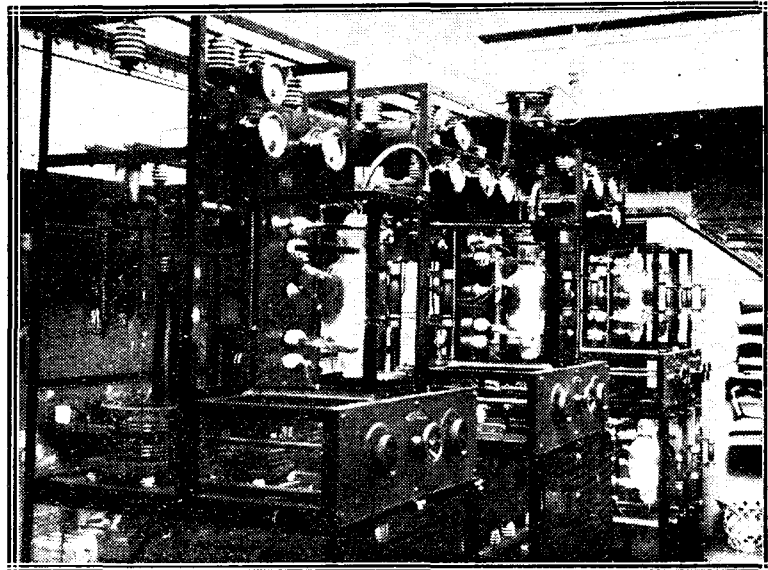

*In the transmitting room at the Glasgow Station. This photograph shows the independent drive, power oscillator and modulator panels, reading from left to right.*

quency transformers than to give us those things which everybody wants.

\* \* \*

Dr. Alfred N. Goldsmith, the chief broadcasting engineer of the Radio Corporation of America and Editor of the proceedings of The Institute of Radio Engineers, very kindly

from stations a thousand miles away. For simple classification he divides the types of service available under four headings:—

Local service (less than 100 miles).

Intermittent service (less than 500 miles).

Occasional service (less than 2,000 miles).

"Freak" service (over 3,000 miles).  
\* \* \*

It is an interesting classification, and gives a much better general idea than the broad sweeping assertions of some dealers and manufacturers. The chief obstacles to consistent reception of stations at long distances are, of course, interference and fading. From 500 to 2,000 miles the "occasional" service means that during three or four of the coldest winter months and during the late hours of the night (generally after 10 or 11 o'clock) you can *sometimes* get them. Above 2,000 miles Dr. Goldsmith says reception of fair character may be possible 10 or 20 days during the winter for an hour or two very late at night.

\* \* \*  
What a lot of trouble and disappointment would have been saved if a few facts such as these had been explained to some new wireless listeners. We are all human, and the tendency is to take one of the best freak nights and try and convey the impression to our friends that such behaviour is normal with the set. To judge from the reports of some crystal users, the strength of signals on their receivers from stations 50 or 60 miles away is such as to rattle their telephone diaphragms!

\* \* \*  
Many readers will probably laugh at the story of the old lady who, on it being suggested to her that it would be convenient to use a frame aerial indoors, thus saving the disfigurement of an aerial in the garden, said that she would not dream of such a thing, as she hated to have the window open all the time she was listening. I was reminded of this in New York, when on listening in the offices of the Telegraph and Telephone Co., where the studios of station WEAJ are situated, I found a room in which it was impossible to receive anything on a frame aerial unless you *did* open the window! The explanation is quite simple. The building is of steel, and, being a sky-scraper, it has, in common with many other American sky-scraper buildings, glass windows in which wire netting is embedded,

so that in the event of a window being broken the glass will not fall into the street below. This wire, of course, afforded a perfect radio screen. By sliding the window up this screen was removed and signals could be heard.

\* \* \*  
Lunching the other day with one of the leading British wireless engineers I was talking about the number of valves (particularly dull emitters) which are spoiled by abuse of the filament rheostat. Modern valves are not critical in their filament adjustment, and each is designed to work at a definite filament voltage. Take the valves of the .06 ampere variety, which are designed to work at from 2.8 to 3 volts on the filament. In spite of repeated warnings from the manufacturers not to overburn these filaments, a large number of listeners persistently do so, their idea being that by brightening up the valve a little they will get just a little more from it. Sometimes they do—often they don't—but the invariable result of

overburning them is to shorten their life considerably. The expert in question told me that, if he had his way, filament resistances in commercial sets would be abolished, their place being taken by fixed resistances. The argument that the filament resistance is needed to compensate for voltage drop in the accumulator is fallacious, as when the voltage drops it is time to get the battery charged.

## WIRELESS AT COWES

Thousands of people viewing the firework display at the conclusion of Cowes Regatta week were entertained by wireless from the new B.B.C. station at Davenport. The *Princessa*, a Gosport steamer belonging to the Gosport Floating Bridge Co., left the Pontoon at 7 p.m., carrying a complete wireless loud-speaking installation. The apparatus consisted of the well-known Metro-Vick Cosmos 5-valve set connected to a Brown Power Loud-speaker.

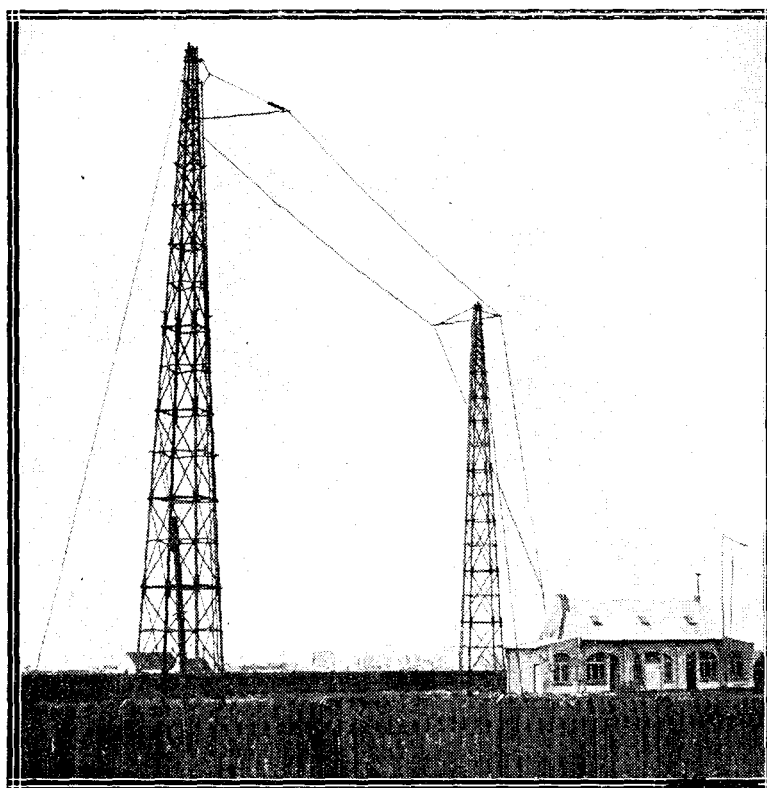

*The aerial of an important wireless station near the Ostend aerodrome. The station is used for communicating with various continental aeroplanes passing in the vicinity.*

# Are You Restricting Your Tuning Range?

By D. J. S. HARTT, B.Sc.

*Until more recently the importance of the casual capacities in tuning and associated circuits has been somewhat neglected. In this article Mr. Hartt analyses their effects and gives a series of typical curves to illustrate their large influence in restricting tuning ranges.*

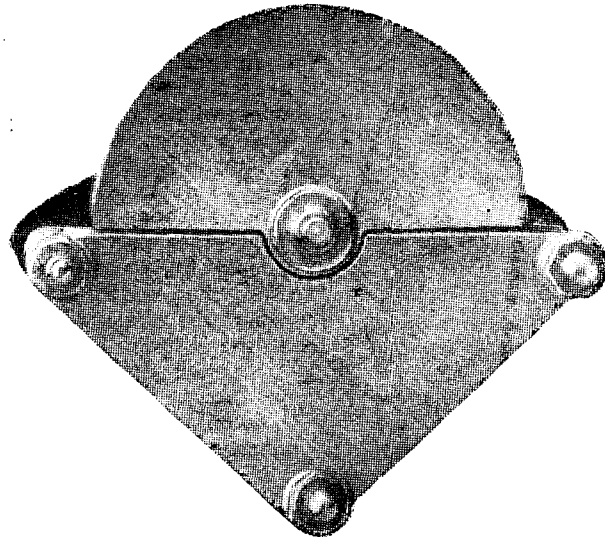

*An example of a high minimum straight-line capacity condenser with the end plate removed. There is very little separation between the edges of the two sets of plates when they are completely out of mesh.*

**W**ITH the more common use of the shorter wavelengths greater attention has been necessarily focussed on the importance of such casual capacities in a receiver as will affect the tuning circuits, and I propose in this article to discuss the effect of these "stray" capacities in restricting the tuning range of a receiver, assuming only one set of coils and condensers, and to indicate generally their sources and relative magnitudes.

### Relative Magnitudes of Casual Capacities

This latter point is particularly important, since in the design of receiving sets we must first obtain an idea of the relationship be-

In the following discussion only the effect of these stray capacities in altering the frequency to which a given circuit is tuned will be considered. The magnitude of

to the aerial (Fig. 1). At the zero tuning position there are present the following casual capacities:—

- (a) The self-capacity of the coil and coil mountings.
- (b) The minimum capacity of the condenser.

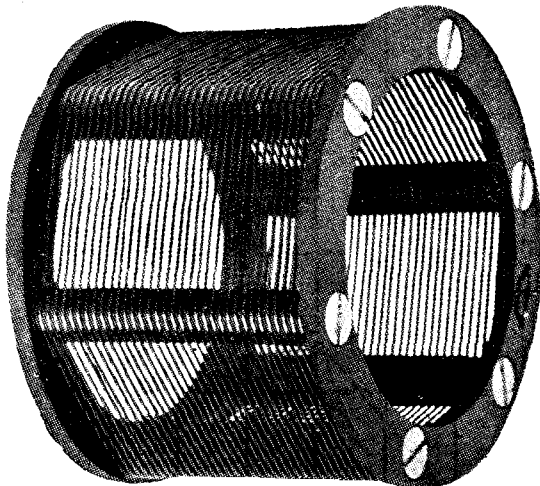

*A coil wound in this fashion has a very low self-capacity.*

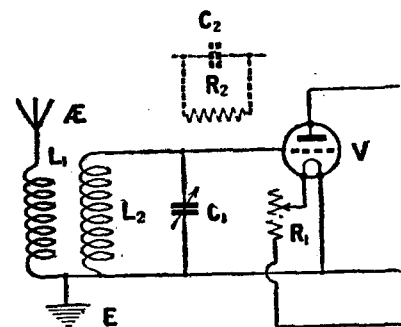

*Fig. 1.—The circuit discussed in the text.*

- (c) The wiring and circuit capacities, including the valve-holder capacities.
- (d) The "effective" grid to filament capacity of the valve.

It is these parallel additive capacities that we have to take into account when considering the tuning range of a given coil with a particular condenser in such a circuit. The relative importance of each of these will be dealt with subsequently.

tween the various factors which affect its working and efficiency before blindly effecting improvements which, on closer investigation, may prove to be of only secondary importance and may well be overlooked until the more important factors have been thoroughly considered.

the capacities introduced is not such as will seriously affect either the H.F. resistance or the inductance in the circuits to be discussed.

### Sources of Stray Capacity

In the first place, take a tuned secondary circuit loosely coupled

It has perhaps been the general practice until recently to regard these casual capacities as unimportant as far as the tuning range is concerned, but no more striking confirmation of the magnitude of

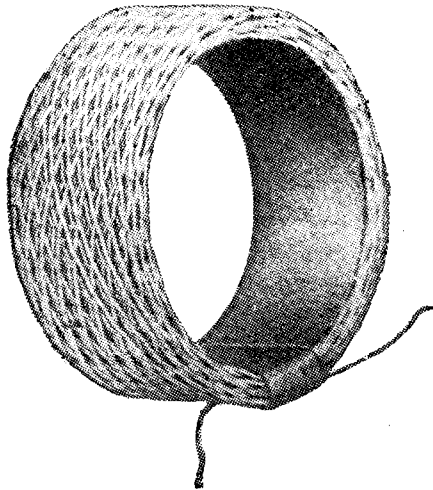

A coil of this type may have a very high self-capacity.

their influence can be gained than from a study of some typical dial-reading / wavelength curves for such a circuit.

Curves by Calculation

I have plotted a large number of curves (reproductions of which accompany this article) for various values of inductance and tuning capacity, which illustrate very strikingly how much the tuning range is actually restricted by varying casual capacities of the order of those obtaining in most circuits of this type. These curves have all been obtained by calculation and substitution in the familiar formula connecting the inductance, capacity and frequency of a circuit, namely

$$f = \frac{1}{2\pi\sqrt{LC}}$$

Expressed in wavelength, this becomes

$$\lambda = 1885\sqrt{LC}$$

where  $\lambda$  = wavelength in metres  
 $L$  = inductance in microhenries ( $\mu H$ )  
 and  $C$  = capacity in microfarads ( $\mu F$ )

For the purposes of our discussion we may write

$$\lambda = 1885\sqrt{L(C+C_s)}$$

where we may look upon the coil as having a pure inductance  $L$ , the tuning condenser a nominal

value  $C$ , all the stray capacities being expressed as  $C_s$ . By substitution it therefore becomes a simple matter to plot a number of curves.

Semi-circular Plate Condenser

In the case of the circular-plate or straight line capacity condenser we can obtain the capacity at any dial setting, since it is simply proportional to the dial setting. For example, the capacity of a nominal .0005  $\mu F$  (maximum) at 30 degrees on a 100 degree dial is simply  $(\frac{3}{10} \times .0005) = .00015 \mu F$ . For the square-law condenser where the capacity is proportional to the square of the dial setting, the capacity ( $C$ ) at any given dial setting ( $D$ ) on a 100 degree dial of a nominal .0005  $\mu F$  max. condenser will be given by

$$C = \frac{D^2 \times .0005}{100^2} \mu F.$$

A Hypothetical Case

The first series of curves shown in Fig. 2 is for an inductance of

200  $\mu H$  (roughly equivalent to a Gambrell B or a No. 60 coil) tuned by a parallel condenser of .0005  $\mu F$  maximum. Curve A illustrates the hypothetical case for a pure inductance and no added parallel capacities. This gives theoretically a tuning range of 600 metres.

Curve B shows the effect of a parallel stray capacity of only 10  $\mu \mu F$ . This figure would represent the self-capacity of a fairly well designed coil of this size. This has not appreciably altered the shape of the curve, but has reduced the tuning range by 81 metres on the lower band, while not appreciably affecting the maximum.

Large Reduction of Tuning Range

Curve C shows the effect of a parallel stray capacity of 70  $\mu \mu F$ , and curve D of 110  $\mu \mu F$ . As will be explained later, these latter figures are by no means unusual for an ordinary circuit of this type. In the former case the

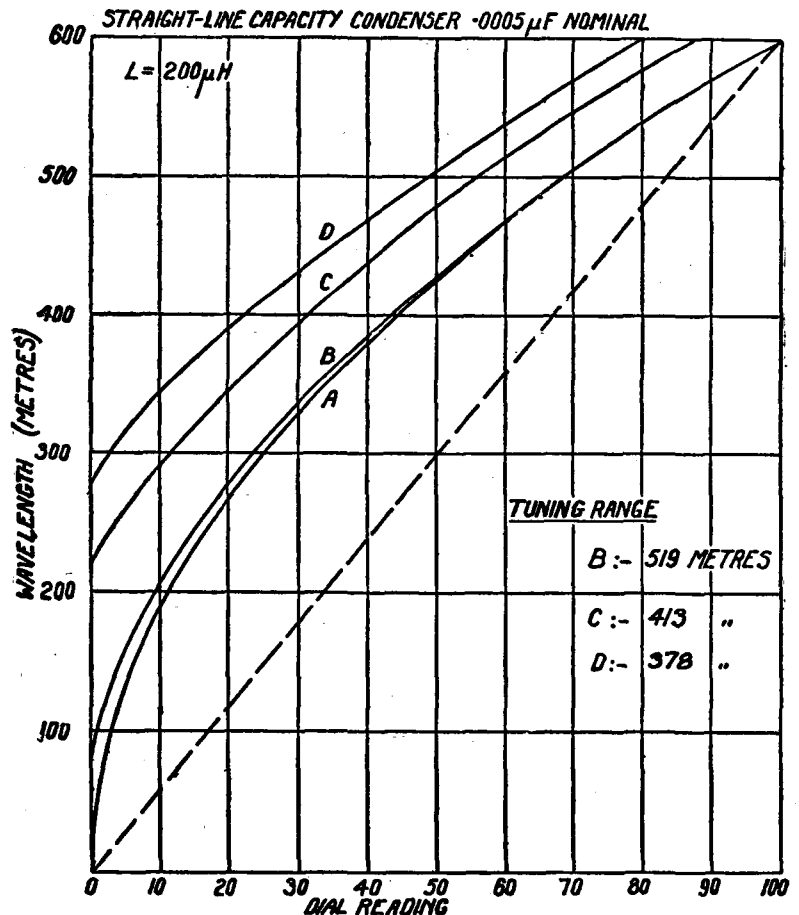

Fig. 2.—Curves showing the effect of stray capacities in restricting the tuning range of a secondary circuit. The dotted line serves to show the extent of curvature of the other curves.

range is now only from 223 metres to 636 metres (1344 to 472 kc.), which represents a reduction of 142 metres off the lower range and an increase of 36 metres at the maximum when compared with curve B.

In the second case the range is from 280 metres to 658 metres (1071 to 456 kc.); here the reduction on the minimum range is most marked. The total ranges for the three curves B, C, and D are thus:—519, 413, and 378 metres respectively. The latter figure more nearly approaches the normal range actually obtained, and thus indicates that the casual capacities are of a high order.

**Square-Law Condenser**

I have drawn a similar set of curves (Fig. 3) for a straight-line wavelength, or square-law condenser of the same nominal capacity, just to indicate how the general shape of the curves differs. Here curve A is for the theoretically perfect case as before, curve B for 10  $\mu\mu\text{F}$

added parallel capacity, curve C for 70  $\mu\mu\text{F}$ , and curve D for 110  $\mu\mu\text{F}$ . Notice that the effect of

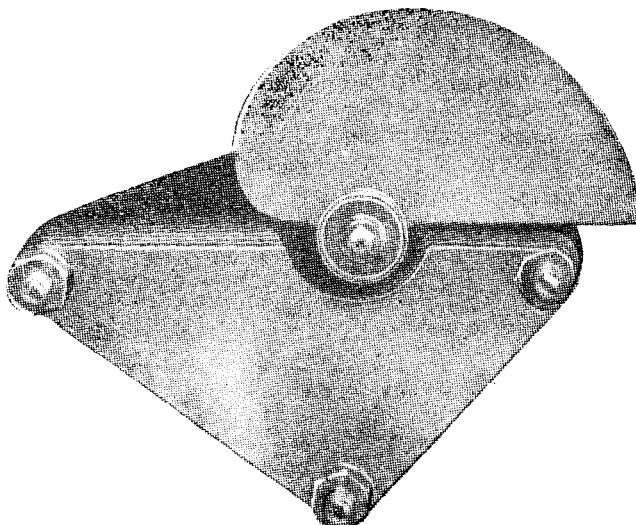

*It is comparatively easy, by careful design, to obtain a lower minimum in the case of a square-law condenser than with a semi-circular plate type. Note the wide separation of the plates in the full-out position (the end-plate has been removed here to show this).*

stray capacity in the case of the semi-circular plate condenser is to flatten out the bend at the lower end of the curve so that it tends to approach more nearly to a straight line; whilst the effect in the case of the square-law condenser is to make the upward bend at the lower end of the curve more pronounced so that the curve departs more from the straight line; the minimum wavelength also is increased, as is the maximum, but to a lesser extent, so that the net result is a reduction in the total tuning range and a greater departure from the straight line as the casual capacity is increased. So much then for the effect of the casual capacities on the broadcast band.

**Lower Wavelengths**

On the lower wavelengths the trouble is more serious since the casual capacities have a relatively greater effect, and much difficulty is often experienced in reducing them sufficiently to enable a particular receiver to tune down to a desired wavelength. This, indeed, is a more important aspect than the actual tuning range here. The curves of Figs. 4 and 5 show this most conclusively. The three curves of Fig. 4 represent the state of affairs for an inductance of 10  $\mu\text{H}$ , and a parallel tuning capacity of .000125  $\mu\text{F}$  of the straight-line capacity type. Curve A is for the hypothetical case of zero minimum

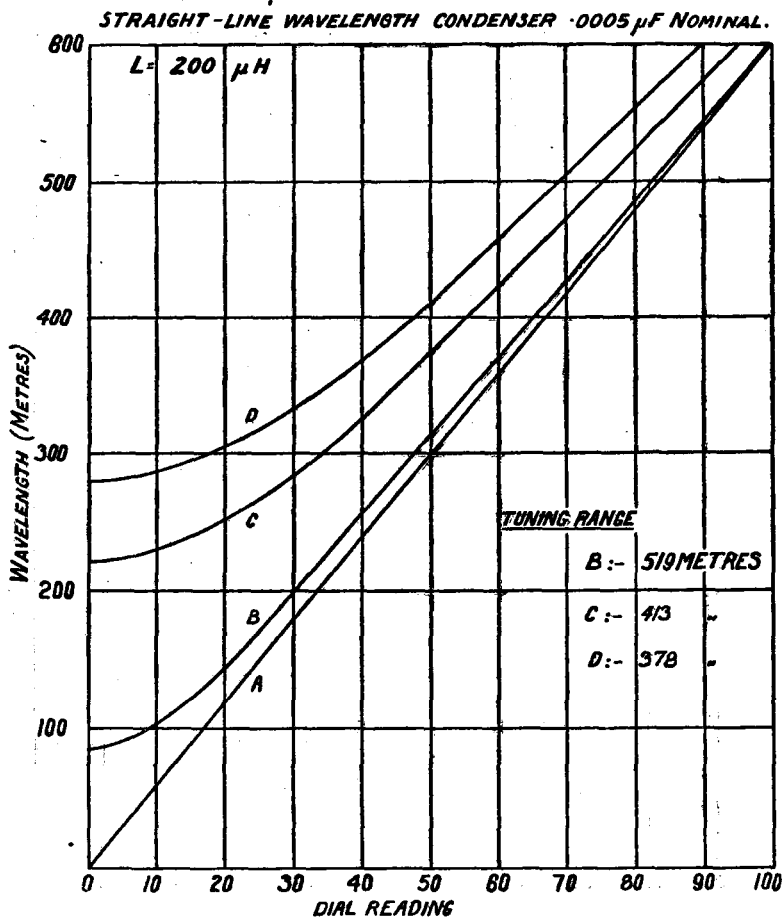

**Fig. 3.—A similar series of curves to those shown in Fig. 2, but for a square-law condenser. Curve A is for the theoretically perfect case which cannot be realised in practice.**

capacity of the condenser and a pure inductance; curve B is for the addition of 50  $\mu\mu\text{F}$  parallel stray capacity, and curve C for 100  $\mu\mu\text{F}$ . The tuning ranges for the latter two cases are 36.7 and 29.8 metres respectively.

The same remarks hold good for the curves of Fig. 5, which are for the case of a straight-line wavelength condenser. In all cases dial readings are marked as abscissæ and wavelengths as ordinates.

**Convenience in Working**

An interesting point is raised in the case of the short waves, and is well illustrated by the curves of Figs. 4 and 5. These clearly show that where the casual capacities are at all high, a semi-circular plate type of tuning condenser will give greater convenience in working, since the curves (B and C, Fig. 4) give a nearer approximation to a straight line. This effect is naturally more pronounced as the wavelength is lowered, the reverse applying for a straight-line wavelength condenser. For the same total casual capacities and equal maximum tuning capacities the wavelength ranges are, of course, equal.

**Magnitudes of Stray Capacities**

As to the relative magnitudes of the sources of stray capacities, I will deal with each in turn in the order given above. Coil capacities can be reduced considerably by the use of single-layer solenoid coils with air-spaced windings. Multi-layer coils of most types must inevitably have large self-capacities. Where compactness is a desirable feature this type, however, scores.

**The Best Type of Coil**

Coils to cover the 300-600 metre band may have as high self-capacities as 30 or 40  $\mu\mu\text{F}$ , whereas the self-capacity of a single-layer air-spaced solenoid is practically negligible, and, in any case, difficult to measure.

With efficient design the minimum capacities of condensers can be reduced to quite small figures, of the order of 5-10  $\mu\mu\text{F}$  in the case of the semi-circular or square-law types. Reference to the accompanying photographs will show that it is easier to

obtain a low minimum in a straight-line wavelength than in a straight-line capacity condenser, and in this respect most good condensers of the former type are an improvement on the old types of semi-circular plate condensers.

**Straight-Line Frequency Condenser**

In the case of the straight-line frequency condenser, as pointed out by Mr. Sylvan Harris in *Wireless Weekly*, Vol. 6, No 17, the question of the minimum capacity raises an important point. However, in connection with this article I have not considered this type of condenser. At the present moment, in this country, where the separation between the frequencies of broadcasting stations is somewhat arbitrary, there is, as yet, probably little scope for this type.

**Wiring Capacities**

The wiring and circuit capacities are no less important than the self-capacity of the coil, and I cannot do better than quote a definite instance to emphasise this point. The capacity between two parallel isolated wires of circular cross-section is given by

$$C = \frac{l}{4 \log_e \frac{d}{r}} \times \frac{1}{0.9} \mu\mu\text{F}$$

where  $l$  = length of each wire in cms.

$d$  = separation between wires in cms.

$r$  = radius of each wire in cms.

Taking the definite example illustrated in Fig. 6, where  $l = 10$  cms.,  $d = 2$  cms.,  $r = .1$  cm., we have:—

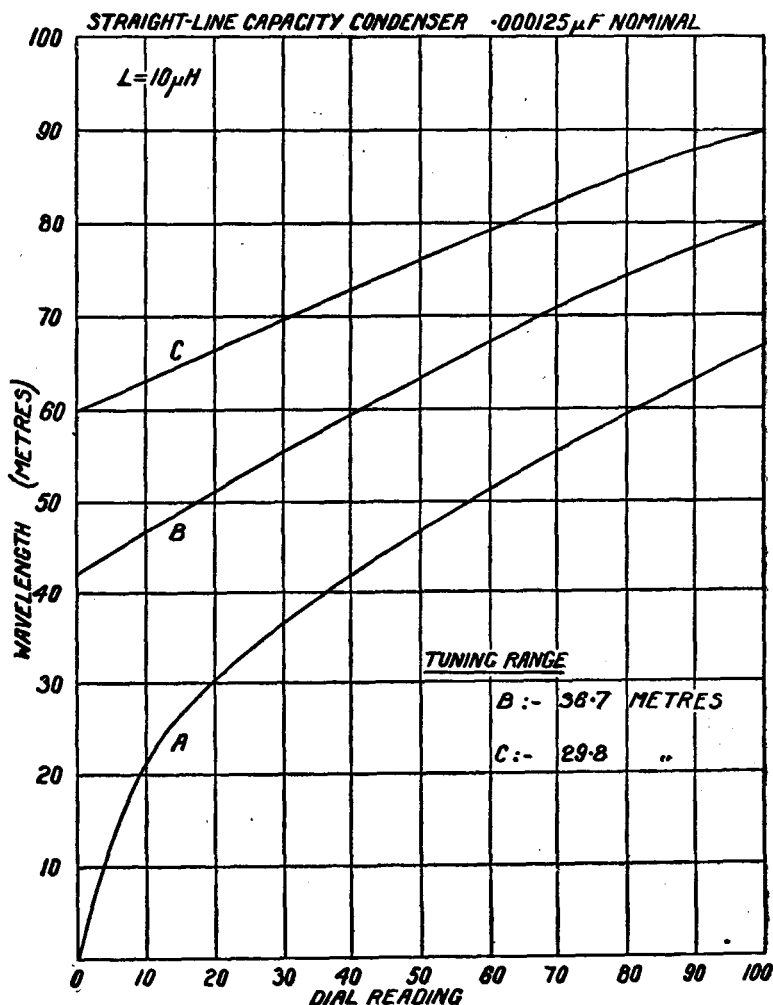

Fig. 4.—Some curves for the higher frequencies with a semi-circular plate condenser. The effect of casual capacities is to make the "curve" more nearly a straight line.

$$C = \frac{10}{3.6 \times \log_{10} \frac{2}{1} \times 0.434} = 5 \mu\text{F.}$$

Thus the capacity between two 4 in. lengths of square wire about  $\frac{1}{2}$  in. apart will be approximately the same. If each of these wires has an appreciable capacity to earth of the same order the effective capacity between them will be increased.

Thus the wiring and circuit capacities are obviously of fairly serious magnitude. They can be cut down, of course, by careful lay out of well-designed components and adequate spacing between the wiring.

**Grid to Filament Capacity**

Finally, there is the grid to filament capacity of the valve to be considered. Morecroft has shown that the "effective" capacity of the input circuit of a valve is given by

$$C_{\text{input}} = C_{G-F} + (\mu + 1) C_{G-P}$$

where  $\mu$  is the voltage amplification factor of the valve, and  $C_{G-F}$  and  $C_{G-P}$  the geometric capacities of grid to filament and grid to plate respectively, that is to say, the measured capacities on a "cold" valve. Thus the actual stray capacity due to this cause is dependent not only on the grid to filament capacity, but also on the grid to plate capacity of the valve, and its voltage amplification factor. Any factors such as the nature of the external anode circuit, which affect the latter, will cause this stray capacity to vary.

**Effect of Amplification Factor of Valve**

A valve having a high amplification factor may thus contribute as much as 50 to 100  $\mu\text{F}$  to the stray capacities. On the short wavelengths, where such valves would be useful, this constitutes a very serious drawback.

A further point arises in such a tuning circuit where we have a grid condenser connected between the top end of the condenser and the grid of the valve. This capacity is in series with the grid to filament capacity, and thus the

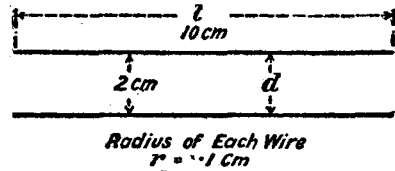

Fig. 6. — The capacity between two wires spaced as shown is about  $5 \mu\text{F}$ .

resultant effective casual capacity in shunt, apart from the other parallel capacities due to wiring, coil capacities, etc., is reduced, and in this case has not such a serious effect.

It is thus seen that of the various casual capacities which we want, as far as is possible, to eliminate, the valve itself may contribute more than any other cause; the next most important factor is the self-capacity of the coils, while circuit and minimum condenser capacities are of minor importance if well-designed components are used, and good layout and adequate spacing between wiring is studied.

**WIRELESS LICENCES**

The Postmaster-General calls attention to the fact that now that the Wireless Telegraphy (Explanation) Act has been passed, the legal obligation to take out a licence for a wireless receiving set—whether crystal or valve—has been placed beyond any doubt. There is reason to believe that, whilst the great majority of persons who have installed receiving sets have taken out licences, some have failed to do so. The Postmaster-General trusts that any such persons will take out licences at once; and he thinks it right to give notice that he proposes in future to institute proceedings in cases coming to his knowledge in which wireless sets are installed or used without licences.

Wireless receiving licences can be obtained on application at any Post Office at which Money Order business is transacted, on payment of the annual fee of 10s.

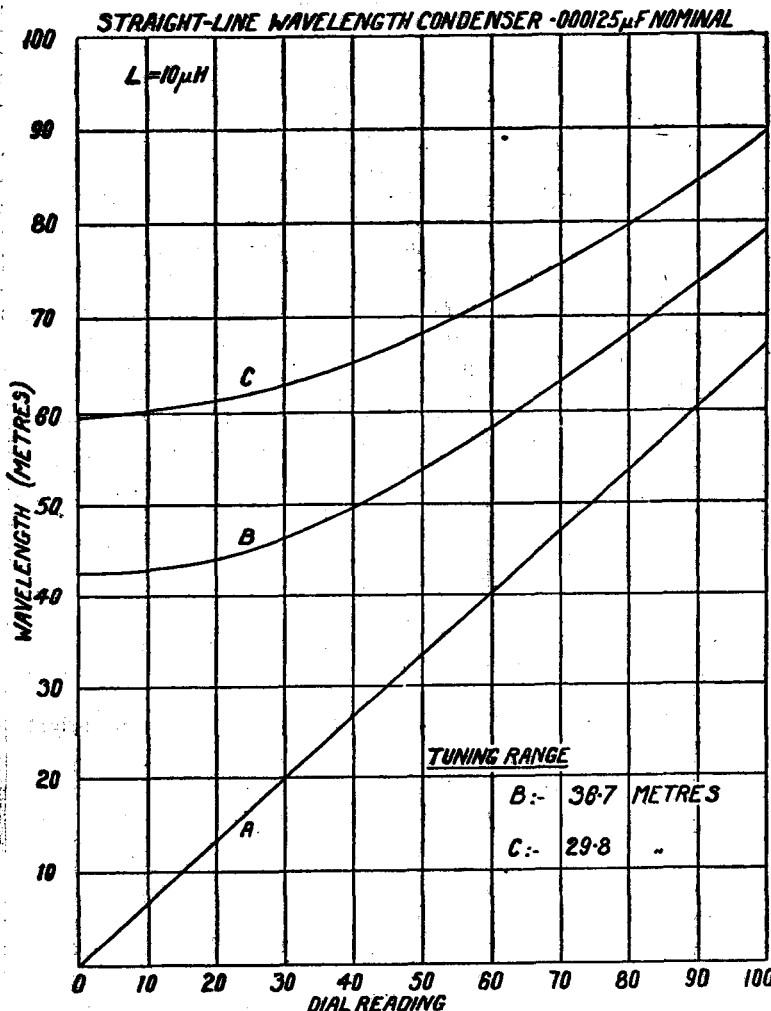
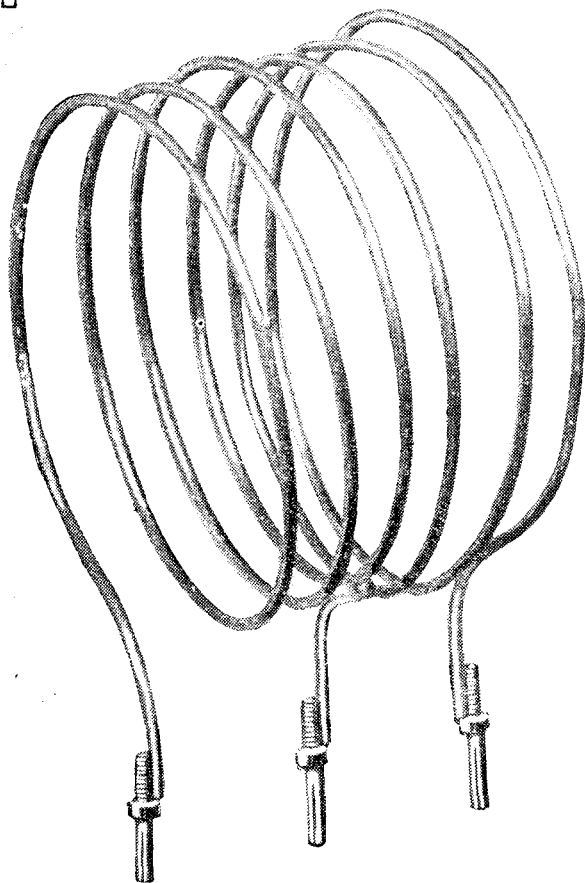

Fig. 5.—The result of increasing the casual capacity on the high frequencies when a square-law condenser is used.

# Success in Short-Wave Reception.

By **STANLEY G. RATTEE, M.I.R.E.,**  
Staff Editor.

*A general review of the factors which contribute to successful reception on the now popular short wavelengths.*



A bare wire coil suitable for reception on frequencies around 10,000 kc.

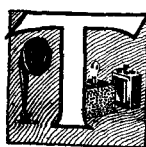

THE outcome of the present low-loss era is the ease with which it is possible to design receivers for use in reception upon short wavelengths; looking at things from another direction, the low-loss era is the outcome of experimental work upon short waves. Without doubt one is dependent upon the other.

During last winter most of the experimental work was confined to research upon wavelengths between 100 and 50 metres (2,998 and 5,996 kc.), whilst since then—that is, during the summer months—successful experiments have been carried out upon wavelengths as short as 20 metres (14,991 kc.), 10 metres (29,982 kc.), and even 5 metres (59,965 kc.), by amateurs, the experimental equipment used being comparatively inexpensive and simple.

### Inexpensive Apparatus

Once one is interested enough to enter into the channel of short-wave experiment, the fascination of the work seems to obsess one, probably due to the fact that very little expensive apparatus is required; further, the apparatus is extremely simple as a whole, a detector and note-magnifier

usually constituting the total number of valves employed.

Without a fair knowledge of how to start, and without an understanding of what is low-loss, one's early attempts at short-wave reception may quite conceivably result in very disappointing conclusions, and in this contribution will be given some brief indications of what should be avoided.

### Choice of Circuit

First, there is the question of circuits, and, since the penetrating effect of short waves is such that almost any transmission can be heard on a well-designed single-valve reaction receiver, used in conjunction with a note-magnifier, the circuits need not include high-frequency amplification. Indeed, with our present knowledge it is an extremely difficult business to obtain high-frequency amplification upon wavelengths below 100 metres (2,998 kc.), exclusive of using a super-heterodyne, and even though it may be possible, the beginner in short-wave reception is not advised to attempt it.

In choosing a circuit for short-wave work, which we will assume to consist of a valve detector and note-magnifier, the main consideration is

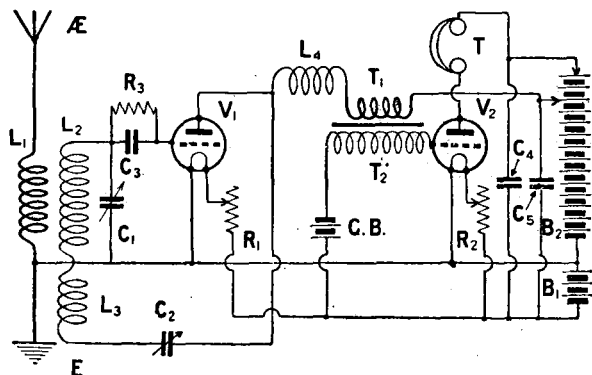

Fig. 1.—A useful circuit for short-wave reception.

which form of reaction control will give the best results. To some, the ordinary straight magnetic reaction circuit, using a swinging coil, makes strong appeal, but since any alteration of the coupling of this coil alters tuning adjustment of the receiver, it will be recognised as having a serious disadvantage. The most generally accepted method is that used in the Reinartz circuit, and this, apart from not having any serious effects upon tuning, allows the reaction adjustment to be so finely made that strong signals will cause the set to fall in and out of



oscillation as the signals start and stop. Further, this form of reaction may be used even down to wavelengths of ten metres without difficulty.

### Aerial Coupling

Another point to be considered in a short-wave circuit is the aerial coupling, and unless some form of loose coupling is used it will be found very difficult to make the receiver oscillate. In the first place, the aerial coupling need not be variable. I say need not be, because in practice there appears to be no great advantage in making it so, and by making it fixed one control is dispensed with. The aerial coil may quite conveniently be separated from the grid coil by a spacing of a full inch, and need not be tuned; indeed, the tuning of this part of the circuit invariably complicates matters. Another form of aerial coupling is to make the aerial coil a continuation of the grid coil as in the Reinartz circuit, when the two coils are wound upon the same former, thus simplifying the construction.

### Practical Circuits

Two circuits showing the arrangements discussed above are given in Figs. 1 and 2, the form of reaction being the Reinartz arrangement in both cases. In Fig. 1 the aerial coil  $L_1$  is fixed at a distance of approximately one inch from the grid coil  $L_2$ , whilst the plate coil  $L_3$  is wound upon the same former as  $L_2$ . The  $L_4$  coil is a radio choke, consisting of 150 turns of No. 30 enamelled wire wound upon a  $1\frac{1}{2}$ -in. diameter former, its length being about three inches. This form of circuit is particularly useful in the reception of wavelengths between 50 and 100 metres (5,996 and 2,998 kc.), and particulars as to coil sizes for use with such an arrangement were given by the present writer in *Wireless Weekly* for June 17, 1925. As to the condensers  $C_1$  and  $C_2$ , these

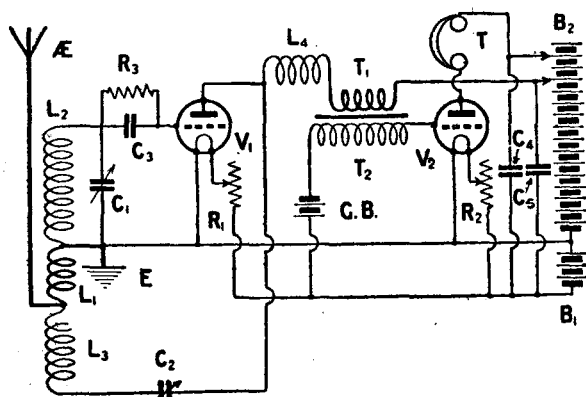

Fig. 2.—A form of the Reinartz circuit particularly adaptable for use at high frequencies.

should each be of  $.00025 \mu\text{F}$  capacity, while the remaining components will be of normal value. From the point of view of construction, the arrangement given in Fig. 2 is the simpler, in that the coils  $L_1$ ,  $L_2$  and  $L_3$  may be wound all upon the same former as a continuous coil, tapplings being made for the aerial and earth connections. In this circuit, the condensers  $C_1$  and

$C_2$  should be of  $.00025 \mu\text{F}$  for the reception of stations on the 50- to 100-metre band, whilst the coil should be wound on a 3-in. diameter low-loss former having eleven turns of No. 22 d.c.c. wire for  $L_2$ , four turns of the same wire for  $L_1$ , and twelve turns of the same wire for  $L_3$ . The choke coil  $L_4$  will be as before, as will also all other values.

### Below Fifty Metres

If it is desired to receive upon wavelengths below 50 metres (5,996 kc.), then it is recommended that air-spaced coils and  $.0001 \mu\text{F}$  variable condensers

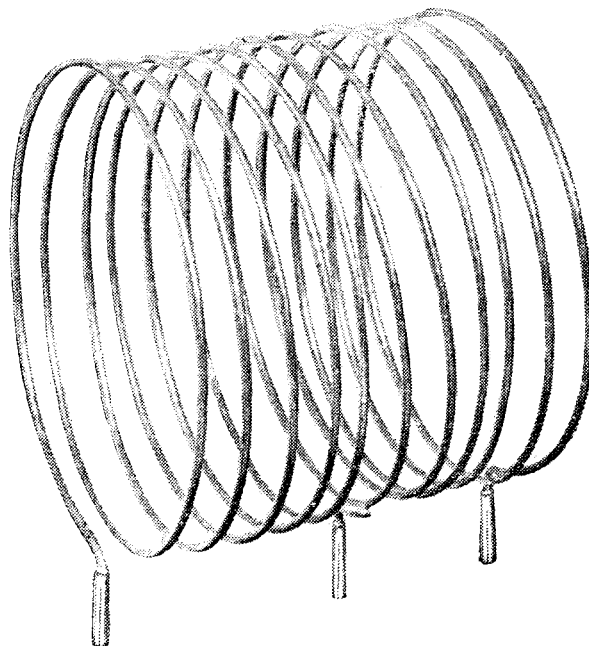

Another size of self-supporting coil wound with bare wire and arranged to plug into ordinary valve sockets.

be used with the circuit given in Fig. 2. Details of coils and how they may be made were given by the writer in the June 24 issue of *Wireless Weekly*, and, using these, wavelengths as low as twelve metres may be reached.

### Aerials

When dealing with short-wave reception from the view-point of obtaining the most successful results possible, considerable experiment should be made with the type of aerial which best suits local conditions. In this connection, though quite satisfactory results are obtainable when using the ordinary P.M.G. arrangement, experiment seems to indicate that still better results can be obtained upon 100 metres (2,998 kc.) and below by using a much shorter aerial, preferably arranged in a vertical position.

### Valves to Use

After the question of circuit has been decided the chief consideration lies in construction, and if it is desired to receive on wavelengths below 50 metres (5,996 kc.), then careful construction becomes a *sine qua non*. The grid coil leads should be as short as possible, and the components connected to the grid coil should be as near as is reasonably

possible. If it is within the power of the constructor to build the receiver in such a way that the usual large ebonite panel may be dispensed with, as in the case of the receiver described in *Wireless Weekly* for June 24, then this is to be preferred. Wrapped up in the question of construction is that all-important matter of which type of valve to use, and though it is generally admitted that valves of the V.24 type are the best for use as detectors in short-wave receivers, the ordinary four-pin valve may still be used so long as the valve holder is one of the low-loss types; but since the matter of components has

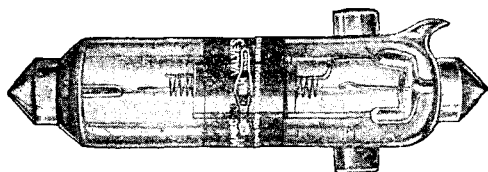

A Marconi low-capacity valve.

already been discussed in a former issue, the subject will not be gone into again.

### Delicate Tuning

Probably the chief stumbling-block in the way to success in short-wave work, apart from faults in design, is the actual operation of the receiver, and though an operator may be able to tune in all the B.B.C. stations with an ordinary broadcast receiver, he may quite conceivably attain poor success upon, say, 20 metres (14,991 kc.). The reason for this statement lies in the fact that short-wave tuning is extremely delicate, and the more we descend in wavelength the more delicate does the operation become. Another point which calls for close observation is the correct value of H.T. for the valve being used as detector, as this, if too high, will give a "floppy" control of reaction.

### Control of Oscillation

Having decided upon the type of valve which is to be used as detector, then, with a given value of H.T. on the anode of that valve with the correct filament current, various values of grid-leak should be tried until such a value is found that the receiver will oscillate easily, yet give a smooth control of oscillation. It is usually found that different values have a remarkable effect on reaction control.

### Stations Audible

As to results which may be obtained on the 50- to 100-metre wavelength band (5,996 to 2,998 kc.) at this time of the year, though conditions are not by any means favourable on account of atmospherics and the long daylight hours, quite good signals were obtained recently from KDKA and the short-wave station at Schenectady when using the circuit given in Fig. 2. As some indication of wavelength, listeners will hear when using the 4-11-12 turn coil referred to above a very loud station sending ABC a number of times and signing

himself. WIR; this station, which sends very slowly, is, according to the August issue of *Q.S.T.*, working upon a wavelength of 74 metres (4,051 kc.).

On wavelengths below 50 metres (5,996 kc.) the reception is mainly confined to daylight hours, when quite a number of distant amateurs may be received, working as low down as 20 metres (14,991 kc.). For reception on wavelengths in this region coils of the type shown in the photographs should be used, which, as will be seen, are self-supporting.

### Coils for Ultra-short Waves

The smaller of these coils will cover wavelengths between 12 and 30 metres (24,987 and 9,994 kc.) approximately when tuned by a .0001  $\mu$ F condenser in parallel in the manner described in the June 24 issue previously referred to. This coil is wound with No. 12 bare copper wire, which is sufficiently "stiff" to enable the coil to be used exactly as shown. The second coil will cover wavelengths between 30 and 70 metres (9,994 and 4,283 kc.) when tuned with the same value condenser and used in the receiver illustrated on the cover of this present issue. This coil is wound with No. 14 bare copper wire, and, unless actually shaken, will not vibrate when mounted in the receiver previously mentioned.

So long as coils and receivers are built in this "skeleton" style, then little difficulty will be experienced in attaining success, and as soon as the first short wave signals have been received the wisdom of these remarks will not only be appreciated but endorsed.

## THE GLASGOW STATION

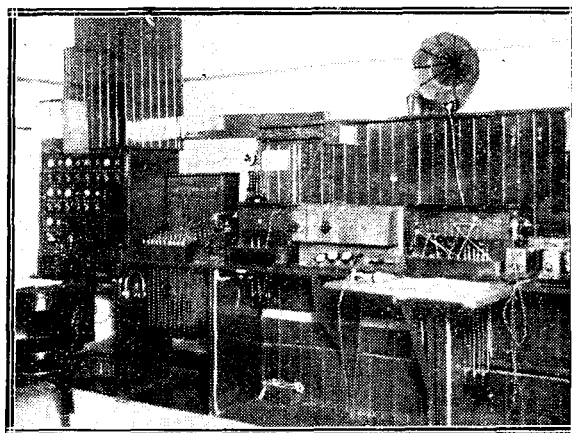

The S.B. switchboard and line amplifiers in use at the B.B.C.'s Glasgow Station.

ARE YOU READY FOR THE AUTUMN?

What Set are You going to Make Up? Before You Decide, get a Copy of

**SIX SIMPLE SETS**

By S. G. RATTEE, M.I.R.E.

PRICE 1/6 or 1/8 POST FREE.

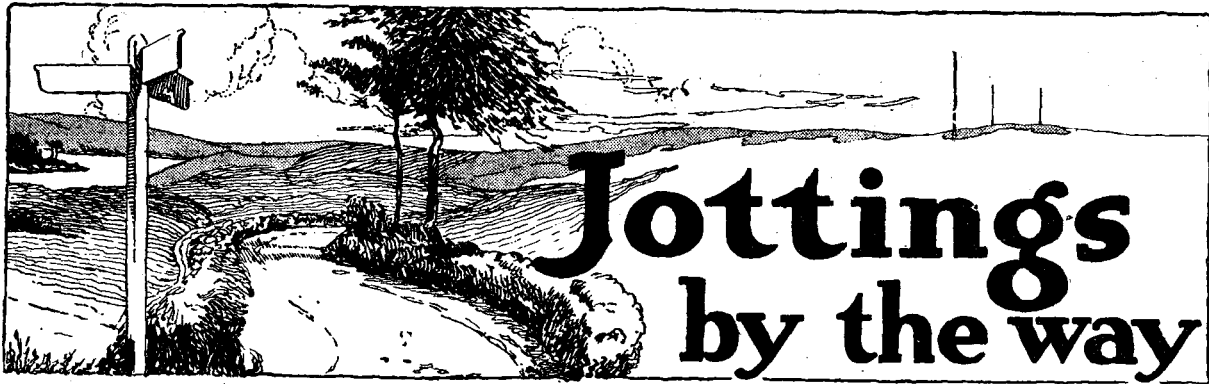

**The Eliminators**

**T**HE world seems simply full of people who spend their time in trying to knock chunks off the wireless receiving set. Not long ago the high-tension battery was abolished, and I was forced to write in these columns a powerful appeal on behalf of those employed in the making of these useful, though at times annoying, components. Luckily those words of mine sufficed to save the industry from the doom with which it was threatened, and there hangs before me as I write a framed testimonial from the Pluscappers' Union in recognition of my efforts on their behalf. The Pluscappers are, as I expect you know, the fellows who make those neat little tin hats which decorate the carbon rods of high-tension batteries—a most skilled calling. The high-tension battery, thanks to my timely aid, has weathered the storm, and now I gather that the accumulator is for it. For this I am not really sorry, since there is only one thing that I hate more than lugging my accumulator round to the charging station, and that is lugging it home again.

**Professor Goop Steps In**

For a long time past I have been pondering over the question of accumulators. When you come to think of it the objections to them are (1) that they require constantly charging up, which means

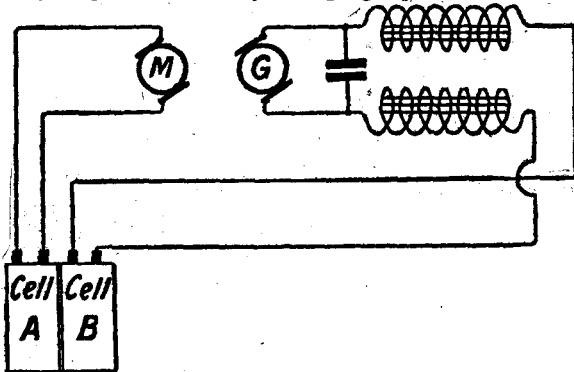
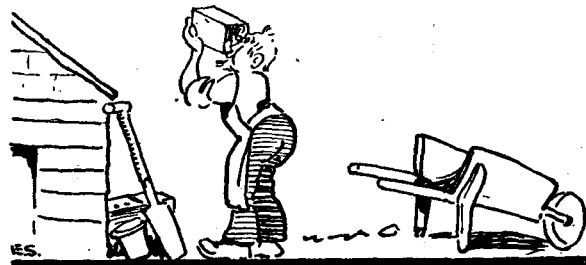

Fig. 1.—The Goop-Wayfarer Circuit for a self-charging accumulator.

that your account is also constantly charged up, and (2) that they weigh at least two tons apiece if you have any distance to carry them. All the efforts of myself and Professor Goop to evolve a self-charging accumulator have so far failed,

though we have obtained some quite promising results with the circuit shown in Fig. 1.

Here current from cell A is used to drive the motor M, which operates the generator G. Current from the generator, after passing through the smoothing circuit in order to eliminate all bumps, is delivered to cell B of the accumulator. As soon as cell B is fully charged the connections are reversed. This cell now drives the motor, whilst the dynamo delivers current to cell A. As will be seen, the scheme is a very sound one.



... the Professor's gardener drank their contents ...

The only difficulty that we have found so far is in finding a really efficient motor. The makers of these things appear to know very little about their business, and most of the machines that they turn out are terribly greedy, so that cell A is apt to run down before cell B is fully charged, and vice versa. Once a really efficient motor is evolved, the matter is automatically solved.

**The Weight Question**

We have also endeavoured to tackle the weight question, though this has been a tough nut to crack. A large proportion of the weight is caused by the presence of water in the electrolyte. In our first experiment we used methylated spirit as being very much lighter, but this did not appear to mix on very friendly terms with the sulphuric acid, and several accumulators were ruined owing to the fact that the Professor's gardener discovered them and drank their contents during the hot weather. Our next experiments led us on to try the effect of a gas electrolyte. What does the ordinary fluid contain? " $H_2SO_4 + H_2O$ ," said he, with a confident smile, having just looked it up in a text-book. And what does this mean in plain English? Why, simply hydrogen and sulphur with a dash of oxygen.

We therefore made up at once our patent

feather-weight accumulator, which has an electrolyte of sulphuretted hydrogen with an admixture of oxygen. But for the fact that it would be necessary for all members of a listening-in party to wear gas masks, and that the gas simply will not stay inside the case to do its proper job, there might have been a great future for this invention. We are still striving to produce deodorised sulphuretted hydrogen, but so far our efforts have not met with the success that they deserve, whilst our neighbours have written begging us to have the drains seen to without delay. Some folk are always poking their noses into other people's business.

**A Substitute**

Since, however, it is obvious that the accumulator in its present heavy form is no longer to be tolerated in the best circles, the Professor and I, having failed satisfactorily to reduce its weight, have decided to abolish it altogether. We have designed the very neat little drawing-room outfit for filament heating purposes seen in Fig. 2, which will shortly be placed on the market at very reasonable cost. Those who wish to make up the Goop-Wayfarer Filament Heater for themselves can do so by following out the instructions which I am about to give. It is expected, however, that those who do so will remember the fact that this invention is a patent, and they will not omit to send in an adequate remittance on account of royalties. On no account should remittances be addressed to Professor Goop. They should come direct to me. Any contribution, from a sixpenny postal order upwards, will be accepted as conscience money.

**Acquiring the Apparatus**

The first requirement is a second-hand locomotive boiler, which can be obtained readily from any railway works. The existing drawing-room grate must be removed and the boiler installed in

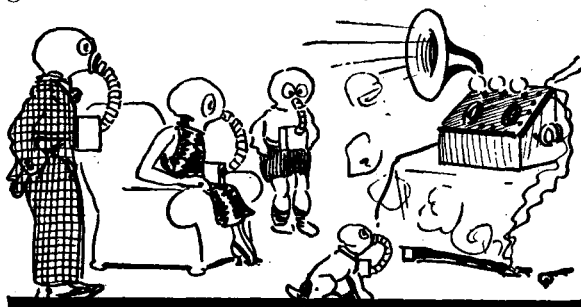

... it would be necessary for all members of a listening-in party to wear gas-masks ...

its stead. Readers will find that their wives will go into ecstasies over the possibilities of the cab, which they will turn without delay into a delightful cosy corner or an inglenook for winter use, whilst in summer it makes an extremely effective Turkish bath for the home. Next we need a steam engine of some neat type capable of developing about three horse-power per valve to be lighted. Any kind of steam engine will do, though if you can possibly obtain one with the Goop-Wayfarer Buffle-shunt Valve Gear, Interlocking Stuffing-box and Bi-Polar Cross Head, so much the better—for us, at any rate, who live largely by our patent royalties.

**Other Gear**

The engine is used to drive an air compressor of the well-known Sloophly-Flopwoggle type, which is quite the most efficient that I know. Air from the compressor is fed into a Stickit-Seesup turbine, which in its turn drives a generator capable of delivering up to 8 amperes at 6 volts. From the output terminals of the generator leads are taken to a Goop-Wayfarer smoothing circuit, in which all creases are ironed out of the current. Further leads connect the smoother with the low-tension terminals of the receiving set, and there you are.

**A Real Boon**

In the old days, when wireless sets were always breaking down, life was full of excitement, but

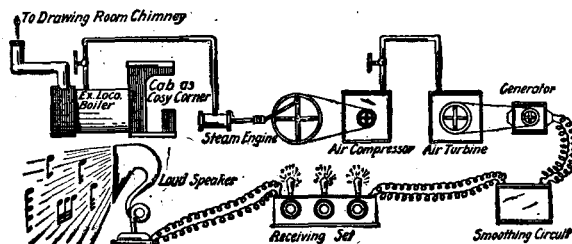

Fig. 2.—The Goop-Wayfarer drawing-room outfit for filament heating.

now they have been brought so near perfection that nothing ever happens to them, the wireless man's lot is apt in the ordinary way to become rather a dull one. To all sufferers from ennui the Goop-Wayfarer Filament Heater will come as a boon and a blessing, since there are so many parts which call for constant attention on the part of the operator.

The happy tuff-tuffing of the steam engine, the soothing boom of the air compressor, the whirl of the turbine, and the busy hum of the generator, all combine to produce a medley of sounds that is at once satisfying to the mind and soothing to the nerves.

**Wives Love It**

The analysis of the reports that we have received from delighted users of the Goop-Wayfarer Filament Heater show that in the majority of cases the lady of the house leaves instantly to go to her mother when the installation of the apparatus begins. As soon as the piano is moved into the potting shed to make room for the air compressor, she packs up her trunks and goes. This, of course, gives her worse half a chance of getting things done without interruption or criticism. On the average, the lady returns in about three weeks from the word "go" and immediately falls in love with the new arrangement of her drawing-room. Having painted the boiler black, picked out with yellow, and having fitted crêtonne covers to the various pieces of apparatus, she promptly adopts the Filament Heating outfit as entirely her own idea and invites all her friends round to a tea-fight in order that she may display to them the very last word in ultra-modern drawing-rooms.

**WIRELESS WAYFARER.**

## WIRELESS NEWS IN BRIEF

**I**n view of the many successes attending the use of short wavelengths for long-distance communication which have recently been recorded, it is interesting to note that a patent has just been granted in America in which it is proposed to use very long waves for radio signalling. It is claimed that wavelengths of from 300,000 to 600,000 metres have utility in signalling over short distances, as, for example, between warships at sea. In some cases this would be an advantage, as the long waves would not travel far enough to produce interference at a distance or be readable by enemy stations far away. Long wavelengths are used at present mainly for transatlantic and other long-distance work.

\* \* \*

We understand that, as a result of a special agreement drawn up between the British Broadcasting Company and the British National Opera Company, an extensive opera broadcast programme will be available for listeners next month, when the opera company's provincial tour starts.

The B.B.C. have the option of broadcasting an act from any of the operas performed on any night.

The opera company will be at Leeds from September 14-26, where the first broadcast will be made. Each transmission during the whole tour will probably be simultaneously broadcast to other stations of the B.B.C.

\* \* \*

Mr. Gerald Marcuse has added a new achievement to the list of amateur wireless successes, having communicated by telephony during daylight with Mosul in Iraq. Tests were first carried out at night-time, and the signals recorded were of such strength that Mr. Marcuse considered there would be no difficulty in working during daylight, and this he has now accomplished.

The distance between the two stations is 2,050 nautical miles. Mr. Marcuse uses both for modulator and for oscillator the Marconi Osram Type T. 250 valve. The power employed was approximately 400 watts and the wavelength 45 metres.

\* \* \*

Powerful wireless apparatus is being installed in the United States dirigible airship *Shenan-*

*doah*, and it is expected to have a range of between 8,000 and 9,000 miles. It weighs some 1,600 lbs., and is composed of a main transmitter operating on a series of wavelengths varying between 507 and 1,500 metres. A short-wave transmitter is also being carried. The aerial used for the main transmitter is a great length of wire let out from a reel.

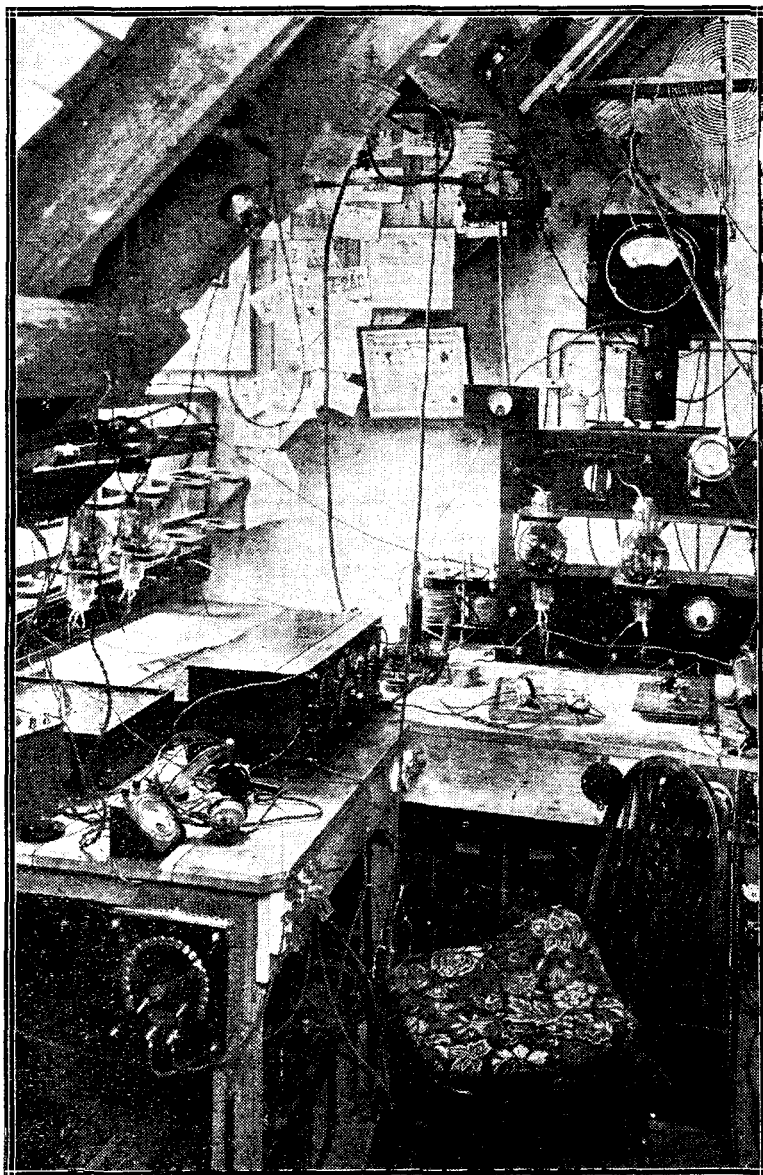

A corner of Mr. Marcuse's station (2NM) at Caterham.

# SOME BRITISH SUPER-HE



The intermediate frequency transformers, input filter and oscillator coupler produced by the Bowyer-Lowe Co., Ltd., are neatly enclosed in cases of the same type. The circuit for these components makes use of a separate oscillator.

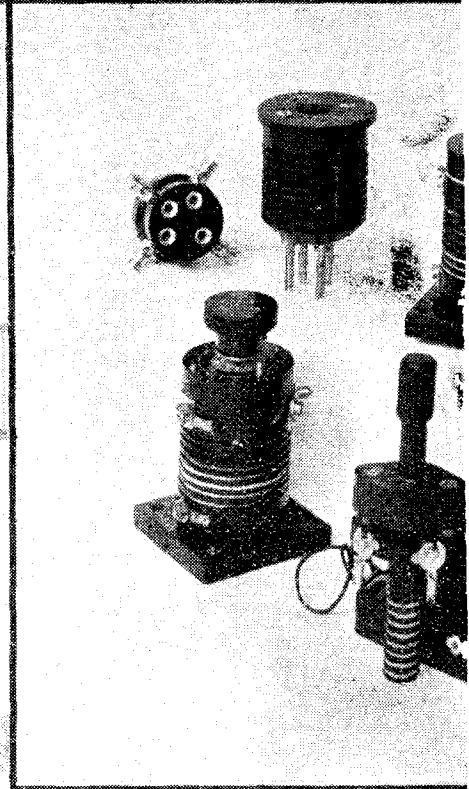

The sets of components make a centre tap autodyne oscillator. The intermediate frequency transformer baseboard mounting or with unit seen in front is used for the Tropadyn of the Tropadyn

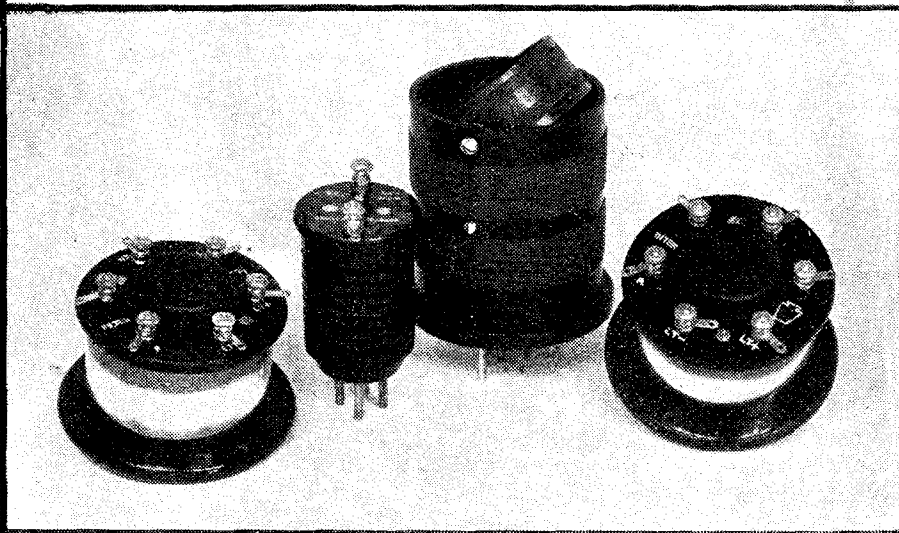

Some of the components made by the Peto-Scott Co., Ltd. Two forms of oscillator coupler are shown in the centre. The long-wave transformers shown have a valve-holder incorporated in the top.



A selection of components for autodyne receivers, manufactured by the Peto-Scott Co., Ltd. The device on the right is the Tropadyn variable coupling to vary the

# HETERODYNE COMPONENTS

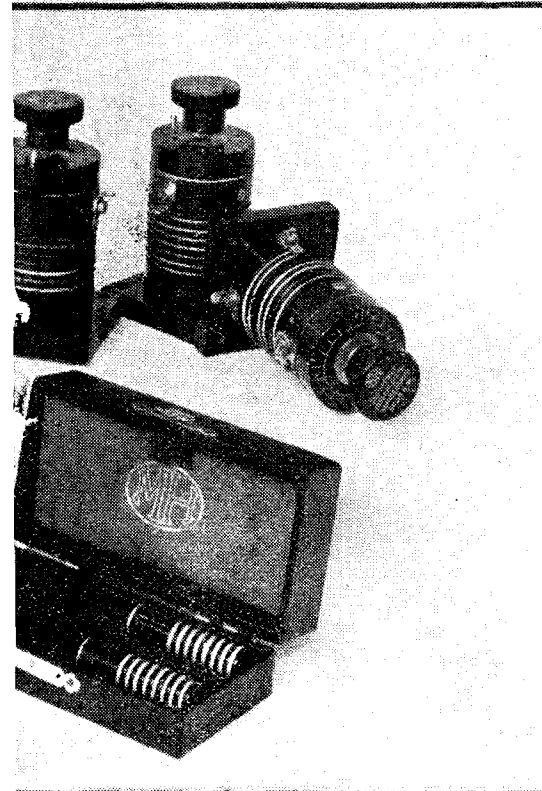

Designed by L. McMichael, Ltd., consist of a coupler, one long-wave filter and three transformers. These are produced either for the usual 4-pin fittings. The reactor is oscillator and detector valve, a form of circuit being employed.

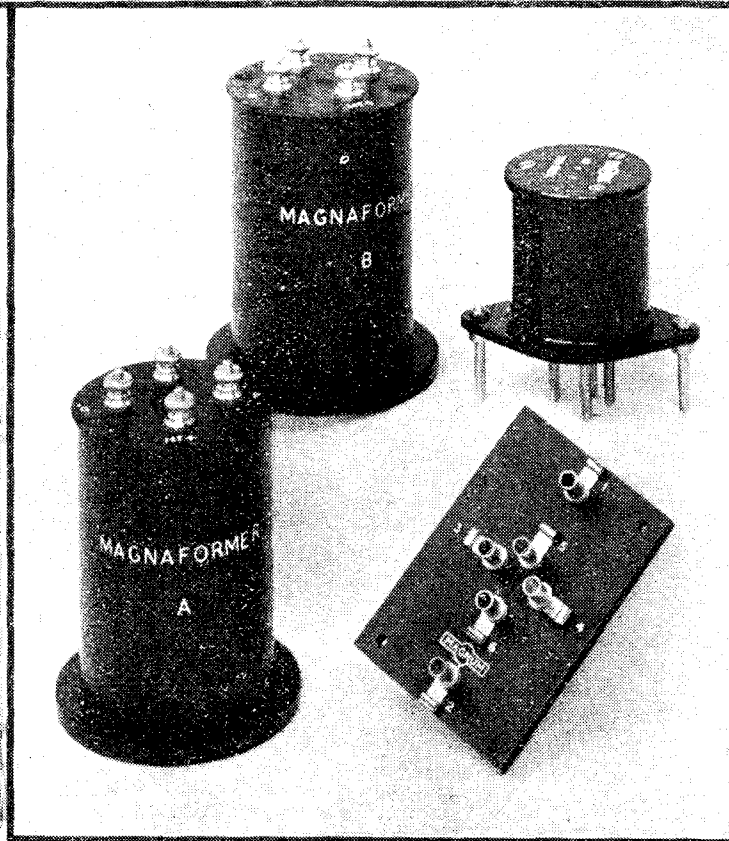

Messrs. Burne-Jones & Co., Ltd., manufacture an oscillator coupler for a separate oscillator, a filter, and intermediate frequency transformers, these latter being alternately tuned and untuned; four stages of long-wave amplification are used.

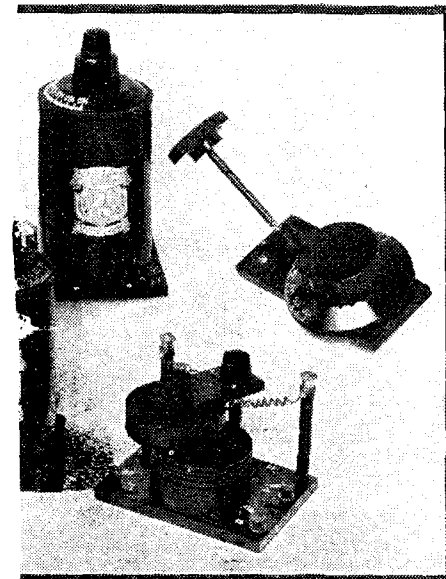

Designed by Beard & Fitch, Ltd. The oscillator coupler, provided with a strength of the local oscillations.

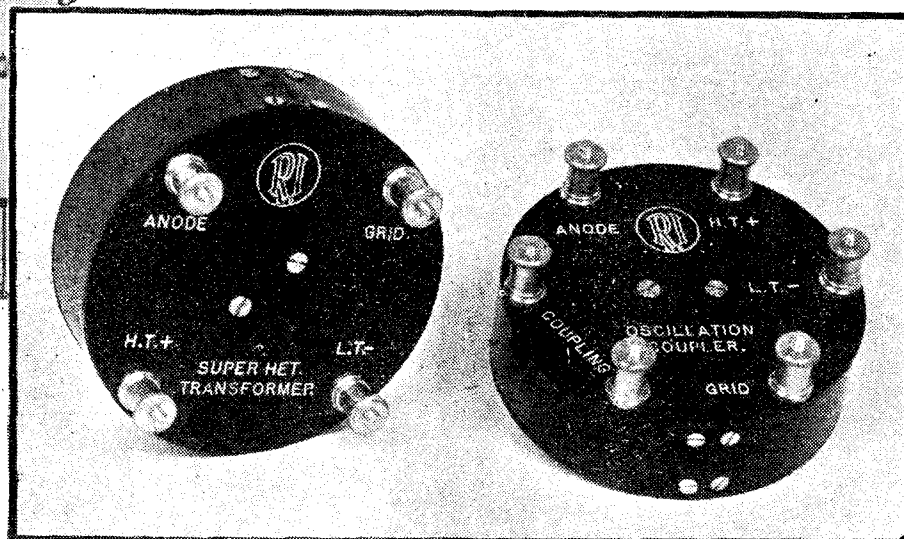

Radio Instruments, Ltd. produce some very compact instruments; above are shown the oscillation coupler and one of the intermediate frequency transformers. The input filter is of the same type.

# A NEW SHORT-WAVE SYSTEM?

Some details of a special investigation which is being carried out by Mr. J. H. Reyner, B.Sc. (Hons.), A.C.G.I., D.I.C., of the Radio Press Laboratories, on a new method of short-wave working proposed by Messrs. Autoveyors, Ltd.

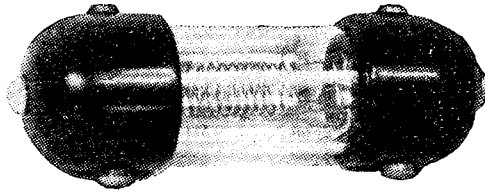

The valve relay used with the system discussed in the text.

REFERENCES have appeared from time to time in the Press concerning a new short-wave system by means of which communication is possible over considerable distances on a very small amount of power. The system, which is controlled by Messrs. Autoveyors, 84, Victoria Street, has been claimed to make communication between London and New York possible on a power of only half a kilowatt. In order to ascertain exactly what this new system was and where it differed from the existing methods, I obtained a special interview with Mr. A. E. Chapman, Technical Director to Messrs. Autoveyors, Ltd. It is understood that details of the system have been submitted to the leading interests in the country.

### Short-Wave Transmission

We are able to give here some indication of the method

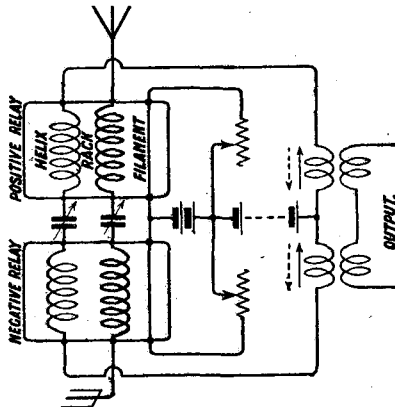

Fig. 1.—One form of receiving circuit it is proposed to use.

which it is proposed to adopt. It is, by now, a well-known fact in short-wave working that the influence of the Heaviside layer upon transmission is very considerable. One effect of this layer of ionised atmosphere is that wavelengths which are suit-

able at certain times of the day are no use at all at other times. Transmission between any two points, therefore, is usually accomplished by the use of several wavelengths; and by appropriate changes of wavelength at different times of the day practically continuous communication can be established. Recent developments have certainly indicated that there may be bands of wavelengths which are equally effective throughout the twenty-four hours, but information on this point is not yet by any means complete.

### Polarisation of Waves

Another aspect of the question, which may possibly have even more influence than the previous one, is the rotation of the plane of polarisation of the wave. That is to say, the electric field is not vertical or nearly so, as in the case of the longer wavelength radiations, but may be tilted at various angles and may even rotate in its transit from point to point. Some such action as this was indicated in the "Inventions and Developments" column of *Wireless Weekly*, Vol. 6, No. 18. Certain short-wave experimenters have certainly noticed that by tilting their receiving aerials they can obtain better results.

### Compound Focus Apparatus

Comparatively short wavelength radiations can be reflected by means of suitable apparatus in a similar manner to the reflection of light by a mirror. Beam systems are at present in use and in the course of erection, in which the radiations are

focussed in a horizontal plane but not in a vertical plane. That is to say, although the radiations are not permitted to spread out in all directions over the earth's surface, but are limited to the confines of a certain more or less parallel beam, they are enabled to spread in a vertical direction to any extent.

### Restricting Beam to Solid Ray

If a second focussing arrangement could be incorporated in the apparatus by means of which the rays would be kept within the confines of a certain vertical beam as well as a horizontal beam, a more or less solid ray would be emitted from the transmitting point. This, briefly, is the outline of the system which is proposed by Messrs. Autoveyors, Ltd. By the use of what is termed compound focussing apparatus the radiations are to be emitted from the transmitting point in the form of a more or less solid ray, and at the receiving point the receiver is to be in the form of a simple oscillator pivoted about its middle and capable of rotating in any direction. By this means it can be placed in the most suitable position at each time of the day to allow for the variations in the plane of polarisation of the electro-magnetic wave radiating from the transmitting point.

### Magnetic Fields

It is claimed that this system makes use of the magnetic field in the wave rather than the electrostatic field. We presume that what is meant is that the system does not employ any earth connection, but that the radiating



and receiving systems are more of the nature of Hertzian oscillators than of the ordinary aerial and earth transmitting arrangements.

It is, of course, well known that the electric and magnetic fields of a wireless wave are inseparable, being merely different manifestations of the same phenomena, but it is sometimes more convenient to regard the effects from a magnetic point of view.

#### A New Type of Valve

An important point in connection with this new system is the use of a special type of valve. One of the chief difficulties encountered in dealing with the very high frequencies necessary to produce ultra-short waves lies in the capacity effects experienced with the ordinary types of valve. In this system, therefore, a special form of valve relay is employed in which the tuning coils are incorporated in the electrodes themselves.

The device consists of a filament of wire surrounded by two spirals, which are termed the "rack" and the "helix," corresponding to the grid and the anode in an ordinary valve. The ends of these spirals are brought out to separate connections on the ends of the valve, so enabling the high-frequency oscillating current to be passed round the electrodes themselves. By this means it is claimed that an electro-magnetic control is obtained on the electrons emitted from the filament, and the effect of inter-electrode capacities is minimised.

#### The Receiving Circuit

A circuit incorporating these new valves is shown in Fig. 1. There are two types of valves, known as the positive and the negative types. In one of these the spirals are wound clockwise, while in the other they are wound anti-clockwise.

It is claimed that the aerial currents, which flow round the "racks" of the relays, exercise a magnetic control on the emission.

#### "Push-pull" Arrangement

Due to the reversing of the direction of the spirals in the negative relay, it is claimed that an increase of current in positive relay is accompanied by a de-

crease in the negative relay, and vice-versa, so giving a "push-pull" arrangement.

For scientific reasons we do not agree with this explanation.

We were informed that this relay is very much more sensitive than the ordinary valve, and in one form or another it is used in all the apparatus embodied in this new system.

#### Practical Tests

It is understood that this type of relay will very shortly be placed on the market for the use of amateurs, and although it is designed primarily for very short waves, it is claimed that by the use of suitable loading inductances it may be used very suc-

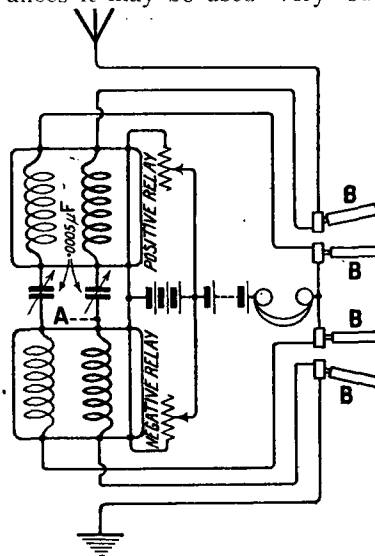

Fig. 2.—A second form of receiving circuit.

cessfully on the ordinary broadcast band of frequencies.

In order to verify this statement and find out whether there was any appreciable improvement resulting from the use of this relay, some tests have been carried out at the Radio Press laboratories, with the following results:—

The two valves were connected up in a manner similar to that shown in Fig. 1, except that loading inductances were inserted in the "rack" and "helix" circuits. The output circuit, of course, contains high-frequency currents, which will be inaudible unless rectified. Hence the output coil was tuned and applied to the grid of a valve arranged to give the usual cumulative grid rectification.

The resulting signal strength was disappointing, being little, if any, greater than that obtainable with a simple single valve set.

A certain reaction effect was produced by coupling the "rack" and "helix" circuits together. Oscillations could be produced, but in this case the circuit became "floppy," which one would rather expect, seeing that the "rack" is free. The case is identical with the building up obtained in a valve having a free grid.

With the idea of dispensing with any apparatus other than that proper to the relays themselves, the circuit shown in Fig. 2 was tried, and was found to give results almost as loud as the original arrangement.

#### Magnetic or Static Control

At this point, in order to gauge the effect of the "rack" on the emission, one of the "racks" was short-circuited. No difference in the signal strength could be observed, so the other "rack" was short-circuited. The signals remained as loud as before!

In order to investigate this effect the characteristics of the valves were taken. With a filament voltage of 1.8, and a current of 0.25 amp., the emission (with an H.T. voltage of 60) was 1.45 milliamps. The passage of current through the "rack," in either direction, had practically no effect.

Actually, a current of 0.5 amp. through the "rack" increased the emission by 0.015 milliamp., irrespective of the direction of such current.

These tests appear to indicate conclusively that the magnetic control of the emission is negligible, and that any effects which are obtained are electrostatic, as with an ordinary valve.

#### Use at High Frequency

Since these relays, however, were designed for high-frequencies, experiments are in progress to ascertain whether they exhibit any superiority over ordinary valves at such frequencies. A certain benefit may accrue from the fact that the electrodes themselves can be used as part of the tuning circuits, but this will remain to be seen.

## A WIRELESS MAGAZINE'S BROADCASTING STATION

**W** RNY, the latest broadcasting station to add its voice to the already existing chorus in New York City, is owned and operated by our American contemporary, *Radio News*, and is situated on the top of the Hotel Roosevelt immediately adjacent to the Grand Central Terminus, one of the two great railway termini in New York City. The equipment is of the latest Western Electric type, and the aerial is supported on two steel masts of the tubular type.

This station was receiving its final tune-up when Mr. Harris visited it recently. It is well laid out, particular care having been taken to

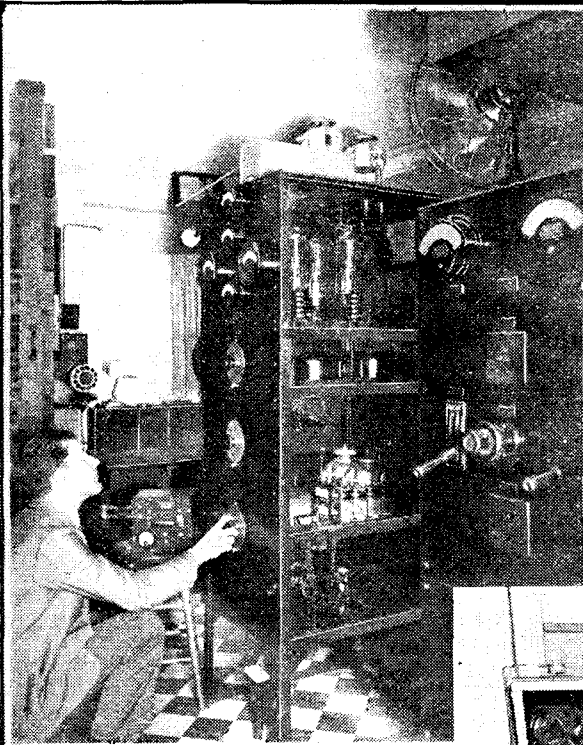

*Top—Tuning the transmitter at WRNY.*

*Centre—The neat portable outfit used for outside broadcasts.*

*Below—Listening for distress calls on the 600-metre band.*

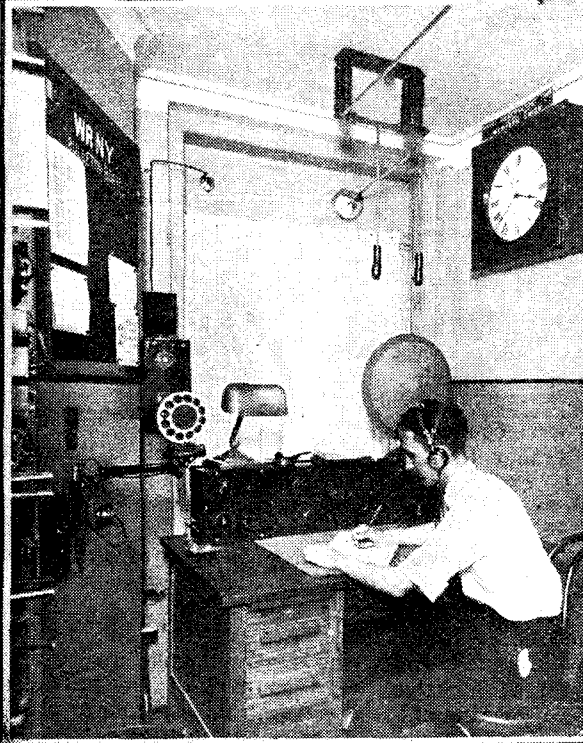
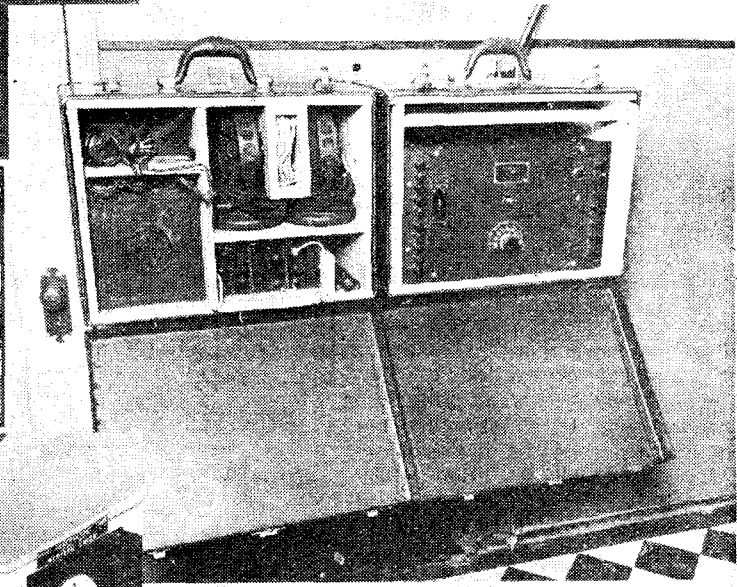

give a neat and businesslike appearance, not only in the studio, which is situated on one of the upper floors of the hotel, but in those portions of the station which are given up to the technical equipment.

Our first photo shows the engineer tuning up the station with the aid of the wavemeter, which can be seen on the stool to his left. The middle photograph shows the particularly neat equipment, containing two Western Electric microphones and the necessary amplifying apparatus, so that when desired special events can be broadcast from any place which can be rapidly connected to the telephone lines. Below will be seen the operator listening on the 600-metre wavelength band, according to regulations, for any distress signals that may be heard, so that in the event of ships being in trouble, the broadcasting station is shut down at once. These regulations apply to every broadcasting station in the United States.

# Experiments on Leaky Grid Condenser Rectification.

By C. P. ALLINSON (6YF).

*This article describes in an interesting manner some preliminary experiments carried out on the effect on received signals of different values of grid-leak and condenser, showing graphically some of the results obtained.*

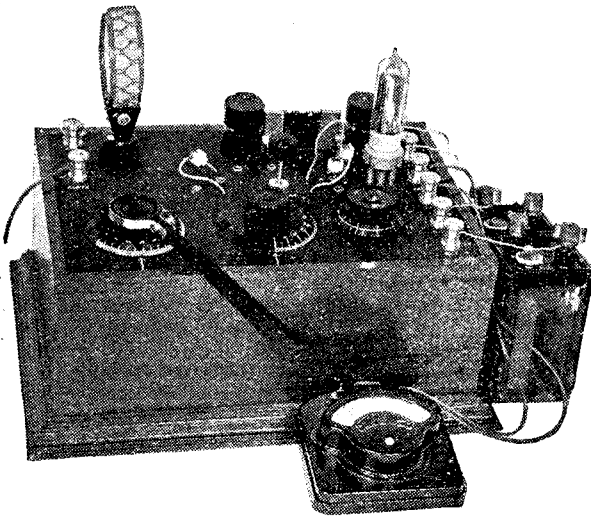

The arrangement of the test panel and other apparatus used by the author in his experiments.

valves require different values of grid-leak to give the best results, but no definite readings appear as yet to have been published showing this definitely to be the case. Nor have we been informed whether different values of H.T. require a different value of grid-leak. Further, although it is understood that connecting one end of the grid-leak to L.T. positive is the best method to employ, it may be asked what exactly is the order of the improvement gained?

## The Test Panel

It was therefore decided to go into these questions, and take a large number of readings. A special test panel was made up for the purpose to allow of various schemes of connections being used, a clip-in type grid condenser being employed so that various capacities could be placed in circuit, while a variable condenser could be substituted for it if desired. By this means values from the lowest to the highest could be tried. The variable grid-leak used had each end connected to a Clix plug, and sockets were provided so that the leak could be connected either between grid and L.T.— or L.T.+, or else across the grid condenser.

The test panel is shown in the photograph and the theoretical circuit is given in Fig. 1. Most of the readings were taken on 2LO's carrier, the



QUESTION that is often asked is, "Why is a .0003  $\mu$ F capacity condenser used as grid condenser with a detector valve?" and again, "Why is 2 megohms the correct value for the grid-leak?" and a third time, "Why should the grid-leak be connected to L.T. positive?"

Although these questions may seem very simple, it is not possible to answer them directly without going into a mathematical exposition of the whole question of leaky grid condenser rectification. What can be done, however, is to give facts and figures resulting from quantitative experiments carried out on the subject.

It has frequently been stated that different

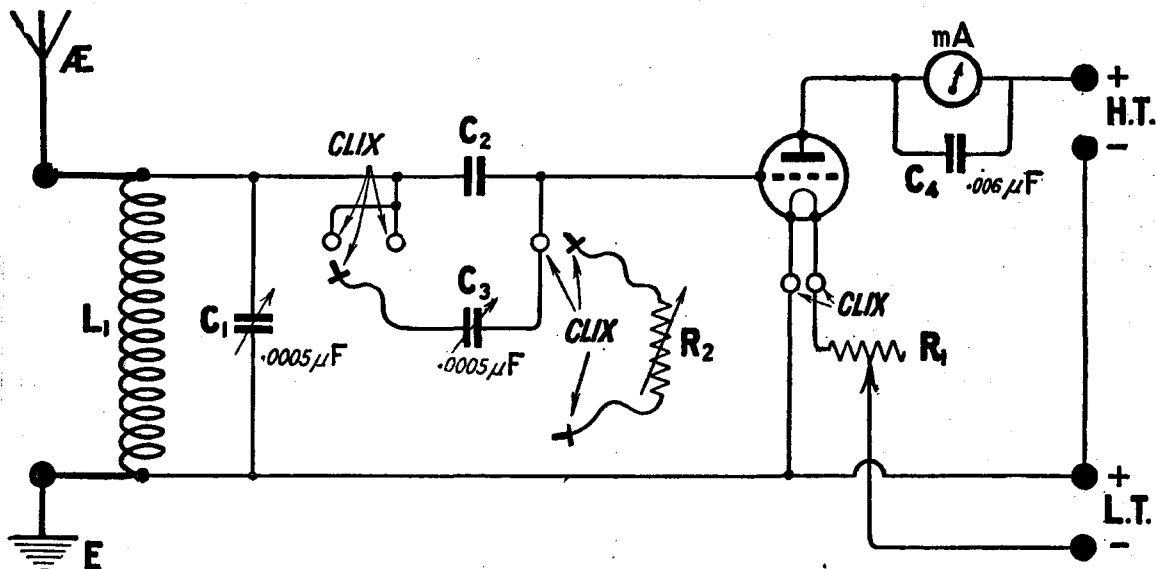

Fig. 1.—The circuit of the test panel. The condenser C2 is of the clip-in type, so that various values can be readily substituted.

unit of signal strength taken being one-tenth of a milliampere drop in the plate current representing a signal strength of 1. Thus, if on tuning in to 2LO the drop in plate current was .65 of a milliamp., then the signal strength was taken to be 6.5. The milliammeter used was calibrated in half-tenths of a milliamp., while .025 of a milliamp. could be read with certainty by interpolation and .01 with a fair amount of accuracy. It will be noticed in the circuit diagram that the milliammeter is shunted with a large fixed condenser, and, as reaction must not be used, the need for this condenser is not at once apparent. In the writer's case, however, the milliammeter windings happened to be tuned approximately to 2LO, so that reaction effects

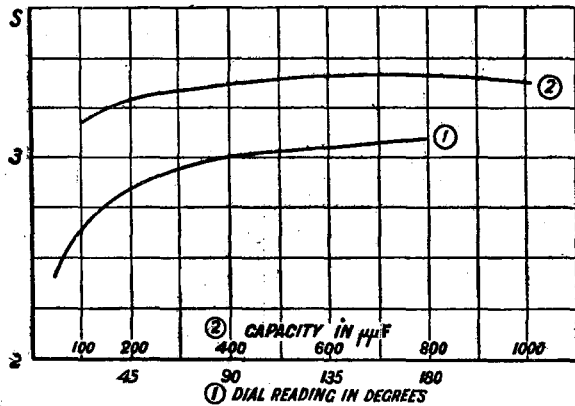

Fig. 2.—The effect of different values of grid condensers on the signal strength. The two horizontal scales apply to the correspondingly marked curves.

were obtained due to the inter-electrode capacity of the valve, and misleading results were obtained. It was therefore necessary to use the large shunting capacity shown.

**Signal-strength Variations**

A great deal of difficulty was experienced at times in getting accurate readings owing to large variations in signal strength occurring, and, in case this was due to interaction from neighbouring aerials, an indoor aerial only was used throughout the tests. The figures given are therefore merely for comparison, and are not in any way an actual measure of signal strength obtainable. Later experiments were carried out with a small transmitter working in the room. The test panel inductance, L<sub>1</sub> in the diagram, was loosely coupled to it, being about 2 ft. away. This gave very constant readings, and was a very satisfactory method.

**Method of Measuring**

When taking readings the H.T. and L.T. are adjusted so that a convenient plate current is passed, say two or three milliamps., and all readings are taken relative to this value. The reference point should be checked up periodically during the experiments or else inaccurate results may be obtained. It must be borne in mind that the actual movement of the milliammeter needle will be downwards when a signal is tuned in, when using leaky grid condenser rectification, for the received signal causes a negative charge to accumulate on the grid, so that a drop in plate

current results. If, however, anode current rectification, or lower bend rectification, is employed, then a rise in plate current will, of course, be obtained when a signal is tuned in.

**Elimination of Leakage**

For the benefit of those who may wish to carry out experiments on lines similar to those indicated

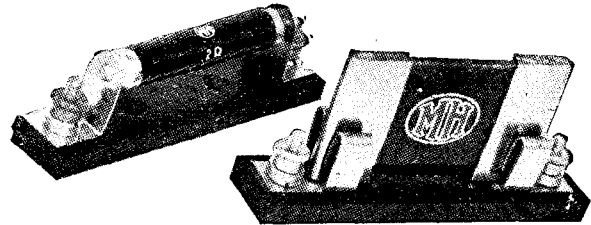

Some typical clip-in grid-leak and condenser units.

in this article, the following hints may be of use. The panel *must* be of the best ebonite, and every risk of surface leakage eliminated. It is preferable to use valve legs tapped into the panel for the valve holder, so as to reduce capacity effects, unless an anti-capacity valve holder is available. Particular care should be taken not to let any flux fall on the panel when connecting up, for in work of this description the question of insulation is most important. An extension handle on the tuning condenser C<sub>1</sub> is desirable, and

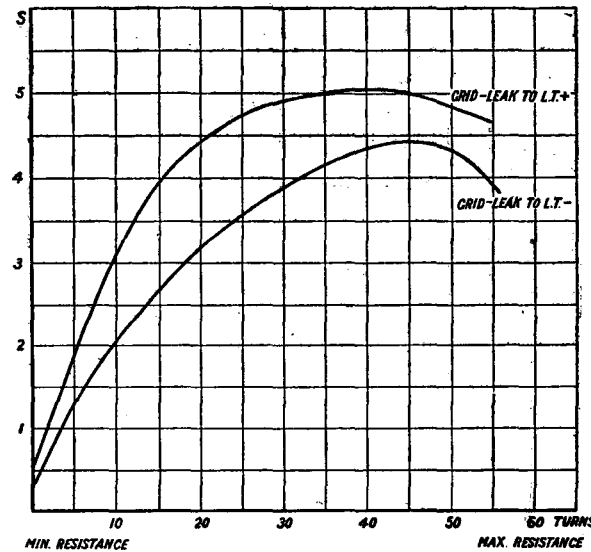

Fig. 3 shows the effect on signal-strength of various values of grid-leak connected to either L.T. + or -. A '06 type of valve with 50 volts H.T. was used. (Refer to note under Fig. 6.)

even with this it may be found quite a critical matter to get on the exact resonance point of the carrier. At any rate, it was found necessary at three miles from 2LO.

Most of the readings taken in the following experiments were obtained with a .06 type of valve, though, of course, other types of valve are quite suitable. Before taking a series of readings, the L.T. and H.T. were switched on, and left on, for a quarter of an hour previous to starting work. This allows the "working parts" to settle down, so that no variations should occur in the middle of readings. In any case, the reference point was checked up from time to

time. Under these conditions the accuracy of readings obtained is pretty good.

**Details of Experiments**

**EXPERIMENT I.**—To determine the effect of different values of grid condenser on signal strength. The grid-leak R2 was connected between grid and L.T.+ and adjusted to some arbitrary value; L.T. and H.T. were adjusted as requisite. Different value condensers were inserted in the clips, and readings taken, C1 being adjusted every time for maximum deflection of the needle.

There was not much difference in signal strength when C2 was varied between .006 and .0003  $\mu$ F. Below this latter value signal strength fell off more rapidly. The variable condenser C3 was substituted for C2 by means of the Clix provided for the purpose, and readings were taken down to 10 deg., at which value (approximately equal to .000035  $\mu$ F) the signal strength was three-quarters of its normal value. Fig. 2 shows the results plotted in graphical form, and it will be noted that the curves are very flat topped, tending, if anything, to drop a little after 600-800  $\mu$ F.

A single-valve reaction receiver was next connected up with the usual .0003  $\mu$ F grid condenser in use. This was tuned to Birmingham and a .001  $\mu$ F grid condenser substituted. A slight

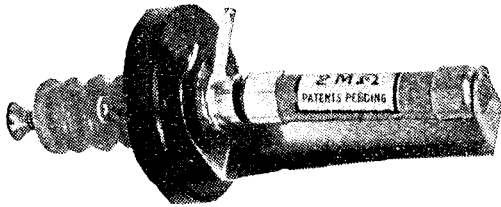

**A novel grid-leak and condenser mounting, secured to panel or baseboard by a single screw.**

drop in signal strength was noticed; otherwise, there was no difference in handling the receiver, though a little less reaction was needed with this latter value than with the normal one. This result tallies roughly with the readings given in Fig. 2.

**EXPERIMENT II.**—To determine the effect of connecting the grid-leak between grid and L.T.— or L.T.+, and also to find out the effect of using different values of leak. The grid-leak plunger of a continuously variable grid-leak was screwed right in (minimum resistance), and then screwed out five turns at a time, connecting the one end of the leak alternately to L.T.— and L.T.+ by means of the Clix. The results were plotted out and the curves shown in Fig. 3 obtained. A curious point that was noted was that, on transferring the grid-leak from L.T.+ to L.T.—, the plate current took a considerable period to attain a steady value, the needle slowly creeping up and up. This time lag was sometimes as much as two or three minutes; the longest time lag observed for the reverse action (i.e., when transferring leak from L.T.— to L.T.+) was only ten seconds. The results obtained here were confirmed in a later experiment, and show definitely that in every case the connection to L.T.+ gives the best results. Further, it will be

seen that with the particular valve used, and the particular value of H.T. applied to the anode, there is a value of leak which gives the greatest signal strength.

**EXPERIMENT III.**—To show that different valves require different values of grid-leak, and that this needs to be altered with any variation of the H.T.

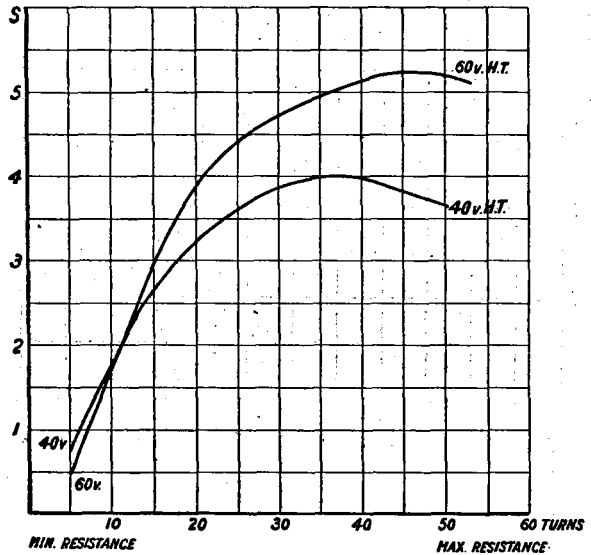

**Fig. 4 illustrates the fact that for best results different values of leak are required for various H.T. voltages. Both curves were taken with a D.E.5B valve. (Compare with Fig. 3.)**

voltage being applied to the plate. The results are shown graphically in Fig. 4, and should be compared with those obtained in the previous experiment. It will be seen that there is a marked difference between the two curves plotted as the result of readings taken for two different values of H.T., and also that the value of the leak required is different for different valves to get the best results.

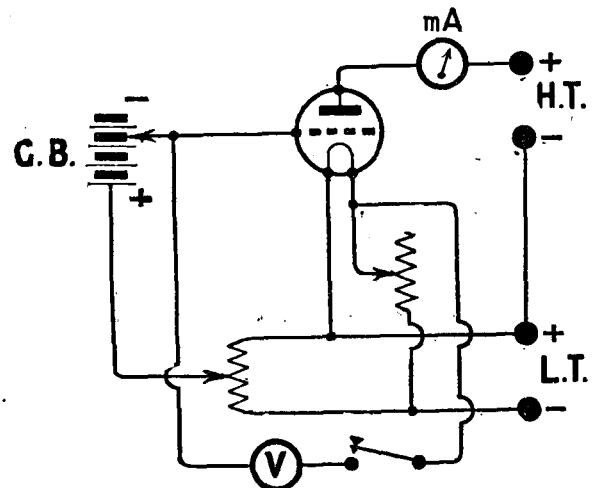

**Fig. 5.—The circuit used for obtaining the curve of Fig. 7.**

**EXPERIMENT IV.**—To determine the effective negative potential of the grid, obtained by the use of a grid condenser and leak, and to show the effective negative potential applied to the grid by an incoming signal. These readings were obtained by means of a local oscillator, as at that

particular time the variations in signal strength of the local station's signals were so great as to make it impossible to get accurate results.

First of all, without the local oscillator being switched on, readings of plate current were taken with different values of grid-leak, connecting this alternately to L.T.- and L.T.+ . The results were then plotted (see Fig. 6). Readings were then taken of grid volts against plate current,

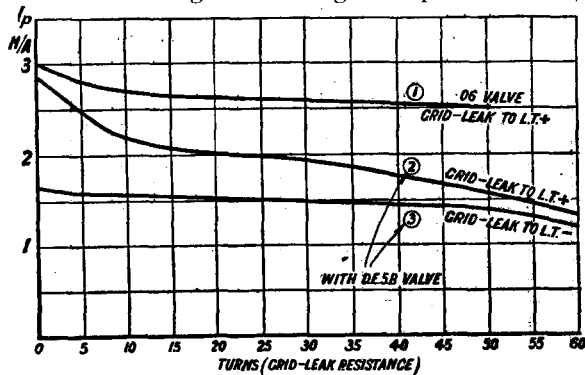

Fig. 6.—Curves showing variations of signal strength with grid-leak resistance under various conditions. (A continuously variable leak was used so that the number of complete turns of the knob from the full-in position gave a measure of the resistance.)

using the circuit shown in Fig. 5. These results were plotted in the curves of Fig. 7. By taking equal values of plate current for points on the curves in Figs. 6 and 7, we can then evaluate the steady potential at which the grid is held by a particular value of and means of connecting the grid-leak.

The curve marked 1 was taken with the .06 valve previously used (having an amplification factor of 6.5); the others were obtained with a D.E.5B., having an amplification factor of 20.

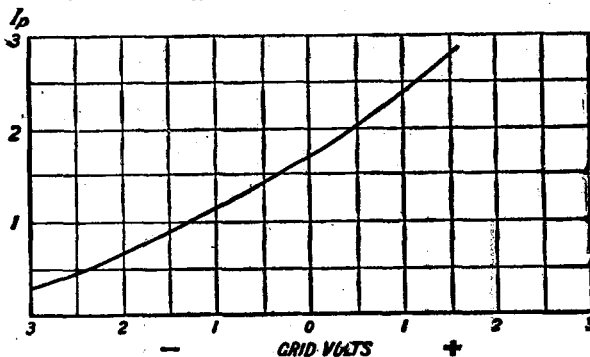

Fig. 7.—A curve of grid volts against plate current for the D.E.5B. valve used by the author.

This is shown by the difference in slope of the two curves. With the D.E.5B. it will be noticed that the curve obtained by connecting the leak to L.T.- is much flatter than the other, and has the effect of applying an average negative potential of .35 volts on the grid. The L.T.+ connection gives an average potential of approximately +.3 volts, and the greatest signal strength was measured when the highest value of leak was used, i.e., when the plunger was screwed full out, at which position the potential of the grid is about -.5. The numbers shown are turns on

the plunger, and should be proportional to the resistance of the leak over the greater part of the curve. That this is so is shown by the fact that the curve is nearly a straight line.

The results, which are tabulated below, show the six readings obtained by connecting the three highest values of the leak alternatively to L.T.- and L.T.+ , and give a comparison of the equivalent signal voltage applied. These figures were obtained by the method previously outlined.

Actually the procedure was as follows:—With the circuit L1C1 out of tune to the source of signals, Ip the normal plate current was read for the leak connected to LT- and LT+. The effective negative potential can be read off from Fig. 7. L1C1 is then tuned to the local oscillator, and the plate current Is noted. The voltage that must be applied to the grid by a grid battery to obtain the same drop in plate current is then found, and gives us Vs. Then Vs-Vg is a measure of the signal strength in terms of volts negative on the

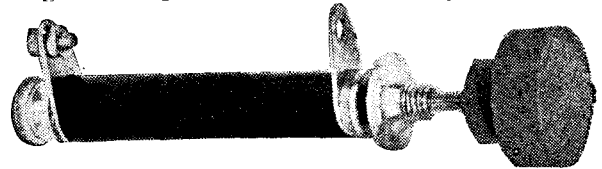

A well-known type of variable grid-leak.

grid. These confirm the results that were obtained on 2LO's carrier, showing that the connection of the grid-leak to L.T.+ is best.

In the table Ip=normal plate current.

Vg=equivalent potential applied to grid by use of condenser and leak.

Is=plate current when circuit is tuned to local oscillations.

Vs=equivalent potential applied by incoming signal and condenser and leak.

Ve=Vs-Vg, which is a measure of signal strength in terms of additional negative potential applied to grid by the signal.

R =number of turns grid-leak plunger is screwed out.

The maximum signal strength is obtained with the grid-leak going to L.T.+ , and every reading taken with it connected to L.T.- is less than the corresponding reading when it is connected to L.T.+ .

This completes the work done so far by the writer on the subject of leaky grid condenser rectification, and it certainly serves to throw some interesting light on the question.

Grid Leak connected to	Ip	Vg	Is	Vs	Ve = Vs - Vg	R.
Negative	1.42	-0.5	0.25	-3.4	-2.9	50
	1.37	-0.55	0.22	-3.5	-2.95	55
	1.25	-0.75	0.16	-3.8	-3.05	60
Positive	1.55	-0.2	0.3	-3.2	-3.0	50
	1.47	-0.3	0.25	-3.4	-3.1	55
	1.37	-0.5	0.19	-3.7	-3.2	60

# Correspondence



## A READER'S SUCCESS

SIR,—As an enthusiastic amateur during the past three years I have had many sets at one time and another, but the two which held my interest most were (1) the Family Four-valve Receiver (Radio Press Envelope No. 2, by Percy W.

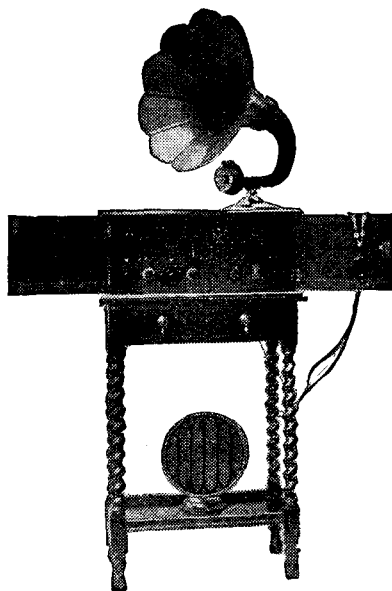

*A modified Family 4-valve receiver built by T. F. S.*

Harris, M.I.R.E.) and (2) Mr. Harris' modification of the Grebe C.R.13 Circuit. In consequence, last September I built a set which I considered embodied all the best features of these two sets.

One stage of H.F. only is used and no magnetic reaction is employed; using ordinary general-purpose valves in the H.F. position the tuning is moderately sharp; but I found that by substituting a B.6 valve for a B.5 valve in the L.F. the strength of signals was much enhanced.

No potentiometer is used or needed on this set, whilst the set can only be made to oscillate by over-running the high-frequency valve filament. I consider the tonal quality of the set to be considerably superior to the Four-valve Family Receiver, which, as most people know, employs magnetic

reaction and potentiometer control (this with identical components in each case).

Results obtained are as follows: My aerial is about 26 ft. high at one end and 16 ft. high at the lead-in end; this is not high, but I am admittedly in a good, un-screened position. I get what most people claim to get with a good 4-valve set employing one stage of H.F., i.e., all main B.B.C. stations and quite a number of Continental ones at good L.S. strength during winter. I cannot always separate Birmingham and Aberdeen, but with a closed aerial tuning circuit I would hardly expect to do so, especially when one considers how Rugby is placed in relationship to these two stations. I have not received America on this set, which I designed to bring in good-quality speech and music, and not as a stunt set. I have a little single-valve KDKA set on which I can hear U.S.A. any time I care to wait till 11.15 p.m.

I am sending you copies of photos I have recently taken of my set.—Yours faithfully,

T. F. S.

Rugby.

reaction and potentiometer control.

The sets constructed are the "ST100" (Radio Press Envelope No. 1, by John Scott-Taggart, F.Inst.P., A.M.I.E.E.), "Family 4-Valve Receiver" (Radio Press Envelope No. 2, by Percy W. Harris, M.I.R.E.), and "2-Valve Amplifier de Luxe" (Radio Press Envelope No. 7, by Herbert K. Simpson).

All the foregoing sets are very successful and can be highly recommended both as regards results obtained and ease of manipulation.—Yours faithfully,

STANLEY BEAUFORT.

Antwerp.

## ENVELOPE No. 9

SIR,—I thought that possibly it might interest you to know of the results obtained with "An Efficient Single-Valve Set" described in Radio Press Envelope No. 9 by Herbert K. Simpson.

I live just over a mile from 2LO, and one would imagine that that station would drown all the others, but not so. One night during 2LO's transmission I received at comfortable headphone strength at

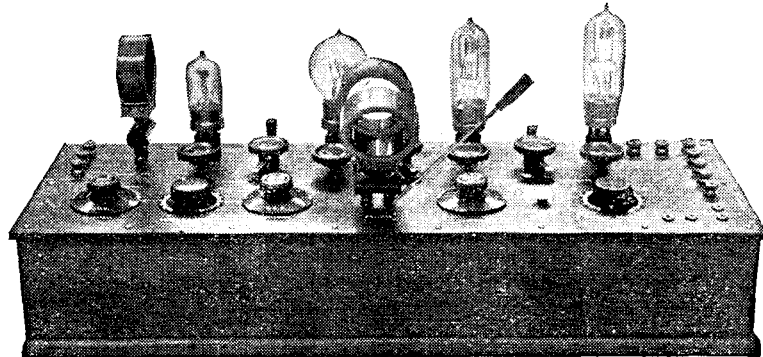

*Another version of the Family 4-valve receiver, as constructed by a reader in Belgium.*

## RADIO PRESS SETS IN BELGIUM

SIR,—I have pleasure in sending you some photographs of sets built by an amateur from Radio Press designs, though each with slight modifications, such as the introduction of a master rheostat, variable resistances on the transformer secondaries, constant aerial ter-

9.35 p.m. part of the programme from Newcastle. Two other stations were then tuned in, one being identified as Birmingham, but Morse and atmospherics prevented me from hearing the call-sign of the other. The set has the following other stations at comfortable strength to its credit: Cardiff, Glasgow, Manchester, Daventry, Petit-

Parisien, Radio Paris, and one German station, besides 2LO, which I get at sufficient loud-speaker strength to fill a small room. I shall soon be adding the "Two-Valve Amplifier de Luxe" (Radio Press Envelope No. 7) to it, and am looking forward to plenty of music. Is not this performance very good?—Yours faithfully,

London, W. J. M. P.

**WIRELESS FUND FOR HOSPITALS**

*From Viscount Knutsford, Chairman of the London Hospital, etc.*

SIR,—As Chairman of the Advisory Council of this Fund, please allow me in your columns to give public thanks to all those Radio Manufacturers whose generous gifts have helped to equip the London Hospitals.

Within three weeks of the appeal made by the *Daily News*, gifts in value over £8,000 had been made by the "Industry," and this generous gift has enabled us to equip nearly half the number of beds in the Voluntary Hospitals.

We want to give every patient the companionable headphone, to help lessen their sufferings and to give them a happy issue out of all their afflictions.—Yours faithfully,

KNUTSFORD.

**THE "FAMILY" 4-VALVE RECEIVER**

SIR,—May I sing my praises in favour of the "Family 4-Valve Receiver," by Percy W. Harris (Envelope No. 2). I have enclosed the set in a writing bureau, and it makes a very handsome piece of furniture. I am using two D.E.R. valves as H.F., and detector and 2 Ediswan P.V. 6D.E. as L.F. amplifiers, with 6 and 7½ volts grid bias respectively. I have altered the lay-out of the panel somewhat, but it seems to have had no detrimental effect on the efficiency of the set. It is a first-rate set and gives splendid results. Bournemouth is really too loud on the L.S. on 2 valves for an average size room. Cardiff, 2LO, Newcastle, Glasgow, Manchester, 5XX, Radio Paris, and Edinburgh (relay) all come in on the loud-speaker with 3 valves. Many Continental stations come in well, including Madrid and Rome on the L.S., and Hamburg, Munich, Berlin (Voxhaus), Rome, Barcelona (?) and several others at good 'phone strength; Petit-Parisien L.S., of course. Several amateurs have been heard, but not very well.

Six coils are mounted, those for 300-500 wave-band and for 5XX and Radio Paris. By means of a 6-pole double-throw switch either set may be put into circuit according to the stations required. No efficiency seems to be lost through this arrangement.

The Radio Press A.B.C. wave-trap (Envelope No. 6, by G. P. Kendall, B.Sc.) has recently been added, and Bournemouth can be cut out and many other stations picked up. Cardiff and 2LO are good L.S. strength. My aerial is about 35-40 ft. high, double wire, and 90 ft. long (each wire). The earth is the water main. I don't think these results are much to grumble at. I am more than pleased, and thoroughly recommend the circuit.—Yours faithfully,

E. J. B. CURTIS.

Bournemouth.

**THE "ALL-CONCERT DE LUXE" RECEIVER**

SIR,—I thought I would drop a line regarding the 3-valve "All-Concert de Luxe" (by Percy W. Harris, Envelope No. 4). I first made a "Simplicity 3-Valve Set" (Envelope No. 3, by G. P. Kendall), but decided to take it to pieces and use the parts to try out the All-Concert set, as some of them are identical. Other parts, of course, I bought to complete the component parts as specified in your envelope. I may say that I am

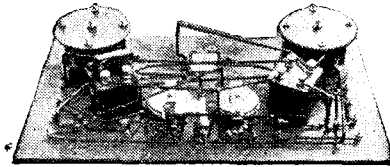

*The neat wiring of the S.T.100 receiver made by Mr. Stanley Beaufort can be clearly seen in this photograph.*

delighted with it, the volume and clearness of speech and music are wonderful, and in a 10-ft. x 12-ft. room it is easy to hear the general news and forecast at the other side of the room from telephones only. I have not got a loud-speaker. The only trouble so far is that I cannot tune in any other stations, only 5XX, 2LO and 5BM, and one Continental on the same wavelength as 2LO. On the "Simplicity 3-Valve Set" I could get, in addition to these, Newcastle, Aberdeen, Paris, using the same aerial as I am doing now, which is Electron wire, 60-ft. span, height at house end 25 ft., garden end 20 ft. I am halfway up on one of the hills, and trams pass the door, and the interference was very bad on the old set but is very much reduced on the de Luxe. It is a pleasure now to listen in, and I only lay down the 'phones at the conclusion of the programme, it is so enjoyable now. So I wish you the best of luck in bringing out such a fine set.—Yours faithfully,

F. V. PETERS.

Brighton.

SIR,—With reference to your request that makers of your "All-Concert de Luxe" receiver, Envelope No. 4, by Percy W. Harris, M.I.R.E., should inform you of its performance, let me say that I have just finished building this set.

I had had absolutely no experience whatever, either in building or operating wireless sets, and until I started on the work I was entirely ignorant of the technicalities of wireless work, though I had a good general knowledge of electrical matters.

A few small modifications were made to your lay-out, the chief being that I used variable condensers of different make from those described.

One modification to your cabinet design was, that instead of having holes at the back for the H.T. and L.T. leads, I put in a hinged flap, which makes it very easy for the lead terminals to be handled, without withdrawing the set to get at them.

At the moment I have only the Daventry coils, using two D.E.R. valves and one D.E.3 for the L.F., with two 2-volt 60-amp. cells.

I had never tuned a set before, but well within five minutes of first connecting up I had tuned in Daventry at splendid strength.

I switched out my first valve and found adequate strength on two.

I tried to get Paris, but could not, probably owing to inexperience.

Lelant is between St. Ives and Penzance.

My aerial (Electron) is 100 ft., 70 ft. long, 30 ft. down-lead; height 50 ft. further end, 30 ft. down-lead end; situated on fairly open ground, but on the low side.

I am aware that this is but a meagre and, possibly, useless report, but I am so extremely pleased with the results on 5XX that I feel perfect confidence that corresponding results would be obtained on various stations when using suitable coils.

I am proud of the appearance and high finish of my set. No trouble in detail has been too much, and I am full of admiration for your design and admirably clear instructions.—Yours faithfully,

JOHN DE WALTON, R.W.A.

Lelant, Cornwall.

**EARTH CONNECTIONS IN DRY SOIL**

SIR,—Where soil is of dry sand, it is not easy to make a good earth connection. This difficulty I was able to overcome by hooking up the earth lead to the wire netting surmounting a party wall dividing the garden from adjoining property. The result was perfectly satisfactory, the wire netting apparently acting as a counterpoise earth, although not below the aerial, which



is an indoor one fixed in the roof rafters.

This idea may help your correspondent "A. P. II." (*Wireless Weekly*, Vol. 6, No. 15, Information Department) and your other readers.—Yours faithfully,

GEORGE L. BOAG.

Aguilas (Murcia).

**WIRELESS AND THE LIGHT AEROPLANE TRIALS**

SIR,—A few particulars of the transmitting and receiving apparatus installed at Lympe for the Light Aeroplane Trials organised by the Royal Aero Club may be of interest to your readers.

At the Light Aeroplane Trials held at Lympe on August 1, 2, and 3, by the kind permission of the P.M.G. and at the request of the Royal Aero Club, three wireless stations were installed by Messrs. N. V. Webber & Co., Ltd., of Oatlands Park, Weybridge, in order to maintain rapid communication between the aerodrome and the two turning points on the course, namely, Hastingley and Postling, these points being about four and five miles respectively from headquarters station at the aerodrome.

The two out-stations were similar in design and consisted of a 2-

valve receiver and a single-valve transmitter, equipped both for C.W. and 'phone. Power was derived from large-capacity dry-cell H.T. batteries, about 5 watts being drawn at 220 volts, giving an aerial current of .3 amps between 150 and 200 metres; both transmitter and receiver were combined in one instrument.

A single-wire aerial 75 ft. long was employed, supported by two bamboo poles 25 ft. high, and a single-wire counterpoise immediately under the aerial and 3 ft. from the ground was used instead of an earth system. An earth pin about 6 in. long was used for the receiver.

At Headquarters Station two aerials at right-angles were used—one for transmission and one for reception. Two receivers were connected in series—one tuned to Hastingley Station (6ZB) and the other to Postling Station (6ZC). Remarkably little interaction was experienced between these two receivers, even when tuned within a few metres of each other, although 6ZB was tuned to 200 metres and 6ZC to about 150 metres as a precaution. 6ZA—H.Q. Station—was tuned to about 175 metres. By this means reports were received from both out-stations simultaneously without diffi-

culty, and as both receivers were tuned to headquarters, orders could be transmitted to them as desired.

In spite of the adverse conditions—such as rain, wind and thunderstorms—everything went off as per schedule, 'phone being worked nearly all the time, with C.W. as a stand-by when static and oscillations from curious local B.C.L.'s made 'phone reception unreliable.

Two conclusions were definitely drawn, however. First, all field stations using portable aerials must have loose-coupled aerial circuits—both on transmitters and receivers; and, secondly, each lead-in from the aerial and the counterpoise must be taken at the top and bottom of the tent respectively and firmly staked to prevent swaying, great difficulty being experienced during the preliminary tests in keeping the waves constant.

In conclusion, it may be said that there was great satisfaction in knowing that all the arrangements worked—and worked well—and that reports could be given to the Royal Aero Club officials not only on the progress of the races but on the safety of the pilots and passengers in the very frequent forced landings occurring during the meeting.

(Signed) P. DORTE.

Weybridge.

(6DO.)

**Why is**

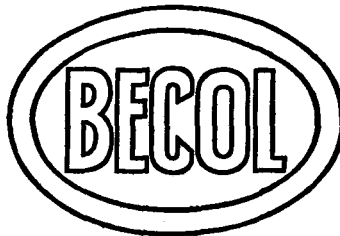

**THE HALL MARK OF "QUALITY" EBONITE?**

*Because* it is made from finest rubber and sulphur

IT HAS  
PROVED ITSELF

ITS POLISH  
SPEAKS FOR ITSELF

All branded panels guaranteed free from surface leakage.

The **BRITISH EBONITE Co., Ltd., HANWELL, LONDON, W.7**

*Rods, Tubes and Mouldings*

## "An Opportunity for the Experimenter"

It will be remembered that it was recently announced in *Wireless Weekly* that Dr. Hoyt Taylor, the Superintendent of the Radio Division of the United States Naval Research Laboratory, was particularly anxious to secure the co-operation of British experimenters in the short-wave work carried out by the Naval Station NKF. As a result of the visit of Mr. Harris to NKF, arrangements are being made for the transmission of special schedules, details of which will appear in *Wireless Weekly*, and the assistance of readers is invited.

A letter just received from Dr. Taylor is reproduced below, and the details which he gives of the present times and wavelengths will enable readers to pick up NKF and calibrate their receivers in readiness for the special tests. The times given have been converted to British Summer Time.

Naval Research Laboratory,  
"Bellevue," Anacostia, D.C.  
July 28, 1925.

DEAR SIR,—Permit me to thank you for your communication of July 11. Last May we had direct contact with British 5LF, but as the hot summer months came on, the signals gradually faded out. We shall be glad to keep you informed of our schedules, but believe that on account of the frequency with which we make changes, we should try to establish some radio amateur contact. I will give you the present list of schedules and suggest that you arrange with . . . or someone else who can possibly reach us during our daylight working hours, which means between 3 p.m. and 10.30 p.m. If we can establish such contact we can forward you immediate notice of special test schedules, which

will, we think, be of international interest.

The following schedules are liable to remain in effect for an indefinite time:—

71.35 metres, work intermittently from 1 a.m. to 12 noon.

41.7 metres, 6 p.m., with 1MY (traffic relative to MacMillan Expedition as a rule); also 3 p.m. and 8 p.m.

The following schedules are in effect at the present time, but are subject to change:—

We call MacMillan ships WNP and WAP on 20.8 metres for about 15 minutes, at 3.5 p.m. and 8.5 p.m. 4.30 a.m. schedule with NPM on 20.8 metres (does not usually last over one half-hour).

9 a.m. schedule, with NRRL, on 41.7 metres.

In between times, during the night hours, we work various amateurs at home and abroad, but not according to schedule.

(Concluded on page 658)

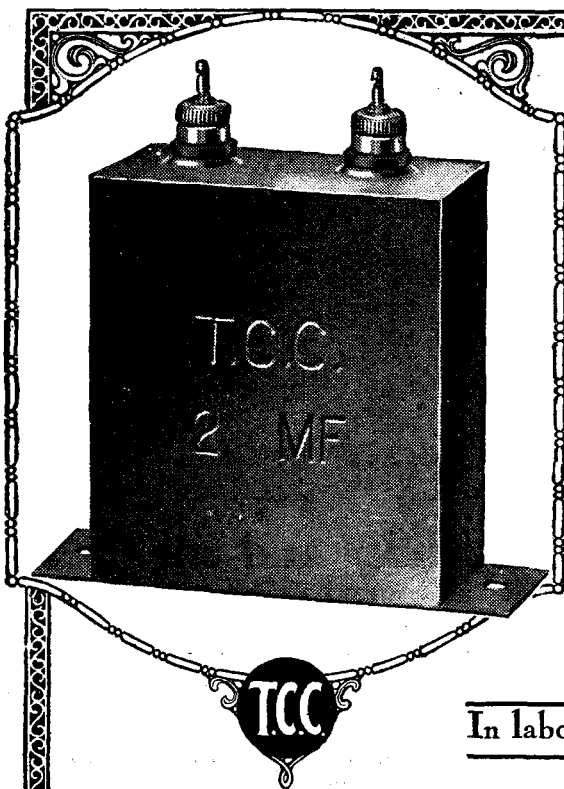

## The new improved T.C.C. Mansbridge

IN Radio—the youngest and most virile of our industries—progress is essential. While it has not been found possible to improve the accepted principles of the Mansbridge Condenser—recognised as the standard large capacity condenser throughout the world—we have found it practicable to improve the famous green T.C.C. Mansbridge in certain important constructional details.

The new Duplex terminals (patent applied for) can be used as soldering tags or to hold connections by means of their knurled heads. The top of the Condenser is now all-metal which is, of course, quite impervious to the heat of the soldering iron or the action of the atmosphere.

T.C.C. Mansbridge Condensers are made in the largest factory in this country solely devoted to the manufacture of condensers. They are backed by a twenty-year-old reputation for accuracy and dependability. They are fully guaranteed and British made throughout. Every Wireless Dealer stocks them in a wide range of capacities.

In labour, design and material—British throughout

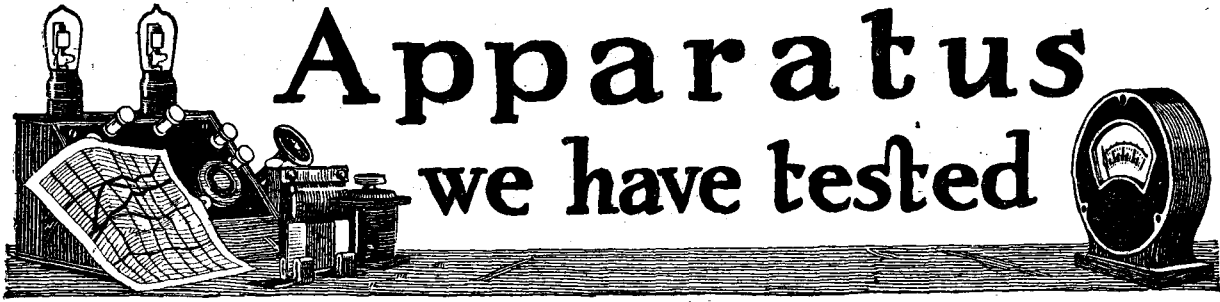

# Apparatus we have tested

Conducted by A. D. COWPER, M.Sc., Staff Editor.

### Telephone Jacks

Telephone jack-plugs of novel pattern have been submitted by Messrs. The Electrical Equipment and Carbon Co., Ltd., for use in the ordinary plug-and-jack arrangement. One neat and effective plug has, enclosed in a fluted insulating barrel measuring 2 in. by  $\frac{3}{4}$  in., two small screw chucks to grip the ends of telephone tags, together with a ring to which to attach the usual cord, which is calculated to take the strain of a sudden jerk, instead of trusting to the electrical connections for mechanical strength. Another plug, this time with a rectangular body, has two sets of terminal bushes with set-screws to grip terminal tags or wire-ends along the opposite sides of the

body; and a small snap switch in the body, actuated by projecting buttons, to switch over the plug connections to either pair of terminals for alternative use of headphones or loud-speaker without disturbing connections. A third plug has a row of four such terminal bushes on each side of its rectangular body, connected across, and with the first pair connected to the plug-contacts. Thus various combinations of several pairs of headphones can be tried. These components were highly finished, and showed good workmanship; on test the insulation-resistance was high enough for their purpose in every case, and they performed their functions in a satisfactory manner. We can certainly recommend these jack-plugs

for the neat and convenient connection of headphones, etc.

### Panel Switches

Messrs. The Electrical Equipment & Carbon Co., Ltd., have sent for our inspection samples of two very neat enclosed types of switches, with one-hole-fixing, and with convenient terminals arranged in the rear for accessible connections. In the one case a swinging arm in moving through about 180 degrees presses down a contact spring on to another piece of metal, so completing the circuit; in the alternative pattern a snap-switch effect is obtained by a lagging-spring action which, with a 90-degree movement of the controlling knob, snaps a contact-arm in between two spring

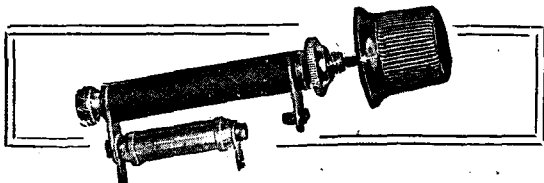

### Blotting Paper and Wireless

THE connection may not at first be apparent, but some variable grid leaks consist of pellets of the first soaked in indian ink, and are put into sets for the reception of the second. The absorbent properties of blotting paper results in every atmospheric change affecting the value of the leak, and

so soft is it that after every compression its value is altered. As much care should be paid to the design of a Variable Grid Leak as to any other portion of a receiver, and this has been done in the case of the "Bretwood." Proved by trial to be the best, it should be found in every set.

PRICE 3/-  
Postage 2d.



With Condenser  
(as illustrated)  
4/6  
Postage 3d.

SPECIALITIES  
are obtainable from most Wireless Dealers.

**BRETWOOD LIMITED**  
12-18, London Mews, Maple St., London, W.

Bardays Ad.

### THE PANEL DE LUXE

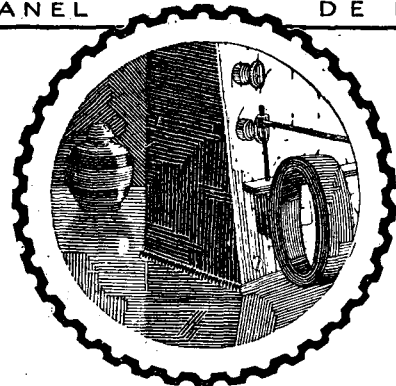

SUCCESS in Wireless is ever dependent upon trifles. One man will succeed where another will fail. No component can exercise such influence for good or ill as the panel. Start with a Radion Panel and you will be sure that your foundation is correct. Radion is recognised throughout the wireless industry as the highest grade ebonite panel it is possible to make—and its superb surface will add considerably to the appearance of any Receiver.

Radion is available in 21 different sizes in black and mahogany. Radion can also be supplied in any special size. Black 1d. per square inch, mahogany 1 1/2d. per square inch.

# RADION

American Hard Rubber Company (Britain) Ltd.

Head Office: 13a Fore Street,  
London, E.C. 2

Depots: 120 Wellington Street, Glasgow.  
116 Snow Hill, Birmingham.  
Irish Agents: 8 Corporation Street, Belfast

Gilbert Ad. 3376.

contact-fingers, or out again with a rapid action that should discourage excessive sparking when breaking the circuit. These switches operated correctly on test, and showed a good insulation resistance.

**"An Opportunity for the Experimenter"**

(Concluded from page 656.)

9CXX we generally call right after schedule with 1MY.

If you can suggest some schedule in the 20-metre band which will fall between the hours of 3.30 p.m. and 10.30 p.m., and which will not conflict with other schedules, we will be very glad to test with you as soon as you can make up your mind what time you want to work. You can shoot the information to some member of the A.R.R.L., and they will get it to us promptly.

All of our waves except 17 metres, which has been tested but little, are reported as being received very well in England, but we believe the 20.8 will be the best for daylight work.

Some time we would like to run a 24-hour test with you on this wave. You can absolutely rely on our frequencies being correct to better than 1/10 of one per cent. You will probably notice that our signals do not lilt or fluctuate up and down as most other signals do.

I am enclosing one of our station cards.—Very truly yours,  
A. HOYT TAYLOR,  
Superintendent, Radio Division.

**Arrangements of Schedules**

Arrangements have been made for an experienced British transmitter to get into communication direct with Dr. Taylor at NKF, and this will probably have been accomplished by the time that this announcement appears in print. The co-operation of other British transmitters with good experience of short-wave working would be welcomed, especially in connection with Dr. Taylor's suggestion of a 24 hours' schedule of tests, and we take this opportunity of extending an invitation to take part.

We shall be glad to receive

reports from readers who succeed in obtaining good reception of NKF with the aid of the schedule we are publishing this week, with a view to obtaining the names of experimenters in suitable localities for any special listening tests which Dr. Taylor desires carried out. Any tests which are conducted, of course, will be open to all readers of *Wireless Weekly*, and reports from all quarters are valuable.

**Reports of Reception**

In the first announcement which appeared in *Wireless Weekly* it was mentioned that no reports had been received of the reception of NKF's short-wave signals in this country, but following upon this we had reports from several readers. Mr. Robert Carlisle (G6WG) and Mr. Gordon Ritchie (both of Glasgow) report hearing the 20.8-metre signals at good strength, while Mr. J. H. D. Ridley (G5NN, of London) reports hearing both the 20.8- and the 41.7-metre transmissions, finding that both of these can be received regularly at remarkable strength.

**Quality RADIO APERIODIC DUPLEX COIL**

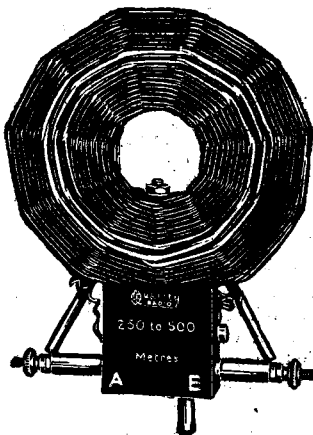

This consists of primary and secondary wound together in large gauge in different coloured wire, mounted on standard plug-in fitting. In a large measure eliminates interference and greatly improves the selectivity of tuning, made for the broadcast wavelength and with a .0005 condenser tunes from 250 to 500 metres.

Price 6/6, post 3d.

**Quality RADIO TERMINAL CLEANER**



A useful little tool which enables the terminal to be cleaned by a twist of the holder between thumb and finger. 6d. each, post 2d.

**GOSWELL ENGINEERING CO., LTD.**  
95, 96, 97, 98, WHITE LION ST., LONDON, N.1

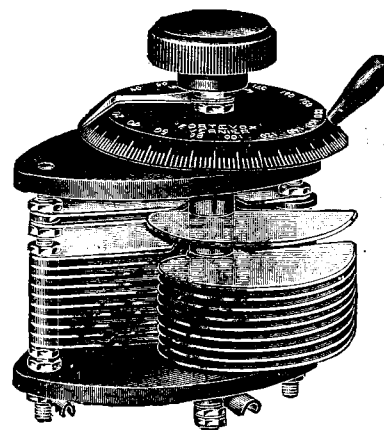

**If you fit a FORTEVOX Component**

you get RELIABLE and EFFICIENT working, an ORIGINAL DESIGN giving you the "Something Different," and Skilled Workmanship with High Class Finish. Look, for example, at the FORTEVOX SQUARE LAW VARIABLE CONDENSER

**This NEW DESIGN**

is the only Condenser giving READINGS on both Main Condenser and Vernier. Full Instructions and Recording Charts with each instrument. One Hole Fixing.

**PRICE**

	Plain s. d.	Vernier s. d.
.001	16 6 each	20 6 each
.00075	15 6 "	19 6 "
.0005	12 6 "	16 6 "
.0003	10 6 "	14 6 "
.0002	10 0 "	14 0 "

Postage 5d.

Prov. Patent 9127/25.

For the Discriminating Buyer :

"We cannot recall having seen a better finished article."

THE BRITISH TRADE JOURNAL.

**The "Fortevox" LIGHTNING ARRESTER**  
Protects your Property



Prov. Patent 14127/25.

**Price 2/6 each. Postage 2d.**

Stocked by all reputable dealers, or obtainable direct from :

**FRASER & GLASS, Assembly Works, Middle Lane, Hornsey, LONDON, N.8.** Phone, Mountview 2225.  
Scottish Agents: KEITH & IRWIN, 35, Robertson Street, GLASGOW.

# Information Department

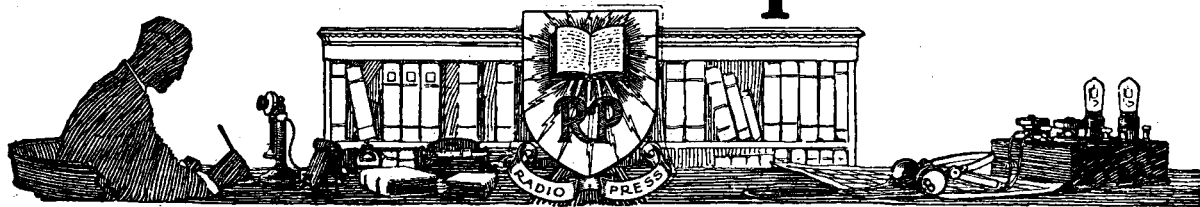

E. R. K. (RAMSGATE) has, since reading Mr. Kendall's article in "Wireless Weekly" Vol. 6, No. 10, on "Comparing Earth Connections" tried some experiments with two arrangements and is considerably puzzled by his results. He asks for an explanation. Briefly the contents of our correspondent's letter are that some months ago he made two earth connections, one being taken from the second floor flat in which he resides to some iron railings, which were filed bright before the wire was twisted tightly round them. The other was made to the kitchen tap, and on trial was found to be slightly the better. Some months passed, during which our correspondent built a 4-Valve Set, and on reading Mr. Kendall's article he

decided to test the two earth connections again to the best of his ability, although not able to duplicate exactly Mr. Kendall's experiments, since the necessary instruments were not available.

The results were as follow: With the earth to the iron railing signals were louder, the aerial and reaction coils could be widely separated and tuning was critical, so that London could be lost two degrees on either side of the maximum position. With the water tap earth signal strength was not so great and London could not be lost within less than ten degrees on either side of the best position. This was confirmed by several independent observers listening to a loud-speaker in a room remote from the set.

Having thus determined that the outside earth was the better of the two, our correspondent decided still further to improve it, and with this end in view untwisted the wire from the railings, brightened up both, refastened the wire, covered the joint with waterproof tape and soaked the earth round the railings with water.

On re-trial the earth to the water tap was found to give very much louder signals than the outside earth; when using the latter it was now necessary to couple the coils much more tightly to obtain oscillation, while tuning was scarcely affected over twenty degrees of the aerial-tuning condenser scale.

The somewhat puzzling results obtained by our correspondent are fairly easily explained. When the two earth connections were origin-

 **"TELWAVE"**  
(Registered)  
**RADIO COMPONENTS**  
(MARTIN-COPELAND PRODUCTS)

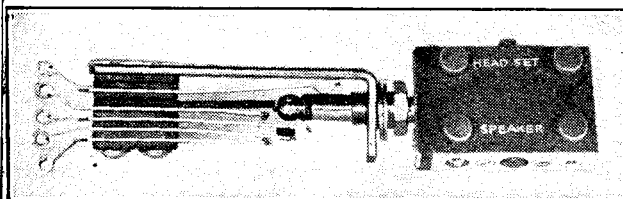

"Telwave" Switch-Plug and Jack.

The "Rolls Royce" of the Radio World.

Our New Illustrated Catalogue will interest you.

**HIGH-GRADE COMPONENTS ONLY.**

**THE ELECTRICAL EQUIPMENT & CARBON CO., Ltd.,**

109/111, New Oxford St., London, W.C.1

RADIO  
**TANGENT**  
FITMENTS

Charm your friends with a pleasing performance—

Install  
THE  
"TANGENT"  
TYPE "D"  
RADIOMATIC  
2-VALVE

PRICE—  
£7-0-0

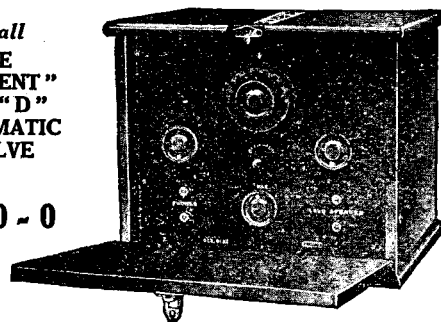

Try it on Daventry with Loud Speaker—  
even though you be 100 miles away!!

All gadgets completely enclosed. Not an eye-sore—an ornament to your room.  
If not in his stock all good dealers can obtain by return.

Insist on "TANGENT"  
**GENT & CO.**  
LTD. Estd. 1872.

"Faraday Works," LEICESTER.

London: 25, Victoria Street, S.W.1.  
Newcastle/Tyne: "Tangent House," Blackett Street

ally tried, it would seem that the wire and the railings to which it was connected formed a comparatively efficient counterpoise, since apparently the whole was insulated from earth. When, however, the connection to earth was improved by watering the surrounding soil, the arrangement was at once changed from what, to all intents and purposes, was a counterpoise earth to a direct earth. The assumption that the earth connection in this case was by no means a good one, and was of high resistance, would completely explain the somewhat puzzling phenomena noticed by our correspondent.

I. W. (BILLERICAY) has a crystal set from which he obtains excellent results when the crystal detector is critically adjusted, but experiences trouble in that the sensitive spots are not easily found and the slightest jar causes them to be lost. He asks our advice in choosing some form of detector which is more stable in operation.

In reply to our correspondent, we would advise that either one of the permanent type of crystal detectors, such as are advertised in the pages of our journals, or the carborundum and steel combination be used. A Perikon combination, that is, of

the zincite-bornite or similar type, will also be found less troublesome to keep in adjustment than a crystal requiring a catswhisker.

In practice the most stable detector is usually found to be the carborundum and steel combination. To obtain the most sensitive working point, however, it is necessary to apply a certain potential to the crystal, and this is best carried

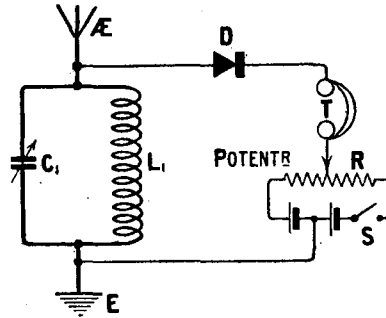

Showing the method of applying a suitable potential to the crystal when a carborundum-steel combination is used.

out by the arrangement shown in the accompanying diagram. From this it will be seen that a potentiometer is required, and also two small dry cells which should be of 1½ volts each. A lead is taken from the lower 'phone terminal to

the slider of the potentiometer, across which are connected the two dry cells in series. From the middle point of the battery a lead is taken to the earth terminal of the set. It is advisable that a switch, S in the diagram, be incorporated to break the battery circuit as shown, so that no current is taken from the cells when the set is not in use. By adjusting the position of the slider the crystal can be made to work on the best part of its characteristic curve for rectification purposes. The resistance of the potentiometer should be as high as possible in order that minimum current may be taken from the dry cells. We would suggest that the instrument has a resistance of 300 ohms or higher. Fairly small cells, such as the Siemen's "J" type, will be found perfectly satisfactory in practice.

THE SEPTEMBER ISSUE OF  
**"THE WIRELESS  
 CONSTRUCTOR"**  
 IS NOW ON SALE. PRICE 6d.  
 Remind your friends who are just beginning wireless that this is the ideal Magazine for them.

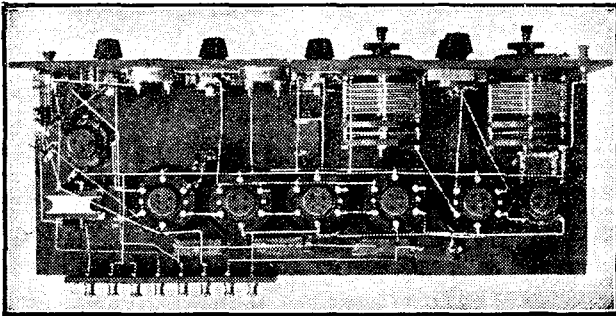

## The Keystone Super-Het.

THE Keystone Super-Heterodyne is the cheapest and simplest British Super-Het. it is possible to build. It is considerably less intricate than a five-valve Set and costs but very little more. And when you compare the two... well, it is just like comparing an ordinary touring car with a Rolls Royce! The Keystone Super-Het. uses only genuine Keystone transformers and the best components. All parts are British made, therefore you can be sure that they are a correct match for British Valves. You should remember that American Super-Het. parts are designed to work with American Valves—their characteristics are entirely unsuitable over here.

Before deciding on your Super-Het., send two penny stamps for our large Keystone Folder showing how the Super-Het. works and how economical and easy it is to build one with Keystone parts. Remember, the Keystone Super-Het. will enable you to tune out your local station and receive a distant one within ten metres of its wavelength. Only a Super-Het. can do this.

Experimenters should send 3d. for our large 48-page Catalogue of Components. Set builders should get our Pilot Chart of 32 easy-to-build Receivers, post free 3d. Have you read Peto-Scott's Wireless Book, post free 1/5?

**PETO-SCOTT Co. Ltd.** Head Office, Mail Order & Showrooms: 77, City Rd., London, E.C.1  
 P.S. 3371.

### EFFICIENCY and ELEGANCE.

The addition of a "Scientific" NON-METALLIC HORN to your Speaker will give faithful sweet-toned reproduction that is a pleasure to listen to.

POSITIVELY ELIMINATES DISTORTION AND BLARE. Finished in an attractive dull bronze—as pleasing to the eye as to the ear.

From a genuine unsolicited testimonial—"It is a work of art, and the results are all that a music-lover could desire."

	Height.	Flare.	Price.	Post.
SMALL SWAN-NECK with PETAL FLARE	16"	10"	7/9	1/3
MEDIUM WESTERN pattern with PETAL FLARE	21"	12"	9/9	1/9
LARGE WESTERN pattern (as illustrated)	24"	14"	11/9	1/9
CURVED HORN for Amplion Juniors	—	12"	11/9	1/9
LARGE SWAN NECK Do. with PETAL FLARE	24"	13"	14/9	2/-
Do. with PETAL FLARE	25"	15"	15/9	2/-

When ordering, please state size of ferrule required.

SCIENTIFIC SUPPLY STORES, 186, NEWINGTON CAUSEWAY, LONDON, S.E.1.  
 Branches: 30, Newington Causeway, S.E.1; 7, St. George's Cross, S.E.1; 16, Manacle St., Charing Cross Rd., W.1; 291-293, Edgware Rd., W.2; 94, Church Rd., Upper Norwood, S.E.20.

TRADE ENQUIRIES INVITED.  
 Phone: HOP 4177.

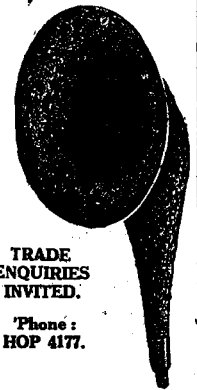

### The New "SOLENEX" RADIO COIL

The Coil you will eventually use! NO varnish impregnation, extra capacity losses, or undesirable wire kinks.

BUT totally enclosed in beautiful gold tinted celluloid case, hollowed patented coil mount and hollow plug pin and highly efficient eccentric generative winding.

The smartest and highest efficient coil on the radio market to-day.

Supplied in all Wavelengths. From 4/6 to 10/- each

F. G. KETELBEY, A.M.I.E.E. Manufacturers and Main Wholesale Distributors, Worcester Chambers, 14, New St., Birmingham.

# The ALL-CONCERT DE LUXE RECEIVER

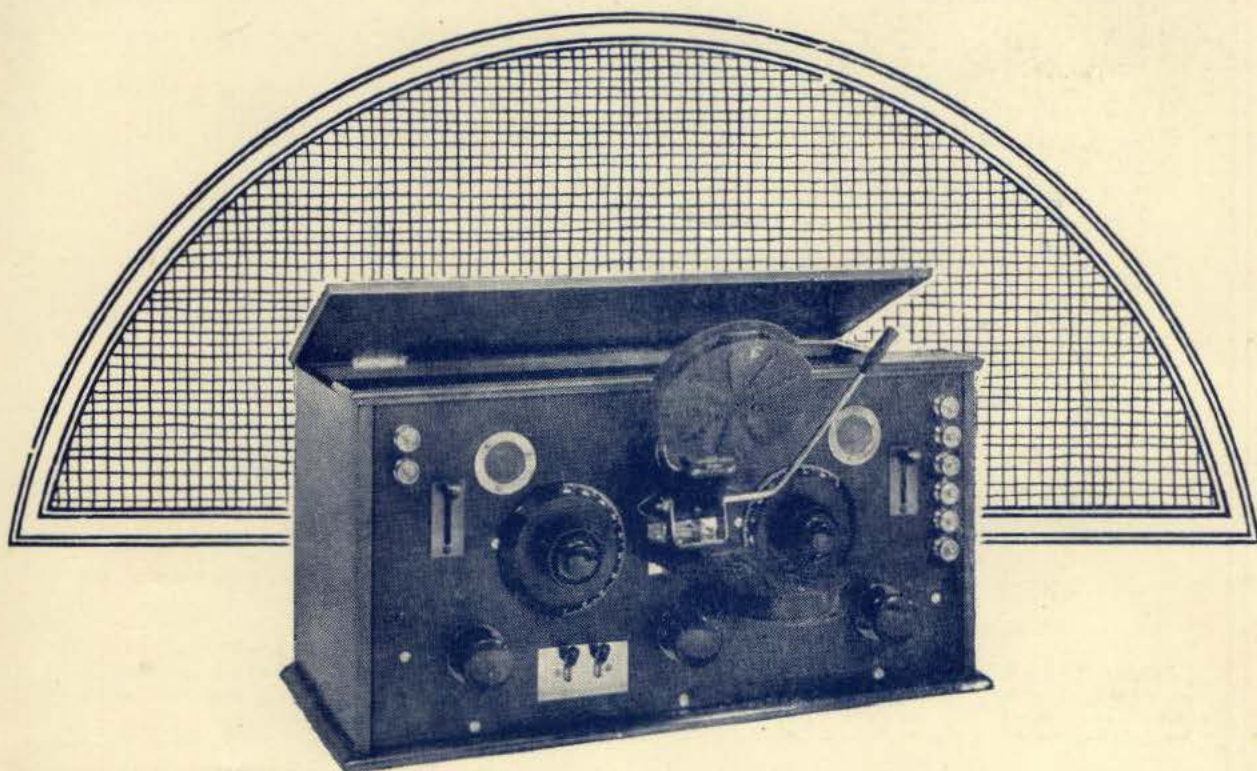

## RADIO PRESS ENVELOPE No. 4.

PRICE

**2'6** POST  
FREE 2/9

You can obtain Radio Press Envelope No. 4 from all Bookstalls, Newsagents, your local Wireless Dealer, or direct from Dept. S., Radio Press, Ltd.

## The Set for the fastidious

A radio set to be efficient need not be ugly. The "All-Concert de Luxe" Receiver is as handsome a set as ever there was, yet its appearance does not hide poor capabilities.

In conjunction with a moderate outside aerial it will receive all the B.B.C. stations and many continental ones. Three valves are used, and Loud speaker results are usual from at least two stations.

To possess this wonderful set you don't have to buy it complete. You can make it. Radio Press Envelope No. 4, the "All-Concert de Luxe" Receiver by Percy W. Harris, M.I.R.E., Editor of "The Wireless Constructor," contains all the instructions you require in constructing this receiver. It also contains Working Diagrams, Blue Prints of Wiring and Panel drilling, and a set of reproductions of photographs showing all the details of the receiver.

**RADIO PRESS LTD.** BUSH HOUSE, STRAND, LONDON, ————W.C.2.

RADIO PRESS  
ENVELOPE  
No. 4.

How to make  
*The "All-Concert de Luxe"*  
Receiver.

By PERCY W.  
HARRIS, M.I.R.E.  
EDITOR OF  
"The  
Wireless Constructor."

INDOOR DAYS ARE ON THEIR WAY

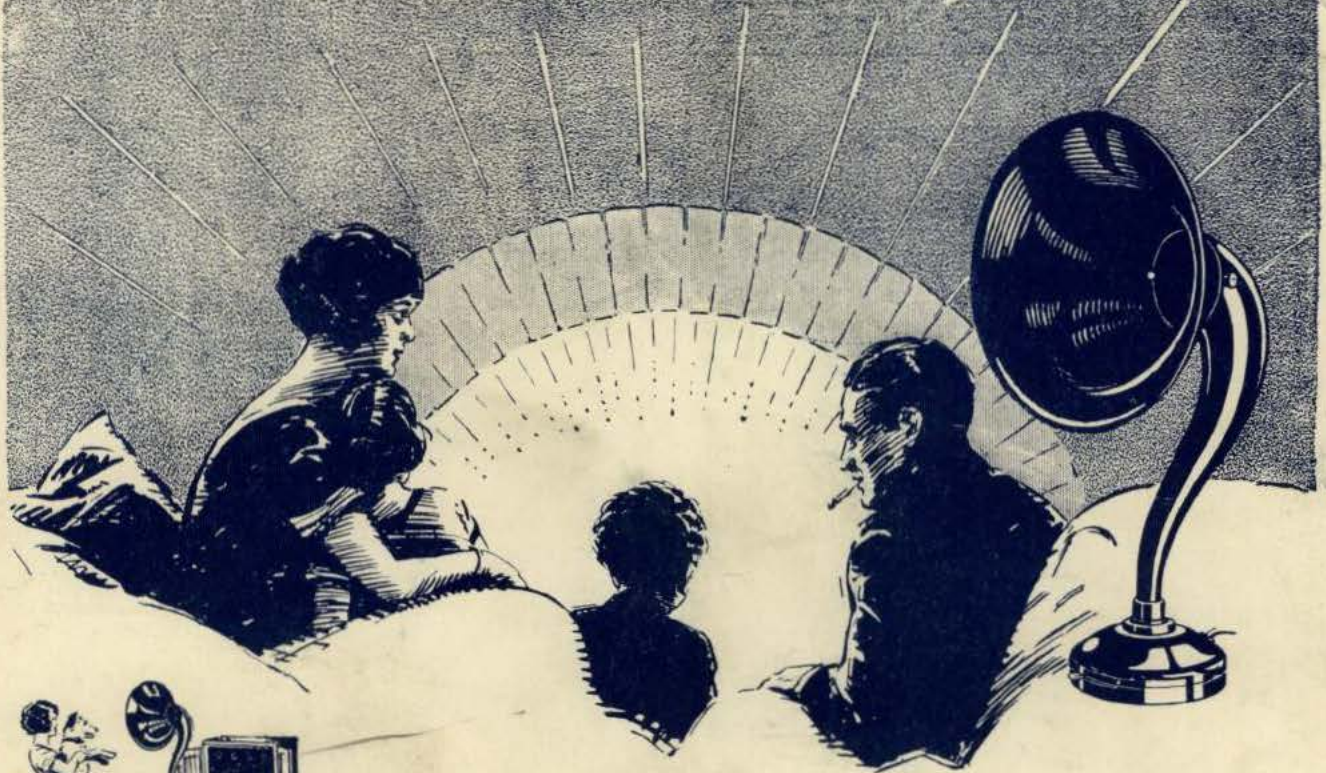

THE long evenings are not far off. Soon tennis, cricket, country walks and the pleasures of the garden will be no more for many a month. What will take their place? Sterling Radio beyond a doubt. Sterling Radio to fill the home with music, song and interest; Sterling Radio to bring music for the dance; Sterling Radio to make the children happy for an hour. Now is the time to make your plans.

Recent improvements in design incorporated in the "Baby" Loud Speaker provide greater mellowness in tone, whilst the extraordinary volume of the original model is maintained. In black enamel, or in an attractive brown-tinted finish 50/-

*Decide on a good set—A Sterling Set*

*and a*  
**STERLING**  
**BABY**  
**LOUD SPEAKER**

*At your Radio Dealers*

Ask your dealer for a demonstration

**Sole Agents:—THE MARCONIPHONE COMPANY, LTD.**  
210-212, Tottenham Court Road, London, W.1

Printed for the Proprietors, RADIO PRESS, LTD., of Bush House, Strand, W.C.2 by THE AVENUE PRESS (L. Upcott Gill & Son, Ltd.), 55-57, Drury Lane W.C.2. and Published by the Proprietors, RADIO PRESS LTD., at Bush House, Strand W.C.2, on Wednesday of each week. Address for Subscriptions and Editorial Communications:—Bush House, Strand, London W.C.2. Advertisement Managers:—BARCLAYS ADVERTISING LTD, Bush House, Strand, London W.C.2. Registered as a newspaper and for transmission by Canadian Magazine Post. Subscription rates:—32/6 per annum, 16/3 for six months, post free. Sole Agents for Australasia:—GORDON & GOUGH (Australasia) LTD. For Canada:—IMPERIAL NEWS, LTD.



# Wireless Weekly

Vol. 6. No. 21.



HOW TO RECEIVE NKF



# Burndept specialise in wireless . . .

**A** Company manufacturing wireless apparatus as a side-line can never obtain the success for its productions as one specialising solely in the subject. The birth of Burndept coincided with the inception of domestic wireless. The Company has specialised in wireless apparatus manufacture from its foundation, until to-day the word Burndept stands for the world's best in wireless goods. Because Burndept are specialists, they are equipped in the best possible manner for the production of the world's finest wireless apparatus. Our much-repeated slogan, "The Burndept range includes everything for radio reception, from components to complete installations," is no idle boast, but simply a plain statement of fact. We may also say that there is a Burndept set for every pocket. The building-up of such a comprehensive range as ours is the outcome of much patient research and development and represents the combined effort of many brains.

At the Blackheath Works, a special department is devoted to the study of radio in all its aspects. The equipment of this laboratory is so complete that there is hardly a problem which cannot be tackled by scientific means. Every piece of apparatus is rigorously examined and tried out before it is produced in bulk and every stage of manufacture is carefully supervised. Thorough testing ensures that finished sets or components are perfect when packed. If difficulties arise, Burndept Service-after-Purchase ensures your protection in the form of a generous guarantee.

It is by far the wisest plan to buy Burndept Apparatus. Demonstrations, which will gladly be given by your local Burndept agent, will finally convince you. Write for our latest catalogue and the name of the nearest agent.



**LOOK OUT FOR THE  
BURNDEPT  
SUPER VALVE  
ON SALE SHORTLY**

**Head Office:— Aldine House,  
Bedford St., Strand, London, W.C.2**

Telephone: Gerrard 9072.  
Telegrams: Burndept, Westrand, London.

BRANCHES at Birmingham, Brighton,  
Bristol, Cardiff, Exeter, Glasgow, Leeds,  
Manchester, Newcastle, Northampton  
and Nottingham.

*Agents throughout the world.*

# BURNDEPT

**WIRELESS LIMITED**

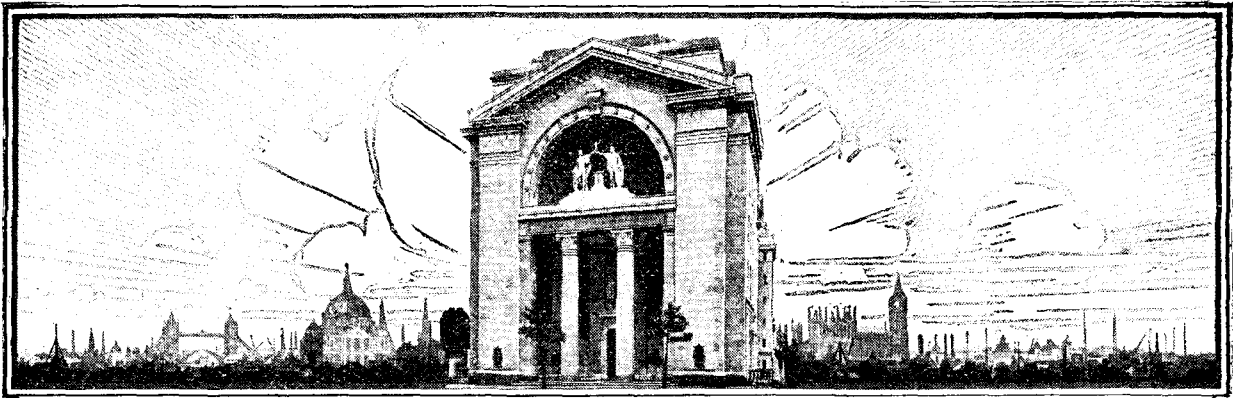

Radio Press LTD

Wireless Weekly  
Phone City, 5911

Bush House STRAND W.C.2

## "Wireless"

ON the fifteenth of September will appear a new wireless periodical of unique character with the title "Wireless." The Radio Press has never yet attempted the production of a weekly wireless journal of really wide national appeal: *Wireless Weekly*, of course, is intended to appeal to the more technical section of the wireless public, and thus there is no weekly journal bearing the Radio Press imprint which directly competes with the cheaper of the weekly wireless papers, or caters for the necessarily very large public, which at present contents itself with only a monthly magazine.

It is now announced that a new enterprise is to be embarked upon which is already creating very great interest. The new journal is to be priced at the figure of 2d., and it is to have the one-word title of "Wireless." The first issue will appear on September 15, and the new paper will, of course, receive the full backing of the organisation of Radio Press, Ltd., in that its articles will be written by the Radio Press staff, including the newly appointed engineers of the Elstree laboratories, with contributions from outside writers of outstanding ability.

Mr. Percy W. Harris will occupy the position of Editor of the

new paper, and there can be no question that the publication will occupy a unique position. It will be of a definitely lighter character than some of the other Radio Press publications, will

### CONTENTS.

	Page
The New Broadcasting Committee	662
Capacity Regeneration in Amplifiers	663
Improving a Set for NKF	667
Inventions and Developments	670
What We are Going To Do at Elstree	671
A Remote Control Device for the Receiving Set	673
Appointment of Capt. H. L. Crowther, M.Sc., as Deputy Director of Research to the Radio Press Laboratories	675
Real and Nominal Capacities of Condensers	676
Jottings By The Way	677
Wireless News in Brief	679
A Talk on Selectivity	680
Removing the Base from a Valve	684
Securing a Silent Background	685
Some American Super-Heterodyne Components	687
How to Receive NKF	688
Correspondence	689
Apparatus We Have Tested	693
Information Department	695

be essentially readable and stimulating to the interest, but its policy will be identical with that of all other Radio Press journals, technical soundness and accuracy being its foundation.

The contents of the first issue will demonstrate that "Wireless," the one-word weekly, will be a periodical in a class by itself.

### Appointment

Upon page 675 will be found an announcement which indicates that the position of Deputy Director of Research to the Radio Press laboratories has now been filled, by the appointment of Capt. H. L. Crowther, M.Sc. Capt. Crowther's distinguished career is detailed in the announcement in question, and possibly some of our readers whose wireless experience dates back to before the War will remember hearing his early transmitter, which was one of the best known of the relatively small number at that time operated by amateurs.

Capt. Crowther has been for the last eleven years connected with radio research work for the Royal Air Force, and thus possibly the general wireless public will not be familiar with his achievements. The fact that he has recently been appointed to the same position, in charge of the Wireless Research and Design Laboratories of the Royal Air Force, as was occupied by Dr. Robinson before he became Director of Research to the Radio Press, will convey an appreciation of Capt. Crowther's standing. His appointment marks another step in the completion of the research staff of the Radio Press Laboratories.

Assistant Editor:  
PERCY W. HARRIS, M.I.R.E.

Scientific Adviser:  
Prof. G. W. O. HOWE, D.Sc.,  
M.I.E.E.

Advisory Editors:  
Prof. R. WHIDDINGTON, M.A. D.Sc.  
F.R.S.  
Prof. C. L. FORTESCUE, M.A., M.I.E.E.

Edited by  
**JOHN SCOTT-TAGGART,**  
F. Inst. P., A.M.I.E.E.  
August 26, Vol. 6, No. 21.

Staff Editors:  
E. H. CHAPMAN, M.A., D.Sc.  
A. D. COWPER, M.Sc.  
R. W. HALLOWS, M.A.  
G. P. KENDALL, B.Sc.  
A. JOHNSON-RANDALL,  
STANLEY G. RATTEE, M.I.R.E.  
J. H. REYNER, B.Sc. (Hons.),  
A.C.C.I., D.I.C.

# THE NEW BROADCASTING COMMITTEE



Capt. IAN FRASER, M.P.

**T**HE duties of the new Broadcasting Committee, photographs of the members of which are given on this page, are, in the words of the Postmaster-General, Sir William Mitchell-Thomson, to "advise as to the proper scope of broadcasting services, and the management, control and finance thereof, after the expiry of the existing licence on December 31, 1926, and to indicate what changes in law, if any, are desirable in the interests of broadcasting." It is expected that the committee will begin its sittings in November.

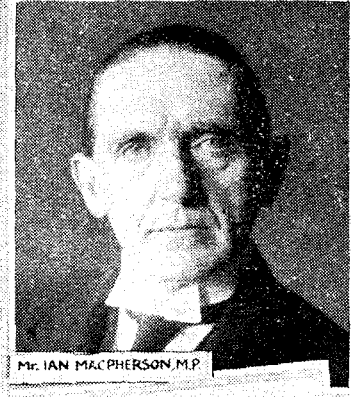

Mr. IAN MACPHERSON, M.P.



Mr. WILLIAM GRAHAM, M.P.



EARL OF CRAWFORD, CHAIRMAN



LORD RAYLEIGH



DAME MERIEL TALBOT



SIR THOMAS ROYDEN



SIR HENRY HADGW.



LORD BLANESBURGH

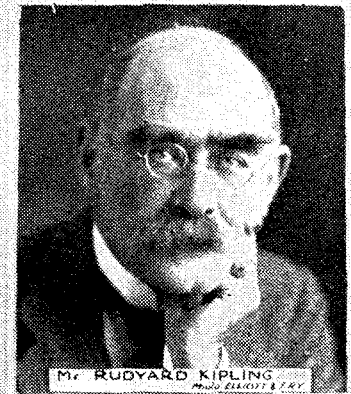

Mr. RUDYARD KIPLING

# Capacity Regeneration in Amplifiers

By J. H. REYNER, B.Sc. (Hons.), A.C.G.I., D.I.C.

This article is the conclusion of the investigation of the effects of inter-electrode capacities in valves which appeared in the August 12 issue. It deals with the conditions under which self-oscillation may occur in high-frequency amplifiers.

**SUMMARY.**—The theory of regeneration due to valve capacity is discussed, and it is shown that currents flow through the capacity of the valve from anode to grid and thence through the grid coil to the filament.

These currents set up voltages across the grid coil, which may, under certain conditions, be in the same direction as those already existing, in which case regeneration or "feed back" occurs.

It is shown that the nature of the external anode and grid circuits has an effect on the feedback voltage produced, and that there are only four cases in which regeneration is possible.

Finally, the methods of overcoming the effects of valve capacity are briefly reviewed.



THE theory of regeneration through the capacity between the anode and grid of a valve has been briefly considered in *Wireless Weekly*, Vol. 6, No. 19. In that article the effect was considered more from the point of view of valves having either the anode or grid circuits tuned.

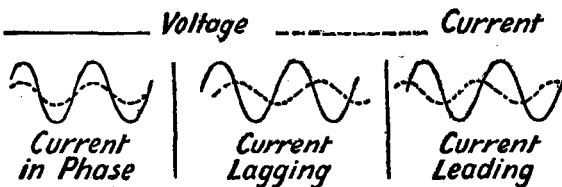

Fig. 1.—A diagrammatic representation of alternating voltage and current in and out of phase.

It is quite possible, however, for regeneration to take place even when the circuits are untuned, and this constitutes a rather different problem.

## Theory of Regeneration

In order to understand this matter fully, it is necessary to consider the principles underlying regeneration or "feed back" in a little greater detail.

The whole question is one which involves "phase difference," one of the most important factors in alternating current theory, and in wireless circuits in particular.

Fortunately an idea of what is meant by this term may be obtained very readily without the use of mathematics.

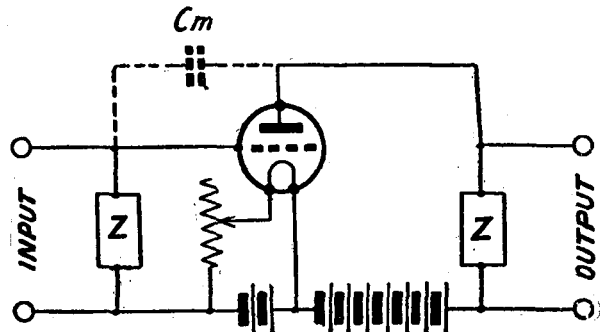
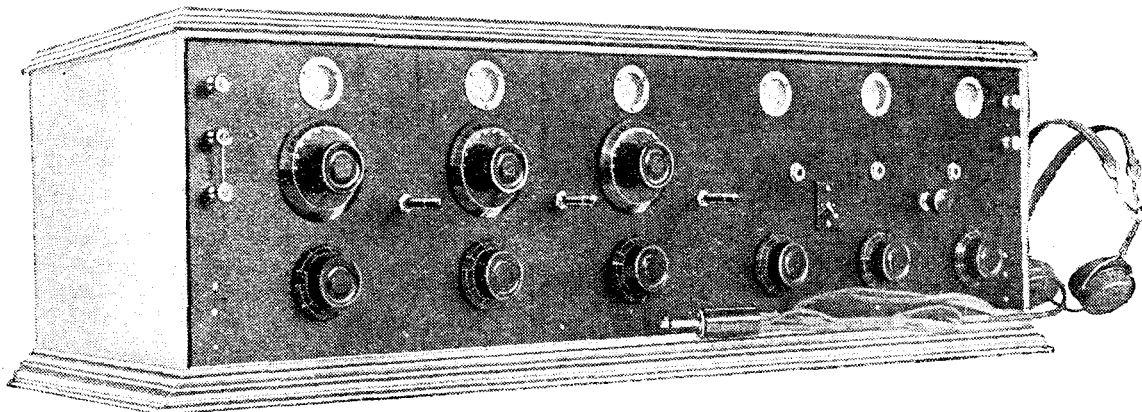

Fig. 2.—In this simple valve circuit the impedances in the grid and anode circuits are represented by Z, and the internal capacity of the valve by the condenser  $C_m$ .

## Phase Difference

If a varying voltage is applied across a resistance, the current which flows follows the variations of voltage faithfully and at the same time. An increase of voltage is accompanied by an increase of current and *vice-versa*. Since these



In the "Anglo-American Six" receiver, described by Percy W. Harris in the January issue of "The Wireless Constructor," the capacity effects in the three H.F. valves have been neutralised by the neutrodyne method.

effects occur at the same time they are said to be *in phase*.

If the voltage is applied across a coil, however, the current does not follow the voltage variations immediately. The current has to produce a magnetic field, and this requires a certain amount of time. Consequently the changes of current, although similar in form, take place *after* the voltage changes. There is then said to be a *phase difference* between the voltage and the current, and the current is said to *lag behind* the voltage.

In a somewhat similar manner the current through a condenser takes place *before* the voltage change producing it. (This, of course, only applies to voltages which are varying regularly, so that the current can anticipate, as it were, the changes of voltage. At the actual commencement of an oscillation the current and voltage start off together.) A condenser current is thus also out of phase with the voltage, the current in this case being said to *lead* the voltage.

**Currents Flowing in a Valve**

This explanation of phase difference is necessary in order to understand the real effect of valve capacity.

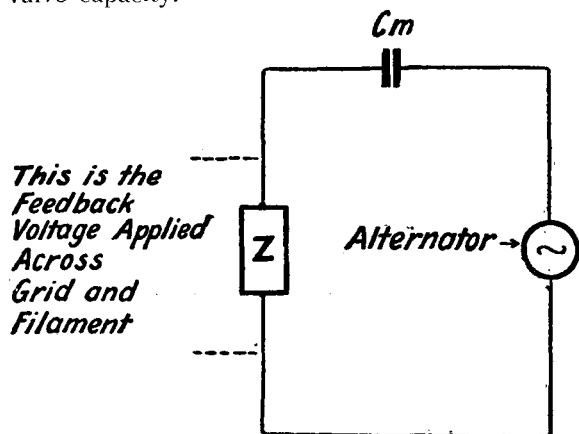

Fig. 3.—A simplified version of Fig. 2, the alternator representing the varying anode voltage.

Consider the circuit shown in Fig. 2, which is a simple valve circuit. Assume a certain voltage variation to be applied to the grid. This will produce a certain varying anode current, and the voltage on the anode of the valve will thus vary also.

The anode current will have to flow across the gap between anode and filament, and also through the external circuit.

If this circuit is a pure resistance the variations of anode voltage will be in phase with the variations of anode current.

If the external circuit contains any inductance or capacity, however, then the anode voltage will be out of phase with the anode current, the extent of the phase difference depending upon the value of the inductance or capacity.

**Voltage Fed Back to Grid Circuit**

Now consider the effect of the valve capacity. Connected across the anode and filament is a circuit comprising the valve capacity in series

with whatever happens to be in the external circuit of the grid of the valve.

It will assist in the clear understanding of the effects if this portion of the circuit is redrawn, as in Fig. 3.

Here we have the varying anode voltage shown as a small alternator, and connected across it

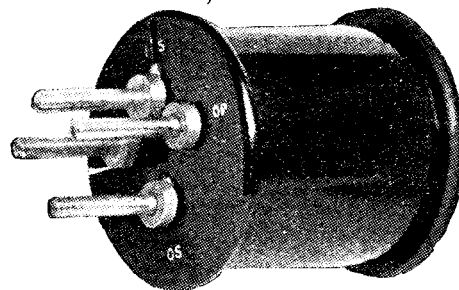

A typical form of Neutrodyne unit, consisting of an H.F. transformer with special windings, first suggested by Percy W. Harris.

we have a capacity in series with an impedance  $Z$ . This impedance, of course, is the external circuit between grid and filament. It may be a resistance, but is more usually an inductance or a tuned circuit.

Now it will be clear that if any current flows through the circuit  $C_m Z$  there will be voltages produced across both  $C_m$  and  $Z$ , the sum of these voltages, of course, being equal to the voltage applied across the whole.

Since the impedance  $Z$  is in the grid circuit, it follows that the voltage developed across  $Z$  will be applied across the grid and filament of the valve.

**Effect of Phase Difference**

This voltage may or may not be in the same direction as the voltage which is already being

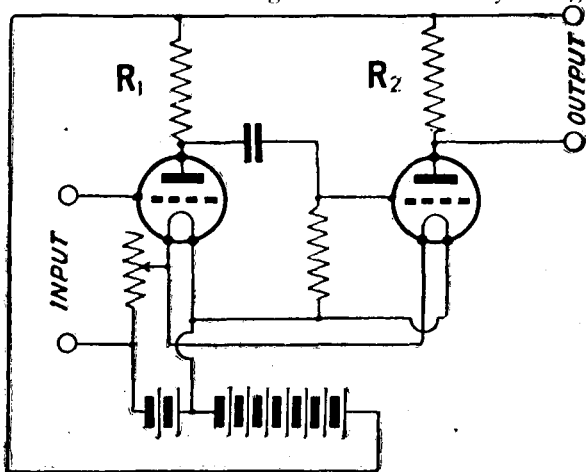

Fig. 4.—The circuit of a resistance coupled amplifier, in which regeneration cannot take place through the capacity coupling of the valve.

applied across the grid by the incoming signals. If it is in the same direction, *i.e.*, if it is in phase with the grid voltage, the signals will be increased, or, in other words, regeneration will occur.

If the voltage is not in the right direction the reverse effect will be obtained, and the signals, instead of being increased, will be reduced in strength.

It will be seen that there are two conditions controlling the direction of the voltage developed across  $Z$ . In the first place, the voltage on the anode of the valve itself may not be (and usually is not) in phase with the voltage on the grid.

Secondly, the current through the circuit  $C_m Z$  obviously will not, as a general rule, be in phase with the voltage applied across it, *i.e.*, the voltage on the anode.

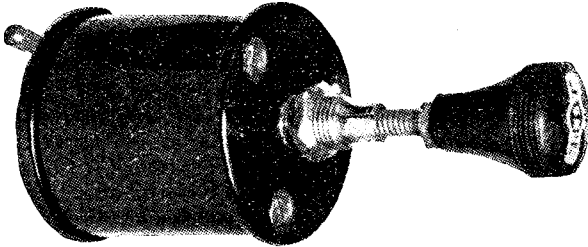

A small semi-circular plate neutralising condenser for use in neutrodyne circuits.

Consequently the tendency to oscillation, which demands that the voltage developed across  $Z$  shall be in phase with the voltage on the grid, depends upon the values of

- (1) The external impedance in the anode circuit;
- (2) The external impedance in the grid circuit;
- (3) The value of the capacity between grid and anode.

**Conditions for Regeneration**

The conditions for regeneration are obtained by working out the phase difference between the voltage developed across  $Z$ , *i.e.*, the feed-back voltage applied across the grid by the signal. The component of the feed-back voltage, which is in phase with  $V_g$ , is then found. For feed-back this component must be positive. If it is zero, no feed-back occurs, while if it is negative the signals are reduced in strength.

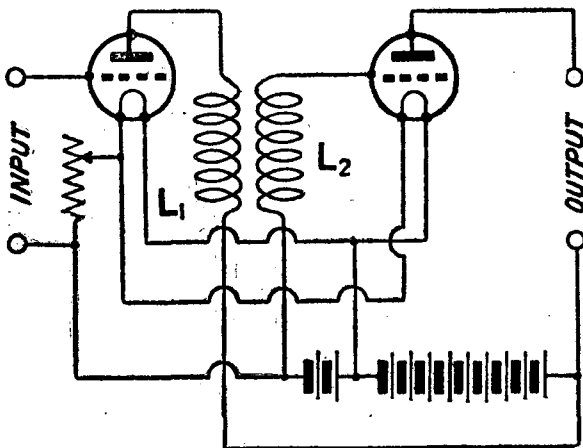

Fig. 5.—Under certain conditions valve capacities may cause regeneration when untuned transformer coupling is used.

The expression itself is somewhat complicated, but by substitution of the appropriate values it is found that there are only four cases in which regeneration can occur. These are:—

- (1) Resistance in the grid circuit ( $R_g$ ). Then feed-back is positive if the anode circuit is inductive and such that  $\omega^2 L_a R_g C_m < r_i$  where  $C_m$  is the capacity between anode and grid;  $r_i$  is the internal impedance of the valve;  $L_a$  is the anode circuit inductance;  $\omega = 2\pi \times \text{frequency}$ .

If the anode circuit is resistive or capacitive no regeneration is possible.

- (2) Inductance in the grid circuit ( $L_g$ ). Then regeneration will occur, irrespective of the impedance in the anode circuit, provided that  $\omega^2 L_g C_m < 1$ .

These are the remaining three cases corresponding to the three possible forms of anode circuit.

If the grid circuit is capacitive, feed-back is negative, and no regeneration will occur.

**Analysis of the Results**

These results may now be applied to some practical forms of circuit. Consider first the case of resistance amplification, as illustrated in Fig. 4. In this case no regeneration is possible through the capacity coupling of the valve.

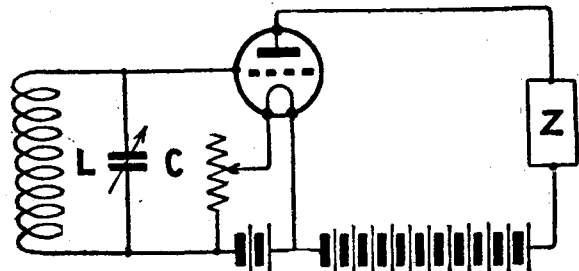

Fig. 6.—With the tuned grid circuit shown, the setting of the variable condenser C is the critical factor in controlling regeneration.

The howling which does occur in some cases of resistance coupling would thus appear to be due to other causes, such as resistance in the H.T. circuit.

**Untuned Transformer Coupling**

A second method of coupling is that using untuned transformers. We see that in this case, since the grid circuit is inductive, regeneration will occur if  $\omega^2 L_g C_m < 1$ .

The average value of  $C_m$  allowing a certain proportion for circuit capacities is of the order of 25  $\mu\text{F}$ .

At frequencies of 1,000 kc. (300 metres) this requires that the inductance shall be less than 1,000  $\mu\text{H}$ . Now the values employed in practice are of this order, but somewhat less, so that there would be a marked tendency to regeneration with this type of amplifier.

**Tuned Circuits**

It is more usual, however, to tune one or both of the transformer windings, or to employ some other form of coupling, utilising tuned circuits, such as the tuned anode arrangement.

In such cases the tendency to self-oscillation becomes of importance. It was explained in the

August 12 issue that while regeneration merely required that the capacity should be less than a critical value, in order that the feed-back should be positive, self-oscillation required that it should also be greater than a certain minimum value in order that the losses in the oscillating circuits may be made up.

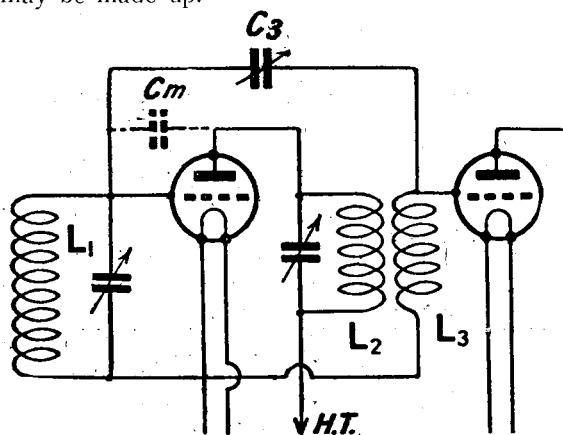

Fig. 7.—A form of neurodyne coupling. By adjustment of  $C_3$  the tendency to regeneration can be neutralised.

The effective impedance of the tuned grid circuit shown in Fig. 6 is inductive if the condenser is below the tuning point, and becomes capacitive just above the tuning point.

When the impedance is capacitive no regeneration is possible, but for a band of frequencies just around the tuning point the circuit will oscillate. As the capacity is still further reduced self-oscillation ceases abruptly, the feed-back being insufficient.

Using a tuned anode circuit regeneration will generally occur, since the circuits normally in use employ an inductive grid circuit. Self-oscillation may occur if the requisite conditions are satisfied. (These conditions were outlined in the August 12 issue.) If the grid circuit is a resistance, oscillations will only occur if the anode condenser is at or just below the tuning point. This applies also to circuits shown in Fig. 6, in which the grid circuit is tuned and the anode circuit varied.

These are some of the applications of the theoretical treatment to practical cases. We may now consider methods of controlling this regeneration.

### Methods of Counteracting the Effect of Valve Capacity

One method of counteracting the effect of the inter-electrode capacity is to connect a small capacity across the grid and anode. This condenser may then be adjusted in operation so that the feed-back is not positive, but just slightly negative, by making the capacity greater than the critical value.

This method, of course, has the disadvantage that it requires readjustment for each different frequency received, and also that it does not necessarily check the self-oscillations due to the tuned grid or anode coils. If these coils are large, however, it will usually be found that the capacity required to check feed-back will check

the self-oscillation as well, and in such cases the method has a certain limited application.

### The Neurodyne Method

The more satisfactory method, however, is that of the neurodyne. In this arrangement a second circuit is connected between the anode and grid in such a manner as to introduce a voltage into the grid circuit equal and opposite to that due to the self-capacity.

Fig. 7 shows a simplified form due to Hazeltine. Here the voltages developed in the tuned anode circuit produce currents through  $C_m$  which, under suitable conditions, may give regeneration. The anode coil, however, normally induces voltages in the coil  $L_3$ , and these are in the opposite direction to those across  $L_2$ . Hence a "neurodyne" condenser  $C_3$ , connected as shown, will produce voltages across  $L_1$  in the opposite direction to those due to the valve capacity, and by suitable adjustment of the value of  $C_3$  the feed-back can be neutralised.

### Advantages of Neurodyne Method

The principal advantage of the neurodyne method is that it prevents not only regeneration, but also self-oscillation, so that the circuit becomes absolutely stable.

The adjustment, moreover, remains sensibly constant over a band of frequencies on each side of the one for which it is adjusted, so that searching for other stations is facilitated.

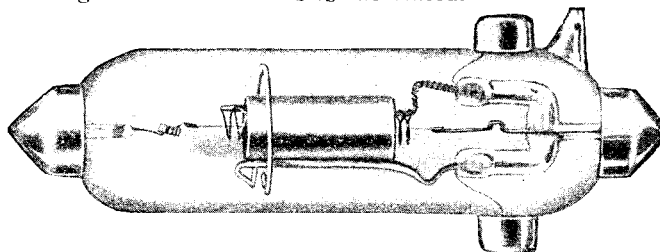

In ordinary types of valve the main source of inter-electrode capacity is in the "pinch" where the wires are sealed into the glass. In the type shown above this has been minimised.

Other forms of neurodyne circuit have been described from time to time in this journal, and the stability obtainable by this method is undoubtedly very good.

### AMATEUR TELEPHONY TO NEW ZEALAND

For more than an hour on several nights last week Mr. Gerald Marcuse (2NM), of Caterham Hill, successfully transmitted speech and gramophone records to the United States warship *Seattle*, lying in Wellington Harbour, New Zealand. Mr. F. H. Schnell, traffic manager of the A.R.R.L., was the operator on the *Seattle*; he replied to 2NM in Morse. Mr. Marcuse was using a power of 500 watts, and the wavelength employed was 45 metres.

□ □ □

We have pleasure in announcing that Professor Whiddington, M.A., D.Sc., Advisory Editor to *Wireless Weekly*, *Modern Wireless* and *The Wireless Constructor*, has been made a Fellow of the Royal Society.



# IMPROVISING A SET FOR NKF

By G. P. KENDALL, B.Sc.,  
Staff Editor.

In view of the interest taken in the test schedules being arranged by "Wireless Weekly" with the United States Naval Station, NKF, whereby test transmissions on accurately calibrated short waves will be sent out, readers will welcome Mr. Kendall's hints on the construction of a simple and quickly-made set capable of receiving these signals.

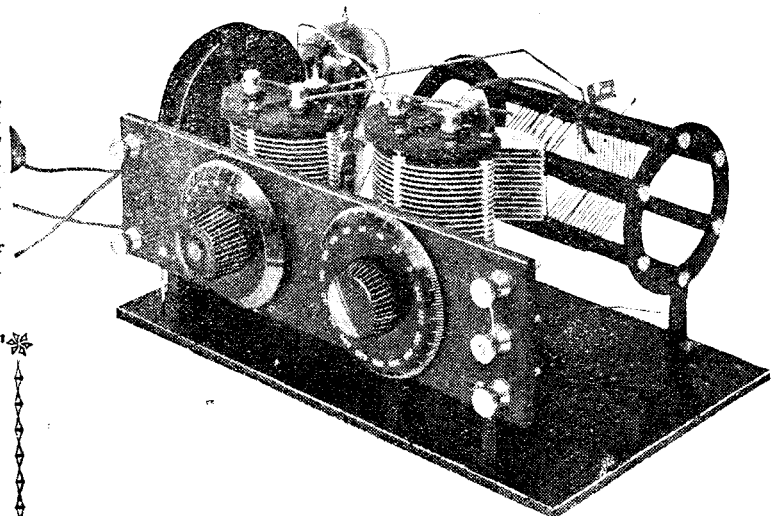

A receiver on the lines of that illustrated above is very readily made and comparatively easy to operate.

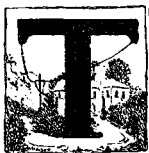

**T**O take part in the special tests which are being arranged by *Wireless Weekly*, in which the United States naval station NKF will be transmitting on various short wavelengths, all that is required is the ability to read fairly slow morse and the possession of some sort of a receiver which will tune to waves in the neighbourhood of 20 metres (14,991 kc.). With regard to the receiver, no doubt the best course to adopt is to follow some properly worked out design, such as that given by Mr. Rattee in a recent issue, and to which he refers in some notes upon its use elsewhere in this number. However, there must be a considerable number of readers who do not possess a receiver capable of operating upon these shorter wavelengths, and who wish to put together some

improvised arrangement which shall serve merely for the present tests, and it is for their assistance that these notes are being written.

### A Suitable Circuit

The question of the circuit to be employed need not detain us long. Only one valve is needed, since NKF is extremely powerful, and what is required is some arrangement which will oscillate readily when quite small coils are used. The circuit illustrated in Fig. 1 is very largely used in some form or other for these wavelengths, and can be recommended on account of its extreme simplicity and relative ease of

handling. The single valve used is simply a detector using the leaky grid condenser method, reaction of the type usually associated with the name of Reinartz being employed to obtain the necessary local oscillations for heterodyning the incoming signal, and, of course, to improve signal strength. An entirely separate aerial circuit is used, usually quite loosely coupled to the receiver itself.

### Easy Assembly

As will readily be understood, such a circuit lends itself very conveniently to makeshift arrangements, since the coils are all wound upon a single former, or in some other way combined into a single winding, the tapplings being taken at the necessary points, and the total number of components involved is extremely small. Probably the best method is to adopt some sort of bread-board mounting, rather than to attempt to build the set into a cabinet with an ebonite front, in the usual manner. At this point a word of warning should be given regarding the arrangement of the parts, to the effect that it is quite possible that when first assembled the set will refuse to oscillate, and no alteration in the number of turns in the reaction

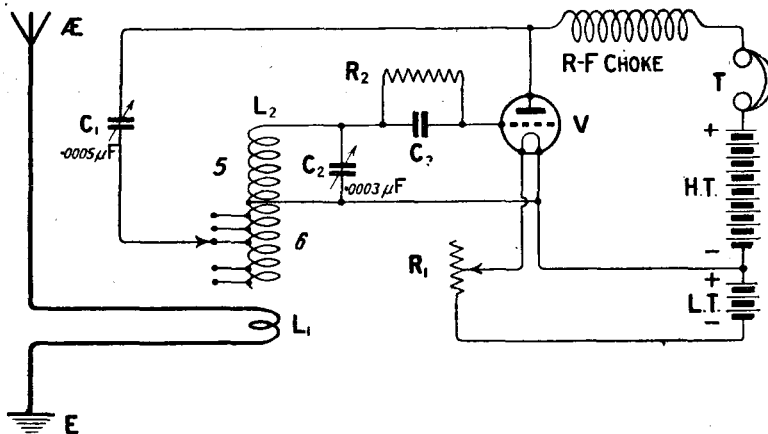

Fig. 1.—The circuit diagram of the receiver illustrated on this page. The form of aerial to use is discussed in the text.

winding, etc., will persuade it to do so.

**The Remedy**

In such a case as this, the procedure to be adopted is simply to alter the layout of the parts, and to space the more important wires of the connections as far apart from one another and from earth-connected wires as possible. I have had such an experience in the case of the receiver illustrated on these pages,

results. The expedient is simply to take a Collinson skeleton former, and to wind upon this a sufficient number of turns of No. 20 enamelled wire, *double spaced*, that is to say, wound in alternate grooves on the rod, tapplings being prepared at suitable points after the winding is finished.

**Making Tapplings**

When the winding is completed, and it should contain

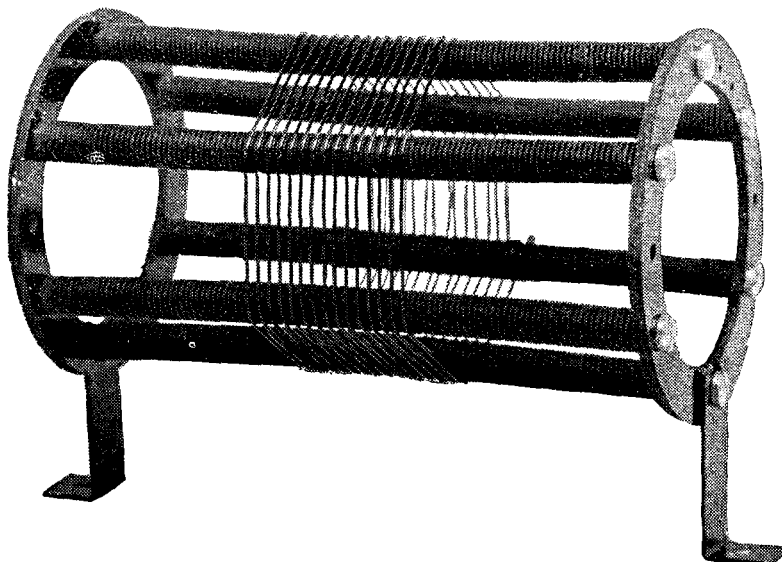

*A close-up view of one of the coils used by the author, which is wound with double spacing on a skeleton former.*

and was quite at a loss to see why the set would not oscillate when first laid out, and am still equally in the dark as to why it now behaves perfectly, as a result of some apparently unimportant re-arrangements. The general layout should certainly be such as to keep the coils fairly well away from metallic objects, such as condensers, and more particularly the coil should be placed with no metallic object coming directly within its more intense magnetic field (the field around its ends when a cylindrical winding is employed).

**The Coil**

Probably the best arrangement of the coils to be employed is the self-supporting type wound with stiff bare wire, such as that used in Mr. Rattee's set (*Wireless Weekly*, Vol. 6, No. 12), but since these are a little troublesome to make, and I am assuming that it is desired to improvise a set as quickly and easily as possible, I will describe an alternative which I have found to give quite good

about 11 turns in all, scrape bare a space about  $\frac{1}{2}$  in. long on the 3rd, 4th, 5th, 6th, 7th, 8th and 9th turns, so arranging these bared parts that they do not all come close to one another, but are arranged alternately one on each side of one of the supporting rods. Then to each of these bared portions, solder a little piece of tinned copper wire in the manner illustrated in Fig. 2, the object of these being to provide a projecting end to which connection can be made by a suitable tapping device.

The method of making contact to these little projections is to use either some of the very convenient Burndept clips, or alternatively, one of the spring clip terminals found on certain H.T. batteries, which can be slipped over the projecting end of the wire. These ends of wire should be cut down to the minimum length, which gives a fairly satisfactory grip to the tapping device chosen.

**The Lay-Out**

The actual arrangement of the parts upon the baseboard will naturally depend upon the method of construction adopted, and quite a convenient one is illustrated in the photograph, from which it will be seen that the two condensers are mounted upon a vertical panel which is held by two brackets. This enables the wiring to be considerably shorter, and is to be recommended.

**Wiring Hints**

Whatever the arrangement adopted, it should be such that the wiring can be carried out in a way which spaces out the connections from one another to a much more considerable extent than is usual upon ordinary broadcast receivers. My experience of re-arranging the set which I improvised for the tests, and which is illustrated in one of the photographs accompanying this article, convinces me that the spacing out of the leads is more important than their actual shortness. To keep the wires short is no doubt desirable, but if it also involves a number of wires running within quite a short distance of one another it will probably do more harm than good. Keep all the wires at angles to one another, and see that they do not anywhere approach within one and a half or two inches of each other, and you will achieve a reasonably efficient set.

**The Choke**

The choke coil deserves a word or two of explanation, since on these very short wavelengths it is imperative that a coil of really low capacity be used here. If you possess a plug-in coil of good size (I used a Gambrell H coil) which you are certain is of

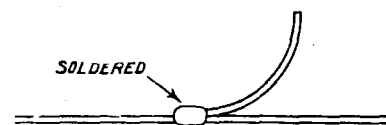

*Fig. 2.—Illustrating how the tapping points are made.*

reasonably low capacity, this can be used by all means, but if the coil must be bought, it is probably wise to obtain one of the special high-frequency chokes now being sold by a number of firms.

### Turn Numbers

The actual number of turns upon the tuning and reaction coil which must be included in the circuit to obtain reception on 20 metres will depend to a considerable extent upon the actual arrangement of the wiring, and upon the minimum capacity of the condensers, which should, it is hardly necessary to state, be as low as possible. In my own set I can just get down to stations working on the neighbourhood of 20 metres with five turns in the grid winding, and for this number it requires three or four turns in the reaction coil to give satisfactory working. With a different arrangement of wiring, however, I have found it necessary to reduce the number of turns to only three, that is to say, to the first tapping on the coil.

### Characteristic Noises

I am afraid, therefore, that it is not possible to be as definite as I could wish about these dimensions, but I would advise the reader to adjust the turns experimentally, until he finds a number which will enable him to tune in the characteristic noises from the ignition systems of motor vehicles at a fairly low

### The Condensers

The two variable condensers, as has already been stated, should be of very low minimum capacity, and it is of course imperative that a good make should be used. Some sort of slow-motion gearing is desirable either

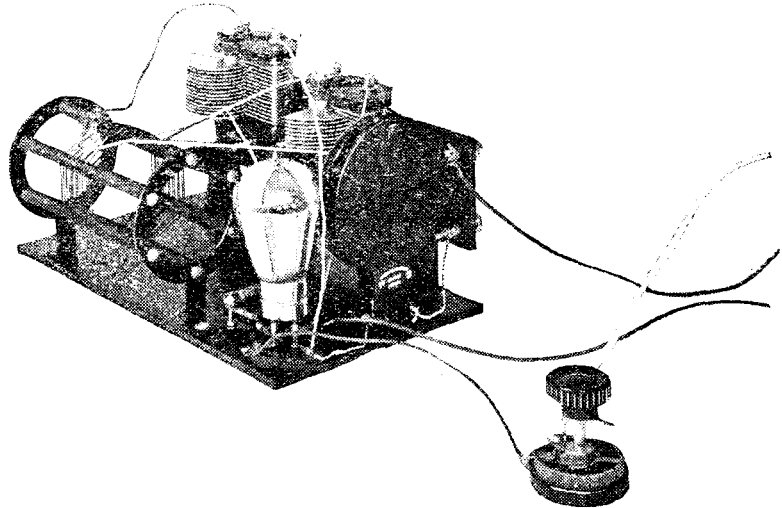

*A further view of the improvised set. The filament rheostat is inserted in one of the L.T. leads away from the receiver.*

in the condenser itself or in the dial arrangement, the condensers shown being two of Messrs. Collinson's geared type. Failing such condensers, of course, separate verniers can be used.

ample if it is desired to receive on 20 metres only. For the reaction condenser any component which happens to be at hand will serve, the particular one which I used having a maximum value of  $.0005 \mu\text{F}$ , which is quite manageable with the aid of the gearing

provided on the Collinson instrument. Anything from  $.0001 \mu\text{F}$  upwards again will serve.

### The Aerial Circuit

The arrangement of the aerial circuit is a matter demanding a certain amount of experiment before good results will be obtained, and this should be deferred until the set has been assembled and is found to be capable of oscillating. As a matter of fact, I do not think I can do better than refer the reader to the notes given by Mr. Rattee elsewhere upon the aerial circuit arrangements which he employs, since they are equally applicable to this makeshift instrument.

Similarly, the subject of operating such a receiver has been very carefully covered by Mr. Rattee, and readers will be well advised to refer to his notes, since the operation of this particular set is very similar. The valve to be used, it should perhaps be mentioned, should be of the variety which oscillates very readily, such as the B.4 or D.E.5B types, and at least 72 volts should be applied to it. Under these conditions little difficulty should be experienced in obtaining quite free self-oscillation and adequate control, even on the lowest range of the condenser.

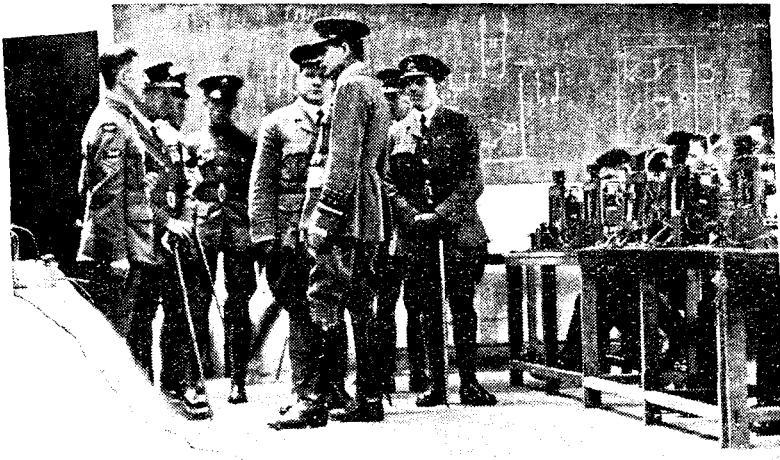

*Sir Hugh Trenchard (centre) in the wireless school on the occasion of his inspection of the R.A.F. Electrical and Wireless School at Flowerdown, Winchester.*

reading on the tuning condenser dial. He will then be able to receive 20-metre signals conveniently, and by adding another turn or so to the winding, will be able to go up to the 40-metre band when NKF chances to be transmitting thereon.

The capacity of the two condensers is not very important, the one for tuning purposes having preferably a maximum value of  $.0002 \mu\text{F}$  or  $.0003 \mu\text{F}$ , if it is desired to cover both the 20- and the 40-metre bands easily, a value of  $.0001 \mu\text{F}$  being

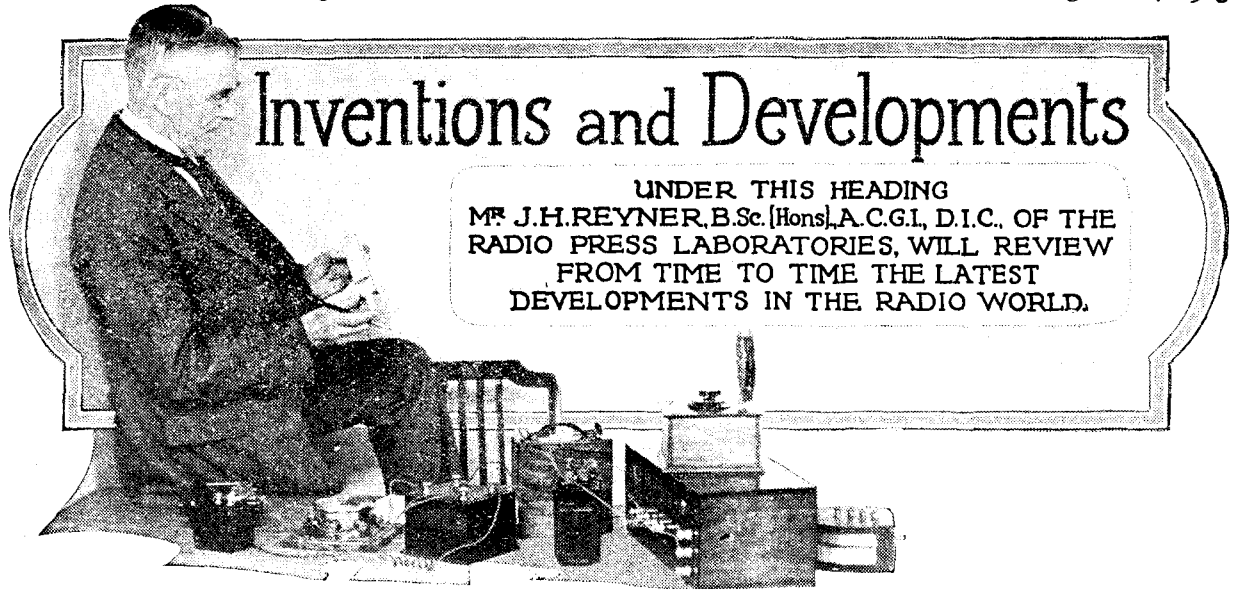

# Inventions and Developments

UNDER THIS HEADING  
 MR. J. H. REYNER, B.Sc. (Hons.), A.C.G.I., D.I.C., OF THE  
 RADIO PRESS LABORATORIES, WILL REVIEW  
 FROM TIME TO TIME THE LATEST  
 DEVELOPMENTS IN THE RADIO WORLD.

### A New Neon Tube Rectifier

An interesting development of the neon tube has been recently produced in America. This device contains two electrodes, a hollow cylinder about  $1\frac{1}{2}$  in. long and  $\frac{1}{2}$  in. in diameter, in the centre of which is a small rod having a surface area less than  $1/200$ th that of the cylinder. Both the electrodes are of aluminium. The tube contains neon gas at a pressure of between 3 and 6 millimetres of mercury.

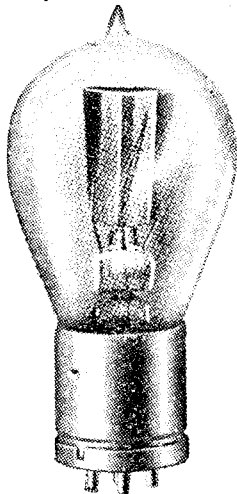

The neon tube described in the accompanying article.

Now the properties of neon tubes have been described before, the most important property of the device being, first, that, although a certain voltage is required to strike an arc between the two electrodes, yet this arc can subsequently be

maintained with a much smaller voltage. This is, of course, characteristic of all arcs. Secondly, if the electrodes are made of widely different sizes as in the present case, the conductivity in the two directions is not equal.

### Asymmetrical Conductivity

In the actual tube, if the cylinder is made positive, no current passes until 135 volts is reached. At this point a small current of about one-twentieth of a milliamperes will pass, which may be slightly increased by increasing the voltage. If, on the other hand, the cylinder is made negative, no current will flow until 175 volts is reached. At this point, however, a current of 150 milliamperes or more will flow, and a current of this order will continue to flow until the voltage drops below 110, when the discharge ceases.

### Use as Rectifier

It will be seen, therefore, that if this tube is connected to a source of alternating voltage, no appreciable current will flow during the positive half-cycle, but that when the cylinder is made negative with respect to the central electrode an appreciable current will flow. In this way we obtain substantial rectification of the current passing through the device. A diagram of this new rectifier is given in Fig. 1, and a picture of it is also appended, from which it will be seen that the device is made up in a form similar to the usual American valve, and can in fact be made to fit the usual American valve socket.

### Four-Pin Sockets for Four Electrode Valves

A patent has been taken out by the British Thomson-Houston Co., Ltd., for a four-electrode valve of the space charge grid type. In this type of valve the inner grid is maintained at substantially the same potential as the external anode, and the purpose of this invention is to complete this connection inside the bulb of the valve, thereby dis-

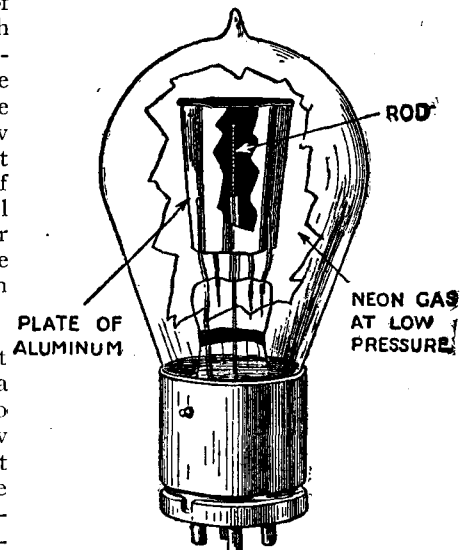

Fig. 1.—Here the outer cylindrical electrode is cut away to show the inner rod-shaped electrode.

persing with the necessity for a fifth external connection. The two electrodes are actually connected through a small resistance mounted inside the cap of the valve, the electrodes being so designed that with this resistance in circuit the space-charge grid acquires its correct potential.

# What we are going to do at Elstree

By Major **JAMES ROBINSON, D.Sc., Ph.D.,**  
*F.Inst.P., etc.,*  
 Director of Research to Radio Press, Ltd.

**O**UR laboratories at Elstree are in course of erection, and two buildings for the research and service departments respectively are already up. Progress is being made with the general equipment, and, having a free hand, I propose to see that this is complete in every detail. The laboratory staff appointed includes Capt. H. L. Crowther, M.Sc., (who is resigning from his present position in charge of the wireless laboratories of the Royal Air Force, a position formerly held by myself), Mr. J. H. Reyner, B.Sc. (Hons.), A.C.G.I., D.I.C., who for four years has been with the Post Office, and has been in charge of receiver design, and Mr. Barton Chapple, Wh. Sch., B.Sc. (Hons.), A.C.G.I., D.I.C., A.M.I.E.E., a radio research worker and lecturer in electrical engineering at Bradford Technical College. Mr. W. R. Tingey, M.I.R.E., who has hitherto been in charge of the test department, will continue in a similar capacity. Needless to say, the existing staff of Radio Press, Ltd., will enjoy the full facilities of the laboratories. Competent junior engineers have been engaged, and when building operations have progressed further, and new departments have been created, further staff will be engaged.

## Sub-Divisions

It is my intention to divide the functions of the laboratories into eight separate departments, which on suitable occasions will co-operate. It is obviously desirable that all the Radio Press staff should be acquainted with all new technical developments and data, and arrangements have been made for weekly technical conferences of all departments of the company.

Below I have tabulated the eight departments, with notes as to some of the work that will be done in each.

**1. Research Department.**—In this country there are really very few investigators employed on entirely new fields of work in wireless. There are some experimental establishments for commercial firms and for Government departments, but in most cases their time is fully occupied in investigating problems which have reasonable certainty of leading to immediate applications. In order to obtain entirely new developments in wireless, it is usually necessary to devote time to investigations which may not lead to immediate or even early commercial application. Such research work, however, must be undertaken, and it is highly desirable that much more time and money should be devoted to it in this country. It is a lamentable fact that most of the valuable wireless inventions in use at present have come from other countries, particularly the United States and Germany.



Great importance will be attached to this department at Elstree, where problems will be worked on which may not lead to any immediate application, but, on the other hand, where there is some hope that great discoveries will be made.

**2. Experimental Department.**—This department will deal with problems which will lead to immediate practical application. Its work will follow on the results of the work in the research department, developing ideas which have been produced there. This type of work very often leads to useful inventions, and the staff of the laboratories has been chosen to include a large amount of inventive ability as distinct from those carrying out standard routine tests. The whole staff will be kept in close touch by current literature and otherwise with developments in radio throughout the world, and members will periodically visit different countries with a view to seeing at first hand what is being done elsewhere.

## Quantitative Measurements

This department will also obtain accurate quantitative data regarding such subjects as high-frequency amplification, degrees of distortion, etc., and will work generally towards the improvement of radio technique.

Results of the work of this department will be published at the earliest opportunity. We consider it of the greatest importance that any new idea shall be given to our readers at once, if it is good, but we must not do so until we are certain that it has definite possibilities. We do not consider it in the interest of our readers to publish new ideas which have not been thoroughly tried out, and which have merely sensational value.

**3. Standards and Measurements Department.**—Standards of frequency, of resistance, capacity,

inductance, etc., will be kept at the laboratory, and all test apparatus will be checked periodically against these standards. The greatest pains will be taken to see that these standards conform to those of the National Physical Laboratory at Teddington and of the Bureau of Standards in the United States. It is hoped that transmissions will take place from time to time on various wavelengths, when the actual wavelengths can be announced with great accuracy, so that listeners can check their wavemeters and receivers. Schemes of this kind depend largely on whether the Postmaster-General will agree, and also whether the National Physical Laboratory extends its present service or not.

**4. Designs and Construction Department.**—This department will design receivers in the best possible manner. This is a very important branch of our work. Good designing of sets is by no means easy, and involves important technical considerations. A mere circuit is by no means the end of the story. Often the most important work consists in getting the different values correct, in suitably arranging the components, etc.

The designs department will carry out instructions from the research and experimental departments, and where necessary embody in sets the experimental results obtained by these other departments.

**5. Set Testing and Demonstration Department.**—Sets constructed for description in the Radió Press publications are, of course, already subjected to severe test by members of the staff. In addition to such tests, the sets will in future undergo further thorough test in the laboratories. These further tests will be carried out with the costly and in some cases necessarily complicated apparatus required for accurate measurement. Various types of valves will be tested in these sets, and results will be obtained with different values of high and low tension, etc. Different sets will be compared for signal strength, purity and selectivity, etc., and the general result of this will be to obtain new and higher standards, against which future sets will be compared.

**6. Service Department for Readers.**—Readers will still continue to have the opportunity of sending their sets to us for locating faults, when they have attempted to construct sets to our instructions, but for some reason or another the anticipated results are not obtained. Readers' sets according to our design will also be put right, but our service, of course, only applies to *bona-fide* amateurs.

**7. Tests of Commercial Apparatus for Published Reports.**—Apparatus will be set up permanently to make reliable tests of any commercial apparatus which may be submitted. All test apparatus will be standardised, and will be maintained at an accuracy equal to the highest precision apparatus of to-day. The actual constants of capacities and inductances will be measured, and the manufacturers' values checked. The frequency or wavelength ranges claimed will also be tested. In addition to these, the efficiency of various parts will come under scrutiny. It is of great importance to minimise loss of efficiency,

and apparatus will be installed to measure the resistance of coils at various frequencies, and the high frequency losses which occur in coils, condensers and in any composite parts. Valves will have special tests arranged for them. The characteristics will be measured, and the values of filament current, filament voltage, and emission claimed by the manufacturer will be checked.

#### Tests on Accessories

Facilities will also exist for testing batteries of various types. The life claimed for high-tension batteries will be submitted to test. Telephones and loud-speakers again will have special test apparatus. Particular attention will be given to purity of reproduction. To enable reliable results to be obtained in this connection, the reproduction for different frequencies will be tested, in addition to speech and music. Oscillographs will be installed, and these will be useful for detecting any distortion produced by loud-speakers and telephones. Transformers both for low and high frequency will also have special tests.

Complete receivers will also be tested under various conditions. Sensitivity, signal strength

---

## WIRELESS AT SEA

---

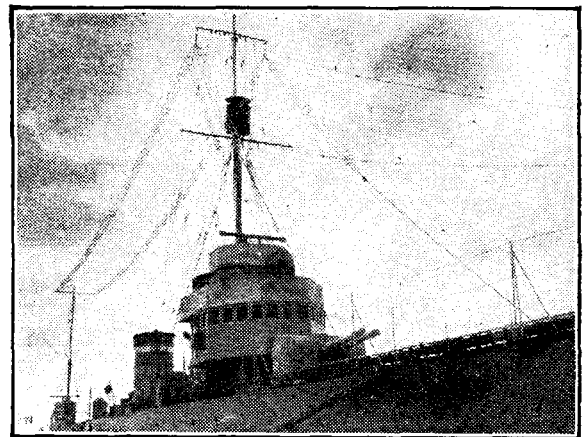

*The elaborate aerial system on the Italian warship "Tigre."*

and range under different conditions will be observed.

#### Mechanical Tests

The tests enumerated so far are a few of those for actual wireless features. These alone do not give a complete account of manufacturers' apparatus, for mechanical features are of great importance. Readers will wish to know how robust any particular apparatus is, and whether it is likely to remain satisfactory over prolonged periods. Reports on such features will also be published.

Manufacturers will welcome these facilities of test of their apparatus. They are always anxious to obtain independent opinions of the suitability of their sets or components, and many of them already send their apparatus to the National Physical Laboratory for tests. This institution gives reliable tests, and gives certain quantitative data, e.g., capacities of condensers. It is not its function to go further than this, and to give an opinion as to whether apparatus is broadly satis-

*(Concluded on page 686)*

# A Remote Control Device for the Receiving Set

By JOHN UNDERDOWN.

*Apparatus for switching a receiver on and off from a distance is often a great convenience, and a simple method of constructing an instrument for this purpose is described in this article.*

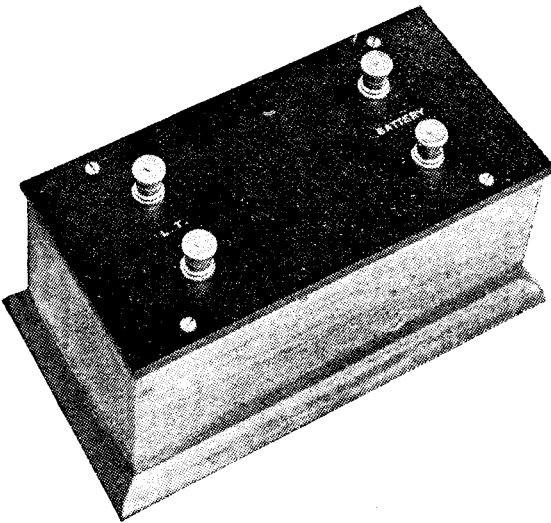

*The completed instrument is easily connected to an existing receiver by means of the terminals shown.*

WHERE the set is, of necessity, placed in a room somewhat remote from that in which it is desired to listen to the programmes, a device which will readily allow the set to be brought into and out of operation without one having to leave the room is a very desirable piece of apparatus, provided it is thoroughly reliable, simple, and not costly. It is not generally realised how very simply these operations may be effected, and in the course of this short article it is proposed to outline an easy scheme and to give constructional details which may, without difficulty, be elaborated if desired, even by the novice.

## Apparatus Required

The necessary apparatus consists of a Siemen's switch-board relay (the relay used has the numbers  $\frac{3}{4}$  N2167A, 657A marked on the armature), a single filament jack and plug, the normal long leads for 'phones or loud-speaker, and two other leads of similar length, and, if desired, some type of case to house the first-mentioned component. I have employed a flat type of box and mounted the relay on one side by means of two  $\frac{3}{4}$ -in. 4 B.A. screws and nuts, bringing out the necessary connections from the contacts of the latter to 4 terminals on an ebonite panel 7 in. by  $3\frac{1}{2}$  in. by  $\frac{3}{16}$  in. thick. The relay itself, which was obtained from W. H. Agar, as was the box, costs 10s. 6d., so that it will be seen that the whole is by no means costly when its usefulness, especially in the case of an invalid confined to bed, is realised.

## The Relay

A relay consists of an electromagnet so arranged that a weak current through its magnet coil attracts an armature, and this, when attracted, closes a contact or contacts, thus closing another circuit or circuits. Reference to

the photograph on the next page will show that the relay employed has two sets of contacts which are closed when the armature is attracted to the magnet core when a small current flows through the winding.

## The Simplest Scheme

The most simple application of the device is to employ it to make or break the filament circuits of the receiving set, which action, when the latter is connected to the aerial and earth and tuned to a station, brings the set in or out of operation. The scheme of connections will be easily grasped from the circuit shown in Fig. 1. Here the four terminals shown to the left are those for the low-tension supply and the telephones or loud-speaker of the receiver. The relay is shown in the centre of the diagram, and the "single-filament" jack to the right.

## Operation

The device operates as follows. The insertion of the plug, to which the telephones or loud-speaker are connected, into the jack makes connection between contacts 1 and 2 and at the same time places the telephones or loud-speaker

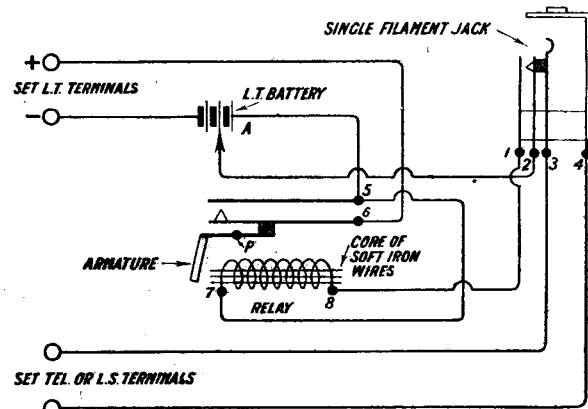

*Fig. 1.—The insertion of a telephone plug into the jack on the right causes the relay to switch on the filament supply to the receiver.*

in circuit. The closing of the contacts 1 and 2 completes a circuit through the coil of the relay and the part "A" of the filament battery (through 1, 8, 7, 5, "A" and 2). A current flows through the relay and the armature, which is pivoted at P, is attracted to the core, closing

the contacts 5 and 6. This completes the filament circuit of the set (from the + L.T. terminal through 6, 5, and the filament battery to - L.T. terminal), and the set is brought into operation.

**Batteries**

From this it will be seen that the necessary current to operate the relay is obtained from the filament battery itself. Actually, I find that satisfactory operation is obtained when "A" consists of 2 volts only, and at this voltage 10 milli-amperes are taken. This current is, of course, negligible when an accumulator is employed, but where .06 valves are run from a dry battery it is advisable to employ a separate battery which replaces the part of the filament supply "A." A 3-volt cell should be utilised in this case. For the telephone or loud-speaker leads which go to contacts 3 and 4 of the jack I use ordinary twin flex, and for those from 1 to 8 and 2 to the L.T. battery 24-gauge d.c.c. wire.

**Long Leads**

Where these leads are taken out of doors lead-covered cable with four wires may be substituted. Ordinary bell wire is also suitable.

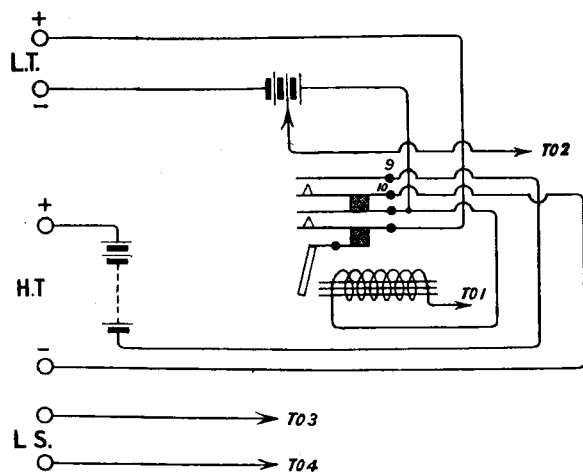

Fig. 2.—Here the two sets of contacts on the relay bring the L.T. and H.T. batteries into circuit simultaneously.

Should the distance from the set necessitate very long leads and trouble be experienced from howling, a 1 to 1 telephone transformer or filter circuit arrangement should be placed at the set end between the "output" terminals of the set and the twin flex lead to the telephones or loud-speaker.

**The Relay Unit**

I have adopted the Fig. 1 scheme and have joined the two sets of contacts of the relay in parallel and brought the two sides corresponding to 5 and 6 out to the two terminals marked "L.T." This will be clearly seen from the photograph of the unit removed from the case. Both contacts are therefore employed to carry the filament current, a desirable arrangement where

this is heavy through using bright emitter valves. The above terminals marked "L.T." by means of Radio Press panel transfers are connected externally to one terminal of the low-tension battery and one L.T. terminal of the set. Those

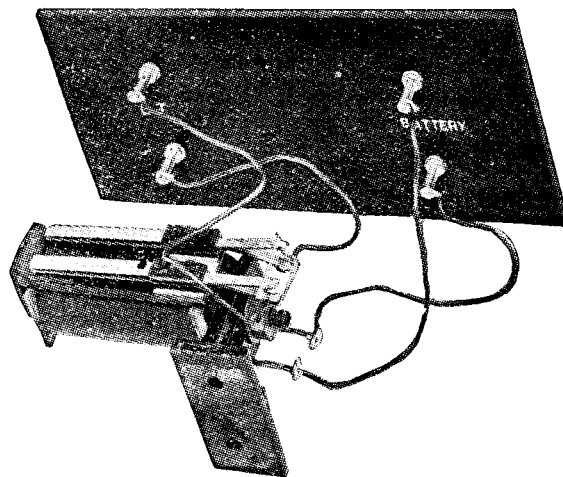

The wiring of the relay unit can be clearly seen in this photograph.

marked "Battery" go to the part of the accumulator "A" or to a separate battery externally and to the ends of the magnet winding internally. No difficulty will be experienced in deciding which are the correct points to wire if the photographs and diagrams are consulted.

**Double Switching**

Since the relay has two sets of contacts which are made when the armature is attracted, it follows, therefore, that these may be used to make both H.T. and L.T. circuits of the set as shown in Fig. 2, 9 and 10 completing the former circuit by connecting the negative side of the

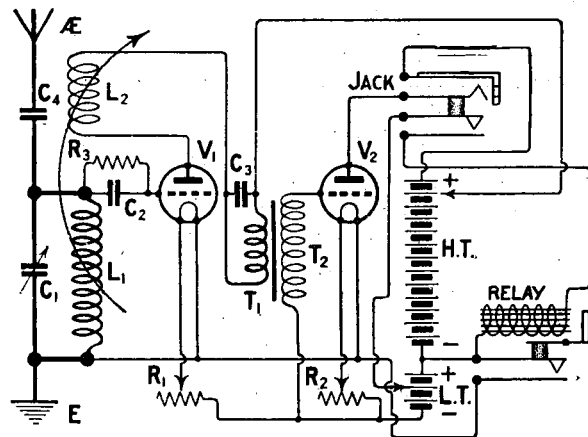

Fig. 3.—The relay may be built into a receiver, instead of being used as a separate unit. A complete circuit diagram for this arrangement is shown here.

H.T. battery to the H.T. negative terminal of the set.

**An Alternative Arrangement**

Instead of placing the relay in a case, it may be incorporated in the set itself



and both sets of contacts employed together to make the L.T. circuit, as shown in Fig. 3, the H.T. circuit being completed by the insertion of the plug into the jack. The jack, although not shown mounted, may be encased in a suitable box and arranged in a convenient position in the room where the programmes are required. If desired, the whole house may be wired in this way, only one relay being required, although four leads will of course be necessary for each jack installed. A practical point to be observed is that it is always desirable to place contacts 5 and 6 (Fig. 1) in the L.T. lead which

is joined to H.T. negative when the L.T. battery is used for "A," and then if inadvertently a short takes place between 1 and 2 and 3 or 4 no damage is done to the valves.

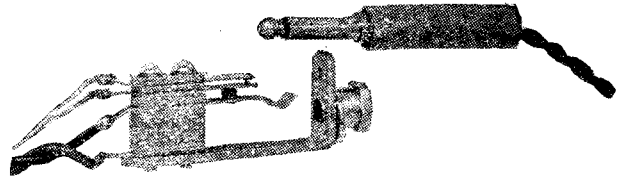

The type of plug and jack used by the author.

---

## Appointment of Capt. H. L. Crowther, M.Sc., as Deputy Director of Research to the Radio Press Laboratories

---



Capt. H. L. Crowther

READERS of *Wireless Weekly* will have seen, no doubt, our advertisement regarding the vacancy for a Deputy-Director of Research for the new Radio Press Laboratories at Elstree, this post carrying a minimum salary of £1,700 per annum. The appointment has just been filled, the successful applicant being Captain H. L. Crowther, M.Sc., who, curiously enough, has just been appointed to the same position as that held by Dr. Robinson (our Director of Research) under the Air Ministry.

### The Radio Press Laboratories

Captain Crowther is at present in charge of the Wireless Research and Design Laboratories of the Royal Air Force, and it is a coincidence that two successive holders of this position should have been appointed to the Elstree Laboratories. Dr. Robinson is now with us, of course, and Captain Crowther will join the Company about September 15.

### A Wireless Career

Captain Crowther was born in 1891, and studied at the University of Birmingham when Sir Oliver Lodge was Principal. His special subjects were physics, mathematics, engineering and chemistry, and in 1912 he received the B.Sc., with honours, and later obtained the degree of M.Sc. for research work. Before the war he held an important scholarship for research work, while from as far back as 1911 he was a prominent amateur wireless experimenter, his transmitting and receiving station being probably one of the best known in the country. In 1914 he joined a Special Wireless Corps, and at the beginning of 1915 received a commission in the Royal Naval Air Service. He was later transferred to the wireless experimental staff at Eastchurch for the development of wireless in aircraft. For the last 11 years Captain Crowther has been engaged entirely on radio research and design work for the Royal Air Force, and has now risen to the highest position available to him.

### A Valve Expert

Captain Crowther is an expert on valves, and is a member of the Valve Committee of the Radio Research Board. He has also served on the Wireless Board. A number of his inventions were extensively used during the war, and many, of course, are still in use. For these he has received awards from the Air Inventions Board.

The appointment of Captain Crowther will give a further indication of the great importance we attach to the new laboratories which will serve the Radio Press journals.

# Real and Nominal Capacities of Condensers

By C. P. ALLINSON (6YF).

*A short discussion of some measurements made to determine the actual capacities of a large number of variable and of fixed condensers.*

ONE frequently hears discussions between amateurs as to the tuning range of their receivers, and it is by no means seldom that one finds that though the same size coil and condenser are being used in two otherwise identical receivers on practically identical aerials, there is a very large difference between the wavebands covered by these two sets.

### Small Tuning Range

In one case, a receiver employing two valves, H.F. and detector, was being discussed, and it appeared that the tuned anode coil, for this method of H.F. amplification was being employed, would not tune over the range that one would expect with the .0003  $\mu$ F condenser used. In another case, C.A.T. (constant aerial tuning) was in use. As is well known, this consists in placing a fixed condenser of .0001  $\mu$ F in series with the aerial when using single circuit tuning. Developed by Mr. John Scott-Taggart, F.Inst.P., A.M.I.E.E., this scheme has the advantage, among others, of increasing the selectivity of the receiver. In the case referred to this increase in selectivity was by no means what would have been expected.

In both these cases the trouble was found to be due to the condensers in use not being anywhere near the rated value. In the case of C.A.T. it is specially important that the condenser used should have the correct value, or else the various advantages obtained by this method are seriously diminished.

### Comparative Tests

As a matter of interest it was therefore decided to measure the actual, as compared with the rated, capacities of a number of different makes of condenser, some of which are made by makers of known reputation. The results were illuminating and are tabulated below:—

Condenser.	Rated Value.	Actual Value.	Percentage Error.
A (variable) ..	.0005 $\mu$ F	.00055 $\mu$ F	10.0
B (variable) ..	.0001 "	.00012 "	20.0
C (variable) ..	.0003 "	.000315 "	5.0
D (fixed) ..	.0003 "	.00033 "	10.0
E (fixed) ..	.0002 "	.00029 "	45.0
F (fixed) ..	.0002 "	.0002 "	—
G (variable) ..	.0005 "	.00048 "	4.0
H (variable) ..	.0003 "	.00022 "	26.6
I (fixed) ..	.00025 "	.00024 "	4.0
J (fixed) ..	.0003 "	.00028 "	6.6
K (fixed) ..	.0001 "	.00017 "	70.0
L (fixed) ..	.0005 "	.00049 "	2.0
M (fixed) ..	.0003 "	.00016 "	46.6
N (fixed) ..	.0002 "	.00014 "	30.0
O (fixed) ..	.0005 "	.00047 "	6.0
P (variable) ..	.0003 "	.00017 "	43.3

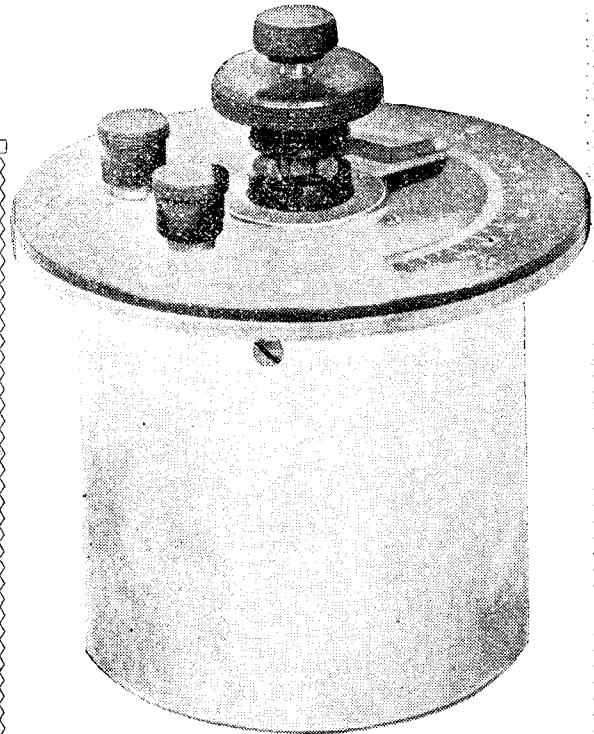

*The standard variable condenser used by the author in making the tests.*

It might be mentioned with regard to condensers M and N, that when these were included in an oscillatory circuit with an H.F. milliammeter in series, a much lower current was registered than with any of the other condensers, and on inquiries being made it was found that through some error occurring a faulty batch had got out. Luckily this was discovered in time to call them back, and so none got into the hands of the public.

### Method of Measurement

The above readings were taken by substitution with a standard variable condenser, and can be taken as being of a fairly high order of accuracy. It will be noticed that of 16 condensers tested only five are within 5 per cent. of their rated value. (All condensers bracketed together are of the same make.)

From a practical point of view, as long as a variable condenser is not less in actual value than its rated capacity no great harm is done, provided that the difference is not large, but when a fixed condenser is required for a specific purpose where its value is fairly critical, then the importance of its being within a small percentage of the rated capacity at once becomes apparent.

Of all the condensers on which these readings were taken there are only three manufactured by firms of repute that are more than 10 per cent. out, and as these were picked out of a collection of condensers, some of which were some years old, the results are by no means unsatisfactory.

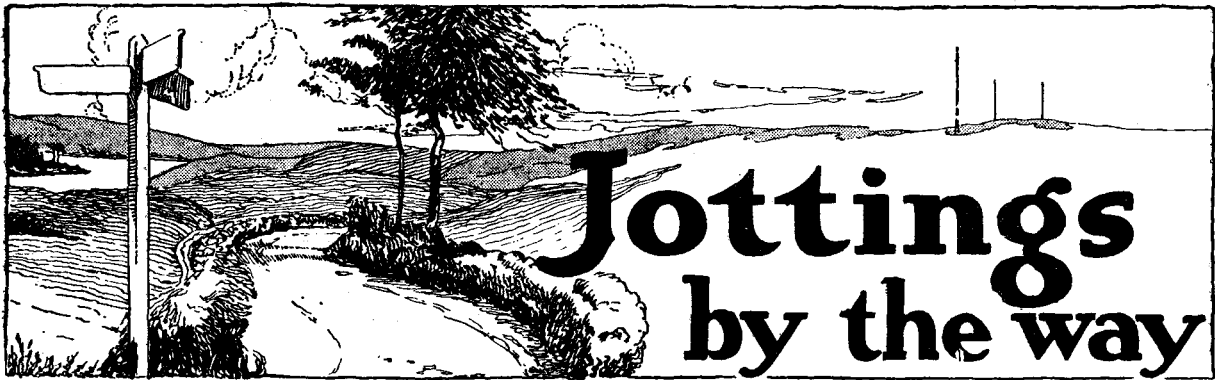

**A Felt Want**

**I** SEE that in America, the land of liberty and of never doing things by halves, they have instituted for the proper regulation of those that go down to the road in cars a very special arm of the law. This is the traffic cop, who is described as a "tough baby." A tough baby is nothing whatever to do with eating one's young; it means quite simply a he-man who will stand no durned nonsense from anyone.

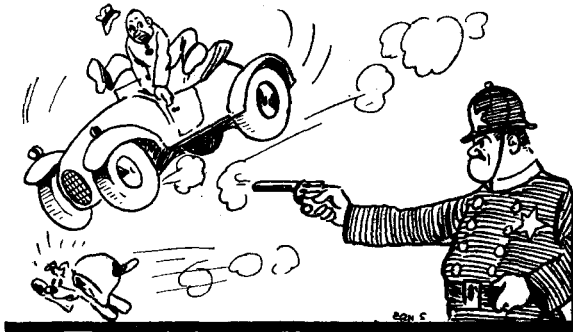

... He merely pulls out his gun ...

The traffic cop is stationed at a cross-road, where he is provided with a kind of signal post by means of which he indicates his desires to drivers. Down the middle of each road is painted a white line. To any driver who is so misguided as to cross to the wrong side of the white line or to fail to take due notice of the signal the tough baby does not say a word. He merely pulls out his gun and goes on shooting until something happens. Now that, I think, is the way to do things. There is no tomfoolery about methods such as that. Some people, no doubt, will be horror-stricken by this kind of thing, but personally I am so taken with the tough baby idea that I am going to endeavour to persuade the Little Puddleton wireless club to import a supply of the toughest type.

**In the Neck**

When they arrive we may have a little difficulty at first in breaking them of their lifelong habit of potting motorists at sight. It would be necessary, though, to do this as a preliminary, since it is not for the destruction of road fauna that we require their services. What I propose that we shall do is to equip them with portable direction-finding sets and to turn them loose

upon Radiating Rupert and others of his brotherhood. In future we shall not pass resolutions against radiation at the club; we shall not send letters (signed by "Disgusted") to the *Gazette*, or anything of that kind. We shall simply summon to our presence the tough babies who are on duty and to them we shall say, "Say, you guys, there's some gink handing out squeal-stuff with his tickler. Go to it." And to it they will go. Having tracked down Rupert, or whoever it is, they will not ring his front-door bell and remonstrate politely with him. They will simply stride to the window of his wireless den, through which they will pour in a devastating volley.

**Precautions**

We shall, however, have to make quite sure before we turn them loose that they understand that the houses of all the members of the club are taboo. It would simply never do to have the General or Admiral Whiskerton Cuttle punctured by a zealous but misguided tough baby. I intend to propose that in order to mark them out quite clearly the aerial masts of all members shall be painted in red, green and blue rings. This will, I fear, mean that one will receive a certain number of visits from the hirsute desiring to be shorn or shaved, but that anyhow is far better than being visited by a tough baby



... A devastating volley ...

who shoots first and asks for explanations afterwards.

**Butterfly Bill**

I have been bothered just lately not a little by the machinations of an oscillator whom I have named Butterfly Bill. Just as those engaging, though squasy, insects can never remain for more than a few seconds imbibing the sweetness of one particular flower, but must be incessantly

moving on from blossom to blossom, so Bill flits about the broadcasting stations, drinking in half a dozen words from this, two bars of music from that, four of the six dot seconds from a third, and Big Ben's chimes in two portions from a couple more. Now the worst of this fellow is that he puts me whithersoever I go.

**Disgusting**

This mania for running round the stations is really disgusting. Why cannot Bill pick out one and go on oscillating for all he is worth, if he wants to, on its wavelength? Naturally I like to have a little jaunt to distant parts two or three times during the evening, but that is quite a different thing.

I found on discussing the matter with Professor Goop that he had been similarly troubled by someone who would insist upon accompanying him on his wireless travels. In fact when each of us told his story there was a moment's tense silence and then suddenly we both said, shaking threatening fists, "You must be Butterfly Bill!" As I never strike an older man than myself (unless he is very much smaller), and as the Professor makes a point of never hitting a smaller man than himself (unless he is very much older), no unseemly scrap resulted, though I must admit that for some seconds it looked as if one of us might get a thick ear.

**The Professor's Scheme**

On talking the matter over we came to the conclusion that the only way of escaping the attention of Butterfly Bill and others of that ilk was to evolve some means whereby we should be able to tune in stations much more rapidly than he can. We felt that if we could do this it would soon be possible to leave Bill far behind and that eventually he would give up the chase as hopeless. By putting our heads together we have designed a tuner which is, I think, destined to revolutionise wireless reception, for the Pro-

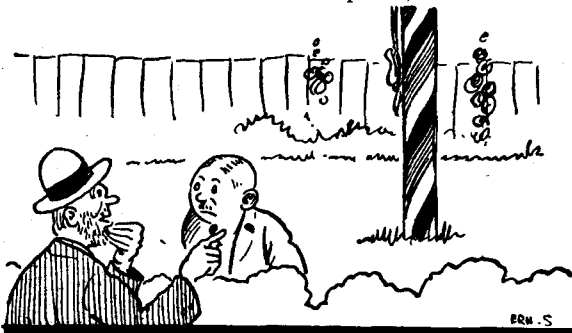

... desiring to be shorn or shaved ...

fessor and myself at any rate. Space does not permit me to give you the full details of it, but without giving away any secrets, I may tell you enough to make your mouth water.

**A 27-way Switch**

We decided that there were just twenty-seven stations that we wished to be able to tune in. We therefore constructed a tuner containing twenty-seven inductances, twenty-seven variable condensers and a 27-way switch. The great difficulty was that in order to avoid absorption

effects we found it necessary to place each inductance at right-angles to all the others. This involves getting into the twenty-seventh dimension, a difficult matter for the ordinary person, but a simple one to a mathematician such as the Professor. Those who are incapable of tackling the practical part of the problem themselves may get out of it by placing the coils two or three feet apart. This is most easily done by building the tuner on the lines of a sectional bookcase right round the room. By means of the 27-way switch any inductance with its condenser may be thrown into circuit, and this makes the thing if not as easy as pie at all events as simple as  $\pi$ .

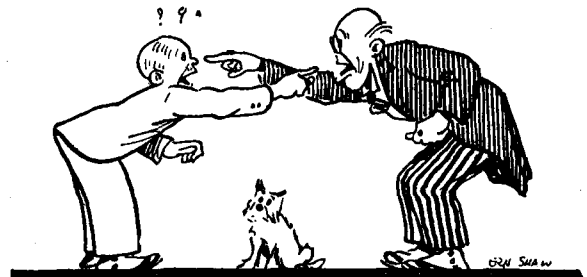

... YOU must be Butterfly Bill !!! ...

**Operating the Tuner**

Each inductance is first of all tuned by means of its condenser to the wavelength of its corresponding station. If one starts with the British stations during the Children's Hour, one is usually through with the job of getting the whole twenty-seven before it is time to go to bed. This having been done, one sits with one hand upon the 27-way switch waiting for Butterfly Bill. When he hoots at you upon Manchester a flick of the wrist takes you to Barcelona, and by the time that he has got there you are in Rome or Copenhagen. Faint, but pursuing, he labours after you for a while, though in the end he gives it up as a bad job, unless, of course, you are unfortunate enough to do what runners call "lapping" him. When this happens you must start all over again, but thanks to the Goop-Wayfarer Anti-Butterfly tuner this involves no great labour on your part, and you may sit back in your chair picturing Bill with his tongue hanging out trying to follow upon your track.

**We Know the Worst**

Having constructed two of these tuners the Professor and I have just been trying them out. My worst fears are confirmed; the Professor is Butterfly Bill. . . . Excuse me just for a moment or two, I heard the telephone. . . . The worst has happened. The Professor—it was he who rang me up on the telephone—is firmly convinced, as the result of this evening's work, that I am Butterfly Bill. This complicates matters very much. If those tough babies were to arrive I am quite sure that I should find some means of removing the Microfarads from the list of taboo houses, and I feel that the Professor might find a way of doing the same to my little home. On the whole, I think that the tough babies will be better left upon their own side of the Atlantic.

**WIRELESS WAYFARER.**

# WIRELESS NEWS IN BRIEF

The night of August 31-September 1 has been chosen for the all-Europe broadcast test in connection with the scheme, decided on some weeks ago at Geneva, to allocate every station such a wavelength as will prevent interference between the transmissions of one country and another.

Practically every broadcasting station throughout Europe will alter its wavelength. Only three British stations, Newcastle, Cardiff, and Edinburgh, are unaffected, and the alterations at present sanctioned by the Post Office are:—

	Present Wavelength.		New Wavelength.	
	Metres.	Kc.	Metres.	Kc.
Aberdeen ..	495	606	496.0	605
Swansea ..	482	622	488.0	614
Birmingham	479	626	480.0	625
Belfast ..	439	683	438.0	685
Glasgow ..	422	711	420.0	714
Bournemouth.	386	777	387.5	774
Manchester	378	793	377.5	794
London ..	365	821	364.0	824
Leeds ..	346	867	343.0	874
Plymouth ..	338	887	339.0	884
Hull ..	335	895	335.5	894
Dundee ..	331	906	331.5	905
Liverpool ..	315	952	314.1	955
Nottingham	326	920	229.0	1,309

The test, which will last for two hours, will begin at midnight; every station will transmit its own programme, and announce its identity every few minutes.

\* \* \*

A great wireless development is expected in India as a result of the new work undertaken by the Indian Radio Telegraph Company. A licence was recently granted to this company to erect a beam station for direct communication between India and Britain.

The transmitting station for India will be in the cantonment of Kirkee, near Poona, on the site of the old Marconi station, long begun but never completed. The receiving station will be at Dhond on the G.I.P. Railway. Land has been acquired and buildings are about to commence, and it is expected that the station will be ready for work by the middle of 1926.

\* \* \*

The Postmaster-General announced recently that a site at Wintorpe, near Skegness, for the receiving station, and a site near Grimsby for the transmitting station, have been allotted for the Beam Services with Australia and India. The stations are due to be completed by May 8, 1926.

Mr. Spencer Nolan, a Sydney wireless amateur, exchanged Morse messages for half-an-hour on the night of August 19 with the MacMillan Expedition (call sign WAP) at Etah, Greenland (a distance of about 12,000 miles).

The expedition was operating then on a wavelength of 34 metres, while Mr. Nolan's wavelength was 35 metres.

Mr. Walker Hannan, another Sydney amateur, on the same night also communicated with WAP.

\* \* \*

Commander E. F. McDonald, President of the Zenith Radio Corporation, Chicago, who is second-in-command of the MacMillan Arctic Expedition now stationed at their main base, Etah, Greenland, 11 degrees from the North Pole, has stated that the transmissions from the expedition are heard nightly in every radio district in the United States, Canada, England, France and Holland, and they only wish that they had more hours so that they might work more of

General to prosecute him for not having taken out a licence for his wireless set, has now received three summonses issued at the instance of the Postmaster-General in connection with the Wireless Telegraph Bill.

\* \* \*

The London Wireless Exhibition organised by the National Association of Radio Manufacturers and Traders will again be held this year in the Royal Albert Hall. It will extend from September 12 to 23. Heavy bookings are already announced, and amateurs will find all the latest novelties on the stalls.

\* \* \*

The Duke of Sutherland, President of the Radio Association, has consented to open the Annual National Radio Exposition at Grand Central Palace, New York, on September 12 next from London by radio.

\* \* \*

Listeners to the Manchester station are promised a very fine band programme on Monday, August 31,

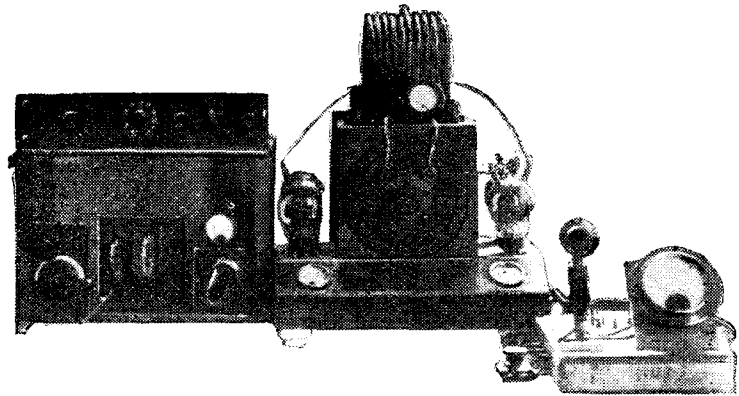

*The transmitter at station HVA, situated at Hanoi, in French Indo-China. This station has been heard on several occasions in this country.*

the amateurs who nightly call them. They were trying to get quality in their 40-metre voice and music broadcast programme on Wednesday nights, so that it could be re-broadcast from the WJAZ transmitter.

\* \* \*

We are informed that new broadcasting stations are to be opened at Milan in Italy and Brno in Czecho-Slovakia.

\* \* \*

We understand that Mr. R. M. Ford, of East Lodge, Park Row, Albert Gate, S.W., who some time ago challenged the Postmaster-

when the Plymouth Division of the Royal Marines will be paying a visit to the studio. In the intervals of the well-selected band items, Miss Winifred Ceci will give songs and monologues at the piano.

\* \* \*

On Sunday afternoon, August 30, a new chamber music combination—the 2ZY String Trio—is making its first appearance. The Trio consists of Don Hyden (violin), Walter Widdop (viola), Sidney Wright (cello), all members of the 2ZY Orchestra, and of the Halle

(Continued on page 683.)

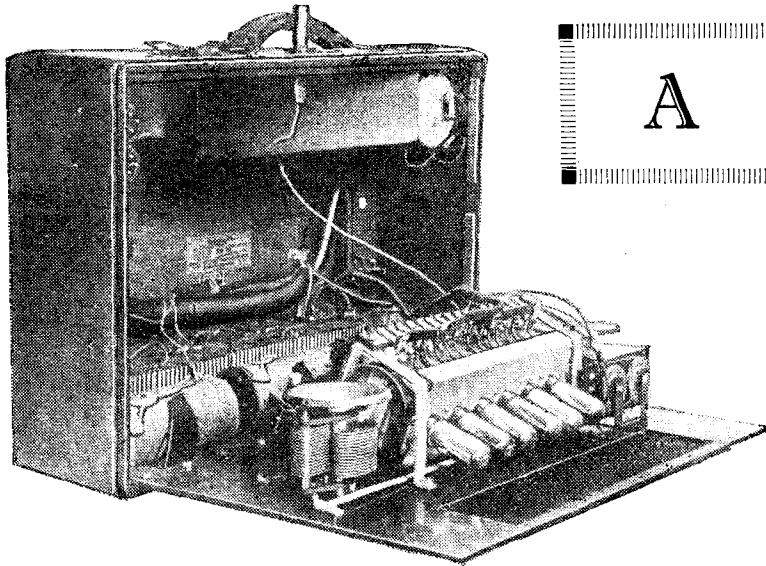

The interior of the Radiola super-heterodyne, showing the compactness of the intermediate frequency transformer unit.

# A TALK ON S

By PERCY W. HARRIS, M  
 Mr. Harris, who has only r  
 tour of the States, is well  
 question of selectivity, for h  
 with all aspects of both Am  
 conditi

**T**HE question of the selectivity of a set is one of much greater complication than most experimenters imagine. I think I can claim to be one of the first, if not actually the first, to emphasise the necessity in building a set of copying the exact disposition of the parts if you want it to equal the model in its working. Every experienced wireless man knows that you may have half-a-dozen receivers all built to the same theoretical circuit, yet differing from one another astonishingly in the degree of selectivity obtained. My recent visit to the United States, where I had the opportunity of examining and using a large number of highly selective receivers, together with experiments I have been conducting in my own laboratory, has convinced me that the problem must be tackled from at least half-a-dozen different angles if satisfactory solutions are to be found.

### Pick-up and Selectivity

A clue to one valuable line of work is found when we examine a very common case. I often have it said to me that a particular receiver is so sensitive that it will work a loud-speaker

20 miles from the nearest broadcasting station without any aerial or earth or frame connected to it. A set which will do this is, of course, very sensitive, but the mere fact that it will do it is an indication that the "pick-up" of the set is sufficiently great to prevent any really high selectivity being obtained!

It means, of course, that the coils and wiring of the set act as a receiving aerial, whereas the ideal set would be so arranged that even in sight of a broadcasting station nothing would be heard without an aerial and earth connected to it.

### Lines of Research

This article is not intended to be a complete solution of the selectivity problem; its sole object is to indicate a few lines of research and experiment which should be very fruitful.

Think over this question of pick-up in a receiver and you will see that there is much which can be done in this respect.

The question of pick-up from an outside station is closely related to the pick-up of energy by one part of a receiver from another. Let us imagine we have a set with, say, two stages of high-frequency amplification, the intermediate stages being tuned very sharply. If the aerial

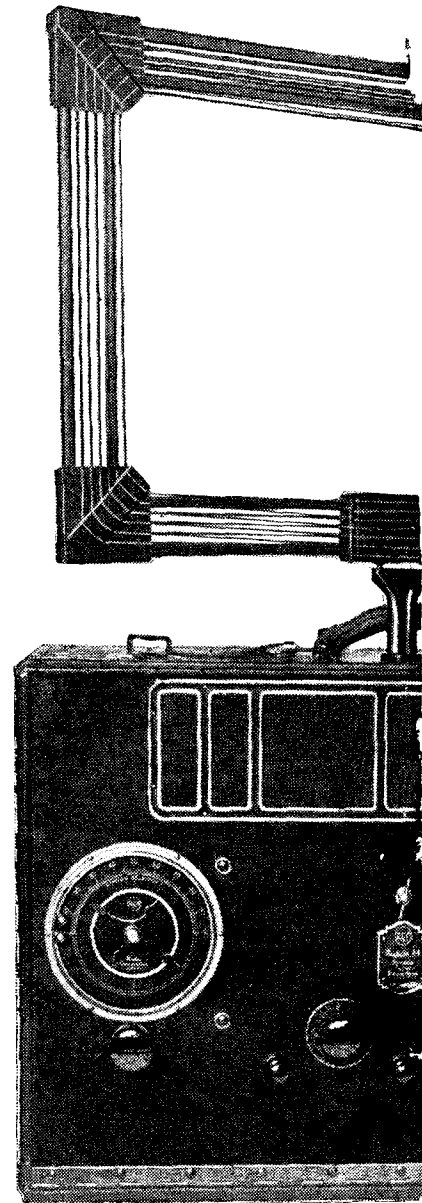

The well-known Radiola super-heterodyne in America

# SELECTIVITY

*I.R.E., Assistant Editor.*

*Recently returned from his  
qualified to discuss the  
is intimately acquainted  
American and British radio  
ons.*

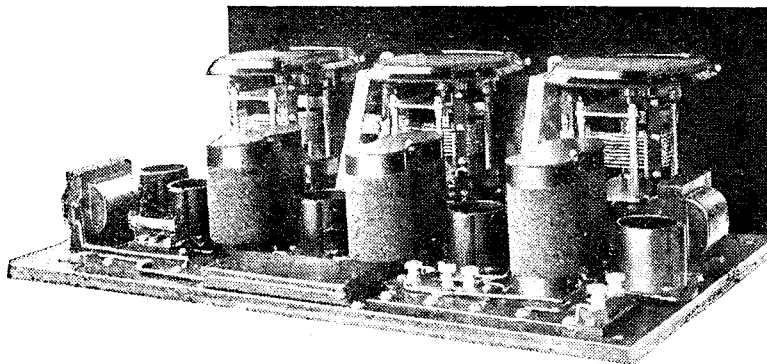

*The Syncrophase receiver incorporates three sets of binocular coils, which have very little external field.*

coil radiates a sufficiently large field to encompass the last transformer, the selectivity of the intermediate stage is largely lost. I am referring at the moment, of course, to inductive fields.

### Loose Coupling

Particularly on the shorter broadcast wavelengths, the coupling between two circuits to give an effective transfer of energy can be extremely loose, and a single turn primary will give a remarkable transfer in many cases. In a set in which the wiring has been badly arranged, or worked out without any regard to the facts I am mentioning, a long lead parallel and close to another may transfer energy from one circuit to another in such a way as largely to reduce the selectivity you are aiming to obtain. This particularly applies when high-frequency amplification of an efficient order is obtained, for the slightest transfer from one circuit to another can be amplified up to such a degree as to overpower the weaker signal one is trying to hear.

### Stray Capacities

Capacity couplings are also fruitful sources of trouble; in fact, many experimenters in America have come to the con-

clusion that stray capacities between circuits are more dangerous than stray magnetic fields. Both magnetic and capacitive coupling can be considerably reduced by careful placing of the wiring and avoiding long parallel leads.

### Super-Heterodyne Receivers

There is, of course, no question that super-heterodyne receivers are the most selective at present available to the public, although, of course, I do not think high selectivity is necessarily tied up to the use of supersonic heterodyne receivers. In considering the selectivity of a super-heterodyne receiver we again have many points to take into consideration. It must not be concluded, for example, that because a receiver is of the supersonic variety that it must therefore be highly selective. Much depends on the design, and, most of all, on the sharpness of tuning of the intermediate frequency transformers.

### Frame Aerials

It is astonishing to hear some experimenters comparing the supersonic receiver with the better-known tuned-high-frequency receiver, without taking into account that one is almost invariably used with a frame

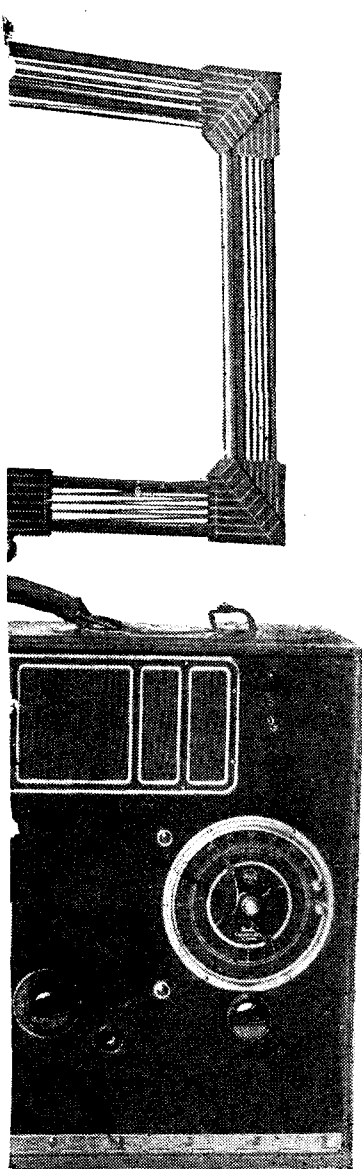

*Super-heterodyne receiver is very popular.*

aerial, whilst the other is generally functioning with an outside aerial. Although I do not recommend the use of an outside aerial, or indeed anything but a frame, with a supersonic receiver (on account of the interference which may be caused), experiments show that the selectivity of a supersonic heterodyne re-

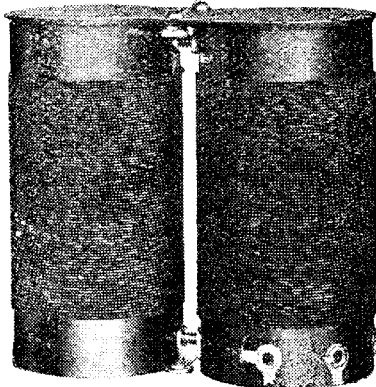

*The Grebe binocular coils.*

ceiver is in a great measure contributed to by the use of the highly selective frame aerial.

**Long-Wave Interference**

Another point in which the supersonic scores is in its absence of pick-up of the actual local station. The amplification, of course, is done at a frequency corresponding with a long wavelength, therefore the impact of the waves upon the wiring of the set will not give rise to the same trouble as in sets which are designed to amplify wavelengths close to that of which we are speaking. If, however, you want to tune your intermediate frequency transformers to the wavelength of some station which is continually working, you will have a great deal of trouble to prevent interference from this longer wave station. For example, on one occasion I happened to connect up a super-heterodyne receiver, the intermediate frequency wavelength of which was the same as that of Chelmsford. Without any frame aerial connected to the set, and, indeed, with the oscillator valve turned off, Chelmsford signals came in at great volume, and, as a consequence, the frequency of the intermediate stages had to be altered at once.

The mere fact, of course, that a receiver uses the supersonic heterodyne circuit is not proof

that it must necessarily be highly selective. The selectivity of a super-heterodyne receiver is dependent upon the choice of a suitable intermediate frequency for the beat-note, suitable design of the tuning circuit, whether or not it is used with a frame aerial and, perhaps more than is generally realised, the sharpness of tuning of the intermediate frequency transformers. The limit of selectivity in a supersonic heterodyne is extraordinarily high, and, in fact, can be made far higher than is desirable, for if the receiver is so sharply tuned that the side bands of telephony are cut off, then the result will be so distorted as to be unpleasant to the ear. It is, for example, quite possible to make the supersonic heterodyne receiver so sharply tuned that stations which otherwise would give an audible beat with the carrier of the station you are desiring to receive can be cut out.

**Neutrodyne Receivers**

In a fairly short article it is only possible to indicate some of the points which require attention in considering selectivity and to indicate a few of the lines which may be pursued in solving the problem. I have already shown that stray fields, both capacitative and magnetic, are causes of trouble. Stray capacities can be minimised by careful lay-out of wiring, and magnetic fields by suitable disposition of parts. In

exactly from his design worked satisfactorily at this angle, which was fairly critical, but many experimenters are under the impression that this particular angle has some magic about it, and so set about using it in other receivers of quite different design. There is no magic in this neutrodyne angle, and it is not an angle which suits every lay-out and every design.

**Exterior Field of Coils**

It sometimes happens by chance that in arranging high-frequency transformers the windings may be so situated as to give a reverse reaction effect, thus checking the tendency to oscillate. At other times a home constructor may be copying a well-known design and, to suit his own purpose, may change the disposition of his transformers slightly, so that he gets strong reaction effects between them. In the latter case, if the set is potentiometer controlled to check oscillation, a considerably greater positive bias may be necessary on the grid to check the tendency. Further losses will be introduced and the tuning will be flat.

Lately, in America, considerable progress has been made in the design of coils which have little or no exterior field. The advantage of such coils is that on the one hand there is practically no tendency to interaction between them, and secondly, a point the importance of which I

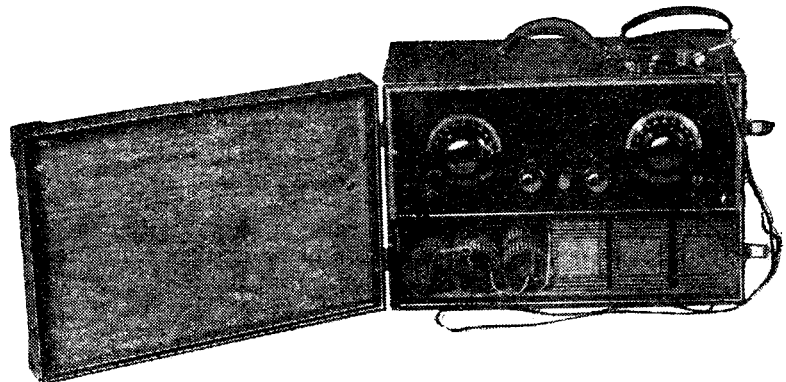

*Another American portable super-heterodyne receiver is the Silver Marshall. Note the batteries in the lower part of the case.*

this connection it is interesting to note that when Prof. Hazeltine made his first neutrodyne receiver he arranged by careful experiment that the angle of the transformers should be such as to give the minimum interaction between them. Any other receiver made

cannot over-estimate, they do not "pick-up" unwanted energy from the local station. A receiver incorporating such coils can be used almost within a few yards of a broadcasting station, and if the aerial and earth are disconnected nothing will be heard,



whereas with the ordinary type of receiver, the signal would be just as strong, whether or not aerial and earth were connected.

**"D" Coils**

One of the first of these coils used by experimenters (I described it and showed one of my own construction in "Random Technicalities" last year (Vol. 4, No. 13) was the D coil, in which a slit cylindrical former was used. One half of the circumference of the former was used for winding in one direction, whereupon the wire was taken through the slit at the opposite side of the former and brought round in the opposite direction. After completing another half turn the wire re-entered the slot, and was taken back once more, and the winding continued in its original direction. Such coils have a very small exterior field. One of the most successful of the American commercial receivers, The Grebe Synchro-phase, uses what this Company has termed the binocular coil. It actually consists of two coils of Litz wire, placed side by side and joined up in such a way that their fields are in the opposite direction. This receiver is very highly selective and practically uninfluenced by nearby signals, such as are generally a source of great trouble in obtaining successful long-distance reception.

**Toroidal Coils**

Toroid coils in different sizes are rapidly appearing on the American market, although few of the designs are really efficient. A number of them consist merely of cylindrical coils bent round so that the two ends meet. The design of a successful coil of this nature is rather complex, and measurements made recently of several of the commercial toroids showed that some had ten times larger high-frequency resistance than others. One of the minor problems in the design of a set using toroid coils is to obtain suitable magnetic coupling where it is desired.

Metallic shielding, of course, can do much in improving the selectivity of a receiver, provided this is skilfully done and does not introduce eddy current losses. Shielding is particularly useful

for the intermediate frequency amplifiers in a supersonic heterodyne receiver when these show a tendency to pick up long-wave continuous wave stations, as is sometimes the case.

I have already exceeded the space I intended to occupy in this article, and there are many points on selectivity which I have not yet mentioned in it. Before closing, however, I must not forget to point out that aeriels vary enormously in their effect on selectivity, and that a set which seems flat in its tuning on one aerial may give great selectivity on another.

**Wireless News in Brief**

*(Continued from page 679).*

Orchestra, and well-known in musical circles in Manchester. In the same programme will be piano duets by the Herman van Dyke's, which will provide a change from the usual type of instrumental playing.

\* \* \*

A broadcasting station which, we understand, can now be heard in this country on 100 metres is that of Nijni-Novgorod, in Russia. There are also several other Russian stations in operation, including the "Komin-tern" station in Moscow, which transmits on 1,450 metres (206.8 kc.).

\* \* \*

A step towards the consolidation of the wireless industry of Great

Britain has been taken by the manufacturers of Mullard valves.

The outstanding features of this movement are:—

(1) To effect the stoppage of imported valves.

(2) To secure the advantages of foreign radio research by the use of certain patents.

(3) To obtain the very latest designs in machinery for *increased production* in this country.

This effort has been accomplished by a collaboration between the Mullard Radio Valve Co., Ltd., and Messrs. Philips Glowlampworks, Ltd., of Holland, whereby amongst many advantages the following are of particular interest:—

(a) The use of all Messrs. Philips' patents with all improvements, manufacturing processes, etc., both present and future.

(b) The use of all designs of Messrs. Philips' machinery in connection with the manufacture of radio valves specially designed by and for Messrs. Philips and exclusive to them.

(c) The advice and assistance of Messrs. Philips' experts, technical and otherwise, and the material advantages to be obtained from experiments and research carried out in the respective laboratories of Messrs. Philips and Messrs. Mullard.

(d) Under the arrangements secured *no further valves are to be imported into Great Britain, Ireland or the Irish Free State by Messrs. Philips* whilst the agreement is in force. This is a very material advantage to the British trade generally, inasmuch as Messrs. Philips were by far the largest importers of radio valves into this country.

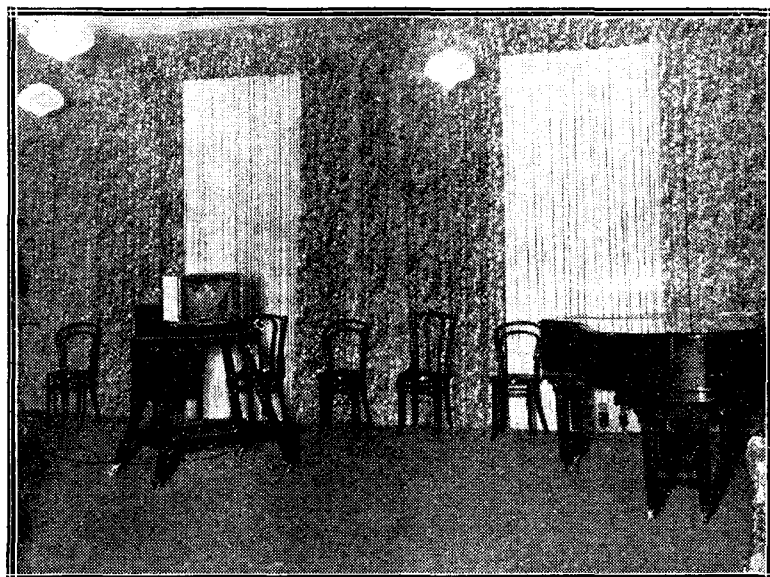

*The studio at the Edinburgh station is arranged on conventional lines and has the usual hanging draperies to reduce the echo effect.*

## Removing the Base from a Valve

*Some useful hints on how best to remove the base from a valve for short-wave experiments when the purchase of special valves is not desired.*

**I**T often happens that an experimenter wishes to do some work on the ultra high frequencies and is desirous of reducing casual capacities, including the inter-electrode capacities of the valve, to a minimum, but does not wish to purchase special valves for the preliminary experiments.

In such cases it is often desirable to remove the base from an ordinary four-pin type of valve. It is true that in some valves the source of the

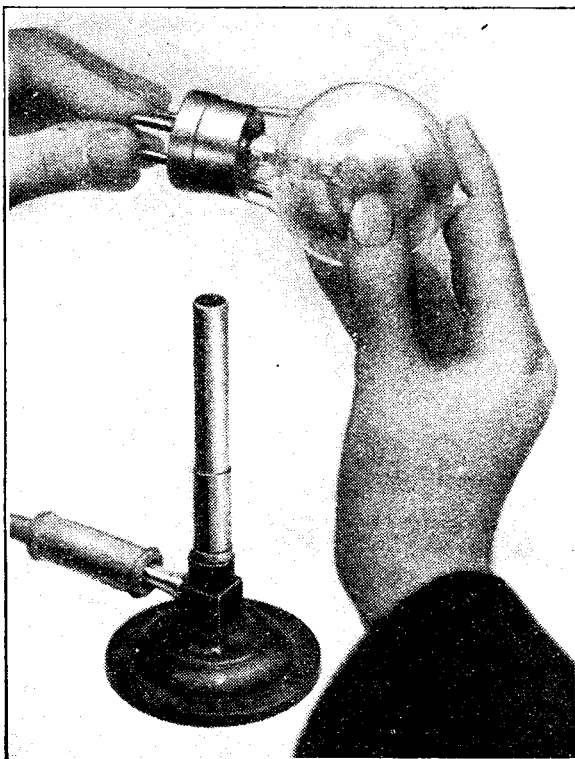

*Gentle heating is all that is necessary in some cases to remove the base.*

greater part of the inter-electrode capacities is in the "pinch," that is, where the connecting wires to the electrodes are sealed into the glass.

However, the removal of the base is a step in the right direction and, in addition, may help to reduce leakage losses, for instance; removing the base is generally a fairly simple operation, and the accompanying photographs show how this may be effected with certain types of valves.

### The Best Procedure

The valves referred to are those where pitch or some similar composition is used to seal the

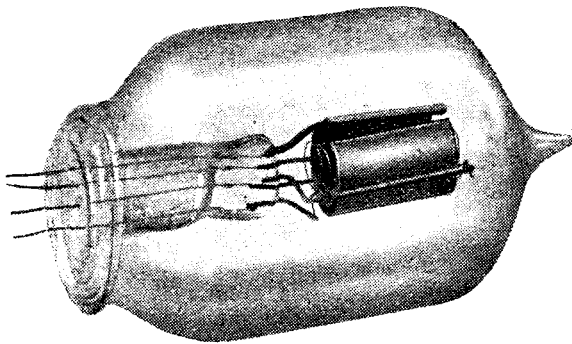

*In a valve of this type where the "pinch" is narrow the effect of removing the base will not reduce the inter-electrode capacity to such a large extent.*

bulb into the cap. In this case the thin wires which are usually brought out through small holes in the composition or ebonite portion of the base and soldered to the pins, should be cut just where they are soldered.

If the valve is then held over a *small* flame, as is seen in the centre photograph, and rotated fairly rapidly, so that the metal part is evenly heated, the pitch will gradually soften. When the pitch is fairly soft and begins to run, a gentle pull or slight twist on the base will usually be sufficient to enable one to remove it.

### Care Necessary

If this is not sufficient, do not pull hard, since the thin wires are liable to be broken, but continue the heating carefully until the pitch is thoroughly soft. Several methods of holding the bulb of the valve will suggest themselves to the experimenter according to the type and size of valve, and well-spaced connections may be made directly to the thin wires.

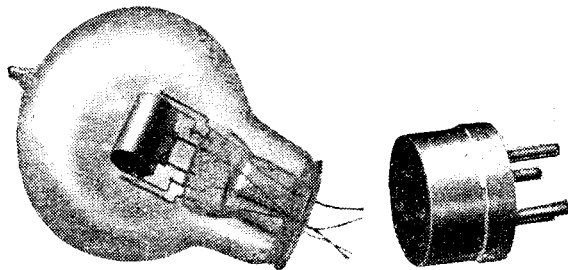

*An improvement will result by removing the base from a valve such as this.*

Where the bulb is sealed to the base with heat-resisting compositions a more drastic method of removing the base may be required, and it may even be necessary to remove the metal part first with the aid of a file and a penknife.

# Securing a Silent Background

By A. V. D. HORT, B.A.

*It is not always the actual signal strength that counts when listening to distant stations, but more particularly the signal strength to "noise" ratio. In this article the Author gives some hints on how to reduce the background noises to a minimum.*

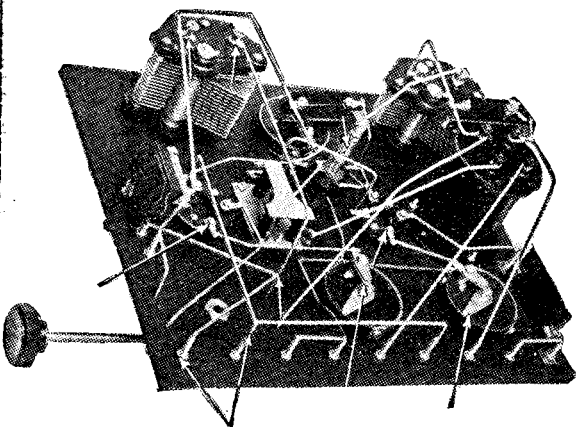

*The arrows indicate some of the points which should receive special attention when a receiver is noisy in operation.*

if they are prevalent. It will be convenient for the purpose of illustration to refer to the accompanying back of panel photograph of a two-valve receiver, which includes a number of components commonly used. The arrows indicate some of the points to which attention should be paid.

## A Simple Test

If noises of the kind mentioned are troublesome, a simple test may be performed, first of all, to determine whether they are due to constructional faults or to faulty batteries, or possibly even atmospherics. This test is to tap the panel of the receiver lightly, and note the resulting noises. If the construction is sound, the only noise which should be heard is the familiar humming noise due to microphonic noises in the valves; this will be particularly noticeable with dull-emitter valves, bright emitters responding to a less degree.

## Loose Connections

If well-sprung vibratory types of valve-holders are in use, possibly the tapping will produce no noise at all. In this case the batteries should be tested, or the aerial connection removed to see whether atmospherics are the cause of the unwanted cracklings. If, however, the crackling noises become more prominent when the panel is tapped, a loose contact or a bad joint is the most



**ALTHOUGH** the careful choice of good components may contribute in large measure to the success and efficiency of a wireless receiver, the mere fact of their individual soundness does not necessarily mean that the best results are certain to follow from their incorporation in the set. The first steps towards the desired results are, of course, careful and accurate mounting of the components and well-made connections in the wiring between them. In this connection it is well to note that a good deal may depend on the accurate drilling of the holes for the fixing screws of the components, since it is only too easy to damage such instruments as filament rheostats or variable condensers by straining them in the operation of mounting.

## Crackling Noises

Assuming, however, that the receiver is completed and that signals are received fairly well, it may be that the set works satisfactorily when once a station has been tuned in, but that tuning is rather difficult to carry out owing to rustling and crackling noises when the tuning controls are operated. On the other hand, these noises may persist even when the receiver is not touched, the least vibration causing disturbing sounds.

Such noises as these can completely spoil the reception of a broadcast programme, or may make it a very difficult matter to tune in a distant broadcasting station. If the receiver is one designed to operate on shorter wavelengths than those in use for broadcasting, the noises will become the more prominent. Below 100 metres (2,998 kc.) it may be found practically impossible to use the set.

It is proposed to discuss here some of the possible causes of such noises, and to indicate the points in a receiver which should be attended to

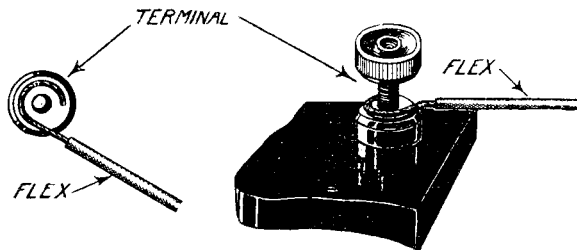

**Fig. 1.**—The ends of flex leads should be twisted together and placed round the terminal shank as shown.

likely cause of the trouble, and it remains to locate the fault. If no loose connections are visible on inspection, the various components must be tested. Wearing the telephones, and with the set switched on, gently move all the connecting wires in turn close to the soldered joints. If these

pass the test, the valves should be wriggled in the holders; a fault here may usually be corrected by opening the legs of the defaulting valve slightly with a penknife.

### Valve Faults

A somewhat rarer fault may be that the valve filament has sagged and is touching the grid intermittently, this being mostly confined to bright-emitter valves. A cure can sometimes be effected by using the valve for a time in such a position that the filament will bend back again towards its normal position; but this is unlikely to be a permanent one, and it will generally be found preferable to discard the valve. Plug-in coils should also be tested for good contact, since, if they are not quite rigid in their holders, a noisy background will be obtained when a swinging coil is moved.

### Loose Nuts

Any nuts which hold soldering tags in position should be making firm contact, and the nuts on the terminal shanks should be hard up against the back of the panel. It often happens that these nuts are found to be loose when the soldering of the set is finished.

Especially when working on short wavelengths, a nut loose on its bolt may cause noises, even though the connection is soldered to the bolt and not merely secured under the nut. The aerial and earth leads should also be checked over in the same way, together with the battery leads and plugs.

### Flex Leads

It not uncommonly happens that, when the end of a piece of stranded flex is inserted under a terminal head, only a few strands are really gripped, with a poor connection in consequence. To ensure a good connection with flex, the end should be twisted and placed on a terminal as shown in Fig. 1, the loose end passing clockwise round the shank, so that the terminal head tends to draw it in tightly when it is screwed down.

The connections, perhaps, are all in order. We have assumed that the components are of good make, so that there will probably be no need to suspect the constructional features of such parts as coil-holders, variable condensers, or filament resistances. It may be, however, that in mounting them or in soldering connections, some part has been loosened or incorrectly adjusted. The points to examine with this in mind are the moving coil connections in a coil-holder, the moving-plate contact in a variable condenser, and in a filament resistance the contact of the moving blade on the resistance spiral and the connection between the spindle and its soldering tag or terminal.

All that remain are the grid-leak, the L.F. transformer and the fixed condensers. The leak is most satisfactorily tested by the substitution method; the remaining components may be checked with a dry cell and a pair of telephones, as described recently in these pages.

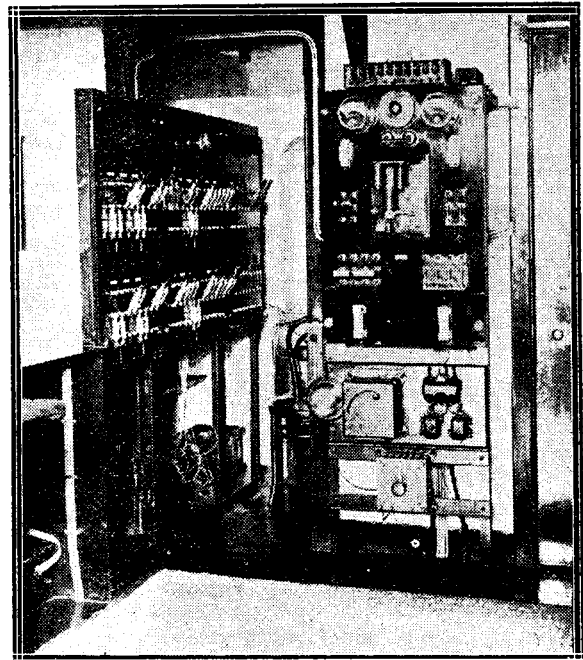

*In our last issue the transmitting room at the Glasgow station was shown. This view shows the switchboard and generator controls.*

## WHAT WE ARE GOING TO DO AT ELSTREE

*(concluded from page 672)*

factory. We shall not have any such restrictions, and we shall be able to express our opinion as to whether apparatus is to be recommended for our readers or not. Apart from being able to give figures, there are very important factors (*e.g.*, likelihood of breakdown, mechanical defects, etc.) which we shall comment on favourably or adversely as the case may be, whereas the N.P.L. obviously only does what it is asked to do, and it is sometimes not asked to carry out tests which would show a weakness in the apparatus submitted. Moreover, the policy of the N.P.L. is to give figures, not comments. We, on the other hand, shall give figures *and* comments.

**8. Commercial Service Department.**—We are at present considering whether we can give manufacturers the benefits of our test department described in the preceding paragraph, by furnishing them with test reports of their apparatus. Our other functions, however, will absorb almost the whole of our facilities, and a decision as to whether we can undertake this further work will be postponed for the present. In any case manufacturers will still have the advantage of having their apparatus tested for the purpose of having the results of tests published, whether good or bad. It is in any event our intention to make the laboratories entirely non-commercial, and to make them a service to Radio Press readers, while the scale on which operations will be conducted will also give the work a national aspect.

# Some American Super-Heterodyne Components

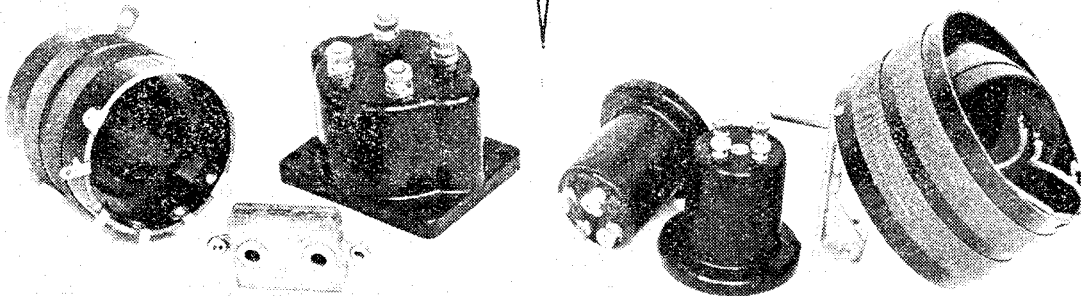

A few of the Silver Marshall components, showing the oscillator coils, and one of the long-wave transformers with the fixed tuning condenser specially supplied with each to ensure careful matching.

One of the Haynes-Griffin intermediate frequency transformers, the input filter and the oscillator coupler. The long-wave transformers are of very small size.

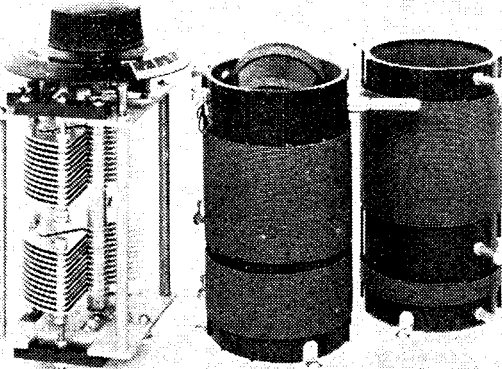

Some components for building the McLaughlin One-control Super-Heterodyne, obtainable from Messrs. C. G. Vokes & Co. When the set is satisfactorily adjusted, the sole control is that of the dual condenser shown on the left. The oscillator & tuning coils are shown on the right.

In our last week's issue we published reproductions of photographs of some of the most well-known super-heterodyne components produced by British Manufacturers. This week we give a similar selection of American components all of which are obtainable in this country. A noticeable point about the American components is that nearly all of them are designed for special circuits combining the functions of oscillator and first detector in one valve. Only one of the examples of British components shown last week was designed for use in an autodyne circuit.

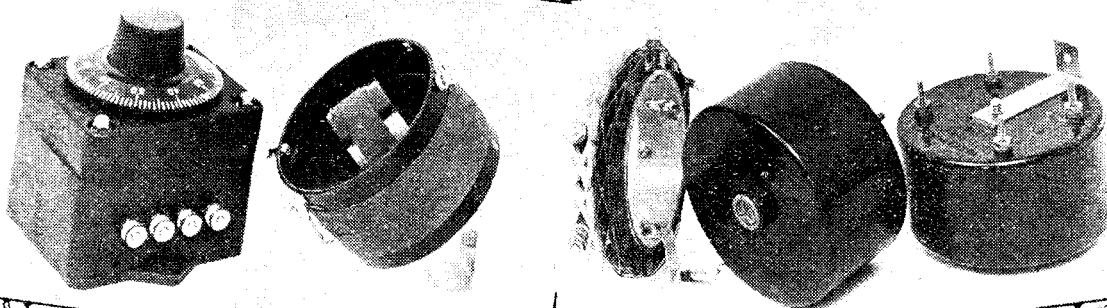

Some of the components for the Tropadyne circuit. One of the Tropadyne transformers (long-wave transformers) is seen on the left and the oscillator coupler on the right. These components are obtainable in this country from Messrs. R. A. Rothermel Ltd.

Part of the "Ultradyn Kit" produced by the Phenix Radio Corporation. The components on the right will be recognised as the input filter and a long-wave transformer, and on the left is the oscillator coil.

# HOW TO RECEIVE NKF

By **STANLEY G. RATTEE, M.I.R.E., Staff Editor.**

*In a recent issue a receiver was described by Mr. Rattee for the reception of the ultra-short waves. Instructions are given here to enable those readers who may have constructed the set to use it for the reception of the test transmissions from NKF.*

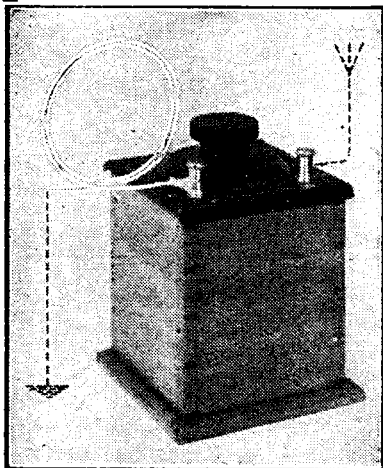

*The aerial circuit of the Author's set consists of a variable condenser and coil in series, with aerial and earth connected as shown.*

**I**N view of the test transmissions which are being conducted by NKF, particulars of which were given in last week's issue of *Wireless Weekly*, those readers who constructed the short-wave receiver described in the June 24, 1925, issue, will no doubt be interested in some brief notes upon how to receive signals from NKF upon the receiver mentioned. Readers will remember that this receiver was arranged so that either a 6-turn or an 11-turn coil could be used, the wavelength covered by these two coils being approximately 12 metres to 70 metres (24,987 to 4,283 kc.).

In the first place we will consider reception upon 20 metres (14,991 kc.), which is a "day-light" wavelength, and upon which signals are received at very good strength.

## Twenty and Forty Metres

Using the 6-turn coil, it will be found that the 20-metre adjustment is at a point on the higher reading of the grid tuning condenser, while with the 11-turn coil the adjustment will be at the lower reading of the same condenser. For the reception of signals on the 40-metre (7,496 kc.) wavelength, the 11-turn coil only should be used, when the adjustment will be found at a point about half-way

round the grid tuning condenser dial. Signals upon this wavelength can be received after sunset.

When tuning on the 20-metre wavelength some indication of whether or not the receiver is tuned to that wavelength will be given by a considerable amount of "crackling" whenever a motor car or 'bus passes within reasonable distance of the house, and though the loudest "crackles" do not indicate 20 metres, their presence will give a rough and ready indication of "position."

## Aerial Circuit

As all particulars as to valves and so on were given in the June 24 issue, these will not be again gone into, save that I may add that since that date a Marconi D.E.4 has been used with success, the anode voltage being 72. With regard to the aerial circuit, a photograph of the actual arrangement used is shown, the coil having three turns of No. 16 d.c.c. wire wound to a 4-in. diameter and held together by means of string.

The aerial is connected to one of the condenser terminals, as shown, which aerial may be either the ordinary outdoor arrangement or else a vertical length of wire inside the house, and the earth is soldered to the end of the coil; the other end of the coil is attached to the free terminal of the condenser.

## Aerial Coupling

The advantage of this arrangement is that the coupling between the 6-turn and the aerial coils may be varied by merely moving the condenser box to any required position; the value of the condenser is .001  $\mu$ F. The tuning of the receiver for either 20 or 40 metres is extremely critical, and the turning of the grid condenser should be made very slowly, whilst the reaction

condenser should be adjusted so that the set is just oscillating, otherwise the desired signals will be missed altogether, even though they be loud with the correct adjustments.

Probably the best procedure to adopt is to set the grid tuning condenser to zero reading, and to turn the reaction condenser from its zero position towards its maximum reading until the set just oscillates. Now place the aerial coil to within 2 in. of that end of the 6-turn coil which forms the reaction turns, when it will be probably found that the set will stop oscillating. On turning the reaction condenser slightly the oscillating condition will again be established.

## Critical Tuning

Keeping the set in this condition, the two condensers, grid tuning and reaction, should be turned simultaneously, the grid tuning condenser being turned slightly faster than the reaction condenser. Once signals have been found then the best results should be tuned for by means of the grid condenser, and final adjustments made to the reaction condenser.

After the best results have been found in this way, then the coupling between the aerial and 6-turn coils should not be interfered with, otherwise the adjustments which have been made with such care will no longer be correct.

## Control of Oscillation

Should it so happen that the receiver will not oscillate at one position of the grid tuning condenser, then the .001  $\mu$ F aerial condenser should be turned, say, 10 deg. either one way or the other, whereupon the difficulty will be overcome. It must be remembered, however, that this condenser must not be used for tuning purposes.

(Concluded on page 692.)

# Correspondence

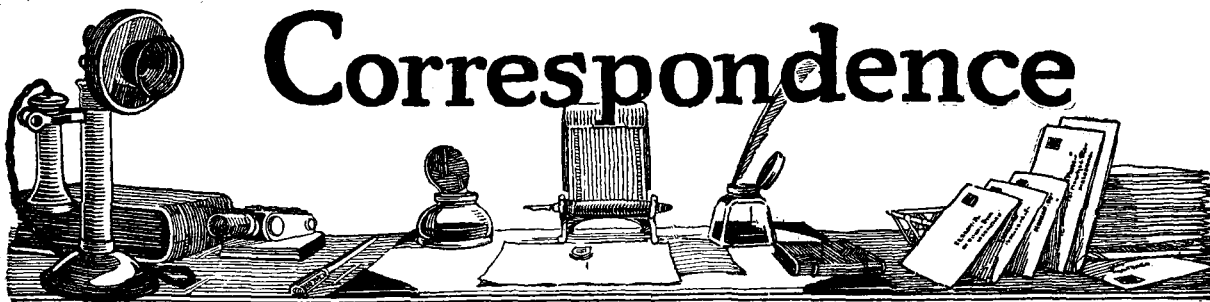

## THE PROPOSED BRITISH INSTITUTE OF RADIO ENGINEERS.

SIR,—With reference to the statement issued by the Institute of Electrical Engineers regarding the qualifications necessary for a wireless engineer to become a member of the Institute, there are one or two points which appear to have been omitted.

In the first place, it does not state that an application must be accompanied by the signatures of two corporate members as proposers and three corporate or associate members as supporters, *all of whom must endorse the application from per-*

*to act unless these signatures are obtained by the applicant.*

Secondly, no explanation is given as to how one may discriminate between the wireless engineer and the electrical engineer (and there must be a difference, otherwise, why have a Wireless Section?) Again, do the Institute realise that by accepting a wireless engineer with no power-engineering experience they are proclaiming him as a *chartered electrical engineer*, and in doing so are rather slighting the truly professional electrical man.

Thirdly, M.I.E.E. and A.M.I.E.E. denote professional electrical standing and give no indication that the holder is in any way connected with wireless, a point which is more important than anything else. True, he may add the words (Wireless section), but this conveys nothing definite.

Fourthly, the I.E.E. does not govern the Profession of Radiology or Electro-Chemistry, which professions utilise electricity in a much smaller proportion than do wireless engineers. The I.E.E. could sponsor wireless as it appeared in 1914, but now that wireless is almost as important an industry as electrical engineering, it should be governed by its own body.

In view of the above conditions there still appears to be room for a separate Institute, and I am asked to state that the organisation of the proposed new Society will still be carried forward with a view to providing the wireless engineer with a definite professional standing, as distinct from the electrical engineer.

Proceedings will be issued dealing only with wireless subjects, thus providing 100 per cent. wireless instead of the minimum percentage as at present published in the proceedings of the I.E.E.

The first meeting of the proposed Society will take place during the early part of September, at which date the Articles of Association will be drawn up and presented in the usual way.—Yours faithfully,

Y. W. P. EVANS,  
Hon. Secretary, Temp.,  
Proposed Radio Institute.  
Manchester.

[With regard to the point raised in the second paragraph of Mr. Evans'

letter, it seems obvious that *some* recommendation of the candidate should be required. The Institute of Radio Engineers requires the names of five persons willing to act as proposers to be submitted, and to each of these letters of inquiry are written. Surely Mr. Evans does not wish to set a lower standard than this?—Ed.]

## RADIO PRESS SETS.

SIR,—As a reader of all your publications since the first issues, I thought it might interest you to have the enclosed photograph of my present "selection," or better, perhaps, "collection" of home-made apparatus:—

(1) Top left: Mr. Percy Harris's excellent low-loss crystal set (*The*

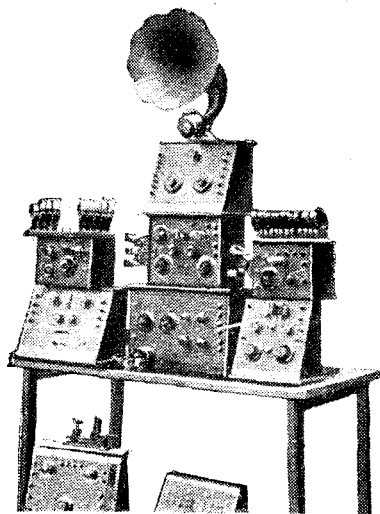

*The comprehensive collection of Radio Press receiving apparatus constructed by "Template."*

*sonal knowledge of the applicant.* As the prospective candidate for admittance to the wireless section will not, in the majority of cases, have been connected with electrical power engineering, his chance of being intimately acquainted with members of the Institute is very remote. Furthermore, the majority of the members of the wireless section are resident in and around London, which does not give the provincial applicant much chance of making their acquaintance. This condition of entrance must be published by the I.E.E., owing to the fact that *the Council are powerless*

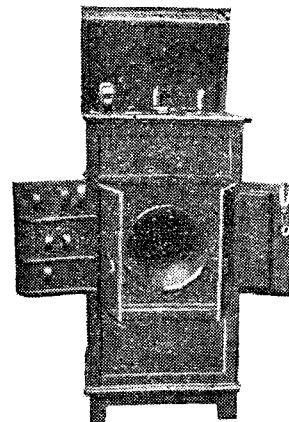

*An attractive S.T. 100 cabinet receiver made by Mr. Harfield.*

*Wireless Constructor*, February, 1925).

(2) Bottom left: Two-valve amplifier (own design).

(3) Bottom centre: Mr. Percy Harris's low-wave receiver, 40-210 metres (*Wireless Weekly*, Vol. 5, No. 21).

(4) Above No. 3: Mr. Underdown's excellent two-valve neutrodyne (*Modern Wireless*, November, 1924).

(5) Bottom right: Mr. Kendall's "Experimenter's Tuner" (*Modern Wireless*, September, 1924), a really first-class instrument.

(6) Above No. 5: Mr. Redpath's 1-valve Flewelling type Receiver (*Wireless Weekly*, Vol. 4, No. 21).

A friend remarked, "You ought to get something with that lot," and I certainly do!—Yours faithfully,

TEMPLATE.

Norwich.

**AN S.T. 100 RECEIVER.**

SIR,—I am enclosing a photograph of my wireless set and cabinet, which is entirely constructed by myself. I am an amateur wood-worker, as well as an amateur at wireless, so I thought it would be interesting to you, as you are so keen on encouraging amateurs. The set is the S.T. 100, with the addition of another valve. I will not say anything about results, as you know the results of which the S.T. 100 is capable.—Yours faithfully,

H. A. HARFIELD.

Portsmouth.

**AN "IMPROVED TWO-VALVE" RECEIVER.**

SIR,—A short while ago I completed the set described by Mr. Stanley G. Rattee, M.I.R.E., an "Improved Two-Valve" Receiver, in *Modern Wireless* for January, 1925.

I have adhered as closely as possible to his design, but in adapting a receiver already constructed, I was prepared for some slight losses, but these are apparently non-existent. Already I have received the following stations quite satisfactorily and without difficulty:—Eiffel Tower, Radio - Paris, Daventry, Königswusterhausen, Hilversum, Aberdeen, Birmingham, Glasgow, Newcastle, Manchester, Belfast, Madrid, and Leipzig. Several other unidentifiable stations have been faintly heard.

I have also incorporated a wave-trap.

May I be permitted to congratulate Mr. Rattee on his set.—Yours faithfully,

A. S. HODGSON.

Middlesbrough.

**THE "FAMILY" FOUR-VALVE RECEIVER.**

SIR,—I have great pleasure in sending you the enclosed photograph of my "Family" Four-Valve receiver, constructed from your "Radio Press Envelope," No. 2, by Percy W. Harris, M.I.R.E. This set has been in use practically every evening since it was set up in May, 1924, and I have had nothing but satisfaction and pleasure from it. I can get 2LO and 2ZY on two valves and all the B.B.C. stations at L.S. strength on four valves. I also get a number of Continental stations (on the 'phones), including Hamburg, Radio Paris, Frankfurt, Petit-Parisien, and Madrid. During the winter months I received the following

American stations very clearly:—WBZ, WGY, KDKA, and WJY. I built the cabinet in two parts; the lower portion holds the L.T. and H.T. batteries, and these are connected up to the set as follows:—I have four terminals on the right-hand side of the lower cabinet; these are connected to the batteries inside the cabinet. I have also four terminals on the same side of the upper cabinet; these are connected up to the terminals on the panel to connect my batteries to the set. I have four short leads connected to the terminals outside, and as I use spade-terminals, they are easy to attach, and I find this very con-

Harris, M.I.R.E., to which has been added a wave-meter and the ABC Wave-Trap (R.P. Envelope No. 6, by Mr. G. P. Kendall, B.Sc.), both of which increase the pleasure of long-distance reception.

The receiving set is placed in a bureau, at the bottom of which is a cupboard containing the batteries, etc., and is therefore self-contained.

The valves used in this set are all dull emitters of the .06 type, and I find them very efficient, using 70 volts H.T. on all four.

This circuit is one of the most interesting and efficient I have tried, and with the use of the wave-trap it is quite easy to receive all B.B.C. stations and many Continental ones at full loud-speaker strength, and these can all be received using only two valves, viz., H.F. and Det. with 'phones.

For London, the detector and one note magnifier is usually quite sufficient for a small room, and it is an easy matter to switch on the second L.F. valve, with the switches so conveniently arranged as they are in this circuit, if greater volume is required.

The ABC Wave-Trap is also very efficient, and the only departure I have made from the original design is the switches, which are D.P.D.T., and the trap is laid lengthwise to fit in the bureau over the set.—Yours faithfully,

F. A. PIPER.

Lewisham, S.E.13.

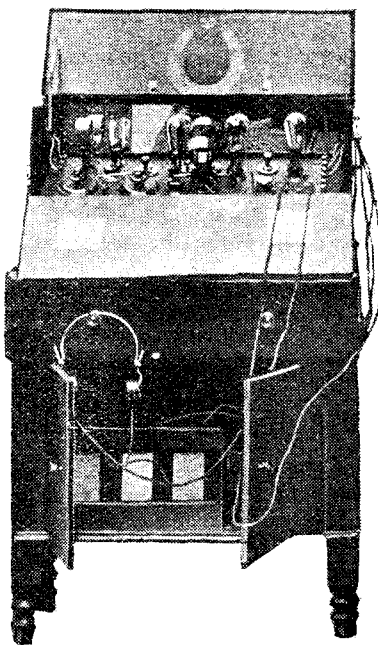

Mr. Keenan's "Family" Four-Valve receiver.

venient, as I can move the set to different rooms. I have my aerial and earth so arranged that I can connect them up to three different rooms, and so save having to use long indoor aerial and earth leads. As you can see by the photograph, there is a "drop front" to the cabinet and a close-down lid, so that when not in use the set is practically dust-proof. The back of the cabinet is also hinged; this gives easy access to the wiring and is a great convenience. I also fitted several mirrors behind the valves; this gives the panel a very bright appearance when the valves are lit. I wish to take this opportunity to thank you for the many pleasant evenings I have had with this set.—Yours faithfully,

W. J. KEENAN.

Portarlington, I.F.S.

SIR,—I have recently constructed the "Family" Four-Valve receiver from Radio Press Envelope, No. 2, by Mr. Percy W.

**AN INTERESTING CRYSTAL-VALVE CIRCUIT.**

SIR,—I feel that I must write a few words in praise of the "Interesting Valve-Crystal Circuit" as described in the March, 1925, issue of *The Wireless Constructor* by Mr. John Scott-Taggart. I have constructed a set on a base-board, using this circuit. It is only wired roughly, but it gives splendid results. I did not expect such a number of stations. I have so far received and identified the following:—Birmingham (100 miles), Cardiff (150 miles), London (100 miles), Nottingham (100 miles), Sheffield (80 miles), Leeds (90 miles), also Manchester and Newcastle, and, of course, Daventry (about 90 miles); the later comes in on loud speaker ("Dragonfly"). I have also heard several foreign stations at good strength, among them Petit-Parisien and Radio Paris (300 miles). You will notice that I am a long way from the nearest station, and it was with some doubt that I wired up the set.

My aerial is about 70 ft. long and 25 ft. high, unscreened. Hoping this will be of use and interest to other readers.—Yours faithfully,

KENNETH H. ROBINSON.

Friskney, Lincs.



**THE B.B.C. AND SUMMER RADIO.**

SIR,—Permit me to support your leading article, "The B.B.C. and Summer Radio," in your August 12 issue. I agree with all your comments against them.

Take my own case, for instance. I have built a 4-valve portable set and portable aerial costing about £10 to £12, but what use is it? Who wants talks on rambles and picnics? What we want is two hours at least of light music. No, the B.B.C. have too much "talk" altogether in their programmes.

The whole of their broadcasting programmes want revising. Take the case of the Sunday evening programme on August 9; the piano solo, who enjoyed it? Over forty minutes' glorified exercise and physical endurance. Why, the "Maiden's Prayer" would have been a "tit-bit" compared with it. Not satisfied with that, they give us more piano on Monday—the "high-brow" type, I mean.

What we want is music, music, music, and more music, and that to be of a light and tuneful character.

The only solution to my mind is two broadcasting stations, one giving all music and one giving all "talk."

My idea of the day's programme is:—

- 10.30 a.m.—Time signal.
- 12—2 p.m.—Time signal, special news, concert.
- 3—5.30 p.m.—All music.
- 5.30—6.30 p.m.—Usual children's programme.
- 6.30—7.0 p.m.—Dance music.
- 7.0—7.30 p.m.—Usual signal and news.
- 7.30—10.0 p.m.—Concert.
- 10—.—As long as they like with their "gas-bags" who teach us to become engineers, architects, artists and "what nots" in 15 minutes' talk!

In conclusion, I would like you to understand I am considered a respectable citizen (20 years' ratepayer), but I am not taking out another wireless licence until I am forced, for I object to paying 7s. 6d. to the B.B.C. for high-brow "twaddle" and for programmes in the making of which I have no word.

I am employed at a large works, and you can take my word for it that the public are not satisfied with the B.B.C. programmes.

Wishing you every success.—Yours faithfully,

"REGULAR READER."

Woolwich.

[We do not agree with all our correspondent's statements, and, in

particular, would point out that the fact that he dislikes part of the programmes in no way lessens his obligation to take out a receiving licence.—Ed.]

**RE ALLOCATION OF CALL-SIGNS.**

SIR,—Referring to Mr. Evans's letter in the August 12 issue of *Wireless Weekly* regarding call-sign 2FZ, this Society would appreciate your kindness if you would give publicity to the fact that 2FZ is the call-sign of the Radio Experimental Society of Manchester, and reports of reception should be sent to the Hon. Secretary, Mr. E. Butterworth, B.Sc., 102, Grenville Street, Stockport.

For the benefit of your Manchester and district readers I would state that the Manchester Wireless Society was re-named The Radio Experimental Society of Manchester in October last, and any Society styled "Manchester Wireless Society" must therefore be a new Society.—Yours faithfully,

JAS. HUDSON, Hon. Treasurer.  
Manchester.

**THE TWO-VALVE AMPLIFIER DE LUXE.**

SIR,—As a matter of general interest to amateurs who make

**THE PANEL DE LUXE**



**G**OOD news travels apace—and it is not surprising, therefore, to find that wireless enthusiasts are gladly paying the few shillings extra for Radion Panels. Already they have realised that at a very small extra cost they can insure against surface leakage and all the deadly ills to which cheap ebonite is prone.

Radion is available in 21 different sizes in black and mahogany. Radion can also be supplied in any special size. Black 1d. per square inch, mahogany 1½d. per square inch.

**RADION** Trade Mark

American Hard Rubber Company (Britain) Ltd.

Head Office: 13a Fore Street, London, E.C. 2  
Depots: 120 Wellington Street, Glasgow.  
116 Snow Hill, Birmingham.  
Irish Agents: 8 Corporation Street, Belfast

Gilbert Ad. 3401.

**RADIO TANGENT FITMENTS**

Charm your friends with a pleasing performance—

Install THE "TANGENT" TYPE "D" RADIOMATIC 2-VALVE

PRICE—  
£7-0-0

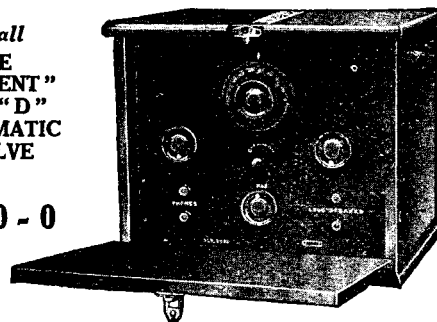

Try it on Daventry with Loud Speaker—even though you be 100 miles away!!

All gadgets completely enclosed. Not an eye-sore—an ornament to your room. If not in his stock all good dealers can obtain by return.

Insist on "TANGENT" **GENT & CO. LTD.** Estd. 1872.  
"Faraday Works," LEICESTER.

London: 25, Victoria Street, S.W.1.  
Newcastle/Tyne: "Tangent House," Blckett Street

their own wireless sets, may I please draw your attention to the question of L.F. transformers?

I recently desired to construct the 2-Valve Amplifier de Luxe (R.P. Envelope No. 7, by Herbert K. Simpson), with a view to obtaining as efficient results as possible, both in *volume* and *purity*. I made up my mind that only the very best of components should be used, of course, and before purchasing my transformers, I decided to ask several of the most prominent manufacturers of these units the impedance of their respective transformers at, say, 500 cycles frequency. I required this information so as to enable me to choose power valves whose impedances were the most suitable for use in conjunction with the transformers decided upon.

My inquiries came to nought, as one noted maker informed me that their transformer would suit *any* valve; another eminent firm evaded (either purposely or otherwise) the question by telling me that they could not give the impedance, as this varied so much with the frequency.

Surely there is a mean figure which could be given to help us to match transformer and valve as closely as possible? This is, after all, one of the items to be observed by serious experimenters who desire to keep up

to the best possible standard of tone on the L.F. side.

Many people's ideas of loud-speaker reproduction are entirely spoiled by hearing some of the ghastly "barrel - organ" type of music turned out on badly - designed and constructed receivers. Needless to say, if all wireless amateurs made receivers as designed by the efficient staff of Radio Press, we should soon see a very big improvement in the above-mentioned "tone question."

Trusting that my remarks may be of useful purpose,—Yours faithfully,  
H. H. DARBY.

**HOW TO RECEIVE NKF**

(Concluded from page 688)

With regard to the reaction adjustments, really fine control of this is given by varying the adjustment of the filament rheostat of the detector valve, and since this is conveniently placed next to the reaction condenser, the adjustment is extremely handy; further, this method of control is practically free from any hand-capacity effects.

When operating a receiver of

this type readers should bear in mind my former remarks (made when describing the constructional details of the set) anent the use of radio chokes in the battery leads. Further, all unused coils and long wires should also be kept well away from the receiver, otherwise there may be some difficulty in making the set oscillate.

**Actual Experiences**

As to the actual reception of NKF, this was accomplished using the above receiver and methods, with the aerial coil illustrated, on August 18, during the 8.5-8.15 p.m. transmission, the wavelength used at that time being 20.8 metres (14,414 kc.). Signals were good and strong, and easily read. Other 20-metre signals were also picked up as a matter of interest, and these were held until 9.5 p.m., when fading became particularly noticeable. During these tests it may interest readers to know that signals were also heard emanating from PCMM and PKX, though their wavelengths are not known by me.

**BUILD THE VOKES McLAUGHLIN ONE CONTROL SUPER-HETERODYNE**



Note the simplicity of the panel design. The turning of one dial is all that is required to tune over the whole broadcasting range.

The well-known Radio Magazine—"Q.S.T."—says: "We consider it the outstanding development in recent Super-heterodyne progress as it provides the simplest imaginable control for what is undoubtedly the best reception arrangement known to-day."

The paper goes on to say: "RESULTS OBTAINED."

"It is certainly a strange sensation to turn one knob and hear station after station come in without any further adjustment."

Write or call for full particulars and prices. There is no difficulty in constructing this set. It works admirably with English valves. Demonstrations will be arranged by appointment.

Write for list of other famous components made by such world-renowned firms as:—

American Specialty Company. Un-ni-dial. Erla. Signola. E-Z-Toon. Ajax. The Teagle Company. Precise. Wade. Barrett & Paden. Metro. Branston. Brand.

**C. G. VOKES & COMPANY**

(C. G. VOKES, A.M.I.Mech.E., etc.),

38, CONDUIT STREET, REGENT STREET, LONDON, W.1.

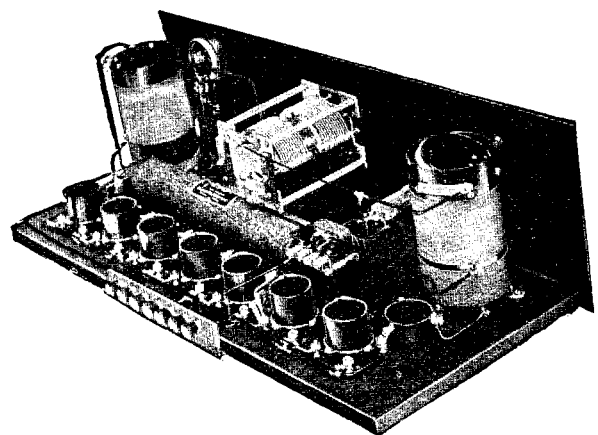

View at back of panel, showing neat lay-out and simple wiring.

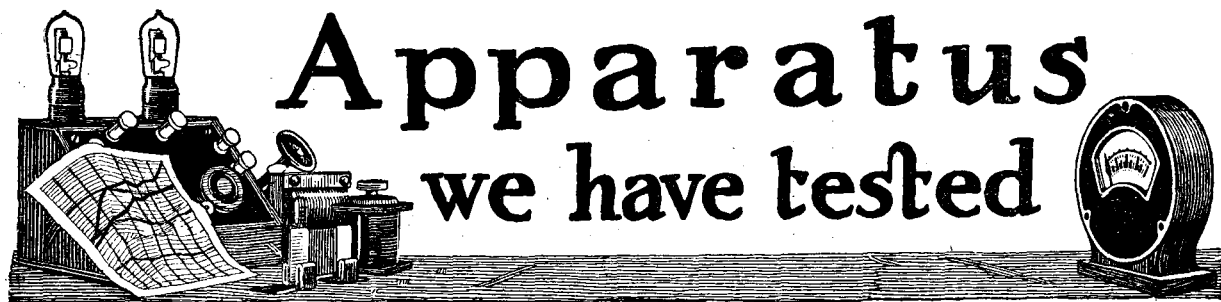

# Apparatus we have tested

Conducted by A. D. COWPER, M.Sc., Staff Editor.

## "Wyray" Crystal

We have received from F. R. Hickson samples of a crystal which appears to resemble in many ways the standard galena, but which on practical test showed rectifying powers of an order which actually excelled that of a good standard galena when used with a fine cat's whisker on strong signals. One sample when tested showed on six consecutive haphazard settings most excellent signal-strength on the microammeter, only one falling appreciably short of the optimum with ordinary galena—and that would be described as a good setting in the absence of means of measurement. The crystal could be cut readily to fit into a small cup without waste, and showed the same

properties on the fresh surface. It appeared to be stable, and no very delicate setting of the whisker was called for to give good results. We can strongly recommend this crystal if the several samples submitted are representative of the average quality.

## "Liberty" Permanent Crystal Detector

A well-tried and thoroughly satisfactory crystal combination, that of tellurium-zincite, is used in the "Liberty" permanent crystal detector, a sample of which has been sent for our trial by Messrs. Radi-Arc Electrical Co., Ltd. This instrument has the proper provision for setting the crystals by means of a small knob projecting through the

panel, and is housed in a neat casing only 1 1/4 in. long and 1/2 in. diameter, with the customary one-hole-fixing device. A good-sized terminal at one end is provided for connection in a crystal receiver circuit; the other connection is made to the fixing collar. One crystal is carried on the end of a small spring plunger, which can be withdrawn a short distance and rotated to find a fresh setting for the crystals; the spring action renders a good setting, when once found, quite secure under any ordinary circumstances. On practical trial, the average of six extremely uniform readings for consecutive settings gave an efficiency of 57 per cent. as compared with a carefully hand-set galena at optimum setting, measuring by

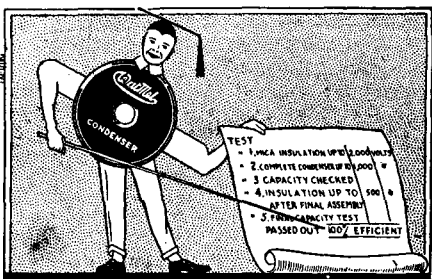

## Folks, meet a really good Condenser!

**THAT'S me!** The Efficient Watmel, radio men call me. Efficient—it's my middle name, and you'll say it is when you hear the improvement I make in the results from your radio. Read my test report. Something to be proud of, isn't it? I possess all the good points you look for in a Fixed Condenser and a few more besides. If you're interested in better condenser efficiency—visit your dealer and ask for me. Closer acquaintance will prove to you my sterling qualities.

- Watmel Test Report.**
1. Mica Insulation up to 2,000 volts
  2. Complete Condenser up to 1,000 volts.
  3. Capacity checked.
  4. Insulation up to 500 volts After Final Assembly.
  5. Final Capacity Test PASSED OUT 100% EFFICIENT.

**Prices.**

Capacities for Standard Grid Condensers.	
-00005 to -0005	- 2/6 each.
Standard Fixed Condensers.	
-002, -001	- 2/6 each.
-0025, -006	- 3/6 each.
Combined Grid Leak and Condenser is	- 2/- each.

**The Watmel Wireless Co., Ltd.**  
332a, GOSWELL ROAD - LONDON, E.C.1.



Representative for Lancashire and Cheshire—  
Mr. J. B. LEVÉE, 23, Hartley Street, Levenshulme, MANCHESTER.

## FOUR CAPACITIES No Spacing Washers

With losses so low that it will oscillate on wave-lengths well below 20 metres; with solid brass vanes soldered in position, and balanced on ball bearings; with four alternative capacities, three single and one double, in every instrument. The Bowyer-Lowe Four Square Condenser is a precision tuning device of unequalled efficiency. It is on the square law principle,

moves so smoothly that tuning of almost vernier accuracy can be obtained with finger and thumb, and has a micrometer adjustment of the most sensitive order. This instrument will give you selectivity and signal purity greater than you have ever known, with laboratory precision in tuning. Install it in all your sets. Fully descriptive brochure free on application.

## THE BOWYER-LOWE FOUR-SQUARE SQUARE LAW CONDENSER

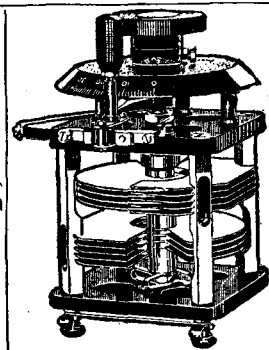

Obtainable from good dealers everywhere. In case of difficulty write direct.

The Bowyer-Lowe Co., Ltd., Letchworth.

microammeter on the local broadcast station's wave in the usual manner. This indicates a possibility of obtaining a uniform and certain performance in daily broadcast reception, which will actually compare favourably with that commonly obtained with galena crystals, without the nuisance of daily or hourly re-setting which the latter often imply under average domestic conditions. We can certainly recommend this detector for such service.

**"Tripart" Terminal and Spring Plug**

Messrs. Ward & Goldstone, Ltd., have sent for our comment examples of their terminal devices, the "Tripart" terminal and spring plug. The first is a versatile fitting which will take at will either a wire, a spade terminal, a telephone tag, or a (large diameter) wander-plug, giving a secure connection in each case. This is achieved by making the upper portion of the terminal of larger diameter than the back-stud, by which it is fixed as usual in the panel, the latter being of ordinary No. 4 B.A. size. This larger screwed upper portion then accommodates a wander-plug socket; it has a cross-drilled hole for telephone tags, and also a lower

grooved section, into which will fit the ordinary spade terminal. The usual knurled-head nut gives the grip in the latter cases, and for securing wire ends by a loop around the stem in the ordinary way. The terminal is neatly finished in nickel and appears no larger on the panel than the standard type.

The spring-plug and wander-plug attachment has, in place of the usual rather unsatisfactory split-pin, four hard-drawn phosphor-bronze springs, making thus a secure contact in a socket. A large coloured insulating handle is provided, in black and red respectively, concealing a simple screw-chuck for holding the end of the flex connection. Whilst rather large for ordinary H.T. battery tapping sockets, these plugs fitted securely in the "Tripart" terminals, giving a very neat and convenient connection, removable at a moment's notice, but providing really silent contacts.

**Terminal Tags**

Samples of various types of terminal tags, both in bright brass, tinned brass, and tinned copper, have been submitted for our inspection by Messrs. S. H. Collett Manufacturing Co. These are in a variety of useful shapes—spade, ring, plain and forked tag, eyelet, bus-bar carrier, etc.—to meet the most likely

requirements in the wiring up of radio receivers. They appeared to be well made and of uniform quality; on trial the tags gave a good grip on flex and proved sufficiently substantial to stand up well in use. They can be recommended to the attention of the radio constructor.

**"Solderese" Outfit**

An accessory which proves, on trial, to be of a considerable practical assistance in that always troublesome operation, the soldering of a few connections in a radio receiver under construction or repair when the elaborate professional equipment of ready-tinned electrical soldering irons, etc., is not available, is the "Solderese," a sample of which has been sent for our trial by Messrs. Stephen Heath & Co. This consists of a small heavy cast-iron box, with loose lid, suitable for standing on the stove or work-bench, measuring about 4 $\frac{1}{8}$  ins. by 2 $\frac{3}{8}$  ins. In compartments in this shallow box are a double-sided file, sticks of solder, fluxite, and a quill for applying the flux. The ends of the box are also grooved so as to supply a stand for the iron, and can be screwed down to the table if desired. Detailed instructions are enclosed as to how to use this neat and compact set which can be strongly recommended to the home constructor.

**Scrap your H.T. Batteries !!** Use your Electric Lighting Mains!—  
The "DYNIC" D.C. REGULATOR.



Does away with the necessity for H.T. Batteries with their attendant troubles. Simply plug into a convenient lampholder, and a perfectly smooth H.T. supply is obtained. Variable outputs used with ordinary wander plugs, like H.T. Batteries. No breakable parts. Entirely insulated. Can be supplied wound for special requirements—e.g., larger output. Impossible to burn out valve filaments even if they are inadvertently connected to the H.T. Infinitesimal running costs. For D.C. MAINS ONLY of any voltage above 50.

Price complete with Plug and Flex. **60/-** Postage 9d.

Send for Descriptive folder.  
**JONES & STEWART,**  
59, Robertson Street, GLASGOW, C2.

**Experience Tells!**



Our 32 years' manufacturing experience is behind this  
**WONDER WIRELESS BATTERY**

The C.A.V. H.T.3, 60 volts, outlasts dozens of dry cells and can be re-charged for 2/6. Supplied in painted crate (with lid) at 1/- per volt, plus 3/- for initial charge  
**63/-**

**C.A. Vandervell & Co. Ltd.**  
MARPLE WAY ACTON LONDON, W.3

**BATTERIES ABOLISHED**

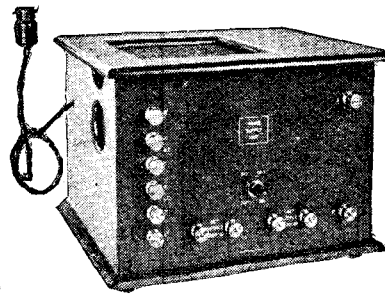

Plug into Electric Light or Power Socket. Any D.C. Electric Light System may be used.

H.T. Supply Unit - £3-15-0  
Mains Supply Unit (H.T. and L.T. for any set) - £12-0-0  
Ditto, with 3 H.T. Positive - £13-10-0  
4-valve Receiver fitted with "Dynamergy" Mains Supply system and Valves - 38 Gns.

In ordering, state voltage of system.  
**25, Grove Terrace, TEDDINGTON.**

**DYNAMERGY MAINS SUPPLY,**

**EACH A KING IN ITS CLASS**  
—AND GUARANTEED BRITISH MADE.

<b>Radion G.P.</b> A 4-volt bright valve that only consumes 48 amp.	<b>7/-</b>
<b>Radion D.E. '06</b> A wonderfully efficient filament valve "very dull"	<b>10/6</b>
<b>Radion D.E. '34</b> A 2-volt dull emitter of fine performance	<b>10/6</b>
<b>Radion Pyramid (1) Valve,</b>	<b>22/6</b>

**THE POWER VALVE DE LUXE.** Can be used with lowest loud-speaker without valve distortion. Filament robust: works at a low temperature, ensuring long life. **SPECIAL CONSTRUCTION GIVES HIGHEST EFFICIENCY AND MECHANICAL STRENGTH.** Fil. Volts, 6.5; Fil. Amps., .34; Anode Volts, 50-100; Neg. Grid Bias, 3-9.

From united Dealers or direct, Post Free.

**RADIONS LTD., BOLLINGTON, nr. Macclesfield, Cheshire.**  
Interesting literature concerning Radion Valves and our unique valve repair service gladly sent Free on request.

**RADION**  
Reliable Valves

# Information Department

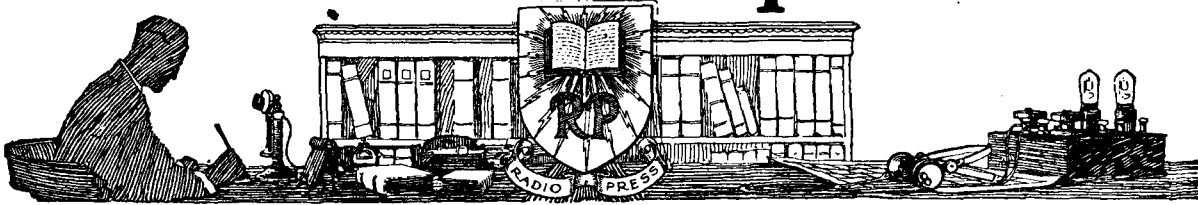

**F. S. V. (LONDON, W.4)** lives in a flat near the top of a block, has an aerial on the roof, but for an earth uses a 100-feet length of insulated wire which is taken eventually to a water cistern on the top of the building. He finds the earth connection unsatisfactory, and asks if there is any reason why he should not use the ordinary telephone earth.

Apart from any objection which might be raised by the Post Office authorities who have installed the telephone, we are disinclined to recommend this latter earth, since when the bell rings, interference from this source is almost certain to be experienced. The present arrangement whereby the earth lead is taken up to the top of the build-

ing and connected to the main water cistern is a poor one, which in effect reduces the useful height of the system, and at the same time appears to introduce considerable damping so that selectivity is not high. Probably tuning would be considerably sharpened if the connection to the cistern were severed and the end of the earth lead remote from the set left free and well insulated. A fairly efficient counterpoise should result which might be further improved if it were confined to the floor level of our correspondent's flat. Such an arrangement can easily be made inconspicuous if the wire is taken round the skirting of rooms or under carpets, and need not necessarily be directly under the aerial, although this position is preferable.

**W. H. C. (RUGBY)** has a variometer tuned crystal set which he now wishes to adapt to receive Daventry, and asks our advice as to the position and size of a loading coil for this purpose.

For the reception of 5XX on 1,600 metres a No. 150 plug-in coil is required. This should be placed between the aerial terminal and the end of the variometer winding which is at present connected to it. It is essential that the lead from the crystal detector to this end of the variometer and the aerial terminal should still be left joined to this latter point. Tuning will now be carried out on the variometer with the 150 coil connected as explained. The inductance of the latter is large compared with that of the former, and it may happen that insufficient

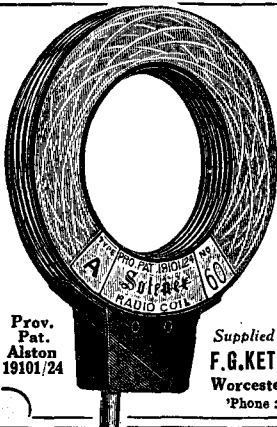

**The New "SOLENEX" RADIO COIL**

*The Coil you will eventually use!*

NO varnish impregnation, extra capacity losses, or undesirable wire kinks.

**BUT** totally enclosed in beautiful gold tinted celluloid case, hollow patented coil mount, and hollow plug pin and highly efficient eccentric generative winding.

*The smartest and highest efficient coil on the radio market to-day.*

Supplied in all Wavelengths. From 4/6 to 10/- each

**F.G.KETELBEY, A.M.I.E.E.** Wholesale Distributors,  
Worcester Chambers, 14, New St., Birmingham.  
Phone: Cen. 6623. Grams: "Ketelbee, B'ham."

Prov. Pat. Alston 19101/24

**All Post Free At Callers Prices**

Orders 5/6 value, carriage paid. Under 5/6, 2d. per lb- for packing, etc.

**MARK OF QUALITY**

<b>Ebonite Panels.</b>									
Matt.	1"	3/16"							
9" x 6"	2/2	1/10							
12" x 6"	4/6	3/9							
12" x 12"	5/6	5/-							
15" x 9"	5/8	4/9							
15" x 12"	7/6	5/8							
4" x 4"	8d.	6d.							
7" x 5"	1/6	1/2							
6" x 6"	1/4	10d.							
Any size cut.									
Sq. in 1", 1 1/2", 1", 1", 1d.									

**Square Law Var. Condensers with knob and Dial.**

.001 panel type	6/8
.0005 .. .. .	5/-
.0003 .. .. .	4/6
Vernier Bladeextra 1/4	
" J.B." " Ormond "	
" Utility " usual prices	
Vernier, no dial	2/6
5 vane, 3/3; 7	3/6
Polar types ..	10/6

**SEND FOR NEW FREE Comprehensive Price List.** TRADE ENQUIRIES INVITED Generous Terms - Prompt Service.

<b>Aerial Wire</b> 7/22 1/2	<b>1,000-ohm. ex Gvt.</b>	<b>H. T. Batteries.</b>	<b>Transformers L.F.</b>
Enamelled. Bright	8d. "Choke Coils"	With Wander Plugs.	Radio Inst. (new) 25/-
100' 3/8	"Coil Plugs"	60v. 8/- 36v. 4/10	Silvertown .. 21/-
" Electron 1/8	Ebonite .. 10d.	10d. 30v. 4/- 15v. 2/-	Igranite 21/- & 20/-
" Mars 9/6	Superior .. 1/3	4v. P.L. Btry. 5d.	Burndept (new) 24/-
Lead-in 4d. yd.	Narrow .. 5d.	66v. Ever-Rdy. 13/6	Reliability 10/- & 12/6
<b>Insulators</b>	Basket .. 11d.	36v. 8/- 16v. 3/6	Ferranti .. 17/6
Shell, 2 1/2" x 2 1/2"	"Athol" " Ebonite 1/3	<b>New Jacks 4-Contact.</b>	Tangent 12/6 & 14/6
Crystor type .. 8d.	Do. Porcelain 1/-	One hole fixing 1/9	R.A.F. Modulation, or Telephone type 8/-
" Lead-in 4/-	Horned Coil Plugs 8d.	Standard Plugs 1/3	H.F. Tangent 5/6
" 4" & 6" .. 9d.	Basket Coil Sets, 6-1/8, 4-1/-	Potentiometer 300 ohms ex-Govt. 5/-	McMichael's .. 10/-
" 9" 1", 12" & 15" 1/3	<b>British Wires.</b>	Microphones .. 2/-	Coiah 900 .. 5/6
<b>Valve Holders.</b>	swg. dec. sec. dec.	Alum. H'bands. 2/6	<b>Phi. Resistances.</b>
Type A 7d., Polar 1/3	18 1/11 2/11 3/5	Ex-Govt. Dewar Switches 12 contact 2/6	Good quality .. 1/8
Screwed 8 nuts 8d.	20 2/2 3/4 4/2	<b>All 'Igranite', 'Lissen', 'Burndept', 'Edison', 'Bell', 'Atlas', &amp; 'Star' Bing' goods supplied.</b>	Igranite .. 4/6
Ebonite .. 10d.	22 2/6 3/9 4/7	A Reader writes - "Many thanks for your Catalogue. This is an admirable book-let, concise and well arranged and will be exceedingly useful."	Vernier type .. 7/-
Do. Open Type 6d.	24 2/11 3/10 5/-	"Have you got one?"	Ormond 20-Ajax 4/-
" Security " Valve Holder 1/-	26 3/4 4/2 5/9	<b>Resistances 2/6 IT'S FREE.</b>	Burndept .. 5/-
<b>Condensers.</b>	30 4/10 5/4 7/8		T.C.H. 4/- & 5/-
Mullard (Usual Edison Bell prices)	32 5/6 6/- 8/9		Microstat .. 2/3
New Mansbridge, 2 mfd. 3/6, 1 mfd. 2/6	36 8/- 8/6 12/-		Petersen Jar. .. 2/6
<b>Coil Holders.</b>	40 17/- 14/8 20/-		<b>Headphones.</b>
Ashley fixed .. 2/6	<b>Variable Leaks.</b>	Filttron 0-7 meg. 3/-	4,000 ohms. Brown's "P" B.T.H. Siemens, Brandaes, General Radio .. 20/-
" moving .. 3/6	Watmel 0-5 meg. 2/6	Lissen type .. 2/6	Ericsson, Claritone and Sterling .. 22/8
Igranite 3 set 3/6	" Lissen type .. 2/6		Fellowes .. 16/4
Ebonite 3 Coil 3/6	" Resistances 2/6		Air weight .. 8/-
" 2 Coil 2/6			Adjustable 10/6

**J.H. TAYLOR & CO.**  
5 RADIO HOUSE, MACAULAY ST., HUDDERSFIELD  
Tel: 341 Grams: THOROUGH HUDDERSFIELD

**Peerless in name and in performance**



As soon as you use the "Peerless Junior" Rheostat you will find it gives the full degree of faultless service that the name implies. The resistance element is immune from damage and will safely carry the current of two valves. An off position is provided and definite stops are so arranged that it is impossible for a short circuit to occur. Complete, with handsome engraved nickel dial and one-hole fixing. Made in three types.

From your dealer, or  
**THE BEDFORD ELECTRICAL & RADIO CO., LTD.,**  
22, Campbell Road, Bedford.

Size, 1 1/2 in. dia., 1/2 in. high  
6, 15, or 30 ohms.  
**2/6**

variation in wavelength range is obtained to give maximum signal strength from 5XX. In this case a variable condenser of .0005  $\mu$ F should be connected across aerial and earth terminals, the fixed vanes going to the aerial terminal.

**A. H. (EDINBURGH)** asks whether a low-frequency transformer which gives poor quality reproduction would function better in a choke amplifier and also the values of the coupling condenser and of the grid leak required.

Should the iron core of the transformer be of ample cross-section and no other faults present except that of insufficient turns, connecting the two windings in series in correct sense, so that the inductances act in the same direction and are not opposed, usually results in a fairly efficient choke. Experiments should be carried out to see which connections give the best results, one primary terminal being connected to a secondary terminal, and the other ends of the windings taken to plate and H.T. positive respectively, the effect, for example, of connecting OP to IS and OS in turn being tried. The value of the coupling condenser employed may be from .01 to .25  $\mu$ F, and its insulation should be of a high order,

whilst the attendant leak may have a resistance of  $\frac{1}{2}$  to 2 megohms, the lower value being the safer.

**L. W. G. (RHYL)** notices that when not employing reaction with the S.T. 100 receiver, that is, with the aerial and anode coils as loosely coupled as possible, the removal of the 100,000 ohms resistance slightly increases signal strength.

The function of the 100,000 ohms resistance in the ST100 receiver is to stabilise the set should there be any tendency towards self-oscillation. It follows, therefore, that when minimum reaction effects are obtained by placing the coils at right angles, the removal of the stabilising resistance will permit of this inherent reaction effect being obtained. Signal strength should, therefore, be improved under these conditions, as our correspondent has found in practice.

**H. F. (WORCESTER)** has constructed the "Anglo-American Six" but finds that 3 H. F. stages are unnecessary in his case, and asks us to supply a wiring diagram to convert the set into a 2 H. F., detector and 3 L.F. stages type of instrument.

The alteration our correspondent desires to his set is one that we

cannot advise, and it would not be satisfactory for us to give a wiring diagram for this purpose. The design of any receiver utilising an H.F. stage or stages is one calling for a considerable amount of experimental work, and before we could give a wiring diagram it would obviously be necessary to re-design, re-wire and test the arrangement. This is obviously impracticable in an individual case. It has been found in practice by various members of the Radio Press staff that the construction of a neutrodyne receiver utilising two high-frequency stages differs considerably from one in which three are incorporated. The reading of the anode condenser directly preceding the detector valve is always found to be higher than that obtained for any other stage, and it follows, therefore, that the double condenser in the "Anglo-American Six" could not well be utilised, whilst the layout of the set would have to be considerably altered. Three low-frequency stages could be obtained with less likelihood of trouble, provided that such an arrangement as one transformer and two resistance-coupled valves was employed, but this amount of low-frequency amplification should not be necessary unless considerable volume is required.

## A Method that eliminates failure

Building one's set to Radio Press Envelope specifications is an absolute fool-proof operation. The simple and concise instructions they contain, together with numerous illustrations and wiring diagrams, ensure a set perfect in every detail.

The novice will find Radio Press Envelopes of great assistance, making set building almost a mechanical operation.

Radio Press Envelopes are obtainable from all Bookstalls, Newsagents, your local Wireless Dealer, or direct from Dept. S., Radio Press, Ltd.

**RADIO PRESS LTD.**  
BUSH HOUSE,  
STRAND, LONDON, W.C.2

### RADIO PRESS ENVELOPES.

No.		Post Price. Free.
1	How to Build an ST100 Receiver By John Scott-Taggart, F.Inst.P., A.M.I.E.E.	1/6 1/9
2	How to Build the "Family" 4-Valve Receiver By Percy W. Harris, M.I.R.E.	2/6 2/9
3	How to Build the "Simplicity" 3-Valve Set By G. P. Kendall, B.Sc.	2/6 2/9
4	How to Build the All-Concert de Luxe Receiver By Percy W. Harris, M.I.R.E.	2/6 2/9
5	How to Build the Omni Receiver By John Scott-Taggart, F.Inst.P., A.M.I.E.E.	2/6 2/9
6	How to Build the ABC Wave Trap By G. P. Kendall, B.Sc.	1/6 1/9
7	How to Build a 2-Valve Amplifier de Luxe By Herbert K. Simpson.	1/6 1/9
8	How to Make a 1-Valve Reflex Receiver By Herbert K. Simpson.	1/6 1/9
9	How to Build an Efficient Single-Valve Set By Herbert K. Simpson.	1/6 1/9
10	The Twin-Valve Loud-Speaker Receiver By John Scott-Taggart, F.Inst.P., A.M.I.E.E.	2/6 2/9
11	An Adaptable Crystal Set By Percy W. Harris, M.I.R.E.	1/6 1/9

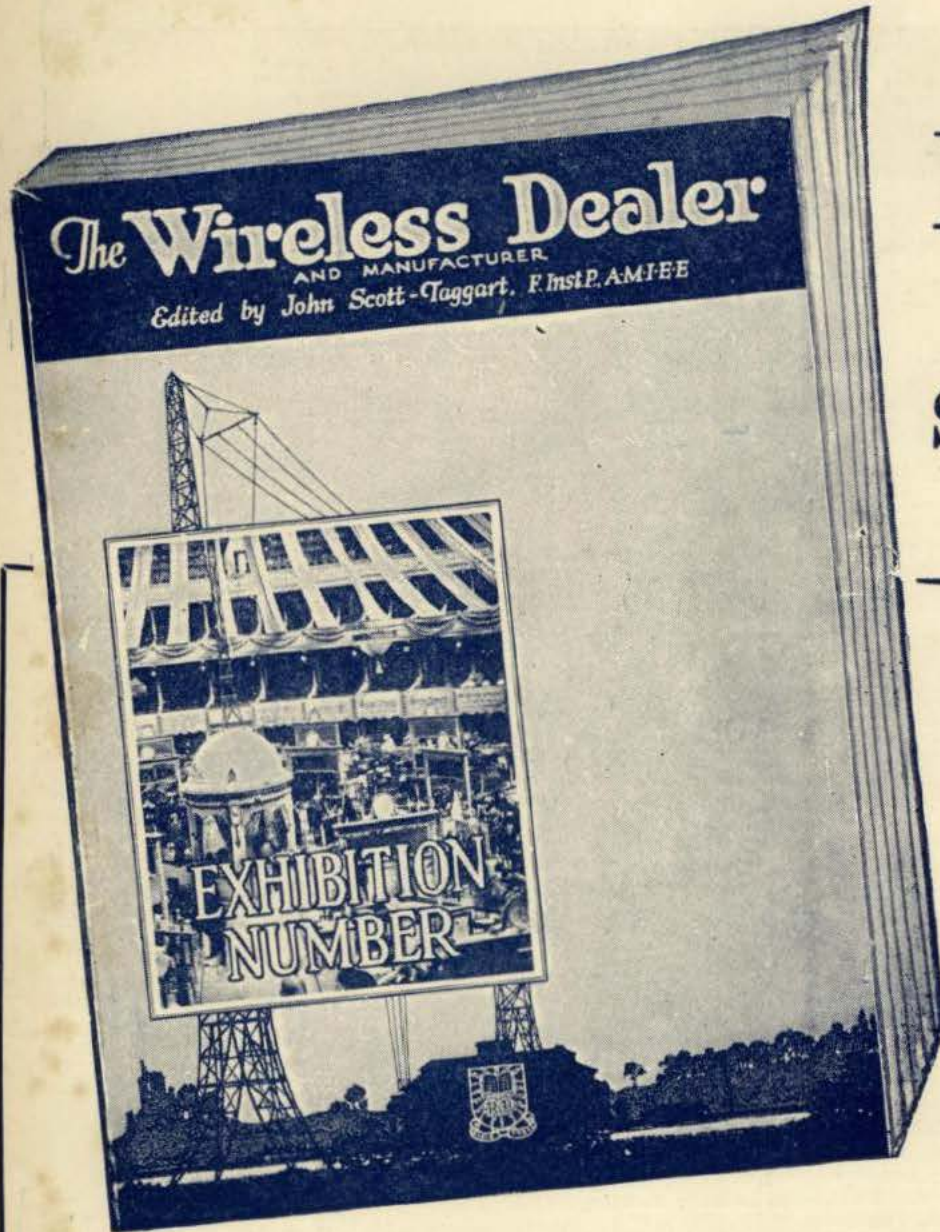

# No. 1 OUT SEPT. 12TH

## EXHIBITION NUMBER

*Send your  
subscription  
immediately  
for this new  
Radio Press  
TRADE  
MONTHLY*

THE WIRELESS DEALER will prove of great value to retailers and manufacturers. It will contain advance information on what the enthusiast is likely to require in the future, thereby enabling the dealer to cope with large demands. Radio Press Research and Test Laboratories under the supervision of MAJOR JAMES ROBINSON, D.Sc., Ph.D., F.Inst.P., Etc., and a fully qualified staff, will provide a wealth of information of great value to every dealer.

Every Dealer, if he is to maintain his position in these competitive days, must have the very latest and best information relative to technical developments in wireless. We are prepared to guarantee this for a year for the small payment of 7/6, which hardly covers the cost of the paper on which the periodical is printed.

Copies can be obtained only by entering a subscription. It will not be available to the public and will therefore not be on sale at bookstalls. The Subscription List is now open. Kindly complete the form below and post, together with remittance of 7/6 (10/- abroad) and ensure the receipt of copies for twelve months from No. 1.

**FILL IN THE ORDER FORM NOW** 



**SUBSCRIPTION ORDER FORM.**

Radio Press Ltd.,  
Sales Department, Bush House,  
Strand, London, W.C.2.

I enclose my remittance for a twelve-monthly Subscription  
to "The Wireless Dealer" commencing with No. 1, September  
1925, in the sum of 7/6 (10/- abroad).

NAME.....  
ADDRESS.....

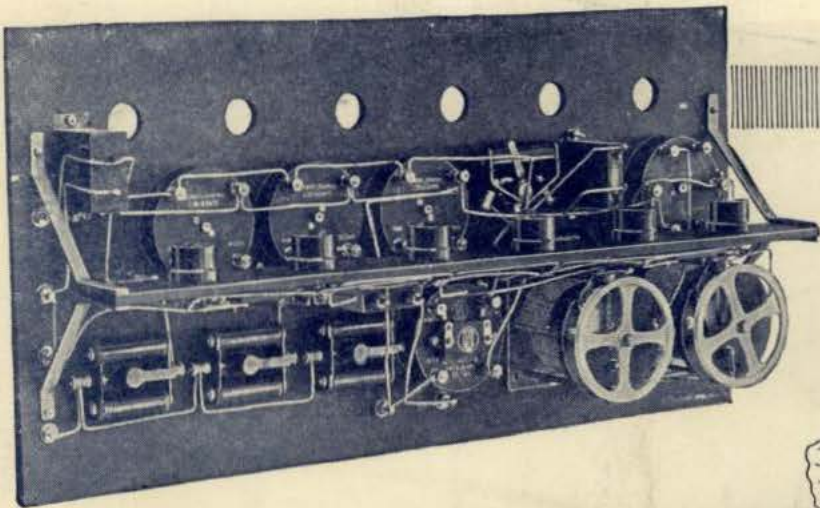

## THE SUPER-HETERODYNE PARTS YOU WANT

In placing the R.I. Super-heterodyne parts on the market many thousands of enthusiasts will receive the benefit that they have already enjoyed from the designers of the first high frequency intervalve components placed on the British market.

The R.I. Super-heterodyne Transformers will become famous for their remarkable stability and minimum stray field losses. It is essential in super-heterodyne circuits that the energy from the primary circuit of intervalve transformers be transferred as fully and quickly as possible to the grid of the succeeding valves.

In the R.I. units there is a greater freedom from self-oscillation with a maximum amplification per stage. The R.I. winding eliminates sharp amplification peaks, and enables easier tuning.

PRICE PER SET OF 3 TRANSFORMERS **£3 0 0**

## THE R.I. OSCILLATION COUPLER

Consists of a specially wound anode and grid circuit and the efficiency of the Coupler is such that practically no attention need be paid to filament and anode voltage, due to the adjustments necessary not being critical. In addition to this, there is a smaller winding which can be connected in the earth lead of the aerial or frame coil circuit.

It is intended that a variable air condenser should be connected across the grid coil, the capacity of this condenser being '0005. PRICE **25/-**

## THE R.I. COMBINED OSCILLATING UNIT

Comprises a low-loss efficient variable air condenser of '00025 mfd. capacity connected to the most efficient grid anode and coupling circuit.

The windings are all of 9/38 double silk stranded and enamelled wire; therefore the efficiency of this coupling is as high as possible in the dimensions.

Panel mounting is by one-hole fixing. PRICE **35/-**

## The R.I. FILTER

PRICE **25/-**

We feel confident that there are no units on the British market giving the same quality and results as the R.I. Super-heterodyne units.

With each set of components a full diagram of connections is given, which enables one to get the best out of the Super-heterodyne circuit.

Full Particulars Free on Application.

VISIT OUR STAND, No. 36,  
All-British Wireless Exhibition,  
ROYAL ALBERT HALL, Sept. 12th to Sept. 22nd



**12 HYDE ST NEW OXFORD ST LONDON W.C.1.**

Contractors to the Admiralty and all Government Departments

Printed for the Proprietors, RADIO PRESS, LTD., of Bush House, Strand, W.C.2. by THE AVENUE PRESS (L. Upcott Gill & Son, Ltd.), 55-57, Drury Lane, W.C.2. and Published by the Proprietors, RADIO PRESS, LTD., at Bush House, Strand, W.C.2. on Wednesday of each week. Address for Subscriptions and Editorial Communications:—Bush House, Strand, London, W.C.2. Advertisement Managers:—BARCLAYS ADVERTISING LTD, Bush House, Strand, London, W.C.2. Registered as a newspaper and for transmission by Canadian Magazine Post. Subscription rates:—32/6 per annum, 16/3 for six months, post free. Sole Agents for Australasia:—GORDON & GOTCH (Australasia) LTD. For Canada:—IMPERIAL NEWS, LTD. For South Africa:—CENTRAL NEWS AGENCY, LTD. For Japan:—SALE & FRAZER LTD.