

Wireless Weekly

Vol. 5.
No. 8

CONTENTS

Two-Valve Amplifier of
New Design.

Making Your Own H.F. Trans-
formers.

High Tension Supply from D.C.
Mains.

Another Circuit on the Omni
Receiver.

Notes on Transmitting Valves.

Jottings by the Way, Valve Notes,
Random Technicalities, Corres-
pondence, Apparatus We Have
Tested, Information Department,
etc., etc.



Free Photogravure Supplement

Issued by the Publicity Department of Burndept Ltd.

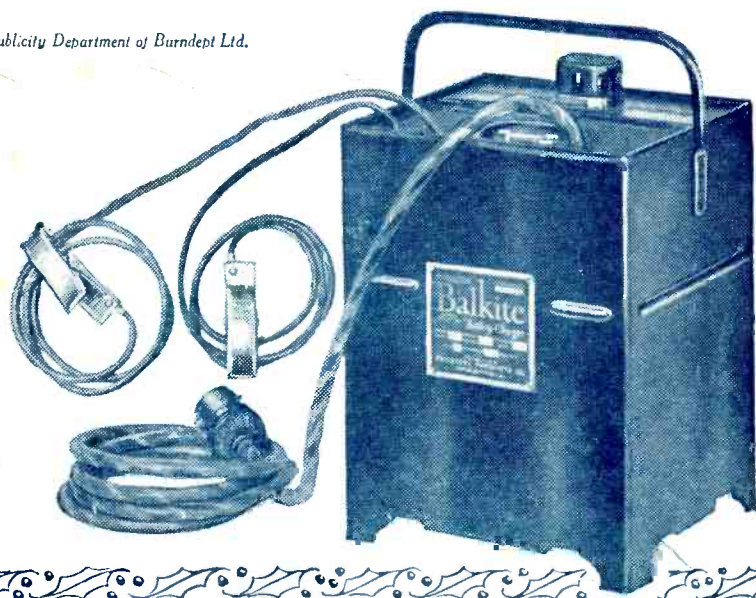

No. 491. Balkite
Battery Charger.
200-240 volts, 50-60
cycles (alternating
current). Without
acid or oil.

£5 15s. 0d.

The most acceptable Christmas present for anyone who has a valve set—this *noiseless* Battery Charger

YOUR wireless set will give the best results if you keep your battery fully charged—and the life of the battery will be considerably prolonged. If your electric supply is alternating the Balkite Charger is the cheapest, simplest, cleanest and most convenient method—you only plug it into your electric light socket.

This Christmas, your wireless set will be working "overtime," and you do not want your accumulator to run down at a critical moment. The Balkite Charger will enable you to charge your battery just when you wish to do so, and will save you from being inconvenienced.

The Balkite Charger is entirely noiseless. It is based on a new principle, the use of Balkite, a rare metal which changes the ordinary A.C. current used for lighting to the D.C. current necessary for charging accumulator batteries,

without the use of noisy vibrators, contact points, fragile bulbs or valves.

This Charger has no moving parts, and nothing to break, adjust or get out of order. It cannot deteriorate through use or disuse. It delivers a taper charge, and cannot discharge, shortcircuit, or damage the battery by overcharging. It needs no attention other than an occasional filling with distilled water. Its operation does not create disturbances in your set or your neighbours. It is simple, efficient, cannot fail to operate if properly connected, and is practically indestructible except through abuse.

It operates on a supply from 200-240 volts, at a frequency of 50-60 cycles. Several other voltages and frequencies can be supplied to order. The charging rate being $2\frac{1}{2}$ -3 amps., a 6-volt 50-ampere accumulator will be completely charged in 20 hours at a cost of less than $\frac{1}{2}$ d. per hour.

The Balkite Charger can be obtained through leading radio dealers everywhere and at Burndept Agents and Branches.

BURNDEPT LTD., Aldine House, Bedford Street, Strand, London, W.C.2

Telephone : GERRARD 9372 (Private Branch Exchange). Teleg-ams : BURNDEPT, WESTRAND, LONDON.

LEEDS : 12, Basinghall Street, (near City Square). CARDIFF : 67, Queen Street. NORTHAMPTON : 10, The Drapery.

BURNDEPT

WIRELESS APPARATUS



Wireless Weekly

Radio Press, Ltd.
BUSH HOUSE, STRAND, W.C.2
Tel.—City 9911.

Assistant Editor:
PERCY W. HARRIS.
Scientific Adviser:
Prof. G. W. O. HOWE,
D.Sc., M.I.E.E.
Advisory Editors:
Prof. K. WHIDDINGTON,
M.A., D.Sc.
Prof. C. L. FORTESCUE,
M.A., M.I.E.E.

Staff Editors:
E. H. CHAPMAN,
M.A., D.Sc.
A. D. COWPER,
M.Sc.
R. W. HALLOWS,
M.A.
G. P. KENDALL,
B.Sc.
S. G. RATTEE,
Member I.R.E.



EDITED BY JOHN SCOTT-TAGGART, F.Inst.P.,
A.M.I.E.E.

Vol. 5, No. 8

DECEMBER 10, 1924.

Price 6d. net.

Too Much S.B.

SIMULTANEOUS broadcasting from all stations of a programme produced at one—more often than not at London—and commonly referred to as "S.B.," has long since lost its novelty. On all hands we hear complaints that there is "too much simultaneous," and it may well be asked why S.B. occurs so frequently in the programmes.

We must always remember that the great majority of listeners are primarily interested in good, clear, reproduction of a programme which has a broad appeal. In nine cases out of ten the quality of S.B. is far inferior to that of the direct transmission—sometimes it is so bad that it is scarcely worth listening to. Of course, S.B. is economical, and in the early days of broadcasting, when rigid economy was necessary, its frequent use could be understood. At the present time, with a large and assured revenue, such arguments for economy carry little weight. As indicated above, the novelty has passed, so that there only remains as a justification the possibility of exceptionally good programmes which transcend in interest and value those which are sent out from the local station. In our opinion the items sent out S.B. rarely justify the prominence thus given them.

As so many S.B. transmissions originate in London, listeners in the area served by this station are not fully aware of the exasperation caused in provincial centres by the frequent S.B. from London.

So far we have purposely omitted mention of any inconvenience to

experimenters who are working for the improvement of the art. It is, of course, impossible to test out a receiving circuit on different stations when the same programme is being sent from all. In our opinion this argument against S.B., although often advanced, does not carry any great weight, for there are many evenings when stations

phone recitals in the midday programmes? We have often referred to the many objections arising from the transmission of gramophone records. It is upon the midday transmissions that dealers so frequently rely when demonstrating their apparatus to likely customers, and nothing is more disconcerting than to see a possible customer walk out in disgust for no other reason than that the transmission to which he or she has listened is "exactly like an ordinary gramophone." The lunch-hour programmes should be carefully designed to give the best possible impression to newcomers to the art—at present we have the impression that they are looked upon as a necessary nuisance to be run through with the least trouble and difficulty to everyone.

Finally, we have the ever-present complaint of the mediocrity of the humour in the broadcasting programmes. With one or two brilliant exceptions the "entertainers" are of the "parish-hall" type. Their feeble songs and even feebler jokes not only resemble one another in a remarkable fashion, but what is worse, the same jokes are often repeated within a day or two by different entertainers. Incidentally, some of these "turns" are not free from vulgarity. We would also suggest that the B.B.C. turn their attention to the Children's Hour, which seems to be losing its appeal to many of the little ones, possibly due to the fact that the copious back-chat between Uncles and Aunties can only be appreciated—if at all—by older listeners.

CONTENTS	
	Page
Some Notes on Transmitting Valves	270
Jottings by the Way	273
What is the Best Wireless Weather?	275
The ST152 Circuit on the Omni Receiver	276
Supersonic Heterodyne Reception in Theory and Practice	278
Random Technicalities	281
Valve Notes	283
Useful Panel Supports	285
Photographs by Wireless	286
A Two-Valve Amplifier for Pure Reproduction	287
High-Tension from D.C. Mains	294
How to Make a Highly Efficient H.F. Transformer	297
Correspondence	299
Apparatus We Have Tested	302
Information Department	305

are transmitting their own programme and when tests can be carried out adequately.

Concerning the programmes and their quality it is generally recognised that the technical excellence of the transmissions is excelled in no other country. Why, therefore, should we still be treated to gramo-

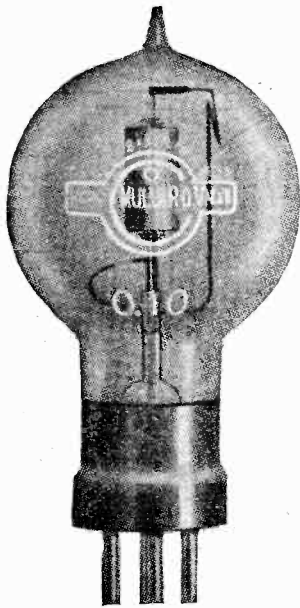

Fig. 1.—The Mullard 0/10 valve.

MANY wireless experimenters are no longer satisfied with receiving wireless signals, but are in increasing numbers working on the problems involved in the transmission of Morse signals and speech.

The Mullard Radio Valve Co. have a large selection of valves suitable for transmission, and the purpose of this brief article is to give working particulars of them.

Technical Terms

To explain some of the terms used in connection with transmitting valves, let us suppose we have a transmitting station and we will divide it, for the purpose of this article, into three parts, viz., the generator or H.T. battery, the valve itself, and the aerial system. Neglecting for the time being the battery system that provides power for heating the filament, we can say that the generator or H.T. battery provides all the power utilised in the station, and this power is transferred to the valve and the aerial system. With an ideal, but unattainable outfit, all this power would appear in the aerial and none in the valve, because that used in the valve is waste, whilst that generated in the aerial is chiefly useful power. The waste power in the valve appears as heat developed at the anode, and usually transmitting valves are designed to work with the anode at a dull red heat. It is possible to design

**Some Notes on
Transmitting
Valves**

transmitting valves that work relatively cool, but they must then possess larger anodes and larger bulbs, and, generally speaking, they are not so efficient as the valve with the smaller anode.

As mentioned earlier, the power developed by the generator is passed to the valve, and thence to

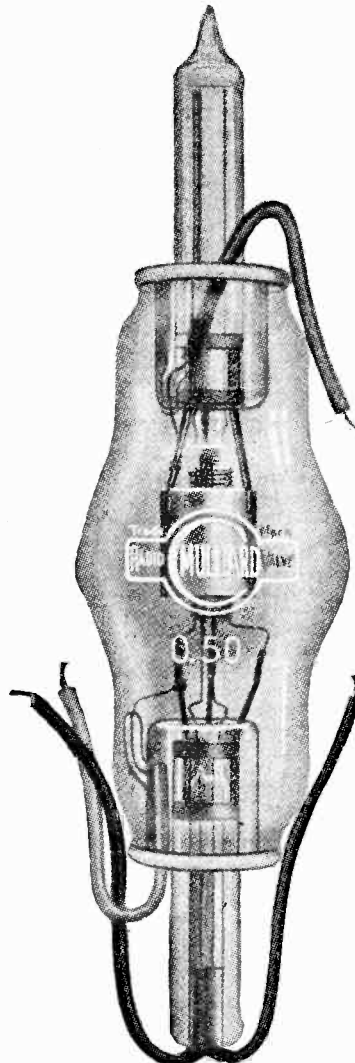

Fig. 2.—The 0/50 valve with renewable filament construction.

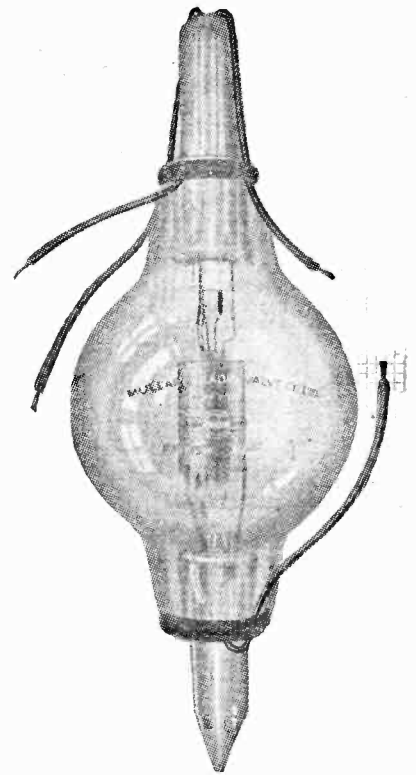

Fig. 3.—The 0/150, a medium power valve.

the aerial system, and in this process the valve unavoidably wastes some of the power. The relative amounts of power wasted in the valve and delivered to the aerial depend upon the efficiency of the circuits used. With inefficient circuits more power may be wasted in the valve than is utilised in the aerial, but with efficient circuits the valve wastes one unit of power for every two (or more in very efficient circuits) that reach the aerial.

Power Rating

Now there is a limit to the power that the valve can waste without injury to itself. The waste, as we have seen, is spent in heating the anode, and, incidentally, the valve envelope. If the power wasted in the valve is excessive, either the anode melts or the vacuum is spoilt. It is this power wasted in the valve that determines the valve rating. For example, a valve designated as a 50-watt valve is capable of wasting 50 watts within itself and, with efficient circuits, of delivering at least 100 watts to the aerial, and requiring a generator capable of delivering 150 watts of power.

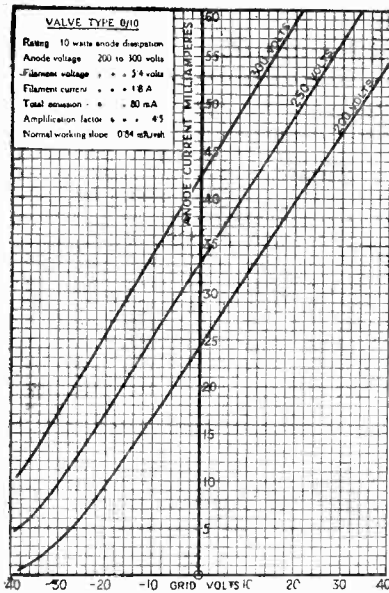

Fig. 4.—Characteristic curves of the 0/10 valve.

Transmitting valves are usually worked with a grid leak in the circuit so that the grid is maintained at a negative potential during oscillations. With a grid leak in the circuit it is possible to use higher plate voltages, and in general to work the valve more efficiently.

Low-power Transmitting Valves

The Mullard Radio Valve Co. make a series of low-power transmitters with ratings from 5 to 50 watts, viz., the 0/5, 0/10, 0/15, 0/20, 0/30A, 0/30B, 0/40, and 0/50. Working data concerning these valves will be given later. (See Table I, Figs. 1 and 2, 4 and 5.)

The 0/50 valve differs from the others in that the 4-pin cap is no longer used, but a patented construction is made use of which permits a burnt-out filament to be removed and a new one inserted without removing the other electrodes. Fig. 2, which illustrates the 0/50 valve, shows the long re-entrant glass tubes supporting the filament. They serve another useful purpose in ensuring high insulation between the electrodes by increasing the distance between the lead-in wires of the various electrodes. This type of valve is economical to use, for the price of the renewal of filament is considerably less than that of a new valve.

The medium-power transmit-

* * *

In our issue Vol. 5, No. 2 the Marconi Osram Company furnished particulars of their transmitting valves. In this article the Mullard Company afford similar interesting information on their products.

* * *

ters of the Mullard Radio Valve Co. are also made with this construction. There are four in this group, viz., 0/150, 0/250, 0/350, and 0/500 valves. These valves are rated somewhat differently. They were originally made for Morse signalling, and during this operation the valves are in operation discontinuously. The Morse rating for these valves is somewhat higher than the figures quoted, viz., 175, 300, 450, 600, and the continuous rating (like that applying to the 0/5 to 0/50 valves) about half these figures.

Dissipation

For example, the 0/500 will dissipate safely 300 watts continuous working, and about 600 watts Morse keying, and the aerial will receive respectively at least 600 watts and 1,200 watts. (See Figs. 3, 6 and 7.)

The 0/150 watt valve is shown in Fig. 3. It will be observed that the sealing-off pip is not on the

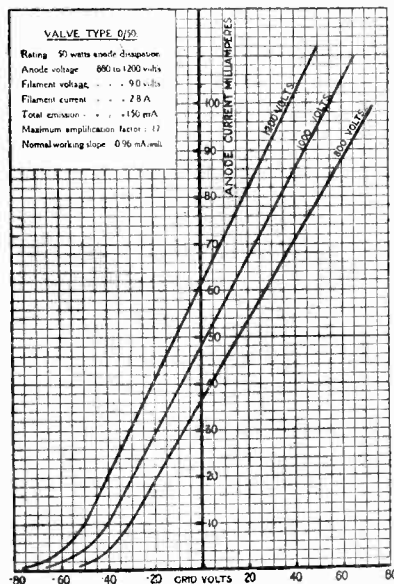

Fig. 5.—Curves of the 0/50 valve.

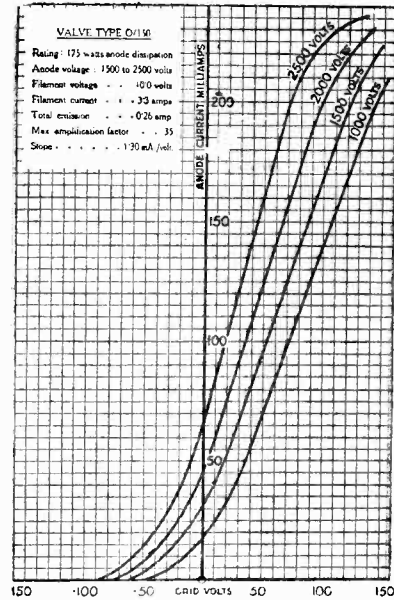

Fig. 6.—Characteristics of the type 0/150 valve.

side of the bulb, but is arranged as a continuation of one of the re-entrant tubes. This greatly reduces the risk of breakage of the sealing point due to faulty annealing on the thin wall of the bulb, which trouble was liable to occur in the older types of transmitting valves with the sealing point on the side of the bulb.

Silica Valves

For valves of higher power than this, glass was no longer suitable as an envelope, and the Mullard Radio Valve Co., working in conjunction with the Admiralty, developed valves in Silica envelopes. Silica, or fused quartz, has a much higher melting point than glass, which makes it possible to have the anode much closer to the envelope without the danger of the envelope softening when the valve is working with the anode hot. There are three transmitters in the group of Mullard high-power valves, viz., the 0/1 kw., 0/2½ kw., and the O.C./2½ kw., and each of these will dissipate their rated value continuously. These valves deal with enormous power, and are fitted in both Government and private stations throughout the world.

The 0/2.5 kw. Valve

The 0/2.5 kw. transmitter is shown in Fig. 8, and its characteristic curves in Fig. 9.

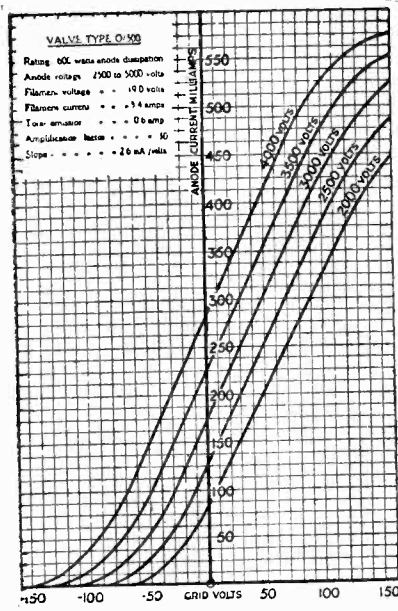

Fig. 7.—Curves of the 0/500 valve.

From this comprehensive group of valves the experimenter is sure to find one to suit the power supply he has available, and fitted also for the purpose he has in view.

A series of power rectifiers for use in conjunction with these valves is also made by the Mullard Radio Valve Co.

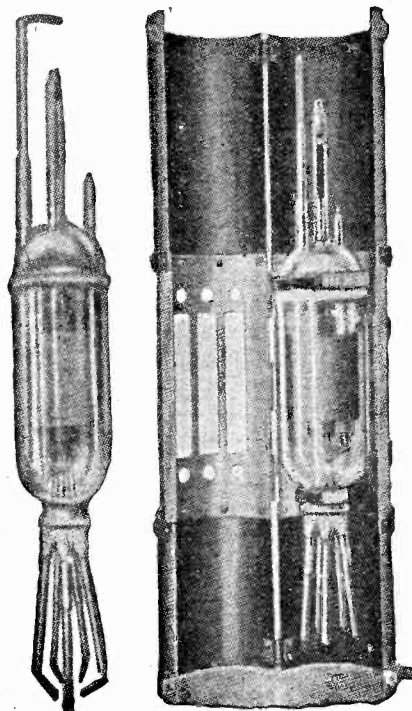

Fig. 8.—The Mullard type 0/2.5 kw. Silica valve.

TABLE I.
Valve Data (Low Power Transmitters).

Valve Type.	Filament Approx.		Anode.			Maximum Overall.			
	Volts.	Amperes	Emission Millmps.	Watts Dissipation.	Voltage.	Length.		Diameter	
						Ins.	mm.	Ins.	mm.
0/5	5.0	0.75	35	5	200 to 400	4 1/4	108	2 1/8	55
0/10	5.4	1.8	80	10	200 to 300	5 1/8	130	2 3/8	60
0/15	5.0	0.95	45	15	500 to 700	4 3/8	114	2 1/8	53
0/20	5.4	1.8	80	20	200 to 400	5 1/8	130	2 3/8	60
0/30A	5.4	1.8	80	30	1,000 to 1,200	5 1/8	130	2 3/8	60
0/30B	7.0	2.4	120	30	400 to 600	5 1/8	136	3	75
0/40	7.0	2.4	120	40	600 to 800	5 1/8	136	3	75
0/50	9.0	2.8	150	50	800 to 1,000	11	280	3	75

TABLE II.
Valve Data (Medium Power Transmitters).

Valve Type.	Filament Approx.		Anode.			Maximum Overall.			
	Volts.	Amps.	Emission Amps.	Watts Dissn. Morse Rating.	Volts.	Length.		Diameter	
						mm.	Ins.	mm.	Ins.
0/150	10	3.2	0.26	175	1,500 to 2,500	320	12 1/2	101	4
0/250	12	5.2	0.45	300	2,000 to 3,500	370	14 1/2	127	5
0/350	18	5.3	0.50	450	2,000 to 4,000	470	18 1/2	153	6
0/500	19	5.4	0.60	600	2,500 to 5,000	470	18 1/2	153	6

TABLE III.
Valve Data (High Power Silica Valves).

Valve Type.	Filament Approx.		Anode.			Maximum Overall.			
	Volts.	Amps.	Emission Amps.	K. W. Dissn. Morse Rating.	Volts.	Length.		Diameter.	
						Cms.	Ins.	Cms.	Ins.
O 1 KW	14	10	0.6	1.5	4,000	60	24	8	3 1/2
O 2.5 KW	16	14.5	1.0	3.5	6,000	60	24	10	4
OC 2.5 KW	18	40	3.0	4.0	8,000	68	27	10	4

The Radio Society of Great Britain

An Informal Meeting of the Society will be held at the Institute of Electrical Engineers, Savoy Place, W.C.2, at 6 p.m. to-day, on which occasion Mr. W. K. Alford will give a talk on the Supersonic Heterodyne.

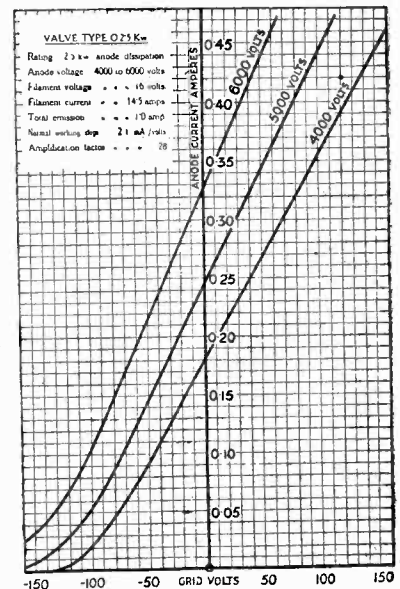
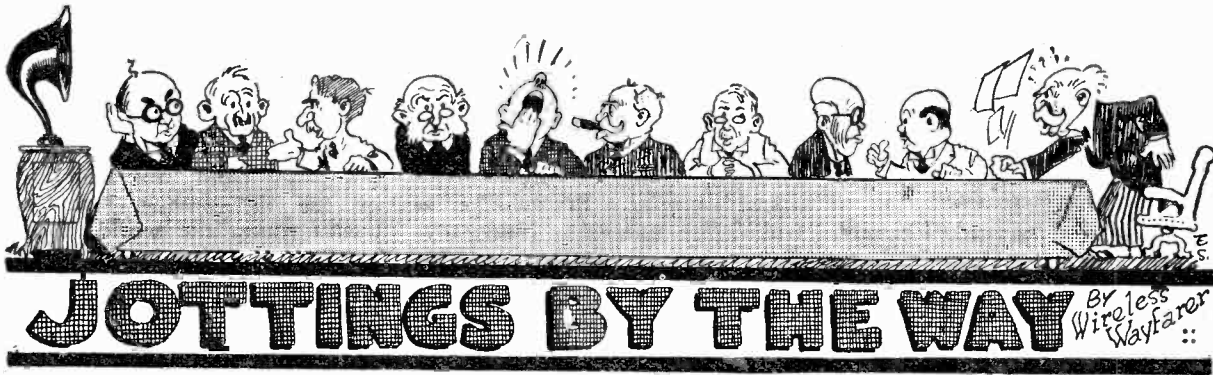

Fig. 9.—Curves of the 0/2.5 kw. valve.



A Changed Town

WE in Little Puddleton have been passing recently through a rather difficult time, for the house of every real wireless man in the place—and that means, as you know, every member of the population—has been servantless for some weeks. It all came about when with envious hearts we read that other amateurs had been the first to receive signals from the far side of the world and to get messages across. It was decided unanimously at the Club that every effort must be made to wipe out this blot on our escutcheon at the earliest possible moment.

A Difficulty

But here a difficulty arose. It appears that the best time for receiving Antipodean waves is somewhere about five o'clock in the morning. Now there are two ways of being at your wireless set at this rather horrible hour. The first is to sit up and the second is to get up. It was

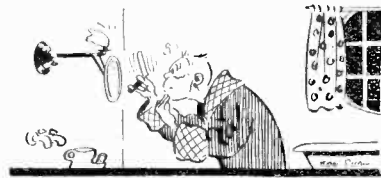

... shaving by gaslight on chilly mornings ...

Admiral Whiskerton Cuttle who pointed out to the meeting that though it was quite seemly to receive and transmit after dinner it was certainly hardly decent to do so before breakfast. Now between the ordinary kind of dinner-time and five in the morning there is a great gap, and even we at Little Puddleton, wedded though we are to science, must occasionally stay the inner man with food. The Admiral therefore proposed, and Pod-

dleby seconded, that members should be requested for the future to dine at midnight. The proposal was carried unanimously. This, as you will readily see, has had a far-reaching



... lured our servants away ...

effect upon the life of the town. Under the new scheme we breakfast at 1 p.m., have luncheon at 5.30, partake of afternoon tea at 8.30 and sit down to dinner on the stroke of twelve. This was, in many ways, a most excellent arrangement, and we all welcomed it, for it meant, in the first place, that nobody need rise until all dusting, scrubbing, polishing and such like was finished and done with; secondly, that shaving by gaslight on chilly winter mornings became a thing of the past; thirdly, that it was now possible for us to enjoy American broadcasting at meetings of the Club, which we held at half-past one in the morning; and, fourthly, that the utterly useless hours of daylight were reduced to the absolute minimum. We did, in fact, name our new scheme the Darkness Saving Movement, and there was considerable talk at one time of having a Bill introduced in Parliament to make it national instead of merely Little Puddletonian.

Breakers Ahead

The chief snag that we encountered was in the attitude of our domestic staffs, who refused resolutely to see how they were to benefit by the change.

The neighbouring hamlet of Bilgewater Magna got news of the unrest that filled the air. Its inhabitants, I am sorry to say, seldom play the game, and on this occasion they showed a more than usually unsporting spirit. By promising to have their meals at ordinary times and not to introduce reforms, they lured our servants away in a body and left us to fend for ourselves. We were, of course, determined that no little *contre-temps* of this sort would be allowed to stand in the way of progress. All of us undertook to do the bulk of the housework and the cooking in our own establishments. My own culinary attainments do not run beyond the buttering of eggs and the frying of sausages. My household subsisted on these two dishes for a fortnight, after which time my wife went off for a long visit to her mother.

Domestic Strife

Poddleby, who cannot claim to be quite so accomplished a chef



... Professor Goop tripping over the door-mat ...

as myself, fed his family on sardines, Worcester sauce and tinned tongue. Mrs. Poddleby is now living with her sister in Bilgewater Magna, and the young Poddlebys have been sent away to boarding schools. Little Puddleton at the present moment has a population that is almost entirely masculine. We all of us look a little wan, chiefly I think owing to the fact that we never see the sun, but possibly

also because there are not sufficient whatyoumaycallems in our diet. But what, after all, does a pale complexion more or less or a hobnailed liver matter so long as wireless goes forward?

Our Records

I am sorry to say that I cannot record as yet any undoubted reception of signals from the people on the opposite side of the globe. We have all been trying very hard with all manner of circuits, and though Gubbworthy tells everybody that he heard loud and distinct signals from Dunedin the other morning which he was unable to read perfectly, owing to his limited acquaintance with Morse, nobody believes him. I myself quite thought that I had registered a success a couple of days ago when dots and dashes came through slowly enough even for me to be able to read them. The message that set my heart leaping as I spelt it out said, "New Zealand calling. Hullo, Wayfarer, old bean, how are you?" The wavelength, as measured by my super-Harrisdyne wavemeter, was exactly 101.2263 metres. I therefore tuned my transmitter and sent a suitable reply. I was just thinking of how I would astonish them at the Club when the dots and dashes began again, and this time they tapped out, "Bet I had you that time. This is Gubbworthy key wag-gling."

All Records Broken

But if we have not received New Zealand so far, we have accomplished a very much greater feat. The other evening, rather I should say the other early morning, when the club was holding a meeting, the door was suddenly flung open, and Professor Goop, tripping over the doormat, fell flat on his face before the chairman's seat. The General picked him up with his usual courtesy, and explained that it was really unnecessary for members to show their respect for the chair by prostrating themselves in this way. Professor Goop was inarticulate for some moments; but when, with the aid of a buttonhook, we had fished up his half-swallowed false teeth he was able to tell

us something of the marvellous feat which he had just achieved.

A New Epoch

"I have done it at last," he said simply. "Done what," we all cried. "Got New Zealand?" asked Bumbleby Brown. "Australia?" queried Snaggsby. But the Professor smiled.



... Poddleby can never see his feet ...

"No," he said slowly. "I have done something much greater than that. This evening marks a new epoch in the history of wireless. It happened some hours ago, but I did not care to spread the good news until I had verified all my calculations. I have accomplished the greatest long-distance feat in wireless reception that has ever yet been recorded." By this time we were all agog with excitement. "It must be New Zealand at last," said Poddleby, "for you cannot get a greater distance than that." "It is not New Zealand," said the Professor, "and you can get a very much greater distance." "Tell us, tell us," we shouted in chorus. The Professor waved his hand for silence, motioning us to resume our seats.

How it was Done

"Before I tell you everything," said Professor Goop, "I would like to go a little into the theory of the question and to



... I need hardly say who blushed ...

describe to you the new circuit, which, with the help of my distinguished colleague, Wayfarer, I have evolved for long-distance work." I blushed suitably, and the Professor proceeded. I cannot remember his exact words, but his statement of the theory was something on these lines,

Light waves, save when Professor Einstein catches them bending, travel in straight lines. This is why Poddleby, who is inclined to adiposity, can never see his boots. Wireless waves, on the other hand, are bent back by the thingamejig layer and hustle round the world, following its curved contours. So far the whole house was with him. But when the Professor dashed to the blackboard and began to do appalling calculations about $\text{Cos } \phi$ and $\text{Sin } \theta$ and things of that sort, we all looked intelligent, and said, "Yes, yes," or "Oh, of course," at intervals without really grasping, I must confess, what he was trying to convey.

The Professor Justified

The Professor beamed, looking at us over his glasses. "I am sorry to see," he said, "that you are so impatient, for I would have liked to elaborate the theoretical point which I was demonstrating. However, since the meeting desires to know I will tell you. My friends, I have received 2LO." "2LO!" we shouted. "But, good heavens! Professor, that's only thirty miles away." "Thirty miles," said the Professor genially, "for you, yes; but for me, no; as I will show you. Wireless waves, as I have demonstrated, travel round the world. Now I have arranged to receive 2LO's transmissions not as they leave him, but as they come back again after having made one complete circuit of the globe. By means of an ingenious little arrangement of screens, perfected with the aid of a friend who I need hardly name (I need hardly say who blushed again), I am able to rid myself of 2LO's direct transmissions and to receive his programmes after a journey through the ether that is nearly double that of transmissions from New Zealand or Australia. If we take it that the circumference of this world of ours is 24,000 miles, then the Antipodes are a mere 12,000 miles away. By means of my screens I now receive 2LO at a distance of 24,000 minus 30, that is to say at 23,970 miles." I do not think that I need tell you more. You will realise at once that Little Puddleton has once again scored,

WIRELESS WAYFARER.

What is the Best Wireless Weather?

By M. J. CAVENEY (Canadian 3GG)

Some final remarks upon this interesting subject.

(Concluded from p. 208)

Clouds

Many lovers of radio prefer clear bright nights and others favour a dark cloudy night. Let me tell them that the records show that first-class reception has been tabulated on innumerable occasions with both clear and cloudy nights, with the balance in favour of a night with low-lying rain or snow clouds after a generally cloudy day which seems to prevent the bright sun from sucking the life out of the air.

Rain

No evidence is at hand that rain helps or hinders radio transmission. Rain is generally prevalent after a barometer decline, and very often also when the glass is recovering after a bad "low." However, we find that DX can be brought in during a deluge, whereas again, very poor work on the receiver will be recorded under like conditions.

Snow

Usually the majority of snowy nights are good, but so is the season during which snow is encountered.

Blizzards have a bad habit of tying up reception, on first thought, until we note that it is the falling barometer that foretells the blizzard, so why blame the blizzard?

Wind

Severe fading has been noticed on many nights during a high wind, and on quoting figures we find that fading appeared on 83 nights out of 100 nights that signals were known to be swinging.

I am prone to blame quite a deal of this upon aerial systems both at the transmitting and receiving ends. A high diving or fast climbing barometer invariably brings winds ranging from a brisk breeze to a young tornado

and a characteristic symptom of unsettled weather is the slow "fade out" of our music, which appears to leave us and go somewhere to recoup its strength and after periods ranging from 15 and very seldom not more than 90 seconds, return to us with apparently renewed vigour. It might be interesting to note here that very often when a station fades from the East coast receivers it is reported strong to the West of the transmitter, and vice versa.

Northern Lights

While the Northern Lights may have a lot to answer for in the way of interfering with telegraph and cable communication, the records reveal nothing substantial in the way of evidence to show that they are very detrimental to radio reception.

Both excellent and poor reception have been our lot when the Lights have been playing. I will quote the logs of some exceptionally unique displays:—

October 14, 1922, 11.5 p.m.—North Lights magnificent to-night, swinging low in broad curtains of varied colours, coming from the N.W. horizon to the S.E. Some curtains sweep so low a hissing crackle is plainly heard overhead. Reception is splendid to-night.

March 26, 1923, 11.30 p.m.—North Lights making wonderful picture to-night. Dogs are loaded with static, sparks flying from ears, nose and tail when fur is rubbed. Radio is simply rotten.

Phases of the Moon

It may not be generally known that the first quarter of the moon surely earned a bad reputation in 1923 as a breaker up of good radio weather. Look at these records:—

January 24, 1923.—Reception has fallen off considerably to-

night.—First quarter of the moon.

February 23, 1923.—First quarter of the moon.—No radio concerts heard at all for three nights after that date.

March 26, 1923.—First quarter of the moon.—Hardly a radio station in the world for the next six nights!

It looked very bad for that particular phase of the moon, but before or since I have been utterly unable to fasten anything definite on to that, or in fact any phase of the moon. There is nothing consistent about it. Even as I write (September 6, 1924) it is the first quarter of the moon and my wife is filling the sitting-room with radio music from almost anywhere on the American continent. As the Irishman said, "There's good an' bad everywhere."

So with the following remarks, I will close:—

There is abundant evidence on hand to show that good radio reception is liable to be crippled more or less by the arrival of a depression (falling barometer) and that a person is justified in looking for great improvement on poor reception if he notices the glass climbing after a fall, but it would be wise for those who may be tempted to forecast radio reception to remember that the super DX nights in America and Canada are generally super DX nights all over the world on that particular night, and that while you may have a rising barometer in Greenville, Ohio, and a clear starry night with radio reception that sends you into raptures, don't forget that some Yankee ship operator, lashing around in a howling gale off the coast of England, is altogether likely to be raking in the DX stations too, with the ship's glass still falling!

Therefore, when all is said and done—where are we?

The ST152 Circuit on the Omni

THE circuit shown in Fig. 1 possesses several interesting peculiarities. Readers familiar with the famous ST100 circuit will perceive that the depicted circuit is arranged on somewhat similar lines, in that the first valve acts both as a high-frequency and low-frequency amplifier, the signals being detected by the crystal detector D, and further amplified by the second valve V2. The ST100 circuit, however, is rather prone to picking up alternating current when such is used in the proximity of the receiver, resulting in an irritating humming noise in the telephones or loud speaker. The Fig. 1 circuit, which is numbered ST152, was designed to overcome or very much reduce this trouble, its full theoretical functions being given

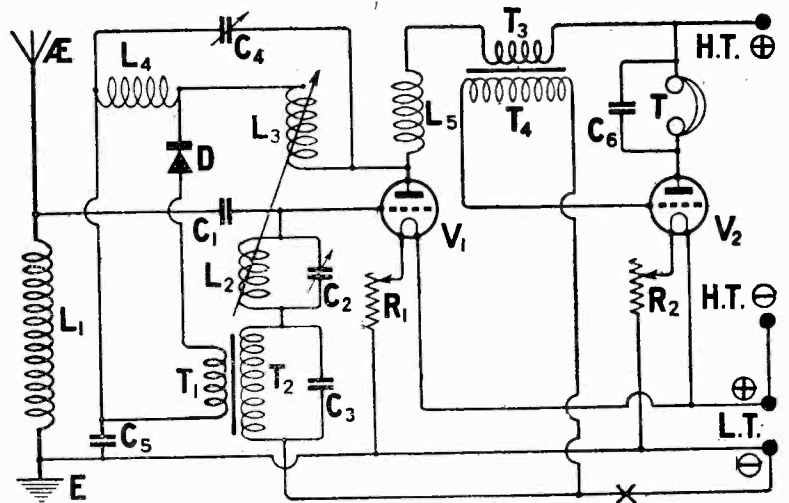

Fig. 1.—The ST152 circuit arranged for use on the Omni receiver.

in "Valve Notes" in the July 30 issue of *Wireless Weekly*.

A brief description of the working of the circuit will doubtless be of interest here.

How the Circuit Functions

The aerial oscillatory circuit comprises the aerial, L1, C1, C2, L2, C3, and earth, tuning being made by varying the condenser C2, of .0005 μF capacity. The two condensers C1 and C3 are of the fixed capacity variety. The former condenser, whose value is .0003 μF , acts as a stop to low-frequency currents, and is necessary to prevent short-circuiting of the second

dary winding T2 of the transformer T1, T2, through L1. C3 is a by-pass condenser of .001 μF , while C5 has a capacity of .0001 μF . The purpose of the coil L1 is to allow any possible low-frequency alternating currents picked up by the aerial to pass direct to earth. Aerial tuning is affected by this arrangement of coils and condensers, and details for correct working are given later.

The Anode Circuit of the First Valve

In the anode circuit of the first valve are two coils in series, tuned by the variable condenser C4 of .0005 μF , this comprising an ordinary tuned anode circuit. Across L4 are connected the crystal detector D and primary T1 of the transformer T1, T2, the low-frequency potentials induced into T2 resulting in amplified low-frequency currents in the anode circuit of V1. Reaction is obtained by coupling L3 to L2, and in general L3 will be kept fairly small. L5 is a radio frequency choke, which, however, offers negligible impedance to the low-frequency currents flowing in the circuit.

The Second Valve

V2 acts solely as a low-frequency amplifier, and the telephones T shunted by C6 of .002 μF are included in the anode circuit of this valve. At the point marked X a small battery may be inserted with advantage to



Mr. C. F. Elwell demonstrating a new form of camera.

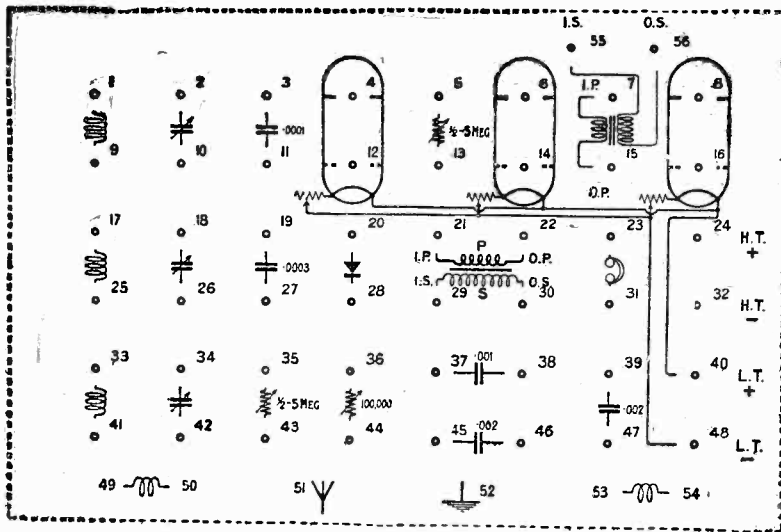

Fig. 2.—The terminal board.

bias negatively the grids of the two valves.

Connections for the Omni

On the Omni receiver the circuit may be wired up by making the following connections on the terminal board:—

- | | |
|-------|-------|
| 51—49 | 21—28 |
| 50—52 | 20—9 |
| 49—19 | 26—1 |
| 27—12 | 54—7 |
| 33—27 | 15—24 |
| 33—34 | 32—40 |
| 41—42 | 56—14 |
| 41—30 | 55—48 |
| 30—37 | 48—52 |
| 29—38 | 22—3 |
| 4—53 | 11—48 |
| 4—17 | 6—47 |
| 17—18 | 39—24 |
| 25—9 | 47—31 |
| 1—22 | 39—23 |
| | 29—55 |

Coil Sizes

On the usual broadcast wavelengths L₁, which is to be inserted in the left-hand fixed socket on the front of the panel, may be a No. 75 coil. L₂ is plugged into the front moving socket of the 3-coil holder on the side of the cabinet, and may also be a No. 75 coil. The coil L₃ is plugged into the centre socket of the 3-coil holder, and L₄ into the rear moving socket. Suitable sizes for L₃ and L₄ are Nos. 25 and 50 respectively. The remaining coil L₅ may be a No. 200 or 250, or, since the value is not critical, any other large coil may be employed.

A further circuit which may be experimented with upon this popular receiver. Readers who experience trouble from A.C. hum will find this circuit an effective means of its elimination

available, and should be kept as far as possible from L₃. The crystal detector requires careful handling for best results, for it plays an important part in the working of the circuit.

Experiments

If reaction is not obtained when L₂ and L₃ are coupled closely, the leads to L₂ should be reversed by disconnecting 33—27 and 41—30, and joining 41—27 and 33—30.

Grid bias in conjunction with a higher anode voltage is likely to prove beneficial, and is applied by disconnecting 55—48 and joining 55 to the negative terminal of the grid battery, and 48 to the positive terminal. A flash lamp battery may be employed, but a battery whose voltage may be varied is preferable.

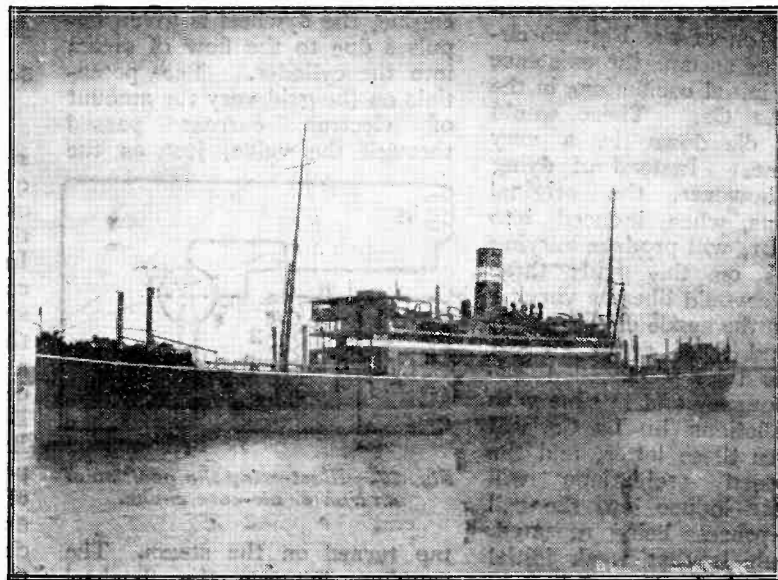

The s.s. "Mulbera" upon which the Duke and Duchess of York sailed for Kenya Colony. Special apparatus was installed for the reception of broadcasting.

Supersonic Heterodyne Reception in Theory and Practice

By JOHN SCOTT-TAGGART, F.Inst.P., A.M.I.E.E.

Part VIII.

ANOTHER circuit in which regenerative amplification takes place is shown in Fig. 26. In this arrangement we have a tuned-anode oscillatory circuit $L_2 C_2$, and an aperiodic grid circuit L_1 . This arrangement works in the same way as the Fig. 25 arrangement; all that is necessary is to connect or couple the two circuits, the input and the output circuits of the valve. This is done in Fig. 26 by the magnetic coupling between L_2 and L_1 . If the coupling between L_2 and L_1 is sufficiently strong, the valve will oscillate of its own accord. If the coupling is not sufficiently strong for this purpose, any initial high-frequency oscillating potentials in either coil, L_1 or L_2 , will be prolonged and magnified.

An Explanation

Let us examine the self-oscillating action of the Fig. 26 circuit; let us assume the existence of a few initial oscillations in the circuit $L_2 C_2$. These would normally die down in a very short time. Instead of dying down, however, the original oscillations, when induced into the coil L_1 , will produce varying potentials on the grid; these potentials would liberate varying energy in the anode circuit of the valve, and these anode current variations taking place at the same frequency and in time with the oscillations in $L_2 C_2$, will strengthen these latter, and the strengthened oscillations will once more induce into the coil L_1 , the process being repeated. The result is that weak initial oscillations in $L_2 C_2$ will be amplified by the valve, and will be caused to persist; in other words, continuous oscillations will be set up in the circuit $L_2 C_2$, and the

energy for these will come from the anode battery B_2 .

The circuit of Fig. 26 is a very suitable one for comparing with the above explanation of the action of the steam engine and the clock. The circuit $L_2 C_2$ is comparable to the flywheel of the steam engine. Impulses to the

maintain the oscillations in the circuit $L_2 C_2$. The coupling between L_2 and L_1 is to be compared in the modern steam engine to the slide-valve operated from the crankshaft of the fly-wheel.

In some circuits both the grid and anode circuits are tuned by means of condensers, but if we are to obtain the regenerative action we must tune both circuits to the same frequency. When one of the circuits is aperiodic we can obtain the regenerative amplification or self-oscillation effect over a wide range of wavelengths by simply adjusting the tuned circuit. The regenerative circuit of Fig. 25 is generally used in receiving apparatus, whereas the Fig. 26 arrangement is used for transmitting purposes. When it is desired to generate considerable power, the anode circuit is always used as the power circuit, and contains an inductance shunted by a capacity.

Separating Direct and Oscillating Current Circuits

In various regenerative and self-oscillating circuits it is frequently desirable to have the oscillatory circuit separated from the direct current anode circuit. In Figs. 25 and 26, the anode coil is connected so that the steady anode current passes through it. In Fig. 27 we show a circuit similar to Fig. 26, except that we now have a separate D.C. anode circuit, the plate, Z , B_2 , filament, through which passes the steady anode current of the valve. Across the anode and filament is the oscillatory circuit $L_2 C_1$, which is connected to the output side of the valve through the coupling condenser C_2 . The anode circuit contains a choke-coil Z ; this choke-coil may have an iron core, but is

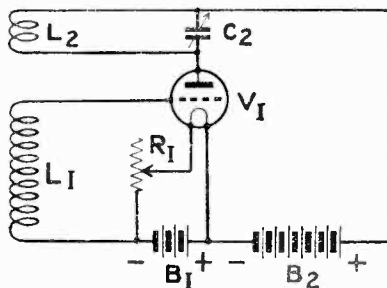

Fig. 26.—A self-oscillating arrangement in which the anode circuit is tuned.

circuit are given by variations of electron current through the valve; in the case of the steam engine, the flywheel is given impulses due to the flow of steam into the cylinder. The potentials on the grid vary the amount of electron current passed through the valve, just as the

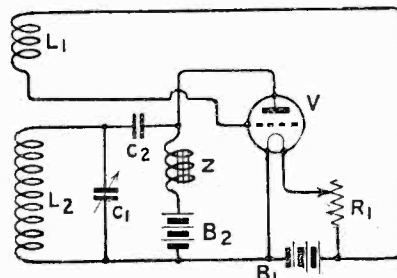

Fig. 27.—Illustrating the position of an iron or air-core choke.

tap turned on the steam. The coupling between the flywheel circuit $L_2 C_2$ and the inductance L_1 enables suitable spurts of current to pass through the valve at the right moment to

usually an air-core coil having a large number of turns. The natural frequency of such a choke-coil is often made equal to the frequency of the oscillations.

Owing to the choking effect of the coil Z, the high-frequency currents generated in the output circuit of the valve pass through the condenser C2 and energise the oscillatory circuit L2 C1. Instead of a choke-coil Z, a resistance of high value is occasionally used, but since it lessens the steady anode current, it is not as desirable as the choke-coil, which usually has a low resistance. The regenerative and self-oscillating action of the Fig. 27 circuit is exactly the same as that of Fig. 26.

Single Circuit Oscillators

In the three circuits already given we have obtained regenerative action by means of separate coils in the grid and anode circuits of a three-electrode valve. We can, however, produce oscillations, or obtain a reaction amplification effect when there is only a single oscillatory circuit. This oscillatory circuit must be connected in or be coupled to the anode circuit of the valve, and potentials must be derived from it and caused to influence the grid of the valve. Moreover, the potentials on the grid must be of such a phase with respect to the anode current that the energy liberated in the anode circuit is such as to tend to maintain or strengthen oscillations. In the circuits of Figs. 25 and 26, if we turn the coils L2 round the reverse way with respect to the coils L1, or reverse the connections to these coils, the energy transferred from the anode to the grid circuits would be such as to damp out and oppose the original oscillations. There would thus be no reaction effect.

Grid Potential Variations

As a broad principle, we must see in the case of valve circuits where there is to be a regenerative action, that the grid potential variations are such as to liberate energy in the anode circuit at the right time. This will be accomplished if, when we make the grid positive, the anode is negative and vice versa.

In Fig. 28 we show a very simple circuit for producing continuous oscillations. A single oscillatory circuit L1 C1 is provided; this circuit is energised by the flow of current pulses in the anode circuit of the valve. The anode current flows from the filament to the anode, through the battery B2 through the portion XM of the inductance L1, and back to the filament. It is

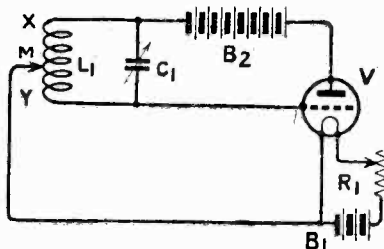

Fig. 28.—A self-oscillating system employing a single circuit.

to be noted that the anode current need never flow through the whole of the inductance of an oscillatory circuit; it is sufficient that there is a flow through a part of the inductance. The point Y at the foot of L1 is connected to the grid. The filament is connected to a point M, preferably half-way along the inductance L1. This point, however, may be adjustable, but must lie between the extremities, X, Y of the coil L1. If we

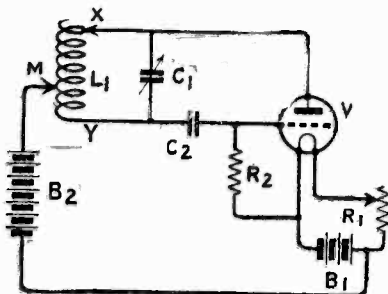

Fig. 29.—A re-arrangement of Fig. 28 circuit, incorporating a grid leak.

consider the oscillations flowing in the circuit L1 C1, we will readily appreciate that the ends X, Y will be of opposite potential sign with respect to the filament. If, for example, there is a flow of electrons from X to Y due to the discharge of the condenser C1, the point X will be negative with respect to the filament, and the point Y will be positive with respect to the

point M, and, therefore, with respect to the filament.

Anode and Grid Potentials

At any given instant the anode and grid will have potentials of opposite sign with respect to the filament; a retroactive or regenerative effect is, therefore, possible, and self-oscillation may be obtained. The circuit fulfils the conditions stated above, that the grid potential variations with respect to the filament should be of such phase and sign as to liberate variable anode currents which will flow through the oscillatory circuit or a portion of it, at the right moment to assist the existing oscillations in the circuit.

The H.T. Battery

The battery B2, in Fig. 28, is shown connected between the point X and the anode of the valve. This position of the anode battery is useful in some ways—for example, it does not affect the normal potential of the grid which is about zero volts; on the other hand, it is at a point of high-frequency potential with respect to the filament, and, therefore, with respect to earth. It has been pointed out that batteries and other apparatus which possess capacity to earth, or which are liable to produce leakage, should always be connected next to the filament, and the additional advantage of doing this is that the circuit may be used with a number of other valve circuits, all working off the same anode battery and filament accumulator.

The Blocking Condenser

If, however, we connect the battery B2 next to the filament in the Fig. 28 circuit, we would be giving the grid a positive potential of, perhaps, 50 volts. To avoid this high positive potential we can use the circuit of Fig. 29, which illustrates the use of a fixed blocking condenser C2 connected in series with the grid. This condenser allows high-frequency potentials to be communicated to the grid, but prevents the steady positive potential of the anode battery having any effect.

To prevent an accumulation of electrons on the grid, a leak R2

is connected as shown. This use of a grid condenser and leak is to be distinguished from its use for leaky grid condenser rectification. The usefulness of a grid condenser for this purpose is very great in numerous circuits, and should be remembered. In oscillating circuits the leak may frequently be connected directly across the condenser C2, but there is always a tendency for the positive potential of the anode battery being communicated to the grid through the leak to a certain extent; as a general principle, therefore, the grid leak should be connected directly across the grid and the negative side of the filament. The negative side of the anode battery should preferably be connected to the positive side of the accumulator, so that the volts across the accumulator add to the anode voltage.

(To be continued.)

Cleaning Condensers

It very often happens that a noisy receiver may be entirely cured by removing dust from the panel and component parts. Variable condensers are severe offenders, and are particularly difficult to clean, as the close proximity of the plates prevents the insertion of a rag or other such material. Great care must also be taken that the plates are not bent or distorted in any way during the cleaning process.

By far the easiest method of cleaning dust from between vanes of a variable condenser is to use a pipe cleaner of the type obtainable at any tobacconist's. This is easily passed between the vanes, and there is no possibility of the latter being bent by

reason of the bulk of the cleaning material.

An Accumulator Tip

When an accumulator has been in use for some time, it will be found that the terminals tend to become corroded. This corrosion may be removed, but will reappear in more aggravated form later, after the next charge. This "sulphation," for such it is called, may be avoided by coating the terminals of a new accumulator with vaseline; the treatment may be applied to batteries in use, provided the terminals are well cleaned before the vaseline is applied.

J. W. B.

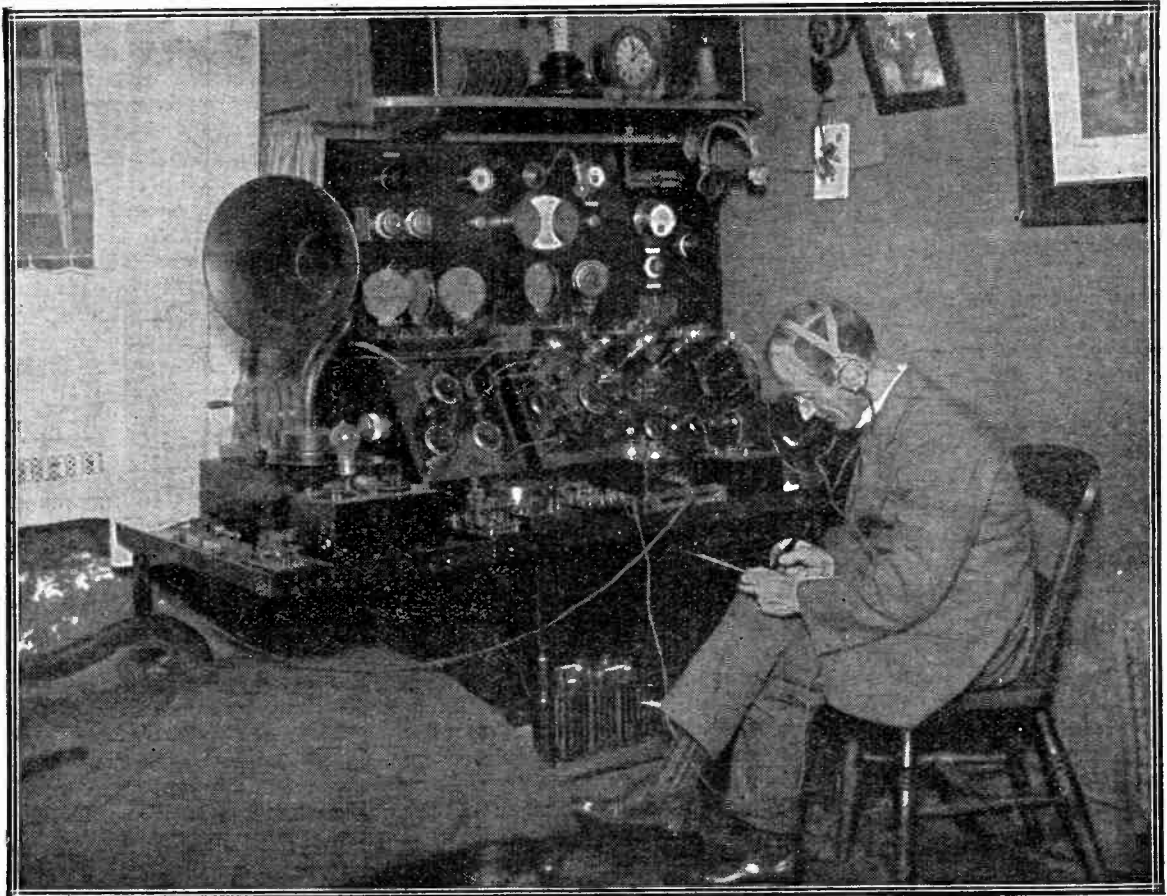

Mr. S. W. Heath, of Plymouth, with his efficient receiving set.

Random Technicalities

By PERCY W. HARRIS, Assistant Editor.

Some Notes of general interest to the Home Constructor and Experimenter.

AN epidemic of howling, and that by people who are obviously living very close to me, has led me to wonder whether the average howler really knows he is interfering or whether he deliberately starts his set oscillating for the purpose of picking up a carrier wave of some distant station. Only a few days ago I was reading an article purporting to be for beginners, in which it was stated that the particular single valve set described must be used in an oscillating condition for long-range reception. Whenever I hear a man boasting of the wonderful distances he has been able to get with his single-valve receiver, I always wonder what his neighbours think of him, for ten chances to one he is a terrible nuisance to any listener within a mile or so.

* * *

Howlers are often referred to as "condenser swingers," and many people, even experts, seem to be under the impression that howling is caused by a rapid swinging backwards and forwards of the tuning condenser. To my mind the real trouble is not a wild searching for stations, but the deliberate endeavour to settle down on the neutral point of the carrier wave. It is astonishing how a slight variation of the condenser will send the beat note from zero to beyond audibility. Most single-valvers have their sets so arranged that a really effective use of reaction is impossible. In a great majority of cases far too large a reaction coil is used, with the result that very little build-up of signals is obtained until the set is absolutely in oscillation.

* * *

Unsuitable high tension is another cause of trouble. A suitable valve in a suitable circuit with a suitable reaction coil and

suitable H.T. voltage can be arranged for excellent long-distance reception without any oscillation, and with a purity which gives the lie to those who do all their long-distance reception with the set in an oscillating condition. Beginners are also apt to ignore the fact (if they actually know it, which is doubtful) that every alteration of reaction coupling alters the tuning. The Reinartz circuit is the excep-

tion to this rule if it is properly arranged.

recently had the misfortune of having his house burgled and his wireless apparatus stolen. Being fully insured (as he thought) he made application in the usual way to the insurance company, and was promptly informed that wireless apparatus was not covered as it was not specifically mentioned in the policy! Those readers who are under the impression that they are fully insured in this should make certain

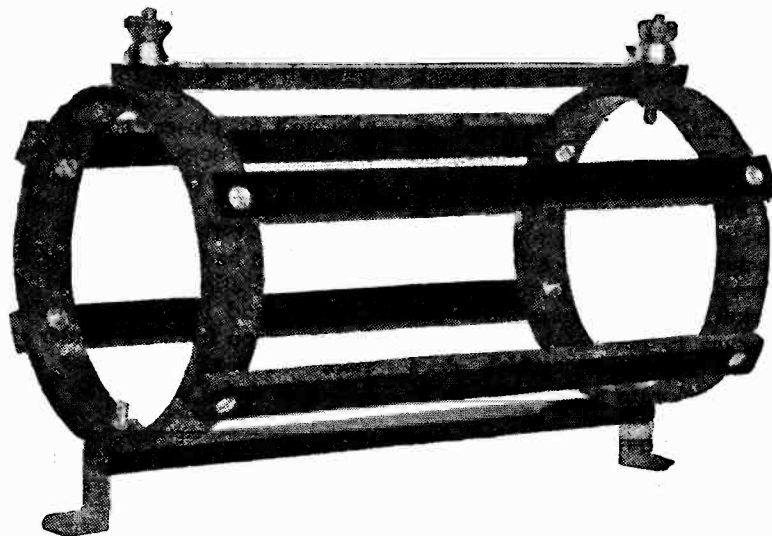

A well-designed low-loss coil former.

tion to this rule if it is properly arranged.

* * *

A few days after the publication of my recent notes on the need for a low-loss coil former, the Bowyer-Lowe Company sent me the specimen illustrated herewith, and which seems to fill the need admirably. I understand it is now on the market, and should be quite popular amongst the more advanced experimenters who realise what losses can exist in the ordinary type of former.

* * *

I met a man the other day who

by applying to the insurance company to have their wireless apparatus included.

* * *

About a year ago I observed in these columns the fact that many of the telephone manufacturers still put out their telephones without any marking on the leads to show which is the positive. The same remark applies to many loud-speakers. I so frequently hear of telephones becoming insensitive after use, that I am inclined to believe that in a very large number of cases the decrease in sensitiveness is due to nothing more than the

demagnetisation by the steady anode current flowing through the telephones and/or loud-speakers in the wrong direction. However, the telephone manufacturers are not the only ones to blame, for a large number of commercial sets are not marked in any way to show which terminal is the positive. This is a matter which the N.A.R.M. might quite well standardise.

* * *

Radio panels finished to resemble mahogany are becoming popular everywhere. At least three different makes are obtainable in England, whilst in America practically every manufacturer of insulating panels is putting out a mahogany finish.

* * *

Speaking of the appearance of wireless sets reminds me that I have recently received a number of inquiries from readers who wish to know whether it is possible to obtain ebonite-covered terminals, such as are used on some measuring instruments. So far, I have not been able to trace any such terminals as being commercially available, although I am sure they would sell like hot cakes if they were placed on the market. Such terminals are pleasant to handle, have an excellent appearance, which does not deteriorate with time as is

the case with many of the brass terminals, and, of course, can be readily engraved. I should like to see some manufacturers putting out ebonite-covered terminals with H.T., L.T., TEL., A., E., etc., clearly marked on them. It should be possible to produce them at a reasonable price, and, in any case, the Americans have them, so why should not we?

* * *

All kinds of theories have been put forward at different times to account for the long-distance transmission of wireless waves, but not one of them, to the best of my knowledge, will account for the following strange fact, which can be vouched for by many experienced amateurs. Certain stations, such as 2OD at Gerrards Cross, whilst easily audible in various parts of the country, never come in very strongly, and yet are able to transmit regularly to enormous distances. Other stations which, although no closer, sound many times as strong, seem to have little carrying range; the phenomenon cannot be explained by stating that the observing station is in a bad receiving position for the station which is the weaker, and in a good position for reception from the louder station. We all know that some localities are "dead" so far as

reception of certain broadcasting stations is concerned, but when we find reports throughout the country of the same fact, the dead spot theory will not hold water. I should like to hear from any reader who thinks he can explain the phenomenon, as it is of general interest and frequently commented upon in transmitting circles.

□ □ □

A Reader's Results with the Low-Loss Tuner for Short Waves

SIR,—I would inform you that I have just made up the short wave tuner in accordance with the particulars contained in the issue of the 19th inst. Frankly, the results after a first trial are amazing. Components used were the same as in the set described with the exception of the L.F. transformer, which was a standard R.I.

This locality is well known to be extremely bad for long-distance work, and therefore my surprise at finding KDKA at 11.10 p.m., at good 'phone strength without difficulty was not entirely unnatural—this result without any special precautions as to length of battery leads and the like, all of which were jumbled together mainly to see if the set would oscillate. I have, unfortunately, no knowledge of Morse, but a number of stations were readily tuned in when once the fineness of the tuning had been appreciated.

In conclusion, let me congratulate you on the design of a ridiculously simple but extremely efficient and economical short-wave set.—Yours faithfully,

SOLDER.

Windsor.



Lady Tree (right) and Mrs. Kendal (centre) who helped to present a one-act comedy, "Granny's Juliet," from 2LO.

Do not miss the
Special CHRISTMAS NUMBER
of
**"The WIRELESS
CONSTRUCTOR"**

Out December 13th

Some articles of note are:

The Anglo-American Six, a three-stage H.F. Receiver, by Percy W. Harris

A Fool-Proof Crystal Set.

Many useful articles for the beginner.

Price 6d., at all Bookstalls.

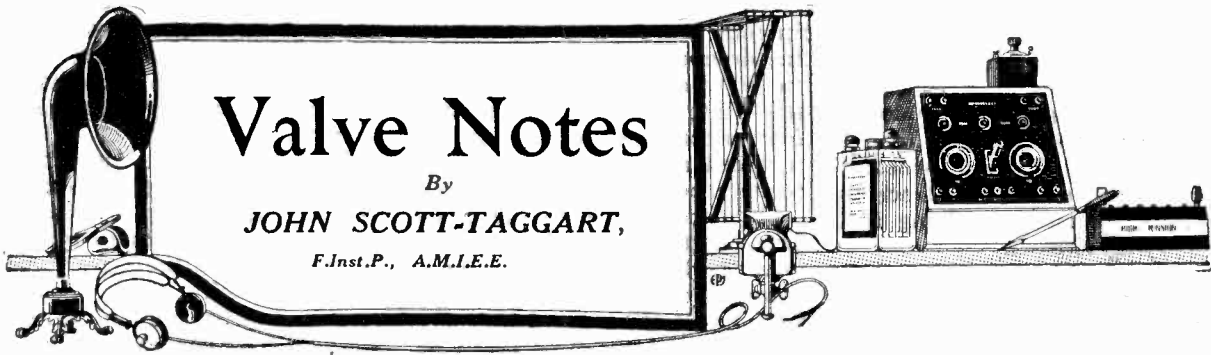

H.T. Plugs

THERE are one or two high-tension plugs now on the market which employ a resistance which may have a value of, say, 1,000 ohms inserted, so that a serious short-circuit of the high-tension battery is not possible. In some cases a high resistance is included as part of the plug in such a way that the total currents that can pass through that resistance is less than that sufficient to burn out the filament of the valve.

Although the idea is quite sound from the point of view of avoiding a short-circuit of the battery, and except, perhaps, as regards dull emitters, quite sound as a means of limiting the amount of current that can pass through, say, a filament due to an accidental short-circuit, yet it must be borne in mind that the inclusion of any common resistance or impedance in the joint anode circuits of several valves is liable to give rise to peculiar reaction effects which may cause distortion and possibly buzzing of the receiver.

Internal Ohmic Resistance

Let us look, for example, at Fig. 1. Here it will be seen that the ordinary circuit is employed without any special resistance being used. Nevertheless, the battery B₂ (the high-tension battery) is, perhaps, run down and has acquired a considerable internal ohmic resistance represented by the letter R. No such actual resistance is inserted in the circuit, but R represents the internal resistance of the high-tension battery B₂. As very frequently the high-tension battery is not shunted by a fixed condenser C, the variations of anode current of the last valve produce

varying potentials across the internal resistance R of the high-tension battery, and these varying potentials across the battery will be communicated to the

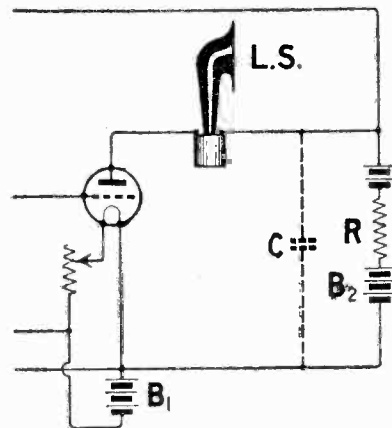

Fig. 1.—Illustrating the position of the condenser connected across the H.T. battery to overcome the effect of internal ohmic resistance.

anode circuits of preceding valves.

Likewise, the anode currents

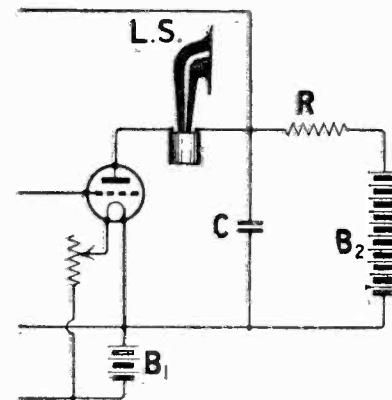

Fig. 2.—The position of the condenser when using special wander-plugs fitted with a resistance safety device.

of these valves are varying, and will set up varying potentials

across the internal resistance of the battery.

It is little wonder, therefore, that peculiar reaction and reverse reaction effects should take place, and those who have used two or more stages of low-frequency amplification may have found that buzzing, *i.e.*, low-frequency oscillation of the receiver, may sometimes be traced to the high resistance of the high-tension battery. This can be overcome by the use of a fixed condenser C, which, of course, should be a thoroughly well-insulated condenser, and may have a capacity of 2 microfarads. This condenser serves as a by-path for any alternating currents, whether of high or low frequency, and the existence of any resistance in the battery will make little difference.

Wander Plugs

In the case of the special components, however, such as wander-plugs, in which a high resistance is inserted, it is absolutely vital that a large capacity condenser should be connected across the high-tension terminals of the set. This is shown in Fig. 2, where R shows the extra resistance which is deliberately inserted so that if there is a short circuit the high-tension battery will not suffer.

The resistance R will make no difference, as regards high-frequency currents, provided C has a capacity above, say, .002 μF. The only effect of the resistance R will be to cut down somewhat the voltage on the anodes of the valves.

Value of Condenser

In the case of low-frequency currents, however, a condenser of even .002 μF

will not act as a virtual short-circuit. It is consequently important to have a larger capacity condenser, and 2 μ F is the lowest value which should be employed for this purpose. Even then I am somewhat doubtful whether the use of such a resistance is desirable in many receiving and amplifying circuits.

Dating Batteries

I have had some trouble recently with regard to high-tension batteries, and also the dry batteries used for lighting filaments. There is no doubt that these batteries are liable to deteriorate considerably when in stock, and it would be a good idea if manufacturers of these batteries, for the sake of their own reputation as well as for the benefit of the public, would mark the date on their batteries, so that it could be seen at once whether the battery had been kept in stock or not.

As for high-tension batteries, I think it is desirable that these should be wrapped up in such a way that they cannot be used by a dealer, as there is no doubt that some of these batteries are used for demonstration purposes, and afterwards sold, although it is to be hoped that this is not frequently done.

Testing Batteries

Cossors have introduced an excellent idea with regard to their valves, which prevent them being used for demonstration purposes, while enabling the purchaser to see that the filament is in good condition. This principle should be widely extended to apply to batteries as well.

There is a lot to be said for taking a voltmeter when purchasing a high-tension battery. These articles are not very cheap, and there is no reason why a salesman should raise his eyebrows when a high-tension battery is tested by the purchaser. It is a very reasonable precaution, and an enterprising dealer will provide a voltmeter on the spot to enable purchasers to test the battery voltage themselves.

Life of Batteries

As regards the life of high-tension batteries, I have had a 60-volt high-tension battery in

use regularly for family purposes for four months, and the voltage has dropped to 42 volts. Since the set in question—a three-valve set—using three .06 valves has been in constant use, this may be regarded as a fairly reasonable performance.

My experience with the cylindrical batteries usually used for valve work has been much more unfortunate, and three of them working three .06 valves, only lasted three weeks. The batteries either are of very poor manufacture, or they had been kept in stock for a long period by the dealer from whom I bought them.

Stamping

There are few wireless experimenters who, sooner or later, do not have a set which may sud-

denly stop working, or stop working properly, that when the table is banged, or the floor stamped upon, will immediately proceed to give forth the usual strength of signals.

The first thing to look for is trouble in the valve holders. Splaying out the valve pins will do a lot in the ordinary type of holder, but with the newer types of anti-capacity valve holders considerable trouble may arise if valves are continually being changed. It is all right if the valves are allowed to remain in position, but if new valves are constantly being inserted or changed, the contacts lose their springiness and a poor connection will very readily result. This is the only disadvantage of what is otherwise an excellent type of valve holder.

A Holder for Spare Pairs of Telephones

The experimenter who possesses several pairs of telephones which are not always in use at once will require some device for

apparatus. The board may be secured to the wall by means of Rawlplugs (a very useful fitting), which thus prevent any possibility of the board falling down and damaging the receiver. Ordinary dresser hooks are screwed into this board and the telephones, when not in use, may be hung upon these hooks, the cord being looped over the hooks also.

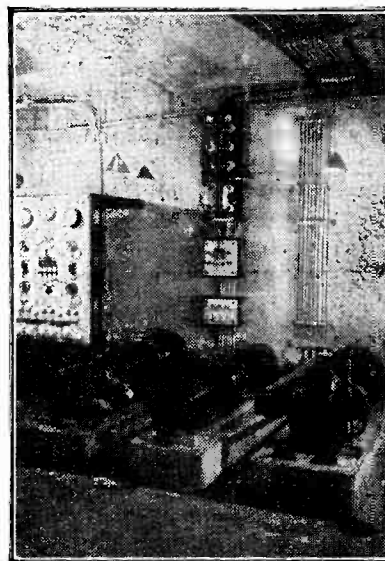

The generator room at L'École Supérieure des Postes and Telegraphes.

Another useful device which the writer has seen used consists of a hat rack of the pedestal pattern, which stood in a corner of the wireless room. Spare pairs of telephones were then hung upon the rails provided. Although this latter stand takes up considerably more room than the board previously mentioned, there is no doubt that many will prefer it on account of its better appearance. For those who have a table set apart for their wireless gear, a very useful thing is to screw a dresser hook under the top of the table and to hang the telephones upon this when not actually in use. Should the phones be laid down for a moment during an interval, this method will prevent them being accidentally swept off the table.

J. W. B.

storing his telephones out of harm's way when not in use.

A useful way of doing this is to construct a telephone board which may conveniently hang on the wall near the receiving

Useful Panel Supports

Very often when making up a set it is desirable to be able to support the panel by some means while drilling, mounting or wiring is in progress. If the panel, when completed, is to be

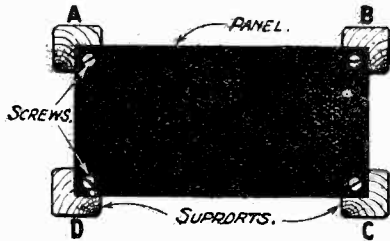

Fig. 1.—A simple method of supporting a panel.

mounted in an expensive cabinet, it is not desirable that the panel should be rested in the cabinet during the process of construction, owing to the possibility of the cabinet becoming scratched or otherwise damaged.

A simple method of supporting a panel is shown in Fig. 1. A, B, C and D are four pieces of wood about 2 in. by 1½ in. by 5 in. high. These have a small piece cut away from the corner, as shown in Fig. 2, in order that the panel may rest in the groove thus formed. A screw is passed through the panel into the support in order that the whole may be rigid.

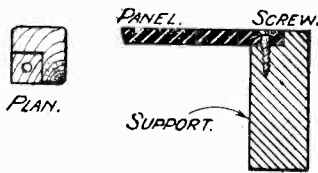

Fig. 2.—Constructional details of the wood supports.

Fig. 3 shows another method of supporting a panel. The supports have slots cut out, the same thickness as the panel, the latter being slipped into the slot in the support. There is, of course, one support at each corner of the panel. If the slots are made deep enough, the panel will be rigidly supported and there will be no risk of its falling down and damaging any components which may be mounted upon it. These supports are also

very useful when testing a completed set before mounting it in the cabinet, as any alterations which may have to be made to wiring, etc., are thus greatly facilitated.

B. J. W.

A Useful Board for Spare Valves

When trying out a new receiver one often wishes to compare the working of different makes of valves, in order to decide which will work best in any given position. When doing this, it is very dangerous to pull out a valve and replace it by another, leaving the extracted valve lying on the table. Valves are made in such a way that they will easily roll, and it will not take very many seconds for the experimenter to have lost by breakage a valve which, perhaps, he has valued exceedingly. It is a tedious process to replace each valve in its box as it is taken out of the receiver, and, indeed, in so doing much valuable time may be lost, as, for example, the station may have ceased sending during that time.

A very useful device was evolved in order to overcome this difficulty, and, at the same time, to provide a safe resting place for valves which were not actually in use at the moment. This consists of a piece of wood about 15 in. long by 6 in. wide, and may be about ½ to ¾ in. in thickness. Two strips of wood, 6 in. long and ½ in. square, are fastened to the shorter sides of the base board in order to give the latter a clearance from the table. Sufficient 1-in. diameter holes are then drilled in the board according to the number of valves generally in use. The board may, of course, be smaller if the number of valves does not warrant such a large size. The pins of the valve just clear the hole and the cap of the valve rests on the board. The valves are thus prevented from rolling off the table and are easily accessible when it is required to effect a change in the receiver.

J. W. B.

Test for Insulation

When poor results are obtained and all other tests have failed, the constructor often wishes to test the insulation of his panel. This might at first seem a task far beyond his ability, as the usual insulation tests necessitate the use of a megger or some such expensive instrument. There is no need, however, for the construc-

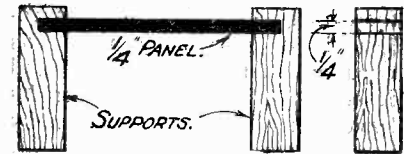
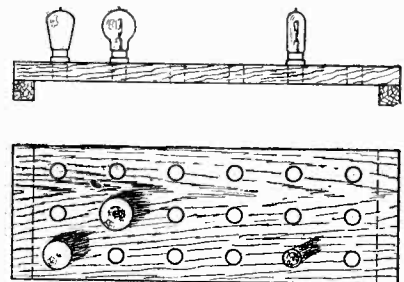

Fig. 3.—An alternative method of supporting a panel.

tor to worry, as a very simple test may be performed in the following manner. All that will be required is a high-tension battery and a pair of telephones. The positive of the high-tension battery is connected to the tag of the telephones usually marked in red, and a lead is taken from the negative terminal of the battery to a terminal on the panel. This terminal should preferably have no wires connected to it, in order that the insulation test may be a certain one, obviating the possibility of



Illustrating the board for spare valves.

leaks through condensers, and so on. The other tag of the telephone cords is then moved about the panel, lightly tapping in the neighbourhood of the terminal to which the negative of the high-tension battery is connected. Any faint clicks or scraping noises as the tag is passed near the terminal will indicate poor insulation, and the panel should certainly be replaced by one of better quality.

W. B.

Photographs by Wireless

SOME NEW DEVELOPMENTS.

The transmission of photographs by wireless is not new, but it has not by any means reached the commercial stage. Marconi's Wireless Telegraph Co. have just taken up an improved method which promises well.

WITH such rapid developments in the transmission of speech and music by wireless, it is only natural to expect that further developments in radio communication are likely to arise from time to time. The transmission of pictures by wireless is a possibility that has occurred to many inventors, and it seems quite successful results have been obtained already by the process developed by M. Belin. A description of M. Belin's experiments, together with some photographic reproductions, of messages, appeared in *Modern Wireless* for September, 1923.

The Method

Practically all methods which have given any measure of success have been based upon the variation in resistance in certain substances when a beam of light is centred upon them. But if a photographic film is rotated and a spot of light is made to traverse a spiral path upon the film, any increase in the intensity of the light will make a darker mark on the photographic film after it is developed. If, for example, the

light ceases for a moment, then the portion of the path normally traversed by this spot of light will be clear; if the light is strong for a period, then, so long as the light persists, then will a black mark be made upon the photographic film. This method is that adopted in the new apparatus which has recently been demonstrated by Marconi's Wire-

less Telegraph Co., Ltd., to a number of Press representatives.

In this Country

At the present time only the transmitting apparatus is available in this country, and by its beams it has been found possible to transmit by wireless to New York certain photographs which, it is reported from the American end, have gone over remarkably well. The first process is to prepare a photographic film which is wrapped round a glass cylinder. This cylinder is seen in the photograph on the lower half of this page. A beam of light is projected against this film, and where it is opaque no light passes through; where it is transparent, light permeates it and affects a sensitive bell within, thus varying its resistance. So long as the sensitive bell is affected no waves are radiated from the transmitting station, and these waves actuate the receiving apparatus and make a corresponding black mark upon a similar photographic film at the receiving end. As both the cylinders in the receiving and the transmitting apparatus are synchronised, the result is to give a reproduction

(Continued on page 301)



A photograph of President Coolidge as it appeared after transmission by the new method.

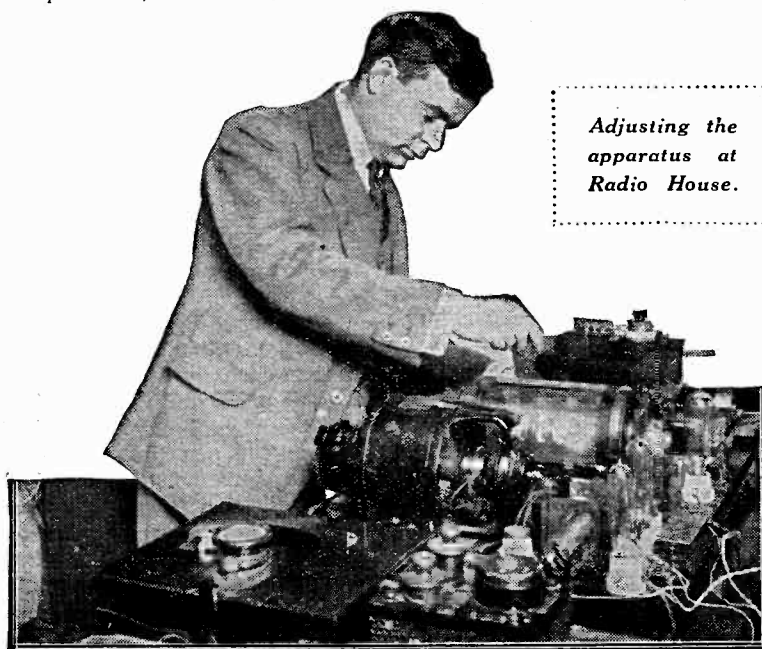

Adjusting the apparatus at Radio House.

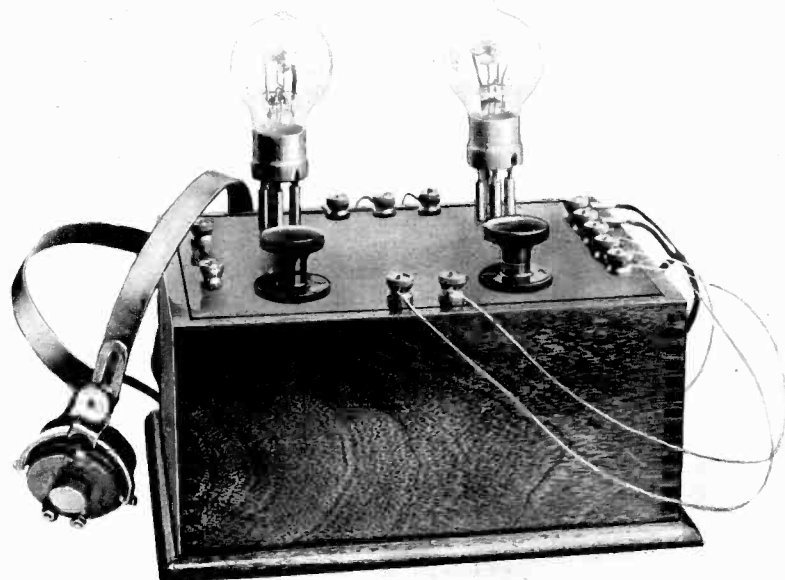

Fig. 1.—The amplifier when complete is a very neat instrument.

A Two-valve Amplifier for Pure Reproduction

By JOHN W. BARBER

For those who require an inexpensive amplifier giving volume and purity, the instrument described in this article will be of considerable interest.

MANY designs of amplifying arrangements are put forward from time to time, and of late those in which resistance coupling is employed have been to the fore. The reader is told that resistance amplifiers are, as a general rule, more faithful in their reproduction than an instrument employing low-frequency transformers, and therefore those who wish for purity, above all else, should inevitably use the resistance-capacity method. On the other hand, the would-be constructor learns that, valve for valve, the resistance amplifier does not give such loud signals as its "rival," the transformer amplifier, and hence he is in many cases sorely tempted to give up the extra purity in favour of more volume, in preference to adding another valve. Actually, in quality, there is little to choose between a well-designed amplifier using the best of modern transformers and one using resistance amplification.

Amplification Problems

The writer, who has been experimenting for some time with low-frequency amplifiers, has designed the amplifier to be described with the object of obtaining good amplification without sacrifice of purity. In the hands of a serious experimenter a low-frequency transformer-coupled amplifier consisting of several stages may be made to give excel-

lent results, but for the broadcast listener, who has, perhaps, little time for experimental work, an instrument is required which is at once easy to construct and simple of operation when put into use.

Intervalve Coupling

Such an instrument is that depicted in Fig. 1, which shows the appearance of the amplifier when ready for use, with valves, telephones, and battery leads connected. The coupling between the valves is such as will give, in the first place, purity of reproduction, and in the second, good volume of sound for the operation of a loud-speaker. A low-frequency transformer is used for the first stage, namely, the coupling between the first valve of the amplifier and the receiver, which may be either of the crystal or

valve type, which precedes it. For the second stage, the one where the trouble usually occurs in poorly designed amplifiers operated by unskilled persons, I have used resistance-capacity coupling, the valves being provided with separate anode supply terminals, in order to permit of suitable high-tension voltage being supplied, to suit the particular valve used.

Purity of Reproduction

It should be particularly noted, however, that as this instrument gives, at its "output," or telephone, terminals, a magnified reproduction of the applied variations at its "input" terminals, the applied rectified currents should be as free from distortion as possible, in order that the loud-speaker may give pure music,

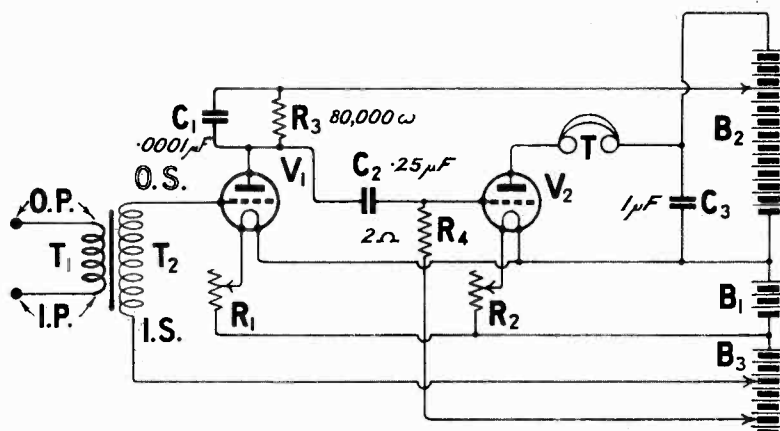

Fig. 2.—The circuit arrangement adopted.

free from the horrible noises one, unfortunately, so often hears issuing from it.

In this connection it must be pointed out that the low-frequency transformer used must be of good quality, as the whole question of final results will depend very largely upon this component. In the case of this amplifier the connections shown for the transformer were found best with the particular type used, but in cases where other makes are employed the connections to primary and secondary windings should be reversed, separately, in order to find the best scheme of connections.

Fixed Condensers

It will be noticed that no condenser is included across the primary, or input, winding of the low-frequency transformer, the reason being that if the amplifier is used in conjunction with a valve receiver, a condenser is almost certain to be provided across the telephone terminals of the re-

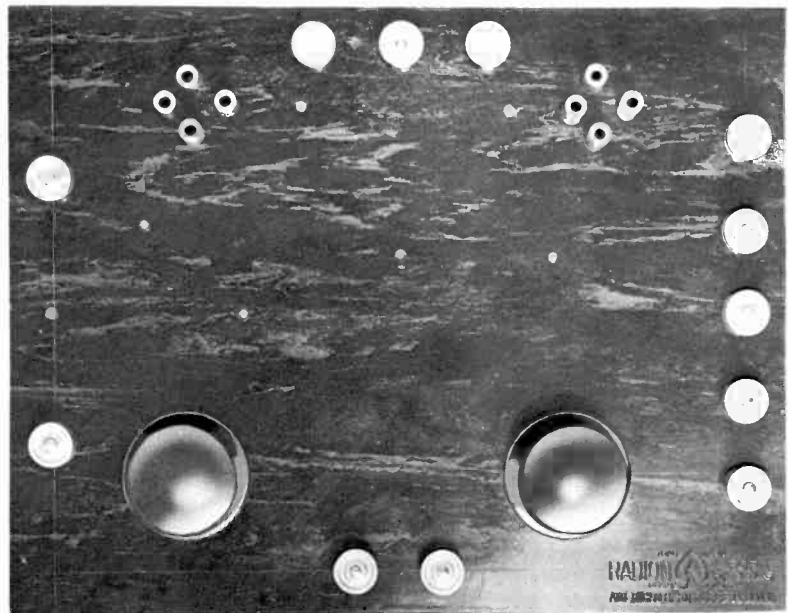

Fig. 3.—A plan view of the panel, showing the neat layout of the parts. Mahogany finish ebonite is used for the panel.

ceiver, in which case a condenser in the amplifier itself would be superfluous. In cases where no such condenser exists in the re-

ceiving equipment, however, a fixed capacity of .001 or .002 μ F should be connected across the terminals IP and OP of the

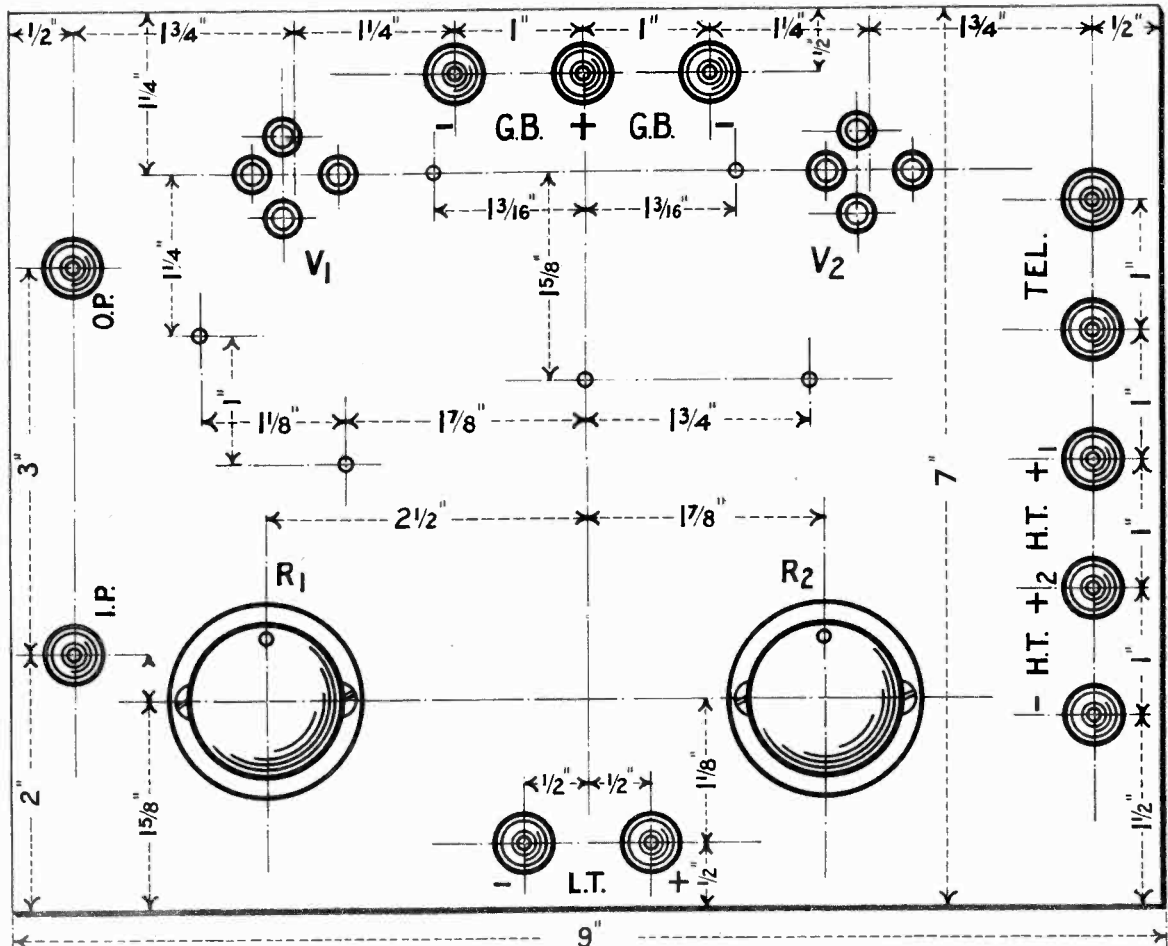

Fig. 4.—How the panel is drilled. The terminals are arranged to keep wiring short.

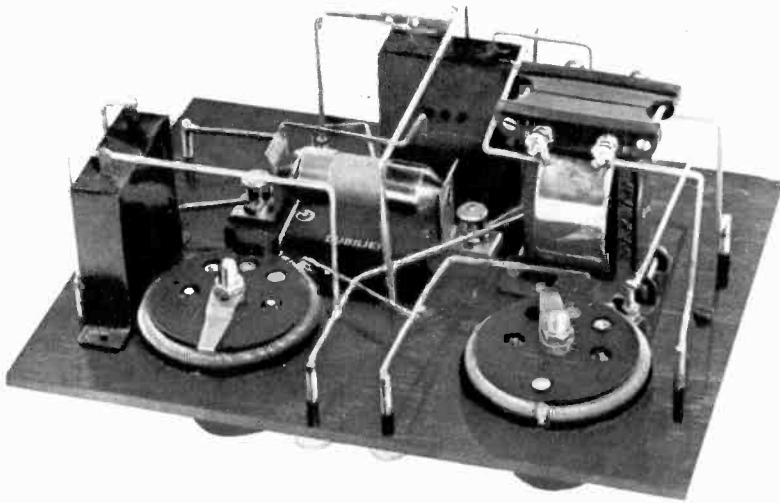

Fig. 5.—The compactness of the instrument is apparent.

circuits where short wires are essential. On the left of the panel are the input terminals, from which wires are joined to the primary winding of the low-frequency transformer. At the back of the panel are three terminals for the application of suitable grid-biasing potentials by means of a few cells, the centre terminal being for the positive of the battery, while the other terminals, which are the negative ones, enable negative bias to be applied to each valve respectively. On the right-hand side of the panel are, reading from the back, the two telephone terminals, the two high-tension positive terminals, and the high-tension negative terminal. In the front of the amplifier are the low-tension terminals, to which the filament-heating battery is connected.

amplifier. Again, I have not included a condenser across the "output," or telephone, terminals, owing to the fact that, for the best results, every loud-speaker requires a different value of condenser across it, and as this value is only found by experiment, it is

left to the constructor to provide a condenser of suitable capacity for the loud-speaker in use.

The Arrangements of Terminals

The terminals of this amplifier are arranged in a somewhat unconventional manner, in order to facilitate direct wiring of the cir-

Components Required

Many readers like to know the names of the actual components used; so these are given. While it is not essential that the parts

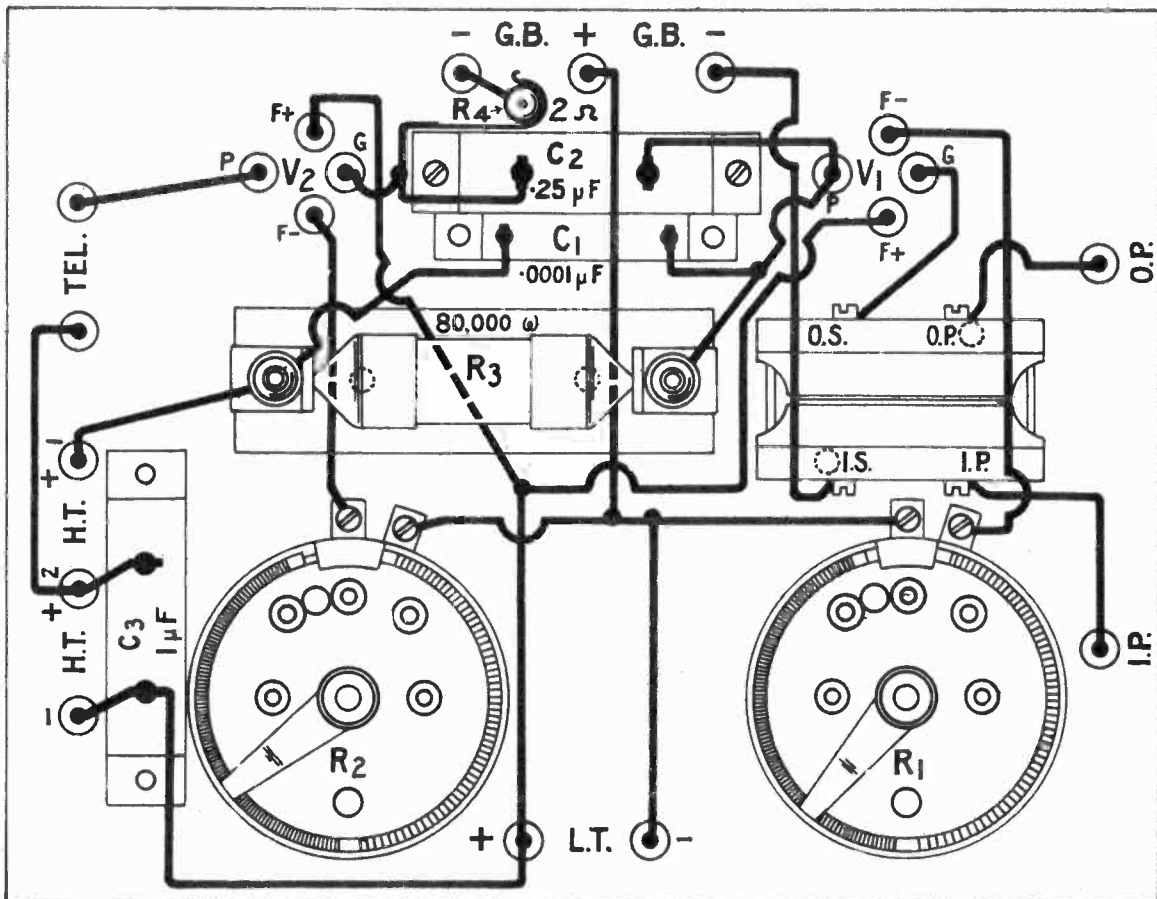

Fig. 6.—Practical wiring diagram. The planes of the various wires may be seen in the back-of-panel photographs.

specified should be used, the reader should satisfy himself that those which he chooses are of good quality.

- 1 ebonite panel, measuring 7 in. by 9 in.
- 1 low - frequency transformer (Max-Amp, Peto-Scott, Ltd.).
- 2 valve holders, or alternatively, 8 valve sockets.
- 2 filament resistances, suitable for bright or dull emitter valves (Burndept, Ltd.).
- 1 80,000-ohm resistance (Dubilier Condenser Co.).
- 1 .25 μ F T.C.C. condenser.
- 1 .0003 μ F condenser (Dubilier Condenser Co.).
- 1 2 megohm leak, with clips (Dubilier Condenser Co.).
- 12 terminals, nickel plated (Peto-Scott, Ltd.).

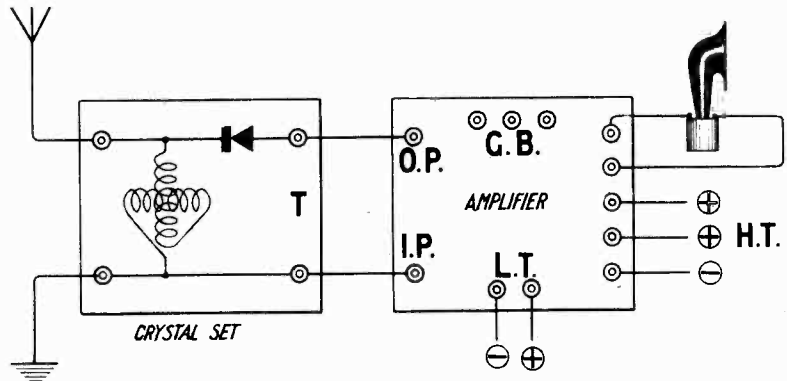

Fig. 7.—Showing how the amplifier is joined to a crystal set.

In cases where unguaranteed material is used for the panel, after the necessary holes have been drilled the panel should be thoroughly rubbed on both sides

as of .0001 μ F capacity, but actually this value is not very critical up to about .0006 μ F, above which purity of tone was noticed to fall off slightly. In the event of a .0001 μ F condenser not being available, one of the usual grid-condenser type, usually of .0003 μ F, will be found satisfactory.

Fig. 4 shows how the panel is drilled, while the wiring is made clear in Figs. 5 and 10. No difficulty should be experienced in following these drawings, but it will be noticed in the photographs that there are no nuts either on terminals or valve sockets beneath the panel, whereas these are shown diagrammatically in the wiring diagram. The reason is that the holes were all tapped to the correct size, and the sockets and terminals screwed in, thus reducing, in the case of the valve sockets, capacity between the separate pins. For the benefit of those who have no facilities for tapping holes, however, nuts are shown in position on the wiring diagram.

Square section wire has been used for wiring up, but if the constructor should anticipate any

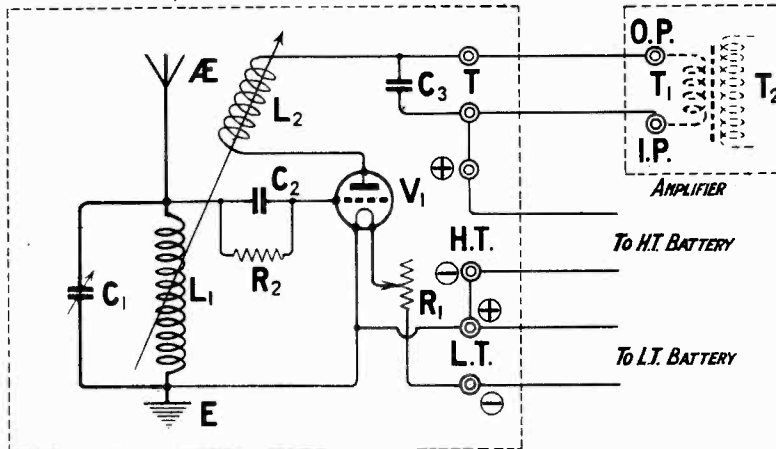

Fig. 8.—Care should be taken to connect the "input" terminals as shown, with the particular make of transformer specified.

Quantity of square section wire for connecting purposes.

A suitable box or cabinet to take the panel, and deep enough to accommodate the transformer used.

The Panel

The panel material used is known as Radion Mahoganite, which gives a distinctive appearance to any receiver in which it is used, being at the same time guaranteed free from surface leakage, notwithstanding its highly glazed finish. This material is particularly strong, and panels of ordinary size need be of only 3/16 in. thickness; but if any other kind of ebonite is used the constructor should satisfy himself as to its good qualities, at the same time ascertaining whether 3/16-in. material will be strong enough for the purpose.

with emery-cloth, in order to remove any surface leakage which may exist.

The Circuit

Fig. 2 is a diagram of the circuit used, and it will be seen that it is quite a straightforward arrangement. The condenser C1 across the anode resistance R3 is shown

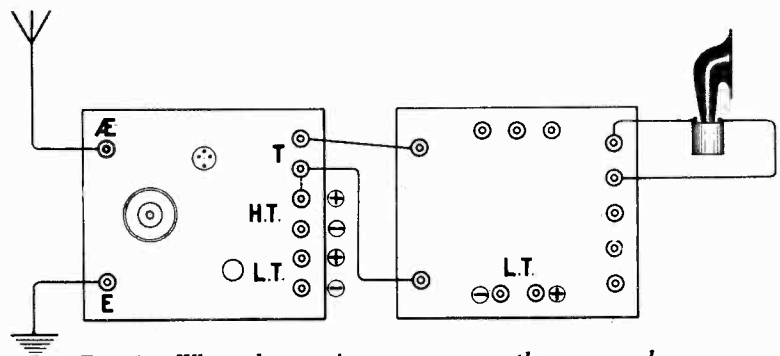

Fig. 9.—When the receiver uses more than one valve connect up as above.

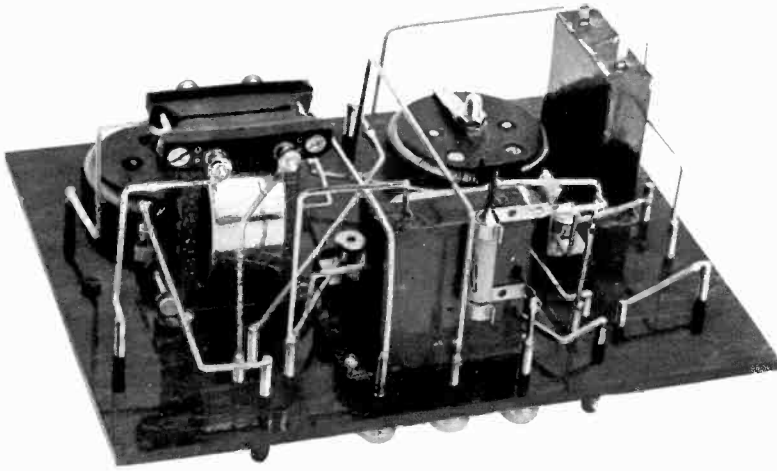

Fig. 10.—A further back-of-panel view. Note how the gridleak is mounted.

difficulty, he may revert to either of the older methods, namely, stiff finned copper wire of round section (say, No. 16 gauge) or, alternatively, a thinner wire covered with insulating sleeving may be used, provided the wires are spaced as much as is possible.

The choice of a cabinet is left to the constructor to suit his own particular needs. A flat-top type of box was used in the writer's case.

Connecting the Amplifier to a Crystal Set

Fig. 7 shows how the finished instrument is connected up to an existing crystal receiver of the variometer-tuned type, the telephone terminals of the latter being joined to the I.P. and O.P. terminals of the amplifier. In any type of crystal set the same scheme of connections will apply.

When the amplifier is to be used in conjunction with a valve receiver, care must be taken that the connections to the low-frequency transformer are made the correct way round; that is, with the O.P. joined to that telephone terminal which is nearest the anode of the preceding valve. The low-tension terminals of the receiving set are joined to those of the amplifier, while the high-tension negative terminal of the receiver is connected to that of the amplifier. The H.T. positive terminal of the receiver may conveniently be taken, by means of a flexible lead, to a suitable tapping on the high-tension battery, thus permitting the best operating

voltage to be applied to the detector valve.

Valves

Any good make of general-purpose receiving valve will be found to work satisfactorily in this instrument, and since suitable filament resistances are incorporated, dull emitter valves may also be used, provided that correct anode and filament voltages are applied. Full instructions will be found on the maker's leaflet or on the box in which the valve was packed.

A Safety Precaution

Before connecting this amplifier to a valve set it is necessary to ascertain whether the H.T. negative is connected to the L.T. positive or negative of the valve receiver. A simple method is to remove from the valve set all

the battery connections and to test, by means of a pair of telephones and a dry cell, for continuity between the H.T.— and the L.T. terminals. A loud click will be heard when the leads are joined to those terminals which are connected together. Be sure that in the receiver the H.T.— is joined to the L.T.+, otherwise the L.T. battery will be shorted when the amplifier is joined up.

(A Test Report of this amplifier will be found on page 296.)

NOTE.

A blueprint of the back-of-panel wiring (No. 76) is obtainable. Price, 1/6, post free.



This handsome "Sterling Primax" loud-speaker was one of the most attractive exhibits at the Albert Hall exhibition.

The "Twin-Valve," a new loud-speaker receiver, designed by Mr. Scott-Taggart, to be described in the January issue of "The Wireless Constructor," published December 15th.

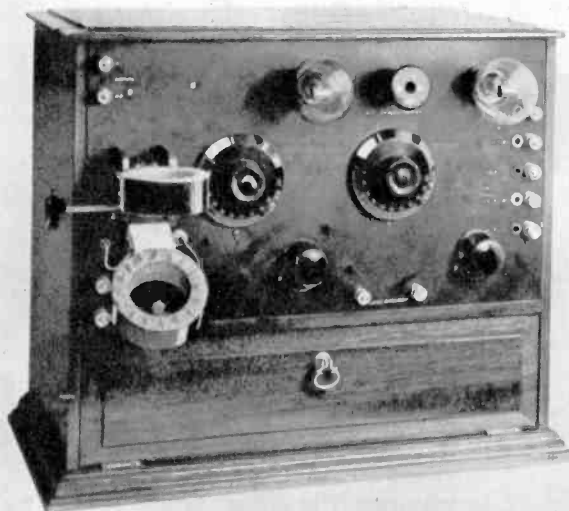

Hornless loud-speakers are only just making their appearance on the American market, although several types are already available here. Our photograph shows a cone-shaped model recently produced in the United States. Very pure reproduction is claimed.

The interior of a German broadcasting studio, showing two different types of microphone on stands. As is customary, the room is heavily draped to avoid echo effects.





Uncles and Aunties at the Birmingham Station.

A photograph of Mr. Goyder's station at the Mill Hill School. Mr. Goyder was the first amateur to establish two-way communication with New Zealand.

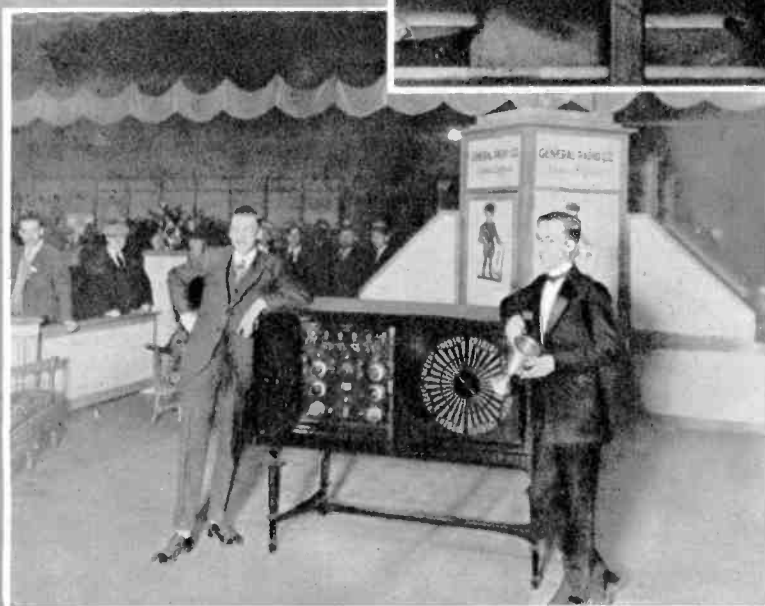
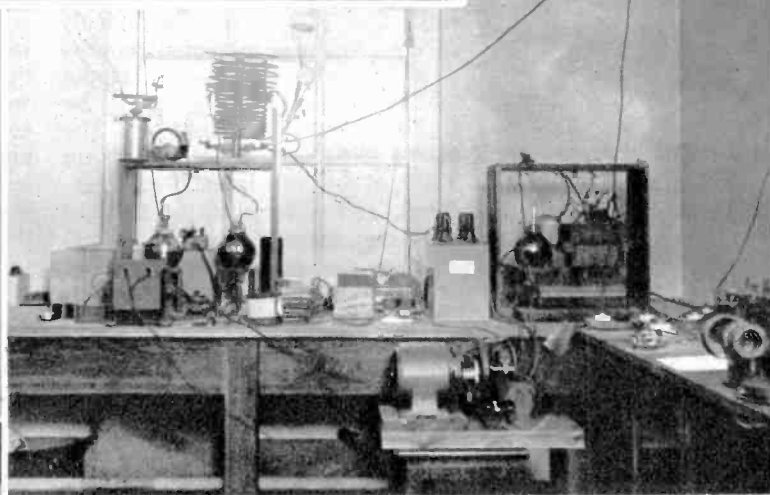

Mr. E. T. Flewelling, the inventor of the circuit bearing his name. He is seen holding a silver cup presented to him at the New York Radio Show.



Fig. 1.—The unit ready for plugging into a lamp-holder.

THERE must be a large number of amateurs who have D.C. supply installed at their homes, and who do not use it for obtaining high tension for the valves of their receiving sets, simply because they do not know how. The apparatus to be described in this article was designed specially for obtaining a suitable H.T. supply from the D.C. mains. In this connection it may be said that commutator ripple is always present to a greater or lesser degree in D.C. supplied from the mains. If it is desired to obtain the high-tension supply from the D.C. mains it is clear that, should any appreciable ripple be present, means must be provided to reduce or eliminate this, since such fluctuations in the anode voltage would cause buzzing to be heard in the telephones. The greatest effect due to this ripple is experienced in low-frequency circuits, particularly with *multi-stage* low-frequency amplifiers and reflex circuits. The reason for this is that when any unwanted voltage fluctuation, such as that of the ripple, is present in the anode circuit (say, of the detector valve),

buzzing would be caused in the telephones if the latter were placed in the anode circuit of that valve. This buzzing or hum would be considerably amplified by each note magnifier in turn, and the result would be a loud hum in the telephones or loud-speaker connected in the anode circuit of the last valve, perhaps sufficiently loud to blot out or render very indistinct the signals it is desired to receive. However, the difficulties of "smoothing" any ripple which may be present in the D.C. supply are largely exaggerated, and a very simple method will be indicated later.

Now, the problem of using the D.C. supply for providing high tension on a receiving set is twofold, and resolves itself into the cutting down of the voltage, economically and safely, and of smoothing the voltage.

As a means of reducing the voltage to a convenient value,

High Tension from D.C. Mains

A
Neon Tube "Smoother"
for D.C. Supply

The apparatus described in this article was designed by Mr. E. K. SPIEGELHALTER, and should prove a valuable accessory for amateurs having D.C. supply.

the use of some form of potentiometer suggests itself, but this method has several important disadvantages. In the first place, a potentiometer wound with resistance wire would seem the only practicable thing to use, and this would have to be shunted directly across the mains, and tappings taken from it to obtain the required voltage. For economical working its resistance would have to be high and much wire used; and here the liability of the resistance to become excessively hot, necessitating some cooling device, becomes very serious. Consequently, a more suitable method must be sought, bearing in mind that economy in current and safety in use are the important factors.

It is found that a Neon lamp or tube will function satisfactorily in cutting down the voltage if connected in series in the supply

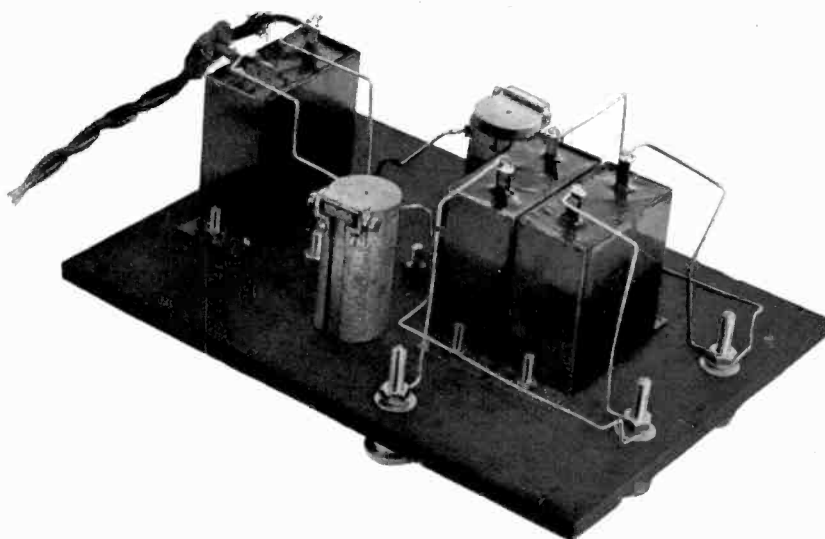

Fig. 2.—The underside of the panel.

circuit from the mains to the valves in a receiving set. A few words on the construction of Neon tubes may be of interest here. The Neon tube consists essentially of a glass bulb evacuated as highly as possible, and then filled with the inert gas, neon, under a pressure corresponding to several millimetres of mercury. Fitted inside the bulb are two electrodes, supported in a similar manner to those in an ordinary three-electrode valve. In the case of the "Osglim" tube, which is one of the commercial types of Neon tube on the market, these electrodes are constructed of iron, one being a vertical helix of thick wire, at the lower end of which is supported, horizontally, a circular disc. The bulb is fitted with a cap, and a standard two-pin bayonet fixing is provided, the contacts being similar to those of an ordinary electric lamp. In this partic-

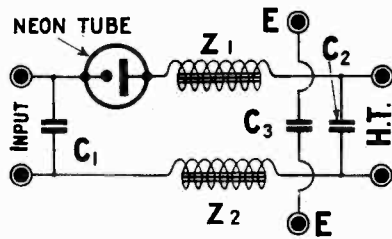

Fig. 3.—Theoretical diagram. Z1 and Z2 are choke coils.

ular type of tube a resistance is incorporated in the base or cap.

A peculiarity of the Neon tube is that it requires a higher voltage, known as the "upper critical voltage," to start it glowing, than that voltage, termed the "lower critical voltage," to maintain it in this condition. Should the upper critical voltage, however, be exceeded to any great extent, the characteristic orange-coloured glow located round the cathode will be displaced by a more violet-coloured glow, and the tube loses its previous constants, which then assume new values. For instance, a tube rated normally at 250 volts may, by the application of a sufficiently high voltage, cease to function at such rating, and require an upper critical voltage nearer 400 volts to start it glowing.

A suitable method of reducing the voltage being available, it now remains to have an effective smoothing device. Iron-core

choke coils, in conjunction with condensers of fairly large capacity, will be found quite satisfactory for this purpose. The action of chokes and condensers in effecting a smoothing of a fluctuating D.C. current has been described by Mr. Scott-Taggart in a recent issue of *Wireless Weekly*. The action may be briefly indicated thus: Take the arrangement shown in Fig. 7. Suppose there is a slightly fluctuating voltage across C2. These fluctuations may be considered as alternating current of, say, one volt, amplitude,

superimposed on a steady current. Now, disregarding the steady voltage across the input, we may consider that this one-volt A.C. is distributed across the choke coil Z and across the condenser C1, which acts as a conductor of alternating current. Let us assume that the potential variation across the choke Z is, say, three-quarters of a volt, and that across C1 is one-quarter of a volt. A similar state of affairs may be realised in practice by choosing chokes of suitable impedance and condensers of convenient value. It is thus seen that there will be a fluctuation of only one-quarter of a volt across the output.

A Practical Instrument

An instrument, based on the principles briefly outlined above, for obtaining H.T. supply from D.C. mains, has been designed by Mr. E. K. Spiegelhalter. The theoretical circuit is shown in Fig. 3. The condensers C1 and C2 have capacities of 2 μ F, and Z1 and Z2 are iron-core choke coils. A third condenser, C3, also of 2 μ F capacity, is also shown connected to terminals marked E, but not connected to any other part of the D.C. circuit. This con-

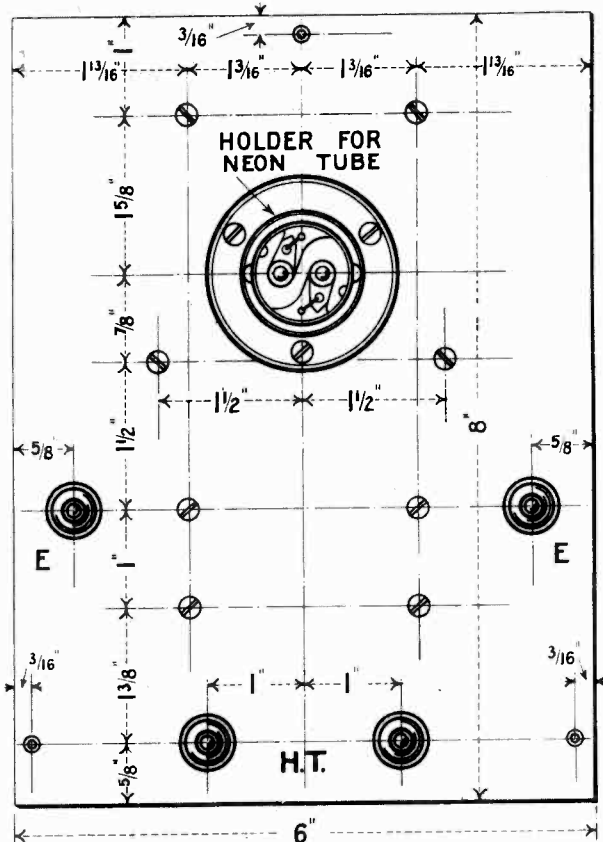

Fig. 4.—Drilling diagram.

denser is incorporated in the instrument for the reason that one side of the D.C. mains is usually connected to earth, and, consequently, if the instrument was used to supply H.T. to a receiver, and the usual earth connection from the set was made, a direct short, either of the L.T. battery or the mains, would result. To avoid this the set is earthed through the condenser by connecting the earth terminal of the set to one terminal marked E and the other terminal marked E to earth.

The components required are :
 1 ebonite panel, 6 in. by 8 in. by 3/16 in. or 1/4 in.

1 Neon tube (an "Osglim," made by the G.E.C.) and holder.

3 fixed condensers of 2 μ F capacity.

2 iron-core choke coils. (Those used were taken from an old telephone indicator board.)

4 terminals.

Length of twin-flex and plug-in adaptor.

Suitable wire for wiring.

An ordinary polished wood case to take the above.

The panel is prepared in the usual manner, and is then marked

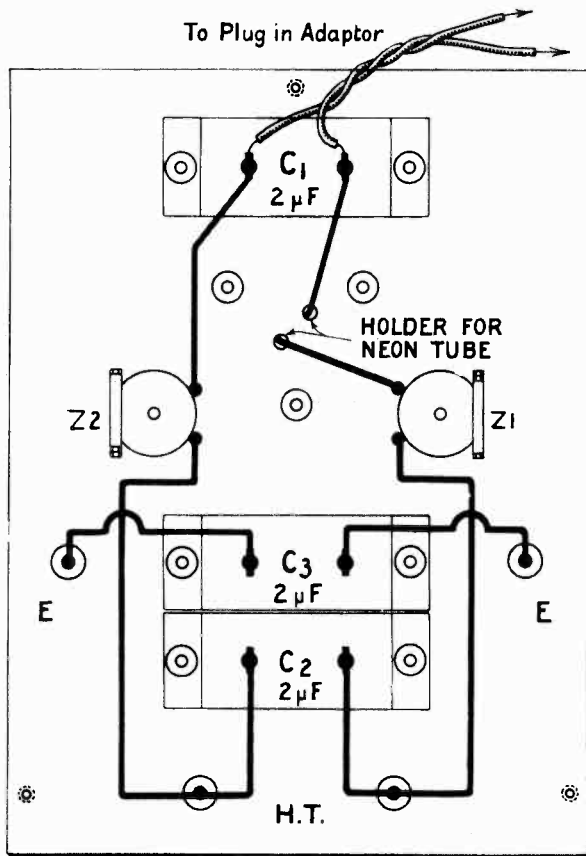

Fig. 5.—Practical wiring diagram.

out for drilling, as shown in the diagram of Fig. 4. The wiring diagram is shown in Fig. 5, and is so simple as to need little comment. The Neon tube is mounted in a standard two-pin bayonet socket, connections being provided by wires passing through two small holes drilled in the panel beneath the holder. The components are subsequently mounted as indicated in the diagrams, and the wiring carried out, using bare wire and soldering all connections. From the terminals or soldering-tags of the condenser across the input is taken a lead of twin flex, of suitable length, attached to a standard two-pin adaptor. The panel is then screwed down on to the top of the polished wood case, provision being made to take the flex through one side.

The Finished Instrument

Photographs of the finished instrument are shown in Figs. 1 and 2, the latter being of the underside of the panel. The method of connecting to a set is illustrated in Fig. 6. The correct way round for connecting the plug

to the socket of the mains is found by experiment. If the plug connected to the mains is fixed so that the anodes of the valves are made negative, no current will pass in the anode circuit due to valve action, and consequently the Neon tube will not glow. It is therefore necessary to determine by experiment the correct way round the plug, so that the anodes of the valves are made positive, thus ensuring that a current will pass and the Neon tube will glow.

The Neon tube should be tried both ways in its holder, as different voltages are obtained, and reception may be better with one than with the other.

Using a 250 v. D.C. supply, 50 v. was obtained with the tube one way round and 70-80 v. with the tube reversed. Further, if the instrument were designed so that another Neon tube could be used in parallel a voltage of approximately 140 would be obtained, and by changing the tubes round this would be reduced to about 100 volts. Two Neon tubes in parallel should thus provide a voltage range of 50-70-120-140.

The actual instrument described has given considerable satisfaction in the hands of several members of the Radio Press staff, an anode voltage free from any objectionable fluctuation being obtained.

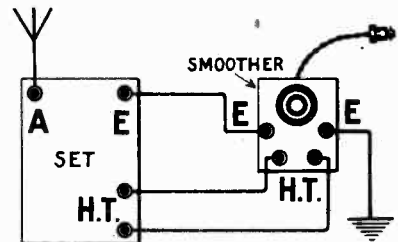

Fig. 6.—Connections to set.

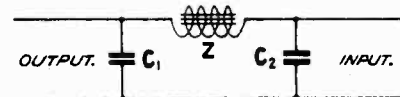

Fig. 7.—Explaining the action of chokes and condensers.

A Two-valve Amplifier for pure reproduction. Test Report.

The amplifier as described on page 287 *et seq.* was connected to a standard type of crystal receiver at a distance of about six miles from 2LO, and gave good loud-speaker results, the purity of reproduction being equal to that obtained with a well-designed resistance amplifier, while the volume was not far short of that obtained with a two-valve amplifier, employing low-frequency transformers for both stages.

When coupled to a valve detector using properly controlled aerial reaction the degree of amplification obtained was very satisfactory, all stations within range being magnified to an extent which was as good as many transformer amplifiers that the writer has tried. The more distant transmissions were noticeably free from distortion, the music and speech being of the purest quality.

J. W. B.

The "All Concert De Luxe" at Durham.

SIR,—I am just writing to thank you for designing so neat and useful a set as the "All Concert de Luxe." I am six miles from Newcastle, with an aerial 72 feet long of single-flex laid behind the picture rail, the earth being a 4 ft. 6 in. copper pipe.

The coils are used with two 0005 variable condensers without verniers (which I am altering), Cossor valves, Exide 6-volt and Ever-Ready 66-volt H.T. On the two valves I have received every station of the B.B.C. except Belfast; also a French station at 11 p.m. nightly.

On Sunday morning, November 9th, I received America, keeping the station from 1.7 a.m. to 1.25 a.m.; but interference was very bad, and I am hoping to get them better on my next attempt.—Yours faithfully,

JOHN J. HALLIDAY.

Birtley, Durham.

How to Make a Highly Efficient H.F. Transformer

By DONALD STRAKER

The ingenious method devised by Mr. Straker has the additional virtue of high efficiency. Notice how one adaptor can be made to serve for a number of different ranges.

It would appear that the mere mention of a particular component in a Radio Press constructional article is a signal for that component to vanish from dealers' stock, and while this may be pleasant for the trader it is very inconvenient for the constructor. Thus, the number of sets employing H.F. transformers described in recent articles is probably the cause of the famine

the type of X former, devised by Mr. Percy W. Harris, are even better, and in view of their many electrical and constructional advantages it was decided to adopt similar formers for these H.F. transformers. To avoid drilling and tapping the ebonite for the valve legs a special adaptor was designed. This is shown in the photographs and enables the construction of the trans-

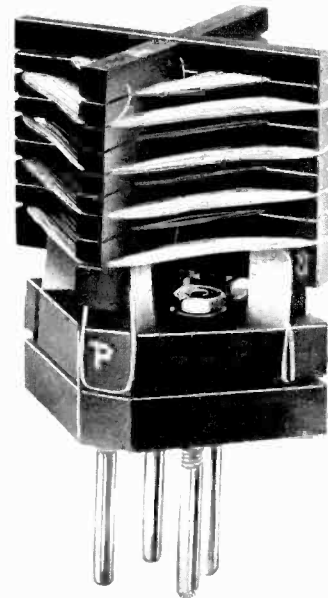

The complete plug-in transformer in adaptor.

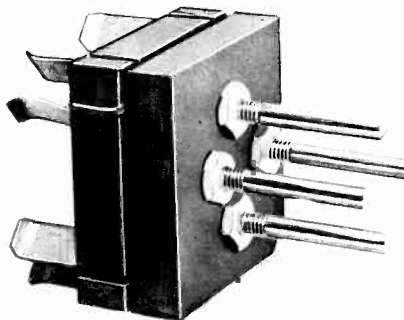
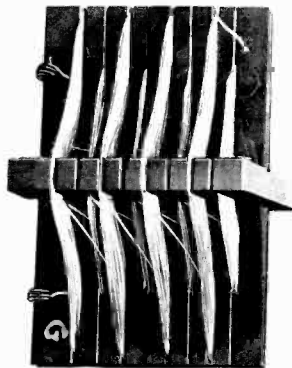

The transformer and adaptor separated.

which at present exists in that useful component. However, the constructor need not despair on this account, for it is really quite easy to make transformers which will compare favourably with the very best commercial article. The cost is almost negligible, and nothing but simple tools are necessary. These will consist of a vice, a fine hack saw, a flat file, square and scriber, and a small drill.

In the article to be described the construction of the formers to carry the windings received much thought, for it was realised that expensive ebonite rod and lathe work were undesirable if a satisfactory alternative were possible. Now the best commercial tuning coils are good, but the writer has found that home-wound coils on

former to be greatly simplified.

When used in the Puriflex receiver the secondary of the transformer is tuned and with quite a small condenser it will be found to cover the B.B.C. transmissions.

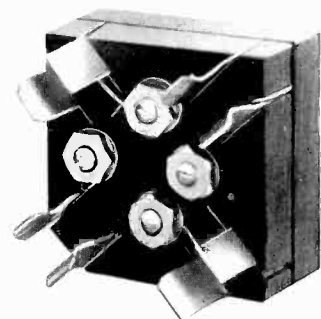
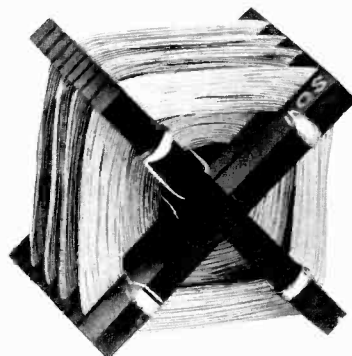

A further view of the two parts.

The writer has a number of transformers of various well-advertised makes, and these vary considerably in the characteristics mentioned, but while each of them cost many shillings the transformers to be described cost only a few pence and in practice they give rather better results than the best of the commercial articles both in volume and selectivity.

**FULL CONSTRUCTIONAL
DETAILS FOR BUILDING
THESE TRANSFORMERS
WILL BE PUBLISHED IN
OUR NEXT ISSUE.**

SOME RADIO PRESS ENVELOPE SETS

On the right: The famous ST100 set. Full particulars of how to build this appear in Radio Press envelope No. 1.

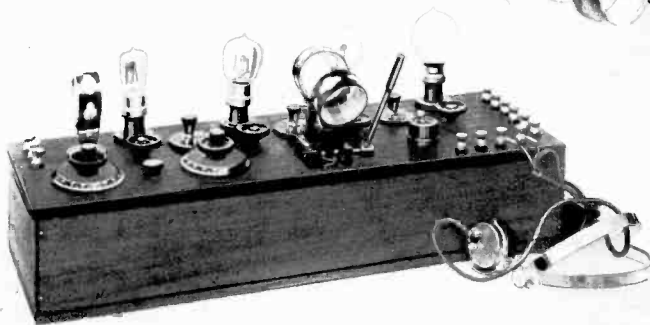
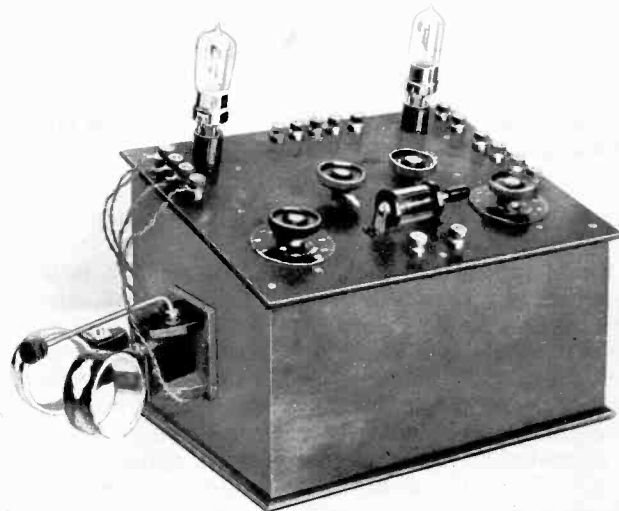

On the left: "The Four-Valve Family" set, described in detail in Radio Press envelope No. 2.

Radio Press envelope No. 3 describes the three-valve "Simplicity" set, which well deserves its name.

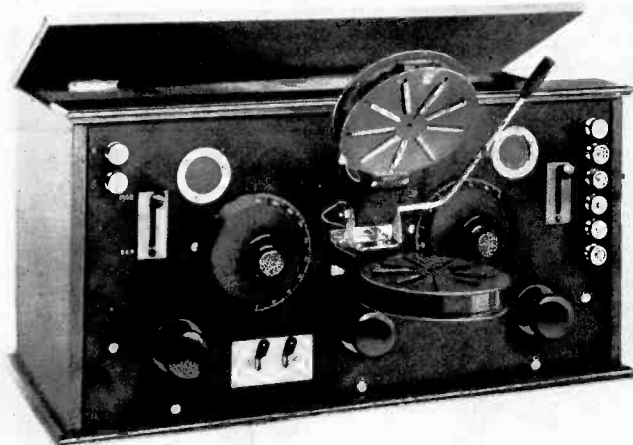

Building the "All Concert de Luxe" three-valve receiver with enclosed valves and many refinements, is explained in most copious detail in Radio Press envelope No. 4.

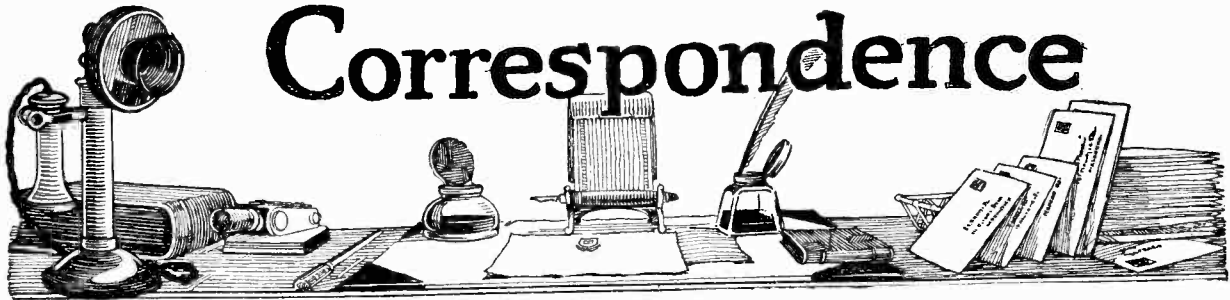

Correspondence

ENVELOPE NO. 2

SIR,—I have much pleasure in writing you after having completed the Family Four-Valve Receiver. The instructions being so explicit no difficulty in construction was experienced whatever. My aerial being badly screened, using four wires having a length of only 30 ft., including leading-in, I naturally did not expect too much of the set. Much to my surprise, however, when testing, all B.B.C. stations came in at good loud-speaker strength. Bournemouth, the nearest station, when using two valves, came in on loud-speaker at good strength, while Paris stations are quite as loud as 5SC. You can imagine that I show the set to my friends with pride. Trusting others may reap as much pleasure as I.—
Yours faithfully,
Portsmouth. G. ROBINSON.

B.B.C. STATIONS AND REVAL LISTENERS

SIR,—It may be of some interest for you to learn that we here, far in the East—about 1,200 miles east from London—enjoy the very excellent programmes of British broadcasting stations almost every night.

In spite of the fact that we have practically no broadcasting regulations in the country and likewise no broadcasting station of our own, we have here quite a number of amateurs who, I am proud to state, are fairly successful experimenters, and it is quite an ordinary thing for them to tune-in to English or German stations with one- or two-valve sets. I have had sometimes the unique experience as well as pleasure of listening-in to Madrid, it being the most distant station hitherto heard in Esthonia. The set used was a simple three-valve affair,

with one stage of tuned-anode high frequency amplification, detector, and one stage of low-frequency amplification.

The results thus obtained in Esthonia are, in my opinion, very good, and speak volumes for the efficiency of the British broadcasting stations. Concerning the quality of the programmes I think it is of the very highest order; I cannot praise them well enough.

If you think it may be interesting for your amateurs to learn that others at a distance of about 1,200 miles can attend to the same programmes as themselves, please kindly let my letter be printed—which has been prompted by nothing but admiration for the very fine performance of your stations.

Thanking all British broadcasting stations for the very splendid programmes which we thoroughly

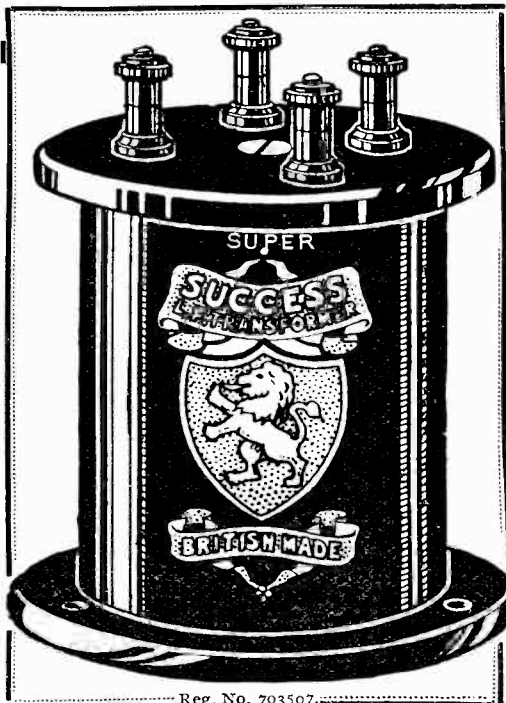

Reg. No. 703507

During final assembly—and following a series of bench tests—the windings and iron core of the SUPER SUCCESS are completely impregnated and surrounded in damp and air resisting compound. The instrument may be subject to any weather condition—regardless of rigour—and the performance of the SUPER SUCCESS will not be impaired in any way.

A PRINCE AMONG INSTRUMENTS

The production of suitable power valves, both for use in conjunction with bright or dull emitters, has placed a new responsibility upon inter-valve transformers.

Those types which technical authorities neither use nor recommend, whose design, manufacture and reproduction can only be distinguished one from the other by the maker—certainly not by the experimenter—are totally unsuitable for inclusion in any amplifier where power valves are to be employed.

The many types of inter-valve transformers, whose name are legion, will, sooner than later, break down under the strain of the heavy currents.

DESIGNED for POWER AMPLIFIERS

The SUPER-SUCCESS L.F. TRANSFORMER embodies such features as are particularly necessary in power work.

The primary is wound in such a position that minimises the sudden breaks in the magnetic field—a kick-back which has sounded the death-knell of many an amplifier. The turn ratio—a matter of importance—but more vitally so—use only is made of good wire, evenly wound to a very large number of turns so that the output across the secondary terminals is one of remarkable signal voltage.

Extract from article in "Wireless Weekly," Nov. 12, 1924:—

In a recent test, carried out by this department, later patterns of the "Success" Transformer gave satisfactory results. The finish of the brass case is now in black with black terminals. On testing the instrument, in comparison with our standard and with other instruments of similar moderate price, the "Success" showed a very satisfactory performance. The tone was good but little of the lower audio-frequencies being absent, and compared favourably with ordinary types.

Tested in the second stage of L.F. amplification, the performance of this instrument was excellent, and the amplification of a high order. Powerful loud-speaking resulted, with little noticeable distortion in general.

Properly used these instruments should give every satisfaction at the price asked. The insulation resistance, on a severe D.C. test, both between windings and from windings to the case, proved excellent; the general finish and appearance of the instrument are distinctly pleasing.

The SUPER-SUCCESS PRICE is a power Transformer. 21/-

Obtainable from all dealers of repute.



COMPONENTS

enjoy.—I remain, your sincere reader and Reval correspondent,
C. M. FREIBERG.
Reval, Esthonia.

A HOME-MADE LOUD-SPEAKER

SIR,—I enclose a photograph of a loud-speaker I have made on the lines indicated in a recent article in *Wireless Weekly*, the main interest being the method of mounting the pleated diaphragm. I bought an electric table lamp and fitted the rim of the diaphragm where the bowl originally was. In addition I painted the paper diaphragm with gold paint, and it makes a beautiful speaker, both as regards appearance and operation. I have three commercially-produced loud-speakers, but this beats them all. It is also a decoration rather than an eyesore.
—Yours faithfully,

C. B. DEAN.
Headingley, Leeds.

BRITISH EXPERIMENTERS CO-OPERATION WANTED

SIR,—Having just returned from a business trip to America in connection with radio, I naturally met a number of the leading radio fans across the other side, and this morning I have received a letter from Mr. E. T. Flewelling, whom, no doubt your readers are fully aware, is the inventor of the

famous Flewelling super-regenerative circuit.

He wishes to know if any amateurs on this side would listen in for his station, 9XBG (Chicago, Ills.), on a wavelength of 70 metres,



The loud-speaker made by Mr. Dean.

as he is confident he can get his signals over to this side, it being only necessary to have a pre-arranged time for working.

If any amateurs interested would care to communicate with me I shall be only too pleased to send

Mr. Flewelling their names and addresses, and also forward to them the times and dates arranged.

If readers will kindly forward me the replies to this address their co-operation will be much appreciated.
—Yours faithfully,

J. H. E.
(A.R.R.L.)
C/o Messrs. the General Radio Company, Ltd.,
6, Imperial Buildings,
Oxford Road,
Manchester.

WIRELESS v. GRAMOPHONE

SIR,—With regard to the gramophone v. broadcast receiver controversy, concerning which correspondence has appeared in your paper, I find it difficult to understand why the two instruments should be regarded as rivals for a place in a man's home. The sphere of usefulness possessed by each instrument is so different that each may be developed to a high degree of perfection to their mutual advantage rather than, as is suggested by so many writers, to their mutual detriment. It is contended that the perfection of one will result in the extinction of the other.

I would suggest that the difference between the above-mentioned instruments might be aptly likened, for the purpose of analogy, to the

RADIAX UNIVERSAL RECEIVER.

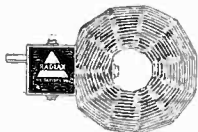

RADIAX DUPLEX BASKET COILS.

Far more efficient than honeycomb, or any other type of coil. Exceedingly strong and rigid, mounted on standard ebonite plugs. Brown finish, no wax or shellac used. MOUNTED

No.	Price.	No.	Price.
25	1/6	75	2/3
35	1/9	100	2/9
50	2/-	150	3/-

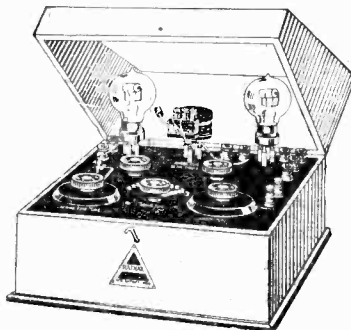

These powerful regenerative sets will deal efficiently with all wave lengths, and embody detail refinements which few other sets, however expensive, can boast. They are wonderful for distant reception. Get our list. As supplied for Home Constructors, they are complete with plan, diagram, fully drilled and engraved panel, and every detail required. Get our list.

The following is a small selection. Send stamp for full list. Constructor's Completed and Set. Tested Set.

2-valve No. 24 P	£4 15 0	£6 12 6
3 26 P	£7 5 0	£10 17 6
4 28 P	£9 15 0	£15 0 0

Marconi Royalties extra on Completed Sets. A Super-Power, beautifully finished Crystal Set is our Challenge. No. 40 for Broadcast. No. 41 for Chelmsford also. Prices £2 2 0 and £2 10 0 respectively.



The "Herald" L.F. Transformer.

This new Radiax Component is built to the proved most efficient design. It is manufactured with the utmost precision and care, and it is subjected to all reasonable

PRICE 15/-

and practical tests. It will give a high amplification without distortion, and in these respects it does not equal any first-class transformer against which it is compared, we will refund cash if returned within 10 days.

FIX RADIAX SQUARE LAW CONDENSERS.

Of splendid quality and finish, very strong construction and highest possible electrical efficiency, this new Radiax production will Revolutionize Your Tuning.

The use of a good square law condenser facilitates the tuning on that portion of the scale hitherto difficult or impossible, and gives uniform results over the whole range.

A Radiax Chart FREE with Each enables you to identify by wavelength each station you tune in. It includes valuable hints on logging all stations heard.

	Without Vernier.	With Vernier.
0.001	9/-	—
0.0006	7/6	—
0.0005	7/-	8/6
0.0003	6/6	8/-

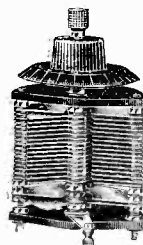

2-VALVE LOUD SPEAKER.

Designed to meet the demand for a powerful, simply controlled, low-priced set.

This set enables you to get splendidly powerful reception under average conditions. It gives Loud-Speaker Reception at 15/20 miles and very much greater distances on Headphones. Extremely selective, enabling British and Continental Stations to be heard in most parts of the British Isles.

Ordinary terminals are not used, instant connection or disconnection being made by plugs and sockets. Strong cabinet covered with high quality black leather cloth, ebonite panel with nickel fittings throughout. Tunes to all wavelengths.

Price: £4 : 15 : 0
Including pair of Broadcast Coils.
Complete with Phones, H.T. and L.T. Batteries, Two Valves, £8 : 13 : 6
aerial and insulators. Above prices plus 2s. Marconi Royalty.



SET No. 61.

Full list of Sets and Components Catalogue on request.



RADIAX, LIMITED,

50, Radio House, Percy Street, Tottenham Court Road, London, W.1.
3 minutes from Tottenham Court Road and Goadge St. Tube Stations.

difference between a telescope and a cinematograph-projector. The telescope enables us to see that which is actually taking place at a distance and within its range, at a given moment, just as the broadcast receiver enables us to hear. The cinematograph allows us to view the same scenes just as often and whenever we wish, but we are limited to the films in our possession, just as with the gramophone we are limited to the records we have. Yet surely no one would say that the possession of a telescope prevented the enjoyment of a cinematograph or vice-versa.

The owner of both a broadcast-receiver and a gramophone will have many delightful melodies introduced to him through the medium of the former, which he can then proceed to play (after having purchased the records) to his heart's content on the latter at all times including that during which the broadcast programme is not quite to his taste. As for broadcasting, the programme includes many items which do not bear repetition, it is unnecessary to give details.

Finally, I cannot allow the statement that no gramophone has ever reached the perfection of the best broadcast reception to pass unchallenged. To my knowledge there is only one gramophone which can refute this contention, but it exists.

In tests before large and critical audiences, chiefly in America but also in this country, it was found that no member could discern the slightest difference between the voice or instrument of the living artist in direct comparison with the reproduction. Only a scientific instrument could detect that there were a few of the harmonics missing from the phonographic reproduction. I may add that I did not credit the above statements until I had heard the machine, and I now possess one of my own as well as a broadcast-receiver.—Yours faithfully,

C. H. CAMPBELL GRAY.
Oxford, Kent.

PHOTOGRAPHS BY WIRELESS

(Continued from page 286)

similar to that on page 286 in the photograph of President Coolidge. This photograph, by the way, is not one of those sent across the Atlantic, but was recently sent by wireless from America and is reproduced here, as it is the only available photograph in this country.

Time of Transmission
We understand the time taken

to transmit a photograph such as this is approximately half an hour, so that it will be seen that at the present time only a limited number of pictures could be sent per day, even if the whole circuit was devoted to nothing else.

The actual photographs sent in the public demonstration on November 30 were a photograph of Queen Alexandra, Mr. Baldwin, and other pictures of interest.

In the actual transmission the cylinder moves laterally 1/128th of an inch for each revolution, but for ordinary reproduction the photograph might be moved 1/64th of an inch, thus giving a result similar to the coarse screen used in the photographic illustrations in newspapers.

The apparatus has been developed by Mr. D. Ranger, of the Radio Corporation of America, which acts in close association with Marconi's Wireless Telegraph Co., Ltd. It is hoped to have the receiving apparatus available shortly in this country when fuller demonstrations will be given.

Put the World on your Dial.



"I would like to congratulate you on the wonderful valves which you manufacture. They are the only distortionless and perfectly made valves on the market, and they are all and more than you claim for them.

"I was testing my one-valve set between 1 and 2 o'clock in the morning using a MYERS valve when I was surprised to hear telephony which I discovered to be KDKA—viz.: Pittsburgh.

"There is one more thing I wish to say. It is this: Good luck to MYERS Valves, THE ONLY PERFECT RADIO VACUUM TUBE WHICH DOES ALL THAT ITS MAKERS CLAIM FOR IT."

Myers PRACTICALLY UNBREAKABLE
Valves

Distributors: CUNNINGHAM & MORRISON, WINDSOR HOUSE, VICTORIA STREET, LONDON, S.W.1. Phone Victoria 827.

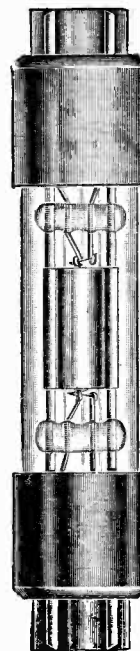

Universal, 12/6
4 volts .6 amp.
Dry Battery, 21/-
2½ volts .25 amp.

The valve's the thing. Long distance reception with the minimum of equipment—that's your aim. Get to earth as soon as you can—but fit suitable valves—MYERS.

There is no secret about the success of the MYERS in Trans-Atlantic short wave work—undoubtedly the most critical and difficult side of wireless reception. Receivers fitted with ordinary valves suffer from short distance paralysis due to their high internal capacity.

MYERS are low internal capacity valves. Their design brings the grid and anode leads out at opposite ends—a method of construction which gives you "Radio on Wings."

If you would span Continents, fit MYERS—they give you distance and POWER.

MYERS are obtainable from all dealers, Agents, or direct from the distributors:

- LONDON.—Dull Emitter Valve Co., 83, Pelham St., Kensington, S.W.7.
- MANCHESTER.—R. Davis & Sons, Wireless Depot, Bilsberry St.
- NEWCASTLE.—Charles Bailey, 26, Cloth Market.
- LIVERPOOL.—Apex Electrical Supply, 59, Old Hall St.
- GLASGOW.—Milligan's Wireless Co., Ltd., 50, Sauchiehall Street.
- YORKSHIRE.—Wadsworth Sellers & Co., Standard Buildings, Leeds.
- BRISTOL.—Bristol Wireless Co., Radio House, Queens Road.
- TAUNTON.—A. Montague Cooper, 29, East Street.



Apparatus we have tested

Conducted by A. D. COWPER, M.Sc., Staff Editor.

"Magnum" Plug-in High-frequency Transformers

Messrs. Burne-Jones & Co., Ltd., have sent for test two samples of their "Magnum" plug-in high-frequency transformers. Those submitted covered the range from 300 to 600 metres with a .0003 μ F parallel tuning condenser, and were in the form of an ebonite cylinder $1\frac{1}{2}$ in. high and $1\frac{1}{2}$ in. diameter, with six grooves for the windings and the ordinary 4-pin base.

On test, the range indicated was exactly covered with a .0003 μ F (actual) tuning condenser, and the two samples showed quite close correspondence in their tuning. The insulation-resistance between windings was excellent. In actual reception the usual degree of amplification associated with fine-wire

plug-in transformers was obtained; and in the modification suggested by Mr. Harris of the writer's neutrodyned tuned-anode coupling, using the one winding as a tuned anode and the other as the neutrodyn coil, good stable amplification resulted with a very small neutrodyning condenser in a circuit loose-coupled to the aerial. The finish and workmanship of these transformers was all that could be desired.

"Perfection" Crystal Holder

We have received from F. H. Middleton a quick-release crystal-cup—the "Perfection" crystal-holder. In this device, which is about the size of an ordinary crystal-cup and is adapted for fixing in the crystal-detector by the usual small central screw, a deep slot is

cut in the wall of the cup, nearly across it; in this slot there slides a bar provided with a small insulated handle on one end. This bar is retained in the slot and pulled inwards by a small spiral spring passing round outside the cup. The handle is pulled outwards, and a crystal-fragment dropped in the cup between the movable bar and the back wall of the cup; on releasing the handle the bar is pulled back on the crystal by the spring, and retains it securely in the cup, making at the same time good electrical contact with the crystal. As the points of contact with cup and bar are actually limited, the crystal does not suffer much from the treatment, and a large proportion of its surface remains available for further use by releasing the grip and turning the crystal round.

Pilot Receivers

Before making up any Radio Press Set—such as the All Concert, the Transatlantic V, and others—send at once for a free copy of our large Folder illustrating every instrument and showing complete range of prices. Sent free of charge on receipt of post card.

Free Folder.

Red Triangle Ebonite

We have recently concluded arrangements to take the whole output from a prominent British manufacturer of ebonite.

Each panel will bear a small triangle engraved in red as a mark of identification and guarantee. Every panel $\frac{1}{8}$ in. thick with velvet matt finish for immediate use. 16 stock sizes at $\frac{1}{2}$ d. per square inch with edges squarely cut.

Special Radio Press sizes:			
All Concert de luxe	..	16 x 8 x $\frac{3}{4}$ "	8/-
Transatlantic V	..	22 x 11 x $\frac{1}{2}$ "	15/-
All Britain	..	16 x 9 x $\frac{1}{2}$ "	9/-
ST. 100	..	12 x 9 x $\frac{1}{2}$ "	7/-
Harris Crystal Set	..	9 x 5 x $\frac{1}{2}$ "	4/4
Puriflex	..	14 x 10 x $\frac{1}{2}$ "	9/2
Resistoflex	..	12 x 8 x $\frac{1}{2}$ "	6/-
Transatlantic 4	..	16 x 8 x $\frac{1}{2}$ "	8/-
Anglo-American	..	36 x 9 x $\frac{3}{4}$ "	20/-

Packing and Postage 6d. per panel extra.

Catalogue 3d.

Send at once for copy of our large 48-page illustrated Catalogue showing every component. Lowest prices in London for high grade apparatus. Peto-Scott's Wireless Book (containing over 80 circuit diagrams and much information), 1/3 (1/5 post free).

A new high-grade Square Law

ALTHOUGH every experimenter realises the tremendous advantages of square law Condensers many who would otherwise use them are deterred by the necessarily higher price. The new Peto-Scott square Law Condenser shown here is an attempt to place on the market a really good instrument possessing most of the advantages of higher priced condensers at a figure within the reach of all. It is substantially made with fine spacing washers and solid ebonite end pieces—both ends of which are brass bushed to prevent wear. It is affixed to the panel with one hole only—a great convenience to the home constructor.

A special feature is its two-piece dial which is absolutely self-centring. Any dial that must be set on its shaft with some form of set screw cannot be true and develops an unsightly wobble. Remember that such authorities as Mr. Percy W. Harris and others emphatically state that every Variable Condenser ought to be of the square law type.

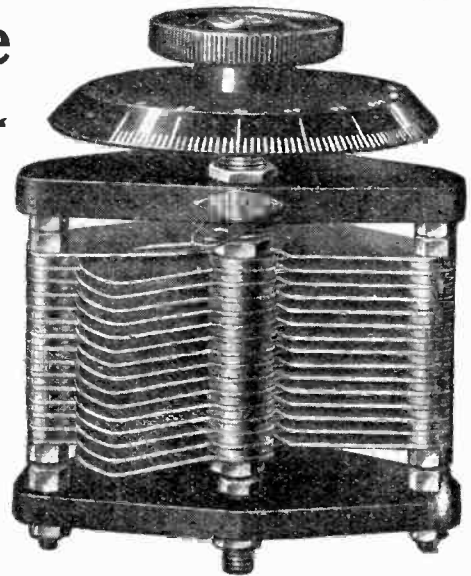

PRICES:

.0001 mfd. ..	7/-	.001 mfd. ..	11/6
.0002 mfd. ..	8/6	Dual Condenser	
.0003 mfd. ..	10/-	for two stages	
.0005 mfd. ..	10/6	of H.F. Each	
		half .0003 mfd.	15/6

PETO-SCOTT CO., LTD.

Registered Offices, Showroom and Mail Order:

77, CITY ROAD, LONDON, E.C.1.

Branches—LONDON, 62, High Holborn, W.C.1. PLYMOUTH—4, Bank of England Place. LIVERPOOL—4, Manchester Street. CARDIFF—94, Queen Street. WALTHAMSTOW—230, Wood Street. P.S. 1893

On test, it was found exceedingly easy to mount crystals of different shapes and sizes, so as to expose a good surface to the cat's whisker. A change of crystal could be made in a few seconds. We can recommend this device for listeners who wish to maintain a high standard of reception, and who have realised the necessity of frequent change and adjustment of their crystals for this purpose.

Diamond Sunflower Coils

A set of "Diamond Sunflower" plug-in tuning-coils has been submitted for test by Messrs. Diamond Wireless, Ltd. These coils have a novel type of winding, within a ring of insulating material. Both edges of the ring have a number of radial slots, and the wire is passed to and fro, crossing the ring inside each time, from the one to the other set of winding slots, giving a curious type of open air-core inductance resembling to some extent a honeycomb coil in external appearance whilst actually having a roughly V-shaped winding. The ring is approximately 3 in. in diameter, and the inside diameter of the winding about $2\frac{1}{4}$ in. The ordinary plug-and-

socket fitting is provided, carrying the ring in a light brass cradle which can easily be removed or swung over at an angle to the plug if desired. The brass strips making up this cradle provide the electrical connection to the coil: when used as, e.g., reaction-coils, it was noticed that there was some risk of a H.T. short-circuit if the brass strips of two coils came into contact.

On trial with a tuning condenser of .0005 μ F (actual) capacity, and with an aerial of .0003 μ F (i.e., the standard P.M.G. aerial), in valve-reception, the No. 25 coil covered the range from 230 to 300 metres, the No. 35 from 300 to 395 metres, the No. 50 from 350 to 460, the No. 75 from 580 to 880, the No. 85 from 730 to 1,080, the No. 100 from 860 to 1,320, and the No. 125 from 960 to 1,440 metres.

Accordingly, there was good overlap. On a 70-foot single aerial of moderate height but fair efficiency, using an R valve with the usual amount of H.T., above No. 75 a combination of coils

could be always chosen to give steady oscillation; and Nos. 35 and 50 oscillated with a No. 75 plug-in reaction-coil of standard type; No. 50 would give oscillation with No. 75 or 85 as reaction with a bright filament and ample H.T., not otherwise; whilst Nos. 25 and 35 would not oscillate with any combination tried. The magnetic coupling between the coils, even when close up against one another, appeared to be rather less than with several other types of coils. In actual reception, when critical reaction was once obtained, there was but little difference noticeable between these and standard types of plug-in coils.

Tapped Anode Inductance

A tapped anode inductance for tuned - anode H.F. coupling, covering a large range in one small instrument, has been submitted by Messrs. Radiax, Ltd. This accessory plugs in on the customary four valve-legs, three of which provide the necessary electrical connections, and has a coil, tapped in six places, wound in six small slots in the barrel



"Here,
just listen to this
I've never before had
such fine reception!"

You can share this lucky fellow's enthusiasm when you have tried a "Uralium" Crystal on your set. — "Uralium" is a natural product and the finest thing in the way of wireless crystals that has ever been discovered.

You naturally want the best reception your set is capable of. Well, there is one way to get it. Use—

Uralium
NATURE'S WONDER CRYSTAL

"Uralium" is put up in neat little boxes with a silver catswhisker. The price is 1/6.

Of all Dealers or direct from—
BOWER ELECTRIC, LIMITED,
15, Grape St., Shaftesbury Ave., London, W.C.2.

USE ONE
AND BECOME
A
URALIUM
ENTHUSIAST

For Very
Accurate
H.F.
Work.

PRICE
2/6

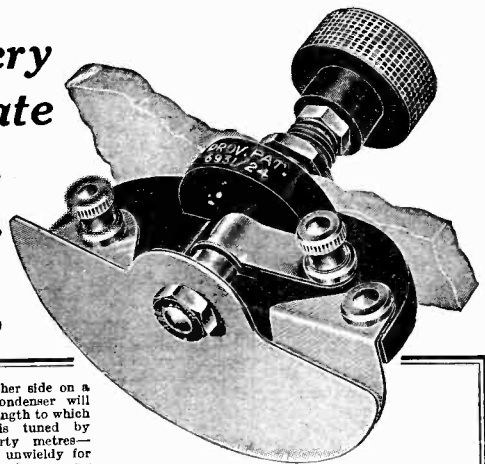

One degree either side on a large tuning condenser will vary the wavelength to which the receiver is tuned by twenty to thirty metres—obviously too unwieldy for any selective receiver, or any receiver which is designed to be selective. The weaker the H.F. impulses which reach your tuner the greater the necessity for accurate tuning—for a low maximum capacity condenser which allows very fine tuning so close as to be dead accurate.

COLVERN Tuning Condenser

Solves tuning difficulties. It has only to be tried for a few seconds upon an existing receiver to realise that your Set is more sensitive to perfect balance than you have yet experienced. Any receiver into which the COLVERN is built yields its utmost power—simply, your receiver can be tuned dead accurate. For multi-stage H.F. the COLVERN is a vital essential; for local broadcasting you will find it equally useful in persuading maximum power.

BUILDERS of NEUTRODYNE RECEIVERS incorporate the COLVERN NEUTRODYNE CONDENSER. A very efficient instrument designed similarly to the COLVERN GENERAL PURPOSE VERNIER. Price 3/6

Obtainable from your dealer. When ordering direct kindly give name and address of your dealer.

COLLINSON'S PRECISION SCREW CO., LTD.

Macdonald Rd., Walthamstow, London, E.17. Tel.: Wal. 532.

Barclays 438.

body, after the pattern of a H.F. transformer. A small six-point switch is mounted on one side of the body. This switch is arranged to short-circuit the next section of the coil to that in use, as well as the whole of the remainder of the windings, so as to minimise dead-end effects. A fitting carrying a swinging reaction-coil can also be plugged into the top, though that provided was suited rather to the lower range than for the higher wavelengths.

On test, this instrument covered from 200 to 3,800 metres wavelength in the interval position with a .00025 μ F parallel tuning condenser, showing ample overlap on the switch-points. It had evidently been the subject of careful design, as well as showing good workmanship and finish. On actual trial in reception on a two-valve set with this interval coupling, in addition to B.B.C. stations, Radio-Paris and 5XX came in well on the upper range, but not effectively separated at 35 miles from the latter station.

Legless Valve Holder

An improved pattern of the legless valve holder marketed by the Goswell Engineering Co., Ltd., a report on an earlier pattern of which has already been published in these columns, has been submitted for our examination. This type of holder, which is turned from solid ebonite rod, acts as its own drilling-jig; and since small screws are tapped into the side so as to make contact with each socket, connections can be made without the aid of solder either on the front or at the back of the panel. A single centre screw fixes the holder in position on the panel. A safety feature which the nervous experimenter will appreciate is that the plate socket is sunk, as to the metal part, below the level of the top of the holder, and made distinctive by a red insulating bush; it is thus impossible to connect the filament legs to it, as became apparent on actual trial. It was found that with certain valves, which have rather thicker legs than usual, it was necessary to reamer the sockets out a little

larger in order to have a reasonably easy fit. Incorporated into an actual receiver, excellent insulation was noticed, and the holder could be used even on a wooden base-board with success.

"Antifroth"

Messrs. Cowlishaw Bros. have sent for test a sample of their "Antifroth," a preparation to prevent the troublesome frothing up which sometimes occurs in accumulators while being charged. This liquid has been given an extensive practical trial with three different makes of accumulators which had been giving trouble with frothing, each of which has been recharged several times since, and in the interim used regularly in radio receivers. In each case, the frothing trouble was completely cured, the electrolyte is now quite clean, and the cells apparently in first-class condition. We can, accordingly, recommend this material to those of our readers whose accumulators suffer from this troublesome condition.

TO TRANSMITTERS.
TO EXPERIMENTERS.
TO CONSTRUCTORS.

Something new for coils

500 Readers of "Wireless Weekly" may test the new "MARS" Coil Wire BEFORE IT IS PLACED ON THE MARKET.

One of the largest makers of coils in the country has already proved that coils made from this wire give 20% greater efficiency than coils made from any wire previously tested.

Other expert opinions indicate that it is the best coil wire produced. But our heavy delivery commitments in connection with the Mars Aerial prohibit us from making the coil wire in commercial quantities—at present.

We are continuing our tests and to meet our research requirements have spun 10 miles of coil wire.

We invite 500 readers of "Wireless Weekly" to co-operate with us in our experiments.

A SPECIAL TEST OFFER
For the nominal charge of 1s. we will send, to the first 500 readers who apply, one 72 ft. length of Mars wire, approx. 24 d.c.c., provided that applicants agree to furnish us with a short written report of their findings.

PLEASE NOTE:
Only one length can be sent to each applicant. All requests must be accompanied by the coupon printed below. Send P.O. (not stamps). The wire cannot be obtained through dealers. Technical or commercial enquiries in connection with the wire cannot be dealt with until after the Christmas holidays.

TEST LENGTH OF THE NEW MARS COIL WIRE: 72 ft.

1/-

Sent in one simple condition

"Wireless Weekly" Coupon.

To E. & W. G. MAKINSON, LTD.,
Coil Dept., Wellington Works,
Wellfield Road, Preston.

I enclose P.O. for 1/- (Note: Stamps not accepted). Please send me 72 ft. of "Mars" spirally wound wire, 24 d.c.c. I agree to furnish a short written report of my test results.

Please attach this coupon to a slip of paper, bearing your name and address, written clearly, and make out the P.O. to E. & W. G. Makinson, Ltd. The right is reserved to withdraw this offer without further announcement, in which case all P.O.'s received will be returned. All requests will be dealt with in rotation.

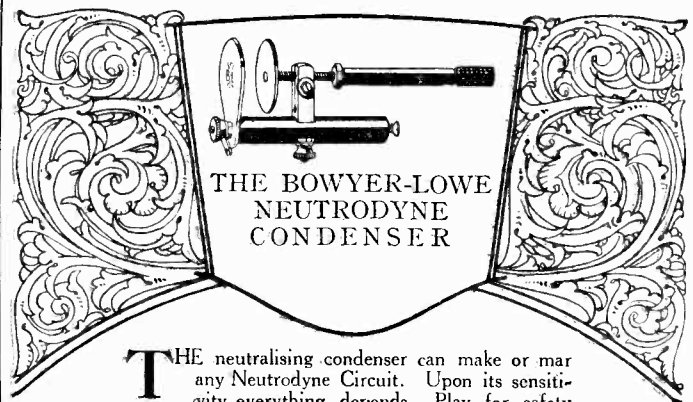

THE BOWYER-LOWE NEUTRODYNE CONDENSER

THE neutralising condenser can make or mar any Neutrodyne Circuit. Upon its sensitivity everything depends. Play for safety by insisting on having the Bowyer-Lowe Neutrodyne Condenser—it is sold after test.

Its minimum capacity is practically zero, its maximum is less than the minimum of an ordinary condenser. Made of Ebonite and solid brass. One screw fixing with additional 3/8-inch hole for spindle.

Packed in individual carton with drilling template. **PRICE COMPLETE 5/-**

Order direct if your dealer cannot supply.

Bowyer-Lowe Tested Radio Components

BOWYER-LOWE Co., Ltd., LETCHWORTH.

Information Department

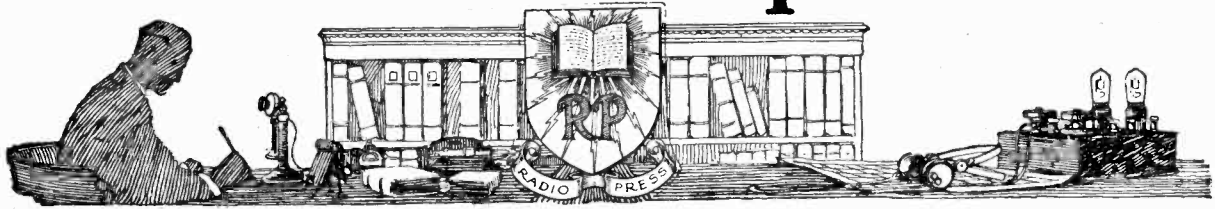

SUPPLIED BY RADIO PRESS SERVICE DEPT., LTD.

N. V. C. (BEVERLEY) possesses a rather small outside aerial which he is unable to improve, and asks us to recommend a receiver to suit him, explaining that he requires headphone reception only.

Since your locality is a bad one and you are further handicapped by your small aerial, we think two high-frequency valves will be needed. Low-frequency amplification should not then be necessary, and therefore a three-valve set will suffice. We advise the "Transatlantic" receiver described in "Twelve Tested Wireless Sets," by Percy W. Harris (Radio Press, Ltd., 2s. 8d., post free), this being an ideal instrument for long-distance head-phone reception.

E. A. B. (MATLOCK) has built a "Transatlantic V." receiver (his

first set) and reports that although he can get all stations at fair strength in the phones, when he switches over to the full five-valves only weak signals are heard from the loud speaker.

There may be an actual fault in the circuits of the low-frequency valves, but the symptoms given in detail in our correspondent's letter make this seem improbable. It is more likely that the trouble results from a characteristic of all sets in which resistance capacity coupling is used on the low-frequency side. In such sets switching in the low-frequency valves involves bringing a resistance of (usually) 80,000 ohms into the anode circuit of the detector valve, with a consequent drop in the effective anode voltage of perhaps 50 per cent. The result, of course, is to upset completely

any critical adjustment of reaction, and throw the set a long way from its most sensitive state. Hence, it is quite possible that a station which was quite strong in the phones when the reaction was critically adjusted will scarcely be heard from the loud-speaker unless the set is readjusted after switching in the low-frequency valves. In the case of the "Transatlantic V," the set should be brought back to its most sensitive state after switching in the L.F. valves by turning the potentiometer towards the negative end, or by bringing up the reaction coil to the necessary amount and slightly re-tuning as may be required. Another possible cause is that the accumulator is too small, so that the additional load of the last two valves causes a voltage drop on the previous three.



UNSHROUDED EFFICIENCY

Low Self Capacity!!!

TO BE EFFICIENT YOUR TUNING COILS MUST HAVE A MINIMUM

This is guaranteed if you use **"Tangent" Tuning Coils**

||
THE REASON—

Owing to the method of manufacture, the impregnated cord not only passes between each layer to give the air spacing, but also firmly braces up the whole coil, thus — no SWATHING or SHELLAC is required. The immediate result — **LOW SELF CAPACITY.**

Sizes			
Coil No.	Price	Coil No.	Price
25	4/3	200	7/-
35	4/3	250	7/6
50	4/3	300	8/-
75	4/6	400	9/-
100	5/-	500	10/-
150	6/-		

COMPLETE SETS.

4 Concert Coils
(Nos. 25 to 75)
16/- the set.

11 Concert Coils
(Nos. 25 to 500)
67/- the set.



RIGID AS A MOTOR WHEEL

SUGGESTION—

These Sets make excellent Christmas Gifts.

Ask your dealer—Take no substitute
See Leaflet 107

GENT & CO. LTD.

Est. 1872.

Manufacturing Electrical Engineers,

Faraday Works,

LEICESTER

London: 25, Victoria Street, S.W.1.
Newcastle-on-Tyne: "Tangent House," Blckett Street.

A.W.R. (Bradford) receives excellent signals when using telephones, but when employing a good loud speaker results are poor, and asks what he should do?

Assuming that distortion has been eliminated as far as possible in the circuits of the receiver itself, first turn the adjusting screw of the loud-speaker until the best result is obtained, and then experiment with various sizes of fixed condenser across its windings. In the case of a low-resistance instrument the requisite capacity will be quite large, an average value being 0.25 μ F, and it will greatly improve the performance of the loud-speaker when provided. The effect is less marked with the high-resistance type, but is nevertheless present, and should be taken into account. A good value in this instance is 0.005 μ F.

A very important adjustment to obtain the most satisfactory results is that of the volume or loudness of the signals; it is utterly useless to apply an input power large enough for a Magnavox Senior to one of the "baby" or "junior" varieties of loud-speaker, for the inevitable result is severe distortion from the ruthless overloading. Always adjust the strength of the signals to such a point that the loud-speaker is taking

just as much as it will carry without beginning to distort seriously, and never give it more.

M.O.D. (Liverpool) is troubled by a faint humming sound heard accompanying telephony transmissions, and asks its cause?

This is due to the fact that the carrier wave is not perfectly smooth and continuous but contains a ripple derived, usually, from the high-tension supply of the transmitter. (Plate current for transmitting valves is commonly obtained by rectifying high-voltage alternating current, and the resulting direct current may carry a ripple equivalent to the frequency of the A.C.)

M.E.W. (Streatham) asks why is it that a continuous subdued rustling and crackling noise is heard in the intervals of the programme of a broadcasting station?

Various phenomena may assist in producing this sound, such as microphone-rustles at the broadcasting station, or "line noise" from induction effects in the underground cables used in broadcasting public entertainments, but the usual cause is partial heterodyning of the more or less continuous stream of minor

atmospherics by the carrier wave. A similar faint rustling is heard when a receiver is kept in continuous oscillation by means of reaction. If the noise is very pronounced, and is accompanied by occasional louder clicks and bangs, it may indicate either a defective H.T. battery or a bad night for atmospherics. To distinguish between these possible causes, disconnect aerial and earth from the set and note whether the noise continues; if it does the H.T. battery is implicated, although it may also be due to a loose or otherwise faulty connection somewhere, leaky insulation or a defective grid-leak.

W.A.S. (Croydon) is troubled by a neighbouring amateur using excessive reaction and asks up to what distance will a self-oscillating valve receiver cause interference as he wishes to catch the offender?

Quite strong interference may be caused at distances up to several miles when the receiving set comprises only one valve. With more sensitive receiving apparatus, say a two-, three- or four-valve set, the effect of the interference is proportionately increased, or alternatively the effective range of the interference is increased.

Quality RADIO BASKET COIL HOLDERS

Basket Coils are undoubtedly the most efficient form of compact inductance for short waves.

If you make your own, or buy them ready made, you need good holders for the best results. The **BASKET COIL HOLDERS** are efficient in design, manufactured from the best British materials and finished in an unsurpassed style. Made from best British ebonite (not fibre), brass parts polished and lacquered and polished knob.



No illustration can do them justice. The price is so reasonable—

1/3 EACH

Postage 2d.

that you can fit one to every coil.

This is the original **BASKET COIL HOLDER** of its type, all good dealers stock them but insist on seeing the trade mark stamped on each one. All others are inferior copies. Each packed in

Quality RADIO transparent envelope.

If your dealer has not got them we send post free if you mention his name and address. LIST POST FREE.

GOSWELL ENGINEERING CO., LTD.,
12a, PENTONVILLE ROAD, LONDON, N.1.

LIBERAL TRADE TERMS.

Phone 1 North 3051.

The SHIPTON New Type Strip Rheostat & Potentiometer

Gives you perfect control. They are silent in operation, mechanically well constructed and are altogether quite the most efficient

filament controlling devices Wireless has so far produced. The 7 ohm Model is fitted with a safety fuse, which in the event of shorting the H.T., will prevent burning out a costly valve. A tension spring fitted on the spindle ensures perfect contact at all times. One hole fixing.

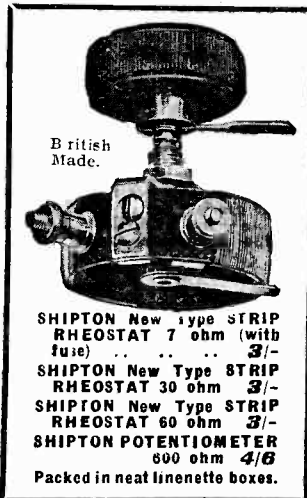

SHIPTON New Type STRIP RHEOSTAT 7 ohm (with fuse) 3/-
SHIPTON New Type STRIP RHEOSTAT 30 ohm 3/-
SHIPTON New Type STRIP RHEOSTAT 60 ohm 3/-
SHIPTON POTENTIOMETER 600 ohm 4/6
Packed in neat linenette boxes.

THE MOST PERFECT RHEOSTAT YET INTRODUCED

SHIPTON Rheostats are obtainable from all dealers. If you have any difficulty write or call.

Sole Agency applications will be considered for certain territories.

E. SHIPTON & CO., LTD.

37, TOTHILL STREET, WESTMINSTER, S.W.1.

Telephone: Victoria 7.

Telegrams: "Reutphones, Parl."

Also at 14, KING STREET, COVENT GARDEN, W.C.2

Buy this Splendid Xmas Number

ON SALE DEC. 13th.

The Great
6^D.
MONTHLY.

The Contents are even more pleasing and up to date than the splendidly illustrated cover which you will see on every Bookstall on December 13th. Its 96 pages will help greatly to increase your pleasure during the festive season.

Young and old, beginners or experienced wireless enthusiasts, will be surprised that a 6d. Monthly Magazine, constructional and instructional, yet simple to read, can contain so much of interest and value while giving pleasure and education combined.

Among the comprehensive list of contents in this issue is a Set of outstanding merit:—

THE "TWIN-VALVE" RECEIVER.

By JOHN SCOTT-TAGGART, F.Inst.P., A.M.I.E.E

Has received five B.B.C. Stations on a Loud Speaker at Bedford!

A FREE BLUE PRINT of this Set is included in every copy.

MAKE SURE OF YOUR COPY.

Obtainable from all Bookstalls, Newsagents and Booksellers,
or 8s. 6d. per annum, post free.

RADIO PRESS, Ltd., Bush House, Strand, LONDON, W.C.2.

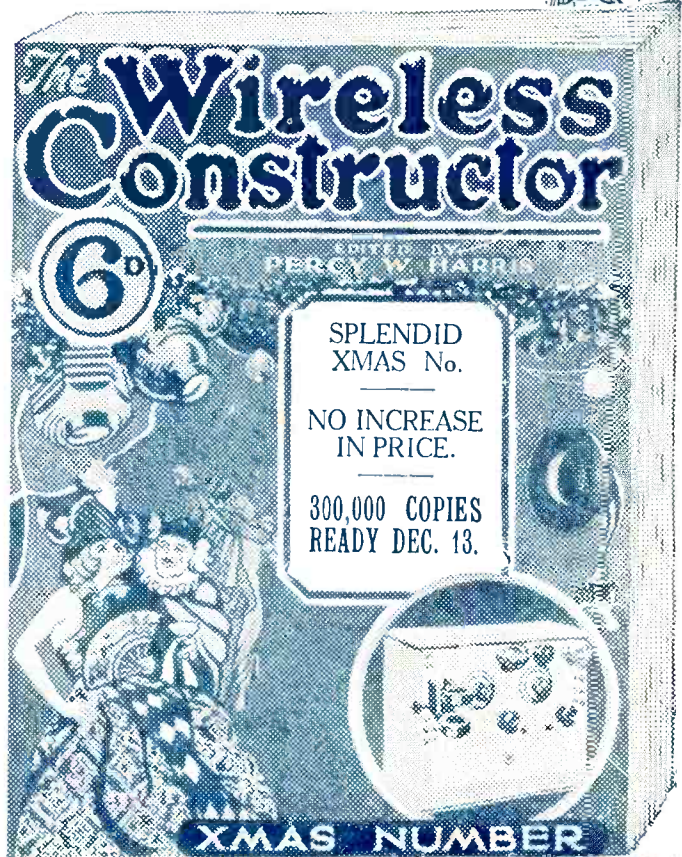



This Xmas



STERLING LIGHTWEIGHT Headphones

Clear, light, and comfortable. Supreme in tone, volume and quality. Fitted with polished duralumin headbands, multiple permanent magnets and tungsten steel polepieces. Complete with flexible cord (4000 ohms resistance) - - **25/-**

120 ohms resistance - **22/6**
2000 ohms resistance - **24/-**

Even now people are beginning to wonder what they did for entertainment before radio came in. It would be strange to go an ordinary evening without music, but Christmas without radio would be a tragedy!

See that you have all you need to make the Christmas festivities gay with radio. Perhaps another pair of Sterling Headphones? Perhaps a Sterling "Baby" Loud Speaker?

Get your own radio equipment complete—give Sterling Radio for Christmas presents. There are four good days in the holiday this year. Then let us see that we have a real good time—and that others do, too.



STERLING BABY Loud Speaker

The most popular entertainer in the world. Flawless in reproduction, natural in tone and wonderfully loud for its size. In Black or an attractive Brown tinted finish, complete with flexible cord (2000 ohms resistance) - - **55/-**

Black and Gold floral design - - **57/6**
Black matt decorated in Oriental style - - **95/-**

STERLING RADIO

at your dealers

Adv. of **STERLING TELEPHONE AND ELECTRIC CO., LTD.**
Telephone House, 210-212, Tottenham Court Road, London, W.1
Works: DAGENHAM, ESSEX

Printed for the Proprietors, RADIO PRESS, LTD., Bush House, Aldwych, W.C.2, by THE AVENUE PRESS (L. Upcott Gill & Son, Ltd.), 55-57, Drury Lane, London, W.C.2. Published on Wednesday of each week at 3, Bolt Court, Fleet Street, London, E.C.4. Address for Subscriptions and Editorial Communications:—Bush House, Strand, London, W.C.2. Advertisement Managers:—BARCLAYS ADVERTISING, LTD., Bush House, Strand, London, W.C.2. Registered as a newspaper and for transmission by Canadian Magazine Post. Subscription rates:—32/6 per annum, 16/3 for six months, post free. Sole Agents for Australasia:—GORDON & GOTCH (Australasia), LTD. For Canada:—IMPERIAL NEWS, LTD. For South Africa:—CENTRAL NEWS AGENCY, LTD. For Japan:—SALE & FRAZER, LTD.