

WIRELESS, incorporating "Wireless Weekly," JULY 17, 1926.

WIRELESS



INCORPORATING
WIRELESS WEEKLY

2^D
WEEKLY

Vol. IV.] JULY 17, 1926 [No. 8

SPECIAL AMPLIFIER NUMBER

IMPROVE YOUR PRESENT
CRYSTAL RECEIVER

SIMPLE INSTRUCTIONS FOR
BUILDING THREE COMPLETE
AMPLIFIERS FOR LOUD-SPEAKER
WORK

Special Free Blueprint Scheme

[Registered at the G.P.O. as a Newspaper.]

*That's
Better!*



COMPLIMENTARY
COPY



No coil changing for Daventry

BY building The "Davlow Three" you will be saved the nuisance of coil changing when you want to listen to the alternative station—one simple change-over switch giving either Daventry or the Local station with equal facility.

As will be observed from the photograph there is only one tuning dial on the set, the other knob belonging to a variable condenser controlling reaction. Arrangements are made in the design so that the batteries are housed inside the cabinet, the whole presenting a neat and attractive self-contained receiver.

Besides his popular feature "Talks to Beginners" Mr. Harris describes under the heading "Australia on Two Valves" a short-wave Receiver, the results from which, by carefully observing the author's instructions, may be duplicated even by the beginner in short-wave work.

In this issue Mr. Stanley G. Rattee introduces an interesting Single Valve Receiver designed to permit a change of circuit from "Reinartz" reaction on the ordinary broadcast band to a direct coupled aerial circuit on the longer wavelengths.

A Novel Plug-in coil unit obviates any necessity for intricate switching. The author having carefully described every point in construction, this receiver will prove both efficient in operation and universal in application.

Contents include:

- The "Davlow Three." By W. Q. Kay.
- Making the Best Use of Your Environment. By A. V. D. Hart, B.A.
- Australia on Two Valves. By Percy W. Harris, M.I.R.E.
- In Scandinavia with a Super-Het. By Capt. L. F. Plunge.
- Change Your Coil and Change Your Circuit. By Stanley G. Rattee, M.I.R.E.
- Do You Keep a Crystal Check? Talks to Beginners. By Percy W. Harris, M.I.R.E.
- Try These New Selective Circuits. By W. S. Percival, B.Sc.(Hons.), A.R.C.S.

The Wireless Constructor

AUGUST ISSUE

ON SALE JULY 15

From all Newsagents, Bookstalls and Booksellers, or direct from the Publishers, Radio Press, Ltd., Bush House, Strand, London, W.C.2. Subscription Rates, 8/6 per annum United Kingdom. 7/6 per annum Canada and Newfoundland, and Other Countries 8/6 per annum. Lesser periods pro rata.

Contents include:

- Was the Designer Wrong? By John Pugh-Price.
- Have You Made Your Portable Set? By D. J. S. Hart, B.Sc.
- A Home-Made Vernier Condenser. By P. H. Wood, B.Sc., F.P.S.L.
- Workshop Hints for the Home Constructor. An All-Purpose Valve Unit. By L. E. Thomas.
- Where Insulation Matters. By G. P. Allinson, A.M.I.R.E.
- Points to Watch in Coil Holders. By H. J. Barton-Chapple, Wh. Sch. B.Sc. (Hons.), A.C.G.I., D.I.C., A.M.I.E.E.
- How to Wind Spaced Single-Layer Coils. By W. H. Fuller.

DUAL CONDENSERS

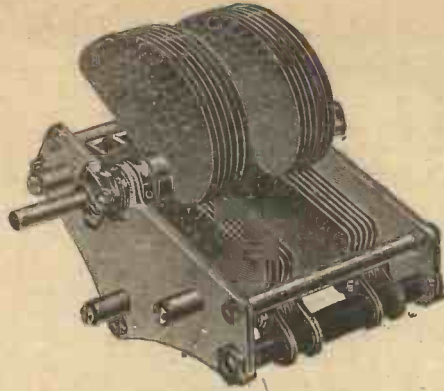

FOR THE ELSTREE SIX

For Your Elstree Six

Look through your copies of Radio Press journals—notice the number of receivers in which Igranic Variable Condensers have been used with such outstanding success.

If you are building the Elstree Six, or any other receiver, and you wish to obtain the best possible results, profit by the example of experts and use Igranic Low Loss Square Law Variable Condensers.

IGRANIC LOW LOSS, SQUARE LAW,
DUAL VARIABLE CONDENSER
(Patent No. 220312)

SEND FOR LIST No. S20



149, QUEEN VICTORIA ST., LONDON
WORKS - - BEDFORD

Igranic Dual Condensers

These condensers have extremely low electrical losses, accurate square law characteristics, positive connection to moving vanes, and best possible workmanship throughout. The two halves are closely matched.

PRICES :

.0003 mfd. (each section) . . . 25/-
.0005 mfd. " " " " . . . 29/6

With handsome 4 in. Combined Knob and Dial which facilitates accurate adjustment. Prices 2/6 less if supplied without knobs and dials.

Experimenters who prefer a slow motion mechanism generally use the Igranic Indigraph Vernier Knob and Dial.

PRICE 7/6

HI!

HIGH TENSION ACCUMULATOR UNITS



"DUROS" H.T. UNITS TYPE "W"

constitute

A **SILENT** source of H.T. supply.

The most **ECONOMICAL** H.T. battery

to use. With power amplification the "DUROS" H.T. Units are absolutely

INDISPENSABLE and are only

SEVENPENCE FARTHING A VOLT!

10-VOLT UNIT - 6/- 20-VOLT UNIT - 12/-

ASK YOUR DEALER TO SHOW YOU ONE—
YOU'LL BE IMPRESSED.

Advt. of A. F. A. ACCUMULATORS, LTD., 9a, Diana Place, Euston Road, N.W.1.

Simple, Accurate, and Easily Adjusted

Don't experiment! Get a "Lotus" and be certain of better results.

The vernier movement comprises three sets of enclosed precision machine cut gears and reduces the speed of the moving coil block by eight times.

*Moving block
cannot fall*

The moving block moves in the same direction as the knob, which prevents confusion. It also becomes absolutely rigid in any position, holding the heaviest coil securely. No screws required to tighten it.

LOTUS

VERNIER COIL HOLDERS

From all Radio Dealers.

Two Types :

For outside panel mounting:

Two-way 7/-
Three-way 10/6

For inside baseboard mounting, with 6 in. handle:

Two-way 8/-
Three-way 12/6

Garnett, Whiteley
& Co., Ltd.,

Lotus Works, Broad-
green Road, Liverpool

Makers of the new improved
"LOTUS" Valve Holder.

Bakelite mouldings for the side plates, coil blocks and knobs; heavy nickel plating for the metal parts.

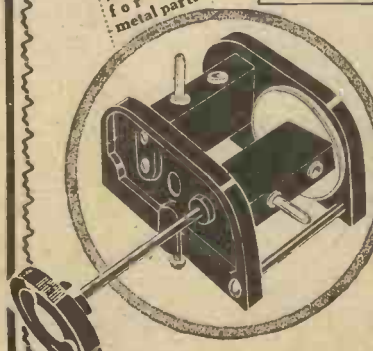

All Valves

have constructional features
but only P.M. Valves have the
P.M. Filament—

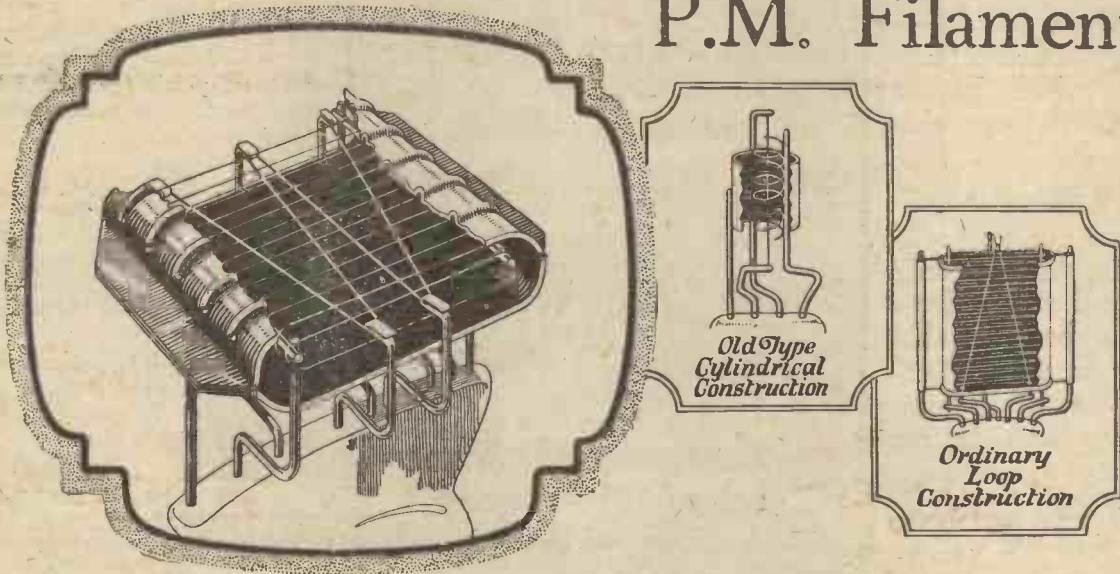

Which valve construction gives you the most for your money

For 4-volt accumulator or
3 dry cells

THE P.M.3. (General Purpose)
0.1 amp. 16/6
THE P.M.4 (Power) 0.1 amp. 22/6

For 6-volt accumulator or
4 dry cells

THE P.M.5 (General Purpose)
0.1 amp. 22/6
THE P.M.6 (Power) 0.1 amp. 22/6

For 2-volt accumulator

THE P.M.1 (General Purpose)
0.1 amp. 15/6
THE P.M.2 (Power) 0.15 amp. 18/6



These prices do not
apply in Irish Free State.

Look at the length, thickness and design of the Mullard P.M. Filament and you will appreciate why those who understand valves place its results 33% higher than any other on the market.

This wonderful P.M. Filament

Is supported by 5 strong but resilient hooks.
Cannot be broken except by the very roughest handling.

Has up to $5\frac{1}{2}$ times greater emission surface.
Requires only one-tenth ampere.

Has the abundant flow of electrons entirely controlled.

Remains ductile even after 1,000 hours life.

Wastes no heat by glowing.

Is free from microphonic noises.

Gives majestic volume.

ASK YOUR RADIO DEALER FOR THE
VALVES WITH THE P.M. FILAMENT.

Mullard

THE MASTER VALVE



WIRELESS

INCORPORATING
WIRELESS WEEKLY
 JOINT EDITORS
PERCY W. HARRIS
 M.I.R.E.
J. H. REYNER
 B.Sc.(Hons.), A.C.G.I., D.I.C., A.M.I.E.E.
 ASSISTANT EDITOR
G. P. KENDALL
 B.Sc.
 TECHNICAL DIRECTOR
JOHN SCOTT-TAGGART
 F.Inst.P., A.M.I.E.E.



THIS WEEK'S NOTES AND NEWS

Two Programmes

JUDGING by the undoubted success of the B.B.C.'s tests with two stations in London transmitting simultaneously, I do not think we shall have very long to wait now before a "two-programme" service for every listener is established on a firm basis. The second station, however, will almost certainly not be at Marconi House, on account of its proximity to the Air Ministry, and it is only by special arrangement with the latter and with the Post Office that the B.B.C. are able to use this station at all.

A Triangular Affair

THE amateur transmitters have now extended their activities to a "three-continent talk." This was carried out a little while ago by three amateurs—Mr. Mayer (G-2LZ), of Wickford, Essex; Mr. Cooley (U-1AAO), of Newton Centre, Mass., U.S.A., and Mr. McGill (Z-4AM), of Palmerston, New Zealand. The test was carried out at 5 a.m. one morning, and a triangular conversation was kept up for some time. The American was heard to say that it was the best fun he had had "since Hector was a pup!"

Should You Like It?

I WONDER whether many of my readers realise how absolutely different the American radio conditions are from those in force in this country? Imagine what it would be like here if we had over thirty stations within twenty miles of London, twenty-five of them often transmitting at once! Pity the poor crystal-scratcher!

"Beam" Delays

THE progress of the "beam" transmission service to Australia has again been unavoidably delayed, and the commencement is now provisionally fixed for October. The second service, between Australia and Canada, will, it is hoped, begin in December.

A Novel Excuse!

AT a recent Police Court case it was stated that the fact that

distinctly bad influence upon wireless reception. Below 300 metres further interference was noticed, in the form of a swishing and roaring noise similar to some types of atmospherics. "A roar o' Borealis," in fact!

Forthcoming Events

I HEAR that Mr. Edward Knoblock, the author of "Milestones," a specially condensed version of which is to be broadcast on July 15, is interesting himself very much in the production of this version, for which Mr. R. E. Jeffrey is responsible. This comedy was first produced by Mr. Dennis Eadie in 1912.

* * *

On Sunday, July 18, the World's Christian Endeavour Convention is to be relayed from the Crystal Palace at 8.15 p.m. The service will consist of hymns, a scripture reading, prayers and an address by the Rev. Tom Sykes.

* * *

One of the best-known educational institutions in North London is Highgate School, from which we are to hear a school concert by radio on July 26.

* * *

Leeds has a gay time from July 8 to July 17, when the celebrations held in connection with the tercentenary of Leeds are being held. Special broadcast programmes will be broadcast in connection with the festivities.

Pity the Poor Crystal!

MANCHESTER listeners have, I hear, recently been disturbed by unwelcome visitors, in the shape of minesweepers in Manchester docks (Continued on next page.)



Sir William Joynson-Hicks performed the presentation ceremony on the occasion of the "opening" of the wireless installation of the Hounslow hospital. The outfit was provided by the Hounslow Wireless Society.

wireless apparatus was used on the premises was very often the cause of offences in the nature of supplying drink "after hours."

Oh!

RECENT tests in America during a very fine show of the Aurora Borealis showed that it had a dis-

This Week's Notes and News—continued

which, "for reason or reasons unknown," suddenly took it into their heads to start up and burn out the neighbouring cat-whiskers!

Would It!

I NOTE that several owners of valve sets fairly close to the London station are dead against the permanent establishment of two stations in London working simultaneously, as it would then, they say, be quite impossible for them to receive the majority of the foreign stations.

Some Juice!

THE amount of wireless apparatus used at Hendon for the wireless section of the R.A.F. pageant was little short of incredible. The total voltage of the high-tension accumulators used, for instance, was 2,460, and the feed current in the various power banks was 1.1 amps. Fourteen miles of wire were used.

More Wireless Control

TWO wireless-controlled fog signals have now been erected in the Firth of Clyde, and such is the reliability of the installation that they are absolutely unattended except for replenishing the supplies of acetylene. The "guns" are operated by the explosion of a mixture of air and acetylene.

High Power!

"THE largest broadcasting station in Europe" is now nearing completion at Langenberg, near Cologne. A power of 60 kilowatts will be employed, and will ensure good crystal reception within a radius of well over a hundred miles. It is even rumoured that fishermen over here who own crystal sets will be able to receive this station on a loud-speaker.

The Voice of the Diver

DID you hear the queer echoing effect of the voice of the diver, whose comments were recently broadcast from the Thames, near the County Hall? I first heard the weird noise emanating from my neighbour's loud-speaker, and at first I thought they were letting their set oscillate. That curious "moaning" effect after each word he spoke was, of course, due to a peculiar form of echo inside the helmet he was wearing.

No Eisteddfod

IT is now absolutely certain that the Welsh national Eisteddfod will not be broadcast this year. The B.B.C. offered the normal fee for a

the B.B.C. orchestra to illustrate his points, and Mr. Jack Hylton will have his own band there to defend him.

A Strange Aerial

DID you know that in recent experiments with wireless on aeroplanes the exhaust gases have been used as an aerial. These gases consist largely of minute carbon particles, and make quite an efficient conductor. I am contemplating using the chimney of the kitchen fire as my aerial in future!

Was It Advertising?

THE B.B.C. state that their broadcasts from various well-known seaside resorts are for two purposes—to secure varied and seasonable material, and to further the "Spend Your Holiday in Britain" campaign.

Simple!

IN his speech during the debate on "Is Scientific Invention a Nuisance?" Mr. E. V. Knox ("Evoc" of *Punch*) said that he could think of few worse nuisances than the man who built a two-valve wireless set and drove his family destitute into the streets. Why didn't he add another "note-mag," and use a loud-speaker? Then he would have been a nuisance to his neighbours instead!

In Norway

THE Norwegian station at Bergen is now working with 1 kw. on 400 metres and the broadcasting company is definitely formed. Other stations are to follow shortly.

Use Wire!

DOES your aerial look all "hot and bothered" after a spell of damp weather? Particularly if rope halyards are used does it tend to become a bit of a wreck after heavy rain, as you can see for yourself by taking a train journey out of London! The remedy is obvious—use wire for halyards and guides, and then there will not be that combat between shrinking ropes and leaning poles which is so common nowadays.

Incidentally, if you have found that your reception has improved slightly after a spell of rain, you can fairly safely put it down to the fact that your earth is normally none too efficient.

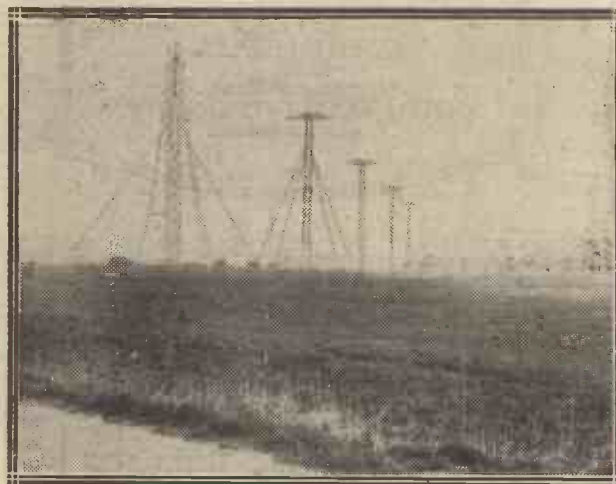

The Skégness high-power station, which is intended to work with India and Australia, is making good progress. This view shows the aerial in process of erection.

broadcast of that type, but the organisers were dissatisfied, although the same fee was paid last year for the broadcasting rights.

An Amusing Item

A VERY entertaining debate is to be broadcast on July 20, when



The Golders Green and Hendon Radio Society recently held a radio outing at which they used this 45-metre transmitter.

Sir Landon Ronald will champion the cause of music and Jack Hylton will stand for jazz. Sir Landon will use

MORE POWER AND MONEY FOR THE B.B.C.!

Captain IAN FRASER, M.P.,
endorses the Demand for a More
Adequate Service.

In this special article Captain Ian Fraser gives his views on the high-power station question and shows that the only way to give a really complete and satisfactory service is to permit the B.B.C. to increase the power of all the main stations by a really substantial amount.

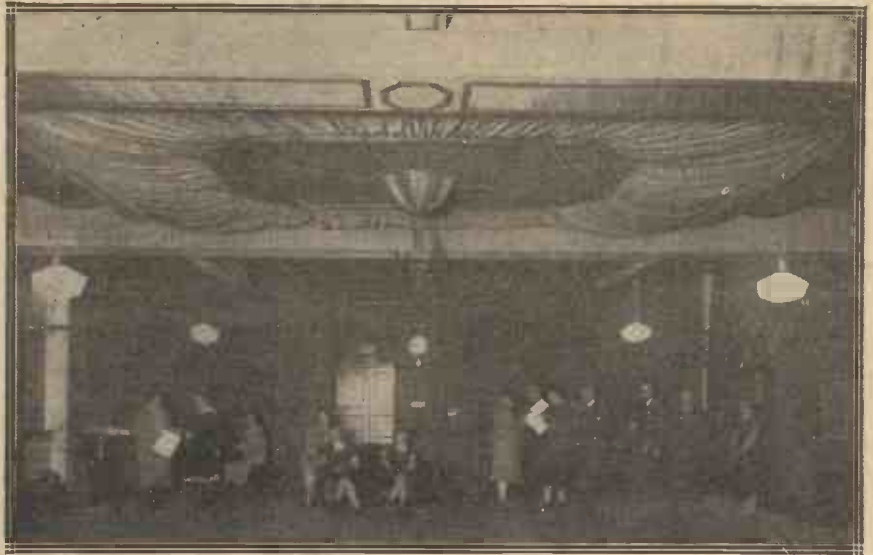

THE first essential of a British broadcasting service is that it really covers Britain. Possibly in the future crystal sets will die out, but for the present, and for some time to come, hundreds of thousands of people will only be able to afford crystal sets, and many will, I am convinced, continue to prefer them because they require for their operation no local power. If this be admitted, then our present broadcasting system does not cover the country adequately, for there are many areas in which reception with a crystal set is impossible. The international arrangement at Geneva precludes an increase in the number of British stations working on different wavelengths, so that only one solution is left to enable broadcasting to become really universal, namely, greatly increased power of existing or similar stations.

The Ideal

There ought not to be a house in the land in which it is not possible to receive one station on a crystal set. From the national point of view, in my opinion, the real importance of broadcasting lies in the fact that it is, or can be, the cheapest imaginable method of disseminating entertainment and information to the poorer people who cannot or would not otherwise have it.

Alternative Programmes

The next step is, of course, to give everyone alternative programmes. This is an ideal which is unattainable at present, and will, I fear, be unattainable for some little time to come, for it is almost inconceivable that stations should be so arranged that a crystal set in every house in the land could choose one of two alternative programmes. Gradually, however, as more selective sets become really cheap and power is increased, two programmes could become universally available, and this is a real necessity for which the B.B.C. should strive as hard as it can. Fortunately, those of us who can afford sets utilising valves will benefit enormously by an increase in the power of British stations, for if they are judiciously placed both as regards location and wavelength, two, three or four different programmes could very readily be placed at the disposal of the owner of a simple valve receiver. Manufacturers will have to study selectivity, but this they will quickly do when thousands of listeners want sets which will tune out, let us say, a ten kilowatt 2LO at five miles in favour of a ten kilowatt Bourne-mouth.

The Serious Listener

I particularly want to see that section of the community catered for which, though a minority, is, nevertheless, an important minority, and which desires less entertainment and

more serious matter. They cannot receive what they want in the ordinary programmes, for too many people would be disappointed, but higher power would enable listeners with moderate sets to exercise a choice in this direction.

The Language Question

I want higher power for British broadcasting stations for another and entirely different reason. Our peculiar inability or objection to learning other people's languages has led to English being more universally spoken than any other tongue. Let English continue to be spoken with good quality and much power, and let the quality of British musical programmes be maintained, and hundreds of thousands of persons on the Continent will look to England for their amusement, and will be unable to avoid learning even more English than they know now. This will retard the spread of Esperanto, which will please me, and will turn people's thoughts to English music, English artists, English technique, and English methods of thought. Daventry has done much in this direction. I would like to see our low wavelength stations continue the good work with plenty of power.

Can It Be Done?

I would like to see manufacturers produce a set which would utilise the transmitted energy from the broad-

(Continued on page 286.)

SPECIAL FREE BLUE PRINTS

It has been decided that one Blue Print of each amplifier published in this special issue of "Wireless" will be supplied FREE on application. The coupon to be found in this issue of this journal must accompany the application, which should be made through the post; callers will not be supplied.

REMEMBER:—

1. Only one Blue Print will be supplied free to each applicant. (Extra Blue Prints may be obtained at 1s. 6d. each, post free.)
2. Only postal applications for Blue Prints will be considered, and the necessary coupon must be sent.
3. When ordering state the serial number of the Blue Print required as well as the name of the amplifier.

The "Wireless" Transformer-Coupled Amplifier

By **STANLEY G. RATTEE, M.I.R.E.**

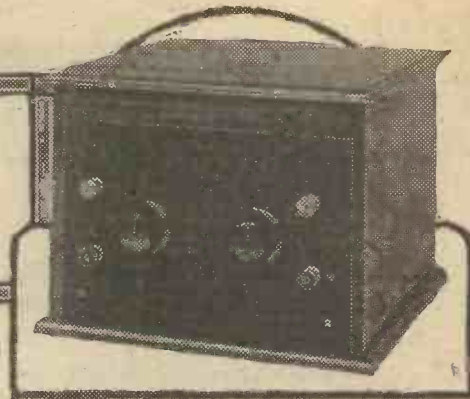

THOSE readers whose radio receivers are of the crystal type will possibly have envied those of their friends who own loud-speaker sets, thinking that to put themselves in a similar happy position would necessitate dispensing with the crystal outfit and purchasing or making a complete new valve apparatus.

Don't Blame the Loud-Speaker

Few people will deny the advantages of the loud-speaker against the restricted freedom of telephones, but there are some who claim that whereas the telephones give pure results the loud-speaker gives reproduction less favourable.

This conclusion has often been arrived at after listening to a poorly-made set, connected to an unsuitable loud-speaker considerably overloaded. In most of these cases investigation goes to show that the distortion is present in the set itself, that is, distorted results are being fed to the loud-speaker, which unfortunate instrument is often blamed for the unpleasant noise.

So long as a well-designed set is used and the loud-speaker is not overloaded the results will bear very favourable

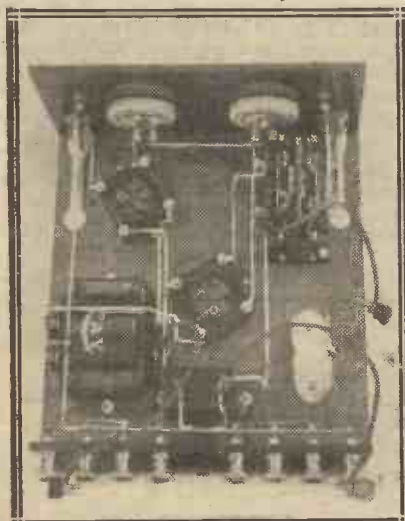

The three flexible leads bearing plugs on their ends are the grid-bias connections.

A special design for an easily-built amplifier which can be added to any set without L.F. stages, crystal or valve, home-made or commercial, and will give good volume on the loud-speaker.

comparison with those usually obtained when using 'phones.

No Scrapping Needed

Another point which often crops up

terminals of the receiver to one set of battery terminals of the amplifier (the H.T. negative terminals need not be connected); the remaining battery terminals on the amplifier should be connected to the batteries themselves.

Terminals

It will be observed that the amplifier is fitted with two H.T. negative terminals, and as stated above, when using a valve receiver one of these should be connected to the negative of the H.T. battery, while the other may remain free. The only reason why this particular terminal is duplicated is to enable the crystal user to use either set of terminals, and place his batteries to left or right as desired.

Power Valves

Should it be desired to use power valves in the amplifier when connected to a valve receiver it should be borne in mind that whatever H.T. voltage is applied across the H.T. terminals of the amplifier will also be applied across the H.T. terminals of the receiver, therefore, when, say, 120 volts H.T. are connected across the amplifier H.T. terminals, the H.T. positive of the receiver should, instead of being connected to the amplifier

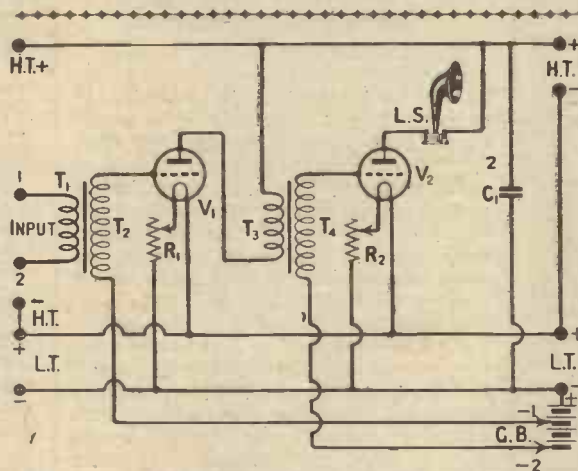

Fig. 1.—The circuit is a perfectly simple and straightforward one. T1 T2 and T3 T4 are the two L.F. transformers.

in the mind of the crystal user is that, were he to contemplate using a loud-speaker, the money already expended upon acquiring his crystal set would be lost, in that the set would need to be laid aside to make room for the more expensive valve set.

Let it be understood from here on that such a view is wrong. The crystal set, no matter of what type it may be, can be retained, and valve apparatus can be added to it to give the desired loud-speaker results. Indeed, the amplifier to be described will not by itself give any results at all, so dependent is it upon being added to some sort of receiver or other apparatus.

Universal Use

Though the instrument is primarily intended for use with crystal sets, it is nevertheless designed so that it may be connected to valve receivers which do not already include any low-frequency stages. To facilitate connections to sets of the valve type the terminals for the battery connections are duplicated, so that connecting strips may be taken from the battery

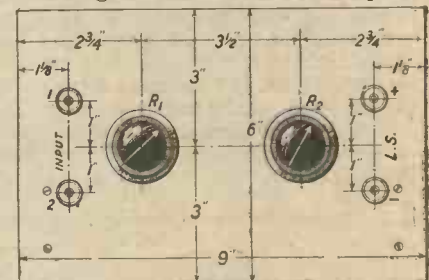

Fig. 2.—Drilling the panel can be done in a few minutes. (Blueprint No. W. 2007 A.)

H.T. positive terminal, be connected direct to, say, the 60-volt tapping on the H.T. battery, still neglecting the H.T. negative link between amplifier and receiver.

(Continued on next page.)

A Simple and Easily-Built Instrument

With a Crystal Set

When connecting the amplifier to a crystal receiver, all that it is necessary to do is to connect the batteries across the appropriate terminals, and to connect the telephone terminals of the crystal set to the "input" terminals of the panel of the amplifier, whereupon the loud-speaker should be connected across the two terminals on the right-hand side of the panel, the positive tag of the loud-speaker lead being connected to the top terminal.

What You Will Need

Those readers who are desirous of building an amplifier of this type should first collect together the following components and materials.

It will be observed that in some cases the names and trade marks of the manufacturers concerned follow upon the items mentioned. Since this informa-

Drilling

The preparation of the panel for mounting the terminals, filament resistances and so on is so simple that



The panel material is finished with a "wavy etched" surface, while special terminals are used which are ready-marked to indicate their purpose.

satisfactorily drilled the two brackets should be fitted, and the baseboard secured to them, whereupon both panel and baseboard should be slid into the cabinet to make sure that an easy fit results.

The terminal strip should be drilled in the ordinary way and secured to the baseboard by means of wood screws.

Assembly

The components and terminals should then be mounted in their various positions, and with regard to those upon the baseboard the arrangement seen in the photographs and wiring diagram should be followed. The reason for this instruction lies in the fact that if the transformers are placed, say, too close to each other there is quite a possibility of the amplifier "whistling" when it is tried out, the loud-speaker results in such circumstances being most

WIRING INSTRUCTIONS

- Join input terminal (1) to "+ H.T." of transformer T1 T2.
- Join input terminal (3) to "Plate" of T1 T2.
- Join "Grid" of T1 T2 to G of V1.
- Join "Grid Bias" of T1 T2 to G.B.-1 plug (flex lead).
- Join A of V1 to IP of T3 T4.
- Join L.S. + to H.T. + (1). H.T. + (1) to H.T. + (2). One side of C1 to nearest point on

- the latter wire. O.P. of T3 T4 to nearest point on wire between L.S. + and H.T. + (1).
- Join L.S. of T3 T4 to G of V2.
- Join O.S. of T3 T4 to G.B.-2 plug (flex lead).
- Join A of V2 to L.S.
- Join H.T. -(1) to L.T. +(1), and thence to L.T. +(2) and H.T. -(2). L.T. +(1) to one filament contact on V1 and thence to one filament contact on V2.

- Join L.T. -(1) to L.T. -(2), thence to remaining side of C1, and thence to G.B.+ plug (flex lead). Same side of C1, also to one side of B1 and thence to one side of R2.
- Join other side of R1 to remaining filament contact of V1.
- Join other side of R2 to remaining filament contact of V2.

tion is only given as a guide to those readers who wish to duplicate in every detail the original amplifier, it must be understood that other suitable components may be used by those readers who are desirous of using some parts they have in stock.

One ebonite strip 9 in. x 2 in. x 1/4 in. ("Trolite").

One ebonite panel measuring 9 in. x 6 in. by 1/4 in. ("Trolite").

One special amplifier cabinet with baseboard 9 in. x 8 1/2 in. x 3/8 in. (Camco).

Two "Etherplus" valve holders (Mandaw).

Twelve terminals marked: 2, H.T. +, 2, H.T. -, 2, L.T. +, 2, L.T. -, 2 loud-speaker (one red, one black), 2 without markings (one red, one black) (J. J. Eastick & Son).

Two filament rheostats, 30 ohms each (A. F. Bulgin & Co.).

One grid battery clip (A. F. Bulgin & Co.).

One Mansbrink condenser 2 microfarad ("T. C. C.").

One "A.F.4" L.F. transformer (Ferranti).

One "All Purpose" L.F. transformer (C. A. Vandervell & Co., Ltd.).

Quantity No. 16 "Glazite" connecting wire.

Short length of rubber-covered flexible wire.

Three Wander plugs (two black, one red).

Two right-angle brackets ("Magnum").

all details may be understood from the drawing. When the panel has been

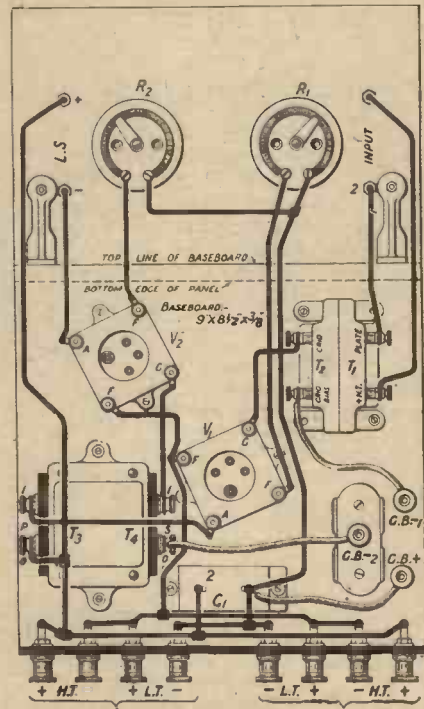

Fig. 3.—When wiring the amplifier use this diagram and check off the various leads carefully against the instructions given above on this page.

unpleasant. Another point in the arranging of the baseboard components is that any appreciable alteration of these may quite possibly result in there not being sufficient clearance for the valves and grid battery when they are placed in position.

Wiring

With regard to the wiring this will be found quite straightforward so long as the filament battery terminal connections are made first; these should be followed by the grid connections and so on.

The type A.F.4 Ferranti transformer has included within its casing a fixed condenser connected across its primary, so should the constructor contemplate connecting a condenser across this transformer by external means he is not recommended to do so.

In cases where the receiver is already fitted with a telephone condenser the experiment of trying the amplifier with the telephone condenser still connected should be made, but in the event of the results being muffled or otherwise unsatisfactory, the telephone condenser in the receiver should be removed.

Valves

The types of valves which should be used are largely a matter of the reader's choice so long as he confines himself to "low-impedance" valves, (Continued on page 282.)



WITH the advent of the fine weather (it will probably be raining when this appears in print!) much attention is paid to the use of the loud-speaker in the garden. There are one or two different ways of achieving this, but perhaps the most common, and certainly the easiest method, is that of running long leads from the re-

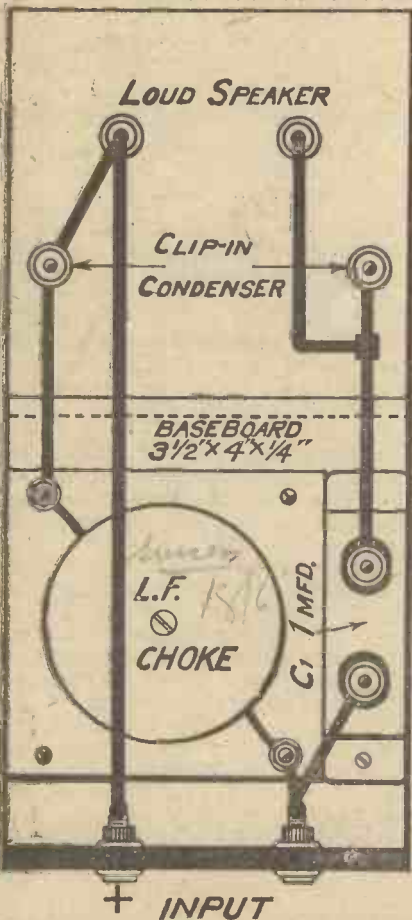

Fig. 1.—For purposes of clarity, the "output" panel is shown in the same plane as the baseboard.

ceiver in the house to the loud-speaker out of doors. Leaving the "outside" part for a moment, let

Protect your Loud-Speaker!

By GEORGE T. KELSEY

The effective life of your loud-speaker may be considerably shortened by connecting it in circuit the wrong way round, but if a filter is used, such as the one described in this article, the direction of connection may be disregarded without fear of damage.

us consider what happens at the receiver end.

The Importance of Polarity

When any valve receiver is in use, regardless of whether a signal is being received, a steady anode current flows in one direction through the windings of the loud-speaker. Now, as readers have probably noticed, one of the two terminals on most makes of loud-speakers is marked positive, usually by means of a red binding on one cord or by a positive (+) sign next to the appropriate terminal, and this is so marked to ensure that the steady anode current shall flow through the windings in the right direction.

Damaging the Magnets

If the loud-speaker is connected in circuit the wrong way round, then the flow of current will tend to demagnetise the permanent magnets, which form an essential part of the loud-speaker. The results of such an error can be very briefly summed up. The effective life of the loud-speaker may be considerably shortened, and eventually the signal strength may be reduced.

The Use of a Filter

If, therefore, the loud-speaker is taken into the garden, it is essential to know which of the two leads goes to the H.T. positive loud-speaker terminal on the set, so that the winding can be connected the correct way round. In practice, however, it is not desirable that this steady anode current should flow through the length of wire necessary to reach the loud-speaker in the garden, and by using a filter circuit this can be avoided.

What the Filter Does

A filter circuit, while allowing the fluctuating current to pass, offers a barrier to the direct current, this

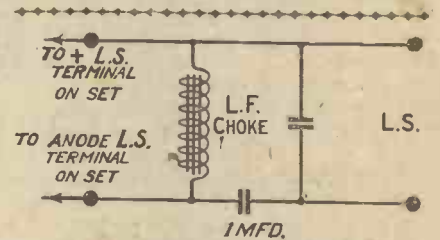
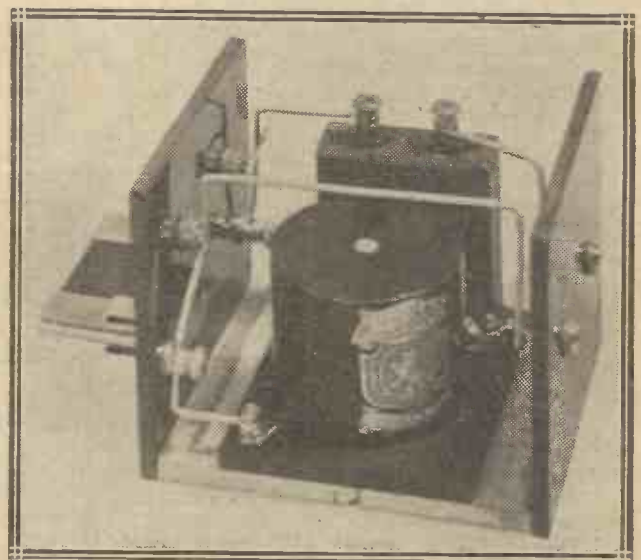

Fig. 2.—No value is given for the condenser across the loud-speaker terminals, as this will depend upon the requirements of your own loud-speaker.

being by-passed through the L.F. choke.

The advantage of using such a filter is that the "polarity" of the loud-speaker may be ignored, and however the wires are connected no damage



The shanks of the screws holding the fixed condenser clips in position have been equipped with terminal heads to obviate soldering to these two points.

will be done to the permanent magnets. If only for this reason, then, the advisability of using a filter is obvious, regardless of whether the
(Continued on page 281.)

A great improvement in Valve design

—Filament, Grid and Anode are now secured at top and bottom in the new Cossor Point One

ONCE again Cossor has blazed a trail in Valve design. First in 1922 with an arched filament operating within an electron-retaining hood-shape Anode system—first in 1924 with a triple-coated filament producing a prolific electron stream at a phenomenally low temperature—and now first in 1926 with a constructional system which automatically aligns and secures the filament, grid and anode at the top as well as at the bottom. The only valve in which the elements are fixed in three distinct positions.

The principle of Co-axial Mounting is not new. In fact, it has been the ultimate goal of every valve manufacturer since the invention of the three-electrode valve. But for years the difficulties proved insurmountable until Cossor—by reason of the peculiar advantages afforded by the hood-shaped Anode—was able to perfect a method sufficiently robust and accurate.

Co-axial Mounting ensures greater uniformity

The Cossor system of Concentric Mounting possesses far reaching advantages. In the first place, it ensures absolute uniformity of characteristics for all valves made to a certain specification. Experienced wireless enthusiasts know that in the past—in spite of the most critical manufacturing supervision—it has been difficult to prevent variations between valves of the same class. Two valves—identical to the eye—might give varying performances owing to minute differences in the spacings of the internal elements. Even if complete uniformity were possible in the factory, the wear and tear of everyday use causes changes in the relative positions of the filament, grid and

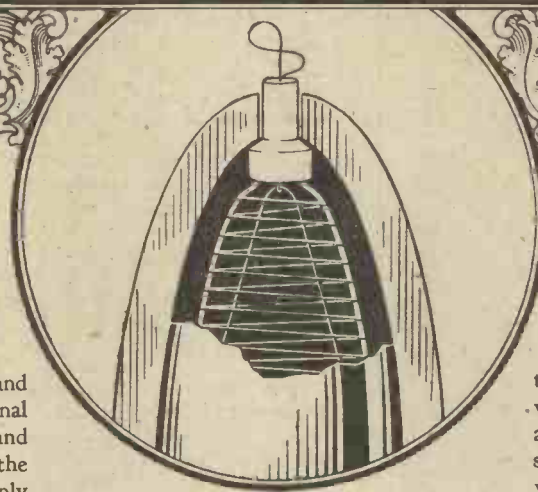

Sectional view of the elements in the new Cossor Point One

In the above illustration a section of the Anode is cut away in order to expose the grid and the filament. Observe the seonite insulator which securely holds in position the grid and the anode. To all intents and purposes this insulator becomes an integral part of these two elements—the slightest individual movement of either of them is quite impossible. Through the centre of the insulator is passed the fine wire which retains the filament in position. Thus—come what may—even the hardest shock cannot disturb the exact relative positions of the filament, grid and anode.

anode. And thus, alterations in the working characteristics of a valve become inevitable throughout its life. In the new Cossor Point One, Co-axial Mounting—backed by the most accurate and sensitive machinery and jigs it is possible to devise—is a positive safeguard against variation in performance. Valves made to any specification must be identical and constant throughout the whole period of use—variation is impossible.

The supreme importance of this will be at once obvious to users of Neutrodyne Receivers employing two stages (or more) of matched high frequency amplification.

Tests prove a great increase in life.

A further tremendous advantage of this new system of construction lies in its shock-proof filament support. Whereas in many valves the filament, being straight, is retained under tension and is therefore subjected to considerable mechanical strain, that used in the new Cossor Point One is arched and retained in position by a fine wire passing through a seonite insulator.

It is not kept under tension and the sole object of the fine wire support is to hold the filament in position and to permit the slight elasticity necessary should the valve be dropped or otherwise subjected to accidental rough usage.

A series of tests—far more rigorous than any conditions under which the Cossor Point One would normally be used—has proved the complete efficacy of this new shockproof filament system. A concussion which caused an immediate fracture of the filament in an ordinary valve was easily and harmlessly absorbed by the filament in the Cossor Point One.

The new Cossor Point One

Red Top: For H.F. use 15/6 (Consumption '1 amp.)

Plain Top: For Detector 15/6 (Consumption '1 amp.)

The New Cossor Stentor Two

Green Top: For power use 18/6 (Consumption '15 amp.)

All operate at 1.8 volts.

Cossor Valves

—The new Dull Emitters with the long-life '1 amp. filament.

RADIO IN THE R.A.F. PAGEANT

By OUR SPECIAL REPRESENTATIVE

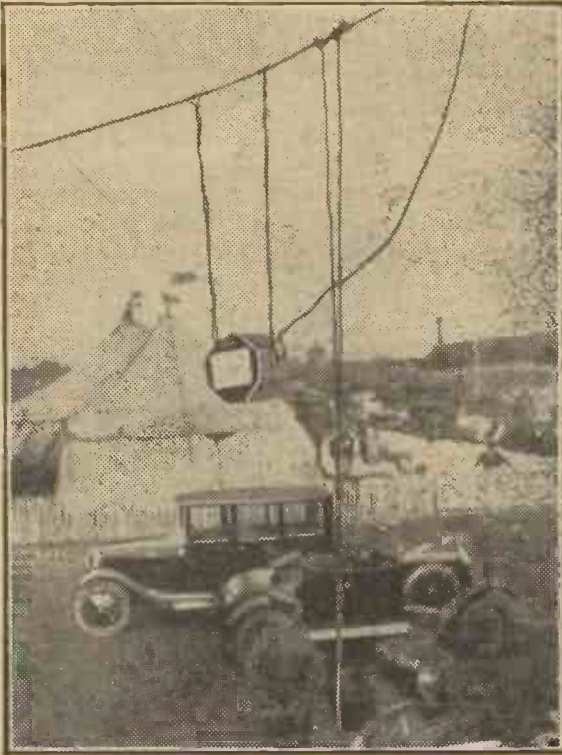

The special new microphone which was used at the R.A.F. Pageant for broadcasting the band.

How the Band was Broadcast

A picture is shown on this page of the special new microphone, which may be seen hanging from a wire suspended

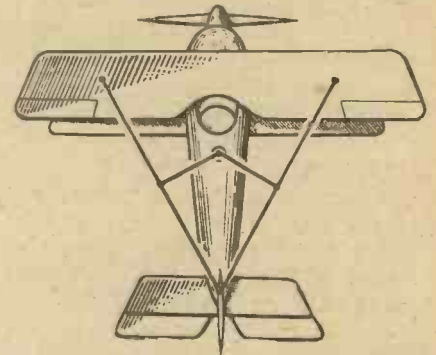

Fig. 2.—The impossibility of using trailing aerials in formation "stunting" such as that at Hendon is obvious, and to overcome the difficulty the arrangement shown in this figure was adopted.

between two poles on the raised dais on which the band performed. From this microphone connection was made to a standard Marconiphone amplifier situated underneath the platform. The output of this amplifier was linked



HE seventh annual Royal Air Force display, in which radio played such an important part, took place at Hendon on July 3. The show from the time the first planes entered the air at noon until the conclusion

The "Padded Cell"

Immediately next to the control room was another room, rather smaller in size, from which announcements and orders were given.

The microphone in this room was similar to those in use at B.B.C. stations, and to guard against the transmission of extraneous noises, this room was heavily padded with hair matting.

Twenty-Six Loud-Speakers

The vast crowd—over 100,000 in number—was entertained with music played by the Central Band of H.M. Royal Air Force, and it is interesting to note that the music was disseminated by what was said to be the largest single loud-speaker installation hitherto attempted.

The apparatus consisted of twenty-six powerful Marconiphone loud-speakers, and these were distributed at various enclosures. From the control room to the loud-speakers the necessary connections were carried out with buried cables.



Fig. 1.—The Royal enclosure was situated to the right of the bandstand.

shortly after 6 p.m. can be described as nothing short of one long thrill, and in order to ensure that no hitch should occur in the part played by radio, no less than four receiving stations were employed.

Four Receiving Stations

The transmitter and one of the four receiving stations were situated at one



The powerful loud-speakers which were placed at intervals round the enclosures were linked to the main control room by means of buried cables.

direct to the control room, which was only a short distance away.

(Continued on page 283.)

OUR READERS' VIEWS ON HIGH-POWER STATIONS

More Power All Round

SIR,—I was really glad to see "Average Listener" put forward, in no uncertain voice, a suggestion which has been on the tip of my tongue for some little time. I, myself, must confess that I should not be much better off if the B.B.C. did erect another station in each town at present served by a main station. What I want is a choice of several alternative programmes.

The obvious and common-sense plan is for the B.B.C. to push up the power of all the main stations, sufficiently to enable the one-valve set owner, even in London, to receive several of the other stations clear of jamming, and at a respectable strength.—Yours faithfully,

F. A. KNOWLES.

Clapham Common.

A Valve User's View

SIR,—With regard to the article by "Average Listener" in the July 10 issue of WIRELESS, may I ask why the B.B.C. did not push up the power of their main stations long ago? It is the one obvious way of maintaining a really good alternative programme service, for the owner of the very simplest valve set would then have a choice of three or four stations. Apparently the B.B.C. are bent on assisting the owner of the 2s. crystal set, who can receive nothing more than the local station. Why not give him an alternative

programme via Daventry (on 1,600 metres) and stick to the plan of one main station only in each town that is at present served? Another point is that most of the crystal sets of my acquaintance are so thoroughly bad that they would be quite incapable of receiving anything intelligible if two main stations started up in one town. I am sure that there are fewer

IN JAPAN



A Tokyo reader sends us this view of his outfit, in which an "Anglo-American Six" will be seen.

good crystal sets than valve sets about at the present time, and I think the B.B.C. should cater better for the valve user.—Yours truly,

C. R. MURRAY.

Caterham.

A Real Service!

SIR,—I think "Average Listener" has hit the nail squarely on the head in say-

ing that the one good way of providing alternative programmes is to push up the power of all the main stations. If we are to have an alternative programme service, let it be a good one.—Yours faithfully,

BERNARD R. DUNSTAN.

Woking.

Abolish Relays

SIR,—"Average Listener" has made the one common-sense suggestion that should have been made long ago. I think it is quite obvious that the best and cheapest alternative programmes could be arranged simply by increasing the power of all the main B.B.C. stations, and taking such nuisances as the relay stations "off the air" altogether. I have no doubt that with a power of 10 kw. 6BM and 5IT, and probably 2ZY and one or two others, would be really worth listening to in London. At present they are nothing more than still small voices feebly attempting to break through a habel of mush.—Yours faithfully,

L. E. COBHAM.

Harringay.

"MODERN WIRELESS"

Have You Got Your Copy of the JULY ISSUE?

1/- ON SALE EVERYWHERE 1/-

For extreme accuracy and uncommon dependability —specify T.C.C.



FOR over 20 years T.C.C. have been manufacturing nothing but Condensers. The fruits of these years are now contained in the familiar green case. For each T.C.C. product has to pass so many strenuous tests that when it comes to you, you know it is accurate to the smallest possible percentage of error.

You do well when you specify T.C.C. Condensers.

Price and Capacities:

- Mansbridge, 2 mfd 4/8
- Mansbridge, 1 mfd 3/10
- Mansbridge, .5 mfd 3/4
- Mansbridge, .25 mfd 3/-
- Mansbridge, .1 mfd 2/6
- Mansbridge, .09 to .01 2/4
- Mansbridge, .009 to .005 2/-
- Mica, .004 to .001 2/4
- Mica, .0009 to .0001 2/4



Manufactured only by

Telegraph Condenser Co., Ltd.,

Wales Farm Rd., N. Acton, London, W.3.

G. A. 5519

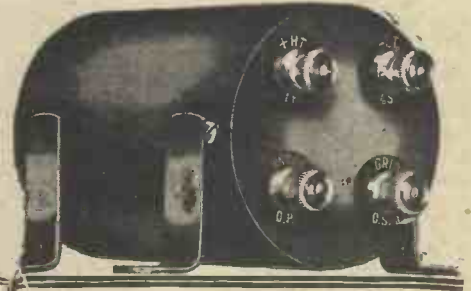

For your Amplifier.

You cannot be too discreet in your selection of a Transformer. You may spend pounds on the other components, yet if your L.F. Transformer is inferior, the whole of your expenditure will be prejudiced. You will be wise if you follow the lead of thousands of Constructors throughout the Country, and choose Eureka—the proven Transformer.

- In five Models: Concert Grand ... 25/-
- No. 2 21/-
- Baby Grand Nos. 1 and 2 ... 15/-
- Eureka Reflex 15/-



EUREKA

the Aristocrat of Transformers

Advt. Portable Utilities, Fisher St., W.C.1

G.A. 5520.

From my Armchair

BY EARL RUSSELL.

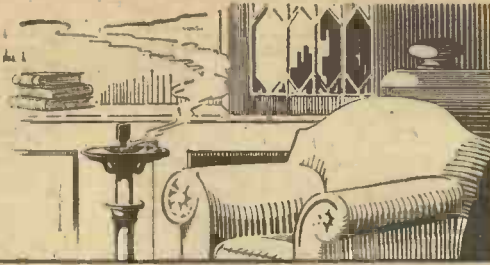

In these columns Lord Russell expresses each week his own personal views on matters of interest to "Wireless" readers.

National Physical Laboratory

I went the other day to the annual inspection of this Laboratory at Teddington, and found very great changes since I was there twenty years ago. There are the fullest possible arrangements for weighing, measuring and gauging everything that one can think of in science, from thermometers to alloys. There are also several wind tunnels for measuring wind resistance and other matters in connection with aeroplanes.

Interesting Apparatus

Perhaps the most interesting thing of all is the huge experimental tank in which model keels of various shapes can be tested for bow wave, skin friction, and the like. Some wireless measurements are also being made, but not very many at present. But, of course, besides its regular research

work, the Laboratory undertakes any scientific tests that are offered it.

B.B.C. Control

I am not proposing to take any part in the discussion as to the organisation that is to replace the present B.B.C. on December 31, nor, as a humble contributor, shall I presume to criticise the Editor's optimistic vision of some controlling body which should be neither commercial nor Government. Mine is a simpler theme and relates only to the control exercised by the P.M.G. over the present organisation.

A Deprivation

It appears that he has been so alarmed by the letters in the *Times* complaining of the B.B.C. editorials that he has refused them permission to broadcast a description of the conciliation scheme in the boot and shoe trade. This scheme has worked well

for thirty-one years, and apparently it was thought that it would unduly excite the public to hear of it while the coal strike was still on. Personally, I should have thought it would have been rather cheering, in these days of continuous industrial disputes, to hear of any industry which was free from them. However, the P.M.G. has decreed that gloom shall descend upon the country and that they shall not hear about the boot and shoe trade.

Government Surplus

What wonderful advertisements one reads from time to time of Government surplus stock for disposal, and how cheap some of the things look. Some of them really are cheap and use can be made of them, but some would be dear at any price, and when the amateur has been had once or twice he generally refrains from buying this sort of stock without seeing it himself first. I very well recollect, about two years ago when I was more confiding in these matters than I am now, buying a three-valve receiver (Mark IV it was called, or some similar imposing name) for about £3 at an auction, and going home proudly with my purchase. It did receive with difficulty when quite close to a station at a strength equal to about one valve in any modern receiver. After a time I eviscerated it in despair, and, like some other things, it has been more useful in death than in life.



Another SHORTPATH Valve

S.P. 18/B (BLUE SPOT)

This new S.P. 18 Valve supplements the well-known S.P. 18 Red Spot and Green Spot Valves. It is designed especially for use in resistance-capacity coupled sets and for use as a Detector and in H.F. neutrodyne tuned anode stages using 80-120 Volts H.T., so that where this H.T. is employed in the last stage, the difficulty of two H.T. supplies is avoided.

In addition, it gives still more amplification and consumes very little H.T. current.

The S.P. 18/B (Blue Spot) is an excellent valve for anode bend detection. Designed to work in parallel with the S.P. 18 Red Spot and Green Spot Valves, it operates from a 2-volt accumulator and consumes only 0.69 amp. filament current.

PRICES OF "COSMOS" SHORTPATH S.P. 18 VALVES.		
RED SPOT.	GREEN SPOT.	BLUE SPOT.
12/6	12/6	12/6

METRO-VICK SUPPLIES, LTD.
(Proprietors: Metropolitan-Vickers Electrical Co., Ltd.),
METRO-VICK HOUSE, 145, Charing Cross Road, LONDON, W.C.2

"Cosmos" SHORTPATH S.P. 18 Valves are recommended for use as shown below with alternative H.T. values:—

Stage.	Coupling	Recommended Valves H.T. 20-80 V. 80-120V.	
		Green	Blue
H.F. Amplifier	Tuned Anode (neutrodyne)	Green	Blue
	Tuned Anode (not neutrodyne)	Green	—
	Transformer (loose coupled)	Red	—
	Transformer (tight coupled)	Red	—
Dual or Reflex	All Couplings	Red	Red
Detector (Grid Leak)	Resistance Coupling	—	Bl. or Blue
	L.F. Transformer or Choke	Green	Blue
Detector (Anode Bend)	All Couplings	—	Blue
L.F. Stages	Resistance	Green	Blue
	L.F. Transformer or Choke	Green	Green
Last Stage	All Couplings	Red	Red

Cosmos

RADIO VALVES

The "Wireless" Choke-Coupled Amplifier

By A. JOHNSON-RANDALL

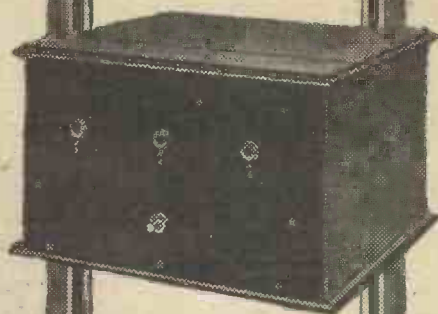

IN the mind of every crystal user sooner or later comes the desire to obtain signals loud enough to operate a loud-speaker on the local station or Daventry. With this wish comes the question, how can this be carried out? Is the solution the construction of a complete new valve receiver or is there some means whereby the existing set can be used? It rarely occurs to the listener that a separate amplifying unit will suit his needs admirably, and moreover that the construction of such a unit will be much cheaper than that of a completely new receiver.

Dual Purpose

There is one other advantage which a separate amplifier possesses, and that is it can be used in conjunction with an existing valve receiver if at any time the crystal owner desires to change over to a valve rectifier, hence the listener already in possession of an amplifying unit will only need to purchase the parts necessary for a separate valve detector unit to become the

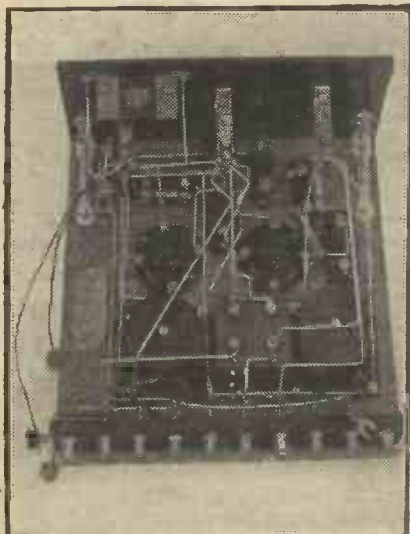

A helpful view of the wiring of the baseboard components.

Jack switching is used in this amplifier, so that any number of the valves can be used, and it can, of course, be added to any receiver which does not already incorporate L.F. stages.

proud owner of a three-valve receiver. Alternatively the constructor may wish to make up a set consisting of one or more stages of high-frequency amplification. If so, an amplifier unit can still be joined to the set for loud-speaker work.

place switching, since this is a refinement—desirable but not essential.

The chief features which influence the design are, therefore:—

- (1) Good quality.
- (2) Volume.
- (3) Simplicity.
- (4) The use of any type of valve.
- (5) Switching.

To incorporate these features, however, it is necessary to effect a compromise, since to obtain perfect reproduction with the maximum magnification per valve is practically an impossibility. Splendid reproduction, with some slight sacrifice of volume per valve can be obtained with resistance, and great volume with possibly a small loss in quality can similarly be obtained with transformer coupling. It is simply and solely a question as to what percentage loss in either volume or quality is permissible.

It was with these points in mind that I designed the choke-coupled magnifier described in this article.

With choke-capacity coupling it is possible to obtain both good quality and a good degree of magnification. Provided suitable chokes are used any type of valve can be employed, although, of course, the magnification per stage will be greater with some valves than with others.

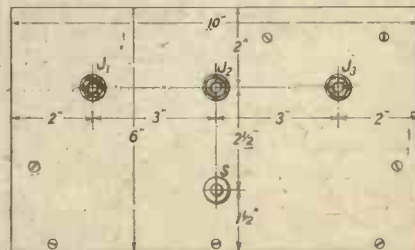

Fig. 2.—The drilling of the ebonite panel is a very simple task, since there are only eleven holes. (Blueprint No. W2008A).

The Circuit

The circuit used is shown in one of the diagrams herewith. It will be (Continued on next page.)

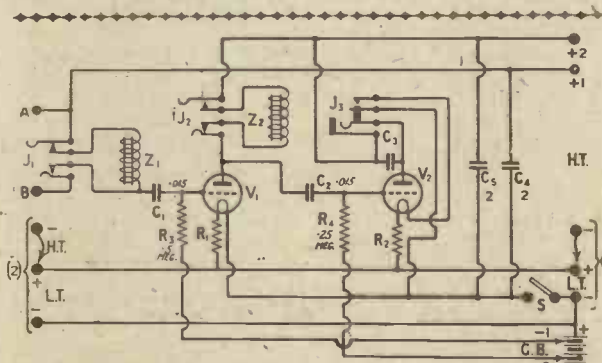

Fig. 1.—The jacks provide a handy means of cutting out one or both of the valves.

Which Type?

The question then arises as to which type of amplifier is most suited to his needs for all-round work.

Suppose we consider, briefly, without going into technical details, the features most desirable in any amplifier, or to use a more suitable term magnifier, for that is what our amplifier is. It is merely an arrangement which enables us to magnify the speech or music, thereby obtaining greater volume.

Good Quality

At the same time it is of little value if the magnified signals are not a true replica of those which are obtained without the magnifier, hence I think that we may safely say that our foremost desirable feature should be good quality.

Other Considerations

The next in order of merit I would place volume, that is to say, the maximum magnification per valve. Then comes simplicity in operation, and after this the desirability of so designing the magnifier that any type of valve can be employed. Lastly, I

The "Wireless" Choke-Coupled Amplifier—continued

seen that the coupling condensers have a capacity of .015. This capacity is a little lower than the theoretical ideal, but in practice in a circuit of this type there is no noticeable difference in the results obtained. The chief point is that the condensers have a mica dielectric—an important feature—since any slight leakage will cause a small positive potential to be impressed on the grid of the valve, thereby tending to spoil quality.

Switching

Jack switching is incorporated, the insertion of the plug carrying out the following operations:—

(1) Plug inserted in J₁. Amplifier cut out of circuit and crystal or detector valve only in use.

(2) Plug into J₂. First amplifying valve V₁ in use, V₂ cut out and filament circuit disconnected.

(3) Plug in J₃. Both the amplifying valves in use.

No filament rheostats are employed, fixed resistors being used instead. These fixed resistors can be obtained in values to suit any valves.

A "push-pull" switch enables the amplifier to be switched "on and off."

Terminals

Another feature is the use of an extra terminal on the strip at the back of the baseboard to permit the amplifier to be employed with commercial or other receivers having the high-tension negative terminal joined to the low-tension negative. The flexible leads on the H.T. - 1 and H.T. - 2 terminals permit connection to be made to either L.T. - or L.T. + once and for all, if desired.

It is important, however, to note particularly whether the receiver to be used with the amplifier has its H.T. negative joined to L.T. + or -.

H.T. - 1 or H.T. - 2, to correspond with the set and not to both, otherwise the L.T. battery will be short-circuited. This is important.

Two low-frequency chokes (Beard & Fitch).

Two .015 fixed condensers, type 610 (Dubilier).

Two Dumetohm grid leaks with holders, one of .5 megohm and one of .25 megohm (Dubilier).

Two "Temprytes" with mountings (Sydney S. Bird). Those in the amplifier are intended for 6 volt .25 ampere valves, and have a resistance of 3 ohms.

Two double circuit jacks (Formo).

One single circuit single filament jack (Formo).

Two 2-microfarad condensers (Dubilier).

Two anti-microphonic valve holders (Lötus).

One terminal strip, 10 ins. long by 2 ins. wide, with 10 terminals (Burne-Jones & Co.).

One baseboard, 10 ins. x 9 ins. x 3/8 in.

One panel, 10 ins. x 6 ins. x 1/8 in.

One cabinet to suit (Peto-Scott).

Two small angle brackets (Magnum).

One "Push-pull" switch (Igranic-Pacent).

One grid bias battery clip (A. F. Bulgin & Co.).

One clip-in condenser and clips for tone control (L. McMichael). The size is a matter for experiment, but .006 is a good all-round value.

Glazite and a set of Radio Press panel transfers.

Construction

The construction is quite a simple matter, since there are only four components to be mounted on the panel apart from the clip-in condenser. The three jacks and the "push-pull" switch require 3/8 in. holes, and the screws for the clip-in condenser clips may be either 4 or 6 B.A.

The wiring can be followed quite easily from the diagram, the only

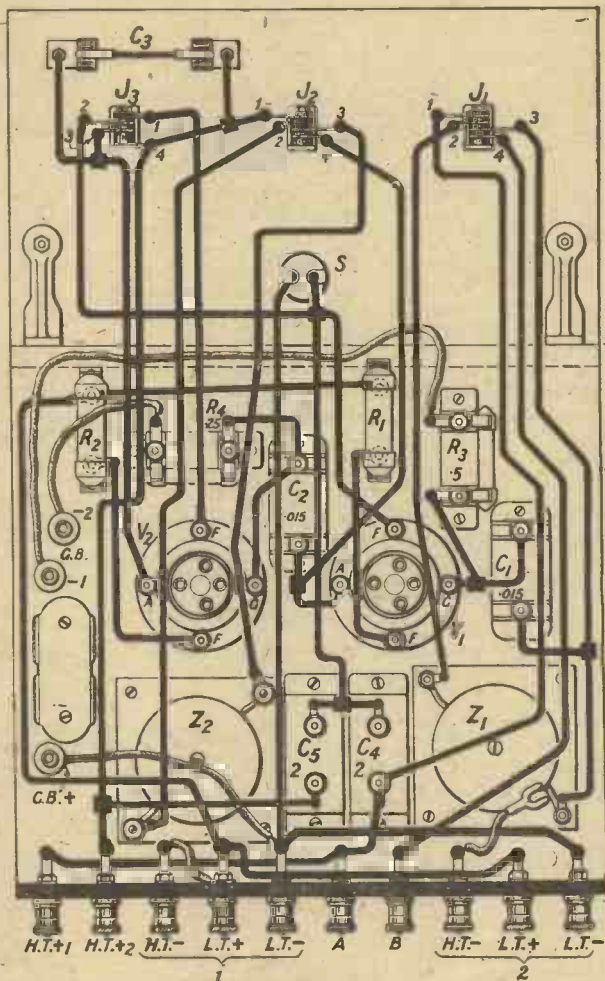

Fig. 3.—If the wiring of the amplifier presents any difficulty, refer to the verbal instructions below. (Blueprint No. W2008B).

Components

You will require the following components, but it is not absolutely neces-

WIRING INSTRUCTIONS

- Join terminal A to one side of C₄ and thence to contact (1) of J₁.
- Join terminal A to H.T.+1.
- Join terminal B to contact (4) of J₁.
- Join contact (2) of J₁ to one side of Z₁.
- Join contact (3) of J₁ to other side of Z₁ and to one side of C₁.
- Join other side of C₁ to G of V₁ and to one side of R₃.
- Join other side of R₃ to G.B.-1 plug (flex lead).
- Join A of V₁ to one side of C₂ and to contact (4) of J₂.

- Join other side of C₂ to G of V₂ and to one side of R₄.
- Join other side of R₄ to G.B.-2 plug (flex lead).
- Join A of V₂ to contact (3) of J₃ and thence to one side of C₃.
- Join contact (4) of J₃ to contact (1) of J₂, and thence to other side of C₃. Contact (4) of J₃ to H.T.+2 and thence to one side of C₅.
- Join H.T.- (1) to spade tag (flex lead).
- Join H.T.- (2) to spade tag (flex lead).
- Join L.T.+ (2) to L.T.+ (1), thence to one side of R₂ and thence to one side of R₁.

- Join remaining side of R₂ to one filament contact of V₂.
- Join remaining side of R₁ to one filament contact of V₁.
- Join L.T.- (1) to L.T.- (2) and to G.B.+ plug (flex lead) and to one side of switch S.
- Join other side of switch S to remaining sides of C₄ and C₅, and to remaining filament contact of V₁, and to contact (2) of J₃.
- Join contact (1) of J₃ to remaining filament contact of V₂.
- Join contact (2) of J₂ to one side of Z₂.
- Join contact (3) of J₂ to other side of Z₂.

If, for instance, H.T. - 1 is joined to L.T. + 1 in the amplifier, and H.T. - 2 to L.T. - 2, the H.T. - lead must only be joined to either

sary to adhere to those used if others of similar quality are available. Only those of first-class make should be employed, however:—

point to note being that adequate clearance must be allowed for the valves. This can be appreciated from photographs of the back of the panel.

The "Wireless" Choke-Coupled Amplifier—continued

Testing Out

When the wiring is completed the testing out may be proceeded with. Place two valves into the sockets V₁ and V₂. I use a 6-volt .25 ampere valve of the resistance-capacity type in V₁ and a small-power valve in V₂.

Connect up a 6-volt battery, if you are using these types of valves, to L.T. + 1 and L.T. - 1. Insert a telephone plug into J₁, and place the "push-pull" switch in the "on" position. Both valves should light. Pull out the plug from J₁ and V₁ should go out, V₂ remaining alight. Switch off S₁ and V₁ should now go out. All being correct, connect up the H.T. battery, joining H.T. - to H.T. - 1 or 2 according to whether the existing receiver, if of the valve type, has its H.T. - joined to L.T. + or -.

I would suggest that H.T. - 1 be joined to L.T. + 1 in the amplifier, and H.T. - 2 to L.T. - 2. If your existing receiver has its H.T. - joined to L.T. + then following out this scheme connect the

H.T. - lead of your H.T. battery to H.T. - 1.

A Safety Test

Join H.T. + 2 to the 6-volt tapping, and after having switched on

ments light. If they do not all is well, and the L.T. battery may be joined up. Place a 9-volt grid battery in the clips taking G.B. - 1 to the 1.5 volt tapping for a valve of the resistance-capacity type in V₁, and G.B. - 2 to the 6 or 7.5 volt tapping if a small power-valve is used for V₂.

With a Valve Set

If your existing receiver is of the valve type, join terminals A and B to the existing telephone terminals, taking A to the positive 'phone terminal, the H.T. to the detector valve being supplied from H.T. + 1. The L.T. to the existing receiver may be taken from L.T. + 2 and L.T. - 2. For valves of the 6-volt types mentioned H.T. + 2 may be 100-120 volts.

Joining up to a Crystal Set

If the existing receiver is of the crystal type the H.T. + 1 terminal will not have to be plugged into the battery, and should be disconnected, terminal B going to the telephone terminal joined to the
(Continued on page 282.)

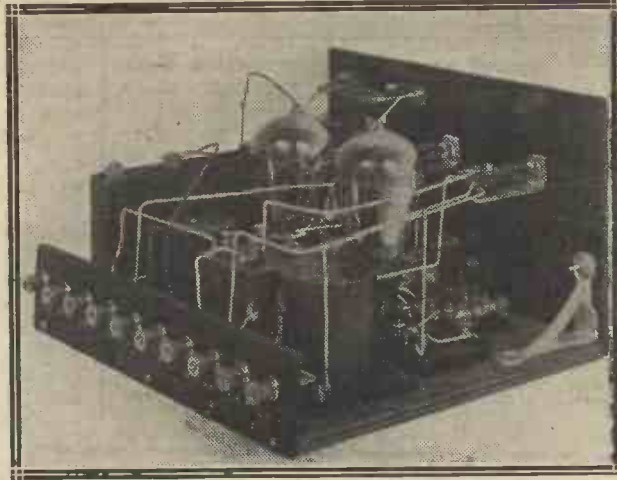

The numerous terminals are duplicated connection points for the batteries, to facilitate joining up to the receiving set.

the set but with the L.T. battery disconnected, note whether the valve fila-

the telephone terminal joined to the

CHOKE AMPLIFICATION —is preferable

GIVEN a good circuit with suitable valves you can demonstrate for yourself that choke amplification is decidedly superior to transformer coupling. This Success product embodies the essential features indicative of a good choke. It is wound with ample turns of large gauge wire upon an effective iron core.

With the Success Super Choke we claim that you can secure consistent amplification over audio frequencies—in fact, the power of reproduction and its remarkable mellow tone will be a revelation and immediately convert you to choke amplification.

As used in The "Wireless" Choke Amplifier, described in the current issue.



BEARD & FITCH, Limited, 34, Aylesbury Street, London, E.C.1

And at 1 Dean Street, Piccadilly, Manchester.

SUCCESS SUPER CHOKE. Price 18/6

On Guard!

There is no leakage with a "Lotus" Buoyancy Valve Holder on guard.

Immediate and lasting connection made when valve pins enter valve sockets. The leg socket expands and automatically locks.

Absorbs shock, protects the valves and eliminates all microphonic noises.



Made from best bakelite moulding with springs of nickel silver and phosphor bronze valve sockets.

Garnett, Whiteley & Co., Ltd., Lotus Works, Broadgreen Rd., Liverpool.

Makers of the famous "Lotus" Vernier Coil Holder.

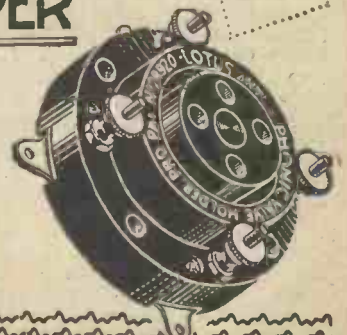

Without Terminals 2/3

With Terminals 2/6

RADIO CONTOURS IN THE NORTH-EAST SECTOR

By Captain E. A. ANSON

This week we complete the publication of the results of our special investigation into the distribution of 2LO's signals. A special map summarising the whole work will appear next week.

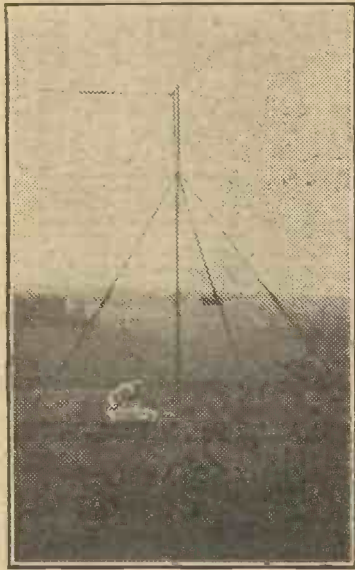

Captain Anson at work in a lonely spot.

spaces gave no better results than other parts that appeared more screened.

Why should Southend be so unfortunate? Why should Braintree be so lucky? Nobody knows; the intangibility of the ether frustrates man; he can but feel his way. In wireless common-sense and practice have become bogged, theory lags behind; meanwhile the B.B.C. continue to put out an excellent programme for those to hear who will.

A Shadow

An examination of the radio con-

tours in this area show an increasing tendency to weak signals as they proceed South. This is relieved by a patch of good reception around Braintree. This tendency to poor reception reaches a crisis in a clearly defined kink, a sub-normal kink, stretching along a line Wanstead-Ilford-Wickford-Burnham. The cause of this would appear to occur within the first six miles from 2LO, as if some radio obstruction cast its shadow over miles of country. To the north of the area the contours are on the whole better than normal.

The Last Sector

This completes the radio survey of 2LO up to a radius of 50 miles, merely a rough framework for others to embroider. It is the first attempt in this country to obtain information about a rather difficult subject. In all the measurements an aerial normal for broadcast reception has been used, and results are thus directly comparable to most receivers and their aerials.

The actual receiver and measuring instruments used have travelled 2,000 miles in the dickey of a car. No valves were broken, nothing went wrong with the instruments at all. The tuning condensers were set for 2LO when the first measurement was made some five weeks ago, and every time a subsequent measurement was made 2LO came in O.K. without altering the condenser setting.

LOFTY aerials, good earths and low-loss coils are advisable generally in this area. As mentioned in the last instalment of these articles radio contours of low strength were noticed lurking on the 50-mile radius and pointing in this direction. In this sector they come into full force or perhaps full weakness would be better, much nearer London than they should.

Contradictory

From a geographical point of view this area is flat everywhere except west of Saffron Walden. There are no large areas calculated to impede ether waves, and it should be a good area from a wireless viewpoint for 2LO, but isn't. It seems impossible to foretell results by looking at the country either in reality or on the map. In many places good open

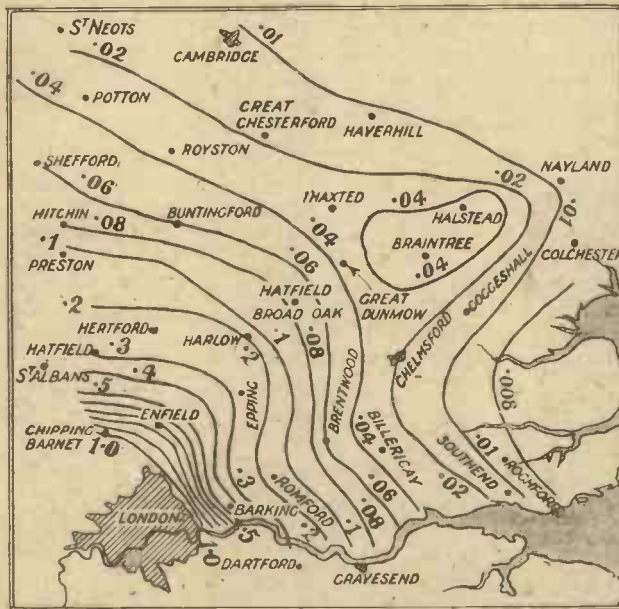

The area as a whole is a decidedly bad one.

PURE TONE!

The Etherplus + "Concerto" L.F. Transformer gives exquisite tonal purity. Completely shrouded in nickel-plated case. One-hole fixing. Extra bracket for baseboard mounting supplied free.



Fixed Retail Price, 12/6
 W/61 Ratio 1:5
 W/62 Ratio 1:3
 W/63 Ratio 1:2

From dealers or direct from
MANDAW,
 9-15, WHITECROSS ST.,
 E.C.1.

ETHERPLUS

RADIO ACCESSORIES
 = ENSURE PERFECT RECEPTION

For EASY WIRING-UP and BEST RESULTS, use "KRISCROS" CONNECTORS

in building your amplifier, or other set.

SOLDERING COMPLETELY SUPERSEDED!

Perfect-Joints: Simple: Quick: Easy.

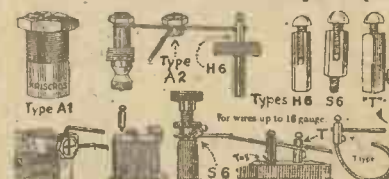

Used and recommended by Mr. Percy Harris. See "Wireless" 16/1/26 ("Talk on Wiring").

A "Kriscros" for every thread, every component and every purpose. From 1/- doz.

Send for List (Mail Order Dept.)

KRISCROS Co., 50, Gray's Inn Road, LONDON, W.C.1

Why Do We Use Different Ratios?

By J. H. REYNER,
B.Sc. (Hons.), D.I.C., A.C.G.I., A.M.I.E.E.



What is the "step-up ratio" of a low-frequency transformer? Do you understand why we sometimes use a high-ratio transformer and at other times a low-ratio one? This is a most important point, yet it is one over which many people make mistakes and consequently fail to get the best results.

THERE are now on the market a large number of different types of low-frequency transformers, all similar in general principle, but differing as a rule in the actual ratio of primary to secondary turns. We have transformers labelled first stage and second stage, with ratios ranging from $2\frac{1}{2}$ up to 9 to 1, or possibly more.

The average amateur must at times wonder why this considerable diversity is necessary. Is a high ratio of transformation a good thing, and if so, why are not all transformers made with the highest possible ratio? Again, what is the difference between first and second stage transformers?

How a Transformer Works

These are interesting questions, and they raise points which are very often not appreciated. Let us consider for a moment exactly what a transformer does. A simple transformer consists of two coils of wire wound round an iron core. A current is passed through one of the coils, then due to the magnetic interaction between the two windings, corresponding currents will be produced in the other coil.

Obviously, therefore, any two coils which are coupled together magnetically behave as a transformer in this sense of the word. An arrangement such as this, however, would not be efficient because the magnetic field produced by one coil would not all interact with the second coil, but there would be considerable stray or leakage field.

The Iron Core

The aim, therefore, is to obtain an arrangement whereby the coupling between the two windings, as we call it, is as tight as possible. In a low-frequency transformer this can be done comparatively easily by winding the two coils close together and also winding them round an iron core, which is

usually closed. The effect of this is that all the magnetic field tends to flow in the iron instead of in the air, and this confines it to the proper paths, so that practically all the magnetic field which is produced by the one coil interacts with the second coil.

Transformation Ratio

Now, when this is done we can obtain a definite relation between the turns in the primary coil and the turns in the secondary coil. For example, if we have a source of supply at a voltage of 50, and we apply this across the terminals of the primary, then if the secondary coil has twice the num-

transfer this voltage to the next valve, and if by so doing we can arrange to increase the voltage, then the amplification of the whole stage will obviously be increased.

Using a transformer, therefore, we arrange that the secondary winding has a larger number of turns than the primary, so that we get a certain step-up effect; making the voltage applied to the grid of the second valve several times greater than that in the anode circuit of the preceding one.

From this point of view it would obviously be desirable to make the transformation ratio or step-up ratio of the transformer as large as possible,

but although this is actually done in practice as far as possible, there are certain very drastic limits.

Self-Capacity

Suppose for a moment that we keep the number of turns on the primary winding the same, and alter the number of turns on the secondary winding. As we increase the secondary turns, the step-up ratio of the transformer gradually increases, but unfortunately this process cannot go on indefinitely. It is well known that if a coil of wire is wound in multi-layer fashion there is a capacity effect between

the various turns, and if a very large coil is wound, this effect begins to become considerable. Thus, after a certain limit is reached, the self-capacity of the secondary winding becomes too large for convenience. When this occurs, the voltage produced by the secondary winding does not operate the grid and filament of the succeeding valve, but simply sends a current through the capacity of the winding itself. In other words, the valve becomes short-circuited by the self-capacity of the winding.

A Definite Limit

It is obviously useless to carry on (Continued on next page.)



★ ★ ★
The transformer ratio which is appropriate in any given case is closely related to the type of valve in use.
★ ★ ★



ber of turns that there are on the primary, the voltage produced across the terminals of the secondary coil will be twice that on the primary, that is, to say, 100 volts. Thus the voltage produced on the secondary is N times that on the primary, where N is the ratio of the secondary turns to the primary turns, or, as it is called, the transformation ratio.

Intervale Transformers

Now, in a low-frequency amplifier we have a certain voltage which is produced in the anode circuit of one valve. This voltage, of course, is varying rapidly at the frequency of the speech or music vibrations. We wish to



under such conditions as this. It only means that extra expense is incurred in putting on the extra turns, and that no additional benefit is being gained. Thus we see that there is a definite limit to the number of turns of the secondary winding. The actual limit itself depends upon the method of winding and the skill of the designer of the particular transformer.

The Primary Winding

So far we assumed that the primary winding was fixed. Unfortunately, with a valve in a low-frequency amplifier, there are other conditions which affect the value of the primary winding. It is an essential principle in valve amplification that the impedance of the anode circuit of the valve must be comparable with that of the valve itself. A little thought will show that this is obvious.

Due to the voltage which is applied to the grid of the valve we have a certain current flowing in the anode circuit. We therefore put some device in the anode circuit itself and the current through this produces a voltage in the circuit. If we had no such device we should obtain a short circuit between the anode and the high-tension battery, and obviously there would be no external voltage in the anode circuit whatever. Consequently we should obtain no effective amplification from the valve.

A Conflicting Condition

We have therefore the condition of affairs that the higher we can make the impedance in the anode circuit, that is to say, the greater the number of turns which we can put on the primary winding of the transformer, so the larger becomes the actual amplification of the valve preceding the transformer. It will immediately be realised that this condition is in direct conflict with the conditions governing the secondary.

If we want to get a high step-up ratio then we want the secondary turns to be several times as great as the primary. We have just seen, how-

Why Do We Use Different Ratios?

A simple explanation of an important point.

ever, that the number of turns on the secondary is limited, so that we cannot increase these beyond a certain point, while finally the number of turns on the primary should be large in order to produce effective amplification from the valve in use. Obviously, therefore, if we increase the primary turns and leave the secondary turns fixed, we are going to reduce the amplification ratio, which is just what we do not wish to do.

A Compromise

The design of a transformer is therefore a matter of compromise. It is found in practice that provided the primary winding of the transformer is greater than a certain value



With what is called a "low-impedance" valve it is desirable to use a higher ratio transformer.

depending on the valve in use, then reasonably efficient amplification (something like 70 per cent. of the maximum possible) can be obtained from the valve, while at the same time a reasonable step-up ratio is possible.

This is the secret of the diversity of various ratios. The actual value of the primary winding depends entirely on the valve with which the transformer is to be used. If the valve preceding the transformer in question is one having a high impedance, such as a detector valve, then the primary winding must have a large number of turns and so the ratio of step up is only small.



Various Ratios

For the first low-frequency stage, however, we need not use a high impedance valve, but we can employ one having a much lower internal impedance. If this is done the transformer used in the second stage need not have so many turns on the primary winding, and the effect of this will be to obtain a greater step-up ratio. Consequently, according to the valves in use and the type of circuit, so we have a large number of different ratios of transformer, ranging from $2\frac{1}{2}$ or 3 to 1 for the first stage transformers following detector valves to 4, 5, 6 to 1 or even more for stages of low frequency and power amplification.

Other Factors

This brief discussion can, of course, only touch on the fringe of the subject. There are many little points which are sometimes apparently in conflict with this general theory. In the olden days some manufacturers kept the primary windings of their transformer fixed, and varied the number of turns on the secondary. Thus, in some cases, they obtained high-ratio transformers in the first stages and lower ratio transformers in the subsequent stages. This procedure is, of course, inefficient, and is now dropping out of use, but traces of it still remain and are encountered from time to time.

The points raised, however, will serve to indicate why there is a necessity for different ratios of transformers, and will give some idea as to what ratio of transformer should be used in various circumstances.

**"THE WIRELESS
CONSTRUCTOR."**

**6d. AUGUST ISSUE 6d.
ON SALE JULY 15th. 6d.**



I SEE we are promised in the near future a Turkish broadcasting station which is to be erected at Heni/Bagtche, not far from Stamboul (the Turkish name for Constantinople). If the transmissions succeed in reaching England—and I doubt it, as I know from personal experience that wireless conditions around Constantinople are very bad—the listener will be able to judge for himself how Turkish music differs from the imitations which are served up to us here. "Eastern music" (Turkish music should be classified under this heading) has a rhythm of its own, with little relation to the type of tune one hears in plays of the "Chu Chin Chow" variety.

When you have listened to it for several months, as I had the pleasure of doing in pre-war days, you may come to like it, but at first hearing you will get the impression that two stations are heterodyning one another! What I really would like to hear, if the establishment of broadcasting in Egypt will enable it to be effected, is the broadcasting of the haunting call to prayer floating on the still air of a summer evening from the tower of an Eastern mosque. To hear the chant from a slender minaret ringing out above the city below in the quiet of an Egyptian evening would give the listener an intimate contact with the East which would otherwise be obtainable only by a personal visit.

I WONDER what the average listener thought of the very crude advertising of a southern seacoast resort last Friday week? I see the Mayor of Margate has expressed the view that he did not see why one or two selected places should be given such an advantage over competitors, and the B.B.C. in their reply say in effect that if other seaside places like to provide programmes, there is no rule which would prevent references to the attraction of a particular resort.

IF this kind of thing goes on, heaven only knows where it will end! We have heard plenty of gibes

at America for permitting advertising by radio (although Mr. Harris has pointed out on many occasions that crude advertising is never permitted from the American stations) that one is surprised to see such flagrant cases permitted here. If you were to ask the average publicity committee of a seaside resort which they would prefer—the front page of a prominent London daily or half an hour "over the broadcast"—I know which they would choose, and so do you!

The advantage from the B.B.C.

THE experiment of broadcasting a diver's description of the bottom of the Thames as he saw it was not, after all, a very thrilling affair, although praise must be given to the exceedingly well-delivered lecturette preceding the actual diving broadcast. It so happened that the diver "drew a blank" as far as treasure was concerned, and, in fact, was able to give the listener little other than the repeated statement that nothing could be found. Considering the difficulties of getting satisfactory reproduction from inside a relatively small diver's helmet, the broadcasting itself was quite a good technical achievement. But for an irritating resonance in the helmet, we should all have heard every word, provided, of course, our apparatus was up to the scratch. Personally even with the resonance effects I do not think I missed anything, but several friends who spoke to me afterwards were only able to make out a word or two here and there. I suspect their loud-speakers were at fault, or still more probably, their amplifiers were distorting.

THE USEFUL "SUPER"



At a wireless society's outing: a six-valve super-heterodyne and portable loud-speaker being used to receive Dublin.

point of view is that an entertainment of this kind costs them nothing. Presumably the seaside resorts in question pay the expense of the programme in return for the "boost" they are able to give themselves through the microphone. By consistently adopting similar but more delicate methods, the American broadcasting stations are able to provide listeners with quite good programmes free of cost. Our Transatlantic friends are not required to take out any licence or to pay any fees for the use of broadcast receivers, while in spite of gloomy prophecies made a year or two ago, their programmes tend to improve rather than to deteriorate.

LUNCHING at the Holborn Restaurant the other day I noticed the microphone in evidence above the orchestra was of the new Reiss type, which is fast supplanting the old magnetophone for most transmissions. The Reiss microphone consists in part of a block of marble about as big as half a brick and a very ingenious arrangement of finely-powdered carbon in a wide and shallow front pocket. This form of microphone has been found to have many advantages, among which should be mentioned its portability and robust construction and its exceedingly good reproduction of a very wide band of frequencies.

THE orchestra's reproduction of Jahnfeld's Praeludium came as a refreshing change from the eternal jazz, which, however suitable for dancing, to my mind does not go well with the mid-day meal. The lunch-time transmissions from well-known (Continued on next page.)

The Week's Diary—continued

restaurants are becoming increasingly popular with the stay-at-home population, and much of this popularity is due to the nature of the music played.

SOME interesting legal actions have recently been fought in the United States over some of the patents used in modern receiving sets. For example, the Court has ruled that the Hazeltine patents do not infringe the Rice and Hartley patents in an action taken by the Radio Corporation against a firm known as the Twentieth Century Radio Corporation, who were acting as distributors for a well-known manufacturer of neotrodynes. This is of particular interest to set manufacturers who have wondered where they stood in the face of conflicting patent claims.

ON the 15th inst. a luncheon is being given by our trade contemporary, *The Wireless Dealer*, in honour of Professor L. A. Hazeltine, who arrived in England on the 14th. The

neotrodyne circuit associated with his name has done more to abolish howling in the United States than any other contribution to the art, for an enormous number of receivers built on

this principle have been disposed of in the last year or two. None of them are capable of radiating save when grossly misused after deliberate maladjustment.

MUSIC HATH CHARMS . . . !



The Sheffield Wireless Society's effort to locate a secret transmitter in Derbyshire aroused interest in an unexpected quarter.

IN spite of summer conditions, the Madrid stations are still coming in with very great strength and can be heard almost any night after the British stations close down, Union Radio, Madrid, often continuing until about 2 o'clock in the morning. It is interesting to note that the difference in wavelength between Union Radio and Radio Iberica (both Madrid stations) is about the same as that between the two wavelengths used for the simultaneous London test recently. Personally, I find that Union Radio on a wavelength just above that of London comes in considerably better than Radio Iberica, but others may have found the reverse. I find that howling, at one time very bad on these stations, seems to be subsiding of late. WAVE-TRAP.

A REAL WIRELESS SERVICE

We have in stock all the Components and Cabinets for the New Marvellous ELSTREE SIX.

Place your orders now.

Have you seen the new DARIMONT CELL? No more carrying heavy accumulators to town. No more worries with damaged Batteries. Instal a Darimont Cell Battery giving a guaranteed life of 100 hours constant discharge of $1\frac{1}{2}$ volts at $\frac{1}{4}$ ampere. Price 5/- each. New charges $\frac{1}{4}$ each.

Why not secure a copy of our latest Catalogue, which is practically a Guide Book to the Industry, for the cost of postage and packing, viz., 6d.

N.B.—Call and see the ELSTREE SIX at our Showrooms.

WILL DAY, LTD.,
19, Lisle St., Leicester Sq., London, W.C.2

Telephone: Regent 4577. Telegrams: Titles, Westrand, London.

Without Doubt —the Best D.E. Valve



TYPE K
2 VOLT
.3 amp.

4/11

Buy a Frelat and prove it!

The low price of 4/11 is not indicative of its wonderful service, but it is a remarkable example of how efficiency in your Set can be accomplished without undue expense.

Next time you are replacing Valves put a Frelat to the test. You will find that it gives greater tone volume, lasts much longer, and gets the very best out of your Set.

Continental Radio Import Co., Ltd.,
8, Spital Square, London, E.1.

ASK
YOUR
DEALER
FOR
FRELAT
VALVES



If your Dealer cannot supply, send P.O. for 4/11, or if C.O.D., send 6d. in stamps.

You can be confident of success by building these Amplifiers the PILOT WAY

WHEN you build your Set the PILOT Way you save money, time, and trouble and yet your set looks better and gives perfect results. Pilot Service a veritable insurance against failure, is explained in the Pilot Manual (post free 6d.). Write for it and build any of these Amplifiers this safe way.

The "Wireless" Choke Amplifier.

2 "Success" L.F. Chokes	1 1 0
2 Dubilier Fixed Condensers, Type 610, .015 mfd.	0 9 0
2 Dumetohm Grid Leaks, with holders 5 meg. and .25 meg. respectively	0 5 0
2 "Temprytes" with mountings (3 ohms)	0 8 0
2 "Fantail" Double Circuit Jacks	0 5 0
1 "Fantail" Single Circuit Jack	0 2 0
2 T.C.C. Fixed Condensers, 2 mfd.	0 9 4
2 Benjamin Anti-microphonic Valve Holders	0 5 6
2 Peto Scott Aluminium Angle Brackets	0 2 6
1 Lissen Push Pull Switch	0 2 9
1 pr. Peto Scott Grid Battery Clips	0 0 6
1 McMichael Clip-in Condenser, with Clips .005 mfd.	0 4 0
10 Mark III. Terminals	0 1 8
3 Wander Plugs (2 red and 1 black)	0 0 6
Square Tinned Copper Wire, Screws, Flex, etc.	0 1 6
	£3 18 3
1 Terminal Strip, 10 x 2 x 1/4 in., drilled and engraved	0 2 0
1 "Red Triangle" Ebonite Panel, 10 in. x 9 in. x 3/16 in., matted and drilled	0 4 0
Engraving, extra, if required	0 1 6
Polished Mahogany Cabinet, with Baseboard	0 18 6

The "Wireless" Transformer Amplifier.

2 Peto Scott Board Mounting Valve Holders	0 2 6
2 Peto Scott 30-ohm Filament Rheostats	0 8 0
1 pr. Peto Scott Grid Leak Clips	0 0 6
1 T.C.C. Fixed Condenser, 2 mfd.	0 4 8
1 Ferranti A.F.4 L.F. Transformer	0 17 6
1 C.A.V. All Purpose L.F. Transformer	0 15 0
2 Peto Scott Aluminium Angle Brackets	0 2 6
3 Wander Plugs (2 black, 1 red)	0 0 6
12 Indicating Terminals (2 H.T. + 2 H.T. - , 2 L.T. + , 2 L.T. -), 2 loud speakers (one red, one black), and two without marking (one red and one black)	0 4 6
1 Terminal Strip 9 x 2 x 1/4 in., drilled and engraved	0 2 0
Square Tinned Copper Wire, Screws, Flex, etc.	0 1 6
	£2 17 2
"Red Triangle" Ebonite Panel, 9 x 6 x 1/4, matted and drilled	0 5 0
Engraving, extra, if required	0 1 6
Polished Mahogany Cabinet, with baseboard	0 15 0

The "Wireless" Resistance Amplifier.

1 Burneapt Dual Rheostat	0 6 0
3 Benjamin Anti-microphonic Valve Holders	0 8 3
3 T.C.C. Mica Condensers .01 mfd.	0 10 6
3 Varley Anode Resistances, 100,000ohms, with clips and bases	1 2 6
3 Igranite .5 meg. Grid Leaks with clips	0 0 9
1 T.C.C. Mansbridge Condenser, 2 mfd.	0 4 8
3 Wander Plugs	0 0 6
1 Terminal Strip, 5 x 1/4 x 1/4 in., drilled and engraved	0 1 0
8 Mark III. Terminals	0 1 4
Square Tinned Copper Wire, Screws, Flex, etc.	0 1 6
	£3 3 0
"Red Triangle" Ebonite Panel, 9 1/2 x 4 x 1/4, matted and drilled	0 4 6
Engraving, extra, if required	0 1 6
Polished Mahogany Cabinet, with baseboard	0 15 6

When complete Sets of parts and panel are purchased together a royalty of 12 6 per value must be remitted.

PETO-SCOTT CO., LTD.

Head Office & Works: 77, CITY ROAD, LONDON, E.C.1.
Branches: 62, High Holborn, London, W.C.1. WALTHAMSTOW—230, Wood Street. PLYMOUTH—Bank of England Place. LIVERPOOL—4, Manchester St.

P.S. 5521

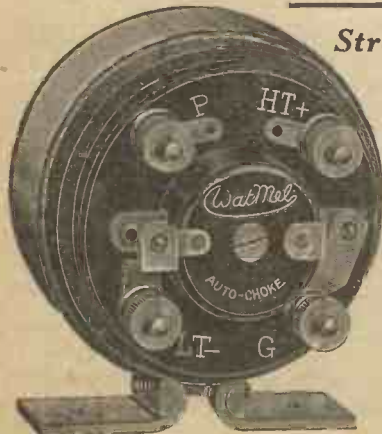

Straight as a die!

The amplification curve of the Watmel Auto-Choke—literally as straight as a die—speaks for itself. It tells of unsurpassed purity of tone—of whispers built up into voluminous sound.

Patent core and specially balanced windings, give step-up increase in volume equal to transformer-coupled stage of low frequency. Price 18/6

WATMEL AUTO-CHOKE

The WATMEL WIRELESS Co., Ltd., 332a, Goswell Rd., London, E.C.1.

Lancs. & Cheshire Representatives: Mr. J. B. Levee, 23, Hartley St., Levenshulme, Manchester.

START RIGHT by Building Your Set on a—

TROLITE

PANEL . DE . LUXE

EASILY WORKED—use acetone as adhesive, thus making a strong and neat joint without screws

EFFICIENT & ELEGANT



Supplied
Ex Stock
Thickness
3" 1"
16" 4"

4 Finishes:

- Polished Black
- Polished Mahogany
- Polished Walnut
- Wavy Etched Black

A most attractive panel finish which does not show scratches or finger marks

PRICES	{	Polished Black	3" 1d.	1" 3d.	Sq. Inch
			16" 2	4" 4	
		Mahogany, Walnut and Wavy	3" 3d.	1" 1d.	
			16" 4	4" 4	

IF YOUR LOCAL DEALER IS OUT OF STOCK, PLEASE INFORM US HIS NAME AND ADDRESS AT ONCE

F. A. HUGHES & CO., LIMITED
204-6, GT. PORTLAND STREET - - - LONDON, W.1.

Telephone ... Museum, 8630, -1-2
Telegrams—"Distancing, Wesdo, London."

"Goltone"

(Regd.)

HIGH TENSION BATTERY

ELIMINATORS

(BRITISH MADE)

FIRST COST SAVED IN A SHORT TIME.
A REFINEMENT AND CONVENIENCE BEYOND PRAISE.



Entirely dispenses with the use of high tension Dry Batteries or Accumulators, and provides a ready, convenient and cheaper method of high tension supply with greatly improved reception.

Simply plug-in to the most convenient lamp-holder.

Complete with Flexible Cord, Adaptor, Switch and Flexible Cords for connections to Receiver.

DIRECT CURRENT MODEL

5 Different Voltage Tappings.
£3 : 0 : 0

ALTERNATING CURRENT MODEL

4 Different Voltage Tappings, each duplicated.

£5 : 10 : 0
Please state voltage and frequency when ordering.

Users Write:

Mr. C. R. B., Littleborough:—"Have installed the 'Goltone' A. C. H. T. Battery Eliminator, and must say that it has exceeded expectations. It has not the slightest suggestion of hum or distortion of any kind, and is very satisfactory."

F. S., Westcliff-on-Sea:—"I purchased through a London firm one of your High Tension Eliminators. On test I found it far superior to dry batteries and the increase in volume and clarity is surprising."

M. & Co., London:—"It may interest you to know that the Eliminator that you supplied is giving our customer complete satisfaction."

S. & Co., London:—"I should like to say I find the Eliminator excellent, no hum whatever, and giving wonderful volume."

New large fully illustrated Radio Catalogue R 114, on request.

Write for name of nearest stockist. Traders should enclose Business Card for Trade Terms.



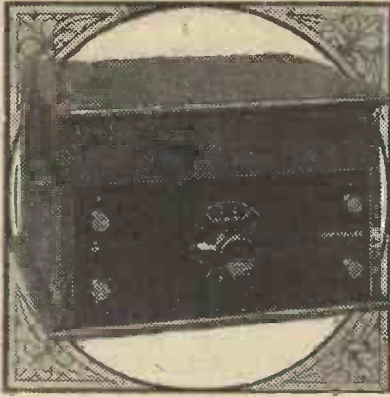

THE "WIRELESS" RESISTANCE-COUPLED AMPLIFIER

By JOHN UNDERDOWN

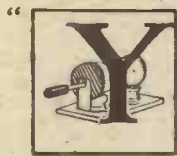

ES, but I may lose the very excellent tone which I obtain upon my crystal set," is an argument put forward by those who are undecided upon employing a loud-speaker in place of the unsociable telephones. In my time I have spent whole days wearing telephones, and nothing would induce me, for pleasure, to listen for hours on end in this manner when it can so easily be avoided.

The fact that you have heard "gramophony" demonstrations from some small wireless shop, where the one aim and object appears to be the maximum amount of noise regardless of tone, should not be allowed to prejudice you against listening in real comfort to really good reproduction.

A Simple Matter

It is an easy matter to build and add to your set a simple amplifier which, when correctly operated, will give you reproduction of which you will be proud and which will allow your family to listen sociably and in comfort, without the rustle of a newspaper or a movement in the room causing you profound annoyance, and perhaps a few hasty words which you wish later were unspoken.

The 3-valve resistance amplifier about to be described is one which is extraordinarily easy to build and is so designed that it can be employed with either a crystal or a valve receiver. By this I mean it can be coupled directly after a receiver with crystal or valve rectification, but I would not suggest that it be used after a receiver in which one or more stages of note magnification are already incorporated.

The Theoretical Circuit

The theoretical circuit chosen is seen in Fig. 1, from which its simplicity will be appreciated. It is

This resistance amplifier has been carefully designed to make it as easy as possible to assemble and wire, and even the beginner will find it well within his capabilities.

unnecessary to go into the arrangement in great detail, but a few words on the method of coupling to a crystal or valve set are called for.

be joined to terminal "E," which latter point will be connected to the other telephone terminal of the crystal set. In practice this terminal is generally connected to the earth terminal, but with certain inductively-coupled receivers this connection may not be made. In such cases it is generally advisable to join the E terminal of the amplifier also to the earth terminal of the crystal set.

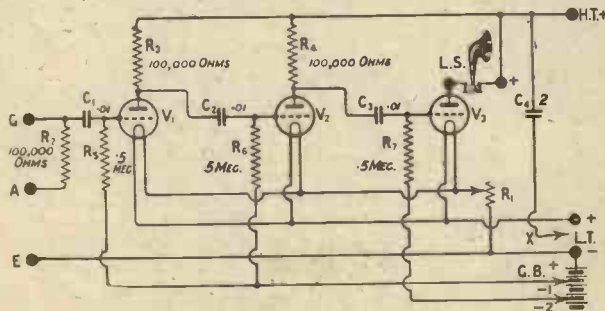

Fig. 1.—When the amplifier is coupled to a crystal receiver, the terminal marked "A" should be joined to that marked "E."

Following a Crystal Receiver

When the amplifier is coupled to a crystal receiver the terminal marked "G" should be joined to the telephone terminal of the set which is

valve, perhaps through a reaction coil, as distinct from the other telephone terminal which will be connected to H.T. positive. The "A" terminal of the amplifier will be joined to the positive telephone terminal of the set, so that the resistance R2 will replace the telephones. No connection will be made from the E terminal, but the L.T. positive and negative terminals on the amplifier will be joined to the L.T. positive and negative terminals of the set or direct to the actual low-tension battery.

An Explanation

In order that the amplifier shall be adaptable for use with any valve set, in which the high-tension negative terminal may be joined to either low-tension positive or negative, I have omitted the H.T. negative terminal from the amplifier. If one H.T. battery is used for both amplifier and valve set there is no need to worry about this point since the connection will be made to the preceding portion of the receiver, and it should be arranged that clip X is taken to

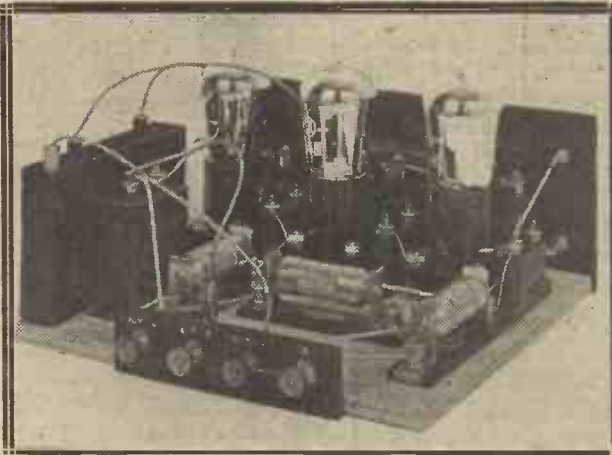

The Mansbridge condenser seen on the left of this picture is so placed that it holds the grid-bias battery in position against the side of the cabinet.

connected internally to the crystal detector. The lower end of the anode resistance R2, marked "A," should

be arranged that clip X is taken to

The "Wireless" Resistance-Coupled Amplifier—continued

either L.T. positive or negative respectively, according to whether H.T. negative in the receiver is joined to the former or to the latter point.

Amplifier H.T. Connections

When the amplifier follows a crystal receiver it will be necessary to take a lead from the negative terminal of the H.T. battery to either L.T. positive or negative, it does not materially matter which, whilst the clip X should be joined to the low-tension terminal to which the former connection is made.

General Design

For household use it is extremely desirable that valves should be en-

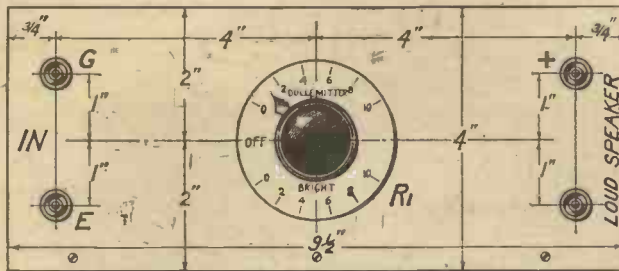

Fig. 2.—Once the receiver has been correctly adjusted, the resistance R1 may be used simply as an "on-and-off" switch. (Blueprint No. W2006A).

One special cabinet to take above panel and baseboard 9 in. deep (Peto-Scott Co., Ltd.). The cabinet is so arranged that the lid and the front wood panel both lift up so that the

instrument may be withdrawn without taking the valves out of their respective sockets.

One ebonite terminal strip, 5 in. by 1 1/4 in. by 1/4 in. (Peto-Scott Co., Ltd.).

One dual rheostat (Radio Instruments, Ltd.).

Three Benjamin "Clearer Tone" valve holders (Benjamin Electric, Ltd.).

Eight Magnum 4 B.A. terminals (Burne-Jones & Co., Ltd.).

Three T.C.C. .01 mica condensers (Telegraph Condenser Co.).

Three 100,000 ohms wire-wound anode resistances, bases and clips (Varley Magnet Co.).

WIRING INSTRUCTIONS

Join terminal G to one side of C1 and thence to one side of R2.

Join other side of C1 to G of V1 and thence to one side of R5.

Join other side of R2 to terminal A.

Join other side of R5 to one side of R6, and thence to G.B.—1 plug (flex lead).

Join A of V1 to one side of C2 and also to one side of R3.

Join other side of C2 to G of V2 and thence to remaining side of R6.

Join other side of R3 to one side of R4, thence to H.T.+, thence to one side of C4 and thence to L.S.+

Join A of V2 to remaining side of R4 and also to one side of C3.

Join other side of C3 to G of V3 and thence to one side of R7.

Join other side of R7 to G.B.—2 plug (flex lead).

Join A of V3 to L.S.—terminal.

Join L.T.+ to one filament contact of V3, V2 and V1, respectively.

Join L.T.— to G.B.+ plug (flex lead) and also to E and thence to one side of R1.

Join other side of R1 to the three remaining filament contacts of V1, V2 and V3.

Join remaining side of C4 to clip X (flex lead).

closed, and the layout adopted has been such that this arrangement is obtained. A very neat appearance results, and this will be appreciated from the photographs shown. A fairly small cabinet has been used, and the only control, once H.T., G.B. voltages have been adjusted is a single filament rheostat which acts as an "on and off" switch also, this being incorporated upon a small ebonite panel. The grid-bias battery is enclosed and the other battery leads are taken from the back of the case.

Baseboard Layout

In order to reduce wiring to an absolute minimum, considerable thought has been devoted to the lay-out of the components on the baseboard, and it will be seen that the resulting arrangement is both compact and simple.

Components and Materials

To duplicate the amplifier exactly the following list of components is given. It is advisable to adhere to these fairly strictly, as otherwise it may be found impossible to arrange the amplifier in the compact manner shown:—

One ebonite panel, 9 1/2 in. by 4 in. by 1/4 in. (Peto-Scott Co., Ltd.).

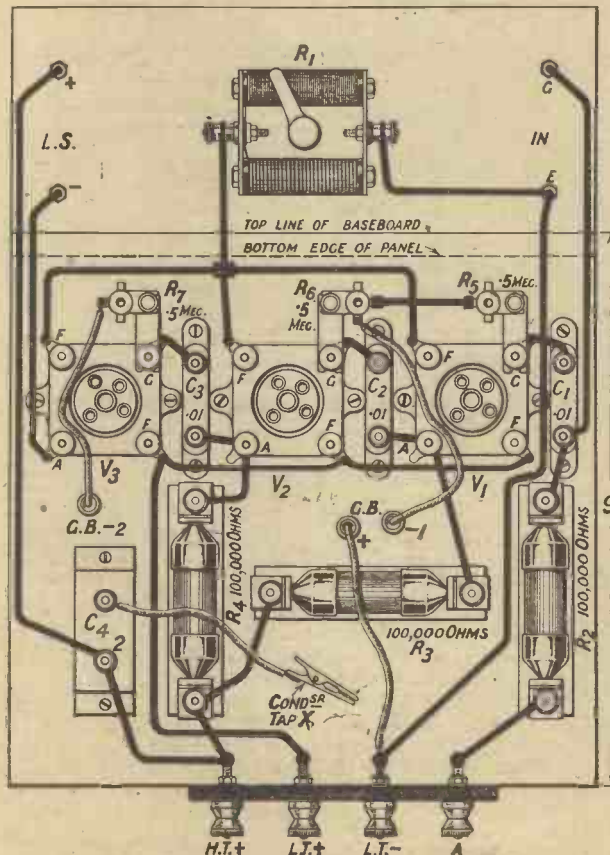

Fig. 3.—Great care has been exercised in placing the components to simplify the wiring, and the few connections which are necessary may be gathered from this diagram. (Blueprint No. W2006B).

Three 5-megohm grid-leaks (Igranic Electric Co., Ltd.).

One 2-microfarad Mansbridge shunting condenser (Telegraph Condenser Co.).

Quantity of Glazite, 20-gauge tinned copper wire and rubber-covered flex.

Three Eelex plugs (J. J. Eastick & Sons).

One "Competa" crocodile spring clip (A. F. Bulgin & Co.).

Constructional Work

The constructional work in making the amplifier is reduced to a minimum and no difficulty should be experienced here. On the front panel the dual rheostat, which also acts as an "on-and-off" filament switch, and four terminals are located. The two on the left-hand side correspond to those shown as G and E in the theoretical diagram, whilst on the right-hand side are the two terminals for the loud-speaker, the upper one being the positive terminal. The simple manner of mounting the grid-leaks by bending and inserting three of the metal mounting pieces supplied will be seen in the photographs.

Wiring

The compact baseboard lay-out adopted makes wiring extremely simple, and extra (Continued on next page.)

Anti-microphonic valve holders must have these five features

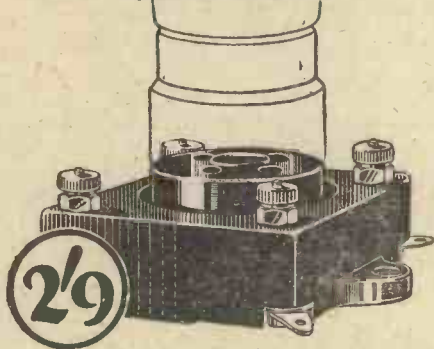

To MOUNT a valve on springs is not enough. It must be "floated"—cushioned against vibration in every direction. Before you buy an anti-microphonic valve holder make sure that it has the following features:

- (1) The socket must be perfectly free to float in every direction—parallel, lateral, and vertical. In addition the springs must be of sufficient strength to "float" the heaviest valve.
- (2) There must be no clamped or riveted joints between soldering tag and valve socket. In the Benjamin Clearer Tone Valve Holder it is one piece of solid metal from tag to socket.
- (3) There must be a straight through hole to assist any cleaning and prevent accumulation of dust.
- (4) Spring movement must be restricted by suitable stops to protect the springs when inserting or removing a tight valve.
- (5) The holder must be so designed that when the valve legs are pushed home they cannot possibly touch the base-board.

The extraordinary success of the Benjamin Clearer Tone Valve Holder lies in the fact that it possesses every one of these essential features. In addition, terminals as well as soldering tags are provided to allow new circuits to be tried out easily.

BRITISH **BENJAMIN** MADE
CLEARER TONE VALVE HOLDER
(ANTI-MICROPHONIC)

Patent Nos. 222086—1923
250431—1925
Regd. Design No. 714847

From your Dealer or direct from
THE BENJAMIN ELECTRIC Ltd.,
Brantwood Works, Tariff Road
Tottenham, N. 17

V.3

THE "WIRELESS" RESISTANCE-COUPLED AMPLIFIER

(Continued from page 275)

short leads can be carried out with 20-gauge tinned copper wire, it being unnecessary to solder the majority of the joints required here. Filament leads and others which are fairly long are carried out with Glazite insulated wire, whilst the three grid-bias leads are of rubber-covered flex, as is that from one terminal of the shunting condenser. The other end of this latter lead is terminated by the clip mentioned, and this will be taken to either the low-tension negative or low-tension positive terminal, according to the manner in which the H.T. negative lead is connected.

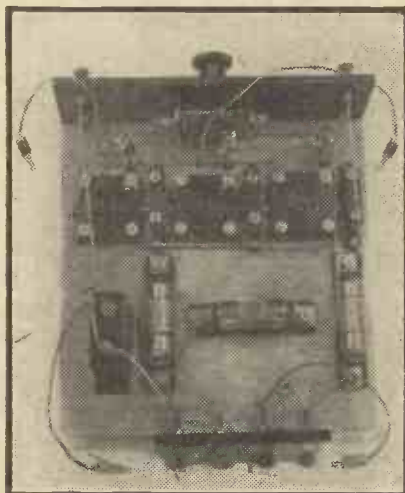

The three flex leads which terminate in plugs are clearly discernible in this photograph as is also the special one terminating in a clip.

Valves and H.T.

Although general-purpose valves will function well throughout, I strongly recommend that in the first two valve sockets resistance-coupling types be employed, and in the V3 valve holder a small power valve of similar filament voltage rating. In the tests which I have carried out I have employed two Electron S.S.6 valves for V1 and V2, with an S.S.4 for V3. A suitable high-tension voltage for these valves is 100 to 120 volts, with 1½ volts grid bias for the first two and 6 or 7½ for the power valve. The counterparts of these valves in other makes, such as the D.F.A.4, D.E.5 B, together with a D.F.A.1, D.E.5, B.4, etc., for the power valve, prove equally satisfactory, of course.

The method of connecting up the amplifier to a crystal or to a valve receiver has been indicated earlier in the article, but fuller details and operating notes will be given next week.

Real Music

In designing the Bretwood Amplifier extensive experiments were carried out to secure amplification with purity of tone. Not only has this been accomplished, but an added advantage is the remarkable silence of the "background" attained through using Bretwood Auto Audio-Frequency Amplifier.

"The purity of amplification when 2 L.F. stages are used is wonderful, and the silence of the 'background,' owing to successful elimination of atmospherics and 'mush,' is remarkable."

The original letter from which above extract is quoted, as well as numerous other testimonials, may be inspected at our offices.

Read also the "Elstree" test report in last week's issue of WIRELESS: it will convince you still more.



Price 20/-

Price 20/-

Bretwood
Auto Audio-Frequency Amplifier

Sold under a three years' guarantee, and money refunded if not satisfied after a week's trial.

BRETWOOD LTD.

12-18, London Mews, Maple St., London, W.1

Parrs Ad.

SPECIAL BARGAINS

We claim **THE EXCELLAITE LOUD SPEAKER** to be the **MOST PERFECT TONED SPEAKER** yet produced.

Send us 2/- and we will send you one of our Excellaite Loud Speakers that cannot be surpassed for Purity of Tone, Volume and Value for Money. If, after testing, you are perfectly satisfied, you pay balance by monthly instalments as follows:—
Baby Model Price 26/- 4-mthly
Standard " " 37/- 5- "
De Luxe " " 57/- 5- "
Complete Sets from 30/- to £30 on the Easiest of Terms. Send at once for our Latest Catalogue (Summer Prices).

THE WIRELESS DISTRIBUTING Co., Ltd. (Dept. W.)
Wireless House, Stoke Newington, N.16.

A WIRELESS DOCTOR.

If your set is giving trouble or you want advice, a competent expert will call and put you right (London and Home Counties). No result, no charge. Sets installed and maintained.

ALEXANDER BLACK,

2a, Woodville Grove, N.16. Clissold 3687.

CAMERAS at BARGAIN PRICES

Take your own Photos with a Camera you can choose from London's Largest Selection of NEW & SECOND-HAND BARGAINS.
See our Windows or write for Lists
SANDS HUNTER'S,
37 Bedford St., Strand, W.C.

For Advertisement Rates apply to—
The Advertisement Manager, "Wireless,"
Bush House, Strand, London. E.C.2.

PRACTICAL TOPICS

By G. P. KENDALL, B.Sc., Assistant Editor

An Instructive Fault—Size of Emergency Aerials—Local Conditions
—Variable Condensers for Portable Sets.

I SHOULD imagine that a removal is more of a trial to a wireless enthusiast than to any other member of the community, particularly when he possesses quite a number of sets and anything in the nature of a stock of valves. I recently underwent the experience, and although I found it a pretty trying business, I owe to it the elucidation of what was fast becoming a rather baffling trouble in my local broadcast receiver.

Strange Symptoms

The set is one with a large frame aerial built into a cabinet holding both set and batteries, and the circuit comprises two high-frequency valves, crystal detector, and two stages of low-frequency amplification with choke coupling. For some little time before the move the quality given by the set had been falling off, with signs of "blasting" on loud notes, and a general roughness which at times suggested that my neighbour was working his receiver in the oscillating condition on the "silent point."

Variations

I was beginning to think that this must be the explanation, because none of the usual adjustments made the slightest difference to the objectionable quality in the reproduction, the grid bias, H.T. and so on being all correctly proportioned. The results varied somewhat from day to day, and at times the set was almost back to normal, at others becoming so objectionable that a fresh attempt would be made to solve the mystery.

On arrival at the new position, only about 300 yards from the old one, the receiver was set up and a short aerial connected, which consisted of a piece of wire hung round a picture rail for the purpose of rendering the picking up of the transmission somewhat easier. It was now found that the defect was very much worse than before.

The Cause

It was evident that some real fault had now developed, and a thorough search was made, with the result that finally I discovered that one of the large grid condensers of the low-fre-

quency valves was apparently in the act of breaking down, and upon replacing this the set was restored to its normal behaviour.

Aerial Size

In order to obtain a fairly loud signal to work upon during the attempts to locate the fault I extended the picture-rail aerial out to the next room, and through a French window, down the length of the garden, finally fastening it to the top of the fence at the bottom, the result being an aerial of almost full length, and an average height of about 5 ft. or 6 ft.



An interesting development is indicated by this photograph of a special news-service receiving station erected in Dublin by the Free State Ministry of Posts and Telegraphs. The gear has a rather "experimental" look!

And its Effect

It was interesting to notice the effect on signal strength as the aerial was increased in size, the increase in the volume of the signals being quite rapid as the aerial was taken in stages to the next room and as far as the French window. Beyond this point, however, it is rather remarkable to observe that very little increase in signal strength took place, the addition of the portion of the aerial out of doors (which was considerably larger than the portion indoors) having only a little effect on signals. This seemed to be a point worth bearing in mind when putting up an improvised indoor aerial for emergency use. It appears

to be about the first 40 or 50 ft. that count the most.

Local Conditions

It will be interesting to note what difference there is, if any, between reception conditions at my old address and the new one, for I have had rather a suspicion that the bad local conditions under which I was previously working were very local indeed. This seemed all the more probable in the light of the fact that less than a mile away Mr. Harris experiences reception conditions which can be described as at least average.

Experiments to be Done

The point seems worth investigating a little, and I propose to use a portable 6-valve super-heterodyne for the purpose, and, since I still have access to the old house, to take it from one to the other upon a number of successive evenings, noting the signal strength of a number of distant stations in various directions at each point, and hope to obtain some interesting information as a result. I should not be surprised if some rather peculiar things come to light, and if they do, I hope to describe them in these columns.

Something Wanted

Mention of the portable set in question reminds me of a problem in the building of such sets which does not receive by any means the attention which it seems to warrant. I refer to the question of the type of variable condenser to use, and it is rather strange that now that so many beautiful new designs of low-loss variable condenser are appearing on the market no manufacturer appears to have thought it worth while to produce a specially light and compact model for use in portable receivers. On the contrary, most of the latest designs are particularly heavy and large, and designers appear to be losing sight of the fact that a component which is light and compact is decidedly attractive in itself.

Limited Choice

As a matter of fact, when one comes to look for a variable condenser which is really small and not weighty, one very soon realises that the choice is extremely limited.

No doubt the production of such a variable condenser is not a very easy thing from the manufacturer's point of view, because it must be understood that to make a condenser small it is not sufficient merely to reduce the space between the plates, because this is an expedient which cannot be carried very far before the risk of the condenser being shorted by dust and moisture between the plates becomes quite considerable.

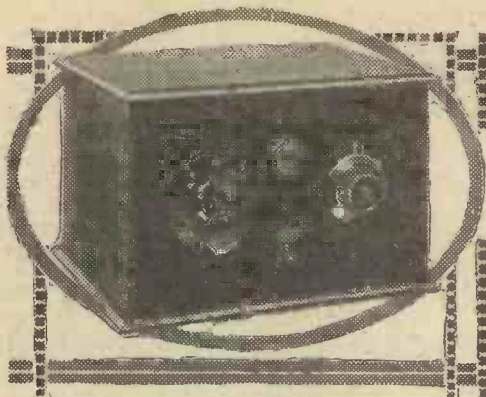

GETTING THE BEST FROM THE "RELAYS TO DAVENTRY" RECEIVER

By JOHN UNDERDOWN



IN last week's issue I dealt mainly with the constructional work in building the "Relays to Daventry Without Changing Coils" receiver, and here it is intended to give somewhat fuller operating details so that the best may be obtained from the set. A number of five- to six-volt valves suitable for the detector position were mentioned, and if you have not valves already to hand I would strongly advise that such types be obtained. Their counterparts in other voltages, such, for example, as the D.E.3 B, which is a 3-volt .06-ampere valve, also give satisfactory working. The essential condition to be obtained is a pronounced bend in the characteristic curve, and this condition is often best fulfilled by high-impedance types, such as those used for resistance-coupling, or for high-frequency work.

Voltage Adjustment

Where valves with characteristics dissimilar to those mentioned in the previous article are obtained I would strongly advise that a 6- or 9-volt grid-bias battery be employed for G.B.1, this battery being tapped in $1\frac{1}{2}$ volt steps. Plug the high-tension positive tapping for the detector valve, that is H.T. +1, into some suitable voltage in the H.T. battery, for example, 60 to 70 volts, and proceed to adjust the value of G.B.1 until strongest signals are heard. The next step is to readjust the H.T. voltage, since this will give, if carried out in three- or four-volt steps, better control than the $1\frac{1}{2}$ volt adjustments of G.B.1. By paying careful attention to these points it will be found that rectification effects will be obtained practically as effectively as if a potentiometer were connected directly across the L.T. battery, and final adjustment were carried out by means of this component.

Adjusting the Note Magnifier

To the plate of the note-magnifier valve, which should preferably be a small power valve, the maximum H.T.

Full constructional details of this easily-built set were given in our last issue. The author now gives some detailed instructions for operating the set to the best advantage.

permitted according to the maker's specification should be applied if a loud-speaker is to be worked, and a 6- or 9-volt grid-bias battery, tapped in $1\frac{1}{2}$ - or 3-volt steps, should be employed for G.B.2. This battery should be adjusted in practice so that the maximum grid bias which does not cut down signal strength, is used. Generally 6 or $7\frac{1}{2}$ volts is a suitable value with 100 to 120 volts H.T.

Filament Control

No adjustment of filament temperature will have to be made if Amperites are used, this being effected automatically, but where certain types of valves for which suitable Amperites are not obtainable are used, other

aerial tuning be employed or alternatively the size of the fixed reaction condenser C_2 may be increased to .0003. Where it is desired to obtain the maximum selectivity C.A.T. will be found of advantage, and if the set oscillates too readily with this connection, C_2 should be decreased in size to .0001.

Although upon my aerial with a resistance-coupling type of valve for the detector I found a .0002 condenser satisfactory for C_2 on both the ordinary broadcast wavelengths and upon the Daventry and Radio-Paris wavelengths, but with valves which oscillate less readily, it may be found of advantage to increase the size of C_2 to .0003.

Sequence in Tuning

To explore the whole of the wave-length range covered by the tapped aerial coil tuned by C_1 , with either aerial connection, place the lower pointer of the Aerial Tuner on stud A and rotate the aerial tuning condenser C_1 slowly, it being arranged that the reaction coil L_2 is in the zero position, that is, with the pointer set at O. When a transmission is heard adjust the reaction knob, that is the upper one on the Tuner, turning this to the left gradually. Signals should come up in strength, and, excepting in the case of very weak transmissions, it will be unnecessary to re-tune upon C_1 , since alteration of reaction coupling has no very marked effect upon

the setting of the aerial condenser. This will be found of advantage in practical working.

Having covered the whole of the wavelength covered by the first part of the coil, advance the wavelength range pointer to stud B and again carry out the same sequence of tuning operations. By carrying on in this manner the whole of the range covered by L_1 in conjunction with C_1 will be explored.

(To be concluded next week.)

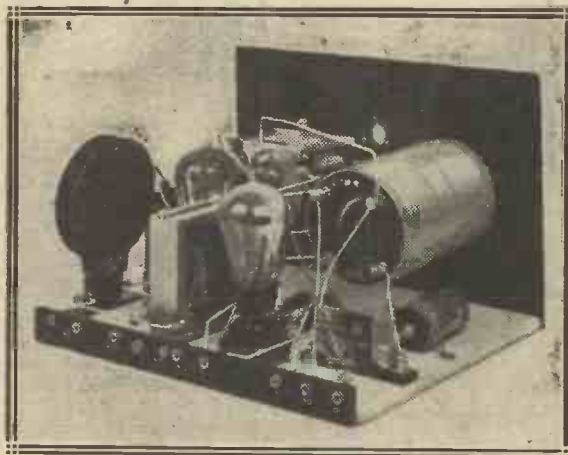

A little experimenting with the interchangeable reaction condenser (seen immediately beneath the tuning coil) may be needed.

appropriate fixed resistors may be obtained from a number of firms.

Aerial Connections

The two aerial connections were briefly outlined in the previous article, for parallel tuning the aerial being taken to A2 and the earth to E, while for constant aerial tuning, which will probably give better selectivity, the aerial goes to A₁. Where the aerial is "stiff," that is, it is difficult to make the receiver oscillate, I would strongly recommend that constant



Correspondence

Summer Programmes

SIR,—I am somewhat disappointed that your correspondent, Mr. Weiner, in his reply to my article on the lack of summer programmes, has not been able to find a more crushing criticism. Granted that the programmes compared were not Saturday programmes, but I was not aware that the summer confined itself to Saturdays.

I would also remind him that there is a large body of workers, in the suburbs in particular, whose weekly half-holiday does not come on a Saturday.

This, however, is not the point. Let us rather examine some of these Saturday programmes which Mr. Weiner infers are so peculiarly suited to the glorious weather we have been experiencing, with its resultant influx of workers (some of us eighteen hours a day, Mr. Weiner) into the country, or open places.

Saturday, June 12.

- | | | |
|------|-----------|---|
| 2LO. | | Radio Times (plays on cover "Summer Dance Music." |
| | 2.45-5.0. | A Radio Carnival at Bristol |
| | 5.0. | Hotel Cecil Dance Band |
| | 6.0. | A Topical Talk |
| | 6.15. | For the Children |
| | 7.0. | Time Signal, News and Talk till 7.25 |

Saturday, June 19.

- | | | |
|------|-----------|---|
| 2LO. | 4.0-6.30. | Theatre Orchestra relayed from Whitechapel and Songs from the Studio |
| | 6.30. | For the Children and Others. National Union of Schools Orchestras relayed from Crystal Palace |
| | 7.0. | Time and News and Talk as usual till 7.25 |

Saturday, June 26.

- | | | |
|------|-------|--|
| 2LO. | 3.0. | Celebration of Bridgewater Charter Day |
| | 4.0. | Concert by Soprano and Baritone |
| | 6.0. | A Garden Chat |
| | 6.15. | For the Children (A Talk on Bells) |

Saturday, July 3.

- | | | |
|------|-------|---------------------------------|
| 2LO. | 4.0. | Concert by Soprano and Baritone |
| | 5.30. | Royal Air Force Display |
| | 6.0. | A Garden Chat |
| | 6.15. | For the Children |

Need I continue? Further, if Mr. Weiner cares to consult his *Radio Times* he will find that the programmes from the provincial stations are much of a muchness with those given above, while the Sunday programmes speak for themselves.

If I take it that Mr. Weiner has examined these programmes and approves of them, then I venture to suggest that the greater part of the British public will disagree on the subject of their suitability for the season.

If, however, he has not examined them, may I ask on what grounds he bursts into print?

In either case I fail to see the necessity to indulge in personalities, since I do not enjoy the privilege of Mr. Weiner's acquaintance.—Yours faithfully,

C. P. ALLINSON.

The Station-hunter's View

SIR,—I should be obliged if you would allow me, through the medium of your

valuable paper, to express my complete agreement with the article by "Average Listener" in the July 10 issue of WIRELESS. "Average Listener" has evidently "had some," and so have I. It is practically impossible nowadays with any set below the standard of the "Elstree Six" to entertain anyone with a loud-speaker working on any other station than the local. If the new plan of having two stations in each town materialises, this would simply be extended to two locals, and the real radio man would be no better off. Surely the B.B.C. appreciate the fact that a large percentage of their listeners do not care so much for the programme itself as the station it is being received from. If only the B.B.C. would push up the power of the main stations all round, instead of contemplating the erection of new stations in districts already well served, the valve-set man would automatically be given a choice of three or more stations that would be perfectly audible through the usual jamming and mush.

Allow me to congratulate "Average Listener" upon having the courage of his convictions.—Yours faithfully,

J. G. BENHAM.

Northampton.

Two Stations: An Opponent

SIR,—I may be dense, but I must confess that I can see no redeeming feature in the B.B.C.'s scheme of erecting two main stations in each town. When the recent tests were on, one could not help noticing that, even with a reasonably selective receiver, it was quite impossible to receive foreign stations. Many of the B.B.C.'s "audience" grow so fed-up with the programmes at times, that were it not for the joy of searching round among the foreign stations, they might give up radio altogether.—Yours truly,

F. M. COOPER.

London, S.E.4.

Support

SIR,—May I venture to express my complete agreement with "Average Listener," whose article "Give Us More High-Power Stations" in last week's issue of WIRELESS puts the case in a nutshell? What is really urgently needed is a general boost-up of the power of all the main stations so that, for instance, London listeners can be certain of receiving Bournemouth and Birmingham at a greater strength than all the mush of spark stations and long-wave arc stations, to say nothing of atmospherics and trouble from fading.

Nothing short of a system of high-power stations throughout the country will, in my opinion, provide a satisfactory alternative programme service.—Yours faithfully,

F. R. SAMUEL.

Chelsfield.



Build your own loud speaker for the summer.

Summer Time! To be spent in the garden basking in the sun—your diversion the invisible entertainer, radio. It is a thing to look forward to, this restfulness and to the full power and mel'ow music of the "Lissenola." And the cost?—negligible; for your finished loud speaker works out at less than 15/- (the "Lissenola" is 13/6, and with it we give you full-size diagrams and clear instructions how to build a proved horn for a few pence). You could not have a better loud speaker whatever price you paid.

If you prefer it you can easily convert the "Lissenola" to carry a cone or any other diaphragm working on the reed principle by attaching the Lissen Reed (1/- extra). In addition, if you possess a gramophone you have only to substitute the Lissenola for the sound-box to convert it at once into a radio loud speaker.



Ask your dealer to show you the

LISSENOLA

LISSEN LIMITED,
18-22, Friars Lane,
Richmond, Surrey.

Managing Director: Thomas N. Cole

THE FIRST WIRELESS LOUD SPEAKER WAS A BROWN



WHEN you first see Brown Instruments you cannot but be impressed by the unusual beauty of their outline; but *hear* them and you will realise that such unique volume and richness of tone comes only from the superior workmanship and extreme care in construction which is lavished upon each Brown

instrument. The most convincing testimony to the superiority of the Brown is its presence among the radio enthusiasts of five continents.

Hear the Brown Loud Speaker at your Dealer's. You'll find a complete range to suit all needs, from the H.4 Model at 30/- to the H.Q., £6, and the "Q," £15 15s.

Retail Showrooms: 19 Mortimer St., W.1. 15 Moorfields, Liverpool. 67 High St., Southampton.

S. G. Brown, Ltd., N. Acton, London, W. 3

Depots (Wholesale only): 2 Lansdowne Place West, Bath. Cross House, Westgate Road, Newcastle.

BRITISH

Brown

THROUGHOUT

PROTECT YOUR LOUD-SPEAKER!—(continued from page 260)

loud-speaker is being used at a distance from the receiver, or actually in the same room.

The Circuit Explained

The circuit diagram of such a filter is given in Fig. 2. It consists of a low-frequency choke, a large Mansbridge condenser of 1 microfarad capacity, and an optional condenser. This latter condenser is optional because it is a tone condenser, and its value, if used at all, depends upon the make of loud-speaker. When using the extension leads into the garden, the capacity of the wire, more particularly if it is of the twisted variety, may be sufficiently high to act as a condenser, in which case C₂ may not be required.

A Practical Unit

A loud-speaker filter unit constructed in a very compact form may be seen in the photographs accompanying this article. It is made up in a small cabinet, which has a panel let in at each end. At one end two Clix sockets are provided, into which leads from the receiver output terminals are plugged, while on the remaining panel two further sockets are provided, to which the loud-speaker or extension leads are connected. On this same panel are fixed two clips, into which



The loud-speaker terminal on the set which goes to H.T.+ should be connected to the left hand socket in this photograph.

a condenser can be placed if required to alter the tone of the loud-speaker. Inside the cabinet, the L.F. choke and the Mansbridge condenser are placed on a baseboard. The panels are fitted one at each end of this latter, as shown, and the baseboard with panels is able to slide in and out of the containing box as required.

Components

Few components are required, and those actually used are listed below. Those of manufacture different from the components specified may of course be used providing that they will fit

into the cabinet and are of satisfactory quality:—

- One "Success" L.F. choke, standard model (Beard & Fitch, Ltd.).
- One Mansbridge condenser, 1 microfarad (Dubilier Condenser Co., Ltd.).
- One pair fixed condenser clips, and condenser if required (L. McMichael, Ltd.).
- Four Clix sockets (Autoveyors, Ltd.).

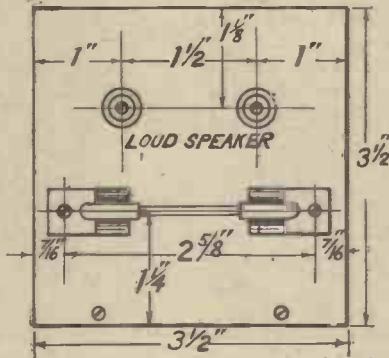

Fig. 3.—A dimensioned view of the "output" panel. To this the loud-speaker can be connected any way round without fear of damaging the windings.

- Two small pieces of ebonite 3 1/2 ins. square.
- Baseboard and containing box.
- "Glazite" for wiring.
- Radio Press panel transfers.

Construction

The construction is quite straightforward, all details being given in the various figures.

Regarding the baseboard, it is important that the two sides on to which the panels are to be screwed should be square, otherwise the panels will not be upright when in position.

It will be noticed that one of the "input" sockets is marked positive, and this should be connected to the loud-speaker terminal on the set which goes to H.T. positive.

Conclusion

When the unit is completed, a small screw may be put through from the underside of the cabinet to hold the baseboard in position.

From previous remarks, the usefulness of the unit should be obvious, and in practice such a device will amply repay for the cost and labour expended on its production.

"The Wireless Constructor"

Have you got your copy of the August Number?

6d. On Sale 15th July 6d.

THE CHOICE OF EXPERTS



GOOD ADVICE!

Good advice in the Radio field is very scarce indeed—Experts usually keep their hard earned knowledge to themselves. Here is the Transformer which is "The Choice of Radio Experts" the world over—the only Transformer which amplifies perfectly evenly both high and low notes. We strongly advise all to purchase no make of Transformer of which the makers do not publish a guaranteed curve right down to 100 cycles. "G.R." does this. The frequency of "Middle C" is but 256! This transformer is the only one amplifying "Middle C" on "the straight" of its curve. Send for free booklet and wiring diagram of 2 stage Power amplifier, and learn the Truth.



"G.R."
Two Ratios 1-6 & 1-2
PRICE, each 27/6

Complete Art Catalogue (36 pages) of "G.R." "Quality Parts" free and post free. A postcard brings it to you per Return. 60 Illustrations, 118 Essentials including Condensers (29 types), Transformers, L.F. and Superheterodyne (with Blue Prints), Low Loss Coils, Wavemeters, Rheostats, Potentiometers, Chokes, H.T. Eliminator Parts, Raytheon Tubes, Special Valves, Circuits of Amplifiers, famous receivers, articles on Transformers, Low Loss Coils, Interference, etc., etc.

From your dealer or (post free):—

CLAUDE LYONS

(Dept. "W")

**76, OLDHALL STREET
LIVERPOOL, Lancs.**

The "Wireless" Transformer-Coupled Amplifier —continued

that is to say, power valves. General-purpose valves may, of course, be used, but for the best results with a reasonable value of H.T. voltage power valves are to be recommended.

The makers' instructions as to H.T. voltage, filament current, and grid-bias values should be strictly observed, these instructions invariably being contained within the carton containing the valve.

Be Careful!

Probably, more disappointment has resulted from carelessness in the choice of voltage values, and more distorted results obtained through the thoughtless choice of valves than the average listener can imagine. Indeed, it may perhaps be said that much of the "distrust" of loud-speakers can be attributed to this absence of care on the part of many valve users.

The present amplifier has been tested with 2-, 4- and 6-volt valves of both power and general-purpose types, and after applying the correct voltage values the results have left little to be desired.

These tests were carried out with both crystal and valve receivers, the stations received being 2LO and 5XX. Various loud-speakers

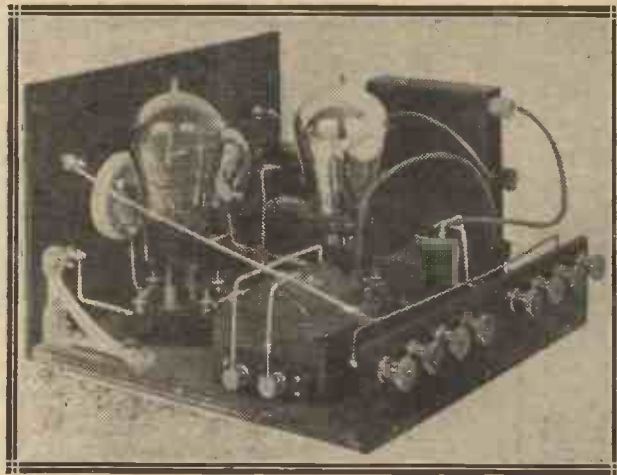

The grid-bias battery stands on end to economise space.

were tried with equal success, the "Mellovox," "C.A.V.," "Brown," "Ultra" and "Amplion" being some of the popular makes that were used.

Connecting Up

When connecting the amplifier to either a crystal or valve receiver for the first time, the connections from the telephone terminals of the receiver to the input terminals of the amplifier should be noted, and after results have been obtained the effect of reversing these connections should be tried, as it is sometimes found that the results are better with one arrangement than with the other.

This amplifier is particularly simple to operate, since there are no switching arrangements, and the various voltages are the only factors requiring adjustment. Operating instructions and notes on getting the best from the amplifier will appear next week.

THE CHOKE AMPLIFIER
(Continued from page 267)

crystal, and terminal A to the remaining telephone terminal. Terminal A should also be connected to L.T. — 2 with a short length of insulated copper wire. (Further details later.)

...lower H.F. resistance than any other commercial plug in coil!



Made by the manufacturers of Glazite

TESTS carried out by the National Physical Laboratory show that the LEWCOS COIL has a lower H.F. Resistance than any other coil on the market. Its Low H.F. resistance combined with great selectivity and mechanical strength make the LEWCOS Coil the finest you can buy.

Try a LEWCOS Coil in

your set—it makes all the difference! Descriptive leaflet sent free on request to

THE LONDON ELECTRIC WIRE COMPANY & SMITHS LTD. Playhouse Yard, Golden Lane, London, E.O.1.

No.	25	35	40	50	60	75	100	150	200	250	300
Price	4/6	4/6	4/6	5/-	5/6	5/6	6/9	7/6	8/6	9/-	10/-

LEWCOS Inductance COIL

JUDD

SPECIAL OFFER of Darimont "HOME-SERVICE" BATTERIES

£1 TO USERS OF DULL-EMITTER VALVES!

To make the merits of the DARIMONT HOME SERVICE BATTERY more widely known we make this SPECIAL OFFER of THREE No. 10 Cells of 1.5 volts each, 42-44 amp.-hour capacity, complete with charging materials, CARRIAGE PAID, at the reduced price of £1 against the regular price of 28/-. If our claims are not completely fulfilled, when the cells are used according to instructions, return them and we will refund your money.



This Special Offer will remain open until 31st July after which full list prices will be charged, as this offer cannot be repeated.

Write to-day for full particulars to Dept. C,

DARIMONT ELECTRIC BATTERIES Ltd.,
Darimont Works, Abbey Road, Park Royal, London, N.W.10
Telephone: Wembley 2807.

RADIO IN THE R.A.F. PAGEANT—(continued from page 262)

For the portion of the programme which was broadcast, a Post Office telephone line was used between the control room in the hotel and the transmitter at 2LO.

The "Wiring" Diagram

A general idea of the complete arrangements may be gathered from Fig. 1, which shows a plan of Hendon aerodrome and the enclosures.

Some of the intricate switching incurred to cope with the many different land-lines at will may be seen in the photograph taken inside the control

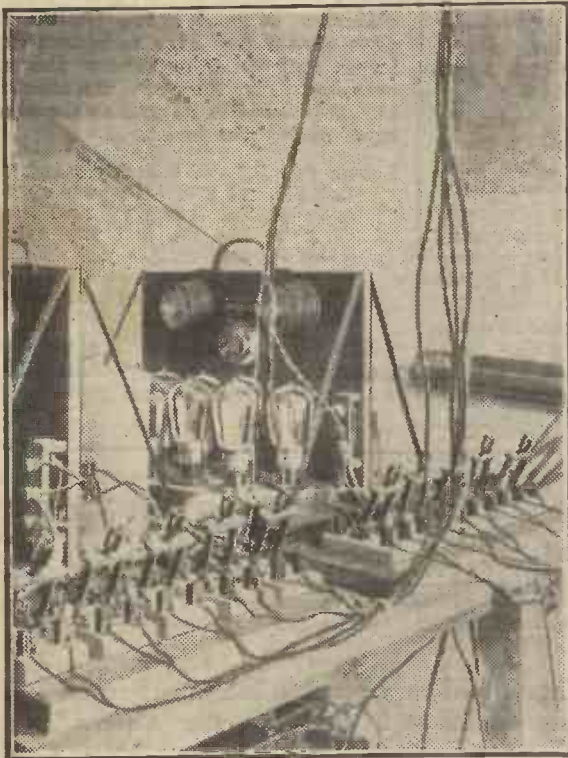

A section of the main control room which was situated in the Aerodrome Hotel. One of the many banks of amplifying valves may be seen in the centre of the picture.

room. In the centre of this picture one of the many banks of amplifying valves is discernible.

"Reform Squadron" by Wireless

An item on the programme which was of particular interest from the wireless point of view was Event No. 5—air manoeuvres by radio telephony. Nothing could have emphasised the value of wireless to the Royal Air Force more than to see a squadron of aeroplanes literally "drilled" in mid-air by an "instructor" on the ground. The orders given to the squadron leader and also his replies were transmitted through the many loudspeakers, so that nearly all present had an opportunity of following the proceedings fairly distinctly.

Of course, a broadcast of this description is extremely difficult, and

some idea of the chief source of trouble will be appreciated when it is known that the microphone on the squadron leader's plane was only three feet away from the open exhaust of a 385-h.p. engine!

Despite this and many other difficulties, however, the attempt can be looked upon as a success.

Aerial Difficulty

For a show such as that at Hendon, the impossibility of using trailing aerials on the planes is obvious, and to overcome the difficulty the arrange-

ment shown in Fig. 2 was adopted. With such an arrangement "looping" and similar "stunts" were possible without fear of the aerial being displaced.

Conclusion

There can be no doubt that the show at Hendon, wonderful as it was, would have been incomplete had radio been omitted, from the programme, and one had only to scan the expression of nearby faces when a command was succeeded by the execution of the order for verification.

In conclusion, the long-distance reliability flight over a course of 600 miles would have been of little interest to those present had it not been for the wireless link which enabled the results to be known from point to point.

Have You
entered the
ELKA Slogan
Competition

1ST PRIZE £25

THE Elka Slogan Competition is catching on. Have you entered yet? We need a happy phrase to cling and remind the public that Elka Batteries are the best in the world. It is not genius that will win the Prize, it is the chance phrase of the contented user. The man who has tried other batteries to his disappointment and finds complete satisfaction in the Elka,

If your Dealer cannot supply send direct.

100 Volt... 14/6
60 Volt... 8/6

Post Free if ordered direct



What you have to do

Each Elka Battery carries an end label explaining the competition. Buy one of these Batteries (which have a storage guarantee) and send in one or two Slogans. The 100 best will be selected and from these the Advertising Manager of Allied Newspapers Ltd. will select the winner and award the prize. Entries must be in by July 30th.

L. KREMNER
49a, Shudehill,
Manchester

SITUATION WANTED.

WIRELESS.—Capable, trustworthy men with spare time who wish to substantially increase income required where we are not fully represented. Applicants must have practical knowledge of installation of Set and Aerial, be a householder or live with parents, and be able to give references; state age and experience. Address: Dept. 38, GENERAL RADIO COMPANY, LIMITED, Radio House, Regent Street, London, W.1.

LITTLE WIRELESS GADGETS.



MAP

SMALL PARTS TO THE TRADE.

MAP Co. 246, Gt. Lister St., Birmingham.

PICKETTS CABINETS
For every Wireless Constructor.
Send for Cabinet Designs and Lists free.
Picketts (W.L.) Cabinet Works, Bexley-Heath.

COUPON.
QUESTIONS AND ANSWERS

This coupon must be accompanied by a P.O. for 2/6 for each question, and a stamped addressed envelope when sending queries to the Radio Press Information Dept. for a postal reply.

"WIRELESS." Vol. IV. No. 8

I HAVE BEEN ASKED . . .



I have a 3-valve set running two loud-speakers in separate rooms, which arrangement functioned well until recently. Now there is a pronounced tendency to howl, the note not being effected by any change in the tuning controls of the receiver, and to overcome which I tried a filter circuit as advised in an issue of this journal recently. The trouble still persists, however, and I should be glad if you could give me further advice.

Since the set originally worked well, and, in fact, functioned well for some time, we are inclined to think that probably your H.T. battery is responsible. If this component has developed a high internal resistance, this resistance will "couple" the valves, giving rise to low-frequency oscillation, which has in your case announced itself by howling, although in less serious cases it may be responsible only for poor quality and lack of volume. Where the trouble is serious the only real

cure is to obtain a new H.T. battery, preferably of large-cell type. A partial remedy, however, may often be effected by shunting each H.T. tapping and H.T. negative with large condensers of 2 microfarads or larger.

Another point which should receive attention is your earth connection, since here a very high resistance or a break may tend to render the set unstable. Try, therefore, the effect of alternative earths as well as the other experiments mentioned.

I have two B.T.-H. B.5 valves and one D.F.A.1, and would like your opinion as to whether it is a practical proposition to run the first two valves, which function as H.F. and detector, with filaments in series, the power valve, of course, being connected in the normal way.

The proposition is both a practical and an economical one, which, if fol-
(Continued on next page.)



FILAMENT RHEOSTATS AND POTENTIOMETERS.

With the windings carried on a porcelain bobbin and having the contact arm moving on its inner side, the "Cosmos" Filament Rheostat takes up remarkably little space, is strong in construction, and has a very smooth and reliable movement. It is fixed by ONE HOLE, and is provided with a handsome knob and dial. Made in four types, two of which are double wound for Dull OR Bright Valves, and one a Potentiometer, the prices are as given below.

METRO-VICK SUPPLIES, LTD.
(Proprietors—Metropolitan Vickers Electrical Co., Ltd.)
METRO-VICK HOUSE, 145, CHARING CROSS ROAD, LONDON, W.C.2. R P40

Description	Ohms	Carrying Current	Price
Single Wound	6.0	1.0 amp.	4 6
Double "	18+2	.4-1.5	5 0
Double "	30+4	.2-1.0	5 0
Potentiometer	300	—	6 0

Cosmos

RADIO COMPONENTS

I Have Been Asked . . . —continued

Some Interesting Questions and their Answers.

lowed, should give you satisfactory results. If L.T. negative is earthed we would suggest that the H.F. valve be connected on one side to low-tension negative and the detector on one side to low-tension positive. The grid return lead of the detector, that is, the filament end of the grid leak (if tuned anode coupling is employed), should be taken to the positive filament leg of the detector valve. If a potentiometer is employed for stabilising purposes this may be connected across the whole of the L.T. battery in the normal way and the lower end of the aerial coil, i.e., the earthed end (and the appropriate side of its tuning condenser if parallel tuning is employed), will be joined to the slider as usual. By running your two .06 valves in series only half the current which would be taken by the parallel connection is used.

I am troubled with hum, which I think emanates either from a near-by dynamo or from the house lighting wires, and should like to know how to eliminate it.

Before any remedy is applied first determine how the interference is in-

roduced into the receiver. This should be done by disconnecting the aerial and earth in turn, noting whether the interference ceases. If it does not do so, it is doubtful whether much can be done to help you, but if either aerial or earth are found responsible, the effect of placing a small fixed condenser, for example, of .0001, in the lead responsible for pick-up should be tried. It will be necessary in such a case to increase the aerial coil by one size. Another useful scheme, which I have proved to be successful by experiment, is given in the June, 1926, issue of *Modern Wireless*, under the title of "That Irritating Hum," which article you would do well to consult.

Where the house lighting supply is of alternating current interference is sometimes picked up on the loud-speaker leads, and here a good remedy to apply is to employ twin metallic covered cable for these leads, such as is sometimes used for house wiring. If the outer metallic sheathing is earthed, the hum will probably be reduced to negligible strength, if not cut out altogether.

BRITISH MADE

DECKOREM

RADIO PRODUCTS

RADIO GEMS



BALANCING CONDENSERS
Rgd. No. 715459.

A Baseboard Unit with exceptionally fine adjustment. Can be locked in position. Highly plated, as used in the "Magic Five."

Price 3/- each.



DIAL INDICATORS

ESSENTIAL for fine tuning. Adds appearance and finish.

No. 1 9d. pair
No. 2 3d. each
No. 3 2d. each

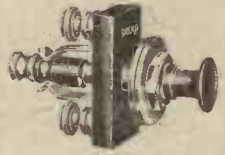

BATTERY SWITCHES

SMOOTH positive action, one hole fixing, polished knob. A switch of outstanding interest

Price 1/6 each.

These are just a few of our new lines. Send for Illustrated Catalogue.

OBTAINABLE FROM ALL THE BEST DEALERS

A.F. BULGIN & CO.

2-M EARLSTREE STREET
CHANCERY LANE E.C.4. LONDON



ABSOLUTELY NON-MICROPHONIC!

At last the perfect valve holder! The Etherplus + "Antivibro" Valve Holder has low capacity legs in a soft rubber base, which in turn is mounted on four phosphor-bronze springs inside a high quality moulding.

Price 2/6

From dealers or from

MANDAW

0-15, Whitecross Street, London, E.C.1



ETHERPLUS

RADIO ACCESSORIES
— ENSURE PERFECT RECEPTION

DESIGNED SPECIFICALLY FOR BUILDERS OF THE "ELSTREE SIX"

So that the countless experimenters who invariably prefer to use J.B. Condensers in all their receivers may incorporate them in the "Elstree Six," we announce the introduction of .0005 J.B. low loss twin condenser.

The design adheres to the type here illustrated (.02 ohms loss at a million cycles certified by the M.P.C.) in addition to the other essential features which characterise the J.B. to give the utmost tuning efficiency.

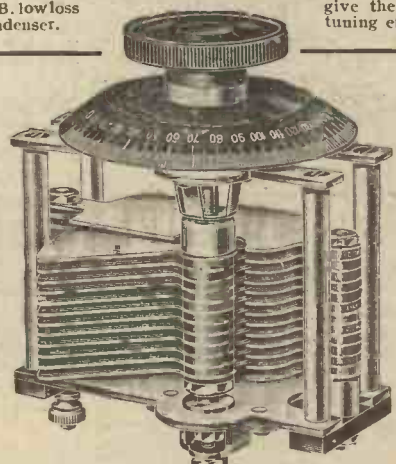

J.B. LOW LOSS GEARED VERNIER (50 to 1).

.001	- 17/6
.0075	- 18/3
.005	- 18/-
.003	- 13/6
.0025	- 13/3
.002	- 13/-
.001	- 12/-

[Pat. No. 246009].

J. B. LOW LOSS.

.001	- 13/-
.0075	- 11/6
.005	- 10/6
.003	- 9/-
.0025	- 8/6
.002	- 8/6
.001	- 8/3

Pat. Nos. 241805 and 246009

This one has two windings!

Two windings, one of a resistance of 6 ohms and a continuation of this on to a 30-ohm strip winding. Made specially to meet demand for a rheostat covering needs of both bright and dull emitter valves. Resistance are wound on hard fibre strip under great tension and immune



THE "PEERLESS" DUAL RHEOSTAT

3/9

from damage. One-hole fixing, terminals conveniently placed. Contact arm has smooth, silky action. All metal parts nickel-plated. Complete with bonite combined Knob and Dial.

From Dealers or direct. Trade Terms on request.

TBE BEDFORD ELECTRICAL & RADIO CO., LTD.
22, Campbell Road, Bedford.

J.B. low loss Twin Condenser for the "Elstree Six" .0005 mfd. 21/- each; £4 for the set of four.

JACKSON BROS.

8, POLAND ST- OXFORD ST
LONDON - W.1
(First Floor)

Telephone: GERARD 7414

Agents for Holland: Radio Beurs, Papestraat 8, Sgavenhage, Hague, Holland.

TREBLE DUTY TERMINALS

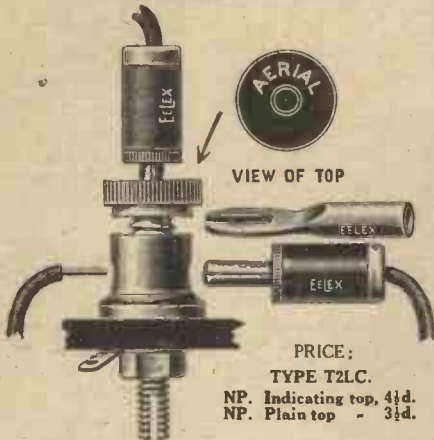

PRICE:
TYPE T2LC.
NP. Indicating top, 4½d.
NP. Plain top - 3½d.

As used by Mr. Rattee, M.I.R.E., in the special transformer coupled amplifier. The special features, which enable any type of connector to be attached instantly, at once hall mark EEXLEX product as the design and choice of experts.

Write for free catalogue showing full EEXLEX SYSTEM.



EEXLEX HOUSE, BUNHILL ROW, E.C.1.

EARTH FAULTS ENDED

Entirely new method of Earth-system efficiency. 80 per cent. to 200 per cent. increase guaranteed. Vastly superior to all metal sulphates. Ideal for all outdoor Earths. 2/6 complete, post 6d. Cash on delivery if desired. Particulars free. J. W. MILLER, 68, Farringdon St., E.C.4. Phone: Central 1950. Approved by Radio Association.

MORE POWER AND MONEY FOR THE B.B.C. !—(cont. from p. 257)

casting authorities' aerial to work a loud-speaker without any local power of any sort. As they can anticipate with fair certainty that higher power will in due course be used, it might be profitable for them to turn their attention to a solution of this problem. Greatly as we are indebted to battery and accumulator manufacturers for the effective articles with which they provide us, it would be a delight to be able to do without them. Is it an impossible hope that with a super 2LO I could work my loud-speaker with the power that is picked up by my aerial, instead of having to provide it myself, and constantly renew it?

Not Valid

The Post Office must regulate the use of the ether, but when a band has been allotted to broadcasting there would seem to me to be no reason for limiting to any very great extent the power to be used on that band. The Fighting Services will object, of course, that too much power jams them. I was a soldier myself once, and a signaller as well, and have much sympathy with the Services, but they cannot in my view sustain any complaint on these lines. If they cannot deal with the jamming of a few

broadcasting stations, they certainly will be unable to deal with the jamming of the enemy! Other services will also complain, but they, too, must learn more efficient methods of reception and scrap obsolete plant.

Hasten !

The slowness of Government Departments is proverbial, but I hope the Post Office will not stand in the way of the B.B.C. making adequate experiments without delay with a view to working out a new high power scheme of distribution. They must have all the freedom they require, and, moreover, more money. The Government Committee on Broadcasting was emphatic in its view that the Post Office, after taking its expenses, should regard it as its first duty to pay over to the Broadcasting Service an amount really adequate not merely to maintain good programmes, but to experiment. "Outlay on bold experiment should not be meagre" were the words they used. Although the new regime has not yet come into being, let the Post Office bear this in mind, and enable the B.B.C. during the next few months to get on with its work in order that perhaps even this winter some stations on higher power may begin to function.



.0005 SQUARE LAW

Dual Condensers

as specified by the designers of the "Elstree Six."

Their unvarying smoothness and ease in action is due to the accurately grounded Rotor.

Price: 27/6 each. Set of 4, £5 10s.

Send for full particulars of

TEMPRYTES

(Regd. Trade Mark)

the perfect control for all Valve Filaments. Manufactured in values to suit all valves. From .3 to .55 ohms. 2/6 each. Holder Mounting for Temprytes 1/6 each.

Cyldo Condensers from your dealer or post free from makers.

Other "CYLDON" Condensers SQUARE LAW.

.001	Mfds.	21/-
.0005	"	"	"	17/6
.0003	"	"	"	16/6
.00025	"	"	"	16/-
.0002	"	"	"	15/6

with 4in. Knob Dial.

S. L. FREQUENCY.

.0005	Mfds.	15/6
.00035	"	"	"	15/-
.00025	"	"	"	14/6

Large 4 in. Knob Dial as supplied with Square Law Condenser, 2/- each.

Sidney S. BIRD & Sons,

"Cyldon Works," Sarnesfield Road, Enfield Town, Middlesex.

Telephone Enfield 672.

THE BEST AMPLIFIER
and the CHEAPEST
both to fix and operate
IS THE NEW NON-VALVE
MAGNETIC MICROPHONE

BAR AMPLIFIER

(Patent No. 248581/25).

Complete
Amplifier
PRICE

38/-

Post Free.

Dry Cells
Extra.

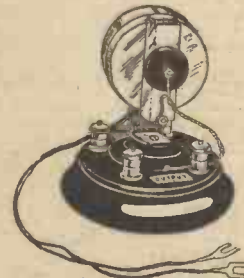

Microphone
and other
parts of
Amplifier
also supplied
separately.

Illustrated lists
free.

REALLY GOOD LOUD-SPEAKER RESULTS from CRYSTAL RECEPTION of average strength. WEAK CRYSTAL or VALVE RECEPTION made STRONG AND CLEAR. ENABLES even very DEAF PERSONS TO HEAR from Crystal Sets.

Not a Microphone Button. Entirely free from distortion and microphonic noises. No valves, accumulators or H.T. Batteries. No fragile parts. Nothing to get out of order. A child can adjust it. Operates on one or two Dry Cells lasting over 3 months.

EQUALLY EFFICIENT ON VALVE SETS.

Order from your dealer or from Sole Manufacturers and Patentees:

NEW WILSON ELECTRICAL MANUFACTURING CO., LTD.,

18, Fitzroy Street, Euston Road, London, W.1.

Phone: Museum 2703.



COMPONENTS WE HAVE TRIED

Conducted by the "Wireless" Laboratories, Elstree.

"Salient" Soldering Flux

WE have received a tin of soldering flux from Messrs. "S. A. Cutters," Ltd. This flux is crimson in colour, semi-transparent, and of a jelly-like consistency. It was used successfully to tin a piece of dirty brass, and proved suitable for making wiring joints. It spluttered very little, and had no effect on the insulation resistance of the panel. We can recommend this flux, since it is non-acid and results in a sound joint being made.

Variable H.F. Transformer

THE Trix variable plug-in transformer sent for test by Messrs. Eric J. Lever plugs into an ordinary valve holder and carries a five-point switch. The

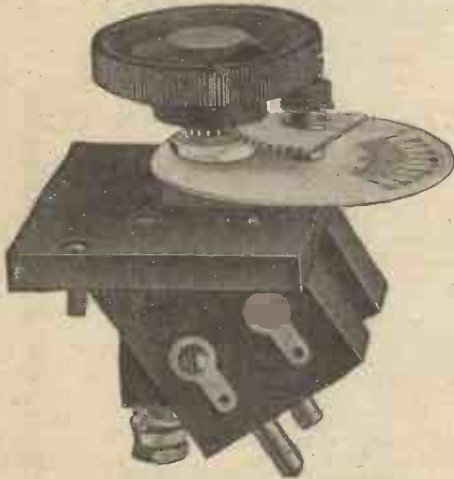

The Trix coil holder possesses a graduated scale to indicate the degree of coupling.

wavelength range was found to be 230 to 3,000 metres, a .0003 variable condenser being used for tuning the secondary winding. In an actual receiver test the H.F. amplification appeared to be up to the average, and although the amplification is not quite so high as that given by an H.F. transformer designed to cover a narrow wave band, nevertheless it can be recommended for use. It affords a means of obtaining H.F. amplification on both short and long waves combined in one instrument.

Coil Holder

WE have received from Messrs. E. J. Lever one of their Trix two-way coil holders for test and report. This instrument, which is of the one-hole fixing type, uses a geared control for the moving holder, a reduction in the neighbourhood of 4 to 1 being obtained. The moving and fixed holders are placed at an angle, so that, instead of the coils standing straight out from the panel, they are inclined upwards at an angle of 45 deg. A white ivory scale, graduated from 0 to 90 deg., together with a pointer fixed to the control knobs, indicates the coupling in use.

The insulation resistance between both plugs and sockets was infinity, and a number of well-known makes of plug-in coils proved to be an excellent fit in the holder.

"Lisenin" Tags, Plugs and Sockets

SPADE tags, plugs and sockets have been received from Messrs. the Lisenin Wireless Co., these accessories being intended for use with flexible battery and other leads. The tags and plugs are fitted with coloured insulating sleeves and incorporate a novel "Positive Grip" device, consisting of a brass cone and nipple. The sockets are fitted with coloured insulating washers. These accessories are very neat and well finished, and the grip device was found to give a very good electrical and mechanical joint.

L. & P. Geared Coil Holder

FROM Messrs. The London and Provincial Radio Co., Ltd., we have received an interesting type of two-coil holder for panel or board mounting. The fixed coil is parallel to the panel, and the moving coil block is made to swing back and away from it by means of a worm gearing. Large terminals can be used for connections, and a useful spanner for adjustments is provided.

On trial this coil holder was found to give fine adjustment and to be free from backlash. The design and finish are both excellent.

The Varley Constant

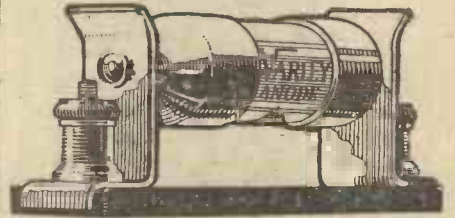

Wire-wound Anode Resistance

A TRUE STORY

After all—the truth will out. Briefly, that's the story of the Varley Anode Resistance. We knew we had a perfectly designed and constructed component, and our advertisements kept telling the Public just the truth. Some believed, but the large majority refused to be open to conviction. And then little by little the Varley found its place in sets constructed by the scientific research laboratories of the leading Wireless Journals, till eventually four of our Resistances were used in the "Elstree Six." What has been the result? Today everybody is talking about the Varley, and already hundreds have listened to that wonderful purity of tone obtainable only with this form of Intervalve Coupling. All we claimed for the Varley Anode Resistance has been more than justified by the results obtained.

The Varley Anode Resistances are non-inductively wire-wound on the famous Varley Bi-Duplex system, with turns silk separated, and we guarantee them to be constant and absolutely unaffected by atmospheric conditions. Perfect design, perfect construction, that's the real secret of the success of our Resistances.

60,000, 80,000 and 100,000 ohms.

PRICE (complete with Clips and Base) - 7/6

PRICE (without Clips and Base) - 6/-

Write for Leaflet.



CONSTANT ALWAYS
THE VARLEY MAGNET CO.,
WOOLWICH, S.E.18

(Proprietors: Oliver Pell Control, Ltd.)
Telephone: Woolwich 0888.

**"WIRELESS"
FREE BLUEPRINT SERVICE
COUPON**

Vol. IV, No. 8. July 17th, 1926.

This Coupon entitles the reader to one Blueprint of any Amplifier described in the above issue, and must accompany each postal application.

All communications regarding advertisements should be addressed to:

The Advertisement Manager,
"WIRELESS,"

Bush House, Strand, London, W.C.2

Telephone: City 9911.

Amateur Transmitting Notes

QRA's Found

- SMUH: T. D. Smith, Rorstr. Gat. 32/2, Stockholm, Sweden.
- S-5NS: Y. K. Pitkanen, Roorpertink 76, Kes.: Korja, Ruotsinkyla, Hamina, Finland.
- I-1BW: F. Francarro, Castelfranco, Veneto, Italy.
- I-1GV: G. Gardoncini, Via Larga 6, Milan.
- EAR10: F. Roldan, Garzia de Paredes 47, Madrid.
- A-7CS: A. C. Scott, 14, Law Street, Launceston, Tasmania.
- Q-2MK: R. V. Waters, Galiano 29, Havana.
- XA1: Tang Fong Laum, Man Chu Tai, 35, Connaught Road West, Hong-kong.
- P-1AB: Alvaro Contreiras, 50-60, Rua do Seculo, Lisbon.
- D-7EW: H. Rafn, 8, Blytsvej, Copenhagen.
- Y-2HX: J. Bremner, Radio Club of Bengal, 19B, Chowringhee, Calcutta.

- Z-4AK: W. L. Shile, P.O. Box 519, Dunedin, New Zealand.
- R-GA2: G. Sarbach, Venedo Tuerto, Argentina.
- R-JD8: B. Fernandez Barrios, Gualaguaychu, Argentina.
- BZ-3QA: T. R. Vianna, S. Francisco de Assis, Estado do Rio Grande do Sul, Brazil.
- IC-BG1: B. Gardarsson, Laufasveg 53, Reykjavik, Iceland.
- U-2AOF: B. Schlaeter, 2053, 61st Street, Brooklyn, New York.
- U-2IL: C. M. Loper, 109, Bayview Terrace, Port Jefferson, N.Y.
- U-3AUV: J. Young, 418, West Miner Street, West Chester, Pa.

QRA's Wanted

- XU-2RV, G-2BOC, G-2XA, G-5DK, G-6CQ, G-2BL, G-6ZP, G-2WX, GW-20B, LA-1B.
- BZ-SN1, BZ-SQ5, BZ-RGT, SME, GP6.

BUSH HOUSE

The Wireless Depot of Lancashire is now open for your inspection at
35, SHUDEHILL, MANCHESTER.

Every Known Wireless Component is stocked.

Retail Showroom.

Call or write for free List.

American Speciality: Fada Neutrodyne Sets and Kits.

**Centralab
Modu ^{C.R.L.} plug**

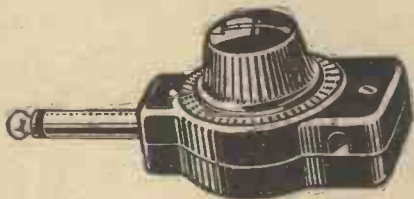

TONE control is featured as one of the outstanding improvements in the new and better radio sets. You can have this feature in your set by simply replacing your present loud-speaker plug with the C.R.L. Modulator Plug. With your set operating at full power you can regulate tone and volume to suit your mood by simply turning the knob on this C.R.L. Modulator Plug. It provides perfect control of volume from a whisper to maximum. If your receiver does not employ jacks you can have style No. 2 Modulator Control which is provided with a 30 in. extension cord for attachment to terminals on your receiver.

List Price (both types) 13/- each.

Write for our 1926 catalogue of High-Class American Radio Apparatus and circuit supplement enclosing 9d. in stamps to cover cost of postage.

The Rothermel Radio Corporation of Great Britain, Ltd.,

24, MADDOX STREET, LONDON, W.1.

Telephone: MAYFAIR 578.

The New **MELLOWTONE**
3 VALVE PORTABLE RECEIVER

The most economical and finest valve receiver produced. Embodies a novel patented circuit; gives results equal to most five valve portable receivers; is entirely self-contained—you simply open the case and switch on to obtain loud speaker reception.

PRICE complete £19 0 0 (as illustrated).
Marconi royalties £1 7 6

Total weight complete is under 25 lbs. Size 18" x 12" x 10".
Finished in the usual MELLOWTONE highest quality style.
Write for List.

MELLOWTONE
MIDLAND RADIO TELEPHONE MFRS. LTD.
BRETTLE LANE WORKS
STOURBRIDGE

London Depot: Triumph House, 189, Regent St., W.1.



Keeps you informed of every latest product

AMONG the permanent features of THE DEALER, that entitled "What the Manufacturers are Doing" should be carefully read by every retailer—particularly upon the approach of the Exhibitions.

Under this heading the Editor gathers every interesting and salient point characterising new products. The Test Reports from the Laboratories at Elstree upon manufacturers' apparatus appear in this feature, the whole containing many essential selling points which will prove invaluable to the enterprising dealer.

By reading this article every month you are kept posted—no new line which you should have in stock will escape your notice.

A subscription to THE WIRELESS DEALER is an insurance against buying obsolete apparatus. Send for a specimen copy to-day.

SELECTION FROM CONTENTS

Speed up the High-Power Stations !

"The Wireless Dealer" Service and Testing Unit

By Percy W. Harris, M.I.R.E.

There is No Slump !

By A. Wragge

Plain Words on Trade Conditions

By Leon A. Sharland

New Components for the Coming Season

By J. H. Reuner, B.Sc. (Hons.), A.C.G.I.,
D.I.C., A.M.I.E.E.

SUBSCRIPTION RATES: 7/6 per annum (abroad 10/-). Available to the Trade only. Trade card or business heading should accompany every subscription to the SALES MANAGER, Radio Press, Ltd., Bush House, Strand, London, W.C.2.

The Wireless Dealer
AND MANUFACTURER

4 Steps to Better Radio

R.I. Components will do more than any others to help you with your set building. They not only make the actual construction easier, but they go a long way towards ensuring the most satisfactory results.

There is a reliable R.I. Product for each successive stage of your set, ready to give perfect results in the capacity in which it can be used.

Let us commence with **The R.I. Permanent Mineral Detector**. Here we have a crystal detector absolutely permanent and unaffected by vibration. No catwhisker is employed, a spring plunger maintains the correct pressure on the crystal, which is sensitive throughout its area, making it unnecessary to search for special sensitive spots.

Manufactured in two different forms. Standard pattern, with supporting clips for mounting either above or below the panel, and one-hole fixing pattern with detachable ebonite cover which protects the adjusting knob when in position.

PRICES:

- Standard Pattern .. 6/-
- One-hole fixing type .. 7/6

The R.I. Retroactive Tuner provides more efficient tuning over the range of wavelengths from 175 to 4,000 metres and costs less than a set of coils with coil-holder to cover the same range. It is wound on the single layer method proved by eminent technicians to be more efficient than the multi-layer method.

PRICE 39/6

The R.I. Duostat, a filament rheostat unsurpassed for silence and surety of control. Its special construction allows it to be used for either bright or dull emitter-valves, a black scale showing the correct position for each type. It is certainly worth your while to pay the little more for this rheostat and take one of the first steps towards better radio.

PRICE 7/6

The R.I. Reactive Anode Unit. Built to tune those distant signals to good strength. Has five tappings covering all wavelengths from 200-4,000 metres, three of them serving to cover the broadcast band and giving excellent adjustment. Owing to the special winding the impedance of each tapping keeps the reactance values approximately uniform for all wavelengths.

PRICE 25/-

Write for the R.I. Blue and Gold Catalogue.



THE MARK OF BETTER RADIO

Advt. R.I. Ltd., 12, Hyde Street, New Oxford Street, London, W.C.1.



P.C. 35

Published by RADIO PRESS, LTD., Bush House, Strand, London, W.C.2, on Tuesday of each week, and printed for them by THE AVENUE PRESS (L. Upcott Gill & Son, Ltd.), 55-57, Drury Lane, W.C.2. Address for Subscriptions and Editorial Communications:—Bush House, Strand, London, W.C.2. Address for Advertisements:—Advertisement Manager, WIRELESS, Bush House, Strand, London, W.C.2. Registered as a newspaper and for transmission by Canadian Magazine Post. Subscription rates:—15s. per annum, 6s. 6d. for six months, post free. Sole Agents for Australasia:—GORDON & GORCH (Australasia), LTD. For Canada:—IMPERIAL NEWS, LTD. For South Africa:—CENTRAL NEWS AGENCY, LTD.