

WIRELESS & TELEVISION REVIEW

ALL ABOUT MAINS-INTERFERENCE SUPPRESSORS

*Special articles which explain methods of eliminating those
clicks and buzzes which so often mar reception.*

FROM SCRIPT TO SPEAKER

*A detailed account of how the simple MS. is moulded into
a complete radio drama.*

INEXPENSIVE MAINS SUPERS

*An informative review of the lower priced all-mains
superhets on the market.*

THE "QUEEN MARY" CALLING

*Details of the wonderful radio installation aboard Britain's
giant liner.*

EVERY MONTH

1¹/₂

VOL 3 NO. 16
MARCH
1936

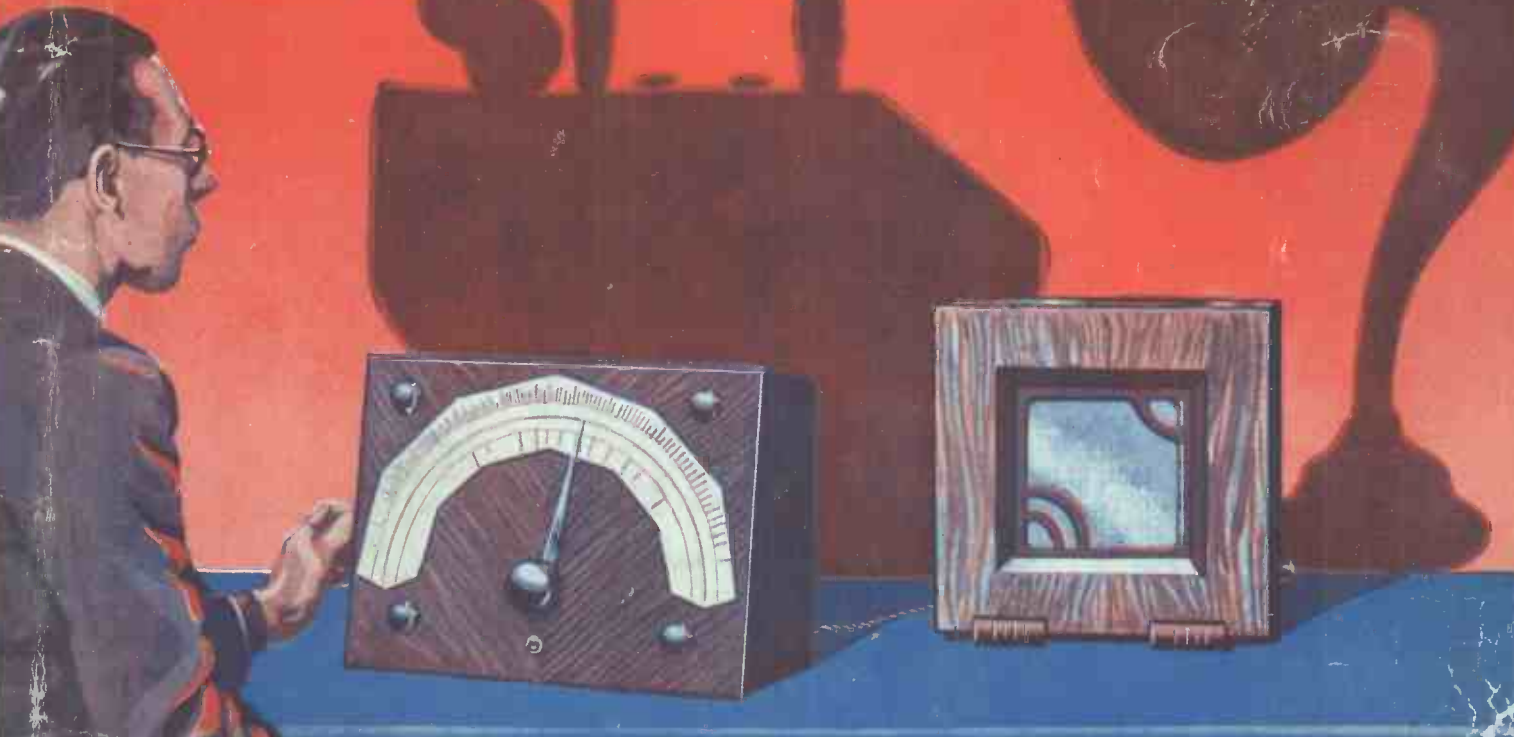

Fully Described Inside

THIS YEAR'S S.T.100

BY JOHN SCOTT-TAGGART, M. I. E. E., F. INST. P., FEL. I. R. E.

FAMOUS Scarlet Gleam NASTURTIUM



GOOD GARDENING is privileged to introduce to amateur gardeners an entirely new and exceptionally lovely variety of Nasturtium — the Scarlet Gleam. Each copy of the March issue contains a big packet of the seeds, which is given absolutely FREE. A short time ago only a few of these seeds existed; a supply, for the exclusive use of GOOD GARDENING readers, has been specially secured for the journal. This flower is destined to become a national favourite. Be one of the first to grow it! Sow the seeds in April—the breath-taking colour in your garden this summer will be the envy of all your friends. Make sure now of your

★
FREE SEEDS

given with the March GOOD GARDENING

More
FREE
SEEDS

GOOD GARDENING continues to maintain its reputation for providing first-class seeds for its readers. There will be a big packet of NEW CHINA LADIES PANSY SEEDS in the April issue—and Seeds of EVERLASTING FLOWERS (*Helichrysum*) in the May number. Give your newsagent a regular order for GOOD GARDENING and make sure of these splendid Free Gifts.

GOOD GARDENING

For March Now on Sale 6^d

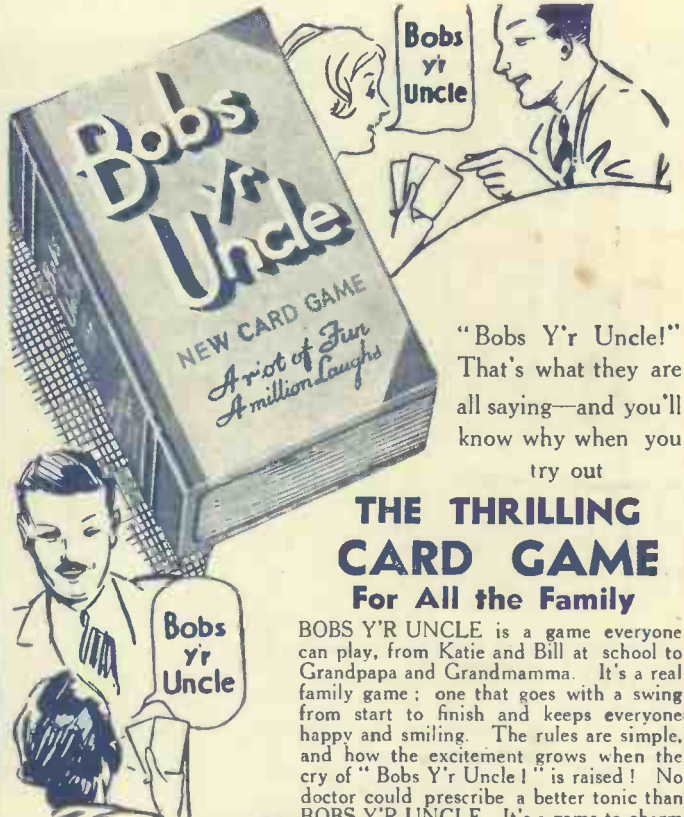

"Bobs Y'r Uncle!"
That's what they are all saying—and you'll know why when you try out

THE THRILLING CARD GAME For All the Family

BOBS Y'R UNCLE is a game everyone can play, from Katie and Bill at school to Grandpapa and Grandmamma. It's a real family game; one that goes with a swing from start to finish and keeps everyone happy and smiling. The rules are simple, and how the excitement grows when the cry of "Bobs Y'r Uncle!" is raised! No doctor could prescribe a better tonic than BOBS Y'R UNCLE. It's a game to charm away dull care, and make any party a success.

*A Riot of
Fun for the
Family*

ON SALE
EVERYWHERE

Made by John
Waddington Ltd.,
makers of the world's
finest playing cards.



Bobs y'r Uncle

Contents

	Page		Page
Editorial	199	Inexpensive Mains Supers	228
The Link of Friendship	200	Stamps with a Radio	
The Queen Mary Calling	201	Interest	234
This Year's S.T.100	203	Television To-day	235
E.M.I. Television Gear	214	The New North Ireland	
Before Broadcasting Came	215	Regional Station	237
All About Mains Suppressors	217	From Script to Speaker	239
For Use at the Set	218	The 1936 Empire Super	242
Screened Down Leads	219	The Wrong Set	243
Suppression at the Source	221	Our Contact Page	246
How Loudspeakers are Made	222	Building an All-Mains All-	
From My Armchair	225	Wave Superhet	247
British Broadcasting News		Short-Wave Developments	254
and Views	227		

As some of the arrangements and specialities described in this Journal may be the subjects of Letters Patent the amateur and trader would be well advised to obtain permission of the patentees to use the patents before doing so.

Published by the
AMALGAMATED PRESS LTD.
THE FLEETWAY HOUSE
FARRINGTON ST., LONDON, E.C.4



BULGIN FOR EVERY RADIO REQUIREMENT

WE ARE THE SPECIALISTS

Years of skill and experience have gone to the making of perfect Bulgin components of every type and description. They can be relied upon to give years of unflinching service.

SOCKET STRIPS

For all connections. Efficient yet inexpensive tinned sockets are fitted to take soldered connections, and the bakelite insulation is lettered to correspond with all general uses. Sockets are to R.C.M.F. Specification and accept standard $\frac{1}{8}$ in. plug connectors.

2 or 3-way, 4d. each.

GROUP BOARDS

To avoid an untidy disarray of components in modern receivers we evolved group boards. They hold wire-end resistors and condensers neatly and conveniently, and add to efficiency and accessibility. Fitted with double-ended tinned tags and best bakelite insulation.

List No. C.31, 5-way, 1/-.
List No. C.32, 10-way, 1/9.

INTERFERENCE SUPPRESSORS

Annoying noises caused by mains-borne interference, modulation hum, etc., may all be suppressed with this adaptor. Simply fitted between the wall socket and apparatus plug, it will, except in the most extreme cases, minimise or eliminate interference.

Connections are standard 2-pin 5 amp. For A.C. or D.C. 250v. max. Shock-proof and safe.

List No. P.50, 5/6 each.

Send this coupon now for our Practical Booklet "Hints to Better Reception," which shows in clear and simple text with PRACTICAL Diagrams just how receivers can be improved and simplified in a dozen inexpensive ways.



QUALITY RADIO COMPONENTS

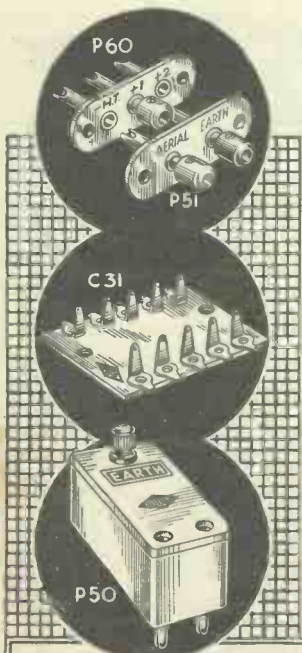

To A. F. Bulgin & Co., Ltd., Abbey Road, BARKING, Essex.

Please send me Post Free your booklet, "Hints to Better Reception," with 44 practical diagrams, for which I enclose 2d. stamps.

Name

Address



(Please write Block Capitals)

B.T.S. ACKNOWLEDGED THE BEST

Produced by Specialists — Preferred by Experts

EXCLUSIVELY SPECIFIED THIS YEAR'S S.T.100

B.T.S. ANODE COUPLER

•0005 SOLID DIELECTRIC

Another quality B.T.S. component exclusively chosen and used by Mr. J. Scott-Taggart, and therefore essential to the complete success of your S.T.100. Rigidly constructed. Complete with knob.

Type No. 601. **2/6** Each

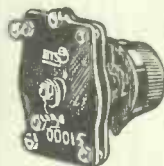

B.T.S. S.T.100 COIL UNIT

Wound exactly to specification for the S.T.100, by B.T.S. experts, and guaranteed calibrated to S.T.100 dial.

Incorporates NO TROUBLE SELF-CLEANING CONTACT SWITCH. The pair screened and mounted as illustrated **12/6**

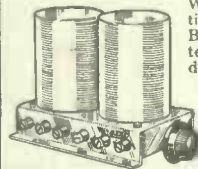

Send 3d. in stamps for "THE SHORT WAVE CONSTRUCTOR No. 1," the new B.T.S. Magazine containing details of 3 latest S.W. Circuits.

Obtainable from all Dealers. Or send direct in cases of difficulty.



BRITISH TELEVISION SUPPLIES LTD.

Television and Short Wave Specialists.

Faraday House, 8-10, Charing Cross Rd., London, W.C.2
Phone: Tem. Bar. 0134-5. Grams: Television, Lesquare, London.



Exclusively Specified For The 1936 S.T.100

● because . . .

. . . there can be no equal where Technical accuracy and reliability of performance are essential. In designing the 1936 S.T.100 Receiver Mr. J. Scott-Taggart demanded the best, and—as with all Colvern products—there is no substitute.

Price 12/6 per pr.

COLVERN

MAWNEYS ROAD, ROMFORD, ESSEX
London Depot: 150 King's Cross Road, W.C.1

Similarly, a full range of highly efficient components, including Ultra Short Wave Coils of special design, Resistances, etc., having the same high degree of Radio Engineering perfection, resulting from years of Technical research, are available to interested Constructors. Please write for free lists.

WEARITE

COMPONENTS . . .

Iron-Cored I.F. Transformers,
H.F. Chokes,
Mains Transformers are listed

IN THIS MONTH'S SETS

● THE ALL - MAINS ALL - WAVE SUPERHET

John Scott Taggart

THIS YEAR'S
S.T.100

- Wearite I.C.I.F. Coil with Pigtail 8/9
- Wearite I.C.I.F. Coil without Pigtail 8/6
- Wearite H.F.C. Choke 3/6
- Wearite H.F.P.J. Choke 2/-
- Wearite Mains Transformer (T21B) 22/6

Complete Extractor Unit cuts out interference.

As described by John Scott-Taggart for the

S.T.700
Price - - 24/-

To Messrs. Wright & Weaire, Ltd.,
740, High Rd., Tottenham, London, N.17

I am interested in your lists and would like you to send me a copy of those I have marked.

A. Descriptive Booklet List W 745.....

B. Special Booklet describing Test Apparatus

C. Prints describing 7 approved circuits.....

W.3.36

POST THIS COUPON TO-DAY!

CHOSEN!

● FOR "THIS YEAR'S S.T.100"

Another epoch-making contribution to the history of radio development has been made by the "Wireless" technicians by the inception of "This Year's S.T.100." A Special J.B. 0005 condenser with long pointer has been embodied in this set.

This choice is the result not of a haphazard shuffling together of indiscriminately chosen components, but of the careful choice of a few "star" components to make a perfect radio receiver.

The price of condenser and pointer complete is **5/6**

● FOR THE "ALL-WAVE ALL-MAINS SUPERHET"

Another J.B. specification is included in this all-wave set, the constructional details of which are included in this issue. The Two-Gang J.B. Unitune with dust cover **17/6**

Jackson Bros. (London), Ltd., 72, St. Thomas St., S.E.1. Tel.: Hop. 1837

WIRELESS *and* TELEVISION REVIEW

Editor: G. V. DOWDING

Assistant Editor: A. S. CLARK

The Suppression of Interference Should be Made Compulsory

IF there were ever need for immediate legislation to stop some big nuisance, there is now. And the nuisance to which we refer is that of interference with radio reception caused by electrical machinery.

The pity of the whole business is that new appliances—electric motors, neon signs, refrigerators—are being installed every day, and interference is consequently getting steadily worse. And the longer the delay in introducing definite legislation, the greater is the task of dealing with existing apparatus going to be.

No solution to the problem will ever be found bar the making of suppressors compulsory by law on all interference-producing plant.

This is not because the users of such plant will wantonly, and without regret, cause inconvenience to nearby listeners.

Rather it is because of the expense incurred in adding silencing devices, and in some cases, to ignorance of the degree of interference caused.

Cost Reduced by Standardisation

The cost of silencing will become almost negligible when the necessary suppressors are incorporated as part of the apparatus. Not only will cost be reduced by bulk manufacture, but expense incurred to find experimentally the best method of suppression is completely avoided.

It is true that committees and international boards are already in existence and considering the best basis on which to achieve suppression, but nothing works slower than such bodies. And all the time interference is getting worse.

Much of the work of the committees is taken up with such items as defining the permissible decibel relations of noise to a given signal. All very necessary and desirable, but why not do something in the meantime?

Why not fix a time, say three years hence, when all electric motors and other appliances capable of causing interference must be fitted with suppressors? And also institute immediately the compulsory incorporation of a suppressor in all such new appliances.

Then we should at least know that interference could not get worse. Even if existing machinery were completely exempted, interference would gradually die out as the present apparatus became obsolete and was replaced by new.

Such a procedure has been adopted with perfect success in regard to certain motor-car considerations, such as the use of safety-glass for windscreens. The present system is to leave bad alone.

No doubt there would be some trouble from the scheme just outlined in so far as the equipment of some appliances with suppressors not efficient enough for the job was concerned. But this could be overcome, and there would be the satisfaction of knowing that "bad was not being left alone."

The B.B.C. and the G.P.O. engineers are doing all they can to help, it is true, and when the owner of the interfering device has been tracked down, he is usually willing to fit suppressors if the listener concerned will pay the cost, or at least, a part of it. But is that the right way of dealing with what is fast becoming "a public nuisance"?

Television is going to bring the matter to a head without a doubt. It is also going to find out a lot of new sources of interference. Even motor cars will probably need to have suppressors as standard if picture reception is to be satisfactory except in the middle of a 50-acre field.

Other countries have compulsory suppression. We seem to lag behind, as so often is the case!

Suppression at the source is the logical cure for interference, but luckily it is not always the only effective way to overcome the trouble. A good bit can be done at the receiver.

Our Special Articles

Realising the lack of complete information on the subject in hand which exists to-day, and in order to help readers who have interference troubles to overcome, we include this month special articles on the subject. They should give a clear insight into the various ways in which interference can be brought to a set and describe the best ways of overcoming it.

BUILD YOUR
S.T.100
 from a
Full-Size Blue Print
 See Page 207 for Details

HE WRITES JAZZ!



Julius Lawson is an unusual writer of dance numbers in that he is the Vicar of St. Saints, Clapham. He conducts a jazz band and his tunes have been broadcast.

The Link of Friendship

By G. BERESFORD CAMPBELL

"I feel this link now as I speak to you"

ALL of us who were privileged to hear the last Christmas message broadcast to his peoples by our late beloved Sovereign, King George, will remember the foregoing, and the memory will be made all the more poignant by the realisation that physically the link has now broken.

Let us consider in its entirety that passage in King George's address from which the above quotation is taken:

"The year that is passing—the twenty-fifth since my Accession—has been to me most memorable. It called forth a spontaneous offering of loyalty—and, may I say, of love—which the Queen and I can never forget. How could I fail to note in all the rejoicing not merely respect for the Throne, but a warm and generous remembrance of the man himself who, may God help him, has been placed upon it.

"It Binds Us Together"

"It is this personal link between me and my people which I value more than I can say. It binds us together in all our common joys and sorrows, as when this year you showed your happiness in the marriage of my son, and your sympathy in the death of my beloved sister. I feel this link now as I speak to you. For I am thinking not so much of the Empire itself as of the individual men, women and children who live within it."

In these words I think may be found the clue to something which, in the fullness of time, will show with the utmost clarity that change which took place during the last twenty-five years in the attitude of the common peoples who do, after all, constitute the body and the backbone of this Empire, towards the Monarchy.

"I Move with the Times"

Once when King George was asked his opinion of certain members of one of his Labour Governments, he replied, "I get on with them very well. My grandmother would not have understood them, my father would not have liked them; but I move with the times." These words can now be found to hold a much greater significance than was perhaps intended when they were uttered, and to a certain degree they not only sum up the feelings of the three monarchs in question, but they also reflect the feeling of the man in the street towards these monarchs. King George did indeed move with the times, and in one of the most revolutionary advances of

these times, i.e. the radio, he found a unique instrument whereby to express to his peoples his personal feelings with an intimacy which had been denied to his predecessors.

Making Personal Contact

It is one thing to read of a personage and another to see him, but as a means of making personal contact both of these come far behind the power of the spoken word when it is actually heard by the person for whom it is intended. We have always known what our monarchs look like, and we have read of their doings, but never before have any but a privileged few heard the voice of the man or woman who sat on our Throne. How great the revelation to the man in the street, therefore, was it, not only to hear his Monarch's voice, but to hear him speak in homely, friendly language, and to receive a message so intensely warm with intimate personality that it seemed as if one's nearest and dearest relation or friend were speaking.

King George broadcast on nineteen occasions, the first of which was the opening of the Empire Exhibition at Wembley in 1924, and the last the Christmas Address in 1935, from which I have already quoted. Each one of these broadcasts forged more closely the link of personal understanding between King George and his subjects, but it was in the intimate heart-to-heart talks broadcast each Christmas Day since 1932 and during the Jubilee celebrations last May, that the voice of our late King entered most deeply into our inmost beings.

The Highest Pinnacle of Performance

Of all the many and varied personalities projected through the ether since the inception of broadcasting, the one that emerged most clearly as the ideal was that of King George. He achieved the highest pinnacle of performance in radio, and by his example set a permanent standard for all others who might subsequently be granted the freedom of the microphone.

The late King by his broadcasts elevated and dignified the status of radio, and in return radio forged the

final link in the chain which bound him to his people, and revealed him as the best of fathers and the wisest of counsellors and friends.



The Royal microphone installed by Marconi's for relaying our late King's voice at special functions.

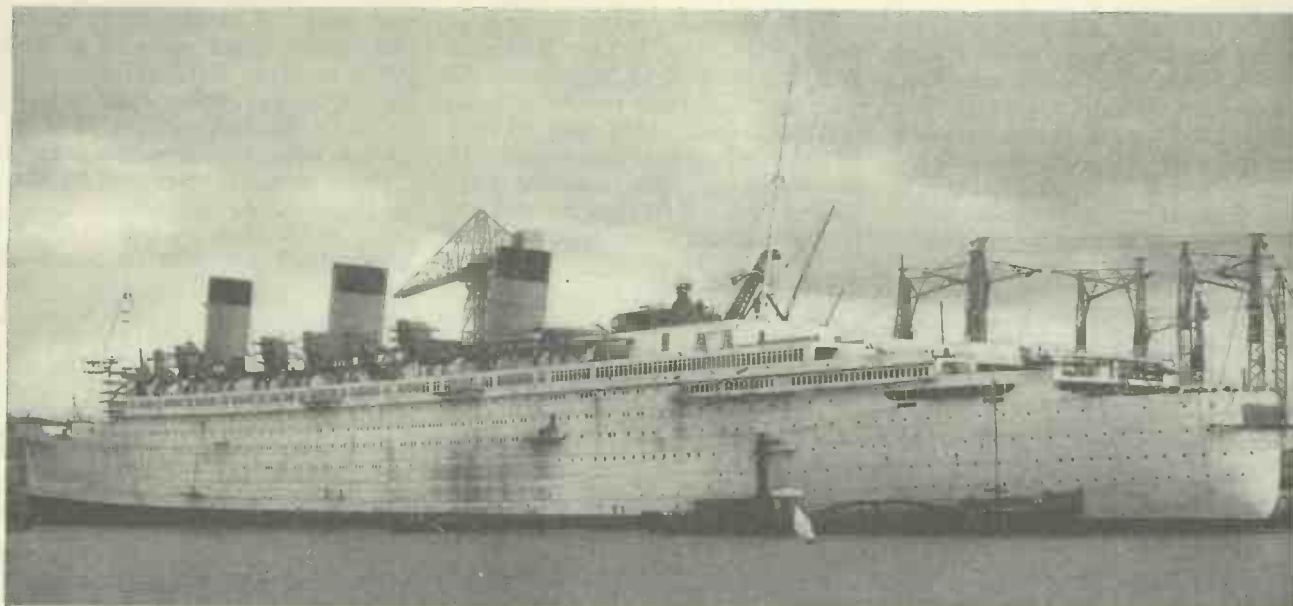

Cunard White Star Photograph

BRITAIN'S giant luxury liner, *Queen Mary*, will soon be far out at

sea ploughing her solitary way across the Atlantic. The 5,000 souls aboard her will be in a palatial floating world of their own, away from the rest of humanity, comfortable but alone, isolated.

Ah! but will they be isolated? In a sense, yes; but it will not be a complete isolation, because at no time during the voyage will they be out of touch with their friends ashore. Any one of the passengers will be able to go to a telephone box—just as we land-lubbers do—and ring up home. The more wealthy will have telephones in their own suites, and even bedside telephones, so that at any time during the day or night they will be able to make calls to other passengers or to land. They might even, in certain cases, be able to speak to passengers in other liners.

Complete Telephone Service

In short, the *Queen Mary* will have a complete telephone service every bit as useful and efficient as the service to which subscribers are accustomed in their own homes or at kiosks in the street.

All this has only been made possible by the rapid advance in recent years of radio telephony and particularly through the progressiveness of the British Post Office in providing ocean-wide—in fact world-wide—telephone facilities. Of course, the *Queen Mary's* radio equipment is in a class of its own at the moment, but very soon every

The QUEEN MARY CALLING

Britain's new wonder ship, the "Queen Mary," will soon be on her maiden voyage to America. Here are details of that important part of her equipment—the radio transmitters.

By

Howard Cooper

big liner will be fitted so as to provide similar facilities for its passengers.

The *Queen Mary* actually has four transmitting stations, all of which have been built and installed by the International Marine Radio Company, which is a licensee of the International Standard Electric Corporation of New York. The apparatus is constructed on solid lines with large "safety margins" so as to ensure as little attention as possible being necessary once the ship leaves port, for although the giant liner will carry a full complement of operators and skilled radio engineers it is always undesirable to risk a breakdown at sea owing to the impossibility of getting spares.

Four Transmitters

As a matter of fact, the *Queen Mary's* emergency transmitter complies in every way with the usual Safety of Life at Sea Regulations, and can be operated for many hours even

in the inconceivable likelihood of the huge liner's normal power supplies failing. Indeed, there are several other emergency installations, if we count the apparatus in motor life-boats.

The four transmitters are as follows:

- (a) Long wave, continuous wave (C.W.), covering all wavelengths between 1875 and 2,725 metres.
- (b) Medium wave (C.W.), and Modulated C.W., 600 to 800 metres.
- (c) and (d) Two short-wave C.W. Modulated C.W. and Telephony transmitters covering wavelengths in the marine bands between 17 and 96 metres. Each transmitter has ten specific crystal-controlled wavelengths.

Thirty Telegrams a Minute

Between them these transmitters are expected to handle up to 30 radio telegrams a minute and simultaneously to carry on two two-way telephone conversations with land or other ships.

Incidentally, all speech will be "scrambled," thus making the conversations absolutely secret. The complete installation will weigh more than eleven tons.

The main transmitting cabin is situated aft of the third funnel, while the receiving centre is amidships, nearly 100 yards away. This separation of the two cabins is necessary owing to the fact that the radio-

telephone service is to be carried on even when the ship's ordinary telegraphic communication is operating. If the cabins were closer to one another it would be impossible to receive while one of the transmitters was working.

Experts will appreciate that it is something of an achievement to be able to operate two independent radio

While discussing wavelengths it is worth while recording that the *Queen Mary* is licensed to operate on 32 wavelengths, the one restriction being that continuous watch shall be kept on the standard maritime wavelength of 600 metres. For handling large numbers of radio-telegrams and for telephonic work, however, wavelengths

mad scramble to the ocean 'phone that would follow news of a Wall Street or Stock Exchange sensation. Experience has shown that at such moments the cost of ship to shore 'phone calls means nothing to a business man. It may well be that £1 16s. spent on a three-minute call from the *Queen Mary* to his office in London will save him thousands of pounds.

THE MAIN HIGH-POWER TRANSMITTER



services even on a 73,000-ton giant such as this.

The operators will normally be in the receiving room where they can work the transmitters from a distance by an ingenious and elaborate system of remote control. They will not only start up the transmitters but also increase or decrease power and change wavelengths at will without leaving their chairs.

Special Dialling System

For wave-changing and varying power the operators have on the receiving panel before them a small device very similar to an ordinary automatic telephone dial. This is connected to the transmitter cabin a hundred yards away and through an ingenious arrangement of relays and selectors enables the changes to be effected within three to five seconds. The operator merely has to dial a code number for each wavelength or degree of power.

This remote control is one of the wonders of the *Queen Mary* because, although remote control of transmitters is common practice ashore, ships have never before been fitted with full and automatic remote control to the extent of even including such delicate adjustments as wave-changing.

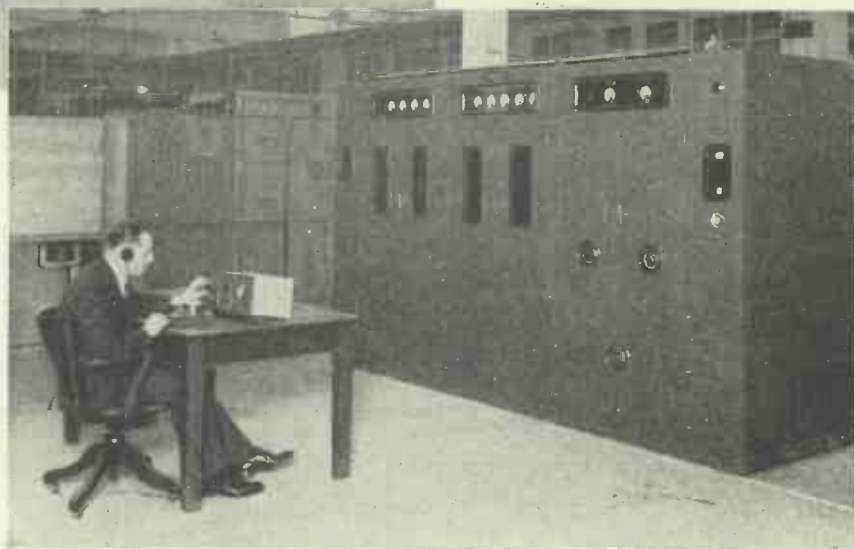

The medium-wave transmitter undergoing final tests before being shipped aboard the giant liner. The top photo shows it in course of assembly. The control panel, at which the operator is seen seated, is about 300 feet away from the transmitter when placed in its actual position on the "Queen Mary."

of the order of 30 metres will most frequently be used. When leaving or entering port the operators will certainly handle several hundred messages each hour.

On the maiden voyage the rush of traffic will be colossal, for in addition to this flow of messages to and from passengers there will be hundreds of thousands of words from Press representatives sending stories back to their newspapers.

The telephone channels may not be so busy, but it is easy to imagine the

A Complete Conference

As a matter of fact that £1 16s. will be the minimum charge for a call. When the *Queen Mary* is on the far side of the Atlantic it will be £3 12s. for three minutes and even, in very exceptional circumstances, up to £7 4s. for three minutes.

One possible facility likely to be appreciated by the super-efficient, high-powered business chief is the ability to talk to both sides of the Atlantic at once. There is, you see, no earthly reason why passenger Jones should not pick up his telephone aboard the *Queen Mary* and ask for Mr. Smith in London and Mr. Robinson in New York, the two to be connected

to him simultaneously. In this way he could have a complete conference!

Up to date in every way, the *Queen Mary* will, of course, have direction-finding apparatus.

The aerials will be ten in number, the main one being more than 600 feet long, another shorter one, three or four short-wave aerials, and a whole series of receiving aerials. In fact, this twentieth-century Atlantic liner will have more aloft in the way of aerials than Columbus' fifteenth-century wind-jammer *Santa Maria* had in rigging!

THIS YEAR'S S.T.100

It is thirteen years since the S.T.100 was unostentatiously launched.

It created, however, such a wave of home construction that some people regard it as the beginning of an era of amateur wireless, which hobby unquestionably laid the foundations of modern broadcasting. Generally speaking, the commercial manufacture of sets was not properly organised, and prices were too high for people to pay. Hire purchase systems were practically unknown, and as regards performance alone, there was a general impression that a home-made set was the better.

An Eccentric Circuit

Did I say the S.T.100 was launched unostentatiously? I am speaking from the book. I have read everything I wrote about the S.T.100 in those days and studied the back numbers of "Modern Wireless" in which its description appeared, and other periodicals with which I was concerned. The technique of explanation and of the giving of full constructional details was hardly known. A great deal of the credit for that technique must go to Mr. Percy W. Harris, who was editor of some of my periodicals at that time.

The S.T.100 was, in fact, issued purely as a circuit at first—and a pretty eccentric one at that! The actual arrangement of the components was a matter left at first to the individual experimenter, for in those days the experimental spirit was unquestionably far more virile than it is now. Component parts were frequently not embodied in a finished stable set and so people did not mind trying out innumerable circuits, thereby gaining a great deal of experience and a degree of amusement which unfortunately petered out as a result of certain circuits becoming themselves stabilised.

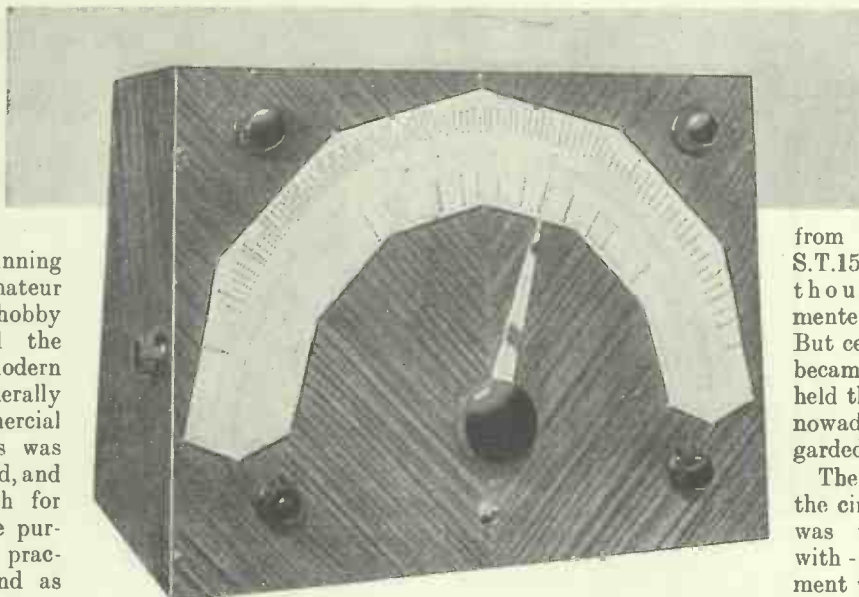

The great interest in different circuit arrangements prompted me to publish two books on Practical Circuits, these being numbered

from S.T.1 to about S.T.150. Very probably thousands of experimenters tried them all! But certainly two of them became standardised and held their ground for what nowadays would be regarded as a long period.

The S.T.100 was one of the circuits, and the other was the "tuned-anode-with-reaction" arrangement which was first published in an article I wrote specially describing it in the "Electrical Review" at the beginning of 1919. This circuit described there for the first time was destined to sweep the country, side by side with the S.T.100.

A MODERN REFLEX RECEIVER

By
JOHN SCOTT-TAGGART
M.I.E.E., F.Inst.P., Fel.I.R.E.

Thirteen years ago Mr. Scott-Taggart designed a reflex receiver which swept the country. He has now produced an up-to-the-minute S.T.100.

A Famous Arrangement

The "tuned-anode-with-reaction" circuit formed the basis of many home-constructed designs, especially those using three and four valves, but was also the basis of very many commercial receivers for broadcasting.

The S.T.100, however, never formed the basis of a commercial design. The same fact applies to the more "special" features of my designs years later, in fact, right up to date it is worth considering why it should be so.

Early Reflex Patents

In dealing with these historical matters it is rather difficult to avoid appearing egotistical, but anyone who consults the Patent Office files (for example the book of Abridgments of Wireless Patents) will find that in those early years, especially from 1919 to 1923, there is hardly a page which does not describe some valve or circuit patent of mine, and to this day practically every radio receiver in this country and America is licensed under a list of patents which include my own. In these days of multi-grid valves in every

THE NEW HARRIS VALVE IS USED

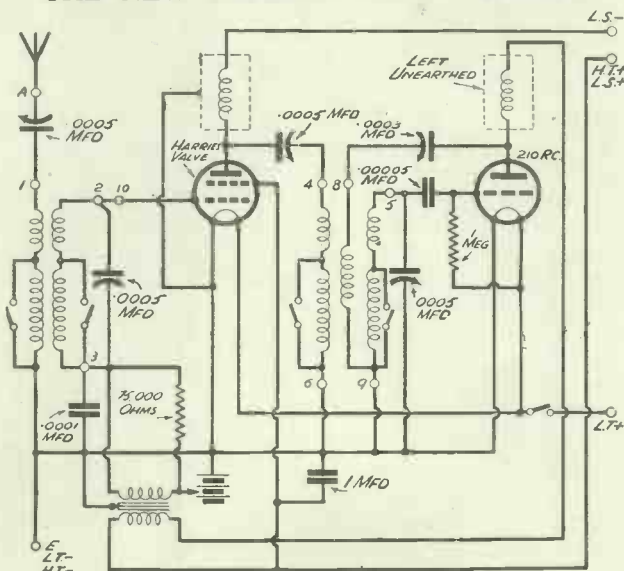

The simplicity of the circuit belies the magnificent results which the two valves produce.

manufactured set, and in these days when superheterodynes are practically universal, it helps us to realise how long ago is 1919 when one is reminded that in this year I obtained the master patent for a receiving circuit in which different varying potentials were applied to two or more grids. Priority of invention is always a matter of debate, but nothing is clearer than the fact that no one in this country had ever before obtained a patent for a valve arrangement using two grids for reception, different currents being led to the different grids. Some of the circuits I then proposed were for amplifying two different frequencies by the same valve for reflex purposes. But other circuits of the same period were for exactly the same purpose as the modern multi-grid valve used for superheterodyne purposes, namely to mix local oscillations with the incoming currents.

Another invention which was well before its time but is now used on almost every superheterodyne in exist-

MANY IMPORTANT INVENTIONS

ence, was a patent of 1920 which used a diode with a negative bias on its anode for a variety of purposes which now flourish in a large number of automatic volume control systems using diodes thus negatively biased. Another patent was the neutralising system which independently of Professor Hazeltine's neutrodyne I had produced in this country. Three-quarters of American commercial broadcast receivers were at one time specifically licensed under my American patents by the Hazeltine Corporation who had bought them. (This concern also acquired my British neutrodyne patent which in this country was

earlier than the first of Professor Hazeltine's.)

There were numerous other patents which contributed their quota to modern set design as produced by manufacturers.

Led a Double Life

What, however, has struck many people is that in the matter of inventions I have led a double life. The more important basic inventions have never been publicised, and possibly only the patent departments of manufacturing concerns are fully aware of my activities in this direction; it is certainly very unlikely that the younger generation of radio engineers would know the historical background of inventions, circuits and devices which, at this late date, it takes for granted.

In 1925 my Elstree laboratories produced the first ganged and the first screened coil set—the Solodyne—which was not only the first "one-knob" set at the Wireless Exhibition of that year but the only one. The

A "studio" picture of This Year's S.T.100. It is built in one plane, all the components being fixed to the back of the panel.

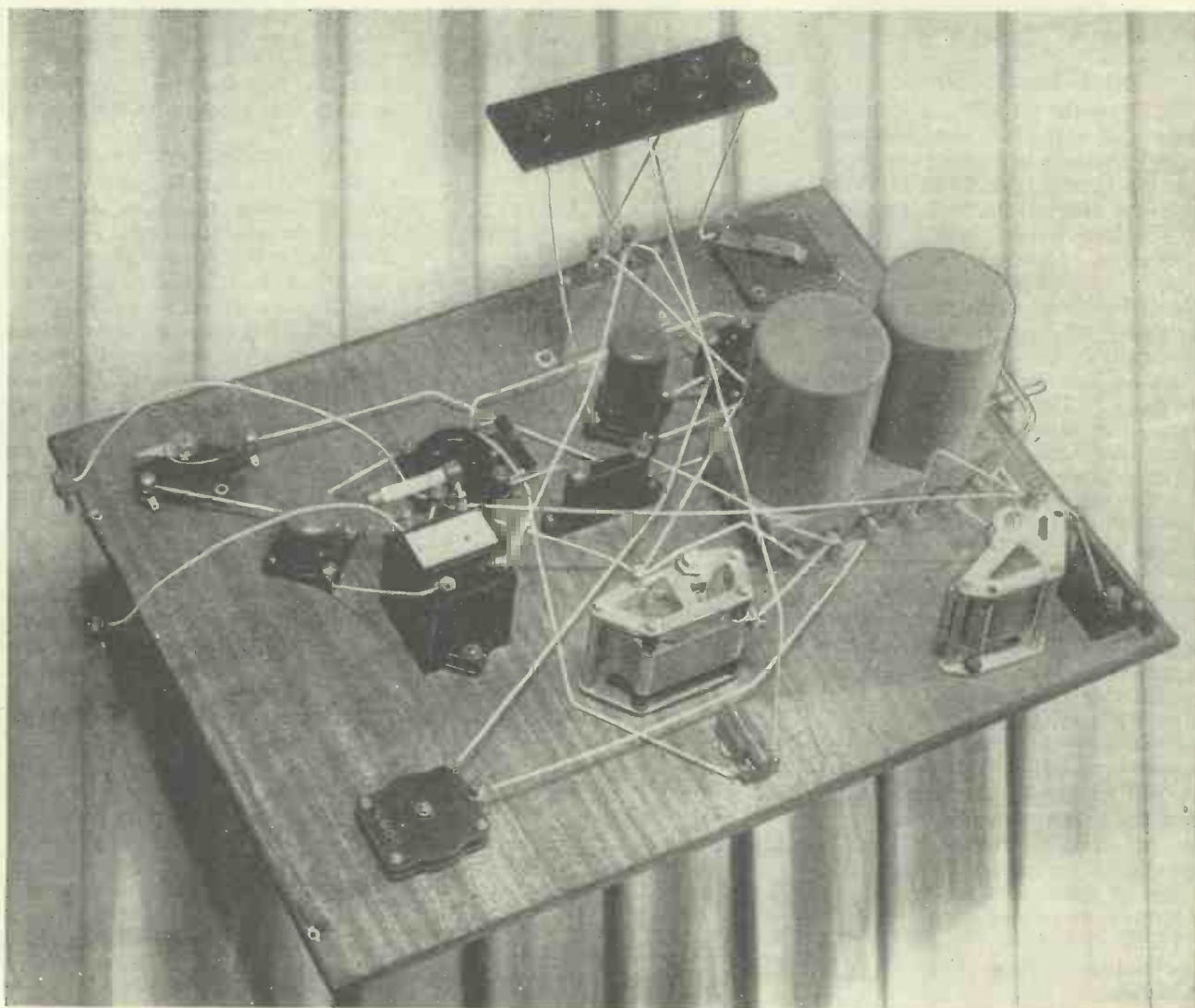

THE
SET
COMPLETELY
WIRED

This photo illustrates, better than any words could, the remarkable straightforwardness of the wiring.

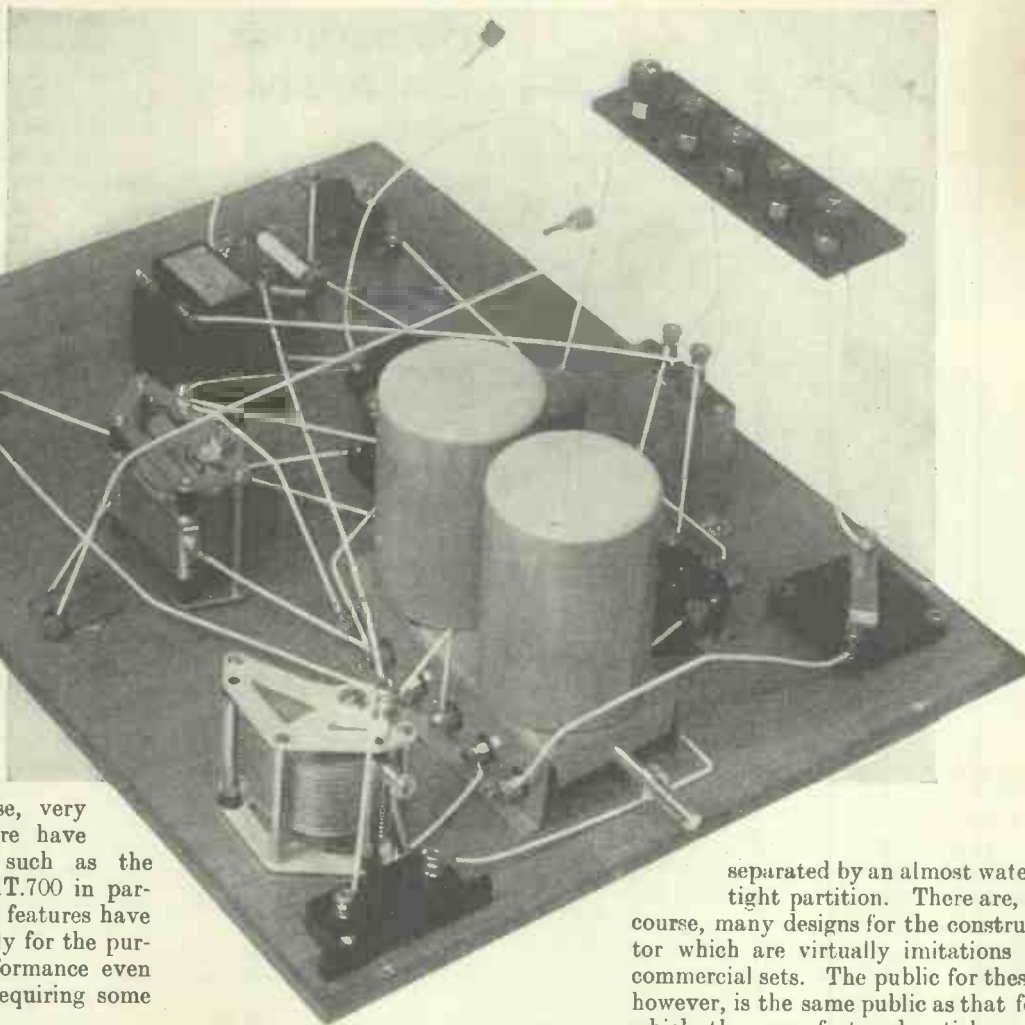

S.T.100 was, of course, very much earlier, but there have been subsequent sets, such as the S.T.400, S.T.600 and S.T.700 in particular, in which certain features have been incorporated purely for the purpose of increasing performance even at some small risk of requiring some extra skill in operating.

The main popular receivers which I have produced represent an inventive or designing side of my activities which is quite different from that which concerns the major inventive work, which receives not a fraction of the publicity attending the launching of, say, the principal set design of the year (as far as my receivers are concerned).

Remarkable Consistency

Some regard these sets as the product of the Jekyll and others the Hyde side of my activities, but, whichever they are, they involve a very special attitude of mind which can be traced back to the S.T.100.

Although all my principal sets have differed greatly from each other and have introduced one or more major new features, yet there is a certain quite remarkable consistency as regards certain features dating from June 1923 when the S.T.100 was launched; or, if you will permit it, it is possible to go back twenty-one years to the first crystal set designed which I published and which incidentally had numerous control knobs even at that date!

The consistent feature in all my sets over this long period is that regard has always been primarily for performance even at the cost of complexity of operation. The wireless amateur who builds his own set has presumably—and in my experience certainly—more intelligence and operating skill than the man-in-the-street who buys a wireless set complete. By capitalising this little extra skill (it need not be much), it is possible to embody all kinds of new ideas and features which no set manufacturer could ever incorporate in a set for universal use. Always, but never more so than now, it is necessary to get new effects or to get old effects very much better, if the home-constructed set is to compete successfully with the complete manufactured article.

Two Separate Markets

Nowadays, at any rate, home construction is not competitive with commercial radio. My own conception of a design for the constructor is so different from what any manufacturer would ever consider producing, that we can regard the two publics as being

separated by an almost water-tight partition. There are, of course, many designs for the constructor which are virtually imitations of commercial sets. The public for these, however, is the same public as that for which the manufactured article was produced, and so it is not surprising that the competition of the finished set has proved so overwhelming.

That Word "Fool-proof"

The reason the S.T.100 circuit was not taken up commercially was that the set was not fool-proof. In fact, none of my receivers has been fool-proof in the broadest sense of the word. That is simply because they have not been designed for fools. The aim, of course, has always been to make the *construction* fool-proof, but it will be found that there have always been some elements in all my sets involving some—however little—extra skill in tuning or adjustment. In the case of the S.T.100 two tuned circuits had to be adjusted and a crystal detector had to be operated at a sensitive spot. This latter requirement was not as severe as it sounds nowadays because the wireless public was trained from the earliest times to tickle a crystal with a cat's-whisker.

Whatever were the reasons, the S.T.100 made little headway until a year had elapsed, and then everyone suddenly seemed to get good results.

HOW YOUR SET SHOULD LOOK

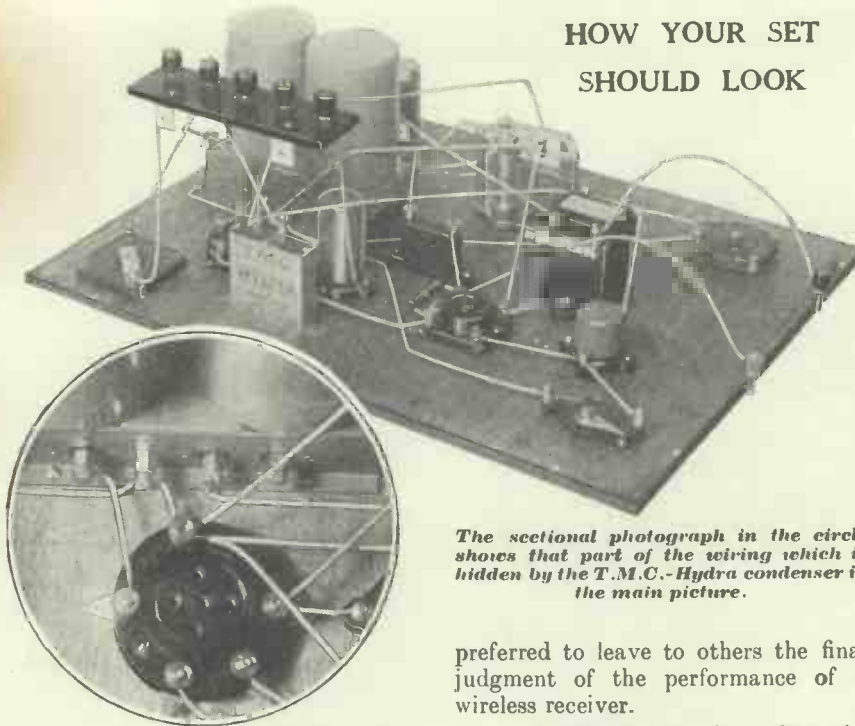

The sectional photograph in the circle shows that part of the wiring which is hidden by the T.M.C. - Hydra condenser in the main picture.

This was largely helped, no doubt, by the fact that I had by then issued a complete constructional guide with blue print, large photographs, detailed list of essential components, etc. The success of the set must have been due to personal recommendations, because apart from a picture of the circuit on the cover of the June, 1923 "Modern Wireless" there was remarkably little publicity. The article itself, in fact, opens with a mixture of modesty and sarcasm which is not without interest considering that we were at the beginning of the broadcasting boom. I then wrote:

"Superlatives have become so common that I hesitate to describe the arrangement either as novel or super-sensitive. As regards novelty, we always have the type of person who has been using something like that for years, and as regard super-sensitivity one is competing with the man who hears all the broadcasting stations in the country on one valve on a loop aerial."

Publicly Demonstrated in 1923

The desire to demonstrate publicly new sets of my design is traceable as early as this, for I note that at 7.30 p.m. on June 28th, 1923, I gave a demonstration of the S.T.100 to the Ilford Radio Society at St. Mary's Church Schools, High Road, Ilford. In radio, at any rate, a willingness to demonstrate is evidence of humility rather than aggressiveness, and it is interesting to note this early example of a consistent policy which has

preferred to leave to others the final judgment of the performance of a wireless receiver.

On September 19th 1926 the S.T.100 was clothed with some dignity by being described in a lecture I gave before the British Association to the Advancement of Science at Liverpool. Other reflex circuits were described and several designs were subsequently produced.

It is rather hard for me to see why the S.T.100 was so successful, because it was by no means as simple a set as those which I now design for the public. Apart from the cat's whisker it was quite a ticklish set to work, and it was certainly not to be compared with a modern receiver as regards station-getting. The crystal detector required a considerable signal before it would work but, having worked, the rest of the circuit certainly gave a substantial volume, even though the valves of those days in no way compared with the modern variety.

"Something for Nothing"

Perhaps the chief attraction of the S.T.100 was the fact that you got something for nothing. This is because one of the valves acted as a dual amplifier, i.e. it amplified the high-frequency currents and then amplified the low-frequency currents produced by the crystal detector. The second valve acted simply as another stage of low-frequency amplification. This circuit therefore involved a stage of high-frequency amplification, a crystal detector, and two stages of low-frequency amplification. Reaction was used and was obtained apparently quite well by the rather odd and unsatisfactory method of swinging an inductance coil (which was part of a tuned circuit) towards the inductance coil of the other tuned circuit.

GB. BATTERY CLAMPING SPAR.

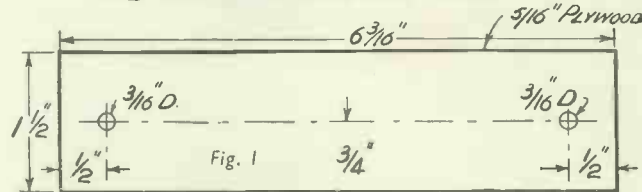

Why 100?

Some people used to express surprise that such a popular circuit should have the number 100 attached to it. This number was the

one in my book of valve circuits, but the book was written a considerable time after the circuit was invented and the number 100 was chosen "for the greater rotundity thereof," to use a term applied to the Millenary Petition of 1603 which was not actually signed by 1,000 clergymen.

Some months ago the Editor of this journal said to me: "How would you design the S.T.100 to-day?" The matter intrigued me so much that I set to work studying the problem from every angle. I realised at once that I would possess all kinds of advantages which were then not available. For example, better valves, better coils, better constructional ideas, better dials, and so forth.

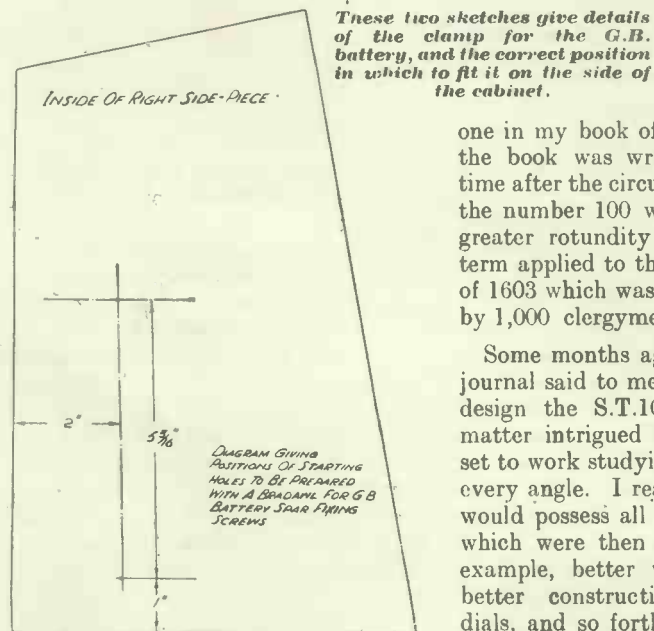

You have the finished result before you now. The first impression you will get is that the 1936 version of the S.T.100 has an astonishing resemblance to the S.T.700. But the resemblance is purely an external one. The circuit and valves used are entirely different, although one principle is retained, namely, that of avoiding swamping by local stations by the use of a Triple Extractor, a device separately described and introduced with the S.T.700 for the benefit of those who require extra help to keep out the local stations. This help, I can say emphatically, will enable the present S.T.100 (1936) set to work within one mile of any of the B.B.C. stations and yet receive scores of foreigners whenever desired. But as all constructors of this set will not require this extraordinarily successful adjunct, it can be omitted from the present discussion.

The Auto-Dial

The dial is exactly the same as that used on the S.T.700; white celluloid printed dials are now immediately available, so that an extremely useful and professional-looking scale will be provided. As manufacturers of complete sets are not accustomed to change

the construction of that set marked an entirely different departure in methods from constructing home radio receivers. Instead of mounting the components on a panel and a base-board with all the consequent difficulty of illustration and understanding and construction, all the components are mounted on one single wooden board. The wiring diagram is greatly simplified and the time taken in construction is certainly halved. But an additional merit is the semi-cabinet which for a shilling or two gives the complete set a handsome, finished appearance. Actually, all that is required are three pieces of wood, called the two side-pieces and the top piece. These are simply screwed to the sides and top edge of the panel. This leaves the bottom uncovered, but as this rests on the table anyway it makes no difference. The back is also open, but so are the backs of most commercial receivers. The back is generally facing a wall. Some of the most popular radiograms made by commercial firms

S.T.100 BLUE PRINTS

By special arrangement we are able to offer genuine, full-size blue prints of the S.T.100 (1936) taken from the draughtsman's original drawing. These cost only 1/- each, post free. Applications for these blue prints should include a postal order for 1/-, and be addressed to Blue Print Dept., "Wireless and Television-Review," Tallis House, Tallis Street, London, E.C.4, AND TO NO OTHER ADDRESS.

course, to prevent your slipping the complete set into another cabinet, but that seems quite a needless procedure, as I assure you that the set looks very well indeed as it is.

Cheapest Set of All

The cost of the S.T.100 (1936) is less than any receiver I have ever designed. The original S.T.100 cost nearly £12, while this year's version (if it can be called a version) costs less than £3.

The great appeal, of course, of this receiver will be its excellent performance for a very low cost both of the components and the valves, while the lowness of the upkeep cost is even more spectacular. The high-tension battery which I recommend for this set is the 120-volt five-shilling type. The reason is that although the set gives full loud-speaker results, the current taken by the valves is only a total of 7 milliamperes. It is quite clear that the H.T. battery will last a very long time, a most important consideration except in the case of those people who desire an extremely loud output.

The set is astonishingly good on the reception of foreign stations, and the special dial is therefore fully necessary. There should be no difficulty in getting at least fifty stations anywhere. If you wish you can use a mains unit (eliminator), excellent results being obtained with these devices, but the extreme economy of H.T. current tends to rob the mains unit of its main advantage.

"A Joy to Use"

I cannot conceal the fascination which this circuit has quite apart from the excellent results which it gives. The set is so really cheap and so really economical to run, and so much is obtained from two cheap valves, that even those who have much bigger sets already will quite likely want to build the set out of curiosity or interest, or to give away. It is true that the set as regards size is fully grown, and I could have put the very simple "internals" into a

FRONT VIEW OF PANEL
7mm PLYWOOD

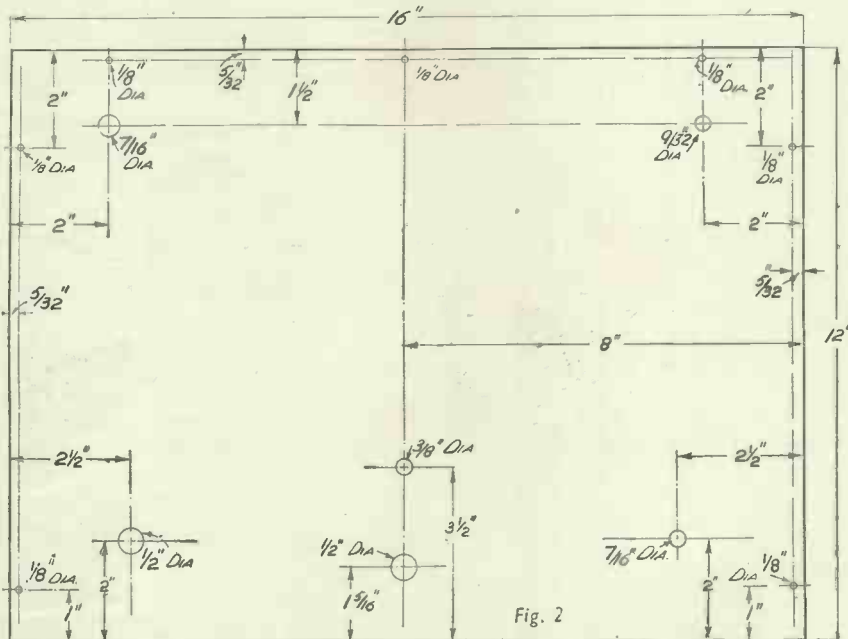

the scales of their condensers for every model they produce, I can see no particular reason why I should, merely for the sake of novelty, alter a dial which in actual practice has proved extremely effective. The cabinet system is also on the same lines as that adopted in the case of the S.T.700. Here, again,

to-day are open both at the bottom and the back. As the panel and side and top pieces may be purchased ready cut and drilled for quite a small sum, it will be seen that for an extra cost of about three shillings the receiver is provided with a completely satisfactory cabinet. There is nothing, of

considerably smaller cabinet or rather "Easi-cabinet" as it may be called. But this would have robbed the set of the special Auto-Dial which I have designed to enable you to go to a particular station by name rather than juggling with degrees or wavelengths. A large open dial of this kind is a joy to use, and I was reluctant to rob constructors of this important "selling feature."

Very Few Parts

There are very few components, and their assembly is so simple that a previous knowledge of wireless construction is quite unnecessary. It is essential, however, to keep to the components which I have used. The greatest trouble with the original S.T.100 was that constructors would insist on using L.F. transformers of a kind different from that specified, with disastrous results. You should therefore keep absolutely to the components recommended. This applies particularly to the H.F. chokes and the L.F. transformer while, of course, the coil-unit should be a Colvern and the second variable condenser, which is fitted with a pointer, should be a J.B.

Some change is possible in the fixed condensers, resistors and solid dielectric variable

USE SPECIFIED COMPONENTS

condensers, and the aerial-balancer condenser. In all cases, however, only the very best makes should be employed and cheap bargain components eschewed, as usually these have some leak or other fault. I would not condemn the trial of different choke coils, provided the one in the anode circuit of the Harries valve is of very good make, but any changes are entirely at your own risk. This, in fact, applies to all substitutions of components, and I cannot too strongly recommend you to build a set exactly as described, especially as the total cost is so reasonable. Changing the L.F. transformer is particularly dangerous. Do not modify the circuit in any way. For example, you may be inclined to earth the can of a choke coil, whereas in the

actual set I have not done so in one case. Please remember that I have designed the set and used it and experimented with it, and that if you alter anything you become the designer and must accept full responsibility!

Celluloid or Card Dial

The celluloid dial for this set is obtainable, I understand, for three shillings post free from Celluloid Printers Ltd., of Surbiton, Surrey. Another procedure is to send 2d. in stamps to Amalgamated Press, Ltd., Bear Alley, London, E.C.4, when you will obtain a printed card suitable for pinning to the panel. This card was the one presented with the S.T. 700 issue of "Popular Wireless" and you may if you prefer obtain this copy for 4d. post free, if any of these are left.

The celluloid dial, of course, is permanent and gives a handsome appearance to the set, but those who desire to save money at the outset are advised to send for the card. Later (provided they do not leave it too late!) they could send for the celluloid dial. The merit of the Auto-Dial is that station names positions are not at the mercy of absolute accuracy of components which of course is never obtained, which is why so

THE WOOD FOR THE CABINET

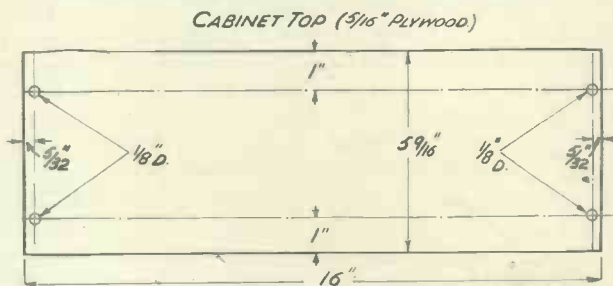

These three diagrams give all the information needed to build the Easi-cabinet for the S.T.100.

OUTSIDE VIEW OF LEFT HAND SIDE-PIECE.

(SHOWING POSITION OF HOLE FOR WAVE-CHANGE SWITCH.)
FIFTHLY JOIN B TO C.
B TO C. SHOULD BE 5 9/16"

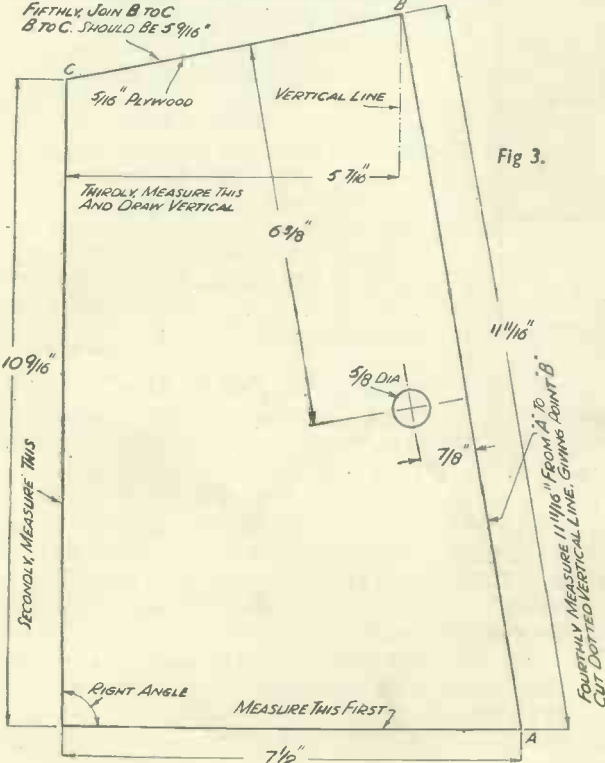

CABINET RIGHT SIDE-PIECE

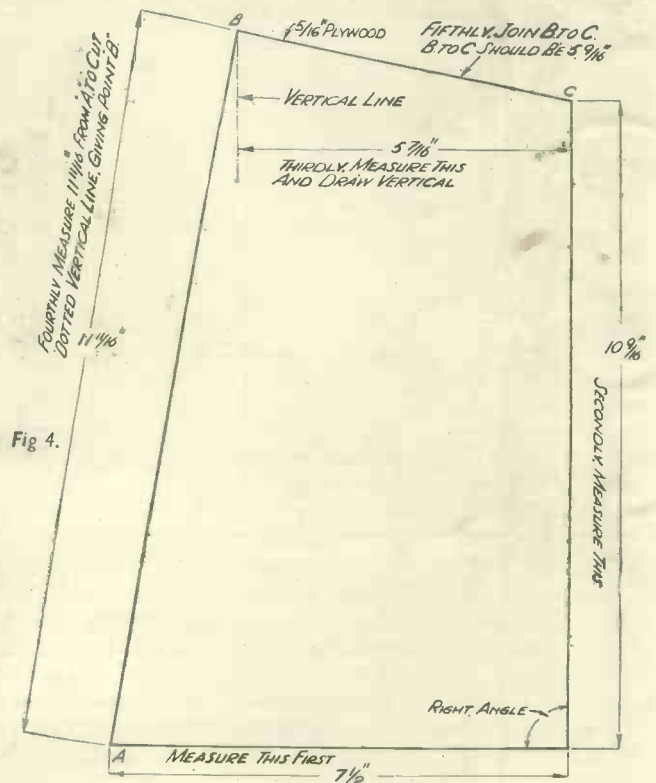

BUILT ON THE FAMOUS UNI-PLANE SYSTEM

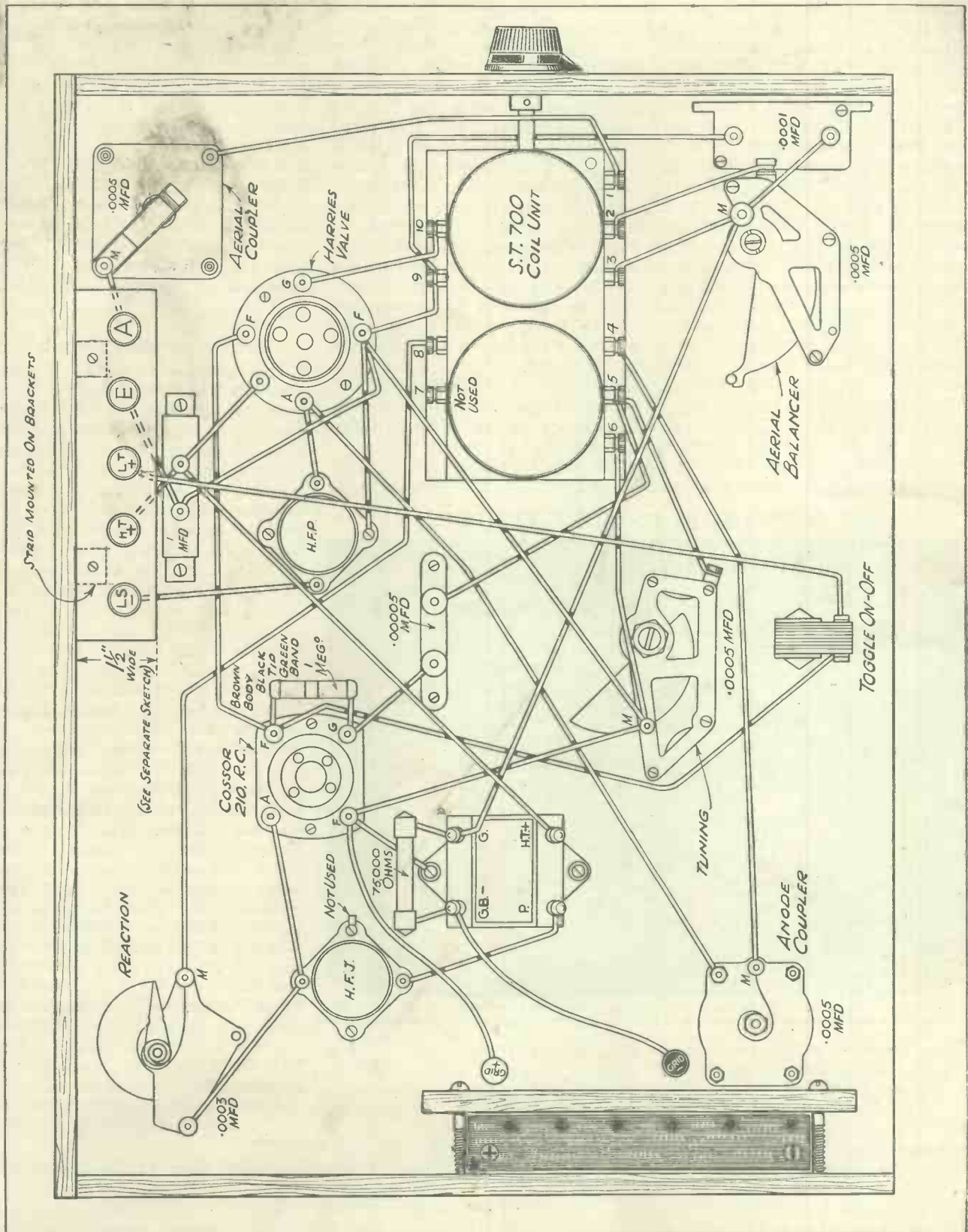

This diagram shows how the various components are disposed on the back of the panel, and also how they are wired up. Note that the levels of the various wires are indicated where they cross one another. A full-size blue print of this diagram is available for those who desire it. See page 207 for full details.

many commercial sets with station names are only approximately correct. Oddly enough, nobody seems to mind having a station name "out" on a commercial set. If the pointer points to a station name next door to the station actually received the user does not seem to mind! Such inaccuracies are really as bad as having no station names at all, though once you have used a dial which is absolutely accurate you will become much more critical of such matters and will realise how enjoyable it is to go back to any particular station by name. It will be seen that there are two semi-circular lines between the station names. The upper line is used for the medium-wave stations and having tuned-in a station which has been identified, a dot in pencil or ink is placed on the dot-line. This line is then joined by a short junction line drawn with a pen or pencil to the end of the station's name. By moving the pointer at any time to the dot on the dot line, you will receive the station concerned provided the aerial balancer condenser has been turned to its correct position.

HOW THE DIAL IS CALIBRATED

points to the station name when the station is tuned-in. This forcing can usually be accomplished even though the grub-screw of the knob is quite tight. If you over-shoot, i.e. over-correct, you simply turn the pointer to the other end of its travel and force the knob round a little in that direction. When this is done the station names will all be approximately accurate, at least on, say, the medium waveband. But in order to ensure accuracy the dot system must be used. Different condensers differ slightly, and coils are not exactly alike, and although no large changes will be found yet these very slight variations are quite sufficient to put a station out. This does not affect the accuracy of the dot system. All it means is that there will be a slight slope in the junction lines, and this of course does not matter at all.

The circuit is simple to understand. The output valve is different from the

output valve. Although as a two-valve set without high-frequency amplification, this combination of valves would represent an extremely sensitive arrangement, yet the addition of the stage of high-frequency amplification increases the sensitivity and general performance of the set enormously. In fact, a two-valve set, except for purely local work, is of no use unless reflexing is used. Reflexing involves a suitable circuit and special design, and consequently the S.T. 100 (1936) is the result of months of experiment resulting in very satisfactory results indeed. I should not be at all surprised if this receiver achieved a very wide popularity even though it is published at a time other than October!

Brief Operating Details

The operation of the set is very similar to that of the S.T. 300. There is an aerial coupler, an anode coupler, an ordinary reaction control and two tuning condensers, one of which is the main tuning condenser with the long pointer, and the other the aerial balancer condenser which does not need to be calibrated at all. This latter point may cause some surprise, but in practice there is no reason at all why one should even look at this knob. You simply set the main condenser to a station dot and then turn the aerial balancer knob until you hear that station. Although fuller instructions will be given for tuning the set next month, I may mention that greater selectivity is obtained by reducing the aerial coupler and the anode coupler, and that the anode coupler should not be set at too large a value, otherwise the set will oscillate. This is a most important practical warning. The aerial and anode coupler do not affect tuning to any extent that matters—a fact which makes the set very much simpler to work than the S.T. 300. Signal strength will increase as the aerial coupler and anode coupler are turned to the right, but here again it is undesirable to increase the anode coupler too far, owing to the risk of the set oscillating. Where high selectivity is required the two couplers should be at as low values as possible consistent with obtaining the station at suitable signal strength.

THE RECEIVER IN ITS COMPLETE FORM

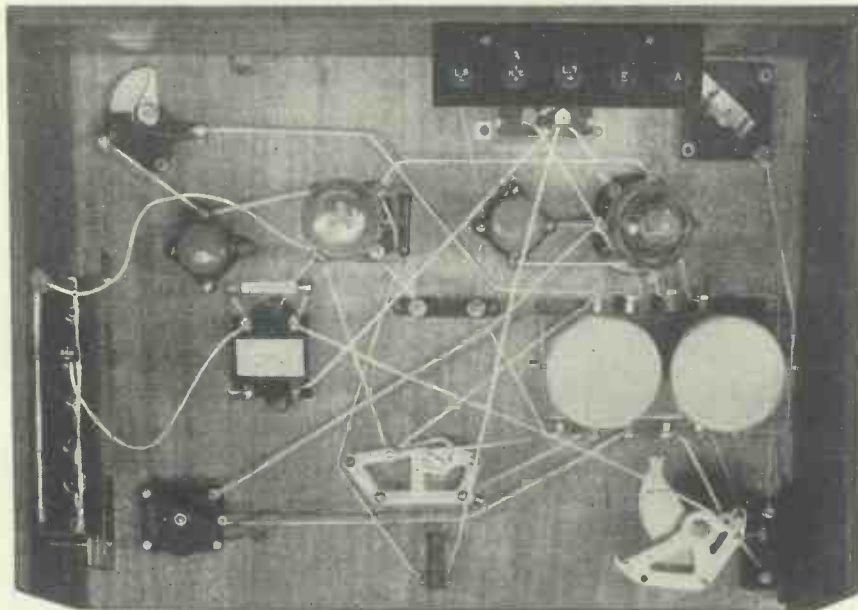

A back-view taken with the cabinet in position. Note the terminal strip fixed to the top piece and the grid bias battery in its position to the left of the photograph.

When receiving long-wave stations, the dot corresponding to any station is put on the lower dot-line. By suitably adjusting the knob on the main tuning condenser, matters may be arranged so that the pointer will come approximately opposite the station name when a particular station is tuned-in. In practice, by turning the knob to one end or the other of its travel, the pointer may be forced a slight amount until the pointer

kind usually used. It is called a Harries valve and is made by Hivac. It ordinarily takes the place of a pentode output valve but possesses certain merits of its own which are especially useful to the home constructor who does not want to be concerned with the matching. This valve is perhaps by accident particularly suitable for this circuit, and it gives excellent high-frequency amplification in addition to acting as the

Special Blue Print Available

The constructional details for the receiver are dealt with under a separate concise heading. A blue print of the set is obtainable post free by sending a shilling postal order to

BRACKET FOR TERMINAL STRIP
(TWO BRACKETS ARE USED)

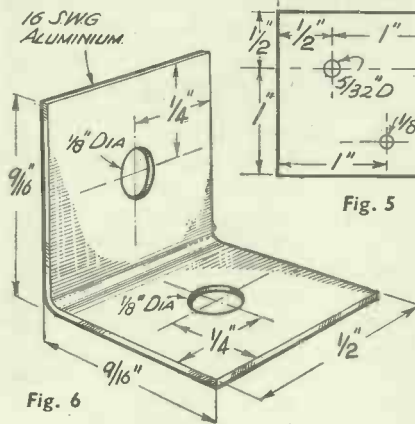

Fig. 6

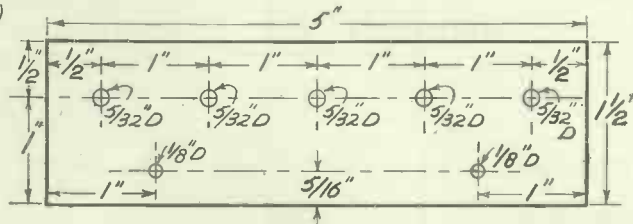

Fig. 5

The diagram above shows the size and drilling dimensions of the terminal strip, while to the left is a sketch from which to make the brackets for mounting the terminal strip.

YOU CAN BUILD THE S.T.100 (1936) FROM BLUE PRINT ALONE. But tens of thousands have reported that my Rapid Guides save them time and guarantee success.

The First Steps

This Guide is obviously most useful if you stick strictly to the original components used in my own set. If you use other components, simple modifications of the Guide will be necessary.

If you have bought a complete Author Kit, including my "Easi-cabinet," or if you have bought a kit

of the Easi-cabinet, cross out sections C, D, F, H, J.

(a) Collect and examine required components. If an author's specification kit, check each item to see that it corresponds to my list of parts *actually used*. Handle J.B. tuning condenser with care, keeping moving vanes closed. Bending of vanes would affect calibration of station names.

(b) Tighten terminal securing nuts (not terminal heads) on components where necessary.

Drilling the Panel

(c) Using Fig. 2 mark out on the front (not back) of panel the positions of the holes. With a fine-pointed bradawl prick all the hole positions. Using a 3/8-in. twist-drill, start each 1/8-in. hole carefully, using light pressure and turning the drill in a reverse direction at first; this is to avoid splitting the veneer. Continue drilling these 1/8-in. holes in ordinary way. Centre-bits are recommended for all the remaining larger holes in panel, but twist drills may be used. Drill these holes.

(d) If you are going to use my

Blue Print Dept., "Wireless," Tallis House, Tallis Street, London, E.C.4.

The Triple Extractor, if used, is connected between the aerial terminal of the set and the lead-in from the aerial. There are three knobs on this Triple Extractor, each of which keeps out an interfering B.B.C. station. The outside knobs will each cut out a medium-wave B.B.C. station, while the middle knob will cut out Droitwich. The whole process of adjusting these knobs can be carried out in a matter of fifteen seconds. All you do is to tune the set approximately to the interfering station and then to turn the knob on the Triple Extractor till that station disappears. You then tune the set to the other medium-wave interfering station and turn the other outside knob till that disappears. Then switch over to the long waves and adjust the middle knob on the Triple Extractor till Droitwich disappears. By this method the B.B.C. may be either entirely cut off or reduced to the strength of a weak foreign station. You can, however, allow just as much of any B.B.C. station to "come through," as you wish.

The Triple Extractor, once adjusted, need not be altered. No changes are made when switching the main set from medium wave to long wave or vice-versa.

SPECIAL CONSTRUCTION GUIDE

Follow these details and you can't go wrong.

THIS Guide is much on the lines of previous ones of mine, and the set is very simple to construct. The absolute novice is told where to start and what to do, even to the best way of pushing in a pin. If you prefer,

THESE ARE THE PARTS USED BY MR. SCOTT-TAGGART

COMPONENTS.	Make Used by Designer.
Coil unit.	Colvern, type S.T.700,
·0005-mfd. tuning condenser (aerial balancer).	Ormond R483 (with small knob complete).
·0005-mfd. main tuning condenser.	J.B. with long pointer (as for S.T.700).
·0005-mfd. solid dielectric variable condenser (anode coupler).	B.T.S.
·0003-mfd. solid dielectric variable condenser (reaction).	Polar "Compax."
·0005-mfd. solid dielectric variable condenser (aerial coupler).	Graham Farish log-mid-line.
·00005-mfd. fixed condenser.	T.C.C. mica, type 34.
·0001-mfd. fixed condenser.	Lissen mica.
H.F. choke (anode feed).	Wearite, type H.F.P.
H.F. choke (reaction).	Wearite, type H.F.P.J. (marked H.F.J.).
1 anti-mic. valve holder (5-pin).	Benjamin.
1 valve holder (4-pin).	Benjamin "Vibrolder."
L.F. transformer, 3·5/1.	Varley Niclet.
75,000-ohm resistance.	Dublier, 1 watt.
1-mfd. fixed condenser.	T.M.C./Hydra, type 30, with terminals.
1-meg. grid leak.	Ferranti G.1.
On-off switch.	Bulgin S.80.
5 terminals: A, E, L.T.+, H.T.+, L.S.—.	Belling-Lee, type R.
2 wander plugs: G.B.+, G.B.—.	Belling-Lee, midget type No. 1019.
2 aluminium brackets, with bolts and nuts.	Peto-Scott.
Terminal strip, 5 in. × 1 1/2 in. × 3/16 in.	Peto-Scott.
Panel, 16 in. × 12 in. × 7 mm., plywood.	Peto-Scott.
2 cabinet side-pieces, 1 cabinet top and G.B. battery spar.	Peto-Scott.
Wire (Maxamp).	Peto-Scott.

VALVES.

Y 220 Hivac Harries. 210 R.C. Cossor.

LOUDSPEAKER.—W.B. Stentorian.

Easi-cabinet system and have not bought the pieces ready prepared, carry out instructions in this section (d). If you have bought the pieces ready prepared skip this section (d). Cut to size and drill panel top, drilling $\frac{1}{8}$ -in. holes as advised above. Using Fig. 3 and Fig. 4 and keeping to the order of drawing the lines shown, mark out the cabinet side-pieces on the

THE LAYOUT AND CONNECTIONS

these screws going through the $\frac{1}{8}$ -in. holes in strip.

(h) If you wish to stain the side-pieces and top, do so now. (I used Jackson's, of Mitcham, Surrey, Oil Varnish Stain, colour walnut, size 6 tin.)

(j) Cut out, drill and stain the spar (see Fig. 1) which holds grid bias battery in place.

(k) Lay the panel face downwards on a cloth-covered table (to avoid scratching veneer). Lay blue print right way round on back of panel. Keep blue print steady with a weight. Using bradawl, prick through to panel the fixing holes of all the components that go on the back of the panel. If in doubt about any holes, check by laying component over its picture. Remove blue print. Using blue

print as check for their positions, screw down the components.

Fit aerial coupler condenser without knob. Fit anode reaction condenser without knob. Fit aerial balancing condenser without knob. Discarding the on-off indicator plate, fit the on-off toggle switch. Fit the anode coupler without knob. Taking care that the whole panel will not rest on the spindle of the J.B. main tuning condenser (whose moving vanes should be closed), fit the J.B. condenser (without knob and pointer) to panel, putting its bush washer on the front side of panel under fixing nut which should not be too tight.

THIS COMPLETES THE FIXING OF COMPONENTS.

Lay panel face downwards, resting it on two books or cloth-covered blocks of wood; this is to prevent scratching of veneer and to prevent pressure on control spindles.

The recommended wire is of the kind that permits the insulating covering to be slipped back, revealing the bare end of the wire. "Maxamp" wire by Peto-Scott is about the best I have tried, and is also of suitable thickness. It is strongly recommended as being very much easier to use than bell wire or similar stiffish wires. A 30-ft. coil is ample for the set. My advice is to use it as follows:

Details for Wiring

Cut off 6-ft. lengths at a time from the coil, as required. Push back insulation about 1 inch and, without increasing this inch, slide the bunched-up fullness of the insulating covering well back along the wire. Using only about $\frac{1}{2}$ inch of the bared end, connect the wire, looping it (preferably clockwise) round under the terminal head of the component to be wired up. Shape wire along route indicated in blue print, and a reference, if desired, to the photographs.

Allow an extra $\frac{1}{2}$ inch on the length of the wire for connection to the terminal it is going to. Cut through the insulated wire, slip insulation

THE WOOD FOR THE EXTRACTOR

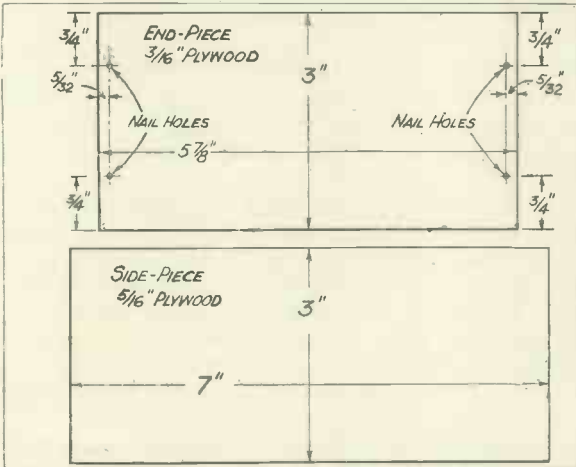

Fig. 7.—Two each of the above-sized pieces of wood are used to house the Triple Extractor.

sides which will show. Cut out side-pieces. Drill hole in one side-piece.

(e) Take the left hand (looking from front) side-piece and the top-piece, and hold them together, resting on a flat surface. Prick with a bradawl through the prepared holes in the top-piece into the top of the side-piece. Insert two $\frac{5}{8}$ -in. No. 4 round-head brass screws and screw top-piece to side-piece.

Finishing the Cabinet

Now do the same with the other side-piece.

Lay the assembled top and sides on the table. Lay the panel the right way round and veneer side uppermost, in its correct position on the framework assembly.

With a bradawl, prick through the seven $\frac{1}{8}$ -in. fixing holes in panel.

(f) Mark out and drill the terminal strip as Fig. 5. Prepare two mounting brackets as Fig. 6.

(g) Fit two mounting brackets to inside of terminal strip, using $\frac{3}{8}$ -in. 6BA round-head brass screws and nuts,

HOW THE PANEL IS DRILLED

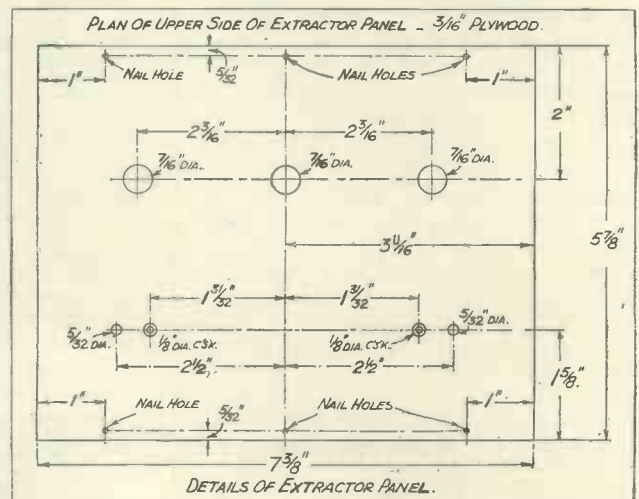

Fig. 8.—All the hole positions in the panel of the Triple Extractor, and their sizes, are given in this diagram.

COMPONENTS FOR THE TRIPLE EXTRACTOR

1 Triple Extractor iron-core coil	WEARITE	J.B. "Popular Log" (without dial or slow motion, but with small knob), Ormond R483 (log condenser) with small knob
3 0005-mfd. air variable condensers	POLAR No. 4 with knob (mention S.T.700)	
1 Wooden Box—5 wood pieces	PETO-SCOTT	
2 Terminals, A1, A2	BELLING-LEE (type R)	Clix, Bulgin
Optional Aerial and Earth Equipment: Aerialite "Levenstrand," Electron "Superial," Graham Farish "Filt" Earthing Device		

back $\frac{1}{2}$ inch and, without increasing this $\frac{1}{2}$ inch, work the bunched-up fullness back along the wire, thus covering the bareness at the starting end. Now loop the finishing end (preferably clockwise) under its terminal-head. This detailed account is of a process which actually takes only a few seconds, and will enable you to do the wiring more neatly and in double-quick time.

(l) USING BLUE PRINT WIRE UP THE SET.

The grid-bias leads are prepared as follows: Take the proper length of "Maxamp" wire, as stated on blue print, and prepare it as usual to have $\frac{1}{2}$ inch of bare wire at each end. Bend one of the ends $\frac{1}{2}$ inch from the end back on itself and push the loop so formed into the hole in the side of the G.B.+ Belling & Lee Midget wander-plug, having loosened the head of wander-plug. Tighten head of wander-plug. Fit other end of wire to correct component.

The G.B. Connections

(m) If you have built the Easi-cabinet frame (as I assume), fix the completed panel on the frame.

(n) Mark in following manner the fixing holes for grid-bias battery spar, which clamps the battery to the left side of the Easi-cabinet looking from the back. Prick with bradawl the lower fixing hole, which is 1 inch up from the bottom edge of the side-piece and 2 inches from the back edge (farthest from panel). Slip a $1\frac{1}{2}$ -in. No. 8 round-head brass screw through the hole in one end (either end will do) of the grid-bias battery clamping spar and insert the point of the screw in the fixing hole just pricked. Give the screw one turn to prevent its falling out. Swing the spar round until it is parallel with the back edge of side-piece. Holding spar against side-piece, prick through the other hole (in spar) into cabinet side-piece, with bradawl.

Insert a second $1\frac{1}{2}$ -in. No. 8 round-head brass screw through the upper hole in spar into pricked hole in side-piece. Give this screw one turn to prevent its falling out. Slip spar along the screws and insert the 9-volt grid-bias battery between spar and side-piece of cabinet, with the battery sockets facing towards the back (away from panel).

Taking care that the voltage figures on side of battery remain in view, screw up spar fixing screws until battery is firmly clamped into position.

WHERE TO GET YOUR AUTO-DIAL

Two types of Auto-Dial are available to builders of This Year's S.T.100.

(a) A version printed on card and costing 2d. post free may be obtained from The Back Number Dept., Amalgamated Press, Bear Alley, Farringdon St., London, E.C.4. Ask specifically for the S.T.700 dial card when writing.

(b) A matt-surface white celluloid Auto-Dial for 3s. post free, from the sole official suppliers, Celluloid Printers, Ltd., Kingston By-Pass Road, Surbiton, Surrey.

(If you have used screws that are too long, you will need to put cardboard or a wad of paper between spar and battery, otherwise screws would go right through cabinet side-piece.) FIT G.B.+ plug in positive (+) socket, G.B.- I in -3 socket.

(o) FIT DIAL CARD AS FOLLOWS (this applies if the dial is of cardboard):

Leaving the centring tab attached, cut out dial card along borders. Cut out (razor blade essential) the hole for slipping over bush, where marked on the tab. Stand the set up in its normal position, front of panel facing you. The moving vanes of the main tuning condenser should be "closed." Put your left hand round the back of set and gently hold the rear

end framework of main tuning condenser. Do not touch the vanes. Remove the fixing nut and washer from the main tuning condenser's spindle portion which can be seen from the front of the panel.

Slip the hole in the centring tab over the spindle bush (the threaded brass collar), and hold centring tab against panel by fitting washer and then nut loosely. Lay set (in Easi-cabinet) on its back, front of panel uppermost. Centre the dial card into its correct general position; as a guide it may be

noted that the top point should come opposite the middle fixing screw of panel, i.e. half-way along top edge.

Fixing the Dial

Ensure dial is in correct position by measuring the distance from the lowest point on the left-hand end of dial to the bottom edge of panel; this distance should be the same as that from the right-hand end of dial to bottom edge of panel.

(p) Prepare 16 ordinary plated brass pins (if a pin is of a type that can be bent, it can be used) by cutting them diagonally with wire-cutters or pincers about $\frac{1}{8}$ inch from their heads. You now have 16 very short and pointed pins. Any other type of very short miniature nails may be used.

There are 16 small circles with white centres along the border of the dial. Keeping dial card flat on panel, start with the top circle and prick through centre of circle with some thin pointed instrument (I used a drawing pin) for about $\frac{1}{16}$ inch. Insert a prepared pin into this hole and push home with any hard flattish-ended instrument (I used the handle of a screw-driver). Carry out the rest of the fastening-down of dial in following order: Circle between pin just inserted and condenser spindle; the two circles (on outer border) on each side of top circle; the two circles (on inner border) between last-inserted two pins and spindle. Carry on in this way, working towards the ends, keeping dial card flat.

WIRE UP FROM THIS DIAGRAM

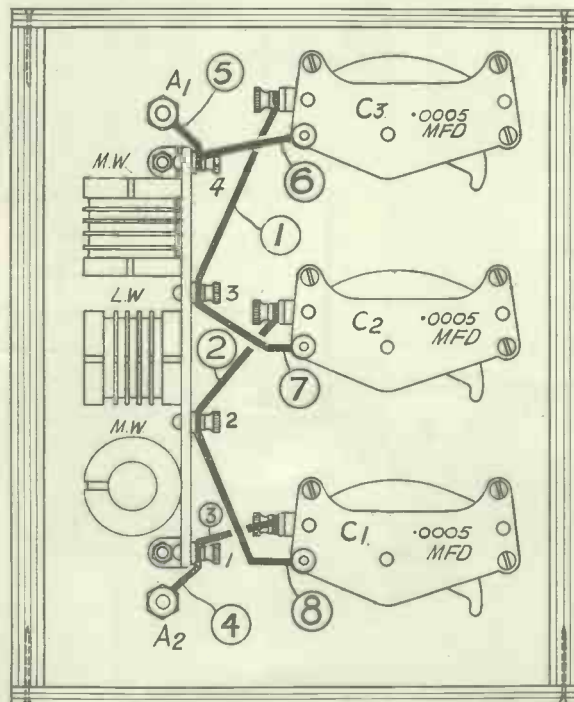

*TRIPLE EXTRACTOR UNIT
VIEW FROM UNDERNEATH*

The simple wiring of the Triple Extractor.

(Please turn to page 258)

E.M.I. TELEVISION GEAR

The photographs on this page illustrate E.M.I. apparatus similar to that which is being installed at Alexandra Palace.



On the left is the "television" tower at Alexandra Palace as it will appear when the aerials are completed. The two independent aerial systems, one for vision and one for speech, are clearly discernible. To the right are the projector and scanning camera for use in the televising of films.

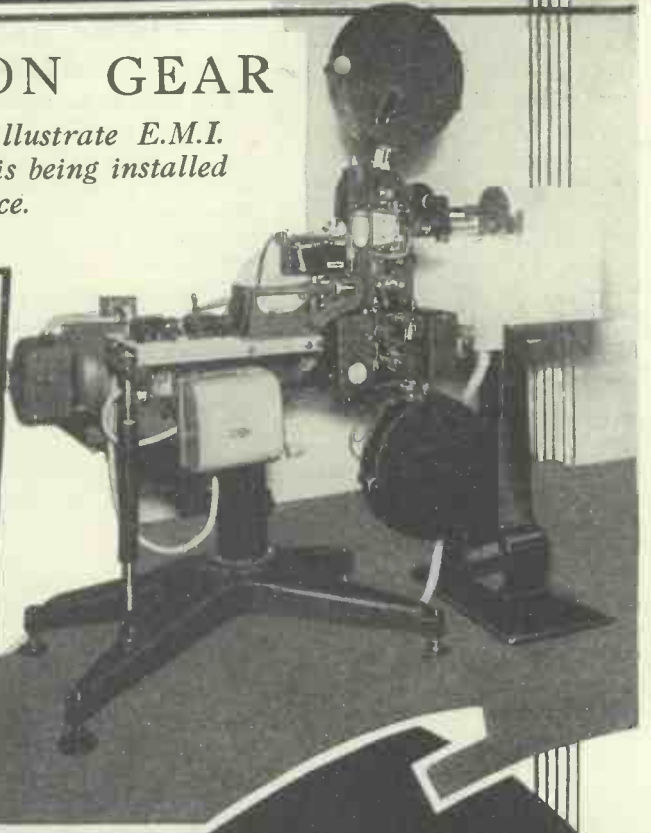

Below is the scanning camera, which picks up the scenes in the studio and passes them on as electrical pulses to the transmitter. On the right is a junction box for joining two lengths of the cable which connects the camera and control equipment.



The final transmitter is seen below. Between this and the "camera" comes the control equipment, which is a large piece of apparatus in itself.

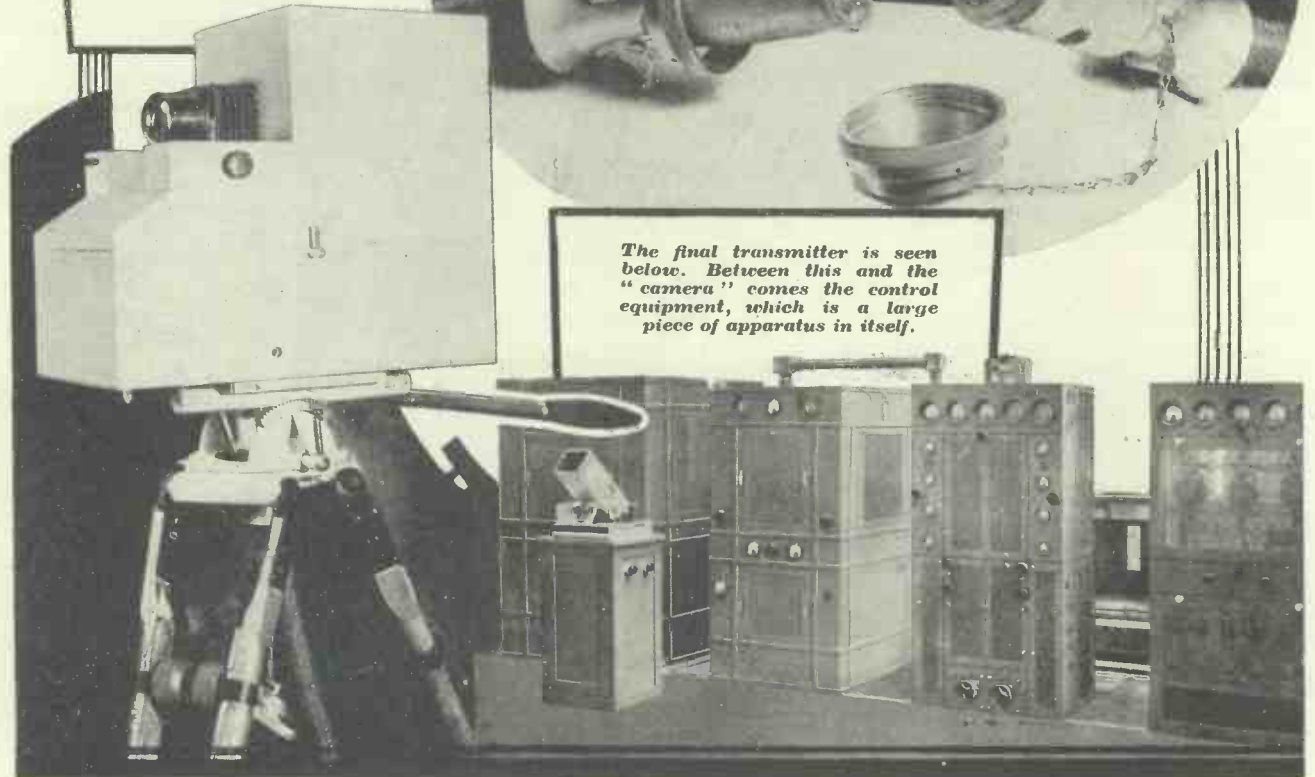

THE B.B.C. is in its fourteenth year. Very young, really! Yet, so much has it become a part of our daily lives, that it's hard to remember those few years back when it wasn't there at all.

It is amazing to realise that, in those years before broadcasting came, there were dotted about the earth's surface the potential "controllers," "directors" and "producers" of the modern marvel to come. They were doing unpretentious jobs in strange places, and were, mostly, quite unknown. Now their names are widely recognised—some, indeed, are dubbed "famous." Broadcasting made them news.

In the Shipyards of the Clyde

Round about the time when Marconi sent the first radio message across the Atlantic, there stood in the noisy sheds of a great Clydeside engineering firm a young Scotsman. He was slaving through five years of apprenticeship. His parson father had put him there to "go through the shops" in the good old way of the good old days.

As he wiped his hands on cotton-waste, I wonder if John Reith—for he it was—dreamed of a knighthood? I should doubt it. But he certainly did dream of getting on, and in 1913 he won an engineering post in London.

The War made him a major in the Royal Engineers. A wound sent him yet another step up the ladder; he

What were they all doing before broadcasting began? Probably you have often asked yourself that question. In this article our contributor tells us about such figures as Sir John Reith, Cecil Graves, Harry Pepper, Stanford Robinson and Henry Hall. Henry, by the way, is a keen listener and likes to keep in touch with the latest radio developments. Here he is with a new Marconiphone all-wave receiver—the 345.



BEFORE

BROADCASTING CAME

By A Special Contributor

was given an administrative job in charge of contracts in America for munitions for Britain. The year 1919 saw him seated in the Civil Engineer's Department at the Admiralty.

Only three more years were to pass before he was to leave his Admiralty desk to answer the call of some new-fangled idea to do with a wireless telephone, or something.

Whitehall lost another of its officials when "2 LO calling" called Captain Cecil Graves, now Controller of Programmes. He was in the Intelligence Department at the War Office, having gone through a number of exciting scrapes in the War, including an adventure in which he was captured by the enemy.

Still further down the years we find a young man living the life of the open spaces on a Canadian cattle ranch. They called him "Mac," as they do now at St. George's Hall where Gordon McConnel produces operettas.

FROM CATTLE TO OPERA

Gordon McConnel came from a Canadian cattle ranch. He now produces operettas for the B.B.C.



With the ease of a quick-change artist, "Mac" transferred himself from his wild ranch to the arty quarters of Paris, and became an art student. From canvas and oils he went to the boards and grease paint; began a musical comedy career under Courtneidge.

After the War, in which he was very much crooked, he returned to the stage until the B.B.C. claimed him at the Cardiff station.

To that station also came Charles Brewer to serve broadcasting. Now Assistant Variety Director and part-"Scrapbook"-maker, he originally left the home of a distinguished father, the late Sir Charles Brewer, composer and organist at Gloucester Cathedral, to study medicine. Leaving his studies to go to war, he took part in the famous Christmas Truce in the trenches, and as an R.F.C. pilot was shot down by his own side and crashed in No-Man's Land. A bit hard on him, that!

Back home, he forgot the chemical formulæ he had previously studied, and toured the music-halls with a song-at-the-piano act.

The last adventurous thing he did before settling down in the comparative peace of the studios was to drive a London 'bus during the General Strike!

Unlike driving a 'bus, which as far as I know is nothing like producing B.B.C. programmes, managing a piano and gramophone shop seems to have a slight affinity with broadcasting. That was Max Kester's job. The shop was at Doncaster.

But before that he had been a farmer and a pianoforte teacher. From the gramophone shop he got to a gramophone company's studios in London, and wrote, produced, and acted records. To the B.B.C. was a natural step.

"Punching the Keys"

Two other young men were eking out a living at the piano keyboard in those pre-B.B.C. days. Henry Hall was playing in a trio at a small provincial hotel. Actually he had been trained for the Civil Service, but the War interfered, and when he left the Army he took to music. In his spare time he perfected violin and trumpet playing, and evolved a technique of arranging and orchestrating which suddenly jumped him up to the Musical Directorship of L.M.S. hotels. He was conducting the Midland Hotel dance band at Manchester when he received that fame-bringing telegram asking him to go to Savoy Hill to take Jack Payne's place.

The other pianist was playing the piano at seven! He held musical "concerts" for his relatives on Saturday nights, formed an amateur orchestra, and then became a cinema pianist, thumping out thunder for cowboy silent films and fingering tender treble *tremolos* for sentimental Pola Negri romances.

From his earnings he educated himself in music, and the

RECORDING A SONG HIT



Max Kester (left) and Evelyn Laye at the H.M.V. Studios. On the right is Ray Noble, who has now left this country to take up his abode in America.

B.B.C. had not long been started before Stanford Robinson became its chorus master.

Round about Fleet Street, in those days, there scintillated a lively young reporter on the "Daily Express" called John Watt. His work took him everywhere, including the entertainment world—first nights, interviews with Hollywood stars, film previews, and so on. In this sphere he felt at home; so he joined the B.B.C. at Belfast as announcer, and producer when there wasn't any announcing to do. Promotion took him to London and made him Public Compère No. 1.

As a very little boy John Watt loved watching seaside pierrot shows, and if he ever went to Clacton for his holidays there is a pretty big chance that he noticed a self-conscious young fellow issuing tickets to people going in to see "The White Coons." Half way through the show, his tickets done with, the young man would appear on the stage and play the piano.

Drummed His Way Up

The young man, Harry Pepper, wanted to take the place of his father, Will C. Pepper, as owner of the show. He did. Then he wanted to be a composer. He did—composing music for two West End shows. He next aimed at becoming a music publisher. He did. There followed an ambition to join the staff of the B.B.C. He did!

Harry Pepper has probably done all his father wanted him to do—maybe more!—but Brian Michie's papa wanted his son to be a schoolmaster. However, the young Brian got ideas about theatres and "acts" into his head so much that it left no room for scholastic thought. So he picked up some jobs on the stage.

Then one night a pal took him to Savoy Hill, and Denis Freeman, hastily looking round for someone to bang a big drum for gunfire in "Journey's End," bumped into Michie and dragged him into the effects studio to do the banging. Michie liked it so much that he worried the B.B.C. for a job with "Effects." He got it, and promotion to the production staff soon followed.

Comedian with Charlie Chaplin

If ever you go to a "Music Hall" show at St. George's Hall you will notice a trim, short, square-shouldered gentleman springing about the place with spritely ease. This is John Sharman, still carrying the traces of the living he once made by physical jerks.

When Charlie Chaplin was beginning on the music-halls, Sharman was acrobat, tumbler and knockabout comedian in the same theatres. For a time he managed a theatre, but went back to the stage and did a spot of juggling! Then he went on to the "legitimate" stage, and did some filming in pre-War "silents." He was general manager of a touring theatrical company when he joined the B.B.C.

And now—Television!

Anywhere in our midst to-day may be the people who are to become the big names of television to-morrow. Some we already know by voice, if not by sight. Others will come out of the unknown. Who will be the "big shots"?

A FAMOUS PRODUCER



Charles Brewer is a name well to the fore in B.B.C. circles. He is partly responsible for the famous "Scrapbook" series besides many other popular broadcast productions.

All About

MAINS SUPPRESSORS

By A. S. CLARK.

Is your radio reception interrupted by clicks, buzzes or other noises? These can be removed with the right apparatus, and you will find the following articles a good guide of what to buy. They also explain just how the interference is picked up.

THE elimination of mains interference is a wide and complicated problem. There are so many combinations of possibilities that it would be useless to attempt to cover them all.

Also, some cases can be so obstinate that it is only possible to advise in relation to them after special investigations of a practical nature have been made in each individual case. But, luckily, the majority of cases follow more or less along recognised lines.

MADE BY T.C.C.

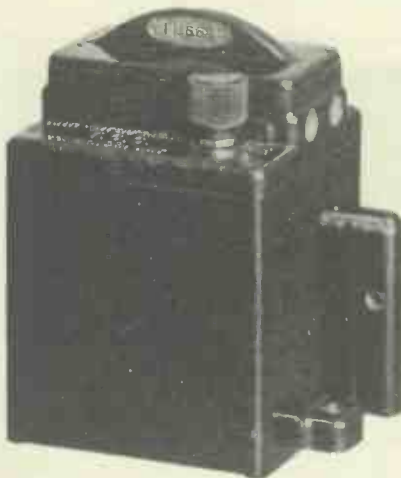

A T.C.C. unit which is ideal for connection at the meter.

We are thus able to give advice which will prove helpful in most instances; and, incidentally, it must be borne in mind that a certain case cannot be labelled unusual until the normal remedies have been tried. There are four distinct ways in which the removal of interference can be tackled.

Radiated from the Mains

It is proposed to deal with these separately, although we shall, as far as possible, show how combinations of two or three of them can be used, as

we go along. This article deals with interference radiated from your mains.

This is the most common form of mains interference, and as such is the one logically to deal with first. There are several ways in which interference can be brought to your set by the mains.

It is often assumed that all mains interference is brought to the set via the mains flex which supplies it with power. It is much more likely that it is reaching the set via the aerial down lead.

The mains it must be remembered travel for miles around the neighbourhood, and pick up all sorts of interference—it does not matter how just at the moment. Arrived at your house complete with interference they proceed to radiate it like a broadcasting station throughout the house and the immediately surrounding ether.

Now, no matter where your aerial is placed, the lead-in has got to pass through this pernicious field of interference, and is thus bound to pass the interference picked up down to the set's aerial terminal.

A Simple Test

By comprehensive tests, seldom within the scope of the ordinary set owner, it is possible to decide fairly accurately in just which way the interference is reaching your set. But the following simple test will tell you whether your down lead is picking up the trouble:

First tune to a non-station part of the set's dial, turn up the volume to maximum position and note the degree of interference. Now remove aerial and earth and join them together. If the interference has



The complete screened down lead kit supplied by E.M.I. Service, Ltd.

now gone, or almost completely gone, the pick-up is at the aerial.

It is now possible that your inter-

FOR INSERTION AT METER.			
Make	Suggested Suppressor	Price	Remarks
Belling & Lee	1118 or 1204	10s. 6d. and 17s. 6d. respectively	The 1204 can be connected into the line without cutting the conductors
Bulgin	A 30	6s. 6d.	Does not include fuses, which must be provided separately
Dubilier	305/051	7s. 6d.	—
G.E.C.	B C 630	10s. 6d.	—
Goltone	R 36/SK 38, and R36/SK 39	10s. and 11s. 6d. respectively	The first one is for A.C. mains, and the latter for D.C.
Graham Farish	"MUM" Suppressor	2s. 0d.	—
T.C.C.	1A	10s. 6d.	—
Trix	Type B	25s. 0d.	—

ference is being radiated (a) by your own house wiring, (b) by wiring in the immediate vicinity, or (c) by some



An inexpensive Graham Farish general purpose suppressor.

electrical apparatus nearby such as a neon sign. Your own knowledge of the local situation will tell you which is most likely to be the cause.

If you live in a somewhat isolated house, for instance, (a) is likely to be the whole cause. In any case, your own mains are likely to be the chief culprits, since they run nearest to the down lead, unless, of course, you live in a block of flats.

Two Methods to Adopt

There are two things you can do: You can stop your own mains from radiating or you can stop your down lead from picking up any interference, either from your own mains or from causes (b) or (c).

The latter is more costly and much more complicated to do, and is dealt with in another article. The first is ideal for those who feel it is their own mains which are wholly or largely responsible. Even many who feel it is doubtful which is the cause will decide to try the simple remedy first.

Incidentally, you are almost certain to be on the same mains as your neighbours, and therefore both your mains and his will most likely radiate the same interference, but

AN EFFECTIVE UNIT



The Trix suppressor for use at the meter. It is inserted in series with the mains, the connector blocks on top being employed for this purpose. The suppressor is housed in a metal case.

yours will be nearer to your own lead-in. So there is a strong chance of your own mains being the chief culprits.

The method of stopping the interference radiated by the mains is to cut it out at the point where the supply leads enter the house. This is achieved by means of a system of by-pass condensers connected to the mains leads on the house side of the main fuses.

There is no point in going into the theoretical circuit considerations of such filters. They vary in various makes, as also do the actual methods of connecting up. But we give a table which shows suitable suppressors and their prices for this type of work.

It must be appreciated that the models mentioned are not necessarily the only ones supplied by the firms mentioned. Also, it is important to pay careful attention to the details for fitting given by the makers with their instruments.

Easy to Fit

The average person can tackle the job of fitting very well, and if the main switch is off there is no chance of shocks. However, anyone who feels dubious about carrying out the work can easily call in an experienced electrician to do it for him.

If the attachment of such a filter leaves a residue of interference, it is not likely—although it is possible—that another similar one in parallel will be of much advantage. The remaining interference is probably arriving in another way, and one of the other points discussed in the following articles is more likely to remove the residue.



This is the neat Belling-Lee suppressor for connecting in series with the set's mains lead.

FOR USE AT THE SET

suppressor at the meter successfully filters all interference from the mains. But if the mains pick up interference between the meter and the set the suppressor already in position cannot do much about it.

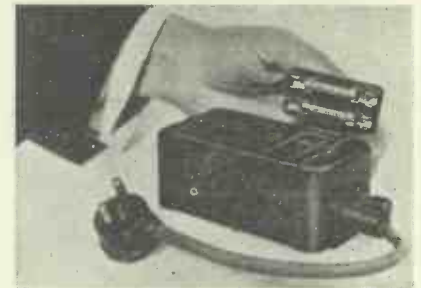

Another picture of the unit illustrated opposite, with the fuses removed.

In this article we are going to consider the use of a suppressor at the set. This is where the average person is apt to try one first, and to be surprised if it seems to make no difference. The reason for such a possibility has already been explained.

A Possible Source

The use of a suppressor at the set is not likely to prove of added advantage when one is already connected at the meter, unless electrical machinery is being used in your own house. But there is one possibility which it sometimes overcomes.

We will suppose that the

In such circumstances a filter at the receiver is in a position to keep this interference out of the set, so far as entering via the mains flex goes. The trouble is that it is most likely that the aerial down lead will pick up the interference as well if it is sufficiently adjacent to affect the house wiring.

Easily Cured

If the removal of the aerial and earth as explained in the preceding article has little effect on the interference—indicating that all, or most, of it is coming along the mains—then a suppressor at the receiver may be all that is required.

Make	Type	Price	Remarks
Belling & Lee	1211	17s. 6d.	Incorporates H.F. chokes and is for use with 5-amp. 2-pin plug
Bulgin	A 49	2s. 6d.	Provided with insulated terminals
Dubilier	68922	40s. 0d.	For use with bulb-adaptor type plug
G.E.C.	B.C.630	10s. 6d.	—
Goltone	R 36/SK 11 or R36/SK22	9s. 6d. and 10s. 6d. respectively	The first is for A.C. mains, and the second for D.C. chokes are available separately
Graham Farish	"MUM"	2s. 0d.	—
T.C.C.	1 A	10s. 6d.	—
Trix	Type A	25s. 0d.	For use with 5-amp. 2-pin plug

As with suppressors for fitting at the meter, a list of suitable ones for use at the set is included with this article. The notes concerning other types which may be available applies equally to this list.

Price Variations

Incidentally, the wide divergencies in the prices are to a large extent due to the fact that some may incorporate one choke, some two and others none at all. There is also the question of the currents on which they can be employed, and the fact that others are suitable for varying purposes.

As a stopper for interference brought in via the mains to the set, a suppressor at the receiver is often desirable with the type of suppression dealt with in the next article, namely screened down leads.

A screened down lead, plus a suppressor at the set, will nearly always stop all interference. When it does not, it will usually be in cases of low aerials in which the aerial proper, as opposed to the down lead, is picking up radiation direct from the mains.

Firms Will Help

In difficult cases like this, if the aerial cannot be moved higher, or to a "cleaner" spot, all three types of suppressor are suggested, and even then it is impossible to predict results.

Several of the firms who make mains suppressors are prepared to help those in difficulties, and in some cases supply a query form for stating the full details of the particular circumstances.

Suppressors at the set are probably the easiest of all to fit. There are simply three connections: two go to the two main leads, and the third is employed for earthing.

The actual method of making the connections will be found to vary with the suppressor employed. Some types have three terminals—types suitable for fitting inside the set's cabinet. Others are plugged into the mains point and the set into a new socket on the suppressor.

FITS IN THE RECEIVER

A Bulgin device for use at the receiver. It may be wired inside the set's cabinet if desired.



SCREENED DOWN LEADS

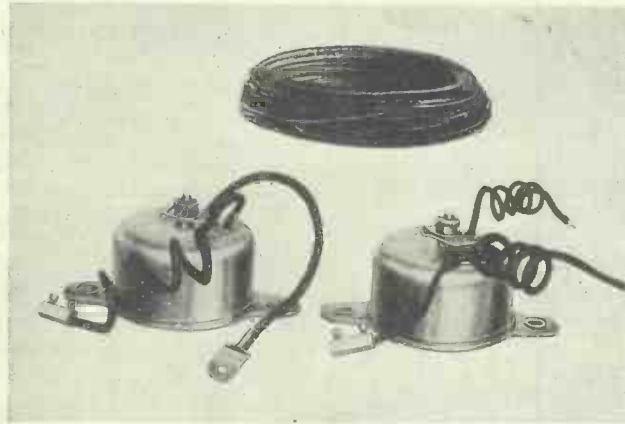

These transformers and screened wire represent the G.F.C. anti-interference kit.

WE have already explained how the greater part of mains interference is picked up by the aerial system from radiation from the mains. There are two obvious ways of overcoming this. Stop the interference from reaching the mains, or stop the aerial from picking up the interference.

We explained how to do the former in the first article. Here we shall be concerned with the use of screened down-lead systems to prevent the aerial picking up interference.

The great advantage of this method over the suppressor-at-the-meter scheme is that it will deal with radiation from your neighbour's mains or from nearby electrical machinery as well as with the actual radiation coming from your own mains.

Two Points to Note

Not only is the down lead more likely to pick up interference because it runs far nearer to the mains wiring than the aerial itself, but it has also been found that interference does not radiate more than about twenty feet in a vertical direction.

The idea of a screened down-lead system, put briefly, is simply that the aerial is erected at a point above or otherwise outside of the interference zone, and the lead-in is screened so that it will not pick up anything at all. So you will appreciate that it is unlikely an indoor aerial, other than the loftiest loft aerial, will be improved by a screened down lead.

Also it is only natural that the pick-

up of the aerial, which is considerably assisted by the down lead, will be reduced, since the down lead can no longer operate in this way. Such reduction in pick-up must never be confused as the introduction of inefficiency by the screening system.

Make	Description	Price	Price of Cable
Belling & Lee	Rejectostat, Type No.1227	27s. 6d.	4½d. to 8d. per yard
E.M.I. Service, Ltd.	Anti-Static aerial equipment No. 1	57s. 6d.	100 feet included in outfit
G.E.C.	Anti-interference aerial equipment,	21s. 0d.	50 feet is supplied with outfit
Goltone	Statofomer noise-reducing aerial system	20s. 0d.	Includes 50 feet of Statolead wire
K.B.	Rejectostat, Unit K.B.341	25s. 0d.	4½d. to 8d. per yard

Aerials and aerial devices with a very small length are most likely to suffer in this way. Use as big an aerial as you can, so long as you keep it well away from metal gutters and other metal objects.

Where a short-straight down lead is in use, improvement can probably be obtained by replacing it with a simple screened lead. But since the screening is connected to earth, you will appreciate that the capacity of a very long screened lead would introduce considerable losses.

Transformer Units

It is to overcome the effects of this capacity that the transformer units of a screened down-lead system are employed. The one at the aerial end of the lead steps down the voltage, so that it is too low to produce large

capacity effects—these being dependent to a large extent on the voltages existing.

A Long Lead Permissible

The transformer at the receiver steps the voltage up again, so that the input to the receiver itself is, to all intents and purposes, the same as though an ordinary aerial and earth were in use. This step-down system has the advantage that it makes possible the use of a very long lead from aerial to set—even 100 yards is well within the permissible length.

Where interference is concerned, this permissible increase in down-lead length means that a position can be chosen for the aerial itself, irrespective of its distance from the set, thus making it easier to get away from any source of interference.

The efficiency of a screened down-lead system is very dependent upon its proper erection. So if you decide to go in for one, pay special care to every detail of the instructions supplied with it.

Good Earth Essential

You will find a list of the various outfits available, and all the makers will send you full details in order to assist you in deciding which one to adopt. Most of the kits include a length of screened wire, and this wire is a very important item—the wrong sort might ruin results.

Another important item is the earth. This must be good, and in some cases two or three good earths will prove beneficial.

So long as you erect your aerial in a position where it is free from inter-

ference, a screened down-lead system is as good as anything in ensuring quiet reception. And if the aerial itself is not free from interfering fields, nothing whatever you do can cure the trouble.

A screened down lead can be as useful on a battery set as on a mains set; so also can a suppressor at the meter. Don't forget that a suppressor at the mains receiver may be wanted with a screened down-lead system to keep out interference brought by direct conduction.

The most important point concerning the installation of screened down-lead systems has already been mentioned, namely to keep the aerial proper clear of all metal objects, as these in themselves may be conducting and spreading interference currents. The ideal to aim at is at least twenty feet from any metal object.

The next important point—really just as important as the first, I should imagine—is that the screening must be earthed well and truly. In some cases it may be desirable to run independent earth leads to different parts of the shielding.

Not Suitable for Short Waves

This, in the case of lead-covered "down leads" is imperative. The resistance of the lead is such that it may want earthing every foot or so. In such cases a copper wire can be run alongside of it for the purpose.

But lead has the advantage that it can be buried and thus earthed direct. This is worth taking advantage of, wherever possible. A depth of at least a foot is desirable.

Screened down leads, as normally installed, are *not* really suitable for

IT PLUGS IN



Behind this Bulgin suppressor are two pins for fitting an ordinary socket.

HOW THE UNITS ARE WIRED

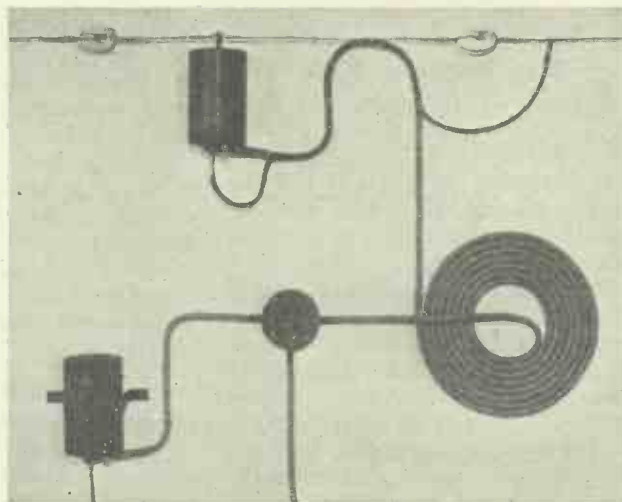

This photograph shows the method to adopt when installing an E.M.I. Service screened down lead outfit. Note the short insulated section on which is hung the aerial-end transformer.

A K.B. PRODUCT



The components for connection at the aerial and set ends of the down lead in the K.-B. Rejectostat system.

short-wave reception. If such is desired, it is best to use a "di-pole" type of aerial for the purpose.

Sometimes, when the shielding of the screened down lead is earthed only at the receiver, satisfactory short-wave reception is obtainable by simply breaking this connection.



A neat Goltone suppressor, ideal for wiring across D.C. motors and other D.O. appliances. The metal cover shuts down over the fuses.

A good deal of the interference experienced when working on ultra-short waves is due to radiations from the ignition systems of cars being picked up by the aerial direct. This is difficult to deal with except at the source.

Cars in which a radio is installed do not cause interference, but it would be a big undertaking to persuade every car owner to fit suppressors because of listeners. Particularly as many do not consider it can be done without affecting the efficiency of their engines.

SUPPRESSION at the SOURCE

THE correct place for an interference suppressor is at the source, that is to say, close to the electric motor or machinery which is causing it. A quite simple filter connected to the mains leads a foot or so—the closer the better—from the motor or other apparatus will prevent interference getting into the mains, and will also reduce direct radiation almost completely.

This applies to all domestic appliances, such as vacuum cleaners, electric fans, sewing-machine motors, hair driers and so on. Perhaps you may feel that such a suppressor will not be needed in your case because you never use your radio set when such domestic appliances are in operation.

Remember Your Neighbour

That may be very true, but it is rather a selfish thought really. When you use your vacuum cleaner in the morning it may be just the time that your neighbour tunes into some favourite programme.

As the Editorial this month points out, until mains suppressors are made compulsory by law, every listener is dependent on the good nature of the users of electrical apparatus. In the case of businesses with many motors, neon signs, etc., the question of silencing is an expensive one, but in the case of domestic apparatus the cost is very reasonable.

There are many homes, well away

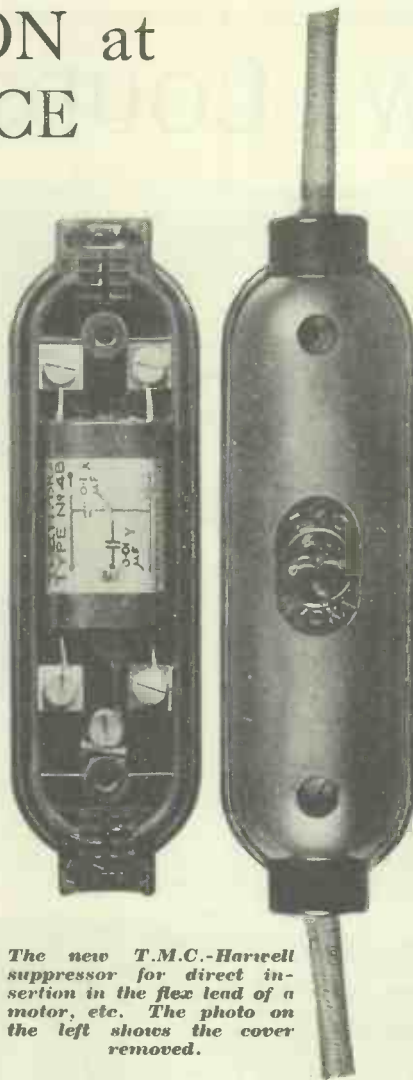

The new T.M.C.-Harvell suppressor for direct insertion in the flex lead of a motor, etc. The photo on the left shows the cover removed.

from any businesses, which are troubled with locally produced interference. A little attention by neighbours to domestic apparatus would give them noise-free reception.

Actually suitable suppressors for small motors, etc. cost no more than the types we have already considered in the first two articles. In very many cases the same units will prove admirably suitable.

But as the types of apparatus to which the suppressor may have to be attached vary considerably, we have not attempted to give a list of suggestions. The best plan is to tell the makers what it is you intend to connect the suppressor to—full details including wattage, voltage, etc.—and also

the type of plug it has. They will then be able to advise you individually.

Where one mains socket is used for a number of different items, it is reasonably effective to attach the suppressor on the wainscoting alongside the mains socket. Types of suppressor are supplied for this purpose in which a socket on the suppressor takes the place of the normal socket so far as plugging in the appliance is concerned. A short length of flex terminating in a suitable plug may be provided on the suppressor, or it may plug direct into the socket itself.

The Earth Point

When the three-pin type of socket—in which one point is wired to earth—is not provided, an extra earth connection will be needed. It is most important that this earth be a good one and that there are no bad contacts throughout its length.

Actually, of course, the nearer the suppressor can be wired to the appliance, the better the suppression. For this reason, the flex-lead type of suppressor, one of which is illustrated on this page, is very hardy and efficient. The point is that even a yard or two of flex may be long enough to radiate enough interference to affect a receiver working in the same house. And in this connection it should be mentioned that even if a suppressor is provided at the meter, one will still be required on any electrical appliance used in the house.

As with suppressors at the meter, or at the radio set, there are three connections to one used on a motor or other electrical device. There are two wires, terminals or plugs which are joined to the two mains leads, and a third point which is joined to earth, either direct or via the third socket on the mains point.

Short-Wave Interference

It is not sufficient to connect the earthing terminal to the case of the motor, etc., unless this is itself joined to earth. It is not advisable to use the same earth lead as that employed for the receiver.

Where interference is particularly bad on short waves there is little that can be done except to tackle the trouble at the source.

Quite often the use of a so-called "di-pole" aerial for short-wave reception will prove beneficial in reducing interference on short waves. As a matter of fact, the whole question of short and ultra-short-wave interference will come in for considerable attention when television starts.

THE GOLTONE AERIAL KIT



On the left is the transformer for the receiver end of the screened down lead, with its cover removed, and to the right is the aerial transformer.

HOW LOUDSPEAKERS

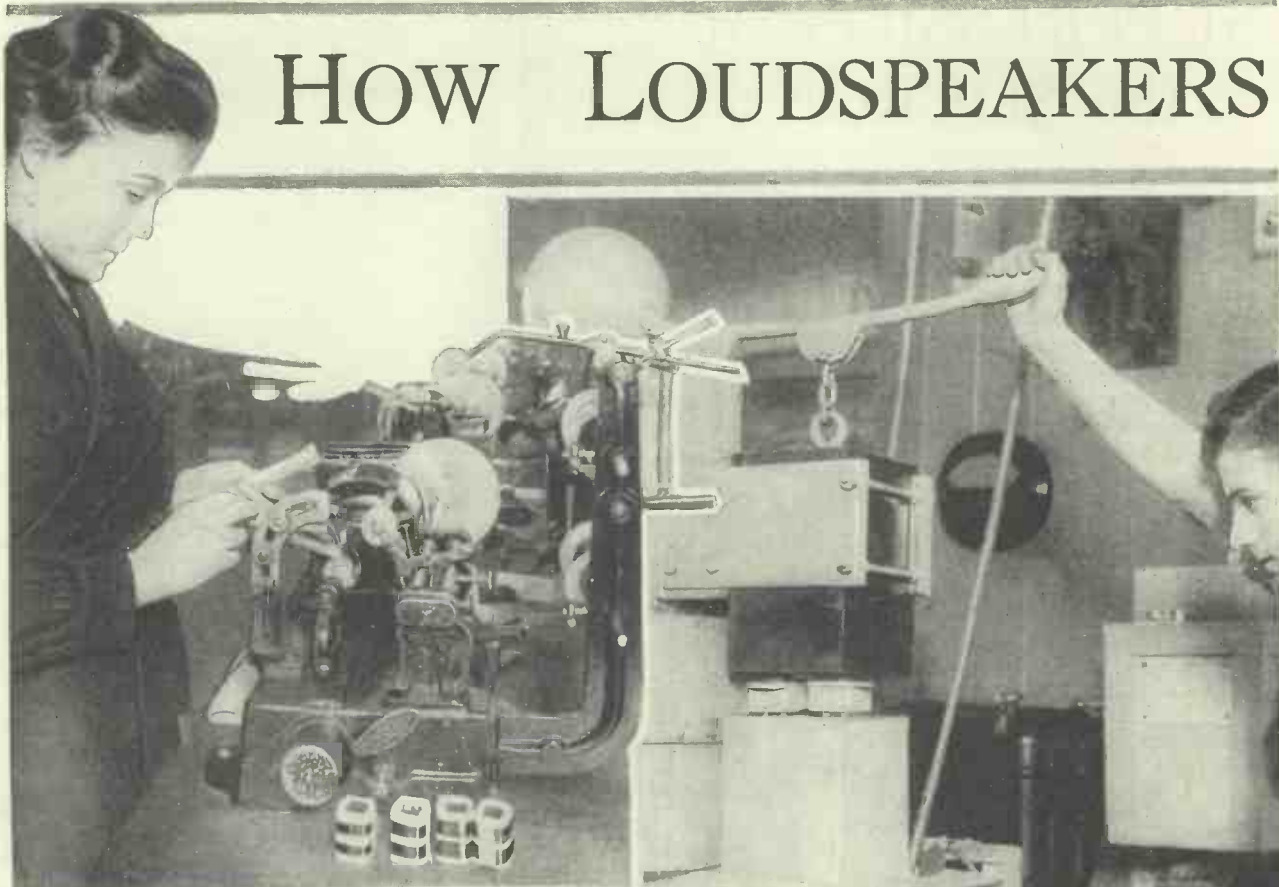

Top left: Winding the output transformer.
Above: How the field magnets are magnetised.
Left: An assembly bench, along which the speaker progresses from stage to stage.
Bottom: A plating room where magnets are given a coating of cadmium.

By G. S. TAYLOR,

“It has taken me months to realise that technical knowledge is of no use when you are designing a speaker. You just have to find a good magnet and then design cone, speech coil, and other parts on the hit-or-miss principle until you’ve got what you want.” This remark was made to me by a highly reputable set manufacturer who for months has been experimenting (unsuccessfully) with a view to manufacturing his own speakers. If he had experimented for a few more years he would have realised that there is a science in speaker design. It is nevertheless true that a knowledge of sets, although necessary, forms but a very small part of the

ARE MADE



Above: A corner of a research room where new ideas are tried.



Right: Perfect centring is achieved with this simple device.



Below: The tricky operation of winding a speech coil

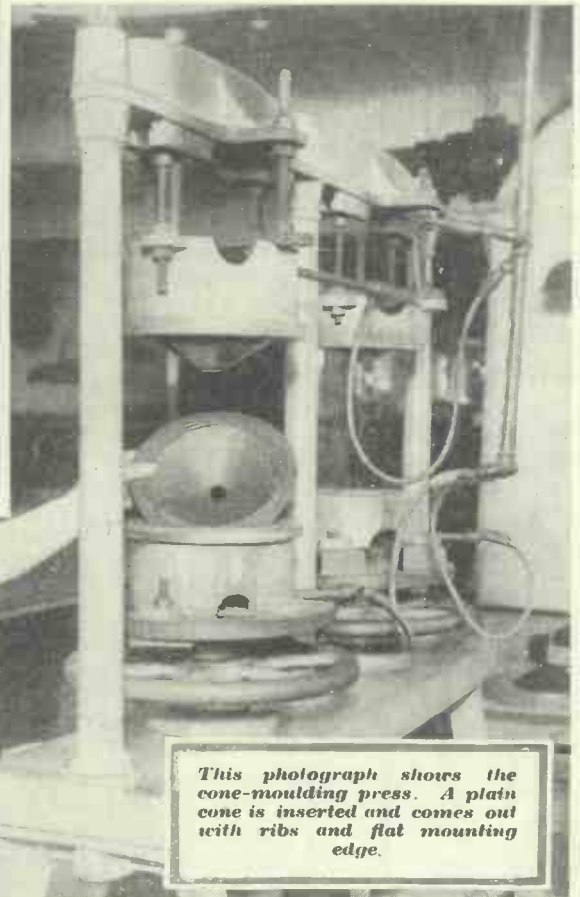

This photograph shows the cone-moulding press. A plain cone is inserted and comes out with ribs and flat mounting edge.

of Whiteley Electrical Radio Co., Ltd.

equipment of those who would design a good reproducer. An intricate knowledge of mechanics, an understanding of the abstruse arts of metallurgy in general and magnetism in particular, plus many years of studying the special problems of sound reproduction, are a necessary groundwork. After that it is purely a matter of continual experiment and the most meticulous care in design and manufacture.

Strangely enough, this most modern of industries has much in common with the older trades. Just as the modern mass-produced shoe or suit can never quite equal the high-class hand-made article, so (given equally

good design) the speaker, in the production of which modern high-speed methods have taken too great a part, can never quite attain the high standard of that in which certain of the delicate manufacturing operations have been carried out by hand. True, good output transformers can be, and are, wound on miraculous machines which wind and accurately count a thousand turns in a few seconds, switching themselves off and throwing out the bobbin immediately they find a break or kink in the hair-thick wire used. If pressure die-cast chassis are used, they also can be turned out at wonderful speed with perfect accuracy.

Quiet Industry

Mechanical conveyors and other modern time-saving devices all play their parts in producing a high-grade speaker economically; but the delicate operations of winding the speech coil, mounting it on the cone, and general assembly call for a high degree of personal care and accuracy which can only be achieved when the operations are carried out by hand, one at a time. Thus, instead of meeting at a good speaker factory the general bustle and clangour of modern production, the visitor finds an atmosphere of perfectly quiet industry.

Designing the Magnet

The most important single feature in a speaker is, of course, the magnet. Designing a good energised magnet—a complicated business in itself—appears simple in comparison with the problems of the "permanent" type. An interesting instance of the apparently inconsistent way in which magnets behave came to my own notice recently. My company had a magnet design incorporating an alloy of iron, nickel, aluminium, and a few other ingredients. That particular magnet gave outstandingly good results. Purely from curiosity to see what would come of it, another was produced precisely the same in every respect except that about 33½% extra weight was added by constructing it with a greater

depth. In spite of the extra cost and weight the larger magnet had on measurement a slightly lower flux density than the original! This provides a striking illustration of the fact

cleaners to keep the atmosphere free from dust! With quantities of partly assembled permanent-magnet speakers lying around this precaution is not so far-fetched as it sounds. To guard against the admission of dirt in the gap through minute and invisible "blow-holes" in the magnet casting, each magnet is thickly coated inside with paint (no metallic pigment in that, please!). Before that, however, it must be cadmium plated to prevent the formation of any tiny spots of rust which might later spoil the even surface of the gap.

Assembly

The speakers are assembled on benches about five feet wide and twenty yards long. Ranged on each side of the bench are operatives, each of whom has one special stage in assembly to perform—by hand. The various compo-

nent parts are fed to each operative by a slowly moving automatic conveyor. As each completes his particular work he passes it to the next; so that the speaker "grows" as it progresses along the bench. Interspersed among the workpeople are testers who check each operation which has so far been carried out. Thus, the speaker which arrives at the end of the line has already had each individual part inspected. It now passes through a small trap-door into a sound-insulated room, where it is tested on a calibrated oscillator having a range from 50 to 15,000 cycles.

The Last Stage

If up to standard it travels through another trap-door into another similarly insulated room where it is tested on an amplifier, first on speech and then on a special record containing "snatches" of every conceivable type of musical instrument and orchestra.

If "tone-colour" and other characteristics are satisfactory, it then goes through its last trap-door straight into a packing room, where it is immediately boxed for despatch. So you see that speaker manufacture is by no means a mass-production matter, but a highly scientific precision task.

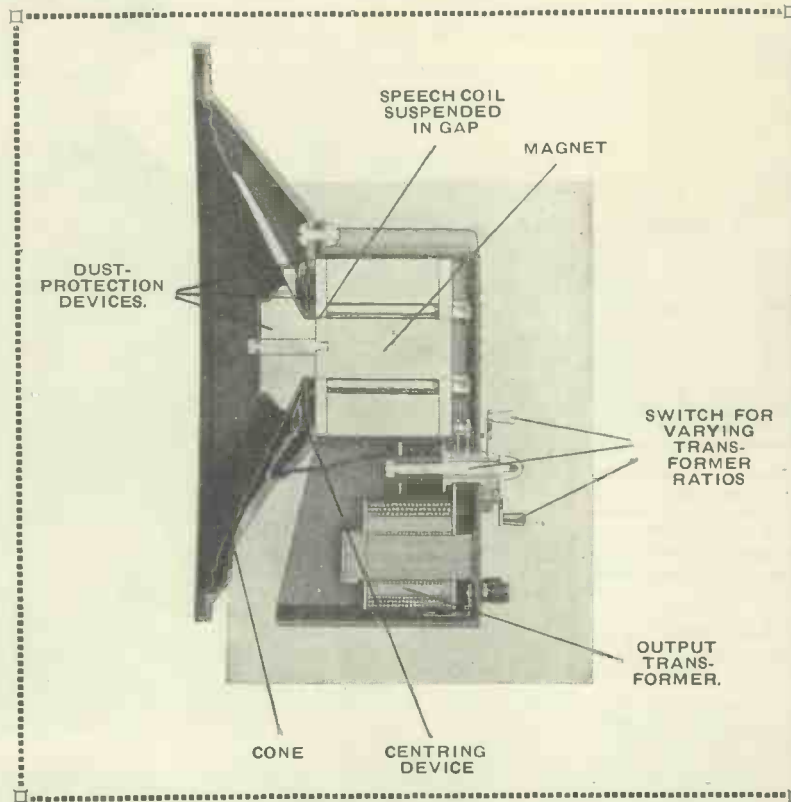

that even if two different magnets are made of similar material, it is quite impossible to judge their respective merits by comparing their appearance and size.

Speech Coil Requirements

The speech coil is another important item in a good speaker. It must be so proportioned that in its movement while the speaker is operating it travels outside the air-gap of the magnet as little as possible. It must be strong enough to withstand the surprisingly high stresses which arise during operation; yet it must not be heavy enough to damp the rapid vibration of the cone by its inertia. The fine wire with which it is wound must lie perfectly even and parallel with the sides of the air-gap, for although it is free to move as far as ⅜ inch forward, yet it clears the magnet by no more than 11/1,000 of an inch laterally. The noise produced by a tiny projection of wire must be heard to be appreciated!

In the manufacture of a really good speaker the most extraordinary precautions have to be observed. For instance, a maker may go as far as employing hands whose sole job is to go round the shops with power vacuum

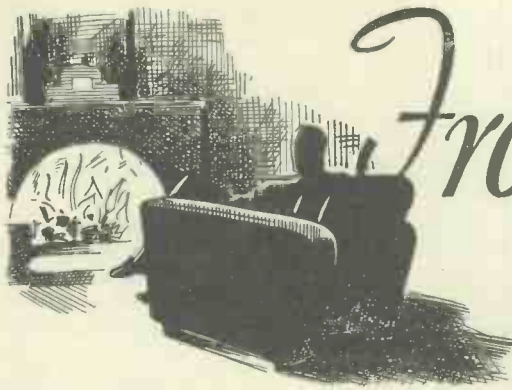

From My Armchair

HAVING just been listening to a Promenade Concert from the Queen's Hall, I have come to the conclusion that the human cough is the most obscene, irritating and selfish noise in existence.

Oh for a Beecham to put a stop to this disgusting habit, or, if not a habit, a disease-symptom disclosing that the victim should not approach within a stone's throw of the Queen's or any other hall at the peril of being stoned to death! Some of Sir Thomas' famous lung power would help enormously. If the conductor would stop the orchestra at every cough and hiss at the culprit: "Shut up, dang you!" the practice might cease.

What is the cure? Simply that coughers should stay away. The B.B.C. can hardly medically examine every two-shilling patron. It is idle to assume that all the coughers have caught the affliction while queueing up outside. They must have known their deadly complaint before ever they conspired to ruin the pleasure of their fellow music-lovers.

Not a single one of these coughers ever dreams of stifling the noise in a handkerchief. Nor do they save up their hideous contributions for the loud passages, or do useful work by backing up the claps of thunder. Oh, not at all! They wait till a quiet part comes along—preferably some very delicate filigree work by the solo pianist—and then ejaculate their hideous barks. They believe Nature abhors a silence, not realising that everyone else abhors them.

A "Cougheteria"

Could not a special part of the hall be partitioned off with holes in the glass connected

Mr. Scott-Taggart complains of the coughing that so often disturbs our broadcasts from public places, and suggests a drastic but certain remedy. Then he goes on to discuss the scientific mind, passing to water softeners and then to an amusing Man-cunian anecdote, before he closes on a more serious note.

by tubes to the ears of the coughers? If they complain, explain gently that their coughs come up through tubes. If this cougheteria idea is too drastic, some sort of hood on gas-mask lines could be used, the ears only protruding.

Believe me, I am not unsympathetic to catarrhal casualties as such. We have all coughed in our time. The odd thing—perhaps Freud could explain it—is that one wants desperately to cough when it is verboten. I remember how, after a ticklish appendix operation (the appendix had been ticklish) I was ordered on no account to cough. Well, I had never dreamt of doing so, but I had no sooner been warned than my lungs nearly burst with an almost irresistible craving to cough the building down.

HE HUSHED THE AUDIENCE



Sir Thomas Beecham examining the recorded wax after he had conducted a recording at the Columbia studios. Sir Thomas, you will remember, stopped the playing of an overture one night to command members of the audience to stop talking. He waited for silence before he would proceed, and then started again at the beginning.

I believe that dozens of otherwise decent folk who never cough from one year's end to another go specially to concerts to have a nice two hours' cough, perhaps just to reassure themselves that they *could* cough if necessity arose, or perhaps just to show their independence.

* * *

They say that all these 'ere new inventions—motor cars, flying machines, the wireless, and all that there—are making people scientific-minded. Bunk! They say that hundreds of thousands cleaning sparking plugs, draining radiators and tinkering with the lower intestines of an internal combustion engine, are bound to be actuated by the spirit of science. Piffle! They say that when boys of ten can make six-valve super-heterodyne receivers their whole lives will be coloured by a scientific outlook. Rot!

You might as well say that when a man suffers from aurora borealis before the eyes, quivering eyelids, hot breath, cold shivers down the spine, ear-flap, cramp in the arches of his feet, or nose-tip twinges (I avoid the more hackneyed symptoms), and then takes two pills before breakfast, he will go through life with the outlook of a doctor. He is far more likely to go through life with aurora borealis

before the eyes, quivering eyelids, hot breath, cold shivers down the spine, ear-flap, cramp in the arches of his feet and twinges at the tip of his nose.

Not One Per Cent

I honestly do not believe that one out of a hundred persons has a glimmer of the scientific mind. The fact is that rarely is the scientific spirit taught. It is slowly seeping into the medical profession, the last of the scientific professions to think with the brain of Euclid rather than the soul of Hippocrates.

But quite a large

number of scientific people are fundamentally unscientific and illogical. While those who tinker with mechanics and potter with radio have usually missed the holy fire altogether.

One feature of the scientific outlook is to disbelieve. Or rather to be agnostic. I do not mean in the realm of faith—although even there the man with the scientific outlook finds it hard to pull the reins of his habitual attitude of mind. The small boy who wrote "Faith is believing what you know quite well isn't true" was probably a scientist. By an agnostic I mean a man who says "Show me."

The young scientist, still wet around the ears and afflicted with the acne of self-conscious graduation, marks his arrival by aggressive disbelief. As he feels his feet he disbelieves all the inventions he reads about—and disbelieves all the theories of his fellow scientists. Unless he mellows into the flexible and open—but not too open-minded progressive type of scientist, his old age is just one long series of conversions from unbelief, but by the time he has been convinced nobody cares what he thinks.

The spirit of "prove it" has its disadvantages. Very few scientists ever invent. That is partly because it is rather vulgar to invent anything, especially if you make any money out of it, but chiefly because a mind that is essentially critical and analytical is not the kind likely to create. The scientist's spiritual home is the jury box. The inventor's home is the dock. Fortunately the judge is History, but often the Lords of Appeal in Ordinary are nearly as good.

The Chemist

The pure scientist may apply the brake to invention through his sardonic unbelief, but he does consolidate the secrets wrung from Nature. And every man, in my opinion, would be the wiser for a strong dash of cautious unbelief. I say "man" advisedly, for practically no woman (*pace* Mme. Curie of radium fame) can so contort her normal mental outlook as to become scientific or logical.

The other day I was in a chemist's shop and saw an odd-looking contraption which a fully-qualified pharmacist

THE WATER-SOFTENER

declared was for softening water. My face ingenuously betrayed explosive disbelief that the contraption could soften anything. It had, however, evidently softened the pharmacist's heart—and possibly even his brain—for he stoutly declared: "It works very successfully. We've sold a lot of them, and we wouldn't have done so unless they worked very well."

What is Wrong?

Now the average woman would have said: "Oh, how interesting, and will it really make washing-up easier?" and, having taken it home, would have hardened her muscles without softening any water. But even so, having paid her money and not being at all scientific, she would say to herself: "Yes, I think the water is rather softer."

Now then, Form I of my school for scientific thinking, what is wrong? Well, first of all, the chemist is either actually incompetent or a lying charlatan who prefers food and lodging for

- swindling the public on a large scale with quack devices;
- (b) that the local inhabitants were more than usually brainless mutts and equipped by heredity with a niggardly supply of horse-sense and therefore peculiarly gullible;
- (c) that the local water was very hard and that the housewives were at their wits' ends and ready to clutch at anything that looked like a straw—even a broken reed.

If Mr. F. tried to push you into buying some shares in the North and South Pole Oil Wells Company, Inc., what would you say if he enthused: "We've sold a lot of these shares, therefore there must be oil there."

The scientific or even sensible person would disbelieve, or at least receive with caution the statement that large sales had been effected. Every salesman says that; just as you, if you write to me grousing about something, are sure to add: "And all my friends think the same."

When the woman gets the contraption home she proves her scientific dishonesty by refusing to nourish a deep-down doubt about the gadget's efficiency. The scientific but not very tactful husband would at once say: "You've been hoaxed. You've thrown away your (or my) money." In other words, it's a wash-out that won't help her wash-up.

Too Credulous?

A woman's touching readiness to believe the best even in a water-softener is partly to be condoned since she has no scientific means of testing water hardness. The scientist would want an analysis before and after using the gadget.

I started by asking for critical comments on this anecdote. It is only fair to admit the

suggestion that I myself may have been prejudiced, ignorant of how the gadget worked, and that the device was, in fact, an admirable one. If you think that makes any difference, it proves you have learned nothing in my school. My scientific retort is that even if the device worked perfectly, the chemist's argument still remained

(Continued on page 253).

IN THE SOUTH OF FRANCE



An enormous pond is used to provide the water for cooling the transmitting valves of the new Mediterranean station "Radio-Cote d'Azur."

his wife and children to the inward exaltation of adherence to a scientific code.

Secondly, only a hare-brained nincompoop would believe that large sales would prove efficiency. They might prove:

- (a) that the chemist was a thorough-paced rascal endowed by nature with a peculiar faculty for

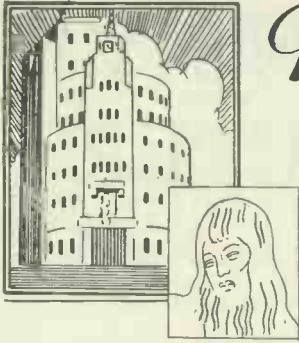

British Broadcasting NEWS & VIEWS

By "Prospero"

Animals to Broadcast—Rocky Mountaineers Again—Useful Propaganda—The May Music Festival—
Music and Microphone Technique

New Belfast Transmitter

THE opening of the new Belfast transmitter will be the occasion for the first week of "gala" programmes ever put on by the Northern Ireland station of the B.B.C. These will begin on March 22nd, and will include the following features, according to present arrangements:

Harry Hemsley in "Winnie's Hour"; "His Last Day in Business," a radio drama specially written by Mr. George Shiels, the well-known Ulster playwright; concerts by Ketelbey and Godfrey Brown; two Music Hall O.B.'s from the Empire Theatre, Belfast, together with features starring the Western Brothers and Larry Adler. This looks like a strong week, and I shall expect the National programmes to absorb a good proportion of the material.

"Camp-Fire on the Karoo"

This is the engaging title which Bill Campbell has given to the new version of Rocky Mountaineers series which he will present in the Regional from 9 to 9.30 on March 19th. Mr. Campbell is becoming one of the most popular B.B.C. artists. Incidentally he has celebrated his rise to fame in this country by getting married. Al and Bob Harvey are his principal sparring-partners now.

Talks on the Zoo

Julian Huxley has at last been persuaded by his cousin, Roger Eckersley of the B.B.C., to broadcast a special series of five talks on Zoo animals during April and May. These will be illustrated by the animals concerned. The presence of Zoo animals at Broadcasting House will not be an entire novelty. Mr. Eustace Robb, when he was running thirty-line television, brought in a couple of sea lions that did better at the microphone than in the lifts.

Subsequently a proposal to include a lioness and a tigress in "In Town Tonight" was vetoed, it is understood, by Admiral Sir Charles Carpendale, who felt that the handling of wild animals in addition to artists might more than tax the resources and good humour of his administration machine. But this time there will be no holding back the denizens of the jungle. Mr. Huxley has most definitely

got it all sealed and signed in his arrangements.

A Dr. Johnson Programme

The great Dr. Samuel Johnson will be the subject and hero of a feature programme which Moray Maclaren of the B.B.C. is building for March 18th, when it will be presented in the Regional from 9 to 9.40 p.m. Mr. Maclaren has got together some rare new material, and this promises to be a really high spot of B.B.C. performance.

Road Safety and Litter

The B.B.C. has been doing a lot of thinking and planning about how to help the causes of road safety and anti-litter. It has been finally decided and approved to undertake a definite experiment in the national transmissions in the April-June period. Five fortnightly periods of five minutes are being put aside for appropriate talks on these subjects. Also there is to be a debate between a motorist, a cyclist, and a pedestrian on road safety. Finally, the various official reports on road safety of children will be specially publicised in the B.B.C. news.

The Toscanini Dates

I have just had the dates of the special Toscanini concerts of the B.B.C. May music festival this year. The six concerts will take place in the Queen's Hall as follows: May 22nd and 27th; June 2nd, 4th, 9th and 15th. This promises to be the high-water mark of B.B.C. musical achievement so far. All the concerts will be broadcast in both parts.

The Presentation Battle

Hostilities have broken out again on the presentation front. By this I mean that the truce between the purist musicians and the broadcasters is off. With the development of the technique

(Please turn to page 257.)



FREDDY DOSH—

the most famous imitator on the Continent, experimenting with a new "noise" device. Has broadcast with the B.B.C. An amusing incident occurred during a broadcast of his in the National programme. He had just imitated a train slowing down in the station, there was a few seconds' silence, and then a sudden clatter—as though the train had run into the buffers. Followed the voice of the announcer, "That was not Freddy Dosh, but my falling over the studio chair!"

INEXPENSIVE MAINS SUPERS

A valuable review of the less costly all-mains superheterodyne receivers, which should prove particularly helpful to the buyer whose first consideration is value for money.

By A. JOHNSON-RANDALL

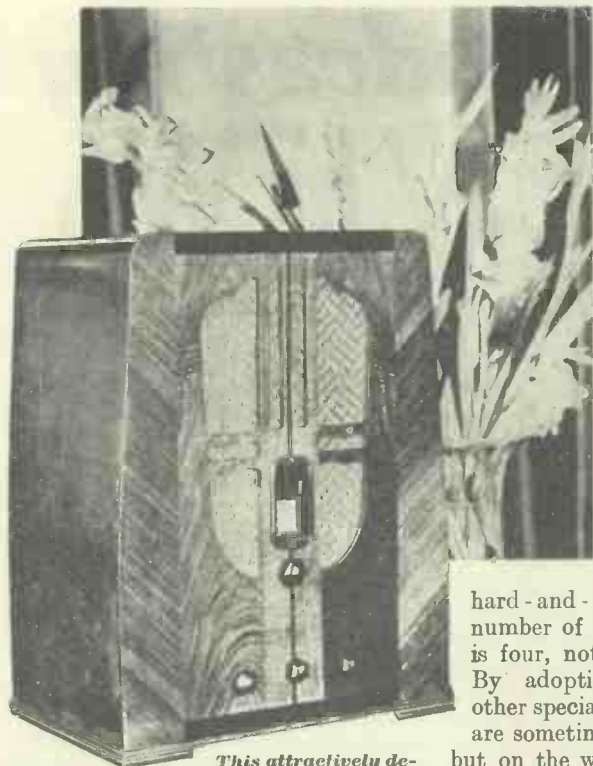

This attractively designed instrument is the Philco Model 250, which costs eleven and a half guineas.

TECHNICIANS have always agreed that the superhet is a very desirable principle where high selectivity, coupled with a big range of reception, is concerned. And there is nobody who will disagree with the necessity for high selectivity at the present time.

But apart from any question of selectivity, there is another point in favour of the superhet, and that is its simple handling. With just one tuning control it is possible to tune in station after station with the greatest of ease, and without having to carry out any subsidiary adjustments in order to achieve the necessary degree of station separation. So great have been the strides made by the set manufacturers that it is now possible to obtain a highly efficient superhet, capable of fulfilling every reasonable need, for a price round about twelve guineas. This is a fair average. One or two of the models are slightly less than this, and a few a little more.

Although there is no

hard-and-fast rule, the popular number of valves in this price-class is four, not including the rectifier. By adopting reflex circuits and other special schemes, manufacturers are sometimes able to save a valve, but on the whole four seems to be a fair average. On this page you will see the theoretical circuit arrangement of the Aerodyne "Silver Wing."

Selective and Sensitive

This particular circuit is the A.C. mains version and consists of an octode, H.F. pentode, a double-diode, and a steep slope L.F. pentode. The rectifier is of the full-wave type. You see what the valve manufacturer has done to simplify matters for the set designers.

In the circuit in question the incoming programmes are fed through a selective band-pass circuit on to the control grid of the octode mixer valve. This valve also performs the duties of oscillator and intermediate-frequency amplifier. The oscillator circuit is ganged to the aerial circuit, so that only one control is necessary for tuning.

Then there are two tuned intermediate frequency transformers, the second valve—an H.F. pentode—giving very high amplification indeed. Moreover these two tuned intermediate frequency stages add further to the selectivity of the set, and the result is that you have a circuit with a very high degree of selectivity.

The double-diode performs two duties. The first is that of second detector, and the other that of applying automatic volume control to the first two valves.

The fourth valve in the circuit shown is a steep-slope L.F. pentode, and is capable of providing all the volume that one can possibly want, together with very good quality.

Representative

Now this circuit may be called representative of a very large number. Although the number of valves is reduced to its minimum, they are so arranged that high amplification, coupled with fully adequate station separation, (Continued on page 231).

TYPICAL OF THE CIRCUITS EMPLOYED

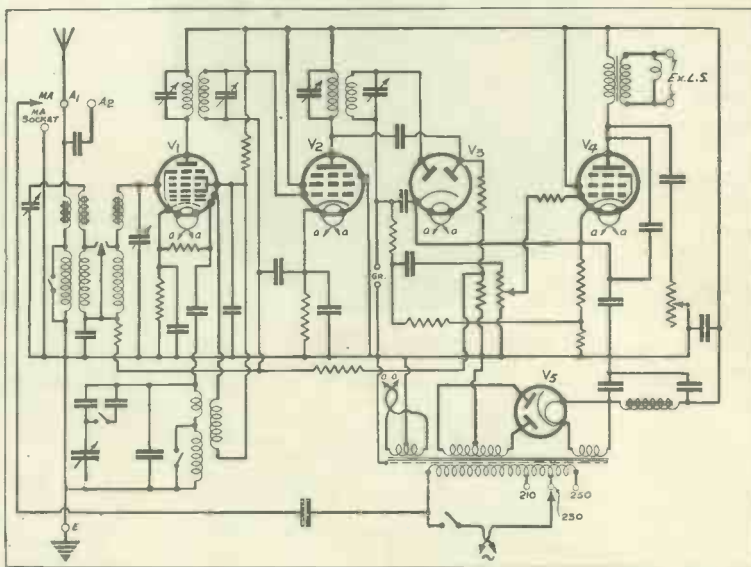

Apart from the full-wave rectifier for H.T., the valves in this Aerodyne "Silver Wing" circuit are: Octode frequency changer, multi-mu H.F. pentode as I.F. amplifier, a double-diode detector and A.V.C. valve, and an L.F. pentode output valve.

Representative Receivers

The sets illustrated on this page are typical of the attractive designs which are available at reasonable cost and which employ all-mains super-het circuits.

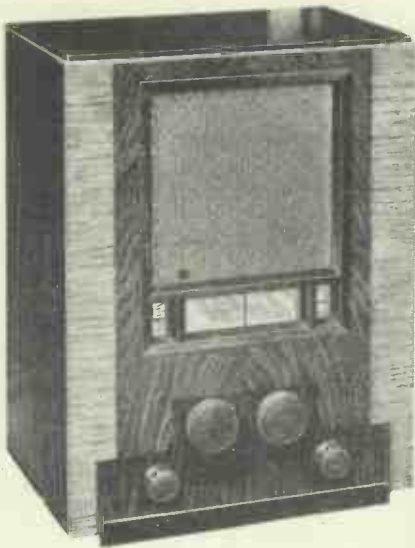

HALCYON 4701 DESIGN



CLIMAX Q.S. 5 RECEIVER

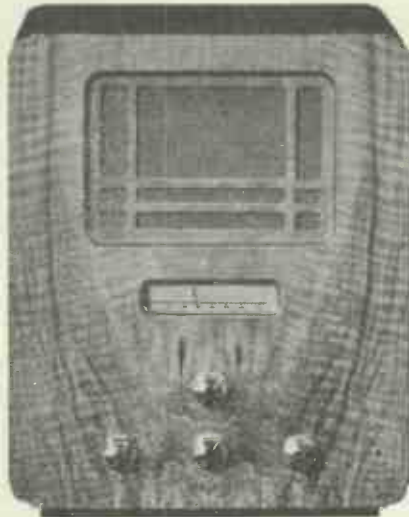

BURNDEPT MODEL 226

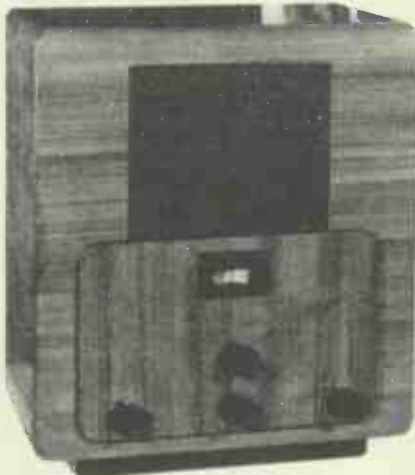

MURPHY A 26 TABLE MODEL



LISSEN MODEL 8111



COLUMBIA TONE RADIO No. 357
THE AERODYNE "SILVER WING"
(BELOW)



BLUE SPOT A.C.5

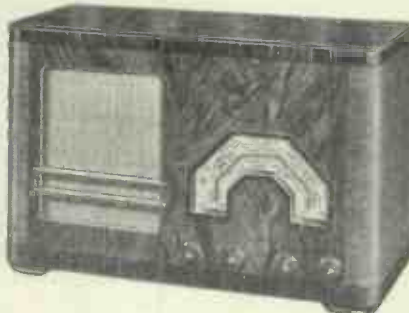

THE G.E.C. A.C.4



CLASSIFIED DETAILS OF POPULAR SETS

MAKE	MODEL	SPECIFICATION IN BRIEF	PRICE
AERODYNE	"SILVER WING"	Model A. Six-stage Consolette for A.C. mains, 200/250 v. 50 cycles. Model B. Universal model for A.C. or D.C. mains, 200/250 v. Band-pass tuning, full delayed A.V.C., variable tone control, inter-station noise suppression, pick-up and external speaker sockets.	Model A : £11 11 0 Model B : £12 1 6
ATLAS	A.758	Four-valves plus rectifier, A.V.C., Spectrum tuning, and tilting dial for easy operation. For A.C. mains, 200/250 volts, 40/100 cycles.	12 guineas, or 11 guineas without pedestal. A.C./D.C. receiver. Model A.D.12, price 12 guineas without pedestal.
BLUE SPOT	A.C.5	Table model with fully compensated A.V.C., seven tuned circuits, image suppression, 2.6 watts, undistorted output, provision for extension speaker. Designed for A.C. mains, 200/260 volts, 40/100 cycles.	12 guineas
BURNDIPT	Model 226	Consolette, 5-valve circuit, A.V.C., visual tuning, variable tone control. For A.C. mains only.	12½ guineas
BUSH	S.A.C.21	Consolette, four valves (not including rectifier), seven tuned circuits, delayed A.V.C., consumption 55-60 watts, undistorted output, 3.5 watts, Escalator tuning. For A.C. mains, 200/250 volts, 40/100 cycles. Provision for pick-up and external speaker.	11½ guineas
BEETHOVEN	Model 77	5 valves, 7 stages, 3½ watts output, Q.A.V.C., with switch for changing over to full A.V.C., image suppression, pick-up and external speaker sockets. Internal capacity aerial to permit set to be used as a "Portable."	11½ guineas
CLIMAX	Q.S.5	Seven-stage circuit with balanced band-pass input, Q.A.V.C., Manual tone and volume controls, gramophone pick-up and extension speaker sockets, mains aerial, 3½ watts output. For A.C. mains.	12 guineas
COLUMBIA	Model 357	Five valves (including rectifier), Q.A.V.C., with adjustable sensitivity, constant tone volume control, pick-up and extension speaker sockets, mains aerial. For A.C. mains, 200/250 volts, 50/100 cycles.	12½ guineas
COSSOR	Model 384	Four valve (plus rectifier) superhet for A.C. mains 200-250 volts, 40-100 cycles. Special anti-fading circuit, thermometer tuning, mains energised moving coil speaker, sockets for extension speaker and gramophone pick-up.	11 guineas
EKCO	A.C.76	See details on another page.	11 guineas. Universal mains version, 11½ gns.
EVER READY	5006 and 5008	MODEL 5006.—5-valve (including rectifier), table model for A.C. mains. Seven tuned circuits, Q.A.V.C., provision for pick-up and external speaker. For A.C. mains, 200/250, 100/150 volts; 25/40, 40/100 cycles (four models). Consumption 60 watts. MODEL 5008.—3 valves (excluding rectifier). Other features similar to A.C. model. Suitable for A.C. or D.C. mains. Consumption 50/70 watts.	Both Models 12 guineas
FERRANTI	Nova Consolette	Three valves (plus rectifier), band-pass aerial input, image rejection, variable tone control, mains aerial, A.V.C., 2½ watts output. Two models are available, one for A.C. mains and the other for A.C. or D.C. No mains aerial or pick-up sockets are provided in the latter instrument.	A.C. Model, 11 guineas. A.C./D.C. Model, 11½ gns.
G.E.C.	"Superhet A.C.4"	Four valves (including rectifier), delayed A.V.C., provision for internal or external aerial, sockets for external speaker, consumption 60 watts. For A.C. mains, 190/250 volts, 40/100 cycles. Also there is special A.C./D.C. model suitable for D.C. 200/250 volts, and A.C. 200/250 volts, 25/100 cycles (Model D.C.—A.C.4.)	A.C.4, 11 guineas D.C.—A.C.4, 11½ guineas
HALCYON	Models 4701 and A.C.7	MODEL 4701, for A.C. or D.C. mains, 4 valves (plus rectifier), 7 tuned stages, A.V.C., tone control, visual tuning, image suppression, provision for pick-up and external speaker, 2½ watts output. Model A.C.7. For A.C. mains only, 200/260 volts, 40/100 cycles. Models for non-standard mains to order at no extra cost.	Both models 14 guineas.
H.M.V.	Models 340 and 441	See details on another page.	Model 441, 12½ guineas Model 340, for A.C.—D.C. mains 11½ guineas
KOLSTER-BRANDES	K.B. 426 and K.B.427	Model 426.—For A.C./D.C. mains. 4 valves (plus rectifier), six tuned band-pass circuits, A.V.C., combined variable selectivity and tone control. Built-in mains filter. Consumption 60 watts. For A.C. mains, 200/270 volts, 40/100 cycles, or D.C. mains, 200/270 volts. MODEL 427.—Similar specification to model 426, but for A.C. mains only.	Both models 12 guineas
LISSEN	Model 8111	For A.C. mains, 200/250 volts, 40/100 cycles. Screened band-pass input with universal aerial coupling, A.V.C., with pre-set sensitivity control, tone control. An A.C./D.C. model is also available (Model 8110).	Model 8111, 11 guineas Model 8110, 11½ guineas
McMICHAEL	Models 235 and 535	See details on another page.	Both models 12 guineas.
MARCONIPHONE	Model 224	See details on another page.	11½ guineas.
MULLARD	MU 35	Six valves, full delayed A.V.C., variable inter-station noise suppression, mains interference filter, 3½ watts output, provision for external speaker and pick-up, tone control. Consumption 60 watts. For A.C. or D.C. mains.	12 guineas
MURPHY	A.26	Five valves (including rectifier), A.V.C., image suppression, variable tone control. Consumption 59 watts at 50 cycles, 61 watts at 25 cycles. For A.C. mains only.	£9 17s. 6d.
PHILCO	Models 280 and 281	Five valves, A.V.C., tone control with bass compensator, 3 watts output, image suppression, extension speaker sockets, pick-up sockets operated by wave-change switch.	Model 280 is for A.C. or D.C. mains and Model 281 for A.C. only. Both models 11½ guineas.
PHILIPS	585 U	Five valve A.C./D.C. receiver, Q.A.V.C., visual tuning, variable tone control, automatic current regulator, provision for pick-up and extension speaker, interchangeable station name dial.	14 guineas.
PYE	Models T.7 and T.4	MODEL T.7.—Five valves (including rectifier), Q.A.V.C., pre-set sensitivity control. Tone control. Consumption 56 watts. Four models are available to suit all A.C. mains voltages. MODEL T.4.—For A.C. or D.C. mains. Similar features to T.7. Suitable for 200/250 volts, 25/100 cycles, A.C., and 200/250 volts D.C.	Both models 12 guineas

Continued from page 228.

ample output and good quality are obtained.

In addition to the anti-fading refinement which is to be found in the modern superhet, it is usual for a tone control to be provided, as well as gramophone pick-up sockets, and sockets for an extension speaker.

The tone control enables the listener to adjust the tonal balance to his own particular requirements. In some instances the volume control, that is the manual volume control, is tone-compensated. This means that no matter what degree of volume is chosen the correct balance of high notes to low notes will be retained.

The Aerial

Although the average superhet is designed for use with a conventional aerial, that is to say, either an external aerial, or a wire in the loft or round the picture rail, many of them also have a special socket enabling the mains to be used as an aerial. One or two are provided with an internal aerial, the set thus being used as a transportable when occasion demands. It will be understood, however, that the sensitivity of the mains aerial or one of the internal type, is very much less than it would be if an external aerial were used. But the scheme is often quite satisfactory, in so far as reception of a large number of programmes is concerned.

The refinements and developments I have already mentioned are to be found in superhets round about twelve guineas. The various models in this price-class are, of course, of the console type: you can't expect to buy a console or a radiogram at this price if it is to embody those features which are so desirable on the radio side.

MAKE THE MOST OF YOUR RADIO

Next month "Wireless" will be presenting a special feature dealing with pick-ups, record-motors and microphones. It will tell you all about the reproduction of records on your set, and how to make the most of the possibilities of the "pick-up" contacts which are provided on most modern receivers.

In all of the twelve-guinea class receivers, a moving-coil loudspeaker is fitted; usually it is of the mains energised type, although there are cases of permanent-magnet instruments being used.

Generally speaking the average undistorted output is from two to three watts. This is, of course, more than

sufficient for ordinary domestic purposes, so that there is no question of distortion due to overloading of the valve taking place under normal conditions of use in the home.

Also the manufacturers have done everything they can to make the actual

A "G.-B." STAR



This is Anna Lee, the Gaumont-British film star, with her Bush superhet receiver, a model which costs 11½ guineas.

finding of a given station as easy as possible. The usual practice is to mark the tuning scale in wavelengths, and in addition to insert the names of the most popular European stations opposite their wavelengths on the scale. One can, therefore, adjust the tuning indicator to the station name, and there is no need to know the wavelength from which the station transmits. But, of course, the wavelength calibration is invaluable for tuning in those stations not marked by name.

There is a very noticeable tendency these days for makers to provide universal mains versions of their A.C. models. You will notice, when you look down the table giving a number of the inexpensive superheterodynes at present on the market, that time after time the A.C. version is available in A.C./D.C. form. There is very little difference between the prices of these models, and the A.C./D.C. versions give a performance fully comparable with that given by their A.C. counterparts.

Twelve guineas is the price of the Mullard MU35 receiver illustrated here.

There are many to whom an A.C./D.C. receiver is essential. For example, those who are at present on D.C. mains and know full well that they are to be changed over to A.C. in the near future. Or those who are residing in D.C. districts and who intend to move into districts where A.C. is supplied.

The purchase of a universal mains set in these cases is a definite economy. On the other hand there is no point in listeners who are already connected up to A.C. mains buying any other than an A.C. mains model.

There are, however, quite a number of people in this country who are on non-standard mains; in some cases, perhaps, the frequency of the supply is 25 cycles, in others the voltage may be less than 200. But this need not cause any undue worry since it is quite usual for the various models to be available having the necessary modifications to suit mains of this type. Perhaps there will be a slight extra charge, but it won't be very much.

First-Class Sets

At any rate, the 1936 mains superhet priced at between 11 and 14 guineas is a first-class job in every way, and one that will give interference-free programmes coupled with tip-top reproduction. And moreover, it will need little or no attention for surprisingly long periods.

When you buy a set get it from one of the makers' authorised dealers, because by so doing you are at the same time getting a guarantee of service should any small fault develop. Your dealer will be only too willing to put your set right if you just give him a call.

MADE BY MULLARD



THE name H.M.V. is synonymous with high quality reproduction.

This great firm is second to none in its long experience in the manufacture of mechanical reproducers of music. After so many years of research and development in the acoustic gramophone field, it was fitting that H.M.V. should, with its vast resources, turn its attention to radio. And it is, of course, unnecessary to state that the various models from the Hayes factory incorporate the most up-to-date advances in radio science.

The two models of greatest interest to readers of this article on inexpensive superhets will undoubtedly be the Superhets 441 and 340.

The 441 is designed for A.C. mains only and costs 12½ guineas. The model 340 is for either D.C. or A.C. mains and its price is 11½ guineas.

Dealing with the A.C. mains model first: This is a console set incorporating five valves, including the rectifier—the rectifier, incidentally, is of the indirectly-heated type. This ensures the absence of high voltages until all the valves have reached their correct operating temperatures.

Tone-Compensated

Quiet automatic volume control is a feature, the functioning of this part of the circuit being such that all noise when changing from one programme to another is obviated. There is also a threshold control by which the user may adjust the setting to his particular local conditions. The volume control is tone-compensated, so that the tonal balance is correctly proportioned, no matter whether the output from the speaker is adjusted for loud or soft reception.

The undistorted output is 2 watts and the

H.M.V. UNIVERSAL SUPERHET FOUR

roofs, water pipes, gutters, and so on.

Another point, and an important one, is that should the back of the set be removed the supply to the mains is instantly cut off. With D.C. receivers the listener should always look for a safety measure of this nature, especially where there are children in the family.

A further refinement is the provision of a local-distance switch, so that the sensitivity can be cut down when listening to the local station.

The circuit of the Model 340 is of a very advanced type. For example, there is a heptode frequency changer, the intermediate frequency output of which is passed to the control grid of a double-diode pentode. This valve functions as an intermediate-frequency amplifier, detector, low-frequency amplifier, and A.V.C. valve.

R.C. Coupled Pentode Output

This particular valve is coupled to a pentode output valve by means of a resistance capacity network.

The rectifier valve is joined in series with one of the mains leads, functioning as an H.T. rectifier when used on A.C. and a low series resistance on D.C. supplies.

The model 340 has a power consumption of 90 watts, and like the A.C. version it is fitted with automatic volume control and other special H.M.V. features.

Both sets are attractively housed in finely finished walnut cabinets, and the makers claim that the polishing process which all H.M.V. instruments undergo, makes them proof against minor scratches.

As is to be expected both of these receivers are excellent examples of the most up-to-date radio practice.

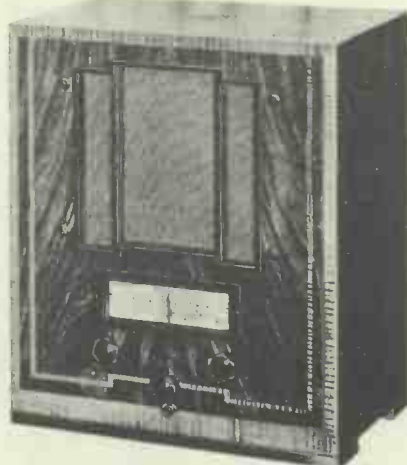

Known as the Model 340, this receiver will work on A.C. or D.C. mains.

power consumption 70 watts. Those who wish to use a pick-up or an extension speaker may do so, since the makers have made provision for these additional fittings.

In the case of the model 340, namely the A.C./D.C. model, the same high performance as regards sensitivity, selectivity and reproduction is achieved.

There are alternative aerial sockets, one being for use with normal aerials and the other for high capacity aerials, such as those which have to be erected in the proximity of a large quantity of metal, such as lead

THE McMICHAEL MODEL 235

—An A.C. Set Using Four Valves

ALL McMichael receivers are built with one end in view: That is, whatever happens the general standard of workmanship and quality must be irreplaceable.

The least expensive superhet in the McMichael range is priced at 12 guineas, and is known as the model 235. The cabinet design is definitely distinctive. While being attractively modern it is, at the same time, not so modern that it would be out of place in other surroundings. As an alternative to the standard walnut finish, those who prefer the ultra modern have the choice of a special black and ivory finish.

The circuit itself is of the band-pass type, special attention having been given to the question of selectivity. This is exceptionally high, and self-balancing aerial coupling provides constant performance over the whole tuning scale.

Mains Static Suppressor

There are four valves, including the rectifier, full automatic volume control operating on the first and second valves, reducing fading on distant stations to a minimum.

The tuning scale is calibrated in station names and wavelengths, the position of each station being indicated by a travelling knife-edge pointer, which intercepts a series of diagonal lines which appear behind the station names upon the scale being illuminated.

In order to ensure silent operation a mains

static suppressor is fitted. This cuts electrical interference troubles down to a minimum.

The undistorted output available is 2½ watts. Sockets are provided for additional loudspeakers and for gramophone pick-up. The speaker in the set can be switched on or off as desired when an extra loudspeaker is connected up.

As regards power consumption, this McMichael superhet requires only 60 watts, that is to say, it will run for 17 hours approximately on one unit of electricity.

There are four controls, namely one for tuning, a knob for switching the set on and off and controlling volume, and two further knobs for tone adjustment and wave-changing.

The Model 235 is, of course, a table receiver, but the makers will supply a special stand at an extra charge of 25s. The hire purchase terms are: Deposit 21s. 11d.

A special stand is available for the McMichael 235, which set can also be had in black and ivory finish.

followed by twelve monthly payments of 21s. 11d.

For those who prefer a universal version there is the Model 535, which is a five-valve set of the same external appearance as the 235. Its performance is equal in every way to that of its A.C. counterpart, and the price is the same. The power consumption is 70 watts.



MARCONIPHONE 224 RECEIVER

—For Universal Mains Operation

IN the extensive Marconiphone range there are set to suit every pocket. And of their superhets, the least expensive model is the 224, a table grand which can be used on either A.C. or D.C. mains. This is a point which will appeal especially to those who are already on D.C. mains, and who may be going over to A.C. mains in the near future.

The circuit is unusual in that it is of the reflex type. There are only four valves, including rectifier, and the designers have arranged them in the most advantageous manner so as to get the very maximum out of each one.

Four-Purpose Valve

There is, for example, a heptode mixer, followed by a double diode H.F. pentode, which performs the functions of intermediate frequency amplifier, detector, L.F. amplifier and also is the source of the automatic volume control voltages. A catkin pentode is employed in the output stage.

As an indication of the maker's determination to get the utmost efficiency from the set, I would mention the fact that the H.F. coils are wound with Litz wire. This type of wire is probably the most effective that can be used for carrying H.F. currents, and owing to its very low H.F. resistance a big improvement is obtained over ordinary methods of winding in so far as selectivity and amplification are concerned. For the benefit of those who have not handled Litz wire, it is a conductor consisting of a number

of strands of very fine copper wire, somewhat similar to the well-known flex for electric lighting. The outer covering is usually of silk and each of the individual wires is insulated by means of an enamel coating or a silk covering. Thus you have a flexible consisting of perhaps 20 or 30 strands of wire, every one of which is a completely separate conductor.

However, to proceed with the receiver under review: There is a mains energised moving-coil speaker fully capable of doing justice to the amount of power available from the output stage. The power consumption is 90 watts—less than many electric lamps.

As in all Marconiphone designs the number of controls has been cut down to the very minimum compatible with efficiency. In the model 224 there is a tuning knob, operating a knife-edge pointer which moves horizontally over a flood-lit wide vision tuning scale. The other controls are for volume and wave-changing, while coupled to the tuning control there is a supplementary sensitivity switch which can be brought into use for local station reception when the full sensitivity of the receiver is not required.

A separate mains switch is located on the left-hand side of the cabinet.

A Point to Note

The standard model is designed for use on mains voltages (D.C. or A.C.) of 200–250, and frequencies from 25–60 cycles.

The price of the Model 224 is eleven and a

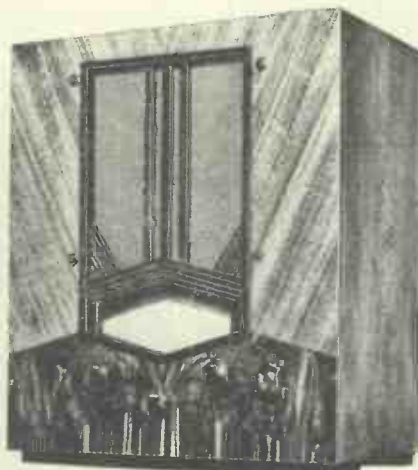

The same chassis as used in this receiver is also available in a console type cabinet.

half guineas, and it is interesting to note that any Marconiphone receiver can be adapted for operation on non-standard mains at a slight extra charge. In the case of non-standard voltages this amounts to 5s., and for non-standard frequencies it is 10s. 6d.

The model 224 is also available in console form, in which case the price is 15 guineas, the console being known as the model 236—and a very handsome job it is.

Walnut with macassar ebony inlays is used for the cabinet work, and in short we would say that this receiver is in every way fully up to the high standards of performance identified with all Marconiphone products.

THE EKCO SEVEN-STAGE SUPERHET MODEL A.C. 76

THE Ekco A.C.76, the particular model we have chosen from the Ekco range, is a very fine seven-stage receiver costing eleven guineas. This, I think you will agree, is an extremely moderate price when you come to examine the specification.

The standard receiver is intended for use on A.C. mains, and the seven-stage circuit incorporates band-pass tuning, a feature which ensures adequate selectivity under present-day conditions. There are five valves in all, one of which is a full-wave rectifier. The remaining valves consist of an octode frequency-changer, followed by an H.F. pentode for intermediate-frequency amplification. This stage feeds into a double-diode, while the low frequency side is looked after by a high-slope pentode.

It goes without saying that full automatic volume control is fitted, and in addition such refinements as the Ekco station pre-selector and automatic noise suppressor are also included.

Unusual Cabinet Design

The undistorted output available is 2½ watts, and this is, of course, more than ample for all domestic requirements.

When you look at the photograph you will at once be struck by the attractive design of the cabinet. This is a bakelite moulding, and as the photograph shows takes the form of a circle.

This particular design has been rendered possible by very clever chassis layout, and you will appreciate something of the amount

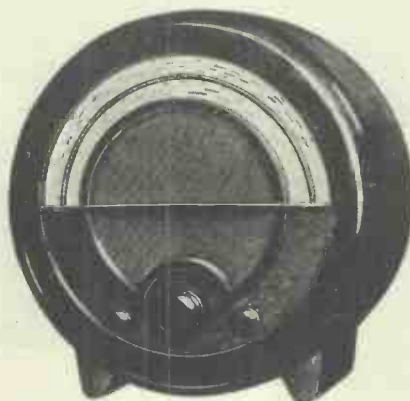

The large dial which surrounds the speaker is a feature of this Ekco receiver.

of thought which was expended on this side when you remember that the centre portion is largely occupied by the moving-coil loudspeaker.

On operating the set for the first time one is impressed by the ease with which the various wavelengths can be picked out on the scale. The large diameter of the scale enables the various readings and station names to be well spaced out, a point which greatly simplifies tuning.

There are only three controls, namely a centre one for tuning, and arranged on each side of it a knob for wave-change switching and also radio or gramophone, and the tone-compensated volume control.

At the back of the set are sockets for connecting up an extension loudspeaker, and also two sockets for the leads from the gramophone pick-up. The pick-up, as we have already indicated, can be switched in and out of circuit at the front of the cabinet. Likewise, the speaker in the set can be switched out of circuit when required, say, for example, when using an extension speaker.

The wave ranges covered are 195–560 metres on the medium broadcast wavebands, and 900–2,000 metres on the long waves.

The price already quoted is for the standard model in walnut finish; the hire purchase terms are £1 deposit and twelve monthly payments of £1. For 10s. 6d. extra on the cash price this model is obtainable in a black and chromium cabinet.

Also a Universal Set

For those who prefer a Universal model, that is one suitable for D.C. or A.C. mains, there is the A.D.76, which has a similar specification to the A.C.76, except that no provision is made for gramophone pick-up. The price of this model in walnut finish is 11½ guineas; the hire purchase terms are an initial payment of one guinea, followed by twelve monthly payments of one guinea.

One of the difficulties which listeners are sometimes faced with is the absence of a suitable table or stand on which to place the set. What is one to do in these circumstances? The answer is, buy a small table, which can be stood near the aerial and earth points, or alternatively a special stand, from the makers of the set.

For the Ekco A.C.76 you can obtain a sturdily constructed stand in either black or walnut finish for 29s. 6d. (Or, if desired, on deferred terms.)

A. J. R.

STAMPS WITH A RADIO INTEREST



PAYING THE POSTMAN

In France, radio licence fees are now paid to the postman, who issues a stamp as receipt. This is fixed to the receiver itself. The stamp used is illustrated at the top of this page (1), and also shows some ordinary postage stamps having a special radio interest. Details of these stamps are as follows:

2. A Belgian Congo aerial postage stamp which illustrates how even the small places in that country are equipped with a radio station.

3. Around the oval picture on this Russian stamp can be seen the dots and dashes of Morse code symbols.

4. A Honduras stamp bearing a picture of a giant transmitting aerial.

5. This Belgian stamp shows a liner with its aerial slung between the two masts.

6. The Aurora Borealis can be seen on this Russian stamp, which illustrates the most northerly radio station of the world, situated in the Arctic.

7. The ancient in travel and modern in communication are united on this Russian stamp.

8. A 1925 Russian stamp which shows Professor Popov and claims him as the inventor of radio.

Television

Go-day

THE two systems of television transmission which the B.B.C. is going to adopt in the first instance, that is, the Baird and E.M.I., will operate for alternate weeks. For one whole week (with the exception of Sunday) the Baird system will be transmitted, and then the following week the E.M.I. system, and so on.

It has been generally assumed that these are the only two systems of transmission which will be used by the B.B.C., but I am informed on very good authority that the B.B.C. will in due course give consideration to any other systems that may come forward. It is hardly likely that anything other than the above-mentioned systems will be used, however, for the first year or so, until the necessary preliminary experience has been obtained.

Provincial Tests First

I am also told that if any other systems are tried they will first be tried in the Provinces, and this in itself indicates that it must be some considerable time before they can be put on the air, because provincial stations will have to wait until the London station has tried out the field.

As regards the two London systems, they will use the same transmitting aerial, and I understand that the same sound transmitter will be used. The aerial is already nearing completion at Alexandra Palace, and by the time these Notes are in print I expect the gear will be partly installed.

A good deal has been said about the range at which the television transmissions can be picked up and, for some reason not very definitely specified, this range has been commonly assumed to be about 25 miles. But with these ultra-short waves all kinds of queer things may happen, and in what may be called "freak" conditions it is quite likely that the transmissions will be received over very much greater distances, even many times this amount. On the other

A "Running Commentary" on the latest developments in television which shows the trend of progress of this science

By Dr. J. H. T. ROBERTS, F.Inst.P.

hand, there will be places much nearer than 25 miles to the Alexandra Palace which at some time or other will be unable to receive the transmissions.

* * *

A question which is exercising the minds of the radio traders very much just now is how the demand for television receivers will develop in the early stages. It is obvious that nobody is going to buy a television receiver until there is some broadcast to be received, and the date at which the B.B.C. service is going to start has even now not been definitely settled. When it does start it will be of an

there is anything at all on the air which can be picked up, even experimental transmissions, and personally I can foresee a repetition of what happened when radio broadcasting started some years ago.

But you can easily see that the radio manufacturers' problem is a difficult one. Supposing you were a manufacturer and were contemplating making television sets, you would find it pretty hard to make up your mind just exactly what type of set to prepare, and when to have it ready for the market, and how many sets to lay down as a first lot, and so on.

A Difficult Position

Questions of appearance, price, etc., all help to make the position more difficult to arrive at. Again, if there is going to be a sudden large public demand it means that you have got to lay in a large stock of receivers, otherwise you will be flooded with orders which you cannot execute.

Some manufacturers think that the orders will come gradually, others that they will come in a rush. Personally, I do not quite agree with either of these views. I think orders will come much more than gradually, but I do not anticipate a tremendous rush right at the beginning. At the same time I believe that by the next Radio Show—assuming all goes well with the inauguration of the B.B.C. transmissions, and so on—television will be all the talk of the day, and everybody, or at any rate everybody who can afford, will be wanting to have television with his ordinary radio receiver.

Studio Make-Up

Some very curious effects arise in the television studio with regard to the make-up of the artists. I dare say most of you know that ordinary make-up, as used on the stage, has to be varied quite a lot for the purposes of the film studio. I don't know how many of

A PARIS TRANSMISSION



Mlle. Germaine Roger singing during a transmission from the Paris television broadcasting station.

experimental character, and this will continue for an unspecified period.

My own personal opinion is that, apart from the experimental transmissions, the regular programmes will be some months yet. In spite of this I feel sure that a large number of people will buy television receivers as soon as

you have ever visited a film studio when a film was being made, but you would find there that the artists looked very different from what they did outside the studio, and some of them very far from prepossessing. If you saw your favourite film star in the flesh, or rather at work on the set, you would get the shock of your life.

Shadow Effects

All this is bad enough, but when it comes to television even the make-up for film work, which you might expect to be suitable for television, has to be completely revised. Owing to the system of lighting, and also the scanning arrangements, you find that an entirely new type of technique is necessary. Just to mention one thing: A person with a prominent nose automatically grows a moustache when televised, due to some shadowy effect in the scanning. This might be advantageous with some of the male artists, but you can guess it plays havoc with the fair sex!

These shadowy effects are different generally to deal with, and for this reason people with narrow or lean faces are apt to grow side whiskers in the television. It seems that people with "fat" faces come into their own in the television studio, because they emerge free from any of these unwonted additions.

No Rouge!

Rouge on the lips, which must date from time immemorial, now goes by the board because, with the television transmitter, rouged lips come out *white*; in order to get the right effect the lips have to be made *green*! At the time of going to press it seems that the television artist, to come out looking like Garbo or Dietrich,

has to go before the transmitter with a very dark red complexion and dark eyebrows, red eyelids, and violet lips.

Even the actual colour of the make-up is not the end of the story, because the colour it comes out eventually depends to some extent on the chemical quality of the make-up, so that two reds, though looking alike, may come out differently over the television. It is all very hard for the make-up man and the artists, but there may be a chance for the worst of us in television who never had much of a show in pictures.

THE PROBLEM OF MAKE-UP

Dr. Zworykin has come to London. This famous American inventor has been invited by the Institution of Electrical Engineers to give a lecture before the Wireless Section of the Institution. By the time these Notes are in print the lecture will, I expect, have taken place. He has been asked particularly to describe his "electron multiplier," and I expect we shall get some very interesting information from his visit. Dr. Zworykin is by way of being one of the foremost men in television in the United States, if not, in fact, in the world, and his various inventions in connection with cathode-ray television have contributed very greatly to the possibility of "direct" transmissions.

People are saying that when the television programmes start they will consist mostly of film subjects, and it was commonly believed for a long time that this would necessarily be the case.

ON THE BOBSLEIGH COURSE



The stands at the "Bavarian Curve" on the Olympic Games bobsleigh course. The commentator's box, from which broadcasts were made, is just visible in the top right-hand corner of the picture. One day everybody will be able to witness such events with the aid of television relays.

Quite lately, however, there have been indications that the technical department of the B.B.C. does not expect to be tied in this way and that it is quite likely that we may have a fair proportion of "direct" transmissions in the programmes.

All sorts of guesses are being made as to how the programmes will be made up, what types of items, and so on. It is impossible for anyone to say what the programmes will consist of, and I can tell you that even the B.B.C. people themselves have not yet been able to arrive at any definite decisions

on this point. Anything you hear must, therefore, be in the nature of a hazard.

Is there going to be a constructor boom when television starts, like that we had during the first four or five years of radio broadcasting? Some people think there will be. The constructor element in ordinary radio has died down quite a good deal during the past three or four years, largely because ready-made sets are now so inexpensive. There will always be, of course, a section of the radio public who like to make up their own receivers—and in particular there is always the coming younger generation, who love experimenting and making things with their own hands.

Home Construction Revival

Whether history will repeat itself in the case of television remains to be seen, but I imagine that, although the constructor boom may not reach the same proportions as it did with radio, there is bound to be a large and important revival in home construction. At any rate, manufacturers think so,

because several manufacturers are already arranging for the production of units and components for the home-making of television receivers. Amongst these firms is the Mervyn Sound and Vision Co., Ltd., who have got out a variety of sets of parts for building up television receivers, including a 3,000-volt high-tension unit and a double time-base. The latter is in the form of a kit outfit and can be had without valves or relays.

S.W. Units

The same Company has also prepared a number of short-wave units, one in the form of a converter which can be used either with battery or on the mains, whilst the other is an A.C. mains type, covering a range from 13 to 50 metres. Those of you who are interested can obtain an illustrated catalogue and full particulars by writing direct to the Mervyn Company.

We hear a great deal about the reactions of the theatrical and cinema and entertainment world generally to the arrival of television. Not so long ago the attitude was, I think, rather

(Please turn to page 257)

The New NORTH IRELAND Regional Station

—And Notes on other B.B.C.
Provincial Matters

By
LESLIE BAILY

transmitter, and I can discover no B.B.C. schemes that are likely to substitute something better on the South Coast than 6 B M—though an improved service down there is to be desired.

Regional predecessors. As you approach it from the small town of Lisburn, some eight miles south of Belfast, your attention is first arrested by the extraordinary 475-ft. mast-aerial which dominates the countryside, and which is in shape and function something quite revolutionary for the B.B.C.

At the base the steel lattice-work is only 4 feet broad, it widens to a girth of no fewer than 26 feet half-way up the mast, and then tapers to 4 feet at the top. Here there is a steel rod projecting upwards and surmounted by a monstrous ring 20 feet in diameter—all this can be raised up or down by means of a winch, to "tune" the mast, for the unique thing about this mast is that it is also an aerial. There are no aerial wires.

Many New Features

The object of this strange design is to minimise fading. Engineers of the B.B.C., from Sir Noel Ashbridge downwards, are awaiting test transmission results with the keenest interest, for although the theoretical performance has been worked out to the last millivolt-per-metre, practical results are the things that count in wireless! The immediate problem is whether the far north-west corner of Ireland, around Londonderry, will get decent reception; but the larger consideration is whether this type of mast shall be adopted for other new stations, such as North-east Regional.

All eyes—or rather, ears—will be on North Ireland from March 20th onwards, and it will be interesting to find what sort of reception we get from it in England and Scotland.

Not only does Lisburn mark a technical break with many precedents,

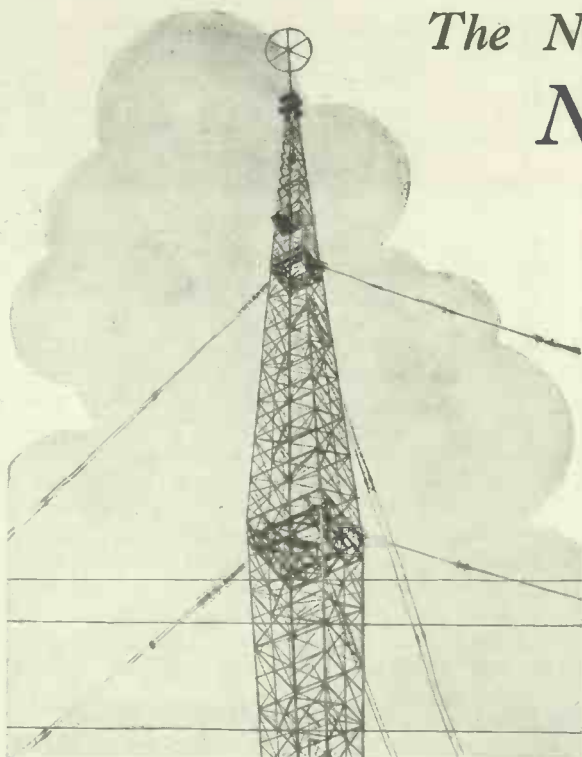

An unusual view of the top portion of the aerial at the new Northern Ireland B.B.C. Regional station which is to be opened on March 20th. The transmitter works on a power of 100 kilowatts and replaces the present Belfast station which will close down. The aerial is of the anti-fading type, and differs from the more usual arrangement in so far as the mast and aerial are one. That is, the mast acts as the aerial. Note the circular ring at the top, a necessary feature of the anti-fading scheme.

THE limelight switches this month across to Northern Ireland.

Regional Director Marshall and his lately-much-augmented staff at Belfast have been making gala plans for programmes in connection with the opening of the North Ireland Regional transmitter.

Among the special programmes to celebrate this event, about which all Ireland is excited, is a sort of panorama of Belfast broadcasting from the day when the present transmitter, 2 B E, was first opened—and as that was away back in 1924, there will be heaps of material to draw upon.

Sudden Power Increase

There being no "sliding-in" process to introduce this new 100-kw. Regional to the world, field strength throughout Ulster will go up with a tremendous bump on March 20th, for listeners there have been accustomed only to the puny kilowatt of 2 B E. This obsolete transmitter will be immediately closed down. It is one of the famous Marconi "Q" type transmitters with which the B.B.C. supplied its original "main stations": now only three of these ancient transmitters will remain in service—6 B M Bournemouth, 2 B D Aberdeen and 5 N O Newcastle.

The end of the Bournemouth and Aberdeen stations is not yet in sight: the inauguration of North Scottish Regional towards the close of this year is not likely to displace the Aberdeen

But the old Newcastle transmitter, which is the most ancient of the lot, will end its long and faithful career when North-east Regional opens. It has been widely reported that North-east Regional will have a power of 100 kilowatts, but I do not attach great validity to this anticipation at the present stage of events.

The original intention of the B.B.C. was to give North-east Regional a power of 50 to 60 kilowatts; it may possibly be greater, but this depends on the international wavelength situation, and it is unsafe to forecast what that will be by the time the North-east's stentorian voice is on the air—a year or so hence.

A Peculiar Mast

The Irish station is the most interesting of all the new B.B.C. transmitters. When I paid it a visit recently, I was immensely impressed by the strides in design which this station represents, compared with its

but the architectural design of the station also strikes a new note. The building is in brick, rather "modern" in style. Inside, there is the usual spacious transmitter hall, but unlike older Regional stations it has only one transmitter, and this is housed behind a single gigantic panel, some 45 feet long, instead of several "units." The circuit employs "series-modulation"—the first time this method has been used on medium waves.

Modernised Studios

In the power-house there is a single Diesel engine, the largest (600 h.p.) I have ever seen at a B.B.C. station, but it is only a standby for emergencies: normally the transmitter will take its power from the local "grid" mains—another innovation.

Going back to Belfast, I found modifications afoot at the Regional Broadcasting House in Linenhall

CAREFUL STAYING NEEDED



An unusual view of one of the masts at the North Regional station at Moorside Edge. There are three 500-ft. masts supporting the Regional and National aeriels, one mast being common to both aeriels. These aeriels, incidentally, are not of the anti-fading type used at Lisburn. Note the massive anchorages to which the supporting guys are attached. These giant steel masts need very careful staying in order to withstand the severe weather conditions met with in the North.

Street, where the studios have been brought up to date—their acoustics improved, their decorative schemes modernised, their number increased to five—so that there is a worthy studio outfit to work with the new transmitter. The speech inaugurating the Lisburn transmitter will, however, be delivered in the emergency studio at

IMPROVEMENTS AT BELFAST

the transmitter, by the Governor of Northern Ireland.

The effort to put on some very special programmes from this transmitter will spread over some weeks. Sir Basil Brooke, for instance, who is Minister of Agriculture for Northern Ireland, will speak to Irish farmers a few days after the opening.

What this all means is that the B.B.C. is going to wave the flag good and hard in Northern Ireland. Athlone, the Free State's station, has had the Irish ether almost to itself—now there is going to be some healthy rivalry.

I can predict that one incidental effect of the opening of North-east Regional will be an extension of excursions by the microphone into some of the more remote parts of Ireland.

Mr. John Suthery, Programme Director at Belfast, told me that he had not, in the past, considered it worth while to relay programmes to any large extent from districts such as Londonderry, because the people there could not receive Belfast broadcasts satisfactorily. But when Lisburn brings all North Ireland within range Mr. Suthery intends to exploit these far corners of the country—though the difficulty occasionally arises of inadequacy of land lines in the remote districts.

The same obstacle confronts programme organisers in the Scottish

Region, but to a greater extent. Large areas of Scotland are telephonically off the map, and often they include places that the B.B.C. would like to put on the air—the Hebrides, for instance, where there are unique customs that would make interesting subjects for broadcasts. The recording van which is to be supplied to Scotland

(to share with North Region) will in some measure help to overcome this difficulty.

One of the few of the Western Isles that is connected to the mainland by 'phone is Iona, and I understand that it is hoped soon to relay a service from this island's church, famous in the early history of Christianity. This scheme is being nursed by the Scottish Region's Outside Broadcasts Director, Mr. Keith-Murray.

Most of Scotland's chief B.B.C. officials operate from the Edinburgh offices, but Mr. Keith-Murray makes Glasgow his centre. He has a room in the Blytheswood Square building which the B.B.C. originally took in 1925, but which is totally inadequate for modern purposes. As soon as possible they intend to move to the Queen Margaret College premises which were bought some months ago. How soon this will be is a question the B.B.C. will not answer.

Glasgow's "Big House"

There seems to be some delay in getting out the plans for altering the college into an up-to-date Broadcasting House. Possibly the necessary alterations are proving more extensive than was at first anticipated; but one thing is certain, that when the job is done Glasgow will possess a fine broadcasting centre, and then it would not be a wild prophecy to suggest that some other of the chief officials will join Mr. Keith-Murray and Mr. Robin Russell at Glasgow.

A certain amount of the programme production now entrusted to Edinburgh will shift back to Glasgow, which was, of course, at one time the Scottish B.B.C. headquarters. Edinburgh will remain the Regional headquarters, but there will be a measure of decentralisation.

A B.B.C. "Scoop"

One of the biggest "scoops" carried out in the provinces lately must be credited to Scotland. They have persuaded Mrs. Edgar Dugdale to give a series of three talks called "Portraits from Memory." Mrs. Dugdale is a niece of the late Lord Balfour, whose official biography she is now writing; her mother, Lady Frances Balfour, was a daughter of the eighth Duke of Argyll, who was a friend of Queen Victoria and a member of two of Mr. Gladstone's Ministries. Thus, Mrs. Dugdale, who was born in the 'eighties, was brought up in the political world, and has known many of the most famous British personalities of the past forty years.

(Please turn to page 259)

Several studios are employed for the production of a play, but all are brought under the control of the producer at the Dramatic Control panel seen in the photograph. He can fade the various studios in and out at will.



From Script to Speaker

How the Simple MS. is Moulded into a Complete Radio Drama

Described by ALAN HUNTER

IT is no accident that in the field of so-called radio drama the B.B.C. is acknowledged as pre-eminent. Drama as mirrored by the microphone—if you will forgive a somewhat flagrant mixing of technical metaphors!—has been the particular business of Val Gielgud for so many years that its consistent evolution towards something like a recognisable art form is not surprising.

Especially when you know Val Gielgud—at once a man of the theatre and an exponent of microphone technique in its most unobtrusive and therefore its most successful form.

Pure art takes no cognisance of mechanics. It is an expression of the soul in whatever medium the artist is most adept. This axiom applies no less to radio drama than to, say, poetry or painting. Unfortunately, the rude mechanics of radio drama, conjuring up pictures of

producers mysteriously weaving knobs and controls, has tended to obscure the ultimate object of radio drama. Which object, oddly enough, is simply to entertain you.

I feel obliged to embark on this preamble at the risk of boring you, because I know so well Val Gielgud's passionate desire to help radio drama find its artistic feet, as though he were saying: "The play's the thing—and hang the mechanics!"

Yet Val Gielgud is, paradoxically enough, the one man who, very early in the development of radio drama, sized up the essential mechanics of production—and who, despite what other countries have done in different ways, has steadfastly adhered to his own system.

In a word, this might be summed up as the multi-studio system—a number of satellite studios revolving around a central nucleus in the form of a Dramatic



Sounds have to be put in at the right moments by the staff of the effects studio.

The Marks on

TWELVE MONTHS BACK

ANNOUNCER: *6A Nineteen hundred and thirty-five.

GE (Fanfare)

ANNOUNCER: *6A A year of Jubilee and national rejoicing,
Of reconstruction in trade and industry.
Achievement in art, science, and entertainment.
Of the passing of great men.
Of suspense and crisis in Europe.
Listen! While the voices of the year that is
past tell their story.

+ Echo *6A Twelve Months Back.

GE (Fanfare)

NARRATOR: *6C On Christmas Day, 1935, His Majesty the King said, broadcasting to the Empire:

R.P.

(Record: Extract from King's speech, Christmas Day, 1935)

H.M. THE KING: The year that is passing - the twenty-fifth since my accession - has been to me most memorable. It called forth a spontaneous offering of loyalty - and, may I say, of love? - which the Queen and I can never forget. How could I fail to note in all the rejoicings not merely respect for the Throne, but a warm and generous remembrance of the man himself who, may God help him, has been placed upon it? It is this personal link between me and my people which I value more than I can say.

NARRATOR: *6C The central act of commemoration in His Majesty's Silver Jubilee took place when the King and Queen joined in thanksgiving with their people on the morning of May the 6th. Brilliant King's weather ... decorated streets ... full-throated crowds ... and through the massed ranks of their subjects the King and Queen came to the City boundary at Temple Bar.

(Record: Procession extract at Temple Bar)

R.P.

four divisions on the scale; so is the output from the associated studio.

So much for that. The next point is the cueing—the bringing into action of each studio as needed by the man at the panel. This is really very simple. Each knob on the panel has associated with it a switch, which works a green light in the distant studio. The actors, or whoever are in the wanted studio at that moment, carefully watch the winking of this green light for their cue.

The Producer at the "D.C." Panel

Imagine a producer sitting at the "D.C." panel, which is arranged in one of two "D.C." Panel Rooms in Broadcasting House. There he sits, veritably the *Deus Ex Machina*. Immediately in front of him on the desk is the script of the play, with the knobs and switches within easy reach.

At the other side of the room is a loudspeaker, through which come the sounds resulting from his mixing at the panel. He hears, in effect, exactly what you hear in your home. Following the marks of his script, the producer fades out, brings in, subdues, increases and generally weaves together the pattern of sounds he wants you to hear.

During a rehearsal you might notice the producer move

TWELVE MONTHS BACK

Here is a typical page from the script actually used by the Producer at the "D.C." Panel for the broadcast of "Twelve Months Back." In addition to a word-for-word copy of what the actors are saying, the Producer is aided by a number of invaluable marginal notes, which he has made during the rehearsals before the actual show. Some of

these look very mysterious, but all are capable of instant interpretation by the Producer. As explained in the article, groups of artists are placed in suitable studios and brought together by the operation of the "D.C." panel.

See that star against 6A for the first line of the script? That means "flick"—press the key switch on the "D.C." panel controlling the green light in studio 6A. The announcer is waiting for that signal—and speaks as soon as it is given. The 6E just below is to indicate the introduction of a gramophone record from the 6E studio—a fanfare. Then comes a flash-back to studio 6A for the announcer. As he is supposed to be talking in a resounding way the producer puts in some echo by turning up the control that superimposes the output of the echo studio on the announcer's voice. A pause and then another flick to studio 6A—for the announcer to say: "Twelve months back!" Then a flick to fanfare record again.

Next, the Producer flicks to 6C studio, where a narrator is waiting for his cue to say: "On Christmas Day, etc." The "R.P." note stands for recorded programme, coming from a record studio. Back to the narrator, who is flicked in studio 6C. At the word "Majesty's" the Producer fades up a record playing in studio 6E of the Temple Bar procession, as a low background to the narrator's words. And so it goes on, with the Producer weaving in and out his various studio sounds to make a continuous programme that you hear as a broadcast play.

a switch and issue instructions through a small microphone on his right. He would be speaking to the actors in the distant studios. They would be listening to him through conveniently placed loudspeakers in these studios.

So that, although the producer is entirely isolated from his material, he is nevertheless in perfect contact with every part of it. And, equally important, he has it under complete control.

A Big Advantage

This, then, is the basis of what might be called the Val Gielgud system of radio drama production. It has a further unsuspected advantage—for by means of the fade knobs the sounds from one studio can be superimposed upon

another, producing an overall effect that is of the very "stuff" of radio drama.

As Mr. Gielgud says: "The control, the mixing and the crossing of these fades, and their handling by means of the 'D.C.' panel, give radio drama its particular shape and its peculiar continuity. As the scene in a film scenario ends with the movement of the camera, so the scene in the radio play ends with a 'fade.'"

All the same, it would be doing Mr. Gielgud a disservice not to add that mere multiplicity of studios, mere virtuosity

Control panel—familiarly known as the "D.C." panel.

Instead of assembling all the actors in one studio and producing them as on a stage, Val Gielgud has developed—I nearly said perfected—the idea of grouping the actors in different studios, welding their efforts into a cohesive whole by virtue of the "D.C." panel work.

To take a simple example: A normal play might involve one studio for its actors, one for its orchestra, a third for "effects" or incidental noises, a fourth for gramophone records specially made or selected for the play, and a fifth for introducing artificial echo to add to the realism.

Electrically Controlled Output

Each constituent studio is under the control of the producer at the "D.C." panel, for the simple reason that each studio's microphone output is electrically controlled by a potentiometer or volume control knob on the panel. As the knob is increased, from zero up to any of its twenty-

The Manuscript

in "playing" the control panel, is not enough to make a good radio play. He regards the "D.C." panel as an essential means to the end—but not the end in itself.

And now let us follow briefly the history of a radio play's production from the auspicious moment when Drama Direction accepts the script until the even more auspicious moment when the announcer introduces it to you on the air.

I have to thank Val Gielgud for giving me this thumbnail sketch at a time when he was particularly harassed by having to produce, at a moment's notice, a revised version of the Scott epic during the sad days following King George's death.

Finding Out How Long It Will Take

"Once the script has been accepted," began Mr. Gielgud, "it goes automatically through to one of my two staff adaptors—Miss Burnham or Miss Hellweg. Or perhaps it will go to a producer who is doing his own adaptation. More rarely still, these days, the play needs no adaptation, having been specially written for the microphone.

"By leaving appropriate intervals for effects and, if necessary, intervals of silence or music, a careful reading through of the script determines the time it will take to play. All through its subsequent 'vetting' the time factor is borne in mind.

"After this preliminary work the original script is sent down to the Roneo room, where a number of copies are taken for future production needs—for each member of the cast has to have a complete script before him, of course.

"The script will then find its way into the forthcoming play schedule. About one month before it is due to be broadcast the producer who has been selected for the work will send for the script. He will then decide roughly on his cast, the necessary effects he will need, and so on.

"A fortnight before the broadcast we hold a production conference. This consists, as a rule, of the 'D.C.' panel operator, the studio manager and the effects men.

"It is at this point we work out the number of studios needed for the minimum movement of artists. Here, too, we decide on what effects will be involved—and whether any special records will have to be made. If the show is a complicated one we may even have a special effects conference to decide on how to achieve the best illusion of atmosphere.

"A week or ten days before the broadcast the show goes into rehearsal, although you must understand that much

GORDON OF KHARTOUM

Another typical page from the script of a broadcast play, complete with the Producer's individualistic notes to help him during his work at the "D.C." panel. The notes "6C" and "6E" at the top of the page indicate that noises are available on a record from studio 6E, while actual crowd voices are available in studio 6C. These are faded in simultaneously on the panel and then 1st Voice is flicked in studio 7C. To indicate distinctly a change, Gladstone is in another studio, 6B. He takes up the tale, and while he is talking the effects then forming a background from studios 6C and 6E are both faded out. That's the meaning of "master-out" half-way down the paragraph. This master control saves manual labour in twiddling two or more knobs at a time.

Then, when Gladstone has finished, there is a note for "master in"—and back come the effects again. Note that Gladstone's studio is only "half out." Then studio 6A is flicked for Gordon's distant voice. When Gordon has finished studio 6B is flicked and Gladstone takes up the tale. At the same time the master knob, which at that moment is still allowing the effects to form a background, is "out." This is to indicate very clearly that Gladstone is speaking at home, as a contrast to Gordon away in Khartoum. The effects and the echo are faded out while the master is out, and at the same time a record in studio D is got ready, so that it forms a suitable background to Gladstone when the master is "up." Then, when Gladstone has finished, studio 7C is flicked for 1st Voice to carry on.

The rest of the extract is more or less self-explanatory—the "6D in then out" obviously referring to the introduction of a background record from studio D. As Gladstone finishes his dictation the Khartoum effects are brought back—hence the marks "6C plus echo plus 6E slow up," the whole three being gradually introduced by the master. The last mark is a flick to studio 6A, where, as already noted, Gordon is waiting for the green light that winks as the "D.C." panel switch is "flicked."

- 29 -

6B + 6E

(Faded in as a distant echo, rifle fire, Arab crowd, and drums)

1st VOICE (7C) (distant): East, West, North and South, the rattle of Arab sniping, the roll of the great copper war-drums ~~and~~ on Khartoum

GLADSTONE (6B) (continuing): In conversation here yesterday, the joint feeling was that an effort should be made to ascertain these, although it cannot be done with the rapidity which was ensured by the telegraph when it was open to Khartoum. The attainment of this end was contemplated by a telegram drawn yesterday in London and concurred in by Mr. Gladstone. Mr. Gladstone hopes that it will draw from General Gordon valuable information.

6B + 6E

(Faded in Khartoum effects - distant)

GORDON'S VOICE (6A) (very distant): I shall await your decision. I shall hold on to Khartoum and await British diversion at Berber.

GLADSTONE (6B) (continuing): Mr. Gladstone humbly joins Your Majesty in the hope that, when adequate intelligence shall have been received from General Gordon, there will be every disposition to support him to the full extent which national interests will permit, and without too nice a computation of risks merely Ministerial.

1st VOICE: The cabinet were called to endorse the policy of the three ministers.

2nd VOICE: The Earl Selborne, Lord Chancellor, threatened to resign if a relief expedition were not promised for the autumn.

1st VOICE: Sir William Harcourt threatened to resign if it were.

2nd VOICE: Lord Granville filled the rôle of peacemaker.

1st VOICE: Finally it was decided to inform Baring that the Cabinet reiterated their former refusal to send troops, and to ask him:

(Faded in Gladstone's voice in 6B - as dictating)

GLADSTONE: ...to obtain further information as to General Gordon's actual condition and prospects as to security, and also, if possible, as to his plans of proceeding and desires under present circumstances.

6B + 6C + 6E slow up Master control * 6A.

of the preliminary spade work of production has by that time already been put in hand.

The Rehearsals

"As far as my own productions are concerned," smiled Mr. Gielgud, "the first two rehearsals are held simply to get the acting right—without any thought of the radio technique that will follow. I note how each actor is shaping in his part—and his angle or point of view.

"At the second rehearsal

I go into all the details that are so essential to final success—the placing of the lines, the phrasing, the emphasis, and so on. I alter as I think fit, and argue with those who have different ideas.

"At about the fourth rehearsal I leave the actors to their own devices and go on the 'D.C.' panel. The acting then falls into its proper radio drama perspective, while I attend to the purely technical details at the panel—fades, cues, superimposition of one studio on another and all

(Please turn to page 260.)

THE 1936 EMPIRE SUPER

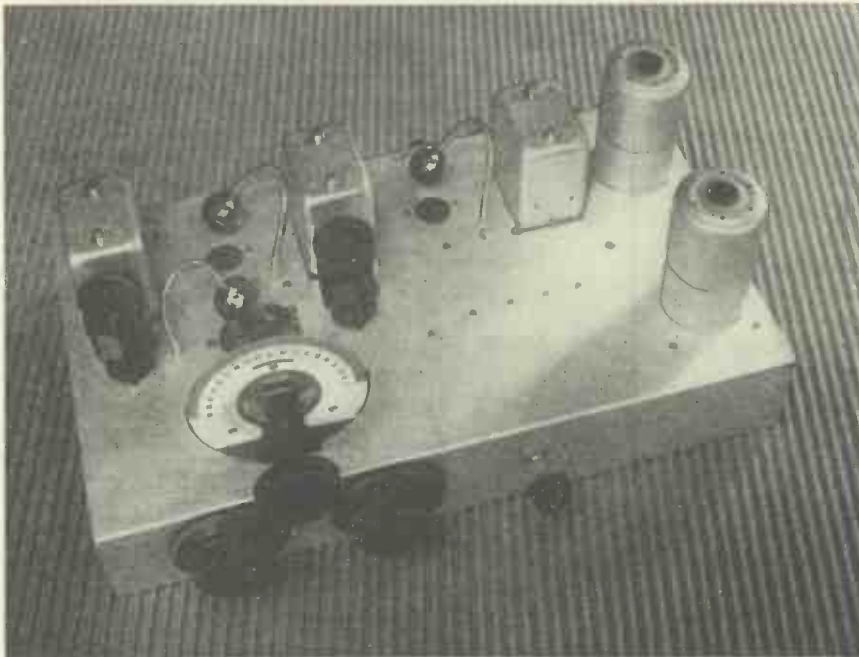

The clear space on the chassis, to the right of the band-spread condenser, can be used to accommodate a chassis loudspeaker. This arrangement is ideal when it is desired to fit the set into a cabinet.

TUNING-IN THE STATIONS

valver, which is reasonably selective. Lyndhurst, Australia (VK 3LR), has been heard on several weekday mornings on 31.32 metres, and the other Americans, W1XAZ and W3XAU, have been consistent in the evenings.

Sydney (VK 2ME) has, of course, been heard regularly on Sundays, but since any single-valver owner can say the same, there is not much point in enlarging on that here!

The 40-metre amateur band occupies some 100 degrees on the band-spreader, and only a slight touch on the detector tuning is necessary between one end of the band and the other.

SINCE I penned last month's article, describing the "1936 Empire Super" in detail, I have had the set on my bench for almost a clear month, and on practically every day I have switched it on and listened to a few short-wave stations. On three occasions I have had proper "field days" with it, logging everything that could be heard, and during the month I have covered the entire twenty-four hours with the periods during which I have listened.

Most Interesting Wavebands

Needless to say, I still think it is rather a nice set! But since I am the designer and constructor of it, my views are quite possibly biased a little. Instead of rhapsodising over the set's good qualities, I will therefore confine myself to facts.

At this time of year the coils covering the most interesting wavelengths are the "Y" (yellow-spot) coils. With two of these in position, the settings for the various wavebands are as follows: 25-metre band, detector 20, oscillator 10. 31-metre band, 45 and 40. 40-metre amateur band, 75 and 70. 49-metre broadcast band, now "spread" between 40 and 50 metres, 75 to 100 and 70 to 100.

Finding the Main Transmitters

The "Y" coil may not take in the upper limit of the 49-metre band, but

although its range is stated as 22-47 metres, W8XK on 48.86 metres has been heard right at the top of the scale.

This is partly because the oscillator is permanently working 465 kc. "off tune." I have not given the settings for the band-spread condenser, since I have been talking in terms of wavebands. But when the dials are set at 45 and 40, for reception of the 31-metre

□.....□

Full constructional details of The 1936 Empire Super were given last month. In this article the dial settings for the various wavebands and other helpful operating hints are given

By W. L. S.

□.....□

band, stations may be found at various settings between 40 and 130 degrees on the band-spreader.

Rome is at the bottom end, unless you count Madrid on 30.4 metres, which is really outside the band. Rio de Janeiro (31.56 metres) is at the other extreme. The two Zeesen stations, DJN and DJA, working on 31.45 and 31.38 metres (9540 and 9560 kc.) are apt to occupy rather a large slice of the band, but W2XAF on 31.48 metres (9530) can be cleared of them with comparative ease, which is more than I can say for my own two-

A New Broadcaster

If anything, the 49-metre band is received with greater efficiency on the larger coils ("R" or red-spot), since it is found near the bottom end of the scale. With the two main controls set at about 20 divisions, the band-spreader will cover most of this waveband, although it has grown rather too big for its boots recently!

Incidentally, an interesting station that has been heard several times is VP3MR in Georgetown, British Guiana, but he works in the centre of the 40-metre amateur band, thereby calling upon him the execration of all true amateurs, who find their bands full enough without the intervention of fully-fledged broadcast stations.

With the smallest coil ("L.B." or blue-spot) the three shorter wavebands of 13, 16 and 19 metres are covered, together with the 20-metre amateur band. The 25-metre band may also be found at the top of the dials, but it is much more efficiently looked after by the next coil.

Below Twenty Metres

The 16-metre band comes in at about 20 on each condenser, the 19-metre at 45 and 40, the 20-metre amateur band at 55 and 50, and the band-spreader is indispensable in each case.

Tuning really is amazingly sharp, and requires considerable dexterity if

(Please turn to page 255).

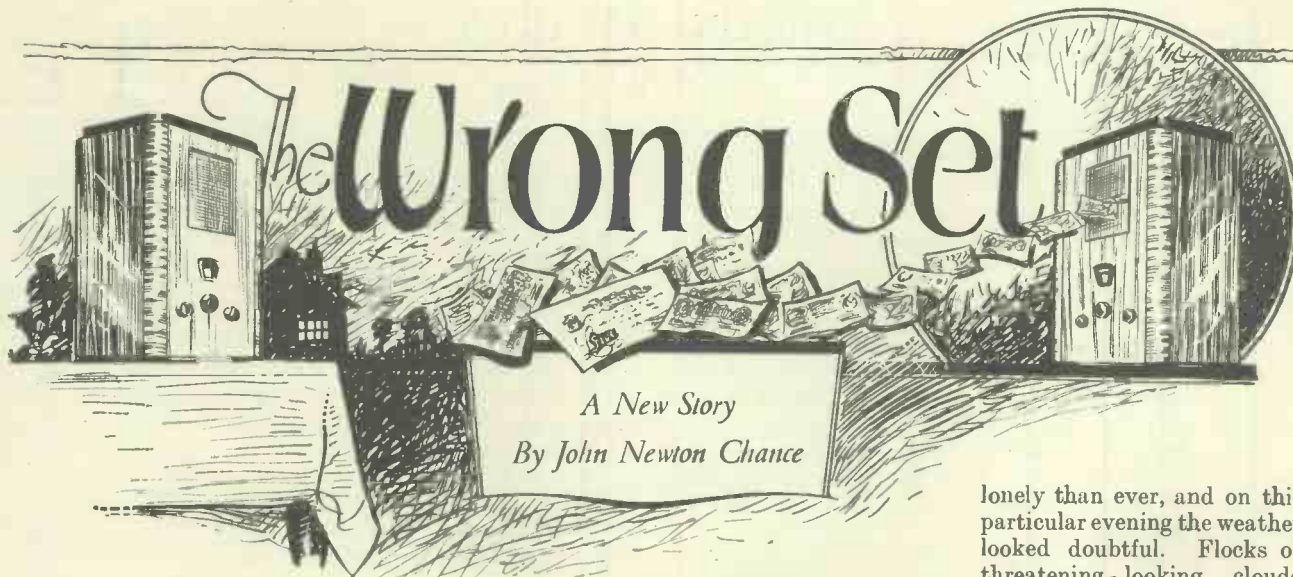

A New Story
By John Newton Chance

IT seems extraordinary—even unnecessary—that any man should go into a panic just because another man's name is Smith, yet I remember when there was an excellent reason for that fear.

The date had much to do with it, because it happened just a few days after the murder.

When murder is committed in a small town of some twenty thousand inhabitants and the murderer isn't caught, there is something like a wholesale panic. There was in the town where I was living, and for weeks afterwards there wasn't a single door or window in the whole town which wasn't bolted, barred, chained and double-locked. People wouldn't go driving after dark for fear of being held up, and never walked beyond the limits of the lighted streets. And all that isolated my little cottage, which was just a mile out of the town.

Cartwright was an old chap who had owned a big house in the town, and needing only two rooms for himself had tried to run it as a boarding-house. But he was bad-tempered, and—so his ex-servants said—a bit mad, too, because he used to talk to himself. He sacked his "helps" at the rate of about three a week until the lodgers, not caring to rely on Cartwright's doddering activities, left him. He was alone in the house on the night of the eighteenth.

Next day he was found dead in his room, with his head broken. The rooms had been turned inside out by the murderer, and left in a state of chaos. Obviously the murderer had come to rob, but nobody knew whether he'd got away with a penny, because nobody knew if Cartwright had had one to be stolen. He had never used a bank account, and only after he was dead did people begin to talk about him having hidden thousands under his floorboards.

Anyhow, that's by the way. Where the thing began to affect me personally was on the day my radio came back from Sergeant's shop. I had been having new valves put in, and various little service jobs done.

My cottage was a mile from the town on a little road which only tradesmen's vans and an occasional lost motorist seemed to find. Since the murder it had become more

and I decided not to risk a wetting by walking into town, because I knew I wouldn't be able to get anyone to give me a lift back.

I turned on my set in time to catch the nine o'clock news, and the police message which had preceded it for five nights. It was an appeal to the people of our town to jog their memories and try to recall anything unusual which they might have seen in the vicinity of Cartwright's house on the night of the murder.

Although I had had no set for some days, I knew that appeal by heart, for it had figured largely in the town's gossip until it threatened to start off a train of imaginative souls into seeing unusual things which had never happened.

I listened through the news, noticing the tones of the announcer's voice; listening for that rattle in the speaker which I had asked should be put right.

Well, the rattle had gone, and the set sounded quite good, but there was something about the sound of it which seemed strange. It might have been the new valves or something, but somehow I didn't think it was.

That type of set was brought off the factory conveyors at the rate of about ten thousand a week, and the total output in appearance would have horrified even a builder of housing estates.

Yet the curious thing about mass production is that, though each set looks the same as the next, no two sets are exactly alike. Each has some individual peculiarity, which, though small, is just the same sort of little thing which makes you different from Griffiths, and Griffiths different from Brown.

This set looked like mine, performed in the same way and made similar noises, but I got the idea that it wasn't mine at all.

The idea grew as I looked at it, and began to tune-in other stations, until I was certain that it wasn't mine. But I couldn't tell where the difference was.

I looked at it closely, then turned it round and looked at the back, searching for any little scratches which I might have remembered. I couldn't find anything familiar, and I tilted it and peered into the inside.

□.....□
An Old Man Murdered in a Lonely House—A Radio Set Which Wasn't All It Seemed to Be—A Telephone Line Which Went Dead—A Violent Storm—And Then . . .
□.....□

"THE LINE HAD GONE DEAD"

The insides of those sets are lit up by little tuning lights, and as I looked in I saw something very strange indeed.

There were four cans, screening coils and valves, and the cans in this set were wrapped round with thick wads of paper. And it didn't look like ordinary paper to me.

I undid the screws at the back and opened up the set. The paper was fastened round the cans with rubber bands, and when I looked more closely I could see that the paper was actually money, and there was enough of it to make the set look very valuable.

I slipped off one of the bands and unwrapped the notes. There were four fivers and six one-pound notes. I took the other three rolls off, and the whole lot added up to a hundred and twenty-one pounds.

Obviously, it wasn't my set, and, equally obvious, this set had never been serviced, or the money would have been found. There was only one thing to do, and that was to ring up Sergeant.

I got through to him almost at once, for he was still working in his shop. I told him simply that I had got the wrong set.

"Yes, I've just found out," he said. "Terribly sorry, but I've been in a bit of a mess to-day, with both my chaps away with colds. Only just had time to bring yours down, and didn't notice it was the wrong one till just now. Wouldn't have noticed it then, only a customer's just been in wanting a second-hand set of that type. I showed him yours, and he spotted that I'd scribbled your name on the back in pencil. Chap must have had pretty sharp eyes."

Something struck me as peculiar there. In a town like ours, everybody knows everybody else, and dealers like Sergeant just don't refer to any but strangers as "chaps."

"Was he a stranger?"

"Yes. Albert Smith he said his name was. I've never seen him before," Sergeant said. "Cross-eyed, too. Better look out for some bad luck!" He chuckled. "Well, I'm sorry about the mistake, sir; but if you'll hang on to that one until the morning, I'll run yours along first thing."

"Thanks very much. . . . I say, just to satisfy my curiosity on a small point—who does this set belong to?"

"It's ours."

"Yours?"

"Well—yes. It is *now*." He sounded hesitant.

"Well, who *did* it belong to?"

He hummed and ha-ed a good deal, then explained. The set had been Cartwright's. He had bought it on the instalment plan, and when it was found he hadn't got any money, it had fallen upon Sergeant to retrieve the thing, which he had done.

"Well, look here——" I began, but stopped, for I had the feeling that I was speaking to myself. I tapped the telephone rest but there was no click. The line had gone dead.

I heard the sudden hissing of heavy rain in the garden outside, and, putting down the 'phone, I went to the window, pulled aside the curtain and looked out. The rain was spraying up from the path like steam and the window-pane was a sheet of running water. I had been wise not to walk into town.

I turned back to do a bit of thinking. I didn't know what to do about the money. The obvious thing was to ring up the police, but the line was dead. I certainly wasn't going to rush out into a storm like that.

There was a drawer in the table where the radio stood, and I decided to put the money in there till the rain stopped. I put it in and closed the door, then stood listening to the fury of the storm outside.

A vicious crack of thunder sounded from above and went echoing through the heavens, leaving the hissing of the rain and the heavy splashing where the water overflowed the gutters outside the window.

Then I heard footsteps running along in the road outside and the groan of my gate being opened. The steps came up to the door and the knocker clacked hurriedly.

Somebody wanted shelter from the storm. As I went to let the caller in I didn't think that it was queer for anybody to have been wandering in that lonely road after dark at a time like that. But I did afterwards.

When I opened the door I saw a man standing on the step, his raincoat and bowler hat glistening with rain. He looked up at me through thick spectacles, obviously worn to disguise a bad cast in his left eye.

As he looked at me it seemed that one eye saw me while the other looked past at something else.

"Sorry to bother you," he said, grinning. "I wondered if you would mind me coming in till the rain clears off?"

"Not at all," I said.

He came into the hall, and I shut out the noise of the storm.

"Chuck your hat and coat down for a minute," I said. "It doesn't look as though it's going to clear off for a while yet."

"Very nice of you," he said, hanging his coat and hat on the stand. "My car broke down along the road, as a matter of fact. I was walking to get some help, when the rain came on."

I led him into the room I had just left. His eyes went at once to the telephone.

"Ah!" he said. "Would you mind me 'phoning a garage?"

He looked at me, and I didn't know which of his eyes to look at; each was staring a different way.

"I'm afraid it's no good. The line's blown down or something."

"Didn't think the wind was as strong as that," he said, grinning.

I didn't like the way he kept grinning, as if he was enjoying a private joke of his own. I turned away and lifted the 'phone again, for his remark about the wind was right. The rain was heavy enough, but there was little wind.

"The line must have busted somewhere," I said, putting the 'phone down again. "It's dead as a doornail."

He rubbed his hands together and nodded, as though the information added to his joke. His eyes went round to the wireless set.

"Doing a few repairs?" he said, jerking his head at it.

I looked round at it suddenly. The open back gave me a bit of a shock.

"No; just thought something was rattling."

He grinned wider and rubbed his hands.

"Of course," he chuckled, "*that* isn't your set."

Then in a flash I realised that the man I had let into my house was "Albert Smith," the cross-eyed man who had been interested in picking up a radio like mine.

"Queer coincidence," he went on. "I saw your name on a set to-day. Curious I should be stranded outside *your* house, wasn't it?"

Many things occurred to me at once. The wind was not strong enough to blow down the telephone line. The wire might have been struck by lightning, but it might so much more easily have been *cut*.

A few seconds only after the line had gone dead Albert Smith had come. Had he been waiting outside all the

time? He might have guessed that Cartwright's money had been hidden on the only place he had not looked on the night of the murder.

He had gone to the wireless shop to try to get the set back, and found that by a mistake the set he wanted was at my house. So he had come after it.

He had probably been waiting outside the house, watching.

I looked at the curtains, carelessly drawn. There was a gap big enough for a man to have seen through and to have seen me find the money and put it away in the drawer.

The storm had been a godsend to him, and I was in a lonely house with a murderer.

He had murdered for gain and gained nothing. He could lose nothing by making another attack, and this time he knew where the gain was hidden.

He stood there watching me with those queer splayed eyes of his and grinning, as if he knew already what the end of this visit was to be. There was something so assured in his queer manner.

He looked past me at the streaming window between the gap in the curtains.

"Looks as though I shall be here for some time," he grinned. "Hope I'm not disturbing you?"

I looked at him, then glanced away quickly.

"Not at all."

I believed that the best way to treat the matter was to pretend that I found nothing strange in it. There was in his almost gloating manner the suggestion of a maniac, I thought, and, if he was one, it would be disastrous to show that I was suspicious of him.

He sat down and I remained standing. I was trying hard to think of what I could do. The 'phone was gone, I couldn't get help. I was scared to go for him, for he was wide-awake and I didn't know whether he was armed.

"I KNEW HE WAS BIDING HIS TIME"

"Lonely sort of place," he said, smiling up. "Have much trouble with burglars out here?"

"No."

There was a long silence between us. The rain hissed dully from outside, while I stood praying that it would end so that I could get rid of him, but it didn't.

He sat back in his chair, looking up at the ceiling. Once or twice I saw his gaze drift across to the radio and the table drawer.

I knew that he was biding his time. He was waiting for the moment to act. I saw his fingers tapping restlessly on the arm of the chair.

I was trying hard to think of what I could do to get out of the house. Occasionally I made some remark to try to appear at my ease, but it sounded hesitant, doubtful. To my ears the sound of my voice gave away my nervousness.

Gradually I forgot the storm, and the only thing that occupied my brain was wondering when he would act. I was certain that his calm was a trick to overstrain my patience and make me lose my temper. Then he looked across at the set again.

"Lot of money in wireless these days," he said, grinning.

I could not answer him. In the hall a clock struck eleven, and, with a feeling of wild relief, I realised that the sound of the rain had stopped. I went to the window and saw the moon breaking through a rift in the heavy clouds.

"I'm going to shove you out now!" I almost shouted, in an agony of relief.

He went quite willingly, thanking me for my hospitality. I watched every movement that he made as he struggled his raincoat on and picked up his hat.

When I slammed the door behind him I felt almost weak from relief at his going. I was alone, secure in my house, and the murderer was locked outside.

Outside! Then I saw the folly of sending him away. He wouldn't go. He would wait about in the darkness outside the house, waiting to catch me off my guard. All night he would wait until the right moment came and I wasn't ready.

Bolts and bars were no good to me against him. He could smash in a window and be inside the house before I could reach the room he would get into.

Suddenly I knew I couldn't stay in that house. It was better to go out and run the gauntlet than stay in a locked box with him prowling outside waiting to break in.

I put on a coat, went back into the living-room and pulled the curtains close, but even the thick folds didn't seem thick enough to shut out the sight from those queer eyes.

With my heart beating like a hammer I brought the money out of the desk and stuffed it into the pocket of the coat. I went out into the hall and stood fearfully by the front door, with my hand on the latch.

He might be outside when I opened it.

At last, in a sort of desperation, I pulled the door open and slipped through into the garden.

The moon broke through for a second and the silver light glistened on the raindrops resting on the hedges of the road. I couldn't see what might be hiding in the shadows below them.

I rushed down the path and into the road, looking around me; but I seemed to be alone. The road was empty; no car was waiting there.

I ran along the road towards the town, splashing through the puddles and slipping over the mud, until I had to stop

(Please turn to page 260).

ONCE OR TWICE
I SAW HIS GAZE
DRIFT ACROSS TO
THE RADIO.





Our CONTACT PAGE

Conducted by the Assistant Editor

THE response to the introduction of this page last month has been very gratifying. Readers have welcomed the suggestion that we might get together more, and so, as you will see by the announcement in the centre column, we are extending the idea. After all, I don't see why there should be no reward at all for readers who try to help others!

One result of my remarks concerning queries has resulted in a whole host of letters containing queries being sent to me personally. Please, much as I would like to be personally responsible for helping every reader in difficulties, I cannot do it. You must remember that it takes a special department to deal with all the queries, which should be addressed, Radio Queries Dept., WIRELESS AND TELEVISION REVIEW, Fleetway House, Farringdon Street, London, E.C.4.

While writing about queries, I would like to quote the first paragraphs of two letters received from a reader on the 3rd and 10th of February respectively. Here they are:

"I have constructed a Fairy Portable Set designed by you, and described in the December issue of "Wireless," but am very disappointed to find, after spending roughly £5 on components, and taking especial care in construction, that no results whatever are obtainable from the set."

"I thank you for your letter of the 7th instant, but am very pleased to say that I have now discovered the defect, and the little set is working admirably."

I think that speaks for itself.

We have received another letter about this same set from a reader away in Egypt. We withhold his name and address just in case he would rather not have it published for some reason or the other. The letter is just as valuable without it.

Dear Sir,

It is with great interest I read of the "Fairy Portable" in the December issue of "Wireless" and, being impressed with its small size, wonder if it would not be possible to produce something similar for short waves.

From the point of view of an overseas reader the only band worth considering is the 10-50-metre one.

Now if you could publish details for the construction of a very small short-wave set, of, say, three valves, complete with batteries without loudspeaker, to work on the 10-50-metre band, so that the only extras required are a pair of ear-

phones and a short temporary aerial to hang up somewhere handy, you would fill the hearts of many people like myself with delight.

Victor King has at least brought out something reasonable in the "Fairy Portable," but such a set designed purely for the short-wave band would bring the news in nightly to us when travelling away from civilisation where newspapers are not available.

Trusting you will give our needs out here some consideration. I would like to hear your views on it.
Yours faithfully, J. L.

Our views on it? Well, judged on an entirely theoretical basis it is quite sound—a jolly good idea. As a matter of fact our Research Dept. is investigating the possibilities from practical viewpoints now.

You may rest assured, J. L., that if it proves a usefully practical proposition, we shall be publishing a design in the near future. If any other readers have any ideas on such a set which they would like to see incorporated, we shall be pleased to hear from them.

WHO WANTS TEN SHILLINGS?

There is no doubt that every reader of "Wireless" has some information, ideas or opinions which would interest other readers. So we are going to offer ten shillings for the reader's letter which, in the opinion of the Editor, is the best of the month. And the sender of every other letter we publish will receive 2s. 6d. So get your pen out and "drop us a line." Anything connected with radio—programmes, sets, experiences, tips—is legitimate material. And length is by no means a necessary feature of a "winner."

And now I must turn to two items which concern articles in the March number. First of all "Inexpensive A.V.C. for Any Set."

This article has tickled the fancy of many experimenters, so much so that some have written in for details of all the component values to use. That is rather out of the question! You see, when you are experimenting you have to find out suitable values by—well, by experiment.

However, we can give you a guide with some of the less obvious values that will ensure your experimental hook-ups will not be far off the mark.

In the case of Fig. 1, the grid coupling condensers are .0003-mfd., and the condenser connected to the anode of V1, .0001-mfd., whilst a .1 mfd. is suitable for decoupling.

A WX6 rectifier is suggested with a .25-meg.

resistance across same, whilst the grid leak for the detector valve is a 2-meg. and the remaining resistances 1-meg.

The circuit shown in Fig. 2, incorporating a double-diode triode, employs a .01-mfd. L.F. coupling condenser, whilst the H.F. coupling condenser is .0001-mfd., the resistance connected to the diode is .25-meg., and the remaining resistances are 1-meg., a suitable decoupling condenser being .1-mfd.

The only resistance calling for special note in the Fig. 2 Westector diagram is the resistance connected to the grid of the associated valve which is 1-meg.

The values of the resistances and condensers in the case of Fig. 3 may be obtained from a careful study of Figs. 1 and 2. There is, however, one condenser which should be noted, and that is the .0001-mfd. between the triode anode and the right-hand diode.

All values for Fig. 4 can be obtained from the above details, not forgetting to note in these circuits the addition of the bias battery.

In the final circuit fundamental details may be taken from the previous details, bearing in mind that the .0001-mfd. condenser between the negative of the Westector and the earth line is shunted by a .25-meg. resistance.

And finally, the article entitled "Make Sure of Your Values." Mr. W. J. Lee has been going into the question of components, and his letter which follows gives the latest information on the subject, which he has obtained from the makers.

Dear Sir,

In the January issue of "Wireless," you published an article entitled "Make Sure of Your Values," in which it is stated that the three standard condensers could be obtained from Dubilier at an increased cost of 10 per cent and an error of 2 per cent.

I have communicated with this firm and they inform me that this statement is incorrect.

The closest tolerance obtainable for the 2-mfd. condenser is ± 10 per cent type B.B. or 9200/9201, price 4s.

The .0005-mfd. can be supplied ± 2 per cent type 620 mfd. but the price is 7s. 6d.

Type B.775 .01-mfd. is 8s. 6d. for the same percentage error.

Resistances can be obtained from Bulgins at 50 per cent on list price as stated in your article.

When calibrating the dial why not leave the 100 divisions permanently marked? One could then calculate any odd value that is not marked on the dial.

Is not the average potentiometer rather small for this instrument, i.e. to get, say, 400 ohms, the gauge of resistance wire is necessarily rather fine, and is liable to wear and break with much use?

In conclusion I would like to say that personally I would like to see more articles of this nature published in your journal.

Yours sincerely,
Weybridge.

W. J. LEE.

Thank you, Mr. Lee. With reference to your query re the potentiometer, if a good class of component is used no trouble should be experienced with it. Naturally a larger potentiometer with thicker wire would be mechanically stronger.

Quite a lot of "Our Contact Page" this month has been written by your readers yourselves. That's fine! That's just what we want. You tell us something for a change.

And now, who's for that ten bob next month?

Building An

All-Mains All-Wave SUPERHET

By
G. V. Dowding,
Associate I.E.E.

Here are full details for the construction of an All-Wave Superhet that compares very favourably, both in performance and in price, with the latest commercial sets in the same category. Nowadays it is often difficult to design a home-constructor receiver that will compare in price with the mass-production sets made by well-known manufacturers, but this all-wave set is definitely competitive and is one we can thoroughly recommend from all points of view.

This is an immense advantage, for it must be admitted that there is nearly always a great deal of fading to be encountered on the short waves.

The A.V.C. in this set "holds" most effectively, and is sufficiently "alert" to deal with that "high speed" signal variation which rises and falls over a considerable compass.

Of course, at times there is a

volume against all but that absolute elimination.

The A.V.C. has an almost equally important task on the medium-wave band, and here you will find that its delayed action almost entirely eliminates the effects of fading. Its powers of volume-level retention are almost

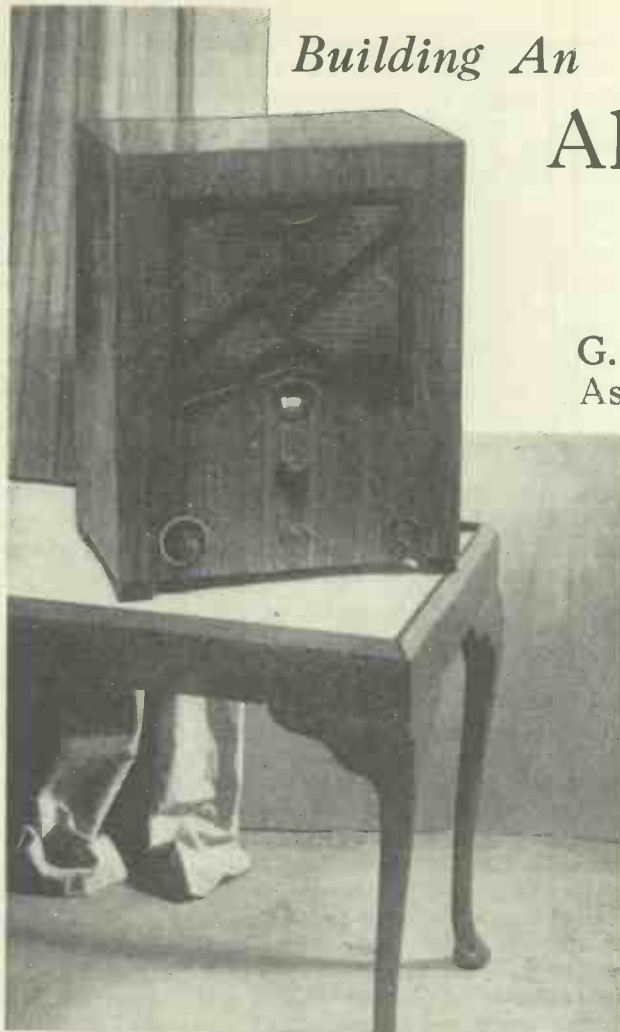

Handsome appearance, completely self-contained, and reasonable in price, this "Wireless" all-waver is a set that will attract thousands of set-builders.

THIS is undoubtedly one of the most attractive mains sets which we have ever produced, for it is not only comparable with the neatest and handsomest commercial sets, but is also very competitive in cost.

Further, it is technically an extremely advanced design within the compass of its price-class, although its construction is well within the scope of the average constructor.

Incorporates A.V.C.

It is an all-wave set in the fullest sense of the term, for merely by switch operation it can be immediately adapted to receive either short waves or medium and long waves.

And the short-wave performance is really first-class. Not only is the set highly sensitive on the short waves, but the automatic volume control functions efficiently on these bands.



THE NEAT CHASSIS

The whole of the radio portion is built on one chassis, which is housed below the speaker and power pack section in the cabinet.

certain amount of what might be termed "complete" fading which results in a station falling right below that point when even the great sensitivity of a modern superhet is unable to make it audible.

Clearly, in such cases the best A.V.C. in the world is unable to hold the programme. However, as against this, the normally well-received stations are easily held at a good level of

uncanny, and after an evening or two's listening you might well be excused the question "What is this fading, anyway?"

Although this all-wave super uses only three valves, it is in effect

THESE ARE THE ITEMS REQUIRED

- 1 Bulgin 4-range aerial coil, type C52.
- 1 Bulgin 4-range oscillator coil, type C53.
- 1 Bulgin switch assembly for above, type S122.
- 1 J.B. "Unitune" 2-gang tuning condenser.
- 2 Wearite I.F. transformers, type I.F./I.C.465, one with and one without pigtail.
- 3 Clix 7-pin chassis mounting valve holders, with screw terminals.
- 1 Polar .0005-mfd. pre-set condenser.
- 1 Polar .0003-mfd. pre-set condenser.
- 2 Dubilier 1-mfd. fixed condensers, type B.B.
- 1 Dubilier 50-mfd. electrolytic condenser, type 3001.
- 4 Dubilier 1-mfd. tubular fixed condensers, type 4503.
- 1 Dubilier .01-mfd. fixed condenser, type 670.
- 1 Dubilier .001-mfd. fixed condenser, type 670.
- 1 Dubilier .0002-mfd. fixed condenser, type 670.
- 1 Dubilier .0001-mfd. fixed condenser, type 670.
- 2 Dubilier .0001-mfd. fixed condensers, type 665.
- 1 Wearite H.F. choke, type H.F.P.
- 1 Erie 500,000-ohm potentiometer, graded type.
- 1 Bulgin semi-rotary on/off switch, type S128.
- 4 Erie 1-meg. resistances, 1-watt type.
- 1 Erie .5-meg. resistance, 1-watt type.
- 2 Erie 50,000-ohm resistances, 1-watt type.
- 1 Erie 20,000-ohm resistance, 1-watt type.
- 1 Erie 10,000-ohm resistance, 1-watt type.
- 1 Erie 500-ohm resistance, 1-watt type.
- 1 Erie 300-ohm resistance, 1-watt type.
- 2 Erie 140-ohm resistances, 1-watt type.
- 3 B.T.S. 2½-in. mounting brackets, with long slot.
- 1 Clix 3-socket strip, engraved A1, A2, E.
- 1 Peto-Scott "Metaplex" (both sides) baseboard, 14 ins. × 8½ ins. × ½ in. with one wood runner, 14 ins. × 2½ ins., × ½ in.
- 1 Cod B.R.G. Quikon connecting wire.
- Screws, flex, etc.
- 1 Bracket for V1. (Peto-Scott).
- 1 Peto-Scott "Fitzall" cabinet.

VALVES.

V1	V2	V3	Rectifier
Cossor	Mazda	Mazda	Marconi or Osram M.U.12.
41.M.P.G.	A.C.V./P.1	A.C.2/Pen.D.D.	

POWER PACK.

- 1 Wearite mains transformer, type T.21B.
- 1 Dubilier 4-mfd. fixed condenser, type 9204/L.E.G.
- 1 Dubilier 8-mfd. dry electrolytic condenser, type 0281.
- 1 W.B. 4/5-pin A.C. valve holder.
- 1 Bulgin twin fuse-holder, type F.16, with 1-amp. fuses.
- 1 Peto-Scott single electrolytic condenser bracket.
- 1 W.B. energised M.C. loudspeaker, type E.M.2/2,500 ohms.

There is a variable-mu heptode which combines the functions of both a mixer and oscillator, and following that there is a variable-mu pentode operating on an intermediate H.F. amplifier. The A.V.C. is applied to both of these valves, and that is why it is so effective.

The third valve is a double-diode pentode, a "three-in-one" device. It acts as an output pentode, a diode detector and an A.V.C.

Nothing at all is lost in such function-grouping as this, and there is a definite saving in space and in components and construction.

One fact alone will at once illustrate this; if

further advantage that the wiring is necessarily shortened as well as reduced, and that obviously must make for superior results.

You will note that we say nothing about the gain in current consumption. It is true that there is this too, but the overall current taken from the mains by such an instrument is at most quite small and in the same category as that of one small electric-light bulb.

So the addition to one's electricity bill is merely a few pence per week at most. To talk about the saving of an odd valve-heater or so is to speak in terms of farthings!

The set owes much of its compact tidiness and ease of operation to the use of all-wave coil units which cover all the useful short-wave bands as well—both medium and long waves.

Simple Control

Short-wave reception is reduced to the simplicity of normal broadcast by the fact that with the superhet principle there is no reaction control.

All you have to do is merely to turn the tuning control slowly until you hit the programme to which you desire to listen. There is none of the fiddling about with a delicate reaction control. It is, of course, for the reason that the new commercial sets are taming the short waves by means of a similar principle that short waves have now been brought within the reach of all listeners.

equivalent to at least a five-, if not a six-valve employing single-purpose valves.

separate valves were employed there would need to be more valve holders and leads. Incidentally, there is the

THE SPECIAL HIGH-EFFICIENCY CIRCUIT OF THIS ALL-WAVER

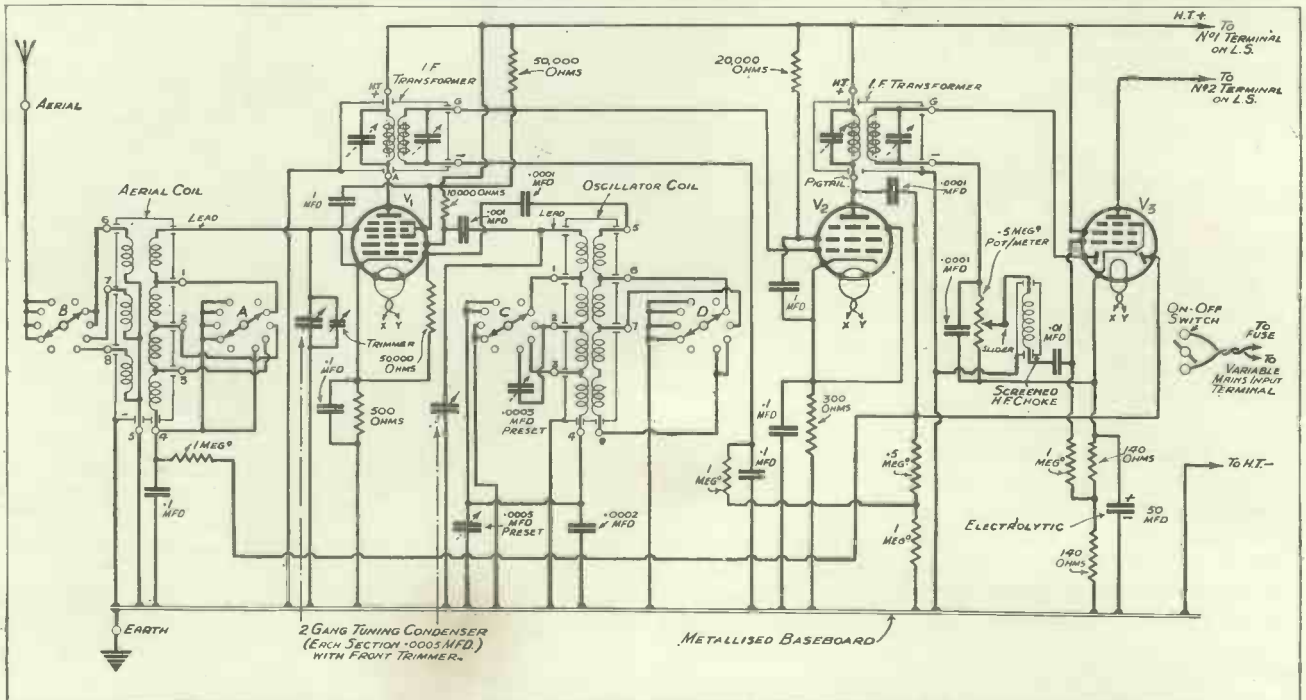

This all-wave set contains only three valves, but a great deal of work is carried out by them. The first valve is the mixer-oscillator, the second the intermediate frequency amplifier, and the third carries out the duties of power amplifier, detector, and A.V.C.

So, as you will observe, the operation of our superhet all-waver resolves itself into the simplest possible terms. There is the wave-band selection (wavechange switching), programme selection (ganged tuning) and manual volume control.

Manual Volume Control

Perhaps a few words of explanation regarding this last are called for. Automatic volume control does not do away with the need for a manual adjustment.

This is required so that the level of volume can be adjusted to meet the requirements of the individual listener, for clearly not all will want the same volume at all times. The A.V.C. automatically holds the volume at the level at which it is set by the manual volume control.

There may be many attracted by the indubitable advantages and qualities of this fine all-wave mains set, who will hesitate to build it because they fear to tackle something destined to connect with the power mains.

They must not worry at all on this score. Providing the set is built as described, the mains current will keep to its well-ordered routes and even

(Please turn to page 252.)

INSIDE THE CONSOLE TABLE CABINET

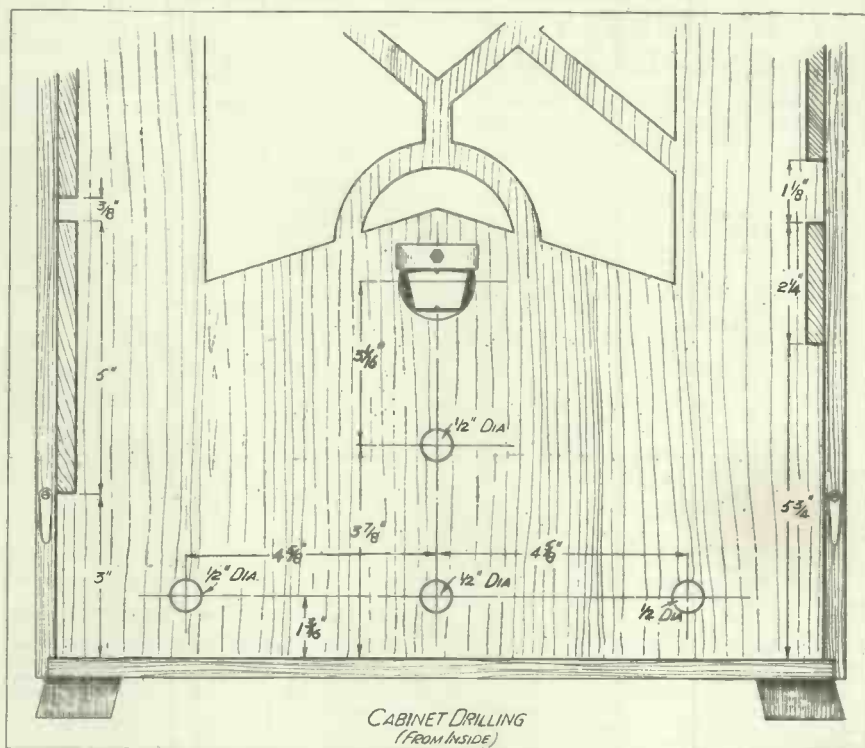

Note that in this drilling diagram of the front of the cabinet the positions of the holes are taken from the centre as well as from the floor of the cabinet.

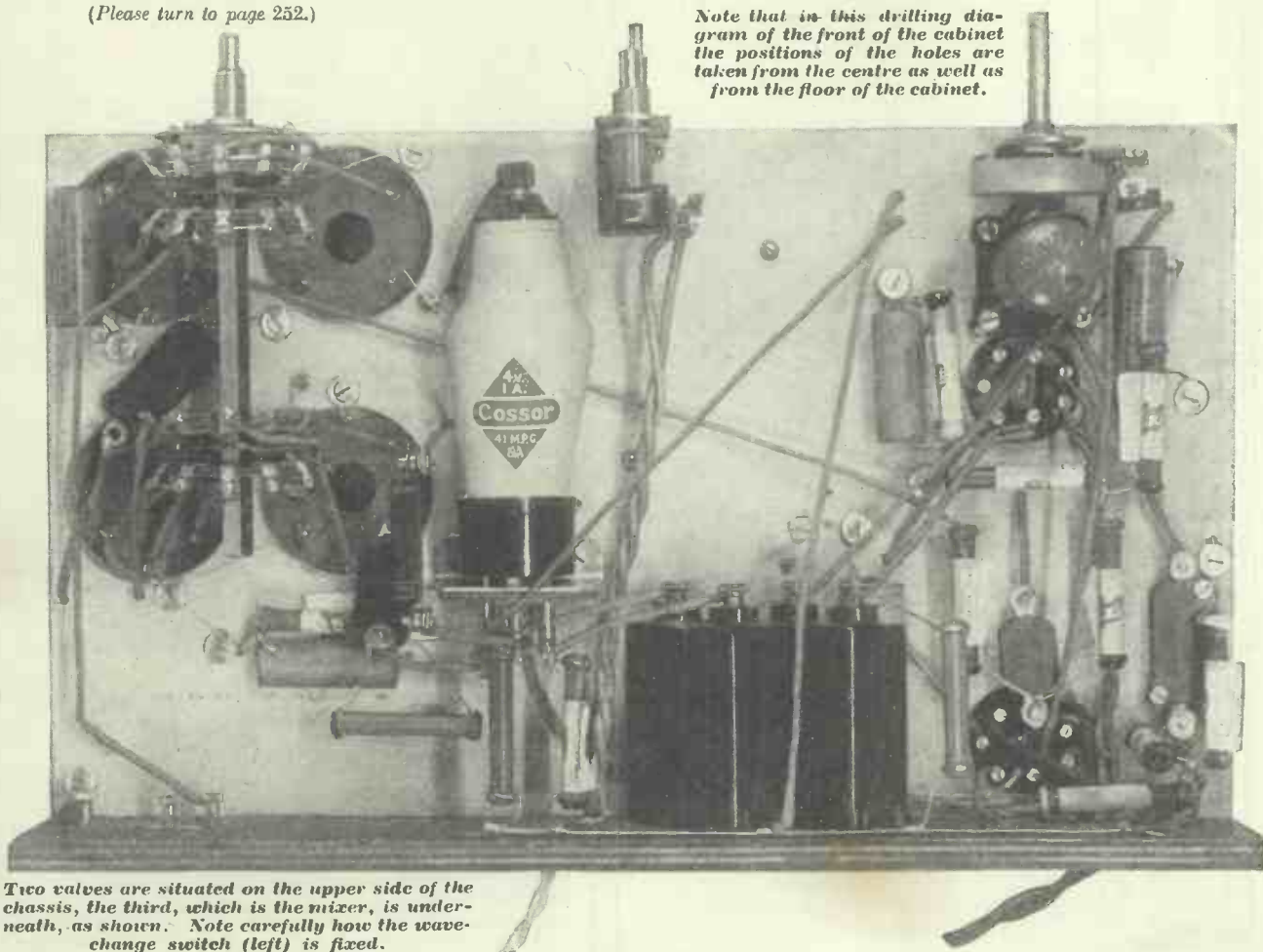

Two valves are situated on the upper side of the chassis, the third, which is the mixer, is underneath, as shown. Note carefully how the wave-change switch (left) is fixed.

COMPLETE WIRING DETAILS

The text on this page and the next explains the relation between the various diagrams.

When all the components have been mounted in accordance with the layout diagrams on this page and at the bottom of the next, the wiring can be rackled. This is all shown on this and the facing page.

To get your hand in, it is a good scheme to start with the speaker and power pack wiring. This is shown in the top diagram on this page. The two flex leads marked "To Mains" go to a two-pin or adaptor plug for connection to the supply.

There are seven points on this power-pack which have to be connected down to the receiver chassis. These points are all marked so that cross reference to the leads which go to them should be quite easy.

The seven leads concerned can be seen along the bottom edge of the above chassis diagram. From left to right, you will see that they go to the No. 1 terminal on the speaker transformer, to No. 2 on this transformer, to the two outside terminals of the 2-0-2 (3-4A) winding on the transformer, to the unconnected fuse terminal and the variable input tap terminal on the mains transformer (it is immaterial which lead goes to which of these two), and finally to the left-hand terminal of the 4-mid. tubular condenser.

When wiring the receiver chassis, commence with the twin flex leads to the on-off switch and the heaters. These are shown in a separate diagram for clarity.

Looking at the two wiring diagrams at the bottom of these pages, you will see that all the holes where leads pass from the underside of the chassis to the top side, or vice versa, are numbered

THE LOUDSPEAKER AND POWER PACK

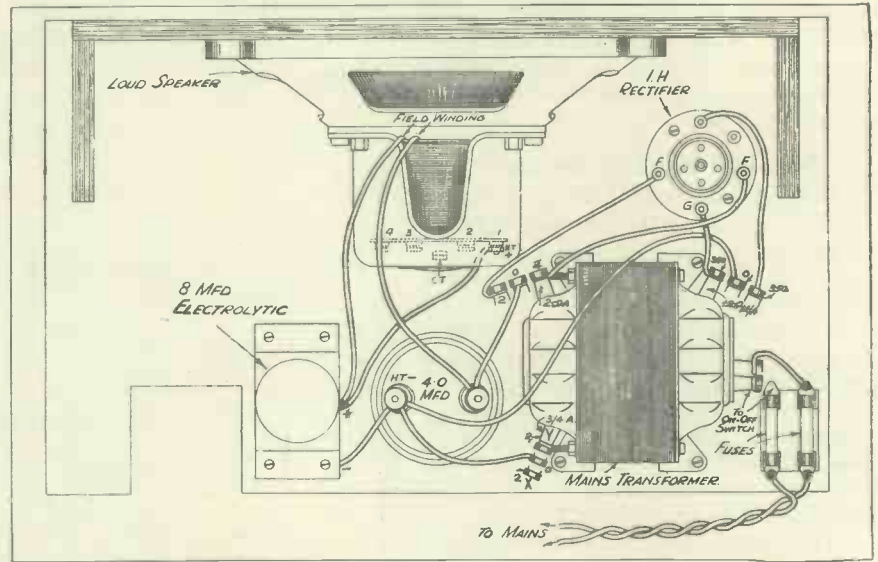

similarly in both diagrams. This facilitates cross reference.

The next point we come to is the wave-change switch with its four "disc" switches. To have shown this in position on the under-chassis wiring would have complicated the diagram considerably.

As it is shown you can imagine it simply slid straight out of the set and upwards towards the

top of the page. The position of the switch spindle is marked on the wiring diagram in dotted fashion.

On the wiring diagram the leads to the switch all end in arrow-heads which are lettered. Similar letters are placed against the leads from the switch contacts to which these wires go on the switch diagram. The points to which the switch contacts go are also marked. The numbers in

PLAN VIEW OF THE RECEIVER CHASSIS FROM ABOVE

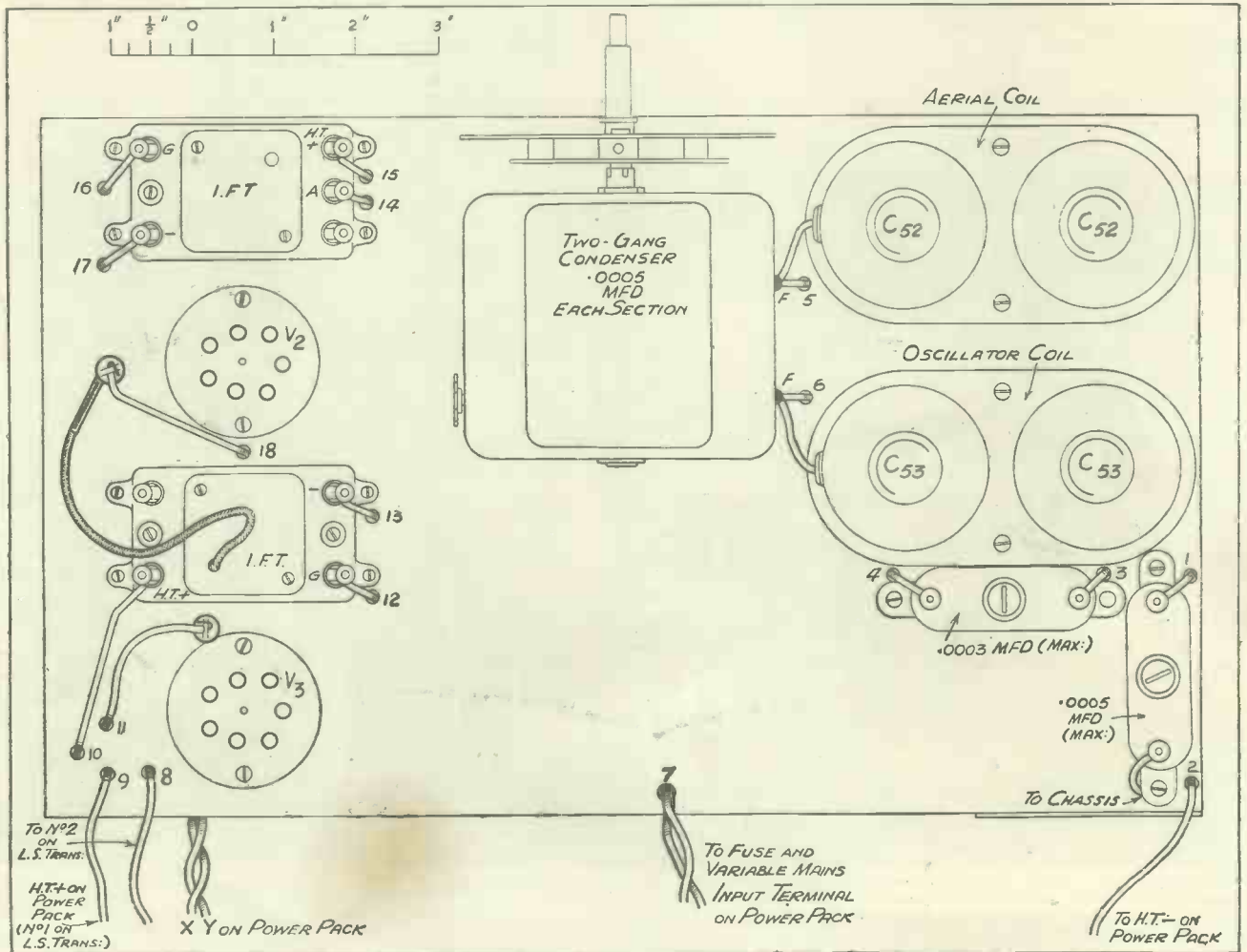

SWITCH CONNECTIONS

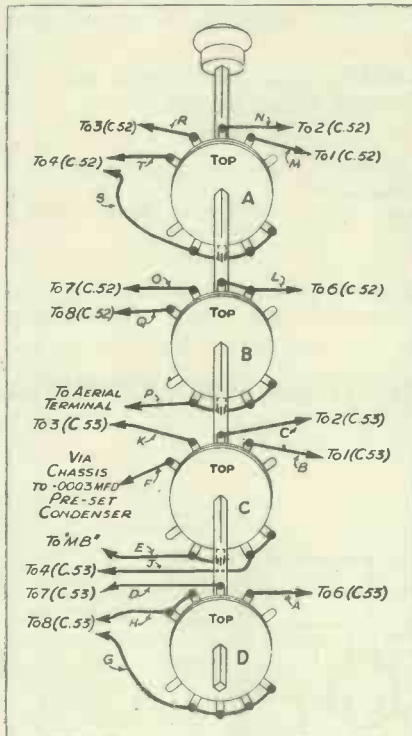

brackets on the coil contacts correspond with the actual numbers on the components themselves.

The letters A, B, C, and D on the switch sections are merely for cross-reference, if desired, with the theoretical circuit diagram on another page.

Then there is the valve holder for V1. In the wiring diagram this is shown as though it were seen in plain view in order to simplify the showing of the wires which go to it. Actually, this holder is mounted vertically, the valve lying horizontally as seen in one of the photographs.

The bracket which holds this valve holder is made from gauge 16 sheet aluminium. It is 2½ inches square, plus a turned-over portion along one edge of ½ inch. This "lip" has two holes for the screws which hold the bracket to the baseboard.

The hole in the bracket through which the "legs" of the valve holder pass is 1½ inch in diameter. Make sure that the valve holder is centrally mounted so that none of the "legs" comes into contact with the aluminium.

Another small constructional point concerns the mounting bracket for the on-off switch. The slot in this has to be slightly enlarged to take the switch. This enlarging is easily carried out with a file and need only be done at the point in the slot where the switch will come.

The slot which you see cut in the loudspeaker-and-power-pack baseboard, adjacent to the 8-mfd.

THE FLEX LEADS EMPLOYED

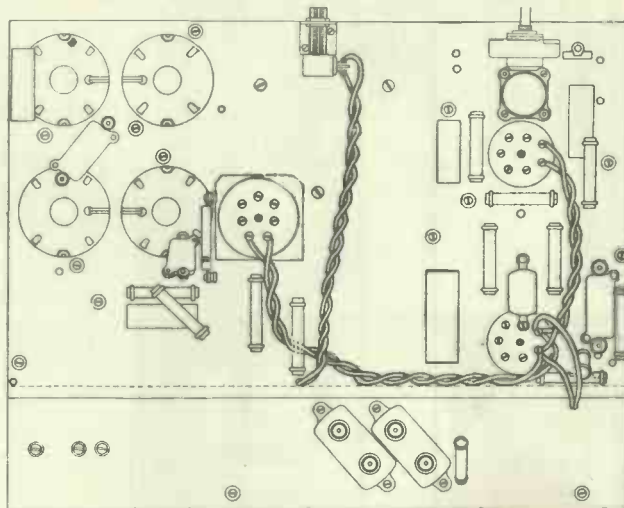

electrolytic condenser, is to allow clearance for the top cap of V3. This valve, being the output valve, is somewhat larger than V2, and stands higher. The cut-away part of the baseboard also ensures that the valve shall have ample ventilation.

Finally, with regard to the three slotted brackets: The wavechange switch, the on-off switch, and the volume-control should be placed on their brackets so that their height corresponds with the dimensions on the drilling diagram.

MOST WIRES ARE BELOW THE CHASSIS

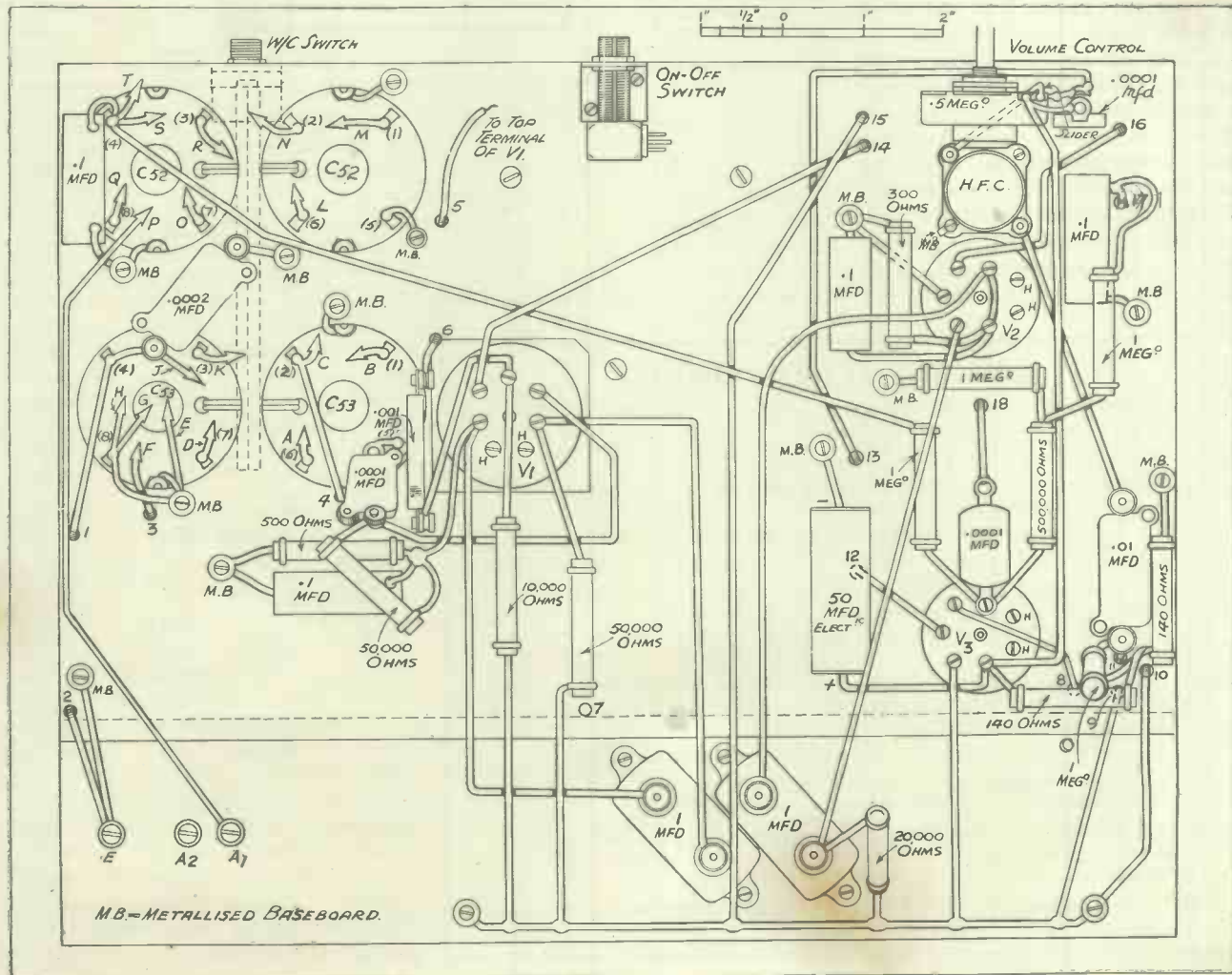

THE COMPLETED SET

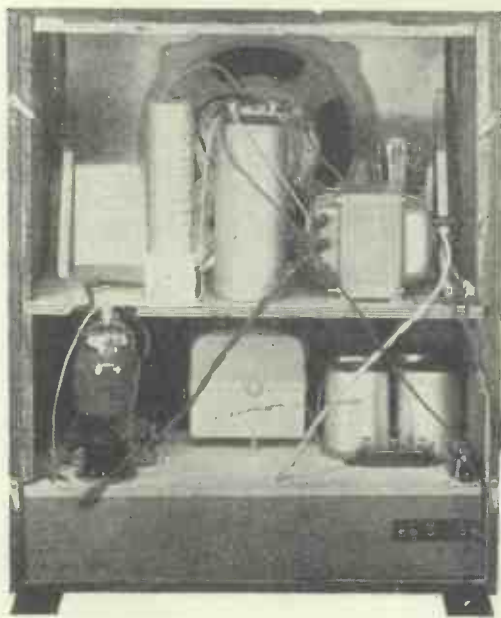

—continued from page 249.

should some mistake be made, there are fuses to protect both the house-wiring and its fuses and the set itself.

Naturally, you won't dig about inside to alter connections and so on while the mains are switched on!

It is an advantage to have a good aerial for the medium- and long-wave stations, but you will find that you will be able to receive even American short-wavers when the conditions are good on two or three yards of wire strung up above the set itself.

On the other hand, to have a longer, better aerial will not reduce the short-wave effectiveness, don't think that.

So if you can do so, it will be to the all-round benefit of the set's performance if you can arrange a fairly good outdoor aerial or an indoor one of normal dimensions.

If you have access to roof-space this is always an excellent position for fixing an indoor aerial, so long as the lead from it does not have to

of H.F. interference which might otherwise manage to creep in.

A buried earth is to be recommended

APPROXIMATE DIAL POSITIONS OF SHORT-WAVE BANDS.

S.W.1	S.W.2
19-metre band approx. 40°.	31-metre band approx. 20°.
25-metre band approx. 80°.	48-50-metre band approx.
29-31-metre band approx. 120° to 140°.	70° to 80°.

if possible, but a sound water-pipe connection will prove itself almost as good. Alternatively, you can use

L.S. FIELD WINDING USED FOR SMOOTHING

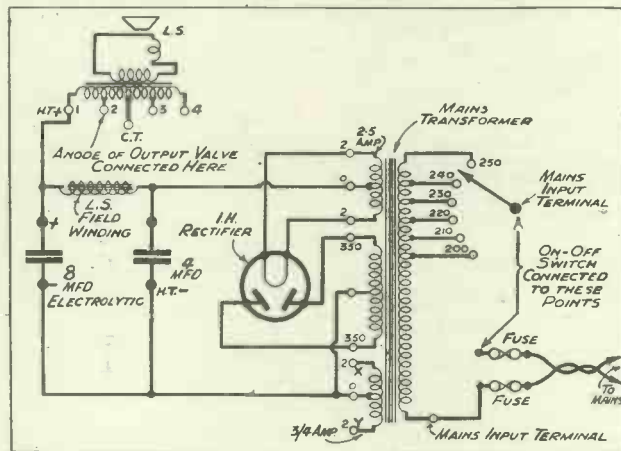

On the right is the power-pack circuit, which is built up on a baseboard and chassis, and fits in the top part of the cabinet. This is clearly seen in the photograph on the left, which shows the all-over fully assembled and ready for use.

wander all round the house before it gets to the set.

The A2 aerial socket is not used. You can leave the aerial lead permanently connected to A1. Although the set will work quite well without an earth connection, it is very desirable to have one, for it will eliminate forms

the earth socket on the power point if this happens to be one of those three-point affairs, one point being an earth.

However, unless you are very well up in house wiring, or have an expert friend to whom you can go for advice, it will be as well to forget this matter of obtaining earths at power points!

Before placing the set on test make sure that you have got the mains transformer adjusted to the voltage of your supply mains. This is done by unscrewing one of the input terminals and twisting the circular

HOW THE SET IS TRIMMED

1. Turn each trimming screw on top of the I.F. transformers clockwise as far as they will go, without forcing them.
2. Now turn them all back half a turn.
3. Set trimmer on back section of tuning condenser to minimum—i.e. turn it some three turns anti-clockwise.
4. Set front trimmer of tuning condenser to the midway position.
5. Set wavechange switch to medium waves, and tune-in the local station.
6. Adjust .0005-mfd. pre-set condenser, so that strength of station is reduced, when front trimmer of tuning condenser is turned either way. The approximate setting of the pre-set condenser is three turns out from the "all-in" position.
7. Now tune accurately to a fairly weak station, not forgetting a final adjustment of the front trimmer, and adjust trimmers of I.F. transformers for maximum signal strength.

That completes trimming of the medium waveband.

8. Turn wavechange switch to the long-wave position, and set front trimmer of tuning condenser to the midway position.
9. Adjust .0003 mfd. pre-set condenser together with the main tuning condenser, until Droitwich is received at maximum signal strength. The approximate setting of the tuning condenser is 90.
10. A final adjustment of the I.F. transformer trimmers should be made on a station on one of the short wavebands.

WAVE-RANGES

S.W.1	15 m. to 35 m.
S.W.2	30 m. to 80 m.
Medium Waves	200 m. to 560 m.
Long Waves	1,000 m. to 2,100 m.

insulating plate round until the right figures appear in the aperture.

The wave-ranges given on this page are those claimed by the makers of the coils. In actual fact this is a modestly conservative specification, and there is quite a bit of useful overlap. That is why the 31-metre band can be heard on the S.W.2 range. Also, of course, it is to be found on the S.W.1 range, as is stated in the list of dial positions.

FROM MY ARMCHAIR

—continued from page 226.

unsound, the wife's belief in it showed her gullibility, while her obvious uncertainty regarding results does her no credit as a judge.

Think scientifically, and you will always be on velvet. But if you do it to extremes you may feel superior but you will starve to death in a barrel.

It is surprising how dramatic and interesting fairly ordinary enterprises can be made on the radio—more so probably than in a novel, certainly more so than in a historical account. I am thinking of the Manchester Ship Canal broadcast to which I listened by accident while in bed with a cold. It was really the story of one man's determination to provide Manchester with a direct outlet to the sea and of his death just before it was completed.

"Use the Canal"

Having on more than one occasion flown over the whole length of this canal, hunting in bad weather for the municipal aerodrome situated adjacent to it, I could visualise all the better the struggles against vested interests, stupidity and the elements. The tragedy, however, seemed to lie in the fact that the pioneer who fought down all opposition received no reward, although but for him there would be no canal.

The broadcast also recalled a profane memory. In the Manchester trams they have two notices hanging up side by side. One commands "Do NOT SPIT IN THIS CAR" and the other advises "USE THE SHIP CANAL."

* * *

How many of the B.B.C. pioneers have received any concrete acknowledgment of their work? There is a board-room in Broadcasting House on whose walls are hung photographs of those senior members of the staff who have left the Corporation. This is a graceful gesture, but is it enough? Amongst that gallery are those whose work laid not only the foundations of broadcasting, but the very structure of the edifice. Because they were not there when the roof was put on, it seems a little unfair that they should go unrewarded.

Recognition at the B.B.C.

The man in the street is apt to regard the Government's recognition of B.B.C. officials as rather like the game of musical chairs in which those who happen to be in the seats of the mighty are rewarded. Those who have been favoured fully deserve their honours,

but their pioneering predecessors should surely not go empty-handed.

Let those radio engineers and amateurs with watches follow the time-honoured example of Good King Wenceslas and "look out."* The most accurate watches have vulnerable parts which are liable to be magnetised, and the modern moving-coil loud-speaker has a very strong permanent magnet which has a considerable external field. Bringing your watch on your wrist near to the speaker may partially magnetise your watch and

* Good King Wenceslas spent all his life in fear of assassination, which presumably is why he had to "look out."

cause considerable time-keeping errors. So when tinkering with your loud-speaker watch out and watch off!

NEXT MONTH

All record enthusiasts and the users of sets which have provision for the attachment of a pick-up, should look out for the special feature in the next "Wireless and Television Review," dealing with record reproduction and the use of microphones.



How are your ears?

A 1936 STENTORIAN is exclusively specified both for Mr. John Scott-Taggart's "THIS YEAR'S S.T.100" and for the "ALL WAVE SUPERHET."

Believe it or not, there are in use this minute literally hundreds of old moving-iron horn type speakers. Their owners like the "purity of tone" (lack of bass). The absurdly narrow frequency range, appalling resonances, and violent colouration are not consciously noticed; and until those listeners hear a good modern speaker for a few minutes they will never realise the true reason for their lack of interest in the broadcast programmes.

This is an extreme instance of the common phenomenon known as "aural tolerance." You are not proof against it. Nobody is. You may even now be satisfied with radio reproduction far inferior to that which your set could give with a W.B. 1936 Stentorian, simply because your ear has become accustomed to the present imperfections.

Make this test. Ask yourself "Am I delighted with my set's reproduction?" "Do I get vivid life-like entertainment from my radio, as distinct from merely treating it as a pleasant 'background accompaniment' to other activities?"

If you cannot honestly answer "yes" go straight to your radio dealer and ask to hear a W.B. 1936 Stentorian loudspeaker. Afterwards, in the intervals between listening to the vivid presentation of broadcast items which it brings you, you can reflect on "aural tolerance," and the pleasure of which it has cheated you for so long.



1936 STENTORIAN CHASSIS MODELS

Senior	42/-
Junior	32/6
Baby	23/6
Midget	17/6
Stentorian Duplex	84/-
Type EM/W	70/-

CABINET MODELS

36S (Senior)	63/-
36J (Junior)	49/6
36B (Baby)	29/6

1936 STENTORIAN

WHITELEY ELECTRICAL RADIO CO. Ltd. (Electrical Dept.), MANSFIELD, NOTTS
Sole Agents in I.F.S., Kelly & Shiel, Ltd., 47, Fleet Street, Dublin.

SHORT-WAVE DEVELOPMENTS

BY W.L.S.

THE connection between sunspots, magnetic storms, and short-wave reception conditions has been well known for some years, and we have all understood that a large amount of real research work on these phenomena was being carried out.

How comprehensive and detailed this has been may be judged from a recent statement by Dr. Dellinger, Radio Chief of the U.S. National Bureau of Standards. He recently called the attention of all users of the short waves to a newly discovered phenomenon—the complete wiping-out of all long-distance short-wave signals for a period of about fifteen minutes in every fifty-four days.

A Very Queer Phenomenon

Last year this complete fade-out was logged on March 20th, May 12th, July 6th and August 30th. Since the publication of Dr. Dellinger's first statement another one has occurred (on October 24th), which confirms the fifty-four day interval pretty well.

As the result of an appeal to all members of the A.R.R.L., many previous instances of this "wipe-out" have been identified, and there will be little chance that any future ones will pass unnoticed.

The interesting question is this: The sun rotates in about twenty-seven days. Why is this queer wipe-out only logged on every second rotation? Obviously it is desirable to investigate very closely the twenty-seventh day for a fade-out, as well as the fifty-fourth, in case it has merely been overlooked.

Watch These Dates

The fifty-four-day periods over which readers may keep watch will occur roughly between March 31st and April 3rd, and again between May 24th and 28th. The intermediate twenty-seven-day periods will be in the region of March 4th-8th, and from April 27th-30th.

□.....□

SOME INTERESTING DETAILS OF THE LATEST RESEARCH THAT HAS BEEN CARRIED OUT ON THE PHENOMENON OF SHORT-WAVE FADING, AND THE FIRST PUBLISHED INFORMATION ABOUT A NEW AIRCRAFT INVENTION.

□.....□

The radio fade-outs have apparently been proved to coincide with solar eruptions which last for only a few minutes, and only the side of the globe which is actually illuminated by the sun at the time is affected.

I should like to quote one paragraph from an article by Dr. Dellinger in the January "QST.": "Magnetic disturbances, sunspot activity, and poor high-frequency radio transmission have hitherto been considered to go together in general, but with many puzzling exceptions. We are perhaps now in a position to begin to unscramble the relation.

"High-frequency radio transmis-

TO PREVENT COLLISION

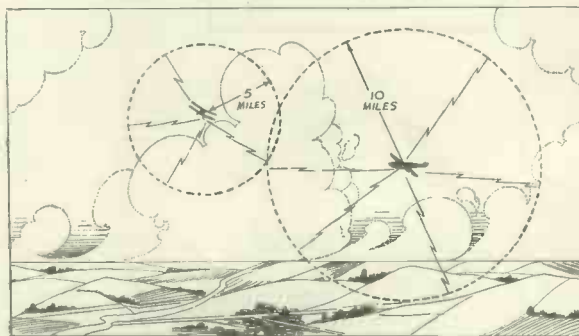

A novel scheme has been invented for preventing blind-flying planes from colliding. A radio-aura is transmitted round the planes and on two auras coming into "contact" a warning light glows in the cockpit of each plane.

sion improves as general sunspot activity increases (probably because of increased ultra-violet radiation), but some particular relatively sudden eruptions on the sun have the reverse effect (impairing high-frequency radio

transmission on the illuminated side of the globe) and also give rise to terrestrial magnetic disturbances."

Those who hold that radio conditions are independent of sunspots, and are caused only by terrestrial magnetic storms might profit by reading once more that phrase in italics!

It is interesting to note that the earliest of these abrupt fade-outs logged by amateurs was on November 28th, 1934. Dr. Dellinger caused old records to be looked up, and received news from Mount Wilson Observatory that a solar eruption was observed on that day, within half an hour of the time of the reported period.

The use of ultra-short waves for aircraft landing beacons is well known, but a novel application is suggested by recent details of an English invention known as the "Radiaura." As its name implies, this takes the form of a "radio aura" surrounding an aeroplane in flight.

Extremely compact apparatus and very low power are sufficient to generate an ultra-short wave with a range of ten or fifteen miles. The whole point of the invention—and the part which we are not allowed to disclose—is that several planes can transmit on identically the same wavelength without interfering with each other until they come within each other's "aura."

The Warning Light

Imagine a plane flying through a blanket of cloud. Ten miles ahead, and heading straight for it, is another plane. When they are five miles apart, a small warning lamp lights simultaneously on the instrument board of each. The pilots know that there is another plane within five miles of them.

I believe the details of the invention go much farther than this, enabling one pilot to ascertain whether the other plane is flying at the same height as his own. The radius of the aura may be adjusted at will.

THE 1936 EMPIRE SUPER

—continued from page 242.

you use only the main controls. There is, however, not the slightest point in trying to do that, and the small band-spreading condenser, with its slow-motion dial, is a very nice control to handle.

The oscillator and detector circuits are perfectly stable; that is to say, they appear to work uniformly on each of the three coils, and oscillation is evenly maintained over the whole of the dial in each case. Accurate adjustment of the I.F. transformers—there are three variable controls on each of them—is a business that is harder to describe than to do. You will find by experience the degree of coupling that each one requires.

When the optimum setting is found, it will probably be possible to make the I.F.'s oscillate just at the very top limit of the volume control. Since this is rather an advantage than otherwise, I need not refer to it again.

You may occasionally find, as I do, that the sudden reception of a powerful station, when the volume control is set in a suitable position for listening to a weak one, will cause the I.F.'s to "spill over"; but this does not imply that there isn't plenty of volume still available when the necessary adjustment has been made.

Plenty of Volume

The variations in the volume of short-wave stations are, of course, vastly greater than those encountered on the ordinary broadcast bands. I have just interrupted my writing to tune-in the Empire Station on 19.82 metres, and W 8 X K on 19.72. The American is, I should imagine, ten times stronger than G S F, who is "fluttering" badly and needs the volume control at maximum for intelligibility. W 8 X K, on the other hand, is terrifically strong and very steady.

I hope that overseas readers will receive the Daventry stations with the same kind of punch with which I get the Americans. If they do, they should be well satisfied.

Incidentally, I have been doing much listening with a small moving-coil speaker actually mounted on the chassis in the blank space between the band-spread condenser and the output valve. It does not cause any microphonic troubles, thanks to modern valves and the sturdy construction of the condenser vanes. The set can be mounted in quite a neat "American-

style" cabinet, complete with loud-speaker, if you want to make it look nice and keep it dustproof.

I referred last month to the use of a filter between the mains input and the set. Instead of the home-made one to which I alluded, I have been trying a commercial variety which gives equally good results. It is not really necessary on my mains, but some readers may find something of the kind necessary.

In any case, the whole subject of mains suppressors is dealt with in detail in a special section on other pages of this issue.

There is definitely no trouble from

A.C. hum; in fact, I find myself completely forgetting that it is a mains receiver, which is as it should be.

Regarding aerials, I have been using two different ones for test purposes. One is 66 feet long and 45 feet high at the far end. The other is 20 feet long and nearly vertical. As far as I can judge, these two give identical results, with possibly a slight balance in favour of the smaller one on the shorter wavelength. In any case, the difference is too slight to worry about.

Any reasonably efficient outside aerial will give good results. I have tried a small indoor length of wire and been perfectly successful with it.

PETO-SCOTT PILOT AUTHOR KITS
Exact to Specification

THIS YEAR'S S.T. 100 KIT "A" CASH or C.O.D. **62/-**
Carriage Paid

These are parts used by Mr. John Scott-Taggart and contained in PILOT AUTHOR KIT "A". Any item supplied separately. Orders over 10/- sent C.O.D.—Carriage and post free.

	s.	d.
2 Peto-Scott aluminium brackets with 2 bolts and nuts	3	3
1 Peto-Scott ready drilled ebonite terminal strip, 5" x 1 1/2"	8	
1 Peto-Scott ready drilled and polished walnut plywood panel, 16" x 12", with 7 nickel-plated screws	3	3
2 Peto-Scott ready drilled and polished cabinet side pieces, 1 cabinet top, and 1 grid bias battery spar, with 6 screws	3	6
1 Colverna S.T. 100 coil unit	12	6
1 Ormond R.483 condenser, with small knob	5	6
1 J.E. main tuning condenser with long pointer	2	6
1 B.T.S. variable condenser, type 601	2	6
1 Polar Compax variable condenser	2	6
1 Graham Parish variable condenser	2	0
1 T.C.C. fixed condenser, type 34	1	3
1 Lissen fixed condenser, type L.N.9	1	6
1 Wearite H.F. choke, type H.F.P.	3	6
1 Wearite H.F. choke, type H.F.P.J.	2	0
1 Benjamin 5-pin valve holder	10	
1 Benjamin Vibroider 4-pin valve holder	7	6
1 Varley Niclet L.F. transformer	1	0
1 Dubilier 1-watt resistance	1	0
1 T.M.C. Hydra 1-mfd. fixed condenser	2	3
1 Ferranti 1-meg. grid leak	1	0
1 Bulgin on-off switch	1	6
5 Relling-Lee type R terminals	1	3
2 Belling-Lee Midget winder plugs	1	9
Maxamp wire, miscellaneous screws, flex		

KIT "A" CASH OR C.O.D. Carriage Paid £3:2:0

S.T. 100 FINISHED INSTRUMENT

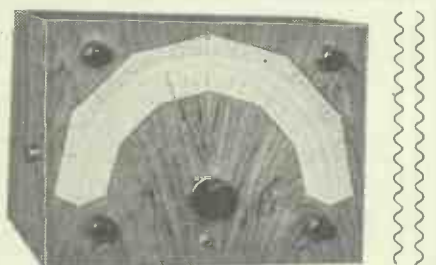

S.T. 100 READY ASSEMBLED and TESTED, LESS VALVES 79/6

Built exactly to Mr. John Scott-Taggart's first specification by Peto-Scott radio technicians. As illustrated, less valves. Cash or C.O.D. Carriage Paid, £3/19/6, or 8/6 down and 10 monthly payments of 8/-. If required with 2 specified valves, Cash or C.O.D. Carr. Paid, £4/15/6, or 12 monthly payments of 8/9.

S.T. 100 FINISHED INSTRUMENTS in Peto-Scott CABINET with valves

Table Model, Cash or C.O.D. Carriage Paid, £5/13/0, or 12 monthly payments of 10/3. Upright Console-ette Model, with speaker, Cash or C.O.D. Carriage Paid, £7/10/0, or 12 monthly payments of 13/6. Type "LL" Console-ette Model, with de luxe speaker, Cash or C.O.D. Carriage Paid, £8/8/0, or 12 monthly payments of 15/3.

Complete Kit of parts as used and first specified by Mr. John Scott-Taggart, including Peto-Scott Structakit detailed below, less valves and cabinets.



Balance in 8 monthly payments of 7/6

KIT "B" Cash or C.O.D. **£3:18:0**
Carriage Paid.
Or 8/6 down and 10 monthly payments of 7/9.
As for Kit "A," but including 2 specified valves, less cabinets.

KIT "CT" Cash or C.O.D. **£4:15:6**
Carriage Paid.
Or 12 monthly payments of 8/9.
As for Kit "A," but including valves and Peto-Scott Table Cabinet.

KIT "CC" Cash or C.O.D. **£5:13:0**
Carriage Paid.
Or 12 monthly payments of 10/3.
As for Kit "A," but including valves and Peto-Scott Upright Console-ette Cabinet with speaker baffle.

KIT "CLL" Cash or C.O.D. **£5:15:6**
Carriage Paid.
Or 12 monthly payments of 10/6.
As for Kit "A," but including valves and Peto-Scott "LL" Console-ette Cabinet with speaker baffle.

STRUCTAKIT C.O.D. PARCEL

Comprising 2 Peto-Scott ready drilled and polished side pieces, cabinet top, and grid bias battery spar, with 6 screws. Drilled and polished walnut plywood panel, 16" x 12", with 7 nickel-plated screws, 2 aluminium angle brackets with nuts and bolts, Drilled ebonite terminal strip, 5" x 1 1/2". Maxamp connecting wire, screws and flex. As specified and used by Mr. J. Scott-Taggart.

9/-
CASH or C.O.D. Postage 9d. extra.

£1 C.O.D. PARCEL

Comprising COLVERNA S.T.100 Coll Unit, J.B. Main Tuning Condenser with long pointer and knob and B.T.S. Anode Coupler Condenser. Cash or C.O.D. Carriage Paid. **£1**

Send for illustrated leaflets of recommended Peto-Scott Table and Console-ette Cabinets.

ALL WAVE All Mains SUPERHET RECEIVER KIT

Cash or C.O.D. **£5:15:0**
Carriage Paid
Or 12 monthly payments of 10/8.

Author's Kit of first specified parts for Receiver only, less valves and cabinet. Power Pack Kit, less valves, £2/2/6, or 9 monthly payments of 5/6.

PETO-SCOTT CO. LTD.

77 (W9) CITY RD., LONDON, E.C.1. Phone: Clerkenwell 9406/7
West End Showrooms: 62 (W9) High Holborn, London, W.G.1. Est. 1919

**The Specified Valveholders
For The
"ALL-MAINS
ALL-WAVE
SUPERHET"
Clix Standard
Type (V2)**

7-pin - 1/-

**Specified
Because :-**

All Clix components, in addition to giving Perfect Contact, are easy to wire; for instance, in Clix Chassis Mounting Valveholders the centre socket of the 5-pin and two sockets of the 7-pin type are made longer than the others; this reduces the possibility of short circuits and adds to the ease of wiring.

Designers of sets described in this journal are firm believers in the efficiency of all Clix types of Valveholders, so consistently specified.

CLIX
Latest List "P" free.

LECTRO LINX LIMITED,
79a, Rochester Row, London, S.W.1



The designer specifies for
**THIS YEAR'S
S.T.100**
these Belling-Lee components.
FOR A GOOD JOB WELL DONE



"R" Type
Terminals
No. 1003.
A, E, LT+,
HT+, LS-.
Five at 3d.
each.



"Midget"
Wander
Plugs
No. 1019.
GB+, GB-.
Two at 2d.
each.

THIS
BOOK
FREE



BELLING & LEE LTD
CAMBRIDGE ARTERIAL ROAD, ENFIELD, MIDDXX

Please send post free "Radio Connections."

Name

Address

W.T.R. 3-36.

Pars for Purchasers

McMichael Radiogram

The set market is changing so rapidly that it takes one all one's time to follow the changes, and so many new things are coming out, especially in the all-wave market, that pages of WIRELESS could be covered with the details. Here, therefore, we have to restrict ourselves to a large extent and be content with giving you some of the outstanding items in brief.

One of these is undoubtedly the new McMichael Radiogram with its twin speakers and five-valve superhet chassis. It is a de luxe instrument with mains interference suppression and an output of over 4 watts undistorted power. The price is 28 guineas.

Philco

A new Philco three-valve battery receiver has made its appearance. It is of low consumption type, taking only 8.5 milliamps H.T. current. It incorporates an eight-inch P.M. speaker, and a new type of dial with station names and wavelengths in white on black. It costs £6 19s. 6d.

Marconiphone Foursome

Marconiphone have issued four new sets. One is an all-waver known as model 345. It costs 17½ guineas and has a wave-range of 16.5 to 2,200 metres in four steps. Five valves and a rectifier are employed in a most up-to-date circuit.

The other three sets are four-valve designs (including rectifier) for use on A.C. mains. They incorporate a special Droitwich wavetrap and have output powers of 3 watts. The prices are: Model 238, table receiver, 8 guineas; 237, in leatherette, 8 guineas; 245A, radiogramophone in figured walnut, 16 guineas.

Truphonic All-Wavers

Two Truphonic all-wavers have been marketed, one for A.C. and the other a universal type. Cost of each is 12 guineas, and each incorporates a five-valve superhet chassis.

Pye Range Extended

Still the all-wavers come out. Pye have brought out a new one, a six-valve superhet. It goes down to 13 metres and up to 2,000, the short-waves stopping at 80 metres. The model is a consoleette costing 18 guineas. In addition, a 21-guinea console five-valve super known as the T12 has been introduced. It incorporates a new tuning scale on which the names of stations are illuminated in correct position on a map of Europe as they are tuned-in.

McCarthy Radio Chassis

Have you ever thought of buying a radio chassis and fitting it into your own cabinet? It is a good idea. McCarthy Radio Ltd. are doing a fine business on these lines.

They provide a number of chassis to choose from at rock bottom prices and of dimensions that are convenient for either consolette or console fitting. From the £4 5s. battery band-pass superhet the range goes to an eight-valve all-wave superhet for A.C. at £11. All prices are inclusive of valves, and full circuit details are provided.

The chassis are completely assembled, of course, and are ready for working. They incorporate the latest refinements and the makers provide a 24-hour service. Chassis can be obtained on 7 days' approval for cash, carriage free on orders over £10, and

all carry a twelve months guarantee. Worth looking into, I think. If you want to find out more about them write to McCarthy Radio Ltd., 44a, Westbourne Grove, London, W.2.

Dubilier Fadover

A new fade potentiometer has been released by Dubilier in the form of a double log-law volume control consisting of two .25 meg. elements in juxtaposition, with a centre zero tapping point. Ideal for pick-up and radio fading in or out, or for any of the other circuits which call for a gradual changeover from one to another.

Wm. F. Brown Radio Ltd.

Do you want a short-wave converter for A.C. mains to enable you to use your present set on wavelengths between 5 and 80 metres? I am not suggesting something that cannot be supplied. It can, and at the remarkable price of £4 15s., less the two mains valves.

The makers are Wm. F. Brown, Radio Ltd., of Ossillo Radio Works, Brierley Hill, Staffs., and it is their latest arrival on the market. The makers state that the instrument is as easy to handle on 10 metres as the ordinary broadcast receiver is on the medium and long waves. Now then short-wave fans, there's a chance for you!

Polar Ultra-Short-wave Trimmers

And here is a new line for the ultra-short-wave enthusiast. Polar trimming condensers with air dielectric, and capacities of 25, 50, 75, and 100 mfd. The price of any size is 3s. Incidentally I should like to remind you that Polar also have a range of "Midget" gang condensers with tracking section for 465 kc. intermediate frequency.

Avo-Oscillator

A new single-valve modulated or unmodulated (at will) oscillator has been brought out by the Automatic Coil Winder and Electrical Equipment Co., Ltd., at a price of £5 10s. It is very compact, and uses one of the Hivac midget valves.

It covers frequencies of 100 to 280 kc., and 500 to 1,600 kc. on fundamental frequency, but with the help of harmonics I.F. values such as 450 and 465 can be covered, while harmonics can also be used for short-wave calibration and testing. Those interested should write to Winder House, Douglas Street, London, S.W.1.

Epoch Speakers

Two new P.M. speakers are being produced by Epoch Reproducers, models D4 and B7. The prices are £6 10s. and £4 4s. respectively. I also hear that Epoch are branching out into the production of short-wave transmitters and receivers—quite a new line.

WHOLESALE DEPOT



For most standard makes of RECEIVERS — COMPONENTS — KITS, including whole or part S.T.100, S.T.700, and All-Mains, All-Wave Superhet.

All usual sundries — enclose trade-card with enquiry.

LEONARD HEYS: FARADAY HOUSE
HENRY STREET, BLACKPOOL.
ELEVEN YEARS EXPERIENCE IN THE WIRELESS TRADE

**BRITISH BROADCASTING
NEWS AND VIEWS**

—continued from page 227.

of broadcasting, people like Eric Maschwitz feel that presentation for the special needs of the microphone becomes increasingly important. They argue that a great deal of the music which is put on the air without presentation is waste effort. They would try variations such as the mixing of programmes and of functions. Thus they would not hesitate to do symphonic music with a dance orchestra, and dance music with a symphony orchestra.

On the other hand, the Music officials of the B.B.C. look upon all this as little short of vandalism. Great music, they think, should be produced as literally as possible in the way the composer meant it to be produced. Any presentation "stunt" to the purist musician is anathema. But the musicians are losing ground. The instant and persistent success of the "presented" shows such as Jack Watt's is good ammunition against the traditional view. My prophecy is that the microphone technique of presentation will gradually pervade the whole field of broadcast music. When this happens the service will be enormously improved from the standpoint of the average listener.

TELEVISION TO-DAY

—continued from page 236.

averse, but latterly a change has taken place, and now I think the entertainment world welcomes the advent of television, because they realise that it is inevitable anyway, and that it will be an adjunct to, or an enlargement of, the means for public entertainment. Sir Oswald Stoll, whose views can be taken pretty well to represent those of the industry, said lately that the entertainment industry was increasing its manifold activities and that not the least of these was television.

"I look forward to the day," he said, "when a show in the Coliseum at eleven o'clock in the morning will be shown simultaneously in Melbourne at nine at night, in Tokyo at eight p.m., Hong Kong at seven, and Calcutta at five. Our normal evening shows, too, will be just right for matinee time in New York.

"Television will make that possible, and a show will not be just a film, but will be stereoscopic and with colour.

sounds, and everything, just as you see it in the Coliseum. And all this will happen within a very few years."

Several readers have asked me whether I am able to tell them at what hours of the day the B.B.C. will send out television programmes. In common with most other things with regard to the television service, this has not yet been definitely decided, but I understand that the periods under consideration are three to four in the afternoon, and then quarter-past-six to quarter-past-seven and half-past-nine to half-past-ten in the evenings, that is, three separate hours during the day.

Arrangements are also being made for newspaper offices, large department stores, manufacturers and others to set up "viewing rooms," similar to those which have already been inaugurated on the Continent, so that the public can get an idea what television looks like. The aim is to have at least fifty of these "viewing rooms" in London, and no doubt large numbers of visitors from the Provinces will come to London specially to see the television shows and get some sort of foretaste of what will be available when the service is extended to other parts of the country.

HIVAC
HARRIES
Y220

*Chosen by Mr. J. Scott-Taggart
for his 1936 "S.T. 100"*

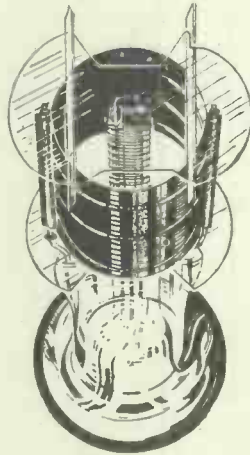

Illustration shows the "critical" distance between anode and outer grid, whereby special characteristics are obtained.

HIVAC Y220
10/6
AS SPECIFIED.

Tremendous interest was created by the Hivac Harries Valves when they were introduced and demonstrated to numerous well-known radio technicians and the public at Olympia in 1935.

The HIVAC HARRIES Y220 has solved the problem of combining Triode quality with Pentode sensitivity, accomplished by a fundamentally new design.

This valve can be used in the output stage of all types of receivers, giving better tonal quality combined with increased volume.

Full particulars and technical details will be sent free to all applying to

HIGH VACUUM VALVE CO., LTD.,
113-117, Farringdon Road, London, E.C.1.

Telephone: CLERkenwell 7587.

LARGE STOCKS AVAILABLE FOR IMMEDIATE DELIVERIES

When to Listen DURING MARCH

By the time March arrives we are beginning to feel that the longer days are coming. Even in the middle of February the short-wave bands are "open" through the whole of the twenty-four hours, and even the 16- and 19-metre bands are sometimes alive till 8 p.m.

It is the eleven-year sunspot cycle that makes it impossible to predict one year's conditions from the previous year, but we do know, by now, which of the wavebands are likely to be the best at any particular time.

The accompanying diagram is intended to show exactly this—the most interesting band at any particular time of day. Where more than one band occupies this favoured position it simply means that conditions are rather similar on both.

The amateur bands occupy a unique position, carrying as much traffic as they do, and it is really worth while to

listen on 20 metres at all sorts of times, both before and after the best time for the 19-metre broadcast band. The 40-metre band is full of interesting signals right through from 2 p.m., when Asia begins to come in, until 8 a.m. next day—hence the long black line.

The 49-metre band would be in the same category if it were so thickly populated by stations working at all hours.

It should not be necessary to show a

BAND	0000-0200	0200-0300	0300-0400	0400-0500	0500-0600	0600-0800	0800-1000	1000-1200	1200-1400	1400-1600	1600-1800	1800-2000	2000-2200	2200-2400
75-85 m (AMATEUR)														
40-50 m.														
40 m (AMATEUR)														
31 m														
25 m														
20 m (AMATEUR)														
19 m.														
16 m.														

The shaded parts indicate the best times to listen

second chart indicating the best times for receiving different parts of the world. The rules are fairly simple, since North and South America come in from 2 p.m. onwards, the best waveband shifting upwards as time draws on.

Australia and New Zealand, whatever wave they use, can be heard in the early mornings and again during the late afternoons and evenings. Asia is an afternoon continent, and South Africa seems best in the early evening.

W. L. S.



CUT OUT THE CRACKLE
It can be stopped
YOU JUST PLUG IN

Do it yourself
in two minutes
—then PEACE!

Plug into your mains set this 17s. 6d. Set Lead Suppressor (Treble Choke and Condenser Filter). Almost essential in flats or semi-detached houses, if receiver is a transportable with self-contained aerial, or if independent frame is used. Fitted with choke-protecting fuses which also protect mains transformer.

***17/6 MONEY BACK** if the interference is not suppressed

USE THIS COUPON

*If for use with radiogram, ask for type 1256. 19s. 6d.

BELLING & LEE LTD Please send free booklet "Wireless Without Crackling"

Name

Address

W. & T. R. 3-36

CABINETS. Write for Free List
GILBERT (cabinet maker), SWINDON.

THIS YEAR'S S.T.100

—continued from page 213.

(g) CUT CENTRING TAB OFF WITH SAFETY RAZOR BLADE by cutting along inner border where indicated (where tab is joined on). Tear away the tab from the condenser bush; there is really no need to remove the fixing nut to do this. Tighten up the fixing nut on bush of main tuning condenser.

A dial of white celluloid, with printed names and exactly similar to the card dial but very much more professional-looking and durable, is

obtainable, I understand, for 3s. 0d. post free from Celluloid Printers, Ltd., Kingston By-pass, Surbiton, Surrey. The constructor's direction lines in pencil or ink may be washed off when desired.

STAND SET IN ITS NORMAL POSITION WITH DIAL FACING YOU.

(r) Turn projecting spindle of main tuning condenser fully anti-clockwise (fully left). Slip the large J.B. knob and long pointer on to end of spindle with the pointer pointing exactly horizontally to the left. Tighten

(Continued on next page).

NEWS ABOUT NEW SOCIETIES, ETC.

Last month we published the name of Mr. R. V. Allbright (G 2 J L), of 2, Palmyra Place, Newport, Monmouthshire, who was seeking co-operation in the forming of a local society. We now learn that the Newport and District Short-Wave Society has been formed.

Meetings are to be held at the Queen's Hotel, Newport, every month, and will take the form of lectures and informal discussions. All readers who are interested are asked to correspond with Mr. Allbright at the address given above.

Tottenham Short-Wave Club

Mr. L. Woodhouse, of 57, Pembury Road, Bruce Grove, N.17, informs us that the Tottenham Short-Wave Club has now made a new start after a period "off the air." New members will be welcomed, and a comprehensive programme has been arranged for the coming season.

Cardiff Transmitters' Society

In spite of its title, the above society exists with the object of popularising short-wave work, both transmission and reception, in the neighbourhood of Cardiff, and has many keen receiving enthusiasts as members. Others will be welcomed, and should approach the secretary, Mr. H. H. Phillips, 132, Clare Road, Cardiff.

South London and District Transmitters' Society

We are also asked to make it clear that the S.L.D.R.T.S. does not confine its activities entirely to transmitters' problems. The receiving section of its membership is very keen, and the meetings form an excellent opportunity for keen receiving enthusiasts to become familiar with transmitting practice and with the more advanced aspects of short-wave reception.

Meetings are held at West Norwood on the first Wednesday of each month, and the secretary is Mr. H. D. Cullen (G 5 K H), 144, West Hill, Wandsworth, S.W.15.

Bideford and District Short-Wave Society

Those interested in short-wave radio in N. Devon are invited to get in touch with Mr. E. K. Jenson, secretary of the Bideford and District Short-Wave Society, 5, Furzebeam Terrace, East-the-Water, Bideford. Meetings are held fortnightly on Mondays at the Red House Café, The Quay, Bideford, and the society has two transmitting members in its chairman, G6 F O, and 2 A D J.

We shall be glad to hear from readers who are desirous either of forming a local society, or of getting in touch with one already in existence. In either case we will give the fullest publicity to their wishes in this section.

THIS YEAR'S S.T.100

—continued from previous page.

grub-screw, which is the little screw which fits into edge of knob and is on opposite side to pointer. (Do not touch screw which secures the pointer.)

(s) Turn spindles of aerial coupler, anode coupler, anode reaction condenser and aerial balancing condenser fully anti-clockwise (fully to left). Fit their knobs with the white spots or pointers pointing exactly in a horizontal direction to the left. Tighten up their grub-screws.

(t) Fit knob on wavechange switch spindle (no special direction).

YOUR SET IS NOW COMPLETE.
(See further article on installation and operation next month.)—J. S.-T.

THE TRIPLE EXTRACTOR

If you use .0005-mfd. air condensers of other box. You must not fit your condensers closer together than described, and the coil assembly should not be nearer to the side of box or nearer to condensers.

N.B.—The Extractor condenser used in S.T.600 should not be used; but the better Ormond condensers, e.g. as used in S.T.300, S.T.400, and S.T.500, are all right. The efficiency of the condensers is of extreme importance; for that reason I have given as alternatives to Polar only condensers proved on measurement to be satisfactory.

(a) Collect and examine (handling carefully) the three specified .0005-mfd. air variable condensers and the Wearite Triple Extractor coil assembly which I designed for this set.

(b) Using Fig. 7 and Fig. 8, mark out and prepare the wooden top and sides of box, unless bought prepared. The blue print is only to show wiring and not dimensions.

(c) You are now going to build the box. Lay one end-piece of box, face upwards, on a table. Knock in about 1/4 in. deep four 1/4-in. ordinary nails at the points indicated in Fig. 7. Hold one side-piece vertical on end. Driving in two of the nails in the prepared end-piece, nail end-piece to side-piece. Drive the other two nails through into the end of the other side-piece which is held vertical on end.

Drive four ordinary 3/4-in. nails 1/2 in. into other end-piece in the same way and complete frame of box. Now lay drilled wooden panel right way up on the table and knock in about 1/4 in. deep six 1/4-in. ordinary nails in position marked on Fig. 10. Lay panel on box frame and hammer in the nails. Sand-paper any rough edges and, if desired, stain. (I used Jackson's—of Mitcham, Surrey—oil varnish stain, walnut shade, a size 6 tin being more than enough for both set and Triple Extractor.)

(d) Using two 3/4-in. No. 6B.A. countersunk head brass screws and nuts, fix the Triple Extractor coil assembly inside the box the right way round. Fit terminals A1 and A2. Fit the three Polar .0005-mfd. condensers. Write with a pencil the markings C1, C2 and C3 on the ends (not vanes) of condensers in order shown on blue print. This will enable you to identify each condenser.

(e) Preferably using "Maxamp" wire in the manner described in S.T.700 Rapid Construction Guide, wire-up as follows: (Do not confuse coil numbers with wire numbers; wire numbers are in circles.) Tick off wire numbers in list as connections are completed.

Wire (1). C3 fixed vanes terminal at side joins coil terminal 3.

Wire (2). C2 fixed vanes terminal at side joins coil terminal 2.

Wire (3). C1 fixed vanes terminal at side joins coil terminal 1.

Wire (4). A2 terminal joins coil terminal 1.

Wire (5). A1 terminal joins coil terminal 4.

Wire (6). Coil terminal 4 joins C3 moving vanes terminal on top.

Wire (7). Coil terminal 3 joins C2 moving vanes terminal on top.

Wire (8). Coil terminal 2 joins C1 moving vanes terminal on top.

(f) Check wiring by asking a friend to read out the above wiring instructions while you look at Triple Extractor. In case of error, correct at once.

(g) Fit knobs of condensers.
THIS COMPLETES TRIPLE EXTRACTOR.
J. S.-T.

THE NEW NORTH IRELAND REGIONAL TRANSMITTER

—continued from page 238.

A rearrangement of the boundaries of the provincial Regions not long ago (the chief effect of which was to transfer Lincolnshire from Midland to North) brought the city of Oxford into the Midland Region.

Mr. Percy Edgar, the Midland Director, has not been long in sending his programme sleuths to the University town, and one of the first results will be a relay of Motets by the New College Choir, from Midland Regional on March 7th.

West Region Plans

The West Regional Programme Director, Mr. R. A. Rendall, who has been advising the Palestine authorities about the organisation of their broadcasting system, was originally "loaned" by the B.C.C. for six months and they were expecting him home at Bristol at the end of this month. His visit has now been extended, however, by six months, so he will not be back before September or October.

When Mr. Rendall returns to his office at Bristol he will find that a good deal has been done towards splitting Wales and the West of England into separate Regions. Both still share a common transmitter (at Washford Cross) and a Regional Director (Mr. E. R. Appleton), but that will not last. How soon Wales gets its exclusive transmitter depends on how soon the engineers settle upon sites for the new West Regional transmitters. Several positions are being considered.

In Mr. Rendall's absence his deputy has been Mr. Francis Worsley, who is likely to be moved to Plymouth to organise big programme developments in South Devon and Cornwall.

The Droitwich Goldfish

When I motored into the depths of Worcestershire—to Droitwich—the other day, I expected to see gigantic masts, and monster valves, and mighty engines, but I scarcely anticipated that the equipment of this famous broadcasting station would include 150 goldfish.

Yet it is so. Outside the building which houses the B.C.C.'s most powerful transmitter there is a reservoir of water, for cooling the valves.

"The pond got covered with scum and full of insects," an engineer told me, "so we imported 150 goldfish. And it's quite remarkable how since then the goldfish have got fatter and fatter, and the pool cleaner and cleaner!"



FREE

We can train you for a successful radio career and introduce you to employers or teach you how to earn money in your spare time. Many of our students are now earning good money solely as a result of our training.

Our Home-study Courses are praised by leading Radio Manufacturers, and are conducted by Radio Experts with practical knowledge of the qualifications that lead to success, employment and a good income.

Take the first step to success by sending at once for your free copy of "Radio as a Career" which tells how you can earn more money by becoming a qualified radio expert. Post coupon below.

TECHNICAL AND COMMERCIAL RADIO COLLEGE
CROMWELL HOUSE, HIGH HOLBORN, LONDON, W.C.1.
Telephone: Chancery 7054 & 7055.

To T & C. RADIO COLLEGE,
Cromwell House, High Holborn, W.C.1.

Please send me a free copy of your book describing your training and telling me how I can get employment in the radio industry or make money in my spare time.

NAME

ADDRESS

36 W. (Post in unsealed envelope, 1d. stamp.)

Specified for the

ALL-MAINS ALL-WAVE SUPERHET

The designer points the way to reliability by specifying Erie resistors for this set. The accuracy of their values remains constant even in face of damp, humidity and extreme working conditions. Follow the leading manufacturers who fit Erie resistors for trouble-free service and economy. 1/- per watt in all values. The precision-built Erie volume control is specified also as the potentiometer required for this set. It gives long and faultless service without hop-off noises.



ERIE
Volume Control
All sizes, 5,000 ohms to 2 megohms. With built-in mains switch 3/6 5/-

ERIE

Send for the Free Erie Colour Code Chart and technical data to:

THE RADIO RESISTOR CO., LTD.
1 Golden Sq., London, W.1.

RESISTORS AND VOLUME CONTROL



FROM SCRIPT TO SPEAKER

—continued from page 241.

the rest of it. For the last two rehearsals I am entirely concentrated on the panel, accompanied by the control engineer, who will be on duty at the actual broadcast.

"This liaison work is, of course, very necessary, otherwise the whole effect I am aiming at might be ruined by the control engineer failing to appreciate my aims.

"Another important aspect of these last two rehearsals is the presence of one or two disinterested people who know nothing about the technique but who are there to judge the result purely as listeners. Their essential criteria are always the same—intelligibility and audibility.

"However good a play may be in all other respects, I realise it may be quite easily ruined from the listener's angle if, at some points, it is either unintelligible or inaudible. Familiarity with the script tends to blind the producer to many minor faults—and it is the duty and function of these outside people to detect them before it is too late.

"I have already said how important is the timing question—and at the last rehearsal my stop watch is used with special care to make certain that we shall not commit the worst crime of broadcasting—overrunning time.

"Rehearsals vary according to the type of play, of course. With a fairly straightforward show where the continuity is easy as few as six rehearsals may be enough. For more complicated shows as many as ten rehearsals are necessary.

Bad Effects Can Spoil a Good Play

"The marking of the script? My dear chap, there is nothing at all mysterious about that! All you will find on the producer's script are the marks indicating light cues, emphasis, and any individual notes that may help in the control of the panel.

"Yes, effects are important. But I would emphasise, as I have done so many times, that whereas good effects cannot make a bad play good, it is very true that bad effects can entirely spoil an otherwise good play.

"As a matter of fact an extremely high standard of intelligence is needed to render effects so unobtrusive that they are not noticed. A mistake in the application of

effects will immediately ruin the atmosphere you have laboured so hard to create.

"Good panel work is essential for successful radio play production. And the best technique is that which produces the desired effect without the listener being aware of the reason for it."

THE WRONG SET

—continued from page 245.

for want of breath. I crouched against the hedge while I tried to get my wind back, eyes and ears wide for the slightest sound of someone approaching in the darkness.

IN THE APRIL ISSUE

PICK-UPS, RECORD MOTORS, and MIKES

How to get the best from your records and make the most of the "pick-up" terminals on your set.

BUILDING A MAINS RADIOGRAM CHASSIS

Details for constructing a simple chassis, including pick-up and turntable, for incorporation in any cabinet design.

Special Articles Concerning the Reception of the Alexandra Palace Transmissions; ALSO Many Interesting Non-Technical Features.

As soon as I could I ran on again, and had I the breath left I would have yelled for joy at the sight of the town street lamps and the solid, red-brick police-station across the road.

I ran into the charge-room and stopped, panting so hard I couldn't speak, while a sergeant and a constable waited impatiently.

"The murderer!" I gasped. "He's been in my house to-night!"

I explained my find in the wireless set, and pulled the money out of my pocket and laid it on his desk.

The sergeant stared at it, frowning.

"I tried to telephone," I ended, "but the line was dead."

"They're all dead to-night," the sergeant said. "The exchange was flooded." He leant forward. "What was this man like?"

I described him. At first the sergeant frowned, then exchanged a quick glance with the constable.

"We know the man you mean," the sergeant said, nodding. "But I'll ask you not to say anything about this outside, sir. This Albert Smith is, to all intents and purposes, a commercial traveller doing a little bit of business in the town. But," he whispered gravely, "he's actually a man from Scotland Yard who's helping us on this case."

It shows you not to put too much faith in circumstantial evidence.

INDEX TO ADVERTISERS

	PAGE
Jackson Brothers (London), Ltd.	198
Lectro Linx, Ltd.	256
Peto-Scott Co., Ltd.	255
"Popular Gardening"	Cover ii
Radio Resistor Co., Ltd.	259
Technical and Commercial	
Radio College	259
Whiteley Electrical Radio Co., Ltd.	253
Wright and Weaire, Ltd.	198
Argosy Magazine	Cover iii
Belling and Lee, Ltd.	256 and 258
British Television Supplies, Ltd.	197
Bulgin, A. F., and Co., Ltd.	197
Colvern, Ltd.	198
"Countries of the World"	Cover iv
Gilbert Cabinets	258
Heys, Leonard	258
High Vacuum Valve Co., Ltd.	257

All communications concerning advertising in "Wireless" must be made to the Advertisement Department, John Carpenter House, John Carpenter Street, London, E.C.4.

ANOTHER RADIO STORY NEXT MONTH



All the World in Nature's Glowing Colours

COUNTRIES OF THE WORLD

The Wonderful Story of the Continents, Countries and Chief Cities of the Globe.

This magnificent art work offers to the British public an opportunity of acquiring in the most agreeable fashion a sound knowledge of every part of the globe, for an expenditure equal only to that of the cost of a daily newspaper.

One hundred and thirty of the leading travel writers of the day combined to produce its wealth of vivid and detailed description, as delightful to read as it is instructive. The thousands of magnificent photographs will bring the entire world, with its countries, cities, rivers, mountains, buildings and monuments to YOU at your fireside.

As an illustrated work COUNTRIES OF THE WORLD is without an equal.

Extensive use is made of the latest processes of photographic production, and each weekly part will contain at least FOUR SUPERB COLOUR PLATES. The complete series of these colour plates forms the most remarkable and faithful pictorial representation of the world's sights and wonders which has ever been brought together.

Every illustration in COUNTRIES OF THE WORLD is a direct photographic document. Every article is authentic, reliable, and of absorbing interest.

Every map—and there is one of every country—is new, being based upon the latest geographical data in every instance. A large number of up-to-date street plans of big cities is also given.

A special feature of outstanding interest in Part One is the chapter dealing with Abyssinia as it is today. It gives a striking picture of the primitive and the modern in Addis Ababa and a vivid impression of the rugged grandeur of its mountainous plateaux, and the little-known barren frontier wastes of Ogaden. Magnificent photographs and a carefully revised map of the country accompany this article.

The Complete work will contain

3000 Beautifully Reproduced Photographs

350 GLORIOUS COLOUR PLATES

200 Maps and Plans

The weekly parts can be bound at small expense into two strikingly handsome volumes worthy of being treasured in any household.



7d Weekly Parts

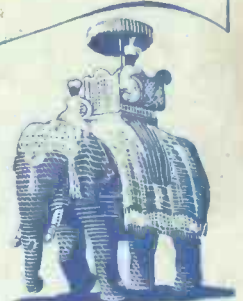

Order PART ONE To-Day

On Sale Tuesday, March 3rd at all Newsagents and Bookstalls.

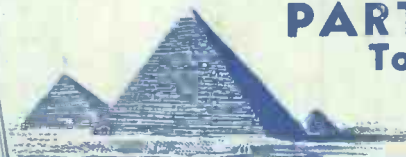

March, 1936

WIRELESS

The World's Greatest Short Stories

Each month THE ARGOSY MAGAZINE brings you a wonderful selection of the world's best fiction. There is no other publication in the world which offers you so much for so little expenditure. Not once now and then but *each month*. If you appreciate good short stories, you will appreciate THE ARGOSY. Look in its pages each month for the best of every kind of literary entertainment.

ALL STORIES
COMPLETE

*Some of the world-famous
writers whose work appears
from time to time in
THE ARGOSY*

**W. SOMERSET MAUGHAM
G. K. CHESTERTON
STEFAN ZWEIG
LEONARD MERRICK
FRANÇOIS COPPÉE
JOHN BUCHAN
GUY de MAUPASSANT
W. W. JACOBS
O. HENRY
THOMAS HARDY
JOSEPH HERGESHEIMER
SIGRID UNSET**

You will never regret it, if you tell your newsagent to deliver this excellent magazine regularly

Monthly. At Newsagents & Bookstalls

The ARGOSY

