

Seven pages of circuit ideas – see page 1010...

# ELECTRONICS WORLD

Austria Asch. 68.00  
Denmark DKr. 69.00  
Germany DM 18.00  
Greece Dra. 1300.00  
Holland Dfl. 12.50  
Italy L. 9000.00  
Malta Lm. 1.65  
IR £3.30  
Singapore S\$7.50  
Spain Pts. 900  
USA \$6.50

INCORPORATING WIRELESS WORLD

DECEMBER 1998 £2.45

A REED BUSINESS PUBLICATION  
SOR DISTRIBUTION

**Win a Grundig 30MHz  
oscilloscope worth over £400**

## Stars on film

**Motor drive  
for ultra-long  
exposures**

**Electronics  
in music**

**Using ecd**

**Measuring  
antennas**

**CCD update**

**RMS watts,  
or not?**

**Speaker coil  
design**

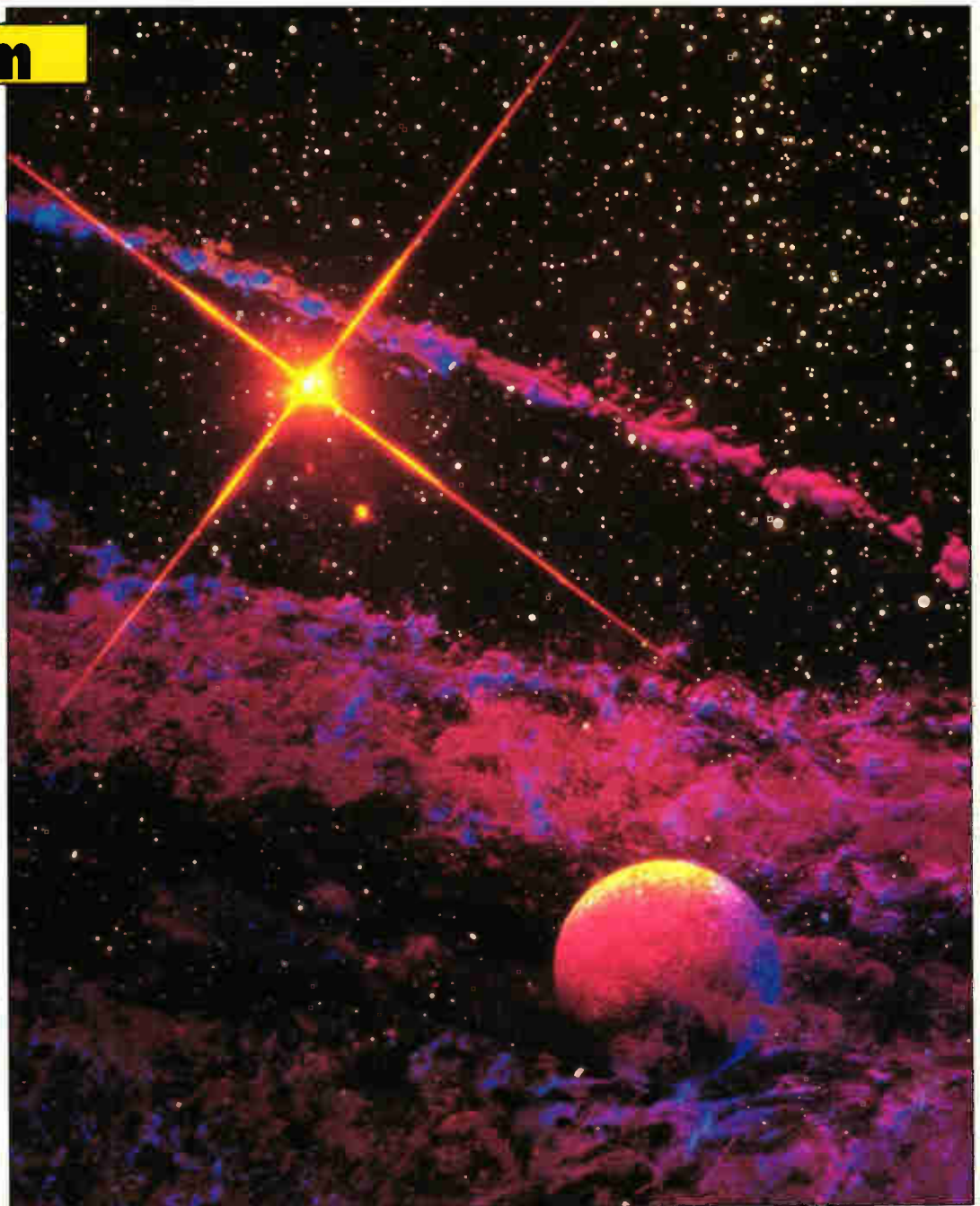

9 770959 833042

# Welcome to our **Hi-Speed World!**



Components by Alcatel  
at **electronica 98**  
in **Munich.**

When it comes to Hi-Speed and reliability, our components set the standard.

Whatever your task might be, we have the right solution for the job.

- ▼ Optoelectronics for fiberoptic communications
- ▼ Custom switch mode converters and power supplies
- ▼ Inductive Components
- ▼ Printed Circuit Boards
- ▼ Equipped Casing Systems
- ▼ Microsystems
- ▼ Switches
- ▼ Dunkermotoren
- ▼ Cable Harnesses
- ▼ Wires and Components
- ▼ Vehicle electrical systems
- ▼ ASICs and communication standard ICs

Feel free to compare component performance – we're looking forward to your visit.

**Alcatel Components**

**electronica 98 Munich, Nov. 10. – 13.**

**Hall A2, Stand 536**

**[www.alcatel.com](http://www.alcatel.com)**



**ALCATEL**

**The Hi-Speed Company**

E-Mail: [www.components@alcatel.de](mailto:www.components@alcatel.de) Fax: (+49) 911/4230 455

**CIRCLE NO. 101 ON REPLY CARD**

# Contents

## 987 COMMENT

Super highway or yellow brick road?

## 989 NEWS

- Web access on a chip...
- ...and on a phone
- Economic forecast
- Mobile phone health research
- Programmable op-amp
- Y2000

## 994 DRIVE TIME

Taking a photograph of a distant star at night needs a long exposure. But the star moves. Find out how **Ian Hickman** tackled the problem, and why it wasn't easy.



This shot of the Moon was photographed with a domestic set-up. Find out how on page 994.

## 1000 SPARKS MAY FLY

**Irving Gottlieb** asks could continuous exposure to electrostatic discharge be affecting our health?

## 1002 MEASURING YAGIS

**Paolo Antoniazzi** and **Marco Arecco** have devised a simple yet accurate method of measuring the gain of Yagis for 2m.

## 1010 CIRCUIT IDEAS

- Monitoring two temperatures
- Super zener voltage clamp
- Differential instrumentation amplifier
- Temporary RS232 hookup
- Long-delay generator
- Linear pwm
- White-light leds operate to 1.5V
- Optically isolated I<sup>2</sup>C interface
- Simple wideband detector for 10.7MHz
- Insulation and earth continuity tester
- Single-transistor constant-current
- Cellphone ringer repeater

## 1024 CCD DEVELOPMENTS

**Leslie Warwick** looks at two breakthroughs in ccd technology for imaging – one the smallest pixel, the other the largest ccd sensor module.



## 1028 SPEAKERS' CORNER

**John Watkinson** considers the choices facing the loudspeaker coil designer.

Is there a link between the Eagle magazine and ISDN? **Andy Emmerson** explains on page 987.

## 1031 LOOKING IN...

Building on his previous work describing the BBC's first television service and the earliest-known recording of broadcast television, **Donald McLean** reveals how he restored that recording.

## 1035 ULTRA-FAST PULSES

**Nick Wheeler** outlines how ecl can produce very fast pulses whose width is accurately determined by a length of coaxial cable.

## 1038 NOTES ON ECL

Using a frequency-doubler design example that runs from a +5V supply, **Nick Wheeler** discusses the benefits of ecl.

## 1043 RMS WATTS, OR NOT?

When you see a power amplifier advertised as delivering 100W rms what – if anything – does it mean? **Lawrence Woolf** explains.

## 1048 FLYING COMMS LINKS TAKE OFF

Could aeroplanes replace satellites for wireless comms? Trials are already underway, reports **Tom Foremski**

## 1050 ELECTRONICS IN MUSIC

From the Theramin to the electric guitar: **Richard Brice** looks at instruments that involve electronics and discusses their uses in modern music.

## 1055 NEW PRODUCTS

Over forty new product outlines, rendered by **Phil Darrington**

## 1061 DIGITAL OUTLOOK

The introduction of digital tv services could be a soap opera in itself. **Richard Wilson** checks out the viewing figures.



Have you heard **Ruby Wax** explaining the BBC's digital tv services? Why not read **Richard Wilson's** side of the story on page 1061?



This **Grundig 30MHz** oscilloscope worth £450 is ours to give away. Want it? See page 1007.

JANUARY ISSUE ON SALE 3 DECEMBER

# PROTEUS

# The IV<sup>th</sup> Generation

## Schematic Capture

NEW Version IV

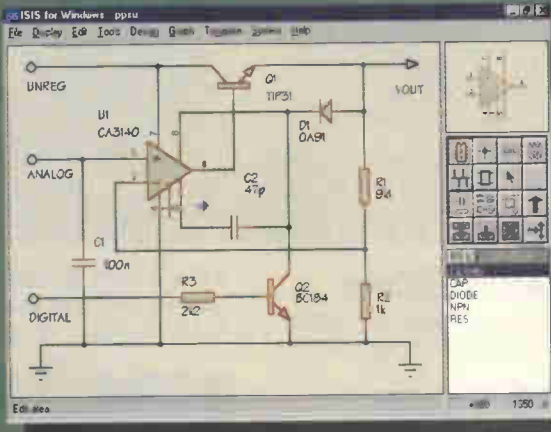

- Produces attractive schematics like you see in the magazines.
- Netlist, Parts List & ERC reports.
- Hierarchical Design
- Full support for buses including bus pins.
- Extensive component/model libraries.
- Advanced Property Management.
- Seamless integration with simulation and PCB design.

## Simulation

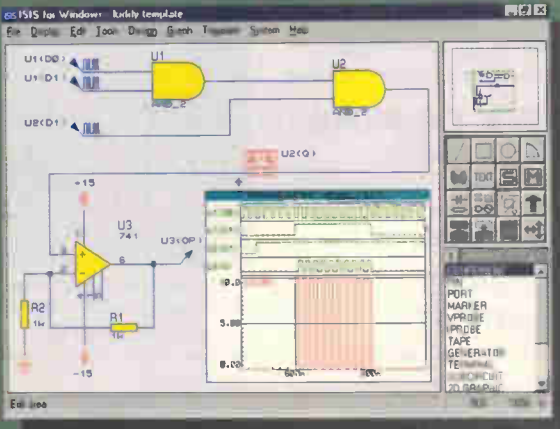

- Non-Linear & Linear Analogue Simulation.
- Event driven Digital Simulation with modelling language.
- Partitioned simulation of large designs with multiple analogue & digital sections.
- Graphs displayed directly on the schematic.

## New Features

- Component Auto-Placer
- Pinswap/Gateswap Optimizer
- Background Regeneration of Power Planes
- Enhanced Autorouting with Tidy Pass
- Full Control of Schematic Appearance
- Extensive New Component Libraries

Available in 5 levels - prices from £295 to £1875 + VAT.  
Call now for further information & upgrade prices.

## PCB Design

NEW Version IV

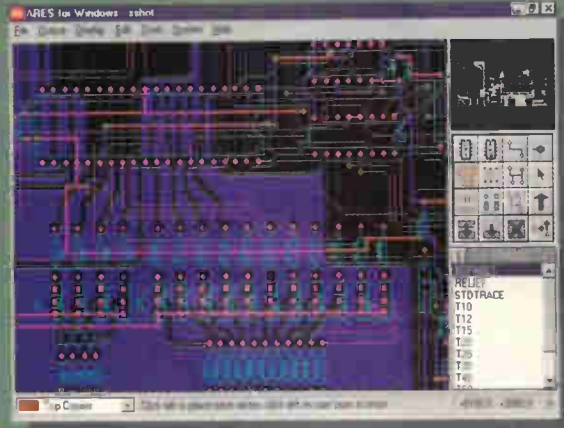

- Automatic Component Placement.
- Rip-Up & Retry Autorouter with tidy pass
- Pinswap/Gateswap Optimizer & Backannotation.
- 32 bit high resolution database
- Full DRC and Connectivity Checking.
- Shape based gridless power planes
- Gerber and DXF Import capability

**“PROTEUS**  
is particularly good

with its rip-up-and-retry **autorouter”**

EWW January 1997

Labcenter  
Electronics

Write, phone or fax for your free demo disk, or ask about our full evaluation kit.  
Tel: 01756 753440. Fax: 01756 752857. EMAIL: [info@labcenter.co.uk](mailto:info@labcenter.co.uk)  
53-55 Main St, Grassington. BD23 5AA. WWW: <http://www.labcenter.co.uk>

Fully interactive demo versions available for download from our WWW site.  
Call for educational, multi-user and dealer pricing - new dealers always wanted.  
Prices exclude VAT and delivery. All manufacturer's trademarks acknowledged.



#### EDITOR

Martin Eccles  
0181 652 3128

#### CONSULTANTS

Ian Hickman  
Philip Darrington  
Frank Ogden

#### EDITORIAL ADMINISTRATION

Jackie Lowe  
0181-652 3614

#### E-MAIL ADDRESS

jackie.lowe@rbi.co.uk

#### ADVERTISEMENT MANAGER

Richard Napier  
0181-652 3620

#### DISPLAY SALES EXECUTIVE

Joannah Cox  
0181-652 3620

#### ADVERTISING PRODUCTION

0181-652 3620

#### PUBLISHER

Mick Elliott

#### EDITORIAL FAX

0181-652 8111

#### CLASSIFIED FAX

0181-652 8938

#### NEWSTRADE ENQUIRIES

0171 261 7704

#### ISSN 0959-8332

#### SUBSCRIPTION HOTLINE

01622 778000

#### SUBSCRIPTION QUERIES

rbp.subscriptions@rbi.co.uk

Tel 01444 445566

Fax 01444 445447

For a full listing of  
RBI magazines:

<http://www.reedbusiness.com>



REED  
BUSINESS  
INFORMATION

## Super highway or yellow brick road?

Are you old enough to remember the *Meccano Magazine*, the *Eagle* and those Boy's Book of Modern Marvels publications? Can you recall those spectacular artist's impressions and hand-crafted cutaway drawings depicting miracles of technology that were just around the corner?

Those were the days. Aircraft refuelling stations that floated in mid-Atlantic, towering cities of the future with autogiros circling skyscrapers like moths around a light bulb. Magical pictures portrayed us using motorways surfaced with rubber, "for reduced noise and better roadholding." And people living in fabulous ranch-style houses with personal helicopter pads atop the garage roof.

Atomic power and fuel cells would bring us cheap, abundant electricity, while high-speed hovertrains would replace normal railways, with multi-lane motorway bridges spanning the English Channel.

All spiffing good stuff in the Tomorrow's World mould – but also all so hopelessly over-optimistic. How could professional engineers and seasoned futurologists manage to get things wrong each time? Never mind. At least this stupidity was confined to civil and mechanical engineering. Information-technology people and other denizens of the electronics world always kept their feet on the ground – not in their mouths.

Actually, if you believe that, you'll believe anything. The fields of computing and communications are thoroughly littered with comparable cock-ups. Flashback to the early eighties: Kenneth Baker, Minister of State for Industry and Information Technology, talks confidently about wiring every house and office to a national grid of optical fibres. Did it happen?

Flashback to autumn 1996: the *Financial Times* reports that cable modems will, "change publishing, telecommunications and working habits all over the world" and Telewest announces at the European Cable Communications Show that its cable modems will "show any doubting Thomases what we can do with cable and the right technology".

My name's definitely Thomas – and cable modems have yet to make any serious impact.

How on Earth do these highly paid – I almost wrote 'qualified' – pundits manage to get things so wrong? Oh never mind, we must move on.

Now journey back to a year ago and to this very magazine. In this self-same editorial slot I described how a solution had finally arrived for small office and home users waiting for a cost-effective connection to the information superhighway. The prospect of 'real' ISDN at an affordable price had been made possible by new

technology, being rolled out a year later by BT under the service names *Home Highway* and *Business Highway*.

And was it all worth waiting for? Huh! Once again the dream of low-cost ISDN service for the mass market of small business and residential customers has eluded us. The tariffs that BT has published for Home Highway are uncompetitive and totally unrealistic for all but the most self-indulgent of telecoms junkies.

The prices may indeed reflect the costs involved but they will certainly not attract the vast majority of those previously tempted to join the digital revolution.

Naturally BT will say that its operating licence clauses forbidding cross-subsidy prevent a lower-cost launch of Highway services. It may also point to the fact that its competitors are not exactly rushing in to fill the vacuum by providing alternative low-cost ISDN services. Nonetheless, a major window of opportunity has been missed and the dream of ubiquitous ISDN connection still eludes us.

Was ISDN just a wild dream then? Not at all. According to Margrit Sessions, managing director of consultancy Phillips Tarifica Ltd, "most of Europe has recognised the benefits of ISDN, and in Germany and France business applications such as teleworking and videoconferencing are almost commonplace."

The problem lies entirely in pricing and a report just issued by Tarifica indicates that ISDN connection and rental charges in Britain are up to six times higher than in other leading European nations. "The UK is in danger of becoming a technological outcast; [ISDN] prices must come down further to ensure that British businesses are given the opportunity to remain competitive on every level – including technologically," warns Sessions.

Should we be concerned? I think we should. The ISDN fiasco is not unique; I could cite many more marketing foul-ups. And we should not tolerate them. Sure, we can live with the enthusiasm of technologists for their latest developments; after all, most technology relies on the successful fulfilment of dreams.

The danger arises when technologists allow their dreams to be hijacked by others. Some product managers have a distorted view of reality and then innocent customers are misled because the marketeers fail to deliver their promises. Credibility is at stake – not to mention the livelihoods of all those who depend on technology for a living. We should be selling science fact, not science fiction.

Or am I taking things too seriously? Is there a problem at all? Perhaps I need to lighten up and take a holiday. I'd really love to know. ■

Andrew Emmerson

**Electronics World** is published monthly. By post, current issue £2.45, back issues (if available) £3.00. Orders, payments and general correspondence to **L333, Electronics World, Quadrant House, The Quadrant, Sutton, Surrey SM2 5AS**. Tlx: 892984 REED BP G. Cheques should be made payable to Reed Business Information Ltd

**Newstrade:** Distributed by Marketforce (UK) Ltd, 247 Tottenham Court Road London W1P 0AU 0171 261-5108.

**Subscriptions:** Quadrant Subscription Services, Oakfield House Perrymount Road, Hove, Sussex RH16 3DH. Telephone 01444 445566. Please notify change of address.

Subscription rates 1 year UK £34.00 2 years £54.00 3 years £68.00. Europe/Eu 1 year £49.00 2 years £78.00 3 years £98.00 ROW 1 year £59.00 2 years £94.00 3 years £119

**Overseas advertising agents:** France and Belgium: Pierre Mussard, 18-20 Place de la Madeleine, Paris 75008. United States of America: Ray Barnes, Reed Business Publishing Ltd, 475 Park Avenue South, 2nd Fl New York, NY 10016 Tel: (212) 679 8888 Fax: (212) 679 9455

**USA mailing agents:** Mercury Airfreight International Ltd Inc, 10 (b) Englehard Ave, Avenel NJ 07001. Periodicals Postage Paid at Rahway NJ Postmaster. Send address changes to above.

**Printed by** BPC Magozines (Corlisle) Ltd, Newtown Trading Estate Corlisle, Cumbria, CA2 7NR

**Filmsetting by** JJ Typographics Ltd, Unit 4 Boron Court, Chondlers Woy, Southend-on-Sea, Essex SS2 5SE.

© Reed Business Information Ltd 1997 ISSN 0959 8332



**'THE RACK RANGE'**  
**MAINS DISTRIBUTION PANELS FOR**  
**19" RACK MOUNTING**  
**HORIZONTAL**

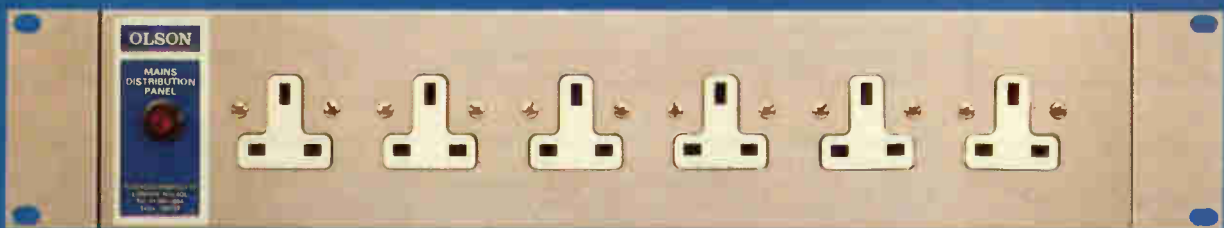
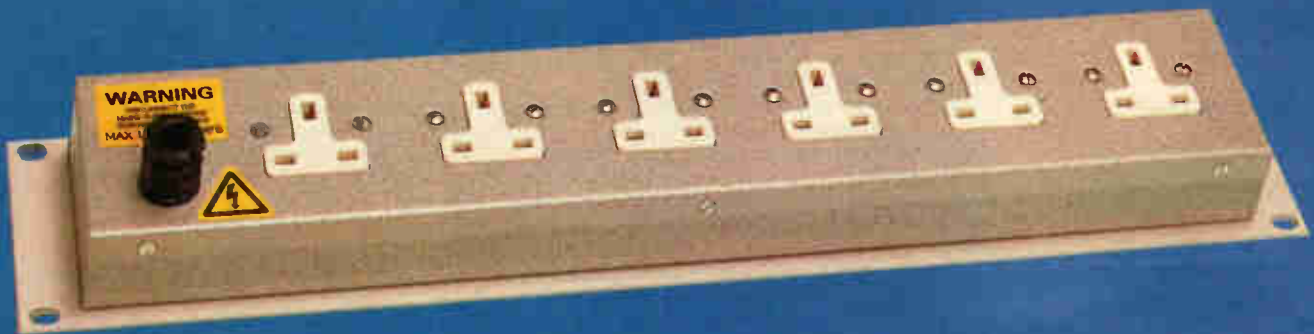

## Web access on a chip...

Toshiba launched its first Internet tuner chips in Autumn '98. These deliver Internet functionality for any electronics product. The so-called Internet tuner ICs are based on a core from Santa Clara start-up iReady Corporation.

Seiko is to use the same iReady core in a range of miniature lcds, with 240 by 160 or 320 by 240 pixels, which will have Internet tuners built into the display.

"We have four licensees all working on products," said Ryo Koyama, founder and president of the two year old iReady adding.

"we'll announce a fifth licensee next month."

The iReady core gives any product the ability to surf the Web, receive e-mail instructions or deliver faxes over the Internet. "The joke everyone makes is 'Why send e-mails to your refrigerator?'" said Koyama. But one benefit of the system is that there are some household appliances which would benefit from being capable of remote operation.

Early next year, a toy manufacturer will bring out an Internet-connected toy using an

Asic incorporating the iReady and fabricated by Toshiba.

Koyama said that the iReady is implemented in 120 000 logic gates which, he said, only cost \$6. This means that Internet capability can be added to a product for a cost of \$10 compared to the \$40+ solutions offered by a microprocessor, operating system and applications software.

iReady has raised \$8.5m in two rounds of venture capital funding and is now looking for a third round from corporate investors.

David Manners, *Electronics Weekly*

## Electronic book standard sought

Major computer, software and book publishers have launched an initiative to set standards for the first electronic books.

Known as eBook, the hand held terminal could become a mass market electronics product fuelling demand for chips and displays.

"The Open eBook standard announced today is designed so that early purchasers of eBook titles will be able to read their 'books' on all devices supporting the standard," said Microsoft v-p Dick Brass, in charge of Microsoft's eBook projects.

Japanese electronics giant Sharp teamed up with US firm NuvoMedia to develop Rocket eBooks. These will be 600g hand-held computer devices with a high resolution Sharp lcd screen. Rocket eBooks will hold 4000 pages of text.

## ...and on a phone

Motorola has unveiled its VoxML technology which allows people to access Web sites via the telephone.

Using voice commands, users can navigate to Web sites and hear the pages' contents. "VoxML will revolutionise the way people access on-line information and Web content," claimed Motorola v-p Maria Martinez.

Motorola gives the example of a user checking an airline departure time. They would ask "Is ABC Airline's flight from Washington DC on time? The airline's VoxML application interprets the the voice request and translates it to a Web request. The application locates and publishes the requested information in VoxML, which is then translated from text to speech for the user.

## Edwin demonstration goes ahead

After enjoying the Edwin CAD package tour on the CD presented with last month's issue, some readers found that they could not load the working demonstration under Windows 95. If you have experienced such problems, click on the Windows 95 'Start' button and select 'Run'. Clear any file path entry text in the panel that appears.

Now type d:\edwincd\workdemo\setup2.exe in the 'Run' window, where d: is the letter belonging to your CD drive. When asked where the Visionics Products source files are, type d:\edwincd\workdemo, again making sure that d: is the letter of your cd rom drive.

This should work regardless of how your version of Windows 95 is set up, and as a bonus, it also works for Windows 98 users. We trust that you will find the working demonstration worth the wait.

## Mobile phone health research...

*The absorption from mobile phones is being tested using an anatomically correct head. The experiment is part of an EU funded testing programme involving 14 partners and led by the University of Rome. The head has been constructed at Bristol University from new dielectric simulation materials using forensic techniques to simulate the bone, brain, muscle, skin and eye. The University of Bradford and the National Physical Laboratory are involved in the measurements for the project.*



David White/Rex Features

## Fab closures could spark UK talent drain

The UK is set to lose some of the most skilled engineers anywhere in the semiconductor industry unless potential buyers are quickly found for the two North Tyneside wafer fabrication plants.

A Siemens manager said it would be a tragedy if the engineering talent at North Tyneside was lost, and that many of those employed at Siemens, and at Fujitsu's fabrication plant in Newton Aycliffe, were preparing to leave the country for jobs overseas.

Siemens' personnel director Llew Avis confirmed that up to 150 Tyneside staff have been offered jobs at other Siemens plants. "There are 500 openings with Siemens worldwide, from Taiwan to the US," he said.

Employees were encouraged to apply for those positions. "One hundred to 150 are settling on those jobs. They are visiting the locations at the moment," Avis added.

Siemens will start moving equipment out of the plant later this

month. "But no equipment essential to manufacturing will move until the end of November," said Avis.

Taiwanese foundry TSMC has been linked with the Siemens fab after it was announced it is considering a formal offer of a fab from a European company.

"We will not comment on any organisation until we get to the point where we have a firm interest," said Avis. "We will not confirm or deny any talks with TSMC."

## First programmable dual op-amp

Xicor has introduced a digitally programmable dual op-amp, which it claims to be the first of its kind.

"Our customers throughout the electronics industry are calling for a single chip that integrates many of the traditional building blocks of

analogue and digital non-volatile memory," said Bob Anderson, product line manager.

Called the X9430, it is programmable for gain, offset and power level through either SPI or I<sup>2</sup>C serial busses.

No performance figures have been

released, but the company does say that it can replace 741, 301A and OP07 amplifiers.

Xicor sees the chip being used for applications such as pagers, cellular telephones, DVD players, printers and copiers. It comes in a 24-pin SOIC.

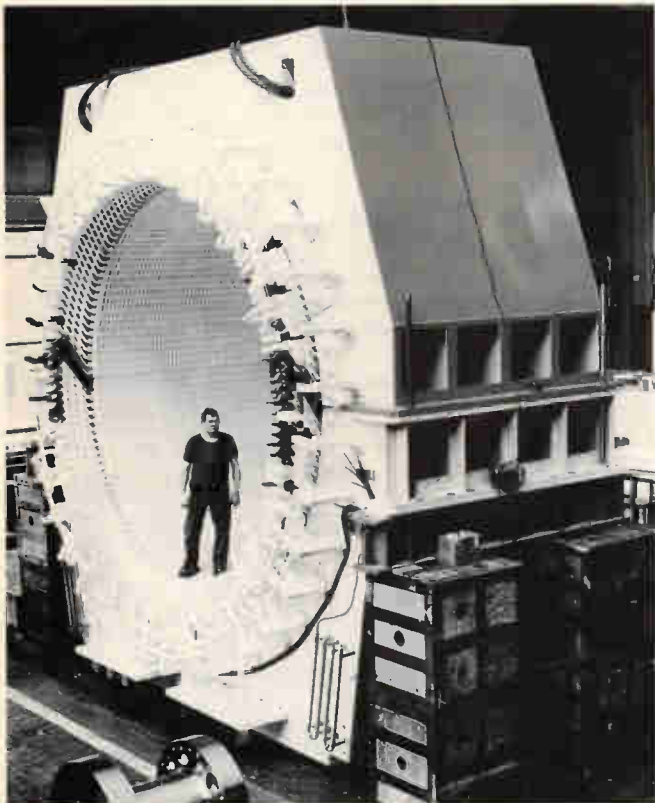

**135 000 horses...** At 101MW, ABB is claiming to have made the world's largest variable speed ac drive and motor system. It runs up to 600rev/min and will power NASA's transonic wind tunnel at the Langley Research Centre in Virginia. The drive is a 'load commutated inverter' type and fills a 10 by 10 by 10cm cube. The motor, anchored 10m away, is 6 by 6 by 7m, excluding its cooling and ancillary system. It weighs 360 tonnes.

## New technology and life quality

There has been a call for an 'informed' public debate over the quality of life implications of new technologies like smartcards and the Internet. Dr John Taylor, in his inaugural address as president of the Institute of Electrical Engineers, told some of the UK's most influential engineers that an individual's life will be tracked with ever greater precision. "Might we need a right to fuzziness which outlaws such accurate and fine-grained surveillance," said Taylor, who is director of Hewlett-Packard's European research laboratories.

## Digital radio licence

The Radio Authority has awarded a national digital radio licence to the Digital One consortium. NTL, one of three companies that makes up the consortium, will build the national transmitter network for commercial digital radio.

## UK votes for TV voting

Sixty per cent of the British adult population would be happy to vote for a future prime minister via the television. The survey, from set-top manufacturer Pace Micro technology, also found that 41 per cent would welcome the opportunity to interact with their local MPs through the tv.



## Spot the antenna...

Tiny mobile phone base stations just a few inches high are being introduced by Vodafone. Known as Street Furniture, the antennas are attached to street lamps, sign posts or CCTV poles. Twenty sites are now on-air, including the pictured site in Bristol.



# PLUG IN AND MEASURE

8-12 bit  
200kHz-50MHz  
100mVolt-1200Volt

STORAGE OSCILLOSCOPE  
SPECTRUM ANALYZER  
VOLTMETER  
TRANSIENT RECORDER



## TiePie introduces the HANDYSCOPE 2 A powerful 12 bit virtual measuring instrument for the PC

The HANDYSCOPE 2, connected to the parallel printer port of the PC and controlled by very user friendly software under Windows or DOS, gives everybody the possibility to measure within a few minutes. The philosophy of the HANDYSCOPE 2 is:

"PLUG IN AND MEASURE".

Because of the good hardware specs (two channels, 12 bit, 200 kHz sampling on both channels simultaneously 32 KWord memory, 0.1 to 80 volt full scale, 0.2% absolute accuracy, software controlled AC/DC switch) and the very complete software (oscilloscope, voltmeter, transient recorder and spectrum analyzer) the HANDYSCOPE 2 is the best PC controlled measuring instrument in its category.

The four integrated virtual instruments give lots of possibilities for performing good measurements and making clear documentation. The software for the HANDYSCOPE 2 is suitable for Windows 3.1 and Windows 95. There is also software available for DOS 3.1 and higher.

A key point of the Windows software is the quick and easy control of the instruments. This is done by using:

- the speed button bar. Gives direct access to most settings.
- the mouse. Place the cursor on an object and press the right mouse button for the corresponding settings menu.

- menus. All settings can be changed using the menus.

Some quick examples:

The voltage axis can be set using a drag and drop principle. Both the gain and the position can be changed in an easy way. The time axis is controlled using a scalable scroll bar. With this scroll bar the measured signal (10 to 32K samples) can be zoomed live in and out.

The pre and post trigger moment is displayed graphically and can be adjusted by means of the mouse. For triggering a graphical WYSIWYG trigger symbol is available. This symbol indicates the trigger mode, slope and level. These can be adjusted with the mouse.

The oscilloscope has an AUTO DISK function with which unexpected disturbances can be captured. When the instrument is set up for the disturbance, the AUTO DISK function can be started. Each time the disturbance occurs, it is measured and the measured data is stored on disk. When pre samples are selected, both samples before and after the moment of disturbance are stored.

The spectrum analyzer is capable to calculate an 8K spectrum and disposes of 6 window functions. Because of this higher harmonics can be measured well (e.g. for power line analysis and audio analysis).

The voltmeter has 6 fully configurable displays. 11 different values can be measured and these values can be displayed in 16 different ways. This results in an easy way of reading the requested values. Besides this, for each display a bar graph is available.

When slowly changing events (like temperature or pressure) have to be measured, the transient recorder is the solution. The time between two samples can be set from 0.01 sec to 500 sec, so it is easy to measure events that last up to almost 200 days.

The extensive possibilities of the cursors in the oscilloscope, the transient recorder and the spectrum analyzer can be used to analyze the measured signal. Besides the standard measurements, also True RMS, Peak-Peak, Mean, Max and Min values of the measured signal are available.

To document the measured signal three features is provided for. For common documentation three lines of text are available. These lines are printed on every print out. They can be used e.g. for the company name and address. For measurement specific documentation 240 characters text can be added to the measurement. Also "text balloons" are available, which can be placed within the measurement. These balloons can be configured to your own demands.

For printing both black and white printers and color printers are supported. Exporting data can be done in ASCII (SCV) so the data can be read in a

spreadsheet program. All instrument settings are stored in a SET file. By reading a SET file, the instrument is configured completely and measuring can start at once. Each data file is accompanied by a settings file. The data file contains the measured values (ASCII or binary) and the settings file contains the settings of the instrument. The settings file is in ASCII and can be read easily by other programs.

Other TiePie measuring instruments are: HS508 (50MHz-8bit), TP112 (1MHz-12bit), TP208 (20MHz-8bit) and TP508 (50MHz-8bit).

Convince yourself and download the demo software from our web page: <http://www.tiepie.nl>.

When you have questions and / or remarks, contact us via e-mail: [support@tiepie.nl](mailto:support@tiepie.nl)

Total Package:

The HANDYSCOPE 2 is delivered with two 1:1/10 switchable oscilloscope probe's, a user manual, Windows and DOS software. The price of the HANDYSCOPE 2 is £ 299.00 excl. VAT.

TiePie engineering (UK), 28 Stephenson Road, Industrial Estate, St Ives, Cambridgeshire, PE17 4WJ, UK  
Tel: 01480-460028; Fax: 01480-460340

TiePie engineering (NL)  
Koperslagersstraat 37  
8601 WL SNEEK  
The Netherlands  
Tel: +31 515 415 416  
Fax +31 515 418 819

## "Start planning for Year 2000 failures" call

Cabinet Millennium bug supremo Margaret Beckett is urging public and private sectors to start planning for failures in the Year 2000. She said contingency plans for equipment that will not be Millennium compliant by the year 2000 had to start being made now.

The leader of the Commons was speaking in an exclusive interview after she admitted at the Labour conference in Blackpool that it was too late to ensure that computers and electronics systems in both sectors

could be made safe from the Year 2000 time-bomb.

She told the fringe meeting at the gathering organised by Labour Industry Forum: "I have come late and reluctantly to the view that we cannot be confident we can deal with all the problems." Afterwards she said "Obviously we need to continue to work towards compliance but some systems will not be able to cope. It may not be the firm or department's computers but those of a supplier."

The international situation is not good: "Both public and private sector organisations need to start to identify those areas which will not be ready and plan for how to deal with any problems that arise," she said.

While Robin Guenier, head of the Year 2000 taskforce said her comments were refreshingly honest, Tory trade and industry spokesman John Redwood said the government was to blame for there now being too little time to deal with the bug.

## It's getting better, say analysts

Latest semiconductor market figures herald a brighter future from next year. But chip manufacturers must do more to reduce oversupply in the memory market.

Dataquest, Future Horizons and IC Insights have all reported an improved outlook for 1999. Europe could even rebound this year, but Asia's problems will delay any world-wide bounce back until mid-1999.

Dataquest is most optimistic, stating an overall decline of six per cent this year will turn into growth of 12 per cent in 1999.

"A stronger dynamic ram market is fuelled primarily by the move to the PC100 specification," said Richard Gordon, memory analyst at Dataquest. The IC Insight report believes the bottom of the cycle has been reached and echoes Dataquest

with a ten per cent growth forecast next year. Year 200 will be very good, says Future Horizons' MD Malcolm Penn: "The long term is going to be fantastic."

IC Insight says the average selling price of ICs has increased. It believes dynamic-ram manufacturers are breaking even, rather than losing money.

Future Horizons, the European analyst, believes the opposite, that all dynamic-ram manufacturers are selling below cost of production.

A few fab closures have done little to affect over supply. "We need at least three Siemens type fabs to close," said Penn.

Oversupply will continue, says Dataquest, for another 18 months in foundries and two years for dynamic ram.

Fortunately, the transition to 0.8µm

processing is delayed due to the increased number of defects. This will help demand catch up with supply.

Richard Ball, *Electronics Weekly*

## Chip sales saw autumn rise

World-wide chip sales showed signs of an upturn last August, according to the Semiconductor Industry Association (SIA).

Global chip sales rose by 1.5 per cent – the first month-on-month gain this year – but were 16 per cent below the same month last year. Total sales increased by \$147m from July to \$9.81bn in August. The sales increase came despite a large drop in sales in Japan, down 30 per cent from last year's figures.

"We are cautiously optimistic about the industry's prospects for additional gains in the fourth quarter," said SIA president George Scalise.

## Output declines...

There has been a sharp decline in engineering output for the second consecutive quarter, according to a survey by the Engineering Employers' Federation (EEF). Export orders also fell steeply for the seventh consecutive quarter. "Our survey shows that the recession in engineering is becoming deeply entrenched," said Graham Mackenzie, EEF's director general.

## ...but pay is stable

Pay settlements in the engineering sector have remained stable in the three month period up till August.

According to the latest EEF survey, the average settlement level was 3.5 per cent. This follows a fall in settlement rates during the previous three month period.

## Are you there?

The first thing you get asked when you answer a mobile phone is: "Where are you?" But if mobile phone operator Orange has its way this won't happen again. The downside is that it will be difficult to lie about where you are. The full colour mobile videophone to make this possible will be available by Christmas 1999. Co-developed with the University of Strathclyde, the phone will work over all the networks, via a data capability that Orange's phones use.

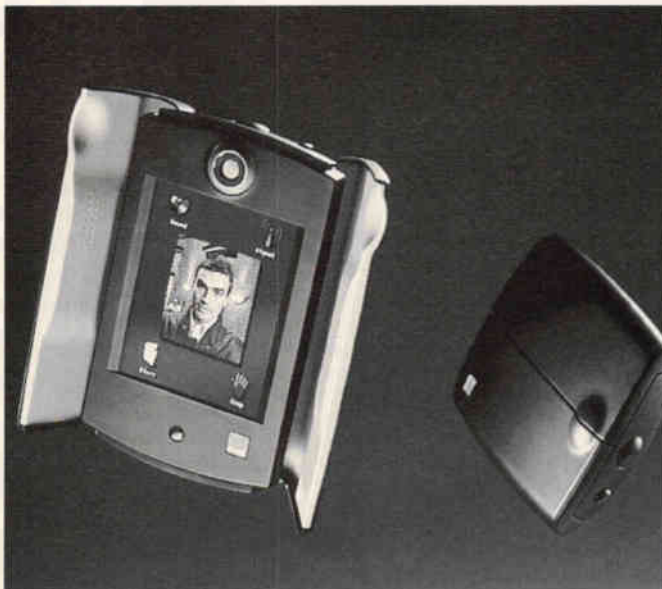

# WINRADIO



**More choice:  
external WINRADIO arrives!**

WINRADIO now brings you a complete choice in computer controlled radio scanning and reception.

With either the internal or external versions, you can couple all the power of the latest Windows PCs (not just the fraction that you can squeeze down an RS232 connection) to the latest synthesised receiver design techniques, and you'll get the ultimate in wide range, all mode programmable radio reception.

**New external WINRADIO™** (WR1000e and WR1500e) provide complete comms systems connecting either via the basic RS232 - or with an optional PCMCIA adapter, for high speed control. Power from existing 12v supplies, or our optional NiMH rechargeable 12v battery pack.

**Use WINRADIO scanning PC comms receiver systems for...**

Broadcast · Media monitoring · Professional & amateur radio communications · Scanning · Spot frequency & whole spectrum monitoring · Instrumentation Surveillance (and recording)

If you still want the ultimate receiver-in-a-PC with full DSP, then you need the WR3000-DSP with its hardware for real-time recording, signal conditioning and decoding applications. (This is available as an ISA card only).



**VisiTune™ spectrum tuning display**



**Your choice of virtual front panel**



The DSP applet provided with the WR3000 spectrum monitor ISA card (£995+VAT) allows continuous control of audio bandwidth and other signal conditioning functions

Model No	WR-1000	WR-1500
<b>Construction</b>	WR-1000i/WR-1500i - Internal full length ISA cards	WR-1000e/WR-1500e - external RS232/PCMCIA (optional)
<b>Frequency range</b>	0.5-1300 MHz	0.15-1500 MHz
<b>Modes</b>	AM,SSB/CW,FM-N,FM-W	AM,LSB,USB,CW,FM-N,FM-W
<b>Tuning step size</b>	100 Hz (5 Hz BFO)	100 Hz (10 Hz for SSB and CW)
<b>IF bandwidths</b>	6 kHz (AM/SSB), 17 kHz (FM-N) 270 kHz (FM-W)	2.5 kHz(SSB/CW), 9 kHz (AM) 17 kHz (FM-N) 270 kHz (FM-W)
<b>Receiver type</b>	PLL-based triple-conv. superhet	
<b>Scanning speed</b>	10 ch/sec (AM), 50 ch/sec (FM)	
<b>Audio output on card</b>	200mW	200mW
<b>Max on one motherboard</b>	8 cards	8 cards
<b>Dynamic range</b>	65 dB	70 dB
<b>IF shift (passband tuning)</b>	no	±2 kHz
<b>DSP in hardware</b>	no - use optional DS software	
<b>IRQ required</b>	no	no
<b>Spectrum Scope</b>	yes	yes
<b>Visitune</b>	yes	yes
<b>Published software API</b>	yes	yes
<b>Internal ISA cards</b>	£299 inc vat	£399 inc vat
<b>External units</b>	£389 inc vat	£449 inc vat
<b>PCMCIA adapter (external)</b>	£30 with 'e' series unit, otherwise: £69 inc.	
<b>PPS NiMH 12v battery pack &amp; charger</b>	£79 with 'e' series unit, otherwise: £139	

## Digital Suite Software

1. WEFAX / HF Fax
  2. Packet Radio for HF and VHF
  3. Aircraft Addressing and Reporting System (ACARS)
  4. Audio Oscilloscope, real time Spectrum Analyzer with calibration cursors
  5. Squelch-controlled AF Recorder
  6. DTMF, CTSS decode and analyse
- £81.05 inc VAT**

(requires SoundBlaster 16 compatible sound card)

For your free info pack and software emulation demo disk contact Broadcasting Communication Systems

<http://www.broadercasting.com>  
email: [info@broadercasting.co.uk](mailto:info@broadercasting.co.uk)

FREEPHONE: 0800 0746 263  
Fax: 01245 287057

Unit B, Chelford Court, Robjohns Road, Widford Industrial Estate, Chelmsford, Essex CM1 3AG



# Drive time

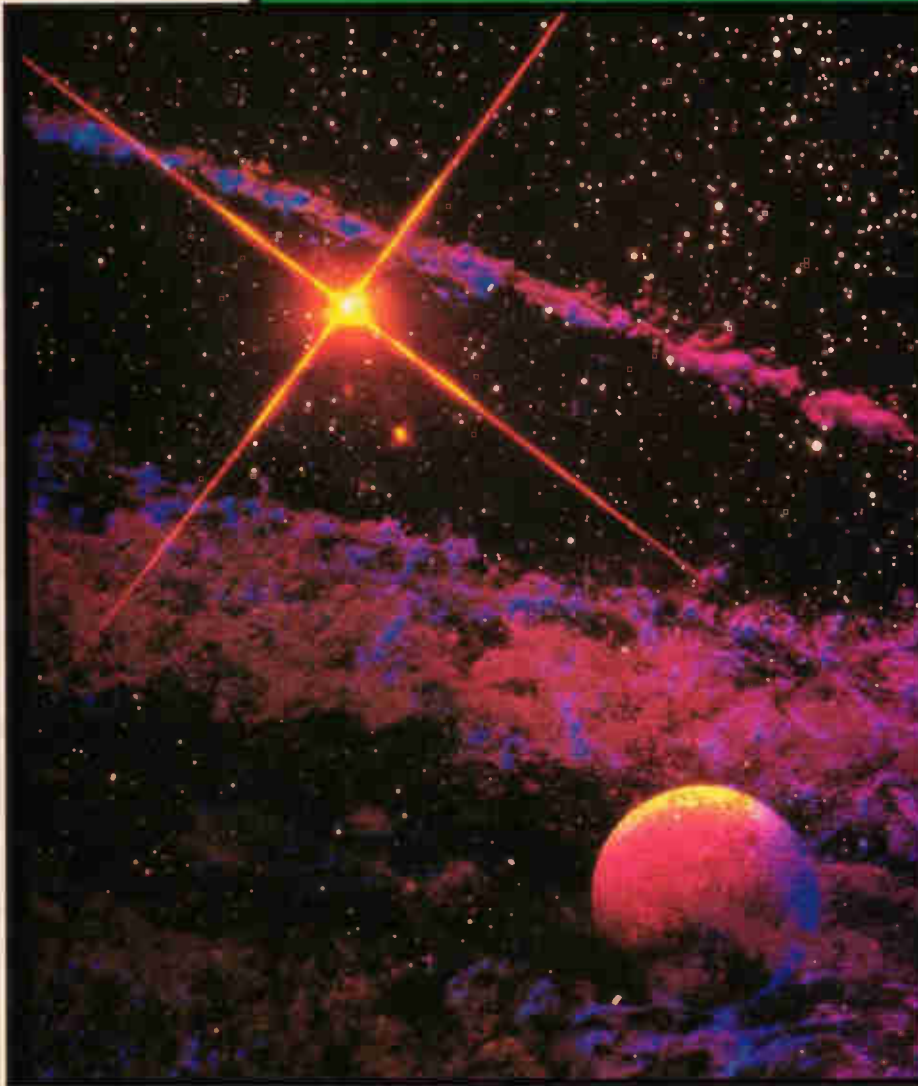

**Taking a photograph of a distant star at night needs a long exposure. But while the shutter is open, the star is moving.**

**Ian Hickman**

**describes a precise motor drive for tracking such celestial bodies, and explains why the task is not as simple as it first appears.**

**A** while ago, I designed a sidereal motor drive and clock for a keen amateur astronomer colleague of mine in exchange for an old Hewlett-Packard spectrum analyser. His specification called for a self-contained and easily portable unit with enough output power to drive a small 50Hz synchronous motor.

The drive had to be capable of working in ambient temperatures from +40°C down to -10°C. It can be cold at 2 a.m. on top of the South Downs. In addition, the motor had to run for at least two hours from a 12V NiCd battery. For longer periods of use, a breakjack was to be included to allow the drive to be powered from the cigar-lighter socket of a car.

The output frequency was to be stabilised to  $\pm 10$ ppm or as near to this as was economically possible. A variable output frequency facility, covering 40 to 60Hz, was also required, as was a clock capable of reading astronomical time, or alternatively, normal time.

Astronomical time and normal time are not the same,

as explained in the panel entitled 'About time'. The information in that panel is reproduced courtesy Datum-Austron, whose details are given later.

## Implementing the drive

The said keen amateur astronomer had a fair-sized telescope, but it was nonetheless readily portable.

He had built himself an equatorial mount for it. Such a mount, set up with its axis at the appropriate angle, i.e. parallel to the Earth's axis of rotation, allows the telescope to follow the passage of the stars as they journey across the night sky.

When observing a particular small area of sky, turning a knob geared to the shaft mount keeps the stars in the same position. Tracking a celestial object in this way is simple enough while you are watching through the telescope, but if the observer is replaced by a camera, the task is more complex.

In contrast with the human eye, a camera has an almost indefinite integrating period. Imagine a steadily illumi-



### Typical results

*Photo 1 is of the Pleiades or 'Seven Sisters', 300 light years away. Six of these are visible with the naked eye. The photo was taken with a ten-inch reflector telescope, with a five minute exposure, on 400 ASA Ektachrome, home developed. The sidereal drive has completely eliminated blurring due to apparent motion of the subject across the sky. A longer exposure would show the famous nebulous veils surrounding the bright stars. All photos here courtesy Rod Armstrong.*

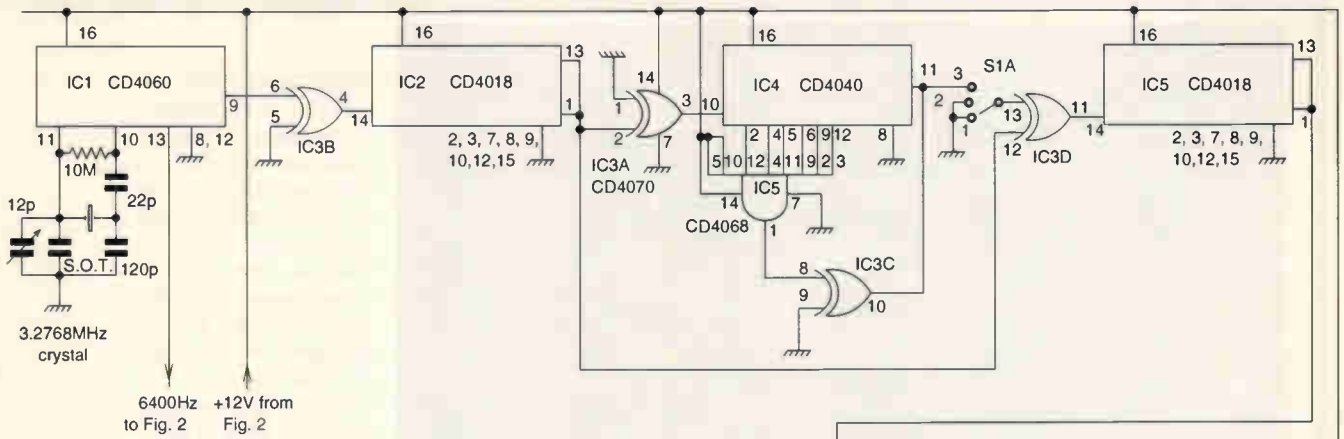

*Photo 2 shows the M42 Nebula in Orion. Taken with a 10 inch Newtonian reflector, using a seven minute exposure. Again on home processed Ektachrome, and using the sidereal drive.*

*Photo 4 is a long-exposure negative of the night sky taken using a fixed camera and is included to illustrate why the sidereal drive is necessary.*



*Photo 3 shows the moon. Not perhaps a great test for the accuracy of the quartz driven motor speed, but to obtain crystal sharp images, the moon is a difficult subject. The sidereal drive is necessary to avoid blurring due to movement, even at the comparatively short exposure of 1/8th of a second, on Kodachrome. With this length exposure, great care is needed to avoid blurring caused by vibration due to the firing of the shutter. This shot was taken with a 4 inch GRUBB refractor, the image being magnified with a  $\times 2$  photographic multiplier attached to the camera. The effective aperture of around  $f32$  required the longish exposure.*



**Fig. 1. Clock generation and display circuitry comprising an ordinary digital clock with lcd. The 32kHz crystal is removed from the clock and the crystal's function is replaced by reference pulses derived from the clock generator shown.**

nated light at the lower limit of visibility to the dark-adapted eye.

If instead the light is flashed on for a short period, it may in fact be invisible. This is because the human eye is a 'leaky integrator', integrating only over about one to two hundred milliseconds. If you can't see the light after you have been looking at it for that amount of time, you won't see it at all. But a camera does not have this limitation.

With the fastest available film and an exposure time of minutes – or even hours – the amateur astronomer can record stars, nebulae, comets and other astronomical curiosities invisible to the naked eye. Normally, such objects could only be observed directly via the largest telescopes in the world – and perhaps not even then.

A proviso is of course that the telescope can be panned to follow the progress of the stars. To do so, it is only necessary to fit a small synchronous motor to the gearing of the equatorial mount, with the right gear ratio, and hey presto.

For this application, the motor runs at 50Hz, supplied by the NiCd-powered inverter mentioned earlier. There is however just one small complication. The 50 cycles per second must be 50 cycles per *sidereal* second – not per GMT second.

A sidereal day lasts 23 hours 56 minutes and 4.09 seconds, reckoned by GMT, so the required motor drive frequency must run a little fast, at  $50 \times 1.00273792\text{Hz}$ . A variable frequency is also handy. This enables the motor to be run faster or slower than the sidereal rate. By altering the speed in this way, a vernier position control is provided enabling the field of view to be accurately centred on the precise area of sky to be studied.

**The solution**

**Figure 1** shows the timekeeping part of the circuitry. With the aid of a 3.2768MHz crystal, IC<sub>1</sub> produces a clock frequency of  $2^{16} \times 50\text{Hz}$ .

Components IC<sub>2</sub> and IC<sub>5</sub>, both dividing by ten, tear this down to the 32.768kHz needed for a small clock with digital lcd. At least, they do while S<sub>1A</sub> is in position 2, which causes the lcd clock to display GMT. Counter IC<sub>4</sub> counts to 365 and then resets itself, cycling round repeatedly.

When S<sub>1A</sub> is in position 3, an extra clock pulse is fed to IC<sub>5</sub> for every 365 pulses from IC<sub>2</sub>. In this way, the clock reads faster than GMT by the ratio  $365/366 = 1.002739726$ . This is within the specified 1.8 parts per million. In addition, the difference is also small compared with the accuracy that you could expect from the crystal over the operating temperature range.

I mounted the small lcd clock on the front panel of the enclosure. Normally powered by a small watch type button cell, here it is fed with the appropriate supply voltage via a 100kΩ resistor and a BC109.

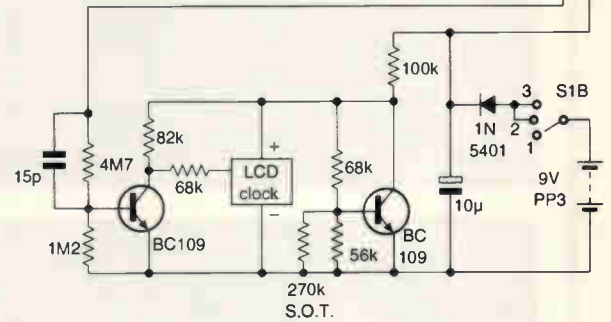

The clock's original internal 32.768kHz crystal was removed, and external clock pulses gently fed in via another BC109 and a 68kΩ resistor. Switch S<sub>1</sub> provides a choice of GMT or sidereal time. Its third position allows you to turn the unit off, although off does not mean disconnected from the supply. More on this later.

**Figure 2** shows the equatorial mount drive part of the circuitry. The divide-by-512 output from IC<sub>1</sub> provides a 6400Hz clock to IC<sub>7,8</sub>. These ICs provide the same 365/366 choice as in Fig. 1.

The GMT or sidereal-time clock frequency is then divided by 128 in IC<sub>11</sub>, to provide a 50Hz output. Timer IC<sub>10</sub> provides an alternative frequency range at IC<sub>11</sub>. This is adjustable between 40 and 60Hz.

Gate IC<sub>7B</sub> provides the alternative phase. The Phase A and Phase B signals drive a simple inverter involving a standard mains transformer working in reverse.

The low voltage windings are 15V nominal, corresponding to 21.2V peak, and the average value of a 21.2V peak sinewave is 13.5V, the form factor of a sinewave being 1.11.

With this arrangement, the 12V squarewave applied by the fets is well clear of exceeding the allowable volt-second product, avoiding any possibility of core saturation. The resulting 240V output at nominal 50Hz was a little on the low side. But the synchronous motor ran perfectly happily, easily coping with turning the mount in view of the mechanical advantage provided by enormous gear ratio. After all, at one revolution per day, the speed of the output shaft is only 0.000696347rev/min!

When S<sub>3</sub> is on, the 12V NiCd battery pack powers the inverter. With it in the 'off' position, in the absence of base drive waveforms to the fets, the inverter is effectively off, although it is still connected to the supply.

Either way, the NiCd battery pack keeps the clock running continuously, via the 1N4148 diode. The clock will register GMT or sidereal time according to the setting of S<sub>1A</sub>. Provided that S<sub>1</sub> is not in position 1, the 9V PP3 battery will keep the clock running, even if the NiCd battery should become exhausted or be removed.

The clock and the motor drive can each be set either to GMT or sidereal time, independently of the other. In practice,

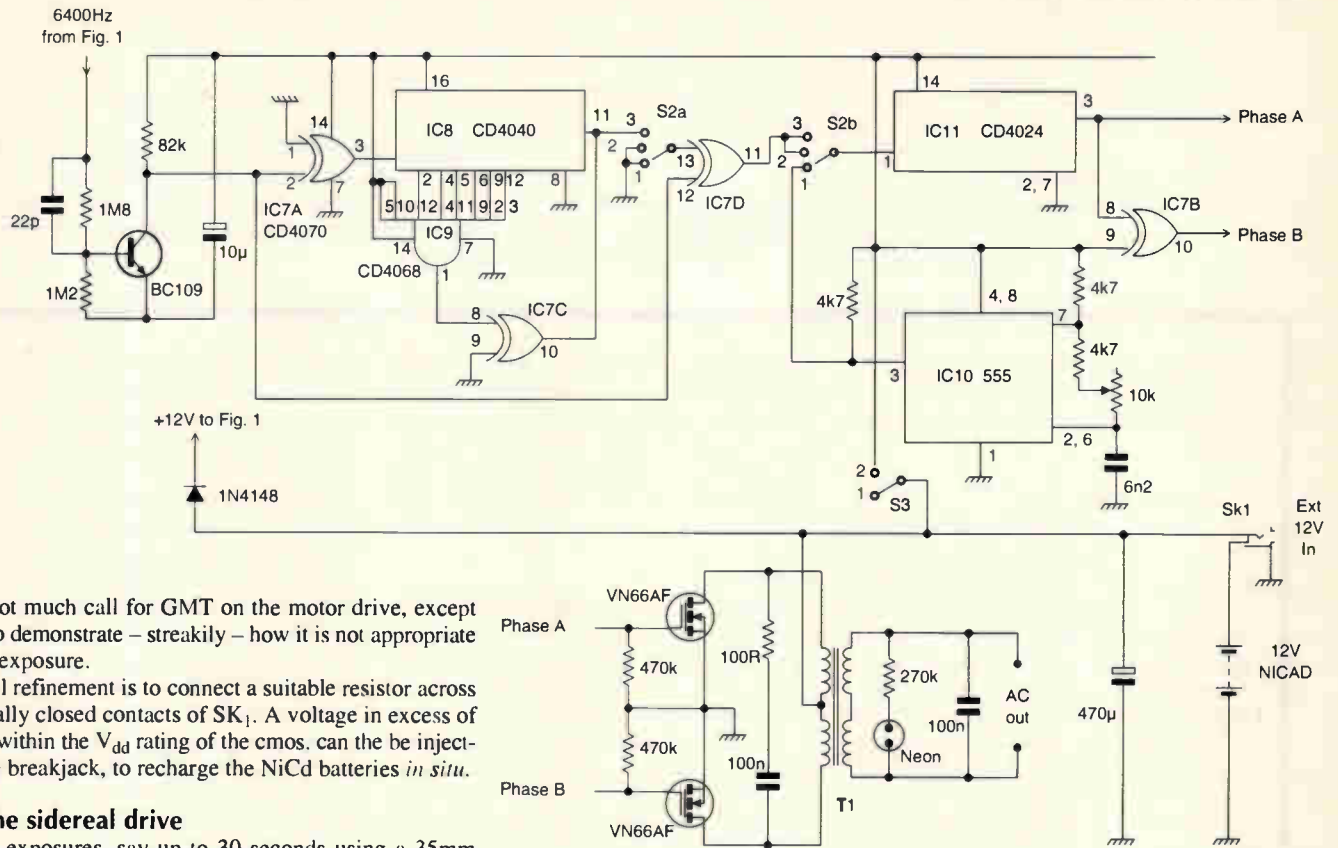

Fig. 2. Synchronous motor inverter circuitry for the equatorial drive. The output transformer is a mains isolating transformer used back to front.

there is not much call for GMT on the motor drive, except perhaps to demonstrate – streakily – how it is not appropriate to a long exposure.

A useful refinement is to connect a suitable resistor across the normally closed contacts of SK<sub>1</sub>. A voltage in excess of 12V, but within the V<sub>dd</sub> rating of the cmos, can be injected via the breakjack, to recharge the NiCd batteries *in situ*.

**Using the sidereal drive**

For short exposures, say up to 30 seconds using a 35mm camera with 50mm lens, sidereal tracking of the telescope to follow your star is not necessary. For longer exposure times and or longer focal lengths, some form of tracking is necessary, to avoid trailed star images. The sidereal motor drive does the job, provided that the rest of the kit is up to the mark.

In use, the telescope support pillar will typically be driven a metre into the ground, to provide a firm, vibration-free support. The axis must be accurately aligned, for the single axis drive can only follow the object of interest in azimuth, preventing horizontal trailing of the image.

With the telescope aligned parallel to the axis of rotation, it is set to view the pole star in the centre of the field of view. If the axis of the telescope is not accurately aligned, there will still be some trailing of the image on long exposures, but in the vertical direction.

At high magnifications, such as two hundred times and greater, clear images on long exposures will only be obtainable with very high quality mechanics. The final drive to the telescope shaft will typically be a worm and wormwheel, and these are crucial. If not of the best precision, they will impart

# About time...

Until fairly recently in man's history, the Sun's position defined the time of day. When the Sun was not visible it was impossible to know exactly what time it was. So man developed clocks to measure out the hours between checks with the sun.

All clocks measure time, but different clocks can have different statuses or importance. For example, a clock can be a primary reference, like the Sun's position. Or it can be a secondary reference, which only interpolates. Such a device provides an approximation of the time between periodic checks with the primary clock or time standard.

**Date, duration and synchronisation**

The word 'time' can mean either date or time interval – i.e. duration. An example of a date is 15 November 1978, 15h, 35m, 14.2s EST (Eastern Standard Time), where h, m and s denote hours, minutes,

and seconds.

An example of a time interval, or duration, is the length of time taken to fly between a certain pair of cities, say 3h, 51m, 2s. This example gives no indication of when the flight occurred, only that it lasted for almost four hours. Note that hours, minutes, and seconds can indicate either time of day or duration.

Synchronisation is the third important time concept. For example, it is not normally crucial for an orchestra to begin its concert at a precise hour of the day. But it is essential that all members of the orchestra begin and stay on the same beat. Many electronic navigation systems, computer networks – and even television receivers – require synchronisation to transmitted signals with an accuracy of a millionth of a second or better.

**Time scales**

A time scale is a system of assigning dates

to events. The Sun's apparent motion in the sky provides one of the most familiar time scales, but it is certainly not the only one.

In order to completely specify a solar date, you must count days – i.e. make a calendar – from some agreed upon beginning. In addition, depending on the accuracy needed, you must measure the fractions of days, commonly in hours, minutes, and seconds. In summary, you must count cycles and fractions of cycles of the Sun's daily apparent motion around the Earth.

Time derived from the Sun's apparent position is called *apparent solar time*. A sundial indicates the fractions of cycles, i.e. time of day, directly. Calendars, like the Gregorian calendar we commonly use, are an aid for counting the days and naming them.

Another system, used by astronomers, is called the Julian day. It numbers the days that have occurred since noon, January 1, 4713 BC. In this system – which is not related to the Julian calendar – noon on

a tiny rocking motion to the telescope, in sympathy with each revolution of the worm, blurring the picture.

### Talepiece

What happened to that elderly HP spectrum analyser that I received in exchange for this design? Unfortunately, owing to the need for a new backward-wave oscillator, plus a host of

other less fundamental faults, it proved beyond economic repair. But as it represented somewhat of a milestone in electronics, being probably the earliest true spectrum analyser and dating from the mid sixties, I was loath to scrap it. In the event, the Science Museum was more than happy to accept it as a donation, where I trust it enjoys a happy and permanent retirement. ■

January 1, 1986 began Julian day 2 446 796. This time scale is useful for calculating the number of days between two events.

### Universal time

Since the Earth's orbit around the sun is not a perfect circle, apparent solar time cannot be a uniform time scale. That is, the time interval between successive, apparent, noons changes throughout the year. The length of this solar day is also affected by the inclination of the Earth's spin axis to the plane of the Earth's orbit.

To correct for the non-uniformities, astronomers calculated the effects of the Earth's noncircular orbit and the polar inclination on apparent solar time. Universal Time (UT0) is apparent solar time corrected for these two effects. The correction used to obtain UT0 is called the Equation of Time. It is often engraved on sundials, a correction which adds, or subtracts, up to 15 minutes to – or from – apparent solar time, depending on the season.

Astronomers actually measure Universal Time using the stars rather than the Sun. If you count cycles – and fractions – of a distant star's apparent position, you get a different time scale – sidereal time.

Since the Earth circles the Sun once each year but does not circle the distant star, sidereal time accumulates one more 'day' each year than Universal Time, and our calendar.

The 'clock' for both Universal Time and sidereal time is the spinning Earth; only the counting methods differ. In practice, astronomers observe sidereal time and correct it to get Universal Time.

### Time and navigation

Time is essential to navigation. In effect, a navigator, using a sextant, determines local time based on the Sun's apparent position. The difference between the navigator's local time and Universal, or Greenwich, time is equivalent to his longitude, since zero longitude passes through Greenwich, England.

Even though we express longitude in degrees, not hours, minutes, and seconds, the difference in time is proportional to the difference in longitude. Since the earth makes about one revolution relative to the Sun in 24 hours, the translation to degrees is simple:  $360^\circ/24 \text{ hrs} = 15^\circ/\text{h}$ .

The navigator's sextant is his means of

determining local apparent solar time and the navigator's clock, or chronometer, is his means of determining Universal Time. As a result of using Universal Time for navigation, scientists developed two refinements of UT0, namely UT1 and UT2.

### UT1

Scientists discovered many years ago that the Earth is not fixed on its axis. In effect, what one sees is a wandering of the poles relative to the fixed astronomical observatories, which causes UT0 to vary.

The logical response to such a situation is to calculate a correction for polar motion and apply it to UT0. UT1 is the result of this correction. The difference between UT0 and UT1 is quite small; only about  $\pm 0.3\text{s}$ .

### UT2

As the accuracy and constancy of pendulum and quartz-crystal clocks improved, scientists discovered many years ago that UT1 had periodic fluctuations of unknown origin with periods of one year and one-half year. Since these periodic variations are predictable, astronomers are able to correct UT1 to get a still more uniform time scale, UT2. Again, the corrections are small: about  $\pm 0.3\text{s}$ . Thus, there exists a family of universal times based on the Earth's spin and other refinements:

**UT0** is apparent solar time corrected for the Earth's noncircular orbit and inclined axis.

**UT1** is the true navigator's time scale related to the Earth's actual angular position relative to the sun.

**UT2** is a smoothed time scale and does not reflect the real periodic variations in the Earth's angular position. At least in principle, if not in practice, UT2 passed by the navigator's needs. UT2 is not used much any more.

### Ephemeris time

Near the end of the 19th century, Simon Newcombe at the US Naval Observatory compiled a set of tables which predicted the future positions of the Sun, Moon, and some planets. He based these predictions on the best data and physical principals available at that time. A table of this sort

is called an ephemeris.

Newcombe discovered that the actual positions gradually departed from the predicted positions in a fashion too significant to be explained either by observational errors or approximations in the theory. He noted that if the time were somehow in error, all the tables agreed well with the observations. At this point he correctly determined that in addition to all the variations noted above, there are random fluctuations in the Earth's rotational rate. Later, quartz and atomic clocks confirmed that the variations exist.

The astronomer's natural response to this was, in effect, to use Newcombe's tables for the Sun in reverse to determine time, a time scale called Ephemeris Time, or ET. The Earth's orbital (not rotational) position determine Ephemeris Time, and ET should be more uniform than Universal Time because geometrical changes in the earth's shape do not affect the orbital motion.

Ephemeris Time is not very convenient to use because an accurate determination of it requires literally years of astronomical observations. In the early fifties, more convenient and precise clocks were developed: atomic clocks. The atomic clocks provide the uniformity of ET, but are far more convenient to use.

### Atomic time

It was mentioned earlier that counting the number and fractions of cycles of the apparent Sun determines a date on the Universal Time scale. Similarly, counting the number of cycles of an electronic signal whose frequency is controlled by an atomic or molecular resonance determines date on an atomic time scale.

In most atomic clocks, electronic circuits steer a radio frequency into resonance with a specific atomic or molecular transition – i.e. vibration. The resonance is an atomic or molecular property, and its frequency can be relatively insensitive to temperature, magnetic fields, and other experimental conditions. Thus, these resonances form natural standards of frequency.

Atomic clocks are formed by counting the cycles of these atomically or molecularly controlled radio signals.

Today scientists and engineers have perfected clocks based on a resonance in caesium atoms to an accuracy of better than one part in  $10^{-13}$  – one part in 10



## More time

The information on time scales in this article is reproduced from the *Austron Timing Reference Handbook*, by kind permission of Datum-Austron. Contact information: e-mail [telecomsales@datum.com](mailto:telecomsales@datum.com).

Web address: [www.datum.com](http://www.datum.com), tel. 512 721 4038. In UK, contact Sematron UK Limited, Sandpiper House, Aviary Court, Wade Road, Basingstoke, RG24 8GX, Tel. 01256 812222 or Fax 01256 812666. Web address: [www.sematron.com](http://www.sematron.com).

trillion. Expressed another way, these clocks keep pace with each other to within two or three millionths of a second over a year's time.

The Earth on the other hand, might randomly accumulate nearly a full second's error during a year. Since there are now literally thousands of atomic clocks in use, and since they all agree well with each other, the variations in the Earth's rotation rate are easily measurable.

International Atomic Time, or TAI, is an atomic time scale maintained by the Bureau International de l'Heure (BIH) in Paris, France. BIH forms TAI from an average of nearly one hundred atomic clocks located in many countries.

The BIH initially synchronised TAI with UT2 at zero hours 1 January, 1958. Since that time TAI and UT2 have accumulated a difference of about 23 seconds (July 1, 1985).

The difference is partly due to variations in the Earth's spin, but mostly to the fact that atomic time was simply defined to run slightly faster than UT2. Even if TAI had been defined to have exactly the same rate as UT2 in the beginning, i.e. 1958, it would soon begin to diverge, because TAI is very constant, while UT2 is always varying with the erratic Earth's rotation.

During the past 27 years, two conflicting demands on standard time have developed. On one hand, science, communications systems and electronic navigation systems have needed and exploited the extreme stabilities offered by atomic clocks. On the other hand, astronomy and celestial navigation still need time related to Earth position, no matter how erratic it might be relative to atomic clocks.

### Co-ordinated universal time

To achieve a workable compromise between these two opposing demands, the International Radio Consultative Committee (CCIR) created a compromise time scale called Coordinated Universal Time (UTC), which became effective January 1, 1972.

The rate of UTC is exactly the same as TAI. In fact, the 'ticks' that mark the beginning of each second of TAI and UTC are precisely synchronous. However, the date of any given event on the UTC scale must agree with its date on the UT1 scale – not TAI or UT2 – to within 0.9 seconds.

Offsetting UTC from TAI by a precise,

whole number of seconds accomplishes both requirements; as of 1 July, 1985, UTC was 23 seconds behind TAI. However, since the Earth continuously changes its rate of rotation, this 23-second time offset cannot be permanent. In order to keep UTC within 0.9 seconds of UT1, the BIH will occasionally add (or delete) a second to (or from) the UTC scale. Every standard time system in the world follows suit.

The CCIR recommended that these "leap seconds" should occur at the end of December or at the end of June of any year that they are needed. In fact, leap seconds were added at the end of June, 1972 and at the end of every December from 1972 through 1979, and on June 30, 1981. No leap second was added in 1980.

Since the Earth's rotation rate is not perfectly predictable, scientists cannot forecast leap seconds more than a few months in advance.

We will always have to use leap seconds as long as we use UTC and desire to keep our clocks approximately in step with the Sun. Otherwise, our clocks would gradually show the Sun rising later and later until after thousands of years, our clocks would say the Sun was rising at noon.

### Local time

In most places, local time differs from UTC by a whole number of hours, depending on the local time zone. For example, you subtract five hours from UTC to get Eastern Standard Time (EST).

In the summer, from 2:00 a.m. on the last Sunday in April until 2:00 a.m. on the last Sunday in October, local time, EST is advanced one hour. Hence, you subtract only four hours from UTC.

### Formal definitions of time interval

The Treaty of the Meter, which the US signed in 1875, established an international organisation to oversee and administer the International System of units – i.e. the metric system. This international organisation determines the definitions of the various units of measure, including the unit of time interval, the second.

Prior to 1956, the second was defined to be 1/86 400 of a mean solar day, or  $86\,400 = 24 \times 60 \times 60$ . From 1956 to 1967, the second was defined in terms of Ephemeris Time: 1/31 556 925.9747 of the tropical year 1900. In 1967 atomic clocks took over the role of defining time inter-

val. The new definition reads:

*"The second is the duration of 9192631770 periods of the radiation corresponding to the transition between the two hyperfine levels of the ground state of the caesium 133 atom." (13th General Conference of Weights and Measures (CGPM) (1967), Resolution 1)*

The definition of the International Atomic Time scale (TAI) incorporates the definition of the second. The formal definition of TAI reads:

*"International Atomic Time (TAI) is the time reference co-ordinate established by the Bureau International de l'Heure (BIH) on the basis of the readings of atomic clocks operating in accordance with the definition of the second, the time unit of the International System of Units." (14th CGPM) (1971), Resolution 1)*

### Accurate time: a summary

It was mentioned earlier that local time typically differs from UTC by an integral number of hours, and UTC differs from TAI by an integral number of seconds. Since standard time broadcasts all use UTC by international agreement, almost the whole world runs on UTC.

In many countries the legal basis of 'standard time' is UTC. Thus, from a legal point of view, accurate time must mean UTC, adjusted by the appropriate number of hours to give local time.

To a navigator on the oceans however, accurate time really means UT1. UTC may be close enough – give or take 0.9 seconds – for many navigators but, strictly speaking, navigators need UT1. To a scientist who doesn't want to be bothered with leap seconds, accurate time means TAI.

So, in a very real sense, accurate time has different meanings to different people. The idea of accuracy relates to the use made of the time information.

Fortunately, most of us do not need to bother with all these different time scales, since the time we get from the telephone, radio, or television is adequate. If we trace the telephone, radio, or television time back to its source, however, we would actually find that UTC is the master clock in our lives.

# Sparks may fly

**Irving Gottlieb** asks could continuous exposure to electrostatic discharge be affecting our health?

**A**t one time, the marginally-safe level of soft-X-ray radiation from tube-type television receivers was a matter of concern. Not only the picture-tube emitted this form of ionising radiation. The rectifier, damper and regulator tubes gave off X-rays too. In modern solid-state sets, the problem has been largely alleviated; besides, a more-respectable viewing distance is now dictated by the larger display-screens.

But we may be overlooking an elusive, yet possibly health-affecting source of ionising radiation that has always been with us. A useful aspect of the ensuing speculation is that you can make a reasonable appraisal of its merit without having a degree in the life-sciences.

Having had a long-time interest in radiation, I sensed particular relevance in Darren Heywood's article in the May 1998 edition. His allusion to ultra-violet radiation "and perhaps X-rays" resonated my own thought-patterns and experiments.

High-voltage spark discharges can give rise to an extremely wide band of electromagnetic radiation encompassing audio, rf, microwave infra-red and visible-light frequencies.

Any ionising radiation in the ultra-violet and soft X-ray portion of the spectrum could logically be anticipated to be negligibly small. It is here that we come to the gist of this article – is 'negligibly small' always negligible?

Imagine a camera with a 'negligibly-small' light leak. We know that in due time, the film will be thoroughly fogged, as if subjected to a single intense burst of light. It may also be that a cumulative effect of long-time bodily exposure to weak ionising radiation could be damage to cell tissue.

The high-voltages required to cause such sparkovers can stem from electrostatically charged dielectric surfaces. Mixing the wrong combinations of clothing textiles, wool and linen for example, causes sparkovers. Synthetic textiles make particularly good generators.

One can envisage weather conditions favourable to round-the-clock discharge of static-electricity. Despite the low energy-level and dose-rate of the accompanying ionising radiation, the intimate proximity of the sparkovers to the skin may be significant. Is it mere coincidence that the relatively small radius of the female breast favours concentration of charge-density?

Not long ago, it was considered that there was a threshold of radiation below which the risk of any adverse health effects were negligible. Today, the prevailing thought is that it is best to avoid exposure altogether, if it is possible and practicable. ■

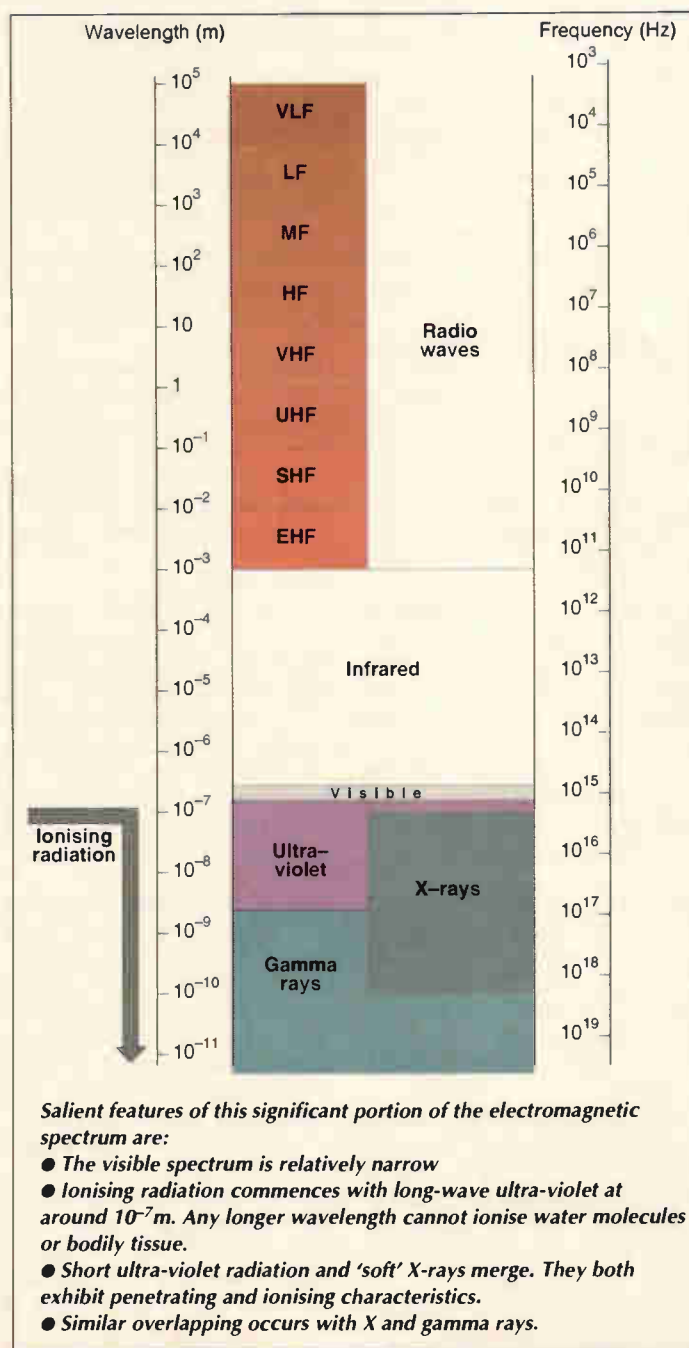

# R

QUICKROUTE

www.quickroute.co.uk

## THE QUICKROUTE

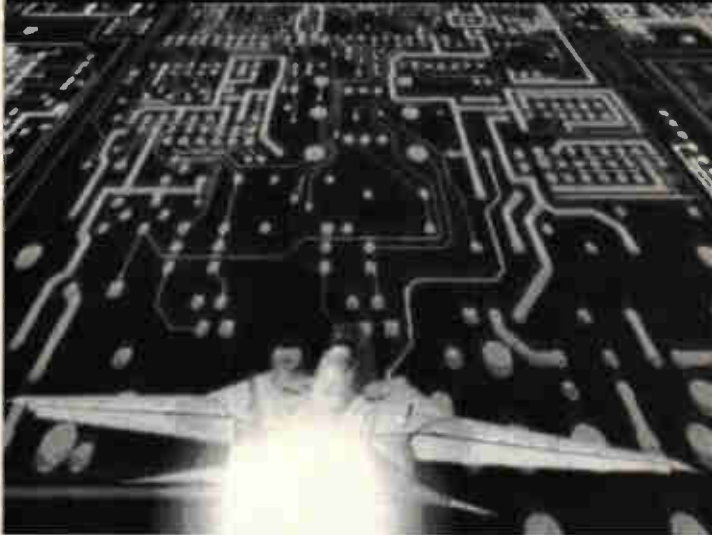

## Simulation Circuit Capture PCB Autorouting CAD/CAM

Imagine an electronics design system that lets you draw schematics onto the screen and then simulate them at the touch of a button. Now imagine pressing another button and seeing the schematic replaced with a PCB rats-nest. Pressing another button starts the autorouter, and finally you can click on File then Save As to create a complete set of CAD/CAM files.

Too easy? We hope so. Quickroute has always been designed first and foremost to be easy to use. That's why simulation, circuit capture, PCB autorouting and CAD/CAM support are all integrated into **one** package, so that you only have to learn **one** package.

If you would like to find out more about Quickroute, why not call us on FREEphone 0800 731 28 24, or visit our web site on [www.quickroute.co.uk](http://www.quickroute.co.uk). Prices start at under £100 including UK P&P and VAT for a complete system.



**"modern, powerful  
and easy to use"**

*Elektronik 97*



FREEphone

**0800 731 28 24**

Int +44 161 476 0202 Fax 0161 476 0505

Copyright © 1998 Quickroute Systems Ltd Regent House Heaton Lane Stockport SK4 1BS UK

CIRCLE NO.108 ON REPLY CARD

## Antrim Transformers Ltd

*Toroidal Transformers*

Large standard range + custom designs on  
**15 core sizes approved to EN60742**  
(KEMA agreement 919691)

Large standard range + custom designs on  
**23 core sizes approved to UL506 & C22.2**  
No.66-1988 (UL file no.E179800)

Medical isolation transformers approved to  
**EN60601-1**

Audio grade, 100V line, valve output &  
valve psu transformers

Lead time typically 3 weeks, minimum  
batch size of 10 off

Rapid quotation & prototype service



100% UK  
manufactured



UL File No. E179800

Tel: 01227 450810  
Fax: 01227 764609

CIRCLE NO.109 ON REPLY CARD

## CONTROL & ROBOTICS

from Milford Instruments

### BASIC Stamps-

- Re-Programmable
- BASIC language
- RS232 Serial ports
- 8 or 16 I/O lines
- SPI/DTMF
- Fast development



### Scenix

- Fastest 8-bit micro
- 50MIPS
- Flash Eprom
- 18/28 pins
- PIC16C5x pin replacement



### Serial LCDs

- RS232 Serial interface
- 2x16 to 4x40
- Simple 3-pin connection
- Integral Keypad option
- Large Numerics option
- Driver chips available for OEM use



### Robotics

- Humanoid
- 5-Axis Arm
- Walking Insect



### 3-Axis Machine

- Stamp 2 based
- Drills PCBs
- 3-Axis movement
- Stepper drive
- 4 thou resolution
- Win 3.1 software



### Servo Controller

- Control up to 8 servos
- RS232 Commands



### IR Decoder

- Uses any remote
- 7 digital outputs
- Toggle/momentary
- Re-Programmable

Milford Instruments 01977 683665 [www.milinst.demon.co.uk](http://www.milinst.demon.co.uk)

CIRCLE NO.110 ON REPLY CARD

# Measuring Yagis

Paolo Antoniazzi and Marco Arecco have devised a simple yet accurate method of measuring the gain of Yagi antennas for the 2m band.

**M**easuring a Yagi is much more difficult than simulating one. Henry Jasik<sup>1</sup> once said, "The measurement of total gain of antennas is probably the most difficult measurement of antenna technology..."

For decades the Yagi antenna has been the first choice for television reception and amateur radio applications. But the most important properties – gain, efficiency and radiation pattern – could be evaluated only by difficult and time-consuming measurements. The accuracy of these measurements was poor too.

During the seventies, large simulation programs for antennas were developed on mainframe computers for research purposes. These simulators were eventually modified for use on microcomputers.<sup>2</sup>

Today, good programs such as *NEC-Win Pro* for Windows NT/98, are available for all serious experimenters. The simulations they produce are often more accurate than the results obtained from making field measurements.<sup>3</sup> **Figure 1** shows a current-density optimised plot of an eight-element Yagi simulated using *NEC Win Pro*.

**Fig. 1.** Current-density optimised eight-element vhf Yagi, simulated using *NEC-WinPro*.

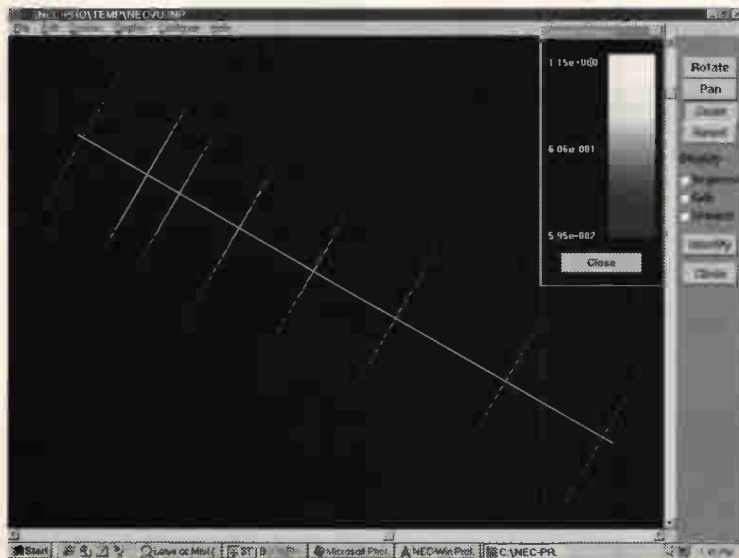

## Measuring antenna gain

Many people have attempted to measure Yagi antennas. For all of them, the biggest problem during tests on field strength has been that of interaction between direct and reflected wave.<sup>4,5,6</sup>

Due to this interaction phenomenon, the level of the signal received by the horizontal Yagi antenna at the receiving site changes when the height of the antenna is altered.

By linearly varying the height of the antenna under test by about 3m, which is slightly more than one wavelength at 144.5MHz, it is easy to see where the minimum received signal occurs, i.e. when the reflected signal at the antenna is in antiphase with the direct signal. If the reflection is almost total, the notch depth can exceed 20dB.

In the case of the maximum reflected signal being in phase with the direct signal, the sum could be as much as, but not exceed, +6dB. Of course, all intermediate values are possible. But when the ratio between the direct and reflected waves exceeds 24dB, the curves in figure 1 have converged to a maximum error of  $\pm 0.5$ dB.

**Figure 2** thus shows the maximum error that can occur when positioning the antenna at any given height. Note that it is not easy to reduce the reflected wave significantly. But by measuring and plotting the received signal at various heights, it is possible to determine exactly the direct/reflected signal ratio and, therefore, the value of the direct signal itself.

By comparison with the results for a reference antenna, more accurate results can be derived. These, together with information from the horizontal radiation pattern, permit a more accurate estimation of the true value of the gain of the antenna under test. Note that since the vertical radiation patterns of both the transmit antenna and the antenna under test affect the value of the received wave, it is important to compare both plots of the received signal versus height, and not just the two apparent gains.

One of the most important sources of information is that produced by Kraus.<sup>7</sup> His work shows that the reflected-wave problem can be reduced by making measurements using buildings of 5-10 storeys high, **Fig. 3**.

To obtain a 25-30° angle for the reflected wave over a useful distance of about 100m, two buildings between 30 and

50m high are needed. As you will see later, the 100m distance necessary for long-Yagis.

We carried out such testing using a 16-element high-gain Yagi. We placed the transmitting antenna on the roof of a 14m high house and orientated it towards a park with no obstacle around. Fig. 4. This diagram allows you to calculate the effective radiation angles and the path of direct and reflected signal for the 6dBd reference yagi and for the eight-element antenna under test. The test antenna was 3.2m long and had a simulated gain of about 10.6dBd.

### Analysing the theory

The following considerations assume a horizontally polarised wave since horizontal polarisation is most widely used in both television broadcasting, ssb, cw and tropospheric links at 300-1000km.

As is well known, the electrical field received from the antenna is given by the vectorial sum of direct and reflected wave.

The electrical field equation is,<sup>5</sup>

$$E = E_d \sqrt{1 + k^2 + 2k \cos\left(\frac{2\pi\delta}{\lambda} + \pi\right)}$$

where,

$E$  is intensity of the resulting field in V/m,

$E_d$  is field intensity of the direct wave in V/m.  $k$ , which is less than unity, is the ratio between reflected and direct electrical field.

$\pi$  is 180° rotation of the reflected wave relative to the direct one (horizontal polarisation)

$\delta$  is the difference of path in metres between direct and reflected wave ( $\sim 2h_t h_r / d$ )

$\lambda$  is wavelength in metres.

There is an accurate expression for calculating the difference in distance between direct and reflected wave.  $\delta$ . This expression was the starting point for a simplified formula that can be used when  $(h_t+h_r)^2/d^2$  and  $(h_t-h_r)^2/d^2$  are both much less than one,

$$\delta = \sqrt{(h_t + h_r)^2 + d^2} - \sqrt{(h_t - h_r)^2 + d^2}$$

Here,  $h_t$  is the height of transmitting antenna,  $h_r$  is the height of receiving antenna and  $d$  is the distance between the foot of the two antennas. All three distances are in metres.

We used this expression for our analyses. Thanks to personal computers, it can be applied for very complicated designs. We estimated that the simplified formula results in an error of about 7%.

To reduce measurement errors, the distance between transmitting and receiving antennas has to be considered. To determine this distance, you need to be able to measure the signal level easily with a filtered rf voltmeter having a 30-40dB dynamic range. Also, the wave reaching the receiving antenna should be as planar as possible.

The first condition can be easily established starting with the received power and calculating the attenuation experienced by the wave in the open space,

$$\alpha = 32.4 + 20 \log(f) + 20 \log(d) - G_t - G_r$$

Here,  $\alpha$  is attenuation in decibels.  $f$  is frequency in megahertz.  $d$  is distance in km.  $G_t$  is the gain of transmitting

antenna in dBi and  $G_r$  is the gain of receiving antenna, also in dBi, obtained by simulation.

There is also a simple, easy to remember method of calculating the attenuation by considering the distance between the two antennas in terms of wavelengths.

When  $d=\lambda$ ,  $\alpha$  is always 22dB between isotropic antennas. This equates to 2.08m at 144MHz. The attenuation increases by 6dB for each doubling of the path distance. This means that the free space attenuation is 22dB at 2m, 28dB at 4m, 34dB at 8m, etc.

To make the wave reaching the receiving antenna as planar as possible, the capture area in square metres of the receiving antenna and the maximum acceptable phase error are needed.

$$A_c = G_r \frac{\lambda^2}{4\pi}$$

This expression is valid for an antenna with no thermal losses and was certainly useful for our experiments.

Assuming that the capture area is circular, the minimum

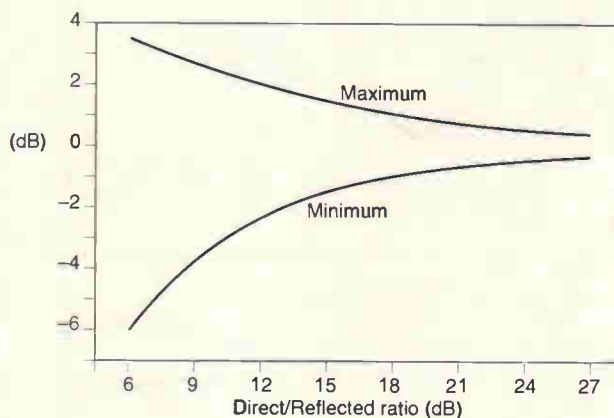

Fig. 2. Absolute maximum test error versus direct/reflected signal ratio. This is the maximum possible gain measurement error when moving the antenna up and down the mast. As you can see, the error in decibels can be positive or negative, depending on the relative phase of the two signals.

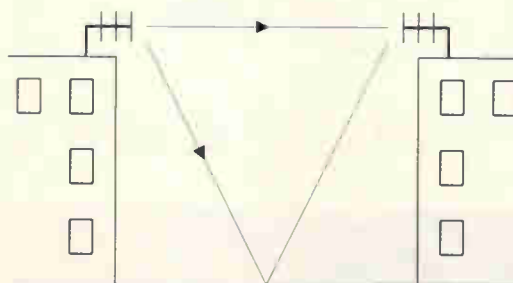

Fig. 3. Kraus suggests that Yagi tests should be carried out using two reasonably high buildings to reduce reflection errors.

distance in meters between the two antennas will be,

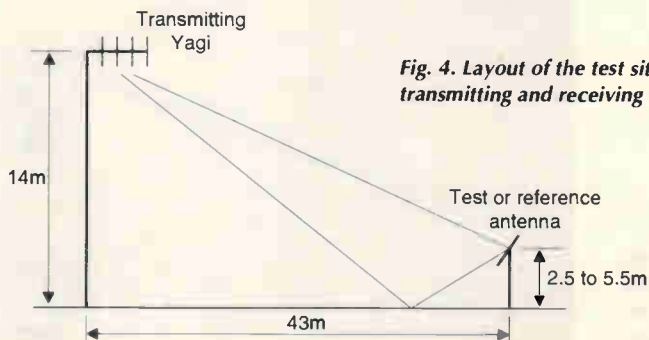

Fig. 4. Layout of the test site with transmitting and receiving antennas.

$$d > nG_r \frac{\lambda}{\pi^2}$$

For a maximum phase difference of 22.5°, which is usually enough,  $n=2$ . If a phase error of only 5° is required,  $n=9$ . In the case of Yagi antennas, where one dimension prevails over the other ones, the maximum length, instead of the capture diameter, is used. In this case, the minimum distance in metres becomes.<sup>4,8,9</sup>

$$d > n \frac{L}{\lambda^2}$$

where  $L$  is the maximum Yagi length in metres.

**Siting and antenna height**

The minimum height from ground of the antenna under test is another parameter to be controlled during the measurements. This is because the proximity of ground can modify the radiation resistance.

In our case, the minimum height is  $h_r$  is more than  $\lambda$ , but the relevant points of the curve have been measured at 2 $\lambda$  and above. Note that the simulation software that we used (NEC-WinPro) does not take into account the ground plane. Also, the typical parameters of the antenna – gain, radiation angles, impedance – are calculated in the free space.

To define the correct receiving height, it must be considered that the electrical field, and hence the voltage measured by the millivoltmeter – have maximum and minimum values due to the different path of direct and reflected wave, sum or difference.

To be confident about the measurements, it is necessary to find at least a maximum and the nearest minimum using the first two formulas. This was done allow us to draw the curves of Figs 5, 6.

A suggestion from an article that appeared in *VHF Communication*<sup>10</sup> convinced us to incline the antenna to be measured with respect to ground. This allowed us to have the maximum signal for the direct wave and the maximum attenuation for the reflected one, exploiting the shape of Yagi radiation diagram. In particular, the approximate 40° angle of reflected wave relative to the receiving antenna attenuates it by around 2 to 4dB.

We decided not to incline the transmitting antenna to improve the ratio between reflected and direct wave. Instead, we exploited the directivity of the antenna. The advantage is about 5dB as the reflected wave is about 23° under the plane of maximum radiation and 13° under the direct wave path.

Another way to reduce the reflected wave, which we did not try, is to place a metal screen near the reflection point. This plate needs to have significant dimensions with respect to the wavelength: 2 by 4m for instance.

According to previous considerations and the availability of a suitable area for field testing, the conditions of the measurement site are defined as follows:

Transmitting Yagi, – 16 elements.  $G=13\text{dBi}$ .  $h_t=14\text{m}$  with the boom parallel to the earth plane.

Fig. 5. Calculated and measured values of signal level versus antenna height and direct-to-reflected signal ratio. These values are for the three-element reference Yagi at 144.5MHz.

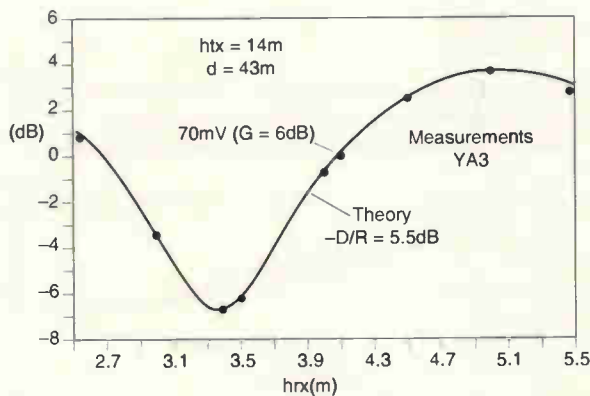

Fig. 6. Performance of the eight-element Yagi at 144.5MHz. As with the previous graph, these are calculated and measured values of signal level versus antenna height and direct-to-reflected signal ratio.

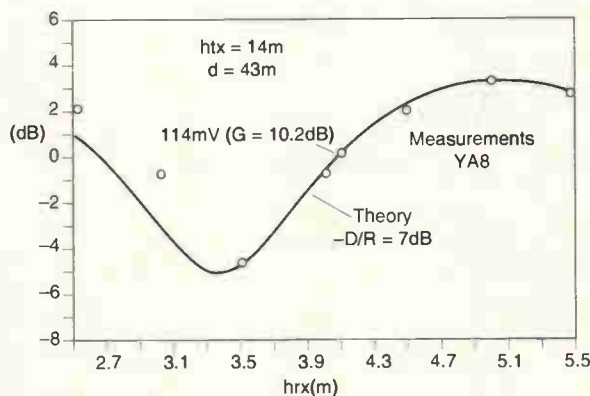
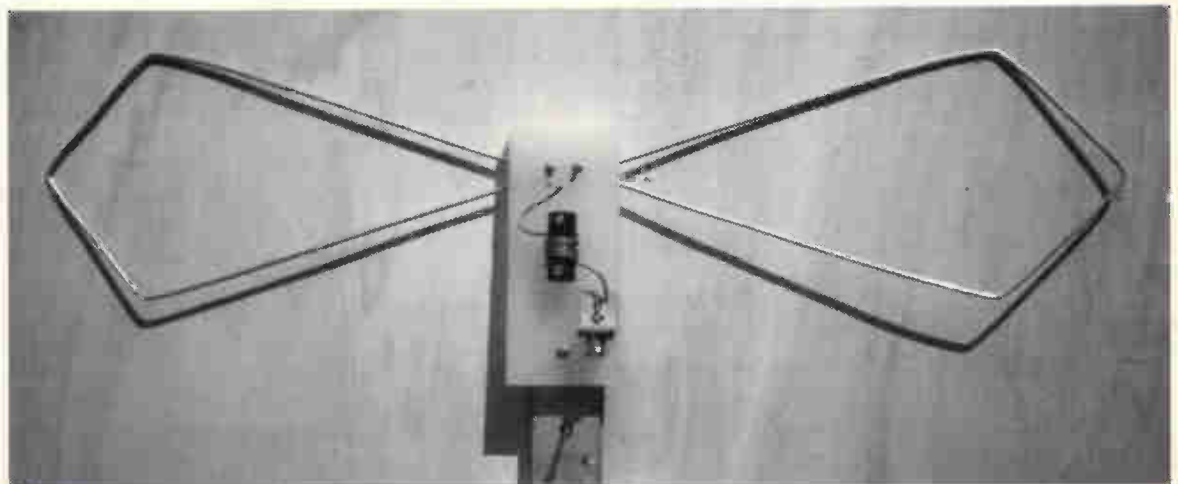

Fig. 7. Rhombic reference dipole realised for comparison tests.



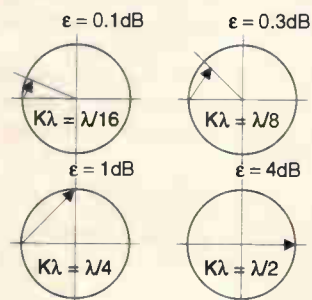

Fig. 8. Planar wave concept and phase error.

Reference antenna – home-made three-element Yagi, G=6dBd, calibrated by the reference dipole described next and shown in Fig. 7,  $h_r=2.5$  to 5.5m. Minimum received signal was at 3.4m and maximum at 5.1m. The boom had a 13° angle with respect to the ground plane.

Antenna under test – this was a 3.2m long (1.8λ) eight-element home-made Yagi.

The site we selected is useful for measurements of antennas up to 6m long. This equates to about 3λ at 144.5MHz).

For accurate antenna gain measurements, the distance between the transmitting and receiving (test) antennas should be greater than that needed to satisfy the far-field conditions for  $d>5λ$  and greater than the approximate uniform plane wave.

So if you want to measure a 10m long Yagi, it is necessary to increase the distance using,

$$d > n \frac{L}{\lambda^2}$$

to maintain the error due to a non-uniform plane wave within a fraction of decibel, Fig. 8.

To detect the received signal at the receiving antenna we used a Boonton 92B millivoltmeter. This meter is well suited for these applications but it is possible to make your own instruments with good sensitivity and accuracy. The signal under test ranged from 143 to 146MHz and was swept by means of a small remote control.

To conclude, Figs 5 and 6 show the obtained values superimposed with the curves calculated with the first two formulas, normalised to the direct wave and given in decibels.

The difference in signal between the 6dBd reference Yagi YA3 and YA8 at the null point – i.e. with no reflected wave – is 4.2dB. This allowed us to conclude, after a critical analysis, that the gain of the 1.8λ long eight-element Yagi is 10.2dB.

The analysis considered the optimum matching between measured and simulated radiation diagram was ±20° at -3dB. The maximum test error is probably around 0.5dB.

The measured value of front-to-back ratio at 180° was 21.5dB.

**Error sources**

Most errors that occur during antenna measurements are related to the reflected wave. The total error can vary from a maximum of +6dB, when the direct wave is summed to the

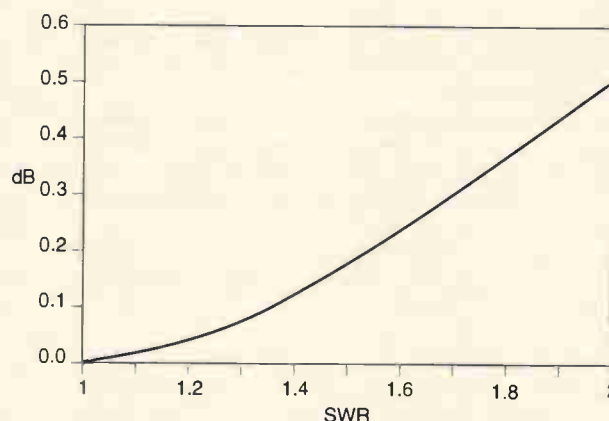

Fig. 9. Maximum error versus standing-wave ratio of the antenna under test.

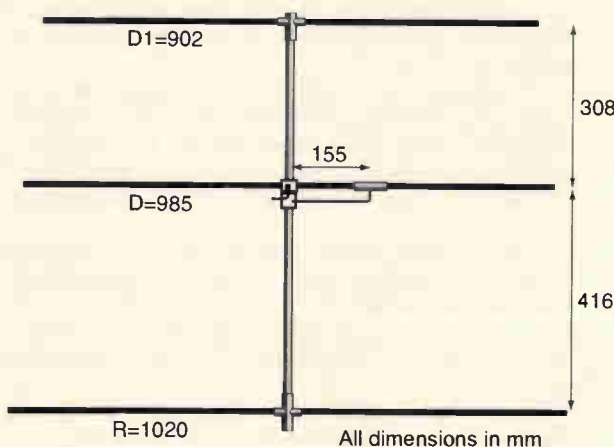

Fig. 10. Three-element reference Yagi dimensions.

reflected one, to -20dB or less when the two components of received signal are subtracted each other according to the first mathematic relation we presented.

Broadcast fm signals received by the antenna under test can affect the measured voltage significantly. To minimise this problem, we performed the measurements as near to the antenna as possible. How close the measurements can be made depends on the antenna dimensions and the planar wave effect must be catered for. We incorporated a good helical filter for 144.5MHz, ±5MHz to reduce interference and obtained a useful received signal of about 100mV.

Another source of error is related to the antenna impedance mismatch, relative to 50Ω. The mathematical relationship that describes the signal loss on the receiving antenna output or on the load is given by the following equation when the antenna impedance is greater than 50Ω,

$$\frac{V_a}{V_o} \text{ (dB)} = 20 \log \left[ 2 \frac{1}{1 + SWR} \sqrt{\frac{Z_a}{Z_o}} \right]$$

Here,

- $V_a$  is antenna voltage in volts when  $Z_a \geq 50\Omega$
- $V_o$  is antenna voltage when  $Z_a = 50\Omega$
- SWR is standing wave ratio
- $Z_a$  is antenna radiation impedance
- $Z_o$  is load impedance (50Ω)

When  $Z_a > Z_o$ ,  $SWR = Z_a/Z_o$ . For an antenna impedance of less than  $50\Omega$ , the equation becomes,

$$\frac{V_a}{V_o} (\text{dB}) = 20 \log \left[ 2 \frac{SWR}{1 + SWR} \sqrt{\frac{Z_a}{Z_o}} \right]$$

Here,  $SWR = Z_o/Z_a$  when  $Z_o > Z_a$ . The behaviour of the maximum error versus receiving antenna standing-wave ratio is shown in Fig. 9.

A load impedance different from  $50\Omega$  can also introduce a measurement error which is minimised using a 10dB fixed attenuator connected directly to the antenna output. In our practical case, load standing-wave ratio was better than 1.05 with a tiny error of less than 0.03 dB.

A 10MHz-wide band-pass filter is normally included to screen out possible out-of-band strong signals mainly from fm broadcasting stations.

### Reference antenna

The reference antenna is a log-periodic wide-band type that is frequently used in this type of application. Its approximate bandwidth can be calculated by using the lengths of shorter and longer elements. Bandwidth is about half of the maximum and the minimum wavelength at which the antenna can be used.

When working at a single frequency, only part of the whole antenna is active: the elements have a physical dimension nearest to one half of the wavelength. It is important to remember that input impedance and radiation properties of this antenna are repeated periodically with the logarithm of the frequency.

Commercial log-periodic antennas often used in electromagnetic-compatibility measurements are manufactured by companies including Hewlett Packard and Emco and are available with calibration graphs. The *HP11966D* for example covers the range 300-1000MHz and costs around £1500 pounds.

Considering the narrow band involved in our measurements, and the consequent small variation of standing wave ratio versus frequency we decided to build-in a reference Yagi with similar behaviour and accuracy as the log-periodic.

We calibrated our Yagi with reference to a half-wave dipole, the performance of which is well documented.<sup>9</sup> Assuming no losses, the features of a half-wave dipole are,

Horizontal half-power beamwidth	78.1°
Directivity	2.14dBi
Receiving area	0.131λ
Effective length	0.318λ.

The main characteristic needed for our reference dipole is a standing-wave ratio lower than 1.2 with a negligible error of  $\pm 0.05\text{dB}$ . As a result, we made our dipole rhombic in shape. Its length is 798mm, its width is 180mm and it is made from 4mm diameter aluminium wire.

It is necessary to 'balance' the antenna using a choke comprising six turns of teflon-coated cable on a 20mm diameter insulated support. Due to the addition of this cable, 0.2dB must be subtracted from the gain of the dipole, making it -0.2dBd instead of the 0dBd theoretical value.

We do not advise the use a dipole for repeated tests since it is omnidirectional. It also has a significant gain in the fm broadcast range, which contains strong unwanted signals.

A dipoles<sup>11</sup> can be useful as a reference, but it does not have the flexibility and measurement reliability of a Yagi with more than 25dB of front-to-back ratio.

At the beginning we thought of a two element Yagi, i.e. a dipole plus reflector, but its front-to-back ratio was not high enough for our needs. Also, to optimise standing-wave ratio,

we would have had to work with many different values of gain.

After many hours of simulation with NEC-Win Pro 1.1<sup>3</sup> and some field measurements, our choice was a three-element Yagi built with 10mm diameter rod. It had a gamma matcher made from copper and teflon.<sup>10</sup> Its gain was 6dBd and it had a high front-to-back ratio.

The passive elements have insulated supports 30mm high, while the dipole has an aluminium support, connected electrically with the boom via a type-N connector.

The final reference antenna, Fig. 10, is easy to make and repeatable. When made precisely to the drawing and well trimmed for standing-wave ratio, it meets the design requirements of 6dBd gain at 144.5MHz.

### In summary

There are many potential sources of error when performing Yagi gain measurements and there has been a great deal of optimism when analysing them.

If you consider that a typical site for professional measurements described in reference 12 certifies the gains of the antennas under test within  $\pm 2\text{dB}$  between 30 and 1000MHz, you can better understand the difficulties that arise.

We have examined the subject of dipole calibration and presented a three-element reference yagi for easy comparison tests at very high frequencies.

We believe that by averaging repeated measurements, it is possible to obtain results with maximum error of around  $\pm 0.5\text{dB}$ . ■

### References

1. Jasik, H, 'Antenna Engineering Handbook,' McGraw Hill, 1961.
2. Bertelmeier, R, DJ9BV and Hoch, G, DL6WU, 'Yagi Simulation by Computer,' *DUBUS*, 3/91-4/91-1/92-3/92.
3. NEC-Win Pro Antenna Analysis Software, version 1.1, Nittany Scientific Inc, 1997, www.nittany-scientific.com
4. ARRL Antenna Book, 1991, VHF and UHF Antenna Measurements, pp. 27.43 to 27.48 and p. 3.11.
5. Aubin, JF, Berlekamp, JD & Frey, DT 'Antenna Measurements in Commercial World,' Proceedings of AMTA 1995, pp. 69-74.
6. Knott, EF, 'Radar Cross Section (RCS) Tests Utilize Ground-Plane Effects,' *Microwave & RF*, March 1984, pp. 79-84.
7. Kraus, JD, 'Antennas,' Second Edition, McGraw-Hill 1988, pp. 44-46, pp. 60-61 and pp. 809-813.
8. White, DRJ, 'Electromagnetic Interference and Compatibility,' Vol.2, 1980.
9. Reference Data for Engineers, 7th edition, Sams 1989, pp. 32.14 and 33.17 to 33.19\*
10. Asbrink, L, SMSBSZ, 'The Optimum 6-element Yagi,' *VHF Communications*, No 1/82.
11. Littlefield, R, K1BQT, 'A Reference Dipole for 2-Meters,' *Communications Quarterly*, Fall 1997, pp. 90-91.
12. Walsh, DP & Kremer, D, 'Design and Verification of an Antenna Measurement Facility at 30-1000 MHz,' Proc. AMTA 1996, pp. 235-238.

### Further reading

Brown, F, W6HPH, 'Antenna Gain Measurements,' *QST*, Nov. and Dec. 1982.

\* **Reference Data for Engineers** is now published by Newnes and available via *Electronics World's* editorial offices. E-mail jackie.lowe@rbi.co.uk or fax 0181 652 8111 for details.



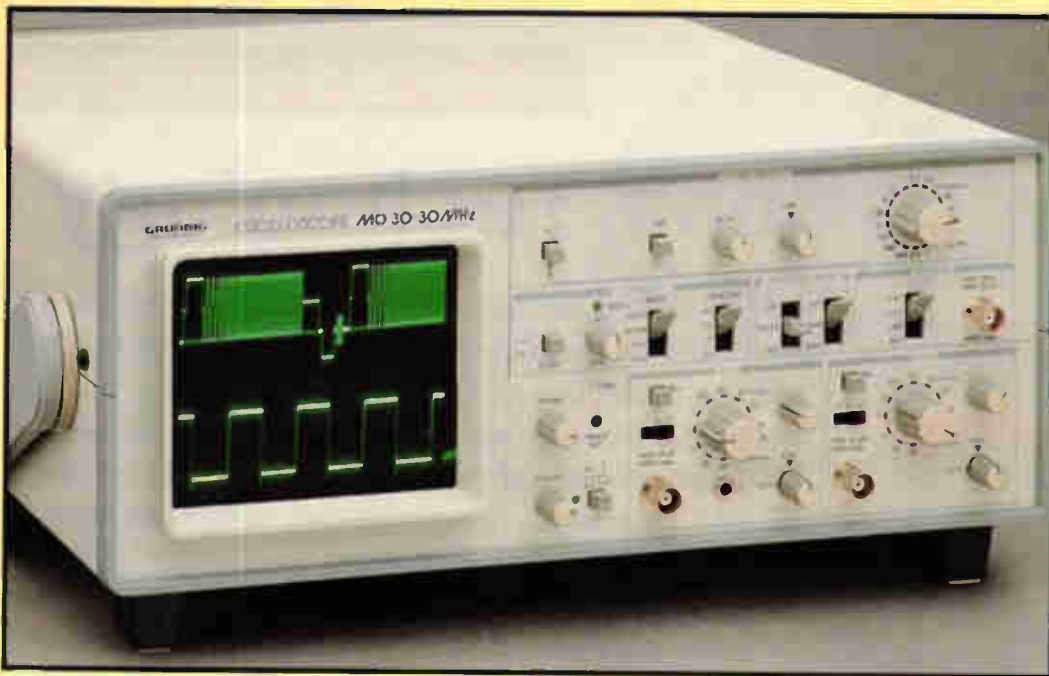

## Win a 30MHz oscilloscope worth £450 or one of two superb £70 dmms

Simply tell us what topic you enjoy reading about most in *any* electronics magazine and you could win an oscilloscope or digital multimeter. Send your entry – including your name and address – by post only to 1998 Prize Draw, Electronics World Editorial, Quadrant House, The Quadrant, Sutton, Surrey SM2 5AS. The draw will take place on 4 January 1999.

### LP310 professional hand-held dmm

The LP310 3.5 digit hand-held digital multimeter retails at just under £70.

#### Features

44 ranges  
 Frequency to 20MHz  
 AC & DC current to 10A  
 AC & DC volts 3.5 digit  
 Gold plated switch contacts – long life  
 Auto power off  
 Data & peak hold  
 Input warning beeper  
 Overload protection  
 Logic test  
 Diode, continuity & transistor test  
 Protective rubber holster  
 Resistance & capacitance

#### Key specifications

Frequency : 2k, 20k, 200k, 2M, 20MHz auto range  
 Capacitance : 2n, 20n, 200n, 2 $\mu$ , 20 $\mu$ F  
 Resistance : 200, 2k, 20, 200, 2M, 20M $\Omega$ , 2000M $\Omega$   
 AC current : 200 $\mu$ , 2m, 20m, 200m, 20A, 2A, 10A  
 DC current : 200 $\mu$ , 2m, 20m, 200m, 20A, 2A, 10A  
 AC volts : 200m, 2, 20, 200, 750V basic accuracy 1.2%  
 DC volts : 200m, 2, 20, 200, 1kV basic accuracy 0.25%

Ready to use complete with test leads, rubber holster, battery, instructions.

### Grundig MO30 30MHz oscilloscope

**Selling at over £450**, the MO30 features two channels, a 3dB bandwidth of 30MHz, 2kV accelerating voltage, 8 by 10cm screen, and X/Y modes. Vertical sensitivity is 5mV to 20V/div in 1-2-5 sequence and the time base covers the range 0.5 $\mu$ s to 200ms also in 1-2-5 sequence.

#### Features

- Peak-value trigger, trigger filter 2mV/cm, addition and subtraction measurement. Both channels invertible, CRT with internal graticule.
- Automatic peak-value trigger ensures stationary displays without the need of manual trigger level adjustments.
- AC/DC trigger, high-pass filter (HF) and low-pass filter (LF) for a clear display of complex signals.
- Triggers on field and line frequency of video signals. No manual adjustments in case of changing amplitudes or varying video contents.
- 2mV/cm with full bandwidth. Addition and subtraction.
- Both channels invertible. Important for characteristic curves in X/Y mode.
- Free choice of X deflections by trigger source selector switch. This enables dual-channel Y displays in X/Y mode.
- Non-parallax reading due to CRT with internal graticule.
- Automatic focusing.

#### Rules:

Anyone can enter, subject to the proviso hereunder, but only one entry per person is allowed ● This draw is not open to employees of Reed Elsevier ● No correspondence relating to this draw will be entered into ● The winners will be announced and notified as soon as possible after the draw. ● Each of the three prizes will go to a different entrant ● Entries arriving after the closing date of 4 January will not be considered ● No responsibility for lost entries will be taken by Reed Elsevier

**new edition**

# Dictionary of Communications Technology

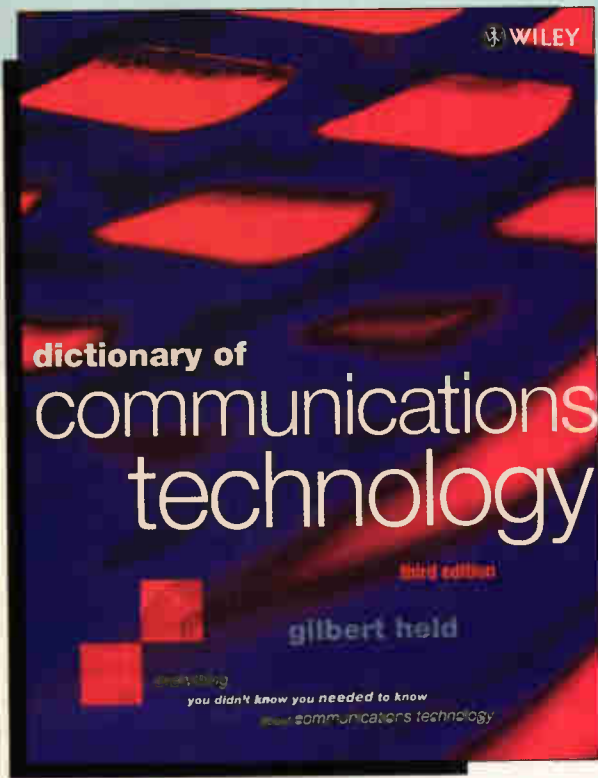

With over 9000 entries and 250 illustrations, this book is an invaluable reference work for anyone involved with electronics and communications. Dictionary of Communications Technology provides comprehensive coverage of data and communications and has entries on PC lans, the Internet, communications testing and client-server applications - in 500 pages.

Over 20 major companies helped prepare the Dictionary of Communications Technology, including AT&T, IBM and Digital Equipment Corporation.

Gilbert Held, author of Dictionary of Communications Technology, is an internationally author who has used his enormous expertise to make this work one of the most comprehensive sources of telecommunications information.

**UK Price: £38.95 Europe £42.95 ROW £46.95**

**\*\* Price includes delivery and package \*\***

**Fax your order to 0181 6528111 or post to Room L333, Quadrant House, The Quadrant, Sutton, Surrey, SM2 5AS**

Please supply the following title:

**Dictionary of Communications Technology**

Total \_\_\_\_\_

Name \_\_\_\_\_

Address \_\_\_\_\_  
\_\_\_\_\_  
\_\_\_\_\_

Postcode \_\_\_\_\_

Telephone \_\_\_\_\_

Method of payment (please circle)

Access/Mastercard/Visa/Cheque/PO

**Cheques should be made payable to Reed Business Information**

Credit card no \_\_\_\_\_

Card expiry date \_\_\_\_\_

Signed \_\_\_\_\_

**Please allow up to 28 days for delivery**

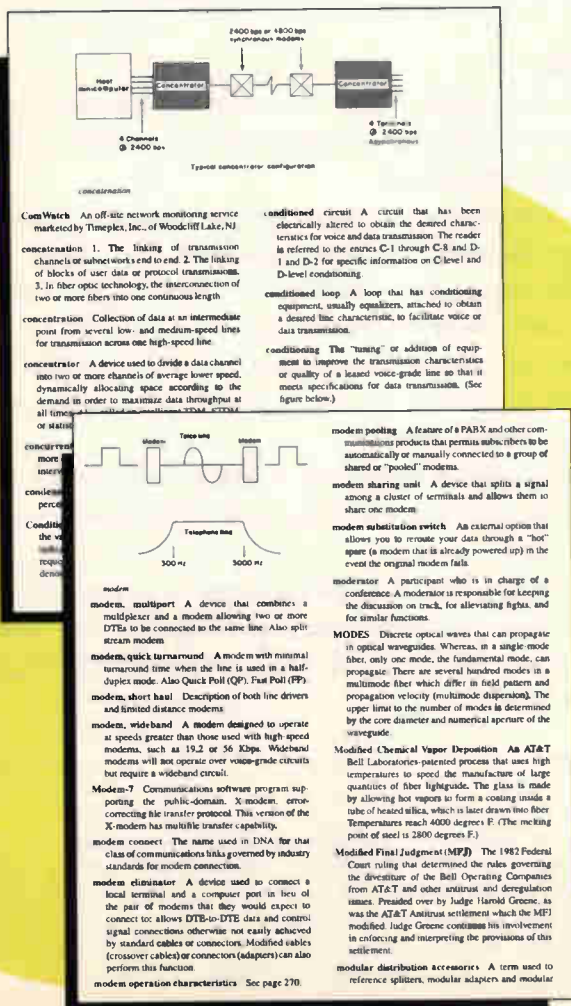

Have you got  
the **capacity**  
to **resist** this  
**inducement?**

12  
ISSUES  
*free*

**ELECTRONICS  
WORLD**  
INCORPORATING WIRELESS WORLD

# Subscribe to **Electronics World** for 3 years but pay for just 2!

**Please enter my subscription for:**  
(tick one of the following)

	UK	Europe	Rest of World	
1 year	<input type="checkbox"/> £34	<input type="checkbox"/> £49	<input type="checkbox"/> £59	
2 years	<input type="checkbox"/> £54	<input type="checkbox"/> £78	<input type="checkbox"/> £94	<b>SAVE 20%</b>
3 years	<input type="checkbox"/> £68	<input type="checkbox"/> £98	<input type="checkbox"/> £119	<b>1 year FREE!</b>

## **In every monthly issue**

- Detailed circuit diagrams
- New product reviews
- Informative design-oriented explanations
- CAE software
- and more .....

## **Full money back guarantee**

If you're not completely satisfied with **Electronics World** within the first 60 days we'll refund your money in full - no questions asked.

Please allow 28 days for delivery of your first issue.

Please tick here if you do not wish to receive direct marketing promotions from other relevant companies.

## **Three ways to pay**

**1** I enclose a cheque for £ \_\_\_\_\_ made payable to **Electronics World**.

**2** Please charge my Visa/Mastercard/American Express/Diners Club  
(please delete as appropriate)

Card Number

Expiry date  /

Signed \_\_\_\_\_ Date \_\_\_\_\_

**3** Please invoice me/my company. Purchase Order No. \_\_\_\_\_

Name \_\_\_\_\_

Job Title \_\_\_\_\_ Company \_\_\_\_\_

Address \_\_\_\_\_

Tel. No. \_\_\_\_\_

Company VAT registration number \_\_\_\_\_

Return your completed form to:

Electronics World Subscriptions, FREEPOST RCC 2619,  
PO Box 302, HAYWARDS HEATH, UK, RH16 3BR

087

## **Credit Card Orders**

Tel: +44 (0) 1444 445566 (quoting code 087)

# Telnet

Tel: 01203 650702

## Quality second-user test & measurement equipment

<b>Hewlett Packard</b>	
8920A R/F Comms Test (various options)	£4995
8922 BGH G.S.M. Test	£POA

<b>Rohde &amp; Schwartz</b>	
CM5 54 Radio Comms service monitor (0.4 to 1000MHz)	£6250
CMTA94 GSM Radio Comms Analyser	£7500

<b>Schlumberger - Stabilock</b>	
4031 Radio comms test (0.4 to 10.00MHz)	£4995
4040 'High accuracy' Radio comms test	£2995

<b>Wandel &amp; Goltermann</b>	
PFJ-8 Error & jitter test set (All options fitted)	£12500
PCM4 PCM Channel measurement set	£POA

<b>Marconi</b>	
2305 Modulation Meter	£1995

<b>Racal</b>	
6111 GSM test sets	£POA

<b>Hewlett Packard 8642A</b>	
High Performance R/F Synthesiser - 0.1 to 1050MHz	£8500

<b>Textronix 2467B</b>	
400MHz - 4 channels - high writing speed oscilloscope	£8500

### Marconi Radio Communications Test Sets



2955	£2250
2955A	£2500
2958 (TACS)	£2750
2960 (TACS + Band III)	£2750
2960A (TACS)	£2950
2955B	£4000
with 2960B added	£4250

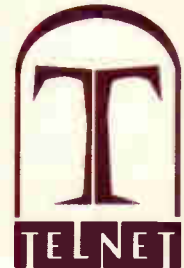

## Fax 01203 650 773

### OSCILLOSCOPES

Beckman 9020 - 20MHz - Dual channel	£150
Hewlett Packard 54100D - 1GHz Digitizing	£1500
Hewlett Packard 54200A - 50MHz Digitizing	£500
Hewlett Packard 54201A - 300MHz Digitizing	£1250
Hitachi V152/V212/V222/V302B/V302F/V353F/V550B/V650F	from £125
Hitachi V1100A - 100MHz - 4 channel	£1000
Intron 2020 - 20MHz - Dual channel D.S.O. (new)	£450
Iwatsu SS 5710/SS 5702 -	from £125
Kikusui COS 5100 - 100MHz - Dual channel	£350
Lecroy 9450A - 300MHz/400 MS/s D.S.O. 2 channel	£2250
Meguro MSO 1270A - 20MHz - D.S.O. (new)	£450
Philips 3055 - 50MHz - Dual channel	£450
Philips PM 3335 - 50MHz - D.S.O. Dual channel	£1200
Philips 3295A - 400MHz - Dual channel	£1750
Panasonic VP574 I A - 100MHz D.S.O. Dual channel	£1750
Tektronix 455 - 50MHz - Dual channel	£275
Tektronix 465 - 100MHz - Dual channel	£350
Tektronix 464/466 - 100MHz - (with AN. storage)	£350
Tektronix 475/475A - 200MHz/250MHz -	from £450
Tektronix 468 - 100MHz - D.S.O.	£650
Tektronix 2213/2215 - 60MHz - Dual channel	£350
Tektronix 2220 - 60MHz - Dual channel D.S.O	£1250
Tektronix 2225 - 50MHz - Dual channel	£395
Tektronix 2235 - 100MHz - Dual channel	£600
Tektronix 2221 - 60MHz - Dual channel D.S.O	£1250
Tektronix 2245A - 100MHz - 4 channel	£900
Tektronix 2440 - 300MHz/500 MS/s D.S.O.	£3750
Tektronix 2445A - 150MHz - 4 channel	£1250
Tektronix 2445 - 150MHz - 4 channel + DMM	£1200
Tektronix TAS 475 - 100MHz - 4 channel	£995
Tektronix 7000 Series (100MHz to 500MHz)	from £200

### SPECTRUM ANALYSERS

Ando AC 821 1 - 1.7GHz	£2250
Avcom PSA-65A - 2 to 1000MHz	£850
Anritsu MS 62B - 50Hz to 1700MHz	£2500
Anritsu MS 610B 10KHz - 2GHz	£4750
Advantest/TAKEDA RIKEN - 4132 - 100KHz - 1000MHz	£2500
Hewlett Packard 3561A - Dynamic Signal Analyser	£4750
Hewlett Packard 3562A Dual channel dynamic signal analyser	

64µHz - 100KHz	£6250
Hewlett Packard 3585A - 20Hz to 40MHz	£4500
Hewlett Packard 8591A - 9KHz - 1.8GHz with tracking generator, option 10	£6500
Hewlett Packard 8505A - 1.3GHz - Network Analyser	£1995
Hewlett Packard 8753A - 3GHz - Network Analyser	£6000
Hewlett Packard 8753B + 85047A - 6GHz - Network Analyser 6GHz 5 parameter test set	£12000
Hewlett Packard 8756A/8757A Scaler Network Analyser	from £1000
IFR A7550 - 10KHz-1GHz - Portable	£2950
Meguro - MSA 4901 - 30MHz - Spec.Analyser	£850
Meguro - MSA 4912 - 1 MHz - 1GHz Spec.Analyser	£1250
Tektronix 495P Spec analyser prog. - 1.8GHz	£5000
Tektronix 469P - 1KHz to 1.8GHz	£4500
Wiltron 6409 - 10-2000MHz R/F Analyser	£2000

### MISCELLANEOUS

IFR 1200S - Radio comms test set	£2995
GN ELM1 EPR31 - PCM Signalling Recorder	£3000
HP 339A Distortion measuring set	£1500
HP 3488A - Switch/Control unit	£650
HP4279A - 1MHz - C-V meter	£4500
HP 436A Power meter + lead + sensor various available	from £995
HP 435A + 435B Power meters	from £200
HP 8656A Synthesised signal generator	£1500
HP 8656B Synthesised signal generator	£2750
HP 8657A - Signal generator 100KHz - 1040MHz	£3250
HP 37900D - Signalling test set	£5000
HP 5385A - 1 GHz Frequency counter	£750
HP 8901B - Modulation Analyser	£4000
HP 8903E - Distortion Analyser	£2000
HP 8903B - (add with 8903E)	from £2000
HP 5359A - High Resolution Time Synthesiser	£4000
HP 3488A - Switch/Control unit	£650
Marconi 2610 True RMS Voltmeter	£700
Philips PM 5193 Synthesised Function Gen 50MHz	£1500
Philips 5515 - TN - Colour TV pattern generator	£1500
Leader 3216 Signal generator 100KHz - 140MHz - AM/FM/CW with built in FM stereo modulator (as new) a snip at	£995
Racal 9087 - 1.3GHz Synthesised Signal Generator, low noise	£2,250
Tektronix 1751 PAL Waveform/Vector Monitor	£2200
Wiltron 6747A-20 - 10MHz-20GHz - Swept Frequency Synthesiser	£6000

All equipment is used - with 30 days guarantee.

Add carriage and VAT to all goods.

Telnet, 8 Cavans Way, Binley Industrial Estate, Coventry CV3 2SF.

## Tel: 01203 650702

## Fax: 01203 650 773

# CIRCUIT IDEAS

## Over £600 for a circuit idea?

### New awards scheme for circuit ideas

- Every circuit idea published in *Electronics World* receives £35.
- The pick of the month circuit idea receives a Pico Technology ADC42 – worth over £90 – in addition to £35.
- Once every six months, Pico Technology and *Electronics World* will select the best circuit idea published during the period and award the winner a Pico Technology ADC200-50 – worth £586.

### How to submit your ideas

The best ideas are the ones that save readers time or money, or that solve a problem in a better or more elegant way than existing circuits. We will also consider the odd solution looking for a problem – if it has a degree of ingenuity.

Your submission will be judged on its originality. This means that the idea should certainly not have been published before. Useful modifications to existing circuits will be considered though – provided that they are original.

Don't forget to say why you think your idea is worthy. We can accept anything from clear hand writing and hand-drawn circuits on the back of an envelope. Type written text is better. But it helps us if the idea is on disk in a popular pc or Mac format. Include an ascii file and hard-copy drawing as a safety net and please label the disk with as much information as you can.

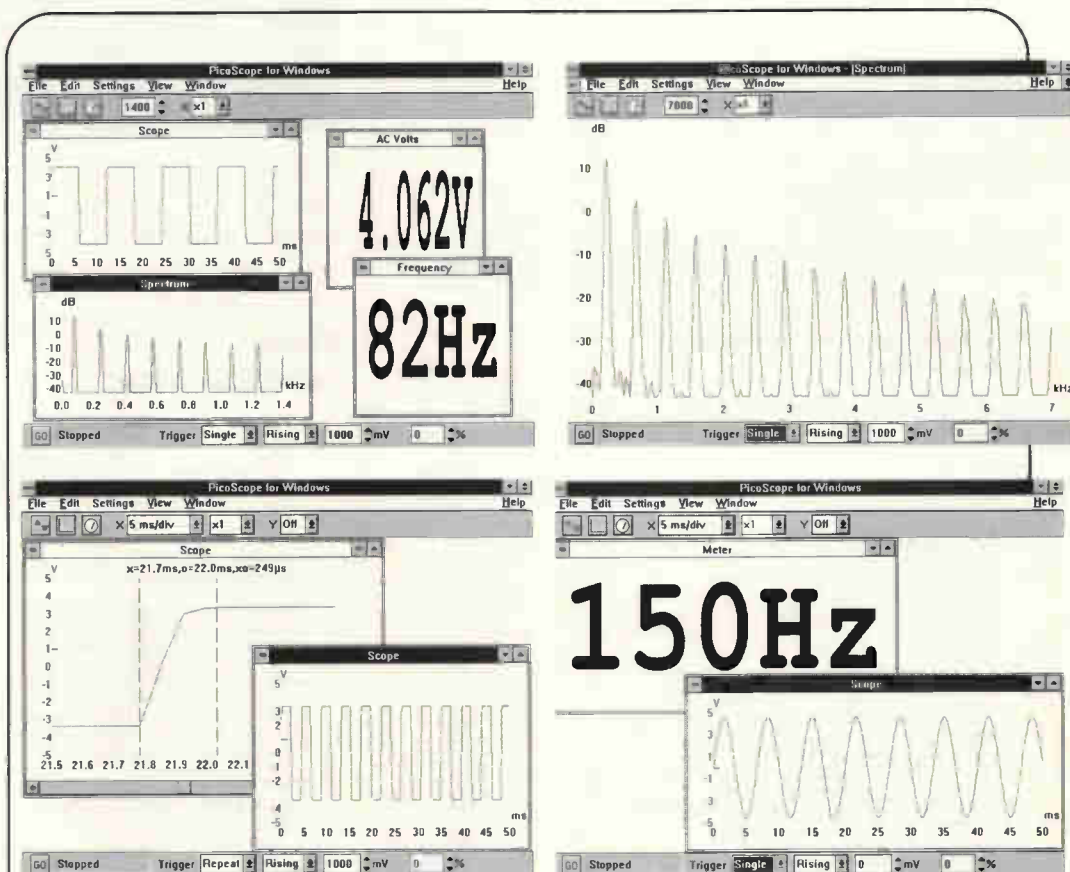

### Turn your PC into a high-performance virtual instrument in return for a circuit idea.

The ADC200-50 is a dual-channel 50MHz digital storage oscilloscope, a 25MHz spectrum analyser and a multimeter. Interfacing to a pc via its parallel port, ADC200-50 also offers non-volatile storage and hard-copy facilities. Windows and DOS virtual instrument software is included.

ADC42 is a low-cost, high-resolution a-to-d converter sampling to 12 bits at 20ksample/s. This single-channel converter benefits from all the instrumentation features of the ADC200-50.

# Monitoring two temperatures

A PIC16C72 controls the unit, being chosen for its 8-bit a-to-d converter to give the 1°C resolution wanted and because it will drive the four-digit display and the a-to-d conversion simultaneously.

All the PIC's B port is taken up with drive for the 4511 decoder/driver and the four cathode resistors, port A accepting analogue input from the sensors and 2.55V reference. The 2.55V would give 255 10mV steps, but only 100 of them are used to give 1°C steps from 10mV to 990mV.

Temperature sensing is carried out by the two LM35Zs, which give an output of 10mV/°C, taken to the PIC analogue input. If this input exceeds 990mV, a subroutine detects the fact and blinks the display with a reading of 99.

To ensure PIC reset, I used the HT7044A 4.4V detector, the output of which zero if its input is less than that level.

**Jose Luis Cavasassi**  
Buenos Aires  
Argentina  
B93

**Object code in hexadecimal form.**

```

:040000008316FF293B
:080008008207633462346134A5
:100100060345F345E345D345C345B345A3459345C
:10002000583457345634553454345334523451348C
:1000300050344F344E344D344C344B344A344934BC
:1000400048344734463445344434433442344134EC
:1000500040343F343E343D343C343B343A3439341C
:10006000383437343634353434343334323431344C
:1000700030342F342E342D342C342B342A3429347C
:10008000283427342634253424233422342134AC
:1000900020341F341E341D341C341B341A341934DC
:1000A000183417341634153414341334123411340C
:1000B00010340F340E340D340C340B340A3409343C
:1000C000083407340634053404340334023401346C
:0400D00000340034C4
:0203FE000030CD
:1004000086001F308500C0306200081488108312F7
:100410008501A00186019B01633099000F2A80307D
:10042000880008148810201000000000815881C9F
:10043000172A09081902031C202AA0139800B72ABA
:1004400000309800A017B72A18088D00883088005F
:10045000081488102014000000000000815881CF3
:100460002F2A09081902031C382A20139800B72ADA
:10047000003098002017B72A18088E000D08812236
:10048000432A0E088122C8309B000000A01B522A7C
:100490000F08860006169A22860110088600861626
:1004A0009A2286010000201B662A1508860006177E
:1004B0009A2286011A08860086179A2286019B0BCB
:1004C000452AA01B6722201B74220F2A5F2AA01A2C
:1004D000732A193086009A229A22860129308600D2
:1004E0009A229A2286010034201A802A49308600F6
:1004F0009A229A228601893086009A229A228601BF
:100500000340D0897000A30922216089000170850
:100510008F000E0897000A30922216089A001708DA
:100520009500003496019702031C982A960A932A94
:1005300097070034043093000A3094000000000054
:10054000000940B9E2A930B9C2A0034FF309200EB
:10055000FF3091000000000000000000000000DB
:1005600000000000910BA82A920BAA2A0034180858
:0A05700004209800201C242A3C2AD5
:00000001FF
    
```

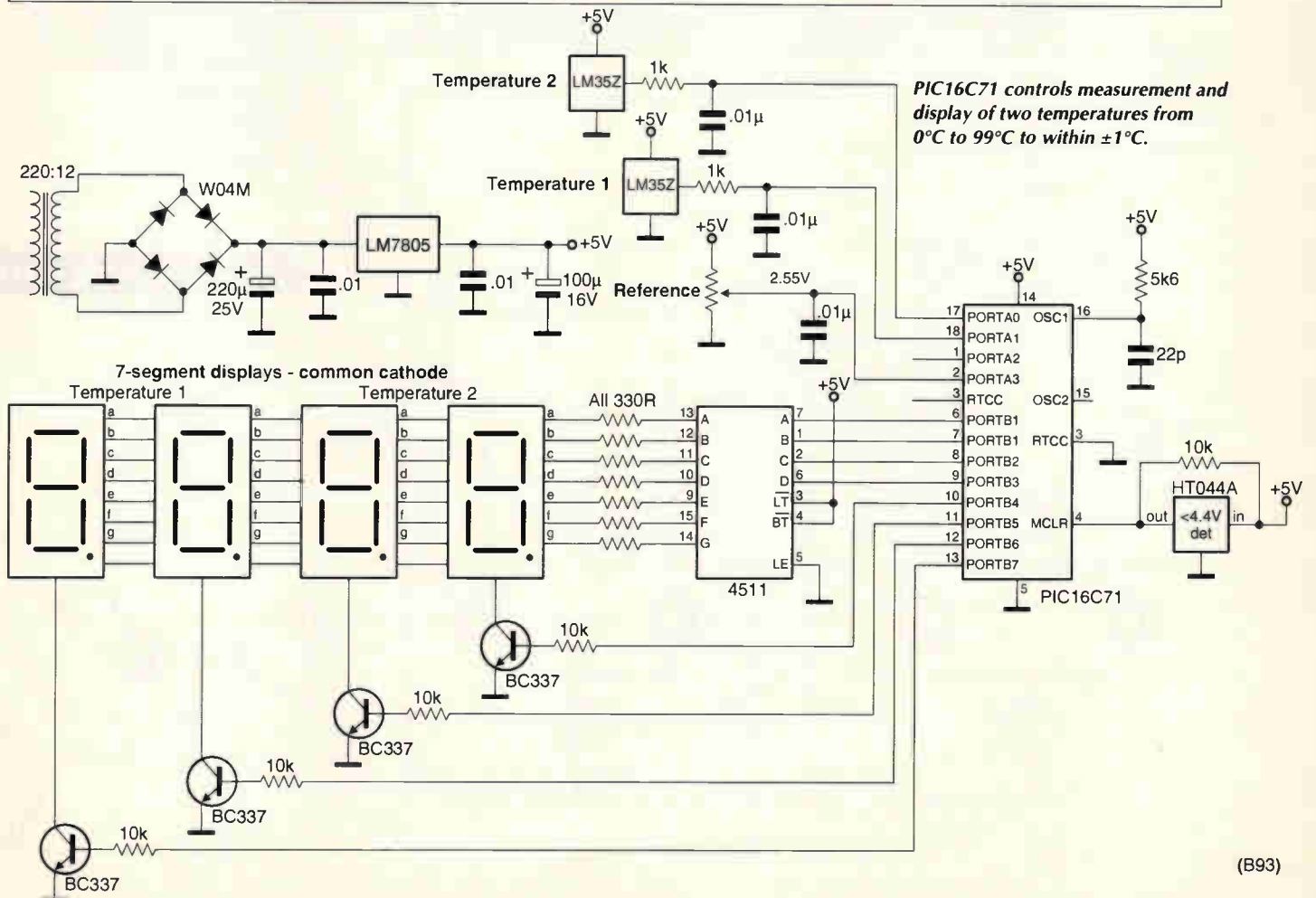

PIC16C71 controls measurement and display of two temperatures from 0°C to 99°C to within ±1°C.

(B93)

## Super zener voltage clamp

To absorb more pulse energy than a zener diode or transient voltage suppressor alone is able to, a mosfet and resistor across the zener "amplifies" the zener's power rating. A 33V zener (more of an avalanche diode at this voltage) turns the mosfet on,  $R_2$  dissipating most of the power and ensuring that the mosfet is safe. Current pulses of 20-25A at 10kHz were clamped at 41-45V; at lower currents, the mosfet does not saturate and the clamp voltage barely rises over 39V. Before the

mosfet turns on, there is an initial transient of about 100ns, which may be absorbed by the addition of  $C_1$  and, if the duty cycle is likely to be more than 0.2%, both mosfet and  $R_2$  may well need heatsinks.

**CJD Catto**  
Cambridge  
B88

*Extending the pulse-clamping capabilities of a zener with a mosfet and resistor.*

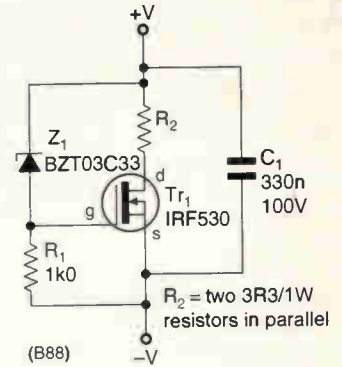

## Variable-gain, differential instrumentation amplifier

Unlike many such circuits, this one has differential input and output, which reduces noise caused by large ground currents.

Voltage drop across  $R_1$  is amplified by  $A_1$ , which controls the  $Tr_{5,6}$  pair, driving them to the state in which the collector currents of  $Tr_{3,4}$  are equal. This feedback greatly reduces the effect of the non-linear base voltage/collector current characteristic of the transistors. Op-amp  $A_1$  also drives  $Tr_7$  to produce a

current signal proportional to input voltage, after which  $A_2$  provides a voltage output.

Circuit gain is,

$$A_v = (I_{s2} / I_{s1}) (R_2 + R_3) / R_1.$$

If  $R_2=R_3$ , this is equal to  $2R_2I_{s2}/R_1I_{s1}$ .

The current sources may be formed by op-amp circuits or by current mirrors and made variable, if required. Transistors  $Tr_{1,2}$  were used instead of resistors to remove the effect of  $I_{s1}$  and varying temperature

on the stage gain.

Current  $I_{s1}$ , together with  $R_1$ , sets the differential input range. It must not be set so low that the transistor  $f_T$  is low enough to affect the phase margin round the feedback loop; resistor  $R_b$  prevents the inputs exceeding their common-mode range.

For best distortion performance, transistors  $Tr_{5,6,7,8}$  should be matched. The bias voltage may be a simple resistive voltage divider and the current sources may use the same reference, since gain depends on their ratio, not magnitude.

**Lee Szymanski**  
Stamford  
Lincolnshire  
B81

Variable-gain, differential input/output instrumentation amplifier.

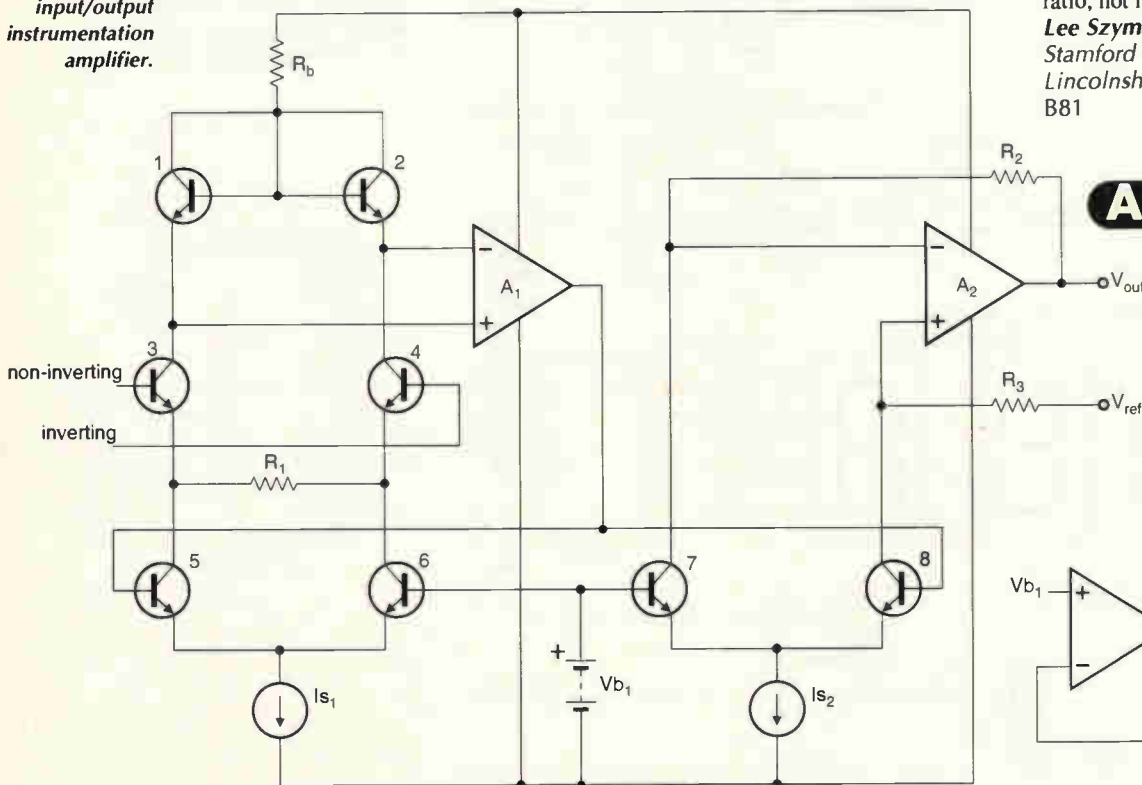

## ADC42 Winner

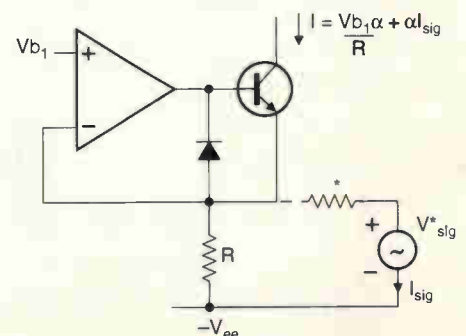

(B81)



## Win95 PIC PROGRAMMER

- Uses standard printer port.
  - Requires 15 to 18v AC or DC
  - Versions for Dos, Linux, Acorn RiscOS, AmigaOS
- Call for details.

### Chips Supported

PIC16C84, 16F84, 12C508, 12C509, 14000  
PIC16C61, 62, 62A, 63, 64, 64A, 65, 65A  
PIC16C620, 621, 622, PIC16C71, 72, 73, 74

## EVALUATION BOARDS

- Evaluation boards available for many types of Microprocessor / DSP chips.

## LCD Display and Controllers

- RS232 interface or I2C Serial interface
- Displays from 1 x 16 to 4 x 40 Character Displays.
- High contrast supertwist display.
- Software controlled backlight.

## R/C SERVO CONTROLLER

Control R/C servos using the RS232 port of any computer.

- Each board can control up to 8 R/C servos.
- Up to 256 servo motors using multiple controller boards.
- Computers supported PC, Sun Solaris, Linux, Acorn RiscOS, AmigaOS, etc.

## CD-ROMS

Red Hat 5.1 Box set (3 CDs & Book)	£ 29.95	Walnut Creek Slackware 3.5 (4 CDs)	£ 19.95
Red Hat Power Tools v5.1	£ 19.95	Complete FreeBSD 2.2.8 (4 CDs & book)	£44.95
Red Hat Linux Complete Command Ref	£ 46.95	Aquila Budget Linux CD's	from £ 2.00
Red Hat Motif	£129.95	Simtel for MSDOS (2 CDs)	£ 19.95
S.u.S.E. 5.3 Box Set (3 CDs & Book)	£ 29.95	CICA 32 for Windows 95/98/NT (4 CDs)	£ 19.95
S.u.S.E. Decathlon (13 CDs)	£ 31.95	Electronics 2000 £ 11.06	£ 12.99
Linux Developer's Resource	£ 21.95	Hardware Technician 2000 £ 11.06	£ 12.99

This is just a small selection of titles from our extensive catalogue covering Windows, Dos, Linux, FreeBSD, Unix, etc.

£39.95 Inc Vat, P&P



Programmers also available for Atmel AVR Devices

From £19.95 Inc Vat, P&P



£25.95 Inc Vat, P&P



These products are a small selection of the products available visit our web site or phone for a catalogue :-



**Aquila Vision (Dept EW)**

46 Gaisby Lane, Shipley, Bradford, BD18 1AX.

Tel 01274 775117 (24 Hour Order line) Fax 01274 775116

[www.aquila-vision.co.uk](http://www.aquila-vision.co.uk)



**CIRCLE NO. 112 ON REPLY CARD**

## CROWNHILL ASSOCIATES LIMITED

The Old Bakery, New Barns Road,  
Ely Cambs. CB4 7PW

Tel: +44 (0)1353 666709 Fax: +44 (0)1353 666710

## Low cost professional quality Smart Card Systems

### CHIPDRIVE EXTERN

Intelligent programmer for Smart Cards using the International Standard T=0 or T=1 protocols also Memory and Secure Memory using I<sup>2</sup>C, 2-wire & 3-wire interfaces. Supplied with software to read and write to most popular secure smart cards, inc GSM, PAY PHONE and ACCESS CONTROL cards.

T=0 or T=1 @ 3.579MHz  
RS232 @ 9600 - 115000 bps **£69 + VAT**  
Internal Supply / Ni-MH **P&P £7.50**

Size: 100x70x80mm Weight 660 Gram  
Supplied with **CARDSERVER API** for easy development of SmartCard Applications using Visual Basic, Delphi or C++. Supplied with Sample Memory cards and Secure Smart cards



CE Compliant

### Chip Drive Intern

3.5" floppy bay version of the CHIPDRIVE

Applications are available to provide SmartCard controlled access of data on Hard Drives or "PC-LOCK", to control access to the whole PC Fully Compatible with **TOOLBOX** for systems development. Supplied with **CARD-SERVER API**

**£85.00 + £5 P&P + VAT**



CE Compliant

### NEW CHIPDRIVE - micro

Fully Compatible with **TOOLBOX** for application development. Featuring the same functionality as Chip Drive Extern but in a small neat low cost package, similar in size to a smart card. Supplied with **CARDSERVER API**

**£65 + £5 P&P + VAT**



#### NEW APP-LOCK

Use a CHIPDRIVE and SMART CARD to protect applications from Unauthorised access under Win 95/98/NT  
**£125 inc Chipdrive + Smart Card**

**FREE**

GSM CARD READING Application

### CHIPDRIVE Developer Kit

CDK consists of: CD ROM containing cardserver.dll, Applications and Source code examples. CHIPDRIVE-micro a selection of Smart Cards offering protected memory, processor and memory cards, Typical uses are Control access, Pay Phone cards and Data transport. PIN codes for the cards are supplied along with data sheets and programming data for use with cardserver.dll. A useful application with source code shows how the CHIPDRIVE can be used to identify and Smart card inserted, giving manufacturer info, and memory map if available. Applications produced with the developer kit will operate under Windows 3.11/95/NT and are compatible with the whole CHIPDRIVE family. The CDK uses easy to use 16 bit or 32 bit DLLs with just one function call to the "CardServer" to identify the card or carry out any instruction. Card-server is a powerful Background task which relieves the application programmer from device and card administration. Featuring automatic protocol and card type detection. Allowing several applications to access one terminal dependent only on the type of card inserted.

**CDK - Everything that you require to start using Smart Cards NOW!**

**£99.95 + P&P + VAT**



<http://www.towitoko.co.uk>

<http://www.crownhill.co.uk>

<http://edsim.cambs.net>

#### SMARTCARDS Available from Stock:

GemPlus, Atmel, Xicor, Siemens, SGS Crownhill and more.....  
SLE4442, 4432, 4418, 4428, 4404. AT88SCxxx, AT24c01-16.  
GPM103, GFM1K, 2K, 4K, GPM416 Phone Cards, Loyalty Cards

#### THE SMARTEST SOLUTION

Crownhill can offer a broad range of smart cards from just £1.00 and Smart Card sockets for just £1.45 ea. PIC Microchip based Smart Cards now available from just £3.50 ea.....**DEVELOP YOUR OWN SMART CARD!**

Crownhill can supply over 150 different types of IC from more than 12 silicon suppliers, which can all be incorporated into smart card format. Some cards are available from stock, most are manufactured to the customers' specification.

**CIRCLE NO. 114 ON REPLY CARD**

**LANGREX SUPPLIES LTD**  
DISTRIBUTORS OF ELECTRONIC VALVES  
TUBES AND SEMICONDUCTORS AND I.C.S.

**PHONE 0181 684 1166** **FAX 0181 684 3056**  
**1 MAYO ROAD • CROYDON • SURREY CR0 2QP**  
24 HOUR EXPRESS MAIL ORDER SERVICE ON STOCK ITEMS  
email: langrex@aol.com

Part No.	£ p	Part No.	£ p	Part No.	£ p	Part No.	£ p
AZ31	6.00	KT86 China	12.00	5Z4GT	3.00	6V6G	8.00
CL33	10.00	KT89 China	12.00	6AQ5	2.00	6V6GT	5.00
E88CC	8.50	N78	8.00	6AR5	20.00	6X4	3.00
E180F	3.50	OA2	3.00	6ASTG	7.50	6X5GT	3.00
E810F	20.00	OB2	3.00	6AUSGT	4.00	12A7T	3.00
EABCB80	2.00	OC3	3.00	6AU6	2.00	12AU7	3.50
EB91	1.50	OD3	3.00	6AW8A	4.00	12AX7	5.00
EBF80	1.50	PCF80	2.00	6BA6	22.00	12AX7A	7.50
EBF89	1.50	PCL82	2.00	6BA6	1.50	12AX7W	6.00
EBL31	15.00	PCL85/805	2.50	6BE6	1.50	12BA6	2.00
ECC33	12.00	PCL86	2.50	6BH6	2.00	12BE6	2.00
ECC35	12.00	PD500	6.00	6BQ7A	2.00	12BH7/1	10.00
ECC81	3.00	PL38	3.00	6BR7	4.00	12BY7A	7.00
ECC82	3.50	PL81	2.00	6BR8	4.00	12D7	15.00
ECC83	5.00	PL504	3.00	6BW6	4.00	12E1	10.00
ECC85	3.50	PL508	3.00	6BW7	3.00	13E1	85.00
ECC86	6.00	PL509/519	10.00	6BZ6	3.00	57ZB	85.00
ECC808	15.00	PL802	4.00	6C4	2.00	805	45.00
ECF80	1.50	PY800/801	1.50	6CB6A	3.00	807	7.50
ECH35	3.50	QOV02-6	12.00	6DC6G	5.00	811A	25.00
ECH42	3.50	QOV03-10	12.00	6CL6	3.00	812A	55.00
ECH81	3.00	QOV03-20A	10.00	6CG7	7.50	813	27.50
ECL82	3.50	QOV06-40A	12.00	6CH6	3.00	833A	85.00
ECL86	3.50	UI19	8.00	6CW4	6.00	866A	20.00
ECLL800	25.00	UABC80	1.50	6D05	17.50	872A	30.00
FE37A	3.50	UCH42	5.50	6D06B	10.00	931A	25.00
EF39	2.75	UCL82	2.00	6F6G	6.00	2050A	12.50
EF40	4.00	UCL83	2.00	6FQ7	7.50	7025	6.00
EF86	10.00	UF89	4.00	6GK6	4.00	5763	6.00
EF91	2.00	UL41	12.00	6J5G	6.00	5814A	5.00
EF183/4	2.00	UL84	3.00	6J5M	4.00	5842	12.00
EL33	15.00	UY41	4.00	6J7	3.00	6072A	6.00
EL34	8.00	UY85	2.00	6JB6A	27.50	6080	6.00
EL34G	6.00	VR105/30	3.00	6JE6C	27.50	6146B	15.00
EL36	5.00	VR150/30	3.00	6JS6C	27.50	6201	8.50
EL41	3.50	Z759	10.00	6K6GT	4.00	6336A	35.00
EL84	2.25	Z803U	15.00	6L6G	15.00	6550A	25.00
EL95	2.00	2D21	3.50	6L6GC	15.00	6883B	15.00
EL360	15.00	3B28	12.00	6L6WGB	10.00	7025	7.50
EL509/519	12.00	4CX250B	45.00	6O7	3.00	7027A	25.00
EM34	15.00	5R4GY	7.50	6SA7	3.00	7199	15.00
EM814/7	4.00	5U4G	10.00	6SC7	3.00	7360	25.00
EN91	7.50	5U4GB	10.00	6SG7	3.00	7581A	15.00
EZ80/81	3.50	5V4G	4.00	6SJ7	3.00	7586	15.00
GZ32	8.50	5Y3GT	2.50	6SK7	3.00	7587	20.00
GZ33/37	6.00	5Z3	5.00	6SL7GT	5.00		
KT61	15.00	5Z4G	6.00	6SNTGT	5.00		
				68A8	1.50		

Prices correct when going to press.

#### OPEN TO CALLERS MON-FRI 9AM-4PM. CLOSED SATURDAY

This is a selection from our stock of over 6,000 types. Please enquire for types not listed. Obsolete items are our speciality. Valves are new mainly original British or American brands. Terms CWO/min order £10 for credit cards.

P&P 1-3 valves £2.00 4-5 valves £3.00  
Add 17.5% VAT to total including P&P.



**CIRCLE NO. 113 ON REPLY CARD**

# Temporary RS232 hookup

It can be convenient, when developing software for a microprocessor project, to be able to dump register contents and data to a computer terminal from which commands may also be obtained. If,

however, the project in question needs no RS232 interface and does not have the relevant voltages available, it presents a difficulty. This device takes its voltages from the host without overloading it.

In essence, it is a level shifter and inverter between the logic levels of target and host, which needs symmetrical voltages. For most of the time, the TXD line is held at -12V idle line voltage, which can vary. Capacitor  $C_1$  charges via  $D_1$  to this voltage, which is the negative power rail to  $IC_2$  and the rest of the circuit.  $IC_2$ , an ICL7660, acts as a voltage doubler and generates the positive supply. Diode drops prevent the rails being symmetrical, but they are near enough.

Level shifting is performed by the LM393 comparator. Data Out from the microprocessor idles at 5V in its logic 1 state, which is higher than the comparison level at  $R_{6,7}$  junction and RXD is taken high by the emitter follower, the bootstrap  $C_4$  making the output as near +12V as possible. This is effective for the short duty cycles needed.

For data coming back from the terminal, the idle TXD and the junction of  $R_{1,2}$  is below ground, turning  $Q_1$  off and allowing Data In to the processor to float high. Data takes TXD high therefore turns  $Q_1$  on and pulls Data In low.

**Peter Levesley**  
Walsall  
West Midlands  
B89

Using a host computer to hold register contents and data during the development of a microprocessor system, when the target has no RS232 interface or available voltage supplies.

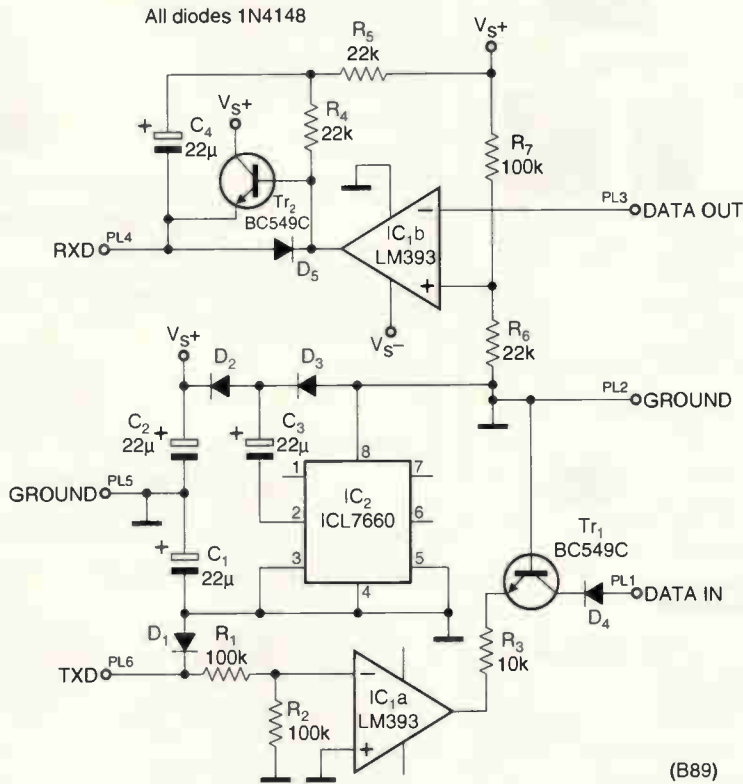

# Long-delay generator

While not being totally original, this timer avoids the need to design a circuit using electrolytic

capacitors or high-impedance circuitry. The MC14521B is a 24-stage

frequency divider with an input usable as an oscillator. With ground or no signal applied to the trigger input, the relay output goes low after a delay determined by the potentiometer setting and the range selected.

Connecting point X to C gives a delay between 1m40s and 18m30s, while at B the delay obtained is 13m20s to 2h28m. Connection to point A results in delays variable between 1h47m and 20h and using a bigger capacitor will give delays of over a week. A positive signal at the trigger input resets the divider.

Timing is reliable and stable, but a regulated power rail is to be recommended, producing 6-15V. The above results were obtained using 12V.

**D Di Mario**  
Milan  
Italy  
B82

Delays of more than a week without the use of huge capacitors or high impedances, using a 24-stage frequency divider and oscillator.

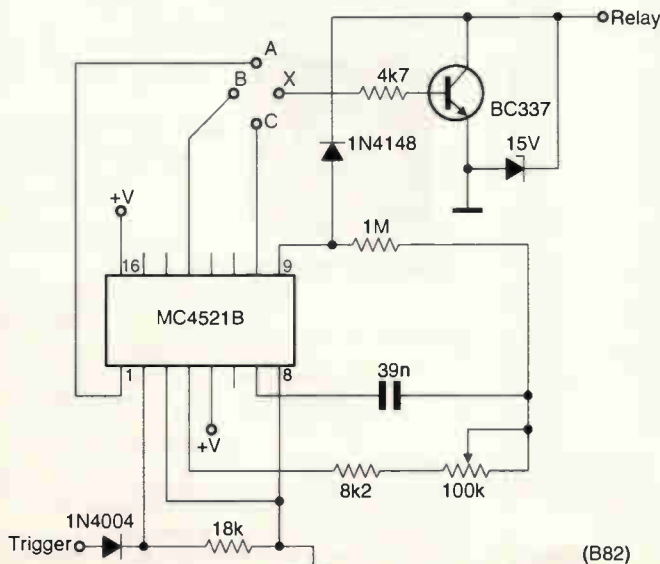

# 1



## Technical products

The Electromail CD-ROM Catalogue provides a virtual technical superstore, product encyclopaedia, and a help line with round-the-clock service - the moment you slip it into your computer!

It's quite amazing just how much you can get out of it. Products from batteries to bearings, fuses to fans, semi-conductors to computers, hand tools to power tools. On-line advice, and access to a full library of data sheets, providing detailed information on almost every product in our range. But the best thing about Electromail, is that it's open just when you want to go shopping. 24 hours a day. 365 days a year.

And in most cases your order will be despatched on the very



a more professional choice

same day you order (failing that, the next working day).

The Electromail CD-ROM Catalogue offers you more products and services than any of the alternatives. Send for your copy and get a head

start in your business, your home or hobby ... and at just £3.99 with free delivery, it's not worth struggling on without it!

### HOW TO ORDER



Tel 01536 204555 or Fax 01536 405555

When ordering by fax or phone quote stock no. 322-9973 and have your credit card details handy. Alternatively, you can open your own Electromail account - please ask for details.

**Electromail, P.O. Box 33, Corby, Northants, NN17 9EL. Tel: 01536 204555 Fax: 01536 405555**

CIRCLE NO.115 ON REPLY CARD

## The Alternative Oscilloscope

Pico Technology provides an alternative to costly, bulky and complicated oscilloscopes. Our range of virtual instrumentation enables your PC to perform as an **oscilloscope, spectrum analyser and digital multimeter.**

- ▼ Upto 100 MS/s sampling and 50 MHz spectrum analysis
- ▼ A fraction of the price of comparable benchtop DSOs
- ▼ Simple Windows based user interface

The **practical** alternative  
Connection to a PC gives virtual instruments the edge over traditional

**"...the most powerful, flexible test equipment in my lab."**

oscilloscopes: the ability to print and save waveforms is just one example. Advanced trigger modes, such as save to disk on trigger, make tracking down elusive intermittent faults easy. Combining several instruments into one small unit means it is lighter and more portable. When used with a notebook computer, field engineers can carry a complete electronics lab in their PC.



The **simple** alternative  
Virtual instruments eradicate the need for bewildering arrays of switches and dials associated with traditional 'benchtop' scopes. The units are supplied with **PicoScope for Windows** software. Controlled using the standard Windows interface, the software is easy to use with full on line help. Installation is easy and no configuration is required; simply plug into the parallel port and it is ready to go. We provide a two year guarantee and free technical support via phone, fax or E-mail.



The **low cost** alternative

The Pico range of PC based oscilloscopes work with your PC - anything from a dustbin-ready 8086 to the latest pentium. The PicoScope software utilises your monitor to display data.

This gives you a larger, clearer display than any scope, at a fraction of the price.

The savings don't stop there: All those expensive upgrades needed for traditional oscilloscopes: such as FFT maths, disk drives and printers are already built into your computer. The PC has made computing affordable, now Pico has made test equipment affordable too.

**Seeing is understanding**

Call for a **FREE** demo disk or visit our web site.

Fax: (0)1954 211880 Tel: (0)1954 211716

E-mail: [post@picotech.co.uk](mailto:post@picotech.co.uk) <http://www.picotech.com>

Broadway House 149-151 St Neots Road Hardwick Cambridge CB3 7QJ UK

CIRCLE NO.116 ON REPLY CARD

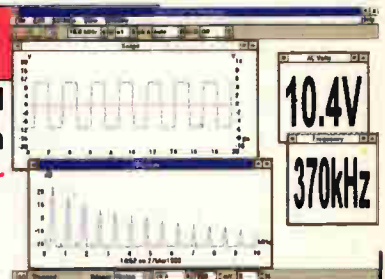

**FROM £59**

**Pico**  
Technology Limited

Simple pwm modulator for communications or control use.

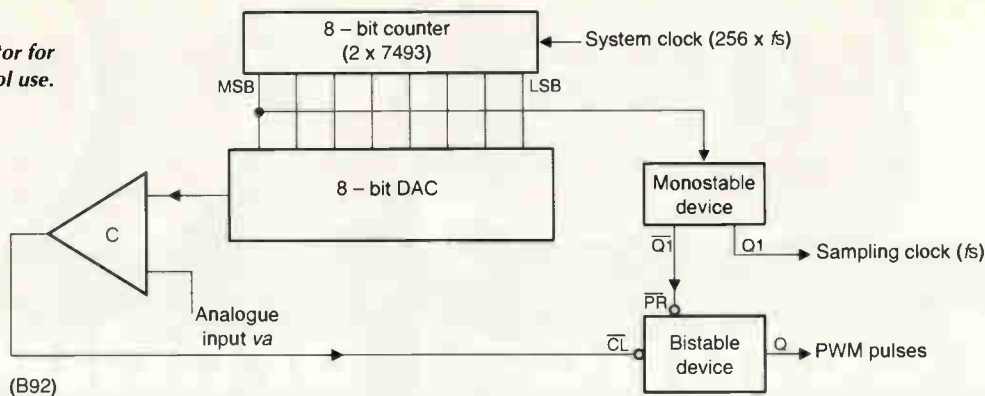

## Linear pulse-width modulator

The output  $Q$  of the flip-flop consists of positive-going pulses whose width is dependent on the voltage at the analogue input, the circuit therefore constituting a pulse-width modulator.

At a frequency of 256 times the signal frequency, the system clock drives an 8-bit counter, whose outputs go to an analogue-to-digital converter driving a comparator with the resultant staircase

waveform.

A monostable, triggered by the falling edge of the most significant bit of the counter, presets the flip-flop with its  $Q$  output, so setting the rising edge of the width-modulated output pulse.

As the analogue output from the digital-to-analogue converter reaches the level of the analogue input, the comparator flips and terminates the output pulse from

the flip-flop, the width of which is therefore dependent only on the analogue input.

Sampling clock signals are produced by the  $Q_1$  monostable output.

**K Balasubramanian**  
**Husseyin Camur**  
European University of Lefke  
Turkish Republic of Northern Cyprus  
B92

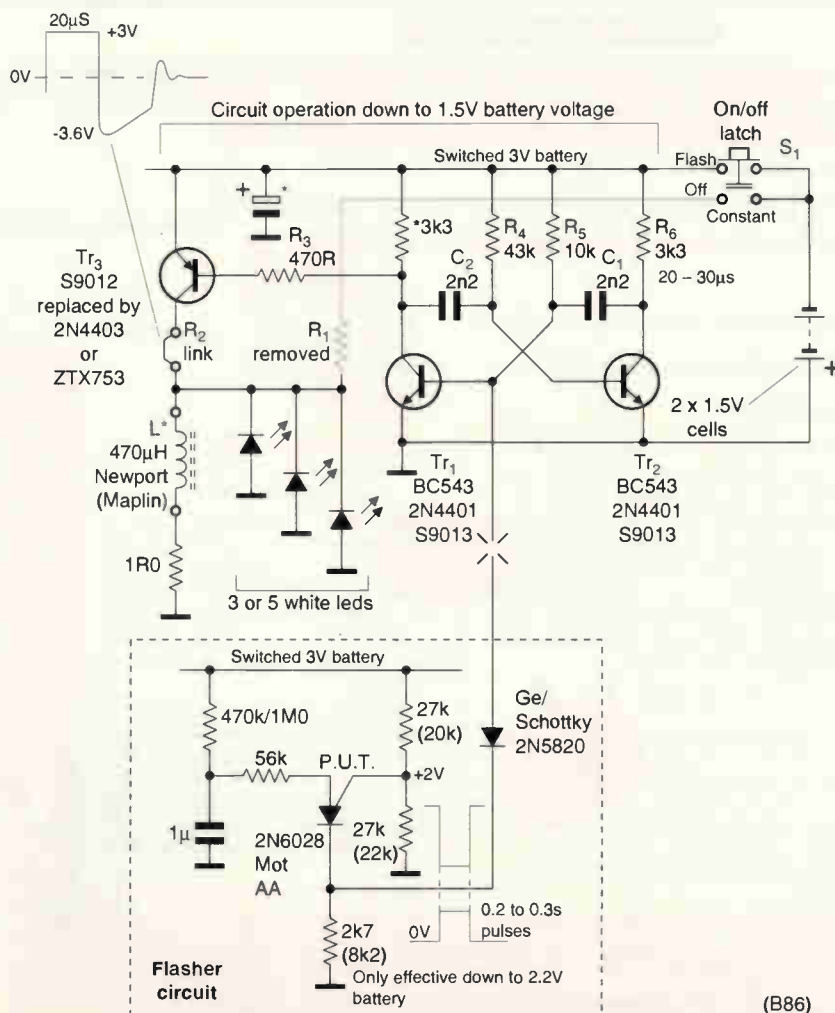

## White-light leds operate down to 1.5V

Two 1.5V cells are enough to operate three or five white leds, the original circuit, from which most of the components have been discarded, being a *Vistalite 300* cycle lamp.

The inductor increases the forward bias on the leds, since white leds need between 3 and 3.6V; it is also a more efficient method. If flashing is wanted, the circuit shown dotted may be used to switch the multivibrator on and off, a programmable unijunction providing the waveform, but the battery voltage needed for this is a little higher at 2.4V. The original  $Tr_3$  was replaced by the one shown to obtain a better saturation voltage.

At an operating frequency of 20kHz, the free-running multivibrator causes a little interference with long-wave radio at distances under 1m.

**Robert Comer**  
Edinburgh  
B86

*A much-modified cycle lamp was the starting point for this two-cell white led driver and flasher.*

# Easy-PC

## New Version 2!

## Electronics CAD for Windows 95, 98 and NT

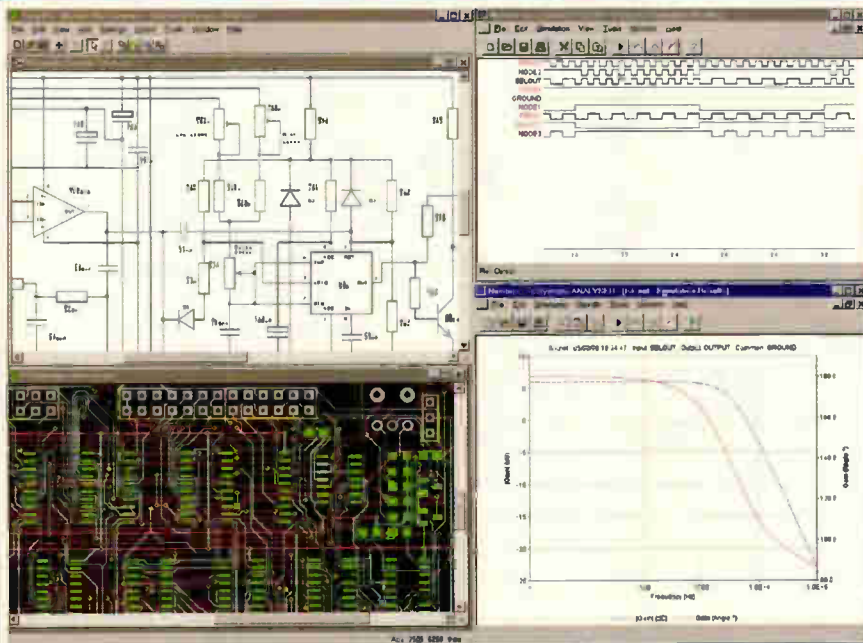

- True Windows graphical user interface
- Multi-sheet Schematics - Projects.
- New, Sub-circuit re-use facility allows copying of sections of designs from proven projects.
- Now with Multiple level Undo / Re-do.
- Full links to our Analogue, Digital and Electromagnetic Simulators.
- Impressive, high speed, gridless, shape-based autorouter options.
- Full Design rule and connectivity checks.
- Full Windows outputs.
- Gerber, Excellon and DXF outputs.
- Free technical support! No dongles or maintenance contracts.
- Trade up allowance from other products.
- Entry level version available.
- New Demo available - please call.
- Overseas dealer enquiries welcome

### Number One Systems

Ref: WW Harding Way, St. Ives,  
Cambridgeshire, PE17 4WR,  
United Kingdom

Tel: 01480 461778 Fax: 01480 494042  
International: +44 1480 461778/494042

email: sales@numberone.com

http://www.numberone.com

**From £49.95**

No Quibble 30 Day Money back Guarantee

CIRCLE NO.117 ON REPLY CARD

# FM Embedded Controllers at a ground breaking price!

WEB SITE  
<http://www.cms.uk.com>

**£95** each  
PER 100 UNITS

The range of 'FM-Controllers' provide most of the features required for embedded control at a very low cost

#### FEATURES FM-200 Controller

- ◆ 68K Micro-Controller 14 MHz clock
- ◆ 512 Kbytes Flash EEPROM
- ◆ 512 Kbytes SRAM Battery Backed
- ◆ 2 RS232 Serial Ports
- ◆ 1 RS232/RS485 Serial Port
- ◆ Real Time Calendar Clock (Y2K Compliant)
- ◆ Watchdog & Power fail detect
- ◆ 10 Digital I/O Lines
- ◆ 2-16 bit Counter/Timers
- ◆ I<sup>2</sup>C Bus or M-Bus
- ◆ Expansion Bus
- ◆ Size 100 x 80 mm

#### OTHER FEATURES

- ◆ Up/Download removable card for data logging and or re-programming
- ◆ STE I/O Bus, 68000 and PC Interface
- ◆ Designed, Manufactured and supported in the UK

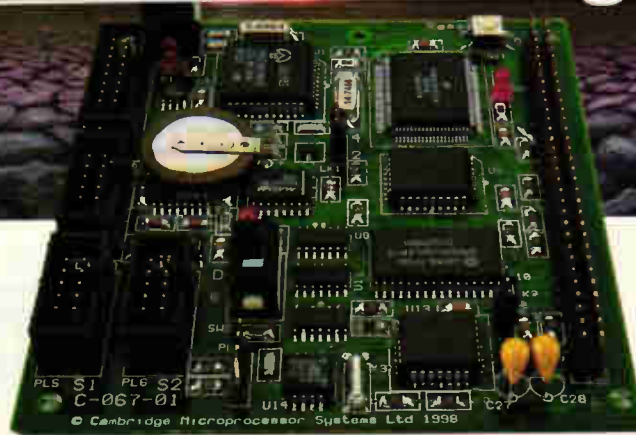

#### OPTIONAL EXTRAS

##### Additional extra features to the FM 200

- ◆ LCD Port Graphics or Alphanumeric
- ◆ Key Pad Port 64 Keys 8 x 8
- ◆ 8 Channels 8 bit analogue in
- ◆ 2 Channels 8 bit analogue out
- ◆ 8 Channels 13 bit analogue in
- ◆ Up to 32 Digital I/O Channels
- ◆ Up to 8 Mbytes of SRAM Battery Backed
- ◆ Up to 512 Kbytes of Flash EEPROM
- ◆ 1 Mbyte EPROM Space

#### DEVELOPMENT

The PC Starter Pack provides the quickest method to get your application up and running

#### Operating System

- ◆ Real Time Multi Tasking
- ◆ Unlimited copy licence

#### Languages

- ◆ 'C', Modula-2 and Assembler
- ◆ Full libraries & device drivers provided

#### Expansion

- ◆ Easy to expand to a wide range of peripheral and I/O cards

#### Support

- ◆ Free unlimited telephone, FAX, email and Internet support

#### Custom Design

- ◆ CMS will design and manufacture to customers requirements



**CAMBRIDGE  
MICROPROCESSOR  
SYSTEMS LIMITED**

Units 17-18, Zone D Chelmsford Road Industrial Estate, Great Dunmow,  
Essex UK CM6 1XG Tel +44 (0) 1371 875644 Fax +44 (0) 1371 876077

CIRCLE NO.118 ON REPLY CARD

# Optically isolated I<sup>2</sup>C interface

The I<sup>2</sup>C interface format uses data and clock wires to transfer addresses, data, read/write commands and acknowledgements and, in some applications, the two users of the bus must be isolated. This circuit performs that function.

Both ics are high-speed optocouplers by Siemens, the SFH636, which has a gallium aluminium arsenide infra-red-emitting diode and integrated photodetector and transistor.

When there is no signal, both SDA (data) and SCL (clock) lines are held up by R<sub>1,6</sub>, so that, although the internal transistors are on, no current passes since the emitting diode is off.

A low on, say, SDA/SCL<sub>1</sub> turns IC<sub>1</sub>'s emitting diode on, its current going through R<sub>3</sub> and Tr<sub>1</sub>. IC<sub>1</sub>'s internal transistor turns on, pulling down SDA/SCL<sub>2</sub> through D<sub>2</sub> and by-passing Tr<sub>2</sub>'s base current from R<sub>5</sub>. This cuts Tr<sub>2</sub> off to avoid lockup through feedback from IC<sub>2</sub>.

Propagation delay is 0.8µs low to high and 0.4µs high to low.

**Yongping Xia**  
Torrance  
California  
USA  
B91

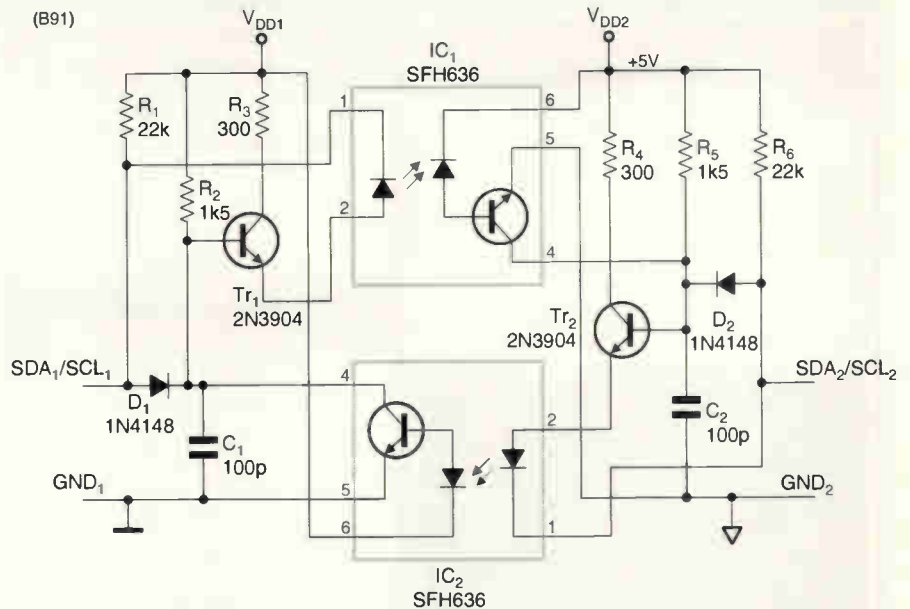

For use when both parties using the I<sup>2</sup>C interface must be isolated, this symmetrical circuit uses high-speed optocoupling.

## Nine year index: new update

### Hard copies and floppy-disk databases both available

Whether as a PC data base or as hard copy, SoftCopy can supply a complete index of *Electronics World* articles going back over the past nine years.

The computerised index of *Electronics World* magazine covers the nine years from 1988 to 1996, volumes 94 to 102 inclusive is available now. It contains almost 2000 references to articles, circuit ideas and applications - including a synopsis for each.

The EW index data base is easy to use and very fast. It runs on any IBM or compatible PC with 512k ram and a hard disk.

The disk-based index price is still only £20 inclusive. Please specify whether you need 5.25in, 3.5in DD or 3.5in HD format. Existing users can obtain an upgrade for £15 by quoting their serial number with their order.

**Photo copies of *Electronics World* articles from back issues are available at a flat rate of £3.50 per article, £1 per circuit idea, excluding postage.**

**Hard copy *Electronics World* index**  
Indexes on paper for volumes 100, 101, and 102 are available at £2 each, excluding postage.

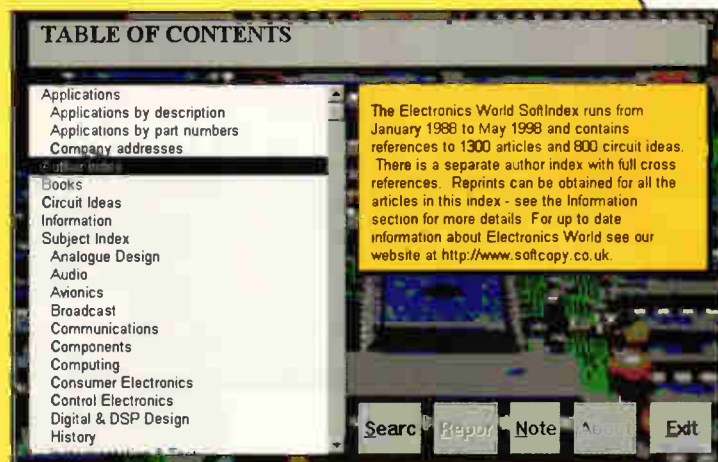

[www.softcopy.co.uk](http://www.softcopy.co.uk)

### Ordering details

The EW index data base price of £20 includes UK postage and VAT. Add an extra £1 for overseas EC orders or £5 for non-EC overseas orders

Postal charges on hard copy indexes and on photocopies are 50p UK, £1 for the rest of the EC or £2 worldwide.

For enquires about photocopies etc please send an sae to SoftCopy Ltd. **Send your orders to SoftCopy Ltd, 1 Vineries Close, Cheltenham GL53 0NU.**

Cheques payable to SoftCopy Ltd, please allow 28 days for delivery.

e-mail at [SoftCopy@compuserve.com](mailto:SoftCopy@compuserve.com), tel 01242 241455

Further

Beyond ordinary PCB CAD

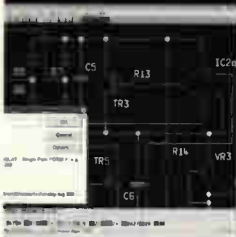

VUTRAX™ is still the only adaptive PC-based modular software that:

- Excels at analogue, RF & microwave design.
- Facilitates mechanical and electrical design on the same database.

New

- Ten-fold increased resolution.
- Customisable toolbars, function keys & colours.
- Gerber RS-274X support.
- Year 2000 compliant.

Computamation Systems Ltd.  
e-mail: sales@vutrax.co.uk

PROVEN FACILITIES INCLUDE:

Schematic Capture, Design Validation, 2D Technical Drawing, SMT, On-line DRC, Bi-directional Modification, Groundplanes & Gluepot/ Testpoint Analysis, Ripup & Shape-based Routing, Powerplanes, 3D, Gerber & DXF in/out, CNC, ATE, Pick & Place and Stock Control, Logic and Analogue Simulation, EMC Analysis, TrueType Fonts.

www.vutrax.co.uk

01525-378939

CIRCLE NO.119 ON REPLY CARD

# ITW Pancon

Formerly P Pancon Electronic Connector Division

Flatcables can be terminated safely with IDC-technique - now also for HI-CON™ female connectors type B1/2.

Pancon enriches its HI-CON™ Connector system in IDC-technique for flat cables in AWG 28. Now also female connectors with 32 contacts of type half B (series 120) are available. The measurements and technical data are all according to DIN 41612.

These HI-CON™ connectors are available for three performance levels:

- Performance level 1 = 500 mating cycles
- Performance level 2 = 400 mating cycles
- Performance level 3 = 50 mating cycles

Furthermore HI-CON™ female connectors are manufactured with or without mounting flange. Therefore they are also applicable for backplane-mountings. The locking between cover and connector housing is done with metal clamps so that a high quality termination is granted.

The polarization of HI-CON™ connectors is also another advantage. Due to the outside-placed polarization pin there is no loss of contact. This outstanding feature can be essential when using high-density-application. A data-sheet is available upon request.

**PANCON GmbH**

Peter Kastner, Steinmühlstraße 14, 61352 Bad Homburg  
Tel.: ++49 (0) 61 72 / 1 75 - 2 51

CIRCLE NO.120 ON REPLY CARD

## Good Stuff!

### ALL-11

#### Windows based Universal Programmer

- programmes over 3000 ICs, including EPROM, EEPROM, Flash and Serial PROM, BPROM, PAL, GAL, PEEL, EPLD, EPL, FPGA, CPLD, MPU/MCU/DSP, etc. ...
- various adapters available, including Gang/Production Modules
- supports 3V and 5V devices from 8 pins up to over 300 pins
- uses fast approved algorithms
- high speed RS-232 host interface
- comfortable Win 3.1x/Win95 software
- free software and device list updates



£695.00

### 386EX-Card

#### Embedded (DOS-) PC for control applications

- Intel 386EX CPU (enhanced 386SX)
- software selectable clock frequency 4 MHz to 25 MHz, 15mA to 280mA
- 1 MB SRAM (battery buffered)
- 1 MB FLASH memory, expandable with optional 2 to 16 MB FLASH disk
- BIOS with flexible setup options
- Datelight ROM-DOS optional
- 2x RS-232 (TTL), 3x timer, 1x RTC
- starter kit with evaluation board, a/c-adaptor and cable available

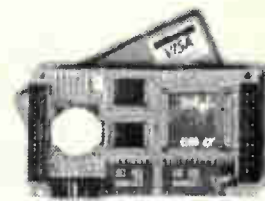

from £95.00

### 68HC12 Welcome Kit

#### Get familiar with a powerful new CPU

- Motorola 68HC812A4 CPU
- 16 MHz crystal, 8 MHz CPU clock
- 1 KB RAM, 4 KB EEPROM (in CPU)
- 2x RS-232 (MAX3232), BDM interface
- TwinPEEKs target monitor for download and debugging via RS-232 interface
- tools: loader, terminal, cross assembler
- docu: hardware manual, tutorial, data books (software and documentation on a CD-ROM)

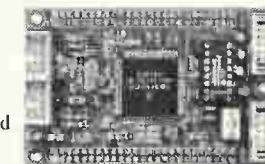

£65.00

### Serial LCD Modules

#### Easy to use LCD displays from Matrix Orbital

- alphanumeric LCD displays with LED backlight
- simultaneous RS-232 and I2C communications
- RS-232: 4 baud rates up to 19.2 KB
- I2C: up to 16 modules on the same 2-wire interface, up to 400 Kbaud
- fast! ... write a 20 char x 2 line message in as little as 1 msec
- software controlled backlight with timeout setting up to 180 min.
- line wrap, auto screen scroll, bar graphs, large digits ... use with PC or any µ-processor with RS-232 port

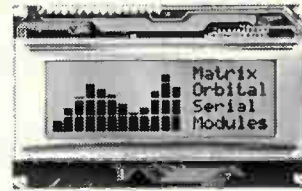

LCD1521 16 char x 2 lines £35.00

LCD2021 20 char x 2 lines £45.00

LCD2041 20 char x 4 lines £55.00

LCD4021 40 char x 2 lines £65.00

### Curtis ICs!

CEM13310, CEM13320, CEM13330, CEM13350, CEM13360, CEM13365, CEM13371, CEM13372, CEM13374, CEM13378, CEM13379, CEM13381, CEM13382, CEM13387, CEM13389, CEM13394, CEM13396, CEM15510

from £9.90

all prices exclude shipping and VAT

## SySonic Systems Ltd

184 Royal College Street, London NW1 9NN  
Tel: 0171 424 0297, Fax: 0171 267 9555  
eMail: info@sysonic.com

<http://www.sysonic.com>

CIRCLE NO.121 ON REPLY CARD





# MARCONI TF 2019A

Synthesised Signal Generators  
80Hz to 1040Mhz AM/FM, Memories, LCD  
A REAL Anchor Special ONLY £750



## Frequency Counters

**Racal Dana 9903/4**  
7 segment 30Mhz £24  
**Racal Dana 9916**  
8 segment 520Mhz £65  
**Racal Dana 9918**  
9 segment 560Mhz £75  
**HP 5314A**  
7 segment 100Mhz £50

## Signal Generators

**Marconi TF2019A** 10Hz to 1040Mhz Synthesised NOW ONLY £750  
**HP 8640A**  
To 512Mhz NOW ONLY £245  
**HP 8683A**  
2.3-6.5 GHz AM/FM NOW ONLY £499

**Marconi TF2015**  
10-520Mhz NOW ONLY £95  
**Marconi TF2171** Synchronizer  
for 2015 NOW ONLY £95  
**BOTH TF2015 and TF2171**  
ONLY £180

## Conference Equipment

**Elite OHP's**  
Choice of 4 types from ONLY £35  
**UNICOL**  
Stands Choice from ONLY £45  
**KODAK SAV1030**  
Carousel Slide Proj ONLY £175  
**KODAK EKTAPRO 3000**  
Carousel Slide Projectors  
NOW ONLY £225

## Video Equipment

**Panasonic AG6200**  
VHS ONLY £99  
**Panasonic AG6810**  
HiFi Duplication machines  
VHS NOW ONLY £99  
**SONY VO5630**  
Low Band Umatic ONLY £225  
**PANASONIC AG6100**  
VHS Players ONLY £100

## Audio Equipment

**Sonifex**  
Cartridge Decks Only £75  
**Marantz**  
Cassette decks. Choice of 2  
Only £45

## Oscilloscopes

**HP 1741A** 100Mhz Storage Dual  
Time base only £350  
**TEK 465B** 100Mhz Dual Trace/  
Timebase Now Only £295  
**TEK 465M** scope as 465B but built only  
for Military. Only £350  
**TEK 475** 200Mhz Dual Trace/Timebase  
Now Only £395  
**TEK 2445** 150Mhz Four Trace/2 Time base  
with Cursors, etc. Now Only £495  
**TEK 2445A** 150Mhz Four Trace/2 Time base  
with Cursors, etc.  
Now Only £995  
**TEK 2465** 300Mhz Four Trace/2 timebase  
Now Only £1250  
**IWATSU SS-5711** 100Mhz  
Four Trace Dual Time base  
Now Only £345

**Philips PM 3217** 50Mhz  
Dual Trace Dual timebase  
NOW ONLY £275

**Hameg 1005** 100Mhz  
Dual Trace/Timebase  
Now Only £295

**GOULD OS300** 20Mhz  
Dual Trace NOW ONLY £125

**NICOLET 2090-111**  
1Mhz Digital Scope, Cursor ctrl  
NOW ONLY £150

**GOULD OS3500** with  
**DM3010 DMM fitted**, 60Mhz  
Dual Trace, Dual Timebase  
NOW ONLY £350

**TEK T922R** 20Mhz  
Dual Trace, Single Timebase  
ONLY £225

## Miscellaneous

**EIP 451**  
Microwave Pulse Counter  
To 18Ghz, Auto sweep.  
Variable sample rate. £350.  
GIGA Pulse internal counter  
2-8Ghz ONLY £150

**FARNELL AMM**  
Auto Modulation Meters  
110Khz to 2.5Ghz  
NOW ONLY £195

**FARNELL SSG 520**  
Synthesised Signal Generator  
10Mhz - 520Mhz AM-FM-Sinad  
ONLY £425

**FARNELL TTS620**  
Transmitter Test Set which  
Matches SSG 520 (above)  
ONLY £425  
**BOTH SSG520 and TTS620**  
For ONLY £795

**AVO Model 8 Mk 5/Mk 6**  
Multimeters . . . THE Standard  
ONLY £85

## NEW EQUIPMENT

**DTA20 Oscilloscope 20Mhz**  
Twin trace incl probes ONLY £225

**DTA40 Oscilloscope 40Mhz**  
Twin Trace incl probes ONLY £299

**DTS40 Oscilloscope 40Mhz**  
Digital Storage twin channel  
Cursors + readouts  
Incl. Probes. ONLY £399

**DSM3850A Multiscope**  
Digital Scope, Multimeter,  
Logic anal in one box,  
5" LCD panel. Incl case  
ONLY £399

**AMM265 Automatic Mod Meter**  
1.5Mhz to 2Ghz, LCD  
IEEE488 ONLY £495

**SCG50 Synth Clock Gen.**  
To 50Mhz, LED display  
ONLY £125

**Black Star Meteor 100 Counters**  
With fitted TXO option to 100Mhz  
REDUCED NOW - ONLY £50

**SCOPE PROBES**  
X1/X10 switchable to 100Mhz  
Complete with adaptors  
ONLY £9.95

## THIS MONTH'S SPECIALS

**TEK 2445 Scopes**  
DC-150Mhz 4 Trace/2 Timebase  
and Cursors  
A REAL Anchor Special ONLY  
£495



**Philips PM3217 Scopes**  
DC-50Mhz 2 Trace/2 Timebase  
A REAL Anchor Special ONLY  
£295

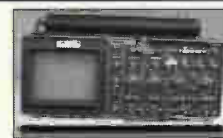

**Marconi TF2955B**  
Radio Comms Test Sets  
SPECIAL NOW ONLY  
£3995



**GOULD OS300 Scopes**  
DC-20Mhz 2 Trace  
Special NOW ONLY  
£125



## ANCHOR SUPPLIES LTD

The Cattle Market Depot  
Nottingham NG2 3GY, UK

Tel: (0115) 986 4902

Fax: (0115) 986 4667

<http://www.anchor-supplies.ltd.uk>

[sales@anchor-supplies.ltd.uk](mailto:sales@anchor-supplies.ltd.uk)

MAIL ORDER A PLEASURE

Also at  
Peasehill Road, Ripley, Derbys

All prices are EX VAT and Carriage

## Single-transistor constant-current generator

This may not be the last word in constant-current generators, but it is simple and cheap and is well suited to use as a bias current generator with a small compliance, in which less than perfect accuracy and a certain temperature dependence are not problems. It is an obvious application for what appears to be an emitter-follower.

Choose  $R_e$  to give the required output current  $I_g$ ; then,

$$I_g \approx \frac{V_{be}}{R_b} \approx \frac{0.65 \pm 0.1V}{R_b}$$

Then choose  $R_e$  so that, at maximum compliance, the current in  $R_e > 0$ ;

$$\frac{V_a - V_{be} - V_{g(max)}}{R_e} > \frac{V_{be}}{R_b}$$

where  $V_g$  is the output voltage.

Transistor current variation directly affects performance: a 10:1 variation in transistor current causes a 10% output current change, a 2:1 variation causing 2.5%. For example, with  $R_b = 680\Omega$  and  $R_e = 6.8k\Omega$ , a supply  $V_a = 15V$  into a circuit compliance of 1V-3V gives an output of 1mA from an equivalent resistance of 150kΩ. Temperature dependence is -0.3%/°C.

**Mark Hughes**

*Ashby de la Zouche, Leicestershire*

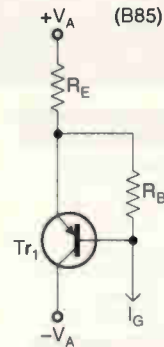

*Low-cost and very simple constant-current source.*

## Cellphone ringer repeater

Ringers in some mobile telephones are so muted that they cannot be heard over traffic noise or through clothes. This circuit rectifies that, producing a screech when the 'phone rings. No modifications to the 'phone are needed; it simply needs to be near the 'phone.

Transistors  $Tr_{1,2}$  form a Knock-White oscillator, which is set by the adjustment of  $VR_1$  to be just short of oscillation. An electromagnetic disturbance from the 'phone, a pulsed rf field, produces damped oscillations appearing as negative-going pulses at  $Tr_2$  collector, being converted to current pulses in  $Tr_{3,4}$  to charge  $C_4$ , which turns  $Tr_5$  on and applies power to the sounder drive circuit. Since the waveform applied to the sounder, and in antiphase to its common terminal, is a rough square wave, the

normal sinusoidal output from the feedback terminal is replaced by a mass of harmonics. Circuitry around  $Tr_6$  low-pass filters this and provides phase shift and gain to allow circuit to oscillate at the sounder's resonant frequency of 3kHz.

To set the circuit up, reduce the resistance of  $VR_1$  until the sounder starts and then increase it until the sound just stops. Call a "dummy" number such as a call box on the 'phone and hold it near the circuit, when the sounder should come on and then quiet as the 'phone is moved away.; if the sounder stays on, increase the setting of  $VR_1$ . Bear in mind that in a good reception areas, the 'phone will start operating at full transmit power and reduce it to the required minimum; if, therefore, the circuit seems to fade out, there is no

fault. If necessary, increase sensitivity by putting a few inches of wire on the base of  $Tr_1$ .

A series of clicks will be heard when the 'phone receives a call, followed by a squeal as the 'phone transmits continuously; the 'phone will then ring and, when it is picked up, will go out of range of the sounder, which will stop. There is the occasional muttering in periods of inactivity as the 'phone converses with the network. You can replace the sounder with another type of warning device such as a vibrator or lamp, if you feel that a sounder might bring vengeance from those close by.

The whole thing draws around 1.5µA when inactive, 4.5mA when sounding, and needs no on/off switch.

**Chris Bulman**  
*Bedford*

*If you find that your mobile phone ringer doesn't annoy enough people, this circuit should do the trick, but may also be used to drive a vibrator or a lamp.*

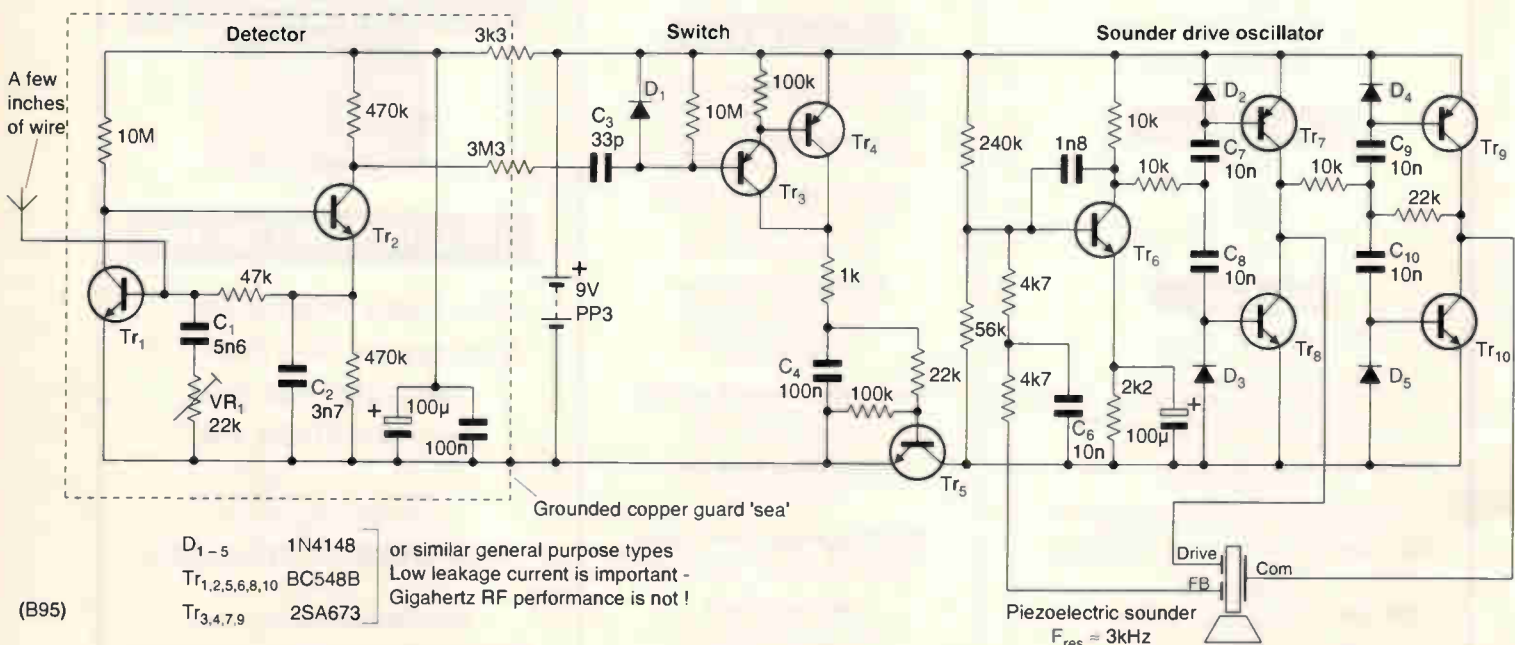

(B95)

# KOMPASS CD-PLUS 1998

The essential source for business information

- 57,000 companies on a single CD
- 41,000 products and services
- 18 search criteria

Indispensable for:

- cost-effective purchasing
- generating new business
- market research
- financial, credit and sales planning

With Downloading, Printing and Networking Functions

NEW for 1998! All of the UK's top 5,000 companies



Please send me a **FREE** trial copy of **Kompass CD-Plus 1998**

Title:	Initial:	Surname:
Job Title:	E-mail:	
Company:		
Address:		
	Post Code:	
Nature of Business:		
Tel No:	Fax No:	



To try out this CD FREE simply fill in the coupon and post it back today to:

Reed Business Information  
Windsor Court, East Grinstead House,  
East Grinstead, West Sussex RH19 1XD,  
England.

or fax it on: 01342-335998

CIRCLE NO. 123 ON REPLY CARD

## LOW COST

## Embedded Control

## ...with extra BYTE!

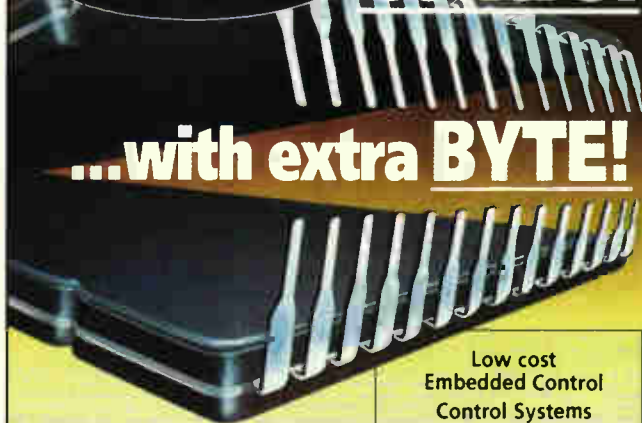

CAMBRIDGE  
MICRO  
PROCESSOR  
SYSTEMS LIMITED

<http://www.cms.uk.com>

Low cost  
Embedded Control  
Control Systems  
Custom Design  
Micro-Controllers  
Logic Controllers  
Data Loggers  
Analogue & Digital I/O

Units 17-18, Zone 'D',  
Chelmsford Road Industrial Estate,  
Great Dunmow, Essex  
UK CM6 1XG  
Tel: +44 (0) 1371 875644  
Fax: +44 (0) 1371 876077

CIRCLE NO. 124 ON REPLY CARD

## How to Save Thousands on EMC Type Examination Testing!

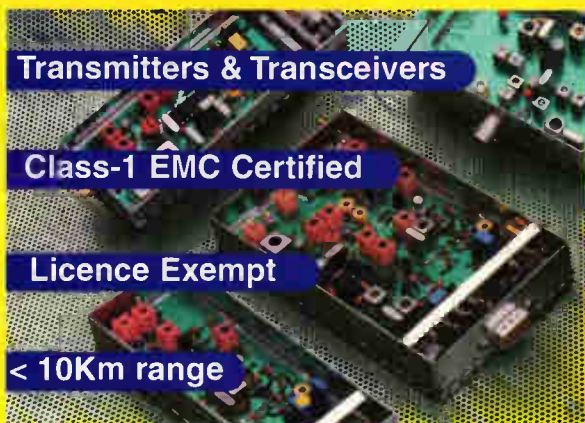

Do you wish to minimise the cost of EMC Type Examination testing on your finished product?

Do you want to use the TCF route to compliance?  
Does a 10-year product track record give you and your customer the confidence you both need?

Yes! Then it's time to switch to one of our Class-1 EMC Type Examined Radio Data Modules.

Telephone +44(0)1992 576107  
Fax +44(0)1992 561994  
<http://www.radio-tech.co.uk>



Radio-Tech Limited

CIRCLE NO. 125 ON REPLY CARD

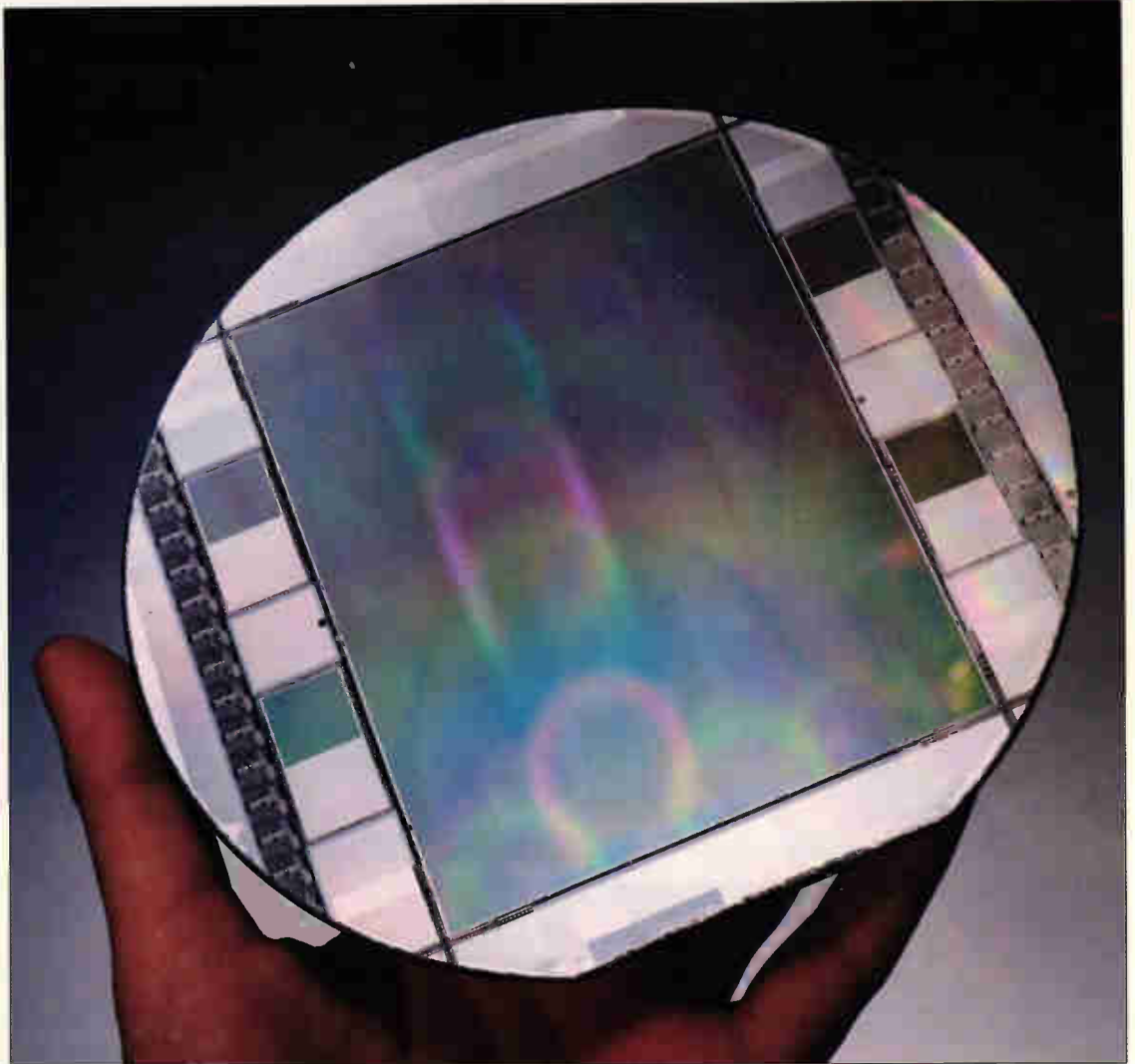

A 6in wafer containing a 7k by 9k ccd with two 1k by 2k frame-transfer ccds on either side.

# CCD developments

Leslie Warwick looks at two breakthroughs in ccd technology for imaging – one the smallest pixel, the other the largest ccd sensor module.

**P**hilips Research has broken world records at the two extremes of ccd technology: for the largest ccd measuring 86 by 110mm and, in a separate development, for a ccd with pixels of just 2.4 by 2.4 $\mu$ m, compared to 4.5 by 4.5 $\mu$ m previously attained. Both developments open the way to new applications.

The largest ccd is modular and consists of an array of 7-by-9 ccds each containing 1024 by 1024 pixels. This equates to over 66 million pixels in total. And each elementary sensor is constructed from component blocks. Joining the individual parts electrically in the silicon is achieved by a patented 'stitching' technique that is claimed not to produce any visible seams in the image.

A 7k by 9k array is the maximum at present due to the

choice of 12 by 12 $\mu$ m pixels and the necessity of fitting it onto a 6in silicon wafer. The minimum for this process is obviously one ccd: and there can be any number between that and the maximum to suit the application.

By using this construction, the configuration can be realised in the production phase rather than the design phase. This lowers development time and costs significantly.

## Step and repeat

The technology takes advantage of the repetitive structure of ccd imagers to use a step and repeat process. This overcomes the present inability of lithography equipment to produce fine details over a large area. Because the com-

ponent blocks are standardised, a universal mask set can be used. The only unique mask needed is the one used to make the interconnect between the bonding pads.

Figure 1 shows how a 3 by 4 layout is produced using four basic blocks: imaging area blocks, vertical blocks, horizontal output register blocks and output amplifier blocks. Figure 2 shows the functions of the individual blocks.

The four phase pixels are constructed using two layers of polysilicon. Eight variations of the vertical blocks are required and four variations of the 40MHz horizontal blocks are needed to allow for all possible working configurations.

Figure 3 shows the architecture of a modular sensor. The vertical and horizontal ccds are divided in the middle of the device. This arrangement allows all the integrated charge packets in each half to be clocked to the same side of the device, or to opposite sides – dividing the ccd into two.

It is possible to read the whole sensor through any one amplifier. Each vertical or horizontal section can be read through two amplifiers and each quadrant can be read through its own amplifier. Using all four amplifiers allows higher frame rates; also the quicker the charge is removed, the less dark current will be generated.

**Building in an image buffer**

Both full-frame and frame-transfer devices can be produced. With the full-frame type, the whole area is used for imaging; with frame-transfer devices, half the area is masked with aluminium to create an opaque charge storage area. This area is then used to hold an image while it is clocked out, simultaneously with capturing a new image in the non-masked area.

If larger pixels are required, to increase light sensitivity, then 2 by 2 or 3 by 3 pixels can be combined in a process known as 'binning'. Vertical binning is achieved by clocking multiple lines into the horizontal register and horizontal binning by clocking multiple pixels under the summing gate used reading the sensor. If the application requires colour, then a colour mask can be added to the ccd.

A 7k by 9k ccd is initially being used for astronomy. The Steward Observatory ccd Laboratory in Arizona has been collaborating with American Digital Imaging to package and characterise the Philips ccd.

**Uses for the new devices**

The device is also expected to be used for digital photography; here, the current maximum for an area array ccd is 6 by 6cm – the size of a medium format film frame.

A 1k by 2k ccd is already in production as a progressive-scan frame-transfer type. It is being used for still imaging, together with medical and scientific applications.

Another possibility for modular construction is high speed imaging, where one block receives the image and eight blocks around it store sequential frames.

Applications for ccds based on the 2.4 by 2.4µm pixels include miniaturised cameras that can be used for blood vessel and lung inspection, as well as replacing the existing imagers in the endoscopic field – to the probable relief of patients.

The technology is also advantageous when it comes to fabricating pixels of conventional size: with the functional parts miniaturised the light-gathering area of the pixels can be maximised, increasing both sensitivity and dynamic range.



Fig. 1. Block diagram of a 3-by-4 ccd showing the arrangement of the basic building blocks.

Block key			
1	Image (1k x 1k)	10/13	Vertical Block bonding pads
2/3	Amplifier W/X		continuous routing
4/5	Amplifier Y/x	11/14	Vertical Block no bonding pads
6/8	Horizontal Block bonding pads		routing split on edge
7/9	Horizontal Block no bonding pads	12/15	Vertical Block no bonding pads
	routing split middle		routing split on edge

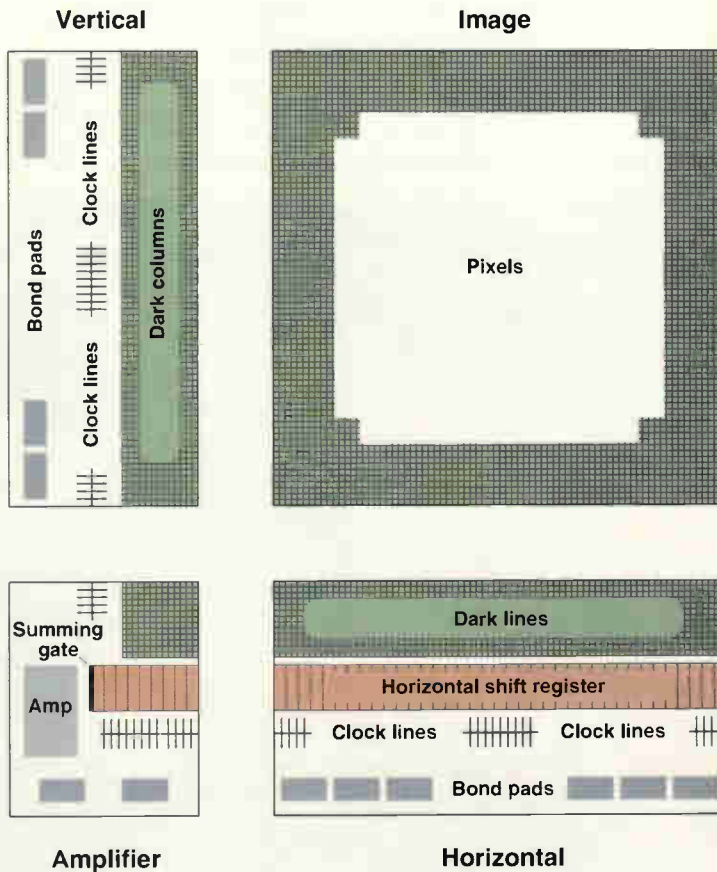

Fig. 2. Basic distribution of the new ccd's layout. A matrix of 1024-by-1024 pixels forms the image block. Included in the the horizontal block are dark lines, shift register, clock lines and possibly bonding pads. The vertical block has dark columns, clock lines and possibly bonding pads. In the bottom left-hand corner are the amplifier, the end of the register, the summing gate, pixels common to the extra lines and columns, and bonding pads.

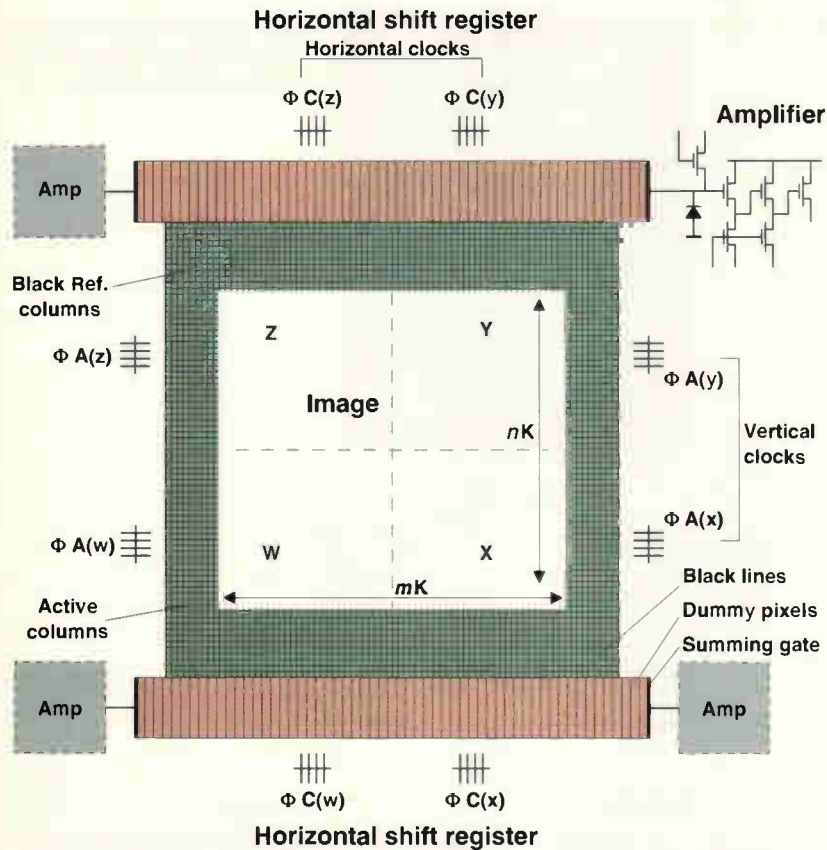

Fig. 3. Architecture of the modular ccd. Vertical and horizontal ccds are split in the middle of the device. Each half is capable of clocking in the same or opposite direction. And read-out can be carried out through one, two or four amplifiers. This division means that frame-transfer ccds, which require two sets of vertical clocks, can be made.

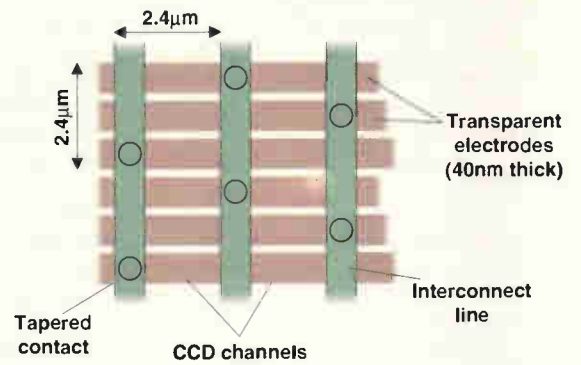

Fig. 4. Schematic top view of the world's smallest image pixels, measuring just 2.4 by 2.4µm<sup>2</sup>.

**Is the lens the limit?**

Figure 4 shows a schematic view of the pixels. Charges are integrated in wells under the central electrode, and then transferred along the ccd channels by appropriate clock voltages applied through the tapered contacts. The electron microscope photograph shows a perspective view of the actual pixels.

Very small ccds will create a problem for manufacturers attempting to design miniature cameras, because the lens will then determine just how small it can be. However, for those applications where lenses are not needed, where there can be direct contact between the ccd and the object, the only limitation is the size of the sensor and the light-gathering capacity of such small pixels.

Since the announcement of the world's smallest pixels, Philips Research has conceived a ccd with 1.3 million pixels of 3.7 by 3.7µm. This is intended for use in consumer high-resolution digital still cameras.

**On-chip data compression**

The use of on-chip data compression will also enable the device to operate in lower resolution monitor mode to feed an lcd viewfinder, and for functions such as auto-focus and autoexposure. Switching between still picture and monitor modes is achieved on-chip to obviate the need for additional processing in-camera.

The principle of charge coupling was invented by Teer and Sangster of Philips Research Laboratories in 1966. Their bucket brigade devices were mainly used for analogue delay lines. However, the potential of bucket brigade devices to be turned into solid-state imagers was realised by the inventors before Boyle and Smith of Bell Labs actually managed to construct working ccds in 1972.

These latest developments show that Philips is still keeping its hand in. ■

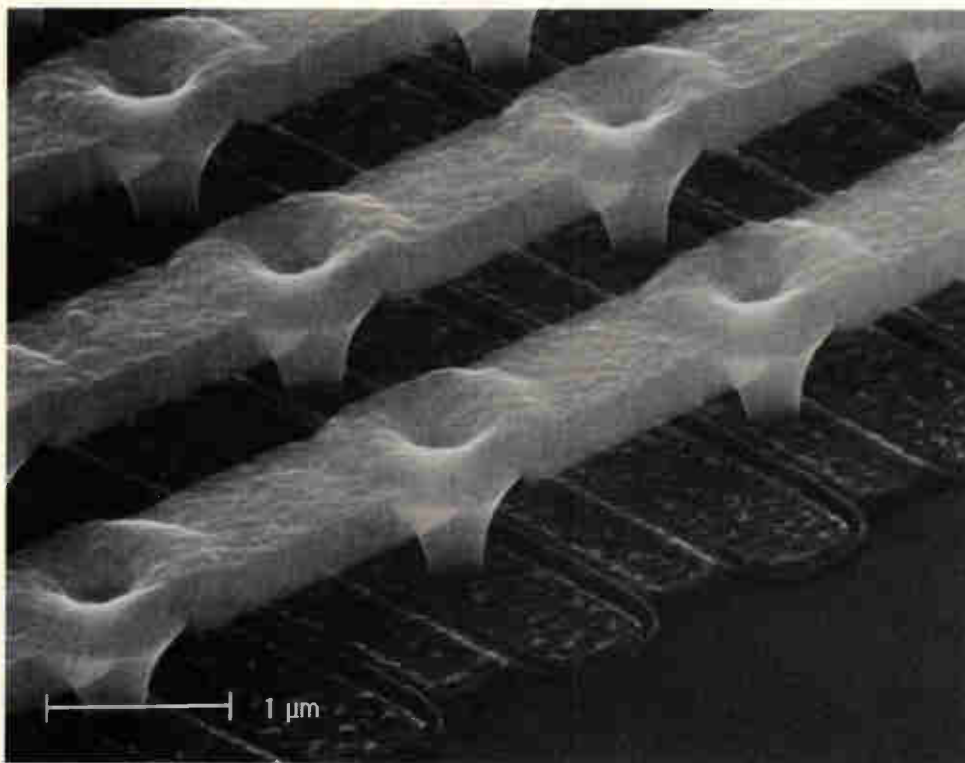

Perspective view of a few 2.4 by 2.4µm ccd pixels with their transparent electrodes. Electrode-interconnect lines with their tapered contacts are also visible.

Amiga genlock pcb (encased) for titling videos it has a 23pin D lead to plug into the computer and pcb pins for composite video in and out. When no video input is connected the normal computer display is shown on the composite video out when the video input is added the white areas on the screen are replaced by the video image. The pcb is powered from the computer £19.98

WATCH SLIDES ON TV "Liesegang diav" automatic slide viewer with built in high quality colour tv camera, composite video output with a BNC plug in very good condition with few signs of use £108.00

Board cameras all with 512x582 pixels 4.4x3.3mm sensor with composite video out. All need to be housed in your own enclosure and have fragile exposed surface mount parts and require 10 to 12vdc power supply 47MMR size 60x36x27mm with 6 infra red leds (gives the same illumination as a small torch would) £50.00+vat = £58.75

40MP size 39x38x23mm spy camera with a fixed focus pin hole lens for hiding behind a very small hole. £57+vat = £66.98

40MC size 39x38x28mm camera for 'C' mount lens this gives a much clearer picture than with the small lenses £68.79 standard 'C' mount lens F1.6 16mm for 40MC £26.43+vat = £31.06

waterproof camera with stylish tilt & swivel case £92.76+vat = £109.00 or 10+ £89.32+vat = £104.95

DTA30 Hand held transistor analyser it tells you which lead is the base, the collector and emitter and if it is NPN or PNP or faulty. HMA20 hand held MOSFET analyser identifies gate drain and source and if P or N channel DTA30 & HMA20 £38.34 each DCA50 component analyser with led readout identifies transistors mosfets diodes & LEDs lead connections £69.95

Speaker cabinets 2 way speaker systems with motorola tweeters

speaker dia	15"	12"	8"
power rating	250WRMS	175WRMS	100WRMS
impedance	8ohm	8ohm	8ohm
frequency range	40hz-20khz	45hz-20khz	60hz-20khz
sensitivity(1W/1M)	97dB	94dB	92dB
size in mm	500x720x340	450x640x345	315x460x230
weight	21.1kg	16.8kg	7.4kg

price each for black vinyl coating £139.95 £99.99 £54.94 grey felt coating £159.97\*\* £119.97\*\* £64.99

\*\* = not normally in stock allow 1 week for delivery

Power amplifiers 19" rack mount with gain controls

STA150	2x160WRMS (4ohm load)	14kg	£202.11
STA300	2x190WRMS (4ohm load)	11kg	£339.00
STA900	2x490WRMS (4ohm load)	15kg	£585.00

LEDs 3mm or 5mm red or green 7p each yellow 11p each cable ties 1p each £5.95 per 1000 £49.50 per 10,000

Rechargeable Batteries

AAP1P7 500mAh	£0.99
AA 500mAh with solder tags	£1.55

All products advertised are new and unused unless otherwise stated. Wide range of CMOS TTL 74HC 74F Linear Transistors kits rechargeable batteries, capacitors, tools etc always in stock. P and £1.95 towards P&P (orders from the Scottish Highlands, Northern Ireland, Isle of Man, Isle of Wight and overseas may be subject to higher P&P for heavy items). VAT included in all prices.

JPG Electronics 276-278 Chatsworth Road Chesterfield S40 2BH  
Mastercard/Visa Orders (01246) 211202 Fax 550959  
Callers welcome 9-30am to 5-30pm Monday to Sa., tuesday

CIRCLE NO. 126 ON REPLY CARD

AA 950mAh	£1.75
CHP11 1.2AH	£2.20
C 2AH with solder tags	£3.60
D (HP2) 1.2AH	£2.60
D 4AH with solder tags	£4.95
PP3 8.4V 110mAh	£4.95
1/2AA with solder tags	£1.55
Sub C with solder tags	£2.50
AAA (HP16) 180mAh	£1.75
1/3 AA with tags (philipsCTV)	£1.95

Nickel Metal Hydride AA cells high capacity with no memory. If charged at 100ma and discharged at 250ma or less 1300mAh capacity (lower capacity for high discharge rates) £2.95

Special offers please check for availability stock of 4 42 x 16mm nicad batteries 171mmx16mm dia with red & black leads 4.8v £5.95

5 button cell 6V 280mAh battery with wires (Varta 5x250Dk) £2.45

Orbital 866 battery pack 12v 1.60AH contains 10 sub C cells with solder tags (the size most commonly used in cordless screwdrivers and drills 22 dia x 42mm tall) it is easy to crack open and was manufactured in 1994. £8.77 each or £110.50 per box of 14 BCl box 190x106x50mm with slots to house a pcb the lid contains an edge connector (12 way 8mm pitch) and screw terminals to connect in wires and 5 slide in cable blanks £2.95

7segment common anode led display 12mm £0.45

GaAs FET low leakage current S8873 £12.95 each £9.95

10+ £7.95 100+ BC547A transistor 20 for £1.00

SL952 UHF Limiting amplifier LC 16 surface mounting package with data sheet £1.95

DC-DC converter Reliability model V12P5 12v in 5v 200ma out 300v input to output isolation with data £4.95 each or pack of 10 £39.50 Airmax A82903-C large stepping motor 14v 7.5 step 270ohm 68mm dia body 6.3mm shaft £8.95 or £200.00 for a box of 30

Polyester capacitors box type 22.5mm lead pitch 0.9uf 250vdc 18p each 14p 100+ 9p 1000+ 1uf 250vdc 20p each 15p 100+ 10p 1000+ Polypropylene 1uf 400vdc (Wima MKP10) 27.5mm pitch 32x29x1.7mm case 75p each 60p 100+ Philips 123 series solid aluminium axial leads 33uf 10v & 2.2uf 40v 40p each 25p 100+ Solid carbon resistors very low inductance ideal for RF circuits 27ohm 2W, 68ohm 2W 25p each 15p each 100+ we have a range of 0.25w 0.5w 1w and 2w solid carbon resistors please send SAE for list MX180 Digital multimeter 17 ranges 1000vdc 750vac 2Mohm 200mA transistor Hfe 9v and 1.5v battery test £9.95

Hand held ultrasonic remote control £3.95

CV2486 gas relay 30 x 10mm dia with 3 wire terminals will also work as a neon light 20p each or £8.50 per 100 Varbatim R300NH Streamer tape commonly used on nc machines and printing presses etc. it looks like a normal cassette with a slot cut out of the top £4.95 each (£3.75 100+) Hensank compound tube £0.95 HV3-2405-E5 5-24v 50mA regulator ic 18-264vac input 8 pin DIL package £3.49 each (100+ 2.25)

## The Phantom Power Box

48 volt microphone phantom powering unit

Professional portable units operating from an internal PP3 battery or external mains adaptor



★ Suitable for converting any microphone amplifier to P48 standard phantom power ★ High efficiency DC to DC converter for extended battery life ★ Accurate line balance for high common mode rejection ★ Low noise and distortion ★ Extensive RFI protection

The Balance Box (mic/line amplifier) – The Headphone Amplifier Box – The OneStop DIN rail mounting radio frequency interference filter and voltage transient protector for voltage and current loop process signal lines

Conford Electronics Conford Liphook Hants GU30 7QW

Information line: 01428 751469 Fax: 751223

E-mail contact@confordelec.co.uk

Web http://www.confordelec.co.uk/catalogue/

CIRCLE NO. 128 ON REPLY CARD



# CHELMER VALVE COMPANY

If you need Valves/Tubes or RF Power Transistors e.t.c. ... then try us!

We have vast stocks, widespread sources and 33 years specialist experience in meeting our customers requirements.

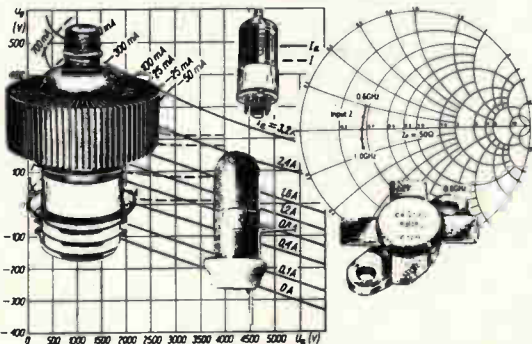

Tuned to the needs of the Professional User

Chelmer Valve Company, 130 New London Road, Chelmsford, Essex CM2 0RG, England

44-01245-355296/265865

Fax: 44-01245-490064

CIRCLE NO. 127 ON REPLY CARD

## STEREO STABILIZER 5



- Rack mounting frequency shifter for howl reduction in public address and sound reinforcement.
- Mono box types and 5Hz fixed shift boards also available.



- ★ Broadcast Monitor Receiver 150kHz-30MHz.
- ★ Advanced Active Aerial 4kHz-30MHz.
- ★ Stereo Variable Emphasis Limiter 3.
- ★ 10-Outlet Audio Distribution Amplifier 4.
- ★ PPM10 In-vision PPM and chart recorder.
- ★ Twin Twin PPM Rack and Box Units.
- ★ PPM5 hybrid, PPM9 microprocessor and PPM8 IEC/DIN -50/+6dB drives and movements.
- ★ Broadcast Stereo Coders.

SURREY ELECTRONICS LTD

The Forge, Lucks Green, Cranleigh GU6 7BG  
Telephone: 01483 275997 Fax: 01483 276477

CIRCLE NO. 129 ON REPLY CARD

# SPEAKERS CORNER

The coil is a vital part of an electromagnetic loudspeaker. Here John Watkinson considers the choices facing the coil designer.

**T**he coil is the part of the loudspeaker which develops the driving force. This is its only desirable feature; everything else the coil does is a drawback. The coil designer has to maximise the desirable while minimising the drawbacks.

The coil works by allowing a current to flow in a magnetic field. This current reacts against the field to produce a force. Force is obtained by multiplying the current by the length of wire,  $l$ , in the magnetic field and then by the field strength,  $B$ .

The last two parameters are seldom quoted singly as only their product, known as  $Bl$ , matters. Unfortunately  $Bl$  is not the product of the flux density and the length of the coil. Figure 1 shows that the flux density in the gap is not constant, but falls at the edges. Fringing flux effectively extends the gap. Not all of the coil is in the field.

In the case of a woofer, there may be more coil length outside the field than inside, and the part outside contributes no force. The actual  $Bl$  product is found by calculating the integral of the field strength over the length of the coil, or by actual measurement.

Above resonance, the moving part of the speaker is mass controlled. If the moving mass is known, it is not hard to find the acceleration for a given force. If the cone remains a rigid piston, knowing its effective area allows the resulting sound pressure to be calculated.

For a given cone area, increasing the  $Bl$  product increases output, whereas increasing the moving mass reduces output. Output is specified as the sensitivity of the driver. This may be power sensitivity or voltage sensitivity.

Power sensitivity is independent of coil impedance whereas voltage sensitivity isn't. In practice both are needed. Power sensitivity allows the necessary amplifier power to be calculated. But it doesn't specify whether that power is delivered as a low current at a high voltage or a high current at a low voltage. Knowing the voltage sensitivity allows that to be worked out.

Every coil has a finite resistance and this is undesirable as it results in heating. Long-throw woofers are especially vul-

nerable. This is because the heat is developed over the whole coil whereas only that part in the field of the gap is producing a force.

There is always a penalty associated with the field in the gap. The gap has a finite volume due to its radial spacing and its length along the coil axis. If the gap spacing is increased, the reluctance goes up and the length of the magnet has to be increased to drive the same amount of flux through the gap. If the gap length is increased, the flux density goes down unless a magnet of larger cross sectional area is used. Thus the magnet volume tends to be proportional to the gap volume.

Maximum efficiency – or the lowest magnet cost – is obtained when the gap is filled with copper. Unfortunately, this ideal can never be reached because some of the gap volume is occupied by clearances to allow motion and by insulation and, generally, a coil former.

Figure 2a) shows how ordinary circular section wire is poor at filling the gap because only 78% of the space is conducting. Square wire, shown in Fig. 2b), gives a much better utilisation of the available flux. Using square wire, the coil would only have 78% of the resistance of an identical unit using round wire.

For the same dc resistance and power sensitivity, a square wire coil could be made 27% longer, allowing longer linear cone travel. As an alternative, coils have been made with hexagonal wire and with flat wire, Figs 2c), d). Both of these methods allow an improvement in packing.

The improved packing makes the coil more rigid and improves heat transfer along the coil. The extra mass of the square wire must reduce the sensitivity slightly, but the moving mass includes the coil former, the cone and dust cap as well as part of the masses of the spider, leadout wires and surround. As a result the increased coil mass does not affect the overall mass significantly.

The interaction of mass and wire conductivity leads to another approach. Copper has very good conductivity, but its specific gravity is quite high: at 8.9 it is not far short of that of lead at 11.3. Thus in some applications, better results may

*Fig. 1. Flux density in the gap is not constant, but falls at the edges. It has to be integrated to find the  $Bl$  product.*

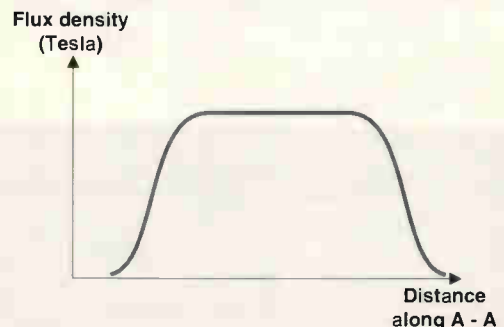
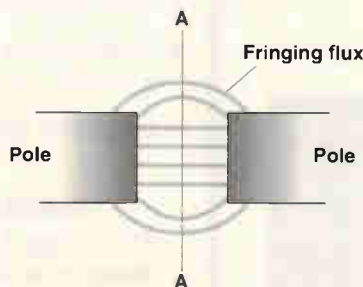



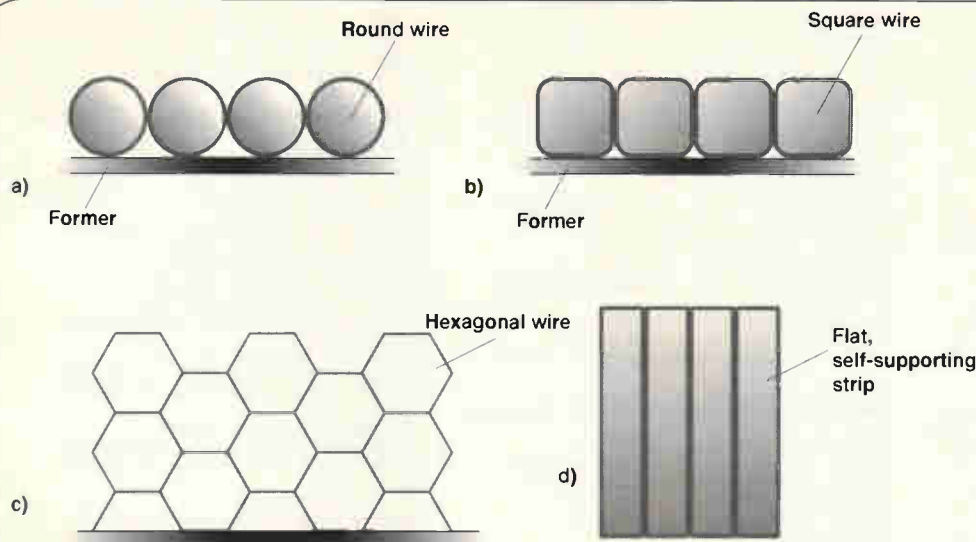

Fig. 2. The more conductive the coil material in the gap, the better. Square and hexagonal cross-section wire reduces the amount of air relative to round cross section. Flat wire goes a step further since it can be wound without needing a coil former.

be obtained by using aluminium whose specific gravity is only 2.7. Although the conductivity of aluminium is only 60% as good as copper, weight for weight the conductivity is twice as good.

For a long throw woofer where the coil mass is a significant part of the moving mass, an aluminium coil can give a significant improvement in efficiency – especially if the wire is square or rectangular. The cross sectional area of the aluminium has to be higher, and this requires a wider gap. However, rectangular alu-

minium wire can be made self supporting so no coil former is needed, allowing the same gap as for a copper coil to be used.

The problem with aluminium wire is that it's difficult to make connections to it without oxidation. This is solved by giving it a copper coating. For real perfectionists, a silver coat may go on top of the copper.

The presence of the coatings changes the conductivity and the manufacturers quote it as a percentage of what it would be for solid copper of the same dimensions. ■

# NOW AVAILABLE

## RANGER 2

for Windows 95™

Demo Software - available from our Web Address

### The Complete, Integrated Schematic & PCB Layout Package

#### Windows Ranger 2

For Windows 95 & NT

- New Hierarchical Circuit
- Split Devices • Gate & Pin Swap
- New Edit Devices in Circuit
- Copper Fill • Power Planes
- Autorouter • Back Annotation

£250

#### Ranger 2 Outputs:

Full Windows Outputs  
Plus - HP-GL  
Gerber  
NC Drill  
AutoCad DXF

#### Windows Ranger 2 with Spectra SP2

Ranger & Spectra Autorouter provide the most cost effective PCB Design system available. A powerful, intuitive system at an outstanding price!

£600

#### Windows Ranger 2 Upgrade

Upgrade your existing PCB Package to Windows Ranger 2.

£150

**SPECIAL OFFER** Ranger 2 Lite £35 (Prices exc VAT/P&P)

Demo Software - download from

<http://biz.ukonline.co.uk/seetrax>

# Call 01730 260062

Fax 01730 267273

Old Buriton Limeworks, Kiln Lane,  
Buriton, Petersfield, Hants. GU31 5SJ

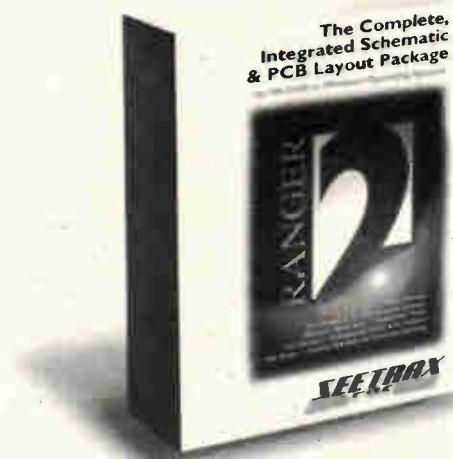

## SEETRAX

Advanced Systems & Technology for PCB Manufacture

CIRCLE NO.130 ON REPLY CARD

# SMALL SELECTION ONLY LISTED - EXPORT TRADE AND QUANTITY DISCOUNTS - RING US FOR YOUR REQUIREMENTS WHICH MAY BE IN STOCK

HP New Colour Spectrum Analysers  
 HP141T+ 8552B IF + 8553B RF -1KHZ -110Mc/s - £700.  
 HP141T+ 8552B IF + 8554B RF -100KHz -1250M - £900.  
 HP141T+ 8552B IF + 8556A RF -20Hz-300KHz - £700.  
 HP141T+ 8552B IF + 8555A 10 MC/S-18GHzS - £1200.  
 HP8443A Tracking Gen Counter 100KHz-110Mc/s - £200  
 HP8445B Tracking Preselector DC to 18GHz - £250.  
 HP8444A Tracking Generator • 5-1300Mc/s - £450.  
 HP8444A OPT 059 Tracking Gen • 5-1500Mc/s - £650.  
 HP35601A Spectrum Anz Interface - £500.  
 HP4953A Protocol Anz - £400.  
 HP8970A Noise Figure Meter + 346B Noise Head - £3k.  
 HP8755A Scalar Network Anz Pl - £250 + MF 180C - Heads  
 11664 Extra - £150 each.  
 HP8903A Audio Anz - £1000.  
 HP8656A 100KHz - 990 Mc/s, S/G AM-FM - £1000.  
 HP3709B Constellation ANZ £1.5k.  
 HP11715A AM-FM Test Source - £500.  
 FARNELL TVS70MKII PU 0-70V 10 amps - £150.  
 FARNELL PSG 520 S/G 10 Mc/s AM-FM - £150.  
 TEK 475 Oscilloscopes 200Mc/s - £300.  
 TEK 475A Oscilloscopes 250Mc/s - £350.  
 MARCONI 6500 Network Scalar Anz - £500. Heads available  
 to 40GHz many types in stock.  
 HP3580A 5Hz-50KHz Spectrum ANZ £750 - £1000.  
 HP3582A .02Hz to 25.6KHz Spectrum ANZ £1.5k.  
 TEK 7L5 + L3 - Opt 25 Tracking Gen - £900.  
 TEK 7L12 - 100KHz-1800Mc/s - £1000.  
 TEK 7L18 - 1.5-60GHz - £1000.  
 Mixers are available for the above ANZs to 60GHz.  
 HP8673D Signal Generator .05-25.6GHz - £15k.  
 Systron Donner 1618B Microwave AM FM Synthesizer  
 50Mc/s - 18GHz £2k.  
 ADRET 3310A FX Synthesizer 300Hz - 60Mc/s - £600.  
 HP Plotters 7470A - 7475A. Up to £250.  
 HP3730A + 3737A Down Converter Oscillator 3.5 - 6.5GHz.  
 HP Microwave Amps 491-492-493-494-495 -1GHz -12.4GHz-  
 £250 each.  
 HP6034A System Power Supply 0-60V 0-10A - £500.  
 HP6131C Digital Voltage Source + -100V/5 Amp.  
 HP3779A Primary Multiplex Analyser - £200 qty.  
 HP3779C Primary Multiplex Analyser - £300 qty.  
 HP5316A Universal Counter A+B.  
 HP8901A Modulation Meter AM-FM - £1000.  
 Marconi TF2374 Zero Loss Probe - £200.  
 Marconi TF2305 Modulation Meter - £1000.  
 Racal/Dana 2101 Microwave Counter - 10Hz-20GHz - with  
 book as new £2k.  
 Racal/Dana 1250-1261 Universal Switch Controller + 200Mc/s  
 Pl Cards.  
 Racal/Dana 9303 True RMS Levelmeter + Head - £450.  
 IEEE Interface - £500.  
 TEKA6902A also A6902B Isolator - £300-£400.  
 TEKF65010 Programmable Function Genr 20Mc/s - £600.  
 TEK2465 300 Mc/s Oscilloscope - £2k + Probes - £150.  
 TEK CT-5 High Current Transformer Probe - £250.  
 TEK J16 Digital Photometer + J6523-2 Luminance Probe -  
 £300.  
 HP745A+746A AC Calibrator - £600.  
 Marconi TF2008 - AM-FM signal generator - also sweeper -  
 10Kc/s - 510Mc/s - from £250 - tested to £400 as new with  
 manual - probe kit in wooden carrying box.  
 HP Frequency comb generator type 8406 - £400.  
 HP Sweep Oscillators type 8690 A+B + plug-ins from 20Mc/s  
 to 18GHz also 18-40GHz.  
 HP Network Analyser type 8407A + 8412A + 8601A - 100Kc/s -  
 110Mc/s - £500 - £1000.  
 HP Amplifier type 8447A - 1-400Mc/s £200 - HP8447A Dual -  
 £300.  
 HP Frequency Counter type 5340A - 18GHz £800.  
 HP 8410-A-B-C Network Analyser 110Mc/s to 12 GHz or 18  
 GHz - plus most other units and displays used in this set-up -  
 8411a-8412-8413-8414-8418-8740-8741-8742-8743-8746-8650.  
 From £1000.  
 Racal/Dana 9301A-9302 RF millivoltmeter - 1.5-2GHz - qty in  
 stock £250-£400.  
 Racal/Dana Modulation Meter Type 9009-9008 - 8Mc/s -  
 1.5GHz - £150/£250.  
 Marconi RCL Bridge type TF2700 - £150.  
 Marconi/Saunders Signal Sources type - 605B-6070A-6055A-  
 6059A-6057A-  
 6056 - £250-£350. 400Mc/s to 18GHz.  
 Marconi Microwave 6600A 1 sweep osc., mainframe with  
 6650PI - 18-26.5 GHz or 6651 PI - 26.5-40GHz-£750 or PI only  
 £600. MF only £250.  
 Tektronix Plug-ins 7A13-7A14-7A18-7A24-7A26-7A11-7M11-  
 7S11-7D10-7S12-S1-S2-S6-S52-PG506-SC504-SG502-SG503-  
 SG504-DC503-DC508-DD501-WR501-DM501A-FG501A-  
 TG501-PG502-DC505A-FG504-7B80 + 85 - 7B92A.  
 Gould J3B test oscillator + manual - £150.  
 Teknison Mainframes - 7603-7623A-7613-7704A-7844-7904-  
 TM501-TM503-TM506-7904A-7834-7623-7633-7844-7854-  
 7104.  
 Marconi 6155A Signal Source-1 to 2GHz - LED - £400.  
 Barr & Stroud Variable filter EF3 0.1Hz-100Kc/s + high pass +  
 low pass - £150.  
 Racal/Dana 9300 RMS voltmeter - £250.  
 HP 8750A storage normalizer - £400 with lead + S.A. or N, A  
 interface. Board fitted.  
 TEKTRONIX - 7S14-7T11-7S11-7S12-S1-S2-S39-S47-S51-S52-  
 S53-7M11.  
 Marconi mod meters type TF2304 - £250.  
 Systron Donner counter type 6054B - 20Mc/s - 24GHz - LED  
 readout - £1k.

Farnell electronic load type RB1030-35 - £350.  
 Racal/Dana counters-99904-9905-9906-9915-9916-9917-9921-  
 50Mc/s-3GHz - £100 - £450 - all fitted with FX standards.  
 HP180TR. HP181T, HP182T mainframes £300 - £500.  
 Marconi 6700A sweep oscillator - 18GHz Pls available.  
 Racal/Dana VLF frequency standard equipment. Tracer  
 receiver type 900A + difference meter type 527E + rubidium  
 standard type 9475 - £2750.  
 HP432A-435A or B-436A-power meters + powerheads to  
 60GHz - £150 - £1750 - spare heads.  
 HP8614A signal gen 800Mc/s - 2.4GHz, new colour - £400.  
 HP8616A signal gen 1.8MHz - 4.5GHz, new colour £400.  
 HP3336A or B syn level generator - £500 - £600.  
 HP3586A or C selective level meter - £500.  
 HP8683D S/G microwave 2.3-13GHz-opt 001 - 003 - £1k.  
 HP8640B S/G AM-FM 512Mc/s or 1024Mc/s. Opt 001 or 002  
 or 003 - £800-£1250.  
 HP86222B Sweep Pl -01-2.4GHz + ATT £1000-£1250.  
 HP86290A Sweep Pl-2 - 18GHz - £1000 - £1250.  
 HP86 Series Pls in stock - splitban from 10Mc/s - 18.6GHz -  
 £250 - £1k.  
 HP8620C Mainframe - £250. IEEE.  
 HP8615A Programmable signal source - 1MHz - 50Mc/s - opt  
 002-£1k.  
 HP8601A Sweep generator .1-110Mc/s £300.  
 HP8349A Microwave Amp 2 - 20GHz Solid state - £1500.  
 HP1980B Oscilloscope measurement system - £300.  
 HP3455/3456A Digital voltmeter - £400.  
 HP5370A Universal time interval counter - £1k.  
 HP5335A Universal counter - 200Mc/s-£500.  
 HP5328A Universal counter - 500Mc/s - £250.  
 HP6034A Power supply -0-60V-0-10 amps - £500.  
 HP3710A 3715A-3716A-3702B-3703B-3705A-3711A-3791B-  
 3712A-3793B microwave link analyser.  
 HP3552A Transmission test set - £350.  
 HP3763A Error detector - £500.  
 HP3764A Digital transmission analyser - £600.  
 HP3770A Amp delay distortion analyser - £400.  
 HP3770B - £450.  
 HP3780A Pattern generator detector - £400.  
 HP3781A Pattern generator - £400.  
 HP3782A Error detector - £400.  
 TEKTRONIX 577 Curve tracer + adaptors - £900.  
 TEKTRONIX 1502/1503 TDR cable test set - £400.  
 Racal 1991-1992-1998 - 1300Mc/s counters - £400-£900.  
 Fluke 80K-40 high voltage probe in case - BN - £50-£75.  
 EIP45 microwave 18GHz counter - £1200.  
 Fluke 510A AC ref standard - 400Hz-£200.  
 Fluke 355A DC voltage standard - £300.  
 Wiltron 610D Sweep Gen + 6124C PI-4-8GHz-£400.  
 Wiltron 610D Sweep Generator +61084D PI - 1Mc/s -  
 1500Mc/s £500 - 10 Mc/s - 18GHz - £1000.  
 HP8699B Sweep Pl YIG oscillator .01 - 4GHz - £300. 8690B  
 MF-£250. Both £500.  
 Dummy Loads & Power att up to 2.5 kilowatts FX up to  
 18GHz - microwave parts new and ex equip - relays -  
 attenuators - switches - waveguides - Yigs - SMA - APC7  
 plugs - adaptors etc. qty. in stock.  
 B&K items in stock - ask for list.  
 Power Supplies Heavy duty + bench in stock - Farnell - HP -  
 Weir - Thurlby - Racal etc. Ask for list. Large quantity in  
 stock, all types to 400 amp - 100kV.  
 Marconi 2955 Radio Test set - £1800.  
 Marconi 2955 + 2958 Tacs radio test set - £2000.  
 Marconi 2955R Radio test set - £2000.  
 Marconi TF2015 S/G 10Mc/s - 520Mc/s AM/FM - £100.  
 Marconi TF2016A S/G 10Kc/s-120Mc/s. AM/FM - £100.  
 Marconi TF2171 Digital synchronizer for 2015/2016 - £50.  
 Marconi TF2017 S/G .01-1024Mc/s. AM/FM. High grade - low  
 noise - LED readout. - £1k.  
 Marconi TF2018 S/G 80Kc/s-520Mc/s. AM/FM - £600.  
 Marconi TF2018A S/G 80Kc/s-520Mc/s. AM/FM - £800.  
 Marconi TF2019 S/G 80Kc/s-1040Mc/s. AM/FM - £1000.  
 Marconi TF2019A S/G 80Kc/s-1040Mc/s. AM/FM - £1250.  
 Marconi TF2022E S/G 10Kc/s-1.01GHz. AM/FM - £1250.  
 Marconi TF2022E As above but as new + Cal cert - £1500.  
 Marconi TF6311 Microwave Sweep S/G 10Mc/s - 20GHz c/w  
 TF6501 amplitude Anz. plus heads 10Kc/s-20GHz. Heads  
 available to 40GHz - £4000.  
 Farnell S/G ESG1000 10Hz-1000Mc/s. AM/FM - £800.  
 IFR 1200S Communications radio test set - £2500.  
 TF2370 Spectrum Anz's 30Hz-110Mc/s. Large qty to clear as  
 received from Gov - all sold as is from pile complete or add  
 £100 for basic testing and adjustment. Callers preferred -  
 Pick your own from over sixty units.  
 A. Early Model - Grey - Rear horizontal alloy cooling fins - qty  
 of 5 - £750 lot - singly - £200.  
 B. Late Model - Grey-Vertical alloy cooling fins - £300.  
 Marconi TK2373 Extender to 1.25GHz - £300 - £400.  
 HP3325A Synthesized function generator - £1000 - £1500.  
 HP3325B Synthesized function generator - £2500.  
 HP8405A Vector voltmeter - late colour - £400.  
 HP8508A Vector voltmeter - £2500.  
 HP8505A Network Anz 500KHz-1.3GHz - £1000.  
 HP8505A + 8502A or 8503A test sets- £1200 - £1500.  
 HP8505A + 8502A or 8503A + 8501A normalizer - £1750-  
 £2000.  
 HP8557A .01Mc/s-350Mc/s - 8558B 0.1-1500Mc/s - 8559A .01-  
 21GHz 180T or 180C-D-T £500 - £2000.  
 TEK492 Spectrum Anz-OPT 2-50Kc/s-21GHz - £2.5k.  
 TEK492P S.A. opt 1-2-3-50 Kc/s - 21GHz £4k.  
 TEK495 S.A. 100Hz - 1.8GHz - £3k.  
 TEKTRONIX - HP Oscilloscopes - 100Mc/s-465-465B-1740-  
 1741 etc - £300 - qty in stock.  
 Phillips 3217 50Mc/s oscilloscopes - £150-£250.  
 Phillips 3296 350Mc/s IR remote oscilloscope - £750.

Hitachi VC6041 Dig storage oscilloscope - 40Mc/s - £500.  
 TEK2430A Dig storage oscilloscope 100Mc/s - £2000.  
 TEK2440 Dig storage oscilloscope 400Mc/s - £2200.  
 TEKTRONIX 2245A Oscilloscope 100Mc/s - £500.  
 TEKTRONIX 2445 + DMM - 250Mc/s - £800.  
**TEKTRONIX 2445A - 150Mc/s  
 - 4 CH - £800.**  
 Schaffner NSG 200E Mainframe - NSG203A low volt var  
 simulator - NSG22A. Interface simulator - NSG226 Data line  
 simulator - all six items at £1500.  
 Schaffner NSG200E - NSG203E low volt var simulator -  
 NSG222A Interface simulator - all three - £1000.  
**LIGHT AND OPTICAL EQUIPMENT**  
 Anritsu ML93A & Optical Lead Power Meter.  
 Anritsu ML93B & Optical Lead Power Meter.  
 Power Sensors for above MA96A - MA98A - MA913A -  
 Battery Pack M295A.  
 Anritsu MW97A Pulse Echo Tester.  
 Pl available - MH914C 1.3 - MH915B 1.3 - MH913B 0.85 -  
 MH925A 1.3 - MH929A 1.55 - MH925A 1.3GI - MH914C  
 1.3SM.  
 Anritsu MW98A Time Domain Reflector.  
 Pl available - MH914C 1.3 - MH915B 1.3 - MH913B 0.85 -  
 MH925A 1.3 - MH929A 1.55 - MH925A 1.3GI - MH914C  
 1.3SM.  
 Anritsu MZ100A E/O Converter.  
 + MG912B (LD 1.35) Light Source + MG92B (LD 0.85)  
 Light Source  
 Anritsu MZ118A O/E Converter.  
 +MH922A 0.8 O/E unit + MH923 A1.3 O/E unit.  
 Anritsu ML96B Power Meter & Charger.  
 Anritsu MN95B Variable Att. 1300.  
 Barr & Stroud LS10 Light Source.  
 BT Power Unit 850 - 1300 - 1500.  
 Photo Dyne 1950 XR Continuous Att. 1300 - 1500.  
 Photo Dyne 1800 FA. Att.  
 NKT Electronic QAM30 Att Meter (MN3032TX) 1300 out.  
 Electro Optic Developments FO-500 TX Laser.  
 Cossor-Raytheon 108L Optical Cable Fault Locator  
 0-1000M 0-10km.  
 Intelco 220 Single Mode Att 1532.  
 TEK P6701 Optical Converter 700 MC/S-850.  
 TEK Orionics 7000 Type PI OTRD-103A.  
 HP81512A Head 150Mc/s 950-1700.  
 HP84801A Fibre Power Sensor 600-1200.  
 HP8158B ATT OPT 002+011 1300-1550.  
 HP8159A RX DC-400Mc/s 550-950.  
 STC OFTX-3 Laser source.  
 STC OFRX-3.  
 STC OFR10 Reflectometer.  
 STC OFSK15 Machine jointing + eye magnifier.  
 Anritsu ME453L RX Microwave ANZ.  
 Anritsu ME453L TX Microwave ANZ.  
 Anritsu MS420B Network Spectrum ANZ.  
 Anritsu MH370A Jitter Mod Oscillator.  
 Anritsu MG642A Pulse Patt Gen.  
 Complete MS65A Error Detector.  
 System MS02A Timer & Digital Printer.  
 Anritsu ML612A Sel Level Meter.  
 Anritsu MS2802A Spectrum ANZ 100Hz-32GHz.  
 Anritsu ML244A Sel Level Meter.  
 Advantest TR98201 Signal Gen.  
 Advantest TR9402 Digital Spectrum ANZ.  
 Siemens D2108 Level Meter.  
 Siemens D2150 Bit Error Meter.  
 W&G PCM3 Auto Measuring Set.  
 W&G SPM14 Sel Level Meter.  
 W&G SPM15 Sel Level Meter.  
 W&G SPM16 Sel Level Meter.  
 W&G PS19 Level Gen - £1k.  
 W&G DA20-DA1 Data Anz.  
 W&G PMG3 Transmission Measuring Set.  
 W&G PSS16 Generator.  
 W&G PS14 Level Generator.  
 W&G EPM-1 Plus Head Milliwatt Power Meter - £450.  
 W&G DLM3 Phase Jitter & Noise - £500  
 W&G DLM4 Data Line Test Set - £750.  
 W&G PS10 & PM10 Level Gen.  
 HP8660C S/G AM/FM - Phase • 01-110Mc/s - 1300Mc/s -  
 2600 MC/s £1-£2k.  
 HP4274A LCR Meter + Adaptor.  
 HP8566A High Performance S.A. - 100Hz - 2.5GHz - 2GHz -  
 22GHz - 300 GHz with mixers.  
 HP8754A Network ANZ 4-1300Mc/s + 8502A + cables.  
 HP8754A Network ANZ H26 - 2600Mc/s + 8502A + cables.  
 HP8116A Pulse function Gen £2200.  
 HP3588A S.A. 10Hz - 150Mc/s opt 001-003.  
 HP54100A DIG Oscilloscope 1GHz - P.O.R.  
 HP54200A DIG Oscilloscope 1GHz - P.O.R.  
 HP54501A DIG Oscilloscope 100Mc/s - P.O.R.  
 R&S CMTA 54 Radio Comms. ANZ - 0.1 - 1000Mc/s - £4k.  
 R&S PSA 5 Process Controller 1006-3008. 02.  
 TEK TDS360 200 MC/s Oscilloscope. £1750.  
 TEK OF150 Fibre Optic TDR.  
 MAR S/G 2022D 10Kc/s - 1GHz - White - £1650.  
 MAR S/G 2022C 10Kc/s - 1GHz - £1400.  
 HP1630-1631-1650 Logic ANZs.  
 BELLING LEE rayproof screened rooms.  
 Size: 16ft x 10ft x 8ft, 12ft x 8ft x 8ft - all inc lighting plus  
 fans.

NEW REVISED LOW PRICES FOR OLDER EQUIPMENT

ITEMS BOUGHT FROM HM GOVERNMENT BEING SURPLUS. PRICE IS EX WORKS. SAE FOR ENQUIRIES. PHONE FOR APPOINTMENT OR FOR DEMONSTRATION OF ANY ITEMS. AVAILABILITY OR PRICE CHANGE. VAT AND CARRIAGE EXTRA. ITEMS MARKED TESTED HAVE 30 DAY WARRANTY. WANTED: TEST EQUIPMENT-VALVES-PLUGS AND SOCKETS-SYNCRS-TRANSMITTING AND RECEIVING EQUIPMENT ETC.

Johns Radio, Whitehall Works, 84 Whitehall Road East, Birkenshaw, Bradford BD11 2ER. Tel: (01274) 684007. Fax: 651160

CIRCLE NO. 131 ON REPLY CARD

*Fig. 1. The photograph that directly gave rise to identification of the performers and the performance. These are the Paramount Astoria Girls rehearsing for the programme on the disc.*



In last month's issue, **Don McLean** described the BBC's first television service and the earliest-known recording of broadcast television. This month Don reveals how he restored that video recording.

# Looking in...

In August 1932, after three years of experimental television broadcasting by John Logie Baird, the BBC's first Television Service started on the low-definition 30-line format.

No means of high quality video recording was available and no professional broadcast video recordings exist from this period. Some viewers, however, tried recording the broadcast video signal onto audio discs.

In April 1933, a mere eight months after the start of BBC tv broadcasting, one viewer recorded part of a famous pioneering programme – the world's first television revue.

## Dancing girls

The key to identifying the recording was an 80-second segment of a 'high-kicking' dance group. By chance, I recognised them by their costumes in a

photograph, Fig. 1, in a magazine<sup>1</sup> that reviewed the highlights of 1933. Ray Herbert identified the dance group in the photograph as the Paramount Astoria Girls and Nicholas Moss of the BBC was able to retrieve the only two dates<sup>2</sup> in 1933 when they performed.

Matching up the programme with what I could see from the disc confirmed the programme was transmitted on 21 April 1933 from the small television studio BB in the sub-basement of BBC Broadcasting House. This was a television special called "Looking In" – the world's first television revue produced by Eustace Robb.

## A myth challenged

Despite its poor quality, this recording is arguably even more important than Baird's experimental television recordings back in 1927-28. It lets us see

exactly what the public saw in the early thirties. And what they saw has come as a great surprise: fast-paced entertainment, full of movement.

At the start of a sequence totalling four minutes there's a caption brought towards the camera in a 'zooming' action. Then five individual presenters make their introductions, Fig. 2. Each of six dancers next gives a 'cameo' head and shoulders introduction. Finally there is a long-shot eighty second dance routine, Fig. 3. This is followed by an announcer, Fig. 4.

Each of the twelve performers and presenters, Fig. 5, are in shot for no more than twenty seconds – long enough to be recognised but not so long that the viewers get bored. This is unique to 30-line television and would not be out of place in a fast-moving production today.



2nd Presenter

3rd Presenter

4th Presenter

Fig. 2. The second, third and fourth presenters from the start of the recording. These and other stills from the disc are difficult to recognise and have been colour-tinted to aid recognition. Such poor quality pictures are more to do with the crudeness of the home recorder than the quality of the received video signal.

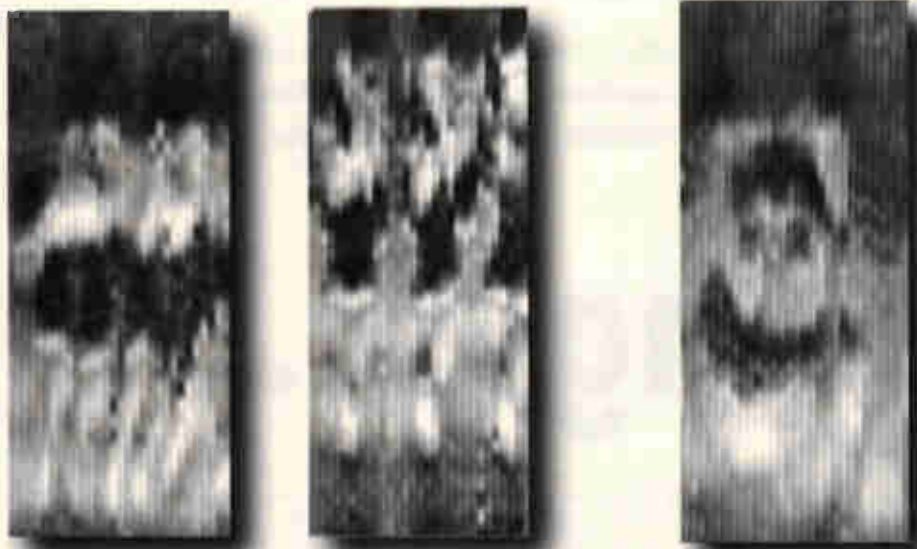

Fig. 3. Two single frames of the Paramount Astoria Girls in long shot during their dance number. As with the other stills shown here, the action and subjects become clear and recognisable when the pictures are shown as a video sequence.

Fig. 4. This unknown presenter appears a few seconds before the end of the recording and just after the dance sequence.

**Production features**

In 1933, the 'camera' being used, Fig. 6, was based on a mirror-drum. This was a cylinder with 30 angled mirrors around its circumference.

The sensitivity and size of the photocells dictated that the most efficient arrangement was to reverse lighting and sensors. The mirror-drum sprayed a raster of intense light into a pitch-black studio and the photocells, mounted where the lights would have been, were fed to a mixing panel in the control room.

The camera could pan across the field-of-view but could not easily be adjusted for tilt.<sup>5</sup> Hence for each of the performers we can tell their relative heights. Indeed we can see that the dancers were all much shorter than the other performers as their heads only just appear in frame. Fig. 7.

When the girls dance in a line, we get a perfect example of that bugbear of amateur home videos – 'hose-pipping' – panning left and right across the girls. Fig. 8.

The producer used two types of shots: the long-shot for the dancers and the medium close-up of the performers from waist-height up. This loose shot allows us to see not just hand gestures of the presenters but also the heads of the height-challenged dancing girls, Fig. 7.

From the action on the disc, the studio had a movable curtain for close-ups. This obscured the long-shot background – probably for scene changing – and came down to about waist height. Each of the performers entered and exited not from the left or right, but unusually from below, from underneath this curtain.

Viewers from around the country described detail<sup>6</sup> that the disc has not been able to capture. The recording, Fig. 9, is but a pale echo of the received transmission and can merely hint at what people saw.

If a television producer today had just one television camera that could only pan, had no zoom and was fixed to the floor, and if he were told to make a live 30-minute programme, I would be surprised if he could better the efforts of the BBC in 1933.

**Movement – the key to clarity**

The technical quality of the BBC 30-line transmissions was in itself excellent. However, 30 lines are only barely adequate to represent people and not suitable as a broadcast medium for any more complex or obscure subjects.

When we watch restored 30-line programmes, there appears to be much more information present than 30 lines could possibly convey. For facial and body movement, our brain fills in and 'builds up' the detail. We see, and

**What the critics said**

"Looking In" was important enough to be cited by Swift (1950),<sup>3</sup> though his dismissive remarks do not match what we see today. Ross (1961)<sup>4</sup> also cites this programme but prints a scathing *Daily Telegraph* review of its technical quality. Viewer's reports on the programme were, by contrast, very positive – and not included by either author.

The evidence we have on the disc does not fit well with what these eminent BBC authors have written. Today, we have the benefit of being truly objective about this historic programme rather than having, as they did, to rely on twenty year-old hearsay to describe it.

What this disc has shown us is that, although technically constrained, 30-line BBC Television was packed with action and as professional and as professionally produced as its higher definition successor.



Fig. 5. Iris Kirkwhite was one of the presenter/performers on the disc. She appeared often on early BBC Television and was renowned for her toe-tap dancing.



Fig. 7. One of the taller Paramount Astoria Girls appearing just in frame. This image has been colour-tinted to aid understanding.

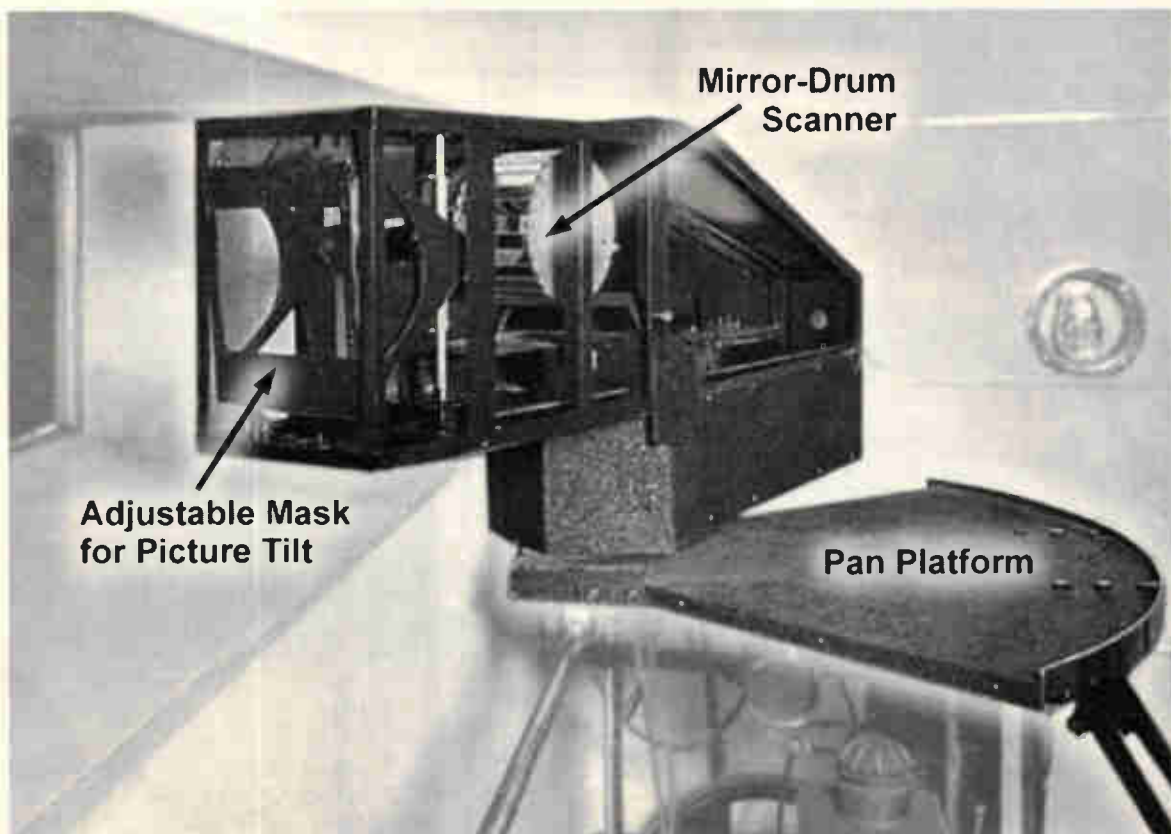

Fig. 6. The spotlight 'camera' in Studio BB of Broadcasting House. This projected a brilliant white raster into the darkened studio. Photocells, positioned as lights, fed the video signal into the control room. The camera rests on a platform allowing only panning. Moving the mask on the left adjusted tilt. Unfortunately this also altered the video timing.



**Fig. 8.** A publicity shot of the Paramount Astoria Girls made at the time of the recording. The images off disc do not resolve a chequer-board floor pattern.

**Fig. 9.** A sequence of the Paramount Astoria Girls from the vision-only disc. The period between the girls' high kicks is 760ms giving a tempo for the music of 79 beats/min.

more importantly recognise, the events in the studio through the limitations of the system.

Low-definition television becomes more effective the more movement there is. From the "Looking In" disc, the producer, Eustace Robb, understood very well the limitations of the 30-line system and exploited movement to increase its impact.

Indeed, the techniques of lighting, camera work and production were all pioneered on the BBC's 30-line service. This provided essential experience for the BBC production staff and engineers for the introduction of high definition television in 1936.<sup>7</sup>

#### The first age of tv ends

Developments and demonstrations in electronically scanned television lead to the BBC's 30-line Television Service being stopped in 1935. The viewing public were keen for transmissions to continue, even in parallel with a high-resolution service.

The service closed however on 11 September 1935. Less than a year later, the BBC started its second Television Service in not one but two new incompatible high-definition formats with the very latest in technology.

In its first few months, the new service was far more 'experimental' than its 30-line predecessor.

#### In summary

For now, the amateur video recording of part of a BBC programme has the accolade of being the earliest-known recording of BBC Television or indeed of any broadcast television service. As you might expect, our unknown viewer was selective about making video recordings on his 'write-once' aluminium discs.

Fortunately, he chose for us the world's first television revue, giving us a marvellous opportunity to share in a historic event. Although he could not have known it at the time, he made the world's oldest time-shifted home video recording in 1933 – not to be seen again for 63 years.

The last word will go to a viewer in London, who, after watching the high-kicking Paramount Astoria Girls in this programme, made this comment on the future of television – "Sound without sight lacks kick".<sup>8</sup>

My thanks to Dave Mason, Eliot Levin, Ray Herbert and Nicholas Moss for helping me make this discovery. ■

#### References

1. *Television*, January 1934, p. 18.
2. Via the BBC Written Archives Centre at Caversham.
3. Swift J, 'Adventure in Vision', Lehmann, 1950 p. 58. Incorrect reference to Paramount Victoria Girls.
4. Ross G, 'Television Jubilee', W H Allen, 1961 p. 24.
5. Bridgewater, T H, 1986, private communication.
6. *Television*, May 1933, pp. 170-171.
7. Bridgewater, T H, 1983 interviewed by Bruce Norman in 'Here's Looking at You', BBC/RTS, 1984 p. 109.
8. *Television*, May 1933, *ibid*.

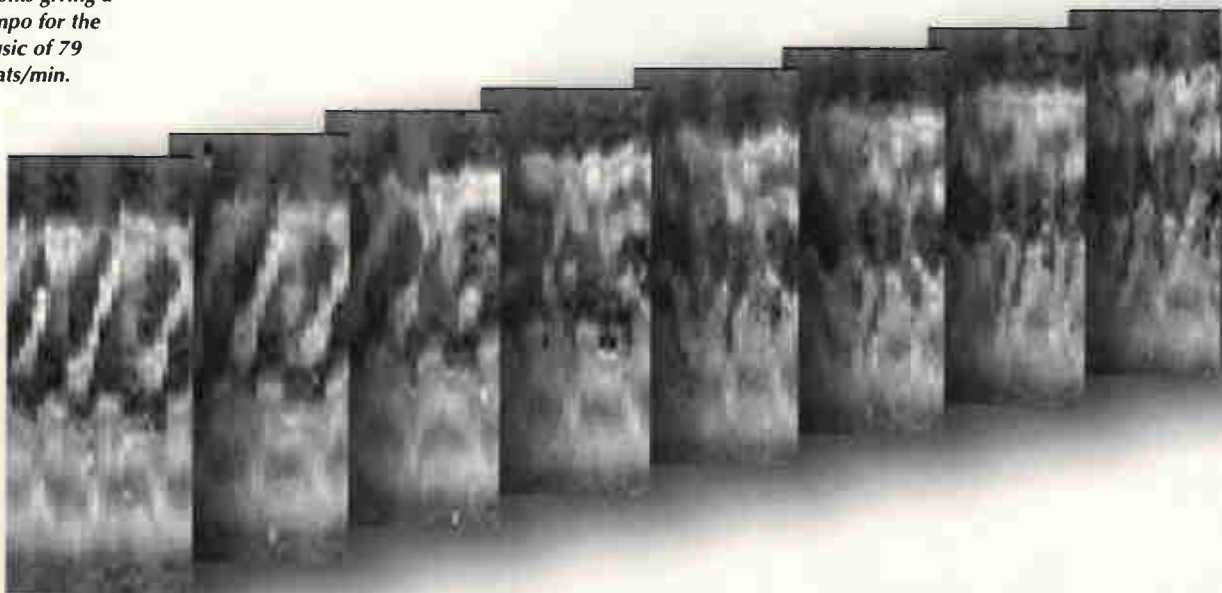

# Ultra-fast pulses

**Emitter-coupled logic offers sub-nanosecond switching times combined with  $50\Omega$  output capability. Nick Wheeler outlines the benefits of these features in relation to pulse-shaping applications. His simple circuit outputs very fast rise and fall time pulses whose width is easily and accurately determined by a length of coaxial cable.**

In its January 1996 issue, *Electronics World* published a circuit idea of mine entitled 'Fast, precise pulse generator'. What follows is a development of this. By using some specialised emitter-coupled logic, rather than advanced cmos, I have managed to obtain some very interesting results.

## Repetitive pulse theory

Mathematical analysis of a series of perfect pulses – i.e. pulses with zero rise and fall times and flat tops – is simple. It is set out in reference 1.

The spectrum is a series of lines separated by the pulse-repetition frequency  $F$ . The amplitude of these lines fluctuates similarly to a damped cosine wave, passing through maxima and minima separated by frequencies represented by  $1/T$ , where  $T$  is the pulse's duration. I have sketched what one should expect to see on a spectrum analyser at Fig. 1.

Emitter-coupled logic, with its sub-nanosecond rise and fall times, produces results which accord closely with theory. Figure 2, which was extremely difficult to capture, shows a 180MHz segment of the spectrum. The difficulty in capturing the segment arises from the interaction between pulse width and repetition frequency.

This photo is not perfect but makes the point. It indicates a pulse width of about 5.5ns. My 100MHz oscilloscope responds to this with very small blips, corresponding with the rising edge of the pulse repetition frequency input.

The spectral lines are 11.5MHz apart. The largest-amplitude blip, just right of centre, is a strobe at 310MHz, conveniently provided by the synthesised source described in reference 3.

## Implementing an ecl pulse generator

Figure 3 shows the circuit diagram, and Fig. 4 the pcb artwork. The large features at the top of the artwork are the footprints for two SMA sockets (RS 111-712). The ends of the coaxial cable referred to below connect to these sockets.

The SY100EL16 differential receiver is manufactured by

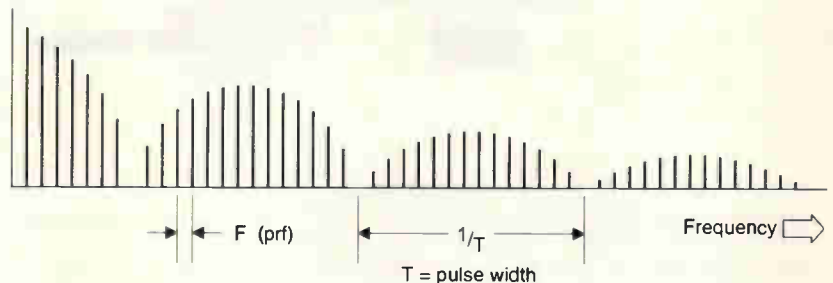

Fig. 1. Theoretical spectrum of a pulse train with pulse width  $T$  and pulse-repetition frequency  $F$ .

Synergy Semiconductors. It conditions the sinusoidal pulse-repetition frequency input to ecl levels. Output /Q is grounded through  $560\Omega$ . Output Q goes directly to  $D_1$  of the SY100ELO4 And gate and also directly to  $D_1$  of the SY100ELO7 exclusive-or gate.

Output Q also goes to  $D_0$  of the exclusive-or gate via a length of  $50\Omega$  coaxial cable. The length of this cable determines the pulse width. In the example described here, it was 95cm long.

The traces on the pcb add another 3cm. This amounts to a delay of about 4.7ns. The velocity factor for solid ptf dielectric is 0.7. There are two transit delays of the order of 250ps in the parts, so it all works according to theory.

The  $D_0$  input to the exclusive-or gate is set at the proper dc level and termination impedance using the Thévenin method. This calls for  $81\Omega$  to  $V_{CC}$  and  $130\Omega$  to ground. I used  $100\Omega \parallel 470\Omega$  and  $150\Omega \parallel 1k\Omega$  standard values for these.

This circuit produces a pulse on the positive-going edge of the prf signal. The And gate prevents another pulse occurring on the negative going transition.

The And gate has an inverted Q output, /Q, so a negative going pulse can be produced if need be.

## Finger on the pulse

Apart from the fact that the very high speed of ecl produces

Fig. 2. Partial spectrum of fast pulse train with a pulse-repetition frequency of 11.5MHz and a pulse duration of around 5.5ns.

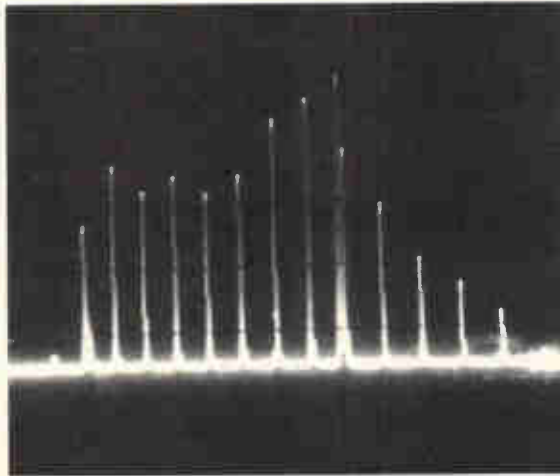

Fig. 4. Circuit layout of the pulse generator. Synergy's number is 0121 7338033.

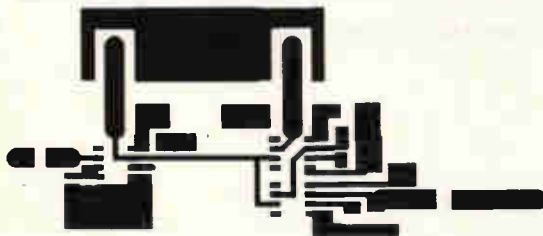
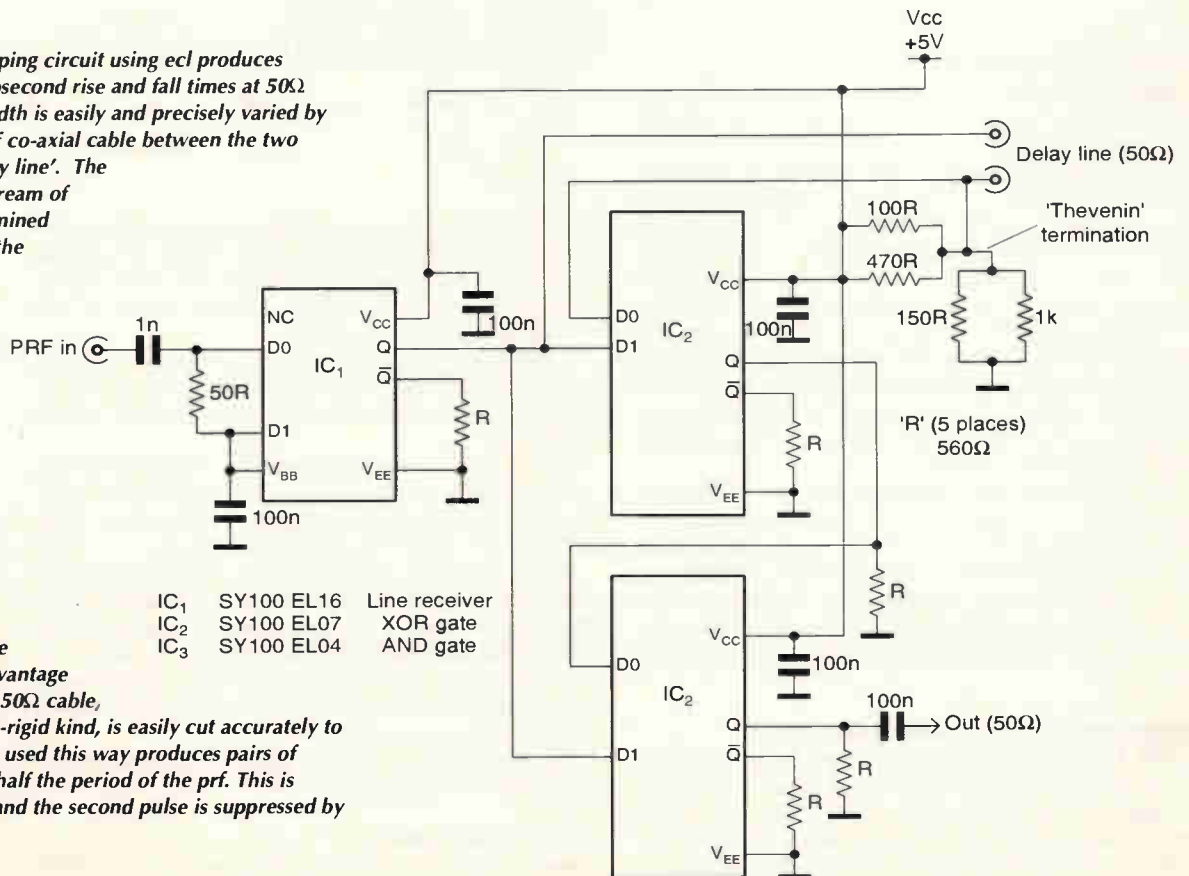

Fig. 3. Fast pulse-shaping circuit using ecl produces pulses with sub-nanosecond rise and fall times at 50Ω impedance. Pulse width is easily and precisely varied by altering the length of co-axial cable between the two points labelled 'Delay line'. The circuit produces a stream of pulses at a prf determined by the frequency of the input to the line receiver. This can be sinusoidal so long as it exceeds 150mV pk-pk. Such a signal is obtainable from most signal generators. The circuit works up to at least 100MHz. Pulse duration is determined by the transit time down the coaxial cable. An advantage of this circuit is that 50Ω cable, particularly the semi-rigid kind, is easily cut accurately to length. An XOR gate used this way produces pairs of pulses separated by half the period of the prf. This is usually undesirable and the second pulse is suppressed by the AND gate.



a nice conformity of practice with theory, the main point of this circuit is the convenience with which pulse length can be determined, since this is by transit time down 50Ω coaxial cable.

Moreover, the spectral lines give an easy way of measuring the pulse width to an accuracy of a few percent, by counting the number between minima. This would be difficult even with an oscilloscope with adequate frequency response.

Separation between the spectral lines can be accurately set to any value, to over 100MHz. The circuit is, in effect, a most useful calibrator for spectrum analysis.

If you need to set the pulse width in a stable, permanent, manner, the coaxial link can be made using semi-rigid cable such as RG405. Ordinary general-purpose SMA-terminated laboratory cables of various lengths can be used to determine approximately the right length.

Another, less flexible, approach might be to establish the delay using a convoluted microstripline. A note on how to implement this appears in reference 2.

It occurs to me that the circuit described could form the modulator for a very short range radar, but I leave experimentation in that area to you. ■

References

1. Services textbook of Radio. Vol. 7, HMSO 1960, p. 104.
2. Wheeler, N, 'Microstrip made easy,' *Electronics World*, Dec. 1997.
3. Wheeler, N, '50-950MHz signal source,' *Electronics World*, Oct. 1998.



Surplus always wanted for cash!

# THE ORIGINAL SURPLUS WONDERLAND!

THIS MONTH'S SELECTION FROM OUR VAST EVER CHANGING STOCKS

Surplus always wanted for cash!

## THE AMAZING TELEBOX

Converts your colour monitor into a QUALITY COLOUR TV!!



**TV SOUND & VIDEO TUNER**  
CABLE COMPATIBLE

The TELEBOX is an attractive fully cased mains powered unit, containing all electronics ready to plug into a host of video monitors made by makers such as MICROVITEC, ATARI, SANYO, SONY, COMMODORE, PHILIPS, TATUNG, AMSTRAD etc. The composite video output will also plug directly into most video recorders, allowing reception of TV channels not normally receivable on most television receivers\* (TELEBOX MB). Push button controls on the front panel allow reception of 8 fully tuneable 'off air' UHF colour television channels. TELEBOX MB covers virtually all television frequencies VHF and UHF including the HYPERBAND as used by most cable TV operators. A composite video output is located on the rear panel for direct connection to most makes of monitor or desktop computer video systems. For complete compatibility - even for monitors without sound - an integral 4 watt audio amplifier and low level Hi Fi audio output are provided as standard.

TELEBOX ST for composite video input type monitors £36.95  
TELEBOX STL as ST but fitted with integral speaker £39.50  
TELEBOX MB Multiband VHF/UHF/Cable/Hyperband tuner £69.95  
For overseas PAL versions state 5.5 or 6 MHz sound specification.  
\*For cable / hyperband signal reception Telebox MB should be connected to a cable type service. Shipping on all Teleboxes, code (B)

**NEW** State of the art PAL (UK spec) UHF TV tuner module with composite 1V pp video and NICAM hi fi stereo sound outputs. Micro electronics all on one small PCB only 73 x 160 x 52 mm enable full software control via a simple 2 wire link to any IBM type computer. Supplied complete with simple working program and documentation. Requires +12V & +5V DC to operate. BRAND NEW - Order as MY00. Only £49.95 code (B)

## FLOPPY DISK DRIVES 2 1/2" - 1 1/4"

Massive purchases of standard 5 1/4" and 3 1/2" drives enables us to present prime product at industry beating low prices! All units (unless stated) are BRAND NEW or removed from often brand new equipment and are fully tested, aligned and shipped to you with a full 90 day guarantee. Call for over 2000 unlisted drives for spares or repair.

- 3 1/2" Panasonic JU363/4 720K or equivalent RFE £24.95(B)
- 3 1/2" Mitsubishi MF355C-L 1.4 Meg. Laptops only £25.95(B)
- 3 1/2" Mitsubishi MF355C-D 1.4 Meg. Non laptop £18.95(B)
- 5 1/4" Teac FD-55GFR 1.2 Meg (for IBM pc's) RFE £18.95(B)
- 5 1/4" Teac FD-55F-03-U 720K 40/80 (for BBC's etc) RFE £29.95(B)
- 5 1/4" BRAND NEW Mitsubishi MF501B 360K £22.95(B)
- Table top case with integral PSU for HH 5 1/4" Floppy or HD £29.95(B)
- 8" Shugart 801/81 SS refurbished & tested £210.00(E)
- 8" Shugart 810 8" SS HH Brand New £195.00(E)
- 8" Shugart 851 8" double sided refurbished & tested £260.00(E)
- 8" Mitsubishi M2894-63 double sided NEW £295.00(E)
- 8" Mitsubishi M2896-63-02U DS slimline NEW £295.00(E)
- Dual 8" cased drives with integral power supply 2 Mb £499.00(E)

## HARD DISK DRIVES

- 2 1/2" TOSHIBA (19 mm H) MK2101MAN 2.16 Gb New £199.00
  - 2 1/2" TOSH (12.5 mm H) MK1002MAV 1.1 Gb laptop. New £115.00
  - 2 1/2" to 3 1/2" conversion kit for PC's, complete with connectors £12.95
  - 3 1/2" FUJII FK-309-26 20mb MFM I/F RFE £59.95
  - 3 1/2" CONNER CP3024 20 mb IDE I/F (or equiv.) RFE £59.95
  - 3 1/2" CONNER CP3044 40mb IDE I/F (or equiv.) RFE £69.00
  - 3 1/2" RODIME R03057S 45mb SCSI I/F (Mac & Acom) £69.00
  - 3 1/2" QUANTUM 40S Prodrive 42mb SCSI I/F. New RFE £49.00
  - 3 1/2" WESTERN DIGITAL 850mb IDE I/F New £185.00
  - 5 1/4" MINISCRIBE 3425 20mb MFM I/F (or equiv.) RFE £49.95
  - 5 1/4" SEAGATE ST-238R 30 mb RLL I/F Refurb. £69.95
  - 5 1/4" CDC 94205-51 40mb HH MFM I/F RFE tested £69.95
  - 5 1/4" HP 97548 850 Mb SCSI RFE tested £99.00
  - 5 1/4" HP C3010 2 Gbyte SCSI differential RFE tested £195.00
  - 8" NEC D2246 85 Mb SMD interface. New £199.00
  - 8" FUJITSU M2322K 160Mb SMD I/F RFE tested £195.00
  - 8" FUJITSU M2392K 2 Gb SMD I/F RFE tested £345.00
- Many other drives in stock - Shipping on all drives is code (D)

## IC's - TRANSISTORS - DIODES

OBSELETE - SHORT SUPPLY - BULK

6,000,000 items EX STOCK

For MAJOR SAVINGS - CALL OR SEE OUR WEBSITE

## VIDEO MONITOR SPECIALS

One of the highest specification monitors you will ever see - At this price - Don't miss it!!

Mitsubishi FA3415ETKL 14" SVGA Multisync colour monitor with fine 0.28 dot pitch tube and resolution of 1024 x 768. A variety of inputs allows connection to a host of computers including IBM PC's in CGA, EGA, VGA & SVGA modes, BBC, COMMODORE (including Amiga 1200), ARCHIMEDES and APPLE. Many features: Etched facemate, text switching and LOW RADIATION MPR specification. Fully guaranteed, supplied in EXCEL-

LENT little used condition. Order as TMT & Swivel Base £4.75 Only £119 (E) MITS-SVGA  
VGA cable for IBM PC included.

External cables for other types of computers CALL

As New - Ex Demo

17" 0.28 SVGA Mitsubishi Diamond Pro monitors Full multisync etc. Full 90 day guarantee. £325.00 (E)

Just In - Microvitec 20" VGA (800 x 600 res.) colour monitors. Good SH condition - from £299 - CALL for info

PHILIPS HCS35 (same style as CM8833) attractively styled 14" colour monitor with both RGB and standard composite 15.625 KHz video inputs via SCART socket and separate phono jacks. Integral audio power amp and speaker for all audio visual uses. Will connect direct to Amiga and Atari BBC computers. Ideal for all video monitoring / security applications with direct connection to most colour cameras. High quality with many features such as front concealed flap controls, VCR correction button etc. Good used condition - fully tested - guaranteed  
Dimensions: W14" x H12 1/2" x 15 1/2" D. Only £99 (E)

PHILIPS HCS31 Ultra compact 9" colour video monitor with standard composite 15.625 KHz video input via SCART socket. Ideal for all monitoring / security applications. High quality, ex-equipment fully tested & guaranteed (possible minor screen bums). In attractive square black plastic case measuring W10" x H10" x 1 3/4" D. 240 V AC mains powered. Only £79.00 (D)

KME 10" 15M10009 high definition colour monitors with 0.28" dot pitch. Superb clarity and modern styling. Operates from any 15.625 KHz sync RGB video source, with RGB analog and composite sync such as Atari, Commodore Amiga, Arc'n Archimedes & BBC. Measures only 13 1/2" x 12" x 1 1/2". Good used condition. Only £125 (E)

## 20" 22" and 26" AV SPECIALS

Superbly made UK manufacture. PIL all solid state colour monitors, complete with composite video & optional sound input. Attractive test case. Perfect for Schools, Shops, Disco, Clubs, etc. In EXCELLENT little used condition with full 90 day guarantee.

20"....£135 22"....£155 26"....£185 (F)

## DC POWER SUPPLIES

Virtually every type of power supply you can imagine. Over 10,000 Power Supplies Ex Stock Call or see our web site.

## LOW COST PC'S

Always over 1000 PC's from stock. 1000's of spares and accessories. Call or see our web site for info.

## 19" RACK CABINETS

Superb quality 6 foot 40U Virtually New, Ultra Smart Less than Half Price!



Top quality 19" rack cabinets made in UK by Optima Enclosures Ltd. Units feature designer, smoked acrylic lockable front door, full height lockable half louvered back door and louvered removable side panels. Fully adjustable internal fixing struts, ready punched for any configuration of equipment mounting plus ready mounted integral 12 way 13 amp socket switched mains distribution strip make these racks some of the most versatile we have ever sold. Racks may be stacked side by side and therefore require only two side panels to stand singly or in multiple bays. Overall dimensions are: 77 1/2" H x 32 1/2" D x 22" W. Order as:  
OPT Rack 1 Complete with removable side panels. £345.00 (G)  
OPT Rack 2 Rack Less side panels £245.00 (G)

Over 1000 racks, shelves, accessories 19" 22" & 24" wide 3 to 46 U high. Available from stock !!

## 32U - High Quality - All steel RakCab

Made by Eurocraft Enclosures Ltd to the highest possible spec, rack features all steel construction with removable side, front and back doors. Front and back doors are hinged for easy access and all are lockable with five secure 5 lever barrel locks. The front door is constructed of double walled steel with a 'designer style' smoked acrylic front panel to enable status indicators to be seen through the panel, yet remain unobtrusive. Internally the rack features fully slotted reinforced vertical fixing members to take the heaviest of 19" rack equipment. The two movable vertical fixing struts (extras available) are pre punched for standard 'cage nuts'. A mains distribution panel internally mounted to the bottom rear, provides 8 x IEC 3 pin Euro sockets and 1 x 13 amp 3 pin switched utility socket. Overall ventilation is provided by fully louvered back door and double skinned top section with top and side louvers. The top panel may be removed for fitting of Integral fans to the sub plate etc. Other features include: fitted castors and floor levelers, prepunched utility panel at lower rear for cable / connector access etc. Supplied in excellent, slightly used condition with keys. Colour Royal blue. External dimensions mm=1625H x 635D x 603 W. (64" H x 25" D x 23 1/2" W)  
Sold at LESS than a third of makers price !!



A superb buy at only £245.00 (G) 42U version of the above only £345 - CALL

## BATTERY SCOOP - 50% off !!

A special bulk purchase from a cancelled export order brings you the most amazing savings on these ultra high spec 12v DC 14 Ah rechargeable batteries. Made by Hawker Energy Ltd, type SBS15 featuring pure lead plates which offer a far superior shelf & guaranteed 15 year service life. Fully BT & BS6290 approved. Supplied BRAND NEW and boxed. Dimensions 200 wide, 137 high, 77 deep. M6 bolt terminals. Fully guaranteed. Current makers price over £70 each! Our Price £35 each (C) or 4 for £99 (D)

## RELAYS - 200,000 FROM STOCK

Save ££££'s by choosing your next relay from our massive stocks covering types such as - Military, Octal, Cradle, Hermetically Sealed, Contactors, Time Delay, Reed, Mercury Wetted, Solid State, Printed Circuit Mounting, CALL US WITH YOUR NEEDS. Many obsolete types from stock. Save ££££'s

## LOW COST RAM & CPU'S

INTEL 'ABOVE' Memory Expansion Board. Full length PC-XT and PC-AT compatible card with 2 Mbytes of memory on board. Card is fully selectable for Expanded or Extended (286 processor and above) memory. Full data and driver disks supplied. RFE. Fully tested and guaranteed. Windows compatible. £59.95  
Half length 8 bit memory upgrade cards for PC AT XT expands memory either 256k or 512k in 64k steps. May also be used to fill in RAM above 640k DOS limit. Complete with data.  
Order as: XT RAM UG. 256k. £34.95 or 512k £39.95

### SIMM SPECIALS

- 1 MB x 9 SIMM 9 chip 120ns Only £8.50
- 1 MB x 9 SIMM 3 chip 80 ns £10.50 or 70ns £11.95
- 1 MB x 9 SIMM 9 chip 80 ns £10.50 or 70ns £11.75
- 4 MB 70 ns 72 pin SIMM - with parity- Only £35.00
- INTEL 486-DX33 CPU £19.95 INTEL 486-DX66 CPU £59.00
- FULL RANGE OF CO-PROCESSOR'S EX STOCK - CALL FOR £££
- MOTOROLA 25 Mhz 68040 (XC68040RC25M) CPU'S £59.00 shipping charges for RAM / CPU upgrades is code B

## SOFTWARE SPECIALS

NT4 WorkStation, complete with service pack 3 and licence - OEM packaged. Special Price ONLY £99.00  
Microsoft - Windows for Workgroups 3.11 & DOS 6.22. Supplied on 3 1/2" disks with licence & concise documentation. £39.95  
DOS 5.0 on 3 1/2" disks with concise books c/w QBasic. £14.95  
Wordperfect 6 for DOS supplied on 3 1/2" disks with manual £24.95 shipping charges for software is code B

## TEST EQUIPMENT & SPECIAL INTEREST ITEMS

- MITS. FA34455ETKL 14" Industrial spec SVGA monitors 1KW to 400 KHz - 400 Hz 3 phase power sources - ex stock £245
- IBM 8230 Type 1, Token ring base unit driver £760
- Wayne Kerr RA200 Audio frequency response analyser £2500
- IBM 53F5501 Token Ring ICES 20 port lobe modules £750
- IBM MAU Token ring distribution panel 8228-23-5050N £95
- AIM 501 Low distortion Oscillator 9Hz to 330KHz, IEEE £550
- ALLGON 8360.11805-1880 MHz hybrid power combiners £250
- Trend DSA 274 Data Analyser with G703(2M) 64 I/O £600
- Marconi 6310 Programmable RF to 22 GHz sweep generator £6500
- Marconi 2022 10KHz-1GHz RF signal generator. £1550
- Marconi 2030 opt 30 10KHz-1.3 GHz signal generator, New HP1650B Logic Analyser £5150
- HP3781A Pattern generator & HP3782A Error Detector £1800
- HP6621A Dual Programmable GPIB PSU 0-7 V 160 watts £1800
- HP6264 Rack mount variable 0-20V @ 20A metered PSU £675
- HP54121A DC to 22 GHz four channel test set £8500
- HP8130A opt 020 300 MHz pulse generator, GPIB etc £950
- HP A1, A0 8 pen HPGL high speed drum plotters - from EG+G Brookdeal 95035C Precision lock in amp £650
- View Eng. Mod 1200 computerised inspection system £1100
- Sony DXC-3000A High quality CCD colour TV camera £1100
- Keithley 590 CV capacitor / voltage analyser £3750
- Racal ICR40 dual 40 channel voice recorder system £3750
- Fliskers 45KVA 3 Ph On Line UPS - New batteries £9500
- ICI R5030UV34 Cleanline ultrasonic cleaning system £2200
- Mann Tally MT645 High speed line printer £945
- Intel SBC 486/133SE Multibus 486 system. 8Mb Ram £2950
- Siemans K4400 64Kb to 140Mb demux analyser

- Intel SBC 486/125C08 Enhanced Multibus (MSA) NEW £1450
- Zeta 3220-05 A0 4 pen HPGL fast drum plotters £1150
- Nikon HF-X11 (Ephoria) exposure control unit £1450
- Motorola VME Bus Boards & Components List. SAE / CALL £550
- Trio 0-18 vdc linear, metered 30 amp bench PSU. New £1950
- Fujitsu M3041R 600 LPM band printer £1250
- Fujitsu M3041D 600 LPM printer with network interface £500
- Perkin Elmer 299B Infrared spectrophotometer A £3500
- Perkin Elmer 597 Infrared spectrophotometer £3750
- VG Electronics 1035 TELETEXT Decoding Margin Meter LightBand 60 output high spec 2u rack mount video VDA's £495
- Sekonic SD 150H 18 chn digital Hybrid card recorder £1995
- Traylor Hobson Talysurf amplifier / recorder £750
- ADC SB200 Carbon dioxide gas detector / monitor £1450
- System Video 1152 PAL waveform monitor £485
- ANRITSU 9654A Optical DC-2.5Gb/s waveform monitor £5,650
- ANRITSU MS9001B1 0.6-1.7 uM optical spectrum analyser £900
- ANRITSU ML93A optical power meter £990
- ANRITSU Fibre optic characteristic test set £900
- VISION ENGINEERING TS3 Dynascopic microscope £1850
- R&S FTD2 Dual sound unit £650
- R&S SBUF-E1 Vision modulator £775
- WILTRON 6630B 12.4 / 20GHz RF sweep generator £5750
- TEK 2445 150 MHz 4 trace oscilloscope £1250
- TEK 2465 300 MHz 300 MHz oscilloscope rack mount £1955
- TEK 1502 Portable TRM (time domain reflectometer) £600
- PHILIPS PW1730/10 66KV XRAY generator & accessories £600
- CLAUDE LYONS 12A 240V single phase auto. volt. regs £325
- CLAUDE LYONS 100A 240V/415V 3 phase auto. volt. regs £2900

DISTEL on the web !! - Over 16,000 items from stock - www.distel.co.uk



ALL MAIL & OFFICES  
Open Mon - Fri 9.00 - 5:30  
Dept WW, 32 Biggin Way  
Upper Norwood  
LONDON SE19 3XF

LONDON SHOP  
Open Mon - Sat 9:00 - 5:30  
215 Whitehorse Lane  
South Norwood  
On 85A Bus Route  
N. Thornton Heath & Selhurst Park SR Rail Stations

NEW DISTEL  
Visit our web site  
www.distel.co.uk  
email admin@distel.co.uk

ALL ENQUIRIES  
0181 679 4414  
FAX 0181 679 1927

All prices for UK Mainland. UK customers add 17.5% VAT to TOTAL order amount. Minimum order £10. Bona Fide account orders accepted from Government, Schools, Universities and Local Authorities - minimum account order £50. Cheques over £100 are subject to 10 working days clearance. Carriage charges (A)=£3.00, (A1)=£4.00, (B)=£5.50, (C)=£8.50, (D)=£12.00, (E)=£15.00, (F)=£18.00, (G)=CALL. Allow approx 6 days for shipping - faster CALL. All goods supplied to our Standard Conditions of Sale and unless stated guaranteed for 90 days. All guarantees on a return to base basis. All rights reserved to change prices / specifications without prior notice. Orders subject to stock. Discounts for volume. Top CASH prices paid for surplus goods. All trademarks, trademarks etc acknowledged. © Display Electronics 1998. E & O E 06/98

CIRCLE NO. 132 ON REPLY CARD

# Notes on ecl

**Emitter-coupled logic is inherently very fast and low noise, yet often avoided as it needs a -5.2V supply. But as Nick Wheeler shows here, ecl has moved forward. Nick presents a frequency-doubler design example that runs from a simple 5V rail.**

**T**his short article is intended to encourage those of you who regard c-mos as the zenith of logic to consider the remarkable features of modern emitter-coupled logic.

To illustrate the article, I will use Synergy's SY100EL16V differential line receiver. Once you understand this part, you will be able to apply all the basic logic building bricks, and more complex parts such as the SY89430V programmable synthesiser.<sup>1</sup>

### Emitter-coupled logic characteristics

The basic circuit element of ecl is a long-tailed-pair comprising conventional bipolar transistors, Fig. 1. The tail is a constant-current source. As a result, the transistors are never driven far into saturation. It is this fact that gives ecl its outstandingly high speed.

Many designers are put off by the apparently odd logic voltage levels of ecl parts, even though they have usable clock rates of hundreds of megahertz, which is undoubtedly attractive.

The long-tailed-pair configuration calls for voltage excursions

referenced to the supply voltage  $V_{CC}$ . In the early days of ecl, and because of the small excursions involved, the standard was adopted of grounding the positive  $V_{CC}$  rail and holding  $V_{EE}$  at a nominal -5V. This results in a logic-high voltage of about -900mV and a logic Low of about -1680mV.

The outputs of most ecl parts are differential and can drive 50Ω transmission lines. These must be properly terminated if more than a few centimetres long. Correct dc conditions are achieved by returning the cold ends of the terminating resistors to -2V dc, a rail normally called  $V_{TT}$ . Under such conditions successive stages can be dc coupled.

Provided the  $V_{CC}$  rail is noise free and reasonably well regulated, a conventional +5V rail can be used, with  $V_{EE}$  grounded. This is termed pecl, or positive ecl, and is becoming increasingly common.

Special translator parts are available which interface between ecl and ttl and vice versa. Operation in the pecl mode is mandatory for this.

Some ecl parts, including the SY100EL16V, are provided with a pin termed  $V_{BB}$ . This provides a bias voltage to

*Fig. 1. Basic, traditional ecl gate. Emitter coupled logic is sometimes called current-mode logic. It is fast because, unlike ttl, there's no transistor storage time involved.*

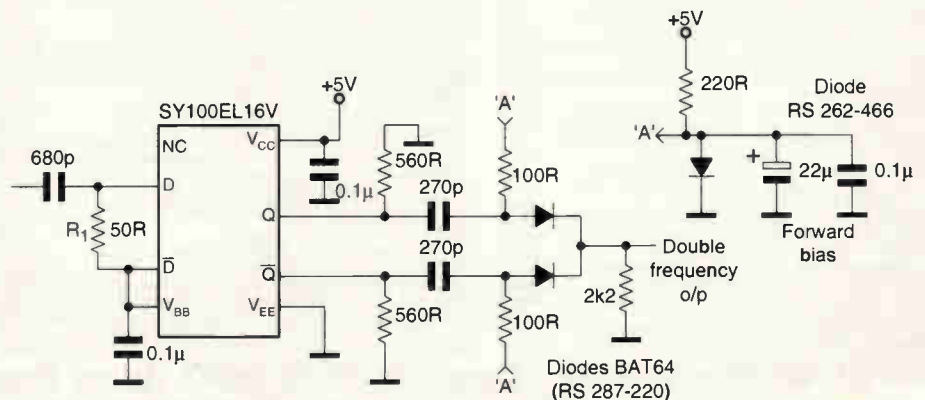
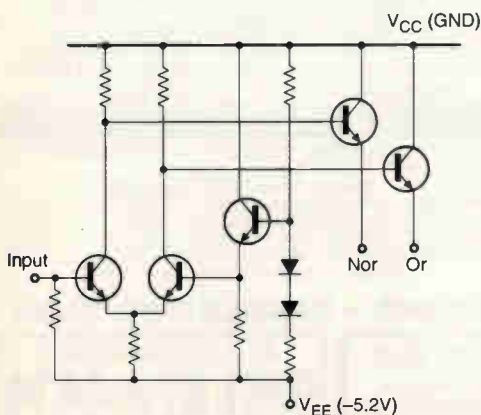

*Fig. 2. Frequency doubler made from emitter-coupled logic. This configuration works between 10MHz and at least 250MHz. Input amplitude must be 150mV or more. Output is a good square wave at twice the input frequency.*

which the inputs can be referenced for ac coupling or single ended operation.

### Using the SY100EL16V ecl receiver

The SY100EL16V comprises two cascaded long-tailed pairs followed by dual emitter followers with open emitters. These followers need to be returned to a suitable negative voltage. More on this later.

My demonstration circuit diagram is shown in Fig. 2 while Fig. 3 illustrates conventional operation at 60MHz. The lower trace in Fig. 3 shows what a good 60MHz square wave looks like on a 100MHz oscilloscope.

A small response at the third harmonic causes the peakiness of the waveform. On a spectrum analyser strong harmonics are detectable up to the 13th.

Output amplitude is virtually independent of the sinusoidal input provided the latter exceeds the specified minimum swing of 150mV. Presence of these high-order harmonics confirms that sub-nanosecond rise and fall times are being achieved.

The circuit diagram illustrates how ecl is driven in ac-coupled, single-ended mode. At the frequencies for which ecl is useful, this will usually be via a 50Ω transmission line. This is terminated properly by  $R_1$ .

The dc conditions at the two inputs are set by using  $V_{BB}$ . For ecl parts with 100 in their part number, this lies in the range of  $V_{CC}-1.38$  to  $V_{CC}-1.26$  and is thermally compensated. One of the inputs, /D, and  $V_{BB}$  are grounded for ac as shown.

There are three possible ways of setting the correct dc conditions at Q and /Q. They are fully discussed in reference 2, but are summarised here for completeness.

Where the distance to the next stage is less than 2cm or so, a matched transmission line is unnecessary. A suitable resistor from each open emitter to  $V_{EE}$  is all that is needed to permit emitter-follower action. A value of 510Ω is often quoted, but anything over this and up to 1kΩ works. I used 560Ω.

As I already mentioned, another method, the use of a terminating voltage,  $V_{TT}$ , is most easily implemented, when  $V_{CC}$  is 5V. The 5V rail can be used to feed a low-dropout 3V regulator such as the LP3982-3.0 (RS 285-4124). Output swing of ecl parts is usually specified for a 50Ω termination at the Q and /Q outputs. The other end of the termination is returned to  $V_{CC}-2V$ . This sets the emitters at the right voltage, i.e.  $V_{TT}$ .

Finally there is the Thévenin termination. In a 50Ω system, at the receiving end, an 81Ω resistor goes to  $V_{CC}$  and a 130Ω resistor to  $V_{EE}$ . In parallel, which these effectively are for signals, they look like 50Ω and at the same time set the correct dc level.

### Other uses for the SY100EL16V

Most logic families are characterised by specifying a maximum voltage which is recognised as a logic zero or low input and a minimum which is recognised as high or logic one. Between these thresholds is a region of uncertainty.

Small input excursions around the middle of this uncertain region are, in some cases, linearly reproduced at the output. This is the basis of such circuits as crystal oscillators, which are readily be realised with cmos. I decided to test the EL16 using the circuit of Fig. 1 with an input well below the specified minimum of 150mV.

A particular attraction of ecl parts with a  $V_{BB}$  output is that using this automatically biases the inputs correctly for this linear mode of operation. I used of 17.5mV pk-pk.

At 60MHz the Q and /Q outputs were a pair of good sinewaves in antiphase. The voltage gain was 37.5, which,

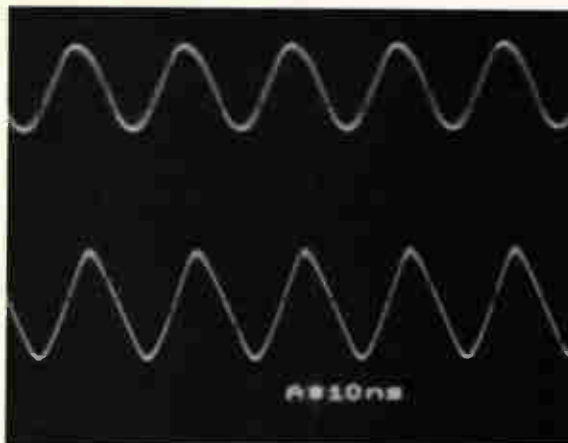

Fig. 3. The lower trace shows what a good 60MHz square wave looks like on a 100MHz oscilloscope. A small response at the third harmonic causes the peakiness of the waveform. The upper trace is a good sinewave at 60MHz and 150mV pk-pk.

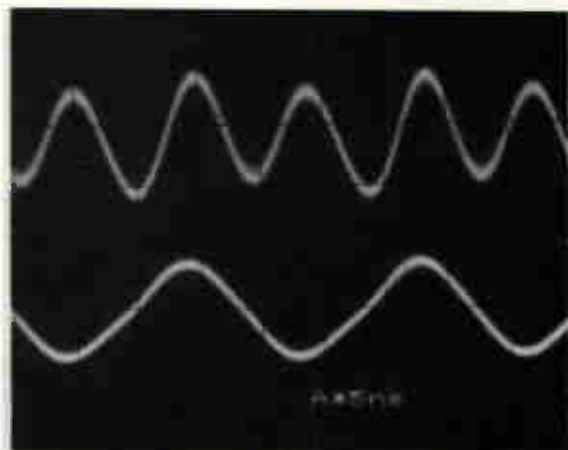

Fig. 4. Frequency doubler output with input at 60MHz, illustrating the effects of differences in stray capacitance.

allowing for measurement errors, agrees well with the specified dc gain of 40 for this part.

Since the transistors within the device have frequency responses of the order of a gigahertz, the part can clearly be used as a vhf/uhf phase splitter. There are several applications for such a circuit since it is aperiodic, e.g. as a constant amplitude phase shifter.<sup>3</sup>

Aperiodic frequency doublers all depend, basically, on full-wave rectification. They can be passive, using carefully constructed trifilar transformers, but use of the EL16 provides a compact alternative.

Figure 4 illustrates this at 60MHz input. At such frequencies the smallest differences in stray capacitance produce the effect shown. The circuit works quite well over a 2:1 frequency range, but the time constants need to be optimised for best results.

Both Q and /Q excursions are about 750mV. These are capacitively coupled to the two Schottky diodes, which have a forward voltage of about 300mV. I biased these forward by 180mV.

Voltages of this order can be obtained using the forward voltage of a Schottky power rectifier diode. These parts are specially made to keep this figure well below that of the 600mV associated with ordinary diodes. ■

### References

1. Wheeler, N, '50-950MHz frequency source', *Electronics World*, Oct. 98.
2. MECL System Design Handbook, Motorola.
3. The Art of Electronics written by Horowitz and Hill, pub. CUP. (Constant amplitude phase shifter, p. 78.)

### Technical support

For information on availability of the SY100EL16, contact Nic Houslip via nic\_houslip@compuserve.com or fax him on 0121 7337772. Prototyping boards for the pulse generator may also be available. Synergy's number is 0121 7338033.

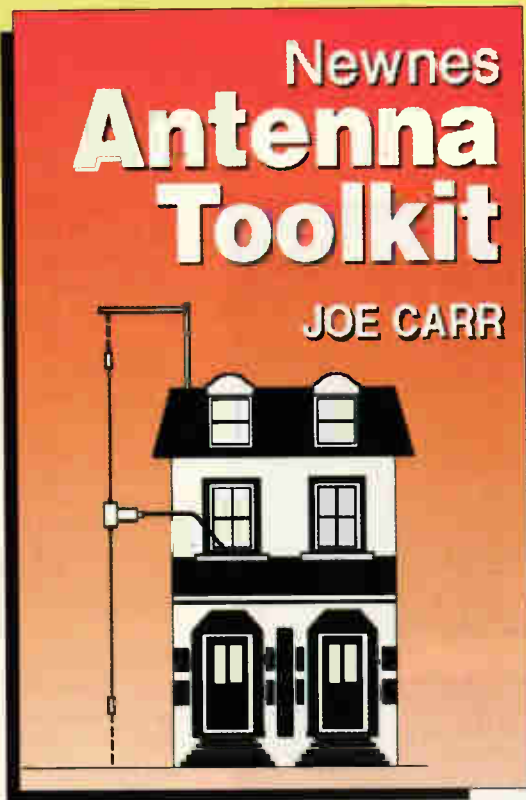

# Antenna Toolkit

by Joe Carr

Combined with antenna design software on CD-rom, Newnes' new book *Antenna Toolkit* provides a complete design solution. Prepared by antenna expert Joe Carr, this package is written for beginners and advanced users alike.

On the CD-rom is a suite of powerful software running on the pc. The software calculates the critical lengths and other parameters of the antennas in the book by having the user select the antenna type and set the frequency.

The main menu screen is in the form of tabs, one for each chapter of the book plus other topics.

This 220 page work includes 185 illustrations and 23 photographs.

**\*\* HF propagation predictor included \*\***

Also included is a Windows freeware package, from the Voice of America organization, called VOACAP. This is an hf propagation predictor which some commercial sources have offered unmodified for hundreds of dollars.

**UK Price: £27.50 Europe £30.00 ROW £32.50**

## What's in the book?

Radio Signals On The Move; Antenna Basics; Wire, Connections, Grounds And All That; Marconi and Other Unbalanced Antennas; Doublets, Dipoles And Other Hertzian Antennas; Limited Space Antennas; Large Loop Antennas; Wire Array Antennas; Impedance Matching; Simple Antenna Instrumentation & Measurements

**Includes free CD with antenna design software**



**Return to Jackie Lowe, Room L333, Quadrant House, The Quadrant, Sutton, Surrey, SM2 5AS**

Please supply the following title:

**Newnes Antenna Toolkit**

Total \_\_\_\_\_

Name \_\_\_\_\_

Address \_\_\_\_\_

\_\_\_\_\_

Postcode \_\_\_\_\_ Telephone \_\_\_\_\_

Method of payment (please circle)

Access/Mastercard/Visa/Cheque/PO

**Cheques should be made payable to Reed Business Information**

Credit card no \_\_\_\_\_

Card expiry date \_\_\_\_\_

Signed \_\_\_\_\_

**Please allow up to 28 days for delivery**

# M&B RADIO (LEEDS)

THE NORTH'S LEADING USED TEST EQUIPMENT DEALER

## OSCILLOSCOPES

HP 5420D 300 MHz 2 channel digitising (27 channels logic state triggering)	£1,500
HP 1740A 100 MHz 2 channel	£350
HP 1715A 200 MHz 2 channel	£400
TEKTRONIX 79037A 26 x 27880 200 MHz 4 channel	£450
TEKTRONIX 76037A 18A x 27853A 4 channel	£350
TEKTRONIX 7A26 200 MHz 2 channel unit (boxed new + manual)	£135
TEKTRONIX 245A 150 MHz 4 channel	£1,000
TEKTRONIX 2445 150 MHz 4 channel GP-IB	£1,200
TEKTRONIX 224A 100 MHz 4 channel autocal	£1,000
TEKTRONIX 2245 100 MHz 4 channel (NEW)	£780
TEKTRONIX 2235 100 MHz 2 channel	£600
TEKTRONIX 2230 100 MHz 2 channel digital storage	£1,500
TEKTRONIX 2225 50 MHz 2 channel	£450
TEKTRONIX 2220 60 MHz 2 channel digital storage	£1,200
TEKTRONIX 2215 60 MHz 2 channel	£335
TEKTRONIX 2150 4 slot mainframe	£150
TEKTRONIX 475A 250 MHz 2 channel	£600
TEKTRONIX 475 300 MHz 2 channel	£400
TEKTRONIX 468 100 MHz 2 channel digital storage	£600
TEKTRONIX 466 100 MHz 2 channel	£350
TEKTRONIX 465B 100 MHz 2 channel opt 05	£500
TEKTRONIX 465 100 MHz 2 channel	from £380
PHILIPS PM 3263K 100 MHz digital storage	£500
PHILIPS PM 3217 50 MHz 2 channel	£335
PHILIPS PM 3057 50 MHz 2 channel	£400
PHILIPS PM 3055 50 MHz 2 channel	£400
WATSU 55 5710 60 MHz 4 channel	£400
NICOLET 4094/4542/F43 digital scope	£900
HITACHI H1100 100 MHz 4 channel with cursors	£400
GOULD 4035 20 MHz digital storage + remote keypad	£600
GOULD 054000 10 MHz digital storage 2 channel	£190
GOULD 1401 20 MHz digital storage 2 channel	£350
GOULD 1421 20 MHz digital storage 2 channel	£400
GOULD D5300 20 MHz 2 channel	£195
GOULD 051105A 10 MHz 2 channel DIL timebase	£120
GOULD 052508 15 MHz 2 channel	£130

## SPECTRUM ANALYSERS

TEKTRONIX 496P 10 KHz-1800 MHz	£3,000
TEKTRONIX 494P 10 KHz-21 GHz (1 year Cal & warranty)	£8,000
TEKTRONIX 491P 10 KHz-21 GHz OPT 001/002/003	£5,500
TAKEEDA NIKENTRA 4172 400 Hz-1800 MHz spectrum/network analyser	£7,000
HP 1650B 80 channel 100 MHz logic analyser (new)	£1,500
HP 1652B 80 channel 100 MHz + 2 channel 100 MHz 400MHz digitizing scope	£1,750
HP CALANI 2010R sweeping analyser	£1,750
HP 8903A audio analyser	£1,500
HP 8590A 10 MHz-1.5 GHz spectrum analyser	£4,000
HP 8550B 182T 10 MHz-21 GHz	£3,000
HP 8558B 100 KHz-1500 MHz analyser + mainframe	£1,250
HP 8557A 100 KHz-250 MHz analyser + mainframe	£780
HP 8407A 8412B network analyser 0.1-110 MHz	£400
HP 3582A 0.02 Hz-25.5 KHz dual channel signal analyser	£1,800
HP 1417/8552B/8555A 10 MHz-18 GHz	£1,500
HP 1417/8553B/8556A 100 KHz-1250 MHz	£1,000
HP 1407/8552B/8553B 100 KHz-110 MHz	£450
MARCONI 3380/3382 100 Hz-400 MHz	£2,750
MARCONI TF3370 30 Hz-10 MHz digital storage	£450

## SIGNAL GENERATORS

HP 8904A DC-400 KHz multiaction synthesiser	£1,800
HP 8603D 2.3 GHz-13 GHz OPT 001/003 solid state generator (as new)	£2,500
HP 8686A 100 KHz-990 MHz signal generator	£1,750
HP 8640A 20 Hz-512 MHz signal generator	£400
HP 8620C/862420 5.9-9 GHz sweeper	£1,000
HP 8620C/86241A 1.3-6.5 GHz sweeper	£900
HP 8620C/86230B 1.8 GHz-2 GHz sweeper	£600
HP 8620C/86230A 10-1300 MHz sweeper	£600
HP 8620C sweeper mainframe (as new)	£250
HP 8005B 0.3 Hz-20 MHz pulse generator	£275
HP 3336B 10 Hz-21 MHz synthesiser/level meter	£400
HP 3320A frequency synthesiser 0.1 Hz-13 MHz	£400
HP 3314A 0.001 Hz-19.99 MHz function/waveform monitor	£1,250

HP 3312A 0.1 Hz-13 MHz function generator	£400
HP 3310B 0.0005 Hz-5 MHz function generator	£200
HP 3200B 10 MHz-300 MHz oscillator	£200
ADMET 742A 100 KHz-2.4 GHz Opt 01	£1,200
THURLEY TG230 2 MHz sweep function generator	£150
TEKTRONIX 2901 some mark generator	£200
MARCONI TF2013 10 KHz-1000 MHz signal generator	£1,500
MARCONI 2019 80 KHz-1 GHz	£1,500
MARCONI TF2018 80 KHz-520 MHz signal generator	£750
MARCONI TF2014 10 KHz-120 MHz (2000 TP201A)	£250
MARCONI TF2015/2171 10 MHz-520 MHz with synchroniser	£400
MARCONI TF2015 10 MHz-520 MHz	£250
FARNELL SSC520 10 MHz-520 MHz synthesised	£335
FLUKE 6011A 10 MHz 11 MHz synthesised signal generator	£1,000
RHOODES & SCHWARTZ APN62 0.1 Hz-260 KHz LF gen (new)	£2,000
GIGA GR110A 1.2 GHz-1.8 GHz pulse generator	£400
PHILIPS PM5190 1 MHz-2 MHz LF synthesiser (new)	£400
WAYTEK 193 20 MHz sweep modulation generator	£400
WAYTEK 182 0.002 Hz-2 MHz function generator	£175
SAYROSA MA 30 10 Hz-100 KHz	£175

## TEST EQUIPMENT

ANRITSU M565A 2 GHz error detector	£950
ANRITSU MS509C1 voltmeter monitor (boxed new with manuals)	£750
AVO 215-LZ AC/DC breakdown/insulation tester	£400
AVO CT1870 valve tester + vilo	£150
BALL EFR10M MRT-M rubidium frequency standard	£4,000
BIRD 8922 5000W 50 Ohm coaxial resistor	£1,000
BIRD 8329 300W 30dB attenuator	£500
BIRD 9323 100W 30dB attenuator	£200
BRADLEY 193 oscilloscope calibrator	£300
BRUEL & KJAER 2515 vibration analyser (AS NEW)	£3,000
BRUEL & KJAER 1023 sine generator	£1,250
BRUEL & KJAER 201 measuring amplifier	£2,000
BRUEL & KJAER 2971 phase meter	£300
DATRON 1085 autocal digital multimeter	£400
EIP 549A 10 Hz-36.5 GHz microwave counter	£2,000
EIP 331 12.5 GHz autocal microwave counter	£175
FARNELL PDA3302A dual power supply 0-35v 2 amp	£400
FARNELL 10335 electronic logic synthesiser	£100
FARNELL SC650 synthesised clock generator	£250
FARNELL TS700 power supply 0-70V 0-10 amp	£195
FARNELL LT320 2a 0.30v 1 amp	£145
FARNELL LT305 0.30v 5 amp	£100
FLUKE 850A digital multimeter	£250
FLUKE 850A thermal RMS multimeter	£1,000
FLUKE 5440B direct volts calibrator	£4,950
FLUKE 5205A precision power amp	£275
FLUKE 5200A AC calibrator	£2,000
FLUKE 3330B prec constant current/voltage calibrator	£450
HP 5943A HP-IB common carrier interface	£125
HP 5940A bus system analyser	£195
HP 11710A down converter	£250
HP 1845B 150 MHz-18 GHz modulator	£350
HP 11552A attenuator set DC-18 GHz	£500
HP 8970A noise figure meter	£3,500
HP 8975A storage normaliser	£300
HP 8505A vector voltmeter	£3,250
HP 8477A RF power meter calibrator	£225
HP 4488A DC power supply 0-600V 0.15 amp	£250
HP 6291A DC power supply 0-60V 0.5 amp	£185
HP 6261A DC power supply 0-20V 0.10 amp	£250
HP 3345A 1.5 MHz-26.5 GHz counter/RS355A/355A-B sensors	£2,000
HP 3342A 1.5 MHz-18 GHz microwave frequency meter	from £900
HP 3335A universal systems counter high stability OPT	
HP 3334A universal systems counter	
HP 1802A waveform recorder	
HP 5087A distribution amplifier (new)	
HP 5004A signature analyser £150 HP 5005A signature multimeter	
HP 8954A protocol analyser + HP 18135A pod	£2,000
HP 3770B telephone line analyser	£500
HP 3761A error detector	£200
HP 3754A selective level meter	£300

HP 3702B/3705 IF/RF Receiver + 3710A/3716A IF/RF transmitter	£400
HP 3586C 50 Hz-32.5 MHz selective level meter	£1,500
HP 3581A 15 Hz-50 KHz selective voltmeters as new	£500
HP 1468A 4.5 digit multimeter/auto cal (LCD)	£400
HP 1466A 4.5 digit autoranging multimeter	£200
HP 3455A 4.5 digit bench multimeter	£495
HP 1437A 3.5 digit high speed signal voltmeter	£1,600
HP 1645 data error analyser	£195
HP 436A RF power meter	£650
HP 4358/81B/81B/484A/11708A 10 MHz-18 GHz (new/HP case/manuals)	£1,000
HP 435A/8482AH 100 KHz-4.2 GHz RF power meter	£500
HP 400 E 10 Hz-10 MHz AC voltmeter	£95
HP 333A distortion analyser	£1,000
HP R332 series R controller	£1,000
KEMO DP1 1 Hz-100 KHz phase meter (new)	£100
LINPLEX X31 HF receiver	£200
MARCONI 6593A VSWR indicator	£250
MARCONI TF2955B RF communications test set	£4,000
MARCONI TF2871 data communications monitor	£750
MARCONI TF2610 true RMS voltmeter	£600
MARCONI TF2306 programmable interface unit	£250
MARCONI TF2305 mod meter 50 KHz-2.3 GHz	£2,000
MARCONI TF2938 audio power meter	£150
NARDA 3044B-20 37 GHz-4.3 GHz 20dB directional coupler (new)	£150
NARDA 3004-10 4-10 GHz 10dB directional coupler	£100
RACAL RA1773 30 MHz receivers	£650
RACAL RA1710 30 MHz valve receivers	£150
RACAL DANA 9921 10 Hz-3000 MHz frequency counter	£1,000
RACAL DANA 9919 10 Hz-1100 MHz frequency counter	£295
RACAL DANA 9916 10 Hz-520 MHz frequency counter	£150
RACAL DANA 9915 10 Hz-520 MHz frequency counter	£95
RACAL DANA 9914 10 Hz-300 MHz frequency counter	£85
RACAL DANA 9908 10 Hz-1100 MHz universal counter timer	£400
RACAL DANA 9904H 50 MHz universal counter timer	£200
RACAL DANA 9301A true RMS RF millivoltmeter	£400
RACAL DANA 9302A true RMS RF millivoltmeter 10 KHz to 1.5 GHz	£475
RACAL DANA 9308B RMS voltmeter (new)	£250
RACAL DANA 9300 RMS voltmeter	£200
RACAL 9343M LCR bridge	£395
RACAL 9008 1.5 MHz-2000 MHz automatic modulation meter	£300
RACAL DANA 1992 10 Hz-1300 MHz nanosecond counter	£595
RACAL DANA 1991 10 Hz-160 MHz universal counter timer 9 digit	£295
RACAL DANA 6000 microprocessing digital voltmeter	£250
RF MICROSYSTEMS INC AN/TCR-176 VHF/UHF K&L filters	£400
RHOODES & SCHWARTZ GA082 PSK analyser	£300
RHOODES & SCHWARTZ URE 10 Hz-20 MHz RMS voltmeter	£400
RYCOM 4040 selection level meter	£250
SAYROSA AMH 1.5 MHz-2 GHz automatic modulation meters	£175
SCHLUMBERGER T102 digital transmission analyser (new)	£500
SIEMENS W2108 200 KHz-30 MHz level meter	£350
SIEMENS W2108 200 KHz-30 MHz level oscillator	£350
TEKTRONIX A6938A isolator	£250
TEKTRONIX 1141/SPGI/75G11 pal video generator	£1,500
TEKTRONIX 521A vector scope	£300
TEKTRONIX 145 pal gen lock test signal generator	£1,500
THURLEY 1503 1 GHz frequency counter	£145
WAYTEK 1018A log lin RF peak power meter DC-26 GHz	£1,000
WAYNE KERR AMM255 audio modulation meter	£450
WALLIS T100 100 Kw insulation tester	£1,000
W & G DLA5 data line analyser	EPOA
W & G DLA3 data bus test set	EPOA
W & G SPN19 50 Hz-25 MHz level measuring set	£500
W & G SPM31 200 Hz-620 KHz level meter	£750

## SPECIAL OFFERS

AVO 8 MHz testmeter with case & probes	£75
BRUEL 43 RF wattmeters	£95
FLUKE 25 high spec digital multimeters with manual & probes (as new)	£70
MARCONI TF3371 digital synchronisers (for MARCONI 2015)	£75
RACAL RA17L 30 MHz receivers	£150

Visit our Web site

<http://www.mb-radio.co.uk>

e-mail [info@mb-radio.co.uk](mailto:info@mb-radio.co.uk)

86 Bishopgate Street, Leeds LS1 4BB

Tel: (0113) 2435649 Fax: (0113) 2426881

CIRCLE NO.133 ON REPLY CARD

Those Engineers Ltd



Spicycle™

## The World is getting onto Spicycles!

Jump onto the future today – tomorrow's electronic engineering CAD from the UK's leading simulation author.

- Schematic editing – publication quality images
- Analogue + mixed mode digital simulation with extended SPICE-like functions
- Upgrade path to extensive range of drawing tools each with high definition visuals
- TrueType fonts
- Back annotation of components from simulator
- Simulate directly from your drawings for the ultimate in design checking
- Import & reverse engineer SPICE net lists
- Library includes electronic + mechanical engineering benchmark devices
- Upgrade path from Geswin (existing customers)
- 12 months maintenance included (limited introductory offer)

Please contact Charles Clarke at Those Engineers Ltd, 31 Birkbeck Road, LONDON NW7 4BP.

Tel +44 (0) 181 906 0155

Fax +44 (0) 181 906 0960

e-mail [Those\\_Engineers@compuserve.com](mailto:Those_Engineers@compuserve.com)

web <http://www.spiceage.com>

CIRCLE NO.134 ON REPLY CARD

# electronicsWEEKLY

## HyperACTIVE

CONNECT WITH THE UK'S  
NO. 1 READ FOR ELECTRONICS  
PROFESSIONALS ON THE  
INTERNET

Electronics Weekly HyperACTIVE is more than just a magazine on the Web. Check out the site and you'll see why thousands of electronics professionals around the world regularly log on to [www.electronicweekly.co.uk/](http://www.electronicweekly.co.uk/)

For **News** HyperACTIVE's Daily News Service brings you the latest news in the industry - as it breaks. For **Jobs** HyperACTIVE has the largest and most varied collection of jobs available in the electronics market. Now we bring you the improved **Jobs and Careers** service with a whole range of new and exciting features.

All this plus, the **latest technology**, market information, toolkit's, a searchable archive, and loads more....

Don't miss out.

Point your browser at <http://www.electronicweekly.co.uk/>  
register now (it's free)

SPONSORED BY

ALTERA®

**EPIC**  
*Good people to deal with!*

**Jones**  
resourcing

**Tektronix**

**TOSHIBA**

**XILINX®**  
The Programmable Logic Company™

ADVERTISER INFORMATION: 0181 652 3639 OR E-MAIL: [richardnapier@rbi.co.uk](mailto:richardnapier@rbi.co.uk)

# RMS

## watt, or not?

**When you see a power amplifier advertised as 100 watts rms, what - if anything - does it mean? Lawrence Woolf explains.**

**I** sometimes see the term 'watts rms' used in published text and advertisements. As 'rms' may be correctly applied to voltage and current it seemed worth while to examine the implications and meaning, if any, of applying it to power. This requires a degree of mathematics. Even if you are not interested in the maths, you might still find the summary interesting.

### DC power

If you apply a constant dc voltage to a fixed resistor, the current through the resistor and the power dissipated in it are easily calculated using Ohm's law,

$$I = \frac{E}{R} \quad (1)$$

where  $E$  is the applied voltage, or electromotive force.  $R$  is the resistance in ohms and  $I$  is the load current in amps. For power,

$$W = E \times I \quad (2)$$

or,

$$W = \frac{E^2}{R} \quad (3)$$

where  $W$  is the power dissipated in watts.

This power may be used in various ways but here we only need to consider that heat is generated. The rise in temperature that results from the power applied will depend on factors such as the power dissipated and the power radiated.

After a period of time a steady state is achieved. At this point, the radiated power balances the applied power and the load stays at a constant temperature somewhere above the ambient temperature.

As an example, a soldering iron takes some time to reach its working temperature and then should maintain it steadily.

### AC power

As far as heating the soldering iron is concerned, it does not matter whether the energy applied involves an alternating voltage or a direct voltage. The next task is to define the

alternating voltage that will supply the same heating energy as the direct voltage.

The problem is that the alternating voltage is, by definition, constantly varying. If the iron is powered by our mains at a frequency of 50Hz then each repeated sinusoidal cycle takes 20ms which is  $1/50$ th of a second, Fig. 1a). At time 0, the voltage is zero but rising.

After 5ms, the voltage reaches its positive peak, which I will call  $E_p$ . After a further 5ms, at 10ms, the voltage is back to zero but falling. At 15ms the voltage reaches its negative peak,  $-E_p$ . At 20ms the voltage is back to zero again and rising again as the sequence is repeated.

During this cycle the voltage has reached a positive peak and a negative peak. It has also been zero three times and has passed through every possible intermediate value twice. Which of these values, if any, could be used as a definitive value?

What is needed is a value that is numerically the same as for the direct voltage that will heat the iron to the same temperature. This is clearly not the peak value as, for most of the time, the magnitude of the voltage is below this.

We need to find a constant that we can multiply the peak value by to give the equivalent heating power of a known dc voltage. The constant seems likely to be less than one. This now raises the problem of also defining the alternating power which is also varying during the cycle.

In Fig. 1b) the ac voltage waveform is shown together with the power waveform. As the power is proportional to  $E^2$  both the positive and negative voltage peaks correspond to positive power peaks. When the voltage is zero, so is the power.

The resulting waveform is a raised cosine and has a frequency that is twice that of the voltage waveform. The load is assumed to be purely resistive so the power cannot, at any time, have a negative value.

A mathematical description is given by saying that,

$$E_t = E_p \sin(\omega t) \quad (4)$$

where  $E_t$  is the instantaneous voltage at time  $t$ ,  $E_p$  is the peak voltage and  $\omega$  is the angular frequency in radians per second, i.e.  $2\pi f$  where,  $f$  is the frequency in hertz.

Lawrence D. Woolf, BA(Hons), BSc, Dip. Math. (Open), GJ3RAX.

By using equations 3 and 4, with appropriate subscripts, the power waveform may be defined,

$$W_t = E_p^2 \times \frac{\sin^2(\omega t)}{R} \tag{5}$$

$$= E_p^2 \times \frac{1 - \cos(2\omega t)}{2R} \tag{6}$$

where  $W_t$  is the instantaneous power at time  $t$  and  $R$  is now the resistance of the soldering iron.

Equation 6 shows, by using a standard trigonometric substitution, that the power waveform is indeed a raised cosine at twice the frequency of the voltage waveform.

Figure 1c) shows that the average value of the power waveform is half the peak value. The waveform is symmetrical about the average power line.

$$W_{AV} = \frac{W_p}{2} \tag{7}$$

where  $W_{AV}$  is the average power and  $W_p$  is the peak power.

This average power is the heating power provided to the soldering iron and must be equivalent to the original dc power if it causes the iron to operate at the same temperature.

It is now possible to equate the dc and ac powers to derive the required constant to equate equivalent dc and ac voltages. Using equation 3, but with the peak ac values,

$$W_p = \frac{E_p^2}{R} \tag{8}$$

so that,

$$W_{AV} = \frac{E_p^2}{2R} \tag{9}$$

but,

$$W_{AV} = W_{dc} = \frac{E_{EQ}^2}{R} \tag{10}$$

where  $W_{dc}$  is the power from the dc source and  $E_{EQ}$  is the equivalent direct voltage.

We can now use equations 9 and 10 to find the relationship between the peak alternating voltage,  $E_p$ , and the equivalent direct voltage,  $E_{EQ}$ .

$$\frac{E_p^2}{2R} = \frac{E_{EQ}^2}{R} \tag{11}$$

This re-arranges to,

$$E_{EQ}^2 = \frac{E_p^2}{2} \quad \text{so that,} \quad E_{EQ} = \frac{E_p}{\sqrt{2}}$$

or

$$E_{EQ} \approx E_p \times 0.707$$

We now have our conversion factor that gives us the equivalent direct voltage that will produce the same heating effect as an alternating voltage, of known peak value, in a constant resistive load. This equivalent voltage is more commonly known as the rms voltage or  $E_{RMS}$  which now needs to be defined.

**Root-mean-square**

I have now stated that when an alternating voltage is applied to a resistive load it will have the same heating effect. in that

load, as a direct voltage whose value is numerically the same as the rms value of the alternating voltage. I will next explain rms, and how to calculate it.

RMS is the abbreviation for root-mean-square. It is used in statistics as well as physics so is a useful concept. In order to apply it to a given waveform, such as a sine wave, rms can be considered in stages.

- Divide the waveform into narrow vertical slices, one is shown in Fig 1d). Each slice is narrow enough to consider it as having a single amplitude value.
- Square each value.
- Sum the values then divide the sum by the number of slices. You now have the mean of the squares.
- Finally, take the square root. This gives the square root of the mean of the squares of the sliced waveform.

The equation used in statistics is,

$$RMS \text{ value} = \sqrt{\frac{(x_1^2 + x_2^2 + x_3^2 \dots x_n^2)}{n}} \tag{12}$$

where  $x$  is the size of each slice or sample and  $n$  is the number of slices.

As we are considering a repetitive waveform that is easily defined mathematically there is a simpler way of performing the calculation. At least it is simpler for those of us who are familiar with integral calculus. The appropriate form of the equation is given by,

$$E_{RMS} = E_p \sqrt{\frac{1}{T} \int_0^T \sin^2(\omega t) dt} \tag{13}$$

where

$T$  is the time period under consideration.

The time period could be any that defines the symmetry of the waveform. For a sine wave just a quarter cycle is adequate as the following quarter cycles may be shown to be rotations or reflections of the first one. Therefore a suitable value for  $T$  is  $\pi/2$ , although the same result is achieved using  $\pi$  or  $2\pi$ .

In order to solve equation 13 we can put in this value and use the same trigonometric substitution used in equation 6.

$$\begin{aligned} E_{RMS} &= E_p \sqrt{\frac{2}{\pi} \int_0^{\frac{\pi}{2}} \frac{1}{2} (1 - \cos(2\omega t)) dt} \tag{14} \\ &= E_p \sqrt{\frac{2}{\pi} \left[ t - \frac{1}{2} \sin(2\omega t) \right]_0^{\frac{\pi}{2}}} \\ &= E_p \sqrt{\frac{1}{\pi} \left[ \left( \frac{\pi}{2} - \frac{1}{2} \sin(\omega\pi) \right) - \left( 0 - \frac{1}{2} \sin(0) \right) \right]} \\ &= E_p \sqrt{\frac{1}{\pi} \times \frac{\pi}{2}} = \frac{E_p}{\sqrt{2}} \approx E_p \times 0.707 \end{aligned}$$

This is the same result as found in equation 11. Previously it was found by considering the symmetry of a sine wave. This result has been derived using the definition of rms and may be applied to any waveform.

A true-rms voltmeter displays the rms value even if the waveform is not a sine wave. However most ac voltmeters actually measure the peak value and are scaled to divide by  $\sqrt{2}$  even if the waveform is not a sine wave. Exactly the same argument applies to defining rms current as voltage.



**But rms power?**

Suppose we now apply the same calculation to the power function as we have done to the voltage function. We have found the ratio of  $E_P$  to  $E_{RMS}$  so we should be able to find the ratio of  $W_P$  to  $W_{RMS}$ .

Where we had to integrate a function involving  $\sin^2(\omega t)$ , we now have to integrate a function involving  $\sin^4(\omega t)$ . This is a little more complicated but there are standard trigonometric substitutions available that make the expression easier to handle.

Start by assuming that there is a meaningful relationship between  $W_{RMS}$  and  $W_P$ . From equations 5 and 8,  $W_i = E_p^2 \sin^2(\omega t) / R = W_p \sin^2(\omega t)$ . This leads to the assumption that,

$$W_{RMS} = W_p \sqrt{\frac{1}{T} \int_0^T \sin^4(\omega t) dt} \tag{15}$$

Again I am taking  $T$  as  $\pi/2$ . Using the same substitution as in equation 6,

$$\sin^2(\omega t) = \frac{1}{2}(1 - \cos(2\omega t))$$

therefore,

$$\sin^4(\omega t) = \frac{1}{4}(1 - 2\cos(2\omega t) + \cos^2(2\omega t))$$

also,

$$\cos^2(2\omega t) = \frac{1}{2}(1 + \cos(4\omega t))$$

so that,

$$\begin{aligned} \sin^4(\omega t) &= \frac{1}{4} \left( 1 - 2\cos(2\omega t) + \frac{1}{2}(1 + \cos(4\omega t)) \right) \\ &= \frac{3}{8} - \frac{1}{2}\cos(2\omega t) + \frac{1}{8}\cos(4\omega t) \end{aligned}$$

Substituting in equation 15 now gives,

$$\begin{aligned} W_{RMS} &= W_p \sqrt{\frac{2}{\pi} \int_0^{\pi/2} \left( \frac{3}{8} - \frac{1}{2}\cos(2\omega t) + \frac{1}{8}\cos(4\omega t) \right) dt} \\ &= W_p \sqrt{\frac{2}{\pi} \left[ \frac{3t}{8} - \frac{1}{4}\sin(2\omega t) + \frac{1}{32}\sin(4\omega t) \right]_0^{\pi/2}} \\ &= W_p \sqrt{\frac{2}{\pi} \left( \frac{3\pi}{16} \right)} = W_p \sqrt{\frac{3}{8}} \approx W_p \times 0.612 \end{aligned}$$

but from equation 7,  $W_{AV} = W_P/2$  or  $W_P = 2W_{AV}$ . This means that  $W_{RMS} = W_{AV} \times 1.225$ .

**In summary**

The implication of all this is that a transmitter that puts out 100W average power might also be said to have an output of 122.5W rms. This is hardly the same thing and would seem to have no practical or physical significance. It is merely a mathematical curiosity.

Alternatively one might assume that if someone claims an output of 100W rms then they are actually transmitting 81.63W average. The fact that it can be calculated does not,

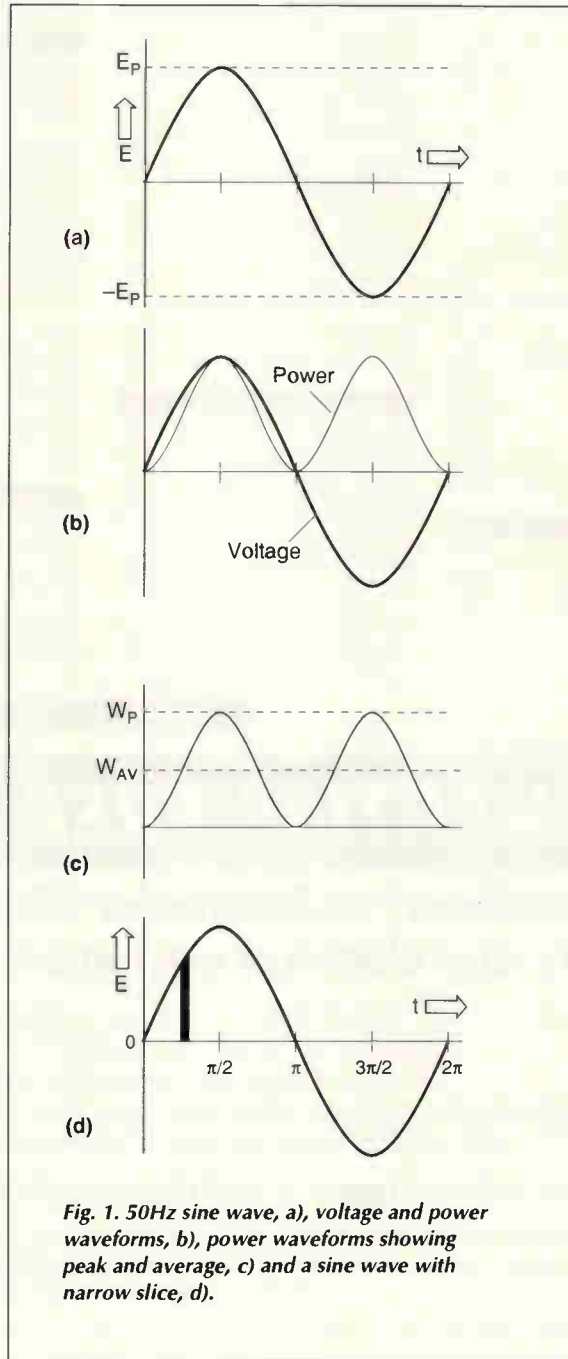

Fig. 1. 50Hz sine wave, a), voltage and power waveforms, b), power waveforms showing peak and average, c) and a sine wave with narrow slice, d).

in itself, imply that it could be useful.

The only useful result is that the product of rms voltage and rms current is average power. It is not rms power – even if it looks like a logical expectation. This is the same for mains frequency power, audio power and radio frequency power.

I suspect that those that use the term probably mean ‘average power under continuous sine wave’. In this case a term such as ‘continuous average power’ would seem more appropriate, especially if an unregulated power supply is used.

If anyone knows of a genuine reason for using the term ‘watts rms’ then please let me know ([lawrence@iil.net](mailto:lawrence@iil.net)). ■



# Vann Draper Electronics Ltd

**The test & measurement specialists**

Vann Draper has announced that it has signed an agreement with **Grundig Test and Measuring Systems** of Germany to represent their complete product line. The Grundig range covers three main areas –

**Laboratory Measuring Instruments** including oscilloscopes, power supplies, function generators, arbitrary function generators, audio signal generators, frequency counters, LF and RF millivolt meters, bench multimeters and RCL meters with a strong emphasis on RS232 and IEEE interfaces.

**Video Measuring Instruments** including PALplus studio encoders/decoders and PAL/PALplus/NICAM signal generators.

**Antenna Measuring Instruments** including combination measuring receivers for terrestrial/satellite analogue and digital transmissions.

Brief details and prices (including free delivery) of just some of the products in the Laboratory Measuring Instruments range are shown here. All units with RS232 are available with optional Labview s/w for £45.00 ex vat, inc del.

**Vann Draper Electronics Ltd at Unit 5, Premier Works, Canal Street, South Wigston, Leicester LE18 2PL. Tel: 0116 2771400 Fax: 0116 2773945 E-mail sales@vanndraper.co.uk www.vanndraper.co.uk**

## **DM100 4.5 digit multimeter £349 ex vat, inc del**

The multimeter features 0.05% accuracy, a 16 digit alphanumeric back lit display, microprocessor self test and RS232 interface.



## **FG100 20MHz function gen £495 ex vat, inc del**

The function generator (synthesiser) operates over the range 0.5Hz to 20MHz and features a 2 x 16 digit alphanumeric back lit display, microprocessor self test and RS232 interface.



## **MO30 30MHz oscilloscope £399 ex vat, inc del**

The oscilloscope features 2 channels, a 3dB bandwidth of 30MHz, 2kV accelerating voltage, 8X10cm screen, and X/Y modes. The vertical sensitivity is 5mV to 20V/div in 1-2-5 sequence and the time base covers the range 0.5us to 200ms also in 1-2-5 sequence



## **RLC100 RCL meter £329 ex vat, inc del**

The meter features 0.5% accuracy, 4 line measurement, 16 digit alphanumeric back lit display, microprocessor self test and RS232 interface.



## **Soft workshop – windows 95/NT £209 ex vat, inc del**

The Soft workshop contains a host of features allowing automated measurements from individual instruments running as virtual instruments within the PC environment.

The minimum requirements are a 486DX with 15MB free hard disk space, at least one free RS232 interface and Windows 95 or NT.



## **SC600 System controller £335 ex vat, inc del**

Each system controller allows up to six individual instruments to be controlled via a single RS232 interface. Its cascading capability allows several controllers to be connected to increase the number of instruments still further.

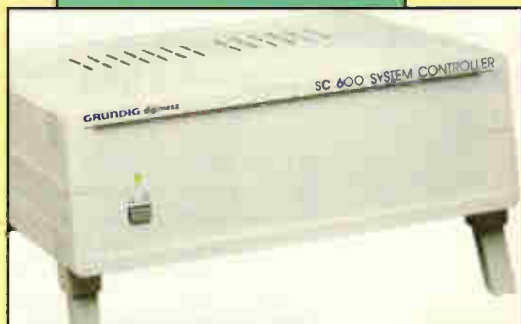

## **UZ2400 2.4GHz frequency counter £329 ex vat, inc del**

The frequency counter covers the range 10Hz to 2.4GHz and features a 16 digit alphanumeric back lit display, microprocessor self test and RS232 interface.





# Flying comms links take off

**Iridium and GlobalStar are well known in the wireless communications field as they try to establish a network of low earth orbit communications satellites. But Angel Communications are hoping to leapfrog the big boys by putting wireless datacomms equipment into an airplane. Tom Foremski reports.**

**I**n the race to provide low priced, wireless broadband data communications, US firm Angel Technologies stands out from other approaches with a novel solution based on high flying planes.

While competitors such as Iridium, and GlobalStar are trying to establish a network of hundreds of low Earth orbit, or LEO, satellites, Angel plans to launch what it terms 'atmospheric satellites' above metropolitan areas around the globe.

By packing wireless data communications equipment into an airplane rather than a satellite, Angel believes it can offer cheaper and better services than satellite-based systems. The plane would fly in about a 30km diameter circle above a metropolitan area offering line of sight communications.

But finding a plane that can carry a payload of about a ton of communications equipment with 30kW of electrical power and fly relatively slowly to conserve fuel, while

reaching an altitude of about 16km, well above commercial air traffic, was not easy explains Angel CEO Marc Arnold.

The company eventually found what it needed, the Proteus airplane, an unusual looking craft, 17m with a 28m wing span and a shorter forward wing manufactured by Wyman-Gordon and Raytheon Systems. Designed by Burt Rutan, Proteus is similar to Rutan's famous Voyager aircraft, the first to circle the earth without refuelling. Using Proteus, Angel will build what it calls the High Altitude Long Operation (HALO) network.

Because of the shorter distance from Earth to sky, in this case about 16km compared with more than 600km for low earth orbit satellites, there is less transmission delay and it is less costly than launching satellites. In addition LEO satellite networks have to be constantly replenished with satellites since the slight bit of atmosphere at those altitudes eventually brings down the satellites. This is not

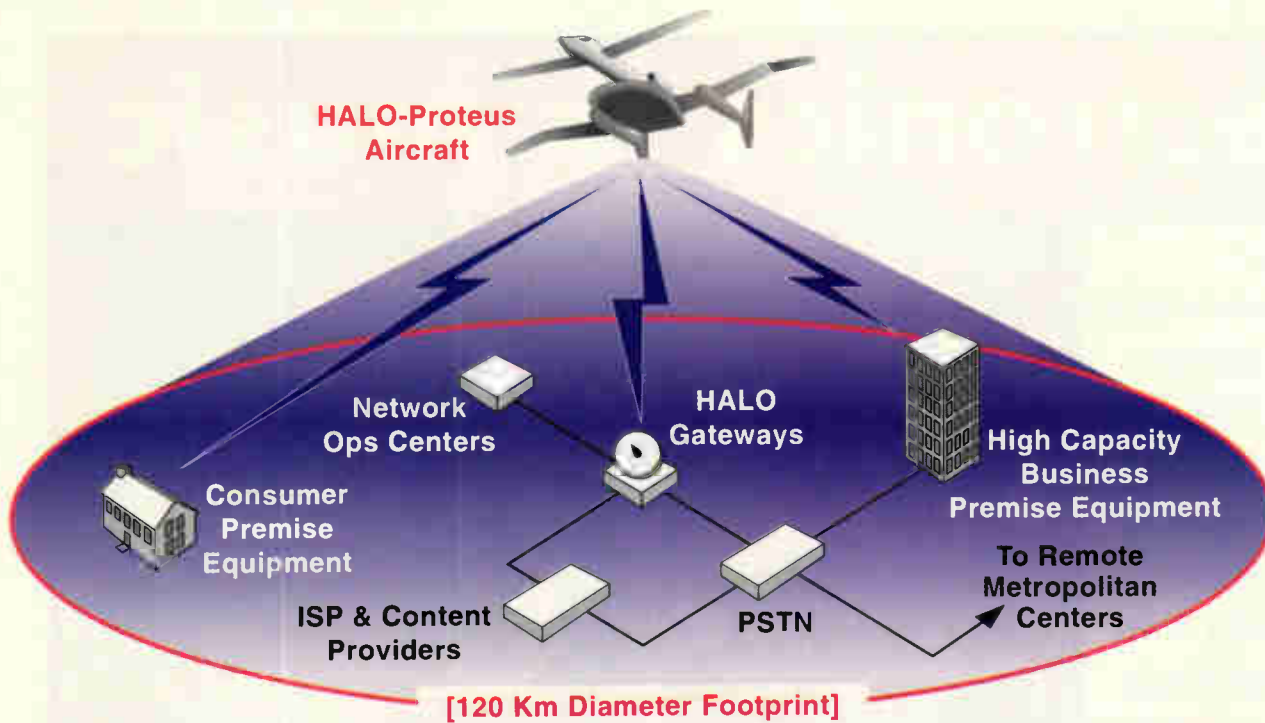

to say that a Proteus can stay up indefinitely of course.

The organisation is setting ambitious targets for system capability. "With the HALO network, we start off with 10Gbit/s data capability, and can offer much higher data densities per square mile than satellites," says Arnold. "In addition, it's easy for us to update the communications equipment as we need, eventually offering as much as 200Gbit/s."

Using the stratosphere for a communications platform is not entirely new. The US venture Sky Station International is proposing a similar idea, but using large blimps carrying telecommunications gear. Operating in the stratosphere, the blimp platforms would relay data traffic in a similar plan to that of Angel's HALO planes.

"We share the same view with Sky Station, that the stratosphere is the best place for locating communications systems. But it will be a challenge for Sky Station to receive the regulatory approval from the FAA (Federal Aviation Administration) for their unmanned vehicles. With the HALO planes, we are using FAA approved systems so there are no regulatory hurdles," says Arnold.

The HALO network also avoids regulatory problems on the ground. Terrestrial wireless data networks need to negotiate a complex and lengthy permit process to establish antennas and relay stations. In addition, increasing numbers of US neighbourhoods are becoming more resistant to allowing a proliferation of antennas on hills and tall buildings.

The first inaugural flight of a HALO plane took place in mid-September. A HALO-Proteus plane, its belly bristling with communications gear, took off from an airstrip in the California Mojave desert, and reached an altitude of 10km. It then proceeded to test out various aerial manoeuvres and its communications equipment. The plane passed all tests with flying colours.

"The plane performed flawlessly. It can climb at 1.2km/min, handles beautifully and takes off and lands easily. It is remarkably stable," said chief test pilot Mike Melvill. "We couldn't be more pleased."

The communications equipment also performed well. Angel demonstrated a 52Mbit/s wireless data link with the ground and more than 1.5Tbit of data were transported during the eight hour test flight.

Angel is so pleased with the performance of the HALO Proteus planes that he has signed an agreement with manufacturer Wyman-Gordon for exclusive rights to the plane for communications applications and options for 100 aircraft in a deal worth about \$760m.

"Making sure that the HALO-Proteus planes can do the job was an important part of reducing the risk in the venture. We can now concentrate on rolling out the system and raising additional financing," said Arnold.

Angel plans to use the best line-of-sight wireless data technologies available. Currently, that would mean microwave Local Multipoint Distribution Service, or LMDS, systems operating in the 20GHz and 24GHz bands. It is currently negotiating for spectrum licenses and is talking with potential investors interested in its first HALO network which will be for the Los Angeles metropolitan area, with a goal to begin services in 2000. That first HALO network will cost about \$250m but additional metropolitan areas will cost under \$100m.

Angel has plans to roll out similar services in 30 US metropolitan areas and also in overseas locations. But will a communications system based on aircraft succeed, especially since weather conditions regularly ground aircraft?

Angel has it all figured out. "Flying at 52 000 feet [16km] we are above most weather conditions, including hurricanes. And if we cannot take off or land from our primary airport, we use secondary locations. Even large weather systems are only a couple of hundred miles wide, which is nothing for the range of our HALO planes," points out Arnold.

Angel claims that its communications technology can easily handle interference caused by rain attenuation and that alongside a ground network, it can provide the reliability customers need.

The goal is to have three HALO planes for each metropolitan area, with three shifts of a two person pilot crew. The pilots will handle the take-off and landing but once they reach cruising altitude, an autopilot will hold the plane in a gentle circular flight pattern.

"One pilot can snooze while the other monitors the craft and communications gear," says Arnold. "Plus, they'll have the fastest Internet access on the planet." ■

# Electronics in music

From the Theremin to the electric guitar: **Richard Brice** looks at instruments that involve electronics and discusses their uses in modern music.

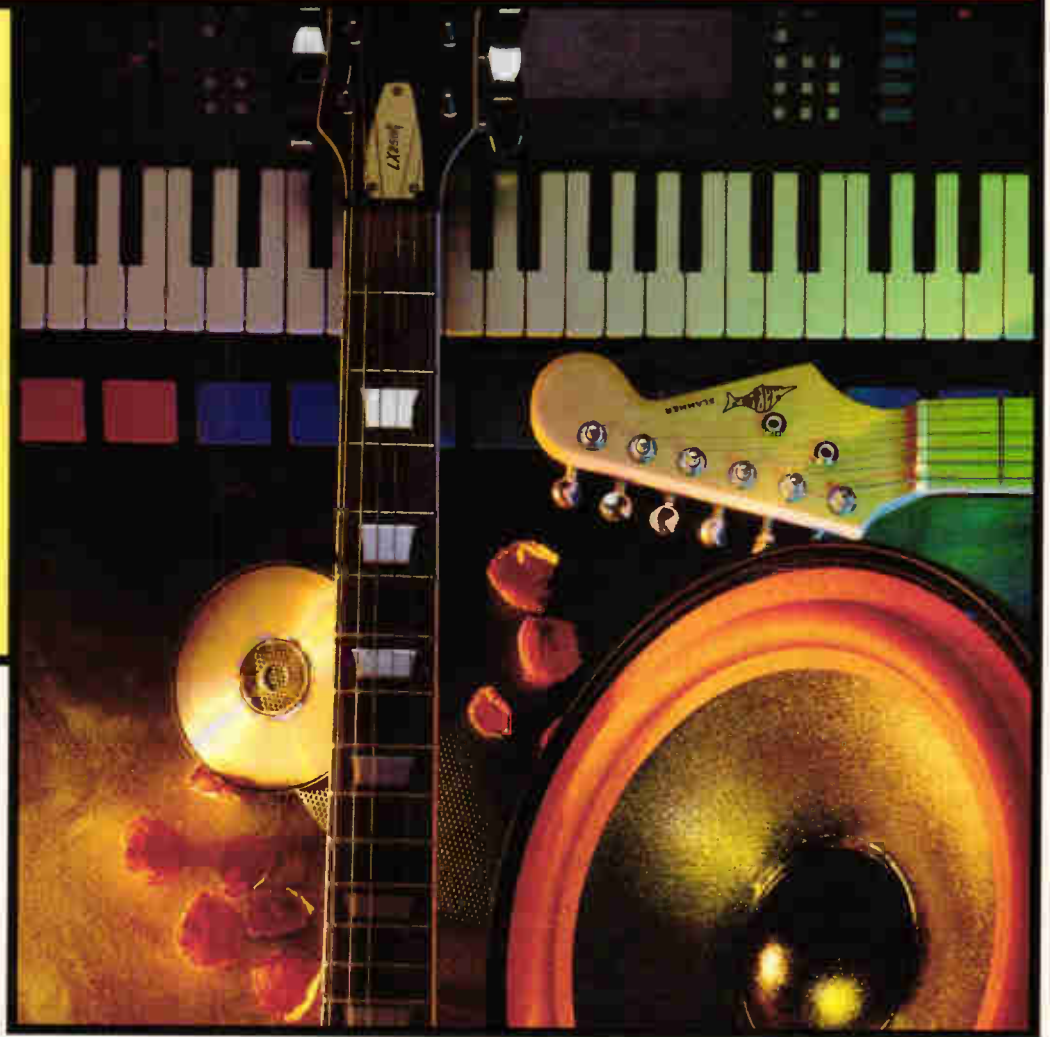

**T**he invention of the microphone, the loudspeaker and the electronic valve amplifier, brought about a revolution in the art of music making. For several centuries preceding our own, a firm distinction may be made between large-scale music making and music for intimate entertainment; or chamber music.

The ability to amplify instruments and solo voices meant that for the first time 'chamber-music' could become a large-scale musical activity. As I researched and wrote the book 'Music Engineering,' I became convinced that the cultural revolution of rock-and-roll – and later rock music – is as much about how the music is made as it is about its sociological and musicological roots.

For the first time in history, and due solely to the progress in electronics, the world-view of a few young men – in those days it was just men – could capture the hearts and minds of hundreds, thousands of young people. And with the intervention of radio, the numbers increased to millions. Little wonder it is then that the establishment has always had an uneasy relationship with rock music!

Technologically a stone's-throw from the early microphones is that icon of rock-and-roll rebellion, the electric guitar. From Scotty Moore's chiming lead guitar on the early

Elvis records to Hendrix's angst-ridden, tortured performances, no other instrument characterises the octane-charged sound of rock-and-roll better than the electric guitar.

So it is with this symbolic, and seminal musical voice that we begin our look at electric instruments.

## Electric guitars

A modern electric guitar is illustrated in Fig. 1. The earliest electric guitars were created by attaching a contact microphone to the top sound-board of a conventional acoustic guitar, the resulting signal being fed to an external amplifier.

The modern electric guitar was born with the invention of the electro-magnetic pick-up and a typical arrangement is illustrated, diagrammatically, in Fig. 2. In principle, all electric guitar pick-ups are formed this way; with a coil wound on a permanent bar-magnet former.

The magnet is arranged so that it points with one pole towards the string and with the opposing pole, away from the string. As the string is excited by the player, and moves in close proximity to the magnetic circuit, the flux in the circuit is disturbed and hence a small electric current is induced in the coil.

Early pick-ups used a single magnet for all the strings but

later models used separate magnets, or separate pole pieces at different heights relative to the strings. This allowed compensation for the different sensitivity of the pick-up in relation to each of the guitar's six open strings.

### Pick-up problems

Guitar pick-up coils contain very many – often several thousand – turns of fine-gauge wire and are thus very sensitive to minute string movements. Unfortunately, this also renders them very sensitive to electromagnetic interference. They are especially sensitive to induced hum due to magnetic fields emanating from the large transformers that find their way into the power supplies of guitar amplifiers.

To counter this, Gibson introduced the Humbucker pick-up. This comprises two magnets and two coils wound electrically in series but arranged in magnetic opposition, Fig. 3. The vibrating string will, of course, create a similar signal in both these coils, and these will add due to the series connection. But an external field will induce a signal of opposite phase in either coil. These fields will cancel due to the series connection.

Most guitars are fitted with a number of pick-ups and furnished with a selector switch to allow players to choose their favoured sound. Pick-ups nearest the bridge tend to sound more 'trebly' and bright. Those nearest the fingerboard have a more 'bassy' sound.

Because players like to have a local control over amplification level and tone-colour, all guitars provide volume and tone controls on the guitar itself. The pick-ups themselves have a relatively high output impedance, so it is necessary that they work into a very high impedance source. For this reason, most guitar volume potentiometers are very high value; perhaps 250 or 500k $\Omega$ .

Similarly, tone control circuits operate at very high impedance. As you may have already guessed, because of this, the action of the guitar cable itself – as well as the amplifier input impedance – all have a marked effect on the overall sound of an electric guitar set-up. This situation has helped fuel the enormous mythology which surrounds electric guitars, pick-ups and their associated amplifiers.

The circuit schematic for the internal circuitry of the famous Fender Stratocaster guitar is drawn in Fig. 4.

### Hammond and Compton organs

At first, electronic organs sought only to emulate the tone of the acoustic organ – a feat which is now so well accomplished that only experts can tell if the organ in a church is electronic or the acoustic original.

But it wasn't long before the designers of these electronic instruments began experimenting with harmonic combinations. The increased flexibility of electronic coupling relative to the traditional mechanical coupling made such experimentation easy. Just such an ambition led to the development of the classic Hammond B3 organ.

The B3, Fig. 5, was developed before solid state electronics became widely available. Its designers wisely forewent the use of electronic oscillators to produce the fundamental sine tones. Instead they opted for an electro-mechanical scheme whereby rotating discs with shaped edges influenced the magnetic field of electromagnets wound near the edge of the disc. The principle, illustrated in Fig. 6, is thus a variable reluctance electro-mechanical oscillator and is pretty well unique.

Other manufacturers displayed equal lateral thinking. Compton used rotary tone generators too, but these operated by means of a variable capacitance technique. Identical electro-mechanical components were used for each note of the scale, the different pitches being achieved by the choice of pulley ratio used to drive the tone generators from a common mechanical drive.

Fig. 1. Technologically a stone's-throw from early microphones is that icon of rock-and-roll rebellion, the electric guitar.

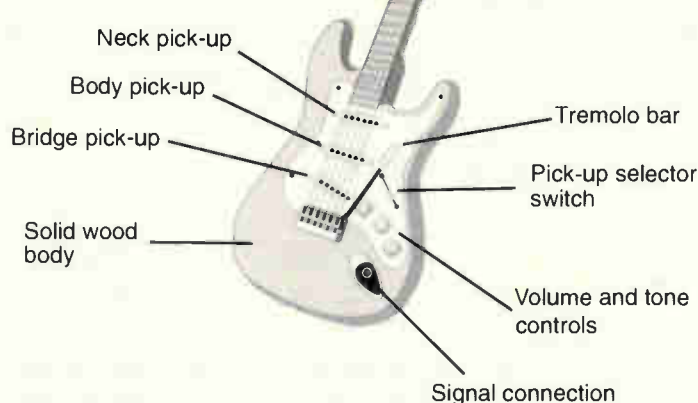

Hammond's ambitions went far beyond that of reproducing a pipe organ sound. Instead the company aimed at recreating the sounds of other instruments. Hammond's additive synthesis technique involved analysing real instrumental sounds – using a Fourier analyser. These sounds were recreated by selecting and adding sine waves generated from the continuous oscillator 'bank'.

Fascinatingly, it is fair to say that Hammond almost totally failed to achieve what it set out to do with the Hammond organ – that is, to simulate the sounds of other instruments. But they did create a 'classic' sound in its own right.

### Theremin

One of the earliest electronic instruments, from around 1920, is the Theremin. This is a monophonic melodic instrument originally developed in Russia by Leon Theremin.<sup>2</sup>

The Theremin player does not touch the instrument and

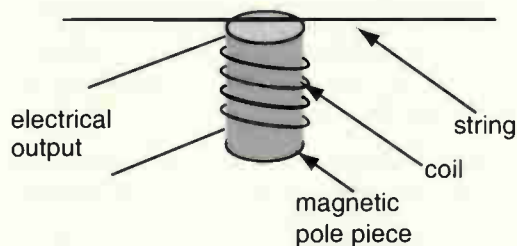

Fig. 2. Electro-magnetic guitar pick-up involves a coil wound on a permanent bar-magnet former. One pole points towards the string. As the string moves, flux is disturbed and a small electric current is induced in the coil.

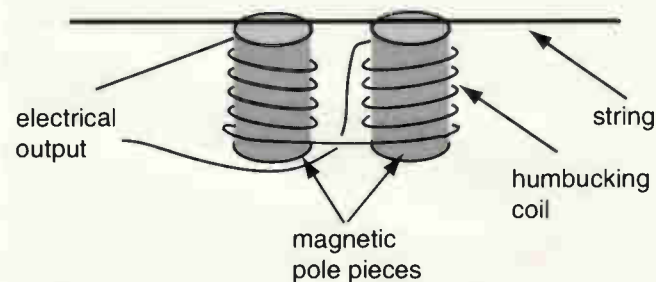

Fig. 3. Since guitar pick-up coils contain sometimes thousands of turns, they are sensitive to electromagnetic interference. This arrangement cancels unwanted fields.

Fig. 4. Internal circuitry of the famous Fender Stratocaster guitar. Note the high impedances involved.

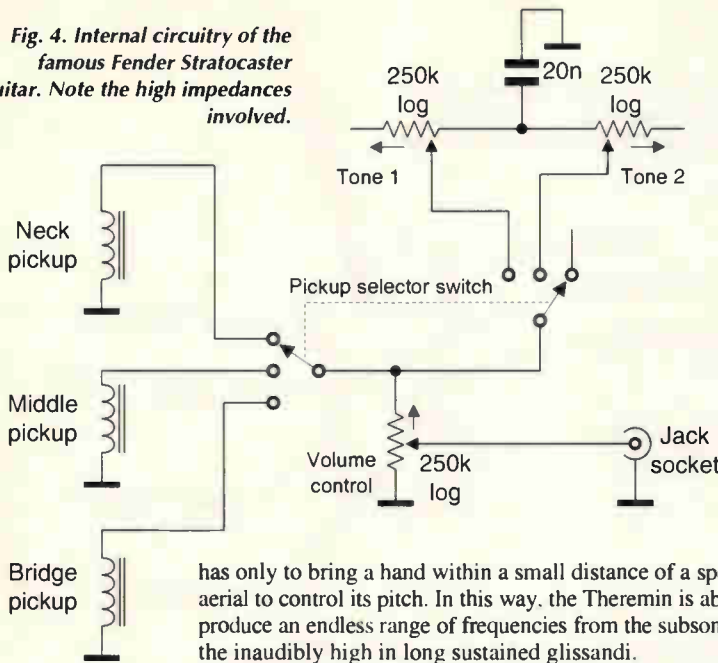

Fig. 5. Developed before solid-state electronics, Hammond's B3 organ has no oscillators. It uses electromechanics instead.

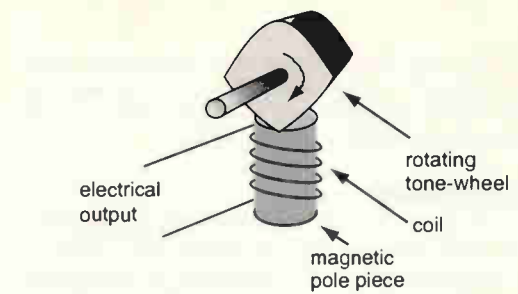

Fig. 6. The Hammond B3 incorporates many rotating cams whose lobes influence a magnetic field.

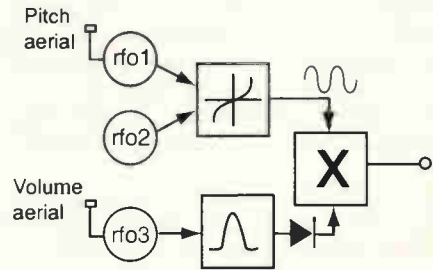

Fig. 7. The Theremin contains three rf generators. Oscillators 1 and 2 are pre-tuned to exactly the same frequency. The third oscillator varies output amplitude.

has only to bring a hand within a small distance of a special aerial to control its pitch. In this way, the Theremin is able to produce an endless range of frequencies from the subsonic to the inaudibly high in long sustained glissandi.

Despite being very difficult to play, the Theremin has achieved limited artistic success. It may be heard in several orchestral pieces and has been used on many film and early tv soundtracks. Furthermore the Theremin remains the emblem of experimental electronic music. It enjoys this status because it is one of the very few instruments designed in historical memory to employ a truly novel playing technique.

The operation of the Theremin is illustrated in schematic form in Fig. 7. Notice that the instrument contains three radio frequency generators operating in the hundreds of kilohertz region. Radio-frequency oscillators 1 and 2 are pre-tuned to exactly the same frequency.

Clearly, the resulting output from the non-linear circuit, i.e. the rf mixer, will be the sum and difference signal; the sum is subsequently filtered, leaving the difference signal alone to be passed on to the following amplifier stage.

Oscillator 1 differs from oscillator 2 with the addition of the extra tuning capacitance, across the main resonant circuit, formed by the metal aerial and its interaction with ground. The player has only to bring a hand within a small distance of the aerial for there to be a change in oscillation frequency and a resultant audible tone issuing from the process of multiplication.

The nearer the player gets to the plate, the more depressed the oscillation frequency of oscillator 1 and the higher the resultant pitch of the Theremin's audio frequency output.

The expressive potential of such a system is inevitably limited, hence the addition of the third oscillator and its asso-

ciated circuitry. This third rf circuit produces a tuneable output, once again variable by means of the interaction of the player's anatomy in proximity to another metal aerial or wand.

But this oscillator does not interact with another oscillator, instead its output is fed to a resonant circuit, tuned to the lower end of the variable oscillator's range. As the player approaches the aerial, the generated frequency drops and the output across the resonant filter rises. Suitably rectified, this signal becomes a control voltage which is employed to alter the gain of the final audio stage.

The complete instrument thus has the ability to change pitch and volume and thereby produce articulate musical phrases. It is generally played with two hands; one to adjust the pitch, the other to adjust the intensity.

### Electric pianos

The most famous electric piano is, without doubt, the Fender Rhodes. This – and its many imitators – is actually more of an electronic Glockenspiel, or Vibraphone, than an electronic piano because the sound producing mechanism is formed from struck metal bars. The hammers striking the bars are actuated via a conventional keyboard mechanism.

Fender's Rhodes Piano dates from the early forties when Harold Rhodes, an American serviceman, built a 'baby Piano' in which metal rods were struck directly by the wooden keys themselves. It was an immediate success with the servicemen, for whom it was built to entertain, and hundreds were constructed.

Later on, an adaptation of the electric guitar type pickup was added so that the piano could be amplified. It was this unit that attracted the attention of guitar maker Leo Fender and thus the Fender Rhodes, as we know it today, was born.

The operation of a Rhodes is simple. The wooden key activates a hammer via a cam. When the key is depressed, the dampers are lifted above the sounding bars which are struck by the hammer. This bar, known as a tine, vibrates and disturbs the magnetic circuit formed by the permanent magnet within the pickup. The movement is thereby transduced into an electric current.



1. Tone Generator Assembly
2. Tine (Part of Tone Generator Assembly)
3. Tuning Spring
4. and 5. Tone Bar Adjustment Screws
6. Tone Generator Mounting Bolt
7. Tone Bar
8. Pick-up Assembly
9. Pick-up Adjustment Screws
10. Damper Felt
11. Damper Assembly
12. Damper Mounting Screw
13. Hammer Head Tip
14. Hammer Assembly
15. Bridle Strap
16. Hammer Butt Flange
17. Action Felt
18. Key
19. Keyboard Felt
20. Action Support Rail
21. Action Rail

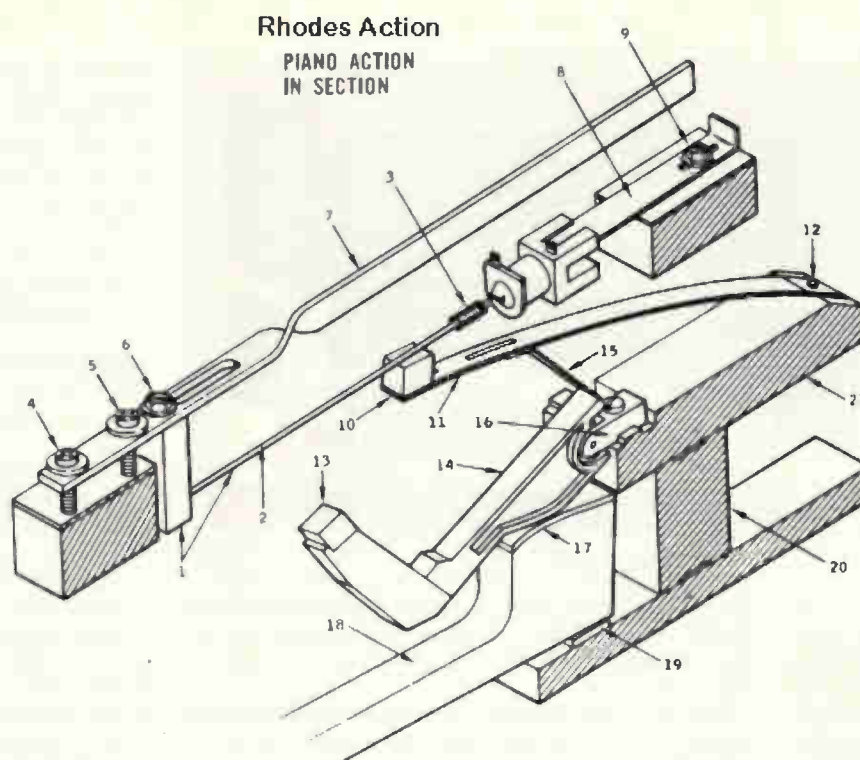

Figure 8 is an illustration of the Fender Rhodes action.<sup>3</sup> Compare this illustration with that of the electric guitar pick-up and the waveform generation mechanism of the Hammond organ.

The Fender Rhodes was made in two types; a Stage model which was entirely passive – just like a guitar – and a Suitcase model which required mains to power the integral amplifier. The physical nature of the mechanism permitted a large variation in expressive tone by means of the force used to strike a key. In addition, the keyboard had naturally unlimited polyphony. These factors ensured the Rhodes was, and continues to be, a widely used instrument.

### Martenot

The Ondes Martenot was invented by Maurice Martenot, professor at the Ecole Normale de Musique in Paris. The words Ondes Martenot literally translate to Martenot waves.

The first model was patented in April 1928 under the name "Perfectionnements aux instruments de musique electriques," which means "improvements to electronic music instruments."

Early versions bore a close resemblance to the Theremin. They consisted of two table-mounted units controlled by a performer who manipulated a string attached to a finger ring. They relied on the body's capacitance to control the sound characteristics in a manner very similar to the Theremin. The string device was later incorporated as a fingerboard strip above a standard keyboard.

The Ondes Martenot was first demonstrated in Paris 1928 and it won first prize at the 1937 International Exhibition of Art and Technics. Many of the first composers to hear and take up the instrument were fascinated by the sounds it could produce, as it combined great responsiveness to touch with its eerie and ethereal electronic tones.

The instrument became popular among members of Les Six in France – particularly Milhaud and Honegger. One of the early virtuosi of the Ondes was Martenot's sister, Ginette Martenot. Later instruments also had a bank of expression keys that allowed the player to change the timbre and character of the sounds. One version even featured micro-tonal tuning.

Martenot's aim, to produce a versatile electronic instrument that was immediately familiar to orchestral musicians,

paid off. The Ondes Martenot is probably the most widely accepted of all electronic musical instruments in the classical oeuvre.

The Ondes Martenot therefore has a surprisingly wide repertoire; far wider than that of the Theremin. Works were written for the instrument by distinguished composers including Olivier Messiaen and Edgard Varese.

Messiaen orchestrated the Turangalila Symphonie and Trois Petites Liturgies de la Presence Divine to include the instrument. Other composers include Maurice Jarre, Jolivet and Koechlin.

The Martenot often figures either as a solo instrument, as in works such as Marcel Landowski's *Jean de la Peur*, or as an orchestral instrument. It is employed from time to time within a score for certain special effects. The birdlike calls and trills distinctive of the work of Olivier Messiaen are a good example of this usage.

Other composers wrote for ensembles of Ondes, sometimes as many as eight at a time.

### Mellotron

Beatles producer George Martin likened the Mellotron to a Neanderthal piano that had been impregnated a primitive electronic keyboard.<sup>4</sup> But this primitive analogue sampler had a profound effect on the tonal palette of popular music of the nineteen sixties.

The Mellotron operated by means of a length of tape with recordings of real instruments on it. When a key was pressed, the length of tape was drawn over a playback head until it was exhausted, in Martin's words, "whereupon a strong spring snapped it back to the beginning again. This meant that if you held down a note longer than a couple of seconds, the machine would give a loud hiccup and stop while it rewound and reset itself."

The Mellotron was conceived by a Californian, Harry Chamberlin, in the late forties. True to its pedigree as the world first sampler, the original model had 14 loops of drum patterns and was aimed at the home organ market.

For the next ten years, Chamberlin designed and manufactured a series of keyboards culminating in a two 35-note console machine; the first console was devoted to the 'sampled' instrumental sound, the second to rhythm tapes and sound-effects.

*Fig. 8. Fender Rhodes striker. The wooden key activates a hammer via a cam. When the key is pressed, the dampers lift above the sounding bars which are struck by the hammer. This bar vibrates and disturbs the magnetic circuit formed by the permanent magnet within the pickup.*

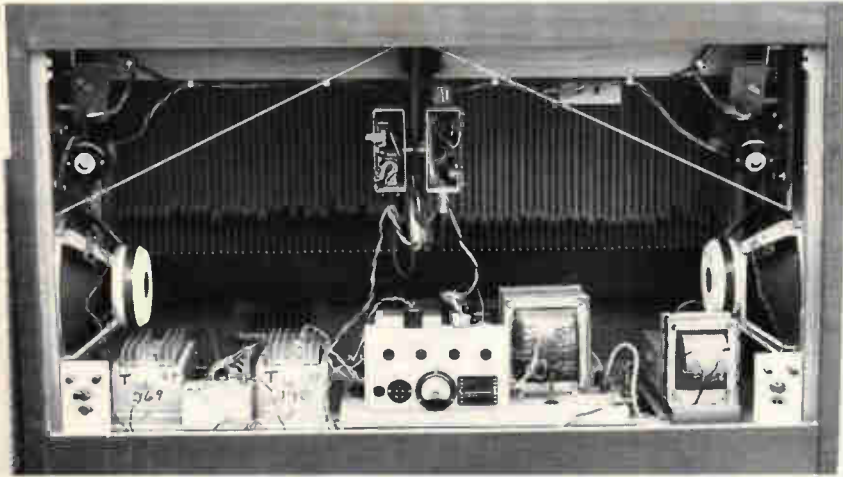

**Fig. 9.** Inside a Mellotron. This instrument operated by means of a length of tape with recordings of real instruments on it. When a key was pressed, the length of tape was drawn over a playback head until it was exhausted.

In the sixties, Chamberlin hired a salesman who, frustrated by the inventor's inability to resolve various technical problems, took the idea to Bradmatic Ltd in England, who supplied tape heads for the Mellotron. He suggested they production engineer a new model of the Mellotron and this they duly did.

Unfortunately the salesman failed to tell Bradmatic that the concept wasn't his and, similarly, omitted to inform Chamberlin about the new 'arrangement'!

After much acrimony, in 1966, Chamberlin agreed to sell the technology to the Bradleys who renamed their company Bradmatic to Streetly Electronics and commenced production of the mature Mellotron keyboard.

Chamberlin continued on a parallel development path with a series of instruments known simply as the Chamberlin. But it was the Bradleys' new Mellotron keyboard that attracted the attention of British bands who were searching for new

additions to their tonal palette. Amongst them were The Beatles, The Rolling Stones and The Kinks.

In 1966, John Lennon composed a small phrase which McCartney played on the Mellotron; it was the beginning of Strawberry Fields Forever. This four-bar phrase alone, forming as it does the opening of one of the most innovative records of all time, guarantees the Mellotron a place in the annals of sonic history.

The interior of a sixties Mellotron is illustrated in Fig. 9 in which the individual pieces of tape are clearly visible.

### Tape-bow Violin

Akin to the Mellotron is the Tape-bow Violin, the invention of Laurie Anderson who was born in 1948 in Chicago Illinois.

Anderson studied sculpture at Columbia University and engaged in various performance artworks while at college. After qualifying, she remained in New York where she met Philip Glass.

During work with a number of electronic musicians, Anderson designed the Tape-bow Violin; an instrument with magnetic tape instead of a bow, and a playback head instead of strings. The musical 'sample' recorded on the bow could be made to play by drawing the bow across the tape head as in conventional violin technique.

The invention's power lies in that variations in bowing can bring about very flexible sample manipulation. ■

### References

1. Brice, R, 'Music Engineering,' Newnes 1988.
2. Theremin, L.S., US Patent: 'Method of and apparatus for the generation of sound.' Serial No. 73,529. 1925.
3. Coates, B, Melbourne Music Centre Web Pages. 1997.
4. Martin, G and Pearson, W. 'Summer of Love - The Making of Sgt. Pepper.' Macmillan 1994.

## Music Engineering

### The Electronics of Playing and Recording

Written by Richard Brice, published by Newnes

● **Highly illustrated guide to the technology of music and recording.**

● **Written in an approachable style using examples of well-known songs, this book is a must-have guide for sound recording engineers and electronic engineers.**

If you are an electronics engineer who needs specific information about music reproduction, or if you are a sound recording engineer who needs to get to grips with the electronic technology, Music Engineering is for you.

This handy volume is a technical guide to electric and electronic music, including the essential science, but concentrating on practical equipment, techniques and circuitry. It covers not only basic recording techniques and audio effects, kit such as microphones, amps and

instruments, but also valve technology, stereo and digital audio, sequencers and MIDI, and even a glance at video synchronisation and a review of electronic music.

Music Engineering lifts the lid on the techniques and expertise employed in modern music over the last few decades. Packed with illustrations, the book also refers to well known classic recordings to describe how a particular effect is obtained thanks to the ingenuity of the engineer as well as the musician.

Richard Brice has worked as a senior design engineer in many of Britain's top broadcast companies and has his own music production company. He is the only writer who can provide this unique blend of electronics and music.

**Contents:** Soul Man - Science and sensibility; Good Vibrations - The nature of sound; Stand By Me - Microphones and their

Inclusive hardback price: £22.50 UK, £25 Europe, £28 ROW.

To order by post, send a cheque or postal order to Jackie Lowe at *Electronics World*, Quadrant House, The Quadrant, Sutton, Surrey SM2 5AS. Please make your cheque payable to Reed Business Information. Alternatively, fax full credit card details to 0181 652 8111, e-mail jackie.lowe@rbi.co.uk.

ISBN: 0 7506 3903

Paperback, 256pp, 150 line illustrations.

● Copies of Richard's previous book, *Multimedia and Virtual Reality Engineering*, are still available, inclusive hardback price: £27.50 UK, 29.50 Europe, £32 ROW.

applications; Message in a Bottle - Valve technology; Roll over Beethoven - Electric Instruments; Wild Thing - Electronic effects; Pet Sounds - Electronic synthesis; Silver Machine - Sequencers & MIDI; Got to Get You into My Life - Sound recording; Bits 'n' Pieces Digital Audio; Space Odyssey - Stereo and spatial sound; Let's Stick Together - Recording consoles; Unchained Melody - Amplifiers; Shout - Loudspeakers; Synchronicity - Video and synchronisation; Dark Side of the Moon - Electronics and the music of the 20th century.

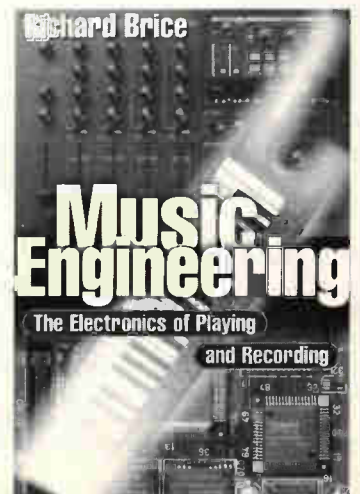

# NEW PRODUCTS CLASSIFIED

Please quote "Electronics World" when seeking further information

## PASSIVE AND ACTIVE COMPONENTS

### Connectors and cabling

**Floppy wire.** Flexiplast by Multi-Contact is insulated with a thermoplastic elastomer, which makes it not only "green", but also very flexible; the fine-stranded copper conductors also make for more flexibility and the result is a low-cost, but environment-friendly cable – two requirements not always compatible. The cables are available with thin walls or with reinforced insulation, the former in sizes from 0.15mm<sup>2</sup> to 2.5mm<sup>2</sup> and taking voltages to 750V, and the latter in sections of 0.5mm<sup>2</sup> to 2.5mm<sup>2</sup> and handling up to 1.5kV. Operating temperature is –30°C to 110°C, with short periods at 130°C. Multi-Contact UK Ltd. Tel., 01908 265544; fax, 01908 262080. Enq no 501

**Better bga sockets.** Aries has a new type of ball-grid array socket that reduces solder-ball deformation. It uses the company's BallLock contact pins that are in the form of a two-fingered contact to take the solder ball – a design that eliminates the need for a lid. The other end of the pin is another solder ball for attachment to the ball-grid array footprint in the normal way. The socket will take the SnapAdapt pins

**Rf power transistor.** Ericsson announces the PTF10120 rf power device for use in the 1.8-2GHz code/time-division multiple-access band. The device is claimed to provide the highest output power currently available at 120W. It is an Idmos type with gold metallisation, giving a linear response to within ±0.5dB over the band. It operates from 28V, has a useful minimum power gain of 11dB at 1.95GHz and at 100W, the Class AB, two-tone, 3rd-order intermodulation distortion figure is –32dB. Efficiency at 120W is 40%. Ericsson Components AB. Tel., 01793 488300; fax, 01793 488301. Enq no 507



already in the device, or added afterwards. Increased height is a mere 1.27mm. Sockets are available in any grid size on pitches of 1.27mm or 1.5mm. Insertion force is 22grams per contact.

Aries Electronics (Europe). Tel., 01908 260007; fax, 01908 260008; e-mail, ianb@arieselec.com. Enq no 502

### Data converters

**Fast, low-power a-to-d.** Combining high speed and low power, the SPT7863 analogue-to-digital converter from SPT is a 10-bit type that is capable of word rates of 10Msamples while consuming 160mW from 5V. It has on-chip track-and-hold and is pin-compatible with other SPT 10-bit converters to ease up-grading. Output levels are selectable to cope with digital ASICs, microprocessors and dsp chips. It is a 0°C to 70°C device.

Signal Processing Technology. Tel., 01932 254904; fax, 01932 254903; e-mail, spt@intonet.co.uk. Enq no 503

### Digital signal processors

**Dual processor dsp board.** Blue Wave introduces the PCI/C6600 dual processor board based on the C6000 chip. This supports either two TMS320C6201s for fixed-point working or two TMS320C6701 for floating-point use at up to 200MHz. Processing power works out at 3200Mips/2Gflops. The two processors are similar to facilitate designs incorporating both, and to allow simpler software or lower cost. Each processor can access 1Mbyte of flash and a 32Mbyte synchronous dram by way of the external memory interface. A shared bus gives both processors access to a bank of up to 1Mbyte of sram for communication. A large amount of i/o is provided, both analogue and digital, and further processors may be added to a mezzanine site. Blue Wave Systems Ltd. Tel., 01509 634444; fax, 01509 634450; web, www.bluews.com. Enq no 504

### Discrete active devices

**Tuning diodes.** SOD323-packed tuner diodes in the ZMV830 and ZMV900 ranges by Zetex provide the same performance as alternatives in the larger SOT23 packs. The two new ranges are based on hyperabrupt and high-ratio hyperabrupt junctions. Minimum Q at 50MHz and 3-4V is between 80 and 350, depending on the particular device. Reverse breakdown is 25V in the 830 range, which has a capacitance range of 8.2pF and 68pF at 2V and 1MHz. In

positions where bias voltage is limited, the higher capacitance ratio of the 900 series is of assistance, being five times that of the hyperabrupt types.

Zetex plc. Tel., 0161 622 4422; fax, 0161 622 4420; web, www.zetex.com. Enq no 505

### Surface-mounted Schottkys.

Second-generation, 15V, 30V and 45V Schottky diodes from International Rectifier are in standard SMA packs and are rated at up to 3A dc and have forward voltage drops down to 300mV. Type numbers are 10MQ015N, ..040N, ...060N, ...100N, all being rated at 1.5A and handling reverse voltages as indicated by the name. An additional type, the 15MQ040N, is rated at 2A with a reverse voltage of 40V. International Rectifier. Tel., 01883 732020; fax, 01883 733410. Enq no 508

### Minute Schottkys.

Rohm's new Schottky barrier diodes, RB521S-30 and RB520S-30, are in the extremely small EMD2 1208 smt pack and also possess the industry's lowest forward voltage and reverse current. The 521S forward voltage is 0.4V and reverse leakage 4µA, while the 520S is rated at 0.5V and 0.1µA. Maximum current for both is 200mA and maximum reverse voltage 30V. Highest allowable junction temperature is 125°C. Rohm Electronics UK Ltd. Tel., 01908 282666; fax, 01908 282528; web, www.rohm.co.jp. Enq no 509

### Inmarsat power transistors.

Two Idmos transistors from Ericsson are designed for the 1.5-1.65GHz band used in Inmarsat applications. The PTF10011/10045 are in driver/ power-amplifier form and are particularly suitable for use in portable equipment. Gain and stability are increased by the use of the laterally diffused process. Power rating is 30W from 28V dc and gain 11.5dB ±0.15dB, this flatness allowing a higher rate of data transfer. Ericsson Components AB. Tel., 01793 488300; fax, 01793 488301. Enq no 510

### Displays

**Colour lcd.** Sanyo's LMU-TF150A1 15in tft lcd colour monitor uses a smoothing function to allow vga/svg images to be expanded without distortion. It also has automatic adjustment for display position and other settings. Power consumption is only 25W maximum and a further attraction is its depth – 20cm. Semicom UK Ltd. Tel., 01279 422224; fax, 01279 433339; e-mail, sales@semicom.demon.co.uk. Enq no 512



**Rf power mosfets.** Philips has a range of laterally-diffused mos, (ldmos) rf power mosfets for use in cellular base stations and uhf broadcast transmitters. A result of using the Idmos technique is that one transistor now covers the entire 840-960MHz or 1.9-2GHz cellular bands. There are four BLF10xx devices to go up to 1GHz, four BLF20xx types for over 2GHz and the BLF861 for the 470-860MHz broadcast band. The three ranges provide up to 90W, 140W and 120W. Input matching is incorporated and output matching in the higher-power devices. Philips Semiconductors (Eindhoven). Tel., 00 31 40 2722091; fax, 00 31 40 2724825; web, www.semiconductors.philips.com. Enq no 506

### Filters

**Dip filters.** Multi-line, common-mode and normal-mode chokes by Tokin in the DIP Series are in a dip package and are made in various configurations, from a three-circuit type to one with 10 circuits. Voltage rating is 50V and current ratings between 100mA and 2.3A. Mercator. Tel., 01493 334000; fax, 01493 334050. Enq no 513

### Hardware

**Flange knockout enclosures.** Ensto Briticent's CUBO-C range of enclosures has pre-pressed flange knockouts and come in sizes from 200mm square by 130mm to 400mm by 600mm by 130mm, in seven models. They will survive difficult conditions and, in particular, temperatures between –50°C to 130°C. All are supplied with a 30mm deep lid and mounting screws and there are optional steel plates to take heavy components, amongst other accessories. The boxes may be obtained in colours to suit, with printed logos, shielded, drilled, threaded, countersunk and cut.

Please quote "Electronics World" when seeking further information

Ensto Briticent International. Tel., 01425 474617; fax, 01425 471595; e-mail, [briticent@ensto.com](mailto:briticent@ensto.com); web, [www.ensto.com](http://www.ensto.com).  
Enq no 514

**Linear integrated circuits**

**Better 5532.** From New Japan Radio, the NJM2114D-D dual op-amp offering some advantages over the industry-standard 5532 and contained in dil, dmp or sil packs. Noise and distortion are reduced and offset is now 0.2mV typical. The device slews at 15V/ $\mu$ s and unity-gain bandwidth is 13MHz. From  $\pm$ 22V, power dissipation is 800mW. Young-ECC Electronics. Tel., 01494 753500; fax, 01494 753501; e-mail, [crown@youngecc.com](mailto:crown@youngecc.com).  
Enq no 515

**Logic**

**3.3V logic family.** LCXPlus 3.3V logic devices by Quality Semiconductor are 51 in number and

**Lcd interface controller.** Digital View's SV-N705 is a versatile flat-panel interface controller to drive the whole range of NEC analogue tft displays. It provides quick direct analogue vga-to-svga connection for panels resolving from 640 by 480 to 1280 by 1024 pixels and there is also an optional daughter board to take PAL/NTSC video input, composite and S-video connections and audio. The controller supports VESA power saving and provides an on-screen display of various functions such as brightness, contrast and tuning. The controller takes 12V dc and cables and housings are available.

Digital View Ltd. Tel., 0181 2361112; fax, 0181 2361116; web, [www.digitalview.com](http://www.digitalview.com).  
Enq no 511



all offer the bus hold and output resistors as an improvement over the standard 5V-tolerant LCX family. They all perform interface functions in octal, 16-bit and 32-bit form. Bus hold enables a device to hold its last logic state after the removal of signals and avoids the need for external resistors on cmos inputs; output resistors reduce overshoot and undershoot without much effect on speed. Propagation delay is down to 4.1ns. Quality Semiconductor, Inc. Tel., 01420 563333; fax, 01420 561142.  
Enq no 516

**Materials**

**Rubber insulation.** Warth's Thermaflex is a silicone rubber, thermally conductive material that conforms to shape of uneven surfaces. It comes in thicknesses from 0.5mm to 2mm and may be specified for shape. Breakdown voltages are in the 8-20kV range, thermal resistance is 0.92 $^{\circ}$ /W and its UL flame retardant rating is 94V-O. It is an alternative to mica and grease and is suitable for power transistor insulation and transformer bases. Warth International Ltd. Tel., 01342 315044; fax, 01342 312969; web, [www.warth.co.uk](http://www.warth.co.uk).  
Enq no 517

**Cable markers.** Heat-shrunk cable markers by Raychem may be printed individually or in indexed sets using a dot-matrix printer driven by a pc running Raychem's TMS Total Software. The sleeves come in s format to accommodate a tractor printer feed and, when printed, are shrunk round the cable. Operating temperature is -30 $^{\circ}$ C to 105 $^{\circ}$ C, tensile strength 1200lb/in $^2$  and flammability to UL224. Abrasion, cleaning solvents and other fluids do not affect the markers. Farnell Components Ltd. Tel., 0113 263 6311; fax, 0113 263 3411, web, [www.farnell.com](http://www.farnell.com).  
Enq no 518

**Memory**

**Eprom, flash and sram module.** BVM's BVME065 is a 3U memory board for use in development and in data-acquisition systems. There are three separate memory banks which may each have a different type of memory, speed and size, up to 12Mb of eprom, 6Mb of flash and 6Mb of sram, with backup from battery or VMEbus +5STDBY. The battery holds the static ram content when the memory is removed from the system to allow its use as a portable memory card. BVM Ltd. Tel., 01489 780144; fax, 01489 783589; e-mail, [sales@bvmltd.co.uk](mailto:sales@bvmltd.co.uk); web, [www.bvmltd.co.uk](http://www.bvmltd.co.uk).  
Enq no 519

**Microprocessors and controllers**

**"Fastest" microprocessor.** With a claim from IDT that it is the fastest 64-bit microprocessor on the market, the RC5000 250MHz device is

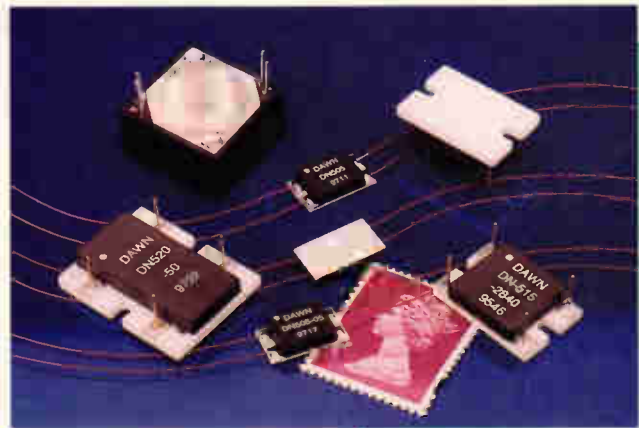

announced. It is meant for use in embedded applications in exotic communications, office automation and graphics. Its compatibility with RC4xxx and earlier RC5xxx devices extends to the use of existing supporting ics and tools. There are dual 32-Kbyte caches and an on-chip secondary cache controller to give a 500Mflops operation. IDT Europe. Tel., 01372 363339; fax, 01372 378851.  
Enq no 520

**Motors and drivers**

**Dual stepper drivers.** Three new dual-circuit stepper driver ics from Ericsson are announced. One of these devices forms a complete controller and driver for a two-phase, bipolar motor; the PBL37751/2/3 provide 500mA/750mA/900mA continuous output current per channel. Each such circuit consists of a fixed-frequency, switched-mode, constant-current driver ic with two channels - one for each motor winding. They will perform microstepping as well as full and half stepping modes of operation, a disable input simplifying half stepping. Supply may be up to 60V and there is a built-in digital filter to avoid the need for external components. Ericsson Components AB. Tel., 01793 488300; fax, 01793 488301.  
Enq no 521

**Passive components**

**Aluminium electrolytics.** Rubycon YXG aluminium electrolytics are expressly designed for secondary smoothing in resonant power supplies. Ethylene glycol with an added ammonium salt base is the electrolyte solvent. A low-loss, low-density electrolytic paper provides low impedance and high ripple-current tolerance. Typically, in a 12.5mm diameter and 25mm long case, figures are: impedance 0.027 $\Omega$  at 100kHz and 20 $^{\circ}$ C, ripple current 2.23A at 100kHz and 105 $^{\circ}$ C. Surtech Distribution Ltd. Tel., 01256 840055; fax, 01256 479785  
Enq no 524

**Protection devices**

**Resettable circuit protectors.** Surface-mounted, positive temperature coefficient circuit protectors in the 1812 range from Littelfuse have large termination pads

**Oscillators**

**Oscillator heaters.** Hawco offers a range of proportionally controlled heaters for the thermal stabilisation of oscillators which are believed to be the smallest available. The smallest type produced measures 12.2 by 7 by 2.8mm. These heaters simply need to be attached to the component in question, no external controller being needed and the temperature being set between 0 $^{\circ}$ C and 100 $^{\circ}$ C by the selection of one resistor. Voltage to the heater is 5-50V dc at up to 40W, ac versions providing 80W. Fast stabilisation is achieved by applying full power at switch-on, this being automatically reduced when the temperature set is reached. Hawco Ltd. Tel., 01483 560606; fax, 01483 575973; e-mail, [sales@hawco.co.uk](mailto:sales@hawco.co.uk); web, [www.hawco.co.uk](http://www.hawco.co.uk).  
Enq no 522

to ensure good soldering and subsequent inspection to suit the devices to high-volume production. They measure 3.25mm by 4.55mm and are claimed to be the smallest available. The range covers current ratings of 200mA at 30V dc to 1.1A at 6V dc. DT Electronics Ltd. Tel., 01203 466500; fax, 01203 466501; web, [info@dtelectronics.com](mailto:info@dtelectronics.com)  
Enq no 525

**Switches and relays**

**Two specialised relays.** International Rectifier announces two new relays: one a semiconductor type to replace mercury-wetted reed relays and the other an electromechanical telecomms relay. PVT442 replaces reeds in positions where higher-powered loads are controlled, such as small motors and heaters. Output switching is by a pair of inverse-series-connected igbts with fast-recovery epitaxial diodes to give low voltage drop in reverse polarity. Input-to-output isolation is 3.75kV and there is no bounce. Maximum load power is 280Wac/400W ac while input

Please quote "Electronics World" when seeking further information

current is 5mA. PVT422 is a spst, normally open relay for use in telephone equipment in which a connection to the line is needed during power failures.  
*International Rectifier. Tel., 01883 732020; fax, 01883 733410.*  
**Enq no 526**

**Coding switches.** Type 07 rotary coding switches by Elma are meant for use in positions where they are set and untouched for long periods. They have hard gold-plated contacts and hermetic sealing, which prevents oxidation and provides a contact resistance of under 25mΩ. There are binary-coded decimal and hexadecimal versions, all of which handle 2A at 42V.  
*Radiatron Components Ltd. Tel., 01784 439393; fax, 01784 477333.*  
**Enq no 527**

### Transducers and sensors

**Dynamic load cell.** To prevent the force produced by the mass and acceleration of fixtures and clamps holding Instron's *Dynacell* load cell to moving machinery from affecting the load cell output, an accelerometer is built into the cell, measuring the acceleration and compensating for it. In conjunction with the company's *FastTrack 8800* electronics, the result is said to be a system with much lower acceleration error than has hitherto been found.  
*Instron Ltd. Tel., 01494 464646; Fax, 01494 456123; web, www.instron.com*  
**Enq no 528**

**Dual-range photosensor.** Matsushita's *UZD352* has two operating ranges, thereby being effectively two separate sensors. It uses a twin, divided photodiode in the sealed standard *UZD3* body, which measures 68 by 40 by 20mm. All sensors in the *UZD3* range work over the range 20cm to 2m and use area reflective sensing to avoid the effects of dust, mist, smoke or oil. Colour does not affect them and there is cross-talk protection for the close mounting of two sensors.  
*Matsushita Automation Controls Ltd. Tel., 01908 231555; fax, 01908 231599; e-mail, info@macuk.co.uk; web, www.mac-europe.com.*  
**Enq no 529**

## EQUIPMENT

### Audio products

**New B&W speaker.** B&W announces its new loudspeaker, the *Nautilus 801*, which incorporates a *Marlan* sphere by Marlan Polyiac Holland, to house the mid-range drive. This is said to eliminate, by virtue of its smooth shape and material acoustic properties, the diffraction patterns that are common with baffled designs. The mid-range sphere is floating, decoupled from the bass cabinet and tweeter, by a gel made by Raychem.  
*B&W Loudspeakers Ltd. Tel., 01903*

524801; fax, 01903 524832; e-mail, [clivefunnel@compuserve.com](mailto:clivefunnel@compuserve.com).  
*Marlan Polyiac Holland BV. Tel., 0031 594 515080; fax, 0031 594 515520; e-mail, [marlanni@bart.ni](mailto:marlanni@bart.ni)*  
**Enq no 530**

### Power supplies

**Programmable bench supply.** *XKW* bench power supplies combine output powers up to 3kW with GPIB programming facilities, the interface being a single-channel card inside the supply. Connectors and switches are at the rear and front-panel leds provide indication for computer control. The GPIB interface gives 14-bit resolution for control and reading of voltage and current and there is programmable overvoltage protection. Versions are available to give 8V, 350A to 300V, 10A and there is also a 1kW range of supplies.  
*Thurlby Thandar Instruments Ltd. Tel., 01480 412451; fax, 01480 450409; e-mail, [sales@ttinst.co.uk](mailto:sales@ttinst.co.uk).*  
**Enq no 532**

### Test and measurement

**Three-phase power meter.** Hioki's 3331 *Power Hitester* measures and integrates power consumption of

three-phase and single-phase equipment to a basic accuracy of ±0.2%, handles direct currents of up to 50A and covers the 10Hz-50kHz frequency range. It will also measure peak current and provides analytic functions not seen previously. True-rms measurement is available, as is average measurement, via a low-pass filter to obtain the basic component of inverter waveforms. There are GPIB and RS-232C interfaces to allow computer control and management.  
*Telonic Instruments Ltd. Tel., 01734 786911; fax, 01734 792338.*  
**Enq no 534**

**Power harmonic analyser.** *OR300* by Yokogawa is a hand-held instrument for harmonic analysis and real-time rms measurement in ac power systems. It will handle live voltages up to 500V and its triggering allow the capture of power disturbances. Harmonics up to the 40th may be analysed, voltage, current, phase and active power being shown for each, its four isolated channels allowing three-phase measurement. When used with a fax modem card, a watchdog function

may be set up, any fault being captured, recorded and transmitted automatically, the facility then being reset. There is an internal memory, a flash memory card and RS-232 for transfer of data to a pc.  
*Martron Instruments Ltd. Tel., 01494 459200; fax, 01494 535002; e-mail [info@martron.co.uk](mailto:info@martron.co.uk); web [www.martron.co.uk](http://www.martron.co.uk)*  
**Enq no 535**

## COMPUTER AND DATA HANDLING

### Computers

**Single-board computer.** New from Advantech is the *PCM-4823/4823L Biscuit PC*, a compact sbc with a 16-bit Ethernet interface and 32-bit svga and lcd interfaces, making a complete processing board. There is a 5x86-133 embedded processor, floppy controller, a parallel port, EDO dram simm socket, enhanced IDE, keyboard/mouse connector and two serial ports. Power-saving modes are supported and there is provision for expansion modules for communications, analogue/digital control, data handling, GPS and others.  
*Semicom UK Ltd. Tel., 01279 422224; fax, 01279 433339; e-mail, [sales@semicom.demon.co.uk](mailto:sales@semicom.demon.co.uk)*  
**Enq no 536**

**PC/104 pc.** DSP Designs' *TB486* module is based on the AMD 66MHz *Elan SC410 80486* code-compatible processor and is in effect a full pc, including Ethernet and graphics. There is an on-board, switched-mode supply fed by one 5V input and an Ethernet port for communications. Twisted-pair 10BaseT facilities allow connection to a transformer module with an RJ45 connector and status leds. Hard and floppy-disk and cd-rom interfaces are included. The module also has a solid-state disk with a 2Mbyte flash chip, a 4-channel, 12-bit a-to-d converter and a socket to take up to 64Mbyte of memory. Both lcds and crts may be driven, simultaneously if required, the module having a local bus graphics processor and 2Mbyte of video memory for displays up to svga. All the usual peripherals are supported.  
*DSP Design. Tel., 01246 545910; fax, 01246 545911; e-mail, [info@dspdsgn.com](mailto:info@dspdsgn.com); web, [www.dspdsgn.com](http://www.dspdsgn.com).*  
**Enq no 537**

**Tough laptop.** Kontron's new *IP Lite P II* laptop uses a Pentium II 233MHz or 266MHz processor and provides six free PCI/ISA slots. It is contained in a magnesium alloy case for resistance to shock and vibration and has a 12.1in tft display showing 1024 by 768 pixels. Removal storage consists of CD-rom, 650MB MO-drive and hard drive and has a slot cpu board and plug-in Pentium II module

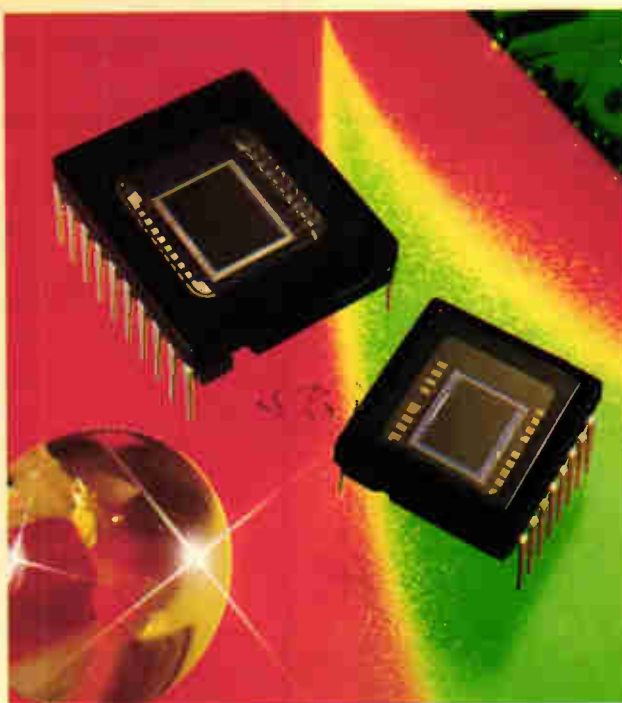

### Cameras

**High-resolution ccds.** Two high-resolution charge-coupled devices, for use in digital still cameras for example, are announced by Sony. *ICX204AK/205AK* are 1/3in and 1/2in sensors which have provision for some "tailoring" to fit individual needs. Both use progressive scanning for low distortion in moving objects and both have a square array to give accurate positioning and measurement. Both use rgb colour mosaic filters and monochrome versions are available. The 204 at 800Kpixels and the 205 with 1.45Mpixels have electronic shutters with variable charge storage time to allow the capture of full-frame images without the use of a mechanical shutter.  
*Sony Semiconductor Europe. Tel., 01256 478771; fax, 01256 818194.*  
**Enq no 531**

Please quote "Electronics World" when seeking further information

to give additional space for adaptor cards. Power comes from replaceable ac and dc supplies and the display is tiltable, with a detachable keyboard and trackball. There are two serial and one parallel interfaces, a vga connection for an external monitor, two PS/2 connections for mouse or keyboard and a USB connection.  
**Kontron Elektronik Ltd.** Tel., 01923 421528; fax, 01923 254118; e-mail newtonc@kontron.de  
**Enq no 538**

**Computer board-level products**

**I/o for PCibus.** Arcom has a versatile i/o board for builders of PCibus systems, that gives a selection of functions for engineering and industrial use and forms a single-board interface for smaller-scale control and instrumentation needs. **APCI-ADADIO** provides for analogue input and output, digital i/o and counting/timing. This covers all that is needed for use with most sensors and transducers in addition to the ability to monitor switches, provide digital output and carry out timing for control or the generation of pc

interrupts. The 12-bit a-to-d converter has a 10µs conversion time and fast s/h circuitry handling input at 100kHz for a single channel or 10kHz channel-to-channel. There are 16 ttl-level digital i/o lines and the board will go into any PCibus expansion slot.  
**Arcom Control Systems Ltd.** Tel., 01223 411200; fax, 01223 410457.  
**Enq no 539**

**Data acquisition**

**PCI data acquisition.** Datel's **PCI-416L2A** 16-channel analogue input board for PCI computers provides 12-bit resolution, the timing of the a-to-d converter being dissociated from the block bursts of the PCibus by the use of fifo. The 16 channels are single-ended, sampled at up to 400kHz/channel simultaneously; this being to avoid the phase skew, in parallel sampling applications, associated with data converters. The board gives seamless sampling with no data loss and a pre-trigger arrangement collects data continuously to the host's ring buffer of several megabytes, counting down the number of post-trigger samples and stopping when all have been collected.

**Datel (UK) Ltd.** Tel., 01256 880444; fax, 01256 880706; e-mail, datel.ltd@ge.geis.com; web, www.datel.com.  
**Enq no 540**

**Data communications**

**Wireless evaluation kit.** RF Monolithics has an evaluation kit for

low-power, two-way wireless data communications, which uses the company's Virtual Wire technique at 868.35MHz. **DR-1012DK** consists of two transceiver boards, two host protocol boards, two reference antennas, batteries, application software and a manual. Straight from the box, it may be used to make a

**Radio systems**

**Synthesised Tx/Rx modules.** Taking advantage of the new pan-European, licence-free 868-870MHz band for use at short ranges, Wood & Douglas has introduced the 800 version of its synthesised radio transmitter and receiver modules, the **ST/SR800**. These are compatible with the **ST/SR500** range of uhf models, are approved to ETS 300 220 and are suitable for use in data exchange and telemetry, alarms and monitoring. The frequency synthesisers are easily re-programmed by way of a serial interface, frequencies being held in non-volatile memory. Switching bandwidth is 10MHz, channel spacing 25kHz and switching time under 50ms.  
**Wood and Douglas Ltd.** Tel., 0118 9811444; fax, 0118 9811567; e-mail, info@woodanddouglas.co.uk; web, www.woodanddouglas.co.uk.  
**Enq no 533**



**BACK ISSUES**

Back issues of Electronics World are available, priced at £3.00 UK and £3.50 elsewhere, including postage. Please send your order to Electronics World, Quadrant House, The Quadrant, Sutton, Surrey, SM2 5AS

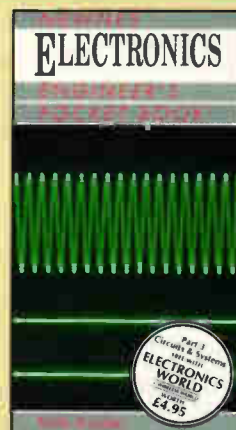

**Free copy of Electronics Engineer's pocket book with every order while stocks last**

**Available issues**

1994	1996	1998
January	January	January
March	February	February
April	March	March
May	May	April
July	June	May
August	July/August	June
September	September	July
November	October	August
December	November	September
		October
		November
1995	1997	
February	January	
April	June	
May	August	
June	September	
September	December	
October		
December		

Note that stocks of some of the above issues are low and will soon sell out. Please allow 21 days for delivery.

Please quote "Electronics World" when seeking further information

data link between two RS-232-equipped pcs. When the system is shown to be viable, the boards may then be adapted to exact requirements by the addition of the appropriate protocol and interface.

**Acal Electronics Ltd. Tel., 01344 727272; fax, 01344 424263.**  
Enq no 541

### Development and evaluation

**H8S evaluation.** Hitachi offers the EVB2655 evaluation kit for the H8S family of 16-bit, low-power microcontrollers. It includes a 20MHz H8S/2655 microcontroller, an evaluation board, a copy of the IAR C compiler, source-level debugging, a GNU C compiler and debugger and a cd-rom holding documentation and tutorials. Since the H8S/2655 is the highest-performance device in the family, the kit is suitable for all the other devices. Memory on the board consists of 256Kbyte of expandable sram and there are two RS-232 links for comms and debugging. All i/o is accessible.

**GD Technik Ltd. Tel., 0118 9342277; fax, 0118 9342896.**  
Enq no 542

### Mass storage

**Fast CompactFlash.** Silicon Storage Technology's SST49CFxx CompactFlash cards can cope with a 1.4MB/s write from host to card. They come in densities of 4MB to 24MB and are intended for use in such equipment as digital cameras and mobile 'phones. They may also be used in PCMCIA interfaces via 68-pin Type II adaptors.

**Silicon Storage Technology Ltd. Tel., 01932 221212; fax, 01932 230565; e-mail, rsawer@ssti.com; web, www.ssti.com.**  
Enq no 543

### Software

**Shock/vibration recording.** Lamerholm Fleming has produced new software for its RD298 ShockLog triaxial shock recorder, which records vibration and shock over a whole journey or static test. The software runs under Windows 95 and NT and the extended recording is seen on a scrollable screen to allow excessive impacts to be identified for analysis by the graphing facility. A 'Timeslot' function in the RD298 provides information on background vibration in three axes as peak readings in any

defined time slot, of which there may be up to 250 000 in non-volatile memory.

**Lamerholm Fleming Ltd. Tel., 01438 728844; fax, 01438 742236; e-mail, sales@lamerholm.com; web, www.lamerholm.com.**  
Enq no 544

## PUBLICATIONS

### Catalogues

**Fans.** Papst has up-dated its free Basics catalogue, the new one having 76 pages, in which more than 100 new products are to be found. Megafans, for example, which have smaller motors with bigger impellers resulting in more air and less racket. Also in are new sleeve-bearing fans using the company's Sintec process to give better performance at reduced cost. There is reference information, advice on fan selection and a section on accessories.

**Papst plc. Tel., 01264 333388; fax, 01264 332182.**  
Enq no 545

**Data acquisition.** Datel's 1998 data acquisition catalogue presents over 50 new items, those included being high-performance boards for PCI, ISA and VME buses. Features of the products described include on-board dsp c-processors, and fifo memory, simultaneous sampling and non-stop data streaming to disk. Free technical assistance is available from Datel on the web site.

**Datel (UK) Ltd. Tel., 01256 880444; fax, 01256 880706; e-mail, datel.ltd@ge.geis.com; web, www.datel.com.**  
Enq no 546

### Application notes

**In-circuit testing.** Not an application note, but a book from GenRad on the principles of the in-circuit testing of printed-circuit boards, from a review of the manufacturing process and the type of fault often found, to a description of the in-circuit tester and its method of use. For copies, contact MediaMania. Fax, 0171 499 3417. ■

**Enq no 547**

## HOW DOES YOUR EQUIPMENT MEASURE UP? AT STEWART OF READING THERE'S ALWAYS SCOPE FOR IMPROVEMENT!

### PHILIPS PM3217 - Dual Trace 50MHz Delay



This is really a very good oscilloscope including 2 probes. Pouch & Front cover. Only **£300**

### GOULD OS300 Dual trace 20MHz. Lightweight.



Very good value. ONLY **£160**

### THIS IS THE BEST CHEAP SCOPE YOU WILL EVER BUY!!!

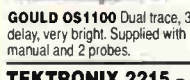

ONLY **£200**

**GOULD OS1100** Dual trace, 30MHz delay, very bright. Supplied with manual and 2 probes.

### TEKTRONIX 2215 - Dual Trace 60 MHz Sweep Delay, Includes 2 probes, Only



ONLY **£350**

### TEKTRONIX 400 SERIES



**468** Digital Storage Dual Trace 100MHz Delay.....£550

**466** Analogue Storage Dual Trace 100MHz Delay.....£250

**485** Dual Trace 350MHz Delay Sweep.....£750

**475** Dual Trace 200MHz Delay Sweep.....£450

**465** Dual Trace 100MHz Delay Sweep.....£350

**HC 3502** 5mV-20Div; 0.2u secs-0.5 Sec/Div; X-Y; X5 Magnifier; TVSync etc.



Un-Used **£180**

PHILIPS PM3296A Dual Trace 400Hz Dual TB Delay Cursors IEEE.....£2250  
TEKTRONIX 2465A 4Ch 350MHz Delay Sweep Cursors etc.....£2500  
TEKTRONIX 2445/2445A/B 4Ch, 150MHz Delay Sweep Cursors etc.....from £900  
TEKTRONIX TAS 465 Dual Trace 100MHz Delay Cursors.....£900  
TEKTRONIX 2235 Dual Trace 100MHz Delay Cursors.....£700  
IWATSU SS5711 4ch 100MHz Delay Sweep.....£550  
PHILIPS 3055 2+1 Ch 50MHz Dual TB.....£475

### NOW THIS IS RIDICULOUS!!!



**MARCONI 2019** Synthesised AM/FM Sig Gen 80KHz-1040MHz LCD Display Keyboard entry. ONLY **£900**

**MARCONI 2017** Phase Lock AM/FM Sig Gen 10KHz-1024MHz.....£1200  
**MARCONI 2022A/C** Synthesised AM/FM Sig Gen 10KHz-1GHz.....from £1500  
H.P. 8672A Synthesised Sig Gen 2-18GHz.....£6000



**H.P. 8640A** AM/FM Sig Gen 500KHz-1024MHz **£450**  
500KHz-512MHz Version - £250

**FARNELL PSG1000** Syn AM/FM Sig Gen 10KHz-1GHz. Portable.....£995  
**Farnell PSG520** Syn AM/FM Sig Gen 10KHz-520MHz Portable.....£450  
**RACAL 9081** Syn AM/FM Sig Gen 5-520MHz.....£400  
**MARCONI TF2015** AM/FM Sig Gen 5-520MHz.....£175  
**MARCONI 6311** Prog Sweep Gen 10MHz-20GHz. £4000  
H.P. 3325A Syn Function Gen 21MHz.....£950  
**PHILIPS PM5134** Sweep Func Gen 0.001Hz-20MHz.....£300  
**PHILIPS PM5132** Sweep Func Gen 0.1Hz-2MHz.....£200  
**MARCONI 2305** Modulation Meter 500KHz-2GHz.....from £1200

**FARNELL AMM2000** Automatic Mod Meter, 10Hz-2.4GHz. Unused.....£1250  
**RACAL 9008** Automatic Mod Meter 1.5MHz-2GHz £200

### SPECTRUM ANALYSERS

H.P. 8562A Synthesised 1KHz-22GHz.....£10,000  
H.P. 8565A 0.01-22GHz.....£3,500  
H.P. 8590A 10KHz-1.8GHz (75ohms).....£2500  
H.P. 8559A with Main Frame 0.01-21GHz.....£2500  
H.P. 8558B with Main frame 100KHz-1500MHz £1500  
ADVANTEST TR4131 10KHz-3.5GHz.....£3500  
ADVANTEST TR4132 100KHz-1GHz.....£1200  
**MARCONI 2382** 100Hz-400MHz High Resolution.....£2300  
**MARCONI 2370** 30Hz-110MHz.....from £500  
**HP141** Systems 8553 1KHz-110MHz from.....£500,  
8554 500KHz-1250MHz from £750; 8555 10MHz-18GHz.....from £1000

**FARNELL LF1** Sine/Sq Oscillator 10Hz-1MHz **£75**

**LEVELL TG200DMP** RC Oscillator 1Hz-1MHz Sine/Square. Meter, Battery Operated (Batteries not supplied).....£50

**CLASSIC AVO METER** A Digital AVO DA 116 3.5 digit Complete with Batteries & Leads Only **£30**

**METROHM 9A** - 500V Battery Meggar (a useful back up for fault finding) Complete with Batteries & Leads. ONLY **£35**

**SOLATRON 7045** - 4.5 Dig Bench Multimeter with leads **£45**

**SOLATRON 7150** - DMM 6.5 digit True RMS IEEE **£300**

**WAYNE KERR AMM255** Automatic Modulation Meter AM/FM 1.5MHz-2GHz 3.5 digit. Unused **£500**

**GOODWILL GFC 8010G** Frequency Counter Range 1Hz-120MHz 8 digit display 15MV RMS sensitivity. Unused **£75**

**ANALOGUE MULTIMETER** Model HC260TR AC DC volts DC current 10 amps; 17 ranges; Continuity Buzzer. Transistor Tester. Unused £15

### BRAND NEW OSCILLOSCOPES - NEVER USED

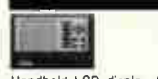

### DMS 3850A Digital Storage/DMM

Handheld LCD display. 2 Channels 50ms/s. Auto range 4 Digit DMM/Capacity/frequency counter. Battery operation or external 7.5-9.5V DC ie. AC adaptor pouch complete with 2 scope probes. DMM leads; Manual. For only **£400**



**DTS 40 Digital Storage** Dual Trace 40MHz 20 MS's Storage. Cursors + On screen readout. Sweep Delay; interface etc etc. Supplied unused in original box complete with 2 probes and manual. **Amazing Value £400**



**DTA 20 Dual Trace 20MHz** All Mag TV Trig etc unused and boxed with 2 probes and manual. **£225**



100KHz-100MHz; FM 0-100KHz; Output - 19dB - 99dB AM 0-60%; 32 preset memory; Digital display frequency and output. Used **£450** Unused **£750**



**KENWOOD FL180A** WOW/FLUTTER METER 0.003%-10%; Freq 3KHz/3.15KHz RMS/AVERAGE/PEAK. Weighted filters. Digital display of rpm. 4 digit. Freq counter 0.01KHz-9.999KHz/0.01KHz-55KHz. Used **£400** Unused **£500**



**POWER SUPPLY** Model HSP3010 0-30 volts, 0-10 amps current limiting. 2 meters. Used **£160**



**GOODWILL GVT427** DUAL CHANNEL AC MILLIVOLTMETER 10uV 300V in 12 ranges Frequency 10Hz-1MHz. Used **£100** Unused **£125**



### STEWART of READING

110 WYKEHAM ROAD, READING, BERKS RG6 1PL  
Telephone: (0118) 9268041 Fax: (0118) 9351696



Callers welcome 9am-5.30pm Monday to Friday (other times by arrangement)

CIRCLE NO. 138 ON REPLY CARD

# Power amplifier circuit boards

**£42 per pair  
fully inclusive  
or £25 each**

Professionally designed and manufactured printed circuit boards for Giovanni Stochino's no compromise 100W power amp are available to buy.

These high-quality fibre-glass reinforced circuit boards are designed for Giovanni Stochino's fast, low-distortion 100W power amplifier described in the August 1998 issue. Layout of the double-sided, silk screened and solder masked boards has been verified and approved by Giovanni.

**This offer is for the pcbs only.** The layout does not accommodate the power supply scheme shown in the article. Note that a copy of the article and a few designers' notes are included with each purchase, but you will need some knowledge of electronics and thermal management in order to successfully implement this design.

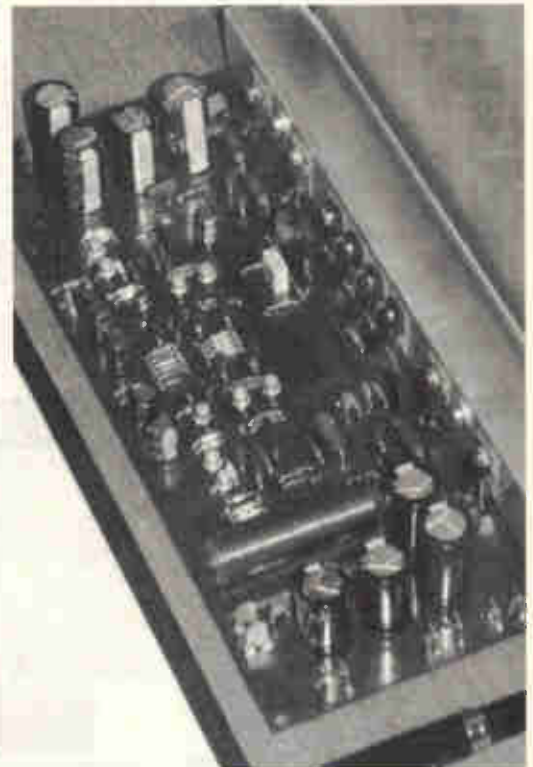
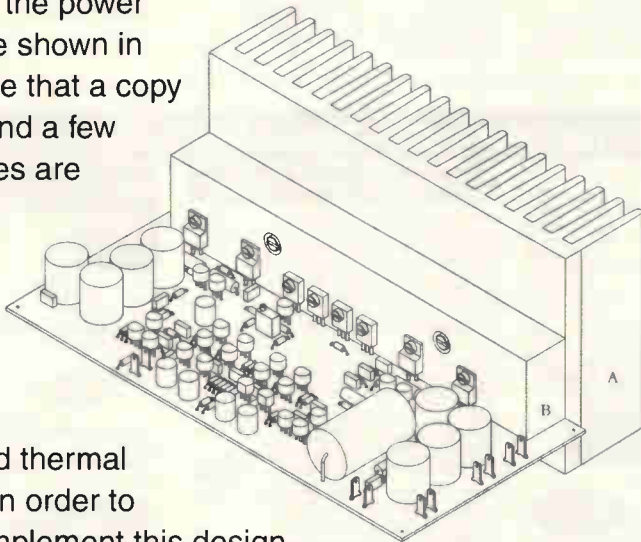

**Giovanni's high-performance power amplifier mounted on its heat sink.**

Please send me \_\_\_ pcbs @ £25 each or £42 a pair.

I enclose my cheque for £ \_\_\_\_\_

Please debit my credit card for £ \_\_\_\_\_

Card type MasterCard/Visa.

Card number \_\_\_\_\_

Expiry date \_\_\_\_\_ / \_\_\_\_\_

Signature \_\_\_\_\_

Name \_\_\_\_\_

Address \_\_\_\_\_

Tel \_\_\_\_\_

Cheques made payable to Reed Business Information.

Post to: PCB Offer, Electronics World, Quadrant House, The Quadrant, Sutton, Surrey, SM2 5AS. Please allow 28 days for delivery.

## Specifications

Power into 8Ω load	100W
Small-signal bandwidth before the output filter	20Hz (-0.1dB), 1.3MHz (-3dB)
Unity gain frequency before the output filter	22MHz
Output noise (BW=80kHz, input terminated with 50Ω)	42μV rms
Measured output offset voltage	+32mV

### Distortion performance

V <sub>out</sub> pk-pk	1kHz	20kHz
5	0.0030%	0.0043%
10	0.0028%	0.0047%
20	0.0023%	0.0061%
40	0.0028%	0.0110%
80	0.0026%	0.0170%

### Slew rate

Positive slew-rate	+320V/μs
Negative slew-rate	-300V/μs





*Waxing lyrical...  
Comedienne  
Ruby Wax – one  
of the stars being  
used, according  
to the BBC, to,  
“...guide viewers  
into the emerging  
world of digital  
broadcasting.”*

# Digital outlook

**The introduction of digital television services could be a soap opera in itself. SkyDigital, BBC and OnDigital are all hoping to be the station of the nation, but all are realistic in realising the British public will have to be convinced digital tv is something worth paying for. Richard Wilson checks out the viewing figures.**

**W**hat have Manchester United and October 1st in common? Both will be pencilled prominently in Rupert Murdoch's diary. After the takeover bid for the football team comes the launch of the UK's first satellite digital tv service.

When Murdoch's satellite tv broadcaster launched its UK digital tv service on the first of the month, Sky struck early in a market that is destined to dazzle us all with activity - technical, commercial and social - over the next half year or so.

The next date to ink in on the digital tv calendar is 15 November. This is when the first terrestrial digital tv service from OnDigital, the 50-50 joint venture between independent broadcasters Carlton and Granada, goes live.

That is by no means the end of the digital-tv story. The

BBC may have launched its first digital channel – BBCChoice – but it has yet to make its big move in the digital-tv market and no one is underestimating the impact super-quality digital tv and interactive services will have in the country's growing cable sector.

Is talk about a digital-tv market just a little premature? No one is foolish enough to write off digital before it has even appeared. The real question is how quickly the market for digital tv and interactive information services will expand. The answer to that question depends on three things; the cost of the hardware – set-top boxes and tvs, the quality of the programme content and how the three broadcast media, satellite, terrestrial and cable will divide up the market.

In the run up to the launch of its terrestrial service next

*Action,  
cameras...  
Focusing on the  
digital tv age.*



month, OnDigital estimates that eight million people are prepared to pay £200 for a set-top box that will enable them to receive Coronation Street in glorious digital picture quality.

Digital hardware will also become even more attractive, according to the broadcaster, when the receiver is integrated into the tv set.

With around four million people estimated to buy new tv sets each year in the UK, the change to digital hardware may not be as painful as some have predicted. When buying a new tv consumers may be prepared to absorb the additional cost of the digital receiver.

If getting enough people to buy the wide-screen tv and digital receiver is no longer the major obstacle, then getting the prospective digital viewers to one of the three broadcast media, terrestrial, satellite or cable, will surely remain the big issue for firms like BSkyB, the BBC and OnDigital.

Surprisingly, one market researcher is convinced that terrestrial operator OnDigital will find it difficult to compete with the satellite service of SkyDigital.

Consumer market research carried out by Strategy Analytics forecasts that while SkyDigital could be beaming services to just over a million homes – 5% of the total – by the end of next year, OnDigital's terrestrial service could have just 120 000 viewers.

The prediction of 250 000 digital tv subscribers for cable is only slightly more optimistic.

Such is the expectation that by 2005, the analysts predict that 29 per cent of UK households will have digital satellite tv, and 24 per cent digital cable. Only 5 per cent are predicted to be watching digital terrestrial tv.

So why the confidence about satellite over terrestrial, which is the means by which most of us get today's tv? The argument seems to rest on the fact that satellite pay-per-view approach to broadcasting is ideal for applying to the market for digital services, which will be wide-ranging by today's broadcast standards.

Terrestrial broadcasters do not charge viewers for services, the licence fee excepted, television programmes

are just there in the front room, free at the point of use. Digital services will simply not be like that.

"OnDigital is boxed into a corner," says David Mercer, a consultant at Strategy Analytics. "It needs pay tv revenues to survive, but is selling to an audience which doesn't want to pay for tv."

There is also the more practical argument that terrestrial broadcasters will be limited by frequencies available in the range of service they will be able to provide, compared to satellite and cable.

Predictions are there to be accepted or scoffed at, and only time will tell whether the arguments hold true. However, it seems that the BBC is already resigned to losing substantial ground to satellite and cable services in the digital revolution.

"Terrestrial won't be dominant in the future," said Charles Evans, the BBC's project director of digital services, speaking in London at last month.

The BBC has insisted that it will not charge subscription fees for many of its digital tv services. If the finances permit such an approach, then it is hard to see how it will not have a major impact on pay-per-view satellite and cable services, as it does in today's analogue tv.

The technology may change but history tells us that human nature is stubborn to conversion.

Today Sky's satellite viewers total no more than half the regular audience for Coronation Street on one of five free terrestrial television channels.

This tells us that there is a considerable chunk of the tv audience which is not used to paying for its programmes.

The introduction of digital-tv services means that more of us must accept that we will have to pay for what came free in the past. However, as long as there is a choice then SkyDigital, OnDigital and the cable firms will have to convince us that digital television is something worth paying for.

Rupert Murdoch won't be writing off terrestrial tv just yet, which is why 15 November is still an important date in his diary. ■

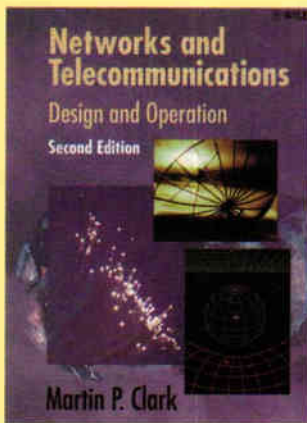

## Networks and Telecommunications Design and Operation

Second Edition  
Martin P. Clark,  
Telecommunications  
Consultant, Frankfurt,  
Germany

Telecommunications network design and operation is now widely regarded as an issue of business management as well as electrical engineering. In this updated edition, Martin Clark, a pioneer of this perspective, applies it to the increasing complex and diverse realm of voice, and data and multimedia networks. Written in an accessible style and clearly illustrated throughout, this is a basic, practical and intuitive insight into modern network engineering and sections including:

- Technical accounts of modern voice, data and multimedia networks
- Coverage of ATM, B-ISDN, SDH, mobile radio and satellite networks, Internet and TCP/IP
- Practical aspects of running and setting-up networks
- Running a business based on telecommunications

A text specifically for readers new to the whole subject of telecommunications, and professional telecommunications managers who need an introduction and reference work on all aspects of technology, operational techniques and regulation.

ISBN 0 471 973 46 7

UK £80.50 Europe £86 ROW £105

## Introduction to Digital Mobile Communication

Yoshihiko Akaiwa

A comprehensive treatment of the digital technologies that make personal mobile communication a reality

Although today's mobile communication engineers and designers can build upon the advances in digital telecommunications, specific technical requirements - robustness against fast fading,

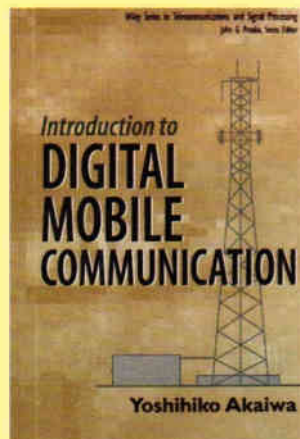

spectrum and power efficiency, and the demand for low-priced equipment - post new technological challenges that demand creative solutions.

Introduction to Digital Mobile Communications is a comprehensive treatment of the digital technologies that are rapidly spawning new advances and applications. Written by a pioneer in the field, this book covers all the important concepts, from the fundamentals of signal analyses and digital communication to descriptions of the latest transmission systems. Rich in detail and broad in its coverage, this remarkable book:

- Describes equipment and circuit implementation methods and their performance characteristics
- Discusses elements of and methods for digital modulation and demodulation schemes
- Provides practical designs and circuits for spectrum-efficient modulations
- Covers mobile radio channels and digital mobile radio systems
- Includes extensive

- mathematical treatments and mathematical models
- Presents the latest research results with detailed references

This valuable resource provides a solid introduction to mobile radio communication for the students or professional in related fields. Most important, for design engineers and equipment manufacturers, its up-to-date findings will stimulate new research and creative design and system development efforts.

Yoshihiko Akaiwa is a leading researcher in the digital mobile communication field. Currently a professor at Kyushu University, he worked as a researcher for over twenty years at the NEC Corporation

ISBN 0 471 17545 5

UK £57.50 Europe £60.50 ROW £73

## Cellular Mobile Radio Systems

Designing Systems for Capacity Optimization

Husni Hammuda, Ericsson  
(UK) Ltd

Rapidly increasing demand for mobile radio frequency subscription is already pushing cellular networks to the point of overload. Of the various methods which are being explored to tackle this problem one of the most notable is the integration of advance modulation and multiple access techniques. In this book, Husni Hammuda, a pioneer of this hybrid, shows how it can be applied in practice to optimise the efficiency of mobile radio cells.

- Provides detailed criteria for

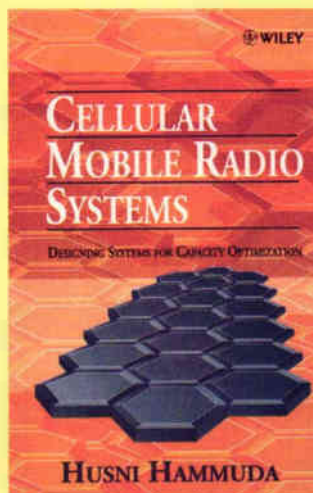

the evaluation of combinations of modulation and multiple access techniques

- Includes primary performance data as well as predictive models
- Theoretical material is explained using examples from first and second generation transmission systems
- Covers recent innovations in personal communications

For the practising cellular communications engineer this is a systematic set of solutions for improving traffic flow in cellular networks. It also includes complete theoretical and case material ideal for post-graduate network engineering researchers.

ISBN 0 471 95641 4

UK £37.50 Europe £39.95 ROW £46.95

## Network-Based Images

A Practical Guide to Acquisition, Storage, Conversion, Compression and Transmission

Gilbert Held, 4-Degree  
Consulting, Macon, Georgia,  
USA

Network-Based Images offers a fresh approach to the acquisition and manipulation of visual images on computer by focusing on the network application side.

This practical Guide explains the methods used to store images electronically and discusses the popular image-based applications, such as storage, conversion and compression. Gilbert Held reviews the procedures used to minimize the effects of other image-based applications to increase efficiency.

This network oriented book provides detailed information on the transmission of images to other systems and includes an overview of the associated problems.

Features include:

- Use of images on LANs includes LAN-based World Wide Web Servers
- Use of HTML image related statements
- Techniques to avoid costly network upgrades
- How to segment LANs
- Network modifications to

counter the bandwidth effect of images upon LAN transmission

Essential reading for network managers and administrators as well as Web server administrators and personal computer users. This book will provide unique coverage of images oriented to efficient use on networks: storage, acquisition, and use in applications  
 ISBN 0 471 97357 2  
 UK £37.50 Europe £39.95 ROW £46.95

### Stereophonic Sound Recording

*Theory and Practice*  
 Christian Hugonnet and Pierre Walder

Recent advances in digital audio have heralded substantial innovations in sound recording techniques and increased the importance of applying the latest microphone techniques. The authors of this book focus on these innovations, giving numerous examples of their use within the framework of an analysis-based recording

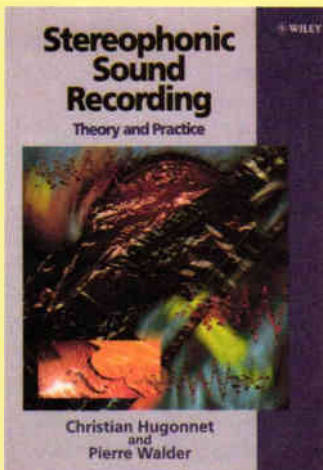

engineering theory. The book provides a complete overview of well-known sound recording procedures practised worldwide, whilst also presenting a methodology that will provide the reader with an efficient approach to sound recording of classical music, rock and pop music, drama and speech. The widely illustrated theoretical knowledge is presented in clear and simple language.

Building on their considerable experience of creating innovative recording techniques, the authors

provide an authoritative analysis of the subject that offers valuable, practical guidance that will aid the development of new recording methods. Their inside knowledge of the requirements of the phonographic, broadcasting, film and other media industries ensures expert coverage of new products and approaches including:

- recording techniques for all types of microphones
- in-depth analysis of the principles and use of stereophonics
- influence and role of the venue acoustics on the sound recording
- guidelines for mastering and mixing different levels of sound from different sources

For professional audio engineers, this manual provides systematic advice for getting optimal performance from studio equipment. For students of audio engineering it will form a comprehensive introduction to the area of stereophonic recording, backed up by real-world case studies and a wealth of practical experience.  
 ISBN 0 471 97487 0  
 UK £32.45 Europe £34.95 ROW £41.95

### Protect Your Privacy on the Internet

*Privacy defense tools and techniques you can use right now*  
 Bryan Pfaffenberger

CD-ROM includes a complete collection of Windows privacy software.

Is your complete life story available to anyone with Internet access? It's really not all that hard to snoop in

*Continued over page*

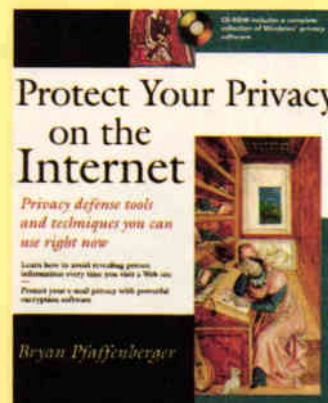

## All prices are fully inclusive of packaging and delivery

Return to Jackie Lowe, Room L333, Quadrant House, The Quadrant, Sutton, Surrey, SM2 5AS

Please supply the following titles:

Qty	Title or ISBN	Price

Total \_\_\_\_\_

Name \_\_\_\_\_

Address \_\_\_\_\_

Postcode \_\_\_\_\_

Telephone \_\_\_\_\_

Method of payment (please circle)

Access/Mastercard/Visa/Cheque/PO

Cheques should be made payable to Reed Business Information

Credit card no \_\_\_\_\_

Card expiry \_\_\_\_\_

Signed \_\_\_\_\_

Please allow up to 28 days for delivery

cyberspace. As more and more business is conducted over the Internet, it has become increasingly difficult for both businesses and individual users to protect private information. Your reputation, Your finances, and your basic right to privacy are on the line every day. What can you do about it?

You can fight back. Protect Your Privacy on the Internet tells you everything you need to know to ensure your privacy and use the same technology that's being used against you to protect yourself. You'll get industrial-strength encryption tools to keep your affairs secret, the way they ought to be.

Bryan Pfaffenberger arms you with privacy defense strategies such as:

- Creating a bullet-proof password
- Getting your name out of the databases
- Cleaning up your browser's trails

Protect Your Privacy on the Internet gives you proven privacy defense strategies and techniques to help you make the Net a safer place to work and play. You'll get the names of Internet privacy organizations that are working to protect your privacy rights and find out what you can do to help. On the accompanying CD-ROM you'll find a collection of Windows Privacy freeware and shareware, including:

- Pronto96 - an e-mail program that works in conjunction with encryption software to protect your e-mail
- Mutilate - software that thoroughly erases files beyond recovery, even by expert snoopers
- Win-Secure-It® - a utility preventing unauthorised access to files on your computer
- AMSD Ariadna™ - a full-featured browser that reads tables and Java but ignores "cookies", text files that transparently save where you've been
- Random Password Generator - a program enabling you to generate up to 1,000,000 passwords to protect you against unauthorized access to your Internet account
- Cyber Patrol™ - parental

control software that prevents kids from uploading personal and demographic information to commercial sites

ISBN 0 471 18143 9  
UK £27.45 Europe £29.95 ROW £36.95

## Internet Audio Sourcebook

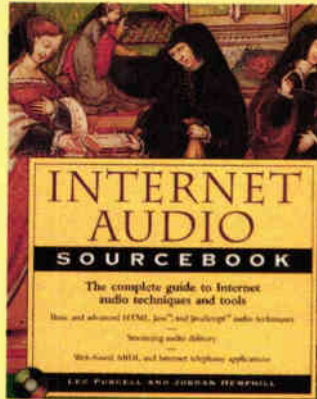

*The complete guide to Internet audio techniques and tools*  
Lee Purcell and Jordan Hemphill

"The World Wide Web has spouted vocal cords, gained a voice, and begun to sing." - Lee Purcell and Jordan Hemphill

Internet Audio Sourcebook offers you a quick, easy way to acquire the knowledge, skills, and some of the tools you need to build cutting-edge audio capabilities into your Web pages, including:

- Music, narration, and sound effects
- Streaming audio for real-time broadcasts
- Automated, spoken-voice instruction
- Audio conferencing and Internet telephony
- MIDI techniques for musical training and analysis

Taking a step-by-step approach, the authors get you up to speed on the latest audio tools and techniques. First they school you in the basics of creating, processing, and storing audio data.

You learn the various methods of working with digital sound and how to use available tools to shape audio content for the Internet. Then they show you how to deliver your digital sound over the Web. They explain the HTML coding used to access audio files and teach you techniques for integrating Java applets,

JavaScript code, and VBScript code into your HTML documents.

Finally, the authors show you how to get the most out of new audio technologies, including streaming audio, MIDI applications, voice synthesis and recognition, and Internet telephony, as well as covering hot new products like the Headspace Beatnik audio engine and Liquid Audio.

### The CD-ROM

You get fully functional demos of top-of-the-line sound processing applications, including Sonic Foundry's Sound Forge and Hohner Midia's Samplitude Studio. Authoring tools such as Symantec's Visual Café, Aimatech's Jamba, and Acadia Software's Infuse JavaScript editor are also included.

ISBN 0 471 19150 7  
UK £28.45 Europe £31.95 ROW £39.95

## Web Security Sourcebook

**A Complete Guide to Web Security Threats and Solutions**  
Aviel D. Rubin, Daniel Geer, and Marcus J. Ranum

The front door is unlocked and wide open. The alarm's not working and no one's home. All of your valuable, money, and intimate details of your life are just sitting inside, waiting to be taken. No, it's not your house, it's your computer.

The Web now penetrates every aspect of our lives, from the home PC to the Business office. But with each advance in convenience comes a geometric increase in vulnerability to the integrity of data and software as well as to the confidentiality of information. Although the flaws inherent in the Web are real, solutions are available. Let Aviel Rubin, Daniel Geer, and Marcus Ranum give you the answers.

Here's a book that's valuable today and indispensable for the future. It includes basic and advanced techniques for client-side and server-side security, browser security, writing secure CGI scripts, firewalls, and secure e-commerce. There's a special appendix that demystifies the complex world of cryptography. And the book comes with access to a dedicated Web site containing

up-to-the minute information on the latest security threats and solutions.

So whether you're a Webmaster trying to close the door on sites and applications, or an everyday user hoping to keep your desktop safe, this is your essential source of:

- Protecting and securing Web pages, search engines, servers, and browsers
  - Writing impregnable applets and scripts, and avoiding the dangers inherent in every language
  - Using (and abusing) firewalls and cryptographic controls
  - Securing commerce and payment transactions
- ISBN 0 471 18148 X  
UK £27.45 Europe £29.95 ROW £36.95

## Encyclopaedia of Acoustics

Edited by Dr Malcolm J Crocker, Auburn University

Sound Information in 167 detailed Chapters. Now there's a new four-volume reference that covers every imaginable area of acoustics, sound and vibration - from the design of a concert hall to the intricacies of the human ear. It's the Encyclopaedia of Acoustics.

In this on-of-a-kind set, edited by well-known acoustical expert Dr Malcolm J. Crocker, you'll get:

- Extensive cross-referencing and indexing
- 2000- plus pages of insights from more than 200 international expert contributors
- An exhaustive examination of the fundamentals of acoustics and vibration in the first two volumes
- A revealing exploration of acoustic applications in Volumes Three and Four
- General Introductions at the start of every section

This up-to-date work is the definitive acoustics resource for students, engineers, scientists, and researchers in the field.

Casebound © 1997, four-volume set approx. 2,000pp. (750pps./volume)  
ISBN 0471 80465 7

UK £372.45 Europe £384.97 ROW £390

## Apple Recruitment – The Taste of Success

We currently have many vacancies on our books for RF, Microwave and Antenna Design, Development and Test Engineers. Below is a selection of some positions we have on our records:

### RF Engineers

**Herts** £23-40k  
Our client has positions at all levels for engineers with 2.1/1st class honours degrees with a good background in developing *transmitters, receivers, filters, I.NAs* and *amplifiers*.

**Hants** £25-36k  
Our client is looking for several RF engineers with good degrees and several years experience developing mobile telecommunications systems. Knowledge of CSM would be an advantage.

**Berks** £24-36k  
Applicants are sought from RF design engineers with a good degree and practical post-grad experience covering some of the following areas – *RF to 2GHz, LNA design, PLLS, GSM, Filters, power amps, VCOs* or *EMC*.

**Hants** £25-36k  
Our client is looking for several RF engineers with good degrees and several years experience developing mobile telecommunications systems. Knowledge of GSM would be an advantage.

**Kent** £28-32k  
Our client is looking to recruit degree qualified RF/Microwave engineers with good post-graduate experience of *I.NAs, filters, diversity systems* and *measurement techniques*.

**Beds** £26-34k  
A designer of cellular radio products is looking for experienced RF engineers to design receivers up to 2GHz. Familiarity with digital modulation and DSP would be beneficial.

**Cambs** £28-35k  
Engineers are sought with good degrees and several years post-graduate experience in developing RF circuits and systems. Some of the following skills are needed – *GSM, PCN, DECT, wireless I.AN, antennas, superhet receivers, oscillators, synthesisers, amplifiers* or *EMC*.

### Microwave Engineers

**Hants** £25-38k  
Our client is seeking qualified engineers to carry out circuit design and testing with *MIC* and *Galls MMIC circuits* (e.g. *low noise amplifiers, phase and gain control units, oscillators and power amps*) with operating frequencies from *0.5 to 100GHz*.

**Scotland** £27-35k  
We are looking for several microwave design engineers with skills in *oscillator design, amplifiers, filters* and *mixer design*. Knowledge of *HP EEs* of design and layout packages would be of help.

**Devon** £22-34k  
A major developer of radar systems is looking for experienced engineers to develop circuits and sub-systems up to 40GHz. Knowledge of antennas would be beneficial.

**Sussex** £22-34k  
A major developer of radar systems is looking for experienced engineers to develop circuits and sub-systems up to 40GHz. Knowledge of antennas would be beneficial.

### RF Test Engineers

**Surrey** £16-21k  
We have several positions for *Test Engineers* with 1 year+ experience testing *RF systems* and circuits using *spectrum analysers, oscilloscopes* and other *test equipment*.

**Hants** £17-19k  
Applicants with experience of testing RF systems and circuits down to component level are sought by our clients.

**Northants** £16-20k  
With an HNC and 2 years experience of testing RF/Microwave products up to 2GHz, you may just be the individual our client is looking for.

### 1st/2.1 Degree or Ph.D

**Nationwide** £Attractive

Many of our clients are looking for both fresh and experienced graduates/post graduates for positions in RF/Analogue/Microwave design and development.



3 Branksome Way, New Malden, Surrey KT3 3AX  
Tel: 0181 549 0100 Fax: 0181 549 9771  
email: [consult@applerec.u-net.com](mailto:consult@applerec.u-net.com)  
Web: <http://applerec.u-net.com/>

# Test

## *opportunities*

## *to £28k*

Test Technician	RF/GSM	Surrey/Wilts/Herts	£23k
Test Support	EMC	Berks	£21K
Support Technician	Production Equip't	Wilts	£22k
Field Service	Printing Equipment	Surrey/Cheshire	£23k
Test Technician	Avionics	Sussex	£19k
Calibration/NAMAS	PSU's	Hants	£18k
Test Development	Sonar	Berks	£20k
Production Support	SMT Equipment	Shropshire	£20k
ATE Functional Test	Cellular Radio	Surrey	£18k
Systems Test	SDH	W. Midlands	£25k
Systems VVI	PMR - TETRA	Berks	£28k
Microwave Test	Radar	Essex	£19k
Systems VVI	SDH	Oxon	£28k
Field Service	Medical	London/Essex	£20k

**For more information, contact John Darby, quoting  
ref 2791H, on 01727 818704, fax 01727 838272  
or email [johnd@jprecruit.com](mailto:johnd@jprecruit.com)**

JPR, The Courtyard, Alban Park,  
Hatfield Rd, St Albans, Herts AL4 0LA.

  
**John Prodger  
Recruitment**  
Connecting people with opportunities

## RF Design Engineer

### Berkshire

#### 1.5GHZ, Integrated Circuits

You will need to be degree qualified with at least 3 or more years RF design experience. As my client is one of the world's leading innovators in the area of high performance, integrated circuits, they are looking for an engineer to deal with RF applications on these IC's of up to 1.5GHZ. Experience in CMOS or BICMOS would be advantageous. Please call in quoting reference if you require further information on this vacancy.

Ref: 61058

## RF Manager

### Midlands

#### GSM

This global leader in the provision of communications sites and network services to broadcasting and telecommunications industries, is currently looking to recruit a key individual to lead a small team of dedicated special projects staff. The ideal candidate will have a minimum of 2 years experience of live networks and a background in planning and analysis of cellular coverage. Please quote reference for more details.

Ref: 61259

## RF Design & Development Engineer

### Northern Home Counties

#### RF, Communications

This communications organisation is one of the UK's leading suppliers of hand portables, vehicular mobiles and base station. The ideal applicant will be involved in the design and development of mobile radio equipment, so it is essential that you have several years experience in this field and in RF circuit design. You must be degree qualified in communications or electronics. To find out more about this vacancy, please call in quoting the reference.

Ref: 61161

## Power Supply Electronics Engineer

### Northants

#### Switch Mode Power Supplies

My client specialises entirely in the design and manufacture of power supplies mainly for the military sector. Due to growth and expansion, they are now seeking to employ a Power Supply Design Electronic Engineer. The ideal candidate will have experience in the design of multi-output switch-mode power supplies. Some of the supplies designed are used in demanding applications, so experience in DEF STAN's and MILL SPEC's would be advantageous. Please quote reference when calling in.

Ref: 61050

## ASIC Design Engineer

### NW London

#### VHDL

This London based company is aiming to lead the emerging market for re-usable semiconductor intellectual property for customisable microprocessor cores. They are currently looking for experienced ASIC Design engineers with a minimum 2 years experience of writing VHDL for Synthesis to ASICs, or integrating microprocessor cores into ASIC designs. If you would like more information on this vacancy, please phone in with reference number.

Ref: 61424

## COMMS 2000

### Communications Consultants

11 Harley Street

London W1N 2EQ

Telephone: 0171-636 7584

Fax: 0171-580 3734

Comms 2000 is a division of

The 2000 Group Plc

e-mail: ctt@2000group.win-uk.net

## Analogue Electronics Design Engineer

### Middlesex

#### Analogue, Digital Circuit Design

My client, a large MOD organisation are currently looking to recruit a design engineer to support the VHF and UHF work of their Sonar Products. You will have experience in analogue and digital circuit design and prototypes, PCB design and microprocessor software development and testing. Design experience in UHF and UHF receiver techniques and technology would be preferred as would a sound background in mobile communications.

Ref: 61610

## LSI Engineers

### Berkshire

#### LSI Design, VHDL, ASIC

My client, a leading developer of chip sets for mobile phones is currently recruiting for engineers with at least 2 years experience of LSI design. You will be required to verify and improve new design flows and definition of design procedures, so knowledge of ASIC design is essential as is VHDL and Verilog HDL coding. Experience and knowledge of DSP techniques and CAE tools such as Cadence and Synopsys is also required. An understanding of mobile communications would be an advantage.

Ref: 61714

## Hardware Engineers

### Newport

#### Xilinx, FPGA

Our client, the defence division of a major global telecommunications organisation is currently looking to recruit hardware engineers with a working knowledge of Modeltech Simulation Tools and Synopsis Synthesis Tools. Knowledge of Xilinx 4000 Series FPGAs and digital design experience would be advantageous.

Ref: 61461

## Mixed Signal Engineers

### M4 Corridor

#### CMOS, BICMOS, CADENCE

This global leader in the development of chip sets for mobile phones requires engineers with 5 or more years experience in mixed signal design. You will be responsible for circuit feasibility studies, circuit design, simulation and layout so a good working knowledge of CMOS or BICMOS processes is essential as is experience of Cadence based mixed signal design flow including Saber and Spice. An understanding of mobile communications would be advantageous. Please call in with reference.

Ref: 61715

## Digital Design Engineer

### Birmingham

#### Digital Design, FPGA

Your role will be to specify, design, implement, test and document all aspects of digital hardware design for a telecommunications equipment developer. You will have 2 years of digital design experience, preferably with a telecomms bias. An understanding of current CAE technology with skills in at least 2 of the following: PLDs, FPGA and Embedded Microprocessor/DSP. You will also be up to date with telecommunications standards and implementations for PDH, SDH, ISDN, PSTN and ATM.

Ref: 61470

## RF/Microwave Design

### Engineers

#### West Yorkshire

#### RF/Microwave

My client is a leading international manufacturer of microwave and RF products for the mobile communications market. They are looking to employ engineers to be responsible for the design and development of RF components and integrated front-ends for the cellular radio and base station equipment markets. The ideal candidate must have experience of rf/microwave components, low noise amplifiers, filters, rf detectors, mixers, couplers and splitters. Working knowledge of microwave CAD tools is also essential.

Ref: 61774

## Manufacturing Cell

### Manager

#### West Yorkshire

#### RF Passive Products

A manufacturing cell manager is required by an international manufacturer of passive RF products. You will be responsible for all aspects of the production of these products. You will have 2+ yrs experience in the delivery of 100% defect free products, achievement of delivery schedules, improvement within a production cell and day to day management of staff including the selection, training and development of them. Knowledge of Health and Safety procedures is essential. To find out more details regarding this vacancy, please call in with reference.

Ref: 61783

## CONTRACT VACANCIES

### Cell Planning Engs

#### GSM, Radio Knowledge

#### UK and Europe

Ref: 59745

### Telecoms Test Engs

#### AXE-10 Experience

#### UK wide, 6 mths

Ref: 59831

### GSM Consultants

#### Project Management,

#### Switch Management

#### Radio Cell Planning

#### Worldwide

Ref: 60753

### Network Development Engs

#### GSM, PMR

#### UK wide

Ref: 59754

### RF Design Engineer

#### 1.9 GHZ, Transmitter

#### Beds

Ref: 59926

### Radio Planner

#### Wireless Local Loop Exp

#### Worldwide

Ref: 61648



## ELECTRONIC PARTS MANAGER

### Rutherford Appleton Laboratory, Oxfordshire

The Rutherford Appleton Laboratory Space Science Department is involved in designing, developing and building a variety of Scientific Research Instruments for operation in Space. Electronic parts manufactured to European Space Agency, NASA and US Military high reliability specifications are used.

There is a vacancy for a parts manager to work with the design engineers and the manufacturing facility at all stages of procurement and manufacture within an ISO9001 system. Duties will include; advising designers on specifications, procuring and storing parts in a secure area and assembling manufacturing kits and maintaining paper and electronic records. Maintaining good contact with suppliers/manufacturers and the wider parts community in order to keep up to date with changes.

The successful candidate will have some experience in this field, understand the handling requirements for electronic parts and be familiar with ESA and NASA Space Specifications or US Military Specifications for electronic parts. Familiarity with PC use and the Access database would be an advantage, although training will be given. A degree or HND in electronic engineering is desirable or NVQ Level 5 or equivalent.

The salary range is between £15,180 & £24,820 (1998 pay award pending). Progression within the salary range is dependant upon performance. A non contributory pension scheme, flexible working hours and a generous leave allowance are also offered.

Application forms can be obtained from: Recruitment Office, Personnel Division, Rutherford Appleton Laboratory, Chilton, Didcot, Oxfordshire, OX11 0QX. Telephone (01235) 445435 (answerphone) quoting reference VN1698/98. More information about CLRC is available from CCLRC's World Wide Web pages at <http://www.cclrc.ac.uk>

All applications must be returned by 16 October 1998.

The CCLRC is committed to Equal Opportunities and to achieving the Investors In People standard. A no smoking policy is in operation.

COUNCIL FOR THE CENTRAL LABORATORY  
OF THE RESEARCH COUNCILS



## ADVERTISERS PLEASE NOTE

FOR ALL YOUR FUTURE  
ENQUIRIES ON  
ADVERTISING RATES  
PLEASE CONTACT  
JOANNAH COX  
ON

TEL: 0181 652 3620  
FAX: 0181 652 8938

## ST Microelectronics Field Application Engineers

Anglia is a well structured, professional organisation determined to offer the electronics manufacturing industry the very best in product, service and support. With STMicroelectronics being our most recent franchise, we need the following people to join our growing semiconductor team.

### 2 Field Semiconductor Applications Engineers:

Based within easy access of the M62 or M4 corridors, applicants for these positions should be qualified HNC/Degree level in Electronic Engineering. Visiting customers throughout the UK, you will need to specialise in the application and design-in of semiconductors. Previous experience in writing Assembler and/or 'C' with microcontrollers would also be an advantage. You will also need to be self-motivated, professional and have excellent all round communication skills.

To apply for either of these positions, call **Michlene Hircock** for a confidential chat on **01945 47 47 47** between 9am & 5pm. Alternatively, send your CV to Michlene Hircock or e-mail her on [mh@angliac.co.uk](mailto:mh@angliac.co.uk).

## Field Sales Engineers

We are looking for additional field based sales engineers to develop and maintain an existing customer base in the following locations.

### 2 Field Sales Engineers:

- 1 Middx, Herts, Bucks, Berks & NW London area
- 1 Wilts, Avon, Glos & Somerset Area

Applicants will be expected to sell a wide range of electronic components, both passive and active and work closely with our application engineers to identify design-in opportunities. Applicants must have previous experience of the electronics industry and ideally have an understanding of commercial volume purchasing. Alternatively a commercially orientated design engineer who wants to move to sales would be considered. Successful applicants should be self-motivated, pro-active and dynamic, with a good sense of humour.

To apply for either of these positions, call **Michlene Hircock** for a confidential chat on **01945 47 47 47** between 9am & 5pm. Alternatively, send your CV to Michlene Hircock or e-mail her on [mh@angliac.co.uk](mailto:mh@angliac.co.uk).

Anglia



Sandall Rd, Wisbech, Cambs. PE13 2PS

☎ 01945 47 48 49    ✉ E-MAIL: [mh@angliac.co.uk](mailto:mh@angliac.co.uk)



## SUPPLIER OF QUALITY USED TEST INSTRUMENTS



### Cooke International

Unit Four, Fordingbridge Site, Barnham,  
Bognor Regis, West Sussex, PO22 0HD, U.K.  
Tel: (+44)01243 545111/2 Fax: (+44)01243 542457

Web: <http://www.cooke-int.com>  
E-mail: [info@cooke-int.com](mailto:info@cooke-int.com)

catalogue available

CIRCLE NO.139 ON REPLY CARD



## OPERATING & SERVICE MANUALS

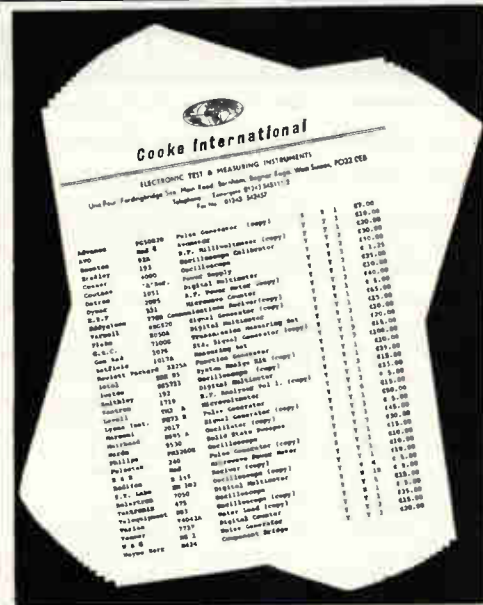

### Cooke International

Unit Four, Fordingbridge Site, Barnham,  
Bognor Regis, West Sussex, PO22 0HD, U.K.  
Tel: (+44)01243 545111/2 Fax: (+44)01243 542457

Web: <http://www.cooke-int.com>  
E-mail: [info@cooke-int.com](mailto:info@cooke-int.com)

catalogue available

CIRCLE NO.140 ON REPLY CARD

# ADVERTISERS' INDEX

ALCATEL.....	IFC	NUMBER ONE SYSTEMS.....	1017
ANCHOR SUPPLIES.....	1021	OLSON ELECTRONICS.....	988
ANTRIM TRANSFORMERS.....	1001	PANCON.....	1019
CMS.....	1017 & 1023	PICO.....	1015
COMPUTUMATION.....	1019	PS CONSULTANTS.....	993
CONFORD ELECTRONICS.....	1027	QUICKROUTE.....	1001
CROWNHILL.....	1013	RADIO TECH.....	1023
DATAMAN.....	OBC	RALFE ELECTRONICS.....	1072
DISPLAY ELECTRONICS.....	1037	SEETRAX.....	1029
ELECTROMAIL.....	1015	STEWART OF READING.....	1059
EQUINOX TECHNOLOGY.....	IBC	SURREY ELECTRONICS.....	1027
JOHNS RADIO.....	1030	SYSONIC.....	1019
JPG ELECTRONICS.....	1027	TELFORD ELECTRONICS.....	1046
LABCENTER ELECTRONICS.....	986	TELNET.....	1009
LANGREX SUPPLIES.....	1013	THOSE ENGINEERS.....	1041
M & B RADIO.....	1041	TIE PIE.....	991
MILFORD INSTRUMENTS.....	1001	WADDICOR.....	1013

**SERVICES**48 hour  
turn-  
around  
service**From  
Concept  
To  
Production**Cost-effective  
electronic  
design and  
engineering  
services

Designer Systems is an electronic product design firm with over a decade of experience designing innovative products for client companies and individuals. If you need to develop a product from scratch, want to re-develop an old product or need documentation / software/Internet site authoring, contact us for more information or see our web site

**Designer  
Systems**  
Bespoke electronic solutions

Tel/Fax: **01872 223389**  
Email: [designer.systems@btinternet.com](mailto:designer.systems@btinternet.com)  
Web: [www.btinternet.com/~orion.consultants/designer](http://www.btinternet.com/~orion.consultants/designer)

## ADVERTISERS PLEASE NOTE

## FOR ALL YOUR FUTURE ENQUIRIES ON ADVERTISING RATES

## PLEASE CONTACT JOANNAH COX

## ON

## TEL: 0181 652 3620 FAX: 0181 652 8938

**ARTICLES WANTED****VALVES, etc, WANTED**

Most types considered but especially KT88, PX4/PX25, KT66, KT77, EL34, EL37, ECC83. Valves must be UK manufacture to achieve top prices. £220 paid for working quad stereo system (II + II + 22).

COURTEOUS, PROFESSIONAL SERVICE

Ask for a free copy of our wanted List.

**BILLINGTON EXPORT LTD., Billingshurst, Sussex RH14 9EZ**  
Tel: **01403 784961** Fax: **01403 783519**

Email: [billingtonexportltd@btinternet.com](mailto:billingtonexportltd@btinternet.com)  
VISITORS PLEASE PHONE FOR APPOINTMENT

**★★ WANTED ★★**

Test equipment,  
Electronic Scrap, Valves,  
Transmitters/Receivers,  
Factory and Warehouse  
Clearance.  
Confidentiality Assured.

**TELFORD  
ELECTRONICS**

Phone: **01952 605451**  
Fax: **01952 677978**

**TOP PRICES PAID**

For all your valves,  
tubes, semi conductors  
and IC's.

**Langrex  
Supplies  
Limited**

1 Mayo Road, Croydon  
Surrey CR0 2QP  
TEL: **0181 684 1166**  
FAX: **0181 684 3056**

**ARTICLES FOR SALE****19" Rack Enclosures**

New and Used most sizes  
16U to 50U side and rear panels  
mains distribution 19" Panel mounts  
optima eurocraft. Prices from £45 +vat

**M&B Radio**

86 Bishopsgate Street Leeds LS1 4BB  
Tel. 0113 2702114 Fax. 0113 2426881

**PHILIPS 5390S  
1GHz RF SYNTHESIZER  
WITH SERVICE MANUAL  
£1099 + VAT**

100KHz to 1020MHz. -127dBm to +13dBm  
Unique video modulation + sound at  
4.5/5.5/6.0MHz, int or ext AM (to 1.02GHz) or FM  
(to 340MHz)  
RF sweep - 8 settings memories - IEEE interface  
**Anode Laboratories Ltd**  
Tel: **01353 649412** Fax: **01353 648128**

**PICO ADC10** data aquisition module with  
compaq SLT286 laptop PC. £100. Portsmouth  
(01705) 818034.

**4CX 15000J** Power Tetrodes - By National  
Electronics. 2 Pieces New and Boxed offer to  
JNL. Fax: 0171 798 5532.

**PLEASE MENTION  
ELECTRONICS  
WORLD**

**WHEN REPLYING TO  
ADVERTISEMENTS**

**RF DESIGN  
SERVICES**

All aspects of RF  
hardware development  
considered from  
concept to production.

**WATERBEACH ELECTRONICS**

**TEL: 01223 862550  
FAX: 01223 440853**

**ADVANTEST TR4131**, 4GHz Spectrum  
Analyser £2,995.00, Anritsu ML522, 300-  
1000MHz Measuring Rx £2,995.00, Racal 1795  
Rx £795.00, Eddystone 1650, 10KHz-30MHz Rx  
£995.00, W.J. 340A-6, 1-900KHz Rx £395.00,  
W.J. 373A-10, .5-30MHz Rx £395.00, W.J.  
RS111-1B-39, 30-1000MHz Rx £995.00, W.J.  
9477, Demodulator £795.00. Tel/Fax: 01908-  
365726 or Email: [phil@two-way.demon.co.uk](mailto:phil@two-way.demon.co.uk)

**UNUSED TMS77C82NL** any quantity con-  
sidered. Tel: 0181 930 0943. Fax: 0181 933 2996.

**ELECTRONIC CIRCUIT SIMULATOR  
PROGRAM FOR PCs**. Calculates gain, phase  
and impedances. Provides graphical output. Many  
circuit examples. £10. Montgomery 01753  
643384.

**WANTED PART-TIME MICROCHIP PIC  
PROGRAMMER**, to work on one-off  
interesting projects. Contact Simon on: 01784  
457953 (Staines). Email: [tecres@globalnet.co.uk](mailto:tecres@globalnet.co.uk)

**DISPOSAL SALE** of PTFE/FEP s/plate  
equipment, wires and multicore cables, mixed  
specs, colours and sizes. Tel: 01772 435858.

**COMPUTER UPS**. 1KVA 240V including two  
12V 24Ah batteries in fair condition. Tel Bristol  
0117 9793883.

## T & M EQUIPMENT



ADVANTEST TR9407 ft spectrum analyser to 1MHz PRICED TO CLEAR\* £1500  
 ANRITSU ME518A pcm error-rate test set 1kbit/sec-150 Mbit/sec \*PTC\* £500  
 ANRITSU ML93A optical power meter with MA96A power sensor (0.75-1.8um) £1000  
 ANRITSU MN950 fibre-optic attenuator 0-65db £250  
 BRAOLEY 192 oscilloscope calibrator \*PTC\* £200  
 CHASE LFR1000 interference measuring receiver 9kHz-150kHz \*PTC\* £200

OATRON 1061 voltmeter, \*PTC\* £250  
 ORANETZ 626-PA-6006 ac neutral monitor, c/w TR2018 clamp £250  
 EIP 575 source locking frequency counter 18GHz GPIB option £1250  
 FLANN MICROWAVE 27072 frequency meter 73-113GHz £275  
 FLANN precision rotary waveguide attenuator 20110 0-60db 18-26GHz £750  
 FLANN precision rotary waveguide attenuator 22110 0-70db 26-40GHz £750

IFR A-7550 1GHz portable spectrum analyser with receiver options AM/FM/SSB £2500  
 IFR A-7550 spectrum analyser 1GHz with tracking generator option \*PTC\* £2000  
 KEITHLEY 192 programmable digital multimeter £400  
 MARCONI 2022A synthesized signal generator 10kHz-1GHz £1500  
 MARCONI 2380/2382 400MHz high-performance spectrum analyser £2750  
 PHILIPS PM5518 video pattern generator pal/ntsc/secam standards £1500

PHILIPS PM5518 video pattern generator £1500  
 PHILIPS PM5580 I.F. modulator (PAL 1) / PM5582 UHF-converter \*PTC\* £100  
 PHILIPS PM5580 I.F. modulator (PAL 1) \*PTC\* £100  
 RACAL-OANA 1995 option 01, 200MHz universal counter/timer \*PTC\* £500

RHODE & SCHWARZ UDS 5, 5.5-digit multimeter IEEE \*PTC\* £250  
 RHODE & SCHWARZ URE rms digital voltmeter IEEE \*PTC\* £250  
 SCHLUMBERGER 1254 4-channel frequency response analyser £3500

## • ralf electronics • exclusively professional T&M ©

• 36 Eastcote Lane • South Harrow • Middx HA2 8DB • England •  
 TEL (+44) 0181-422 3593 • FAX (+44) 0181-423 4009

EST  
45  
YRS



DISTRIBUZIONE E ASSISTENZA, ITALY: TLC RADIO, ROMA (06) 871 90254

SCHLUMBERGER 4922 radio code analyser \*PTC\* £250  
 SCHLUMBERGER SRTG-GA62 selective call test set \*PTC\* £150  
 SYSTRON OONNER 6041A 100MHz 8-digit frequency counter IEEE \*PTC\* £100  
 TEKTRONIX 2432A 100MHz 250M Sa/sec digital storage oscilloscope £1500

TEKTRONIX 1481R video waveform monitor PAL version £750  
 TAU-TRON MN302/MB302N bert transmitter/receiver \*PTC\* £250  
 WANDEL & GOLTERMANN PCMA test sets... call for details & options call

WANDEL & GOLTERMANN PCMA pcm measuring set version 985/01, IEEE opt £10000  
 WANDEL & GOLTERMANN PF2 error ratio measuring set £400  
 WANDEL & GOLTERMANN DLM-20 data circuit test set £250  
 WANDEL & GOLTERMANN SPM31 level meter \*PTC\* £500  
 WANDEL & GOLTERMANN WPM30 level tracer £500

WANDEL & GOLTERMANN PF4 bit error reate tester (BN91/01, Opt.00.01) £2000  
 WAVETEK 23 synthesized function generator 0.01Hz-12MHz £500  
 WAVETEK 1080 sweep generator 1-1000MHz £750  
 WAYNE KERR 3220 20A bias unit (for 3245 inductance analyser) £1000  
 WAYNE KERR SR268 source and detector £250

WILTRON 6637 sweeper generator 2-18GHz (option 03) £2000  
 WILTRON 6659A sweep generator 10MHz-26.5GHz (options 01/10/13) £3000  
 WILTRON 6640B sweep generator 26.5-40GHz (option 03) £3500

NB items marked \*PTC\* are "priced to clear" and have been significantly reduced in price as we need the space. Working, no accessories, no guarantees but 7-day right to refuse.

## HEWLETT PACKARD

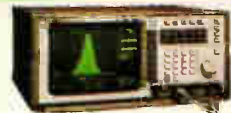

8713C 300kHz-3GHz vector network analyser £5000  
 3585A 40MHz spectrum analyser £4000  
 1640B serial data generator £500  
 10715A digital interferometer £1000  
 11857D 7mm test port cables £500  
 33320G/33322G programmable attenuators 4GHz,

with driver 11713A £650  
 As above but 18GHz set £1000  
 3552A transmission test set £500  
 3561A dynamics signal analyser £5000  
 3586A selective level meter £1250  
 37717B communications performance analyser, call for option configs £9500

4948A (V04) in-service TIM set £500  
 4093B protocol tester base (PT300) £3000  
 436A digital power meter £650  
 5343A/5344A 26.5GHz frequency counter/synchronizer £2500  
 54100A 1GHz digitizing oscscope, 40MSa/s c/w Hi-Z probes £1000  
 8018A serial data generator £1000  
 5334B frequency counter, option D60 £1750  
 83411C lightwave receiver 100/150nm £2000  
 83440C lightwave detector 20GHz 1300nm/1550nm £2000

8350B sweep generator mainframe £2000  
 83572B sweeper plug-in unit (for 8350B) 26.5-40GHz £6500  
 8924C CDMA mobile station test set £25000  
 8561B portable spectrum analyser 6.5GHz £7500  
 8590A 1.8GHz spectrum analyser £2500  
 86222A 10MHz-2.4GHz sweep generator plug-in unit £1000  
 86290B 2-18GHz sweep generator plug-in unit £1500  
 8684B signal generator 5.4GHz-12.5GHz £1000

8903B audio analyser £2500 - [specify your own filter requirements - add £200 for each filter  
 J2215A FDD1 portable multimode test set £1500

All equipment sold calibration-checked by independent laboratories and carries un-conditional refund and 90-day guarantees.  
**FOR EXCLUSIVE ACCESS TO OUR COMPLETE STOCK INVENTORY AND SPECIAL BARGAIN DISPOSAL DEALS PLEASE CHECK OUR WEBSITE**  
[www.ralf-electronics.co.uk](http://www.ralf-electronics.co.uk)



ISO9002 ACCREDITED STOCKIST  
 MEASUREMENT & TEST EQUIPMENT

CIRCLE NO. 141 ON REPLY CARD

# ELECTRONICUPDATE

Contact Joannah Cox on  
 0181 652 3620

A regular advertising feature enabling readers to obtain more information on companies' products or services.

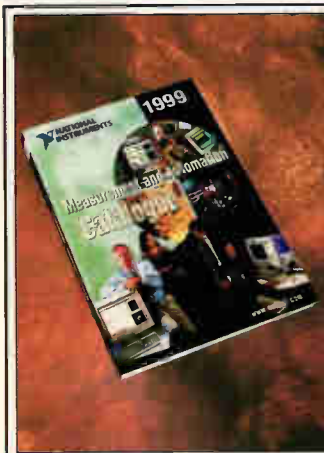

## 1999 Measurement and Automation Catalogue

The National Instruments 1999 catalogue features hundreds of software and hardware products for your computer-based measurement and automation applications. New products include additions to our modular Compact PCI (PXI) platform, new computer-based instruments, and the latest versions of our instrumentation and automation software such as LabVIEW. Call to reserve your copy of our FREE 1999 Catalogue!

National Instruments  
 Phone: 01635 523545  
 Fax: 01635 523154  
 e-mail: info.uk@natinst.com  
 Website: www.natinst.com/uk

CIRCLE NO. 142 ON REPLY CARD

## CABLING SOLUTIONS FROM THE LCD EXPERTS



Trident Microsystems' new LVDS system, provides the cabling solution to overcome all the problems associated with driving Digital TFT over long distances.

Trident's new LVDS system now allows for digital drive of **up to 20 metres in length.**

For further details call  
 Trident today  
 Tel: 01737 780790  
 Fax: 01737 771908

CIRCLE NO. 144 ON REPLY CARD

## LCR & IMPEDANCE METERS

The 3522 LCR HiTESTER and 3531 Z HiTESTER together provide a wide range of test frequencies. The 3522 offers DC and a range from 1mHz to 100kHz and the 3531 covers the range from 42Hz to 5MHz. Test conditions can now come closer to a component's operating conditions. The high basic accuracy of  $\pm 0.08\%$ , combined with ease of use and low price give these impedance meters characteristics.

**TELONIC INSTRUMENTS LTD**

Tel: 0118 9786911  
 Fax: 0118 9792338

CIRCLE NO. 143 ON REPLY CARD

## INDUSTRIAL COMPUTER PRODUCTS

The latest ICP catalogue featuring a comprehensive range of CPU boards and enclosures, complete with price list, is now available from Wordsworth.

Further details from:  
**Wordsworth**  
 Tel: 01732 861000

CIRCLE NO. 145 ON REPLY CARD

# The Affordable Solution for 8051 & AVR™ Microcontroller Support Tools

**DISTRIBUTORS FOR**



**IAR SYSTEMS**

IAR Microcontroller Development Tools  
C-Compilers, Assemblers, Simulators

8051, Atmel AVR, Hitachi H8

**MICRO-PRO DEVICE PROGRAMMER**

The complete programming solution! Supports:

**MICROCONTROLLERS**  
Atmel 89C, 89S, 90S(AVR),  
Generic 87C, Dallas 87C520

**FLASH MEMORY**  
Atmel 29C, 49F

**SERIAL/PARALLEL EEPROM**  
Atmel 24C, 25C, 59C, 93C, 28C

**CONFIGURATORS**  
Atmel 17C, Xilinx XC17

*Not all devices may be supported within each family.*



Now supplied with libraries for:  
29C, 49F, 24C, 25C, 59C, 93C  
28C, 17C, XC17

Only... **£124.95**

Order Code: **MPW-PLUS**

## PROFESSIONAL AVR™ MICROCONTROLLER STARTER SYSTEM

- System Contents**
- Combined Serial & Parallel Device Programmer
  - Evaluation module for 8, 20 & 40-pin DIL devices
  - In-System Programming (ISP) Cable
  - Integrated Windows™ Development Environment
  - AVR™ Basic LITE (1k bytes code) Compiler
  - AVR™ Assembler
  - Mains Power Supply Adaptor
  - PC Serial Cable (Connects to PC COM Port)
  - Atmel CD-ROM Datbook
  - One AT90S1200 DIL Microcontroller



Figure 1

**NEW PRODUCT!**

Only... **£99.95**

Order Code: **AVR2-ST**

## WRITE IN BASIC RUN IN A FLASH

**AVR™ BASIC**

**NEW PRODUCT!**

- Compiled BASIC generates tight AVR™ machine code
- Not a Run-Time Interpreter; NO code overhead!
- Target speeds comparable with assembler
- Breaks the cost barrier for small projects
- Ideal for educational, hobbyist and professional use

Order Codes:  
**AVR-BAS-LITE**  
**AVR-BAS-8K**

Only... **£24.95**  
and **£149.95**

## FLASH 8051 Professional Starter System

**System Contents**

- Combined Serial & Parallel Device Programmer
- Evaluation module for 20 & 40-pin DIL devices
- In-System Programming (ISP) Cable
- Keil PK51-2K Integrated Windows™ Development Environment (2K code limit). Includes C-Compiler, Macro Assembler, Linker, Hex Creator, Editor & Simulator
- Mains Power Supply Adaptor
- PC Serial Cable
- Atmel CD-ROM Datbook
- One AT89S8252 40-pin DIL Microcontroller

System layout shown in Fig 1 above

Only... **£124.95**

Order Code: **EQ-8051-ST1**

## Micro-ISP Series III

Serial Programming System for the Atmel AVR™ & 89S microcontroller families



**NEW PRODUCT!**

Typical In-System Programming (ISP) Scenario shown below:

Supports: Atmel 89S, 89LS, 90S(AVR)

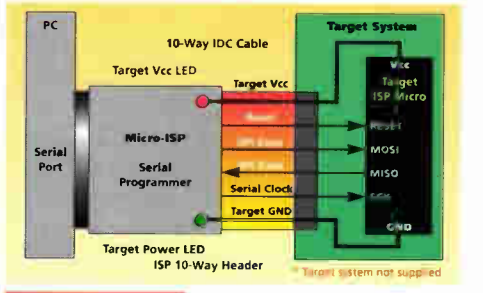

Order Code: **UISP-S3-SYS**

Only... **£39.95**

## KEIL SOFTWARE THE ULTIMATE 8051 TOOL SET

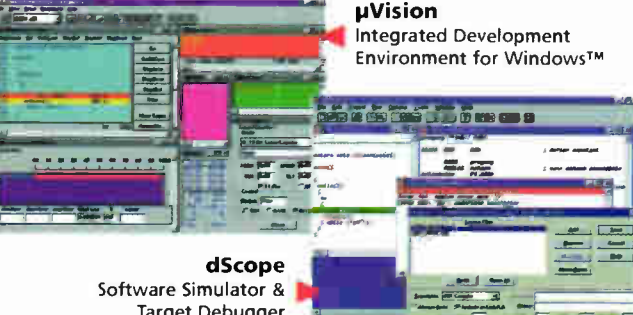

**µVision**  
Integrated Development Environment for Windows™

- Optimising Ansi-C Compiler
- Macro Assembler
- Linker
- Software Simulator
- Integrated Editor
- Hex Creator

Starter Systems supplied with 2K Toolset & Development Systems supplied with 8K Toolset are available for Atmel, Dallas, Siemens, Temic 8051 microcontroller derivatives

**dScope**  
Software Simulator & Target Debugger



**EQUINOX TECHNOLOGIES**  
EQUINOX TECHNOLOGIES UK LIMITED

The Embedded Solutions Company

3 Atlas House St Georges Square Bolton BL1 2HB England

CE

For sales tel: +44 (0) 1204 529000, fax: +44 (0) 1204 535555, e-mail: sales@equinox-tech.com, Web Site: www.equinox-tech.com

**EQUINOX DISTRIBUTORS:** AUSTRALIA Farnell +61 2 9645 8888 AUSTRIA Farnell +43 0660 87 75 BELGIUM Alcom Electronics NV/SA +32 3 227 36 47 BRAZIL Haster +55 11 522 1799 ANACOM +55 11 453 5588 DENMARK Farnell +45 44 53 66 44 ENF Farnell +353 1 8309277 FINLAND Farnell +358 9 3455 400 FRANCE Farnell +33 474 65 94 66 NEWTEK +33 1 4687 2200 GERMANY Elektronik Laden +49 52 32 81 71 Farnell +49 89 61 39 39 39 Inteltek GmbH +49 7321 93850 MSC Vertriebs GmbH +49 08 9945532 12 HIBEL Microlec +30 1 5395042 4 HONG KONG Farnell 800 968 280 (HK Direct Toll Free) ITALY Farnell +44 113 231 1311 Grifo Italian Technology +39 51 89 20 52, Newtek Italia +39 2 33 10 53 08 MALAYSIA Farnell +60 3 773 8000 NETHERLANDS Alcom Electronics BV +31 10 4519533 Antiatek +31 10 450 4949 Farnell +31 30 241 2323 NEW ZEALAND Farnell +64 9 357 0546 NORWAY ACTE NC +47 63898900 Jakob Hatteland Electronic AS +47 53763000 PORTUGAL Anatronc SA +35 119 371 834 Farnell +44 113 289 0040 SINGAPORE Farnell +65 788 0200 SPAIN Anatronc SA +34 1 366 01 59 Farnell +44 113 231 0447 SWEDEN ACTE NC +46 8 445 28 70 Farnell +46 8 730 50 00 SWITZERLAND Anatec AG +41 41 748 32 41 Farnell +41 1 204 64 64 UNITED KINGDOM Abacus Polar +44 1925 626626, Farnell +44 113 263 6311 Rapid Electronics +44 1206 751166 Quandon Electronics +44 1332 332651 USA Hitools Inc +1 408 298 9077 Newark Electronics +1 800 718 1997, Peachtree Technology +1 770 888 4002 Pioneer Standard +1 888 832 3976

Equinox reserves the right to change prices & specifications of any of the above products without prior notice. E&OE. All prices are exclusive of VAT & carriage. AVR™ is a trademark of the Atmel Corporation

Surely not. Surely someone somewhere has developed a portable programmer that has even more features, even greater flexibility and is even better value for money.

Actually, no. But don't take our word for it. Use the feature summary below to see how other manufacturers' products compare.

## Dataman-48LV

- Plugs straight into parallel port of PC or laptop
- Programs and verifies at 2, 2.7, 3.3 and 5V
- True no-adaptor programming up to 48 pin DIL devices
- Free universal 44 pin PLCC adaptor
- Built-in world standard PSU - for go-anywhere programming
- Package adaptors available for TSOP, PSOP, QFP, SOIC and PLCC
- Optional EPROM emulator



## Money-Back 30 day Trial

If you do not agree that these truly are the most powerful portable programmers you can buy, simply return your Dataman product within 30 days for a full refund

CIRCLE NO. 103 ON REPLY CARD

FREE  
30 DAY TRIAL

still  
the world's most  
powerful, portable  
programmers

free software

upgrades +

technical support

for life

3 year  
GUARANTEE

## Support

- 3 year parts and labour guarantee
- Windows/DOS software included
- Free technical support for life
- Next day delivery - always in stock
- Dedicated UK supplier, established 1978

# DATAMAN

Dataman Programmers Ltd, Station Road,  
Maiden Newton, Dorchester, Dorset, DT2 0AE, UK

Telephone +44/0 1300 320719

Fax +44/0 1300 321012

BBS +44/0 1300 321095 (24hr)

Modem V.34/V.FC/V.32bis

Home page: <http://www.dataman.com>

FTP: <ftp://ftp.dataman.com>

Email: [sales@dataman.com](mailto:sales@dataman.com)

CE

£495  
PLUS VAT

## Dataman S4

- Programs 8 and 16 bit EPROMs, EEPROMs, PEROMS, 5 and 12V FLASH, Boot-Block FLASH, PICs, 8751 microcontrollers and more
- EPROM emulation as standard
- Rechargeable battery power for total portability
- All-in-one price includes emulation leads, AC charger, PC software, spare library ROM, user-friendly manual
- Supplied fully charged and ready to use

## S4 GAL module

- Programs wide range of 20 and 24 pin logic devices from the major GAL vendors
- Supports JEDEC files from all popular compilers

## Still as unbeatable as ever!

Beware of cheap imitations. Beware of false promises. Beware of hidden extras.

If you want the best, there's still only one choice - Dataman.

Order via credit card hotline - phone today, use tomorrow.

Alternatively, request more detailed information on these and other market-leading programming solutions.

hotline  
01300 320719



Orders received by 4pm will normally be despatched same day.  
Order today, get it tomorrow!