

Wireless World

ELECTRONICS, RADIO, TELEVISION

MAY 1962

Managing Editor:

HUGH S. POCOCK, M.I.E.E.

Editor:

F. L. DEVEREUX, B.Sc.

Assistant Editor:

H. W. BARNARD

Editorial:

P. R. DARRINGTON

M. G. LAZENBY

R. H. OLIVER

W. J. A. WOODYER

Drawing Office:

H. J. COOKE

Production:

D. R. BRAY

Advertisement Manager:

G. BENTON ROWELL

VOLUME 68 No. 5.

PRICE: 2s. 6d.

FIFTY-SECOND YEAR

OF PUBLICATION

201 Editorial Comment

202 Mobile Transmitter

208 Project "Telstar"

210 U.K. Television

212 World of Wireless

214 Personalities

216 News from Industry

217 Scaling of Analogue Computers

221 Audio Show: List of Exhibitors

222 Printed Circuit Production

225 Poles and Zeros

230 Letters to the Editor

234 Short-wave Conditions

235 Manufacturers' Products

237 Fundamentals of Feedback Design—5

241 Sliding-bias Amplifiers

245 Technical Notebook

246 May Meetings

248 Unbiased

By C. J. Salvage

By N. M. Morris

By "Cathode Ray"

By G. Edwin

By T. Roddam

By "Free Grid"

Chairman: H. S. Pocock, M.I.E.E.

Managing Director: W. E. Miller, M.A., M.Brit. I.R.E.

Iliffe Electrical Publications Ltd., Dorset House, Stamford Street, London, S.E.1

Please address to Editor, Advertisement Manager, or Publisher as appropriate

© Iliffe Electrical Publications Ltd. 1962. Permission in writing from the Editor must first be obtained before letterpress or illustrations are reproduced from this journal. Brief abstracts or comments are allowed provided acknowledgment to the journal is given.

PUBLISHED MONTHLY (4th Monday of preceding month). Telephone: Waterloo 3333 (65 lines). Telegrams: "Ethaworld, London, Telex." Cables: "Ethaworld, London, S.E.1." Annual Subscriptions: Home and Overseas, £2 0s. 0d. Canada and U.S.A. \$5.50. Second-class mail privileges authorized at New York, N.Y. BRANCH OFFICES: BIRMINGHAM: King Edward House, New Street, 2. Telephone: Midland 7191. COVENTRY: 8-10, Corporation Street. Telephone: Coventry 25210. Glasgow: 62, Buchanan Street, C.1. Telephone: Central 1265-6. MANCHESTER: 260, Deansgate, 3. Telephone: Blackfriars 4412. NEW YORK OFFICE: U.S.A.: 111, Broadway, 6. Telephone: Digby 9-1197.

AF127 TRANSISTOR

MULLARD THERMISTORS IN RADIO AND TELEVISION SETS

Mullard thermistors are made from semiconductor materials whose resistance decreases with increases in temperature. Thus, whereas the resistance of a normal resistor rises with an increase in temperature, that of a thermistor falls. They are therefore devices which can readily provide compensation for the effects of temperature variations in radio and television receivers.

For instance, in the field timebase of a television set, the deflection current generates heat in the deflection coils. The rise in temperature causes the resistance of the coils to rise, which reduces the deflection current and so

WHAT'S NEW IN THE NEW SETS

These articles describe the latest
Mullard developments
for entertainment equipment

reduces the height of the picture. When a suitable Mullard thermistor is incorporated in the deflection coil circuits, however, the total resistance, and therefore the picture height, remains substantially unaffected by these temperature changes. Again, in a transistor radio, the biasing conditions in the output stage can be affected by temperature variations, with a resulting increase in audible distortion. Incorporation of a suitable Mullard thermistor in the biasing chain will compensate for such variations and thus ensure consistency of performance over a wide temperature range.

These two examples illustrate the contribution made by Mullard thermistors to the high standards of performance attainable with modern television and radio receivers.

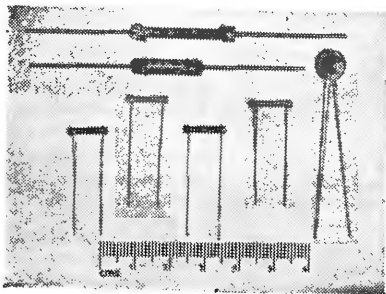

miniature alloy-diffused transistor for pocket radios

Mullard have recently introduced a new miniature alloy-diffused transistor—the AF127—to supplement their existing range of miniature alloy-junction transistors. The AF127 is encased in the TO-18 metal envelope which is less than a fifth of an inch in diameter and a quarter of an inch high. The connecting leads of the transistor emerge through a glass bead set in the metal envelope, and the arrangement of these leads allows direct insertion into a printed-wiring grid.

The AF127 is ideally suited for the r.f. and i.f. stages of portable receivers operating in the medium and long wavebands. The alloy-diffusion process employed in its manufacture has produced high input and output impedances, and has also resulted in a very low feedback capacitance and negligible phase shift at low frequencies. These features enable a high h.f. gain to be achieved without any need for neutralisation, and also give an improvement in receiver sensitivity.

The electrical properties of alloy-diffused transistors have led to simpler circuit designs and improved standards of performance, while the miniature construction of the new transistor has enabled considerable reductions to be made in the size of receivers. The AF127 is thus contri-

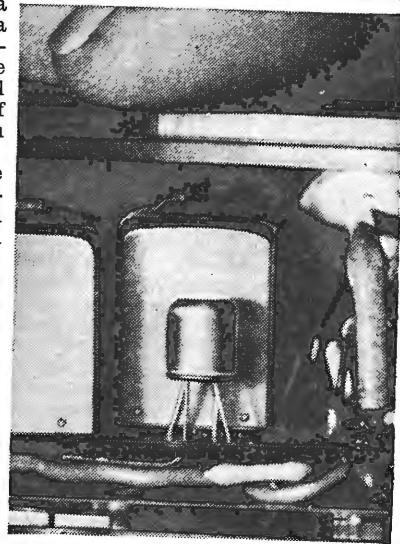

buting to the fulfilment of the demand for high standards of reception coupled with pocket-size compactness in up-to-date portables.

Improvements in valve heaters

*Better performance
and greater reliability*

Mullard now produces a new alundum powder for coating valve heaters. It has an extremely low concentration of certain impurities (some of which are known to be troublesome), and research on the purified powder has led to modifications in its texture. These developments result in improved hum performance and better heater-to-cathode insulation in Mullard valves.

The wire used for valve heaters must be thick enough to carry the current required to heat the cathode ade-

quately. However, thick wire is subjected to severe stresses if it is wound in a tight spiral to fit within the cathode. In valve types where the dimensions are such that the heater could prove to be a source of trouble during life, Mullard are now able to replace the single strand of wire by two or three wires wound together without reducing the rating of the heater. The emissive property of the valve is thus unaffected, but a marked improvement in heater reliability during life is ensured.

MVE 1036

Stereophonic Broadcasting

THE art and science of high-quality sound reproduction have been considerably advanced by the techniques of stereophony, enunciated by Blumlein in the early 1930s and brought to fruition by recent advances in recording methods. The special qualities of "ambience" and depth are often captured in single-channel (monophonic) sound by the judicious use of reverberation, but it is now beyond question that the addition of the extra dimension of breadth can produce these effects with wider scope and with certainty. In this context we are considering scientifically based stereo methods and not the plausible imitations using crudely segregated left- and right-hand microphone channels, which are aptly described as "pseudo-stereo."

After some five years of high-pressure publicity few people can be unaware of what is on offer and all those who are interested have no doubt heard demonstrations or have already provided themselves with the means of enjoying recorded stereo sound. They also listen to sound broadcasting and it is only natural that they should ask why sound broadcast programmes should not now also be extended by another dimension. Their appetite has been further whetted by a long series of B.B.C. test transmissions on Saturday mornings, using pairs of transmitters. It is also known that, in common with the broadcasting authorities of most European countries, the B.B.C. has carried out exhaustive laboratory and studio assessments of the half-dozen or so different systems which have been proposed for transmitting two-channel stereophonic information over a single radio-frequency channel.

Ideal stereo systems call for increased power and spectral bandwidth if a service area comparable with monophonic broadcasting as regards signal/noise ratio is to be maintained. It is possible to trade service area for quality of reproduction, and vice versa, and the difficulty of obtaining international agreement on the admissibility of compromise, and the point at which it should be fixed, has been largely responsible for the delay in establishing stereophonic broadcasting throughout the world. If existing monophonic v.h.f./f.m. listeners in fringe areas are not to lose their service the compatible (combined) signal strength must be sustained. This can be done (as it is in the recently ratified F.C.C. standards in America) but only at the expense of a reduced service

area for stereo listeners. In America where the coverage is by a large number of local stations this is acceptable, but it is by no means certain that the system could be successfully transplanted to Europe. These are matters which have been investigated by Working Party S of the European Broadcasting Union and will no doubt come up for discussion when the International Telecommunications Union meets in June this year at Bad Kreuznach.

Quite apart from the difficulty of increasing powers, and possibly finding increased bandwidth, there would have to be a complete revision of studio techniques and microphone placing. This could soon be effected in the B.B.C.'s permanent studios, but would considerably stretch the resources for outside broadcasts. Altogether a major undertaking calling for comparable if not greater effort than the establishment of the v.h.f./f.m. service itself.

Before a decision to start stereo broadcasting is reached the cost must be weighed against the benefit to the community. This is not a matter which can be left to the decision of individual estimates of necessity or extravagance—as in the case of private stereo disc or tape reproducing equipment. Similar decisions had to be made when sound and, later, vision broadcasting were started. At one time luxuries, they are now regarded as necessities. Some people, favourably placed geographically, still stigmatize the v.h.f./f.m. service as a luxury, but for many more, faced with mounting interference, it is undoubtedly a necessity.

Against this background stereophony must be regarded as a refinement rather than a primary necessity—just as stereoscopy (and dare we say 625-line definition?) must be seen in relation to the satisfactory and well-established 405-line television system.

We are not against progress, but we can understand the Postmaster-General's prudence in hesitating to authorize a peripheral improvement *at any cost*. We hope and expect that regular stereophonic broadcasting will eventually cross the Atlantic, but while we are watching developments in the U.S.A. and profiting by their experience (as we have done previously in f.m. broadcasting and colour television) we need not deny ourselves the experience of stereophonic sound; the art and science of British stereophonic recording and reproducing techniques are unsurpassed in the world.

Mobile Transmitter

DESIGN FOR AMATEUR USE IN A CAR

By C. J. SALVAGE (G3HRO)

This equipment, comprising transmitter and modulator and using a whip aerial system mounting on the car bumper, is the companion to the receiver described by the author in the December 1961 issue of Wireless World (p. 626) under the title "All-Band" Transistor Communications Receiver". Both are award-winning designs: the receiver, entered by Aquila Radio Club, won the award for the Best Club Entry at the 1960 Radio Hobbies Exhibition, whilst the equipment described here gained first prize at the National Mobile Rally held at Woburn Abbey last September.

THE transmitter described here was designed to fit into the glove compartment of a Vauxhall "Cresta", but it is not necessary to buy a new car if you don't have this model as the transmitter shape may be modified to suit individual requirements, provided that the general layout is not substantially altered.

R.f. and Control Unit

The v.f.o. (V1) uses a 6AK5, with coils switched to work on the 1.8-, 3.5- and 7-Mc/s bands. To help obtain good stability all capacitors in the oscillator circuit should be silver-mica types. The output of the oscillator, V1, is taken via C_8 to the grid of a 6F17* valve (V2) which, on 1.8, 3.5, and 7.0Mc/s, provides little gain because of its untuned resistive anode load (R_7). On 14 and 21Mc/s, however, L_4 is tuned to 7Mc/s to provide sufficient output for doubling or tripling. The next stage, another 6F17 (V3), has its anode circuit similarly switched, but this time L_6 , L_7 and L_8 are tuned to the respective v.f.o. frequencies of 1.8, 3.5 and 7Mc/s. L_9 is tuned to 14Mc/s causing V3 to double from 7Mc/s, while L_{10} causes tripling to give 21Mc/s. L_{11} (tuned to 28Mc/s) doubles from the previously-doubled 14Mc/s. The resistor R_{11} across L_6 is included to reduce drive and increase bandwidth on the 1.8-Mc/s range. If drive is found to be excessive on either 3.5 or 7Mc/s it may be found advisable to include damping resistors across L_7 or L_8 also. The drive control (VR₁) is a 50-k Ω potentiometer and is mounted immediately below the 500- μ A meter. Grid drive at 60-W input should correspond to a current of about 2.6mA; but at reduced power on the 1.8-Mc/s band it should be 1mA. Grid current

through R_{14} (22k Ω) should, at full power, develop 57-V drop. As R_{14} is returned to the -12-V line the total grid bias is about 69V, which is sufficient to operate V4 in Class C.

Transmit-receive switching is accomplished by S_3 (a double-pole double-throw switch) mounted at the bottom centre of the front panel. Its action is to change over the aerial from receiver to transmitter and divert the -12-V supply either to the receiver or the relay in the power-supply unit for switching of the d.c. supplies to the transmitter.

The "net" switch (S_4) is a small micro-switch behind the front panel, actuated by a push-button mounted between the drive control and the T-R switch. This micro-switch applies -12V to the 250-V d.c. converter only, which results in the energization of the v.f.o. and driver stages so that the v.f.o. can be tuned to zero beat with the received signal. When switch S_3 is moved to "transmit" both the 250- and 600-V supplies are energized from the 12-V supply.

The chassis is constructed from 18-s.w.g. aluminium and the panel is made from 18-s.w.g. brass, chromium-plated.

Meter.—The 500 μ A meter can be switched to read:—

1. Battery potential "on load." This is very useful for indicating when recharging is required if the equipment is used for long periods with the car stationary.
2. H.t. potential (600-V line).
3. Grid drive to V4, the power amplifier. R_{15} is a shunt, giving an f.s.d. of 3mA.
4. Power-amplifier current. R_{16} (0.6 Ω), in the cathode circuit of V4, provides a shunt giving 150mA f.s.d. In this position the meter reads, of course, screen current as well as anode current;

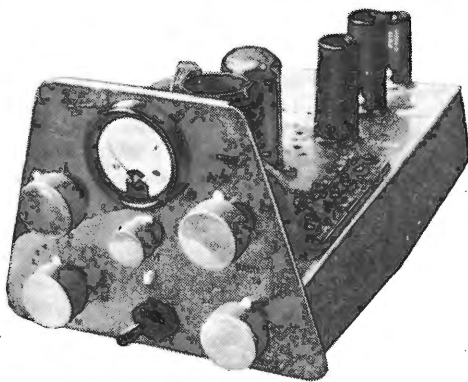

General view of transmitter. Trimmers at right-hand side are pre-set tuning for power-amplifier output filter.

* A.E.I. industrial type. Available from A.E.I. Industrial Valve Department, 155 Charing Cross Road, London, W.C.2.

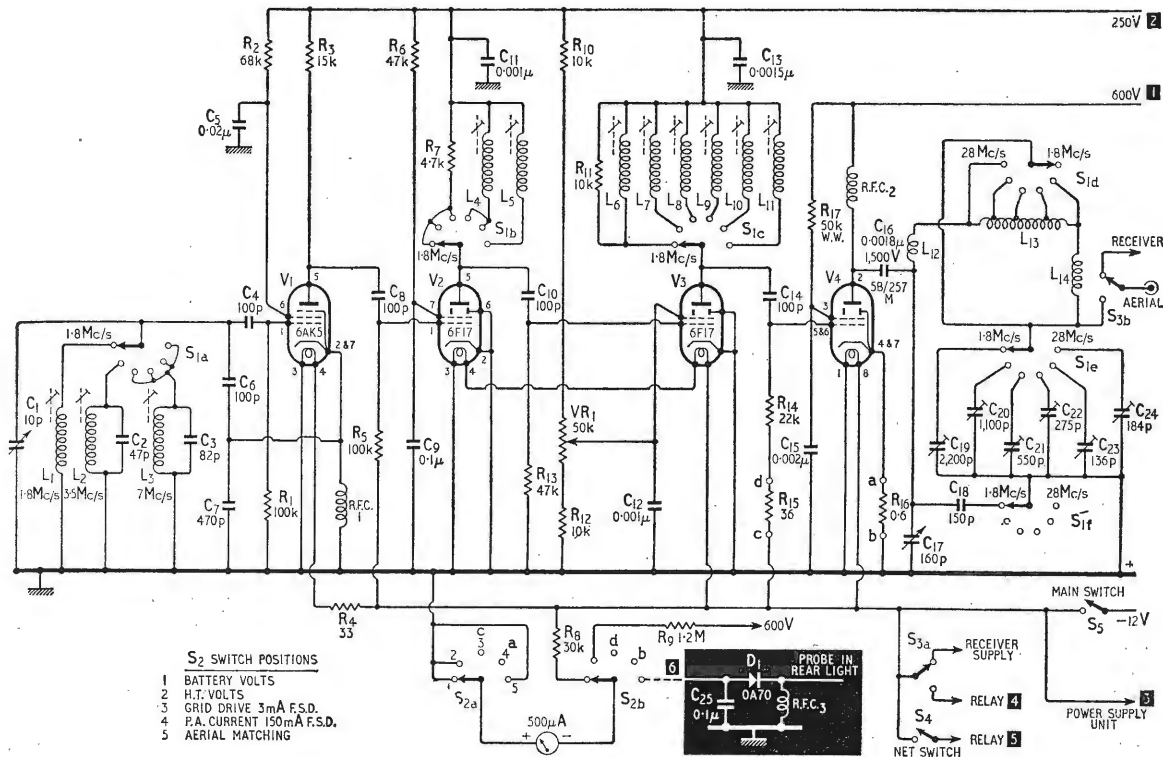

Fig. 1. Transmitter circuit. Power supply enters through this unit for whole equipment. Small section in white-on-black is aerial-match monitor unit mounted in car rear-light housing. (N.B. values of C₂₄ and C₂₃ are transposed on diagram.)

but this connection does prevent the application of high voltages to the meter and switch, as would occur if anode current alone were to be measured.

5. Aerial match. Switched to this position, the meter is used to give a measure of the radiated power of the station. In the plastics housing of one of the rear-lights is fitted a short "probe" aerial wire. The signal picked up by this is rectified by a diode, the d.c. path being completed by a r.f. choke, and passed down a lead to the meter. The system is set up by adjusting the length of the probe (about 6 to 8in), once the aerial is correctly loaded, as shown by a r.f. ammeter temporarily connected in

the coaxial lead. The adjustment is best made on the l.f. bands first.

Modulator

Fig. 2 shows the circuit of the modulator. As anode-and-screen modulation is extremely effective it was decided to use this method, making the modulator amplifier with transistors.

V6 and V7 are direct-coupled and have overall d.c. and a.c. negative feedback and the input stage, V5, is designed to match directly an electromagnetic microphone.

Underside of transmitter. At left (back of chassis) is v.f.o.; then are two amplifier-doublers and on right is power amplifier. Long extension spindle at top of photo is v.f.o. tuning capacitor, whilst band-switch extends along bottom of picture.

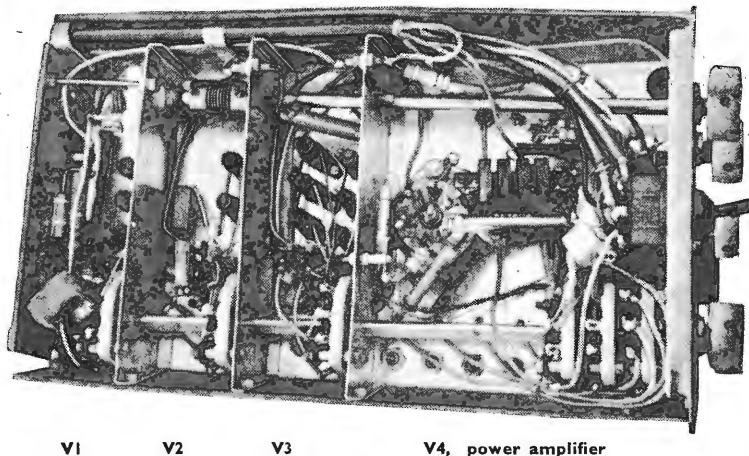

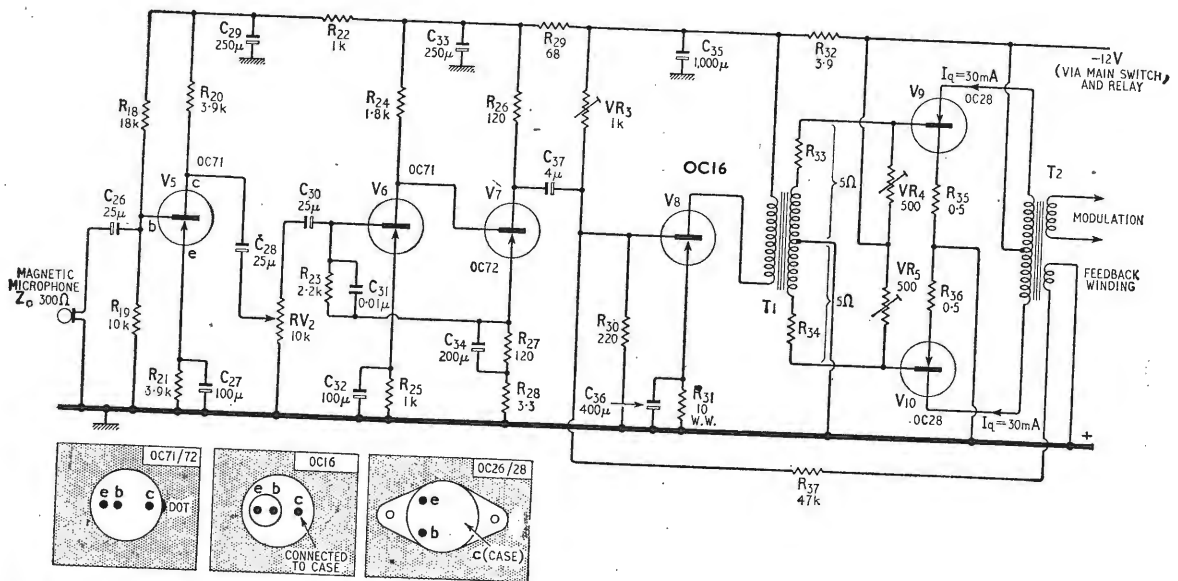

Fig. 2. Modulator amplifier. Old type of driver transistor (OC16) may be replaced by modern OC26. Supplies to modulator enter on three-core cable from power supply unit with which modulator is mounted. Microphone is wired separately back to steering column.

The output impedance of T_2 has to match the anode-circuit impedance of the p.a. (V4) which is $6k\Omega$. The output is taken from the collectors of the two OC28s (V9 and V10) and is thus stepped-up by the transformer. VR_3 sets the no-signal current in the collector circuit of V8: 250mA is the level chosen for the OC16 used, but substitution of the newer

OC26 may render a slight change desirable, both in no-signal collector current and emitter resistor.

VR_4 and VR_5 are adjusted individually to set the quiescent collector currents of V9 and V10 to 30mA each. The photograph of the modulator shows V9 and V10 mounted on their heat sinks of blackened 16-s.w.g. aluminium. These are about 7in by 5in and mica washers are used for insulation.

The microphone is mounted on the steering column of the car and is of the balanced-armature variety (ex-Govt.). This was chosen as it matches the base impedance of V5 (about 300Ω) and has high sensitivity. The modulator gives 25- to 30-W output in the audio-frequency range required and is capable of modulating adequately the transmitter.

Power Supply Unit

The d.c. converters used for the supply of h.t. to the transmitter at both 250 and 600V are commercial items and are manufactured by Aveley Electric Ltd.*.

*Ayrton Road, Aveley Industrial Estate, South Ockendon, Essex.

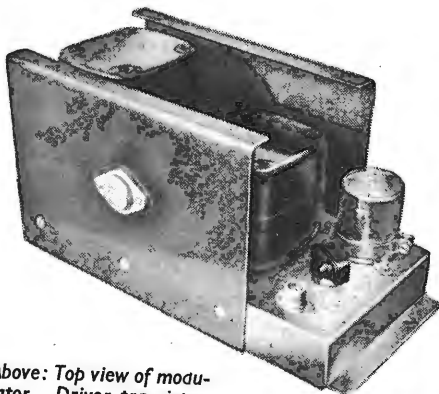

Above: Top view of modulator. Driver transistor, OC16 or OC26, is mounted between transformers.

Right: Modulator—under-chassis view. VR_2 (gain control) is available as a top-chassis control, but VR_3 , VR_4 and VR_5 (bias adjustments) are mounted on brackets under the chassis.

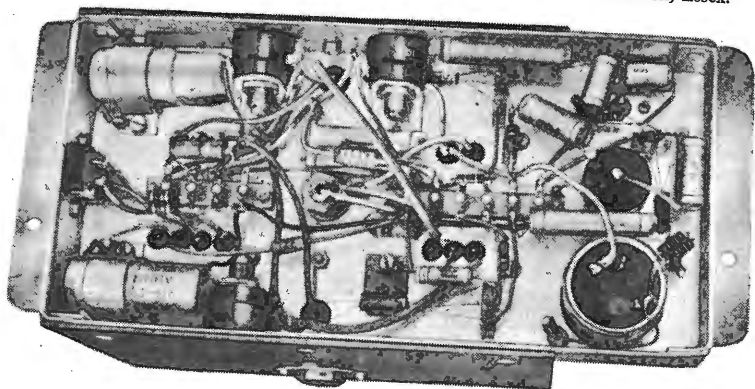

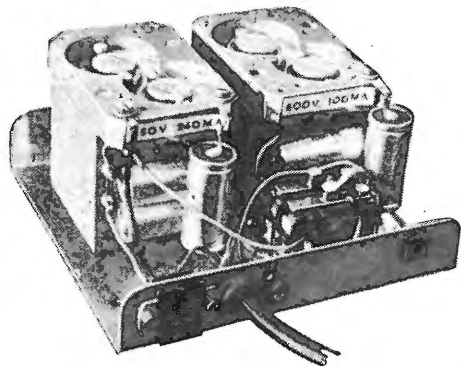

Power-supply unit. In front of transistor converters is transmit/receive relay.

The two units are mounted on an 18-s.w.g. aluminium chassis together with the associated relay that is used to switch them on when the transmit/receive switch is thrown to transmit. It is important to mount the units as shown in the photograph because the heat sinks are "live" and must not be allowed to contact other metal work. C_{37} and C_{38} are necessary to prevent the "hash" produced by the chopping action of the transistors being induced into the 12-V supply and so back to the modulator. The three-core cable to the modulator can be seen in the photograph: two cores are connected to the secondary of the modulation transformer and the remaining one is used for the 12-V supply, which returns via the chassis. As it is desired to energize the modulator only when the p.a. is operating, this supply is taken from the relay contact that feeds the 600-V converter. Two contacts are, of course, necessary so that the 250-V supply alone can be switched on by the net button.

The small socket on the right-hand side accepts

the lead carrying d.c. from the aerial-match indicator mounted in the rear light, and the connections to the six-way socket are as follows:—

1. Modulated 600-V supply.
2. 250-V supply.
3. -12V (after S_5 in Fig. 1).
4. Relay supply from transmit/receive switch (S_3 in Fig. 1).
5. Supply to 250-V converter from net switch (S_4 in Fig. 1).
6. D.c. from the aerial-match indicator.

S_5 is normally closed, so that R_{38} is short-circuited: for reduced-power operation on 1.8Mc/s, S_5 is opened.

Both the power-supply unit and the modulator are mounted together under the back seat of the car.

Aerial

The aerial is an ex-Government, 12-ft-long, tapered tank aerial, in three four-foot sections, mounted on the car's back bumper. On 28Mc/s only the two lower sections are used, and on 21Mc/s the whip is used at its full length, as it is on the other bands. Loading coils are inserted on the bands below 21Mc/s to improve matching and are placed in the joint between the bottom and upper two sections.

Loading coils.—Fig. 4 gives details of the loading coils and their construction and the photograph shows the four coils.

The top and bottom connections of the loading coils fit onto the whip sections, so either the relevant ends of unwanted sections may be used, or a little fitting is necessary.

The ferrite rods are 4in long by $\frac{1}{2}$ in diameter and are Mullard's type no. FX 1356/B2. Their ends are taped to avoid chatter and a rod is "nicked" with a file, broken, and ground to length for the two h.f. coils.

The synthetic-resin-bonded paper (Paxolin) tube that fits round the ferrite rod and provides the main

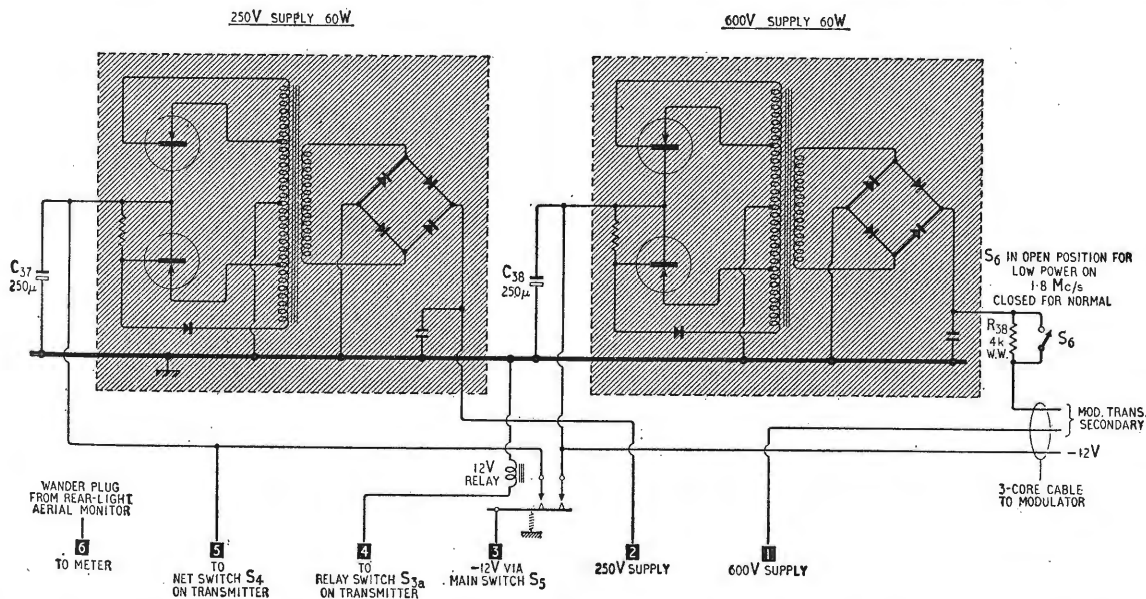

Fig. 3. Power unit. 600 and 250-V supplies are produced by Aveley; circuitry external to the shaded blocks must be added by constructor. S_6 provides for reduced power operation and is normally left closed.

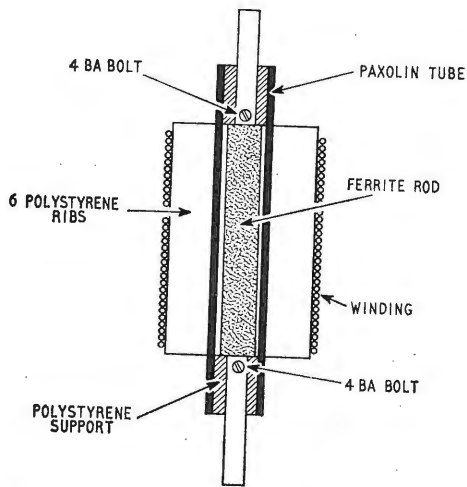
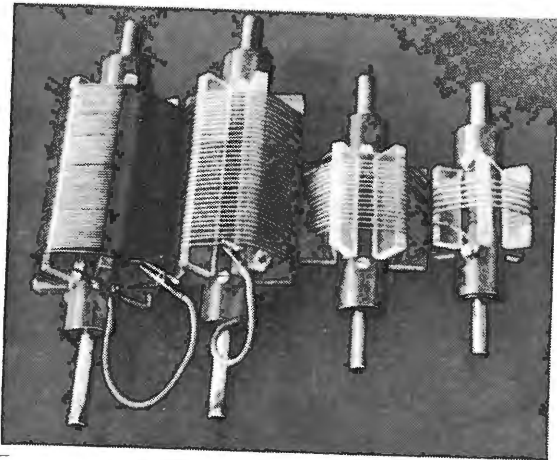

Fig. 4. Loading coil which fits between lower sections of whip. Details of dimensions, turns, etc., are given in associated text. Unit is supported by aerial rods and connectors at top and bottom of unit must fit well ends of aerial rods.



Four loading coils for whip aerial. 1.8- and 3.5-Mc/s coils have tapping points made by flying lead and crocodile clip.

mechanical strength is of 1-in external diameter and is 6in long. The wall thickness is $\frac{1}{8}$ in and polystyrene inserts are arranged to fit between the tube and connections. A 4-B.A. screw passes through Paxolin and polystyrene into a brass insert fitted in the ends of the whip connections. The winding is mounted on six polystyrene ribs $4\frac{1}{2}$ in long by $\frac{1}{4}$ in thick by $\frac{3}{4}$ in wide glued to the Paxolin tube.

1.8Mc/s. 69 turns of 18-s.w.g. enamelled wire, close-spaced.

3.5Mc/s. Grooves are cut in the polystyrene ribs at a pitch of 10/in and 34 turns of 18-s.w.g. enamelled wire are wound on at 10 turns/in spacing.

7Mc/s. For this coil the Paxolin tube is only $4\frac{1}{2}$ in long, the ferrite rod 2in and the ribs $2\frac{1}{2}$ in. The winding is 16 turns of 18-s.w.g. tinned-copper wire wound at 10 turns/in.

14Mc/s. Here the Paxolin tube is $3\frac{3}{4}$ in long, the ferrite rod $1\frac{1}{2}$ in and the ribs are $1\frac{1}{2}$ in long and have

their width reduced to $\frac{3}{16}$ in. Six turns of 16-s.w.g. tinned copper are wound at 10 turns/in.

To check resonance of the whip aerial the appropriate loading coil is inserted between the bottom and upper two sections of the whip. A small one- or two-turn coil of about $1\frac{1}{2}$ -in diameter is temporarily connected between the bottom of the aerial and the chassis of the car. An accurate grid-dip oscillator is used against this coil and the loading coil is "pruned" to resonance at the l.f. end of the band. The temporary coil is now discarded and the 50- Ω cable from the aerial to the transmitter is fitted.

On the two l.f. bands it is necessary to make tapping points on the coils: these are found by loading the whip from the transmitter, starting at the l.f. end of the band and, as the frequency is increased, so the appropriate resonance positions are found on the coil by observing either a series ammeter or the aerial-match indicator. The established points on the coil can then be marked to correspond with the dial readings of the v.f.o. No tapping points are necessary on either the 7-Mc/s or 14-Mc/s coils.

Mounting.—As the Vauxhall's bumper is made in three parts it is possible to clamp the mounting plate between two of the bumper's sections: naturally other cars may necessitate slightly different arrangements.

The mounting is designed to have an impedance of 14Ω which is the value at the base of a correctly-loaded whip. It consists of an inner steel tube (the same material as the whip) about $7\frac{1}{4}$ in long, fixed by adhesive to a polystyrene tube of $\frac{3}{8}$ -in inside diameter and 0.6-in outside diameter, the tube being $6\frac{3}{4}$ in long. A piece of 20-s.w.g. aluminium, $6\frac{1}{4}$ in wide, is formed round this and is clamped between two of the bumper's sections. Adhesive is also applied to the outside of the polystyrene tube.

A small brass ferrule is soldered to the top of the steel tube and a brass insert fitted at the bottom is drilled and tapped for connection of the coaxial-cable inner. Earthing bolts for the cable's braid

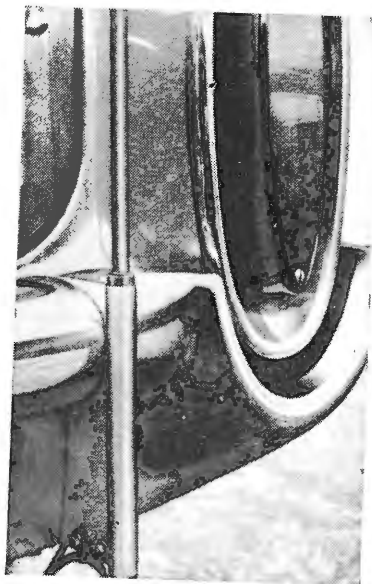

Whip mounting on rear bumper. Also shown is rear light which contains aerial-match indicator unit. On a car with smaller rear lights other arrangements would be made for housing of this unit.

are fitted through the bottom edge of the aluminium plate.

Effect of whip variations.—It will be found in practice that the 12-ft whip can be varied in length if required. The bottom section may be reduced to 2ft without serious detuning on the l.f. bands, although the position of taps on the loading coil may vary slightly. This shorter length is often advisable in town or under trees but does reduce the radiated signal by a small amount. If, on the other hand, space permits, it is possible to increase the bottom section to 6ft and thereby increase its effectiveness. This obviously applies to the l.f. bands only; if the whip length is changed on the h.f. bands the alteration will significantly affect resonance.

The transmitter output and aerial are mismatched; but on the grounds of simplicity a matching transformer is not incorporated. It will be found that the preset capacitors C_{19} to C_{24} should be re-adjusted, after the aerial has been tuned to resonance, to give maximum aerial current as indicated by the match indicator or a r.f. ammeter in the feeder.

Power Consumption

The transmitter and modulator together take a total of eight amperes at 12V. The current taken by the associated receiver is negligible but the transmitter heaters are, of course, left running when the installation is switched to "receive".

COMPONENTS SPECIFICATIONS

Resistors.— $\frac{1}{2}$ -W, 20% tolerance carbon types may be used in all positions except the following:—

Transmitter.—R16 (0.6 Ω). This is made up by winding wire onto a high-value $\frac{1}{4}$ -W resistor. R17 (50k Ω) is a wirewound type rated at 6W.

Modulator.—R28 may be made up from two 6.8 Ω resistors in parallel. R32 (3.9 Ω) consists of a 6.8 Ω and an 8.2 Ω resistor in parallel. R33 and R34: see transformer section. R35 and R36 (0.5 Ω each) are made up by winding wire onto $\frac{1}{4}$ -W resistors of high value.

Power unit.—R38 (4k Ω) is a wirewound type rated at 20W.

Transformers.—Although these were made up there is no reason why suitable commercial alternatives (i.e. with characteristics not differing materially from those given here) should not be used.

Driver transformer, T1. This uses a "C"-core, size 10/12/13, built up to a double loop. The turns ratio is 2:1 + 1, and the secondary is wound in the bifilar manner.

Primary inductance >150mH at 250mA d.c., resistance <2 Ω . This winding consists of 200 turns of enamelled wire, 21 s.w.g.

Secondary resistance is 5 Ω each half, or is made up to this figure with R33 and R34, which may be made from a short length of resistance wire wound round a $\frac{1}{4}$ -W resistor. The winding is made up by taking two 32-s.w.g. enamelled wires and winding 100 turns of the pair of conductors.

Output transformer, T2. A larger "C"-core, a double loop of size 10/24/13, is used for this. The turns ratio is 1 + 1:28. The primary inductance is >25mH and the winding consists of 50+50 turns of 19-s.w.g. enamelled wire. The secondary has an inductance >0.5H at 100mA d.c. and the winding is 1,400 turns of 36-s.w.g. enamelled wire. 50 turns of 36-s.w.g. wire form the feedback winding.

(The C-cores are made by English Electric Co. Ltd., Transformer Sales Dept., East Lancashire Road, Liverpool 10, and Telcon Magnetic Cores Ltd., Industrial Estate, Chapel Hill, Lanarkshire.)

Coils.—L1 to L11 inclusive are wound on "Neosid" type 358/8BA formers 0.3in diameter with grade 900 cores. Coils on these formers are coated with polystyrene varnish to secure the turns. (Neosid Ltd., Stonehills House, Welwyn Garden City, Herts.)

L12, L13 and L14 form the " π " output filter and are all in circuit for the 1.8-Mc/s band, sections being progressively short-circuited for the higher-frequency bands. Tuning is accomplished by the trimmers C19 to C24; the fixed capacitor C18 and the p.a. tuning control C17.

Coil	Band (Mc/s)	Details
L1 & L6	1.8	About 80 μ H, wave-wound (pie 3/16in wide) with 40-s.w.g. d.s.c. to $\frac{3}{8}$ -in diameter.
L2	3.5	76 turns, close-wound, 38-s.w.g. enamelled (en.)
L3	7.0	26 turns, close-wound, 36-s.w.g. en.
L4 & L8	7.0	32 turns, close-wound, 36-s.w.g. en.
L5 & L9	14.0	19 turns, close-wound, 30-s.w.g. en.
L7	3.5	80 turns, close-wound, 38-s.w.g. en.
L10	21.0	12 turns, close-wound, 30-s.w.g. en.
L11	28.0	8 turns, close-wound, 30-s.w.g. en.
L12	28.0	4 $\frac{1}{2}$ turns, 14 turns/in, 1-in diameter air-spaced on polystyrene supports, 20-s.w.g. tinned-copper. This coil is mounted near the top end of L13.
L13	21 to 3.5	23 turns, 14 turns/in, $\frac{1}{2}$ -in diameter on ribbed former 2 $\frac{3}{8}$ in. long, 20-s.w.g. tinned copper. Mounted vertically, top-chassis. Tapping points at 2 $\frac{1}{2}$ turns from L12 L13 junction for 21 Mc/s, 5 $\frac{1}{2}$ turns for 14 Mc/s and 11 $\frac{1}{2}$ turns for 7 Mc/s.
L14	1.8	31 turns, close-wound, 1-in diameter Paxolin former, 20-s.w.g. en. Mounted horizontally near L13 and L12.

" Π " output filter.—As will have been noted from the circuit diagram (Fig. 1) and the coil data the output filter inductance is composed of sections of L12, L13 and L14 together, with preset tuning capacitors for each band and one variable capacitor. Approximate values of inductance and capacitance are given below for the various bands. The filter has an approximate impedance of 50 Ω .

Band (Mc/s)	Capacitors (pF)	Inductor (μ H)
1.8	C17, C18=310 C19=2,200	L12, L13, L14=28
3.5	C17=160 C20=1,100	L12, L13=14
7.0	C17=80 C21=550	L12, L13=7
14.0	C17=40 C22=275	L12, L13= 3.5
21.0	C17=26 C23=184	L12, L13= 2.3
28.0	C17=20 C24=136	L12= 1.7

Switches.—The room available for the band switch (S1) is considerably greater than on the receiver; also the switch has to handle high powers, especially in the output stage. It is thus a standard-size ceramic type with six single-pole six-position wafers. The meter switch (S2) must be of the break-before-make variety to avoid short-circuiting of the 12-V supply when changing function.

R.f. chokes.—Each choke is of 2.5mH inductance, wave-wound and split into pies. RFC2, the p.a. anode choke, is rated at 100mA d.c.

Project "Telstar"

INTERCONTINENTAL COMMUNICATIONS SATELLITE

THE first of the satellites to be launched under the joint Euro-American scheme to provide, at least experimentally, an intercontinental communications system via an earth satellite is due to be put into orbit in the next few weeks. Numerous conferences have been held between the various administrations involved and ground stations in the U.S.A., U.K., France, Italy and Brazil are now in various stages of completion in preparation for the launching of "Telstar," as it is called, which will be followed later by "Relay." The launching from Cape Canaveral, fired by a Delta rocket, is being financed by the American Telephone and Telegraph Company at a cost of \$3M. The 34in sphere has been designed by the Bell Telephone Laboratories of New York, as a private venture. In actual fact, four spheres have been assembled and tested to ensure a "belt and braces" readiness for the project.

The diagram shows the expected orbit of the satellite. Inclined 45° to the equator, the elliptical orbit will have a perigee of 500 nautical miles and an apogee of 3,000 nautical miles. The period of orbit will be about 2 hours 40 minutes.

The satellite is roughly spherical in shape, but with 72 flat facets, and weighs about 170 lbs. The metal framework is made of magnesium and the shell of aluminium. Solar cells are mounted on most of the facets and on one or more of them are metal mirrors that will reflect sunlight to facilitate visual observation.

Two slotted aerials, one for receiving and the other transmitting the communications frequencies, girdle the sphere's "equator." Another aerial at one of the "poles" will be extended from the inside after a protective launching nose fairing has been cast off. This aerial serves the telemetry, command and beacon (or tracking) circuits. During the launch, two small whip aerials at the opposite "pole" of the satellite will be used for telemetry.

Communication frequencies are nominally 6390 and 4170 Mc/s; an additional frequency of 4080 Mc/s being used for tracking. The incoming 6390 Mc/s signal is mixed with the output of a quartz crystal-controlled beat oscillator to produce a signal centred at an intermediate frequency of 90 Mc/s. This lower frequency is within the working range of reliable, long-life transistors. The 90 Mc/s frequency is mixed and amplified to provide a 2.25-watt output at 4170 Mc/s. The power of the tracking frequency (4080 Mc/s) is only 25mW. A travelling-wave tube is used for the output stage of the communications transmitter. It is the only thermionic device in the satellite, which contains 2528 semiconductor devices. Incidentally, 93% of the semiconductors are used in the command and telemetry circuits.

It is known that the Van Allen belt which intersects part of the orbit has a high density of energetic particles, but the present knowledge of the density and energy of these particles, which can damage communications devices at various altitudes, is

sketchy. Therefore, to obtain the needed specific information, Bell Laboratories have incorporated in Telstar a radiation experiment to probe this part of the Van Allen belt. A large part of the satellite is occupied by equipment for the measurement of environmental conditions, the performance of circuits and devices and the transmission of this information to the ground. In all, 115 items are measured and reported. These include the density and energy of free protons and electrons, the temperature at the skin of the satellite and inside the electronics container, the amount of sunlight being received at several points on the skin and the currents and voltages in various parts of the circuits. The measurements are transmitted to the ground stations on a frequency of 136 Mc/s. This frequency is radiated constantly at a power of 0.25 watt even when no information is being transmitted, thus serving as a second tracking frequency. The telemetered information is sent in the form of coded pulses. These pulses frequency-modulate a 3kc/s frequency, plus or minus 225c/s. The resulting signal is then used to amplitude-modulate the 136 Mc/s carrier thus producing a p.c.m.-f.m.-a.m. signal.

There is also a "command" system to switch on and off the communications and the telemetry equip-

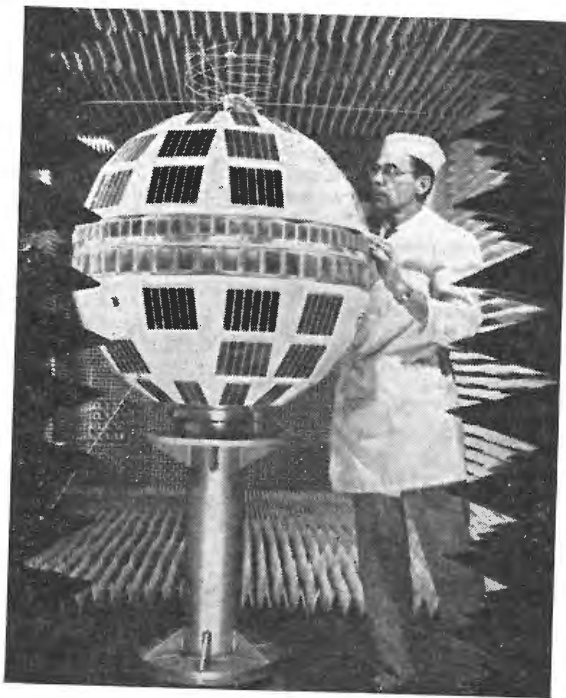

The slotted "equatorial" aerials can be seen in this photograph of one of the "Telstar" models in an r.f. anechoic chamber which simulates the radio environment of space.

Expected orbit of "Telstar". The apogee will at first be near the equator on the south-to-north crossing and the perigee near the equator on the north-to-south crossing. This ellipse is expected to move gradually over a period of months so that the apogee will occur in the northern hemisphere, then continuing to precess until it crosses the equator into the southern hemisphere and so on.

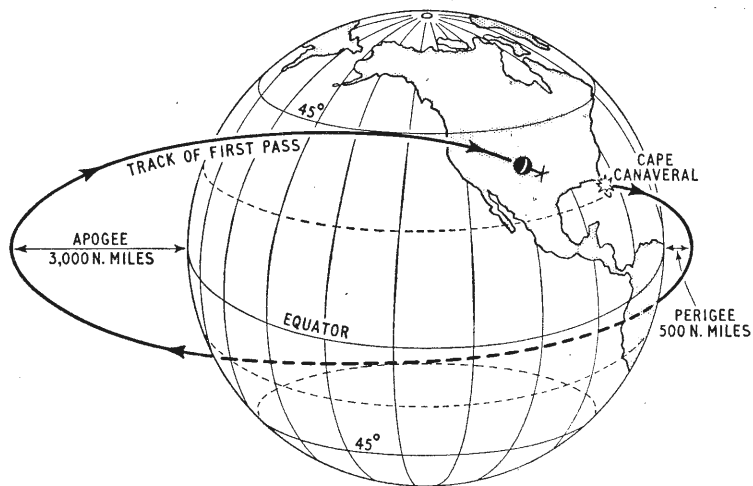

ment in order to conserve power which may be used at a greater rate than it can be replenished by the solar cells (taking into account the periods when the satellite is in the earth's shadow). Power is provided by 19 rechargeable nickel-cadmium cells which are charged by 3,600 solar cells on the skin of the satellite. The frequency used for the command system is around 120Mc/s.

"Telstar" can handle a signal bandwidth of 50 Mc/s and can provide 60 simultaneous 2-way tele-

phone links, but in fact the ground stations have initially multiplexing equipment for only 12. The satellite could, of course, be used to provide an inter-continental television link.

All the electronic sub-assemblies are potted and the complete equipment is contained in a 20-inch aluminium canister into which is poured polyurethane to form a shock-proof structure. The canister itself is suspended inside the satellite's metal framework on nylon cords.

OUTER ATMOSPHERE MEASUREMENTS BY BRITISH SATELLITE

AS this issue goes to press, the satellite which is still known as UK-1, among other names, is ready to be launched by an American Thor-Delta vehicle. Its elliptical orbit (apogee 600 miles, perigee 200 miles) will be inclined to the equator at an angle which will take it over points between 55°N and 55°S (Moscow and Labrador in the north, and New Zealand and Cape Horn in the south). The satellite will travel through the ionosphere, and the purpose of the instrumentation carried is to measure the effects of solar radiation on the behaviour and concentration of free electrons and molecular ions in this region. Measurements will also be made on the energy spectrum of cosmic rays—both high and low energy varieties.

Cosmic ray detection is carried out by both a Geiger counter and a Cerenkoff detector, which takes the form of a hollow Perspex sphere. Flashes produced in the sphere by traversing particles are detected by a photomultiplier and amplitude-discriminated at a threshold corresponding to a particle charge of 6 electron units. Heavier particles than this are counted and telemetered. The Geiger counter responds to all cosmic particles, including those trapped in the Van Allen belts.

The spectrum of the solar X-radiation is determined by proportional counters and a five-level pulse-height analyser or "kick-sorter." Pulse height is directly proportional to the frequency of the X-rays, so that the telemetry is fed with signals proportional to the intensity of radiation at different frequencies or, in other words, the spectrum.

Electron density is measured by the two badminton-racket-like devices on one of the booms. A high-frequency signal is applied to one of these probes, which causes the electrons in the vicinity to oscillate. As this constitutes an alternating current, a voltage proportional

to the electron density is induced on the other probe and is amplified for telemetering.

The results of these and other measurements concerned with the kinetic energy of electrons and positive ions, and with ultra-violet radiation, will be telemetered to 15 receiving stations by a time-division-multiplexed, $\frac{1}{2}$ W transmitter, working in the band 136-137 Mc/s. Tape storage is used, and the information is transmitted on reception of a command signal to Minitrack stations such as the one at Winkfield, Berkshire.*

* "Satellite Tracking," *Wireless World*, March 1961.

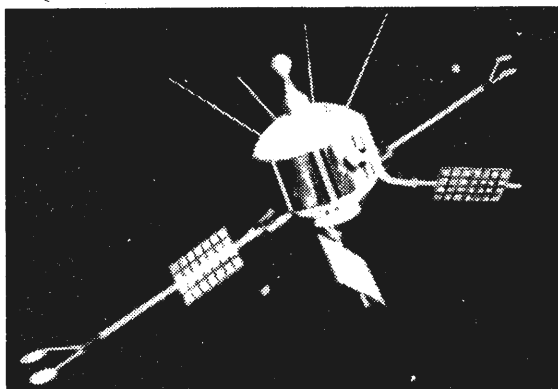

Model of a prototype UK-1 with transducers and solar cells extended. Protuberance between the four aerials houses a mass-spectrometer and the cosmic-ray detectors.

1963/4. The number of transmitters will then be 50, and although the number of people coming within the range of a television station will be increased by only some 300,000, improved reception will be provided for at least 1.5M viewers. By 1964 the service will be available to 99.4 per cent of the population.

As will be seen from the B.B.C. coverage map, there are still large areas of the U.K. not covered, but of course the population in many of these is very sparse.

Now for the I.T.A. With the opening of five new stations this year—three in Wales, one in the Channel Islands and the second transmitter in Northern Ireland—the Authority's service will be radiated by 22 stations and be available to about 95 per cent of the population.

"The uncertainty which prevails about the future technical arrangements for television in this country . . . must inevitably inhibit long-term planning," states the I.T.A. in its latest annual report. It does, however, go on to say that it intends to develop its plans for further extensions to its Band III service, although the timing of a firm programme of building the relatively large number of low-power stations needed "must remain flexible until more is known about the future technical pattern of the Authority's services."

No long-term plans have so far been announced. On the adjacent map there will be found marked only those stations which are at present operating and those, as already mentioned, which are planned for intro-

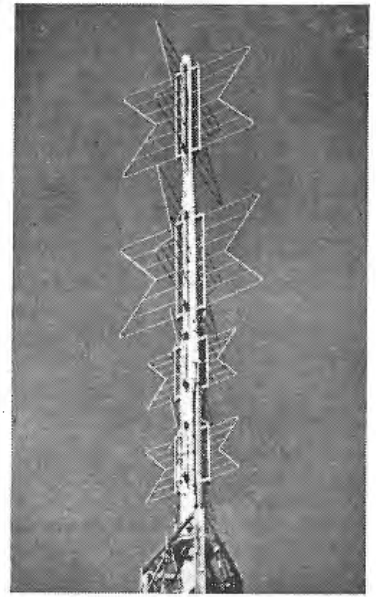

Turnstile aerial array (Channel 1), supplied by E.M.I., atop the 250ft mast at the Llandrindod Wells relay station of the B.B.C. The station also radiates the three sound programmes on v.h.f.

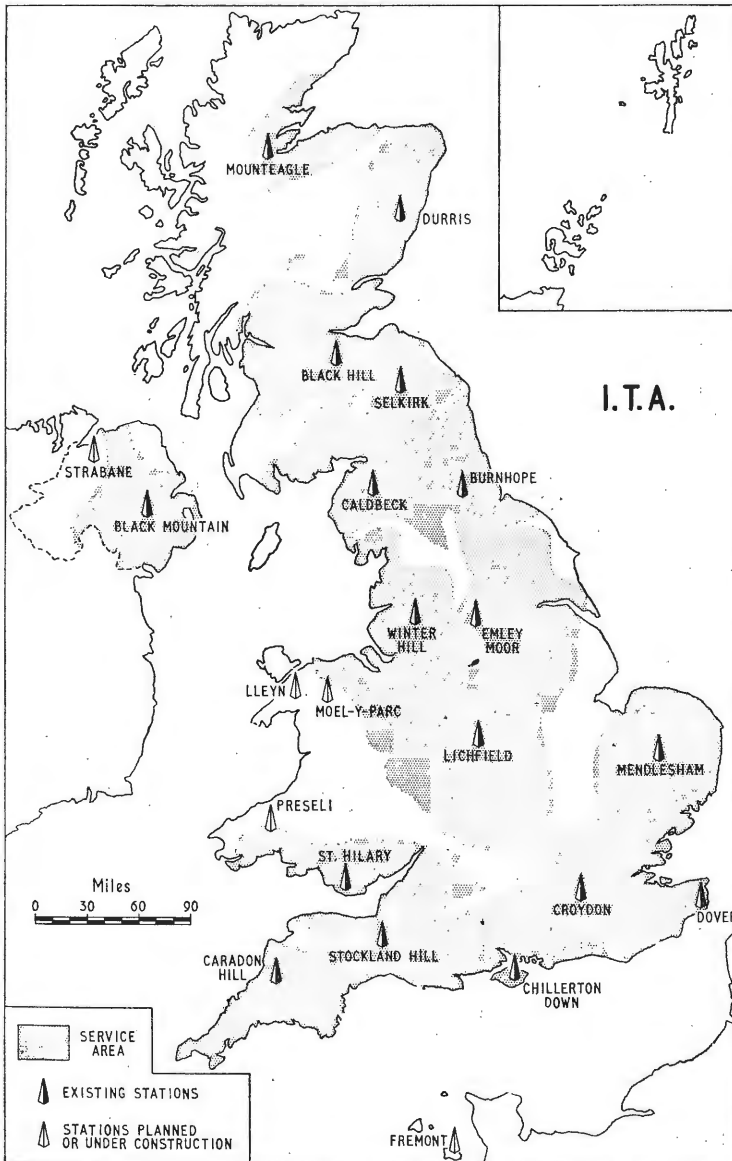

I.T.A.

duction later this year. There has been some delay over the building of the new 500ft tower to replace the existing 200ft one at Croydon. It is now expected that the new tower, with a directional aerial giving an e.r.p. of from 50-400 kW, will be ready at the end of the year. The Authority is planning to include a Band IV aerial on the tower.

References

"B.B.C. Handbook 1962." B.B.C. 6s.
 "Independent Television Authority Annual Report and Accounts 1960-61." H.M.S.O. 5s 6d.

I.T.A. STATIONS

Channel	Location	kW	Polarization
Channel 8	Burnhope, Durham	100*	H
	Lichfield, Staffs.	400*	V
	Preseli, Pembroke	100*	H
	Strabane, W. Ulster	90*	V
Channel 9	Black Mt., Belfast	100*	H
	Croydon, London	120	V
	Durriss, Kincardine	400*	H
	Fremont, Jersey, C.I.	10*	H
	Stockland Hill, Devon	100*	V
	Winter Hill, Lancs.	100	V
Channel 10	Black Hill, Lanarks.	475*	V
	Dover, Kent	100*	V
	Emley Moor, Yorks.	200*	V
	Lleyl Caernarvon	10*	H
	St. Hilary, Glam.	200	V
Channel 11	Caldbeck, Cumberland	100*	H
	Chillerton Down, I.o.W.	100*	V
	Mendlesham, Suffolk	200*	H
	Moel-y-parc, Denbigh.	28*	V
Channel 12	Caradon Hill, Cornwall	200*	V
	Mounteagle, Ross & Crommarty	50*	H
Channel 13	Selkirk, Scotland	25*	V

*An asterisk against the e.r.p. indicates that it is the maximum for a directional aerial.
 V — Vertical polarization.
 H — Horizontal polarization.

WORLD OF WIRELESS

Pay Television

IN its evidence to the Pilkington Committee, British Telemeter Home Viewing Ltd., submitted a scheme which could give a three-programme pay television service to some two-thirds of the population if it were broadcast and not restricted to a cable network. The use of cables, they claim, would "disfranchise" for the foreseeable future large sections of the population—notably those in rural areas where it is uneconomic to run cable networks. The adoption of the scheme would, however, mean that there would be room in Bands IV and V for only one other television service. Their scheme was backed up by a map, showing the geographical distribution of frequencies and the areas covered by the three-programme service, which was produced by Marconi's, their technical advisers.

Yet another system of toll television has been demonstrated in London. Known as "PayVision," it was developed by Marconi's for a new company—PayVision Ltd. Essentially a wired system it is the first to be demonstrated in this country incorporating a central billing system thereby eliminating a slot machine or meter in the home.

Technical Writing Awards

A RECORD number of 119 entries, a rise of 20 per cent on last year, was received for the 1961 awards scheme of the radio and electronics industry. The scheme, which was introduced in 1952, aims to encourage the writing of technical articles illustrating original work taking place in the U.K. in the fields of "radio, electronics and associated instrumentation." Awards of 30gn each are being presented on May 3rd to the authors of the following eight articles:—

- "Silicon Four Layer Devices as High Power Pulse Generators" by R. P. F. Lauder (*Electronic Engineering*).
- "The Theory of Waveguides and Cavities" by R. A. Waldron (*Electronic Technology*).
- "Photoelectric Cells and Photomultipliers" by J. Sharpe (*Electronic Technology*).
- "Solid-State Electronic Instruments for Measurement and Control" by I. C. Hutcheon & G. B. Marson (*Instrument Engineer*).
- "National Telecommunication Network Planning" by E. G. Hancock (*Point to Point*).
- "Computers in Process Control" by M. B. Wood (*Control*).
- "Shaft Position Indicator for Use with Journal Bearings" by J. J. Hunter & C. J. Hughes (*British Journal of Applied Physics*).
- "Long-Distance Waveguide Transmission" by Dr. R. Hamer (*Electronic Engineering*).

Judges for the scheme, which is sponsored by B.R.E.M.A., B.V.A., E.E.A. and V.A.S.C.A., are: Professor C. W. Oatley (University of Cambridge); B. C. Brookes (University College, London); A. H. Cooper (E.M.I. Electronics); Dr. R. C. G. Williams (Philips Electrical); F. Jeffery (Murphy Radio); and G. Reeves (Albert Reed & Co.).

Student Prizewinners.—At the 16th annual dinner of the Radar & Electronics Association on April 13th, attended by some 200 members and guests, prizes were awarded to the "best student members of the year." The recipients, all of whom are students at the Northern Polytechnic, were G. B. Davies (1st), R. P. Van Rixtel (2nd) and D. J. Chapman (3rd).

Purchase Tax.—For the tenth time since the end of the war the purchase tax on sound radio and television receivers and radiogramophones has been altered. The new rate, introduced on April 10th, is a reduction from 55% to 45%—the lowest since 1951. The change means a reduction of, for instance, £3 5s on a television set which previously cost £65 including P.T. Other items affected by the change are valves, c.r. tubes, loudspeakers (not over 10in diaphragm), kits of parts, pickups and records which are now all chargeable at 45%. These changes mean that some of the prices quoted in advertisements in this issue will be amended.

Rank & Murphy.—Since preparing the note on the Rank Organization which appears on page 240 in this issue, it has been announced that the directors have made an offer for the issued share capital of Murphy Radio Ltd. If the £4M offer is accepted, it is intended to co-ordinate the activities of Murphy and those of Bush Radio.

Technical services for the 1962 British Radio Show (Earls Court, August 21st to September 1st), including piping a 625-line picture round the stands, and having a Colour Television Avenue, are going to cost £30,000, state the organizers Radio Industry Exhibitions Ltd. "The industry and the B.B.C. plans ensure that this year's exhibition will be one of the best ever, and we are certain that most manufacturers will want to be in it," say R.I.E.

Satellite Information.—A series of regular broadcasts giving the latest information on satellite launchings and on satellites already in orbit is being transmitted daily, except Mondays, by certain Voice of America stations. The broadcasts are radiated from 03.30–03.35 GMT on the following frequencies:—15.325 (WBOU), 15.290 (WLWO), 15.270 (WDSI), 11.830 (WBOU), 9.750 (WBOU), and 9.650 Mc/s (WLWO). The station's call sign is given in parentheses.

Scientific Instrument Centre.—A joint enterprise by two members of the Pye Group, W. G. Pye & Company and Unicam Instruments, the new Scientific Instrument Centre at York Street, Cambridge, was officially opened on April 11th. At the opening, Pye chairman, C. O. Stanley, said that it was proposed to open the doors of the Centre, at suitable times, to accredited science teachers from any part of the U.K. who would like to examine, operate and find out about the latest instruments made by the Pye companies. Typical of Unicam instrumentation is spectroscopic and crystallographic equipment, while W. G. Pye products include potentiometers, resistance bridges, galvanometers and pH measuring equipment.

R.T.R.A. Conference.—Venue of this year's annual conference of the Radio and Television Retailers' Association is Bournemouth from May 7th–9th. The programme includes a presidential address by R. J. Piercy, and a discussion on technical considerations arising out of a possible change of television line standards, when the speakers will be Sir Harold Bishop, C.B.E., Director of Engineering, B.B.C., and P. A. T. Bevan, C.B.E., Chief Engineer, I.T.A. A manufacturers' "showcase" exhibition is being organized this year as part of the conference.

Electronics and productivity is to be the theme of the next convention of the Brit.I.R.E. It will be held in the University of Southampton in April, 1963.

S.E.E.—At the recent annual general meeting of the Society of Environmental Engineers the following members were elected to the committee: V. A. Austin (Kelvinator); S. S. Duncan (de Havilland Propellers); J. W. Gearing (Electronic Vibrators); Dr. P. Grootenhuis (Imperial College of Science); R. A. C. Ivoes (S. Smith & Sons); F. I. L. Knowles (A.R.D.E.); R. McNamara (Cementation: Muffelite); and J. P. Salter (Ministry of Supply). Mr. Knowles is the new chairman and Dr. Grootenhuis vice-chairman.

Postgraduate Courses.—A booklet giving details of postgraduate courses and of the opportunities for research in the various departments has been issued by the Imperial College of Science and Technology, London. The Department of Electrical Engineering offers a very wide selection of courses, each of one academic year leading to the award of the D.I.C. The subjects include transistors, global communication networks, microwave techniques, automatic control system analysis, and electron dynamics and electron optics. Postgraduate work in the Department of Physics is organized to provide for both lecture courses and research work in preparation for higher degrees and diplomas, the fields covered including electron physics, photo-electronics and acoustics.

Space Technology Symposium.—The second European symposium on space technology is to be held in Paris from June 18th-20th. It is being organized jointly by the British Interplanetary Society and the Société Française d'Astronautique, and Eurospace (the Western European consortium). Details of the programme, which includes the subjects of communications and tracking, are obtainable from the British Interplanetary Society, 12 Bessborough Gardens, London, S.W.1.

Machine Tools and Automatic Control.—An informal discussion on automation techniques for the benefit of designers of machine tools has been arranged by the Institution of Mechanical Engineers in co-operation with the Machine Tool Trades Association and under the sponsorship of the British Conference on Automation and Computation. It will be held in London on May 29th and 30th. Details of the programme are obtainable from the Institution of Mechanical Engineers, 1 Birdcage Walk, London, S.W.1.

This year's Electrical Engineers (A.S.E.E.) Exhibition was the last in the annual series begun in 1952. The exhibition organizers and the British Electrical and Allied Manufacturers' Association have decided in favour of making it a biennial show, the first of which will be held at Earls Court in 1964. It has also been decided to allow the inclusion of overseas exhibitors at the next exhibition, which it is hoped will develop eventually into the International Electrical Engineers Exhibition.

Stockholm.—The largest British exhibition to be held overseas opens in Stockholm on May 18th for a fortnight. Among the 500 or more manufacturers who are participating are a number in the electronics and radio industry who will be showing both capital equipment and consumer goods. The exhibition is organized by British Overseas Fairs Ltd.

M.K.S.—A conference on "The use of the rationalized M.K.S. system of units in the teaching of G.C.E. advanced level physics," intended primarily for physics masters and mistresses in grammar schools and secondary modern schools, will be held at the West Ham College of Technology, London, E.15, on April 30th. The fee, which includes lunch and tea, is 15s.

Sixth Amateur Television Convention of the British Amateur Television Club will be held in the Conway Hall, Red Lion Square, London, W.C.1, on Saturday, September 8th. Details will be available later from D. S. Read, 21 Silverdale, Sydenham, London, S.E.26.

F.R.S.—Among the recently elected Fellows of the Royal Society are Dr. M. Blackman, professor of electron physics in the University of London, and Dr. R. A. Smith, C.B.E., professor of physics in the University of Sheffield. Professor Blackman, who is on the staff of Imperial College of Science and Technology, receives the Fellowship for "his contributions to the theory of vibrational spectra of crystal lattices and his researches on electron diffraction and magnetism." Professor Smith who receives the Fellowship for "his contributions to the advancement of the science solid state physics," was until last year head of the Physics Department of the Royal Radar Establishment, Malvern.

Nigeria now has a government television service as well as the commercial services introduced in each of the regions. The first government station, situated in Lagos, started transmitting in Channel E10 (209-216 Mc/s) on April 1st. Transmitters are also to be opened in each of the Federal capitals—Ibadan (which will operate in Channel E2, 47-54 Mc/s), Enugu and Kaduna. Northern Nigeria's first television station at Kaduna opened on March 15th. The service is being provided by a company formed jointly by E.M.I., Granada and the Northern Nigeria Radio Corporation—a government body.

Educational Television.—E. A. O. G. Wedell, secretary of the Independent Television Authority, recently returned from a three week tour of educational television stations in the United States. The Authority submitted to the Pilkington Committee proposals for the establishment of a separate educational television service in this country. Mr. Wedell also visited the Federal Communications Commission in Washington, in order to study the Commission's methods in the allocation of television contracts, and its supervision of broadcasting developments.

V.H.F. Sound Broadcasting.—Over 1,600 stations are listed both geographically and in order of frequency in the latest list (No. 7) of the v.h.f. sound broadcasting stations in Europe issued by the European Broadcasting Union. The cost is 50 Belgian francs, which includes five bi-monthly supplements and also two charts showing the situation in Band II on January 1st and July 1st. It is available from the E.B.U. Technical Centre, 32 ave. Albert Lancaster, Bruxelles 18.

Kenya's television service is to begin on October 1st. The Kenya government has appointed Television Network (Kenya) as contractors. The company will have three representatives on the nine-man board of the Kenya Broadcasting Corporation.

Conference Reports.—The early publication of the results of a conference can add considerably to its value. The I.E.E. has therefore introduced a new series of publications "Conference Report Series," the first of which covers the symposium on nuclear electronics held on November 30th and December 1st last year. It contains abstracts of the contributions, lectures and discussions at this meeting and also reports on the May, 1961, Belgrade Conference on the same subject. The 32-page booklet costs 5s.

Coventry.—During the celebrations associated with the opening of the new Coventry Cathedral, May 25th-June 16th, the Coventry Amateur Radio Group of the R.S.G.B. will operate a special exhibition station with the call sign GB3COV.

Amateur Mobile Rallies being held in May include the following:

- 20th: Hunstanton (Peterborough Radio Society).
- 20th: Rochester Airport (Medway Amateur Receiving and Transmitting Society).
- 27th: Stockwood Park, Luton (Luton and District Amateur Radio Society).

Personalities

The B.B.C. has appointed **J. E. F. Voss, B.Sc., A.M.I.E.E.**, as superintendent engineer, television (London studios). Mr. Voss rose to the rank of Wing Commander during his wartime service on radar duties. He joined the B.B.C. in 1949 as a lecturer in the engineering training department and was promoted to senior lecturer the same year. In 1954 he transferred to the engineering establishment department as an assistant with special responsibilities for television engineering staff. He was appointed regional engineer, Wales, in 1956.

R. S. Meakin, A.M.I.E.E., has been appointed by the B.B.C. as superintendent engineer, television (recording). Mr. Meakin joined the B.B.C. as a student apprentice in 1936. He became a maintenance engineer at the Daventry transmitting station in 1938 and in this capacity he transferred to the television service at Alexandra Palace later the same year. After serving in studio and telecine technical operations and maintenance departments he was appointed engineer-in-charge, telecine and telerecording, in 1956 and engineer-in-charge, television recording, in 1960.

H. D. Law, engineer-in-charge of the West Region transmitter of the B.B.C. at Start Point since 1951, has retired after more than 37 years' service. He joined the then British Broadcasting Company as an assistant maintenance engineer at the Dundee station. His successor is **J. Brown**, who joined the Corporation as an assistant maintenance engineer at the Moorside Edge transmitting station in 1935. He has been assistant engineer-in-charge at the station since 1953.

New appointments in the engineering department of Marconi Instruments Ltd. include that of **A. Haviland** as chief development engineer, responsible for the design, development and product evaluation of the company's proprietary instrumentation. He will also act as engineering department liaison engineer with Government establishments in the U.K. **N. R. Bell, B.Sc.(Eng.), A.M.I.E.E.**, and **P. M. Ratcliffe, A.M.I.E.E.**, have been appointed assistant chief development engineers with special responsibilities, Mr. Bell for certain product groups including oscilloscopes, and Mr. Ratcliffe for all projects involving the use of microwave techniques.

J. D. Dale Lace, A.M.I.E.E., D.F.H., has been appointed sales development manager at Denbro Ltd., where he will be concerned with the marketing activities of certain of the Denbro subsidiary companies. Mr. Dale Lace was trained as an electrical engineer at Faraday House, and after service in the Royal Navy as an electrical officer he joined Pye, working on the development of television transmission equipment, eventually becoming senior export sales engineer for telecommunications and specialized equipment. After four years at de Havilland Propellers as guided weapons service manager, he joined A.E.I. in 1960 as sales manager of their Radio Components and Special Products Department.

Edward T. Emms, B.Sc., A.M.I.E.E., has been appointed head of the Mullard Semiconductor Measurement and Application Laboratory, Southampton. He succeeds **E. A. Wolfendale**, who recently took up a university post in Kenya. Until latterly, Mr. Emms led a design team working on electronic flight simulators. Before this, he was with Mullard Research Laboratories, working on the design and development of television circuits.

R. H. Pengelly has been appointed general manager and a director of Coscor Radio & Television Ltd. Apart from war service, Mr. Pengelly was with the Edison Swan Company from 1928 until 1949. He then joined Thorn Electrical Industries Ltd. as Northern area manager for the Ferguson Division, eventually becoming sales manager. In 1956 he joined Radio & Allied Industries Ltd. as sales manager for the Sobell and McMichael brands. Following his appointment to the board of that company he was eventually elected chairman. He was also on the board of Radio & Allied (Holdings), but resigned from both these companies in January of this year.

W. G. C. Denny, A.M.Brit.I.R.E., has been appointed commercial manager of the electronics division of Thorn Electrical Industries. Previously he was with the telecommunications division of Elliott Brothers (London) Ltd. in the capacity of technical sales manager, and from 1945 to 1959 was divisional manager of the electronics division of Dowson & Dobson Ltd., Johannesburg. During the war he was appointed radar liaison officer on the staff of the Director of Radio Equipment, Admiralty, and from 1935 to 1941 was with the Western Electric Company. Prior to 1935 he was with E. K. Cole and Murphy Radio.



W. G. C. Denny



I. G. Gardner

I. G. Gardner has been appointed assistant commercial manager of Marconi Instruments Ltd. This is a new post in which Mr. Gardner will be responsible for the sale of the company's products in Western Europe, including Scandinavia. Prior to joining the organization in 1939, Mr. Gardner served as a marine radio officer with Marconi's. In 1941 he was appointed Marconi Instruments' chief of test, a position he held until 1946, when he undertook export duties.

Marconi International Marine Communication Company announce the appointment of **H. C. Maguire** as general manager of the company in succession to **D. P. Furneaux**, who became managing director at the beginning of the year. Mr. Maguire, who has held the post of export sales manager for the past six years, began his career with Marconi Marine in 1927 as a seagoing radio officer. He served at sea until 1936.

T. B. (Jock) Henderson has been appointed to the board of Philco (Overseas) Ltd., and Philco (Gt. Britain) Ltd., subsidiaries of Thorn. Mr. Henderson will continue in his present appointment as general sales manager of the British Radio Corporation.

P. F. Dorey, B.Sc.(Eng.), A.M.I.E.E., has been appointed manager of the digital systems department of Ferranti Ltd. This newly created department integrates a large part of the activities of the company's computer laboratories at Lily Hill, Bracknell, Berks., with a new production unit which has now been established at the Cairo Mill, Oldham, Lancs. It will deal with the military, civil air traffic control, and commercial data transmission sections of the computer department. Mr. Dorey received his preliminary engineering training with the B.B.C. during the period 1941-44. In 1951 he joined Elliott Brothers research laboratories at Borehamwood, Herts., where initially he worked in the research department and later, on guided weapons equipment, until joining Ferranti Ltd. in 1954.

Gerald A. Goodhew has been appointed professional products sales manager of Ampex Great Britain Ltd. Mr. Goodhew obtained a special honours degree in physics at the University of London in 1954, and the following year carried out a post-graduate course in electronics. He was employed by E.M.I. as a research engineer in colour television systems from 1952 to 1957. In 1958 he was appointed senior engineer in the television broadcasting department of Central Rediffusion Services Ltd. Since 1960 he has been chief engineer of Western Nigeria Radio Vision Service.

E. G. T. Charleston has recently joined the staff of English Electric Valve Company as a valve sales engineer. After serving an apprenticeship at Marconi's he was with B.B.C.'s planning and installation department until 1957, when he then took up an appointment with the Plessey Group as a sales engineer for telecommunications equipment. For the past two years he has been employed by Westrex.

Fairchild Semiconductor, Mountain View, Calif., has appointed **Christopher F. Coburn** to the new post of international marketing manager with responsibility for product sales outside the United States. A native of County Durham, he was most recently district sales manager for Rheem Semiconductor in Mountain View. He is now in Milan where he is working with SGS, an Italian semiconductor firm partly owned by Fairchild. He will also work closely with the new SGS-Fairchild Ltd. sales office in London.

John R. Christophers, M.Brit.I.R.E., has joined Cossor Instruments as assistant general manager. On leaving the electrical branch of the Royal Navy in 1953 with the rank of Lieutenant Commander, he held appointments with Decca Radar and with Sir W. G. Armstrong Whitworth Aircraft Ltd. Mr. Christophers was latterly technical sales manager of Marconi Instruments Ltd.

Professor A. G. McLellan, professor of physics, University of Canterbury, New Zealand, is the recipient of an award under the Royal Society and Nuffield Foundation Commonwealth Bursaries Scheme, which is enabling him at present to extend his knowledge of the physics of the solid state at the Clarendon Laboratory, Oxford.

Edward Powell has been appointed managing director of the Chloride Electrical Storage Co. Ltd. in succession to **A. W. Browne**, O.B.E., M.I.E.E., who has relinquished the position at his own request. Mr. Browne remains executive chairman.

Eric G. Wakeling, director and general manager of Advance Components Ltd., has been appointed joint managing director of the company. Prior to joining Advance in January, 1959, Mr. Wakeling was manager of the servo division of Elliott Brothers, Lewisham.

The senate of the Technical High School in Aachen has conferred an honorary doctorate on **Dr. phil. Karl Steimel**, of the AEG research organization, for his work on electronic valves.

T. A. Cross, M.Brit.I.R.E., has been appointed managing director of Redifon Ltd. He first joined the group over 30 years ago as an engineer and in this capacity has been employed in many parts of the world. Eight years ago he was appointed president of Rediffusion Inc. in Canada, where he has been responsible for all the activities of the group, including Redifon and Rediweld, throughout the North American continent. Mr. Cross was elected president, in 1961, of the National Community Antenna Television Association of Canada. He pioneered the introduction and inauguration of the British Institution of Radio Engineers of Canada as well as being the first chairman of the Montreal branch.

H. F. Goodwin has joined the Gresham Lion Group as commercial manager of the electronics and instrumentation divisions and of Gresham Automation Ltd. He joined Rediffusion Ltd. in 1932 and trained as a communications engineer. He extended his training with the Post Office Engineering Department from 1937 to 1939. He then rejoined Rediffusion and was responsible for the development of radio transmitter equipment for the Services. In 1946 he joined Evershed & Vignoles, eventually becoming head of the department marketing instrumentation equipment.

J. G. E. Hone, B.Sc., A.R.C.S., who joined the Gresham group in 1957 as development engineer on data handling and digital techniques, has been appointed chief engineer of Gresham Lion Electronics. He spent two years in the Royal Navy and a period in the National Physical Laboratory before going to Southampton University in 1952 where he obtained a diploma in electronics. In 1953 he went to Philips and from 1954-57 was with Racal as project engineer.

N. M. Morris, B.Sc., A.M.I.E.E., whose article on analogue computer scaling appears in this issue, is lecturer in electrical engineering at the North Staffordshire College of Technology, Stoke-on-Trent. After graduating at Durham University he was with the National Coal Board before joining the staff at the college.

Chilton Electric Products Ltd. have appointed **P. W. Caine**, A.M.I.E.E., to the new post of chief technical executive. Before joining Chilton, Mr. Caine was head of the supplies division of Decca Radar for four years.

G. W. Halse, B.Sc., has retired from the chairmanship of Electrical Remote Control Company and its subsidiary Equipment & Services Ltd. He has been chairman of the parent company for the past ten years.

OBITUARY

Melbourne Dewhurst, M.Sc., M.I.E.E., founder and chairman of Dewhurst & Partner Ltd., died on March 24th at the age of 74. In 1910 he took up an appointment on transmission test and power at the Chelmsford works of Marconi. Subsequently he became assistant to the chief designer of motors and generators at Crompton & Co. and in 1919 set up his own company in conjunction with the late Howard Marrayat.

Arthur H. Harris, deputy engineer-in-chief, Cable & Wireless Ltd., and its associated companies since April 1957, died in February after a long illness. He joined the Eastern Telegraph Company in 1922 as a telegraph operator, and in 1928 was posted to the engineer-in-chief's department. He was transferred to C. & W. on the merger of British overseas telegraph undertakings in 1929.

Leslie C. Bradley, director of Bradmatic Ltd., died at the age of 68 on Monday, April 2nd, at Birmingham, following an operation. He was for many years engaged in the development and manufacture of tape heads and decks.

News from Industry

Industrial Valve Guide for 1962, by Mullard, is now available from their Government and Industrial Valve Division, at Mullard House, Torrington Place, London, W.C.1. For convenience of reference the guide is split into two parts: one giving an equivalents list, and the other abridged data on the current range of Mullard types.

Cawkell's Sales Dept. Move.—Simms Motor & Electronics Corporation Ltd. announce a change of address for the sales department of their subsidiary Cawkell Research & Electronics Ltd., which is now located at Western Avenue, Acton, London, W.3 (Tel.: Acorn 6751).

Wolsey Electronics Ltd. is shortly to transfer its production to the factory of A. B. Metal Products Ltd. at Abercynon, South Wales. Both are members of the Gas Purification Group. Wolsey's electrical development and sales department will be housed at a new address in London to be announced.

Aveley Electric Ltd., South Ockendon, Essex (Tel.: South Ockendon 3444) have been appointed sole agents for the Brush Instrument Company, a member of the Cleveite Group of companies in America.

The Resin Encapsulation Service for electronic components and assemblies, formerly provided by Lion Electronic Developments and Gresham Lion Electronics, has been transferred to the Small Transformer Division of Gresham Transformers Ltd., Lion Works, Hanworth Trading Estate, Feltham, Middx.

New S.T.C. Division Formed.—Standard Telephones & Cables Ltd. has formed an Integrated Electronics Systems Division with headquarters at Burleigh House, Great Cambridge Road, Enfield, Middx., in order to concentrate its electronic systems activities, particularly in the industrial control and automation fields.

Airtech Ltd. have acquired the business of Chartair Ltd., under a merger agreement and the combined businesses, which cover a wide range of activities in the fields of electronics, engineering and aircraft, will henceforth be carried on by Airtech at their works at Haddenham, Bucks.

Rank-Xerox, who recently announced the formation of a new associated company, Fuji-Xerox, to manufacture and market xerographic machines in Japan, have moved to new premises at 84-86 Great Portland Street, London, W.1 (Tel.: Museum 5010).

Ulster Television are building a new £100,000 studio block, and have placed the order for technical equipment with Marconi's. The new block is expected to be completed by the autumn of 1962.

Telegraph Condenser Co. Ltd.—Group profit on trading during 1961 amounted to £674,560 as compared with £701,737 for the previous year. After taxation and all charges the balance carried forward to 1962 is £210,665 as against £195,265 previously.

Racal Electronics.—Group net profit, before taxation, increased to £231,000 for the year to January 31st, 1962. The 1960/61 figure was £182,000.

Gardners Transformers Ltd. have asked us to point out that the price of the A7012 transformer given on page 44 of the advertisement section of the April issue was incorrect. It should have been 52s 6d.

Two new films now available on free loan from the Central Film Library, Government Building, Bromyard Avenue, Acton, London, W.3, cover the subjects of marine radar and electron microscopy. Both films have been sponsored by Associated Electrical Industries. The first is directed at shipowners and those taking nautical training courses and the second at technical college students and industrial research workers. Film UK2197, dealing with the principles of electron microscopy, is in colour and lasts 23 minutes. UK2198 is a 23-minute film demonstrating the sponsor's Escort radar.

OVERSEAS TRADE

E.M.I. Export Activities.—Closed-circuit colour television camera systems manufactured by E.M.I. Electronics Ltd. are being installed in the operating theatres of the Halifax, Nova Scotia, Infirmary, and the "B" Surgical Clinic in the University of Thessaloniki, Greece. Los Angeles television station KTTV has chosen E.M.I. 4½in image orthicon broadcast television cameras to form the nucleus of improved technical facilities in a modernization programme it is to carry out. Two E.M.I. vidicon cameras have been ordered for Richmond Tweed TV Ltd.'s new television studio centre at Goonellabah, N.S.W., Australia.

Marconi TV Cameras for Cairo.—The United Arab Republic Broadcasting and Television Service has placed an order with Marconi's for the supply of five Mark IV camera channels and associated equipment. English Electric Valve Company 4½in image orthicon camera pick-up tubes will be incorporated. The cameras, to be installed in the latest of a series of new television studios in Cairo, will be used in the production of plays and theatrical shows.

A microwave communications system, comprising two routes using the G.E.C. 2000 Mc/s broadband radio equipment having a capacity of 300 speech circuits, has been ordered from the General Electric Co. Ltd. by the Crown Agents on behalf of the Department of Posts and Telegraphs, Fiji.

Automated test equipment, manufactured by Communications (Air) Ltd., a member of the A.C. Cossor Group of Companies, has been supplied to the Royal Malayan Air Force. The equipment provides for the fully automatic, *in situ* testing of aircraft V.O.R.-I.L.S. navigation equipment.

Mashpriboringtorg, Russia's Moscow-based central buying organization, have placed an order with Telequipment Ltd. for several models from the company's range of Serviscope portable oscilloscopes together with complete sets of camera gear and amplifiers.

U.I.C. Belgian Agents.—The United Insulator Division of Telegraph Condenser Company have appointed Antwerp Electronic & Ultrasonic Service, of 9A Kipdorp, Anvers, Belgium, as their agents for electrical ceramics and Unikote ceramic coatings in Belgium and Luxembourg.

Czechoslovakia is the destination of £22,000 worth of welder-type ignitrons and thermostats ordered from the Electronic Apparatus Division of Associated Electrical Industries Ltd.

Reykjavik airport, Iceland, is to be equipped with Decca airfield control radar to provide final approach talk-down facilities.

Scaling of Analogue Computers

USE OF POTENTIOMETERS, AMPLIFIERS AND INTEGRATORS

By N. M. MORRIS,* B.Sc., A.M.I.E.E.

ANALOGUE computers are now being used to a great extent for the solution of engineering problems. These range from the study of simple mechanical systems to the more complicated biological problems concerning nervous systems. One of the difficulties facing the computer operator is that of being able to feed in the correct information, and to interpret the results obtained. Provided the computer is correctly scaled, it should then be possible to vary any of the quantities desired in the problem and to investigate its effect on the solution.

The two factors which require scaling are (a) amplitude and (b) time. It may be that a problem is presented in which the maximum values are not

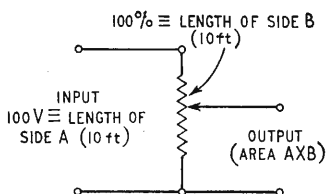

Fig. 1. Coefficient potentiometer.

given, i.e., in a mass-spring-damper arrangement the maximum values of velocity and acceleration may not be given, but it should be possible to estimate these using fairly simple rules which are referred to later. Having predicted these values the computer can then be amplitude scaled, that is to say if at one point in the computer we are studying the displacement of a mass, then we should be able to say that at that point 1 V is equivalent to x ft. In most analogue computers the permissible variation in amplifier output is 100 V, and when a point on a computer diagram is scaled "8 ft/sec", then at that point 100 V is equivalent to a velocity of 8 ft/sec.

The operational amplifiers of an analogue computer are d.c. amplifiers with open-loop gains of several million, and this gain reduces with increasing frequency. This has the consequence that if accuracy is to be maintained, then only low frequency phenomena can be studied in "real" time, and if high frequency problems are to be considered, then it is necessary to slow the problem time down so that it can be programmed on to the computer. If the integrators are to be accurate over many hours' use, then the open-loop gain of the amplifiers has to be much greater than the figure mentioned above, and if problems with time constants of several hours have to be studied, then it will be necessary to speed up the solution. This then is the problem of time scaling.

Amplitude Scaling.—The two main pieces of equipment used in analogue computing are coeffi-

cient potentiometers and amplifiers, and we will consider each in turn.

Let us suppose that we wish to calculate the area of a rectangle of sides A and B, and it is known that side A has a length of 10 ft and that side B has a variable length with a known maximum value of 5 ft. The calculation can be done conveniently by means of a potentiometer.

Suppose we use 100 V as our basic "machine unit", and we scale the input point of the potentiometer (Fig. 1) as "length of side A = 10 ft", i.e. at the input 100 V is equivalent to 10 ft, and the potentiometer has a scale factor of 5 ft, i.e. a 100% setting on the potentiometer is equivalent to the side B having a length of 5 ft. It is obvious that when the potentiometer is set at 100% and 100 V is connected to the input, there will be 100 V at the output, which in turn corresponds to an area of side A = 10 ft and side B = 5 ft, i.e. 50 sq ft. Thus 100 V at the output corresponds to an area of 50 sq ft, and the output point may be marked "50 sq ft". The final scaling of the problem is shown in Fig. 2.

If we decide to investigate the effect of reducing the length of side A, then this can be illustrated as follows: suppose we halve A, the area will now be $5 \times 5 = 25$ sq ft, and all we have to do to perform this calculation on the potentiometer is to feed in the information "side A = 5 ft", that is to say an input voltage of 50 V, and "side B = 5 ft", i.e. a potentiometer setting of 100%, and the output potential will be 50 V, and since the output scale tells us that 100 V is equivalent to 50 sq ft then 50 V is equivalent to 25 sq ft.

In this manner it is possible to investigate the effect

Right: Fig. 2. Scale factor relationships in Fig. 1.

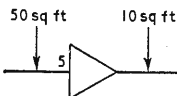
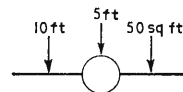

Left: Fig. 3. Effect of an amplifier on scale factors.

of altering both A and B, but it is most essential at the outset of the problem to know the maximum values involved, since it would be impossible to investigate the effect of increasing the length of B to 6 ft as this would require a potentiometer setting greater than 100%, and if side A is to be greater than 10 ft in length then a potential of over 100 V will be necessary, and if analogue computer amplifiers are

*North Staffordshire College of Technology, Stoke-on-Trent.

to be used in conjunction with this voltage, then overloading may occur.

From Fig. 2 it can be seen that a simple relationship results between the input, potentiometer, and output scales, and this may be stated as:—
 Input Scale \times Potentiometer Scale = Output Scale (1)
 and in the above case this gives $10 \text{ ft} \times 5 \text{ ft} = 50 \text{ sq ft}$.

The effect of an amplifier on scale factors can be seen by considering Fig. 3. Here we have a d.c. amplifier with a gain of five, and if a potential of

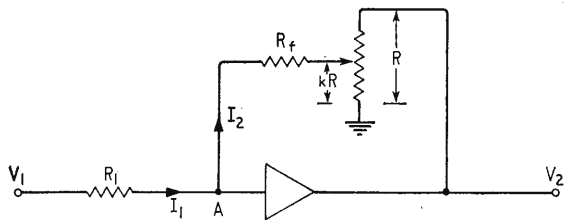

Fig. 4. Circuit for obtaining reciprocal multiplying factor.

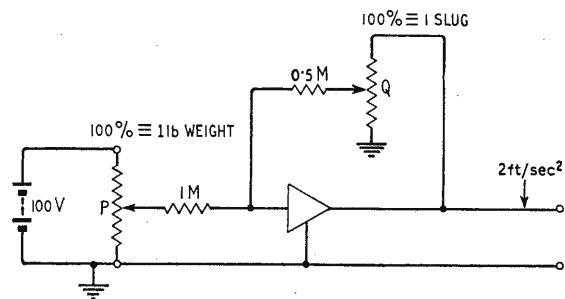

Fig. 5. Circuit for obtaining acceleration from force and mass.

100 V, representing for example an area of 50 sq ft, is connected to the input, then theoretically 500 V appears at the output which represents the same area as the input i.e. 50 sq ft. Since we talk in terms of a unit of 100 V, then we need to know what 100 V represents at the output, which is clearly an area of 10 sq ft. From this simple example the relationship between input and output scales can be seen to be

Input Scale = Amplifier Gain \times Output Scale (2)
 The final scaling of the amplifier is shown on Fig. 3.

In the case considered the amplifier produced no change in the dimensions between input and output, but many practical problems require this, and one such problem is illustrated below. Suppose we wish to calculate the acceleration of a mass M when acted on by a force F. The linear relationship between these quantities is

$$\text{Acceleration} = \frac{\text{Force}}{\text{Mass}} \text{ ft/sec}^2$$

where the force is in lb weight and the mass in slugs. (1 slug is that mass which experiences unit acceleration of 1 ft/sec² when acted on by a force of 1 lb weight, and is $\approx 32 \text{ lb}$.)

We can easily investigate the effect of changing the applied force since this is directly proportional to the acceleration with a given mass, but to study the result of a change of mass it will be necessary to devise a circuit which gives the required multiplying

factor of 1/mass and has a method of adjustment of the effective mass which is linear.

The circuit shown in Fig. 4 will perform this operation. With amplifiers used in analogue computers the open-loop gain is so high that the point A can be assumed to be at earth potential, hence $I_1 = I_2$.

$$\text{or } \frac{V_1}{R_1} = -\frac{kV_2}{R_f}$$

$$V_2 = -\frac{V_1 R_f}{kR_1}$$

If the potentiometer in the feedback path is scaled in terms of mass then the required operation can be performed. As an example let us consider a force between zero and one pound weight being applied to a mass, the value of the mass lying between one-half and one slug. With these values the maximum value of acceleration is 2 ft/sec².

The potentiometer P has 100 V across it and has a scale factor of one pound weight, that is to say a 100% setting of the potentiometer is equivalent to a force of one pound weight being applied to the mass. The feedforward resistor has a value of 1M Ω and the feedback resistor has a value of $\frac{1}{2}$ M Ω so that the amplifier has a gain of $\frac{1}{2}$ when potentiometer Q is set at 100%. This potentiometer is scaled so that 100% is equivalent to a mass of one slug, and the scale of the output point is set at 2 ft/sec² since this is the expected maximum value of acceleration.

The gain of the amplifier shown in Fig. 5 can readily be calculated from equation (2) assuming that all the potentiometers are set at 100% since we have:

$$\text{Input Scale} = 1 \text{ lb weight}$$

$$\text{Output Scale} = 2 \text{ ft/sec}^2$$

The gain factor associated with the amplifier will have the dimensions of mass in order to change the input scale of force to the output scale of acceleration. Applying equation (2) we get:

$$1 \text{ lb weight} = \text{Amplifier Gain (Slugs)} \times 2 \text{ ft/sec}^2$$

The numerical value of gain is thus $\frac{1}{2}$ which can be obtained by having a feedforward resistor of 1M Ω and a feedback resistor of $\frac{1}{2}$ M Ω .

The operation of the circuit can be explained physically as follows. With a force of one pound weight applied to a mass of one slug we would expect an acceleration of 1 ft/sec², which would result in an output of 50 V since 100 V is equivalent to 2 ft/sec². To simulate these conditions P is set at one pound weight (100%), and Q is set at one slug (100%). With 100 V connected to P, the voltage at the input to the amplifier is 100, and since the gain is $\frac{1}{2}$ (since Q is set at 100%), the output is 50 V, corres-

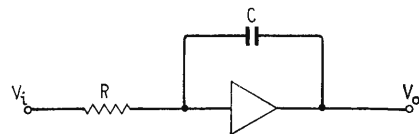

Fig. 6. Integrator circuit.

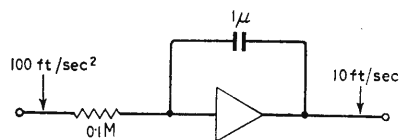

Fig. 7. Integrator circuit for obtaining velocity from acceleration.

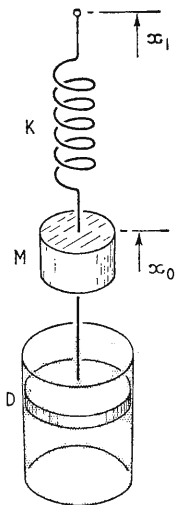

Fig. 8. Mass-spring-damper system.

ponding to an acceleration of one ft/sec². By a similar argument it can be seen that when Q is set at 50% (0.5 slugs) the output is 100V corresponding to an acceleration of 2 ft/sec². Hence P is directly calibrated in lb weight and Q is directly calibrated in slugs.

A typical integrator circuit is shown in Fig. 6, the equation for output voltage being $V_o = -1/RC \int V_i dt$. The "gain" so far as scaling is concerned is $1/RC$, and the scale factor of the integrator has the dimensions of (sec)⁻¹ and, as shown, if the input is an acceleration, then the output is a velocity. As an example, if the acceleration scale is 100 ft/sec²

and the velocity scale is 10 ft/sec, as shown in Fig. 7, then the "gain" is determined from equation (2) as

$$\text{"Gain"} = \frac{100 \text{ ft/sec}^2}{10 \text{ ft/sec}} = 10 \text{ sec}^{-1} = \frac{1}{RC}$$

If a capacitor of 1 μ F is used with the integrator, then $R = 0.1 \text{ M}\Omega$.

Time Scaling.—Suppose the output voltage of the integrator in Fig. 7 changes too slowly, and we wish to speed up the process in order to get the solution more quickly, how can we do this and what will be the effect on the amplitude scaling? We will consider these in turn.

The process of integration is carried out by obtaining the voltage across the capacitor C (Fig. 6) which is proportional to the time integral of the input voltage. If the time-constant of the R-C circuit is reduced, then the capacitor will charge up more rapidly and the process of integration is carried out more quickly. As an example of this we may take $RC = 0.01 \text{ sec}$ and the integration is carried out 10 times more rapidly than in the case previously considered when $RC = 0.1 \text{ sec}$. On the other hand if we had taken $RC = 1 \text{ sec}$ then the process would have been 10 times slower than in the case shown in Fig. 7.

It is shown in "Analog Computation" by A. S. Jackson (McGraw-Hill), that if the problem is time-scaled in the manner outlined, then the amplitude scaling of the computer is unchanged. This can best be seen by way of a simple example. Let us consider the problem of a tank being filled from a tap, a process which may take several hours if the tank is a large one. If this is programmed in real time on the computer a lot of time may be wasted in evaluating the time taken to fill the tank to a certain level, or alternatively the level attained when the tap is turned off after a given time. In the latter case if the process is speeded up by a factor of 10 on the computer, the same level is reached 10 times more quickly, hence the same amplitude scale factors can be used as those used previously.

Initial Conditions.—Many problems have initial conditions, that is to say at the particular time we wish to begin computation the object we are con-

sidering has a given position, velocity, etc, and we may need to account for these in the calculation. An example of this would be the calculation of the trajectory of an electron in a combined magnetic and electric field, where the initial position and velocity would be of importance.

The method of programming initial conditions on a computer is to charge the appropriate integrator capacitor up to the required voltage. If, in Fig. 7, the problem states that the initial velocity is 5 ft/sec, then to simulate this we will have to put an initial charge on the capacitor corresponding to this velocity. The scale at the output informs us that 100 V is equivalent to a velocity of 10 ft/sec, thus to programme 5 ft/sec we will have to charge the capacitor up to 50 V. In all computers a supply is available for this purpose, usually 100 V, and a coefficient potentiometer scaled as the output, i.e. "10 ft/sec", can be used to set up the initial condition by setting it at 50% corresponding to 5 ft/sec.

Estimation of Maximum Values.—If we consider a linear, second order differential equation with no damping term of the form:

$$a \frac{d^2x}{dt^2} + bx = A$$

the maximum values are found to be

$$x_m = \frac{2A}{b} \delta \quad \left(\frac{dx}{dt}\right)_m = \frac{A}{\sqrt{ab}} \delta \quad \left(\frac{d^2x}{dt^2}\right)_m = \frac{A}{a}$$

These values can be used in the initial calculations to ensure that reasonable results are obtained with a minimum wastage of time. It frequently happens that the initial estimates of maximum values are inaccurate, and further estimates have to be made, thus by careful selection the best results can rapidly be obtained.

Simple Problem.—The problem of producing a suitable circuit for a mass-spring-damper system

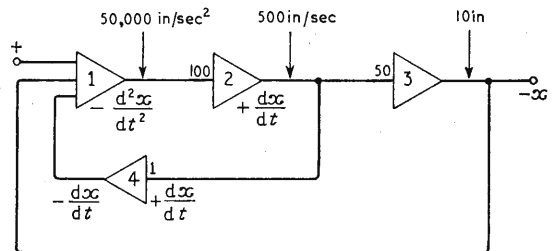

Fig. 9. Circuit for obtaining position of mass in mass-spring-damper system.

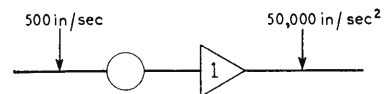

Fig. 10. Input and output scales for velocity feedback term in summing amplifier 1 of Fig. 9.

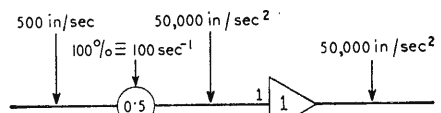

Fig. 11. Possible scaling for Fig. 10.

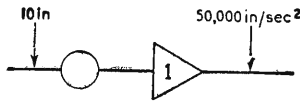

Fig. 12. Input and output scales for positional feedback term in summing amplifier 1 of Fig. 9.

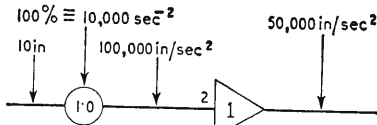

Fig. 13. Possible scaling for Fig. 12.

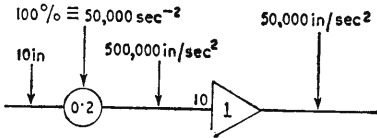

Fig. 14. Alternative scaling for Fig. 12.

is dealt with by most books on analogue computation, and this is briefly dealt with here before considering the aspect of amplitude and time scaling. The general arrangement is shown in Fig. 8. The equation of motion of the system is

$$M \frac{d^2x}{dt^2} + D \frac{dx}{dt} + Kx = F$$

where M is the mass = 0.1 slug
 D is the viscous damping = 5 lb weight/in per sec
 K is the spring constant = 1,000 lb weight/in
 F is the applied force = 5,000 lb weight

$$0.1 \frac{d^2x}{dt^2} + 5 \frac{dx}{dt} + 1,000x = 5,000$$

If the damping term is ignored, we get estimates of maximum values

$$x_m = \frac{2 \times 5,000}{1,000} = 10 \text{ in}$$

$$\left(\frac{dx}{dt}\right)_m = \frac{5,000}{\sqrt{0.1 \times 1,000}} = 500 \text{ in/sec}$$

$$\left(\frac{d^2x}{dt^2}\right)_m = \frac{5,000}{0.1} = 50,000 \text{ in/sec}^2$$

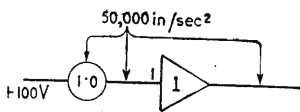

Above: Fig. 15. Scaling for forcing function term in summing amplifier 1 of Fig. 9.

Right: Fig. 16. Scaling of computer of Fig. 9 in real time.

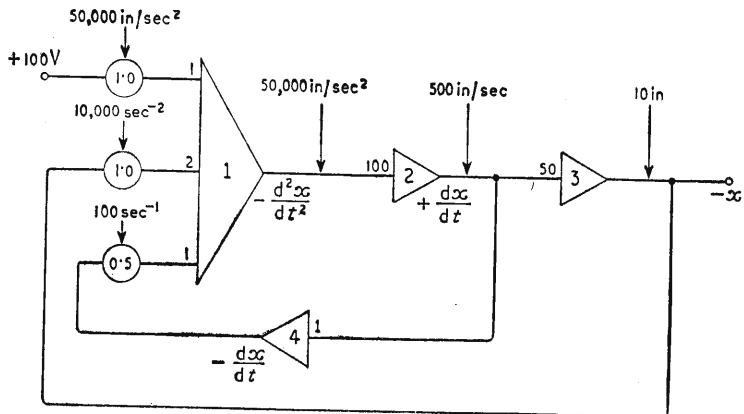

The equation is re-written in terms of the highest derivative

$$\frac{d^2x}{dt^2} = 50,000 - 50 \frac{dx}{dt} - 10,000x \dots \dots (3)$$

and assuming that we have available at some point in the circuit d^2x/dt^2 , we can integrate this twice and obtain the motion of the mass. If we feed back the output signal and its derivative and add these to a forcing function, bearing in mind the fact that all the amplifiers are phase inverting, we can obtain the second derivative of position and so complete the simulation of the problem.

The summing amplifier (shown as amplifier 1 in Fig. 9), adds the three terms on the right-hand side of the above equation, with the result that we have d^2x/dt^2 at the output of this stage. Integrating this once using amplifier 2 we are left with dx/dt , and one further integration gives us the output position x . Amplifier 4 is inserted in the circuit to reverse the phase of the signal appearing at the output of integrator 2.

The "gain" of integrator 2 can be determined from equation (2):

$$\text{Input Scale} = \text{"Gain"} \times \text{Output Scale}$$

$$\text{"Gain"} = \frac{1}{RC} = \frac{50,000}{500} = 100 \text{ sec}^{-1}$$

The "gain" of integrator 3 can also be determined as

$$\frac{500}{10} = 50 \text{ sec}^{-1}$$

Alternatively this integrator could have a "gain" of 100 and be preceded by a potentiometer with a setting of 50%, giving an overall "gain" of 50.

Amplifier 4 has unity again, hence the input and output scales are the same.

To programme summing amplifier 1 we can consider each input separately, but it should be noted that this is by no means the only way of doing this, nor is it always the best method, but it will be consistent with the method outlined above.

Velocity Feedback Term dx/dt .—If we consider the only input to amplifier 1 to be the velocity term, the input scale will be 500 in/sec, and the output scale 50,000 in/sec², and from a consideration of equation (3), we see that it is necessary to have a setting on the potentiometer of 50 sec⁻¹. If the potentiometer has a scale of 100% = 100 sec⁻¹, then the required value can be obtained by setting the potentiometer at 50%. As shown in Fig. 11, the scale at the input to the amplifier is now 50,000

in/sec², and since the output scale has the same value, then the amplifier can have unity gain.

Positional Feedback Term x .—Fig. 12 shows the input and output scales, and one possible solution of the scaling is shown in Fig. 13, which is based on a potentiometer scaling of 10,000 sec⁻², and a setting of 100% giving the amplifier input scale as 100,000 in/sec², which requires an amplifier gain of 2 to satisfy the scaling requirements. An alternative arrangement is shown in Fig. 14 with an amplifier gain of 10, and a potentiometer setting of 0.2.

Forcing Function.—From equation (3) it is seen that the forcing function is 50,000 in/sec² and if, in Fig. 15, the potentiometer is scaled at 100% = 50,000 in/sec², then a gain of unity may be used.

The final scaling of the computer in real time is shown in Fig. 16.

Time Scaling.—The integrator gain factors of 100 and 50 are larger than desired, and if the RC product of both integrators is increased tenfold, then

the process is slowed down ten times in the manner already outlined. This will give integrator "gains" of 10 and 5 respectively without altering the amplitude scaling of the problem.

The basic processes involved in scaling a computer have been outlined, and in a short introductory article of this nature it is only possible to touch the fringe of the problem. We have considered a linear problem here, and in practice it is necessary to account for non-linear properties of circuits such as saturation, backlash in gears, etc. We have only accounted for a second order equation of motion, and this is the simplest possible form of problem that a computer would be used to solve.

For further reading on these topics see:

"Electronic Analog Computers" by G. A. Korn & T. M. Korn (McGraw-Hill).

"Analog Computation" by A. S. Jackson (McGraw-Hill).

"Principles of Analog Computation" by G. W. Smith & R. C. Wood (McGraw-Hill).

AUDIO SHOW

A RECORD number of exhibitors have taken space at this year's International Audio Festival & Fair which opens at the Hotel Russell, London, on Thursday, April 26th, for four consecutive days. In the appended list of exhibitors the names of overseas participants are followed by their agent's name in parentheses. Admission to the show is by ticket obtainable free from exhibitors and audio dealers. Postal requests to *Wireless World* should include a stamped-addressed envelope. The exhibition is open daily from 11.0 to 9.0 (except on the last day, when it closes at 8.0), but admission on the opening day is reserved until 4.0 for holders of Trade Tickets which are supplied only if application is made on business notepaper.

A.K.G. (Politechna)
Acoustical Mfg. Co.
Ampex
Armstrong
B.A.S.F.
B.S.R.A.
Bang & Olufsen (Aveley Electric)
Braun (Brattel Electric)
Brennell Engineering Co.
Butoba (Denham & Morley)
Chapman Ultrasonics
Clairtone (Argelane)
Clarke & Smith Mfg. Co.
Collell
Cosmocord
Decca Record Co.
E.M.I. Electronics
Ferroglyph Co.
Fi-Cord
Field, N.S.B., & Co.
Garrard Eng. & Mfg. Co.
General Gramophone Publications
Gevaert
Goldring Mfg. Co.
Goodmans Industries
Grampian Reproducers
Grundig
Hanover Press
Hansom Books
Iliffe Electrical Publications
Jason Electronics Designs
KEF Electronics

Leak & Co.
Levers-Rich Equipment
Loewe-Opta (Highgate Acoustics)
Long Playing Record Library
Lowther Mfg. Co.
Lustraphone
M.S.S. Recording Co.
Miles Henslow Publications
Minnesota Mining & Mfg. Co.
Mordaunt Sound Reproducers
Mullard
Odhams Press
Oriole Records
Orr Industries (A. C. Farnell)
Ortofon (Metro-Sound)
Pamphonic Reproducers
Parman Electronics
Philips Electrical
Picture Story Publications
Planet Projects
Pye
Radford Electronics
Reslosound
Robuk Electrical Industries
Rogers Developments
Rola Celestion
S.M.E.
S.T.C.
Saga Records
Shure Electronics
Simon Equipment
Sony (Telux)
Soundcraft Magnetics
Stuzzi (Recording Devices)
Sugden, A. R., & Co.

Tandberg (Elstone Electronics)
Tannoy Products
Telefunken (Welmec Corp.)
Teppaz S.A. (Selecta Gramophones)
Thompson, Diamond & Butcher
Truvox
Vitavox

Vortexion
Waverley Records
Wharfedale Wireless
Wireless & Electrical Trader
Wireless World
Whiteley Electrical
Wyndor Recording Co.
Zonal Film

Commercial Literature

Latest additions to Imrak range of racking equipment includes open frames in two widths and four heights and an enclosed mobile base unit that allows a rack of maximum height, heavily loaded at the top, to be moved with safety. Leaflet from Alfred Imhof Ltd., Ashley Works, Cowley Mill Road, Uxbridge, Middlesex.

V.h.f. signal generators for field servicing of communications equipment are described in a leaflet from R.E.E. Telecommunications Ltd., Telecomm Works, Market Square, Crewkerne, Somerset. The range of four models covers bands in the range of 30Mc/s to 200Mc/s, and employs mercury batteries.

Range of measuring instruments for servicing and test bench is offered by Grundig. The instruments are capable of all measurements required in radio and television equipment testing. A catalogue may be obtained from the U.K. distributors—Wolsey Electronics Ltd., Gray Avenue, St. Mary Cray, Orpington, Kent.

"RCA Electronic Components News" carries details of new developments made by RCA, gives hints and tips on operation of equipment and devices, lists new publications concerning RCA products and gives general information. Issue 1, for instance, includes advice on the use of vidicon tubes, a description of several new bi-directional transistor types, a note on Nuistor miniature valves and a report on the application of a new image-orthicon camera tube to colour television. RCA Great Britain Ltd., Lincoln Way, Windmill Road, Sunbury-on-Thames, Middlesex (U.K. enquiries). Outside the United Kingdom, requests should be addressed to the local RCA distributors.

Scanning components for television receivers designed for both 405 and 625 lines are described in a brochure from the Plessey Co. Ltd., Components Group, Ilford, Essex.

Printed-circuit Production

THESE photographs show some of the stages in the production of printed-wiring boards at the factory of Printed Circuits Ltd. (an A.E.I. company) at Boreham Wood, Hertfordshire.

The factory is not devoted entirely to the production of printed-wiring boards, though: allied products are strain-gauge resistive elements, "printed-circuit" wave-guides and transmission-line circuits and even small springs and printed

armatures for motors. These latter, still in the experimental stage, consist of double-sided boards which are stacked and connected together by "plating through" the holes to form, for example, a 97-turn 8-pole wave-wound armature and commutator. Closely associated with Printed Circuits Ltd. are Millett, Levens (Engravers) Ltd. who produce nameplates and panels, often employing processes similar to those used for circuit boards.



◀ The first stage in the manufacture of a printed-wiring board is the photographing of the master drawing. The process camera used is large and heavy and all its components are connected rigidly together: then, to avoid any lack of sharpness due to movement, the apparatus is suspended so that it moves as a whole at the lightest touch. In this way the effects of vibration transmitted through the ground are reduced.

▶ Where many boards are required the photograph of the master drawing is reproduced up to 500 times at accurately spaced intervals by this automatically controlled step-and-repeat camera: thus every circuit produced on the sheet is identical. The cover has been removed from the bank of control relays and circuits, and a typical product of the camera is shown.

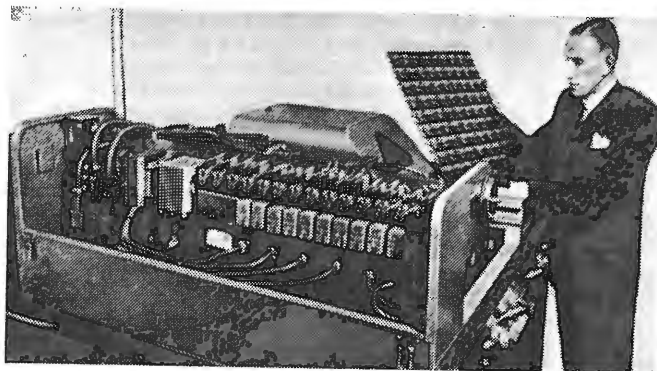

◀ Next a "zinco" or lithographic printing plate is made from the multiplied photograph and is processed in machines like these. Shown here is the "clean air" section where many extra-high-quality or small-quantity operations are carried out, such as the manufacture of strip transmission lines, micro-miniature circuits and strain gauges. The hooded machines contain rotating tables on which the work is placed: these ensure an even spread and rapid removal of the processing fluids and one larger machine (not shown in photograph) can operate on boards up to 25ft² in area.





◀ Offset lithographic printing involves the inking of the "zinc" over which a rubber roller runs, picking up the ink held in the design on the surface of the plate. This roller then transfers the ink to the copper-coated laminate in the pattern of the copper that is to remain to form the circuit conductors.

A pitch-like substance is used to protect the copper from the etchant fluid. The operators here are dusting-on the powdered pitch which adheres to the printed design. The boards then pass through infra-red ovens where the adhering material is fused to form a continuous film over the copper that is to remain.

▼

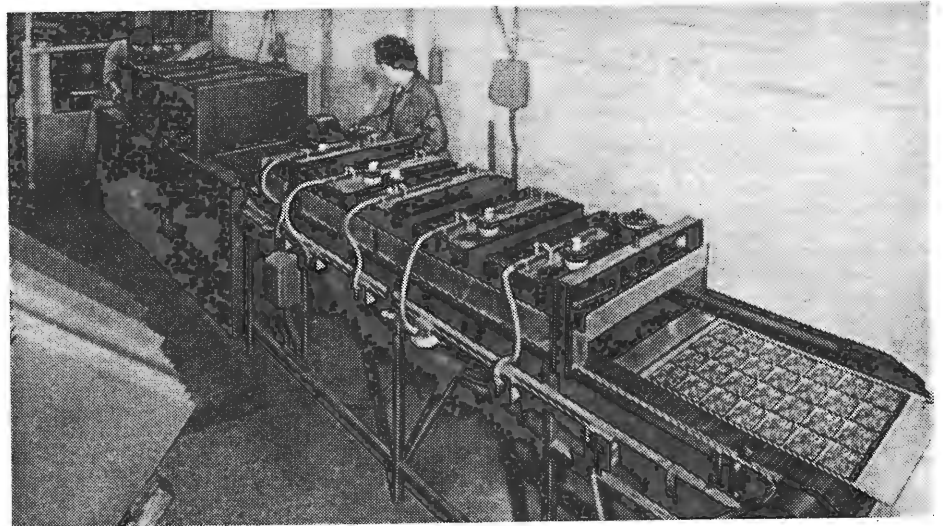

◀ In this large automatic machine the boards are carried on hangers and immersed into the various chemical baths. Every few seconds the hangers are raised (as they are seen here) and the central head rotates to bring the boards round to the next bath. Here the unwanted copper is dissolved away and the boards are washed clean.

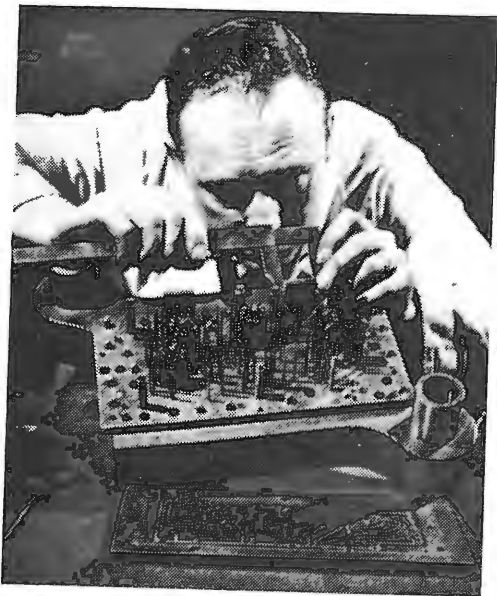

◀ Assembling a blanking and piercing tool (left). At the Printed Circuits factory these operations are carried out simultaneously and the tools used are themselves produced from the original negative to ensure exact correspondence between tool and work. The photograph below shows the blanking and piercing operation in progress.

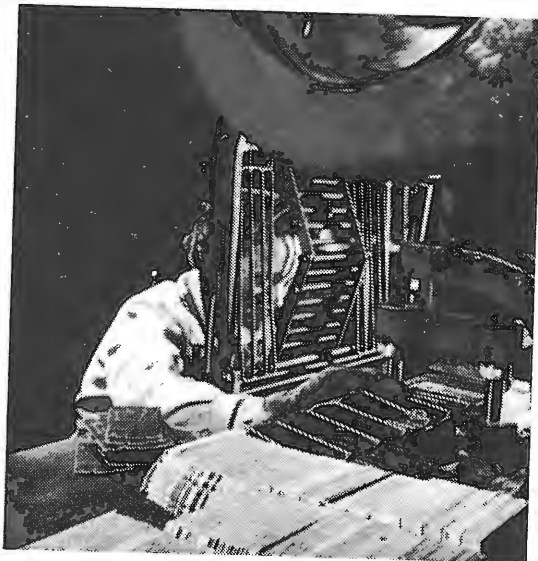

To produce a reliable high-quality product great care has to be taken at each stage in manufacture from the original planning of the board, through the making of the master drawing and its photographing and multiplying, the duration of etching and the close control of etchant-bath strengths and temperatures and the finishing stages of cutting and punching. Accidental damage could occur during any of these operations so a final close inspection is necessary (shown below). As in the servicing of printed boards, a strong transmitted light helps and the boards are seen here spread out on a brightly but evenly lit surface.

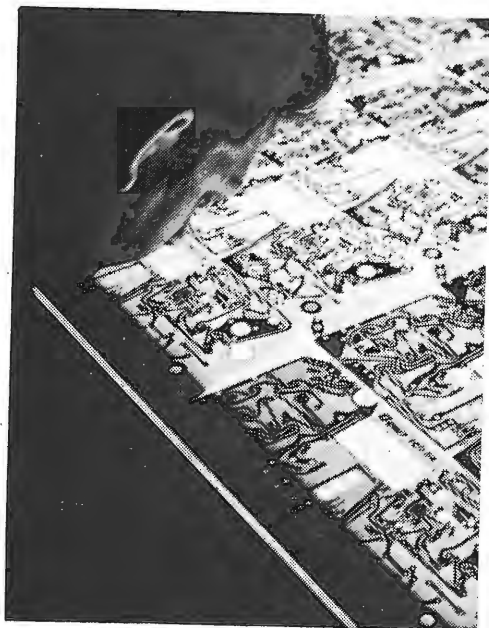

▲ The last stage in the process is the coating of the finished board with a flux or varnish preservative. This is usually done in a booth with a "curtain" of running water to carry away all spray that does not actually hit the board. Often spraying is followed by an infra-red drying phase before the boards are packed up to be sent off to the customer.

POLES AND ZEROS

By "CATHODE RAY"

MORE ABOUT TRANSFER FUNCTIONS

NOTWITHSTANDING their higher-mathematical sounding name, transfer functions (as we saw last month) are nothing more than output-input ratios in which phase as well as magnitude is taken into account. These both vary with frequency, so a transfer function is essentially a function of frequency, and (when sine waves are concerned) is usually denoted by $F(j\omega)$, in which F stands for "function of," ω is (as usual) 2π times the frequency, and the j tells us the function is "complex"; i.e., comprises phase angle as well as magnitude. So at any particular frequency its specification consists of two numbers.

In one type of specification these numbers are simply the magnitude and phase angle. They are then often written in the form $A \angle \phi$. A and ϕ are polar co-ordinates. So they can be represented graphically by a straight line, A units long, inclined at an angle ϕ to the zero position, which is conventionally "3 o'clock." Alternatively, a transfer function can be expressed in the familiar cartesian or squared-paper co-ordinates, $A \cos \phi$ being the "in-phase" or "real" or horizontal one, and $A j \sin \phi$ the "quadrature" or (as the j indicates) the "imaginary" or vertical one.

Among the many systems that have transfer functions are practically everything with an input and output—amplifiers, tone controls, filters, transformers, servomechanisms, and even factory processes. Last time we considered every possible combination of one resistance and one reactance—called first-order systems—and also of one reactance only, with voltage or current input and output. We found that one simple shape of amplitude/frequency characteristic and one shape of phase/frequency characteristic, placed in any of four positions, cover all 16 first-order systems. If last month's issue has mysteriously vanished, Fig. 1 may serve as a reminder. Each of these four positions corresponds to a transfer function containing only the terms 1 and $j\omega T$, where T is the time-constant of the system— CR or L/R .

Often several of these first-order systems occur combined, and as an example of this I have chosen the standard playback characteristic for disk records, now laid down in BS 1928:1960 to end a long era of confusion. As we have seen, there are various ways in which a transfer function can be expressed, and one form of this particular sample was given by T. M. A. Lewis on p. 121 of the March 1961 issue, preliminary to a description of a transistor amplifier providing the characteristic so specified:

$$F(j\omega) = \frac{A(1 + j\omega T_2)}{(1 + j\omega T_1)(1 + j\omega T_3)}$$

where A is the amplification at zero frequency—as can be seen by putting $\omega = 0$ throughout.

Here we obviously have three of the simple first-order transfer functions multiplied together, which means that signals are subjected to the effects of all

three. One of them, having the form $1 + j\omega T$, is type 4 (Fig. 1), and the other two, $1/(1 + j\omega T)$, are type 2. The standard time-constants for long-playing records are: $T_1 = 3,180 \mu\text{sec}$, $T_2 = 318 \mu\text{sec}$, $T_3 = 75 \mu\text{sec}$. The first two numbers look a little odd; they were chosen so that when multiplied by 2π the results are round numbers: 20,000 and 2,000. The turning frequencies—those that make $\omega T = 1$ —are 10^6 divided by these numbers, so are 50 c/s and 500 c/s. The $75 \mu\text{sec}$, presumably chosen to be the same as for f.m. de-emphasis, gives 2,120 c/s as the third turning frequency.

To draw the graphs of gain and phase against frequency (Fig. 2) just use the simple rules given last month for each of these three turning frequencies, and combine them by adding. For both these purposes it is necessary to use a logarithmic scale of frequency—normal practice anyway—and also for gain—which again is normally achieved by reckoning it in dB. Phase angles are additive, so for them a linear scale is correct. Fig. 2 is an example of what is sometimes called the Bode diagram.

From 50 c/s to 500 c/s the linear approximation is a 6 dB-per-octave downward slope. Incidentally, if you have made the dB scale so that 6 dB on it occupies the same distance as a 2:1 frequency ratio you can draw these slopes with a 45° set-square. From 500 c/s onwards the downward slope still applies but is exactly cancelled out by the upward (type 4) slope that begins there. So the resultant is a horizontal section. This ends at

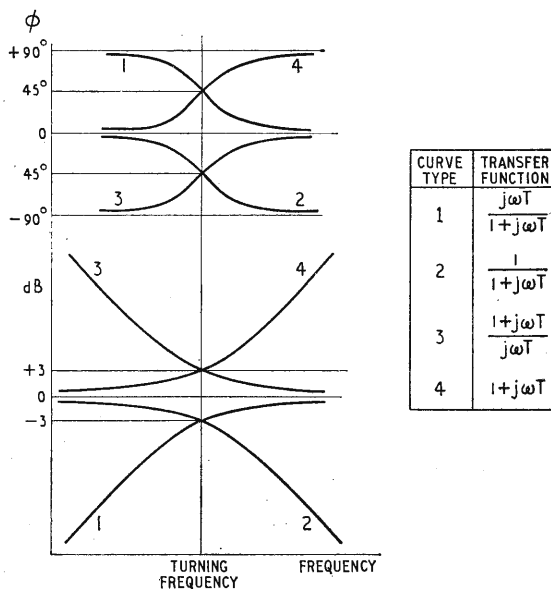

Fig. 1. All systems comprising one resistance and one reactance, with an input and output, voltage and/or current, have transfer functions in this list of four, with characteristic curves as shown.

2,120 c/s, the second type-2 turning frequency. It is so near 500 c/s that when the 3 dB and 1 dB points are plotted those at and near 1,000 c/s are on opposite sides of the line. The curve must therefore be drawn to pass midway between them, as shown.

All this need take only a couple of minutes, and the result is practically as good as (and more likely to be correct than) a curve drawn from points obtained by the very tedious straightforward computation of the whole transfer function. (Try it and see!)

The obvious but inadvisable method of obtaining the composite phase-angle curve is to draw the individual type 2 and type 4 curves and add their ordinates. It is easier (and uses half the space) to draw the negative of the type 4, which is the same as a type 2, and then to add the difference between the curves for T_2 and T_3 (picked out by dividers) to the one for T_1 . This difference is greatest around 1,000 c/s and causes the hump in the resultant curve.

The performance represented by Fig. 2, need one say, is obtained by combining one type-4 resistance/reactance pair with two type-2. And that is where the difficulties begin. The pairs can't just be connected in cascade, as in Fig. 3 for example, because each is supposed to work from and into infinite or zero impedance. In practice one

can allow impedances that are respectively much larger or much smaller than the impedance of the transfer circuit itself. But working into or from another transfer circuit generally won't do. One solution is to use suitably arranged valves or transistors between each. Some are needed anyway to amplify the gramophone signals. But not usually as many as four.

So this is the cue to introduce the slightly more complicated system shown in Fig. 4. It is easy to work out its transfer function:

$$F(j\omega) = \frac{V_0}{V_1} = \frac{1}{j\omega C + R_2} \cdot \frac{1}{j\omega C + R_1 + R_2} = \frac{1 + j\omega CR_2}{1 + j\omega C(R_1 + R_2)} = \frac{1 + j\omega T_2}{1 + j\omega T_1}$$

where $T_1 = C(R_1 + R_2)$ and $T_2 = CR_2$. The third time constant can be brought in with an independent simple type-2 circuit. This, in fact, is basically what T. M. A. Lewis did in his amplifier already mentioned, though he used a counterpart of Fig. 4 in a negative feedback connection. His type 2 was in the output circuit of the amplifier.

Measurements showed the whole thing worked extremely well. Please don't ask me to tabulate every possible combination of one reactance and two resistances; try Heinz. The 16 varieties with one reactance and one resistance were enough of an effort. Suffice to say that Fig. 4 is one of many possible examples of what is known as a step circuit, for a reason that is clear if one looks at the straight-line approximation to its amplitude/frequency characteristic—Fig. 2 below 2,120 c/s. The limited phase shift is one reason for its use in negative feedback amplifiers, as I explained in my treatise on the use of the Nyquist diagram in the January, 1956, issue. In this connection it is worth noting that if the two curves of the Fig. 2 type are arranged on the paper so that the -180° level for one coincides with the 0 dB level for the other, this common level corresponds with the critical point in the Nyquist criterion for instability. The vertical distance below it of the gain curve at the point where the phase curve cuts it (if it does) is the gain margin of stability. And the vertical distance above it of the phase curve at the point where the gain curve cuts it (if it does) is the phase margin of stability. So there is no need to

(Continued on page 227)

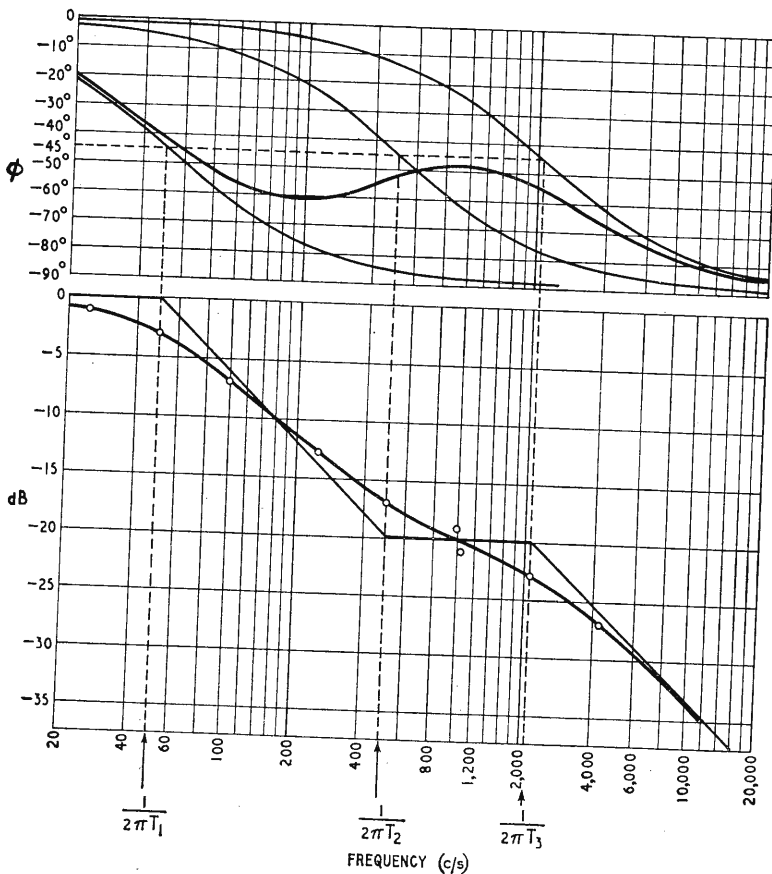

Fig. 2. Characteristic curves (Bode diagram) for standard fine-groove disk playback equalizer, drawn from inspection of the transfer function. The straight lines are the "skeleton," giving a first approximation to the curves.

"Belling-Lee"

'SCREENECTOR'

A range of lightweight
screened connectors
having 1, 2 or 3 poles

PLUGS and SOCKETS*

These versatile connectors for low and medium frequencies are typical examples of the wide variety of screened plugs and sockets made by "Belling-Lee" for coupling signal carrying cables to communications equipment, instruments, etc. Other types range from sub-miniature co-axials, for cable of $\frac{1}{8}$ " overall diameter, to heavy duty multi-connectors for 25-way cables, and cover frequencies from zero up to 2,000 Mc/s or higher.

Cable size: Up 0.24" overall

Capacitance: Less than 3 pF

Insulation resistance: Greater than 6×10^4 megohms

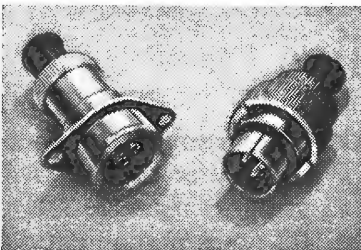
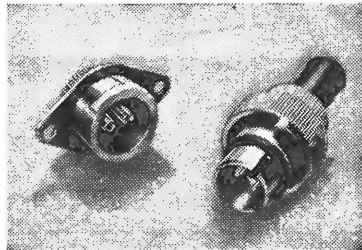
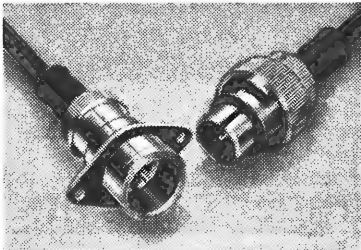

L.788 Coaxial

L.789 2-pole

L.790 3-pole

Suffices: FP (free plug)

CS (fixed socket)

BS (bulkhead socket)

FS (free socket)

Most "Belling-Lee" products are covered by patents or registered designs or applications.

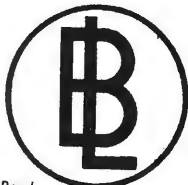

Regd.

BELLING & LEE LTD
GREAT CAMBRIDGE RD., ENFIELD, MIDDX., ENGLAND

Telephone: Enfield 5393 • Telegrams: Radiobel, Enfield

TERMINALS • PLUGS AND SOCKETS* • GLASS SEALS
CIRCUIT PROTECTION DEVICES
INTERFERENCE FILTERS • RECEIVING AERIALS
"PRESTINCERT" COMPONENTS

"BELLING-LEE" NOTES

No. 40 of a series.

Circuit Breakers

In earlier notes we have dealt, at some length, with the subject of fusing. Now let us look at another type of circuit protection device, the Circuit Breaker. The fundamental difference between the two is that a fuse is partially destroyed when it operates, and has to be serviced by replacing the element or fuse-link, whereas the circuit breaker is a switch incorporating protective characteristics; it can be re-set by means of a button or lever, and may even re-set itself after an appropriate interval, if desired. Fuses are made in a range of ratings, from a fraction of a milli-amp to several hundreds of amperes, but circuit breakers deal with currents from a few tens of milli-amperes to thousands of amperes. We are concerned here with those covering the lower part of the range up to, say, about 20 amp.

A circuit breaker coming even in this limited range is necessarily a more expensive device than a fuse, and by the latter we mean a fuse-link and its holder. However, the convenience of being able to re-set it gives the circuit breaker an obvious advantage in circuits which are liable to fairly frequent faults, or transient overloads. Furthermore, it must be borne in mind that a circuit breaker can also perform the duties of an ordinary switch, which are to open and close a circuit for normal operation and, in addition, it gives a visual indication of its state, i.e. whether the circuit is made or broken, according to the position of the operating handle.

Certain types of circuit breaker possess a functional characteristic, which no fuse can emulate without serious loss of protective efficiency, namely, the ability to withstand relatively slow surges such as occur in starting a motor. With all these features, which are combined in a single, compact unit, the circuit breaker has obvious attractions for equipment designers, and its cost is not uneconomical. As a further refinement, auxiliary contacts can be provided for controlling remote signalling and warning devices, or to operate stand-by equipment.

Ideally, a circuit breaker should be "trip free," which means that one should not be able to re-set it by holding the handle while the fault persists, but not all circuit breakers are perfect in this respect.

(To be continued.)

Advertisement of

BELLING & LEE LTD.

Great Cambridge Rd., Enfield, Middx.

ACOS ADVANCE |

styli ✱

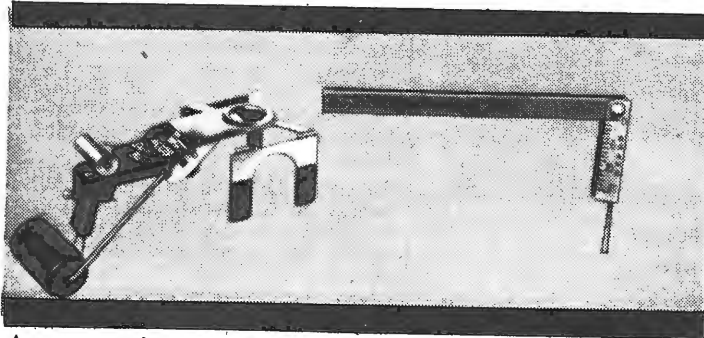
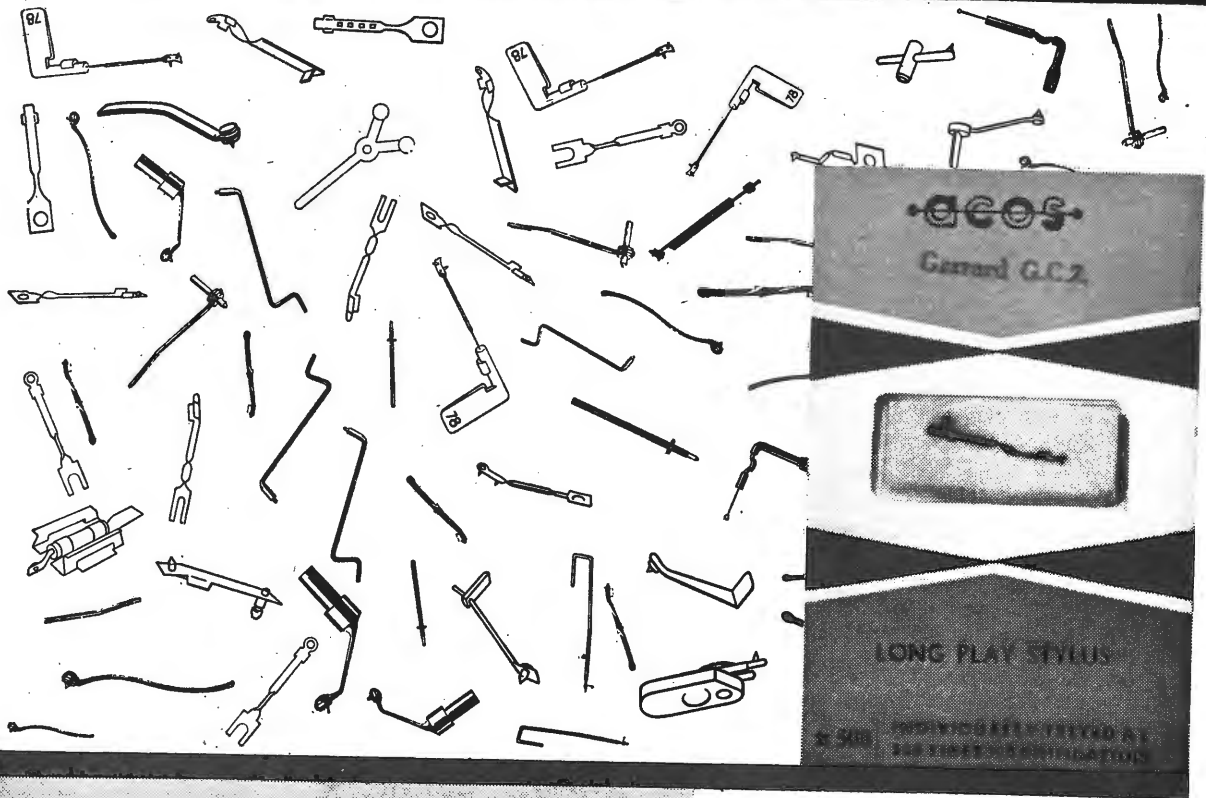

✱
 & changer dust bug
 & stylus pressure
 gauge

Acos continue to advance and be recognised. Recognised as the finest range of replacement styli now available. Diamond and sapphire, mono and stereo, there are now over 150 types of Acos x500 styli, to fit all makes of pick-ups and cartridges. There is one to fit *your* equipment. All Acos x500 styli are individually tested at 500-times magnification, yet they cost no more than other makes. Look for Acos styli in the characteristic pack. *Accessories after the fact:* Don't overlook the Acos Changer Dust Bug that sweeps all before it, and the Acos Stylus Pressure Gauge which stops pick-ups from throwing their weight about.

Other Acos products: mono and stereo pick-ups, cartridges, microphones.

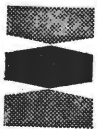

• **acos** •

ARE DOING THINGS IN STYLI

SEE US AT THE AUDIO FAIR, STAND No. 64, DEMONSTRATION ROOM No. 302

COSMOCORD LTD, WALTHAM CROSS, HERTS. TEL: WALTHAM CROSS 27331

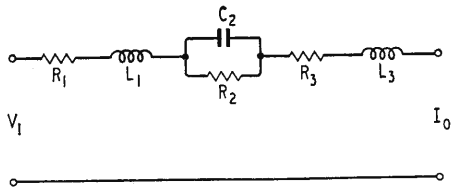

Fig. 3. This way of lumping together three elementary systems would not give a result equal to the product of their separate functions, because the systems would be incorrectly terminated.

draw a Nyquist diagram to find these quantities.

For the fun of it I tried extending the same principle as in Fig. 4 to include all three time constants in one potential divider, shown in Fig. 5. The working-out, in case anyone is interested, appears as an appendix. A practical snag about this circuit is the inductor. Being of the order of henries, it is relatively expensive and liable to pick up hum. A minor comfort is that one doesn't have to keep its resistance low, for that can be anything up to and including R_1 . And the circuit is relatively easy to calculate, all the components being in series.

As many as three alternative three-in-one networks using two resistors and two capacitors were shown by W. H. Livy in the January, 1957, issue, p. 29. These are easier to provide in practice, but the formulæ are a little less simple.

The transfer function for any of these, or for Fig. 5, has two $1 + j\omega T$ factors in the denominator, so squared terms are involved and the description "second-order" applies to it and the corresponding network.

And so one could go on, if necessary into higher orders, with at each step a vast extension in the variety of system and the area of paper and length of time occupied in computation by the straightforward complex algebra we have been using. So several more advanced mathematical techniques have been developed to shorten the work. We begin to see, then, that although transfer functions are basically simple there can be quite a lot to learn about them; hence the expensive books thereon.

The method of poles and zeros has become standard study in America at a fairly early stage in communications, but I have never seen it mentioned in *Wireless World*. So I shall have to be very introductory.

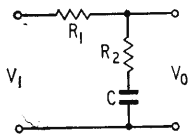

Left: Fig. 4. Example of a step circuit, equivalent to two elementary systems.

Right: Fig. 5. This second-order system is equivalent to three elementary systems, and can be designed to yield the Fig. 2 curves at one go.

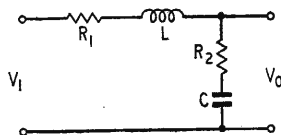
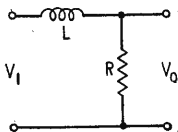

Left: Fig. 6. Example of an elementary first-order system for pole-zero practice.

We have become used to seeing transfer functions with numerator or denominator, or both, made up of factors of the form $(1 + j\omega T)$. The variable quantity is $\omega (= 2\pi f)$ and T is a measure of the component values. If ω is made equal to j/T (or $f = j/2\pi T$), then $j\omega T = j^2 = -1$, and the factor is zero. So if the factor is in the numerator the whole transfer function is equal to zero. If on the other hand it is in the denominator the transfer function goes to infinity.

"So what?" you may say. Imaginary frequency (as denoted by the j) is nonsense, so these situations can never arise and the whole exercise is pointless.

Not quite. The foregoing is a device for constructing a type of diagram that is helpful in the study of networks. It is closely related to what is known as the Argand diagram, which we used last month

Right: Fig. 7. Argand diagram relating to Fig. 6.

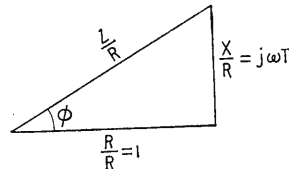
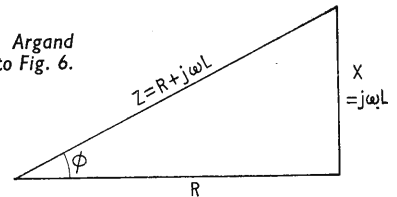

Left: Fig. 8. [Same as Fig. 7 but reduced in scale by dividing all the sides by R .]

for our approach to transfer functions. The relationship will probably be easier to follow if we take a simple example, Fig. 6. Fig. 7 is its Argand diagram for impedance. The value of R is measured along the positive "real" axis, and the reactance of L is measured along the positive "imaginary" axis. (Capacitive reactance is measured along the negative imaginary axis.) The impedance, Z , of the two in series is represented in magnitude by the length of the sloping line, and in phase by its angle of slope, ϕ . It is, of course, the vectorial sum of R and $j\omega L$. The transfer function is

$$F(j\omega) = \frac{V_0}{V_1} = \frac{R}{Z}$$

Substituting $R + j\omega L$ for Z gives us $F(j\omega) = \frac{1}{1 + j\omega T}$, the standard form, as in Fig. 1. R and Z must be reckoned vectorially, to give us the complete transfer function—magnitude and angle.

The magnitude alone, denoted by $|F(j\omega)|$, is the ratio of the magnitudes of R and Z , represented by the lengths of two sides of the triangle.

X is the variable quantity, directly proportional to frequency, f . One can visualize the length of the vertical line increasing from nothing (at zero frequency) and the resulting changes in the reciprocal length and angle of the Z line, which we represented by the type 2 curves in Fig. 1.

The transfer function, being the ratio of two sides of this triangle, is quite unaffected by altering the scale of the diagram. So we are in order in dividing

all the sides by R, giving Fig. 8. This brings the length of the R line to 1, so that $F(j\omega)$ is simply the reciprocal of the length of the sloping line.

In these Argand diagrams, "real" values of ω are measured upwards, because they are prefixed by a j . Now note what would happen if (without bothering to consider whether it makes physical sense) we put $\omega = j/T$, as suggested earlier. This brings in a second j , rotating the direction another quarter-turn anticlockwise. An alternative way of looking at it is to multiply the two j s, making -1 ; either way it means that ω must be measured along the negative real axis; i.e., to the left. And as its magnitude is 1, its length coincides with the horizontal side of the triangle, and the sloping line collapses to nothing, making $Z/R=0$ and R/Z infinity, as predicted.

This seems a fantastic way of approaching the Argand diagram, which in our simplicity we have been using happily from the start without any of this crazy mathematical philosophy. But if we alter the scale of our triangle once more, as in Fig. 9, some method begins to be discernible in the madness. Here we have divided all round by $2\pi T$ as well as by R, with the result that the vertical axis is now definitely a scale of frequency, not depending (as in Figs. 7 and 8) on any particular circuit values. This removes the advantage of Fig. 8, that the reciprocal of the length of the sloping line (to scale) alone gives the magnitude of the transfer function. In Fig. 9 we must revert to taking the ratio of the two lines— $1/2\pi T$ to $Z/R2\pi T$. We can, if we like, regard $1/2\pi T$ as a scale factor that has to be brought in. To make this scale factor stand out clearly we can write the transfer function in this form:

$$\frac{1}{2\pi T} \cdot \frac{1}{\frac{1}{2\pi T} + jf}$$

If we were concerned only with systems as simple as our example, Fig. 6, we would obviously have made an indifferent bargain in exchanging Fig. 8 for Fig. 9. The reward comes with more complicated systems. Take our gramophone equalizer, for example. It has three time constants, so there will be three corresponding points where $f=j/2\pi T$. One of them, T_3 , gives a zero value of the transfer function, and this point is called a zero and marked O. The others, T_1 and T_2 , give infinite values, as in our simple example, and are called poles and marked X (Fig. 10).

We now see the advantage of using a frequency scale, for it is common to all three—and to as many others as a still more complicated system might require.

Fig. 10 has been drawn for one particular value of frequency, f_1 . As the frequency varies, all three slopes vary accordingly, those starting from poles giving reciprocal measures of the corresponding component transfer functions of the system, and the

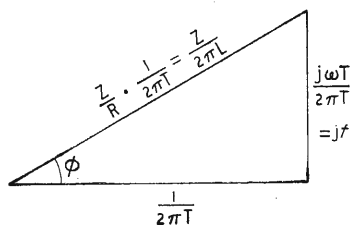
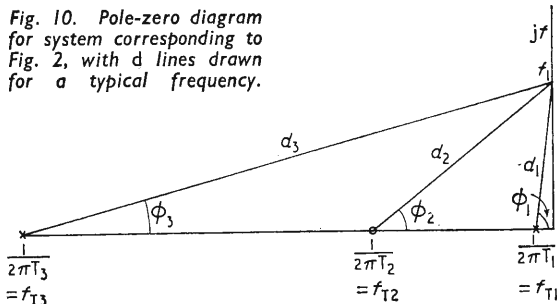

Fig. 9. Same as Fig. 8, multiplied by $1/2\pi T$.

Fig. 10. Pole-zero diagram for system corresponding to Fig. 2, with d lines drawn for a typical frequency.



one starting from a zero giving a direct measure of its transfer function. $1/2\pi T_1$ is of course 50, $1/2\pi T_2$ is 500, and $1/2\pi T_3$ is 2,120, those being the turning frequencies of the system.

If we remember that the function for the system as a whole is obtained by multiplying the magnitudes of the separate ones, and adding their phase angles, we can make general rules for using a pole-zero diagram for this purpose:

(1) The magnitude of the overall transfer function is obtained by multiplying together the distances of all zeros from the point representing the selected value of frequency, and the reciprocals of the distances of all poles, each distance having been divided by the appropriate $1/2\pi T$.

For instance, in Fig. 10, at the frequency for which the lines are drawn,

$$|F(j\omega)| = \frac{d_2}{d_1 d_3} \cdot \frac{2\pi T_2}{2\pi T_1 \cdot 2\pi T_3} = \frac{d_2}{d_1 d_3} \cdot \frac{f_{T1} f_{T3}}{f_{T2}}$$

The $f_{T1} f_{T3}/f_{T2}$ is of course a constant, the same for all signal frequencies, so only needs to be computed once for any circuit.

(2) The phase angle of the overall transfer function is obtained by adding together all the separate phase angles, those at zeros being reckoned positive and those at poles negative.

So in Fig. 10

$$\phi = \phi_2 - \phi_1 - \phi_3$$

Fig. 10 is a pole-zero diagram to which d lines have been added to apply it to a particular frequency, represented by the typical point marked f_1 on the jf scale, from which they radiate. The pole-zero diagram itself includes only the axes and the O and X points. From what has gone before you might easily assume that these points must all lie on the "negative real" axis. Certainly they do for all systems of the types we have been considering. But complex frequency has physical meaning and the poles and zeros can appear almost anywhere. Fig. 11 is an example.

But let's not be led away by complexities of this sort before we have seen how our more familiar Fig. 10 works. If we start from zero frequency, we see that all the angles begin to increase from zero, but the rate they do so is inversely proportional to the distance of the poles or zeros from the origin. So ϕ_1 increases comparatively fast, ϕ_2 only one tenth the rate (on a diagram drawn to scale), and ϕ_3 at less than one fortieth. Similarly d_1 begins to lengthen much faster than d_2 and d_3 . In other words, at frequencies up to and somewhat beyond f_{T1} the whole system behaves almost as if it were a simple type-2 circuit.

As can easily be proved, each angle varies fastest at its turning frequency, and likewise the ratios of the

sides. So at 500 c/s the type-4 part of the system is the major influence, overhauling the negative phase angle ϕ_1 , which is now growing comparatively slowly, and reducing the rate at which the "gain" is falling off. At still higher frequencies, around 2,000 c/s, the second type 2 comes into its own, speeding up the fall-off and phase lag again.

But we see that the total phase shift can't exceed -90° however high the frequency goes; in fact, it can't quite reach it. By that time all three d lines are practically equal in length, so d_2 cancels out d_1 and d_3 is increasing linearly, indicating an inverse linear fall-off in gain (at 6 dB per octave, as we know).

With a little practice one can quickly visualize the performance of a system from its pole-zero diagram. It is easily seen that a pole and a zero tend to cancel one another out as they come closer together on the diagram. And several poles (or zeros) close together indicate a very rapid rate of fall-off (or growth) in gain and increase in phase shift at frequencies about equal to their distance from the jf axis.

A further stage of progress in the art is to draw a pole-zero diagram to represent the performance you want, and then use it to work back to the network that will give it.

Still heeding the warning against trying to run before learning to walk, however, we make quite sure we know how to deal with a simple type 1 or type 3 circuit. Fig. 12 is a type-1 example, which incidentally we studied last month. If we take its transfer function in the form

$$\frac{1}{1 + \frac{1}{j\omega T}} \dots \dots \dots (1)$$

we will be disconcerted to find that the condition for making the denominator zero (and thereby establishing a pole) is the same as for

$$\frac{1}{1 + j\omega T} \dots \dots \dots (2)$$

which is a type-2 circuit. This is because $1/-1 = -1$. Yet type 2 has an exactly opposite performance, frequencywise. The explanation of this paradox is that (1) has a zero too, the condition being $f = 0$. When that is substituted, the denominator goes to infinity. Alternatively, you can multiply (1) above and below by $j\omega T$ to obtain the form I preferred:

$$\frac{j\omega T}{1 + j\omega T} \dots \dots \dots (1a)$$

To make the next step inescapably clear, I'll write this

$$\frac{0 + j\omega T}{1 + j\omega T} \dots \dots \dots (1b)$$

So besides the pole at $j/2\pi T$ there must be a zero at $f = 0$. The complete pole-zero diagram is therefore Fig. 13, and is in accordance with known fact by making the gain zero at zero frequency.

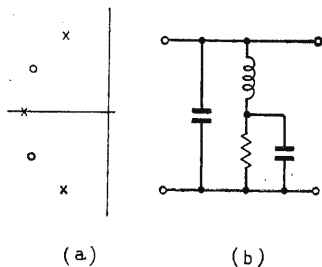
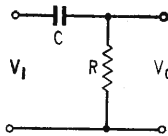
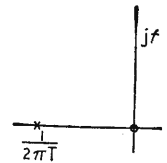

Fig. 11. Example of a more involved pole-zero diagram (a), and the system to which it refers, (b).



Left: Fig. 12. Our original elementary system once more, for re-examination in the light of the pole-zero technique.

Right: Fig. 13. Pole-zero diagram for the Fig. 12 system. Because the transfer function is a simple ratio between the distances to zero and pole, scale factors ($1/2\pi T$) cancel out, so do not come into the calculation.



The same line of reasoning will establish that the type 3 function is distinguished from type 4 by a pole at the origin.

If you have a sense of symmetry you will be crying out that it isn't fair. Types 1 and 3 have been handed out a pole and a zero each, while the even numbers have had only a pole and a zero between them.

Well; let's see what we can do for them. The type-4 function, $1 + j\omega T$, doesn't seem to have much room for hiding a pole besides its obvious zero ($f = j/2\pi T$). But it does go to infinity if $f = \pm j\infty$, so that is a sort of pole. No wonder we couldn't see this pole, right at the back of beyond and therefore equally far to the east as to the west. The same goes for the far-flung zero in the type 2 empire. At that distance, the corresponding ϕ never starts to grow, and d —being infinitely long at the start—has no scope for growth either, so these infinite poles and zeros are of no more concern to us than a tax collector situated in an extra-galactic nebula. Still, symmetry is satisfied, all types now have a pigeon pair each, and no further complaints will be entertained.

APPENDIX

Derivation of time constants, T_1 , T_2 and T_3 , to fit the system shown in Fig. 5 to the transfer function

$$\frac{V_0}{V_1} = \frac{1 + j\omega T_2}{(1 + j\omega T_1)(1 + j\omega T_3)} \dots \dots \dots (1)$$

According to the circuit this must be equal to

$$\frac{1}{\frac{1}{j\omega C} + R_2} \dots \dots \dots (2)$$

The resemblance can be made more obvious by multiplying (2) by $j\omega C$:

$$\frac{1 + j\omega CR_2}{1 + j\omega C(R_1 + R_2) + j^2\omega^2 LC}$$

This compares with (1) multiplied out:

$$\frac{1 + j\omega T_2}{1 + j\omega(T_1 + T_3) + j^2\omega^2 T_1 T_3}$$

$$\text{So } \begin{aligned} T_2 &= CR_2 \\ T_1 + T_3 &= C(R_1 + R_2) \\ T_1 T_3 &= LC \end{aligned}$$

Solving the last two simultaneous equations gives:

$$\begin{aligned} T_3 &= \frac{C(R_1 + R_2)}{2} \pm \sqrt{[C(R_1 + R_2)/2]^2 - LC} \\ T_1 &= \frac{LC}{T_3} \end{aligned}$$

So if one were given the time constants one would choose suitable values of C and R_2 to make $CR_2 = T_2$ and at the same time make their impedance about right

for the circuit. Then $L = \frac{T_1 T_3}{C}$ and $R_1 = \frac{T_1 + T_3}{C} - R_2$

LETTERS TO THE EDITOR

The Editor does not necessarily endorse opinions expressed by his correspondents

Transistor Circuit Diagrams

DISCUSSION on any aspect of circuit delineation invariably generates interest and argument because:—

(a) the majority who draw circuit diagrams consider themselves expert,

(b) professional draughtsmen produce so many bad examples,

(c) the existing rules concerning good circuit delineation are confused and incomplete.

The current problem is illustrative and should be resolved within the drawing office. It is proposed by some that the responsibility for diagrammatic layout should rest with the designer or author—which could be an answer—but plain economics will prevent its general acceptance. The practice of drawing in drawing offices is here to stay.

The fact that the electrical industry is badly served by its drawing offices is a result of a preponderant mechanical influence. "Engineering Drawing Practice," BS.308, is devoted entirely to mechanical engineering, there is no electrical engineering counterpart; and the number of circuit diagrams apparently drawn in "Third Angle Projection" are legion. However, since the advent of the transistor, a general improvement in circuit presentation is noticeable; a direct result of it being a (temporary?) simplifying factor. Symbolically it's as though all valves have changed into "heaterless" triodes; but future development in this field may reintroduce familiar complications.

To formulate conclusions affecting comprehensive diagrammatic layout, which become progressively more difficult to apply with increased size and complication, is impracticable. Having first decided on an optimum size, the constituents of a good circuit diagram should be analysed; and if the conclusions are to be of practical use, they should take the form of simple drawing instructions, e.g.:

1. Connections should be short and straight.
2. Unnecessary crossovers and corners to be eliminated.
3. D.c. paths between supply lines to be vertical and straight.
4. Sequence of events to be from left to right, with power an exception.
5. Supply lines in descending order of potential.

Exceptions to No. 5 introduce complications which are manifest in diagrams of optimum size containing negative and positive active components.

Observance of these rules causes circuit diagrams to be good and one of the effects of their observance is the automatic resolution of the various circuit patterns or forms, which is the premise upon which most of your correspondents base their arguments.

It is preferable that forms be regarded as a perquisite of clear illustration, than as the basis of an argument.

The "negative up" school are obeying a kind of Lenz's Law which, when change takes an imperative form, affects us all. They should heed the philosopher who said, "Be not so bigoted to custom, as to worship it at the expense of truth."

The accompanying redraft of Fig. 2, page 102, March issue, challenges one of these customs. Your diagram is uneconomical with line and illustrates two forms by connection, instead of by function. There is no electrical significance in the words "ring" and "bridge" here, so why introduce unnecessary corners and crossovers to illustrate them.

Fig. 4 of the same issue is drawn with the economy of line natural to this type of diagram, resulting in a clarity of purpose which possible inversion would not affect.

London, S.E.9.

W. W. MARTIN.

THE transistor and its representation is merely one aspect of a problem of general circuit standardization.

I am probably more qualified to judge relay circuits where there are three main drawing conventions:—

(a) The British Standard and Post Office method where contacts appear anywhere on the diagram but coils are generally combined.

(b) A Continental system where both contacts and coils may be separated but found on lines running either across or from top to bottom of the diagram.

(c) A system in which coils and contacts are drawn with strict regard to their physical positions and tags.

Each of these systems has its own particular advantages and disadvantages. For instance, the British system must be somebody's pride and joy with a comparative absence of straight lines, but relay engineers spend literally years of their working lives searching for lost contact units on complicated diagrams. By custom this very serious shortcoming is accepted as a matter of course.

The point is that each system represents a "language" clearly understood by the respective "Nationals" but which requires translating and redrawing to be understood properly by those steeped in other systems. At

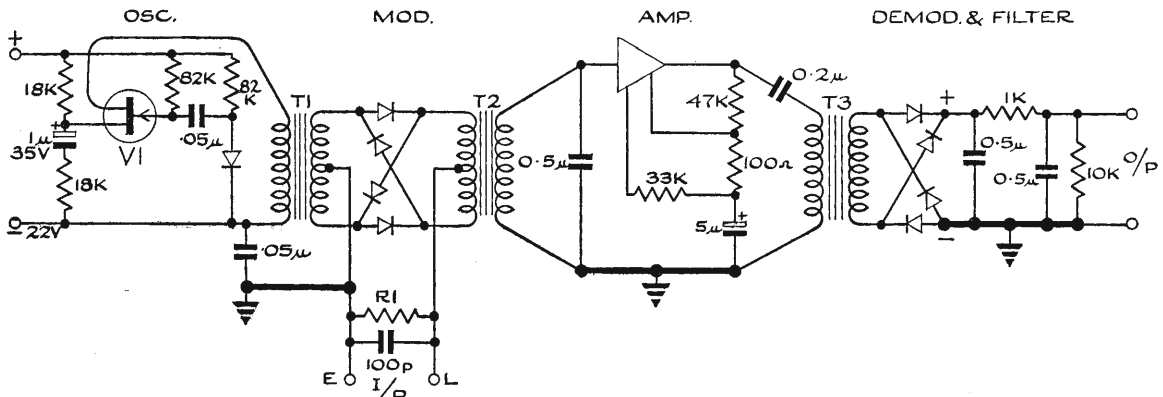

this stage transistor symbols are by comparison merely dialects and everything possible should be done to unify conventions before it is too late.

The British Standards Institution, backed, no doubt, by many powerful organizations, are still insular in many respects and as a Dutchman said to me recently, "British Standards may be British but they're nobody else's."

It is the export trade which suffers; an engineer who uses a British diagram one minute and a German or Japanese the next will always curse the minority which is different.

Standardization is the important thing and minor advantages of things like collectors up or down are insignificant if they are always drawn the same way.

Common Market or not, we British must lift our sights much higher yet and press by all means in our power for international standardization.

What better organization is there than the C.C.I.R. whose existing committees could do the job given a little more goodwill?

Beeston, Notts.

C. E. SEFTON.

ANYONE working on circuit design and maintenance will have been interested in the articles and correspondence concerning transistor circuitry and symbols in the last few issues of *Wireless World*. How many, I wonder, have shared a tendency which I have experienced of being pretty well convinced by one argument until reading the next? On careful reflection, however, I think that the "positive-up" school together with the transistor symbol favoured by Baxandall have the day.

Of course, it would be most satisfactory if the whole argument could be settled once and for all. But I think this is rather doubtful, since even in the comparatively resolved case of valve circuitry, American and Continental conventions differ from our own, and we have nowadays to take increasing notice of their views. Further, the subject overflows the borders of the art of circuit design pure and simple and I feel that the complex matter of individual personality affects each decision. One remembers that some people loathe the eccentricities of grammar and syntax, displayed by languages, whilst others delight in the diversity of interest which these complications introduce. It is obvious from the differing opinions expressed by many highly qualified engineers that every one of them is going to be disappointed in some particular respect whichever system is finally standardized. We must rely on the engineer's enthusiasm and insight to accept the final convention with its weaknesses with the wholeheartedness that the linguist displays in tolerance of and delight in irregular verbs.

Hillingdon, Middlesex.

G. J. POPE.

"Meters and Senses"

I HAVE been reading with considerable interest the article by "Cathode Ray" on "Meters and Senses," in your March issue.

I quite agree about the vagaries of the human ear and the apparent change of pitch with loudness, although I think that the trombonist would adjust his slide so that a low frequency note played loudly would appear to be in tune, both to him and Sir Malcom.

It is, of course, well known that room temperature also affects pitch and the rate of attenuation related to frequency and distance, but I wonder if "Cathode Ray" has also noticed that ambient temperature also seems to affect timbre or tone quality of various instruments? When listening to an orchestra, say in Carnegie Hall, New York, which is heated to 70°F. before the audience arrives and quickly goes up to 80°F., the strings usually seem to me to sound smooth and silky but the brass sounds rather strident. On the other hand, in the average British concert hall, which would be 15° F cooler, the brass is generally smoother but the strings are not quite so pleasant to the ear, after making or trying

to make due allowance for the acoustics of the hall.

Similar differences can sometimes be heard (or imagined!) between American and British recordings, and Leon Goossens once told me that he finds it difficult to produce a good oboe tone if the room temperature is not reasonable.

I have never seen any technical explanation of tone quality related to thermometers and I wonder if "Cathode Ray" or recording engineers could ventilate the subject? I find it hard to believe that our brass players are better than American blowers, or that their string players are superior *in toto* to ours.

Idle, Bradford.

G. A. BRIGGS,

Wharfedale Wireless Works, Ltd.

HAVING been concerned for many years with the design of electronic musical instruments for the music industry I can thoroughly endorse everything "Cathode Ray" says in his excellent article (March issue) on "Meters and Senses." In this particular field the final judgment on any design must always be a subjective one, and due account has to be taken of some of the more obscure subjective effects that defeat scientific analysis. But there is one particular aspect of this subject that I have frequently encountered that "Cathode Ray" doesn't mention. It is this.

In the analysis of a complex sound very rich in harmonics, it is sometimes necessary to suppress the fundamental in order to determine the harmonic structure. If this fundamental is completely eliminated then what was previously the 2nd harmonic becomes the new fundamental and the pitch then appears to have gone up an octave, which, of course, is what one would expect as one instinctively selects the lowest frequency as being the fundamental. This, of course, is obvious, but a peculiar effect occurs if the original fundamental is very slowly reduced to zero. I find that it is almost impossible to say at what point in the reduction of the fundamental the pitch appears to go up an octave. In fact when I have demonstrated this effect some observers insist that the pitch does not rise to an octave above at all, although when the fundamental is suddenly removed they all agree that it does so. I have found that this effect is somewhat dependent upon the phase relationship between the fundamental and the harmonics. The so called Ohm's auditory law stated that the ear tends to analyse complex sounds irrespective of phase relationship but Olson, Stevens and Davis and many others maintain that at certain threshold levels this is not so, and there may be a clue here as to the cause of this effect.

All this does appear to suggest that when the waveform has a rich harmonic structure and the harmonics are much stronger than the fundamental the note will appear to some people to be an octave above the true fundamental frequency.

This has been confirmed by tests I have carried out with musicians who have been very uncertain as to which octave a note belongs when the waveform consists of short pulses. But as such sounds are not very musical this is not of much practical importance. It may be a form of masking but if so then it varies vastly with different individuals.

"Cathode Ray's" reference to television brings to mind the subject of subjective colour vision and the use of Land's subjective colour systems in photography and television. Land's original article in *Scientific American* and articles and correspondence in the *British Journal of Photography* recently will enlighten those who wish to know more about this subject. But it appears that "what is in the eye of the beholder" is the important thing here. In acoustics the same might be said of the ear. It's what you think you hear that counts. These large variations in subjective listening probably account for the continued crop of "sensational" loudspeaker enclosures that frequently appear.

After 30 years design work in the audio frequency field I feel that the very little we can do scientifically must always finally receive a subjective judgment from

whose interpretation of what they hear is sometimes quite different from ours.

In any case, any system of communication must always end at the person being communicated with and the interpretation he puts on the "message" must be subject to modification by either aesthetic or psychological idiosyncrasies. Nowhere is this more true than in the musical instrument industry.

Belvedere, Kent.

L. H. HILLS.

Transistor Power Amplifiers

TWO recently-designed^{1, 2} high quality transistor amplifiers make use of an a.c. mains power supply unit having bridge rectifiers and filter capacitors on the output side. Both use a centre tap on the secondary winding to provide an earth point and to give equal positive and negative d.c. supplies about this point. One end of the load, in practice the loudspeaker, is connected to the centre tap and the resistance of the transformer windings is effectively included as part of the load. No reference is made in either paper to the fact that transformer leakage inductance is present and this also forms part of the load impedance.

To the best of my knowledge, only one paper so far published³ takes account of this point, which clearly will have some effect on the amplifier performance. With a large amount of negative feedback there is an additional risk of instability unless the effect is compensated in some way. In the last paper to which I have referred, the transformer secondary is wound in bifilar form and this technique gives a drastic reduction in leakage inductance. The extra capacitance which results from bifilar winding is of no consequence at 50 or 60 c/s but with high output voltages there is some risk of insulation breakdown between the two contiguous windings.

It is conceivable that the leakage impedance could be transformed into a pure resistance by the addition of compensating network elements. Two well-known constant-resistance circuits are given in the accompanying diagram (a). In each case the total impedance is a pure resistance which is independent of frequency if $L=CR^2$.

In diagram (b) a transformer is shown with compensating elements added to "build out" the leakage impedance, represented by R and L. Naturally, R and L are physically inaccessible since they are, as it were, inside the transformer.

At very high frequencies, a moving-coil loudspeaker has an inductive impedance and it is possible that the effects of speaker inductance could also be compensated

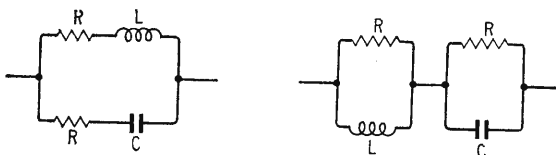

$$Z = R \text{ IF } R^2 = L/C$$

(a)

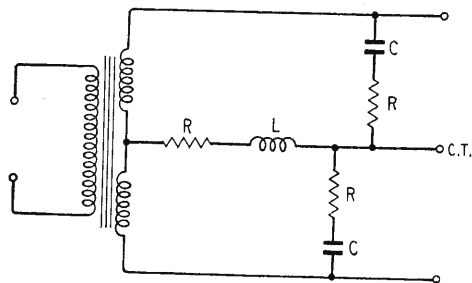

(b)

by suitable adjustment of R and C although in practice it may be more convenient to shunt the speaker terminals by a suitable series RC combination and thus deal with the loudspeaker separately. Suitable values would be of the order of 30 ohms and 1 microfarad for a 16-ohm unit. To correct a transformer it would first be necessary to measure the resistance and leakage inductance.

Cheltenham.

F. BUTLER.

¹ "Transistor Power Amplifiers with Negative Output Impedance," W. Steiger, *I.R.E. Transactions on Audio*, Vol. AU-8, No. 6, Nov.-Dec. 1960, p. 195.

² "Transistor Audio Amplifier," R. C. Bowes, *Wireless World*, July 1961, p. 342.

³ "An Ultra-Low-Distortion Transistorized Power Amplifier," C. F. Wheatley and H. M. Kleinman, *I.R.E. Transactions on Broadcast and Television Receivers*, July 1961.

"High-quality Tape Pre-amplifier"

YOUR correspondent Mr. C. A. Davies (April 1962 issue) suggests several methods of raising the effective input resistance of a transistor audio stage, but concludes that little can be done with RA in his Fig. 2.

If RA is divided and the tap is capacitively coupled to the junction R₄/R₅ (as shown in the accompanying diagram), neglecting the voltage across R₅ the d.c.

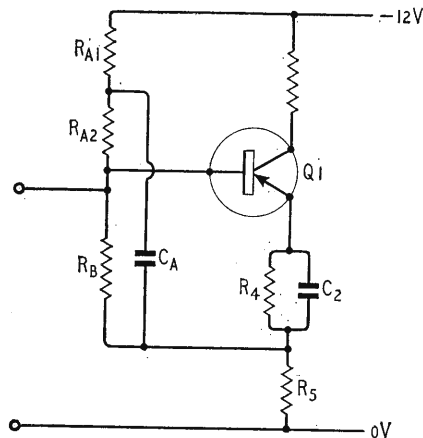

operating conditions are unchanged. The a.c. circuit now has RA₁ in parallel with R₅, whilst RA₂ is in parallel with RB.

A negative feedback voltage developed across R₅ (and RA₁) will now increase the effective parallel resistance of Q1 R_{in}, RA₂ and RB. There is little point in making RA₂ and RB more than several times Q1 R_{in} and this may permit a reduction in value of these resistors thus improving the temperature stability of the circuit.

St. Ives, Hunts.

J. D. COLLINSON.

Hybrid Amplifier

WITH reference to the interesting analysis of hybrid amplifiers by G. W. Short (October 1961 issue) and letters in the December issue, an integrating type of hybrid amplifier constructed here in 1959 is herewith presented. Several amplifiers of this type are used together with a multichannel (36) recording oscillograph for seismic measurements. In the amplifier the output voltage from a dynamic vibration (velocity) pickup is amplified and integrated to give direct reading and recording of the vibration amplitude. Referring to the vacuum tube designation it may be noticed that the amplifier is "hybrid" also in another way because the triode-heptode (ECH83) used is itself of a "hybrid" type designed for working with 12, 6-V anode supply voltage only.

The first experimental amplifiers were all-transistor

types, but difficulties were encountered in the integrating stage ($C_e R_e$) because of, first, the transistor leak currents and the low impedances, secondly, the extensive temperature stabilization circuitry necessary with transistors in this stage. The ECH83 solved the problem both with respect to compactness, high impedance and the restricted supply voltage. It was considered undesirable to have an extra anode power supply for eventual vacuum tubes of higher voltage rating. The heater voltage for ECH83 is 6.3V, thus two amplifier units are coupled in series and a single storage battery may then serve as combined power supply.

It may be seen that the anode series resistor still used by Mr. Short in his versions of the hybrid amplifier, could here be discarded altogether, the emitter-to-base resistance of the transistor being sufficient to obtain a reasonable signal voltage. The transistor is here given the function of "impedance transformer" rather than amplifier, because the oscillograph galvanometer constitutes a rather heavy load, its working (internal + damping) resistance being of the order of 25 to 250 ohms.

The German type transistor OC604 spec. was the only one at hand in sufficient supply when the prototype amplifier was designed, but any equivalent (or near equivalent) type may be used.

Because the amplification factor of the system may be checked and adjusted against a standard signal for each channel separately at any time, merely by pressing a button, the amplifier-integrator unit may be used for recording galvanometers with sensitivities varying over a wide range. The performance has proved satisfactory for the purpose intended, with practically no failure during the two years of use.

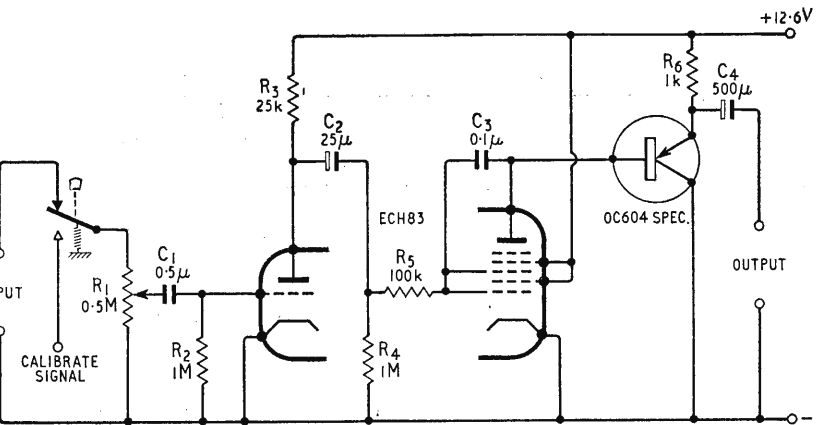

It would appear that there is not any great demand for improved definition except by the video hi-fi enthusiasts, and enthusiasts are proverbially vociferous!!

Welwyn Garden City.

R. B. GREEN.

Spare Parts Overseas

FROM time to time, Canadian users of British and European-made equipment complain that it is difficult to find replacement tubes and components. Part of the difficulty seems to lie in not knowing who are the Canadian suppliers for the different components.

As the Canadian representatives for Mullard and Philips we try, through the medium of advertising, to make our product line as widely known as possible, but we still get the occasional complaint from a customer who has wasted valuable hours trying to find the right suppliers.

This problem could be alleviated if all equipment manufacturers supplied a list of local suppliers of replacement parts to their customers. Not only would this increase customer goodwill, but it would help to dispel that doubt which lurks in the mind of many Canadians concerning the availability of replacement parts for equipment purchased from the U.K. and Europe.

Your co-operation in bringing this to the attention of our readers would be much appreciated.

Toronto.

C. S. HAND,
Philips Electron Devices, Ltd.

Line Standards for British Television

MR. P. SCADENG'S letter in the April issue may be too late in view of the forthcoming report of the Pilkington Committee, but I consider that his views are sound and that we should continue with the present 405-line television system. There are, however, two points worth mentioning if this subject is to be discussed.

Although there will be only a marginal improvement in picture quality by going to the 625-line system, the audible and often objectionable 10kc/s whistle will be raised to about 15kc/s which will be inaudible to the majority of viewers. I feel that this is probably the most important advantage to the ordinary viewer, because I doubt if the improvement in line definition will be noticed. In any case, as Mr. Scadeng remarks, any improvement is likely to be cancelled by the probable degradation of picture quality due to the use of the u.h.f. bands.

It used to be said that the eye would not tolerate poor quality and distortion in the way that the ear will do in certain circumstances. In a way the pundits were correct, but they did not anticipate the use of video tape, Eurovision broadcasts, 8mm film, the misuse of light and shade with consequent over- and under-exposure, and so on. We now have many programmes, on both networks, in which the picture quality and definition vary tremendously from one half-hour to another. Even so, many of the most popular programmes are those which invariably are of poor picture quality, so

"Over the Hump"

IN the historic transatlantic tests in 1901, referred to in recent issues of *Wireless World*, very little has been said about the type of receiver used. It would seem that the coherer-relay-decoherer-morse-inker combination was abandoned at an early stage and that an imperfect-contact detector with earphone was substituted.

As bias was used with some of the many types of detector tested at that period, is it possible that Marconi unwittingly was working on that part of the curve which gave him negative resistance and hence a higher level of signals, or, in fact, made it possible for him to hear them at all?

This theory is supported by the fact that popular stories of the event refer to the "S" signals having been heard through "the crashing of atmospherics." Apart from the possibility of a local thunderstorm or static building up on the aerial, atmospherics would not ordinarily have been prevalent with a simple receiver without amplification on the wavelength used, especially bearing in mind the season of the year, the time of day and the latitude of the receiving site, and as it was a remote spot there was not much likelihood of man-made interference.

Extraordinary high sensitivity was obtained by many

workers at that time using various combinations of detector elements, in fact, some claim to have made them oscillate, but a serious limitation was their instability and susceptibility to mechanical vibration.

Little Baddow, Essex.

E. A. PAYNE.

V.H.F./F.M. Service

LEST the B.B.C. feel discouraged by "Free Grid's" remarks on the v.h.f./f.m. service I wish to support you as another satisfied customer. I felt compelled a few years ago to complain about excessive background noise in some f.m. broadcasts, arising apparently in the studio and in transit through the G.P.O. Extraneous noise is no longer noticeable and the transmitters are above reproach. The results now obtainable are limited only by the reproducing equipment except for some loss of the upper audio frequencies.

I believe it was Lord Reith himself who maintained that the success of a broadcast was not to be measured solely by counting the number of listeners but also by taking into account the degree of enjoyment it aroused. Assessed on this score the v.h.f./f.m. service is an outstanding success.

Troon, Ayrshire.

THOMAS JOYCE.

"Pipeless P.A. Pioneers"

YOUR correspondent, Mr. A. J. Walker (March issue), makes some very valid comments on radio microphones, but I must correct him on one point.

The radio microphones used by A.T.V.—he refers to the Val Parnell "London Palladium Show"—are designed and constructed by A.T.V. Limited. The unit is transistorized, and is, to the best of our knowledge, the first transistorized transmitter used for this kind of work. The Japanese and German models came along later but our tests show that these units are unsuitable for broadcasting in such parameters as signal/noise ratio, frequency response, etc. Further to this the Japanese microphone at 27 Mc/s and the German microphone at 37 Mc/s are on frequencies not acceptable to this country. I would make the point that the Post Office, in their reluctance to issue licences, take very serious

note of the likelihood of the radio microphone receiver picking up unwanted signals which may possibly be broadcast. In granting a licence the Post Office has a dual responsibility, not only to ensure that interference is not caused by the transmitter, but equally that the user is not subject to interference from other signals. Imagine the consequences if an irate taxi driver should suddenly break into "Beat the Clock"!

London, W.1.

BERNARD MARSDEN,
Associated Television Limited.

Electronic Ignition

I WOULD like to thank correspondents who have written to me privately on this subject in response to my letter which appeared in the January issue. I am also grateful to Mr. J. R. C. Moore, of Little Melton, Norwich, for the practical advice contained in his letter, published in March, 1962.

In brief, it appears that the scheme I proposed can be made to work. This is confirmed by Dr. A. V. J. Martin (*Electronique et Automatismes*, Paris), who has been experimenting for some years with a rather similar system. He also mentioned a useful practical point concerning car electrical systems with a positive or negative earth. By using either one or two silicon transistors between the contact breaker and the controlled rectifier the existing wiring need not be disturbed when making the changeover.

After I had written my letter, but before it appeared in print, an article by H. P. Quinn entitled "Gas Tubes and Transistor for Electronic Ignition" was published in the issue of *Electronics* for December 15th, 1961. The principle is almost exactly as in my proposal which is virtually a solid-state equivalent to Mr. Quinn's equipment. The latter is scheduled for commercial production in the near future.

My conclusion is that an ideal but expensive ignition system would use a toothed-wheel type of inductor alternator instead of a standard contact breaker to produce firing pulses to a controlled rectifier. Automatic advance and retard features could be incorporated and, as Mr. Moore points out, timing adjustments would be facilitated.

Cheltenham.

F. BUTLER.

SHORT-WAVE CONDITIONS

Prediction for May

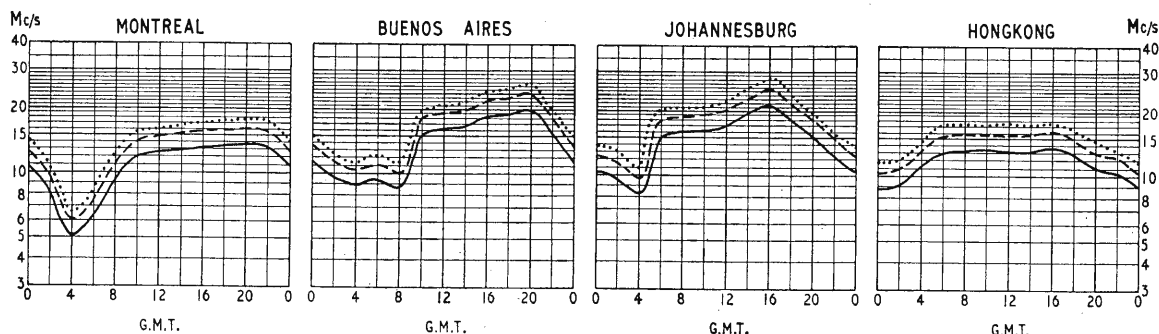

THE full-line curves indicate the highest frequencies likely to be usable at any time of the day or night for reliable communications over four long-distance paths from this country during May.

Broken-line curves give the highest frequencies that will sustain a partial service throughout the same period.

- FREQUENCY BELOW WHICH COMMUNICATION SHOULD BE POSSIBLE FOR 25% OF THE TOTAL TIME
- PREDICTED MEDIAN STANDARD MAXIMUM USABLE FREQUENCY
- FREQUENCY BELOW WHICH COMMUNICATION SHOULD BE POSSIBLE ON ALL UNDISTURBED DAYS

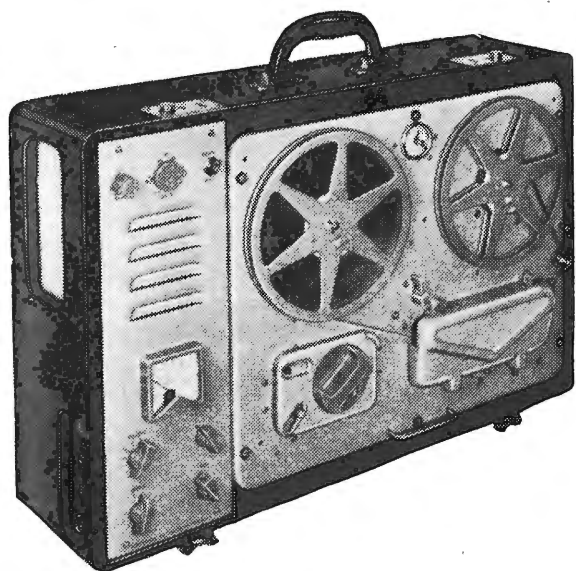

Vortexion quality equipment

The W.V.B. recorder has an additional amplifier and head with provision for "before" and "after" record monitoring while the recording is in progress, and this also has echo facilities.

The W.V.A. recorder has provision for a plug in stereo head and can be supplied with this and stereo playback pre-amplifiers with equalisation each having an output of 1 volt from a cathode follower. This is type W.V.A./S.

A heavy mumetal shielded microphone transformer is built in for 15-30 ohms balanced and screened line, and requires only 7 micro-volts approximately to fully load. This is equivalent to 20ft. from a ribbon microphone and the cable may be extended to 440 yds. without appreciable loss.

The 0.5 megohm input is fully loaded by 18 millivolts and is suitable for crystal P.U.'s, microphone or radio inputs.

The playback amplifier may be used as a micro-

phone or gramophone amplifier separately or whilst recording is being made.

The meter fitted for reading signal level will also read bias voltage to enable a level response to be obtained under all circumstances. A control is provided for bias adjustment to compensate low mains or ageing valves.

The power output is 4 watts heavily damped by negative feedback and an oval internal speaker is built in for monitoring purposes.

THE VORTEXION W.V.B. or W.V.A/S

are eminently suitable for making a high quality recording almost indistinguishable from the original since these models have facilities for monitoring the recording actually put on the tape with only a fraction of a second delay.

By this means, when for any reason the signal is distorted or not as required, the result of the recording on the tape can be heard almost instantly, and adjustments can be made until the results are as required.

Many types of music today have the treble boosted considerably, and may result in greater power being recorded at high frequencies than at

middle frequencies, an overload of the tape at high frequencies gives a mushy quality with lots of hiss and background noise.

Adjustment to the bias level while listening to the result is useful in this connection especially where the brand of tape and the bias setting for it are not exactly known.

Again if clean treble recordings at $3\frac{3}{4}$ in. are of prime importance it is now recognised that no other method is quite so effective in achieving this as reducing the bias slightly while listening to the results. The meter reading of the new bias setting for the particular tape used may be noted for future use.

VORTEXION LIMITED, 257-263 The Broadway, Wimbledon, London, S.W.19

Telephones: LIBerty 2814 and 6242-3.

Telegrams: "Vortexion, Wimbledon, Lon."

OUR
THYRATRONS
ARE SO
PULSATING

BE ATTRACTED BY
OUR MAGNETRONS:

FORWARD WITH BACKWARD
WAVE OSCILLATORS

IT'S QUICKER BY TRAVELLING WAVE TUBE

For detailed information on any of our products ring RIV 3431

and ask for the Technical Information Centre. Or write to:



THE M-O VALVE CO LTD

BROOK GREEN • LONDON W6 • TEL: RIV 3431

SEE US ON STAND K456, IEA EXHIBITION, OLYMPIA (MAY 28-JUNE 2)

MANUFACTURERS' PRODUCTS

NEW ELECTRONIC EQUIPMENT AND ACCESSORIES

Heat Shunt for Soldering

Components, especially transistors or semiconductor diodes, can be spoiled by overheating when soldering them into circuit. Antex have now produced a heat shunt for use when soldering such components: it resembles a simple self-gripping tweezer and, of course,

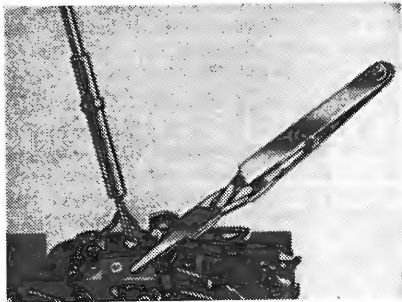

Antex heat shunt in use.

has the valuable advantage that, unlike pliers, it does not have to be held in place.

The retail price is 1s 4d. Anglo-Netherland Technical Exchange, Ltd., 7/8, Idol Lane, London, E.C.3.

Silicon Solid-state Radiation Detectors

CREATION of a hole-electron pair in a semiconductor crystal by the passage of an ionizing particle can be detected by providing an electric field across the crystal. In the Ferranti ZNS 30 series of diffused silicon solid-state radiation detectors the field is formed by using the depletion, or space-charge, region of a reverse-biased p-n junction.

The devices are made of high resistivity p-type silicon with a shallow diffused n-type layer on the active surface. The active volume extends from about one micron of the surface to the far edges of the depletion region, the depth of which depends on the applied reverse bias and the p-type base resistivity.

The active area of each device is 5mm in diameter and body length is 6.8mm. Operating voltages are from

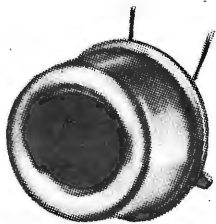

One of Ferranti's ZNS 30 radiation detectors.



Gunza Tape Degausser.

50 to 200V and alpha particles, electrons, protons, heavy ions, deuterons and tritons are detected.

Ferranti Ltd., Hollinwood, Lancs.

Close-tolerance Capacitors

POLYESTER capacitors from the Wima range are now available in the United Kingdom, from Waycom Limited, in close tolerances. The Wima Tropyfol Type "M" metallized-polyester and the Type "F" polyester-and-foil capacitors cost between 2s 6d and 5s each in tolerances of 1 and 2%. Rated at 400V d.c. working, values range from 0.01 μ F to 0.47 μ F, the range being extended to 1 μ F at 125V d.c. The Type "F" polyester-and-foil capacitor is available only in 2% tolerance, rated at 400V d.c., from 1,000 to 6,800pF.

The address of Waycom Limited is Capacity House, Rothsay Street, Tower Bridge Road, London, S.E.1.

Waveguide Slide Rule

THE new E.M.I. Electronics "Waveguide Data" slide rule covers fourteen different waveguides. The data given include transatlantic equivalents, internal and

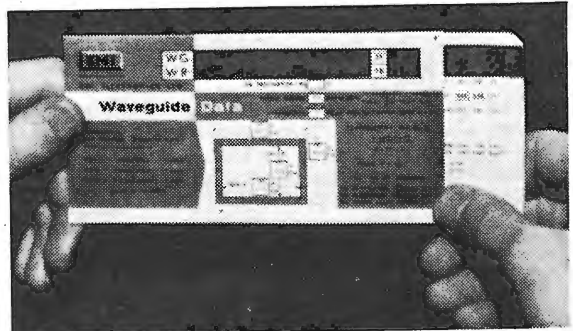

E.M.I. Electronics Waveguide Data slide rule.

external dimensions (with tolerances), upper and lower frequency limits, cut-off frequencies, power ratings, and attenuations per 100ft. These last two data apply at 1.5 times the cut-off frequency, but formulae are given for obtaining their values at other frequencies: the attenuation is for copper guide, but multiplying factors for other materials are also given. Guide and free space wavelengths versus frequency curves are also included. This slide rule costs 7s 6d and may be obtained from the Valve Division of E.M.I. Electronics, Ltd., Hayes, Middlesex.

Bulk Tape Eraser

TO operate the new Gunza Tape Degausser, after first switching on, the tape reel is inserted into the slot between the two coils, manually rotated on the movable rollers provided, and slowly removed from the slot before switching off. Up to 11in diameter, 1 $\frac{1}{4}$ in wide reels can be erased in this device. Its

current consumption is 2.6A from 230V (a.c.). This eraser costs £14 and is manufactured by the Gunza Electronic Development Co., Ltd. of 9 Church Road, Richmond, Surrey.

Fault Finder

INTENDED for the servicing of domestic receivers and sound equipment, the Taylor Model 22 is effectively a signal tracer with a built-in loudspeaker. The instrument may be used for both r.f. and a.f. tests, and r.f. probe being supplied. The loudspeaker may be substituted for the one in the equipment under test, with or without its matching transformer. A leather carry-

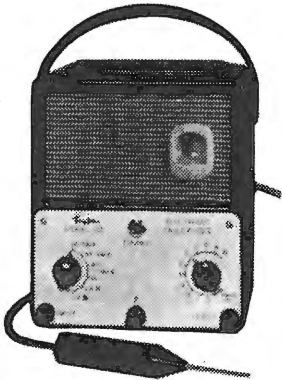

Taylor Model 22 Electronic fault finder.

ing case is available. A leaflet may be obtained from Taylor Electrical Instruments Ltd., Montrose Avenue, Slough, England.

Magnetic Logic Unit

STATIC switching components made by the French company Le Materiel Electrique Schneider-Westinghouse, are now being sold in the U.K. by B & R Relays.

One of Materiel Electrique's products is the "Cypak" logic unit which can operate on the fundamental AND,

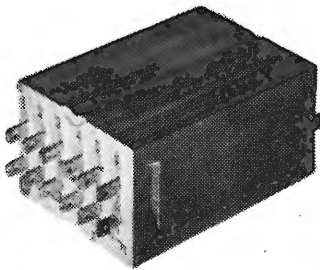

Cypak unit marketed by B & R Relays.

OR and NOT functions. As these units use magnetic-amplifier type circuits it is claimed that great reliability is achieved: to this end solderless connectors are also used. Cypak units can be used for control and automation systems: they can accept inputs from magnetic proximity detectors or photo-sensitive devices, and can be employed for sequence control as is necessary, for instance, for production lines, or lifts.

B & R Relays Ltd., Temple Fields, Harlow, Essex.

High-stability Resistors

THE use of a better ceramic core has enabled Erie Resistor Ltd. to improve the bonding of carbon-film resistive elements to the core, so reducing inherent noise level and providing better life characteristics. The style

N.1 sub-miniature ceramic-encased, high-stability resistor rated at 0.1W has solid end seals and conforms to the new N.A.T.O. specifications (Draft Stanag No. 4065), which correspond with RCS.112 (U.K.), MIL-R-10509C (U.S.A.) and CCTU 04-03 (France).

Rated at 50V d.c. the new range is 0.36in long by 0.13in in diameter and is available in $\pm 1\%$ tolerance over the range 100Ω to $100k\Omega$, the range for $\pm 2\%$ being extended down to 50Ω and 10Ω for greater tolerances. The noise level is less than $0.5\mu V$ per direct volt applied and the endurance tests show a maximum change in resistance of 1% after 2,000hr operation at $70^\circ C$ at full load.

Erie Resistor Limited, 1, Heddon Street, London, W.1.

Closed-circuit Television Equipment

THIS equipment, marketed under the name Vidiaids, is available for 405- and 625-line standards at a field rate of 50c/s and 525-line 60c/s operation. An unusual feature is that the video bandwidth is held within 1dB to 9Mc/s, which allows a horizontal resolution of 650 television lines (picture centre) and 450 at the corners. Vertical resolution with the 625-line system is claimed to be better than 400 lines.

Simplicity of operation is the keynote of this equipment, only three controls mounted on a small remote panel being provided for the camera. Basically consisting of a camera and monitor unit, additional items are an automatic signal level control unit to cope with variation of light levels, a unit providing remote control of pan, tilt and focus, a transistor waveform generator for use with multiple systems (and where interlaced operation of frame scanning is required) and transistorized distribution amplifiers for both video and synchronizing pulse distribution.

The camera has a three-lens turret for $1\frac{1}{2}$ in diameter lenses and operates directly from 200-250V mains. The output is at video frequency and at 0.5 to 0.7V peak-to-peak. Monitors available include 8 $\frac{1}{2}$ -in, 14-in and 19-in diagonal types and all give a 2-V negative peak-to-peak sync output for operation of the camera without a separate waveform generator.

A typical system employing an industrial-grade vidicon and including one lens corrected for the vidicon, a stand for the camera and one monitor costs £470.

Automatic Information and Data Services Ltd., 26, Sheen Road, Richmond, Surrey.

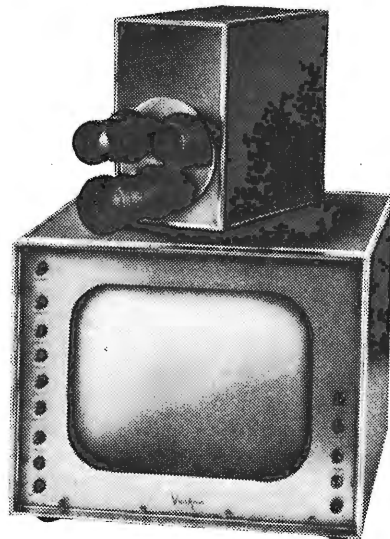

Vidiaids camera and monitor unit which form together a complete closed-circuit television system.

FUNDAMENTALS OF FEEDBACK DESIGN

5.—AMPLIFIER RESPONSE CONSTRUCTION

By G. EDWIN

WE have now reached the point where we can consider the application of the simple response-building bricks to a complete amplifier. The simplest form of amplifier of any real interest is that shown in Fig. 23 and is a three-stage resistance-capacitance coupled amplifier with the pentode screens and anodes fed from zero-impedance sources so that no decoupling is used. The anode load of the n th stage is R_{n1} and the grid return resistance is R_{n2} : the two resistances identified are thus R_{11} and R_{22} . The coupling capacitances shown labelled are, on the same principle, C_{11} and C_{22} . The capacitance C_1 for each stage must be a guess as it consists of the sum of the output capacitance of the preceding valve, the input capacitance of the following valve and the wiring strays. You cannot measure this last factor, nor can you look it up in a book: it is a property of a system which is not yet built.

Since we must start somewhere we assume that at some convenient frequency, say 800c/s, the effect of all the capacitances can be ignored. This assumption is one which is always made in working out the gain of an amplifier. In order to plan our work systematically we write down some substitutions. The effective load of V_1 is R_1 and R_2 in parallel, so we can call this R_1 . The effective mutual conductance of a pentode with a resistance in the cathode is $(1/g_m + R_c)^{-1}$ and this will be called simply g_m . We shall also need $R_1 + R_2$, which we shall call R_s . The impedance of a pentode will be taken as being so much greater than R_1 that we can neglect it.

Immediately we can write down the gain of the n th stage as $G_n = g_{nm} R_1$ and from the first grid to the third anode the gain will be $G_1 G_2 G_3$. It will be necessary to have some numbers in order to plot the response characteristics and it will be convenient if these numbers are moderately realistic as well as moderately simple. A typical small pentode has a g_m of about 5mA/V so that we might take

$$\begin{aligned} R_{1k} &= 800\Omega, \text{ giving } g_{1m} = 1\text{mA/V} \\ R_{2k} &= 300\Omega, \text{ giving } g_{2m} = 2\text{mA/V} \\ R_{3k} &= 50\Omega, \text{ giving } g_{3m} = 4\text{mA/V} \end{aligned}$$

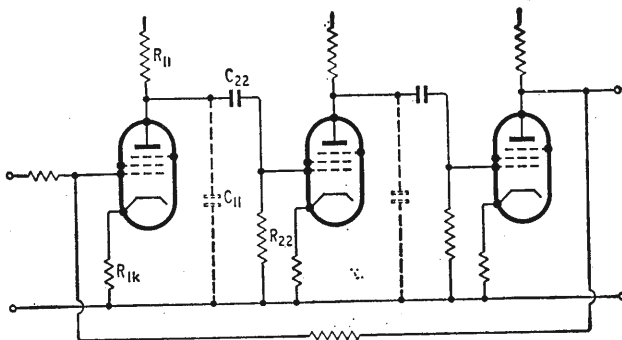

Fig. 23. Three-stage R-C coupled amplifier.

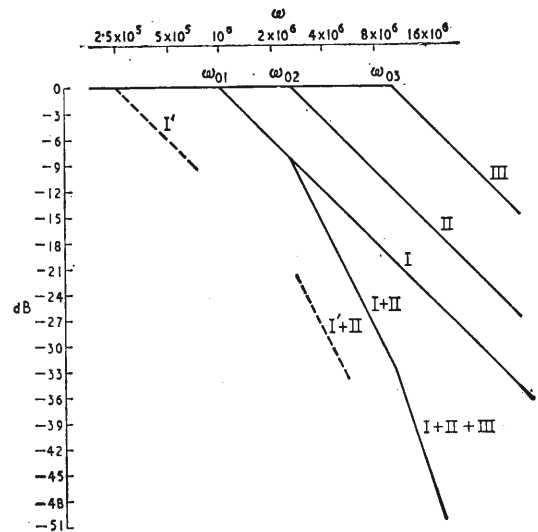

Fig. 24. Straight-line approximations to high-frequency amplitude responses of three stages of circuit of Fig. 23 (labelled I, II and III) summed to give the response of the whole circuit (labelled I+II+III). The dotted lines refer to a modification to the response of the first stage to improve the overall stability.

$$\begin{aligned} R_{11} &= 100\text{k}\Omega, R_{22} = 100\text{k}\Omega, \text{ giving } R_{11} = 50\text{k}\Omega \\ R_{21} &= 25\text{k}\Omega, R_{32} = 100\text{k}\Omega, \text{ giving } R_{21} = 20\text{k}\Omega \\ R_{31} &= 5\text{k}\Omega, \text{ giving } R_{31} = 5\text{k}\Omega \end{aligned}$$

The loading effect of the feedback resistor will be neglected. These figures give us a total gain of $50 \times 40 \times 20 = 40,000$, or 92dB. You will in practice need to do more work than this because the valve g_m depends on the cathode current and each stage must be examined for its d.c. condition before you can get the numbers to be used.

We begin by testing the high-frequency response. We must estimate a value for C_1 and in order to have something to talk about let us take $C_1 = 20\text{pF}$ for each stage. We have already seen that the effect of a shunt capacitance C across a resistance R is to produce a $[1+j\Omega]$ type of response with its characteristic frequency at ω_c where $\omega_c CR = 1$. We have then $\omega_{01} = 10^{12}/50,000 \times 20 = 10^6$ and $\omega_{02} = 2.5 \times 10^6$ and $\omega_{03} = 10 \times 10^6$. Marking these three points on a frequency scale in Fig. 24 we first draw the three basic responses shown as I, II and III and from these proceed to generate the lines I + II and I + II + III. The result is the predicted roll-off at frequencies of 160kc/s (ω_{01}) and above, a roll-off which gets progressively steeper as the other stages begin to have an effect. The same process is now applied to the phase characteristic in Fig. 25.

We now have the material for a rough assessment of the situation. We can take the safe limit of the phase as 160° , a rather high figure on

this rough plot with a potential error of 10° in this particular region, but giving us the rather convenient frequency of 4×10^6 to look at. Referring to Fig. 24 we see that at $\omega = 4 \times 10^6$ the amplitude response has fallen by some 16dB so that with only this amount of feedback we should have, on our rough estimate, a bare 20° of phase margin. Where the phase reaches 180° the gain has dropped by 20dB, so that the gain margin with 16dB of feedback would be about 4dB. It is particularly important to notice, by comparing the two figures, that although curve III on the amplitude response is not showing any appreciable effect in the region we are worried about, it is responsible for about 20° of phase shift and is, indeed, swallowing up all our margins.

Response Modification

If we now set ourselves a target of some 24-30dB of feedback, leaving the exact amount until we can fix it to give round numbers, we can try to modify the response to make this safe. We cannot move any of the basic responses upwards in frequency but we can add capacitance to move any of them down. In this particular example we notice that curve I has produced pretty well its full 90° of phase shift in the danger area so that we can move it to the left at the price of only 5° at $\omega = 4 \times 10^6$. Each octave we move ω_{01} to the left gives us an extra 6dB attenuation in curve I of Fig. 24. Let us move curve I to I', two octaves to the left, so that we get the dotted characteristics added. The choice of two octaves corresponds to 28.5dB of feedback if $\omega = 4 \times 10^6$ is the test point. The dangerous 180° phase shift occurs at 32dB down and if we choose to have 26dB of feedback we shall have a 20° phase margin and a 6dB gain margin.

The circuit modification needed is to add a capacitance across the circuit in parallel with C_{11} . We are reducing ω_{01} by a factor of 4 times, so that we need a total C_{11} of 80pF, of which we already have 20pF, so that the added capacitance must be 60pF.

The next stage in the design is to construct the exact response curves in the sensitive region to see whether in fact we have failed to give enough margin or whether we have given an unnecessarily large amount. On the basis of these we may decide to move ω_{01} perhaps half an octave up or down and we can then construct the final complete amplitude and phase responses. These we shall require for the determination of the performance with feedback and the task of producing them can be left until we reach this topic.

Step Correction

Since we are only asking for an additional 10dB we could have considered using a step circuit here. The use of step circuits takes a certain amount of practice and only a rough indication will be given here of the way in which you need to work. Suppose we first put in a step to begin at $\omega'_{01} = 2.5 \times 10^5$ by using an 80pF capacitor across C_{11} , and limit this step to 12dB by a series resistance of 16.7k Ω , which cuts R_{11} from 50k Ω to 12.5k Ω when this extra capacitance is of zero impedance. The final roll-off of the first stage will then have a characteristic frequency fixed by the 20pF and 12.5k Ω and will actually fall nearly on top of ω_{02} . We shall show later that the closer we make the characteristic frequencies the

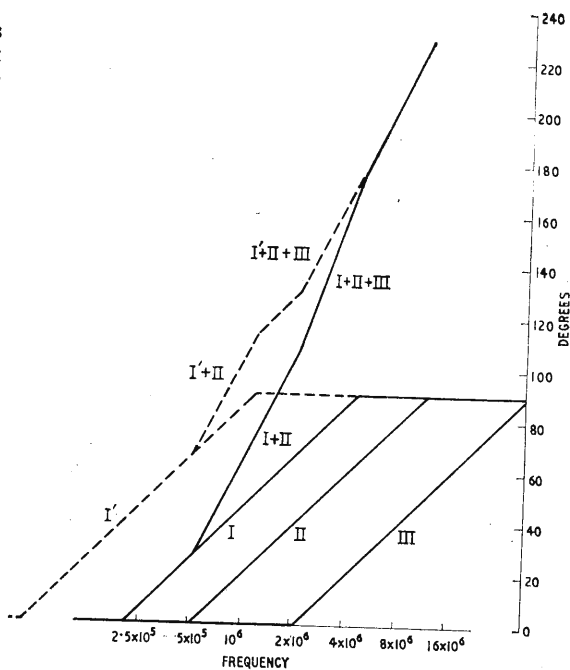

Fig. 25. Approximations to high-frequency phase responses of three stages of circuit of Fig. 23 summed to give the response of the whole circuit. The dotted lines refer to a modification to the response of the first stage to improve the overall stability.

less feedback we can use, so that we have gained 12dB but lost an amount we could calculate. But why should we bother when we have so obviously done the wrong thing.

A much better approach is to apply the step correction in the second stage. We can make this stage roll-off at $\omega'_{02} = 10^6$ by using a 50pF capacitance across the load, and if we make the series resistor 6.7k Ω the step will be 12dB and will end at $\omega =$

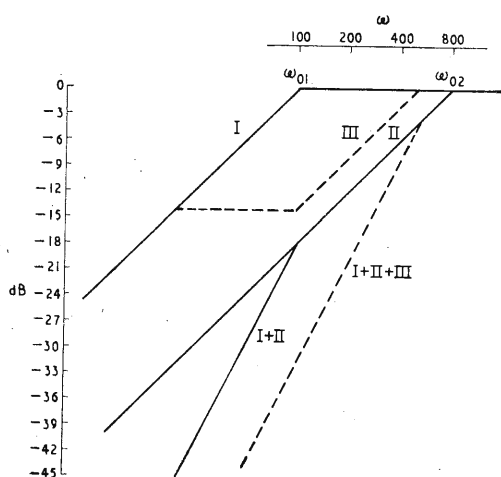

Fig. 26. Approximations to low-frequency amplitude responses of two coupling networks in circuit of Fig. 23 summed to give the response of the whole circuit. The dotted lines refer to the effect of cathode decoupling in the first stage.

4×10^6 . We shall then have a plateau extending to ω_{03} before the final roll-off begins. The maximum phase shift for a 12dB step is 63° and until the phase characteristic of the ω_{03} term starts to take control we cannot possibly have more than the 90° from ω_{01} and the 63° from the step. Without actually drawing anything out it looks as though the critical region will be somewhere up near $\omega = 8 \times 10^6$, where we shall have 18dB from curve I and 12dB from the step. This solution suggests that we shall have about 30dB to play with, so that it is just about as good as the previous one.

Now, however, the response extends up to $\omega = 10^8$ before the first roll-off, rather than to only 2.5×10^5 , so that the intrinsic performance of the amplifier is better. It might be thought that since we are going to put on a good deal of negative feedback this does not matter, but as we shall see later there is a nasty trap in this reasoning. A more detailed study of some of the points must be left until they can be taken up in the right context.

As far as the low-frequency response is concerned the system as it is shown must be stable, for we have only two coupling networks. In analysing these we need $R_1 + R_2$, which is $200k\Omega$ for the first inter-stage network and $125k\Omega$ for the second. If we take C_{22} as $0.05\mu F$ we shall get a characteristic frequency for the first stage of $\omega_{01} = 100$ and with $C_{32} = 0.01\mu F$ the characteristic frequency for the second stage will be $\omega_{02} = 800$. When we come to the calculation of overall responses with negative feedback we shall see the benefits of spacing out these two frequencies.

The amplitude and phase characteristics are plotted as I, II and I + II in Figs. 26 and 27. We see that with a 30° phase margin the maximum feedback according to this single plot will be 27dB. However, as the more exact phase characteristic lies below the approximation, and as the phase does not really reach 180° until we get to zero frequency, we do not worry overmuch.

It may be wondered why the phase shift is in the same direction for both top and bottom end of the response. This is a matter which has been referred to previously and is, indeed, merely the result of a combination of two factors. For drawing purposes it is sometimes convenient to get both ends onto a single sheet of paper and to avoid using too large a sheet, or changing the notation, the plots are made in the same direction. Since these plots are designer's plots and the designer is presumed to know what he is doing, a spattering of minus signs would be quite superfluous. Any reader who settles down to work with these diagrams for some time will find that he too will soon come round to this attitude of mind.

Decoupling Effects

The effect of cathode decoupling must now be included. In order to avoid tedious repetition only one stage will be dealt with, though the same process can be applied to each stage. In the first stage the effective g_m has been knocked down from $5mA/V$ to $1mA/V$ and by adding a capacitance we can regain this at sufficiently high frequencies. We are dealing with a step of 14dB and the obvious way of using this is to let it begin at ω_{02} , provided that this is not a region where we are suffering from response problems. By starting at ω_{02} we will have flattened out again before we get to ω_{01} so that the 14dB is a

real help towards stability and towards the overall response questions to be discussed later. Taking into account the fact that we have to provide decoupling in other stages where the resistance values are lower we try, however, a step with its lower edge on ω_{01} . In Fig. 27 the phase characteristic for the step III has been drawn exactly, simply because it was easier to do so. Only part of III is drawn, and only the really critical region of I + II + III. It will be seen that this step makes it possible to add a good deal more feedback. The two corner frequencies of the step are obviously when $\omega CR = 1$, with $R = 200$ and $1,000\Omega$. Taking the lower one, though either will give the answer, we have $\omega_{01} = 100$, so that $100 \times 1,000 \times C = 1$ or $C = 10\mu F$. An alternative approach is to make C so much bigger than this, and from considerations of the phase response we see that a factor of at least 10 is needed, that we need not take this term into account at all.

The screen decoupling circuits produce a similar step down in the response. If the mutual conductance to the screen is h_m and the effective resistance feeding the screen is R_s , which is the parallel combination of the two resistors in a voltage divider circuit,

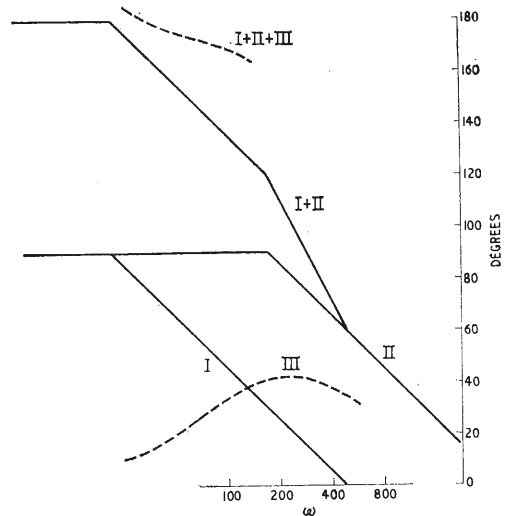

Fig. 27. Approximations to low-frequency phase responses of two coupling networks in circuit of Fig. 23 summed to give the response of the whole circuit. The dotted lines refer to the effect of cathode decoupling in the first stage.

the size of the step will be $20 \log(1 + h_m R_s)$ and the lower corner of the step will be at $\omega R_s C_s = 1$. It is usually not too easy to find out what the mutual conductance to the screen will be: it is frequently desirable to take into account the screen impedance. For these reasons the effect of screen decoupling is not treated in any more detail. There is, indeed, another reason why the use of the screen characteristic can be dangerous. The screen signal can easily have a high distortion content and will thus transfer distortion back into the signal path if this local feedback is allowed to come into play. Monkeying with the screen impedance is a dangerous pastime.

Anode decoupling is quite another matter. At low frequencies the decoupling resistor forms part of the load, so that the gain increases. Again we get a

step characteristic, but this time we must subtract this step from the amplitude and phase characteristics if we are blithely leaving out minus signs wherever possible. Usually these steps are only small, however, and cannot be regarded as really serious aids in seeking stability. When the supply has a finite impedance the decoupling circuits will be determined much more by the job for which they are needed, that of preventing the oscillation produced by too much

feedback, positive feedback, which we find with a three-stage amplifier. This is another topic which must be left until later.

Although the feedback path has been shown in Fig. 23 it has not been discussed at all. We shall see how additional stability can be introduced by using suitable networks in the feedback path, but again we have a subject which requires a good deal of study.

INDUSTRIAL GROUPS—VIII

The Rank Organisation

FACED in the fifties, as was the rest of the British film industry, with a drastic decline in its traditional audiences, the Rank Organisation embarked on a dual programme of rationalization and diversification with the aim of broadening the base of its operations. Once almost exclusively film-based, the Rank Organisation has as a result been transformed into a major trading group with extensive interests in other industries and in many forms of public entertainment.

The latest step in the group's development is the setting up of a new divisional structure to cover all its activities—both industrial and entertainment interests—which has been designed to increase the efficiency and potential of each division. At the same time it is intended to identify all the group's trading activities with the name of the Rank Organisation and its internationally known insignia—"The-Man-with-the-Gong." Thus a trade mark which has been familiar in the radio industry since its earliest days—Bush Radio's "Shrub-in-a-Tub" will eventually disappear.

The industrial divisions of the group now include:

Bush Radio Division

This division has been a member of the Rank Organisation since 1945. Founded in 1932, Bush built its first radio receiver in a room in Shepherd's Bush, London, which is how the name originated. Now there are factories in London and Plymouth, and also in India and Eire. Bush also produces electronic equipment, and is one of the few companies to have secured contracts for colour television receivers and monitors for the B.B.C. and G.P.O.

Rank Cintel Division

Formerly known as Rank Cintel, and before that as Cinema Television, this division, originating in 1928 as the Baird Television Company, rightly claims to be among the first in the television field. As early as 1933, it developed and built the first television receiver to be produced in quantity—the Baird Mirror-Drum Televisor.

In 1945 the electronics side of the business began to expand, with the production of equipment for high-speed counting and for the accurate measuring of frequency and time. The Rank Cintel division is sub-divided into four main groups:—Electronic Tubes (instrument and TV cathode-ray tubes, photo-electric cells and semiconductor devices); Instruments (covering a whole range of industrial and laboratory instrumentation); Television (monochrome and colour studio TV equipment); and Avionics (electronic instrumentation systems for aircraft and guided weapons, including Pilot's Electronic Eye-level Presentation).

Television Relay and Rental Division

Previously known as Rank Relay Services and now using the trade name Top Rank Vision, this division's first move was to acquire a substantial interest in Regency Holdings, a company operating relay services in the Brighton, Hove and Eastbourne areas. A partnership was then obtained in Viewline high-frequency relay, which operates in the Oxford area and in the south-west of England. Since 1959, a number of other relay companies have been acquired, with

the result that the division now operates sound and television relay systems in over 30 towns.

Wharfedale Wireless Works

This Bradford company, a leading manufacturer of high-fidelity loudspeakers, became part of the Rank Organisation in May, 1959.

Thompson, Diamond & Butcher

This old-established wholesale company dealing in gramophone records and reproducers, radio and electrical goods, was acquired in the latter part of 1958. Incidentally, T.D. & B. have recently changed their address to Tramway Avenue, Stratford, London, E.15. (Tel.: Maryland 4533.)

Top Rank Home and Leisure Service

Retail shops are under the control of this division. There are now Top Rank (formerly Visda) retail outlets for household radio and electrical goods in many parts of Britain including London, S.E. England, the Midlands, South Wales and Scotland.

Rank-Xerox

Formed as a joint venture between the Rank Organisation and Xerox Corporation, of Rochester, New York, this company makes and sells document copying equipment utilizing xerography. Rank-Xerox may sell to every country outside the U.S.A. and Canada.

Rank Precision Industries

This grouping of companies will in future operate as the following divisions:

1. Rank Taylor Hobson Division (lenses, machine tools and measuring instruments).
2. Cine & Photographic Division (manufactures under licence and markets Bell & Howell photographic equipment in the U.K. and overseas).
3. Rank Kalee Division (telerecording equipment, audio and visual systems for lecture halls and agents for Dage close-circuit television).
4. Kershaw Division (the Teamatic vending machine).
5. Research and Electronics Laboratories (the laboratories have developed the Xeronic business computer printer).

The Rank Organisation also has a 37.6 per cent interest in Southern Television, the I.T.A. programme contractors for the south and south-east regions of England.

Choiceview was formed in July, 1960, to carry out research and development on Pay-TV and to offer programme and technical services to other intending operators. The company is owned equally by the Rank Organisation and Rediffusion.

Another example of the Organisation's long-term diversification policy is its interest in British Space Development Company, of which Rank was a founder member. B.S.D.C. was formed to promote space research and to develop space communications systems.

"Electrical Who's Who."—Biographies of over 8,000 prominent people in the electrical, radio and electronics profession and industry are included in the seventh edition of "Electrical Who's Who" compiled by *Electrical Review*. Some 700 people appear for the first time in this edition which includes 528 pages and costs 45s. Publishers Iliffe Books Ltd.

Aspects of design

This is No. 38 in the series of articles dealing with advanced problems in circuit design published by The Thorn-AEI Applications Laboratory. No. 39 will appear next month. We shall be pleased to answer queries arising from this or other articles.

38 MAZDA TWIN PANEL TELEVISION C.R. TUBES

Television receiver cabinet design has always been restricted by the need to accommodate both the cathode-ray tube and a separate safety panel. This has usually necessitated elaborate mounting arrangements to ensure accurate relative positioning of tube and panel despite production variations.

Twin Panel 19" and 23" Television Cathode-Ray Tubes of the new Mazda range enable considerable simplifications to be made in the mounting arrangements. In these tubes the safety panel is bonded directly to the tube face by means of a resin specially developed for the purpose. The safety panel is moulded to a shape which closely follows the contours of the tube face and is provided with lugs at each of the corners by which the complete tube may be mounted. The result is that the front of the tube is actually a laminate consisting of the tube face, the hardened resin and the safety panel, a construction which results in several advantages, as follows:

- (a) a tube of greater strength,
- (b) better picture contrast and quality,
- (c) simplified mounting offering new possibilities in cabinet styling.

TUBE STRENGTH

The envelope of the cathode-ray tube is a glass bulb from which the air is exhausted as thoroughly as is economically possible in a mass production process. Every square inch of the outer surface is therefore subjected by the atmosphere to a force of about fifteen pounds weight which results in a large area such as the face of a 23" tube supporting a weight of about one-and-three-quarter tons. Although the bulb is designed to have an adequate safety margin of strength for normal handling and use, there is always the danger of an accidental blow or shock causing a violent collapse of the bulb or "implosion." For this reason the need for a safety panel in front of the tube has always been recognised. Additionally the receiver cabinet has had to be strengthened to contain the violence of a possible implosion.

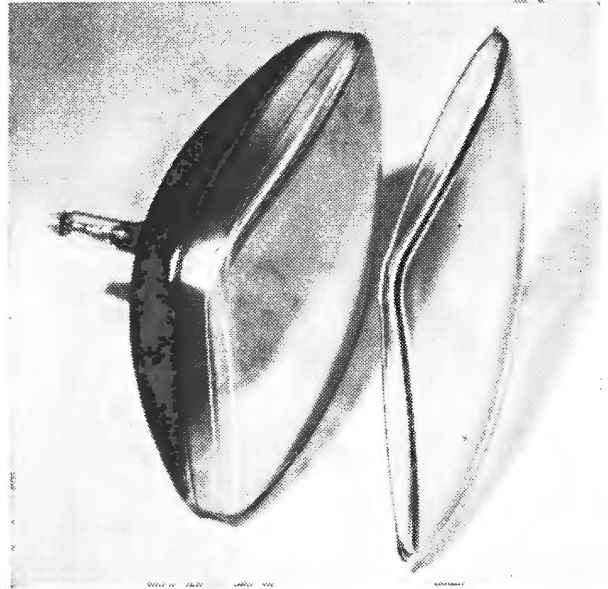

In the case of the new twin panel tubes, not only is the tube far stronger, but if it is subjected to a blow heavy enough to break the bulb there will be no violent implosion. In particular, no glass will be projected forward through the sandwich face to injure a viewer. Thus cabinets can be lighter since they no longer have to be strong enough to contain an implosion, and the separate safety panel may be omitted.

CONTRAST

When viewing a conventional tube through a safety panel the viewer sees the picture through four partially reflecting surfaces, namely, the front and back surfaces of the safety panel, and the front and back surfaces of the tube faceplate. In any or all of these he may see reflections of objects in the room in which he is sitting. On account of the differing radii of curvature of safety panel and tube face these specular reflections will usually be well separated from one another and will thereby interfere considerably with the picture. In addition, these same reflecting surfaces will throw light from energised parts of the phosphor back on to the screen where it may illuminate dark parts of the picture and so spoil contrast.

The refractive index of the bonding resin used in the new Twin-Panel tubes is very similar to that of glass, and so two of these reflecting surfaces are eliminated with consequent improvement of contrast. Probably of equal importance is the elimination of dust collection on the face of the tube and back surface of the safety panel. In the past this has caused loss of light output and a "halation" effect which further deteriorated contrast.

MOUNTING

Mention has already been made of the small mounting lugs at the corners of the front panel of the new Twin-Panel tubes. It is intended that the tube should be mounted by gripping these lugs with suitable clamps. However, it should be noted that some resilient packing material should be included between the clamping surfaces and the glass to prevent localised stressing.

MAZDA VALVE COMMERCIAL DIVISION 155 Charing Cross Road, London WC2 Telephone GERrard 9797

EDISWAN EXPORT DIVISION Thorn House, London, WC2 Telex: London 21521 (Thorn Ldn)

THORN-AEI RADIO VALVES & TUBES LTD

MAZDA

twin panel tubes

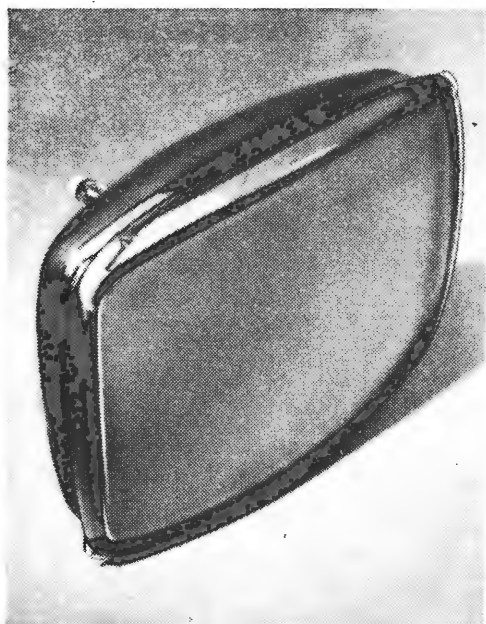

110° 19" and 23" twin panel

SHORT TELEVISION TUBES

CME1906/A47-13W

CME2306/A59-13W

These new tubes differ from previous 19in. and 23in. tubes of the Mazda range in that each has a moulded safety panel of tinted glass bonded directly to the front face of the tube. In neck length and electrical characteristics these tubes are identical to CME1903 and CME2303 respectively, having 110° deflection angle and using magnetic deflection and electrostatic focus.

General Details

Twin Panel	Tinted Grey Glass
Rectangular Face	110° Deflection Angle
Aluminised Screen	Silver Activated Phosphor
Electrostatic Focus	Magnetic Deflection
Short Neck	Straight Gun—non ion trap
	External Conductive Coating
	Heater for use in Series Chain
	Heater Current I_h 0.3 A
	Heater Voltage V_h 6.3 V

Design Centre Ratings

	CME1906	CME2306
Maximum Second and Fourth Anode Voltage $V_{a2,a4}$ (max)	17	17 kV
Minimum Second and Fourth Anode Voltage $V_{a2,a4}$ (min)	13	13 kV
Maximum Third Anode Voltage V_{a3} (max)	+1 to -0.5	+1 to -0.5 kV
Maximum First Anode Voltage V_{a1} (max)	550	550 V
Maximum Heater to Cathode Voltage-Heater Negative (d.c.) V_{h-k} (max)	200	200 V

Inter-Electrode Capacitances

Cathode to All* C_{k-all}	3.5	3.5 pF
Grid to All* C_{g-all}	8.5	8.5 pF
Final Anode to External Conductive Coating (approx.) $C_{a2,a4-M}$	1250	2000 pF

*Including AEI B8H Holder VH68/81 (8 pin)

Typical Operation

Grid Modulation (Voltages referred to cathode)		
Second and Fourth Anode Voltage $V_{a2,a4}$		
	16	16 to 17 kV
First anode Voltage V_{a1}	400	400 V
Beam Current	350	350 μ A
Third Anode Voltage for Focus (Mean) V_{a3} (av)	200	200 V
Average Peak to Peak Modulating Voltage	35.5	35.5 V
Grid Bias for Cut-off of Raster V_g	-40 to -77	-40 to -77 V

Maximum Dimensions

Overall Length	317	374 mm
Face Diagonal	491†	614‡ mm
Face Width	441	544 mm
Face Height	361	443 mm
Neck Diameter	29.4	29.4mm

†The maximum dimension over the complete panel is 507 mm
‡The maximum dimension over the complete panel is 631 mm

Tube Weight

Nett (Approx)	22.5	37.5 lbs.
---------------	------	-----------

Side Contact: CT8 (Cavity)

Base: B8H

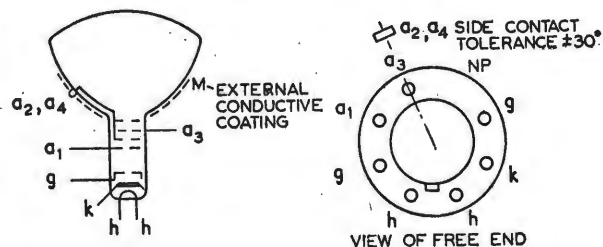

MAZDA VALVE COMMERCIAL DIVISION 155 Charing Cross Road, London WC2 Telephone GERrard 9797

EDISWAN EXPORT DIVISION Thorn House, London, WC2 Telex: London 21521 (Thorn Ldn)

THORN-AEI RADIO VALVES & TUBES LTD

Sliding-bias Amplifiers

ECONOMY OF POWER CONSUMPTION FOR INTERMITTENT USE

By THOMAS RODDAM

A LITTLE time ago I was consulted about a problem in public-address systems. The system was one of those abominable arrangements which can be heard in their fullest glory at trade exhibitions asking for Mr. B. . . . to return to his stand from the bar as he has the only corkscrew in his pocket. While this is repeated, all work stops.

The important technical feature of public-address systems of this kind is that they are quiescent most of the time. The special features with which I was confronted were the use of an elaborate switching scheme and the need for standby-battery operation in case of mains failure. Obviously there must be no delay in signalling the tea break even if the power lines are down and the canteen frozen. The problem resolved itself into the provision of a number of individual amplifiers, one for each loudspeaker, each supplied from a battery which was float-charged from the mains. The amplifiers were each required to deliver something in the region of 4 to 10W.

Choice of Circuit

At first sight this is a situation which calls unambiguously for the use of a Class-B power amplifier, using transistors of course. An alternative presented itself to my mind, however, which at a much later stage was found to have been put there by an exposition in a Mullard reprint*. The principle itself is old and includes such interesting variations as the floating-carrier method of broadcast modulation which you can find in the textbooks but not, I think, in service. The Mullard paper gives a good description of a particular amplifier, but the design method is not the one I prefer, mainly because it seems to me to be an analytical approach, dealing with what a particular circuit will do, rather than a quasi-synthetic approach which can lead one to the choice of specific transistor for a particular job. All published circuits, like ready-made suits, are the wrong size. I suspect that they are the wrong size for everyone.

Having overlooked the Mullard reprint, I began with a circuit described by Roehr†: this is not very different from a Darlington pair, which employs a direct coupling of two transistors (input to emitter of first) with the base of the first connected to the emitter of the second and both collectors joined (output) to produce a compound with α very close to one. We shall see later that we need to have direct coupling between the driver and the power

stage and temperature stability makes it essential to use an emitter-follower as a driver stage. Before going on to discuss this circuit perhaps a few words about the sliding-bias principle are needed, for it does not seem particularly well known.

We start off with the idea of a Class-A amplifier. For discussion purposes we will suppose that this is just a single transistor with a transformer in the collector line, the transistor being biased in some way so that we have 1A flowing and a supply voltage of 10. There is no signal, and the transistor is dissipating 10W. The load seen at the collector is 10Ω and we shall forget all about the collector-saturation voltage and the leakage current, two factors which affect the arithmetic without making much difference to the reasoning. When we apply a signal to the base of the transistor we can drive it up to a collector swing of 10V and we shall get 5W of signal power into the load. The input power from the battery is unchanged at 10W, so that the dissipation is now only 5W.

Suppose now that we only want one watt out and that we are not free to alter the load. In the previous case we demanded a peak-collector-current swing of 1A; but now we only need a peak collector swing of 0.445A. We can alter the bias of the transistor to give us this standing current and we shall then be taking 4.45W from the battery, delivering 1W to the load and dissipating 3.45 in the transistor. Lower power requirements will lead us to even lower currents and lower dissipation in the transistor.

Principle of Sliding Bias

A sliding-bias amplifier makes use of the rather important fact that most speech is almost silence. Only rarely does the programme-meter peak to full level even during words, and there are pauses between words, longer pauses between sentences and, we hope, very much longer pauses between announcements. We therefore operate our transistor at a very low standing current and alter the bias when necessary to allow enough current to flow for the requirements of the moment. It is from this operation that the circuit gets its name. The effect is that the average dissipation over a long period can be very low, so that the transistor heat-sink remains very near the ambient temperature. When full drive is required the thermal capacity of the heat-sink will maintain thermal stability for long enough for all normal requirements. For operational purposes the thermal resistance of the cooling system becomes, if the heat-sink is massive enough, just equal to the internal thermal resistance of the transistor, so that very high power-handling capacity can be achieved.

Let us turn back to the basic circuit, which is

* "A 4.5W Sliding-bias Amplifier using an OC16", reprinted from *Mullard Technical Communications*, Vol. 4, No. 31, July 1958.

† "A Two-watt Transistor Audio Amplifier", W. D. Roehr, *I.R.E. Transactions on Audio*, Vol. AU-7, p. 125 (Sept.-Oct. 1959).

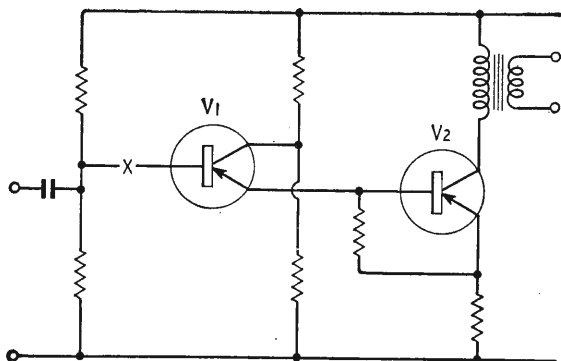

Fig. 1. Basic two-stage amplifier. Input may be introduced by a transformer at X.

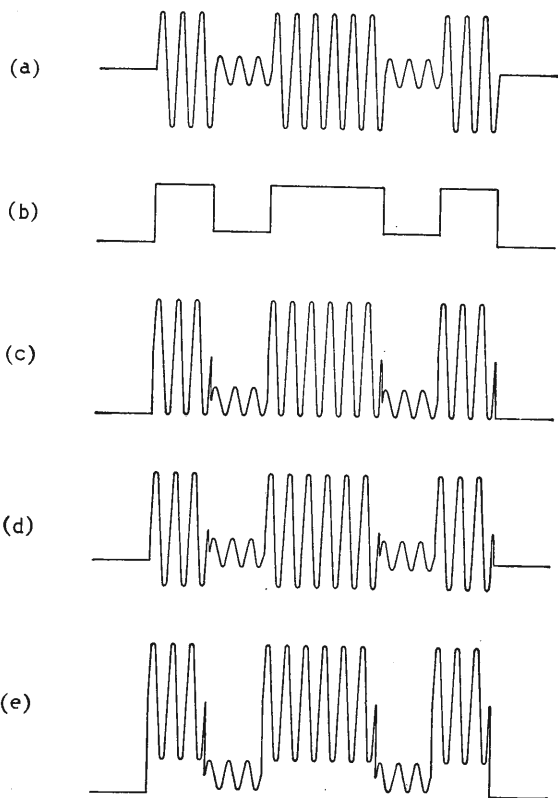

Fig. 2. From speech signal (a) and syllabic-frequency signal (b) we can generate a composite signal and if the proportions are correct (c) troughs are all at the same level. Incorrect proportions give less favourable results, (d) and (e).

shown in Fig. 1. This circuit does not really demand very much comment. The output transistor has a small amount of added resistance in its emitter lead and has the very simple function of reducing the effects of the tolerances in the characteristics of transistor V2. These tolerances are the variation in properties from one transistor to another and also the variations in properties of a particular transistor from one temperature to another. For a system operating from a 12-V supply it is probably reasonable to use a resistance which will bring the base

potential at full drive to about 2V, while for a 24- to 28-V system rather more feedback can be used, giving perhaps 3V.

A resistor from base to emitter of the second transistor provides a stabilizing effect against changes in I_{co} of the transistor, changes which could otherwise disturb the working conditions of the driver transistor V1. The effects of I_{co} in the driver transistor are minimized by the use of the lowest-possible collector-supply voltage and to this end the collector is fed from a point on a bleeder chain. The base is biased in the usual way. I do not propose to go into more detail at this, or perhaps any, stage because this is a fairly straightforward system which, with the right choice of transistor, will give a few watts from a 1-mW input.

Operation Under Drive Conditions

Now let us look at the sort of signal we expect to handle. We want a stylized speech signal and I suggest we might use the form shown in Fig. 2. What it sounds like I cannot imagine; but it contains loud and quiet sections with transitions between them.

At this stage I do not propose to start talking about sliding bias but to approach the end result in rather a different way. If we rectify the signal shown in Fig. 2a we shall obtain, after smoothing, the envelope shown in Fig. 2b. We now proceed to add convenient fractions of each of these waveforms together to give a composite signal and we shall obtain, according to the proportions, one of the forms shown in Fig. 2c, d and e. The waveform shown in Fig. 2c is the right mixture, having its troughs all falling to the same level. If we apply this signal to an amplifier the current will always be driven up and never driven below the quiescent point. There is thus no reason why the device handling this composite signal should be biased above cut-off, except for the need to keep away from the lower curvature of the cut-off region.

This concept of a composite waveform is an extremely useful one. It is of great assistance in determining the circuit values to be used in sliding-bias amplifier. You will have seen, of course, that the waveform in Fig. 2b is just the sliding bias, but do not cling to this knowledge. We must consider the frequency bands occupied by the various signals if we are to apply them to a circuit and we know, of course, that if we want normal speech quality we can limit the basic signal of Fig. 2a to frequencies above about 200 to 300c/s. The signal of Fig. 2b, however, is essentially a syllabic frequency signal and extends upwards from a fraction of a cycle (the best I can do is 1/18c/s) to something in the region of 10c/s. We might just as well take it as extending from zero frequency to 10c/s. The composite signal in Fig. 2c has, or need have, no components in the band between 10c/s and 300c/s. Naturally this statement is based on actual speech waveforms, not on the rather angular form of the stylized waveform we have been considering.

Our way is now clear. We generate the composite waveform and apply it to the input of the amplifier, which must obviously be direct-coupled throughout. At the output we filter out the region above 200c/s and pass this to the load. Because the energy we are rejecting is all below 10c/s the filtering can be very simple and the output trans-

former itself will give us more than 20-dB attenuation at 10c/s and more than 30-dB at 3c/s. This sort of attenuation is more than enough for normal listening purposes.

Generation of Composite Waveform

We know that we are dealing, in a typical situation, with inputs in the milliwatt region. If we try to do any rectification here we shall find that there are two problems: we are working round the bend of the rectifier characteristic so that linearity will be poor and we will be drawing off rather more than half the power so that we lose gain, and lose it through non-linear loading.

At the output there will be plenty of signal power and no one will miss a few milliwatts, nor will the use of rectifier at this sort of level produce appreciable distortion. The syllabic waveform is thus generated by rectifying a small portion of the output. This is smoothed and taken back to the input for addition to the speech signal to form the composite signal.

Stability Criteria

By this approach we come to regard the system as a nice old-fashioned reflex amplifier: for those too young to remember this device a single valve was used for both r.f. and a.f. amplification. We also come to grips with the essential problem of the design: a substantial signal is carried back from the output to the input. Can such a system be made to operate without instability? The answer is certainly yes, because a number of designs exist. It is tempting to say that provided the feedback is arranged to be negative the system can be made by ways well known "in the art". On reflection, however, we see that if we are to use the downward excursion of the signal to provide upward excursion of the bias we shall not be very lucky, because the downward excursions are severely limited during

the transient period before the bias is developed. The arrangement which looks to be ideal will, in fact, lead to very severe transient distortion. We must lift up the bias by the upward swings of the main signal.

This leads us to rely on the attenuation of the feedback loop for stability. In this loop we have the low-frequency cut-off of the transformer to provide attenuation of the added component (the bias) in the composite signal and we also have the smoothing capacitor of the rectifier circuit to attenuate the main signal so that it cannot get back to the input. Although these circuits provide only first-order filter we have a rather large dead band, from 10c/s to 300c/s, in which they can cross over. As you can see, there is no hope of making this simple system provide a good low-frequency response. The situation is, in fact, a swings-and-roundabouts one. You need a good low-frequency response if you can get it; but you also need to carry the syllabic frequency response as high as possible if the transient distortion is to last for the shortest possible time. In problems of this kind there is no right answer: the final judgment is necessarily a subjective one.

Some apparent improvement in response can be obtained by using negative feedback round the amplifier and this is included in both the practical circuits shown. There is certainly an improvement in the steady-state distortion figure using negative feedback and there will be the added advantage of providing a lower output impedance and a higher input impedance. Under transient conditions, however, the amplifier is clipping and all the feedback can do is sharpen up the clipping threshold. While there is no gain there can be no improvement.

Practical Circuits

The circuit shown in Fig. 3 is taken from the Mullard paper which discusses it in some detail, although the possibility of instability is not mentioned and frequency-limitation is discussed only in

terms of distortion. It will be noticed that the use of decoupling for the power-transistor emitter resistor leads to a second low-frequency attenuation term in the forward path: Although the output transformer design becomes less critical the composite signal will not be handled similarly by the two transistors. This seems to lead to a good deal of extra design work and to necessitate the plotting of a number of transistor characteristics. The total quiescent current is 500mA and this is driven up to an average value of 700mA by speech and music with a nominal 4.5-W output.

The circuit shown in Fig. 4 is designed to offer plenty of room for adjustment to suit particular requirements. Operated at 16V this circuit will give at

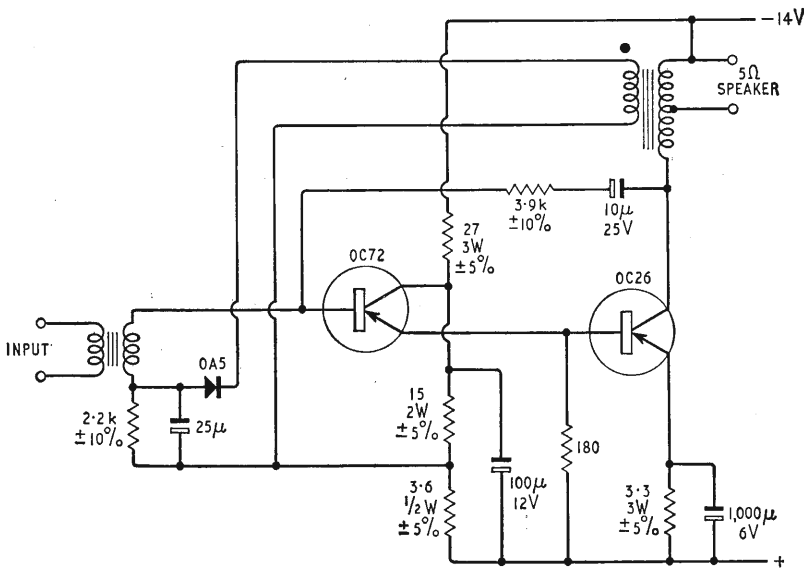

Fig. 3. 4.5-W sliding-bias output stage designed by Pawling and Tharma (based on Mullard Technical Communications, Vol. 4, No. 31). The original OC16 has been replaced by OC26.

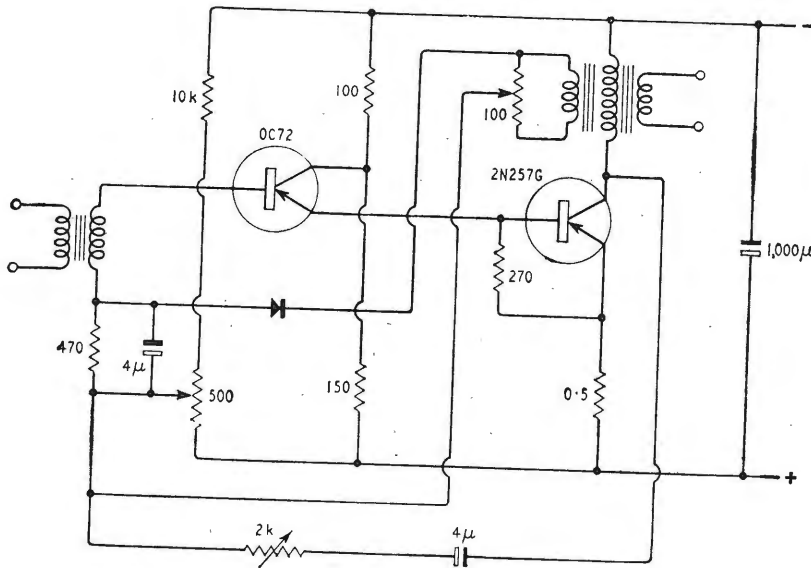

Fig. 4. Flexible design for sliding-bias amplifier of high power output and low quiescent current. Possible alternatives to the 2N257G* are 2N456† and OC35, but circuit may need adjustment.

least 10W and it is probable that it can be pushed up to 10W even with only a 12-V supply. The quiescent current could be brought down to nearly 100mA, although there seemed to be some advantage in keeping it at 200mA. An adjustment is provided by a potentiometer in the bias chain of the OC72 to provide this choice between economy and quality. There are also two other variables provided. One of these is in the syllabic-frequency rectifier path and is used to adjust the amount of bias drive so that the conditions shown in Fig. 2c can be obtained (the observation point is the emitter of the power transistor). As you will see, the emitter resistor here is not decoupled and the value shown is based on the plan to bring the transistor current up to about 2A on full drive. The amplifier up to this point has the same gain for both main signal and syllabic frequencies.

The negative feedback is applied in series with the input so as to increase the input impedance. The input transformer can therefore have a higher step-up ratio. You will note that the feedback is applied across the lower part of the bias potentiometer, so that the feedback control, which is used for gain adjustment, can only be set after the quiescent-current bias point has been selected. As the feedback is frequency-selective, the syllabic control must be readjusted after the gain is set and in practice it seems to be necessary to trim round the system about twice if the best results are to be obtained.

Further Considerations

No attempt has been made to use full-wave rectification, although this might well have some advantage, especially in connection with transient distortion at rather low frequencies. There is also the possibility that the frequency-doubling characteristic of full-wave rectification will so ease the stability problem so that the low-frequency cut-off of the amplifier might be extended down to a much lower frequency.

The reader may have detected at various points in the discussion of this circuit a certain amount of hedging. This has been quite deliberate. We have in this sliding-bias amplifier a characteristic which

we encounter in other voice-operated devices, like the echo-suppressors and other switches of long-distance trunk telephony, the codans (squelch to us) and comparators (compressor-expander) and the anti-singing devices of loud-speaking telephones. We are concerned with speech, not with an arbitrary super-position of sine waves: we are concerned with intelligibility, not with the purely numerate. In a particular application we may have to weigh transient distortion against mid-syllable loudness and there are no instruments which can determine the rate of exchange. For each speaker, for each message, for each listener the answer will be different. The detailed design, in the sense of the setting of the parameters, becomes a matter of art. This is, I think, the main reason for my interest in a circuit which, judged instrumentally, is really a rather second-rate amplifier.

* Transistor type 2N257, available from Brush Crystal Co. Ltd., has slightly higher collector leakage.
† Texas Instruments Ltd.

Audio Consoles for Hong Kong

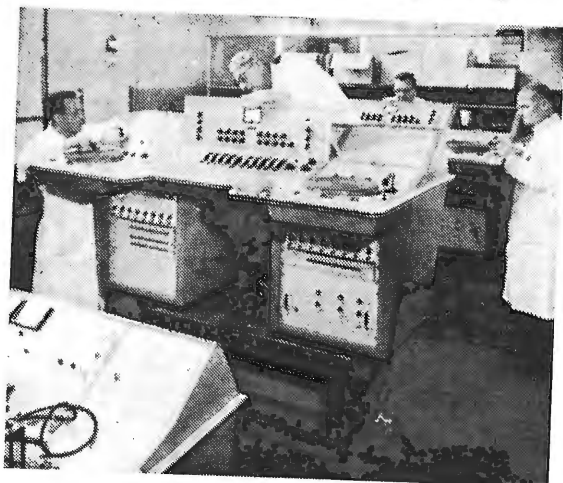

The Audio Engineering Division of E.M.I. Electronics Ltd. have recently completed two special audio mixing and control consoles for the new Civic Hall in Hong Kong. They will provide an integrated sound service for distribution to the concert hall, ballroom, banqueting hall and theatre which comprise the new social centre. There are seven programme channels for live and recorded sources including tape and disc and, in addition to echo facilities, there are talkback and intercommunication circuits. The cost of this equipment was of the order of £9,500.

NEW MARCONI 'SOLID STATE' AUTOPLEX

The most advanced error correcting equipment in existence

ERROR PROOF HF TRAFFIC

WITH 40% less capital cost per channel
75% reduction in size
75% reduction in weight
90% reduction in power consumption

PLUS Considerable savings in manpower, spares and maintenance

- * One cabinet houses equipment for two 2-channel circuits which may be operated as one 4-channel circuit
- * Modular construction means greater reliability and greatly simplified maintenance
- * *Built-in* character storage for 4 or 8 character repetition cycle
- * Fully automatic phasing including rephasing in traffic with no loss or duplication of characters
- * Average rephasing time in traffic 4 seconds
- * Mis-routing of sub-channels is impossible even with sub-division on all channels
- * Error rate Improvement factor of 100-10,000

*** FERRITRANSISTORIZED** code converters and stores surpass fully transistorized designs by significant reduction in power and saving in space.

MARCONI SOLID STATE AUTOPLEX

accurate ERROR CORRECTION MULTIPLEX SYSTEMS

MARCONI'S WIRELESS TELEGRAPH COMPANY LIMITED · CHELMSFORD · ESSEX · ENGLAND

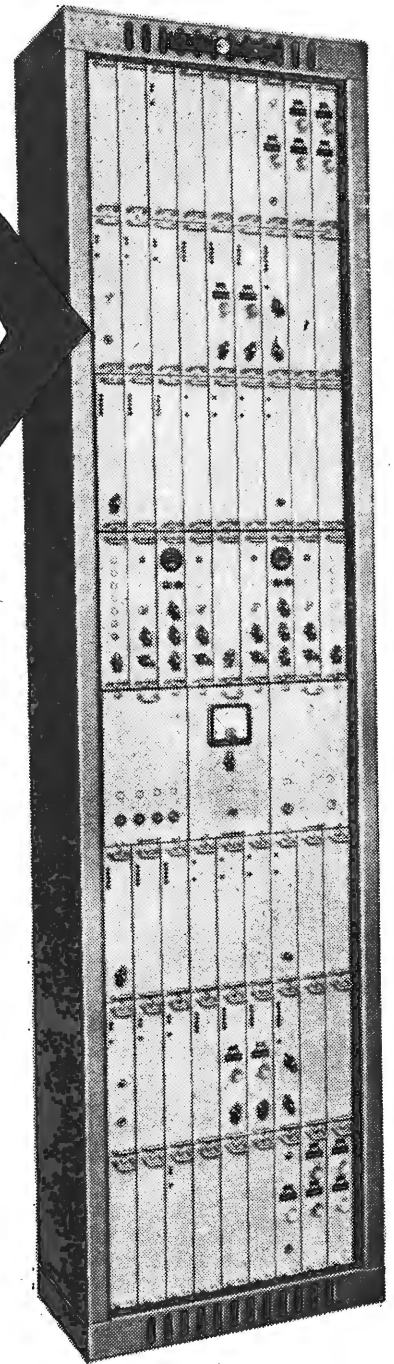

**OUTSTANDING FEATURES
ASTOUNDING PRICE**

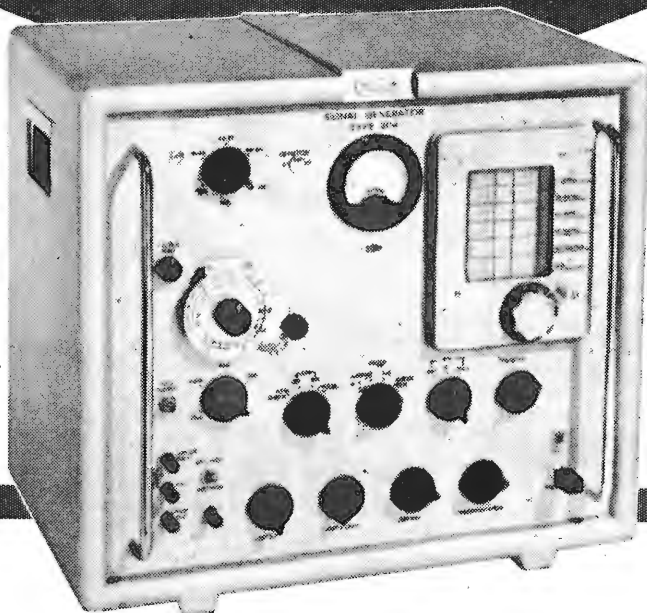

The



V.H.F. Signal Generator

TYPE 204

for development and testing

The Signal Generator Type 204 is of advanced design, and provides, over the frequency range 1 Mc/s to 320 Mc/s, a highly stable signal from a constant impedance. The facilities provided for modulation are comprehensive and the output may be either continuous wave, amplitude-modulated, pulse-modulated or combined amplitude and frequency-modulated.

- ★ 1—320 Mc/s in 5 range
- ★ Scale length 48 inches
- ★ Crystal Calibration
- ★ A.M., F.M., and Pulse Modulation Facilities
- ★ Stabilised output 2 μ V to 220mV r.m.s.
- ★ Output Impedance 75 and 52 ohms

ALL THIS FOR ONLY £240

Airmec

V.H.F. Signal Generator

AIRMEC LTD., HIGH WYCOMBE, BUCKINGHAMSHIRE, ENGLAND. Tel.: High Wycombe 2501/7. Cables: Airmec, High Wycombe

TECHNICAL NOTEBOOK

Shadow-mask c.r.t. screens are usually made by applying a suspension of the phosphor in a light-sensitive lacquer and then allowing light from a point source, held at the same place as the electron gun for that colour, to fall upon the screen through the shadow mask. This forms insoluble dots of phosphor at the right locations and the remaining phosphor and lacquer is washed away. The other colours are applied in the same way, the point source being moved to the corresponding gun position.

The new zinc-cadmium phosphors cause difficulty because as the emitted wavelength becomes longer they are progressively less transparent to the wavelength of the light (long ultra-violet) used to render the lacquer insoluble: thus the dots are not satisfactorily attached to the tube face, especially in the case of the red mixture. A new technique developed by Philips and described by Bathelt and Vermeulen in *Philips Technical Review* (No. 5, p. 133) overcomes this difficulty and results in an improved c.r.t. at the same time. The green and blue dots are applied in the traditional way, and are then coated on their backs with an ultra-violet-absorbing dye by the same means. The red phosphor is then put into the tube and is irradiated from the front of the tube through the glass face plate. This fixes the phosphor over the remaining clear area of the screen so that, if the screen is illuminated by a defocused beam, it appears to consist of blue and green dots on a red ground, rather than the more usual pattern of contiguous circles. The covering of the remaining area has a valuable advantage: with all the phosphors applied as dots the aluminium screen-backing shows through and makes the screen appear lighter than the colour of the unexcited phosphors. The red phosphor is yellowish in colour and thus, when it covers the whole of the space between the green and blue dots, makes the tube face appear darker, so giving better contrast in a lighted room, apart from the increase in brightness consequent upon the higher efficiencies of the sulphide phosphors.

Naturally the technique is not restricted to the production of shadow-mask c.r.t.s: it is equally applicable to any other form of multi-phosphor tube.

Tunnel-diode logic-elements developed by Elliott are made up in two ways to fulfil the same function. In the assemblies made by Elliott (photo R) holes are cut in a glass substrate, gold contacts and a nickel-chrome resistor are evaporated and,

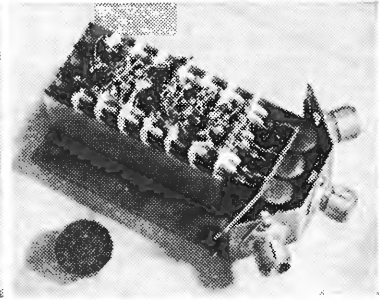
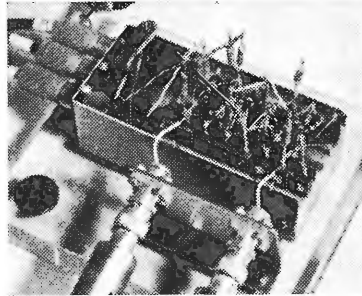

following insertion of the diodes, a silastomer covering is added. S.T.C., who have made some units for Elliott, use another approach (photo L): they use a block of silicon as the resistor, welded to the diodes, and encapsulate the whole. Either type plugs into a three-phase strip-line supply of pump power.

Oscillator control circuit using a symmetrical neon tube was described by J. Tewksbury in *Electronics* for January 26th, 1962. The voltage-variable oscillator produces negative-going pulses, which are mixed with positive-going ones from a reference oscillator. An integrating RC network is fed by the combined pulses, the capacitor charging up to the algebraic peak of the pulses. A symmetrical neon is arranged to fire if the voltage on the capacitor exceeds the neon striking voltage in either the positive or negative senses, the integrating capacitor passing a constant charge into a resistor, which therefore

develops constant-energy pulses. The two pulse trains are selected by diodes and further integrated, the reference pulse being subjected to controlled attenuation. The output of the second integrator is now a voltage which is proportional to the frequency error of the variable oscillator, and this is fed back. Very fine adjustment of the circuit is afforded by controlling the total area of the combined pulses fed to the integrator by means of the attenuator.

Watercooled solenoid for optical Faraday rotator is made by using copper tape wound at coarse pitch with fibreglass "string." When wound into a coil the string spaces adjacent turns allowing intimate contact with the circulating cooling water (Bendix-Ericsson).

Paint-on resistor composition developed by the du Pont Company is available in three approximate resistance values corresponding to 500,

"WIRELESS WORLD" PUBLICATIONS

	Net Price	By Post
PRINCIPLES OF SEMICONDUCTORS M. G. Scroggie, B.Sc., M.I.E.E.	21/-	21/11
COLOUR TELEVISION: N.T.S.C. System, Principles and Practice. P. S. Carnt, B.Sc. (Eng.), A.C.G.I., A.M.I.E.E. and G. B. Townsend, B.Sc., F.Inst.P., M.I.E.E., A.K.C.	85/-	87/3
RADIO VALVE DATA Compiled by the staff of "Wireless World." 7th Edition	6/-	6/10
RADIO AND ELECTRONIC LABORATORY HANDBOOK M. G. Scroggie, B.Sc., M.I.E.E. 7th Edition	55/-	57/3
PRINCIPLES OF TRANSISTOR CIRCUITS S. W. Amos, B.Sc. (Hons.), A.M.I.E.E. 2nd Edition	21/-	22/-
SOUND AND TELEVISION BROADCASTING. General Principles. K. R. Sturley, Ph.D., B.Sc., M.I.E.E.	45/-	46/4
GUIDE TO BROADCASTING STATIONS Compiled by "Wireless World." 13th Edition	3/6	4/-
ELEMENTS OF ELECTRONIC CIRCUITS J. M. Peters, B.Sc. (Eng.), A.M.I.E.E., A.M.Brit.I.R.E.	21/-	22/-
SQUARE-LOOP FERRITE CIRCUITRY C. J. Quartly, M.A.	42/-	42/11

A complete list of books is available on application.

Obtainable from all leading booksellers or from

LIFFE BOOKS LTD., Dorset House, Stamford Street, London, S.E.1.

3,500, and 10,000 Ω /square with a 10⁻³-in thick film. The compositions are composed of a mixture of silver powder, a resistive powder (capable of withstanding the firing temperature of 760°C) and glass frit, all made into a "paint" with an organic volatile binder. The mixture is then either sprayed, painted or silk-screen printed onto a suitable base: this is usually ceramic material which may be either a flat surface such as a printed-circuit board or rods (to form the more common type of resistor). The glass frit fuses on the surface to form a protective layer so that an otherwise unprotected film changes in value by only $\pm 1\%$ after 250hr at 95% relative humidity. Connections are made by firing on a silver composition. Du Pont's distributors in the U.K. are Brown and Forth, Ltd., Clifton House, 83-117 Euston Road, London, N.W.1.

Intelligibility of speech received over noisy a.m. channels can be improved by a technique developed by Reynolds, Voelcker and White, who describe their system in *I.R.E. Transactions on Communications Systems* Vol. CS-9, No. 3. The two sidebands of the signal are demodulated separately as if they were individual single-sideband signals and are then fed to binaural listening arrangements such as a pair of independent headphones. The speech, being coherent, fuses in the usual way for mono signals to produce a "central" image; but the noise does not. Experiments performed so far have used headphones but the use of loudspeakers should result in the classic "cocktail party" type of signal with a diffuse background of noise spread between the two loudspeakers. Test results on sixteen listeners with, except in two cases, no previous experience of articulation testing (which records the ability to recognize monosyllabic words in the presence of interference) showed that the binaural system scored an error rate roughly half that of the conventional system with a signal-to-noise ratio of 30dB (corresponding to an advantage of 4dB). At s-to-n ratios worse than this the scores moved together until at about 10dB the advantage had fallen to zero although the binaural system was still preferred by the listeners.

Four-Level maser in which alternate levels have equal energy differences allows a more efficient pumping system than a three-level maser, because a greater difference can be produced between the populations in the two levels between which transitions give stimulated emission. With a three-level maser in which pumping is between the bottom (1 in the left-hand diagram) and top (3) levels, the intermediate level population (2) remains unchanged. (In the diagrams the lengths of the lines indicating the levels show qualitatively the popula-

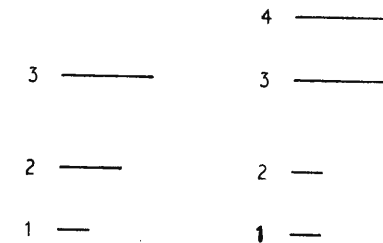

tions in these levels after pumping.) Transitions between the top (3) and intermediate (2) levels give stimulated emission. In a four-level maser stimulated emission can be produced by transitions between the two intermediate levels (3 and 2 in the right-hand diagram). If alternate levels (1 and 3 or 2 and 4) have equal energy differences, then pumping at a frequency corresponding to this difference will simultaneously induce transitions between both these pairs of alternate levels i.e. from 1 to 3 and from 2 to 4. This will deplete the lower intermediate level (2) and augment the higher (3). The populations of both levels between which transitions produce stimulated emission (2 and 3) are then altered in this type of four-level maser, as distinct in the three-level maser to the alteration to only one such level.

Automatic dielectric constant measurement method (for X-band)

has been developed by Elliott. The material sample (which must be in the form of a standard-size cube) is pushed by a moving piston through a square-section cavity. The length of the cavity at which it resonates then gives a measure of the dielectric constant. The non-linear relationship between the dielectric constant and cavity length is converted into a linear relationship by means of a set of variably-spaced metal strips: a contact attached to the piston and passing over these strips feeds a series of unequally timed pulses to a counter. At resonance the counter is stopped and then indicates the dielectric constant directly. The time at which resonance occurs is obtained by modulating the microwave power source and detecting the time at which the fundamental modulation frequency output from the cavity is zero. At the same time the double modulation frequency output from the cavity is also detected. This gives a measure of the cavity Q and thus also of the loss tangent of the material in it.

Transistor digital/analogue converter made by Dobbie McInnes greatly reduces the "dead" time required to reset the store between one reading and the next by means of a twin-store system. Cycles of information are fed alternately to each store and the output delayed until the next cycle is fully stored.

MAY MEETINGS

Tickets are required for some meetings; readers are advised, therefore, to communicate with the secretary of the society concerned.

LONDON

2nd. Brit.I.R.E.—"A loudspeaking telephone" by A. I. Forbes Simpson, M. Millett and Z. A. Kiss at 6.0 at London School of Hygiene and Tropical Medicine, Keppel Street, W.C.1.

2nd. I.E.E.—Discussion on "Aircraft electrical supply system characteristics and their effects on the design of electronic equipment" opened by J. W. McPherson at 6.0 at Savoy Place, W.C.2.

3rd. Society of Instrument Technology.—"A fully integrated production control system by second generation computer" by E. C. Clear Hill at 7.0 at Manson House, 26 Portland Place, W.1.

7th. I.E.E.—"The signalling problems associated with large-register-controlled automatic telephone exchanges" by S. Welch at 5.30 at Savoy Place, W.C.2.

7th. Women's Engineering Society.—"Micro-miniaturization" by P. F. Mariner at 7.0 at Hope House, 45 Great Peter Street, S.W.1.

9th. Society of Instrument Technology.—"Computer control of processes" by A. J. Young and I. Gray at 7.0 at Manson House, 26 Portland Place, W.1.

9th. Brit.I.R.E.—"The integrated radar system for S.S. *Canberra*" by A. J. Harrison and D. Chamberlain at 6.0 at London School of Hygiene and Tropical Medicine, Keppel Street, W.C.1.

9th. British Interplanetary Society.—"Ground-borne microwave aerials for space communication" by F. J. D. Taylor at 7.0 at 4 Hamilton Place, Piccadilly, W.1.

9th. Society of Environmental Engineers.—"The operation of a combined climatic and random vibration test facility" by S. S. Duncan at 6.0 at Imperial College, Exhibition Road, S.W.7.

11th. I.E.E.—Discussion on "Problems associated with (i) blood pressure measurements and (ii) storage devices" at 6.0 at Savoy Place, W.C.2.

15th. I.E.E.—"A survey of telephone speech-signal statistics and their significance in the choice of a p.c.m. companding law," by R. F. Purton at 5.30 at Savoy Place, W.C.2.

16th. I.E.E.—"Radar observations on bird migration" by Dr. E. Eastwood at 5.30 at Savoy Place, W.C.2.

16th. Brit.I.R.E.—"Infra-red radiation thermometry in clinical practice" by K. Lloyd-Williams, F. Lloyd-Williams, C. M. Cade and C. J. Hart at 6.0 at London School of Hygiene and Tropical Medicine, Keppel Street, W.C.1.

17th. I.E.E.—"Some aspects of the application of electronics to medicine" by Dr. F. T. Farmer at 6.30 at Savoy Place, W.C.2.

17th. Inst. of Physics and Phys. Soc.—"Acoustics in Great Britain" by Dr.

R. W. B. Stephens at 5.30 at Imperial College.

18th. B.S.R.A.—Annual General Meeting at 7.15 followed by "The development of wind instruments" by E. McGaving at the Royal Society of Arts, John Adam Street, Adelphi, W.C.2.

23rd. Brit.I.R.E.—Discussion on "Laboratory work in advanced radio and electronic education—its aims and methods" at 6.0 at London School of Hygiene and Tropical Medicine, Keppel Street, W.C.1.

CHELTENHAM

4th. Brit.I.R.E.—"Development of a very high quality loudspeaker system" by D. A. Barlow and H. J. Leak at 7.0 at North Gloucestershire Technical College.

EDINBURGH

1st. I.E.E.—"Trends in computer engineering" by W. S. Elliott at 7.0 at the Carlton Hotel.

LIVERPOOL

10th. Inst. of Physics & Phys. Soc.—"Compound semiconductors and their applications" by Professor D. A. Wright at 7.0 at the University.

MANCHESTER

14th. Society of Instrument Technology.—Annual General Meeting of Manchester Section followed by "Aids to marine navigation" by J. W. Nicholls at 6.45 at the Literary and Philosophical Society, 36 George Street.

'Square-Loop Ferrite Circuitry'

THIS new Iliffe book by C. J. Quartly provides a useful introduction to computer circuits incorporating square-loop ferrites.

In line with the initial use of such materials, a large part of this book is taken up in describing computer storage systems, but a consideration of other uses of such ferrites, in logical and counting circuits, has not been omitted.

After an historical introduction, the properties of square-loop ferrites are discussed in general. Various types of matrix core stores are then described in detail, including coincident drive and word access as well as faster two core per bit systems. The theory and practice of another ferrite configuration which can be used as a store, the multi-apertured plate, is next explained. Additional chapters describe fully suitable drive and output circuits for these stores: non-destructive read-out systems are also considered. The treatment of stores is completed by a consideration of permanent and other special types. The concluding chapters discuss other uses of cores and multi-apertured devices in logical or counting circuits.

"Square-Loop Ferrite Circuitry" contains 166 pages and 93 diagrams. It costs 42s or 42s 11d by post from Iliffe Books Ltd., of Dorset House, Stamford Street, London, S.E.1.

WIRELESS WORLD, MAY 1962

**THE
LARGEST
RANGE
OF
SWITCHES
IN
THE WORLD**

"THE CHOICE OF CRITICS"

BULGIN

The House of Bulgin manufactures over 15 different groups of Laminated Metal Clad Switches, which provides a range of over 150 types, and thousands of varieties. A huge choice of switching arrangements combined with highest quality Polished Chrome panel appearance. All are precision made and guaranteed to give Quick Make and Break action, throughout their long lives. Each switch has the highest quality laminated bakelite insulation (for robustness and shock resistance) and steel clad to give extreme strength under diversified uses.

Our fully illustrated 1962 catalogue No. 202/C incorporates the complete Bulgin range, providing comprehensive details on working, fixing sizes and performance of over

10,000 QUALITY COMPONENTS

Available on request, price 2/6, post free, or free to trade letterhead or order.

QUOTE REF. 202/C

A. F. BULGIN & CO. LTD.

BYE PASS ROAD, BARKING, ESSEX.

TELEPHONE RIPPLEWAY 5588.



By "FREE GRID"

Negative Titles

QUITE recently I was looking at a reproduction of the cover of the catalogue of the first London Motor Show, and I noticed with some interest that it was referred to as a horseless carriage exhibition. In the nineties, the expression "horseless carriage" was, of course, commonplace, and so I suppose it is not really very surprising that it was used in the title of the first motor show.

Such a negative title as "horseless carriage" was soon dropped in favour of "motor carriage," but the word "carriage" did not last long and was soon displaced by the more handy "car." But, as I well recollect, in the early days of the century the contraption which we now call a car, was usually referred to as a motor, and even to-day the Motor Show is not referred to as the Car Show.

In view of the swift disappearance of the negative word "horseless," it may seem surprising that the equally negative word "wireless" has retained its proud position not only in the title of this journal and in that of the oldest of the companies engaged in the manufacture of telecommunication apparatus, but also in general public usage; this in spite of a vigorous campaign to oust the word in favour of "radio." I am quite sure, however, that the word "wireless" will now never lose its place in our vocabulary. I, for one, should be very sorry to see *Wireless World* change its name to "Radio Spheroid"; somehow it wouldn't seem the same journal.

But it certainly is strange how "wireless" has stood up to the buffeting of time, when so many of our original wireless words have gone under. We no longer speak of condensers, nor do we measure our capacitances' capacitance in jars, as they used to do in naval wireless circles, nor in "plates" as amateurs did the variable ones. The "turn" has given place to the microhenry in measuring our tuning coils and, of course, the metre ousted the foot as the yardstick of wavelength as long ago as 1903 when the first International Wireless Conference was held in Berlin.

Strangely enough, an international educational conference was held in the same city only four years later when, in a weak moment, our representatives agreed to jettison our centuries-old insular pronunciation of Latin in favour of a mere Europeanized one, but our lawyers and medical men dug their toes in, and re-

fused to abandon ship which is why the old English pronunciation still stands as a bastion of our insular independence, as does the word "wireless." Long may it be so.

Robotrons

LORD ADRIAN is a man of great eminence in the medical world, and indeed in the world of science in general. It behoves us all, therefore, to take serious note of any statements he makes about matters on which he is an acknowledged authority.

But his remarks in the *Sunday Times* a few weeks ago (March 18th) about the electronic robots which will one day be built by man fill me with a dire foreboding and at the same time with a spirit of thankfulness that what St. Francis of Assisi called "Brother Death" will have overtaken me before their horrors appear.

Lord Adrian tells us it *will* (not it "may") become possible to build machines to match or surpass the human brain in most of its activities. He foresees robotrons—if I may coin a word—which will be as witty and wise as ourselves, will write poetry and will debate in Parliament.

These things will in my humble opinion certainly not have happened by the time *Wireless World's* centenary number is published in the year 2011, but they may have done so I suppose by the time our millenary issue is on the bookstalls in April 2911. It has set me wondering what the *Wireless World* office will be like then—only 949 years ahead.

There will be, of course, a robotron writing these columns of mine for its robotronic readers, for needless to say all human readers will have been permanently earthed by then. There will be another robotron in the Editor's chair. The sloe-eyed sylphs who sit at their typewriters in the *W.W.* office to-day and exert a civilizing influence on it, will be no more. Their work will be done by female robotrons—or gynatrons as they will be called—for I think that even among robotrons there will be a last-ditch stand for male supremacy.

What will happen if the Editor's gynatron develops a fault in one of her transistors so that she fails to function. I suppose she will automatically send out a signal which will summon a first-aid gynatron from the sick bay who will quickly lift her bonnet and do what is necessary. It all sounds too horrible to contemplate; yet who am I to try to contradict Lord Adrian?

Milestones of Wireless

THE letter from a learned curator of the Science Museum, which is reproduced herewith, needs little comment from me. However, I would suggest that among the radio cabins to be exhibited should be a faithful replica of the wireless rooms of world famous ships like, for instance, the ill-fated *Titanic*.

A nicety of accuracy would be to bear in mind that in 1920 an edict went forth from H.M. Customs that all wireless operators should bore a hole of one inch diameter in the top of the vertically mounted reel-of-cotton type inductance of the receiver, so that customs officers could poke a probing rod into the hollow interior. Even the Marconi Company missed this small point in their 1950 jubilee exhibition.

Finally, I think a faithful replica should be shown of the wireless room of the *Navis Ultima* of the day.

Science Museum
28th March 1962

Dear Free Grid,

I was interested to read your paragraph in the April issue of *W.W.* regarding that excellent series of ships' wireless cabins which was staged at the Baltic Exhibition by the Marconi International Marine Communication Company some ten or twelve years ago.

The same thought occurred to me at the time—wouldn't it be grand if we could have that series here?

At the time it was out of the question—on account of space limitations—but with the building of our new Centre Block, a much larger gallery will become available for the communications section, and it will be possible to reproduce the series of ships' cabins.

In point of fact, we started negotiations with the M.I.M.C. Co. with this very object in view almost five years ago. They have been most co-operative and we have already taken over all the early apparatus to complete the 1900/10 and '20 cabins.

I think you'll agree that these cabins formed an incomparable way of showing the development of radio communication over the years—or at least one very important facet of it, and I am very happy that we are going to be able to reproduce them.

Unfortunately it will be at least three years before the new gallery becomes available, but you can at least be assured that the radio cabins *are* going to be exhibited as a permanent part of our collection, even if you have to wait a bit to see them again!

As yet we're a little undecided as to the later cabins. You'll remember that the Baltic exhibition was a Jubilee Exhibition and Marconi's showed a cabin every ten years from 1900-1950. Obviously we can't go on indefinitely showing one every ten years, and we may decide on something like:—1900, 10, 20, 30 and then jump to '50. Whatever we do, the details will be very carefully thought out and assessed with Marconi's and others. I feel that the most important ones are the early ones, and these we have already secured.

Yours sincerely,
G. R. M. Garratt.

WIRELESS WORLD, MAY 1962