

Wireless World

ELECTRONICS, RADIO, TELEVISION

Managing Editor: HUGH S. POCKOCK, M.I.E.E.
Editor: F. L. DEVEREUX, B.Sc.

SEPTEMBER 1958

In This Issue

- VOLUME 64 No. 9
PRICE: TWO SHILLINGS
FORTY-EIGHTH YEAR
OF PUBLICATION
◆ ◆ ◆ ◆ ◆ ◆
- Offices: Dorset House,
Stamford Street, London,
S.E.1
Please address to Editor,
Advertisement Manager or
Publisher, as appropriate
Telephone:
WATERloo 3333 (60 lines)
Telegraphic Address:
"Ethaworld, Sedist, London."
- | | | |
|-----|--|-------------------|
| 403 | Editorial Comment | |
| 404 | Folkestone's Television Transmitter | |
| 406 | World of Wireless | |
| 408 | Personalities | |
| 410 | National Radio Show | |
| 426 | Photocell—Powered Receiver | By R. C. T. Stead |
| 429 | On Understanding Transistors | By K. C. Johnson |
| 433 | Educational Aids | |
| 434 | Letters to the Editor | |
| 435 | Sunspot and Magnetic Activity | By A. M. Humby |
| 438 | Short-Wave Conditions | |
| 439 | Technical Notebook | |
| 441 | Thermally Compensated Crystal Oscillator | |
| 442 | 567 Lines | By P. T. Weston |
| 443 | Improved Television Standards Converter | By T. Worswick |
| 445 | Group and Phase Velocity | By "Cathode Ray" |
| 450 | Potentiometer Tester | By S. Morleigh |
| 452 | Potential Divider Design Chart | By J. Willis |
| 454 | News from the Industry | |
| 456 | Random Radiations | By "Dnallist" |
| 458 | Unbiased | By "Free Grid" |

PUBLISHED MONTHLY (4th Tuesday of preceding month) by ILIFFE & SONS LTD., Dorset House, Stamford Street, London, S.E.1.
Telephone: Waterloo 3333 (60 lines). Telegrams: "Iliffepres, Sedist, London." Annual Subscriptions: Home and Overseas, £1 15s. 0d.
Canada and U.S.A., \$5.00. Second-class mail privileges authorised at New York, N.Y. BRANCH OFFICES: BIRMINGHAM: King
Edward House, New Street, 2. Telephone: Midland 7191. COVENTRY: 8-10, Corporation Street. Telephone: Coventry 25210. GLASGOW:
26b, Renfield Street, C.2. Telephone: Central 1265. MANCHESTER: 260, Deansgate, 3. Telephone: Blackfriars 4412. NEW YORK
OFFICE: U.S.A.: 111, Broadway, 6. Telephone: Digby 9-1197.

Introducing an addition to the Mullard Technical Handbook



Data sheets on Mullard semiconductor and photoelectric devices are now available in a separate volume of the Mullard Technical Handbook. This addition to the Handbook Service enables circuit designers to be kept fully informed of the latest developments in semiconductor diodes, transistors and photocells.

The Mullard Technical Handbook is a loose-leaf publication, issued on a subscription basis and containing data sheets on Mullard valves, tubes and semiconductor devices in current production.

From one to twenty pages are devoted to each type, data including: standard ratings, recommended operating conditions and performance figures for various applications, limiting values, characteristic and performance curves.

Subscribers receive supplementary or revised sheets automatically as they are issued and thereby have early intimation of new introductions.

The Handbook now comprises five volumes with the following contents:—

VOLUMES I and IA

Data on current Receiving and Amplifying Valves. Cathode Ray Tubes. Special Quality Types. Voltage Stabiliser and Reference Tubes. Cold Cathode Tubes. Small Thyratrons. Miscellaneous Valves and Tubes.

VOLUME 2

Data on earlier type Receiving and Amplifying Valves and Cathode Ray Tubes still in limited production for the maintenance of existing equipment.

VOLUME 3

Data on Power Valves for Transmitting and Industrial Equipment. Power Rectifiers. Large Thyratrons. Microwave Devices.

VOLUME 4

Data on semiconductor diodes, transistors, Photoconductive Cells and Photoelectric Cells.

For full details of this service, including subscription rates and application form, will be supplied on request.

We shall be pleased to meet you on Stand Z30A at the Radio Show where a copy of the Handbook may be inspected.

Mullard

Mullard Limited, T.S.D. Data and Publications Section,
Mullard House, Torrington Place, London, W.C.1.



MVM 406

Choosing the Best

ALTHOUGH this is not the only time of the year when new receivers are bought, there can be little doubt that the Radio Show stimulates many people to make a decision as to whether their old set (or new "hi-fi" outfit) will do for another year, or whether the new developments being talked about would justify them in making a change.

The layman in search of information and guidance need fear no lack of advisers. Through advertisements and sales literature the manufacturers will not be backward in plying him with facts and hyperbole calculated to persuade him that theirs is the one he will ultimately buy. If he lacks the technical knowledge to sift fact from fiction or is unwilling to buy merely because "the advertisement speaks highly of it" he may subscribe to one or more of the organizations which have recently sprung up to test goods bought on the open market and to report on them for the benefit of their members.

We would not deny the value of information derived from either of these sources. Manufacturers must be presumed to know as much about their own products as the next man. Not all of them are rogues; the information they give is always open to criticism; quite often it is found to be complete and true. The consumers guidance associations, on the other hand, are invariably disinterested and frankly outspoken both in praise and blame. (We suspect that a large proportion of their clientele is drawn from the ranks of manufacturers who take malicious delight in the discomfiture of their rivals!) But with the best will in the world they cannot always devise objective tests to reveal the qualities which may be decisive in making a choice. It is not so much the weight of glucose per shilling as the taste which will decide which brand of sweets we continue to buy, and if efficiency and value were the only criteria, women would be well advised to wear plain black dresses to absorb all the heat from the winter sunshine, and white to reflect as much as possible of it in summer.

A more serious possibility is that with the increase in the range of products surveyed there may be a tendency to be less careful in presenting the facts, particularly when complex products like broadcast receivers and tape recorders come to be dealt with. We have in mind the "Information Sheet No. 34, Tape Recorders," issued to subscribers by the Consumer Advisory Council of the British

Standards Institution, which seems to us to contain several ill-considered statements. We are told, for instance, that "A gar (*sic*) lever controls the motor for the forward and reverse winding of the spools." This at once suggests one or two particular makes and is unfair to the majority of manufacturers who have adopted other and no less effective forms of control. Neither is it fair to those makers who have succeeded in producing heads with shorter gaps and frequency responses up to more than 15 kc/s at 7½ in/sec to state that "heads are of much the same type and all are satisfactory" or that "15 in/sec is essential for hi-fi music." We are also told that "The *loudspeakers* incorporated in the machines vary in number as well as size. A really close comparison of this component can be made only by listening to the same recording on various machines." Too many variables other than the loudspeakers are involved when changing from one machine to another, and such a test would be valid only if equalization networks as well as heads were "of much the same type."

In other ways this first excursion of the Consumer Advisory Council into the electronics field is disappointing. It is claimed that the Council "is in a unique position. It can draw on the expert knowledge of B.S.I.'s technical officers. These 70 scientists and engineers have a close knowledge of all kinds of goods and methods of testing them." We suggest that the Council should call on their services forthwith—first for a revision of Information Sheet No. 34, and subsequently at an earlier stage in the preparation of any further bulletins which may be contemplated. Failing this we foresee the setting up of yet another organization to advise consumers on the choice of advisers!

It may well be that the best advisers are other users of the goods we contemplate buying and the Consumer Advisory Council endorse this idea by an analysis (in "Shoppers' Guide," No. 5) of replies to a questionnaire sent to owners of television sets. This provides some very interesting and valuable statistical information and from it the statistical average man might deduce the specification of the set which he *should* buy.

But we shall still see crowds of individuals flowing through the turnstiles at Earls Court intent on seeing for themselves, keeping their own counsel and ultimately buying for themselves the best set in the Show—the one they like.

Folkestone's Television Transmitter

CONVERSION FROM DOVER'S CHANNEL 2 TO CHANNEL 4 WITHOUT DEMODULATION

A NEW type of low-power television transmitter, known as a "translator," is undergoing extended service trials by the B.B.C. at Folkestone. This town is typical of small populated areas which are within or adjacent to the service areas of the main B.B.C. stations, but are prevented by surrounding hills from obtaining satisfactory reception.

A translator converts the sound and vision transmission frequencies from one channel to another without demodulation to audio and video frequencies, which occurs when a normal receiver and

transmitter relay installation is employed. This simplification increases the reliability of the equipment which can therefore be arranged for automatic operation without attendant staff. Because the equipment is small it can be housed conveniently in weather-proof and insect-proof cabinets of existing design, thus dispensing with the need for a station building. Power supply circuits are included in the steel cabinets so that the translator can work direct from the mains. Special precautions have been taken to provide sufficient cooling.

The translator must be on high ground where good reception is possible from an existing station in the network and from where its transmissions can be radiated over line-of-sight paths to the area to be served. In this way only a very low power output is required, which therefore does not add to the already serious co-channel interference problem. The Folkestone station, which receives Dover's Channel 2 transmissions, radiates in Channel 4 (vision 61.75 Mc/s, sound 58.25 Mc/s), and uses a directional aerial so as to provide the maximum signal strength in the town. The transmissions are horizontally polarized. It is expected that good reception will be provided for some 40,000 people living in Folkestone, but at some low-lying points in the shadow of the cliffs the signal will be weakened as a result of screening.

Fig. 1 shows the Folkestone translator at Creteway Down where the receiving aerial is in line-of-sight from the Dover B.B.C. television station and the transmitting aerial has a commanding position overlooking Folkestone. As can be seen, the receiving aerial system consists of a double 3-element array and the transmitting aerial has four tiers of single, folded dipoles.

If the sound and vision signals of a television system are amplitude modulated, difficulties are introduced if they share a common amplifier in the

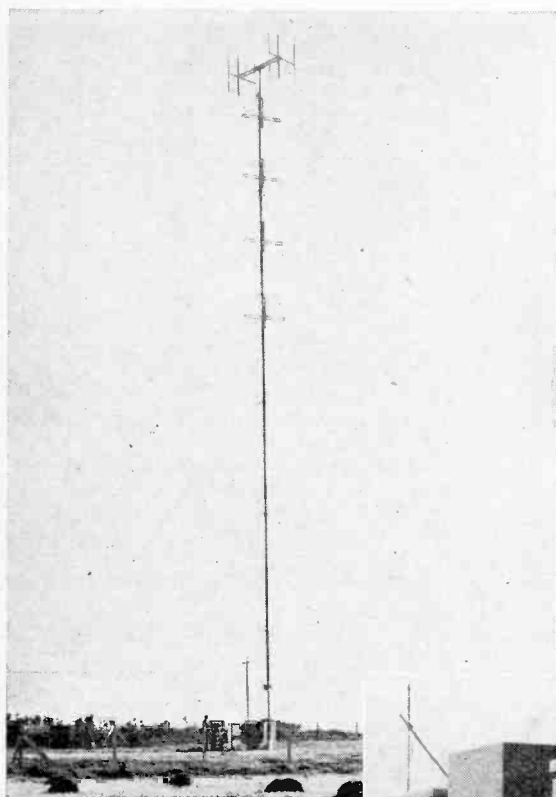
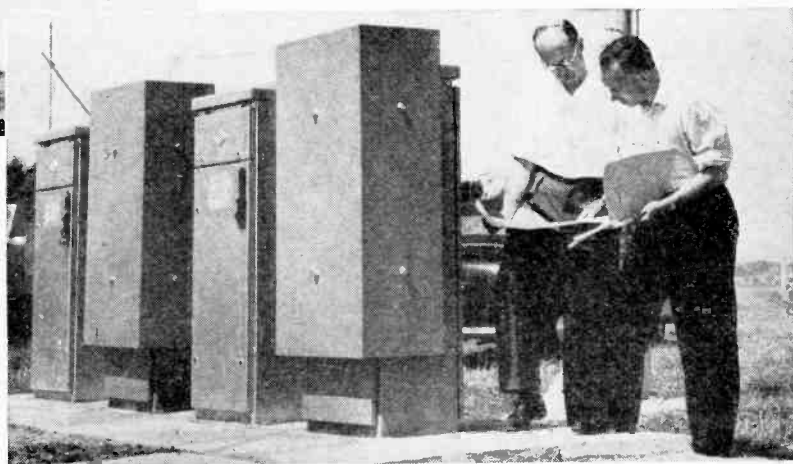

Fig. 1. A double 3-element vertical aerial is used for receiving the Dover transmissions and four tiers of single, folded horizontal dipoles for transmitting. The duplicated receiving and transmitting equipment is housed in cabinets at the base of the 120-ft mast.



translator because of the greater possibility of intermodulation. These difficulties are eased in systems such as those used on the Continent where the sound signal is frequency modulated. It is hoped that these and other difficulties have now been overcome with the system developed by the B.B.C. Fig. 2 shows a simplified schematic diagram from which it will be seen that in this equipment, separate channels have been provided for the amplification of the sound and vision signals using common frequency-changing oscillators. The separate channel arrangement reduces the risk of intermodulation and enables separate automatic gain control to be employed to combat the effects of differential fading between the sound and vision signals, which could occur if a translator were dependent upon reception from a really remote B.B.C. station. The automatic gain control voltages are also used to initiate an automatic changeover to reserve translator equipment should the normal unit become faulty.

The double frequency-changing process facilitates the rejection of spurious signals and provides additional protection against "in band" feedback. The first frequency-changing process resembles that in a normal television receiver, producing vision and sound intermediate frequencies of 34.65 Mc/s and 38.15 Mc/s respectively, and the second frequency-

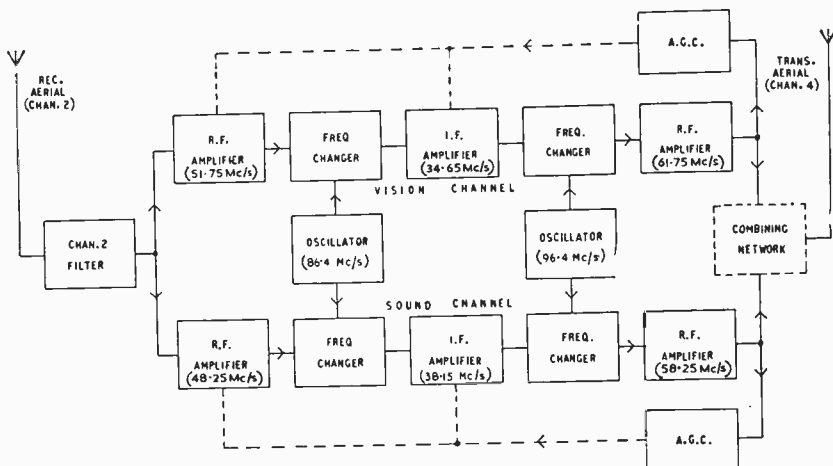

Fig. 2. Simplified schematic diagram of the translator which converts the sound and vision carriers from one channel to another without demodulation to audio and video frequencies.

changing stage produces vision and sound signal frequencies in the required channel.

The Folkestone translator peak white vision power output is 1.5 watts and, in conjunction with the type of transmitting aerial used, gives an effective radiated power of 7 watts in the direction of maximum radiation. It is hoped that the installation of similar low-power translators which have been developed by the B.B.C.'s Designs Department will enable at least some of the small populated areas in which satisfactory reception is difficult to be given an improved television service.

The B.B.C. also intends to develop translators to extend the v.h.f. sound broadcasting service to areas in which intervening high ground prevents direct reception from the main stations.

Unattended Studio at Southampton

A FEATURE of the new television interview studio at Southampton, brought into service by the B.B.C. at the end of July, is that all the vision and sound equipment is in the studio itself, which measures 18ft x 20ft. There is no separate control room and the lighting and transmitting equipment is switched on by the commentator. The camera itself contains the control unit together with an electronic viewfinder and a waveform monitor while a second unit handles the power supplies and pulse distribution circuits.

Detachable printed circuits and transistor sync pulse generator are features of the compact Vidicon camera developed by Marconi's, which is used in this studio.

Picture and sound signals from the studio in South Western House, Southampton, are relayed to the Rowridge, Isle of Wight, station by a radio link transmitter installed on the roof of the building and working in the 4,600 Mc/s band. At Rowridge the received signals can be switched either for local transmission from this station only or to London, via the Post Office link, for distribution over the complete B.B.C. television network. The changeover switching operation at Rowridge can

be carried out remotely from the B.B.C. Television Switching Centre in London.

Marconi Vidicon camera used in the unattended studio at Southampton. Its overall measurements are 19in long, 16½in high and 12¼in wide.

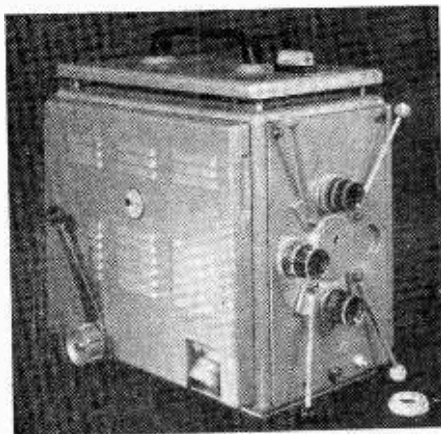

WORLD OF WIRELESS

An American Tribute

"FOR their basic development which provided the first useful high-power pulsed microwave magnetron and which established the fundamental principles upon which all later developments in this field were based," the three British inventors of the cavity magnetron, Dr. H. A. H. Boot, Professor J. T. Randall, F.R.S., and Professor J. Sayers have been awarded the John Price Wetherill medal of the Franklin Institute.

Dr. Boot, who was at Birmingham University where Professor Sayers occupies the chair of electron physics, is now at the Services Electronics Research Laboratory, Baldock. Professor Randall is Wheatstone Professor of Physics in London University (King's College).

In 1949 they received £36,000 from the Royal Commission on Awards to Inventors for the development of the cavity magnetron.

Cabinet Styling

EIGHTY manufacturers of cabinet materials and "embellishments" are participating either directly or through representatives in the second three-day cabinet styling exhibition being arranged by the British Radio Equipment Manufacturers' Association. It will be held in the South Hall, Victoria Halls, Bloomsbury Square, London, W.C.1, from October 7th to 9th. Admission will be restricted to *bona fide* trade visitors.

Two New Editions

THE sixth edition of "Radio Valve Data," just out, has been made easier to use by including the base connection codes in the index, along with the page numbers and equivalents. This is helpful to the user when he wishes to look up only the base connections of a valve and not its full characteristics. The book has been enlarged and brought up to date and now includes over 80 transistors amongst the 3,000 entries of valves, cathode-ray tubes and rectifiers. It is still, however, at the same price of 5s (or 5s 9d by post), and can be obtained from book-sellers or direct from our Publishers, Iliffe and Sons Ltd., Dorset House, Stamford Street, London, S.E.1.

The annual revision of "Guide to Broadcasting Stations" is an essential, if formidable, task and some hundreds of additions and amendments have been made in preparing the 11th edition, which is now available. All the 750 long- and medium-wave stations in Europe and well over 2,000 short-wave broadcasting stations of the world are listed both in order of frequency and geographically. The carrier frequencies listed have been checked against measurements made at the B.B.C. Receiving Station, at Tatsfield. This 80-page *Wireless World* book, which also lists the carrier frequencies of the v.h.f. sound and television stations in the U.K., costs 2s 6d (postage 5d).

London River Radar

THE Port of London control point at Gravesend, where Customs and Port Health Authorities grant *pratique* and where sea and river pilots change over on the 160 ships which, on an average, pass through this area every 24 hours, is to be equipped with radar. This installation, which is part of a new Thames Navigation Service, will provide the P.L.A. with a complete picture of the Gravesend Reach over some five miles of river.

The Decca harbour radar, Type 33, which is being installed in duplicate, employs a 6-foot parabolic reflector with a vertical aperture of 20in providing a horizontal beamwidth of 1.2° and a vertical beamwidth of 20°. The P.P.I. display can be off-centred to five times the radius of the normal 1.5-mile range scale.

The new service, which is planned to be operational by next May, will make use of the recently adopted v.h.f./f.m. marine radio frequencies for co-ordinating the movements of ships. The radio equipment will be provided by Pye and all R/T communications will be tape recorded on B.C.C. equipment.

I.E.E. Conventions

TWO conventions are being planned by the Radio and Telecommunication Section of the I.E.E. for early next year. The first, which will be held on January 29th and 30th, will cover "long-distance transmission by waveguide." There will be six technical sessions covering theory and performance, measurement techniques, special microwave equipment, construction, and aspects of possible systems.

In May a five-day international convention on transistors and associated semiconductor devices is being arranged. Invitations have been sent to Dr. W. B. Shockley, Professor J. Bardeen and Dr. W. H. Brattain (who together developed the transistor when working at the Bell Telephone Laboratories) to deliver the opening lectures at the convention. The range of subjects planned to be covered includes design, manufacture, materials, basic theory, characteristics, measurements, applications and equivalent circuits. An international trade exhibition of transistors and other semiconductor devices is being organized in conjunction with this convention.

Both conventions will be open to non-members. Enquiries regarding registration forms and the submission of papers should be sent to the I.E.E., Savoy Place, London, W.C.2.

Brit.I.R.E. Awards

THE premier award of the British Institution of Radio Engineers, the Clerk Maxwell Premium (20 gns.), is being given to Dr. T. B. Tomlinson for his paper "Principles of the Light Amplifier and Allied Devices," which was based on work carried out at the G.E.C. Research Laboratories. He is now with Computer Developments, Ltd.

The Heinrich Hertz Premium (20 gns.) for the most

outstanding paper on mathematical and physical aspects of radio has been awarded to R. A. Waldron, of Marconi's Baddow Research Laboratories, for "Theory of the Helical Waveguide of Rectangular Cross-section."

For the second year in succession the Louis Sterling Premium (15 gns.) for the most outstanding paper on television technique has been awarded to Dr. Ir. A. van Weel, of Philip's Research Laboratories, Eindhoven. His paper was entitled "The Design of Phase-Linear Intermediate-frequency Amplifiers."

For his paper on "The TALBE—a V.H.F. C.W. Radio Aid for Air/Sea Rescue," W. Kirylyuk (Burndept) receives the Brabazon Premium (15 gns.) for the most outstanding paper on radio aids to aircraft safety.

D. H. O. Allen and J. M. Winwood, of the Mullard Research Laboratories, share the Marconi Premium (10 gns.) for their paper "A Low-noise Travelling-wave Tube Amplifier for the 4000-Mc/s Communications Band."

For the most outstanding paper on improvements in reception techniques, the Leslie McMichael Premium (10 gns.) is awarded jointly to A. F. Wilkins and E. D. R. Shearman, of the Radio Research Station, Slough, for their paper "Back-Scatter Sounding: An Aid to Radio Propagation Studies."

Physical Society Conferences.—Two conferences are being organized by the Physical Society for September. The first from 17th to 20th at the University College of Swansea, will be devoted to gas discharges; and the second, on 24th and 25th at the University of Durham, to cosmic rays. The Society is also arranging a winter conference which will be held in the Cavendish Laboratory, Cambridge, from December 18th to 20th. The subject will be interfacial phenomena. Further particulars of the conferences are obtainable from the Society at 1 Lowther Gardens, Prince Consort Road, London, S.W.7. Investigators wishing to contribute papers at the winter conference should write to Professor N. F. Mott, Cavendish Laboratory, Cambridge.

Electronic Standards.—A conference on electronic standardization and measurements was held at the Boulder, Colorado, Laboratories of the National Bureau of Standards from August 13th to 15th under the joint sponsorship of the N.B.S. and the American I.E.E. and I.R.E. The conference, during which the Bureau's new Electronic Calibration Centre was dedicated, was devoted to new developments, techniques and problems of measurement.

Video Tape Standards.—The U.S. Society of Motion Picture and Television Engineers has set up a video tape-recording engineering committee "to propose standards and good engineering practices for the construction, operation and measurement of video tape recording and reproducing equipment and for those video tape or other characteristics which affect performance and interchangeability."

Derby Radio Show.—The eighth annual radio show organized by the Radio and Television Retailers' Association in Derby will be held in the Drill Hall, Becket Street, from September 17th to the 22nd. Ten local firms are participating and the B.B.C. is also taking space.

European Amateurs.—Representatives of amateur organizations in fifteen European countries, forming Region 1 of the International Amateur Radio Union, met at Bad Godesberg, Germany, in July. At the meeting John Clarricoats (U.K.) and Major Per-Anders Kinnman (Sweden) were elected to represent the amateurs of the Region at next year's Geneva conference of the International Telecommunication Union.

Old Timers' Dinner.—John Clarricoats, R.S.G.B. general secretary, is arranging a dinner for amateurs who have held a full P.M.G. licence in the U.K. continuously since January, 1933. It will be held at the Horse Shoe Hotel, Tottenham Court Road, London, W.C.1, on October 10th.

TV in Orkneys and Caithness.—In order to provide a television service in the Orkneys and Caithness before the proposed permanent stations are completed, the B.B.C. is to provide temporary installations both at Kirkwall (Pomona) and Wick, which it is hoped to complete early in the new year. As previously announced both permanent stations will provide a combined television and v.h.f. sound broadcasting service. The Wick station is to fulfil the dual purpose of relaying the signals to the Orkney station and providing a service for listeners and viewers in Caithness. A temporary v.h.f. sound transmitter will also be provided in Orkney to relay the Scottish Home Service from the v.h.f. station at Meldrum, but it is understood it will not be possible to provide a temporary v.h.f. sound transmitter at Wick.

Northern V.H.F. Station.—The B.B.C.'s fourteenth permanent v.h.f. sound broadcasting station, built on the same site as the television station at Sandale, near Carlisle, came into service on August 18th. It has the distinction of being the first v.h.f. sound broadcasting station in the world to radiate four simultaneous programmes from a single aerial array. The frequencies (Mc/s) are 94.7 (Northern Home Service), 92.5 (Scottish Home Service), 90.3 (Third Programme) and 88.1 (Light Programme) and the effective radiated power on each carrier is 120 kW. Its service area includes most of Cumberland and Westmorland and most of the Scottish counties of Wigton, Kirkcudbright and Dumfries.

I.T.A. Southern Transmitter.—After nearly a month's full-power test transmissions the I.T.A.'s seventh television transmitter, at Chillerton Down, Isle of Wight, opens on August 30th. This is the first U.K. transmitter to operate in Channel 11 (vision 204.75 Mc/s, sound 201.25 Mc/s). It employs a directional aerial giving a vision e.r.p. of from 10 to 100 kW. Its transmissions, like those from the B.B.C. station at Rowridge, are vertically polarized.

Associated Television, Ltd., the I.T.A. programme contractors, recently announced the distribution of £21,000 to the Arts and various bodies "concerned with the technical crafts in television." The Brit.I.R.E. is to receive £400 per annum for 7 years, the Television Society receives 250 gns., and the British Kinematograph Society 250 gns.

Receiving Licences.—During the year ended in June the number of combined sound and television licences in the U.K. increased by 1,083,796 and the number of sound-only licences decreased by 1,013,867, giving an overall increase of about 70,000. The totals at the end of June were: combined television and sound licences 8,253,305, and sound-only licences 6,405,076 including 345,984 for car radio.

B.S.R.A.—R. W. Lowden, who for many years was honorary secretary of the British Sound Recording Association and is the 1958/59 president, will deliver his presidential address at the meeting on September 19th at 7 at the Royal Society of Arts, John Adam Street, London, W.C.2.

I.B.C. "At Home."—The International Broadcasting Co., in association with the British Sound Recording Association and Lockwood & Co., are organizing an exhibition of professional recording and reproducing equipment at the headquarters of the Universal Programmes Corporation (an I.B.C. division), 35 Portland Place, London, W.1, from September 26th to 28th. Tickets are obtainable free from the organizers.

Electronics in the Office.—A number of firms exhibiting at the Business Efficiency Exhibition, which is being held in the City Hall, Manchester, from September 22nd to 27th, are showing radio and electronic aids to office efficiency.

Welsh TV.—On August 8th the vision e.r.p. of the B.B.C. low-power television transmitter at Blaen-Plywyf, near Aberystwyth, was doubled to 2 kW.

British Association Meeting.—Two sessions during the 120th annual meeting of the British Association for the Advancement of Science, which opens in Glasgow on August 27th, are being devoted to electronic and radio subjects. On August 29th three papers on the use of electronic computers will be introduced by Dr. A. D. Booth, speaking on "Prospects and Probabilities in Electronic Data Processing." On September 2nd Dr. R. L. Smith-Rose, Dr. B. G. Pressey and Caradoc Williams will contribute to the session on the use of radio waves for position-finding and navigation.

A.F.C.E.A.—The first meeting of the 1958-59 session of the London Chapter of the Armed Forces Communications and Electronics Association will be held on September 23rd at the Columbia Club, London, W.2. The speaker will be Brig. Gen. W. D. Hamlin, Signals Officer, U.S. Army in Europe. The new president of the Chapter is Capt. H. Williams (U.S.N.). In addition to four American vice-presidents on the Council of the Chapter there are four British vice-presidents: H. Chisholm (Cossor), H. G. A. Kay (Benjamin), Sir Reginald Payne-Gallwey, and F. C. Wright (S.T.C.).

Radar & Electronics Association meetings will now be held at the Royal Society of Arts, John Adam Street, London, W.C.2. The first meeting of the new session will be held on September 23rd, when J. Moir (B.T.H.) will speak on "The Three Esses—Stereophonic Sound Systems."

Five courses in pulse techniques are planned by the Department of Electrical Engineering and Physics of the Borough Polytechnic, London, S.E.1, during the coming session. A 12-week laboratory course in pulse techniques will be held on Monday evenings beginning September 22nd, and repeated on Thursday evenings from September 25th (fee £1). A course of 22 lectures on the fundamental principles of pulse techniques begins on Monday, September 29th. The lectures will be given at 3.0 and repeated at 7.0 (fee 50s). An all-day 23-week lecture-laboratory course covering the theory and design of pulse circuits will be given on Wednesdays, commencing October 1st (fee 50s). There are also short evening courses (six lectures) on storage systems for digital computers commencing October 24th (fee 15s), and another on pulse communication systems (commencing January 23rd).

For electronic technicians interested in biological and medical subjects there are opportunities for doing advanced development work at any of the seventy research establishments of the Medical Research Council. Details of salary scales, qualifications required, conditions of work, further training and terms of service are given in a booklet "Technical Careers in the Medical Research Council" which can be obtained free from the M.R.C. at 38, Old Queen Street, London, S.W.1. The booklet also contains a list of the Council's establishments in Britain and abroad.

E.E.G. Recordists.—The next training course for E.E.G. recordists organized by the Electro-Physiological Technologists Association will commence in November. It will be of ten months' duration and will be held in London. Particulars are obtainable from J. C. Shaw, Graylingwell Hospital, Chichester, Sussex, secretary of E.P.T.A.

EDITORIAL ASSISTANT WANTED

Our sister journal *Electronic & Radio Engineer* invites applications for a post as editorial assistant. The duties are of a varied nature and call for an ability to write clearly as well as a wide technical knowledge. A good background of general physics is desirable and experience in radio and electronics is essential.

Applications should be addressed to the Editor, *Electronic & Radio Engineer*, Dorset House, Stamford St., London, S.E.1.

Insignia Award in Technology.—During the six years since the City and Guilds of London Institute inaugurated the scheme under which the Insignia Award in Technology (C.G.I.A.) is conferred, over 100 have been gained. Among the holders are a number in the radio and electronics industry and this year's recipients include K. G. Beauchamp, whose thesis was "Resonant Return or Efficiency-diode Scanning Circuits"; and P. W. Seymour ("A Critical Review of Methods used in the Field of Linear Network Analysis").

Post-Graduate Courses.—A number of special courses for advanced students are being offered by the Hendon Technical College during the 1958/59 session. Among them are a six-lecture evening course on transistors (commencing October 13th), eight lectures on transistor applications (evenings, commencing January 19th), a twenty-four lecture afternoon course beginning September 24th on electronic measurements, and a twelve-lecture evening course on electronic digital computing (commencing September 24th). The fee for each course is £1.

Courses of study in preparation for the Radio Amateurs' Examination are being organized at a number of further education establishments including the Wembley Evening Institute (Mondays, commencing September 22nd); Islington L.C.C. Men's Evening Institute, Montem School, Holloway, London, N.7 (Mondays and Wednesdays, commencing September 22nd); and the Openshaw Technical College, Manchester, 11 (Tuesdays, commencing September 23rd).

Personalities

The Earl of Halsbury is to retire next March from the managing directorship of the National Research Development Corporation, which he has held since the establishment of the Corporation under the Development of Inventions Act, in 1949. Lord Halsbury, who was only 40 when he accepted the appointment, brought to the new organization a considerable experience in industry, both on the research and administrative sides. He is president of the Institution of Production Engineers and is vice-president of the Parliamentary and Scientific Committee.

O. W. Humphreys, C.B.E., B.Sc., M.I.E.E., has been appointed chairman of the P.M.G.'s advisory committee on radio interference from ignition apparatus in succession to Sir Stanley Angwin, who has retired owing to ill health. The P.M.G. has also appointed W. Nethercot, M.A., B.Sc., F.Inst.P., to be a member of the committee. Mr. Humphreys, who has been director of the G.E.C. Research Laboratories since 1951, is also chairman of the committee set up to advise the P.M.G. on interference from industrial, scientific and medical equipment. He was elected chairman of the International Special Committee on Radio Interference (C.I.S.P.R.) in 1953.

Professor J. D. McGee, O.B.E., M.Sc., Ph.D., A.M.I.E.E., who has occupied the Chair of Instrument Technology at the Imperial College of Science and Technology, London, since its establishment four years ago, has been granted £2,000 by the Paul Instrument Fund Committee of the Royal Society "to enable him to construct a television system for X-ray image intensification." Dr. McGee graduated B.Sc. (maths and physics) from Sydney University where, continuing his physics research, he took his M.Sc. degree in 1928 and was awarded a research scholarship to Clare College, Cambridge, where he worked until 1931 on atomic physics in the Cavendish Laboratory under the late Lord Rutherford. The following year he joined E.M.I. where he remained until his appointment by London University to his present professorship. Whilst at E.M.I. he was concerned mainly with the development of television camera tubes.

Nyman Levin, Ph.D., B.Sc.(Physics), Chief of Research and Development with Rank Precision Industries since 1955, has been appointed deputy director of the Atomic Weapons Research Establishment. Dr. Levin, who is 52, was with Marconi's from 1930 to 1940, when he was seconded to the Admiralty. Whilst in the Royal Naval Scientific Service he was initially concerned with the development of microwave valves and later was responsible for the establishment of cross-channel v.h.f. links in preparation for the Normandy landings. Soon after the war he became head of the Instrumentation Group at the Admiralty Research Laboratory and in 1951 was appointed superintendent of the Admiralty Gunnery Establishment. At Rank's Dr. Levin has been concerned with the development and applications of xerography.

Major H. Stanley Prince, M.B.E., M.C., M.Brit.I.R.E., has retired from the Inspectorate of Electrical and Mechanical Equipment of the Ministry of Supply, and has joined the boards of the Cossor Communications Company and Cossor Instruments and is acting as commercial consultant to the Cossor Group. After service in the Royal Engineers (Signals) in the first world war he entered the radio industry in 1922 and exhibited his own receivers at the first National Radio Exhibition in London. He later joined the Burndept organization, becoming managing director of several of its subsidiaries. In 1932 he formed the National Radio Service Company with Capt. P. P. Eckersley. Major Prince went to the War Office inspectorate before the last war and since the end of the war has been deputy director of the M.o.S. Inspectorate of Electrical and Mechanical Equipment.



P. W. Faulkner, O.B.E., general manager of the Chemical and Metallurgical Division of the Plessey Company Limited at Towcester, Northants, since 1953, has been appointed a director and general manager of Plessey International Limited. Mr. Faulkner, who joined the company in 1952, remains an executive director of The Plessey Company Limited and a director of Technical Ceramics Limited, well known in the piezo-electrics field.

K. Elphinstone, M.B.E., who, for several years after the war was in the B.B.C.'s Planning and Installation Department, has been appointed export manager of E.M.I. Electronics, Ltd. During the war he served with R.E.M.E. on radar and telecommunications, rising to the rank of Major.

E. F. Dunkin, Grad.I.E.E., until recently in the components division of Fortiphone, Ltd., has been appointed by Venner Electronics, Ltd., as their U.K. sales engineer, responsible for technical liaison and sales promotion of the Venner range of transistorized packaged units and test equipment.

G. E. Sugden, since 1951 assistant manager of the Aeronautical Department of the Sperry Gyroscope Company which he joined in 1947, has been appointed sales manager of Ketay, Limited, of Romford, Essex, manufacturers of synchros and servo components. Before joining Sperry, he was in the Applications Section of the M.O. Valve Company's Development Laboratory, and during the war served in the R.A.F. Radar Branch.

H.C. Rylatt, A.M.Brit.I.R.E., has taken over control of the research and development laboratory of the Dulci Co., which he joined in 1956.

Dennis Gabor, F.R.S., D.Eng., Mullard Reader in Electronics at the Imperial College of Science and Technology, Kensington, has been appointed to the London University chair of applied electron physics tenable at Imperial College. Dr. Gabor came to this country from Hungary in 1934 and worked until the end of 1948 in the research laboratory of the B.T.H. Company, Rugby, during which time he was engaged on communication theory and speech-frequency band compression. He has been at Imperial College since 1949, where, during the past few years he has been developing, with the financial support of the National Research Development Corporation, the flat television c.r. tube described in our December, 1956, issue.

W. J. G. Beynon, Ph.D., D.Sc., A.M.I.E.E., senior lecturer at University College, Swansea, has been appointed to the chair of physics at Aberystwyth University College. Dr. Beynon, who is a member of the U.K. Committee of the International Scientific Radio Union—being particularly concerned with radio-wave propagation, is secretary of the Joint International Commission on the Ionosphere. He is also a member of the International Geophysical Year Committee.

C. Buckle, A.M.I.E.E., appointed engineer-in-charge of the B.B.C.'s Droitwich transmitting station in succession to D. A. G. Curd, A.M.I.E.E., has been with the Corporation since 1938. After four years as a maintenance engineer, Mr. Buckle transferred to the Engineering Training Department as an instructor on transmitters. Since 1951 he has been engineer-in-charge of the Holme Moss television station. Mr. Curd, who joined the B.B.C. in 1924, had served as engineer-in-charge at a number of the Corporation's stations before going to Droitwich in 1951.

OUR AUTHORS

K. C. Johnson, M.A., who writes "On Understanding Transistors" on page 429, studied physics and radio physics at the University of Cambridge from 1945 until 1951, when he joined the computer department of Ferranti in Manchester. Since then he has been engaged on problems of basic circuitry and principles of computer design. He has recently been concerned with the adaptation of known circuit principles for use with transistors and the evaluation of their fundamental limitations in comparison with those of valves. His previous contributions to *Wireless World* were on a single-valve a.f. oscillator (1948) and single-valve f.m. oscillators (1949).

T. Worswick, M.Sc., A.M.I.E.E., contributor of the article on a television standards converter, has been in charge of the television apparatus section of the Engineering Designs Department of the B.B.C. for the past ten years. He joined the Corporation as a student apprentice in 1935 and, except for the war years, has been engaged on television work.

Sidney Morleigh, A.M.I.E.E., A.M.Brit.I.R.E., who describes a potentiometer tester in this issue, was from 1956 until recently in the Research Division of Powers-Samas Accounting Machines where, as a senior research engineer, he worked on various digital computer projects and investigated the properties of storage materials. He is now with the Sperry Gyroscope Company. After war-time service with R.E.M.E. he joined Cossor's Research and Development Division in 1948. During part of his six years with the company he was concerned with the development of airborne radar equipment. From 1954 to 1956 he was with the Fairey Aviation Co., where he was engaged on various problems related to analogue computers.

OBITUARY

Guy Campbell, chairman and joint managing director of Benjamin Electric for 47 years, died on August 4th in his 72nd year.

National Radio Show

PREVIEW OF TECHNICAL EXHIBITS

THIS year's Silver Jubilee National Radio Show opens to the public on August 27th. The introduction of a section devoted exclusively to sound reproduction equipment has considerably increased the number of exhibitors. Many manufacturers are exhibiting in both the Main Hall and the Audio Hall on the first floor in which stands are numbered 401 onwards. In addition to the sound-insulated demonstration rooms on these

stands, there are also a number of office/demonstration rooms and these are prefixed with "Z."

We give in the following pages a preview of the technical exhibits compiled from information available at the time of going to press. The stands in the Audio Hall are covered in a separate section at the end. In the October issue we shall give an assessment of trends in the design of equipment as portrayed at the Show.

ALPHABETICAL LIST OF EXHIBITORS

Aerialite	Stand 5	Channel	Stand 213	Ferranti	Stand 21 (Z21)
Alba	37	Collaro	35	Fidelity Radio	54
Ambassador	26 (Z3)	Cossor	10 (Z34)	Fortiphone	106
Antiference	22	Dallas	223 (Z26 & 27)	Fund for the Blind	313
Argosy	39	Decca	25 (Z2)	G.E.C.	8 (Z35)
Avo	60	Defiant	1	G.P.O.	312
B.B.C.	301, 302 & 303	Design Furniture	119	Garrard	51
B.M.B.	122	Domain	110	Goodmans	34
B.R.C.	118	Dubilier	55	Grunther	220
Barclays Bank	101	Dynatron	46	H.M.V.	33 (Z9)
Belling-Lee	49	E.A.R.	62	Hartique	227
Bernards	126	E.M.I. Institutes	308	Hill	217
Bowmaker	211	E.M.I. Records	111	Hobday	121 (Z10)
British Radio & Television		E.M.I. Sales & Service	48 (Z11)	Hunt	47
<i>Retailing</i>	124	Econasign	225	I.T.A.	310
British Railways	112	Ekco	29 (Z8)	Invicta	2 (Z19)
Broomhall Joinery	103	Electrical & Radio Trading	123	J-Beam Aerials	14
Bulgian	56	Ever Ready	16	Johnsons	109
Burwell	219	Ferguson	17 (Z36)	K.B.	43
Bush	3 & 27 (Z24)			Keith Prowse	69
"Careers"	309			Kerry's	23
Champion	206				

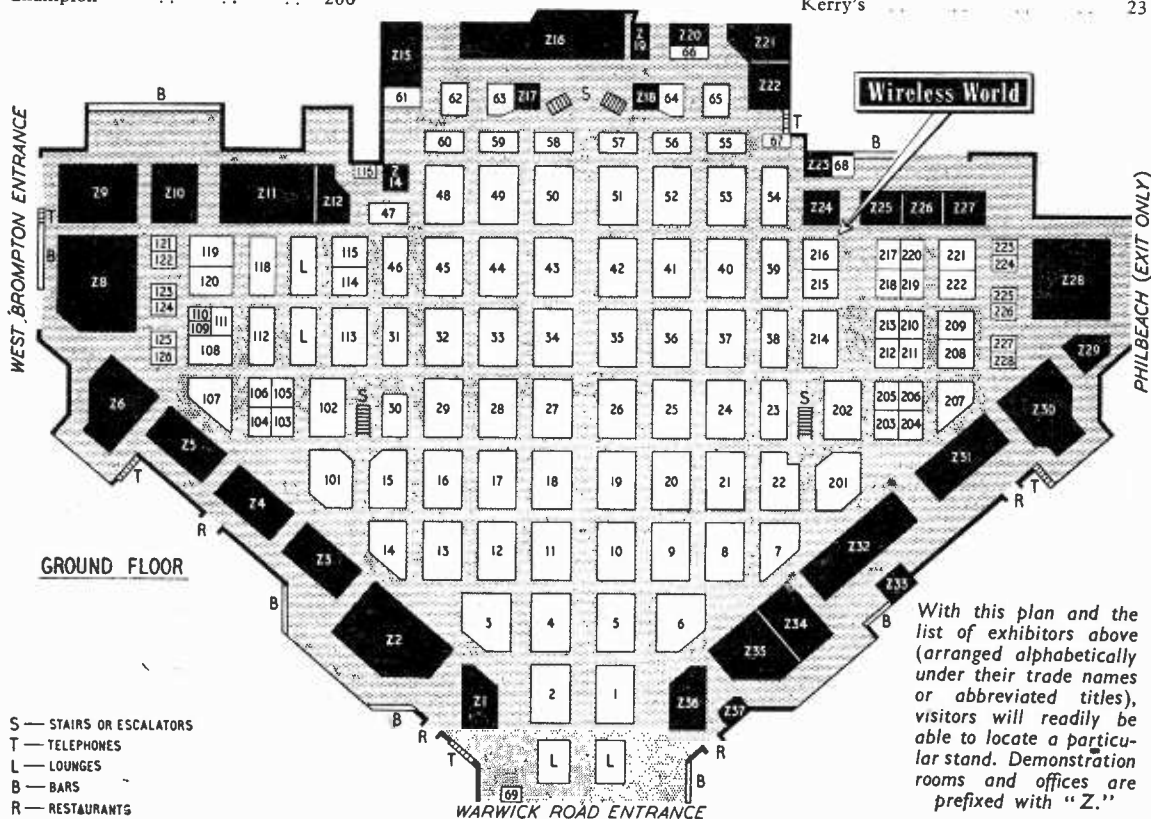

	Stand
Labgear	31
Le Grest	67
Linguaphone	205
Lloyds Bank	7
Lugton	226 (Z5)
McMichael	42
Marconiphone	45
Masteradio	4
Meadow-Dale	105
Mercantile Credit	210
Midland Bank	201
Mullard	41 (Z28, 29 & 30)
Multicore	63 (Z14 & 17)
Murphy	11 (Z1)
N.I.D.	307
National Provincial Bank	102
Navy	305
Noble Lowndes	224
Pam	6 (Z33)
Perdio	65
Perth	204
Peto Scott	12
Philco	19
Philips	52 & 53 (Z16)
Pilot	28
Plessey	66 (Z20)
Plus-a-Gram	107
Portogram	58
Practical Wireless	108
Pye	44 (Z6)
R.A.F.	304
R.G.D.	24 (Z32)
R.S.G.B.	306
R.T.R.A.	207
Record Housing	104
Regentone	9
Roberts	57
Rola Celestion	30
Ruco	120
S.T.C.	18 (Z4)
Siemens-Ediswan	40 (Z31)
Slingsby	215

	Stand
Sobell	50 (Z15)
Spencer-West	218
Stella	13
T.C.C.	59 (Z22)
Taylor	212
Telection	36
Telesurace	214
The Star	311
Thompson, Diamond & Butcher	15
Ultra	20 (Z37)
Valradio	61

	Stand
Veritone	68 (Z23)
Vidor	32 (Z25)
Walter Instruments	115 (Z12)
Waveforms	228
Westinghouse	114
Westminster Bank	113
Whiteley Electrical	64 (Z18)
Winston Electronics	125
Wireless & Electrical Trader	203
Wireless for the Bedridden	116
Wireless World and Electronic & Radio Engineer	216
Wolsey	38

AUDIO HALL (First Floor)

	Stand
Acos	444
Alba	427
Audiomaster	436
Avantic	448 (Z452)
B.T.H.	437 (Z458)
Brenell	440
C.Q. Audio	411
Champion	439
Clarke & Smith	403
Collaro	414
Cossor	404
Decca	425
Dynatron	413
E.A.P.	416 (Z455)
E.A.R.	431
E.M.I. Sales & Service	415
Ekco	442
Electronic Reproducers	417
Emistructor	401
Expert Gramophones	424 (Z454)
Ferguson	432
Ferranti	446

	Stand
G.E.C.	443
Garrard	438
Grammans	434
Gramophone Record Review	406
Grampian	435 (Z453)
Hi-Fi News	407
Jason	441 (Z456)
K.B.	402
Lustraphone	445
Magnafon	419
Philco	449
Philips	425
Pilot	428
Portogram	412
Print & Press Services	405
R.C.A.	447 (Z451)
Reflectograph	418
Richard Allan	430
Rola Celestion	410
Scientific & Technical Developments	433
Sonomag	426
Soundrite	409
Tape Recorders	420 (Z457)
Truvox	421
Walter Instruments	429
Whiteley Electrical	422 (Z459)

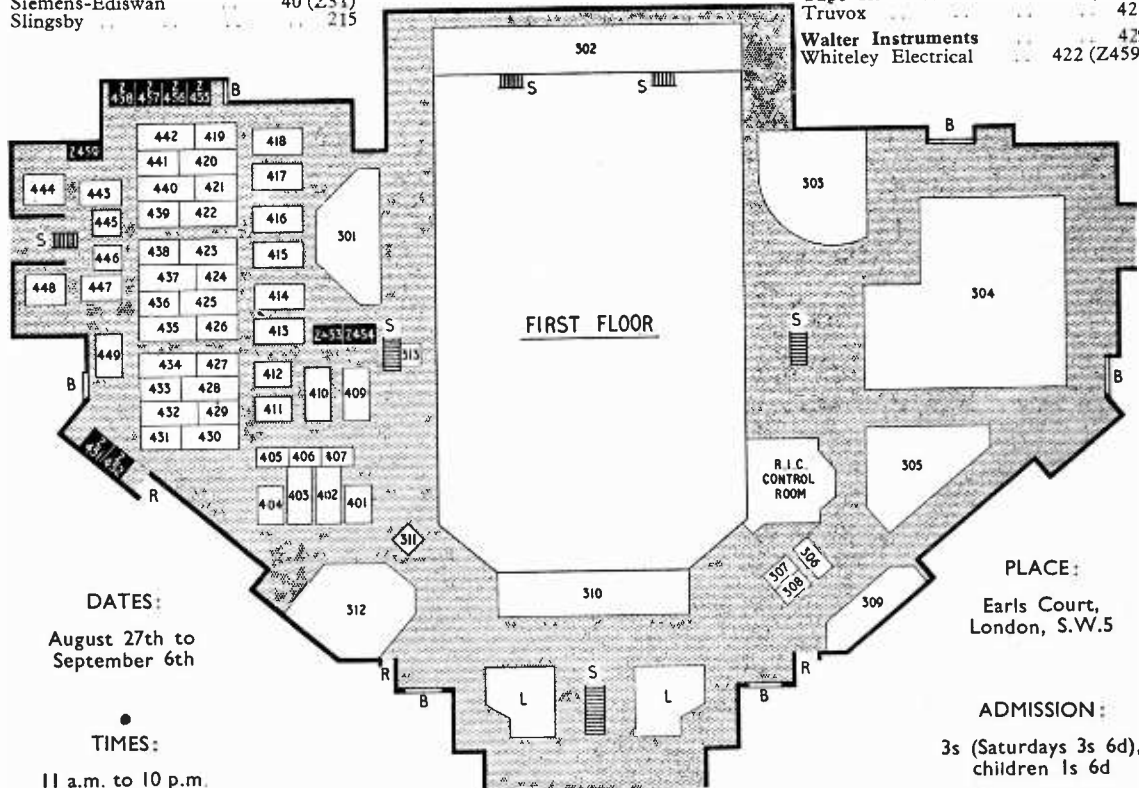

DATES:
August 27th to
September 6th

TIMES:
11 a.m. to 10 p.m.

PLACE:
Earls Court,
London, S.W.5

ADMISSION:
3s (Saturdays 3s 6d),
children 1s 6d

NATIONAL RADIO SHOW

Guide to the Stands

AERIALITE (5)

The main emphasis on this stand will be on the well-established range of dual-band television aerials employing "Crosslink" connection. Most of this range have independently adjustable I.T.A. and B.B.C. directivity. Announced also is a new TV "in-the-room" aerial claimed to be suitable for most normal service areas. A full range of cables and installation components will be exhibited.

Aerialite, Ltd., Castle Works, Stalybridge, Cheshire.

ALBA (37)

Packaged construction, as used in industrial and military equipment, has been applied to the T655 17-inch television receiver as an aid to servicing and a means of cutting production costs. The set divides into four separate units, and 90% of the circuitry is on two plug-in printed panels which can be replaced without soldering. An exchange scheme of circuit panels is being operated.

A complete range of other television sets, sound receivers, record

players and radio-grams will also be on view.

A. J. Balcombe, Ltd., 52-70 Tabernacle Street, London, E.C.2.

AMBASSADOR (24)

A highlight of this exhibit is the "Wondergram" miniature record reproducer measuring $8\frac{1}{2}$ in \times $4\frac{1}{2}$ in \times $1\frac{1}{2}$ in and weighing 2lb. It has no turntable yet is able to reproduce from 7-in, 10-in or 12-in records at 33 or 45 r.p.m. It has a 2-stage transistor amplifier with printed circuit and a 3-in loudspeaker. Transistors are used also in the "Gipsy" 3-speed, 3-stage portable record reproducer.

Two mains-operated record reproducers are included, one a standard model for single-channel reproduction with 2-stage amplifier and automatic record changer; the other has the same general specification but with provision for stereophonic reproduction using external equipment. The additional amplifier is available as a separate matching unit.

Ambassador Radio and Television, Ltd., 39, Dover Street, London, W.1.

aerials; also installation components and accessories.

Antiference, Ltd., Bicester Road, Aylesbury, Buckinghamshire.

ARGOSY (39)

A new 17-inch television set designed for fringe-area reception is the 17F41 table model. It has high sensitivity, a low-noise turret tuner and flywheel sync.

Up to 10 records of any size in any order at any one speed can be played on the four-speed auto changer of the AP7 record player. Co-ordinated bass and treble controls are provided and the $6\frac{1}{2}$ -inch speaker gives 5 watts output.

Argosy Radiovision, Ltd., Eastern Avenue West, Romford, Essex.

AVO (60)

The principal exhibit is the small-size "Multiminor" Universal test meter which uses a number of printed resistors built into the range-selector switch. The Type 378 a.m. signal generator covering 2 to 225Mc/s also shown is useful for narrow-band work as at 30% a.m. the spurious f.m. is less than 5kc/s. Other a.m. and f.m. signal generators are included in the wide range of Avo test and coil-winding equipment.

Avo, Ltd., 92-96, Vauxhall Bridge Road, London, S.W.1.

B.B.C. (301, 302, 303)

The B.B.C. contribution to the exhibition is in three distinct sections. Stand 301 is a television celebrity dais, stand 302 is the information centre, a section of which is devoted to a display of equipment used in both the sound and television services, and stand 303 is an audio theatre. The theatre is being used primarily to demonstrate the advantages of v.h.f. sound broadcasting. The demonstrations also include examples of sound effects, and closed-circuit television equipment is used to enable visitors to see more clearly what is going on on the stage.

British Broadcasting Corporation, Broadcasting House, London, W.1.

B.M.B. (122)

The centre of interest on this stand is the very wide range of sapphire styli now produced for all the principal makes of gramophone pickups. This firm also make miniature ball-bearings and minute rivets and parts for the radio and electronics industries.

British Manufactured Bearings Co. Ltd., High Street, Crawley, Sussex.

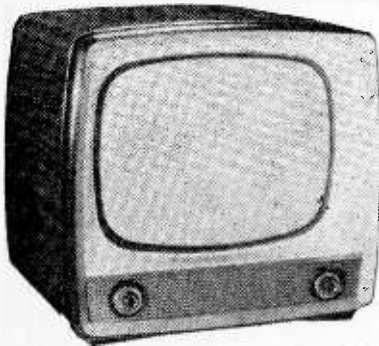

Bush TV77 "Twin Set" receiver.

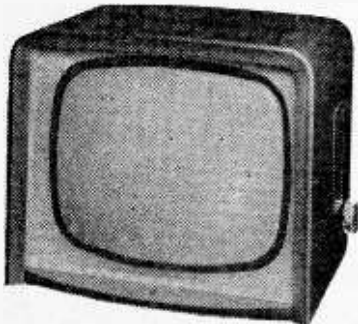

Alba "packaged" television set, T655.



Antiference "Vantenna" Band I/II/III "in-the-room" aerial.

ANTIFERENCE (22)

A new range of loft aerials for Bands I, II and III and a new "in-the-room" Band I/II/III aerial, called the "Vantenna," are announced.

The Vantenna is an adjustable V-type aerial finished in copper and black: an important feature is that the elements are capacity-coupled to the feeder, so reducing the shock-hazard with a live-chassis receiver.

Other items on show will be a full range of television and v.h.f./f.m.

B.R.C. (118)

This company, which was formed last year to merge the interests of E.M.I. and Thorn in the domestic receiver field, is showing a number of export models carrying the H.M.V., Marconi and Ferguson trade marks. Two television receivers for operation on the 625-line standard—the Ferguson 6206T (17-in) and 6208T (21-in)—are among them.

British Radio Corporation, Ltd., 21, Cavendish Place, London, W.1.

BELLING-LEE (49)

The usual wide range of components, including those shown for the first time at the R.E.C.M.F. Exhibition, will be exhibited. The aerials on show will include the "Golden-V" "in-the-room" triple-band aerial and the comprehensive "Unit Plan" types, covering all indoor and outdoor television and v.h.f./f.m. requirements. Aerial accessories include new diplexers (which pass v.h.f./f.m. through the Band I section) and a triplexer, in indoor and waterproofed outdoor versions. Equipment for communal aerial installations (i.e. amplifiers, padded-outlets etc.) and Band V and export aerials will be exhibited also.

Belling and Lee, Ltd., Great Cambridge Road, Enfield, Middlesex.

BRITISH RAILWAYS (112)

This information bureau includes a display of coloured transparencies depicting the use of radio communication, television and radar on British Railways.

British Transport Commission, 222, Marylebone Road, London, N.W.1.

BROOMHALL JOINERY (103)

Design, manufacture and installation of acoustic booths and hoods for gramophone record showrooms, together with record display and storage fittings, constitute the principal activities of this firm.

The Broomhall Joinery Co., Ltd., 222, High Street, Uxbridge, Middlesex.

BULGIN (56)

The already extensive range of Bulgin components has been further extended by the addition of some new nickle-silver crocodile clips and for printed circuit applications there are some new "Domina" stackable plugs and sockets.

New additions to their wide range of switches are models incorporating special contacts for switching signal lamp circuits on different voltages to that of the main equipment and some new micro-switches both of the "closed" and "open" type.

A. F. Bulgin and Co., Ltd., By-Pass Road, Barking, Essex.

BURWELL (219)

The complete "View-well" series of television and v.h.f./f.m. aerials and a new "in-the-room" television aerial will be shown. This latter is a radi-

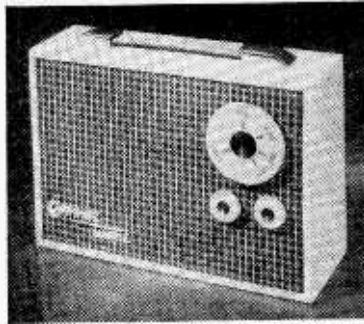

Channel "Magpie" transistor receiver.

cal departure from the more usual type of design, since it is disguised as a vase of plastic flowers, the elements forming the flower stalks.

Burwell Products, Ltd., 116, Blackheath Road, London, S.E.10.

BUSH (3, 27)

A separate v.h.f. sound receiving circuit is a feature of the new TV77 television set, which has been appropriately named the "Twin Set." It is a 17-in model for fringe-area reception. Stand 3 will have nearly a hundred seats for viewing ten recent television receivers, half of which will be working on Band I and the other half on Band III. On Stand 27 a full range of v.h.f. sound receivers will be on view.

Bush Radio, Ltd., Power Road, London, W.4.

"CAREERS" (309)

With the assistance of the Northern Polytechnic and the Wimbledon Technical College the Radio Industry Council has again provided an educational feature on the first floor. Demonstrations provided by the colleges show the type of training given during typical courses they provide. One section of the stand features the training of servicemen and another the education and training of technicians, while the centre piece is designed to show the interests of the radio industry in other than the domestic sound and television fields.

Radio Industry Council, 59, Russell Square, London, W.C.1.

CHAMPION (206)

A complete new range of receivers is shown this year, the majority being a.m./f.m. sets and for a.c./d.c. operation. Included in the range is the Model 851/3 for overseas use and covering the principal short-wave broadcast bands. It also is for a.c./d.c. operation.

Among the larger sets is the Model 882, a radio-gram covering medium, long and v.h.f. wavebands and incorporating an 8-in loudspeaker, ferrite-rod aerial for a.m. and dipole for f.m., with provision for an external dipole. Provision is made for the addition of another



"Floravision" indoor TV aerial, by Burwell.

audio amplifier and external loudspeaker thus enabling stereo records to be reproduced.

Champion Electric Corporation, Ltd., Newhaven, Sussex.

CHANNEL (213)

The size of the "Transette" 4-transistor receiver is only 4½ in × 3½ in × 1½ in. In addition to continuous tuning in the medium-wave band, preset reception of the Light Programme on long waves is also provided. Also shown are the "Magpie" 6-transistor portable, a 45 r.p.m. transistorized record player, and a number of miniature components for use with transistors. Television equipment exhibited includes a Band III converter and also a pattern generator.

Channel Electronic Industries, Ltd., Dunstan Road, Burnham-on-Sea, Somerset.

COLLARO (35)

A variety of pickup arms capable of accommodating most types of cartridge (including a new crystal turn-over model for stereophonic records) is available for a new version of the "Conquest" record player. A new automatic stop mechanism and arm pivot have enabled the stylus pressure to be reduced for playing stereophonic records. Also shown are the Model 4T200 transcription turntable and the Mark IV tape deck.

Collaro Ltd., Ripple Works, By-Pass Road, Barking, Essex.

COSSOR (10)

The latest addition to this firm's range of construction kits is a 6-valve f.m. receiver. A printed circuit is used and the r.f. and i.f. tuned circuits are pre-aligned in the factory.

The range of sound receivers, radio-grams and record players in-

cludes a "bookcase" radio-gram, with storage space for books and records, and a transistor receiver which will work from a car aerial.

Ease of servicing is a feature of the new 17-inch television set Model 948, which is available as a table model or consolette.

Cossor Radio and Television, Ltd., Cossor House, Highbury Grove, London, N.5.

DALLAS (223)

Wholesale distributors to the radio trade, this firm is showing also their own proprietary range of "Scala" 4-speed electric gramophone reproducers. The "Hi-Fi 8" model is now wired for a stereo pickup.

John E. Dallas and Sons, Ltd., Clifton Street, London, E.C.2.

DECCA (25)

To play the first issue of sixty-three stereophonic records to be released by the middle of October, three new Decca reproducers have been developed. The SRG300 and SG188 models are basically similar in using a single central bass speaker housed with the record player and twin 6-watt push-pull amplifiers in conjunction with two separate spaced ESS/1 tweeters. In the smaller SG177 the main cabinet contains a single full-range speaker and the separate speaker ESS/2 is also full-range. New combined television and switched v.h.f./f.m. receivers are also on show.

Decca Record Co., Ltd., Decca House, Albert Embankment, London, S.E.11.

DEFIANT (1)

Latest techniques in circuit design are to be found in several new television sets on show this year. The 17-inch models, with and without v.h.f. sound reception, have pride of place, but there are also 21-inch and 14-inch sets for both fringe and service areas.

A range of sound receivers, radio-grams and record-players includes a "fit-it-yourself" car radio CR100, for medium waves and pre-tuned long wave.

Co-operative Wholesale Society, Ltd., 1, Balloon Street, Manchester, 4.

DESIGN FURNITURE (119)

This firm specializes in the design and manufacture of television tables and record cabinets. The latest version of DF24 TV table is shown together with the most recent types RX1 and RX2 record-storage cabinets.

Design Furniture, Ltd., Carnwath Road, London, S.W.6.

DOMAIN (110)

This firm will be showing trolleys for professional electronic equipment, and a new range of dealers' display stands adaptable for floor, counter

or wall mounting. Fixing holes are spaced to fit standard "peg board."

Domain Products, Ltd., Barnby Street, London, N.W.1.

DUBILIER (55)

New additions to the Type 400 resin-cased, metallized-paper midget capacitors raises the top value to 0.04 μ F for 150V d.c. working. Considerable reduction in size has been effected in the Type BR electrolytics and a new range of sub-miniature electrolytics is introduced for printed circuits and transistor applications. Values range from 1 μ F at 30V d.c. wkg. to 100 μ F at 3V d.c. wkg.

The minimum value of the types BTS and BTA insulated resistors is now 10 Ω and they are available in 10% tolerance preferred values as well as in the 20% series.

Dubilier Condenser Co. (1925) Ltd., Victoria Road, London, W.3.

DYNATRON (46)

The "Condor" and "Marlborough" 21-in combined television and v.h.f./f.m. receivers are also now available fitted with a record player. Two new 17-in television receivers are also on show. A new radio-gram, the "Albany," is entirely switch-tuned with choice of five a.m. and five v.h.f./f.m. stations. It is fitted with a dual-channel control unit to allow easy conversion for stereophonic reproduction. A new six-transistor portable has a loudspeaker as large as 9 $\frac{1}{2}$ in by 4 $\frac{1}{2}$ in.

Dynatron Radio, Ltd., St. Peter's Road, Furze Platt, Maidenhead, Berkshire.

E.A.R. (62)

Stereophonic record reproducers will be introduced with peak available outputs on each channel of between 2 and 5 watts. A number of ordinary single-channel record reproducers with independent bass and treble boost controls and push-pull outputs feeding multi-speaker systems will also be on show. Transistorized units include 4-speed and 45 r.p.m. record players and a 4-speed radio-gram.

Electric Audio Reproducers Ltd., The Square, Isleworth, Middlesex.

E.M.I. INSTITUTES (308)

Details of the Institute's courses for home study and examples of the kits of parts provided for the practical part of each course are displayed. Assimil language records, distributed by the Institute, are now available in 7-in extended-play discs.

E.M.I. Institutes, 43, Grove Park Road, London, W.4.

E.M.I. RECORDS (111)

"His Master's Voice," Capitol, Columbia, Parlophone, MGM and Regal-Zonophone records will be represented. Information can be obtained on all types of recording, including stereophonic discs and tapes.

E.M.I. Records, Ltd., 8-11, Great Castle Street, London, W.1.

E.M.I. SALES AND SERVICE (48)

Two stereophonic record reproducers will be released. Ordinary single-channel record reproducers are represented by the first of a new range, the Emisonic model R11, and also a 4-speed transistor model the R15. The standard range of professional tape recorders shown includes the transportable TR51 and the battery model L2 which weighs only 14 $\frac{1}{2}$ lb. Varieties of "Emitape" exhibited include Type 77 for instrumentation purposes, which is specially tested to ensure a nearly constant sensitivity in any one reel and also between reels.

E.M.I. Sales and Service, Ltd., Hayes, Middlesex.

EKCO (29)

Six transistors and a printed circuit are used in the handbag-size portable sound receiver BPT333, which has a push-pull output, with negative feedback, driving a 5-inch loudspeaker.

B.B.C. and I.T.A. stations are side-by-side on the channel selector of three new 17-inch television sets, T330, T331 and T330F (the last-mentioned being a "fringe" model) and also on the new 14-inch transportable, TP308.

E. K. Cole, Ltd., Southend-on-Sea, Essex.

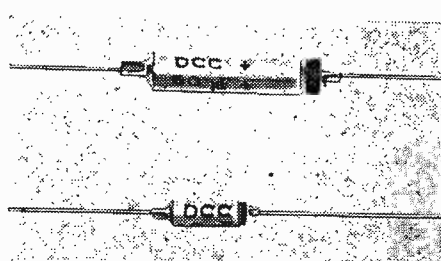

• Dubilier sub-miniature, electrolytic capacitors.

Left: H.M.V. Model 1451 battery/mains portable receiver using valves with 25mA filaments.

EVER READY (16)

New additions to the range of battery portables made by Ever Ready and their associate company Berec include 9-valve a.m./f.m. and transistorized models. Transistorized 45 r.p.m. record reproducers are also on show.

The wide range of dry batteries exhibited include the "Power Pack" series which was specially developed for use with transistors.

The Ever Ready Co. (Great Britain) Ltd., Hercules Place, London, N.7.

FERGUSON (17)

An a.g.c. system giving good cross-modulation characteristics and the best possible signal/noise ratio is a feature of the new "400" series of television sets. They also have improved interference limiting, line sync and interlacing circuits, together with stabilized e.h.t. The

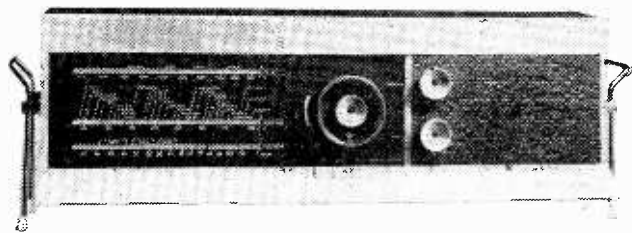

Ferguson "Futura" a.m./f.m. receiver.

v.h.f. sound reception in the 435T and 437T 17-inch and 21-inch models uses entirely separate circuits.

A range of sound receivers, record players and radio-grams includes a 6-valve a.m./f.m. set, the "Futura," with a refreshingly original cabinet design.

Ferguson Radio Corporation, Ltd., 105-109 Judd Street, London, W.C.1.

FERRANTI (21)

To overcome the problems caused by the demands on living space by TV, radio and record player Ferranti have introduced the TCG1019 TV/radiogram. This combines in one compact console cabinet, a 17-in television receiver, v.h.f./f.m. radio and a record player.

Sound-only is catered for by a transistor portable, two transportables, an a.m./f.m. table model and a radiogram which can be adapted for stereo. Seven television models will be shown, four of which include v.h.f./f.m. facilities.

Ferranti Radio and Television Ltd., 41-47, Old Street, London, E.C.1.

FIDELITY RADIO (54)

The range of record reproducers on show includes a model for playing stereophonic records, the HF10. A console radiogram is also available in two versions, one for a.m. and v.h.f./

f.m. broadcasts, and the other for a.m. only.

Fidelity Radio, Ltd., 11-13, Blechynden Street, London, W.11.

FORTIPHONE (106)

Well-known as a hearing-aid manufacturer, this company will be exhibiting many miniature and sub-miniature components and sub-assemblies developed for hearing-aids; but equally applicable to other miniature equipment. Items of particular interest are the range of transformers, switches and variable resistors and a transistor amplifier and loudspeaker sub-assembly for portable radios, etc. The range of hearing-aids will be shown also.

Fortiphone, Ltd., 92, Middlesex Street, London, E.1.

FUND FOR THE BLIND (313)

Displayed is some of the specially adapted test equipment for the use

of blind workers in the radio industry and a blind operator is working on the stand.

Greater London Fund for the Blind, 2, Wyndham Place, London, W.1.

G.E.C. (8)

A new 21-inch table television receiver introduced this year, BT3747, incorporates v.h.f. sound radio and has twin loudspeakers. It can be converted into a consolette by a matching hardwood table. Two new 17-inch models will also be shown, the BT2155 table model and the BT8149 consolette, which has sliding tambour doors and self-aligning feet. A 14-inch table set, BT1156, features a 90° c.r.t. and uses printed-circuit technique.

Push-button control and light weight are features of the latest mains/battery portable sound receiver, BC4450. It has a four-valve circuit using 25mA low-consumption valves.

General Electric Co., Ltd., Magnet House, Kingsway, London, W.C.2.

G.P.O. (312)

The emphasis on the Post Office stand is on the developments in the field of automatic telephone switching and the mechanization of mail sorting, in both of which electronics plays a part.

General Post Office, London, E.C.1.

GARRARD (51)

The wide range of record changers and single record players on show includes two models (RC120 Mark II and RC121 Mark II) designed to occupy the minimum cabinet space. High output (Type GC8HO) and high compliance (Type GC8PA) crystal pickups for use with these turntables are available with sapphire or diamond styli. Other exhibits include the TPA12 high-quality pickup arm incorporated in a single record player (model 4HF), and also the 301 transcription turntable.

Garrard Engineering and Manufacturing Co., Ltd., Newcastle Street, Swindon, Wiltshire.

GOODMANS (34)

The full range of high-quality direct-radiator and pressure driven horn-loaded loudspeakers are on show together with suitable enclosures both with and without acoustical resistance units. New additions are the latest twin-cone speakers, a kit of parts for building a small corner reflex cabinet for the 8-in Axiette, and the IB3 3-speaker system which uses a small totally enclosed cabinet and a specially designed bass speaker.

Goodmans Industries, Ltd., Axiom Works, Wembley, Middlesex.

GRUNTHIER (220)

The "Beamec" c.r.t. tester can be used to check for gas, inter-electrode leaks and partial heater shorts. Various electrode currents can also be measured. A pulse-generator is provided for removing cathode poisoning, and inter-electrode shorts can also be eliminated. Also shown is the frequency meter type F/P1 with a range from 10c/s to 100kc/s and an accuracy better than 1%.

Grunther Instruments, Ltd., 14, Oriental Street, London, E.14.

H.M.V. (33)

The "New Highlight" range of television receivers announced recently has been further extended by the addition of two models equipped for v.h.f./f.m. Unlike the majority of receivers the f.m. section is entirely separate, using the 10.7Mc/s standard i.f. These receivers utilize a new "slot" loudspeaker claimed to give superior reproduction in a smaller space, 90° tubes are used, and a programme indicator glows red for I.T.A. and green for B.B.C.

Radio is represented by a radiogram (with provision for stereo), a portable receiver and two table models.

"His Masters Voice" Radio and Television Sales, Ltd., 21, Cavendish Place, London, W.1.

HARTIQUE (227)

Tables for television sets, record storage cabinets and cabinets for housing complete sound reproducing equipment are shown by this firm in a variety of contemporary and

period styles. One of the new additions is the "Stanhope" cabinet measuring 36in×16½in×32in high with storage space for about 180 gramophone discs, a record player and tape deck and having space on the top to accommodate a TV and a radio set.

Hartique Products, 243, Upper Street, London, N.1.

HILL (217)

Gramophone record showroom display furniture and fittings in steel and finished to tone with contemporary colour schemes are the speciality of this firm. The principal items comprise "browser" boxes, record filing cabinets and racks, display stands of various kinds and acoustic hoods and booths.

Thomas H. Hill and Sons Ltd., Worcester Road, Kidderminster.

HOBDAY (121)

As wholesale distributors of many leading makes of domestic radio, sound-recording and reproducing apparatus their display is largely devoted to examples of this type of equipment.

Hobday Bros., Ltd., 21/27, Great Eastern Street, London, E.C.2.

HUNT (47)

One requirement of a modern capacitor is its ability to withstand wide differences in temperature yet retain its stability. This is typified by the Hunt's metallized-paper, moulded cased "Thermetic" models, Types 97 and 197, and by the metallized-film "Melimet Supermoldseal" tubulars. Their temperature range is -40° C to +100° C.

A combination of metallized paper and film dielectric is used in the "Duolectric Supermoldseal" with working voltages up to 1,000V d.c. and a temperature range of -40° C to +100° C.

Included also is a comprehensive selection of capacitors for printed and transistor circuitry.

A. H. Hunt (Capacitors) Ltd., Bendon Valley, Garratt Lane, London, S.W.18.

I.T.A. (310)

The I.T.A., two of the programme contractors (Associated Rediffusion and Associated TeleVision) and the Independent Television News have collaborated to put on a display depicting the diversity of programmes offered. Some of the material relayed to television receivers on manufacturers' stands originates from the I.T.A. stand.

Independent Television Authority, 14, Princes Gate, London, S.W.7.

INVICTA (2)

Five radio receivers, two gramophones, three radio-grams and seven television receivers will form this company's display. Of particular interest is the transistor portable

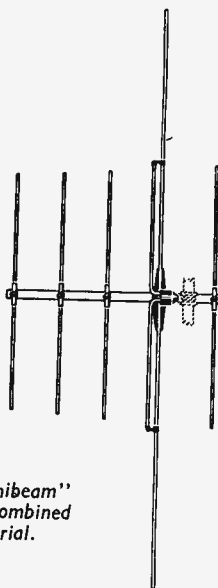

J-Beam "Unibeam"
Band I/III-combined
television aerial.

radio, the Model 62 stereo record player mounted in a "coffee-table" cabinet with two separate loudspeakers, and two stereophonic radio-grams one of which—the 17RG—uses only five valves for a.m., f.m. and audio functions. The TV receivers range from 14-in to 21-in, in both fringe and normal service area types.

Invicta Radio Ltd., 100, Great Portland Street, London, W.1.

J-BEAM AERIALS (14)

In addition to their well-known ranges of skeleton-slot arrays (Band-III) and end-fed aerials (Band-I) this firm will show a new range of combined Band-I/III television aerials for the stronger-signal areas. Another range of dual-band aerials, chiefly for medium and long distance reception, combines a "conventional" H or three-element Band-I aerial with a skeleton slot array for Band-III. V.h.f./f.m. attachments and aerials will be exhibited also.

J-Beam Aerials, Ltd., "Westonia", Weston Favell, Northampton.

JOHNSONS (109)

This company supplies decorative metal trims for cabinets, in polished and lacquered brass, copper, anodised aluminium, stainless steel, chrome and electro-brassed tinfoil in shell or plastic-cored form.

G. Johnson Brothers, Ltd., 103-149, Cornwall Road, London, N.15.

K.B. (43)

K.B. are using printed-circuit panels in all their receivers which range from the 24-in "Regina" down to the "Rhapsody" portable radio. The "Regina" uses a 90° tube so keeping cabinet depth within reason and

is described as a "consolette" ("table" model with legs).

Other television receivers represented are the 17-in "New Queen" range, a 17-in portable and two 21-in receivers with v.h.f./f.m. Other products include radio receivers, radio-grams and record players.

Kolster-Brandes, Ltd., Footscray, Sidcup, Kent.

KERRY'S (23)

In their role of wholesale distributors to the radio trade this firm is showing a comprehensive range of receiving, recording, audio and test equipment by the leading manufacturers.

Kerry's (Great Britain) Ltd., Warton Road, Stratford, London, E.15.

LABGEAR (31)

Several new indoor and outdoor television and v.h.f./f.m. aerials and a "picture equalizer" unit will be featured on this stand. Other equipment shown will include:—non-destructive flash-tester (applying up to 2kV (5kV to order)); transistor inter-communication set for situations where a mains supply is not available; cathode-ray tube rejuvenator and the Labgear range of wire-wound resistors.

Labgear (Cambridge), Ltd., Willow Place, Cambridge.

LE GREST (67)

Manufacturers of the "Finger-Touch" TV trolley for supporting a table-model television receiver at convenient eye level, models are shown for 17-in and 21-in sets and various finishing styles are available. Trolleys are mounted on casters and the top and edges of the trolley are rubber covered.

Le Grest and Co., 58, Fairfield Street, London, S.W.18.

LINGUAPHONE (205)

Specialists in language courses on gramophone records this firm can supply also full courses in the Morse code on records. Part I includes five double-sided records, a textbook and covers instruction up to 4 w.p.m. Part II, also of five records, carries instruction to 12 w.p.m. and over. Each set costs £2 1s 11d.

Linguaphone Institute, Ltd. 207-209, Regent Street, London, W.1.

LUGTON (226)

Primarily wholesalers to the radio trade, this firm have their own special range of gramophone styli for use in all types of pickups, including stereo models. They are known as "Lugton Styli."

Lugton and Co. Ltd. 209-212, Tottenham Court Road, London, W.1.

McMICHAEL (42)

Each of the new range of television receivers (using "plated" circuits) provides a v.h.f./f.m. facility. The

(Continued on page 417)

new sets are: 17in—portable (the Voyager), table model and console; 21in—console. Attention has been paid to improving sound reproduction in the latter two receivers—both have multiple-speaker systems.

Sound-only is well catered for—three versions of a seven-valve a.m./f.m. radio-gram, a record player, a table model receiver and two portables complete the display.

McMichael Radio, Ltd., Langley Park, Slough, Buckinghamshire.

MARCONIPHONE (45)

The new type of radial turret tuner is incorporated in this firm's latest television set, the VT157 17-inch table model. Two printed circuits are used, the main panel being hinged for easy accessibility. "Push-through" presentation of the 90° electrostatically focused c.r. tube ensures maximum picture size. A "fringe" version, VT158, has three vision i.f. stages and two sound i.f. stages with a.g.c.

Marconiphone Radio and Television Sales, Ltd., 21, Cavendish Place, London, W.1.

MASTERADIO (4)

A new introduction this year is the CR800 transistorized car radio, which is designed to fit any make of car. It uses a hybrid circuit with 12-volt valves for direct operation from the car battery, and consists of three separate units—receiver, loudspeaker and transistor box.

The range of television sets, sound receivers, radio-grams and record players on show includes a new 17-inch table television receiver TJ7T.

Masteradio, Ltd., 10-20, Fitzroy Place, London, N.W.1.

MEADOW-DALE (105)

Last year—the Band III parabolic aerial: this year—a "printed circuit" flexible 5-element Band III aerial for indoor use. Other television aerials on show will include an 8-element Yagi and a broadside 10-element array, as well as the full range of TV and f.m. aerials and adaptor kits.

Meadow-Dale Manufacturing Co., Ltd., The Dale, Willenhall, Staffordshire.

MULLARD (41)

On the main stand will be displays showing the production and application of the firm's valves, c.r. tubes, transistors, magnetic materials and electronic equipment. Special models will illustrate progress in electronics over the years, and these will be accompanied by various electronic novelties and amusements. At the associated Home Constructor Centre (Z30A) visitors will be able to consult the firm's engineers and obtain information about its products and copies of its technical publications.

Mullard, Ltd., Mullard House, Torrington Place, London, W.C.1.

MULTICORE (63)

Flux-cored solders being the speciality of this firm, the display features the various forms in which they are now available.

For "do-it-yourself" devotees is a 60/40 alloy solder in 22 s.w.g. size prepared especially for assembling kits which include printed circuits. The "Bib" tape splicer is shown with a new type of clamp.

Shown also is the range of "Reflectograph" tape recorders. The new Model 500 is a professional type instrument in portable form which can be used either in studios or in the home. Included are separate recording and replay amplifiers and provision is made for conversion to stereophonic use. The Model 400, with a similar specification, is intended for fixed installations.

Multicore Solders Ltd., Maylands Avenue, Hemel Hempstead, Herts.

MURPHY (11)

The trend towards somewhat larger cabinets in popular small sound receivers is reflected in the new U698 model. Covering m.w. and l.w., it is notable for its high sensitivity and for the markedly improved bass response over its predecessors obtained by the larger cabinet. Quality of reproduction is also a feature of the first portable record reproducer made by this firm, the four-speed A316G.

Fine tuning has been eliminated in the new 14-inch transportable television set V350, which has vision and sound a.g.c. and electrostatic focusing.

Murphy Radio, Ltd., Welwyn Garden City, Herts.

N.I.D. (307)

Deaf and hard-of-hearing people will be particularly interested in the equipment shown by the National Institute for the Deaf, and the

demonstrations. The latest transistorized Medresco hearing aid, which weighs only 3oz (including battery), the standard Medresco and a number of commercial hearing aids are on show. Other aids for the deaf and hard-of-hearing include a transistor amplifier for telephone receivers. Visitors are able to assess their own acuteness of hearing over the frequency range 250 to 10,000c/s with the aid of a hearing level indicator.

National Institute for the Deaf, 105, Gower Street, London, W.C.1.

NAVY (305)

A comparison is drawn between the first standardized naval transmitter (1908) and the radio equipment used in a modern frigate. Prior to 1908 installations varied from ship to ship, and a replica of the transmitter and receiver used in 1897 by Capt. Jackson is shown. A selection of communications receivers, facsimile equipment and emergency transmitter-receivers is also included.

Admiralty, Whitehall, London, S.W.1.

PAM (6)

New models on show include a stereophonic record reproducer with two separate matching loudspeakers (Model 100); a transistor portable, the TB20, with an unusually large loudspeaker for this type of receiver; and a transportable 17-in television set which is also available in a version capable of receiving v.h.f./f.m. broadcasts. Other 17-in and 21-in television sets, battery and table mains receivers, and record reproducers include the TR30 a.m./f.m. 7-valve table radio with three loudspeakers.

Pam (Radio and Television) Ltd., 295, Regent Street, London, W.1.

PERDIO (65)

The range of miniature transistor receivers on show includes models

Right: McMichael Model M23 HFC 21-in television receiver with v.h.f./f.m. facilities.



Pam "Gayplay" miniature transistor receiver.

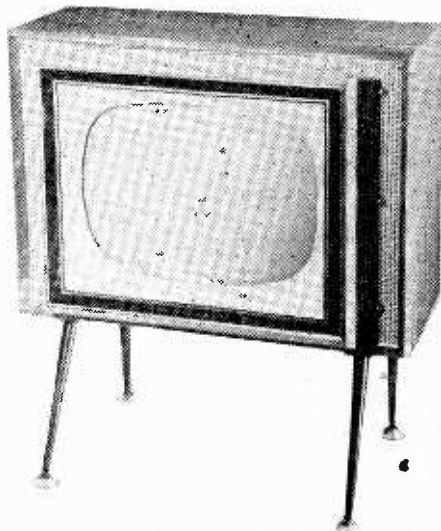

with a push-pull output stage. An optional fitment for all of these receivers is a socket to enable the audio output to be fed to a tape recorder or amplifier. An earphone attachment for private listening and a car aerial for use with these receivers are also available.

Perdio, Ltd., St. Cross Street, London, E.C.1.

PERTH (204)

Radio-grams on show include the 6-valve a.m./f.m. model SFM63. A stereophonic record reproducer will be introduced, and the "Amplidisk" ordinary single-channel record reproducer is being continued.

Perth Radios, Ltd., 39-47, East Road, London, N.1.

PETO SCOTT (12)

Any component of the latest 14-inch television set can be replaced without removing the chassis from the cabinet. This model, TV1422, also offers a delayed a.g.c. system capable of dealing with a wide range of signal conditions and an automatic self-locking sync circuit which prevents line tearing.

The new ARG67 four-speed radio-gram incorporates a v.h.f. band and has a 10-inch loudspeaker and 4-inch tweeter. The lid has a pneumatic hinge to prevent slamming.

Peto Scott Electrical Instruments, Ltd., Addlestone Road, Weybridge, Surrey.

PHILCO (19)

Three new 17-in television receivers will be introduced. Models 1963 and 1964 feature a variable impulsive interference suppressor and the 1964 is also fitted with a switched (on the

turret tuner) v.h.f./f.m. receiver. Six sub-chassis are used for compactness in the model 1000 "Slender Seventeen," which also has a plug-in line output transformer for easy replacement.

The new "Century" model 100 receiver features separate tuning for a.m. and f.m. signals. A number of record reproducers are also on show.

Philco (Great Britain) Ltd., 30-32, Gray's Inn Road, London, W.C.1.

PHILIPS (52, 53)

An attractively designed new sound receiver for a.m.-only is the G81U, a small four-valve set weighing only five pounds and using a printed circuit. The G90U, which incorporates a short-wave band, is suitable for use in coastal areas and on board ship. It will operate from a 110-V supply as well as the normal 200-240 volts, and provides pickup and outside aerial sockets.

Philips Electrical, Ltd., Century House, Shaftesbury Avenue, London, W.C.2.

PILOT (28)

Pilot will show their full range of television and sound broadcast receivers, single-channel and stereo high-fidelity equipment, record players and radio-grams. A new TV receiver is the TV117—this is a high-gain 14-valve-plus-semiconductors receiver fitted with a loudspeaker socket so that it can be used as the second loudspeaker in the "Stereophonic 4" system. Also featured will be the "Clipper"—a luxury a.m./f.m. table radio and the "Super-ten" record player (fitted with a 10-in loudspeaker).

Pilot Radio, Ltd., Park Royal Road, London, N.W.10.

PLESSEY (66)

As at previous Radio Shows, Plessey will not attempt to exhibit their pro-

ducts as their very diversity and number render this impossible. They will, however, be using their stand as an office where trade representatives from the British Isles or abroad will be able to obtain information on the full range of Plessey components, accessories and sub-assemblies.

Plessey Co., Ltd., Vicarage Lane, Ilford, Essex.

PLUS-A-GRAM (107)

Additions to the "Dansette" range of record reproducers include a stereophonic model and the "Hi-Fi," which has a push-pull audio amplifier. Also shown will be a medium- and long-wave table radio-gram with two loudspeakers.

J. and A. Margolin, Ltd., 112-116, Old Street, London, E.C.1.

PORTOGRAM (58)

A range of portable record reproducers and also two console tape recorders with push-pull audio amplifiers are on show. Two of these models also incorporate a v.h.f./f.m. receiver. Two public-address amplifiers are also available.

Portogram Radio Electrical Industries, Ltd., "Preil Works", St. Rule Street, London, S.W.8.

PYE (44)

Stereophonic discs and equipment are naturally the focal point on this stand. A range of stereo gramophones will be demonstrated.

The "Continental" television receivers have variable video bandwidth fitted as a user control. Pye claim that this enables the viewer to select the optimum bandwidth/noise ratio for any picture just as treble cut can improve the sound from worn records. Radio receivers,



Peto Scott ARG67 radio-gram.



R.G.D. Model 202 radio-gram with v.h.f. radio.

radio-grams and high quality sound equipment will also be featured.

Pye Ltd., Cambridge.

R.A.F. (304)

A wide variety of radio and electronics equipment as used by the R.A.F. is shown, including precision-approach and long-range radar, communications gear and digital transmission equipment. Some of the components and equipment being developed for the R.A.F. at the Royal Radar Establishment, Malvern, are also exhibited.

Air Ministry, Parliament Square House, London, S.W.1.

R.G.D. (24)

Housed in a handsome contemporary-style cabinet the Model 202 radio-gram covers long, medium and v.h.f./f.m. wavebands with built-in aerials. It has a 10-in loudspeaker and generous storage space for records and magazines. Another new sound receiver is the Model B56 transistor portable with push-pull output and a 5-in loudspeaker. A printed circuit is used and the set covers the medium waveband and one pre-selected station (usually the Light Programme) on the long waves.

Among the new television sets is one known as the "Deep-Seventeen" (17-in tube) with turret tuner and automatic focusing.

Radio Gramophone Development Co., Ltd., Eastern Avenue West, Romford, Essex.

R.S.G.B. (306)

Examples of home-constructed transmitting, receiving and test equipment are shown, together with a selection of the publications issued by the Society.

Radio Society of Great Britain, New Ruskin House, Little Russell Street, London, W.C.1.

R.T.R.A. (207)

A reception centre is provided for members of the Association and an information bureau for the general public.

Radio and Television Retailers' Association, 15/17, Goodge Street, London, W.1.

RECORD HOUSING (104)

Radiogram and loudspeaker cabinets shown include the new "Rondo" range for the home constructor. Cases and cabinets for gramophone records, including add-on units and one especially for 7-in records, are also made by this firm.

Record Housing, Brook Road, London, N.22.

REGENTONE (9)

A stereo radio-gram (Model Nine—3) in one "box" is being shown by Regentone. This is a 9-valve a.m./

Philco "Century"
a.m./f.m. receiver.

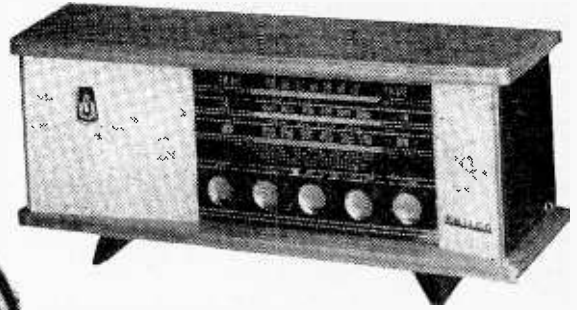

Rola Celestion
"Colaudio" loudspeaker

Right: Regentone Model RT50
three-speed (1 $\frac{3}{8}$, 3 $\frac{3}{4}$ and 7 $\frac{1}{2}$ in/sec)
tape recorder.



f.m. receiver with twin audio amplifiers and a stereo pickup. The loudspeakers are two 8in x 6in elliptical units and two 3in tweeters—an elliptical and a tweeter to each channel. Other products exhibited will be a tape recorder (weight 24lb), a portable record player, radio-grams, a table model a.m./f.m. set and television receivers.

Regentone Radio and Television, Ltd., Eastern Avenue West, Romford, Essex.

ROBERTS (57)

The new model RT1 transistor receiver features a 250mW push-pull output stage and a loudspeaker which has, for this type of receiver, the unusually high flux density of 13,000 gauss and large diameter of 5in. A waterproof carrying case is available for this model. The R66 mains or battery portable, and the R77, which looks like a leather binocular case, are also on show.

Roberts Radio Co., Ltd., Creek Road, East Molesey, Surrey.

ROLA CELESTION (30)

The variety of loudspeakers available for set manufacturers includes models with diameters ranging from 2 $\frac{1}{2}$ to 15in and also oval and rectangular units. Multi- and single-ratio output transformers are also exhibited. A new addition to the range for the high-quality enthusiast is the 15-in "Colaudio" with its 3-in diameter voice coil and two direct

radiator tweeters mounted in column form inside the main cone.

Rola Celestion, Ltd., Ferry Works, Thames Ditton, Surrey.

RUCO (120)

The range of radio-grams on show includes two a.m./f.m. 7-valve models. Also exhibited will be a number of record reproducers including two transistorized 45 r.p.m. models and the 358 with separate bass and treble controls.

Ruco Products (Radio), Ltd., 197, Lower Richmond Road, Richmond, Surrey.

S.T.C. (18)

New transistors for portable sound receivers and record players will be on view, together with symmetrical types for computers and switching circuits. Brimar valves will include a low-noise pentode 8D8 and a side-display magic eye, EM84. Another fairly new product is the G10/200E numerical display indicator. A comprehensive display of rectifiers will include silicon junction types and contact-cooled rectifiers for high-temperature operation.

Standard Telephones and Cables, Ltd., Connaught House, Aldwych, London, W.C.2.

SIEMENS-EDISWAN (40)

New developments in c.r. tubes will include two tubes, 21-inch and 17-inch, with 110° deflection angles. Both have electrostatic focusing.

There will also be new 14-inch tubes on view.

Junction transistors made by this firm are now available with increased voltage ratings. High-lighting the display will be the new XS101 symmetrical transistor for switching applications.

Receiving and industrial valves, batteries, cables and stabilized power units will also be shown.

Siemens Edison Swan, Ltd., 155, Charing Cross Road, London, W.C.2.

SLINGSBY (215)

Trucks for loading, unloading and transporting television sets and radio-gramophones, principally in dealers' showrooms, and various forms of light tubular-metal conveyors for loading delivery vans constitute the principal exhibits of this firm.

H. C. Slingsby, Ltd., 89, 95, 97, Kingsway, London, W.C.2.

SOBELL (50)

All the new television receivers embody a semi-incremental all-band tuner in which switching is used, but the incremental inductances are arranged in banks of three. This is said to ensure very good frequency stability for this type of tuner. Other features are plated, as distinct from printed, circuitry, the conductors being deposited on the laminæ, and hinged circuit panels for ease of servicing.

Two of the new television sets, T23 (21-in) and T178 (17-in), include v.h.f. radio. Provision is made for use of either telescopic or external aerials.

Bureau, table and transportable-type radiograms, with or without v.h.f. radio, complete an interesting exhibit.

Radio and Allied Industries, Ltd., Langley Park, Slough, Bucks.

SPENCER-WEST (218)

The new 17-inch television receiver, Type 172, uses printed circuit technique. A fringe-area model is available with higher gain and appropriate sync performance. The vertically mounted chassis of the Type 174 set is hinged for accessibility in servicing but leaves all hand controls in the mounted position.

Spencer-West, Ltd., North Quay, Great Yarmouth, Norfolk.

STELLA (13)

Two new television receivers and two new radio sets will be the focus of interest on this stand. The ST240U is a 7-valve a.c./d.c. receiver in a wooden cabinet, covering long and medium waves and v.h.f./f.m. For the "second" set the inexpensive ST241U should be suitable. The television receivers are table models and they use identical chassis but are fitted with either 17-in or 21-in 90° tubes.

Stella Radio and Television Co., Ltd., 9-15, Oxford Street, London, W.1.

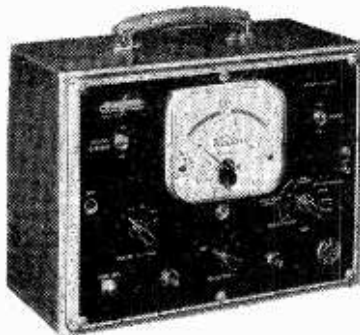

"Radar" Model 202 c.r.t. tester and reactivator by Waveforms, Ltd.

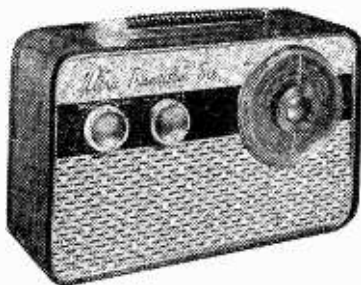

Ultra "Transistor Six" portable.

T.C.C. (59)

A few years ago printed circuits were added to this company's products, and now there is introduced a wide range of ceramic parts such as coil bobbins, resistor tubes, capacitor bodies and hermetic seals, to mention a few only. The existing ranges of sub-miniature tantalum electrolytic capacitors are extended, principally for transistor circuitry, and some new metallized-polystyrene models with very stable characteristics have been produced for use in tuned filters.

Numerous examples are shown of printed circuits for receivers and sub-assemblies, while "flush-bonded" printed circuits for commutator and switch plates are also included.

The Telegraph Condenser Co., Ltd., North Acton, London, W.3.

TAYLOR (212)

Two new multi-range meters incorporate centre-pole moving-coil movements and have sensitivities on the d.c. ranges of 100,000 ohms per volt for the Model 100A and 20,000 ohms per volt for the pocket size Model 127A. Also shown is the combined a.m., f.m. and television pattern generator (all covering 4 to 220 Mc/s) Model 94B, the 68A signal generator covering 100 kc/s to 220Mc/s on fundamentals, the Model 32A oscilloscope, and other test and measuring equipment.

Taylor Electrical Instruments, Ltd., Montrose Avenue, Slough, Buckinghamshire.

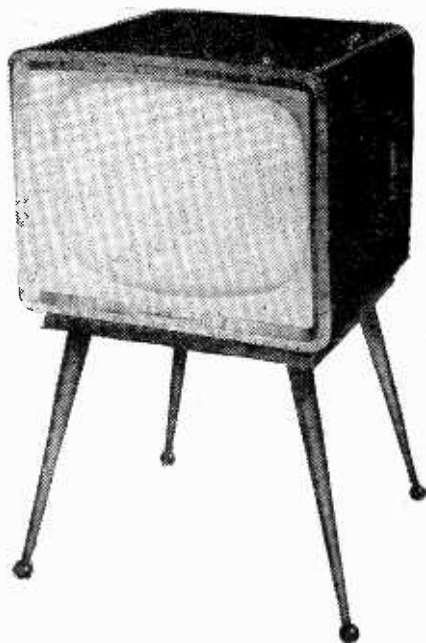

Sobell Model T23 television receiver with "semi-incremental" switched tuner.

TELERECTION (36)

As well as the well-known "Hi-Max" TV/f.m. aerials, this company will show a wide range of television and v.h.f./f.m. aerials for indoor and outdoor use, culminating in an 11-element Yagi and a twin-broadside, delta-matched, 22-element array designed for "deep-fringe" Band III reception.

Also exhibited will be Band V aerials and some export types.

Telection, Ltd., Antenna Works, St. Pauls, Cheltenham, Gloucestershire.

THOMPSON, DIAMOND AND BUTCHER (15)

Distributors to the radio trade of many leading makes of domestic receivers and gramophone equipment, this firm also has a wide range of sound-reproducing equipment of their own design. It includes a number of "acoustic" record reproducers in portable form, and electrical models known as "Convertogram," "Meritone," "National" and "Lamplifier," to mention a few only.

Among the new models is a transistor battery-portable record player and a new "National Band" spring-motored portable reproducer. Carrying cases and albums for disc records, known as the "Estrella" series, are also included.

Thompson, Diamond and Butcher, Ltd. 5-9, University Street, London, W.C.1.

ULTRA (20)

Prominent among the Ultra exhibits are two new table television sets, the

V17-63 with 17-in tube and V14-53 with 14-in tube. The former is also available with v.h.f. sound radio in which form it becomes the VR17-64. The circuitry employed largely eliminates the "ragged-edge" effect sometimes encountered in weak-signal areas, it also enables indoor aerials to be employed more frequently than usual. Modern-style "wrap-round" cabinets are employed with controls in a side recess. An attractive matching table is also available.

Among the sound radio sets is a new "Transistor Six" portable covering medium and long waves.

Ultra Electric, Ltd., Western Avenue, London, W.3.

VALRADIO (61)

Power transistors are beginning to displace vibratory and rotary converters for small d.c./a.c. conversion loads. Transistor-oscillator power units ranging from 6 or 12V units (giving h.t. and l.t. for portable receivers) to 12V input types rated at 120 watts will be exhibited. Other products include high-quality projection television receivers for 405, 525 or 625 lines and power phase-splitters for operating three-phase equipment from single-phase supplies.

Valradio, Ltd., Browells Lane, Feltham, Middlesex.

VERITONE (68)

A new 2-speed tape-recorder, the "Venus" is fitted with three heads to allow monitoring of the recorded tape while a recording is being made. The 3-watt output feeds a 10in x 6in elliptical speaker and 4-in tweeter. Optional extras which can be included in the "Venus" are a 10-watt amplifier and v.h.f./f.m. tuner.

Veritone, Ltd., Avenue Parade, Ridge Avenue, London, N.21.

VIDOR (32)

The wide range of battery and battery/mains portable receivers on show includes transistor models and the a.m./f.m. CN436 "Vanguard." Batteries for use in such receivers and a wide variety of other applications are also exhibited. A transportable 17-in television set and a record reproducer are also available.

Vidor, Ltd., West Street, Erith, Kent.

WALTER INSTRUMENTS (115)

The new two-speed Model 505 tape recorder will be the main feature. Recording, playback, fast forward and reverse, are all governed by a single "joystick" control resembling a car's gear lever, a feature of Walter tape recorders.

Walter Instruments, Ltd., Garth Road, Morden, Surrey.

WAVEFORMS (228)

In addition to their established test equipment such as the Type 301

oscilloscope, the 405-line TV pattern generator providing simultaneous sound and vision outputs and the "Kilovoltter," this firm will exhibit two new pieces of test gear—a strictly-to-C.C.I.R. standards 625-line pattern generator and a c.r.t. tester and reactivator. This latter embodies provision for a new method of pulse-reactivation.

Waveforms, Ltd., Radar Works, Truro Road, London, N.22.

WESTINGHOUSE (114)

The latest contact-cooled selenium rectifiers, the edge-cooled types, permit heat to be removed by conduction from three edges of each square element, the fourth edge being left free for connections. They are extremely small for given outputs, are hermetically sealed and capable of operating at high chassis temperatures.

Conventional copper-oxide and selenium types will be on view and also a compact automatic charger for the batteries of radio-equipped vehicles.

Westinghouse Brake and Signal Co., Ltd., 82, York Way, King's Cross, London, N.1.

WHITELEY ELECTRICAL (64)

Interesting models in the wide range of loudspeakers available are a 2½-in unit with plastic-chassis for use in portable radios and an 8-in model especially designed for horn-loading. New cabinets on show include a horn and also a 5ft vertical column occupying only 13½in square of floor space and suitable for stereophonic reproduction. Also exhibited are two amplifiers and control units, and

a range of transformers and other components.

Whiteley Electrical Radio Co., Ltd., Victoria Street, Mansfield, Notts.

WINSTON ELECTRONICS (125)

Two tape recorders using the Col-laro Mark IV tape deck will be on show. Independent control of the signal levels at two inputs is provided, and one model, the "Thoroughbred," is fitted with a 7in x 4in elliptical speaker and two 3-in electrostatic tweeters.

Winston Electronics, Ltd., Govett Avenue, Shepperton, Middlesex.

WIRELESS FOR THE BEDRIDDEN (116)

Two types of receiver are supplied by the Society and maintained free for the bedridden and housebound aged people. They are the Ever Ready "Sky Lord" all-dry battery portable and the Ekco U245 a.c./d.c. table model.

"Wireless for the Bedridden" Society, 55A, Welbeck Street, London, W.1.

WOLSEY (38)

New installation components on this stand will be a coaxial outlet box and an all-insulated coaxial plug, waterproof and indoor versions of a triplexer (for which 40dB loss between "bands" is claimed), and distribution amplifiers for Bands I, II and III. These provide gains between 20dB and 50dB in Band III, using ECC84 cascode stages. The Type LD123 provides 12 Band I/II and III outputs and has a gain control for each band.

A new television aerial is the "Topper"—a "V" type "in-the-room" aerial.

Wolsey Electronics, Ltd., Cray Avenue, St. Mary Cray, Orpington, Kent.

AUDIO HALL

high-quality radio-gram wired for stereophony, with a stereo unit which can be supplied as an optional extra.

A. J. Balcombe, Ltd., 52-70, Tabernacle Street, London, E.C.2.

AUDIOMASTER (436)

The new tape unit incorporates separate adjustable record and replay equalization and amplification circuits for three tape speeds and also a push-pull bias and erase oscillator. A 1-in c.r.t. is provided for monitoring the bias and recording levels. Also on show are a high-quality 25-watt amplifier with its very comprehensive associated pre-amplifier.

WN Electronics, Ltd., 80-82, Uxbridge Road, London, W.13.

AVANTIC (448)

No fewer than 18 different high-fidelity stereophonic sound reproducing equipments are now made by this firm ranging in price from £29 8s 0d to £325 10s 0d. The range includes

also single-channel equipments. Many are self-contained including main amplifier, control unit, one or more loudspeakers and cabinet. An elegant cabinet, fittingly styled the "Glyndebourne," houses several of the more expensive equipments.

Separate amplifiers, pre-amplifiers, loudspeaker enclosures and radio tuners are also available.

Beam-Echo, Ltd., Witham, Essex.

B.T.H. (437)

This firm has now entered the domestic "hi-fi" market with a range of high-quality equipment including a 20-watt amplifier. In addition to high-impedance inputs of medium sensitivity, it has low-impedance high-sensitivity inputs for direct connection to low-output tape heads and pickups without further pre-amplifiers. The design is based on printed-circuit technique and incorporates a novel filter circuit with infinitely variable cut-off frequency and constant slope.

Loudspeakers, including the K10A 18-in dual-concentric, will also be demonstrated, on both single-channel and stereo disc and tape inputs.

BTH Sound Equipment, Ltd., 5, Gt. Newport Street, London, W.C.2.

BRENELL (440)

Two portable tape recorders are shown by this firm, one, the "Three Star" gives choice of three speeds $1\frac{7}{8}$, $3\frac{3}{4}$ and $7\frac{1}{2}$ i.p.s., has a printed amplifier circuit and digital revolution counter. The other, Mark 5, is a 4-speed model with three motors, accidental erasure prevention and digital counter, among other features.

The Mark 5 tape deck is available separately and there is a stereophonic

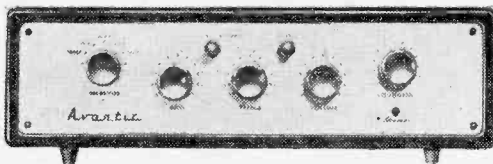

Avantic Model SP21 stereophonic pre-amplifier.

equipment with a Mark 5 deck, four heads and two amplifiers.

Brenell Engineering Co., Ltd., 1a, Doughty Street, London, W.C.1.

C.Q. AUDIO (411)

Two new amplifiers for stereophonic reproduction with power outputs for each channel of $3\frac{1}{2}$ and 2 watts with less than 1% distortion will be introduced. Also primarily for stereophony, a compact new loudspeaker system measures only 13in x 17in x 5in. This is an addition to the well-known range of comparatively small-size loudspeaker systems which includes the interesting "Q-flex" in which the walls are deliberately allowed to vibrate at low frequencies. The "Tetraq" tetrahedral 2-tweeter system will also be shown.

C.Q. Audio, Ltd., 2, Sarnesfield Road, Enfield, Middlesex.

CHAMPION (439)

This display is devoted to high-fidelity single-channel and stereophonic sound reproducing equipment for the discriminating user. It comprises single and automatic 4-speed record players, some of which are portable models, such as the 852B and 884, while others, exemplified by Models 846 and 887, are console types. A feature of most of the portable record players is that the loudspeaker, or loudspeakers, for some

like the Model 884 have two, as this caters for stereophonic reproduction, are quite separate units and for transport purposes are housed in the deep lid of the portable suitcase-type container.

Champion Electric Corporation, Ltd., Newhaven, Sussex.

CLARKE & SMITH (403)

This firm specializes in sound and vision equipment for schools, and will have a comprehensive display of television sets, tape recorders, loudspeakers, amplifiers, record players and receiver/amplifiers for driving several loudspeakers in different classrooms. All models are in stout wooden cases.

Clarke & Smith Manufacturing Co., Ltd., Melbourne Works, Wallington, Surrey.

COLLARO (414)

Equipment demonstrated includes a new crystal pickup for stereophonic records in use with the 4T200 transcription turntable; and also the Mark IV version of the Collaro tape deck among whose new features is included a brake for the flywheel. A stereophonic version of the "Conquest" record changer with several alternative pickup arms is also available.

Collaro, Ltd., Ripple Works, By-Pass Road, Barking, Essex.

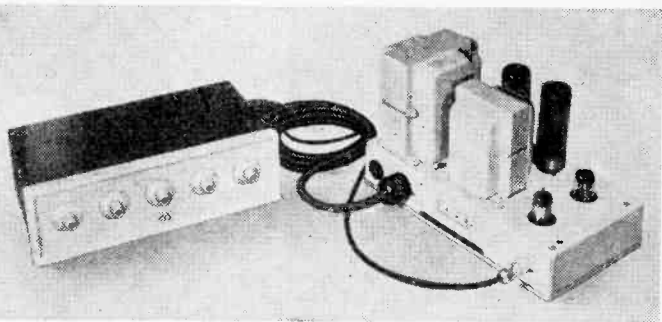

Above: B.T.H. 20-watt high-quality amplifier.

COSSOR (404)

Amplifiers assembled from the new kits supplied by this firm will be demonstrated. Designs with 3-watt, 5-watt and 10-watt outputs are available. Sound receivers, including an f.m. "kit" model, radiograms and record players can also be heard.

Cossor Radio and Television, Ltd., Cossor House, Highbury Grove, London, N.5.

Left: Champion portable stereo record player with two loudspeakers; Model 884.

(Continued on page 423)

DECCA (425)

The variable-reluctance stereophonic pickup which was developed from a model designed to track lateral microgroove recordings up to 30k/cs at 33½ r.p.m. will be of considerable interest. It uses a diamond stylus, the effective mass at the needle tip being only about 1 mgm in a vertical or lateral direction. Two of the stereophonic record reproducers introduced use only a single (central) bass speaker and two separate spaced tweeters.

Decca Record Co., Ltd., Decca House, Albert Embankment, London, S.E.11.

DYNATRON (413)

Reproduction of stereophonic records using the appropriate versions of the Albany and Berkeley radio-grams will be a feature of this stand. New units for the high-quality enthusiasts include a 4-channel controller mixer unit Type TC20 and a 20-watt amplifier the LF20. Three reflex-loaded loudspeaker systems are available each using two Goodman's loudspeakers, a bass unit and a tweeter. Tuners for a.m. and f.m. or v.h.f./f.m. signals only are also on show.

Dynatron Radio, Ltd., St. Peter's Road, Furze Platt, Maidenhead, Berkshire.

E.A.P. (416)

Three loudspeakers with an "ultra-linear" 6-watt amplifier are features of the new "Essex" three-speed tape recorder, which has a response extending to 16kc/s at 15in/sec. Refinements include a pause control and a digit counter place indicator. The "Mayfair" is a similar model in a console cabinet. Also on view will be the lightweight "Escort" tape recorder, an f.m. tuner and a selection of about 30 tape records.

E.A.P. (Tape Recorders), Ltd., Bridge Close, Oldchurch Road, Romford, Essex.

E.A.R. (431)

Stereophonic record reproducers will be introduced with the two speakers mounted in the same cabinet facing upwards. The inputs to these speakers can alternatively be fed to separate speaker units which will be available. Also demonstrated will be a number of ordinary single-channel record reproducers with controls for boosting the bass and treble independently, and push-pull outputs feeding multi-speaker systems.

Electric Audio Reproducers, Ltd., The Square, Isleworth, Middlesex.

E.M.I. SALES AND SERVICE (415)

The two new stereophonic record reproducers will be demonstrated. The RS101 consists of three units, two of these are the loudspeaker systems each containing an elliptical speaker and 2½in tweeter and the third is the control cabinet housing the record turntable, amplifiers and controls. The RS100 consists of only two matching units, each containing an

Right: G.E.C. "Baby Periphonic" loudspeaker system.

Below: E.A.P. "Essex" tape recorder.

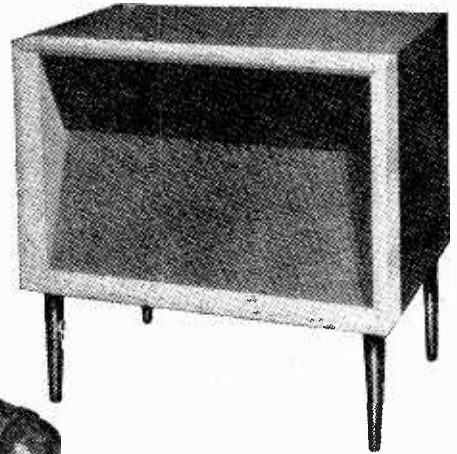

amplifier and loudspeaker system and one containing the record turntable.

E.M.I. Sales and Service, Ltd., Hayes, Middlesex.

EKCO (442)

Demonstrations will be given of the "Nine Octave" record reproducer, RP341, which has a triple loudspeaker system in a tuned, vented enclosure giving a frequency response of 30c/s-16kc/s. For stereophony it is used with an additional matching stereo unit. The model is notable for its compactness, occupying a floor space of only 20in x 17in. A radio-gram, ARG334, has a similar technical specification with the addition of a.m./f.m. reception.

E. K. Cole, Ltd., Southend-on-Sea, Essex.

ELECTRONIC REPRODUCERS (417)

This firm makes piezo-electric gramophone pickups, and will be showing a range of cartridges including single-channel and turnover ceramic stereo types. A range of stereo equipment using the cartridges will also be demonstrated. The company is exhibiting in association with E-V, Ltd., who will be showing their own ceramic cartridge and also sapphire and diamond styli.

Electronic Reproducers, Ltd., Camp Bird House, 39, Dover Street, London, W.1.

EMISTRUCTOR (401)

Instruction manuals and kits of parts for building sound recording and reproducing equipment and a.m./f.m. feeder units are shown. The latest in the range of units are matched amplifiers and pre-amplifiers for stereo reproduction.

E.M.I. Institutes, 43, Grove Park Road, London, W.4.

EXPERT GRAMOPHONES (424)

Stereophonic and single-channel high-fidelity sound reproducing equipment is shown in a wide range of styles and combinations. Special attention is given to the design of cabinets of all types. The "Expert" acoustic-column loudspeaker is included in this exhibit.

Expert Gramophones, Ltd., 39-41, New Oxford Street, London, W.C.1.

FERGUSON (432)

Radio-gramophones demonstrated on this stand will include the 389RG "Felicity" with an 8-in x 5-in elliptical speaker, the 601RG "Futura" with a 9-in x 5-in speaker and the 602RG. All have four-speed auto. changers and a.m./f.m. sound reception. Two portable record players, the 394G "Fortuna II" and 392G "Fan," will also be on show.

Ferguson Radio Corporation, Ltd., 105-109, Judd Street, London, W.C.1.

FERRANTI (446)

The ARG1014 radio-gram can be converted to a stereo reproducer with an additional amplifier and loudspeaker. This system, for which a frequency response of 30c/s to 16kc/s is claimed, will be demonstrated. Also on show will be a TV/radio-gram, a record-player and an a.m./f.m. table receiver.

Ferranti Radio and Television, Ltd., 41-47, Old Street, London, E.C.1.

G.E.C. (443)

The recently introduced "Baby Periphonic" loudspeaker system will be used in a stereo demonstration in conjunction with the 12-W high-quality amplifier. Material reproduced will consist of the most impressive stereo tape recordings made by the company over the past six years and will also include stereo discs. In addition there will be a display of recent metal-cone loudspeakers, "presence" units and audio valves.

General Electric Co., Ltd., Magnet House, Kingsway, London, W.C.2.



GARRARD (438)

Both the length and off-set angle are adjustable in the type TPA12 pickup arm. This is normally supplied with the GMC5 moving coil pickup cartridge and TP1 transformer. The well-known 301 transcription turntable in which each speed can be varied by up to $\pm 2\frac{1}{2}\%$ is also exhibited.

Garrard Engineering and Manufacturing Co., Ltd., Newcastle Street, Swindon, Wiltshire.

GOODMANS (434)

Demonstrations using the interesting new IB3 loudspeaker system will include stereophonic reproduction. This system uses a small totally enclosed cabinet in which the confined air provides most of the restoring force for the specially developed bass loudspeaker. This loudspeaker has a magnet weighing 22lb and a 2½-in diameter voice coil. Middle and upper frequencies are covered by two pressure-driven horn units.

Goodmans Industries, Ltd., Axiom Works, Wembley, Middlesex.

GRAMPIAN (433)

An important activity of this firm is the production of microphones, loudspeakers and sound reproduction and sound reinforcement equipment for public-address applications. New apparatus consists of the "Festival" portable dance-band amplifier, also a guitar amplifier incorporating a loudspeaker with characteristics especially suitable for guitar reproduction.

Amplifiers, pre-amplifiers and loudspeakers are available for high quality sound reproduction in the home.

Gramplan Reproducers, Ltd., Hanworth Trading Estate, Feltham, Middlesex.

JASON (441)

Amplifiers for stereophonic reproduction are in the limelight on this

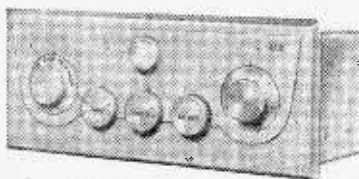

Above: Stereo pre-amplifier by Scientific and Technical Developments.

Left: Contemporary style cabinet housing Truvox stereo tape deck and amplifiers.

stand. The J2-10 is a double version of the redesigned J10 10-watt amplifier. The JSA2 should cater for the gramophile on a limited budget and the output from each channel is 3W at less than 1% distortion from an "ultra-linear" stage. The two sections can be paralleled for single channel operation. Four variations on an a.m./f.m.-tuner theme, a new tape unit using separate record and replay amplifiers and test equipment kits complete the exhibit.

Jason Motor and Electronic Co., 3-4, Great Chapel Street, London, W.1.

K.B. (402)

One feature of the K.B. "hi-fi" equipment is that the control unit is suitable for stereophonic use. The rest of the system consists of power amplifier, radio tuner and a Goodmans loudspeaker system. The units, most of which use printed circuits, will be available individually or mounted in a cabinet.

Kolster-Brandes, Ltd., Footscray, Sidcup, Kent.

LUSTRAPHONE (445)

Recent developments by this firm have been centred on two classes of audio equipment; namely microphones and transistorized mobile and portable public-address equipment. For tape recording there are some miniature, ribbon microphones with bi-directional characteristics, while for mobile use dynamic or carbon types are available with push-to-talk switches.

The transistorized p.a. amplifiers are designed for 12- or 28-volt operation and for 10 or 15 watts output.

Lustraphone, Ltd., St. Georges Works, Regents Park Road, London, N.W.1.

MAGNAFON (419)

A special feature of this display is a portable tape recorder having playback facilities for stereophonic pre-recorded tapes. Shown also are tape pre-amplifiers and the Models M1 and 58 "Magnafon" tape recorders.

Magnafon, Ltd., 3, Baggally Street, London, E.3.

PHILCO (449)

A number of record reproducers fitted with separate bass and treble controls and a push-pull amplifier feeding a bass speaker and one or more tweeters are on show. In the model A3764 "Phonorama," when the lid is closed, the speaker is loaded by two coupled enclosures, the degree of coupling varying with the frequency. This model also incorporates an a.m./f.m. receiver. The model 100 "Century" receiver with independent tuning for a.m. and f.m. signals and the model 3720 f.m. tuner are also exhibited.

Philco (Great Britain), Ltd., 30-32, Gray's Inn Road, London, W.C.1.

PHILIPS (423)

Demonstrations will be given of items from the company's range of "hi-fi" equipment. A new condenser microphone for professional recording, EL6050, is small and inconspicuous and features a change-over switch for giving either omnidirectional or unidirectional response. A new four-speed record changer, AG1014, has push-button controls and will handle up to ten records (of the same speed) at a time.

Philips Electrical, Ltd., Century House, Shaftesbury Avenue, London, W.C.2.

PILOT (428)

This company's range of record-playing equipment (shown on stand 28) will be demonstrated continuously, including high-quality single-channel and stereo systems and the new "Super 10" single-channel and "Stereophonic 4" gramophones.

Pilot Radio, Ltd., Park Royal Road, London, N.W.10.

PORTOGRAM (412)

Two console tape recorders with push-pull audio amplifiers are available. This type of amplifier is also incorporated in some models in the range of portable record reproducers on show.

Portogram Radio Electrical Industries, Ltd., St. Rule Street, London, S.W.8.

R.C.A. (447)

Two new models extend the R.C.A. range of sound reproducing equipment now available. One is a portable record player (PR94) and consists of a 2-stage amplifier giving 4 watts audio output into a dual loudspeaker system consisting of a 6½-in unit for the lower and middle frequencies and a 4-in unit for the upper register. It has separate tone controls for treble and bass and is a.c. mains operated.

The other new item is an Orthophonic high-fidelity loudspeaker system of the panoramic type and consisting of three loudspeaker units in a ported, reflex cabinet with crossover filter.

R.C.A. Great Britain, Ltd., Lincoln Way, Sunbury-on-Thames, Middlesex.

REFLECTOGRAPH (418)

This stand will be used as a private demonstration room for the new "Stereacorder" stereophonic tape recorder. The full range of "Reflectograph" tape machines will be shown on the "Multicore" stand in the main hall.

Multimusic, Ltd., Maylands Avenue, Hemel Hempstead, Hertfordshire.

RICHARD ALLAN (430)

This firm will feature its newly developed range of high-fidelity loudspeakers and enclosures. The "Empress" is a three-speaker system using a 12-in bass unit, an 8-in loudspeaker for the "middle" and a tweeter. The two-speaker "Duchess" is fitted with a 10-in bass unit and a tweeter, which, in this and the "Empress," faces upwards. The "Princess" employs a single high-flux 8-in unit.

Richard Allan Radio, Ltd., Taylor Street, Batley, Yorkshire.

ROLA CELESTION (410)

A new addition to the range of loudspeakers for the high-quality enthusiast is the "Colaudio." This consists of a 15-in bass speaker with 3-in diameter voice-coil and two pressure-driven tweeters mounted one on top of the other in column form inside the cone angle. This gives a good dispersion of high-frequency sounds in a horizontal plane with little wastage in other directions.

Rola Celestion, Ltd., Ferry Works, Thames Ditton, Surrey.

SCIENTIFIC AND TECHNICAL DEVELOPMENTS (433)

The STD/381 stereo power amplifier gives 10-W output per channel for 0.1 per cent total distortion at 1kc/s and less than 0.5 per cent distortion from 40c/s to 20kc/s. This may be used in conjunction with the STD/399 pre-amplifier. For those whose purse-strings are short, another twin amplifier giving 2½-W

A pair of Whiteley loudspeakers for stereophony.

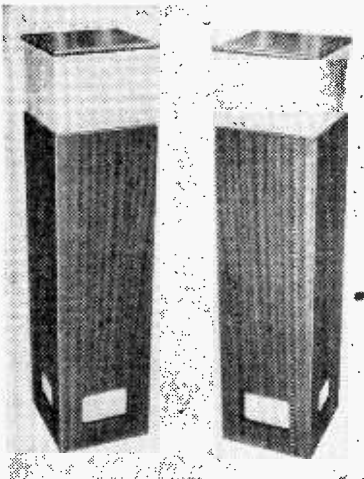

output at a maximum of 0.3 per cent distortion may be the answer. Other equipment includes a 25-W single channel amplifier and pre-amplifier, two versions of an a.m./f.m. tuner and the "Mini-Fi" equipment designed for situations where space is limited.

Scientific and Technical Developments, Ltd., Melbourne Works, Wallington, Surrey.

SONOMAG (426)

A recent addition to this firm's range of tape recorders and associated apparatus is the new "Sonomag 46." It embodies the latest "Motek" three-speed tape deck, a five-valve amplifier and a new design of push-pull oscillator. An Acos microphone is included.

Another new model is a console-type recorder embodying the "Adaptatape" pre-amplifier, Mark IV Collaro tape deck and main

Jason JSMI "tape-unit" providing bias and erase oscillator, record and replay amplifiers for use with most types of head.

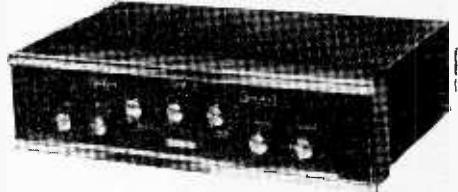

amplifier all mounted in the upper part of the cabinet. Below is an insulated acoustic chamber housing three loudspeakers.

Sonomag, Ltd., 2, St. Michael's Road, Stockwell, London, S.W.9.

SOUNDRITE (409)

In addition to professional stereophonic and single-channel tape recording equipment this firm now has a range of high-grade audio amplifiers with comprehensive pre-amplifiers for both double- and single-channel applications designed especially for the discriminating user. There is one of 25-W rating and capable of handling peaks of 50W and with a sensitivity of 220mV, and one

"Empress" three-speaker system by Richard Allan.

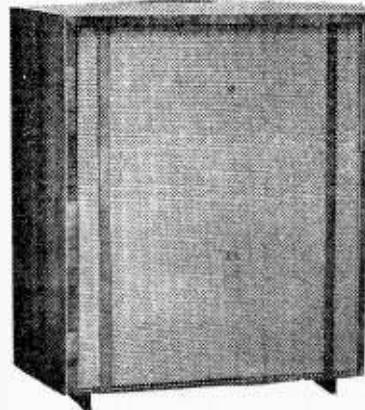

of 12½ watts with sensitivity of 40mV. Output impedances are, 3.75, 7.5 and 15 ohms.

Soundrite, Ltd., 83, New Bond Street, London, W.1.

TAPE RECORDERS (420)

Low price and light weight are features of the new "Sound Belle" tape recorder, which measures only 10in x 7in x 4in. An hour's playing time is possible with the twin-track tape and there is a magic eye recording level indicator. Two other new models are the three-speed "Sound 444" and "Sound 555," both of which use the Collaro Mark IV tape deck. The "Sound 555" has a triple loudspeaker system giving over 4 watts output and includes a stethoscope-type monitoring headset amongst its accessories.

Tape Recorders (Electronics), Ltd., 784-788, High Road, Tottenham, London, N.17.

TRUVOX (421)

Both single-channel and stereophonic tape recording and playback equipment are included in this firm's products. Functional yet attractive cabinets for accommodating their tape deck, amplifier and loudspeakers are available; as, for example, the cabinet for the Mark IV deck with revolution counter and stereophonic head, two "Type K" 4-watt amplifiers and a loudspeaker for single-channel reproduction. For stereophonic reproduction an external loudspeaker system will be needed.

Truvox, Ltd., Neasden Lane, London, N.W.10.

WALTER INSTRUMENTS (429)

Tape recorders being demonstrated include the two-speed models 505 and 303 De Luxe, both of which incorporate a stroboscopic disc attached to the capstan shaft for cinematograph synchronization. A new low-cost, single-speed (3¼in/sec) model, the 101, will also be introduced.

Walter Instruments, Ltd., Garth Road, Morden, Surrey.

WHITELEY ELECTRICAL (422)

Stereophonic and single-channel demonstrations will be given using 8- and 12-watt amplifiers and various loudspeakers and cabinets. Some cabinets are shown fitted with Perspex fronts so that the internal construction can be examined. A 3½-in tweeter is an addition to the wide range of loudspeakers available.

Whiteley Electrical Radio Co., Ltd., Victoria Street, Mansfield, Notts.

Photocell-Powered Receiver

Generator for Operating a Transistor Set from Light Energy

By R. C. T. STEAD

AFTER a preliminary investigation into the possibility of utilizing light energy to operate a transistor receiver, the writer decided to design a photocell generator having an open-circuit voltage of 7.0 volts. An experimental generator was made which consisted of fourteen selenium photocells of the barrier-layer type (Megatron Type B) connected in series to give the required total open circuit voltage. The efficiency of these cells (about 1%) is a good deal less than that of the new silicon photo-voltaic cells manufactured in America (about 10%) but they are considerably cheaper and readily available in Great Britain.*

The physical size of the individual cells was decided to be 37mm by 16.5mm and was selected from the manufacturer's range of standard sizes to give the output required in the space available. The thickness of the cells was 1 millimetre.

The photocells were mounted upon a $\frac{1}{8}$ -in thick Paxolin panel approximately $5\frac{1}{4}$ in long by 3in wide in two rows of seven cells each. Liquid glue was used for fixing. They were insulated from each other by thin strips of $\frac{1}{16}$ -in thick Paxolin, also fixed by liquid glue (see Fig. 1). Fifteen $\frac{1}{32}$ -in diameter holes were made for the connecting wires and fourteen $\frac{1}{8}$ -in diameter holes to expose the rear of the photocells for connecting purposes (see Fig. 2). Sufficient space

was left at one end of the Paxolin panel for two small terminals.

For connecting the photocells in series, 5-amp fuse wire was used. The front electrodes of the cells are negative and the rear electrodes positive. Connections to them were made through the holes already drilled, using a special low-temperature spray metal supplied by the photocell manufacturer. The two front connecting strips of each cell were connected together to obtain maximum current output, as can be seen from Fig. 1. Finally the positive and negative terminations were brought out to the two small terminals. This relieves the photocell connections of any strain from the flexible connecting leads to the apparatus.

Coming now to the receiver itself, this was based on a circuit and component parts for a seven-transistor miniature medium-wave set, supplied by Radio Experimental Products, Ltd., 33, Much Park Street, Coventry. Several resistor and capacitor values were changed to allow the completed receiver to be built into a transparent plastic case approximately $5\frac{1}{2}$ in long by $3\frac{1}{2}$ in wide by 2in deep and also to enable the receiver to operate at a nominal voltage of 4.0 volts. An additional i.f. stage was added to enable the receiver to be used for experimental reception on a short-wave band of about 30 metres with a surface barrier h.f. transistor, and also to increase the sensitivity on the medium-wave band. Specially wound oscillator coils and aerial coils were used when receiving on the short-wave band.

Radio-frequency p-n-p junction transistors were used in the frequency changer and i.f. stages. One audio-frequency p-n-p junction transistor was used in the first a.f. stage after a crystal diode second detector, and other audio-frequency types were used in the second a.f. and push-pull output stages.

The controls and loudspeaker were fitted into the lid of the plastic case and the other components were mounted on internal plastic panels. Initially a $2\frac{1}{2}$ -in Rola loudspeaker was fitted, but this was removed in the interests of space economy in order to fit the components for the additional i.f. stage. The present loudspeaker, supplied by Specialised Electronic Components, Ltd., is $2\frac{1}{2}$ inches in diameter and only $\frac{1}{8}$ in deep. It handles 250 milliwatts output and has an impedance of 3 ohms.

To test the performance of the photocell generator, the measuring instruments used were a Universal

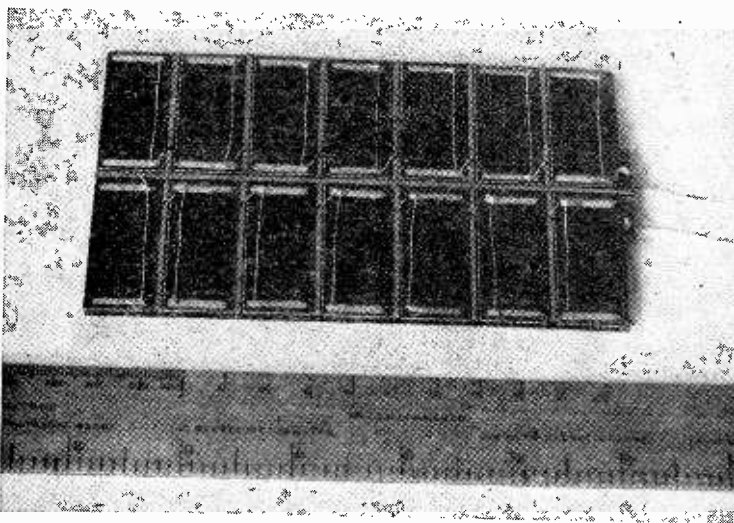
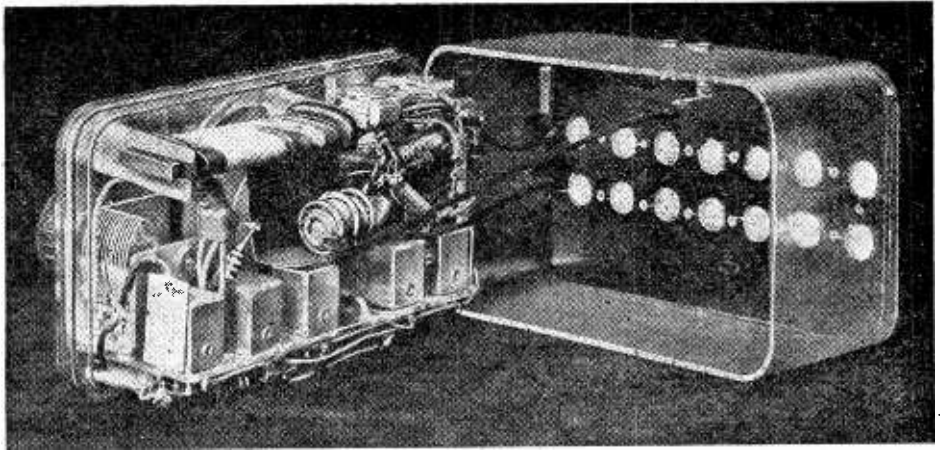

Fig. 1. Construction of the 14-cell generator, showing how the front electrodes are connected.

Fig. 2. The transistor receiver opened, showing the rear of the 14-cell generator mounted in the bottom of the transparent case.



Avominor and a photometer calibrated in foot-candles. The generator was placed in sunlight and the open circuit voltage and short circuit current were obtained at given illumination intensities. The following results were obtained.

Light Intensity (ft-candles)	Open Circuit Voltage	Short Circuit Current (mA)
2400	8.2	9.0
2000	7.5	6.5

The photocell generator was then connected to the receiver in the correct polarity (positive to positive and negative to negative). The receiver was under-powered but the B.B.C. Home and Light programmes were received at a good listening strength and a few other stations were received, including Hilversum, Holland. This test was carried out during April, 1958, and better results are expected from the more brilliant sunlight of the summer months. Below 400 foot-candles and power output was insufficient to operate the receiver.

A test was then carried out with the receiver's push-pull output stage replaced by a single-ended output stage using one a.f. junction transistor. The normal operating current of the receiver was then around 3.5 mA. With the assembly placed in the sunlight the following results were obtained.

Light Intensity (ft-candles)	Receiver Operating Current (mA)
2400	4.5
1600	4.0

The receiver performance was equal to or better than that obtained from the batteries, but below 250 foot-candles the power output from the generator was insufficient to operate it.

After carrying out the above tests the idea occurred to the writer that if the photocells could be used to charge small accumulators, and these used to operate the transistor receiver, power could be stored for use during periods of low sunlight intensity.*

Three tiny nickel-cadmium permanently sealed accumulators of 50mA-hr capacity, manufactured by the Deutsche Edison-Akkumulatoren Company of W. Germany, were obtained in this country from G. A. Stanley Palmer, Ltd. These accumulators have an unlimited storage life, require no maintenance and the discharge voltage curve is more uniform and flatter than that of the usual primary cell. They may be soldered directly into the circuit.

* Provisional Patent No. 22747/53.

The figure of 50mA-hr capacity was chosen because it seemed to be a good value for quick charging time and it would allow typical intermittent use of the transistor receiver at the 10-hour rate. The usual charging current for this size of accumulator is 5mA. The three accumulators were connected together in series and the open circuit voltage was found to be 4.02 volts. The photocell generator was then connected to the accumulators via a milliammeter (connections being of the correct polarity, i.e. positive to positive and negative to negative). When the accumulators were connected to the receiver and the complete assembly was placed in the sunlight, the results obtained were as follows.

Light Intensity (ft-candles)	Charging Current (mA)
2400	5.5
1600	4.0
650	2.8
300	2.0
150	1.5
75	0.85
25	0.35
15	0.2

These results show that even at low sunlight or artificial light intensities the accumulators were receiving a small charging current. Operation at higher illumination intensities will perhaps be possible during the summer months.

In addition to the 14-cell generator described above, an experimental generator consisting of twelve of the same photocells was constructed to give a total open circuit voltage of 6.0 volts. When the 12-cell generator (Fig. 3) was placed in the sunlight the following voltages and currents were obtained.

Light Intensity (ft-candles)	Open Circuit Voltage	Short Circuit Current (mA)
2400	6.6	5.5
2000	6.5	5.0

With the generator connected directly to the transistor receiver supply terminals the receiver was again found to be under-powered, but the B.B.C. Home and Light programmes and a few other stations were received. Below 400 foot-candles the power output from the generator was insufficient to operate the set.

The 12-cell generator was then connected to the

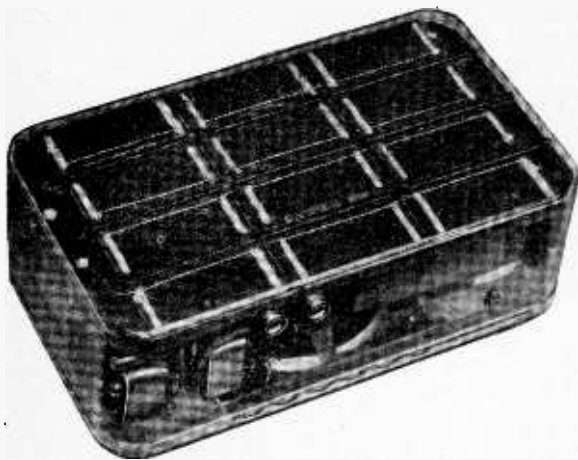

Fig. 3. An experimental 12-cell generator installed in the back of the receiver case.

three nickel-cadmium accumulators of 50mA-hr capacity at the 10-hour rate via a milliammeter, and the accumulators connected to the transistor receiver supply terminals. In sunlight the following results were obtained.

Light Intensity (ft-candles)	Charging Current (mA)
2400	4.1
2000	3.6
1200	3.0
800	2.7
500	2.4
300	1.6
200	1.4
150	1.2
75	0.4
55	0.25
25	0.1

These figures show that, although the 12-cell generator has not the same power output as the 14-cell generator, it does give a useful output. During all the above tests the ambient temperature was 19°C.

The photocells have been found by the writer to exhibit a rectifier function as well as a generator function, and the reverse current through them when the generated voltage falls below the accumulator voltage was found to be negligible even when the cells were darkened.

A small fuse (rated at about 80mA) and an isolating circuit breaker switch of suitable rating could be placed in the charging circuit if desired. Also, a simple form of current control could be incorporated if this was found to be necessary at very high illumination intensities. A milliammeter of suitable range may be fitted into the receiver plastic case and connected to indicate the charging rate. Larger capacity nickel-cadmium accumulators could be used with advantage during the summer months.

The transistor receiver, photocell generator and floating accumulators have been operated by the writer for over four months now from light energy, the actual running costs being nil. Cost of material for the photocell and accumulator power supply would be about £6.

Higher voltages and currents can, of course, be obtained by adding more photocells in series and

parallel. Alternatively a more powerful generator could be developed using larger size photocells. As an experiment a larger photocell size, 50mm by 37mm, was tested by the writer at a light intensity of 2000 foot-candles and the short circuit current was found to be 12.5mA.

A more elegant form of photocell generator could be devised using a moulded transparent plastic mounting, for example. This form of mounting may also be more suitable for larger photocells.

From the work carried out by the writer it would appear that this form of power supply consisting of a photocell generator and floating accumulators could be made to operate transistor radio receivers, transistor operated devices or electrical instruments indefinitely by suitable selection of components and operating conditions. Some measure of current control could be effected by switching photocells in and out of the circuit under varying lighting conditions to keep the output current constant, or a form of shutter could be used.

The writer wishes to express his thanks and appreciation to Dr. G. A. Veszti for his kind help, and also to Megatron Ltd.

Multi-channel Oscilloscope

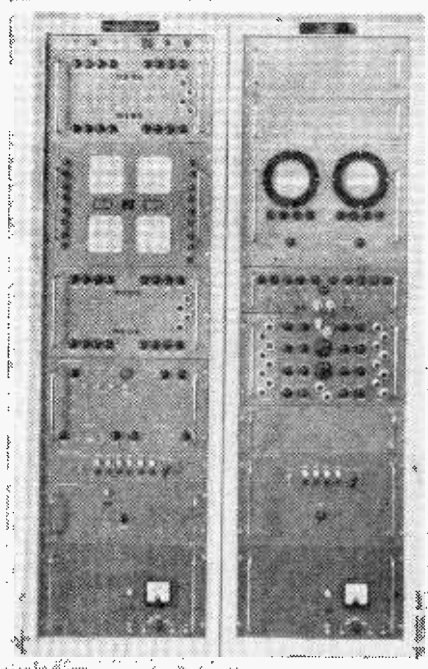

For monitoring and recording simultaneous transient phenomena, for example in thermonuclear reactions, an eight-channel oscilloscope (left, above) and a two-channel storage oscilloscope (right) have been developed by Cawkell Research and Electronics Ltd., 6-8 Victory Parade, Southall, Middlesex.

Four double-gun tubes display the recurrent phenomena, and there is provision for photography. Traces of non-recurrent waveforms on the two storage tubes are retained indefinitely for detailed visual examination.

An oscilloscope similar to the above has been supplied to the Atomic Energy Research Establishment for work on the Zeta project.

On Understanding Transistors

By K. C. JOHNSON*, M.A.

IT is an unfortunate fact of history that the point-contact variety of transistor was discovered some years before the junction device. The last mentioned is fairly straightforward, whereas the former shows a number of effects which we now know to be due essentially to secondary emission processes in the semiconductor and which are comparatively complicated. In the early development this complication in the behaviour of point-contact transistors gave rise to a great deal of regrettable confusion in the drawing of equivalent circuits and the definition of terms, and also to the growth of a number of misleading ideas about the principles of operation. There seems to be a danger now that all this confusion will be transferred to the consideration of the much simpler junction transistors.

It seems probable that if the junction type had been invented earlier the "crystal valve" would have been considered from the first as a close relative of the thermionic valve and the present confusion might never have arisen. This article is an attempt to present the junction transistor from this viewpoint and to put the various differences and similarities between it and familiar thermionic valves in proper perspective.

Thus normal thermionic valve practice will be followed in that the transistor will be treated essentially in the common-emitter connection. This is not an arbitrary choice, as this is the connection that gives the highest power gain at normal frequencies and fits in with the best physical picture of the internal operation. Once a satisfactory equivalent circuit has been obtained, the behaviour of the transistor in either of the other two connections can always be deduced by familiar thermionic-valve methods, since these other connections are essentially only applications of specific types and levels of negative feedback. Consequently all the parameters quoted will be those applying to the common-emitter connection, with the solitary exception of the alpha cut-off frequency as this is found to be a fairly convenient measure of the average transit time. Before considering equivalent circuits, however, we must briefly describe the properties of semiconductors and of electronic valves in general.

Semiconductor Theory

It is well known in fundamental physics that charges are the basic units of electricity, that electric fields make mobile charges move, and that such a movement constitutes a current. Thus, it is generally more satisfactory to regard the voltage in a system as the cause of the currents that flow rather than

the reverse. Semiconductors are no exception to this rule and their properties are most easily understood by considering the electric fields applied and the densities of mobile charges present as causes, and the currents that flow as an effect. Needless to say such a current is often in practice constrained to be constant through regions of varying charge density, and when this is the case space-charges accumulate in such a manner as to adjust the fields and apportion the potential differences in the usual way. Such space-charges frequently arise in the working of transistors and are of great importance, although the actual numbers of charges required to form them are, in general, only a very small proportion of those present.

The applied voltage in such a situation is, of course, the line integral of the varying electric fields between the two points of application on the semiconductor.

The most characteristic property of semiconductors is that, despite their name, they are able to conduct two different electric currents almost independently through the same region at

the same time. More exactly we can say that such material can contain two different types of mobile charge which offer two separate modes for conducting currents. These two types are of opposite sign and carry plus and minus one unit of electronic charge, being known for convenience as "holes" and "electrons" respectively. It is possible by "doping" the semiconductor with minute quantities of impurity atoms to introduce a third kind of charge, of either sign, which is fixed in the structure of the material in both position and, of course, in magnitude. The total charge of each of the three kinds must always balance fairly exactly in any small volume, since any unbalance constitutes a space-charge and affects the electric field so that further accumulation of unbalanced charge is discouraged.

In the absence of any external interference, such as a flow of current from a nearby region of different doping, the densities of the two types of mobile charge are governed only by the need to preserve this charge balance and by spontaneous generation and recombination of pairs of charges. These processes act in a manner which is familiar in many branches of physics and chemistry. The rate of generation depends only on the material, having the usual exponential increase with temperature, whilst recombination is essentially a collision process whose rate is simply proportional to the product of the densities of the two types of charge. Thus there is an equilibrium state in which the product of the two

AN APPROACH FOR THOSE
WHO HAVE SUCCEEDED IN
UNDERSTANDING VALVES

* Ferranti, Ltd.

densities has a value depending only on the particular semiconductor material and its temperature. Clearly a knowledge of both this product and the fixed charge density is sufficient to enable both the mobile charge densities to be deduced.

In particular it will be found that a non-zero fixed charge density has the effect of suppressing mobile charges of its own sign whilst, of course, increasing the density of charges of the opposite sign. In germanium at room temperature the equilibrium product is small enough to allow such mobile charges to be suppressed fairly completely from material in equilibrium by quite moderate amounts of doping. Above about 100°C, however, the product grows too large and the material becomes useless. Silicon has the advantage of a very much smaller equilibrium product and hence is able to work at higher temperatures; some other semiconductors, such as indium antimonide, have such large products that they are useless for making diodes or transistors at any ordinary temperature, although they may have other important applications.

This equilibrium will naturally take time to be established after the end of any disturbance and the precise interval required is likely to be important. A time-constant, or half-life, can never strictly be defined for this process, as "collisions" between two sets of charges are involved and both sets are changing in density. If, however, the minority† carriers are considered in a relatively heavily doped region of material this difficulty is overcome and equilibrium is reached practically exponentially, as the majority† carrier density is substantially constant. The appropriate half-life under these circumstances is usually called the minority carrier lifetime. In general the longer this lifetime in a semiconductor the more sharply its properties differ from those of an ordinary conductor.

Obviously an increase in the density of majority carriers will shorten this lifetime, since collisions are made more likely, and it is because of this effect that it is not possible to make germanium work well at higher temperatures simply by doping it more heavily. The lifetime in a piece of semiconductor is also shortened severely by stresses and faults in the crystal structure and also by complicated effects at the crystal surfaces so that values are never entirely reproducible between different units. In a practical transistor the lifetimes in the heavily doped emitter and collector regions are of the order of tenths or hundredths of a microsecond, so that equilibrium is never seriously disturbed in the operation. In the lightly doped base layer, on the other hand, the lifetime may be ten microseconds or more, so that it is fairly long compared with the transit time. The effects of recombination in this layer are therefore significant but not overwhelming.

Thus, to sum up, any particular region of a crystal of semiconductor is permanently characterized by its fixed charge density. If this is negligible the material is said to be "intrinsic" and charges of the two mobile types will always be present in substantially equal numbers. In equilibrium these numbers will be small, but they may be increased enormously if charges are being swept in from other regions of

the crystal. If the material is doped, then the densities of the two types of carrier will always differ by a constant amount equal to the fixed charge, and, needless to say, neither of these densities can ever be less than zero. Such material is said to be of p- or n-type according to whether the majority carriers have positive or negative charge respectively. When an electric field is applied these mobile charges move to give a current in the usual way. If no charges are present in any region there can clearly be no current flow and that material is an insulator until the conditions are changed. This, of course, happens in a diode when reverse voltage is applied and the region devoid of mobile charges is known as a "depletion layer." It can clearly only be in near intrinsic material, but there is inevitably at least a thin layer of such material at the junction which is the essential part of any diode structure.

It must finally be mentioned that the mobile charges can move also by diffusing from a point where their density is high to another where the density is lower. This is, of course, independent of the effect of any electric field and is important since, if the doping is uniform, diffusion makes the two types of charge move in the same direction whereas an electric field invariably drives them opposite ways. Thus, a combination of a density gradient and an electric field is able to move one kind of charge whilst holding the other substantially stationary. This is important as it happens in the base layer of a transistor and enables a heavy current of minority charges to flow without any serious movement of the majority charges in either direction.

Valves

An electronic valve can conveniently be defined as a three-terminal device in which the voltage applied between two of the terminals is able to control the current flowing from one of the two to the third. The common electrode is called the emitter, or cathode, and is a source of charges which carry the current. The flow of these charges depends on the voltage of the control electrode, which is known as the base or grid, but the design is made so that almost the whole of the flow goes to the collector or anode, which is, of course, the third electrode. In an ideal valve the emitter current will be controllable over a wide range by only negligible changes of input voltage, the control electrode will take none of the current, and the voltage of the collector will have no effect on the current it receives. It is generally true that the interesting properties of any particular type of valve are the various ways in which it falls short of this ideal.

The arrangement whereby the grid of a thermionic valve controls the flow of current without itself collecting electrons is familiar, but it does not seem to be generally realized that the base of a transistor performs an exactly similar function. In a transistor the current from the emitter to the collector is made to flow in one only of the two conduction modes of the semiconductor by doping both these regions heavily with the same sign of fixed charge. The thin base layer which separates them is by contrast doped quite lightly with the opposite sign of charge so that it has a small majority of the other kind of carriers and it is arranged that only these last mentioned are able to conduct freely to and from the base terminal. Thus the voltage of the base layer can

(continued on page 431)

† Minority current carriers are the electrons in p-type material (as they are outnumbered by the holes) and the holes in n-type material (as they are outnumbered by the electrons). Conversely for majority carriers.

be adjusted by means of an increase or decrease of charges in the one conduction mode almost independently of the current from emitter to collector flowing in the other. The doping in the base is kept light so as to minimize the unwanted flow of oppositely charged carriers from the base to the emitter and also to decrease the recombination between pairs of charge carriers, since both these effects cause unwanted base current.

It is unfortunate that the standard symbol being adopted for the transistor (see Fig. 1) is one which suggests that the current from the emitter actually flows to the base electrode and then mysteriously jumps off it again to go to the collector. It would seem both clearer, and also a better representation of the mechanical facts, to use a symbol in which the emitter and collector are drawn on opposite sides

not be forgotten that the collector of a transistor is able to emit if the voltage on it is reversed. The behaviour is very much like that of a thermionic triode in which the anode has a hot oxide coating. Like such a triode the structure of a transistor is by no means symmetrical and the performance is normally inferior when the current is flowing in the reversed direction. In most circuits where this back conduction might cause trouble it can be eliminated by inserting a suitable diode in the collector lead, though this may sometimes cause a loss of power efficiency.

The phenomena of point-contact transistors can now be explained by supposing that these devices have the property that the collector shows secondary emission of charges of the opposite sign to those arriving at it. This can, in fact, happen in a semiconductor, though such secondary emission would be impossible in a valve. The field, of course, is in such a direction that these new charges are driven back towards the base, and since they are of the opposite sign and so are travelling in the other mode they flow to the base terminal rather than to the emitter. Thus, this secondary emission gives rise to an effective current from the base to the collector which may typically be three or four times greater than the original emitter current. This makes the base input impedance negative and these devices have been used in numerous clever circuits founded on this effect, particularly for pulse operation in computers. Unfortunately it does not seem possible to manufacture them consistently and cheaply and they are now being abandoned. The term transistor will therefore hereafter refer exclusively to junction devices. The same type of secondary emission does occur also in these, particularly at high collector voltages, but the effect is very small and appears to be useless in circuit design.

D.C. Conditions

When d.c. voltages are applied to a transistor there are three distinct types of unwanted current flow that may be important. These currents affect the circuit and biasing arrangements that must be used but are d.c. and so receive no consideration in the description of the small-signal equivalent circuit that is to follow. In general they all contribute to the current flowing at the base terminal and make it necessary to keep the effective d.c. resistance of the base circuit low if satisfactory operation is to be obtained.

The first, and normally the most important, of the three is the emitter-base current. This is partly caused by the reverse flow of majority charges from the base to the emitter, but is mainly due to the recombination within the base layer of charges in transit from the emitter to the collector. If bottoming is not permitted this current is almost exactly proportional to the main emitter-collector current but is smaller by a factor in the range between 20 and 100. This factor is close to the current gain β which will be discussed more fully in the section on equivalent circuits, but roughly it is the ratio of the lifetime of the minority carriers in the base layer to their transit time through it. If bottoming is allowed the average transit time necessarily increases, whilst at very high values of emitter-collector current the lifetime of the carriers shortens as there is a significant increase in the density of the majority charges in the base layer. Both these effects result in a reduc-

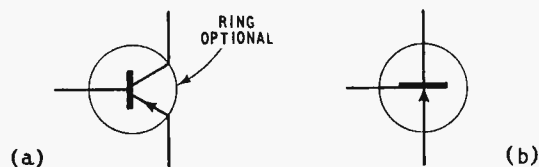

Fig. 1 (a) British Standards recommended symbol for a p-n-p transistor; (b) suggested new symbol for the same type of transistor.

of a thin line representing the base. It would seem also desirable that there should always be a ring round the device to indicate that it ought to be hermetically sealed and, lastly, that a transistor should be described in any text by the familiar letter V, as it deserves the name "valve" no less than does the thermionic device.

The ordinary alloy junction transistors now being made in quantity are of the p-n-p type in which the emitter sends out positive charges, instead of the familiar negative electrons. This means that the polarities of the power supplies and waveforms are all reversed from those familiar with thermionic valves. This reversal is of no real importance, but gives rise to an unpleasant choice in the drawing of circuits. Either the positive power rail remains at the top, or alternatively the valves are drawn so that the emitted charges flow upwards. Both these features are familiar in valve circuits and there is no escaping the fact that one or other of them must be abandoned and the transistor circuit will be upside-down in one of the two respects.

Of course, the ideal engineer will be able to understand circuits drawn on either convention with equal facility. It is practical experience, though, that keeping the charge flow upward makes circuits look the more familiar. This in turn makes them more easily understood, and this consequently seems the more desirable convention. Thus, an "upward" movement of control voltage can be defined as one that increases the emitted current and, in particular, collectors "bottom" at the bottom rather than at the top. It is not claimed that this convention automatically eliminates all the difficulties, but only that it is the lesser of two evils. This question must be considered seriously, as it is not purely transient and will remain when valves have been entirely replaced by transistors, since n-p-n transistors are not at all impossible to make and are, in fact, being used.

When comparing transistors with valves it must

tion of the current gain and a relative increase of this base current.

In normal Class A operation at an emitter current of -1mA , which is typical for a low power transistor, this recombination gives rise to a base current of perhaps $-25\mu\text{A}$. This current flows in such a direction as to make the input resistance positive, so that, unlike the base current in a point-contact transistor, it cannot normally cause circuit instability. The corresponding grid current in a valve is many orders of magnitude smaller than this, so that the newcomer to transistor circuit design must beware of making "base-leak" resistances too large.

The other two of the unwanted currents are leakages due to thermal generation of minority carriers similar to the back leakages which occur in semiconductor diodes. The first of these is the base-collector leakage I_{co} which flows whenever any normal voltage is applied between the two electrodes. The second of the two is the base-emitter leakage I_{eo} which is less important as it flows only when the base-emitter voltage is such that the transistor is cut-off. Both these currents vary little with the applied voltage over considerable ranges, but they increase very rapidly with heating.

The values vary considerably from one transistor to another, but $+5\mu\text{A}$ is typical for the current at the base of a small germanium transistor due to either of them acting alone. Their precise value in and effect on any particular circuit is best found by direct measurement; an increase of one will, for example, normally decrease the other. These leakage currents in any case double for every rise of about 6°C in the temperature of the semiconductor junctions and this effect normally fixes the limit to the power which can be dissipated at any particular ambient temperature, as the junction temperature must not exceed a certain maximum. The relationship between these quantities is usually given in the manufacturer's data.

The quantity I_{co} , which is quoted by some manufacturers, is the apparent leakage current from the emitter to the collector with the base open-circuit. This is an easy parameter to measure, but normally it is simply equal to $(\beta+1)I_{eo}$ and is in any case useless for practical circuit design as no normal arrangement ever allows the base terminal to become open-circuit. Nevertheless it is worth noticing that transistors, unlike valves, are not damaged if the control is accidentally open-circuited whilst voltage is applied to the collector.

The three leakage currents I_{co} , I_{eo} and I'_{co} can easily be measured on a test meter and provide a very rapid means of checking a doubtful transistor by comparison with a satisfactory specimen. Transistor failures are normally of three types: leads may be open-circuit inside the envelope, the semiconductor may have been fused by an excessive power dissipation, or the material may have become contaminated due to old age or failure of the sealing. In the first case the leakage will be suspiciously too small from the electrode in question, whilst in the other cases either I_{co} or all three leakages will be too great.

It is customary to bias transistors for Class A operation by arranging that they receive a certain prescribed current at the base through a resistance from the collector voltage supply, and the emitter is then connected directly to ground. This system has proved much more satisfactory than the use of con-

ventional voltage bias on the base, since transistors have much higher mutual conductances than thermionic valves and the variation of the working point between different specimens would be far too great if voltage bias were used. The fundamental problem of biasing, though, is to fix the emitter current at a desired value and, as we have seen, the base current is the resultant of various unwanted and ill-determined leakages, so that it is still not a very good measure of the emitter current, particularly when changes of temperature must be considered.

Much more precise control of the working point can be obtained by a "long-tail" arrangement wherein the emitter current is determined directly by a voltage and the tail resistance, whilst the base is returned to earth. It is a disadvantage of this kind of circuit that a larger power supply is required, but a substantial advantage in the accuracy of the control of the working point can be obtained, even with valves, whilst transistor power supplies are easy to make. It is not difficult to re-arrange almost any ordinary circuit to incorporate this form of bias, or some equivalent arrangement, and if transistors had been invented before valves with battery heated filaments such circuits would probably have been commonplace. With them the transistor is essentially in earthed-base connection with respect to its d.c. stability, whatever function it may be performing at higher frequencies, and accordingly the more generous maximum voltage and power ratings appropriate to this connection may be used.

(To be concluded)

Denco Transistor Coils

A RANGE of sub-miniature coils designed especially for transistor receivers, and in particular for Mullard OC44 and OC45 transistors, has been introduced by Denco (Clacton) Ltd., 357-359 Old Road, Clacton-on-Sea, Essex. There are two i.f. transformers for 470kc/s; IFT13 with Q of 110 for first and second stages and IFT14 with Q of 130 for third and subsequent stages. The medium-wave oscillator coil has a Q of 90 and there is a ferrite-cored aerial with Q of 125, measured at 1Mc/s.

I.F. transformers and the oscillator coil cost 9s 6d each and the ferrite aerial 7s 6d. I.F. transformers and oscillator coil are wound on pot-type ferrite cores and enclosed in aluminium screening cans measuring $\frac{1}{2}$ in square and $\frac{1}{16}$ in high above seating. Connecting pins project through the base where also is the access to the tuning slug. Fixing is by means of two spring clips which engage in holes drilled in the chassis.

A circuit diagram of a 6-transistor superhet receiver embodying these coils is available and costs 3d and it is understood that a printed circuit board of the same design will be available shortly.

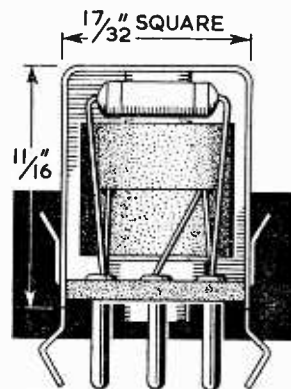

Denco transistor i.f. transformer on small pot-type, ferrite core enclosed in miniature screening can.

Educational Aids Design for an Oscilloscope for Construction in Schools

THE importance of fostering interest in science subjects in schools and training colleges has been recognized by a number of industrial concerns for a good deal longer than it has been fashionable to talk of the shortage of scientists and qualified technicians.

Mullard do a great deal to encourage this interest in many ways, but notably through their Educational Service.

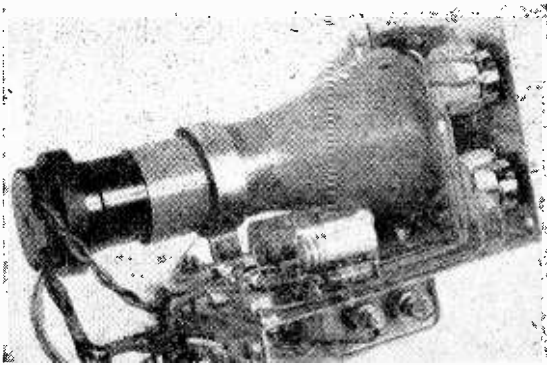

C.R.T. unit of the Mullard students' constructional oscilloscope which employs a 3-inch DG7-31 tube.

Technical films, filmstrips, special showcases illustrating the construction of valves and tubes, wallcharts, booklets giving constructional details of laboratory equipment, and a comprehensive range of instructional publications: all these facilities are available to any *bona fide* teacher, lecturer or educational establishment wishing to make use of them. The Service has expanded rapidly since its formation some five years ago and to-day over 3,000 teachers (using the name in the broad sense to include adult-

education lecturers, Forces instructors, etc.) regularly receive information about the Service.

The number of instructional films currently available on free loan amounts to 17. These deal with subjects such as electric discharge through gases, the linear accelerator, the ionosphere, transistors, valves and, the most recent, the splitting and harnessing of the atom. In addition, 30 filmstrips have been produced, including one series specially compiled for students taking the O.N.C. in electrical engineering and others for use in grammar and secondary modern schools.

The most recent facility to be offered by the Educational Service is the complete constructional details of a simple, yet very useful, oscilloscope which students can build and subsequently use in the school laboratory. The oscilloscope was designed by Mullard laboratory staff after the Educational Service had made an extensive survey among science masters to determine their exact requirements. To make certain that the construction was sufficiently simple and the instruction adequate, boys from a local school were asked to assemble one, which they did accurately without supervision.

Although essentially simple the oscilloscope nevertheless contains several special features. For example, the "Y" amplifier is direct-coupled and has a sensitivity range of 100V/cm up to 10mV/cm, covered in 5 switch positions. This enables accurate measurements of voltage, current and resistance values to be made. There is provision for the instrument to analyse its own supply voltages so that the various waveforms of rectification can be shown readily and an auxiliary power socket to provide h.t. and l.t. supplies for ancillary apparatus. The constructional details are issued as a 28-page booklet containing also descriptions of experiments devised to give the student a thorough understanding of the principles and uses of the instrument.

In Our Next Issue

THROUGH the courtesy of our associate journal *The Architect and Building News* and the B.B.C. we shall be reproducing, as a large-sized (18½in × 14½in) supplement to the October issue of *Wireless World*, a coloured sectional drawing of the B.B.C. Television Centre at the White City, London.

The accompanying reduction is quite inadequate to give more than a hint of the wealth of detail which the artist, R. E. Poulton, has succeeded in working into this masterpiece of perspective drawing, which shows clearly the unique layout of studios, scenery stores, etc., and the location of technical services.

Both as a guide for future reference and as a work of art we are confident that readers will find this forthcoming supplement of more than usual interest and value.

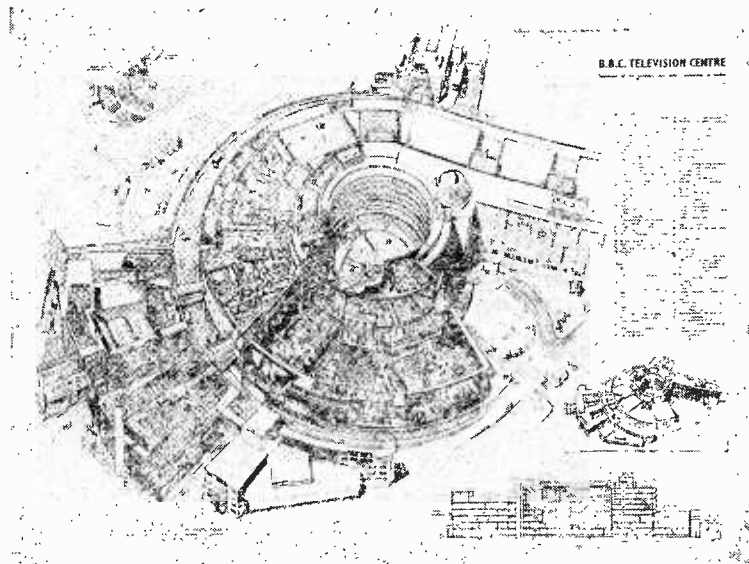

LETTERS TO THE EDITOR

The Editor does not necessarily endorse the opinions expressed by his correspondents

Licence Reminders

IN your comments (page 253 of the June issue) on my letter about the wording of our wireless licence reminders you question whether the Postmaster-General has any "specific obligation" under the Wireless Telegraphy Act, 1949, to see that people do not use broadcast receivers without his licence. Although it is true that the Postmaster-General is under no *express* statutory obligation to do so, it is clearly implicit in the Act that he should exercise this function.

I should like to explain that we much prefer people to take out licences without any prodding. Prosecution must follow where reminders designed to be as helpful as possible have no effect. In asking those who are not renewing their licences to let us know why, we are trying to save them (and ourselves) further trouble, and we find that many appreciate this.

We do not confine our attentions to those who have already been licence-holders. We also approach people who may have a set but who apparently have no licence.

T. A. O'BRIEN

Public Relations Officer, General Post Office.
London, E.C.1.

Technological Qualifications

ONCE again *Wireless World* (p. 364, August issue) encourages holders of the City and Guilds Full Technological Certificate in Telecommunications to believe that at least we tried hard.

It is a pity, however, that significant bodies, such as the I.E.E., are either unaware of the standard involved or, alternatively, subscribe to the closed shop principle in a most insidious form.

Would it not be possible for the Ministry of Education to encourage a less restrictive attitude, as shown by some of the more enlightened British and American firms, by grouping all roughly equivalent qualifications under clearly defined headings, with a view to averting some of the unfair prejudice existing at present.

Cheltenham.

E. HARVEY.

Heater Circuit Earths

THERE is a point of some importance to the "hi-fi" industry that I would like to ventilate through your columns in the hope of achieving some degree of standardization amongst manufacturers.

If the low hum level that it is desirable to achieve in a high-quality sound reproducer system is to be realized, it is imperative that the heater chain be earthed, preferably at the electrical centre point. This is in fact common practice amongst the designers of high-gain amplifiers. It is also fairly common practice to provide sockets or terminals to supply power to a separate tuner unit, pre-amplifier, microphone amplifier or auxiliary unit. However, there seems to be no common practice about heater circuit earthing among the manufacturers of these auxiliary units, some designers leaving the heater wiring unearthed while others earth one side or occasionally include earth centre tap.

If I were a manufacturer of mains transformers I would applaud this diversity as being one of the better methods of increasing my business, but in more serious vein might I suggest that the poor customers' interest would be best served either by omitting the earthing connection on the heater chain in all auxiliary units or

less satisfactorily by earthing the chain through a resistor of about $1k\Omega$ and of appropriate wattage.

This leaves the responsibility for providing an earth on the heater chain fairly and squarely with the manufacturer of the amplifier units, but this is almost always the best technical solution. Would any manufacturer like to suggest an alternative point of view or if not could all manufacturers of auxiliary units agree to omit any heater circuit earth connection on their units.

A. L. WHITELEY,

Electronics Engineering Dept.,
The British Thomson-Houston Co., Ltd.

Rugby.

Tape Spools

I WOULD esteem it a privilege to assist Mr. John Weir of the London Tape Recording Club with his problem concerning the threading of tape reels. Has the questioner tried the Grundig or the Mastertape spool? No quicker system has been evolved, and it is very effective. On the other hand, a practised recordist dispenses with all forms of tape locking. By placing the end of the tape against the hub of the spool, holding with the finger and revolving the spool a complete revolution, the tape is held securely by friction and pressure from succeeding layers. This system obviates any possibility of damage on fast overwinding.

Cinematograph film is somewhat tougher and does require some form of semi-fixing.

To some users, any form of tape fixing is an embarrassment. In view of the enormous pressure exerted at the centre when a spool is full, any break in the surface of the hub can cause deformation to a number of layers of tape.

G. E. SPARK.

M.S.S. Recording Company Limited.

London, W.C.1.

I WAS amused to read Mr. Weir's letter concerning the difficulty encountered in the threading of tape spools in a hurry. This is quite easy if you first of all wrap the first few inches of leader round a thin rod, about $\frac{1}{4}$ -in diameter, press this in between the pages of a book, to prevent unwinding. It is then left for a few minutes. The end thus created will now assume a curled state. This should be smoothed out with finger and thumb. All that is then necessary is to place the tape spool on the recorder, thread the tape through the record/playback heads, leaving enough leader to pass the centre of the take-up spool, set the recorder to fast rewind, slowly turn the tape spool forward until the friction between spool and the leader causes the two to bind on to each other. In practice this usually takes me three or four seconds from the time I pick up the tape.

The end of each leader need only be curled round the pencil (or rod) once, as they retain this curl more or less permanently.

Tipton, Staffs.

B. SADDLETON.

Tape Speeds

CONTINUING the recent discussion on this subject, I would like to put forward a system of my own, which not only avoids the "odd" values of tape speeds, but also simplifies the cumbersome numbers indicating the length of tape on a reel. In addition, it enables the playing time of a reel to be quickly deduced.

The basic unit of the system could be called a

"Stille" as suggested by "Free Grid" (January and March issues). However, unlike some other suggestions in your columns, my "Stille" would be a length, not a speed. Let us take 1 Stille=37.5 feet. The standard tape speeds are then:

$7\frac{1}{2}$ in/sec = 1 min/Stille = Speed 1
 $3\frac{3}{4}$ in/sec = 2 min/Stille = Speed 2

and so on, e.g.

$1\frac{1}{8}$ in/sec = 8 min/Stille = Speed 8
 15 in/sec = $\frac{1}{2}$ min/Stille = Speed $\frac{1}{2}$

The additional advantage of this system is that a reel of tape is described not as 600ft, but as 16 Stilles. This enables the user to see instantly that the reel will play

for 16 min at Speed 1, or 32 min at Speed 2, etc. Some commonly used tape lengths now become:

1,200ft = 32 Stilles
 900ft = 24 Stilles
 300ft = 8 Stilles

Whether this system is used or not, I would like to see all manufacturers rationalize the lengths of normal thickness tape to 150, 300, 600, 900, 1,200 and 1,800ft (4, 8, 16, 24, 32, and 48 Stilles) on spools respectively 3in, 4in, 5in, 5 $\frac{1}{2}$ in, 7in and 8 $\frac{1}{2}$ in diameter. Similarly, for thin base tape, 6, 12, 24, 32, 48 and 64 Stilles should be standardized.

Abingdon.

ROY JENKIN.

SUNSPOT AND MAGNETIC ACTIVITY

THEIR EFFECTS ON H.F. RADIO-COMMUNICATION FROM 1950 TO 1957 INCLUSIVE

By A. M. HUMBY,* M.I.E.E.

RECORDS of sunspot activity over the past 100 years reveal an average cycle of approximately 11 years, with fairly well-defined maximum and minimum values. Similar records of magnetic activity indicate a close relationship, statistically, with the maximum values occurring in general during (or very slightly after) the maximum sunspot activity

(Fig. 1). This review examines some unusual features of recent sunspot and magnetic activity, and their effects on the performance and frequency usage of certain Admiralty high-frequency radio-teletype circuits.

Sunspot Activity.—Increases in sunspot activity are accompanied by increases in:—(a) ionization of

Fig. 1. Geo-magnetic and solar activity from 1835 to 1941 (Extract from N.B.S. circular No. 462, p. 59).

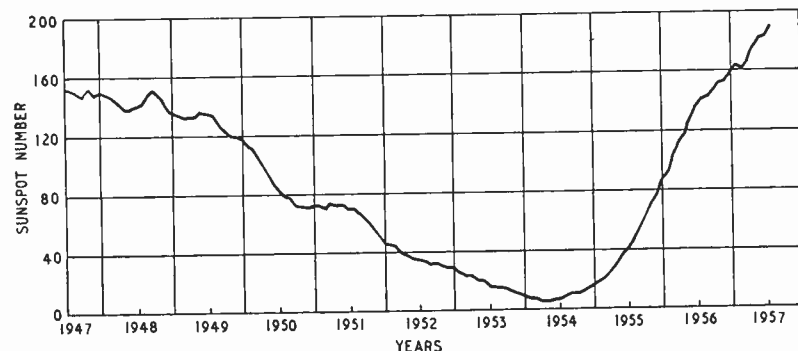
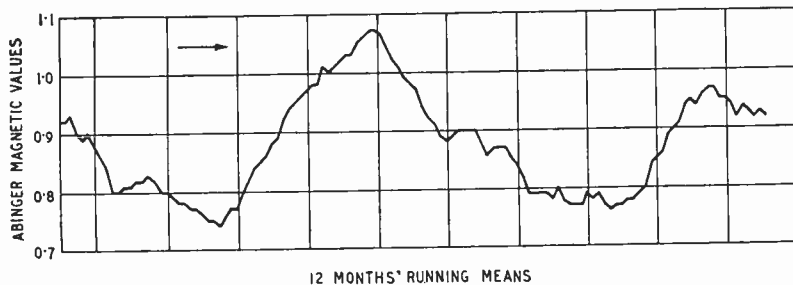
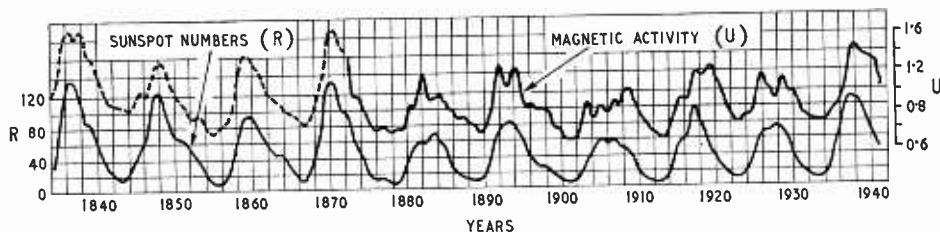

the E and F layers, (b) absorption in the D region, (c) magnetic activity in general.

In consequence of (a) above, higher frequencies may be used for sky-wave communication in sunspot maximum years, and provided suitable high-gain aerials for such frequencies are available, there is generally an overall improvement in h.f. radio-communication with increased sunspot activity, since (b) above has its greatest effect on the lower frequencies.

Failure to take full advan-

* Royal Naval Scientific Service.

Left : Fig. 2. Sunspot and magnetic activity for the years 1947-1957.

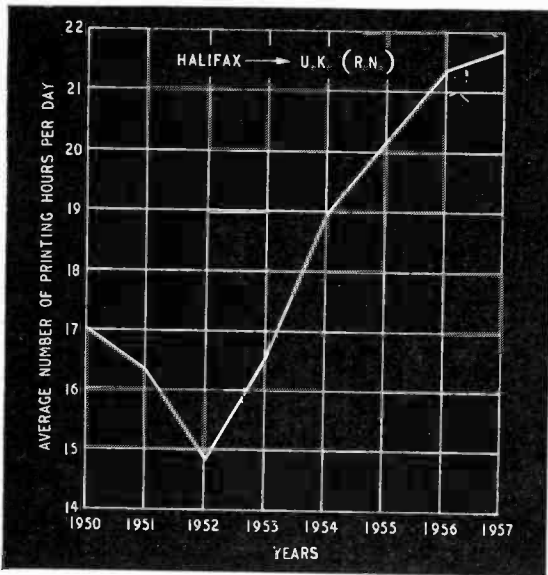

Fig. 3. Operating conditions between Halifax and U.K. during 1950 to 1957.

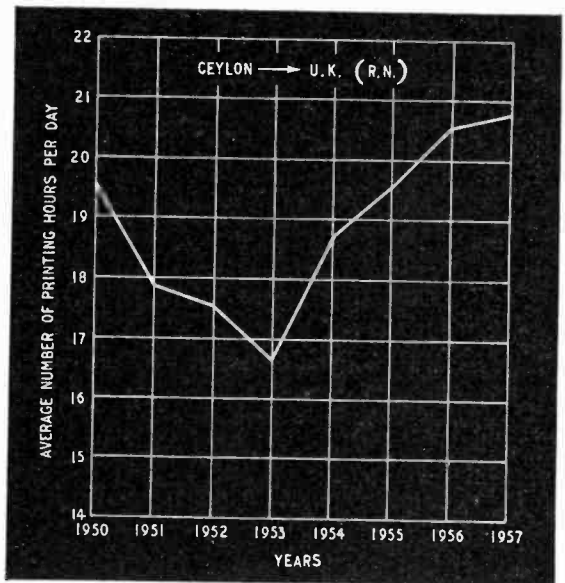

Fig. 5. Working conditions over the Ceylon|U.K. circuit, 1950-1957.

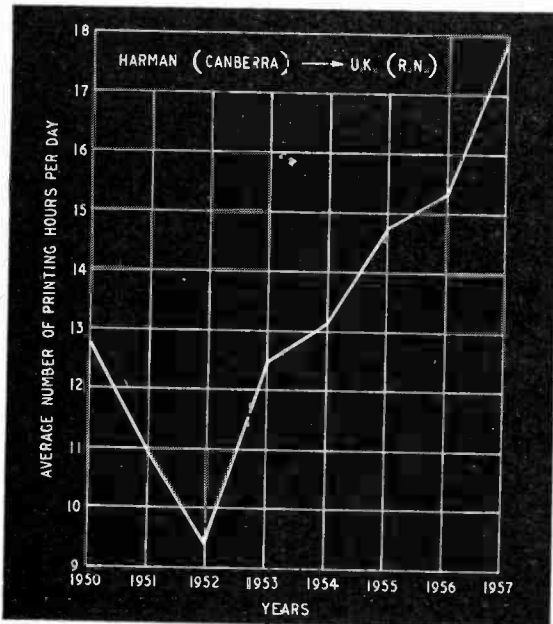

Fig. 4. Harman (Australia) | U.K. working conditions, 1950-1957.

tage of the higher frequencies available during sunspot maximum activity may, however, result in some circuits being unnecessarily interrupted from the effects of sudden ionospheric disturbances and from interference from unwanted transmissions.

Ionospheric Storms.—When the earth's magnetic activity increases, it can be inferred that ionospheric storms (i.e., massed disturbances of ionization) are taking place. Such ionospheric storms, which may last for a period of from several hours to several days, are usually accompanied by a lowering of ionization of the F layer, and an increase in absorption.

During such periods, therefore, there is usually a lowering of the band of frequencies suitable for high-frequency communication, together with impairment of communication at the lower frequencies.

In consequence of the above, whilst in sunspot minimum years magnetic activity is frequently also at a minimum, the disturbing effects of the ionospheric storms on h.f. communication are much more pronounced because of the already restricted

APPENDIX

The following is an extract from C.C.I.R. Technical Circular, ref. TC/5, issued from Geneva on 9 December, 1955.

"We wish to draw the attention of all users of radio waves to the unexpected very rapid rise of the observed 'provisional sunspot numbers' which took place during November 1955. Indeed this rapid rise far superseded all predictions known to us.

There is an empirical rule, deduced from many earlier observations, stating that a forthcoming sunspot maximum will be the higher the faster the sunspot numbers increase during the beginning of the build-up of a new cycle. The last minimum occurred during the middle of 1954, and at present we are in the build-up phase of a new cycle. This build-up is now occurring at an exceptionally rapid rate so that, in all probability, the next sunspot maximum will be of outstanding intensity. Professor M. Waldmeier, Director of the Zurich Astronomical Observatory, the well-known expert in this field, expects the highest 'smoothed monthly relative number' to be about 150, or even larger. Moreover, he expects the coming sunspot maximum to surpass all the sunspot maxima so far observed, and he predicts that this maximum will be reached as early as the middle of 1957.

If the above extrapolations prove to be accurate we may expect the change to higher frequencies for long-distance radio communications to be necessary much sooner than might have been generally thought. It is for this reason that we herewith draw the attention of all concerned to this unexpected phenomenon."

frequency range available during sunspot minimum years.

On certain paths, e.g., transatlantic, the optimum frequency during the period of minimum sunspot activity may be already so low at times that there is little or no margin for reduction during ionospheric storms; in consequence communication may not be possible in the absence of a suitable relay link.²

Recent Changes in Circuit Performance.—Two outstanding features of the period under review (Fig. 2) are:—(i) the unusually high peak of magnetic activity experienced about two or three years before the minimum of sunspot activity of 1954, where normally one would have expected a decline,³ (ii) the exceptionally high value of sunspot activity attained in 1957. (This latter feature was in accordance with a prediction issued in 1955 by the Director, C.C.I.R., see Appendix.)

There seems little doubt that (i) above was a major factor contributory to the difficulties of communication experienced in 1952 on the Royal Navy circuits, Halifax/U.K. (Fig. 3), and Harman/U.K. (Fig. 4). The circuit Ceylon/U.K. (Fig. 5) was somewhat similarly affected, though to a lesser extent.

In this connection, experience indicates that circuits of which the great-circle paths traverse high latitudes are in general more prone to interruption by ionospheric storms than those traversing low latitudes.

For the three circuits referred to above, the maximum latitudes of the ray paths are as follows:—

Harman/U.K. 55° 15' N

Halifax/U.K. 52° 30' N

Ceylon/U.K. 52° 00' N

In regard to (ii) above, the progressive improvement in performance shown in Figs. 3, 4 and 5, as the sunspot activity increased to the outstandingly high value attained in 1957, is typical of the change in performance to be anticipated under such conditions.

Sunspot Activity and Frequency Usage.—Reference has already been made to the ability to use to advantage higher frequencies during sunspot maximum years than those at other epochs of the sunspot cycle.

In practice such changes in frequency usage tend to be more in evidence on medium- and long-distance routes, since on many short-distance routes

there may be adequate reserve of signal strength to enable operation to be carried out on frequencies well below the optimum dictated by ionospheric considerations.

Analyses of the diurnal changes in frequency usage for the Ceylon/U.K. circuit for 1954 and 1957 are shown in Figs. 6 and 7 respectively. Similar data for the Harman/U.K. circuit are shown in Figs. 8 and 9.

These large changes in frequency usage which may be found necessary over a relatively short period of years render impracticable the drawing up of satisfactory time schedules for non-simultaneous sharing of specific frequency assignments, at least on an international basis.

Future Trends.—On the assumption that the peak of sunspot activity has now been reached, a gradual deterioration in circuit performance (other conditions remaining unchanged) is to be anticipated as the sunspot activity declines to a new minimum value (? in about 1965), together with a reversion to the use of frequencies lower than those found necessary

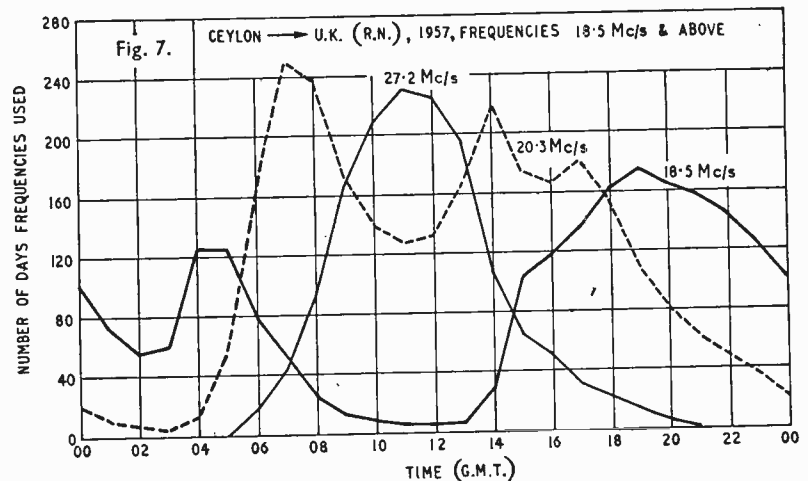
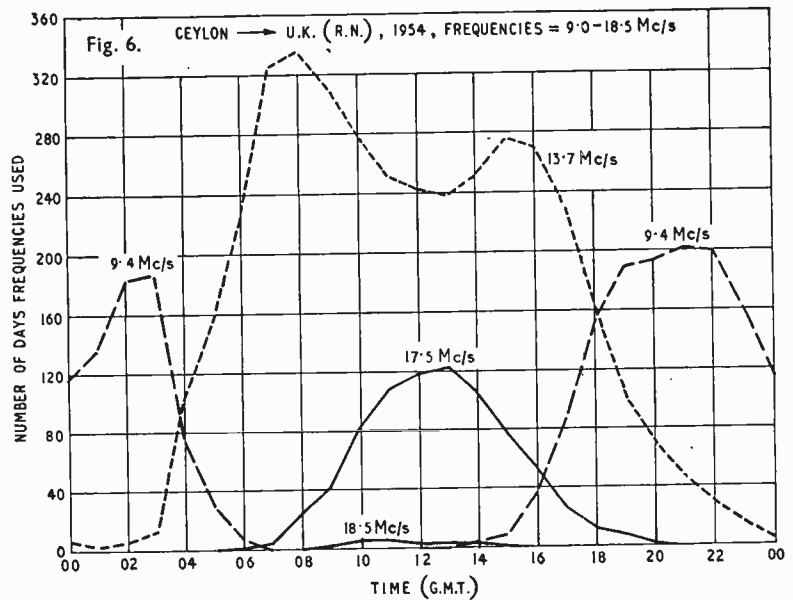

Fig. 6. Diurnal changes in working frequency required on the Ceylon/U.K. circuit during 1954, a year of minimum sunspot activity.

Fig. 7. Changes in frequency required on the Ceylon/U.K. route during 1957, a year of exceptionally high sunspot activity.

Fig. 8. Frequencies employed on the Harman/U.K. circuit during 1954 (low sunspot activity).

Fig. 9. Harman/U.K. working frequencies employed during 1957.

at the present time. Moreover, in view of the increasing use of the h.f. band, and the consequent probability of increasing interference particularly at the lower end of the band, additional difficulties in communication may arise during the next epoch of minimum solar activity, in the absence of any significant improvement in equipment and/or techniques.

Acknowledgments. — The author wishes to thank Miss S. S. Aucken and Mr. B. W. Smith, of the Royal Naval Scientific Service, for their assistance in the presentation of the data in this article, which is published by permission of the Admiralty.

REFERENCES

- ¹ Humby A. M., et al.—“Performance Characteristics of High-Frequency Radiotelegraph Circuits.” *Proceedings I.E.E.* 1955, Vol. 102, Part B, p. 513.
- ² Smale J. A., “Some Developments in Commercial Point-to-Point Radiotelegraphy.” *Journal I.E.E.* 1947, Vol. 94, Part IIIA, p. 345.
- ³ Newton H. W. and Finch H. F.—“Geomagnetic Storms and Solar Activity 1952.” *The Observatory.* Vol. 73, No. 872, p. 35.

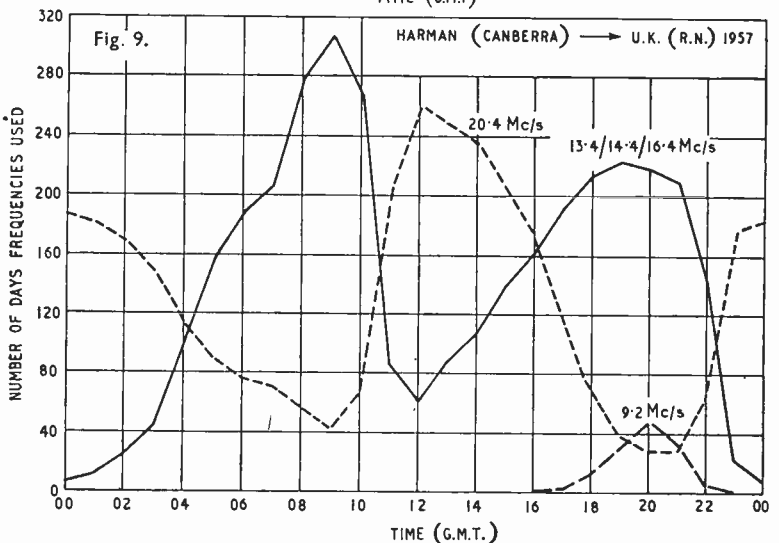
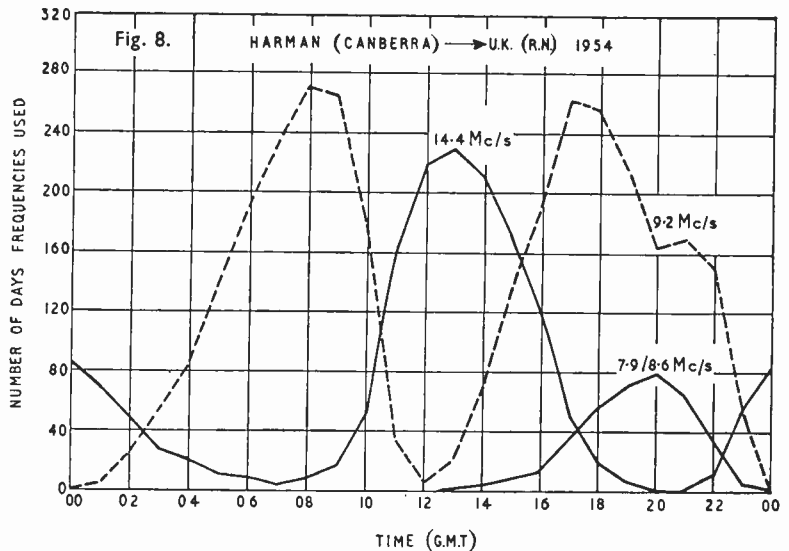

SHORT-WAVE CONDITIONS

Prediction for September

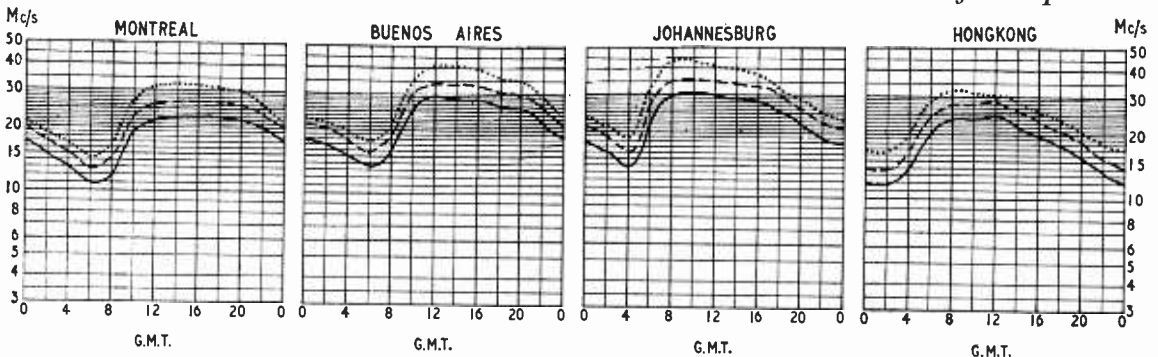

THE full curves given here indicate the highest frequencies likely to be usable at any time of the day or night for reliable communications over four long-distance paths from this country during September. Broken-line curves give the highest frequencies that will sustain a partial service throughout the same period.

- FREQUENCY BELOW WHICH COMMUNICATION SHOULD BE POSSIBLE FOR 25% OF THE TOTAL TIME
- PREDICTED AVERAGE MAXIMUM USABLE FREQUENCY
- FREQUENCY BELOW WHICH COMMUNICATION SHOULD BE POSSIBLE ON ALL UNDISTURBED DAYS

Transistor Electroencephalograph for amplifying and recording brain potentials, made by Offner Electronics, is an unusual design notable for its compactness, reliability and freedom from interference. The use of transistors for the amplifiers in itself accounts for the small size and reliability—at the same time giving freedom from the microphony and mains hum which are problems in valve electroencephalographs (the transistor pre-amplifiers are powered by batteries). No warm-up period is required before use. The most interesting feature of the design, however, is the use of an electro-mechanical chopper, driven by a 400-c/s transistor oscillator, in each of the eight channels, to convert the input potentials into an a.c. signal. The signal is amplified in a six-stage transistor pre-amplifier, then rectified to recover the original waveform, which is applied to a two-stage transistor power amplifier for driving the recording pen. Among other

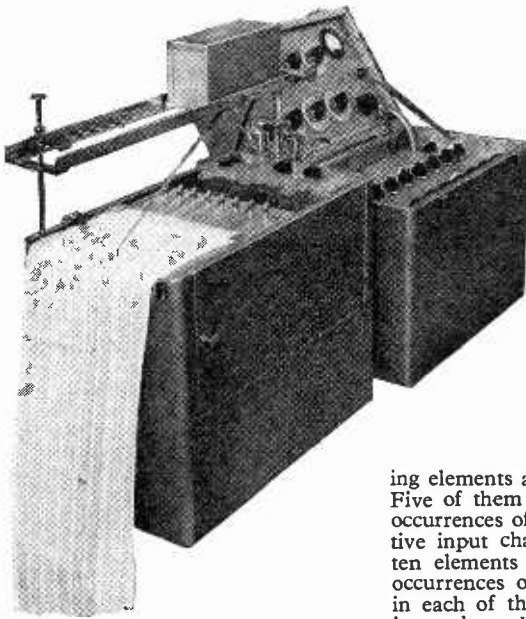

things this technique avoids the blocking on large potentials which is typical of many conventional e.e.g. machines, and makes possible recording even during electrical stimulation of the brain. The noise level of the choppers, of course, has to be extremely low. All the amplifiers and choppers are constructed as plug-in units for easy servicing. The sensitivity of the machine is $1\mu\text{V}$ per millimetre deflection of the pen. In this country the electroencephalograph is available from Faraday Electronic Instruments.

Conditional Probability Computer is a form of electronic "learning machine" under development at the N.P.L. for use in a control system in a South Wales oil refinery. The idea

is that the control system will optimize its function by a trial-and-error process. So far the computer has been shown controlling a moving carriage which follows the boundary between black and white areas, irrespective of whether black is on the left or on the right and even when the steering linkage is reversed. The computer has five input channels which can be "activated" by electrical signals. There are also 31 computing elements which accumulate statistical information about the patterns of input activity in these channels. When one or a group of the input channels is activated the computer determines, on the basis of its stored statistical information, whether this group is usually accompanied by activity in another channel or channels. If it is, the computer makes an "inference" of activity in the other channels.

The 31 computing elements are essentially counters. Five of them count the numbers of occurrences of activity in the respective input channels, while a further ten elements count the numbers of occurrences of simultaneous activity in each of the ten possible pairs of input channels, and so on for groups of 3, 4 and 5 channels. The counts are represented in the computing elements by the amount of charge on a capacitor, which is deliberately made to leak towards the level corresponding to zero count. This leakage ensures that the "inferences" made by the computer are governed more by recent events than by earlier events.

Improved Precision Castings, for waveguides, which reach the required high standard of accuracy and surface finish without expensive machining are being made in this country by the "Mercast" process. A pattern is made by pouring mercury into a steel mould and freezing it in an acetone bath at about -65 deg C. This pattern is then removed

and invested (coated) with a slurry of zircon-based ceramic material to a thickness of about $\frac{1}{4}$ in. After a storage period (still at low temperature) to allow the coating to set, the moulds are raised to room temperature and the mercury runs out, leaving a ceramic shell mould from which a casting can be made either in gunmetal or aluminium alloy with a surface finish of 25 to 35 micro-inch r.m.s. and dimensional tolerances better than ± 0.003 in per inch. Complicated cavities can be cast by making the mercury patterns in two halves using removable cores, and then sticking the two halves together (frozen mercury welds on contact). But the principal advantage of mercury over wax for investment casting is that there is little expansion when changing from the solid to the liquid phase, and less chance of cracking the finished mould. A new company, Sankey-Telcon, has been formed as the sole operating licensee of the "Mercast" process outside the U.S.A. and has established a foundry at Crawley.

Electronic Photo Enlarger recently developed by E.M.I. Electronics provides automatic "dodging" to reduce the overall contrast range of the negative to suit the printing paper so that detail is not lost in highlights and shadows. A cathode-ray tube displaying a Lissajous type of scan constitutes the light source, and the brightness of the spot is continuously controlled, on a negative-feedback principle, by the out-

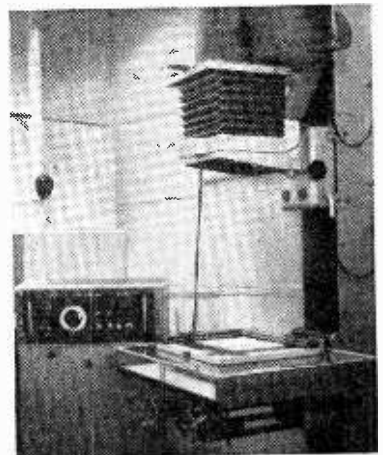

Technical Notebook

put of a photomultiplier which picks up the light transmitted through the negative. The electronic system is similar to that of the E.M.I.-Log-Electronics photo printer described in our November, 1957, issue (p. 547), and has the same sort of automatic exposure control using a second photomultiplier. The enlarger will handle negatives from 35mm up to half-plate size, and the maximum print area is 30in×40in. Magnification with a 3in lens is 11 times and with a 7in lens 10 times.

“Three-D” C.R. Tube for radar-type information, developed in the U.S.A. by the Instrument Research Company, has possible applications in air traffic control for presenting altitude and position data from the airport radar. As indicated in the sketch, the third dimension, or Z

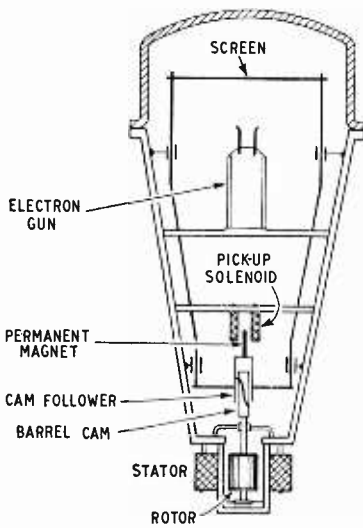

axis, is provided by mechanically driving the screen backwards and forwards in oscillatory fashion (at up to 30c/s) by a motor and cam system. A pick-up coil on the moving assembly gives an output proportional to the instantaneous position of the screen along the Z axis. This output, in conjunction with the Z-information d.c. input signal, is used to operate a gate which switches on the tube's electron beam for a small part of the mechanical cycle. The phasing of the gate determines on which plane in the Z axis the fluorescent spot shall appear. Movement of the spot in the X and Y directions is achieved in the normal way by electrostatic deflection plates. Various dynamic corrections have to be applied to deflection and focusing voltages to cancel out the changes resulting from the mechanical screen oscillation. The Peritron, as the tube is called, is described in more detail by E. L. Withey in the 23rd May, 1958, issue of *Electronics (Engineering Edition)*.

Hum Reduction in magnetic tape heads, using a thin strip of high permeability material threaded through the coil (or coils), is described by Marvin Camras in *I.R.E. Transactions on Audio* for November-December, 1957. The strip is

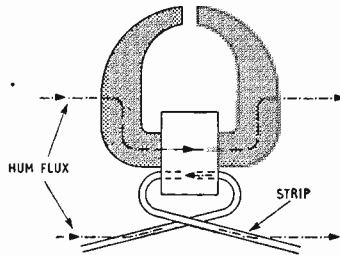

orientated so that it picks up hum flux in the opposite direction to that in the main core. For a single coil, the strip must be crossed over itself as in the illustration. With the more usual double coil used to cancel hum, the strip is threaded through both coils forming a U shape with its ends on the opposite side of the coils to the head gap. In both cases, the hum could be reduced about 20dB.

Ion Trap for Pentode has been developed by the Kaiser Aircraft and Electronics Corporation in America for a special switching application which necessitates very high voltages on the valve anode and therefore greater positive-ion bombardment of the oxide-coated cathode. A cylindrical collector electrode, open at one end, surrounds the conventional cathode and grid assembly (see sketch), and the anode is a circular plate facing the open end. This collector is connected to the screen grid so that, in the absence of anode voltage, an essentially field-free region is created between them. When a voltage is applied to the anode the resultant electric field penetrates into this collector-screen space and causes the electrons drifting there to be

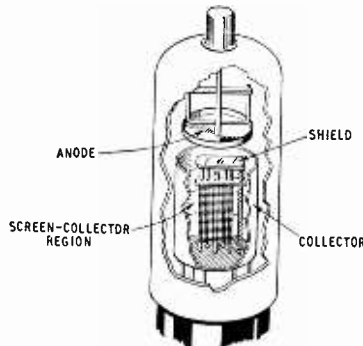

attracted upwards to the anode. Positive ions created in the anode region, however, are deflected down-

ward towards the bottom of the collector, as they travel with a velocity whose downward component is much greater than any horizontal component. The small shield on top of the grid and cathode assembly is necessary to prevent the positive ions from reaching the cathode at the point where it is directly facing the anode. Describing the pentode in the 14th February, 1958, issue of *Electronics (Engineering Edition)*, W. R. Aiken and R. E. Heller say that it operates with 15kV on the anode, 100V on the screen and collector and -4V on the control grid. Typical anode current is of the order of 0.6mA and mutual conductance about 0.6mA/V.

Unusual Wattmeter utilizing electro-mechanical, electro-optical and electronic techniques to measure the product of two currents has been developed by Tinsley. By making one of the currents proportional to a voltage (by connecting this voltage across a standard resistor) power measurements become possible. One current is fed to a pair of suspended coils, and the other to two fixed pairs of coils lying above and below the suspended coils; the two coils in each of the pairs lying on opposite sides of the suspension wire. The coils are connected so that the currents produce forces in the movable coils which tend to twist the suspension wire with a torque proportional to the product of the currents. The suspension wire also carries a mirror which reflects a spot of light between two photocells. Thus, if currents in the coils twist the wire and suspended mirror, the spot of light is deflected more on to one photocell. Any difference between the outputs from the photocells is amplified and fed to a second similar arrangement of fixed and movable coils. These coils are suspended on the same wire, and connected so that the torque produced cancels that due to currents in the first set of coils. The square of the amplified current difference between the photocells thus gives a measure of the cancelling torque, and consequently a measure of the product of the currents in the first set of coils. Use of a third set of coils can allow differential power measurements to be made. This method of measuring power was described by Kanef in *Proc. I.E.E., Part A*, 1955, p. 597.

Ripples in Hearing Threshold level up to as much as ± 4 dB every 70c/s or so in the range 1,000 to 2,000c/s are reported by E. Elliott in a letter to *Nature* for 12th April, 1958. Apparently most people's hearing shows this effect, although it has not previously been reported. The ripples were found to be stable for at least two months, but were different in amplitude and period for a person's left and right ears.

Thermally Compensated Crystal Oscillator

A NEW method of stabilizing the frequency of a crystal oscillator without recourse to temperature-controlled ovens, or other current-consuming devices, has recently been developed and patented by the Automatic Telephone and Electric Co., Ltd. The A.T.E. method makes use of the ability to shift the frequency of a crystal oscillator by varying the effective shunt load. An increase of reactive current in the load causes the frequency to shift up or down according to whether this reactive current is inductive or capacitive. It is not necessary to effect any physical change in the load circuit itself as the desired results can be achieved by varying the phase angle of the reactive load current appropriately with changes in temperature.

Fig. 1 shows the order of compensation effected in a 37-Mc/s overtone crystal oscillator using the compensating network shown and an AT-cut crystal. Certain types of crystal require more elaborate compensating networks and Fig. 2 is an example of the arrangement generally required for a BT-cut crystal. While the former needs only capacitive compensation the latter requires both capacitance and inductance for satisfactory compensation.

In all cases the temperature-sensitive element of the circuit is a thermistor bead, which is mounted

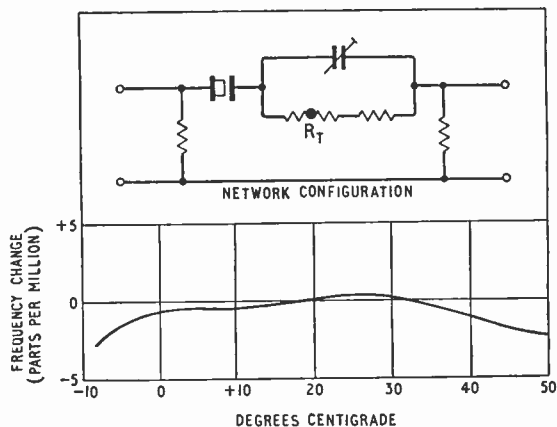

Fig. 1. Frequency drift of a 37-Mc/s overtone crystal oscillator using the compensating network shown and an AT-cut crystal. R_T is the thermistor bead.

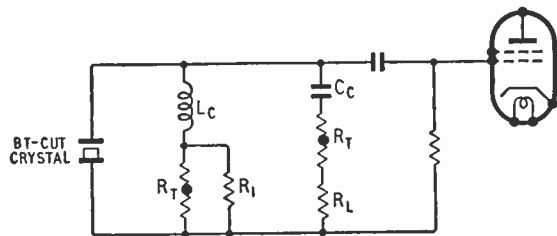

Fig. 2. Compensating network evolved for use with BT-cut crystals and those with similar temperature-frequency characteristics.

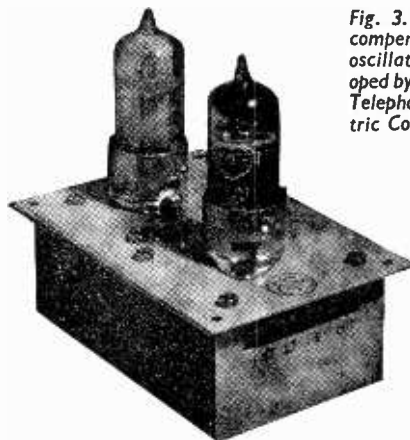

Fig. 3. Thermally-compensated crystal oscillator unit developed by the Automatic Telephone and Electric Co.

in close contact with the quartz plate inside a B7G glass envelope. The remainder of the compensating network is included in the external circuit, which, with the exception of the valve and crystal unit, is mounted on the underside of the top cover plate of the complete unit shown in Fig. 3. This measures $3\frac{1}{2}$ in \times $2\frac{3}{8}$ in \times $3\frac{1}{8}$ in high overall and units are available at present for any spot frequency between 4Mc/s and 16Mc/s, but the principle is applicable to much higher frequency units as exemplified by Fig. 1. A thermally compensated crystal oscillator as illustrated in Fig. 3 costs £15.

Stereophonic Demonstration Disc

E.M.I. have released recently a 12 in $3\frac{1}{2}$ r.p.m. stereophonic demonstration recording, SDD1. One side of the record is devoted to sound effects and a spoken commentary—this is designed to introduce stereo to the listener—and the other side carries eight short excerpts of the types of music most likely to benefit from stereo (“popular,” operatic and orchestral). The concluding band (9) of the latter side is a recording of a metronome, for balancing the sound output from the two loudspeaker systems.

Particularly notable for a good spatial effect are “Express and Goods Trains”—in which, incidentally, two train-spotters at the end of the platform are clearly located—“Table Tennis,” “Beggar’s Opera (Tavern Scene),” “Falstaff (Act 1, Sc. 2),” “Happy Banjos (Goodbye Blues),” “Tchaikovsky 4th Symphony (Excerpts from Last Movement)” and “At San Remo (La Colpa fu).” The disc costs 47s 11½d.

Replacement Line-Linearity Control

THE “shorted-turn,” ring-free, line-linearity control* is in use in some current production receivers. Direct TV Replacements of 138 Lewisham Way, S.E.14, tell us that they have been appointed sole distributors to the retail and wholesale trade of replacement foil stampings (appropriately insulated) for Enanlon Plastics, Ltd.; who manufacture this item. There are two types; one mounted on a former—for insertion under the scanning yoke—and the other is a flat sheet designed to be wrapped round the tube neck and fixed in position before the yoke is fitted. Either type costs 2s 3d retail.

* Technical Notebook, February 1957.

An Alternative Standard for British Television?

IT has long been apparent that the British television system suffers from an undesirably low number of scanning lines. A change to 625 lines, with or without 5-Mc/s bandwidth, etc., has been considered. Another alternative, giving an improved system with the minimum of changes in equipment, is discussed here. It has been pointed out that with a 3-Mc/s bandwidth and 405 lines there is an excess of horizontal over vertical definition of from 50 to 100 per cent, whereas equal horizontal and vertical definition would be desirable. An increase in the number of scanning lines would improve the overall picture definition and reduce the lininess of the picture. Furthermore, the increased line-scan frequency would greatly reduce the effect of "line whistle" from the line output transformers and scanning coils of receivers.

For a given bandwidth, frame frequency and aspect ratio, the requirement for equal horizontal and vertical definition is given by:

$$kN^2 \frac{V}{H} = \text{constant}$$

where k is the value taken for the Kell factor, N is the number of lines, and V and H are the fractions of vertical and horizontal scanning times which are actually used in forming the picture. The value of N used at present, i.e. 405, gives equal horizontal and vertical definition assuming $k=1$. It is now considered, however, that the Kell factor has a value much lower than unity, and that $k=0.5$ approximately for interlaced scanning systems. Other things (bandwidth, V/H , etc.) being equal, it is therefore necessary to double the value of N^2 in order to obtain equality of horizontal and vertical definition, i.e. the optimum number of lines for the British system would be $\sqrt{2}$ times 405, or approximately 570.

Let us now consider practicable numbers of lines. For convenience in line-to-frame frequency count-down circuits, it is desirable that the number of lines chosen should factorize as the product of several small odd numbers. (Even-number factors are not permissible, since they would make N an even number, which

cannot be used in an interlaced system.) If we compute all the numbers between 400 and 650 which have only odd factors less than ten, i.e., factors of 3, 5 and 7 only, we obtain the following limited selection:

$$405 = 3 \times 3 \times 3 \times 3 \times 5$$

$$441 = 3 \times 3 \times 7 \times 7$$

$$525 = 3 \times 5 \times 5 \times 7$$

$$567 = 3 \times 3 \times 3 \times 3 \times 7$$

$$625 = 5 \times 5 \times 5 \times 5$$

Among these magic numbers we recognize several old friends. There is also one interesting stranger, 567, which nicely fills our bill for "approximately 570."

Turning to the practical problems of a change-over to 567 lines, it is necessary to consider in our long-established television system the requirements in transmitting and test equipment, as well as those in existing and future receivers. It will be noticed immediately that for count-down circuits 567 is particularly well-placed as a successor to 405, requiring the alteration of only one count-down factor from 5 to 7. Furthermore, in cases where a series of bi-stable binary counters is used, together with feedback loops for unity reductions in division ratios, the system can be changed from (a) to (b), or from (c) to (d) (see Fig. 1), requiring no change in the number of multivibrators in either case†. Thus it is likely that much of the transmitting and test equipment used for signal generation on 405 lines could be economically converted to 567 lines.

As for receivers, sets giving satisfactory perform-

† "Horizontal versus Vertical Resolution," by L. C. Jesty. *Wireless World*, July, 1957.

† In the case of 9 binaries providing a count-down ratio of $15 \times 27 = 405$, an extra multivibrator would unfortunately be necessary for conversion.

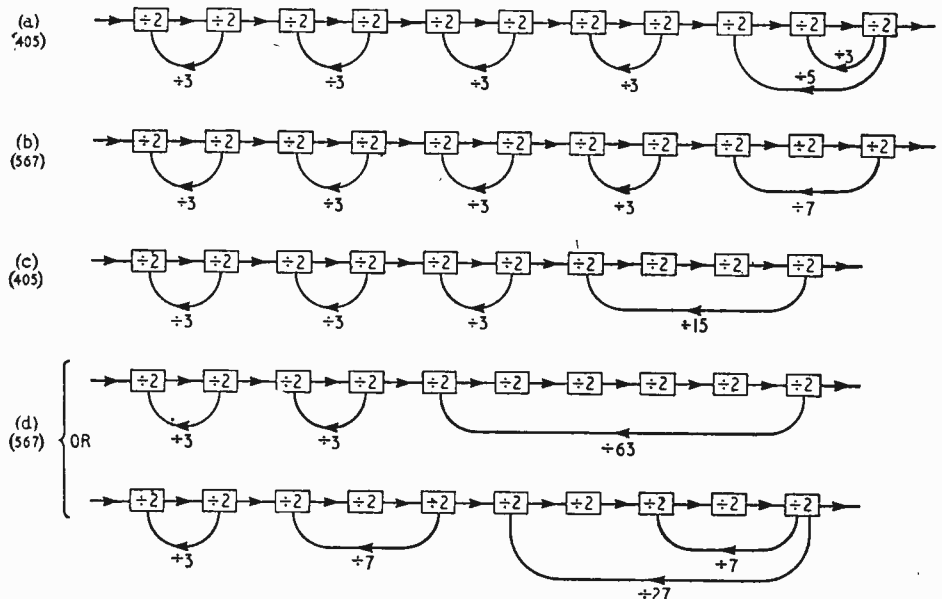

Fig. 1. Systems of multivibrators with feedback loops, indicating count-down ratios for 405 and 567 lines.

ance on either standard could be produced in anticipation of a change-over. The modification of existing 405-line receivers would be a more difficult task. However, a 40% increase in line-scan frequency without disastrous effects on picture width or e.h.t.

voltage could probably be obtained without major modifications in many cases. The line (and frame) flyback times of the new system could be made long enough to avoid embarrassment to the timebases of existing receivers.

Improved Television Standards Converter

Better Pictures from the B.B.C.'s Eurovision Equipment

By T. WORSWICK, M.Sc., A.M.I.E.E.*

THE contribution of Eurovision to the television programmes, though small in total broadcast time, is very important in terms of news reporting and broadcasts of public occasions such as the State visit of H.M. Queen Elizabeth to Holland this year. It is important, therefore, that the technical quality of the picture in the country which is receiving it should be as good as possible.

The main factors which influence the quality of the final picture as presented to the viewers in the receiving country are the quality of the original picture at the programme source, the quality of the long-distance interconnecting links and the mechanism for changing from one set of television standards to another.

When Eurovision was first introduced all these factors made a significant contribution to the overall result which, although often exciting, could only at best be rated technically as acceptable. With more experience in the operating organizations and newer equipment the level of performance of the television cameras and the interconnecting links has improved steadily. While the distortion from these sources is not entirely negligible it is now usually small.

From the very start of the Eurovision transmission the B.B.C. standards converter at Swingate has been operated at or near its best performance by the employment of very skilled operators, and until about a year ago no significant improvement over the original performance when first installed had been obtained. In fact in some respects the standards converter had become the limiting factor in the quality of the final picture.

In April 1957 a major improvement in the standards converter was achieved by the introduction of the 4½in image orthicon tube in place of the older 3in image orthicon. The standards converter consists in essence of a high-quality display of the original picture (on 625 or 819 lines) on a flat-faced cathode-ray tube. This display is presented to an image orthicon camera on the British standard of 405 lines. At the camera output will appear the "converted" picture. The detailed mechanism of the transfer of the image is described by Lord†, but for clarity in assessing the performance figures quoted later the mechanism is described briefly as follows.

The camera tube is a photo-emissive device and besides its capability of producing the required signal output, which is a time position amplitude function depending on the original scene focused on the photo-cathode, it is also a photo-electric cell. That is, it will respond to any variation in the brightness of the scene presented to it. In the case of the standards converter the scene presented is another television picture, which in the time sense is represented by a spot of light varying in brightness. The camera tube will read this variation in brightness and at its output terminals will appear a corresponding current which is independent of the scanning standards of the camera. In fact this current will correspond to a picture in the original 625- (or 819-) line standard and will of course be superimposed on the wanted 405-line signal from the camera.

At this point it is too late to disentangle the two signals, and so it is necessary to prevent the photo-electric pulse signal from achieving any significant amplitude. This is done by giving the display phosphor a long decay characteristic so as to integrate the light over a period of time. By using a 6-millisecond decay time the photo-electric pulse signal is attenuated by about 28dB compared with what it would have been with a short-decay phosphor. The use of this long-decay phosphor has the disadvantage that if there is fast movement of the original scene, for example the camera at the programme source is being panned horizontally, some multiple images or image blurring will occur. On most subjects this effect is quite negligible but just now and again a particular scene shows up this defect in the converter which with the photo-emissive type of camera tube is fundamental.

The picture from the originating country is generally locked to the local mains supply which is not, of course, tied in any way to the British mains frequency. In fact the respective mains frequencies are usually very close, seldom being as much as 1 c/s different. Nevertheless it is desirable for the camera equipment in the converter to have its synchronizing signals tied to the British mains to give the best performance to British viewers. Because, therefore, the frame frequency of the converter camera is not tied to the frame frequency of the converter display it is essential to operate the camera tube in a condition in which it integrates the light input over a whole frame. If this is not done then variations of

* B.B.C. Designs Department.
† "Conversion of Television Standards," by A. V. Lord. B.B.C. Quarterly, Vol. VIII, No. 2, Summer 1953.

light intensity will be seen traveling down or up the picture in a broad band at a repetition rate corresponding to the difference in the mains frequencies in Britain and the originating country.

To obtain full frame storage in an image orthicon camera tube the tube must be operated on the linear portion of its characteristic, i.e., below the "knee." (In studios or outside broadcasts it is customary to operate an image orthicon camera tube $\frac{1}{2}$ to 2 lens stops above the knee, depending on the particular type of tube.) This restriction dictates exactly the performance which can be expected of the camera tube and in turn, therefore, the converter, particularly with regard to signal-noise ratio. With the 3in type P807 image orthicon the signal/noise ratio attained under these conditions was at best 37 dB (peak picture to r.m.s. noise) which is only just acceptable. Using this tube, therefore, means that whatever the performance of the converter in other respects, and however good the incoming picture, the outgoing picture (towards the British viewer) could not have a signal/noise ratio of better than 37 dB.

The 4½in image orthicon type P812 (made by English Electric Valve Company) is superior to the 3in P807 in several respects but particularly in the matter of signal/noise ratio. The improvement in the operating conditions which apply in the converter is at least 10 dB. The noise contribution by the converter to the final signal is, therefore, changed from being only just acceptable to being quite negligible.

The P812 tube has the further advantages that its intrinsic resolution is better, so that it is possible to obtain a better overall resolution response through the converter. It is also a docile tube to set up in the best operating condition.

The contrast characteristic (volts in/volts out) through the whole converter must be kept as linear as possible and this is achieved by using a very low contrast display so that the curvature due to the display tube's grid-volts/brightness characteristic is small. The contrast range used is about 5:1. The use of such a low contrast range also helps to make the setting-up of the converter uncritical.

When specifying the overall resolution of the converter it is convenient to refer the figures to one television standard using the appropriate scale factor. For example the 3-Mc/s lines on Test Card C on 405 lines are equivalent to 4.5 Mc/s on Test Card C on 625 lines. Allowing for this factor, the resolution through the converter is flat, dropping to about -2dB at 3 Mc/s at the centre of the picture and about -4dB at the corners.

This general improvement of converter performance has made it possible to handle satisfactorily almost any type of picture whether it has high-key or low-key lighting. With the 3in image orthicon

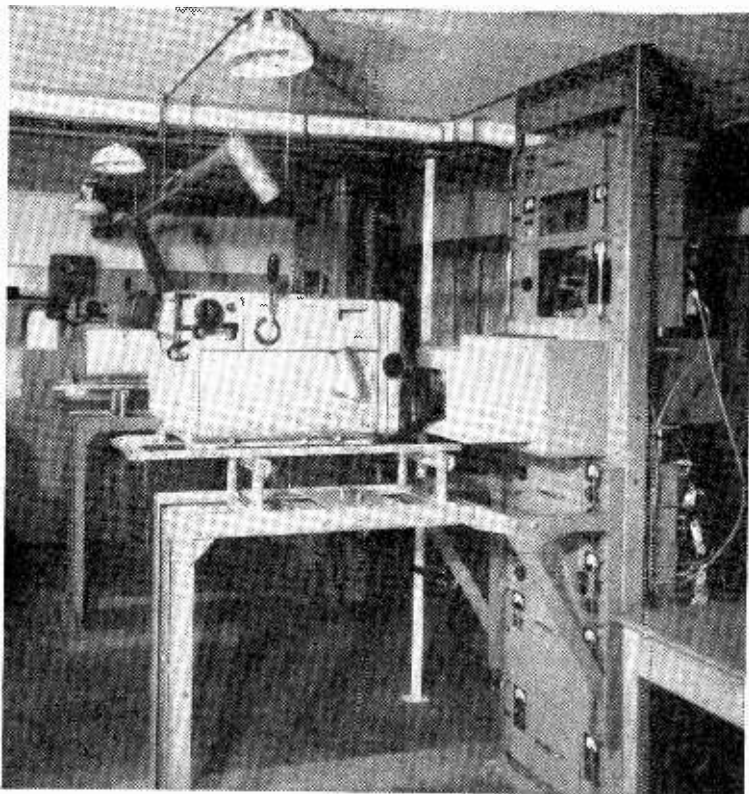

The improved standards conversion equipment installed at the B.B.C. station at Swingate.

converter it was necessary to try to limit the activities of the programme producer to ensure high-key pictures, so that the converted picture should be acceptable. With the overall improvements brought with the introduction of the 4½in image orthicon, it is no longer necessary to impose restrictions on the type of programme offered to the converter. It is of course still desirable to use skilled operators to obtain the best results, but provided this is done it can now be claimed that the distortions introduced by standards conversion are negligible.

Using Semiconductors Correctly

A VERY useful booklet has recently been published by the British Radio Valve Manufacturers' Association to assist equipment designers in obtaining optimum performance and life from semiconductor devices. Entitled "The Use of Semiconductor Devices," it explains the significance of the various parameters in manufacturers' data and tells how the figures should be interpreted. Recommendations for suitable operating conditions are made. Semiconductor diodes, junction transistors and photo-sensitive devices are covered in the booklet, which has been compiled by a committee of semiconductor manufacturers and is being distributed by them.

The "Cathoguard".—To conform with Fig. 3 and the formula $\frac{10R_2}{9g_m R_L}$ on p.313 of the July issue, the two references to R_a immediately after the formula should have read R_L .

Group and Phase Velocity

Some Notes on a Versatile Pair of Artists

By "CATHODE RAY"

THE foreigner has every right to be perplexed when he encounters the English word "box" in such diverse contexts as Christmas, pugilism, gardening, theatres, horse cabs, spanners, the mariner's compass, and game shooting. Again, in the theatrical world there is quite a stir when a character hitherto associated exclusively with the variety stage turns up in Shakespeare at Stratford-on-Avon, or a well-known ballerina appears in the cast of a detective thriller. Similarly, you may be surprised, as I was, to come across group and phase velocity in connection with transmission lines, waveguides, the ionosphere, optics, wave mechanics, and radiation from aerials. When this sort of thing happens I always like to trace what

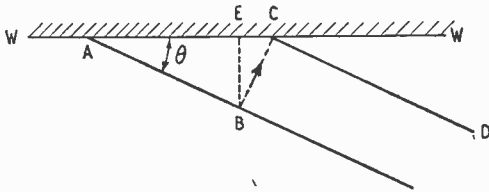

Fig. 1. Waves striking a sea wall provide a good example of phase and group velocity.

ested in how fast that energy can be carried in any desired direction. In one second, the distance the energy travels is the same as the distance the waves travel—BC—but if we are concerned only with its velocity along WW we must take the component of movement in that direction, namely EC. (BE is of course at right angles to WW.) The velocity EC per sec. is called (why, we shall see later) the group velocity. At the same time as reducing θ to zero increases the phase velocity to infinity it obviously reduces the group velocity to zero. On the other hand, if θ is increased to 90° so that the waves travel parallel to the wall then both group and phase velocities (v_g and v_p) are equal to the velocity of the waves (v). Fig. 2 is a graph of the relationships.

It is very easy to calculate them. The three velocities, v , v_p and v_g , are proportional respectively to BC, AC and EC. But $BC/AC = \sin \theta$, so $v/v_p = \sin \theta$ and

$$v_p = \frac{v}{\sin \theta}$$

Also $CBE = \theta$, so $EC/BC = \sin \theta$, so $v_g/v = \sin \theta$ and

$$v_g = v \sin \theta$$

From these two equations it follows incidentally (by multiplying them together) that

$$v_p v_g = v^2$$

Now we can apply this to waveguides. The easiest way of understanding the propagation of

is common to all, for it is usually more or less obscured by different terms and approaches used by specialists in the various fields.

One thing quite sure is that the subject concerns wave motion. The simplest way I know of explaining the difference between group velocity and phase velocity is to imagine waves against a sea wall. WW in Fig. 1 represents the wall, and AB the crest of a wave travelling in the direction at right angles to itself, as shown by the arrow. The position reached by this wave one second later is marked CD. The velocity of the wave itself is obviously BC (in feet, metres, or what you will) per second. But measured along the wall there are two other velocities.

One is the velocity of the splash of the crest, which has moved from A to C, so is AC per sec. By making the angle θ small enough, that velocity can be increased as much as you like, right up to infinity. That might seem strange, seeing that the actual waves cannot move faster than BC per sec. But nothing really moves from A to C, any more than extinguishing a fire in London and at the same time lighting one in Edinburgh means that a fire has travelled instantaneously from London to Edinburgh. It is just a point in a pattern. All along the wall there is a wave pattern—the same shape as the pattern along a line such as BC, but spread out over the longer distance AC—and the velocity of any phase of this pattern (say the crest A) is called the phase velocity.

Waves carry energy, and we are usually inter-

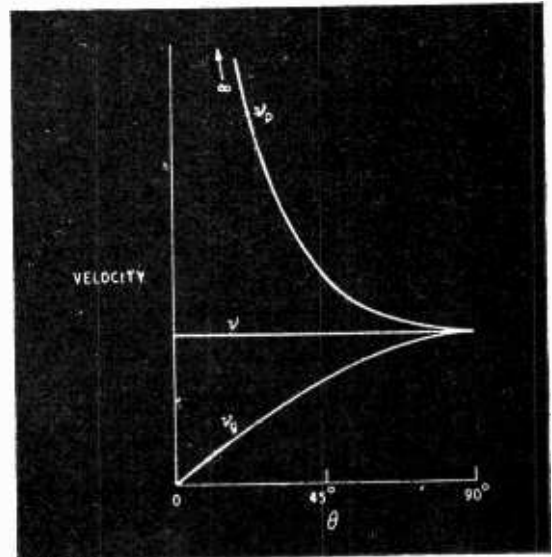

Fig. 2. How phase velocity (v_p) and group velocity (v_g) vary with the angle θ in Fig. 1. The velocity of the waves along the direction they are moving (v) is of course constant.

waves along a guide is to regard them as the resultant of waves zigzagging from side to side by reflection. Fig. 3 represents a short length of rectangular-cross-section guide, and AB the crest of a wave as in Fig. 1. This time, however, CD represents the preceding trough of the wave at that same instant. So the distance BC is half a wavelength, denoted by $\lambda/2$. Similarly JF is the following trough.

To understand what is happening we must remember that the waves are electromagnetic, with the electric-field component at right angles to the paper. That is possible in space, air or solid insulation, but not at the walls of the guide, which are of highly conducting metal and therefore short-circuit the electric field. A current is induced in the metal which gives rise to an outgoing wave in the opposite phase, cancelling out the field along the inner surfaces. So HA represents the trough of the wave resulting from the reflection of the crest AG; similarly AG is the crest from the reflection of the trough GD, JF is the reflection of FC, and FC is the reflection of CD. As these crests and troughs progress, their points of reflection (A, C, F and G) move to the right along the guide.

If you try drawing a diagram of this kind you will find that to make it come right you have to

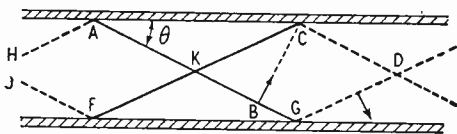

Fig. 3. Fig. 1 can be elaborated slightly to show how waves travel along a waveguide.

put pairs of reflecting points such as A and F or C and G exactly opposite one another, and once you have chosen the angle θ the wavelength is fixed. It is, of course, twice the length BC*. If you want a longer wavelength you must make θ smaller, but there is a strict limit to what can be done in this direction, for θ can't be less than zero, giving a maximum wavelength twice GC. The waves are then simply reflected back and forth across the guide and there is no progress along it. The group velocity is nil. Contrariwise, if you want a shorter wavelength you can get it by making θ larger, and to this there is no limit until with θ at 90° the wavelength is zero (so frequency infinite), when the waves march directly down the tube without reflection, and their group velocity v_g is equal to v .

What about their phase velocity? Fig. 3 clearly shows a positive maximum field strength at K, where two crests coincide, and a negative maximum at D, where two troughs coincide. The intermediate phases cannot cause any positive or negative peaks between K and D. The wavelength of the resultant pattern in the guide is therefore twice KD, and its velocity along the tube relatively high. It is quite easy to see that the same relationships between v_p , v_g and v hold as in Fig. 1, and the graph Fig. 2 applies as well.

For waves to be propagated along a waveguide in this way, then, their wavelength must be less than

twice the width of the guide. This distance is called the critical wavelength, λ_c . The corresponding frequency, f_c , depends on how fast the waves are travelling—the velocity we have been calling v . They being electromagnetic waves,

$$v = \frac{1}{\sqrt{\mu\epsilon}}$$

where μ and ϵ are respectively the absolute permeability and permittivity of whatever the waves are travelling through. In empty space, μ and ϵ have the particular values μ_0 and ϵ_0 , and, when these are filled in numerically, v works out at just under 300,000,000 metres/sec. This, the celebrated "velocity of light," is usually denoted by c . For convenience we usually reckon permeability and permittivity (or dielectric constant) relative to space as 1, if necessary distinguishing these relative values as μ_r and ϵ_r . The equation is then

$$v = \frac{c}{\sqrt{\mu_r\epsilon_r}}$$

We don't usually have to bother about μ_r being appreciably different from 1, and on that assumption $v = c/\sqrt{\epsilon_r}$. You probably know all this very well, and also the relationship between wavelength and frequency: $\lambda = v/f$. But we may be so used to v having the particular value c that it is well to emphasize that the wavelength at, say, 100 Mc/s, is not necessarily 3 metres. If our waveguide were filled with polythene, for which $\epsilon_r = 2.3$, waves would be slowed to $1/\sqrt{2.3}$ or two-thirds of their speed in air, so they would be only two-thirds as long, and such a guide could carry waves one-third lower in frequency than an empty one.

We could profitably spend quite a lot more time over waveguides, but if we did we would miss other items in the group and phase velocity repertoire. The essential thing to remember about a waveguide is that the velocity of waves along it depends on their frequency. For reasons which will appear, a wave-carrying channel or medium with this peculiarity is described as *dispersive*.

In one respect waveguides are exceptionally complicated, because three different velocities are involved. Oddly enough, the one that ought now to be rubbed out, like a temporary construction line in a drawing, is the one we know best— v , the natural velocity of electromagnetic waves through air or whatever the waveguide is full of. But when we feed a waveguide with oscillations of frequency f , their wavelength along the guide is not the λ calculated above as v/f ; it is twice the distance KD, given by v_p/f . The zigzag waves travelling at velocity v are just a convenient way of thinking of what is happening, just as for some purposes it may be convenient to think of a south-west wind as if it were two winds at once, one south and the other west. If we transmitted waves simultaneously through space and along a waveguide, and if we could see or by other means detect their phases and rate of progress, their lengths represented in the usual way would be something like Fig. 4: the waves in the guide would be spread out wider and would therefore (since they are of the same frequency) travel that much faster. Faster than light? Yes, since that is the speed of the waves outside the guide, which are clearly losing the race. But you thought that it was one of the established and fundamental laws of nature

*It could also be made any submultiple of 2BC by duplicating the diamond pattern at intermediate positions, representing what are called higher-order modes of propagation, but we shall leave these out of account.

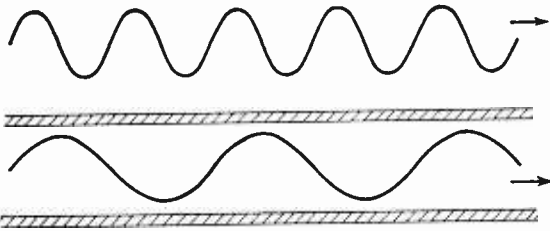

Fig. 4. The phases of waves travelling outside and inside a waveguide are represented here by wavy lines. The waves inside the guide, travelling at a higher phase velocity, are more spread out.

that nothing can travel faster than light? Quite true!

It may help to resolve this paradox if we remember the sea wall and the fires in London and Edinburgh. A more direct answer will come when we really get into our subject, but to do that we ought to make quite sure how the various quantities involved are related.

The reason why the velocity of any waves is equal to their length multiplied by their frequency (as in the well-known equation already quoted, $\lambda = v/f$) is, I imagine, quite obvious if one thinks of the f waves issued in one second, each of length λ metres, spread out as in Fig. 4; the total length, $f\lambda$ metres, is the distance the front of the first wave has travelled in that one second; in other words, its velocity, v metres per second. Over that distance, one second is the time delay between start and finish. It can also be reckoned as a phase delay of f whole cycles. The usual symbol for phase difference is ϕ . Transmission line and cable people like to work in terms of the phase delay per metre (called the phase constant) for which they have the special symbol β . So β is equal to ϕ divided by the distance (say d) over which it occurs: $\beta = \phi/d$. Over $f\lambda$ metres the delay is f cycles, so for one metre it is $f/f\lambda = 1/\lambda$ cycles. Seeing it is usually frequency rather than wavelength one knows, we can substitute v/f for λ and get $\beta = f/v$, and so $v = f/\beta$. Because v is the velocity of a phase pattern, we can particularize and call it v_p . This $v_p = f/\beta$ is a thing to remember. We must also remember that in this form β is in cycles per metre. The more scientific unit of phase difference is the radian, of which there are 2π in every cycle, so $\beta = 2\pi/\lambda$ radians/metre, and $v_p = 2\pi f/\beta$, usually written ω/β . Telephone people, who work with what we consider enormously long wavelengths, are more interested in miles than metres, so reckon β in radians per mile and velocity in miles per second. Finally, a phase delay of ϕ cycles or radians can always be expressed alternatively as a time delay t of ϕ/f or ϕ/ω seconds respectively.

All these things may seem very simple and obvious and perhaps quite familiar, but I want to be able to make use of them from now on without causing any reader to lose touch. For the sake of the less mathematically inclined I shall reckon ϕ in cycles and β in cycles per metre except where otherwise stated. For example, if a certain length of cable is found to introduce a delay of half a cycle at 40 Mc/s, the time delay is $1/80 \mu$ sec. ($t = \phi/f$). If this cable is $2\frac{1}{2}$ metres long, the phase delay is $0.5/2\frac{1}{2} = 0.2$ c/m ($\beta = \phi/d$). The velocity is $40 \times 10^6/0.2 = 200 \times 10^6$ metres/sec, or $\frac{2}{3}c$ ($v_p = f/\beta$). The wavelength is 5 metres ($\lambda = v_p/f$), compared with $7\frac{1}{2}$ metres in the open.

Because $v_p = f/\beta$, if we plot β against f as in Fig. 5, the phase velocity at any frequency is proportional

to the reciprocal slope (that is, the slope looking at Fig. 5 on its side, with the f scale vertical) of the line drawn from the origin (0) to the point on the graph representing that frequency. If β is exactly proportional to f , the graph is a straight line passing through the origin, as for example the dotted line in Fig. 5; and this of course represents the same v_p at every frequency. If you use the scales to calculate it for this particular straight line you will find it is 300,000,000 metres/sec, so it is our old friend c . The dotted line is, in fact, the phase/frequency characteristic of open space, or very nearly of an air-spaced r.f. line. The time delay per unit length, being β/f , is also the same at all frequencies. This sounds like a good idea, because all the parts of a signal made up of a number of frequencies would take the same time to traverse a given distance, so wouldn't become separated or disarranged en route. But more of that later.

By contrast a waveguide, as we saw (Fig. 2), transmits different frequencies at different speeds. As an example I have plotted $1/\lambda$ against f for a waveguide 5 cm wide, for which λ_c is of course 10 cm and f_c is 3×10^9 c/s. This is the full line in Fig. 5. Although it is possible to derive an equation for $1/\lambda$ in terms of f , it is much easier to calculate both for a series of values of θ , using the simple relationships we have already found. Again we must remember that the λ in $1/\lambda$ is the wavelength of the resultant wave pattern that progresses along the guide with velocity v_p , not—like λ_c —a wavelength of the zigzagging components.

As we would expect, this curve only begins at 3×10^9 c/s, because waves of lower frequency cannot travel at all along a 5-cm guide. Calculating the phase velocity exactly at this frequency from $v_p = f/\beta$ we find it is infinitely large, as we have already noted in a different way in Fig. 2, and as we can see from Fig. 5 because the reciprocal slope from 0 to that point is infinite. But as the frequency increases β increases rapidly, so v_p falls accordingly. At very high frequencies the curve tends to follow the dotted line, implying that v_p approaches the value c . This again is as we saw in Fig. 2.

The purpose of a waveguide is to convey signals from one place to another. An important thing to know is how fast it does this. Looking at a guide being fed from a single-frequency oscillator, and seeing (as we could if our eyes were sensitive to such a low frequency through metal and could follow fast

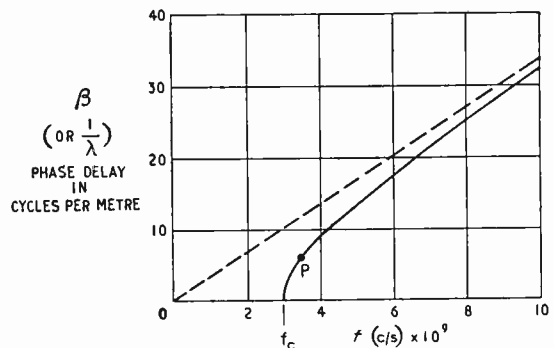

Fig. 5. Graph of phase delay per metre length of a 5-cm-wide waveguide against frequency. The corresponding graph for empty space is shown dotted.

enough) the wave pattern moving continuously towards the other end at velocity v_p , you might think the answer was obviously v_p . Even if you remembered what we said about the unreality of phase velocity, and accepted that nothing can go faster than c , you might have some difficulty in seeing just where the catch is. Surely, you might say, if we switch the oscillator on and off we shall be able to send signals along at that speed. Where is the snag?

The snag is that strictly speaking a single-frequency wave train has no beginning or end, but extends to infinity in both directions, so that every cycle is exactly the same as every other cycle and there is nothing to distinguish one from another. You can't convey a message with that. Directly we switch the oscillator on and off, or modulate it, or in fact do anything at all to distinguish any one wave from others, we inevitably bring in more than one frequency. Suppose we want to send a "dot" or r.f. pulse, like Fig. 6. That is made up of a band of frequencies, both higher and lower than the fre-

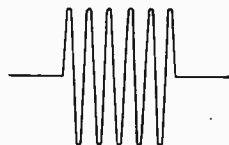

Fig. 6. Interrupted waves such as this occupy a wide band of frequencies, so cannot be reckoned as if they had only the frequency of the cycles.

quency of the cycles in the dot. The squarer the outline of the dot, the broader the band. It is not at all easy to visualize an isolated group of waves like this as the result of adding together a large number of trains of pure sine waves extending to infinity in both directions. Still less easy, perhaps, is it to visualize the continuous band of all possible frequencies from zero to infinity needed to make a single sharp pulse. Some degree of belief can be acquired by looking at the approximate square wave made up by adding together the first few of the infinite series of harmonic sine waves needed for a perfect square wave, as was shown in the December, 1945, issue.

On the whole, signal waveforms cannot be handled on this Fourier basis by simple mathematics, but perhaps we can get somewhere by considering the simplest possible case—sine-wave trains of only two frequencies, Fig. 7(a) and (b). These are well known by experience as well as by theory to add up to make groups of waves called beats (c). These groups can be regarded as a signal waveform. If you like, you can regard (a) as a carrier wave, (b) as a single sideband frequency, and (c) as the complete transmitted waveform, which can if desired be rectified to yield the comparatively low beat frequency. The true speed of signals along the guide or other channel is the speed

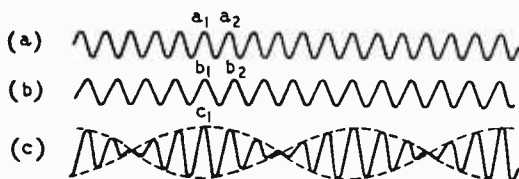

Fig. 7. Waves of two different frequencies, represented by (a) and (b), combine to give groups (c). The rate at which these groups travel is only the same as that of (a) and (b) if these two travel at an equal rate.

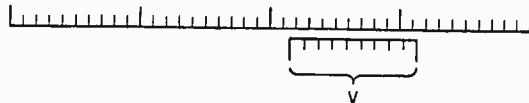

Fig. 8. The relationship between group and phase velocities can be demonstrated with a vernier scale.

at which groups or other distinctive outlines or waveforms can travel, which is why it is called the group velocity. Looking at Fig. 7 and imagining (a) and (b) travelling rapidly from right to left, have we any reason for supposing that the combination of the two (c) will not travel at the same speed?

It is not only obvious, but actually true, that if (a) and (b) travel at the same speed, as they would in open space, then the groups in (c) travel at that speed. But Fig. 5 shows us that no two frequencies travel along a waveguide at exactly the same speed. However, the higher the frequency the more nearly the velocities of two nearly-equal frequencies are the same. And Fig. 2 shows us that at very high frequencies (large θ) the group velocity v_g tends to equal v_p . Near the critical frequency, on the contrary, v_p varies rapidly with frequency, becoming less the higher the frequency. To represent this we have to imagine that Fig. 7(b) gains on (a) as it moves along. Where originally b_1 coincided with a_1 to give a group peak (c_1), b_2 comes alongside a_2 to bring the peak of the group behind c_1 . The greater the difference in speed of the component waves, the more the group outlines or envelopes drop back in the race; in other words, the less the group velocity.

This effect can be seen quite strikingly by getting two combs with slightly different tooth spacing, putting one on top of the other against a light background, and moving the one with wider spacing slowly past the other. The "beat" pattern formed by the teeth alternately coinciding and interleaving moves comparatively quickly in the opposite direction. That does not, of course, mean that signals

Fig. 9. Each division on main and vernier scales in Fig. 8 can be taken to represent one wavelength.

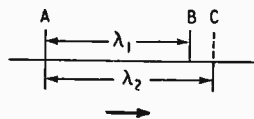

will travel rapidly in the opposite direction to the waves! At the same time as one comb is moving slowly past the other, both combs are supposed to be moving at incredible speed in that direction, which is also the direction in which the beat pattern will move, but more slowly.

Precisely the same effect is obtained with a vernier scale. While the vernier V in Fig. 8 is moved one small division to the left, the point where one of its marks coincides with one on the main scale drops back ten divisions to the right. It is quite easy to imagine each division on the main scale as one whole wavelength of a series travelling to the left at a certain speed, and the slightly larger divisions of the vernier scale as slightly longer (i.e. lower frequency) waves travelling a little faster. The coincident points are where the two lots of waves come exactly into phase, making a group maximum.

Fig. 9 shows a close-up of one such wavelength in each series. Let us suppose that λ_1 (together with all the other waves in its series) is travelling to the

left with velocity v_1 . The frequency of these waves, f_2 , of course, is v_1/λ_1 . Similarly λ_2 , of frequency f_2 is going at speed v_2 . This is a little faster than v_1 , so after a certain time, which we call t , C will coincide with B. So

$$v_2 = v_1 + \frac{\lambda_2 - \lambda_1}{t} \dots\dots\dots (1)$$

During the same time the group peak has dropped back from A to B, so

$$v_g = v_1 - \frac{\lambda_1}{t} \dots\dots\dots (2)$$

From (1) we find that

$$t = \frac{\lambda_2 - \lambda_1}{v_2 - v_1}$$

Substituting this in (2):

$$v_g = v_1 - \frac{\lambda_1 (v_2 - v_1)}{\lambda_2 - \lambda_1}$$

Replacing λ_1 and λ_2 by v_1/f_1 and v_2/f_2 and simplifying out we get

$$v_g = \frac{f_1 - f_2}{f_1/v_1 - f_2/v_2} \text{ or alternatively } \frac{f_1 - f_2}{1/\lambda_1 - 1/\lambda_2} \text{ or } \frac{f_1 - f_2}{\beta_1 - \beta_2}$$

This is in effect what is proved in the textbooks, usually in a more complicated way. The first form is convenient if one knows the velocities at the two frequencies concerned, but the others are given more often because (as in Fig. 5) the phase delay per unit length ($1/\lambda$ or β) is commonly specified.

You will notice that these formulæ say that the group velocity is equal to the *difference* in frequency divided by the *difference* in phase delay. (We have already seen that the phase velocity is equal to the frequency divided by the phase delay.) If the graph of phase delay against frequency (e.g., Fig. 5) is a straight line, at least over the range of frequency concerned, then v_g is constant over that range. But in general it is not, so the custom is to take infinitesimal differences and express the thing in the more official form:

$$v_g = \frac{df}{d(1/\lambda)} \text{ or } \frac{df}{d\beta}$$

(Readers who are unfamiliar with the calculus should note that $df/d\beta$ means the reciprocal slope of the β/f curve at any selected point.) To be still more official one would, as I have said, have to reckon β in radians per metre instead of cycles per metre, in which case the correct (and, to students of line theory, familiar) form is

$$v_g = \frac{d\omega}{d\beta}$$

In the December 1957 issue, p. 584, Thomas Roddam predicted that sooner or later I would probably deal with the question of the two different delay characteristics. In this he was perfectly right, for we have arrived exactly there. In Fig. 5 the point P, for example, expresses the fact that for a 5-cm rectangular waveguide an input at 3.47Mc/s causes a phase delay of 5.78 cycles per metre of length. And because the reciprocal slope of a straight line joining P to O is twice that of the dotted line, we now know that the phase velocity is $2c$. (Or without the dotted line we can calculate it direct as 6×10^8 m/s.) And we have further seen that the reciprocal slope of the curve itself, which at P happens to be half that of the dotted line, tells us the

group or signalling velocity— $c/2$ at that particular point.

The interesting and remarkable thing is that we arrived at the conclusion that the velocity of a group or signal waveform at any frequency is equal to the slope of the β/f curve at that frequency *without any reference to waveguides* or any other particular channel or medium. We arrived at it with the aid of Fig. 7, purely by considering the two sets of waves composing a group to be travelling at slightly different speeds. But when we apply it to the point P on a curve in Fig. 5, plotted for a particular waveguide, we find that the velocity so calculated is the same as the velocity with which we reckoned energy would flow along that guide, by considering the zigzag process in Fig. 3. This is not just an odd coincidence for the particular point P; you will find it holds good for every point on the curve in Fig. 5. More, you will find it holds good for every point on the curve for every other waveguide. And because the calculation based on Fig. 7 is quite general, it holds good for *any* link in which velocity varies with frequency, waveguide or no. Next month we shall look into some of the other dispersive systems, and see why they are so called.

Electronic Letter Sorting

THE FIRST of 20 electronic letter sorting machines has now been delivered to the Post Office for extended trials. Mechanical design is by The Thrissel Engineering Company of Bristol and electronic design by Elec-

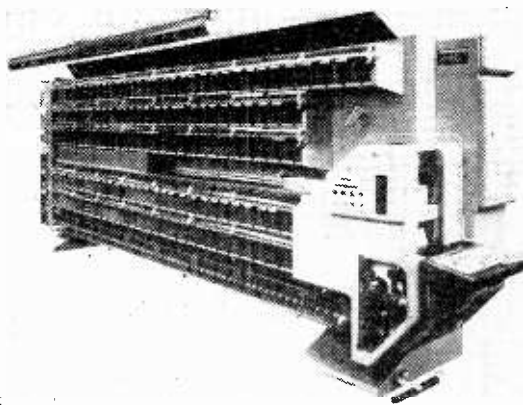

tronic Instruments of Surrey, based on an experimental machine developed by the Post Office. The principle of operation is basically as described in our October, 1956, issue, p. 478. Letters travelling on a conveyor system can be sorted into 144 boxes by an operator pressing code pairs of keys. The codes are translated by a matrix of cold-cathode tubes into signals for actuating the electromechanical gear which diverts the letters into their appropriate boxes.

“Transistor Test Set.”—In Fig. 4, p. 371 of the August issue the value of R_2 should be $22k\Omega$. The symbols for leakage current I_{cbo} and I_{cbo} used in the article are synonymous with the somewhat more conventional I_{ceo} and I_{eco} , respectively.

Potentiometer Tester

Location and Measurement of High-Resistance Contacts

By S. MORLEIGH, A.M.I.E.E., A.M.Brit.I.R.E.

IN many types of electronic equipment, particularly in radar and analogue computing applications or in control systems, there is an increasing reliance upon the accuracy of high-grade potentiometers. These fall into two specific categories:—

- (a) Precision variable resistors (often cam-corrected types) and,
- (b) Inductive potentiometers or I-pots.

The latter consist of a toroidal core of mumetal with an accurately spaced winding and they can be used as autotransformers from 50c/s to above 1,000c/s. The resistance is usually of the order of 50Ω and the impedance is usually high.

With either of these types of potentiometer it is readily apparent that particles of dust or other blemishes on the potentiometer track would increase considerably the contact resistance between slider and track; producing inaccurate output potentials and possibly causing instability in an associated servo system.

Before a high-precision potentiometer is incorporated in a finalized equipment it is usual for a series of tests to be carried out with the slider driven by the servo to specified angular positions. However, defects of the above nature are unlikely to be detected during these tests; but, by means of dynamic testing, it is possible to locate immediately any sudden change of output potential due to contact resistance by arranging for the resultant voltage pulse to operate a suitable type of Schmidt trigger circuit. This could control a relay to stop the servo motor and also give an "alarm" signal.

A practical device with separate applications for testing (a) I-pots and (b) variable resistors, is described under the appropriate headings.

I-Pot Testing Circuit.—The effect of contact resistance is most marked when a relatively high current is passed through the potentiometer under test. As the d.c. resistance of an I-pot winding is considerably less than its reactance, it is preferable to use a d.c. supply. It was found that a current of approximately 30mA ensured direct operation of the trigger circuit for relatively low values of contact resistance.

The circuit is illustrated in Fig. 1 and consists essentially of a "flip-flop" with V2 initially conducting and V1 "cut off": a 500Ω relay is included in the anode circuit of V2. When the grid potential of V1 exceeds a level predetermined by the setting of the trigger controls, V1 conducts causing its anode voltage to fall. This decrease in voltage is communicated directly to the grid of V2 causing a reduction in its anode current and in the current passing through the common cathode resistance. This causes the grid-to-cathode voltage of V1 to become less negative and the effect continues until V2 is cut-off, thus de-energizing the relay.

For the purposes of this test the I-pot should be

rotated slowly (one complete traverse in 3-4 minutes) to prevent any possibility of the circuit being set off by back e.m.f. Current will normally flow through "top half" of the I-pot, passing through the slider to earth. If there is any resistance between the slider and the track (due to dirt, grease etc.) a potential difference appears across this contact resistance so that the grid of V1 rises above earth potential, so triggering the circuit. The $100k\Omega$ grid stopper is included in the input circuit of V1 to prevent damage to the valve if the I-pot slider should be disconnected at any point. Trigger release is brought about by interrupting the biasing voltage applied to the trigger circuit.

The trigger controls in the I-pot testing circuit would be operated in the following manner:—

The coarse control is adjusted initially so that the Schmidt circuit operates in its most sensitive condition; after the location of a bad contact, the coarse and then the fine trigger controls are adjusted progressively to the minimum settings at which triggering takes place. Fig. 3 illustrates the method by which the I-pot can be switched out of circuit and replaced by a set of decade resistors: the value of resistance in circuit is increased slowly

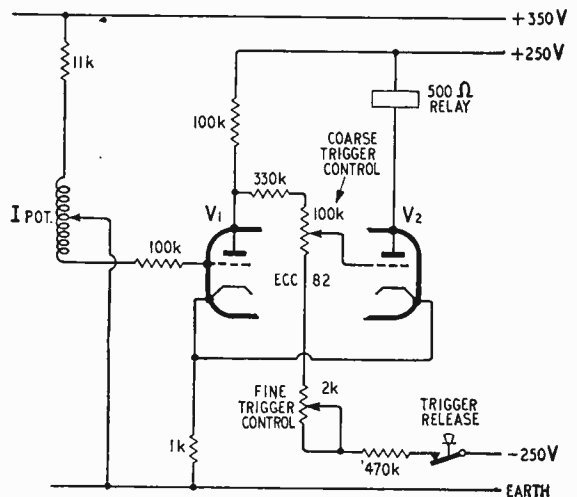

Fig. 1. Basic inductive potentiometer test circuit.

until the trigger circuit operates, thus giving a measurement of the I-pot contact resistance.

Variable Resistor Testing Circuit.—Variable resistors to be tested by this device covered a resistance range of from $1k\Omega$ to $5k\Omega$ and this could probably be extended considerably without much difficulty. Current flow through the winding is,

however, restricted to values well below those used for the previous test circuit. So that trigger pulses of sufficient amplitude to operate the flip-flop are obtained it is essential to provide some amplification. To simplify the type of amplifier necessary, a.c. is passed through the potentiometer winding.

The greater range of operating pulses now obtainable makes it possible to dispense with the variable trigger setting controls which are replaced by fixed resistors determining the bias applied to V_2' (see Fig. 2). This change in operating conditions renders necessary another change—the flip-flop's cathode resistor is increased to $10k\Omega$. The circuit is now most sensitive to a negative trigger; therefore a fixed positive bias of 36V is applied to the grid of V_1' via a resistance network. Thus V_2' is normally cut off and the relay is energized when the valve conducts. Under these conditions the flip-flop operates when the grid voltage of V_1' is less than +14V or greater than +90V; hence for the desired triggering purposes the amplitude of the negative peak must be at least 22V to overcome the bias (i.e. $36V - 22V = 14V$) and the amplitude of the positive pulses must be limited. A two stage r.c.-coupled amplifier (V_3 and V_4 in Fig. 2) provides sufficient gain; but the peak-

to-peak output is limited, by a suitable choice of anode load for V_4 , to about 50V. An amplifier gain control is included to enable the operating point of the trigger circuit to be adjusted for any input potential to V_3 between approximately 20–450mV.

The trigger circuit is operated only by the negative peak of the signal pulse which is derived from the 50c/s a.c. supply. Thus the time constant of the output circuit of V_4 must be relatively large to avoid a reduction in amplitude of the signal; therefore a large value of coupling capacitor ($4\mu F$) is used.

A 100Ω relay is used in the anode circuit of

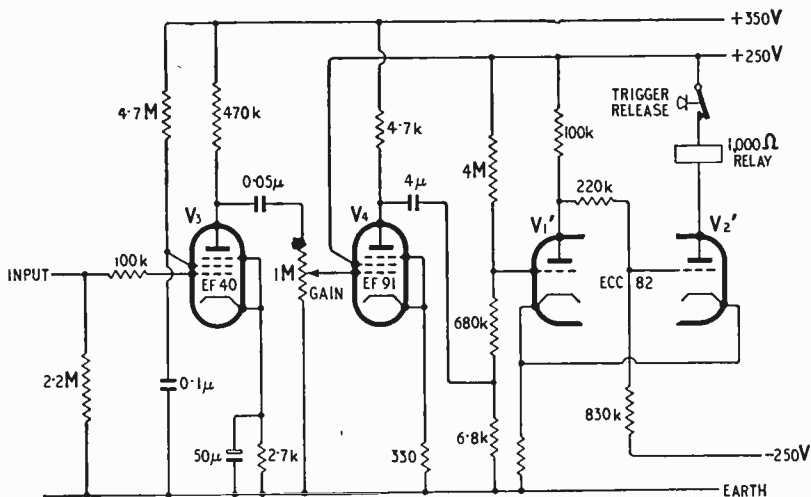

Fig. 2. Basic trigger circuit and amplifier for testing precision resistive potentiometers.

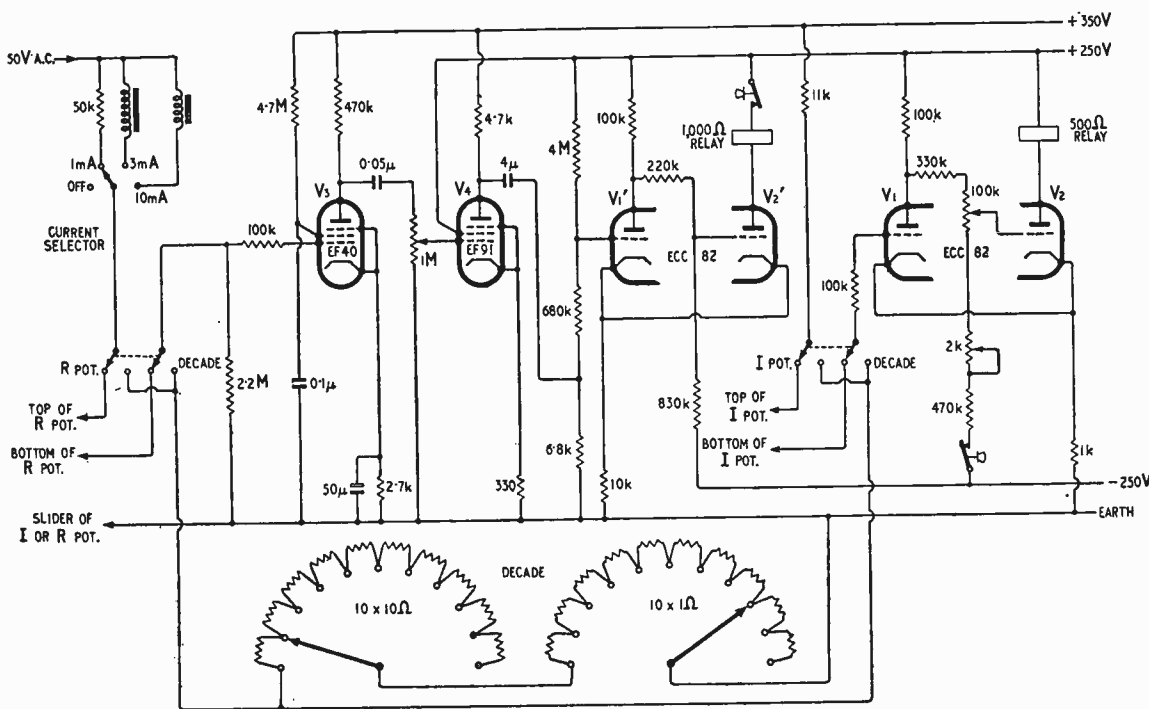

Fig. 3. Circuit of the composite potentiometer tester. Decade box enables the resistance of bad contacts to be found.

V2' as the anode current in this circuit is less than that of the equivalent valve in the I-pot tester. A press-button trigger release device is again fitted to this circuit; but it operates by interrupting the h.t. supply to the anode of V2', thus releasing the relay and allowing the flip-flop to revert to the "ready" condition. Provision is made for passing currents of 1mA, 3mA or 10mA from the 50V 50c/s supply (see Fig. 3) through the variable resistor under test. A resistance of 50 kΩ is employed to limit the current through the 1mA test circuit, while suitable chokes (which were available at the time of construction, but which could be replaced by resistors) are utilized for the 3mA and 10mA circuits.

Variable resistor tests are carried out in a similar manner to that previously described for I-pots, the current controlling switch and the amplifier gain control taking the place of the coarse and fine trigger controls respectively. The range of potentiometers which may be tested by this device can obviously be extended considerably by the appropriate change

of supply voltage and current limiting resistors. However with high resistance potentiometers the resistance between consecutive turns of the winding may be several ohms, so that it might be necessary, under these circumstances, to modify the range covered by the gain and current controls and the decade resistors.

Conclusions.— By means of this system accurate measurements can be taken of contact resistance ranging from a few ohms to comparatively high values. Values of contact resistance greater than about 100Ω are considered as being relatively large in comparison with the potentiometers under test so that there seems little point in taking actual resistance measurements under these conditions. In any case the faulty contact would be located and would soon be noted that the contact resistance was in excess of, say, 100Ω.

Acknowledgement.— Thanks are due to my former colleague Mr. J. N. Burgess for his kind assistance in the preparation of the manuscript.

Potential Divider Design Chart

By J. WILLIS*,
B.Sc., Grad.I.E.E.

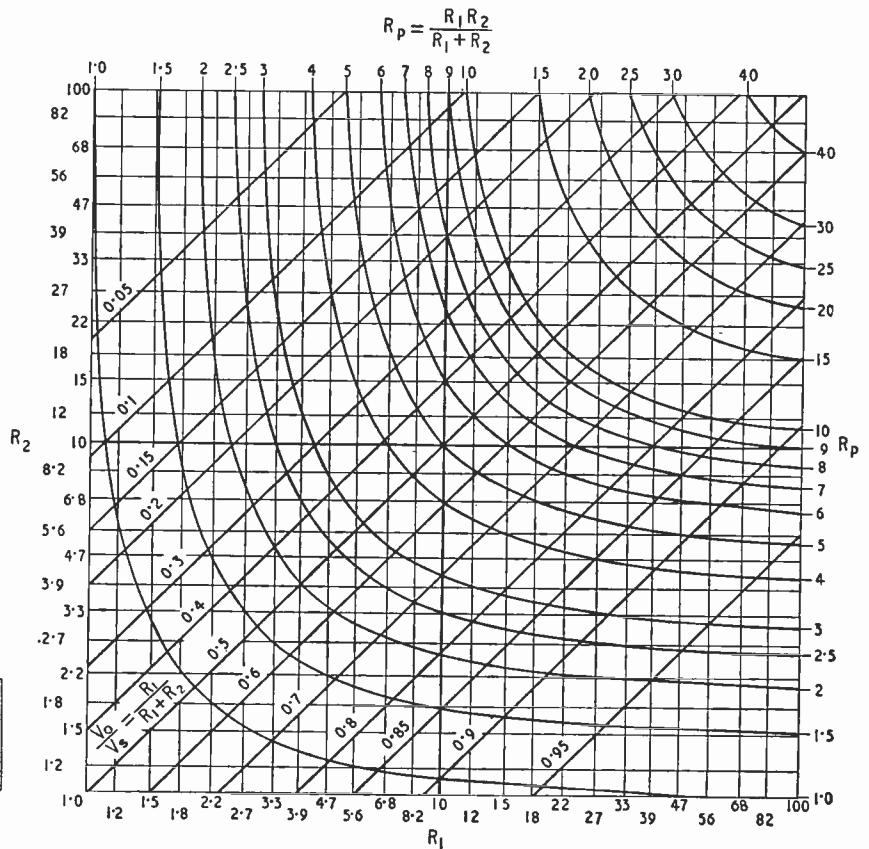
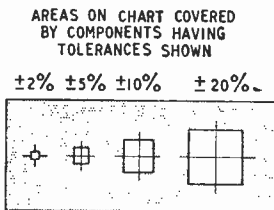

THE chart shown here provides rapid answers to a common circuit design problem—the choice of values in potential divider networks used to provide a specified open-circuit voltage and source resistance, using standard components connected across a supply of known voltage and output resistance.

The network considered is that of Fig. 1. The

source resistance of the supply voltage V_s is assumed to be zero (if finite, it must be included with R_2). The network has the Thévenin equivalent circuit shown in Fig. 2; its open circuit output voltage is $V_o = V_s R_1 / (R_1 + R_2)$, at a source resistance of $R_p = R_1 R_2 / (R_1 + R_2)$. Normally V_s and two of the four quantities V_o , R_p , R_1 and R_2 are specified, and

* English Electric Company.

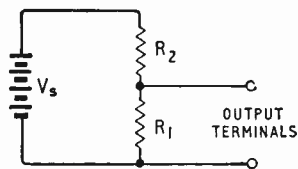

Left: Fig. 1. Potential divider network.

Right: Fig. 2. Thévenin equivalent circuit of network in Fig. 1.

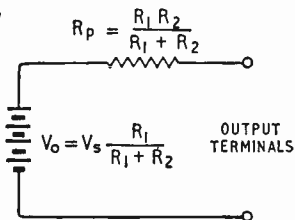

it is required to find consistent values for the other two.

This may be done rapidly and with reasonable accuracy using the chart, on which are provided scales of R_1 and R_2 and families of curves for various values of R_p and the ratio V_o/V_s [$=R_1/(R_1+R_2)$]. Two decade logarithmic scales have been used for R_1 and R_2 , and the scales calibrated in "preferred" values for 10% tolerance components. The scales may obviously be modified to cover any two adjacent decades of resistance values by multiplying the scales for R_1 , R_2 and R_p all by the same power of 10 (the scale for V_o/V_s will not be affected). The chart covers completely those problems where the ratio R_1/R_2 lies between 0.1 and 10, and some cases outside this range; for extreme values of this ratio the problem becomes trivial, as then R_p and V_o can easily be determined independently by using

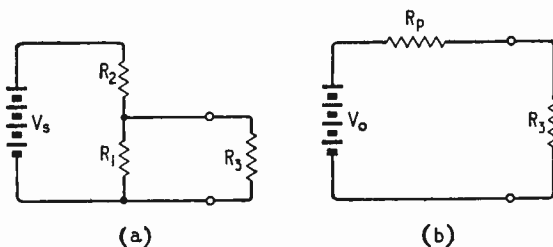

Fig. 3. (a) Potential divider connected to a load, R_3 . (b) Diagram (a) re-drawn using equivalent circuit of potential divider.

suitable approximations in the above formulæ.

The case in which a potential divider is connected to a load of finite resistance (R_3 , say, in Fig. 3(a)) may be solved by applying the chart twice. Two methods are available: in the more direct, the equivalent parallel resistance of R_1 and R_3 ($=R_1'$, say) is found first, either by using the chart or otherwise; the chart is then applied as described above, only reading R_1' for R_1 . Alternatively, the chart can be applied first to reduce the network $R_1R_2V_s$ to an equivalent circuit in terms of V_o and R_p (see Fig. 3(b)) then again to solve the network $R_3R_pV_o$.

The effect of component tolerance in R_1 and R_2 is to make the corresponding values of R_p and V_o/V_s uncertain; all that can be said is that the point representing the values of R_p and V_o/V_s will lie somewhere in a square region centred on the nominal values of R_1 and R_2 . The size of this square is of course (for a given tolerance) the same anywhere on the graph. The sizes of square corresponding to various standard tolerances are shown in the legend.

BOOKS RECEIVED

Wave Propagation and Antennas by George B. Welch, covers a very wide field, which includes such recent topics as forward scatter and the 21-cm hydrogen line in radio astronomy. Mathematics are restricted to the statement of important relationships and the treatment is conducive to straightforward reading, being supported by lucid diagrams. Pp. 257; Figs. 170. Price 43s 6d. D. Van Nostrand Co., Ltd., 354 Kensington High Street, London, W.14.

Acoustics, Noise and Buildings, by P. H. Parkin and H. R. Humphreys. Problems of architectural acoustics are approached from the practical as well as the scientific point of view. The authors, who are acknowledged authorities in this field, give their experience in the design of studios and concert halls, sound reinforcement systems and the insulation and control of noise. Pp. 331; Figs. 130. Price 70s. Faber & Faber, Ltd., 24 Russell Square, London, W.C.1.

A U.H.F. Television Link for Outside Broadcasts by K. C. Quinton, B.Sc.(Eng.), A.M.I.E.E. Engineering Division Monograph No. 19 giving considerations leading to the design and a general description of the Band V fixed and mobile equipment used by the B.B.C. Pp. 20; Figs. 15. Price 5s. B.B.C. Publications, 35 Marylebone High Street, London, W.1.

H. A. Hartley's Audio Design Handbook. After 30 years' experience of the design and manufacture of loudspeakers and amplifiers for "high-fidelity" sound reproduction the author has set down his conclusions. The design of amplifiers is treated stage by stage, and this takes eight of the 12 chapters. Two chapters are devoted to the perception of sound and measurements and testing, and the remaining two chapters explain the author's

approach to loudspeaker and enclosure design. Pp. 224; Figs. 155. Price \$2.90. Gernsback Library, 154 West 14th Street, New York 11. Available also from Modern Book Co., 19-23 Praed Street, London, W.2, price 23s.

High Fidelity, by K. J. Spencer, A.L.A. A bibliography of sound reproduction selected from the world's literature, classified under subject headings in groups covering periodicals, books and trade literature. Includes a list of standards and the addresses of societies and trade associations concerned with sound reproduction. Pp. 325. Price 30s. Iota Services, Ltd., 38 Faringdon Street, London, E.C.4.

Radio Research, 1957. An account of the work in hand at the Radio Research Station, Slough, including ionospheric and tropospheric propagation at h.f. and v.h.f., forward scatter, structure of the troposphere at vertical incidence using a radar technique, research on semi-conductors, magnetic and dielectrics materials (including ferrites). The report also contains an account of the work of the station in the International Geophysical Year and of the observations made on Russian satellites. Pp. 43; Figs. 5. Price 3s 6d. H.M. Stationery Office, Kingsway, London, W.C.2.

Communications and Electronics Buyers' Guide 1958-9. Classified index of manufacturers' products, trade names index, lists of Government departments, professional, trade and research associations, and centres of technical education. Also included are comparative specifications of a number of selected products, a "who's who" of the electronics industry, glossary of abbreviations, lists of home and foreign journals, etc. Pp. 520 (11½ x 8½ in). Price £5 5s. Heywood & Co., Ltd., Russell Street, London, W.C.2.

News from the Industry

Rediffusion Limited report a group trading profit of £4M during the year ended last March. The total number of subscribers to the company's sound relay service in the U.K. is 524,000 with a further 100,000 for the television service. The company's expenditure during the year on station equipment, wiring and receivers increased by £2.6M, of which about £0.5M was for distribution services overseas. The group's principal manufacturing company, Redifon, Ltd., again increased its turnover and over 60% of its production was exported.

Associated Television, Ltd., the programme contractors for the London (week-ends) and Lichfield (week-days) I.T.A. transmitters, report that the profit after taxation for the year ended April 30th was £1,997,909.

Regentone and its associates R.G.D. and Argosy are now wholly-owned subsidiaries of Lloyd's Packing Warehouses (Holdings), Ltd. They recently acquired W. Harries' interest in the companies and he and his son have resigned their directorships. J. H. Williams, who joined Regentone as joint managing director in 1953, is now managing director of Regentone Products, Ltd., the parent company. He is also managing director of R.G.D. and a director of Argosy. J. G. G. Noble is managing director of Regentone Radio and Television and a director of Argosy. F. L. Muller is sales director of Regentone, H. O. Thomas, sales director of R.G.D., and W. J. Fluckiger general manager of Argosy.

Goodmans Industries, Ltd., has been acquired by Relay Exchanges, Ltd., of which it is now a wholly owned subsidiary. J. W. C. Robinson, M.B.E., managing director of Relay Exchanges, is now joint managing director of the company with Mrs. M. E. Newland, who has joined the board of Relay Exchanges.

Peto Scott and Cosmocord.—In view of the liquidation of Pena Industries, Ltd., some concern has been felt for Peto Scott Electrical Industries and Cosmocord, which were taken over by Pena last year. We are glad to learn that despite an order for the compulsory winding up of Peto Scott, they are carrying on business as usual and are exhibiting at Earls Court. Cosmocord, too, are continuing and have taken space in the Audio Hall at Earls Court.

N.S.F.—Simms Motor & Electronics Corporation, of which N.S.F., Ltd., is a subsidiary, had a trading profit, before taxation, of £927,861 at the end of 1957 compared with £841,711 for the previous year. N.S.F., whose main works are at Keighley, Yorks, are the sole licensees in this country for the products of a number of American companies.

Mosley Electronics, Inc., of St. Louis, Missouri, manufacturers of the Trapmaster beam aerials for multi-band amateur operation, are setting up a factory in this country. O. J. Russell, who has frequently contributed to *Wireless World* and other journals on both sides of the Atlantic, has been appointed manager; his address is 15, Reepham Road, Norwich.

Beckman Instruments, Inc., of California, has set up a U.K. subsidiary, Beckman Instruments, Ltd., for which a factory is being built in the new Fife town of Glenrothes. As stated last month, Winston Electronics have been appointed U.K. distributors of Beckman equipment and the new company will concentrate on the Scandinavian and Commonwealth markets. Initially the Scottish factory will concentrate on the production of the Helipot helically wound potentiometer.

Wayne-Kerr Laboratories, Ltd., are forming a company in Philadelphia, Pennsylvania, for the marketing and distribution of their products in the United States. Two of Wayne-Kerr's newer measuring instruments have been adopted by the Services. The component bridge (B.521) which is already being used by the Royal Navy (Ref. C.T.375) has been given a N.A.T.O. reference (6625-99-943-2442). The audio oscillator (S.121) is being used by the Army, and has been given a common test gear reference number (C.T.416).

Hollerith computer training centre, at Bradenham Manor, near High Wycombe, Bucks, was opened by Lord Halsbury, managing director of the National Research Development Corporation on July 24th. This is the sixth educational and training establishment maintained by the British Tabulating Machine Company which, as announced last month, is to join forces with Powers-Samas Accounting Machines.

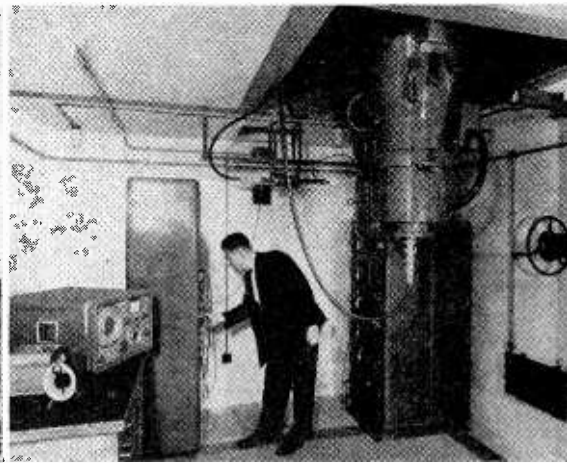
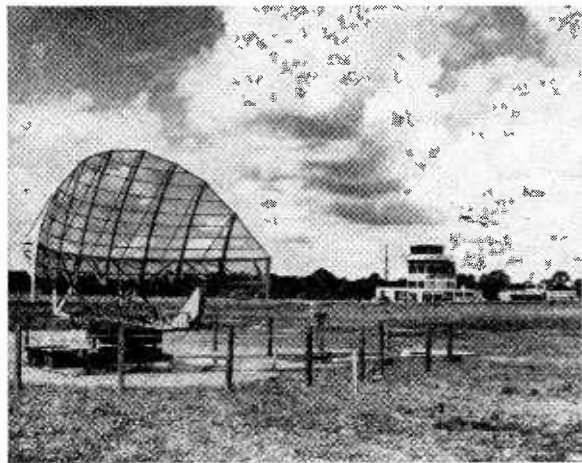

GATWICK AIRPORT RADAR.—The head equipment of the Marconi 50-cm radar (S232) at Gatwick Airport is installed underground directly below the scanner (left). The conical assembly (top right) is the base of the aerial and turning gear. Racks shown contain receiver first stages and crystal-controlled transmitter.

Airmec, Limited, have acquired the exclusive rights to market in the U.K. the ultrasonic drilling and medical equipment made by *Apparacchi Scientifici Federici*, of Milan. The agreement was concluded during the visit of P. B. Ades, Airmec's sales manager, to the International Exhibition of Electronics and Atomic Energy in Rome.

Claude Lyons, Ltd., announce two recent appointments to the staff at their Hoddesdon, Herts., works: B. S. C. Archer is now engineering manager and N. A. Love special production/development engineer. Both of them joined the company from Plessey. Claude Lyons' son, Edward, who has recently completed a post-graduate research course at Imperial College, is now at Hoddesdon investigating u.h.f. and transistor problems.

Racal announced at a reception for delegates to the Commonwealth Conference of the British Joint Communications-Electronics Board that over 1,000 of their RA17 communications receiver (reviewed in our August, 1957, issue) have already been sold.

B. & K. Laboratories have acquired additional accommodation at Tilney Street, Park Lane, London, W.1, where it is planned to provide a permanent instruments exhibition and library. The existing premises at Union Street, London, S.E.1, will continue to be used for servicing and distribution. Sales enquiries will be dealt with at the Park Lane address.

Labgear "Double Diamond" television aerials are to be installed in 500 houses in Stevenage New Town. Outside aerials will not be permitted.

Grundig (Great Britain), Ltd., have moved their factory and offices from Kidbrooke to Newlands Park, Sydenham, London, S.E.26. (Tel.: Sydenham 2211.) The showroom and publicity department remain at 39-41, New Oxford Street, London, W.C.1.

Kelvin & Hughes (Industrial), Limited, have moved their administrative offices from 2, Caxton Street, Westminster, to Empire Way, Wembley, Middlesex. (Tel.: Wembley 8888).

Simon Sound Service, Ltd., have appointed Philip Woolfson, Ltd., of 33, Cadogan Street, Glasgow, C.2, as their sole Scottish representatives.

EXPORTS

Stockholm Show.—Thirty-two member firms of the Radio and Electronic Component Manufacturers' Federation are participating in the components show being organized by the Federation in Stockholm from September 29th to October 3rd.

British Trade Fair.—The next in the series of overseas fairs sponsored by the Federation of British Industries, 21 Tothill Street, London, S.W.1, will be held in Lisbon from May 29th to June 14th next year. It will be organized by British Overseas Fairs, Ltd., the F.B.I. subsidiary responsible for the Fairs in Baghdad (1954), Copenhagen (1955) and Helsinki (1957).

Air Navigation Equipment.—Ground I.L.S. equipment manufactured by Pye is being supplied for the Hungarian airport at Ferihegy, near Budapest. Airborne I.L.S. equipment made by S.T.C. is being fitted in the aircraft operated by Malev, the Hungarian airline. Negotiations for these installations were conducted by International Aeradio, Ltd.

Radio-telephone Equipment.—Further extensions to the Nigerian radio communications system are to be provided by Marconi's who have already supplied most of the equipment for the existing network. Two new contracts valued at approximately £36,000 provide for the extension of the network to the Nigerian Cameroons.

A multi-channel oscilloscope, worth over £4,000, similar to that used for measurements on ZETA at Harwell, is being supplied by Cawkell Radio and Electronics to the Max Planck Institut für Physik at Göttingen.

H.F. transmitters and receivers for the Kuwait communications centre at Shuwaikh on the shores of the Persian Gulf have been ordered from Marconi's. The installation, which will be used mainly for direct telephone and teleprinter services with London, Paris, Beirut and Bombay, is valued at approximately £75,000.

India.—During a three-month world tour S. Sundra, managing director of Electronics, Ltd., importers and manufacturers of New Delhi, will be visiting this country from September 7th to 13th. His address in London will be St. Ermins Hotel, Caxton Street, S.W.1.

Israeli Agency.—Haifa Electronic Co., Ltd., of 34 Nordau Street, Haifa, wish to act as agents for British manufacturers of communications equipment, components and measuring instruments.

Ceylon.—Lewis Brown & Co., Ltd., Inveresk House, McCallum Road, P.O. Box 85, Colombo, have informed the U.K. Trade Commissioner that they are interested in representing United Kingdom manufacturers of a range of cheap portable record reproducers for mains use and battery broadcast receivers, including the small transistor types. Another Colombo firm Siedles Cineradio, of 9, Consistory Buildings, Front Street, are interested in representing a U.K. manufacturer of high-grade amplifying equipment.

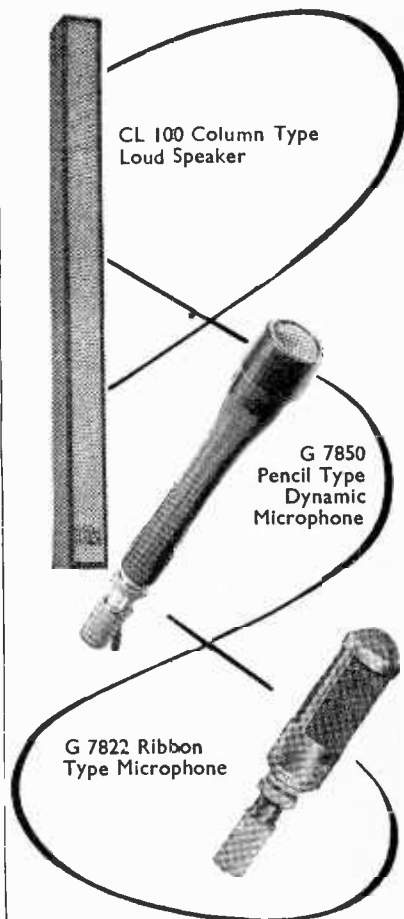

Sound Perfect

When planning your Sound System you can rely on TRIX for speakers and microphones.

The new Sound Columns give a marked directional flat beam effect, with striking improvement in acoustic efficiency and economy in installation.

Both the microphones shown have wide frequency range and are also available with switches.

Write now for latest detailed literature.



TRIX ELECTRICAL CO. LTD.
Maple Place, London, W.1
Telephone MUSeum 5817

RANDOM RADIATIONS

By "DIALLIST"

P.T. on Repaired Tubes

THE recent statements in the House of Commons seeking to justify the imposition of purchase tax on re-gunned c.r.t.s (and even, if I may say so with all due deference, the Editor's summing up of the position in last month's *Wireless World*) leave me unconvinced that such a charge is right and proper. A tube fixed with a new gun is not a new component, it is definitely second-hand and could not lawfully be sold as anything else. When P.T. was first brought in the intention surely was that it should be levied on new goods only. Can any reader tell me of any other case in which it has to be paid on a second-hand article, or on any repaired article, no matter how extensive the repairs are, no matter whether the article having been so treated is virtually as good as new? Certainly I can't think of one. To me it seems that this latest imposition of P.T. may be that dreaded thing, the thin end of the wedge. Once started, goodness knows where it will stop. I sincerely hope that the matter won't be allowed to drop and that the strongest possible representation will be made in the right quarters.

Cathode-Grid "Shorts"

YOU may recall the tip about coping with cathode-grid shorts in other than triode c.r.t.s sent by a Scottish

dealer, which I quoted last month. A letter from a Derbyshire firm tells me that they have used the same method with great success for the last three years. One rather important point is mentioned: the emission must be right up to the mark, for the disconnection of the boosted h.t. voltage supply from the first anode lowers the brightness level. The same firm is also kind enough to give what seems a very useful tip for dealing with intermittent cathode-grid shorts, which are not uncommon sources of trouble. The tube is run for a time until the heater is quite hot. The heating current is then cut off and 90V d.c. applied between grid and cathode. The neck of the tube is gently tapped. This may clear the short, in which case all is well. Or it may cause it to become permanent, when, provided that the tube is of suitable type, it can be dealt with in the way previously described. Hundreds of cathode-grid shorts are stated to have been dealt with successfully in this way.

The First TV Advertisement

HOW long would you say it was since the first advertisement appeared on a TV screen in this country? I'm not thinking of purely incidental displays, such as may come along when a football match or a street scene is televised. I mean something of an

advertising nature deliberately placed in front of the camera. If I'd been asked, I'd have said (as probably you would too) about three years ago during the first I.T.A. programme. But it wasn't; it was far longer ago than that. It happened actually just 30 years ago. I'm indebted for the information to Mr. Ronald F. Tiltman, John Logie Baird's biographer. During the 1928 Radio Show at Olympia, Baird was giving closed-circuit demonstrations of his system, open to the public, in the nearby Maclise Road. Whilst one of these was in progress on 26th September Tiltman borrowed a *Daily Mail* contents bill from a neighbouring news-agent and held it up in front of the transmitter. Even with the 30-line scanning disc system then in use every word was clearly seen and the impromptu test was described in the following day's newspapers as the world's first televised advertisement.

V.H.F. at the Show

IT'S good that the B.B.C. is again giving demonstrations of v.h.f./f.m. reception at the Radio Show. Though it is making steady progress, too many non-technical listeners seem unwilling to discard their a.m. sets and just go on growling about the indifferent quality and the nasty noises due to various kinds of interference which come their way on the medium and long waves. I hope that many such folk are visiting the B.B.C.'s sound theatre and are being convinced of the virtues of v.h.f./f.m. There should, I think, have been a more vigorous campaign in the past to persuade some of those who have provided themselves with receivers for this kind of broadcasting to give them a fair chance of showing what they can do. Certain people don't. A while ago a friend of mine took my advice to go in for a v.h.f./f.m. set. When I met him a little later he complained that reception was still spoilt by ignition interference. Investigation showed that, though signal strength is rather small in his neighbourhood, he was working the receiver from its built-in ferrite aerial in a ground-floor room. A change to a dipole and reflector mounted on a chimney stack effected a complete cure.



"WIRELESS WORLD" PUBLICATIONS

	Net Price	By Post
LOW-COST HIGH-QUALITY AMPLIFIER. P. J. Baxandall, B.Sc.(Eng.)	3/6	4/-
GUIDE TO BROADCASTING STATIONS 1958-59. Compiled by "Wireless World"	2/6	2/11
ABACS OR NOMOGRAMS. A. Glet. Translated from the French by H. D. Phippen and J. W. Head	35/-	36/-
TELEVISION RECEIVING EQUIPMENT. W. T. Cocking, M.I.E.E. 4th Edition	30/-	31/9
TRANSISTOR A.F. AMPLIFIERS. D. D. Jones, M.Sc., D.I.C., and R. A. Hilbourne, B.Sc.	21/-	21/10
LONG-WAVE AND MEDIUM-WAVE PROPAGATION. H. E. Farrow, Grad. I.E.E.	4/6	4/10
RADIO LABORATORY HANDBOOK. M. G. Scroggie, B.Sc., M.I.E.E. 6th Edition	25/-	26/9
RADIO VALVE DATA. Compiled by "Wireless World." 6th Edition	5/-	5/9
TELEVISION ENGINEERING VOLUME IV: General Circuit Techniques. S. W. Amos, B.Sc.(Hons.), A.M.I.E.E. and D. C. Birkinshaw, M.B.E., M.A., M.I.E.E.	35/-	36/2

A complete list of books is available on application
Obtainable from all leading booksellers or from

ILIFFE & SONS LTD., Dorset House, Stamford Street, London, S.E.1

Band III Allocations

AN interesting statement about the possible future of television broadcasts in Band III was made recently in the House of Commons by Mr. K. Thompson the Assistant Postmaster-General. Asked by Mr. Ness Edwards whether he would publish the advice given by the Television Advisory Committee regarding the allocation of further channels on Band III, he replied that though no formal report had yet been submitted by the Committee, they had produced a number of plans for the use of the channels available. The P.M.G., he said, has adopted one of these (presumably the I.T.A.), which will make it possible to provide in the first instance a 98 per cent coverage as well as another Band III service with a substantial national coverage if this should be decided upon. This seems eminently sound, for no single service, nor either of two competing services, can ever suit all tastes at the time. There's a good deal of elbow room in Band III, for the ranges at which mutual interference is likely under normal conditions are comparatively short; and by making use of horizontal as well as vertical polarization the eight channels of Band III might be turned for all practical purposes into sixteen.

Printed Circuit Troubles

FROM Great Yarmouth, D. H. Urquhart, of Erie Resistor's Engineering Technical Services, sends me an interesting letter on the troubles that can arise with printed circuits. The views of an American serviceman on the same subject were given most amusingly by Jack Darr in the November, 1957, number of *Wireless World*. D.H.U. points out that dry joints can and do occur occasionally. And, when one does come along, tracking it down and setting it to rights can be the father and mother of a headache. But, he writes, the use of printed circuit boards had led to great improvements in soldering methods, including dip-soldering. The much greater degree of control needed means that the "average goodness" of the soldered joints is far better than that of those made by hand on the normal production line. In fact, the majority of dry joints appearing in a receiver with printed circuits are usually amongst those that have to be made by hand. Printed wiring has without a doubt made sets more uniform and more reliable. But it's still capable of being improved.

SPEED . . .

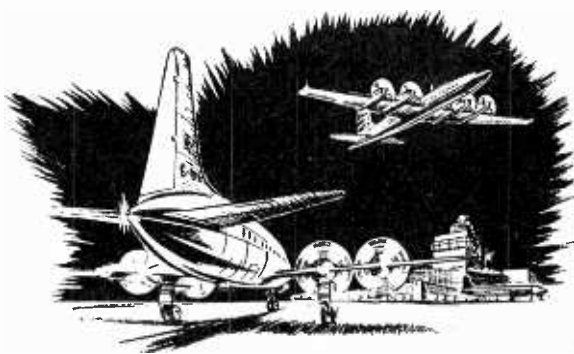

. . . spans the world!

In London today, in Africa tomorrow—from temperate zones to tropical zones within hours. Speed, and change! Modern equipments must be adaptable, superlative, need outstanding Components, and depend on Bulgin manufactures for new achievements.

The Bulgin research and manufacturing Division, with its unique skill and experience is solving many problems of today and tomorrow.

OVER 10,000 COMPONENTS AVAILABLE

★ Full details will be found in fully illustrated Catalogue No. 199/W.W. (Free to trade letterhead or order.)

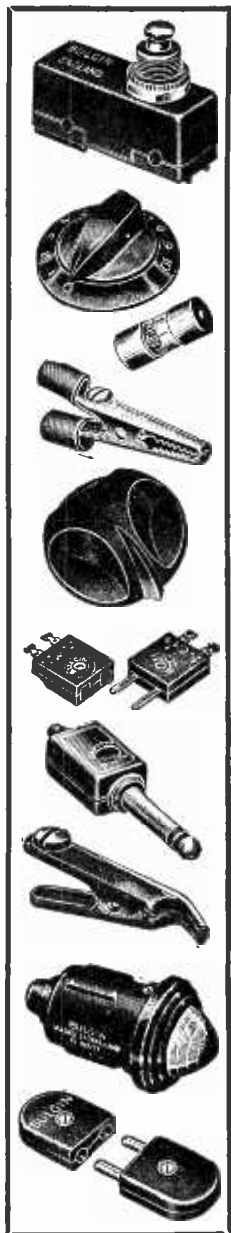

THE HOUSE OF
BULGIN *Components*



A. F. BULGIN & COMPANY LTD.
BARKING · ESSEX Tel.: RlPpleway 5588 (8 lines)

MANUFACTURERS OF RADIO AND ELECTRONIC COMPONENTS

UNBIASED

By FREE GRID

Fools and Angels

IT IS with a great sense of diffidence that I take up my pen to intervene in the war of words between two such doughty champions as W. T. Cocking and "Diallist." I feel very much like a mere sergeant-major attempting to settle a small point of difference between Eisenhower and Montgomery about the Normandy landings. At the same time I take courage in the fact that sergeants-major are forthright when on the spot and may, in some cases, be in a position to shake their heads at the folly of their superiors in their Ivory Towers.

"Diallist" refutes W. T. C. with quotations from the Shorter Oxford Dictionary which seem to show that the word "valve" is used solely to describe a one-way device. It is a pity that "Diallist" did not complete the quotation from the S.O.E.D., for, after finishing with mechanical and anatomical valves, it goes on to deal (page 2333) with electrical ones as follows:—"an arrangement of filaments, etc., in a vacuum bulb designed to regulate or modify a current."

Surely there is no suggestion of one-way traffic in that description; obviously the learned lexicographer has in mind the "on and off" action of a thermionic valve, be it diode, triode or hekatode, which it shares with the bathroom tap, and he passes over its one-way-traffic feature.

Talking of bath taps reminds me that if you ask the local gas board to supply a geyser, they will usually fit it with a device they call a gate valve but which vulgar members of the public like myself would call a large water tap with a wheel control; this simple water control is certainly not a one-way device despite the fact that they call it a valve.

Least I seem to be taking the part of W. T. Cocking rather than

"Diallist" I would point out that I regard myself as the blindfold figure of justice between them and I must, therefore, point out that in my opinion the word "valve" has, by common usage—or misusage—come to mean, nowadays, a one-way device.

The Latin word *valva* has, of course, no suggestion of one-way traffic but, in its anglicised form, common usage has altered all that. Exactly the same thing has happened to the word "prevent" which nowadays means "hinder or stop." I think that the whole argument has arisen because W. T. Cocking and "Diallist" have both consulted "pocket" dictionaries like the "concise" and the "shorter" rather than a man-sized one.

"Magna Est Veritas . . ."

THE saying "history is bunk" is one which expresses in a nutshell the woeful inaccuracies recorded by so-called historians, more especially when they venture into specialized fields of knowledge in which they have not bothered to seek expert advice.

A striking example of this is to be found in a book I have just been reading called "The Last Voyage of the Lusitania," which was published in this country last year. I am sorry to have to record my opinion that, in their account of the part wireless played in the final hour of life, the authors could scarcely have been less accurate had they tried.

The book tells me quite correctly that the ship was torpedoed and sunk about eleven miles off the South Coast of Ireland on May 7th, 1915, and that at 12.40 p.m.—less than two hours before she sank—the Admiralty wirelessed a submarine warning. I have no quarrel with that statement, but when the authors go on to tell me that the Admiralty sent the message via the wireless station at Valencia in Spain I can only feel disgust.

This gross error is only one among several others about the wireless department of the ship. Surely the very idea of the Admiralty using a low-power neutral coast station nearly a thousand miles distant from the ship ought to have struck the authors as being so ridiculous that they would have checked

and re-checked their source material. Did they seriously suppose the Spanish government would have permitted this blatant infringement of its neutrality?

No; it is obvious that they saw the name "Radio Valencia" in their source material and, remembering the geography of their schooldays, they added "Spain." Had they checked the point they would have realised that the wireless station on Valencia Island off the Irish coast was indicated. Maybe they were put off because this Irish Island is sometimes spelt Valentia.

Had they checked their source material still further they would have discovered that their description of the *Lusitania's* emergency transmitting apparatus was hopelessly inaccurate. They would also have questioned the acrobatic ability of the *Lusitania's* wireless operator in steadying himself by holding on to the table and the transmitting panel and then (presumably) operating the transmitting key with his foot.

There are also several obvious inaccuracies in the non-wireless part of the book, but they are no concern of mine. *Magna est veritas et praevalabit*, but in this case there is no question of it "prevailing a bit"—as it did in the schoolboy translation.

Errata or Erranda

WHILE on the subject of marine wireless communication, which it is well known won its spurs when the *Titanic* sank in April, 1912, I should mention the film, "A Night to Remember," which deals with it.

There were so many obvious errors in those sections of the film in which wireless played a part that I soon realized that, for some reason or another, they must have been made deliberately.

For instance, in the *Titanic's* wireless cabin, as the senior operator sits at the transmitter key, we are shown a close-up of his junior watching the needle of a large panel-type voltmeter. As the needle falls back to zero he tells the senior that the power supply is failing. In real life, of course, the junior would have made a fool of himself by stating the obvious to the man at the key, who would have known all about it by the dying-duck sound of the spark transmitter. This was clearly a dramatic trick for the benefit of the audience.

There were many more of these errata—or more correctly erranda as they were so obviously introduced deliberately. But there were several genuine errata which I do not think were deliberate as I could see no point in them. For instance, the *Titanic's* senior operator was not wearing the correct insignia of rank. There were others, but I don't want to spoil the film for you.

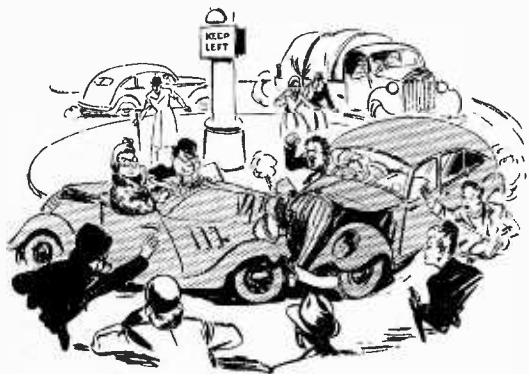

"No suggestion of one-way traffic"